

LSoc4681.16



Harvard College Library

FROM THE

UNITED STATES GOVERNMENT

THROUGH

The Smithsonian Inst.

23 July 1892

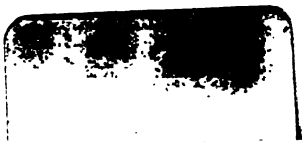

=

,

=



2.

•

ANNUAL REPORT
OF THE
BOARD OF REGENTS
OF THE
SMITHSONIAN INSTITUTION

SHOWING
THE OPERATIONS, EXPENDITURES, AND CONDITION
OF THE INSTITUTION
FOR THE
YEAR ENDING JUNE 30, 1889.

REPORT
OF THE
NATIONAL MUSEUM.

WASHINGTON:
GOVERNMENT PRINTING OFFICE.
1891.

LSoc 4681.16

~~49.7/2~~

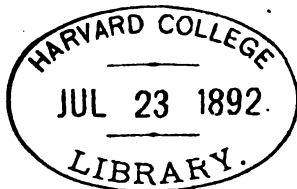

The Smithsonian Inst.

FIFTY-FIRST CONGRESS, FIRST SESSION.

Concurrent resolution adopted by the House of Representatives May 27, 1890, and by the Senate June 17, 1890.

Resolved by the House of Representatives (the Senate concurring), That there be printed of the report of the Smithsonian Institution and National Museum for the years ending June 30, 1888, and June 30, 1889, in two octavo volumes for each year, 16,000 copies; of which 3,000 copies shall be for the use of the Senate, 6,000 for the use of the House of Representatives, and 7,000 for the use of the Smithsonian Institution.

REPORT
OF THE
U. S. NATIONAL MUSEUM,
UNDER THE DIRECTION OF
THE SMITHSONIAN INSTITUTION,
FOR THE
YEAR ENDING JUNE 30, 1889.

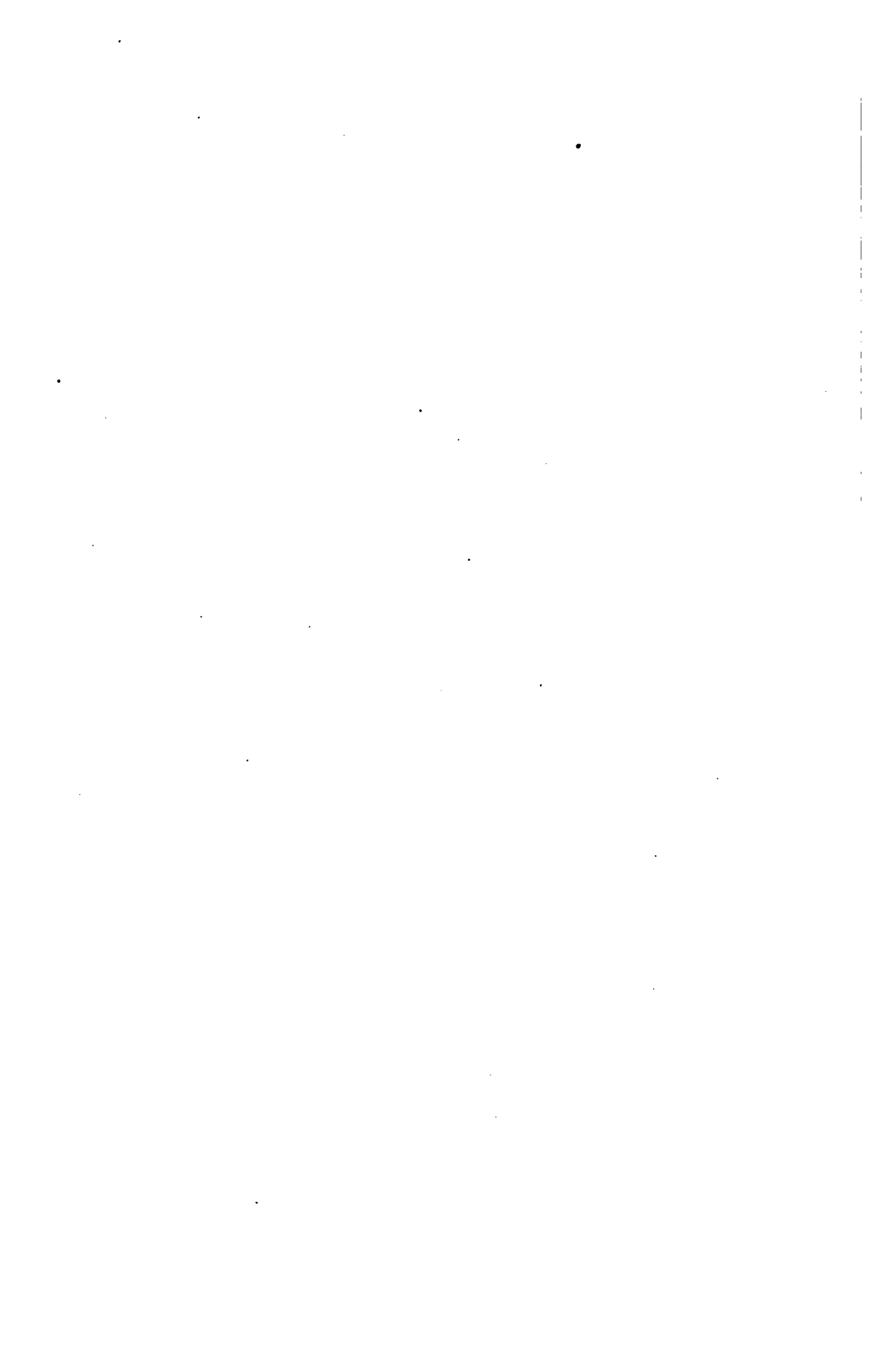

**REPORT OF THE U. S. NATIONAL MUSEUM FOR THE YEAR
ENDING JUNE 30, 1889.**

SUBJECTS.

- I. Report of the Assistant Secretary of the Smithsonian Institution,
in charge of the National Museum, upon the condition and
progress of the Museum.**
- II. Reports of the Curators.**
- III. Papers illustrative of the collections in the U. S. National Museum.**
- IV. Bibliography.**
- V. List of accessions.**



U. S. NATIONAL MUSEUM,
UNDER DIRECTION OF THE
SMITHSONIAN INSTITUTION,
Washington, December 1, 1889.

SIR: I have the honor to submit herewith a report upon the present condition of the U. S. National Museum and upon the work accomplished in its various departments during the fiscal year ending June 30, 1889.

Very respectfully,

G. BROWN GOODE,
Assistant Secretary, in charge of U. S. National Museum.

Prof. S. P. LANGLEY,
Secretary, Smithsonian Institution.

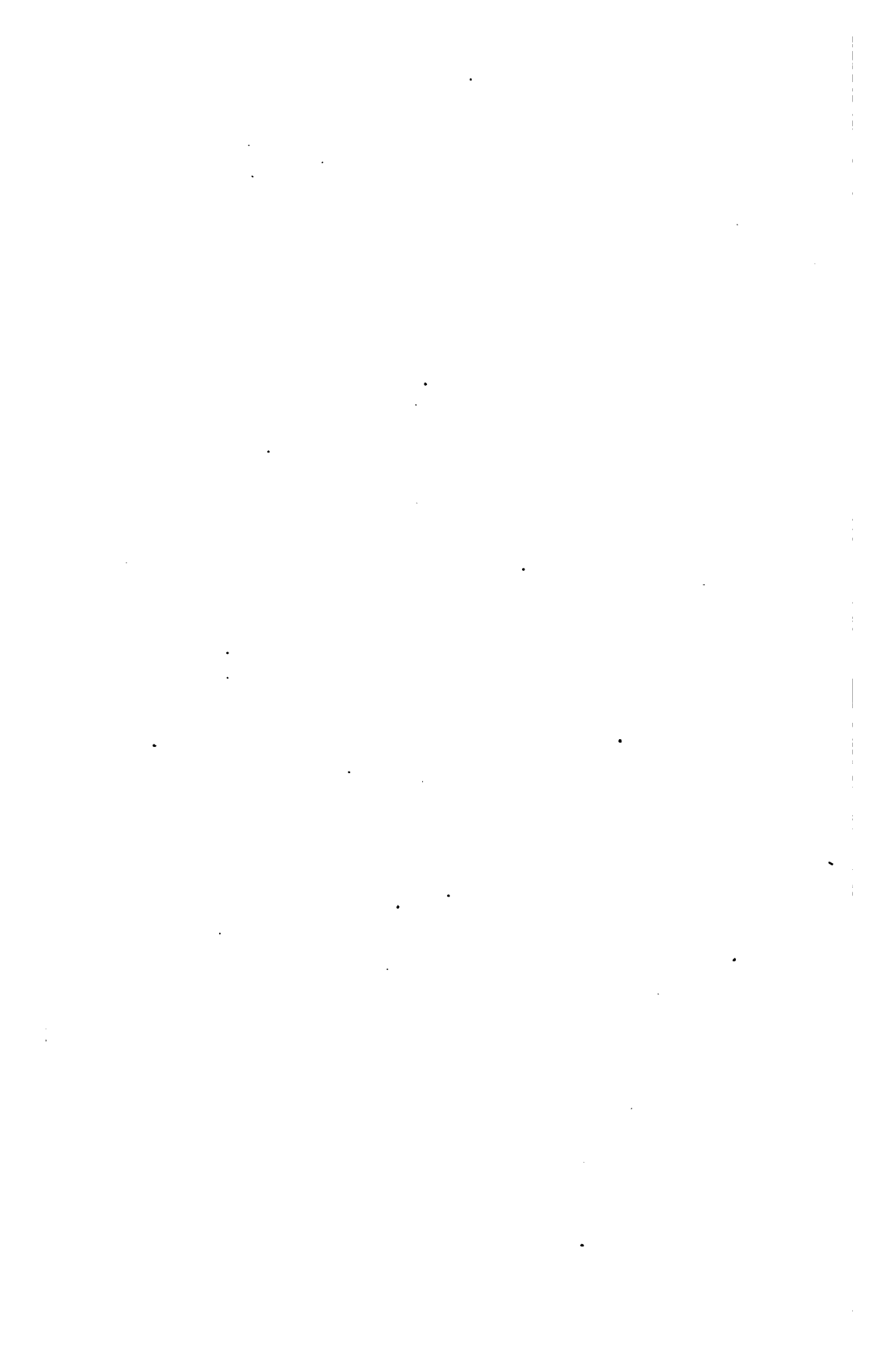

U. S. NATIONAL MUSEUM,
UNDER DIRECTION OF THE
SMITHSONIAN INSTITUTION,
Washington, December 1, 1889.

SIR: I have the honor to submit herewith a report upon the present condition of the U. S. National Museum and upon the work accomplished in its various departments during the fiscal year ending June 30, 1889.

Very respectfully,

G. BROWN GOODE,
Assistant Secretary, in charge of U. S. National Museum.

Prof. S. P. LANGLEY,
Secretary, Smithsonian Institution.

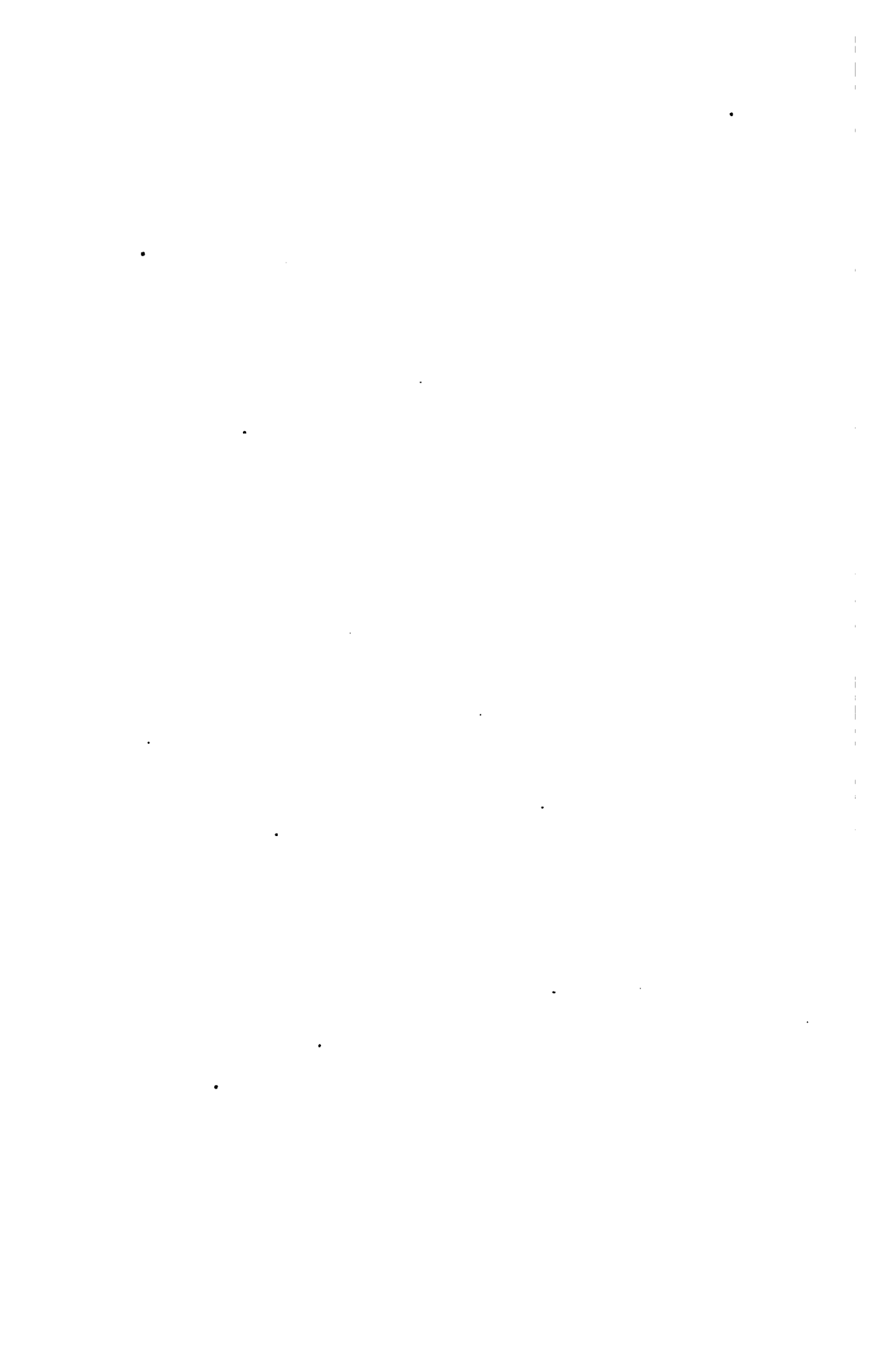

CONTENTS.

	Page.
SUBJECTS	V
LETTER OF TRANSMITTAL	VII
TABLE OF CONTENTS	IX
LIST OF ILLUSTRATIONS	XIII
SECTION I.—REPORT OF THE ASSISTANT SECRETARY, IN CHARGE OF THE NATIONAL MUSEUM.	
A.—Organization and scope of the Museum	3
B.—Special topics of the year	4
C.—The condition of the collections	6
Increase of the collections	6
Census of the collections	7
Museum catalogues	8
Catalogues of the departments in the National Museum	9
Catalogue entries during the year ending June 30, 1889	21
Arrangement of collections and assignment of space	22
D.—The Museum staff	26
The scientific staff	26
Personnel of the scientific departments	27
The administrative staff	28
E.—Review of work in the scientific departments	34
Ethnology	34
Oriental antiquities	34
Transportation and engineering	35
Graphic arts	35
Prehistoric anthropology	36
Aboriginal pottery	36
Forestry collection	37
Mammals	37
Birds	38
Birds' eggs	38
Reptiles and batrachians	38
Fishes	39
Mollusks	40
Insects	41
Marine invertebrates	41
Comparative anatomy	42

	Page.
E.—Review of work in the scientific departments—Continued.	
Invertebrate fossils:	
Paleozoic	43
Mezozoic	43
Botany	44
Fossil plants	44
Minerals	45
Lithology and physical geology	45
Metallurgy and economic geology	46
Living animals	46
F.—Review of the administrative work	47
Progress of general and incidental work	47
Library	47
Transportation, storage, and distribution of duplicates	50
Exchanges	52
Publications	54
Publications during the year	65
Visitors	67
Lectures and meetings of societies	69
Students	70
Property, supplies, and accounts	72
Preservation of collections	72
Furniture and fixtures	72
Standard cases and other Museum furniture	73
Heating and lighting	75
Electrical service	75
List of Museum employés	76
List of vouchers for expenditures for preservation of collections, 1888-'89	77
List of vouchers for expenditures for furniture and fixtures, 1888-'89 ..	84
List of vouchers for expenditures for heating and lighting, 1888-'89	87
Correspondence and reports	88
Preparation of labels	99
Buildings and labor; police and public comfort	100
The work of the Museum preparators	104
Taxidermists and modelers	104
Osteological preparator	108
Photographer	109
Colorist	110
Draftsmen	111
G.—Accessions	111
Geographical review of the more important accessions	112
H.—Specimens sent for examination and report	127
I.—Coöperation of the Departments and Bureaus of the Government	137
J.—Explorations	143
K.—Reports upon the participation of the Smithsonian Institution and the National Museum in the Centennial Exposition of the Ohio Valley and Central States, held at Cincinnati, Ohio, in 1888, (with Plates I-IV), and in the Centennial Exposition at Mari- etta, Ohio, in 1888 (with Appendices A and B)	149-186
Biographical notice of James Stevenson (Appendix C)	187
Lists of institutions and foreign and domestic libraries to which it is desired to send future publications of the National Museum (Appendix D)	191
List of institutions under State control and of colleges of liberal arts to which it is desired to send future publications of the National Museum	193

	Page.
List of the principal libraries in the United States to which it is desired to send future publications of the National Museum	216
List of foreign libraries to which it is desired to send future publications of the National Museum	268

SECTION II.—REPORTS OF THE CURATORS.

Ethnology	281
Oriental antiquities.....	289
Transportation	293
Graphic arts	301
Prehistoric anthropology (with Plates V-XI).....	317
Aboriginal pottery.....	341
Forestry	343
Mammals.....	349
Birds.....	357
Birds' eggs	363
Reptiles and batrachians.....	365
Fishes.....	369
Mollusks (including Cenozoic fossils).....	371
Insects	377
Marine invertebrates.....	381
Comparative anatomy.....	387
Invertebrate fossils:	
Paleozoic	391
Mesozoic	397
Botany	399
Minerals.....	401
Lithology and physical geology	405
Metallurgy and economic geology	413
Living animals	417

SECTION III.—PAPERS DESCRIBING AND ILLUSTRATING COLLECTIONS IN THE U. S. NATIONAL MUSEUM.

I. The Museums of the future. By G. Brown Goode.....	427
II. The Ethnology and antiquities of Easter Island (with Plates XII-LX, and Figs. 1-20). By Wm. J. Thomson, paymaster, U. S. Navy.....	447
III. Aboriginal skin-dressing. A study based on material in the U. S. National Museum (with Plates LXI-XCIII). By Otis T. Mason.....	553
IV. The Puma, or American lion, <i>Felis concolor</i> of Linnaeus (with Plate xciv). By Frederick W. True.....	591
V. Animals recently extinct, or threatened with extermination, as represented in the collections of the U. S. National Museum (with Plates xcv-cv, Figs. 21 and 22, and Maps 1-7). By Frederic A. Lucas.....	609
VI. The development of the American rail and track, as illustrated by the collection in the U. S. National Museum (with Figs. 23-137). By J. Elfreth Watkins.....	651
VII. Explorations in Newfoundland and Labrador in 1887, made in connection with the cruise of the U. S. Fish Commission schooner <i>Grampus</i> (with Plate cvi). By Frederic A. Lucas.....	709
VIII. On a bronze Buddha in the U. S. National Museum (with Plate cvii). By Charles De Kay.....	729
SECTION IV.—BIBLIOGRAPHY OF THE U. S. NATIONAL MUSEUM.....	737
I. Publications of the Museum.....	739

	Page.
II. Papers by officers of the Museum and other investigators whose writings are based directly or indirectly on Museum material.....	741
SECTION V.—LIST OF ACCESSIONS DURING THE YEAR, arranged alphabetically by names of contributors.....	777
Index A.—Arranged by localities	821
Index B.—Arranged by departments in the National Museum.....	833
General index to report	845
Preliminary Hand-book of the Department of Geology in the National Museum, by George P. Merrill (Appendix E)	1-50

LIST OF ILLUSTRATIONS.*

REPORT OF R. E. EARLL ON SMITHSONIAN EXHIBIT AT THE CINCINNATI EXPOSITION.

PLATE	Page
✓ I. General view of the Smithsonian Exhibit (looking north).....	162
✓ II. General view of the Smithsonian Exhibit (looking south).....	162
✓ III. Mammal extermination series.....	166
✓ IV. Section of photography.....	172

REPORT OF THOMAS WILSON.

✓ V. Disk-like implements of slate.....	328
✓ VI. Stone daggers, arrow and spear heads, knives, ornaments, etc.....	330
✓ VII. Rude stone ax, side and edge view.....	332
✓ VIII. Stone bear (plaster cast).....	334
✓ IX. Figs. 1 and 2. Stone carvings representing the llama.....	336
✓ X. Figs. 1 to 8. Rude notched axes.....	336
✓ XI. Figs. 1 to 6. Fragment of pot-stone vessel, and specimens of tools found in aboriginal quarries.....	336

THE ETHNOLOGY AND ANTIQUITY OF EASTER ISLAND. BY WM. J. THOMSON, PAYMASTER, U. S. NAVY.

PLATE	Page
✓ XII. Map of Easter Island.....	447
✓ XIII. Fish net.....	460
✓ XIV. Natives of Easter Island.....	460
✓ XV. Group of natives in employ of Mr. Brander.....	462
✓ XVI. Appearance of Easter Island from the roadstead of Hanga-Roa.....	476
✓ XVII. Crater of Rana Kao.....	476
✓ XVIII. Ancient stone houses at Orongo from which pictured slabs were procured.....	476
✓ XIX. Removing slabs from house at Orongo.....	478
✓ XX. Ancient house at Orongo.....	478
✓ XXI. Group of very ancient houses at the extreme end of ridge at Orongo, showing sculptured doorposts.....	480
✓ XXII. Sculptured rocks at Orongo.....	480
✓ XXIII. Pictured slabs taken from the ancient stone-houses at Orongo.....	482
✓ XXIV. Mutu Rankau and Mutu Nui; islands near Rapa Nui, where bird's eggs were gathered.....	482
✓ XXV. Inside the crater of Rana Roraka, on slope below the ancient work-shops.....	496
✓ XXVI. View of upper work-shops, on inner rim of Rana Roraka.....	496
✓ XXVII. Images standing at the base of outer slope of Rana Roraka.....	498
✓ XXVIII. Plain of Anakena.....	498
✓ XXIX. "Ohau" Platform, No. 12.....	502
✓ XXX. Central section of the great platform of Tongariki.....	506
✓ XXXI. Right wing of platform of Tongariki.....	506
✓ XXXII. Left wing of platform of Tongariki.....	506
✓ XXXIII. Rear view of right wing of platform of Tongariki.....	506
✓ XXXIV. Rear view of central section of platform of Tongariki.....	506
✓ XXXV. Akahanga (King's platform) No. 80, rear view.....	508
✓ XXXVI. Obverse of Easter Island tablet. "Apai".....	514

* The drawings from photographs and specimens in the Museum were made by Messrs. W. H. Chandler and W. H. Burger.

	Page.
PLATE XXXVII. Reverse of Easter Island tablet, "Apai".....	514
XXXVIII. Obverse of Easter Island wooden tablet, "Atua Matariri".....	520
XXXIX. Reverse of Easter Island wooden tablet, "Atua Matariri".....	520
XL. Obverse of Easter Island wooden tablet, "Eaha to ran ariiki Kete".....	524
XLI. Reverse of Easter Island wooden tablet, "Eaha to ran ariiki Kete".....	524
XLII. Obverse of wooden tablet from Easter Island, "Ka ihi uiga." (From photographs presented by George Davidson to the California Academy of Sciences.)	526
XLIII. Reverse of wooden tablet from Easter Island, "Ka ihi uiga." (From photographs presented by George Davidson to the California Academy of Sciences.)	526
XLIV. Obverse of wooden tablet from Easter Island, "Ate-a-renga-hokan iti Poheraa." (From photograph by Paymaster W. J. Thomson, U. S. Navy).....	526
XLV. Reverse of wooden tablet from Easter Island, "Ate-a-renga-hokan iti Poheraa." (From photograph by Paymaster Wm. J. Thomson, U. S. Navy).....	526
XLVI. Obverse and reverse of Easter Island tablet. (From a cast lent by Parke, Davis & Co.).....	526
XLVII. Reverse of Easter Island tablet, obtained by the Chilian corvette "O'Higgins".....	526
XLVIII. Obverse of Easter Island tablet, obtained by the Chilian corvette "O'Higgins".....	526
XLIX. Obverse and reverse of Easter Island tablet, obtained by the Chilian corvette "O'Higgins".....	526
L. Wooden images. Human skulls.....	534
LI. Stone gods. Bulrush wallet. Tapa-cloth. Knife.....	535
LII. Wooden clubs and paddle.....	535
LIII. Dancing wands and fetish-boards.....	535
LIV. Feather hats.....	535
LV. Feather hats.....	536
LVI. Obsidian spear-heads.....	536
LVII. Stone adzes. Obsidian spear-heads.....	537
LVIII. Fish-hooks of bone and stone.....	537
LIX. Ancient scull-ears.....	538
LX. Netting-needles and fetish-stones.....	538

ABORIGINAL SKIN-DRESSING, BY OTIS T. MASON.

PLATE LXI. Navajo Indian skinning deer. (After Shufeldt.).....	590
LXII. Navajo Indian removing hair from deer-skin. (After Shufeldt.).....	590
LXIII. Navajo Indian wringing the water from a deer-skin. (After Shufeldt.).....	590
LXIV. Navajo Indian pulling deer-skin into shape after wringing. (After Shufeldt.).....	590
LXV. Navajo Indian applying brains to deer-skin to make it soft. (After Shufeldt.).....	590
LXVI. Navajo Indian finishing deer-skin by stretching it. (After Shufeldt.).....	590
LXVII. Figs. 1, 2, and 3. Beaming tools.....	590
LXVIII. Figs. 1, 2, and 3. Graining tools.....	590
LXIX. Figs. 1, 2, and 3. Fat-scrapers.....	590
LXX. Figs. 1, 2, and 3. Scrapers.....	590
LXXI. Figs. 1 and 2. Scrapers.....	590
LXXII. Scraper.....	590
LXXIII. Figs. 1 and 2. Scrapers.....	590
LXXIV. Figs. 1, 2, and 3. Scrapers.....	590
LXXV. Figs. 1, 2, and 3. Scrapers.....	590
LXXVI. Scraper.....	590
LXXVII. Figs. 1, 2, and 3. Scrapers.....	590
LXXVIII. Figs. 1 and 2. Scrapers.....	590
LXXIX. Figs. 1, 2, and 3. Scrapers.....	590
LXXX. Figs. 1, 2, and 3. Fat-scrapers.....	590
LXXXI. Figs. 1, 2, and 3. Fat-scrapers.....	590
LXXXII. Figs. 1 and 2. Scrapers.....	590
LXXXIII. Figs. 1, 2, and 3. Scrapers.....	590
LXXXIV. Figs. 1, 2, and 3. Scrapers.....	590
LXXXV. Figs. 1 and 2. Scrapers.....	590
LXXXVI. Figs. 1, 2, and 3. Scrapers.....	590
LXXXVII. Figs. 1 and 2. Scrapers.....	590
LXXXVIII. Figs. 1, 2, and 3. Scrapers.....	590
LXXXIX. Figs. 1 and 2. Fat-scrapers.....	590
XC. Figs. 1, 2, 3, and 4. Beaming and graining tools.....	590
XCI. Figs. 1 and 2. Adze-shaped scrapers.....	590
XCII. Figs. 1 and 2. Adze-shaped scrapers.....	590
XCIII. Figs. 1 and 2. Adze-shaped scrapers.....	590

THE PUMA OR AMERICAN LION, BY FREDERICK W. TRUE.

	Page.
PLATE XCIV. The Puma. (From photograph of specimen presented to the National Museum by Lewis Sells, Esq.).....	591

ANIMALS RECENTLY EXTINCT OR THREATENED WITH EXTERMINATION, BY FREDERIC A. LUCAS.

PLATE XCV. The West Indian Seal (<i>Monachus tropicalis</i>).....	614
XCVI. The California Sea Elephant (<i>Macrorhinus angustirostris</i>).....	616
XCVII. Head of Pacific Walrus (<i>Odobenus obesus</i>).....	618
XCVIII. The European Bison (<i>Bison bonassus</i>).....	621
XCLX. Steller's Sea Cow (<i>Rytina gigas</i>).....	623
C. The California Vulture (<i>Pseudogryphus californianus</i>).....	629
CI. Tibias of Solitaire, Dodo and Turkey.....	634
CII. The Labrador Duck (Male) (<i>Camptalaimus labradorius</i>).....	636
CIII. The Great Auk (<i>Alca impennis</i>).....	638
CIV. Galapagos and Mascarene Tortoises. (Photographs of specimens of animals in the National Zoological Park).....	643
CV. The Tile-fish (<i>Lopholatilus chamaeleonticeps</i>). Reproduced by chromo-lithography from Plate 117 of the Atlas of Plates accompanying section 1 of the Quato Report upon the Fisheries and Fishery Industries of the United States.....	647

EXPLORATIONS IN NEWFOUNDLAND AND LABRADOR IN 1887, BY FREDERIC A. LUCAS.

PLATE CVI. Sketch map of Funk Island.....	709
---	-----

ON A BRONZE BUDDHA IN THE U. S. NATIONAL MUSEUM, BY CHARLES DE KAY.

CVII. Bronze Buddha, Tokugawa period.....	729
---	-----

THE ETHNOLOGY AND ANTIQUITY OF EASTER ISLAND, BY WM. J. THOMSON, PAYMASTER, U. S. NAVY.

FIGURE 1. Native houses built of bulrushes.....	454
2. Kaitae, nearest descendant of the last king of Easter Island.....	461
3. Native women.....	463
4a. Tattooing on a native woman. (Front view).....	466
4b. Tattooing on a native woman. (Back view).....	468
5. View of stone hut in Orongo.....	478
6. Orongo.....	479
7. Sculptured rocks near Orongo.....	481
8. Sculptured figure often reproduced on rocks at Orongo.....	483
9. Observation tower on bluff near Anahoingaraoa Point.....	485
10. Unfinished image, crater of Rana Roraka.....	492
11. Image: Rana Roraka (front view).....	493
12. Image: Rana Roraka (rear view).....	493
13. Buried image: crater of Rana Roraka.....	494
14. Image standing inside the crater of Rana Roraka.....	494
15. "Wry-neck" image, Rana Roraka.....	495
16. The mutilated image "Hiara," outside of crater of Rana Roraka.....	495
17. Platform No. 3, image restored.....	500
18. Showing general plan of construction of platforms, also plan of house construction with details.....	502
19. Sculptured rock: King's platform.....	510
20. Platform 110, Vinapu.....	512

ANIMALS RECENTLY EXTINCT OR THREATENED WITH EXTERMINATION, BY FREDERIC A. LUCAS.

FIGURE 21. Steller's Sea Cow. Facsimile of figure on chart compiled by Lieutenant Waxell, navigator of Bering's party.....	627
22. Facsimile of Pissot's figure of the Dodo.....	632

THE DEVELOPMENT OF THE AMERICAN RAIL AND TRACK, AS ILLUSTRATED BY THE COLLECTION IN THE U. S. NATIONAL MUSEUM, BY J. ELFRERTH WATKINS.

FIGURE 23. Jessop's patent edge rail. (1789).....	657
24. Edge rails, Lawson Colliery, New Castle-on-Tyne. (1797).....	657
25. Wyatt's hexagonal rail, Bangor, North Wales. (1802).....	658
26. Tram rail, Surrey Railway. (1803).....	658
27. Woodhouse's patent concave rail for wagons.....	658
28. Tram rail, Pennydarren works to Glamorgan Canal, Wales. (1804).....	659
29. Tram rail, designed by Charles Le Cann, Llanelly, Wales. (1801).....	659

	Page.
FIGURE 30. Edge rail, patented by Loah & Stephenson, laid on Stockton and Darlington Railroad, 1825. (1816).....	660
31. Lord Carlisle's wrought iron rail. (1811).....	660
32. Wrought-iron rail patented by John Birkenshaw. (1820).....	660
33. Fish-belly rail, designed by George Stephenson and laid on the Manchester and Liverpool Railway. (1829).....	661
34. English rolled rail, Clarence pattern, laid on the Old Postage Railway of Pennsylvania, 1833.....	661
35. English fish-belly rail, laid on the New Jersey Railroad near Newark, 1832.....	662
36. Wooden stringer and strap rail, Albany and Schenectady Railroad, 1837.....	664
37. Stone stringer and strap rail, Baltimore and Ohio Railroad, 1833.....	664
38. Thick rectangular rail, laid on the Baltimore and Port Deposit Railroad, 1838..	665
39. Stevens rail rolled with convex top and base, designed by Robert L. Stevens, 1830.....	668
40. Standard track of the Camden and Amboy Railroad, 1837. (From a drawing in the collection made from an engraving in "Engineering in North America," by G. Stevenson, London, 1837).....	669
41. Track of the Camden and Amboy Railroad. Rails laid on piling through marshes, 1837.....	669
42. First rail rolled in America, Baltimore and Ohio Railroad, 1844.....	671
43. The Stevens rail supported by cast-iron chair. Philadelphia and Reading Railroad, 1837.....	672
44. The Stevens rail as laid on the Vicksburg and Jackson Railroad, in Mississippi, 1841.....	672
45. T-rail, Boston and Worcester Railroad.....	673
46. T-rail, Hempstead Branch, Long Island Railroad, 1855.....	673
47. 92-pound rail, 7 inches high, Camden and Amboy Railroad, 1848.....	674
48-51. Pear-headed rails, 1855.....	675
52. Erie rail with ends stamped for Adams' cast-iron bracket splice, 1857.....	676
53. 73-pound rail, Pennsylvania Railroad, Mountain Division.....	676
54. 62-pound pear-headed rail, Boston and Lowell Railroad.....	677
55. Compound rail, wood and iron. Designed by B. H. Latrobe, 1841, for Baltimore and Ohio Railroad.....	677
56. Compound rail, Baltimore and Ohio Railroad, 1848.....	678
57. Compound rail, New York Central Railroad, 1855.....	678
58-61. Compound rails, New York Central and Troy Union Railroads, 1855.....	679
62, 63. Ashbel Welch rails, 1866.....	680
64. Rails proposed by O. Chanute, 1874.....	681
65. "Box rail," Great Western Railway of England, 1858.....	681
66. Great Western Railway of Canada, 1855.....	681
67. Barlow's "Saddle Back" rail, 1856.....	682
68. Triangular wooden stringer capped with iron, Great Western Railway of England, 1857.....	682
69. Rails for New Orleans, Memphis and Chattanooga Railroad, rolled at Dowls, Wales, 1869.....	683
70-75. Pennsylvania Railroad standard rails.....	684, 685
76-79. Standard Chicago, Burlington and Quincy Railroad Company's standard rails. (From chart furnished by Chicago, Burlington and Quincy Railroad).....	685
80. Rail rolled by the Bethlehem Iron Company, Ashbel Welch pattern, 62 pound. 1866. (From chart furnished by the Bethlehem Iron Company).....	686
81. Rail rolled by the Bethlehem Iron Company, C. V. and W. Railroad pattern, 50 pounds, 1870. (From chart furnished by the Bethlehem Iron Company).....	686
82. Rail rolled by the Bethlehem Iron Company, Lehigh Valley Railroad pattern, 40 pounds, 1875. (From chart furnished by the Bethlehem Iron Company).....	686
83. Rail rolled by the Bethlehem Iron Company, St. Louis and Santa Fé Railroad pattern, 52 pounds, 1879. (From chart furnished by the Bethlehem Iron Company).....	686
84. Rail rolled by the Bethlehem Iron Company, Missouri Pacific Railroad pattern, 52 pounds, 1881. (From chart furnished by the Bethlehem Iron Company).....	686
85. Rail rolled by the Bethlehem Iron Company, Philadelphia and Reading pattern, 90 pounds, 1886. (From chart furnished by the Bethlehem Iron Company).....	686
86. Rail rolled by the Bethlehem Iron Company, "Meat-Yard pattern," 1884 (From chart furnished by the Bethlehem Iron Company).....	686
87. Stevens rail laid on Great Western Railway of England (longitudinal system), 1858.....	687

	Page
FIGURE 88. Stevens rail adopted by the Royal Railway of Sweden, 1854.....	687
89. Stevens rail in use on the Western Railway of France, 1855.....	687
90. Stevens rail, Chemin de fer du Nord, France, 1888. (Called the Vignole rail in Europe).....	688
91. Standard rail of Belgian Government Railways, 1889. Sandberg section.....	688
92. Bull-headed rail, Strasbourg Railway, 1858.....	689
93. Bull-headed rail, Avignon and Marseilles Railway, 1858.....	689
94. Bull-headed rail, Bath Branch, Great Western of England, 1858.....	689
95. Bull-headed rail, London and Northwestern Railway, 1889.....	689
96. Cross-tie—Split quarter log.....	690
97. Cross-tie—Split half log.....	690
98. Cross-tie—Whole log hewn both sides.....	690
99. Steel tie and permanent way, London and Northwestern Railway, 1885.....	691
100. Metal track, London and Northwestern Railway of England, 1889.....	692
101. Metal track, Midland Railway of England, 1889.....	692
102. Metal track, Normanton line, Queensland, 1889.....	692
103. Metal "Pot" tie system, Midland Railway of India, 1889.....	692
104. Metal track, Holland "Post" tie, 1889.....	693
105. Metal track, Great Central Railway of Belgium, 1889.....	693
106. Bergh and Masche metal track system, Elberfeld Railway, Germany, 1889.....	693
107. Haarman longitudinal metal track, Right-Bank-of-the-Rhine Railway, 1889.....	694
108. Metal track, Vantherin system, France, 1889.....	694
109. Metal track, Egyptian Agricultural Railway, 1889.....	694
110. Metal track, Bilbao and Las Arenas, Spain, 1889.....	695
111. Metal track, Central Railway, Argentine Republic, 1889.....	695
112. Half lap joint, Hetton rail, 1874.....	695
113. Joint chair and wedge, Old Postage Railroad, 1832.....	696
114. Stone block, rail, and joint tongue laid on Camden and Amboy Railroad in 1831.....	696
115. Single splice bar for rail, rolled by the Phoenix Iron Company, 1855. (From chart furnished by the Phoenix Iron Company).....	697
116, 117. Double splice bars for rail, rolled by the Phoenix Iron Company, 1856. (From charts furnished by the Phoenix Iron Company).....	697
118. Plain splice bar, Pennsylvania Railroad, 1870.....	698
119. Wooden joint block, New Jersey Railroad, about 1860.....	698
120. Ring, joint, and wedge used on the West Jersey Railroad.....	699
121-123. Angle splice bars.....	700, 701
129. Double angle Sayre-Fitz splice bar, Lehigh Valley Railroad, 1890.....	704
130. Joint fixture used on western railroads, 1869.....	705
131. Fisher & Norris joint fixture as improved by Clark Fisher, 1888.....	705
132. \cap Staple iron used as a makeshift for a frog, Camden and Amboy Railroad, 1831.....	706
133. Frogs, colliery railroads of England, 1835.....	706
134. Frogs, Old Postage Railroad, about 1835.....	706
135. Rail frog, invented by Joseph Wood, New Jersey, 1859.....	707
136. Switches in colliery railroads, England, 1835.....	707
137. Switch with "Ball" counterweight.....	708

ANIMALS RECENTLY EXTINCT OR THREATENED WITH EXTERMINATION, BY FREDERIC A. LUCAS.

MAP 1. Distribution of the West Indian Seal.....	615
2. Distribution of the Rytina.....	624
3. Distribution of Didine birds.....	631
4. Distribution of the Great Auk.....	639
5. Distribution of Pallas' Cormorant.....	641
6. Distribution of Galapagos Tortoises.....	644
7. Showing area of destruction of Tile-fish.....	648

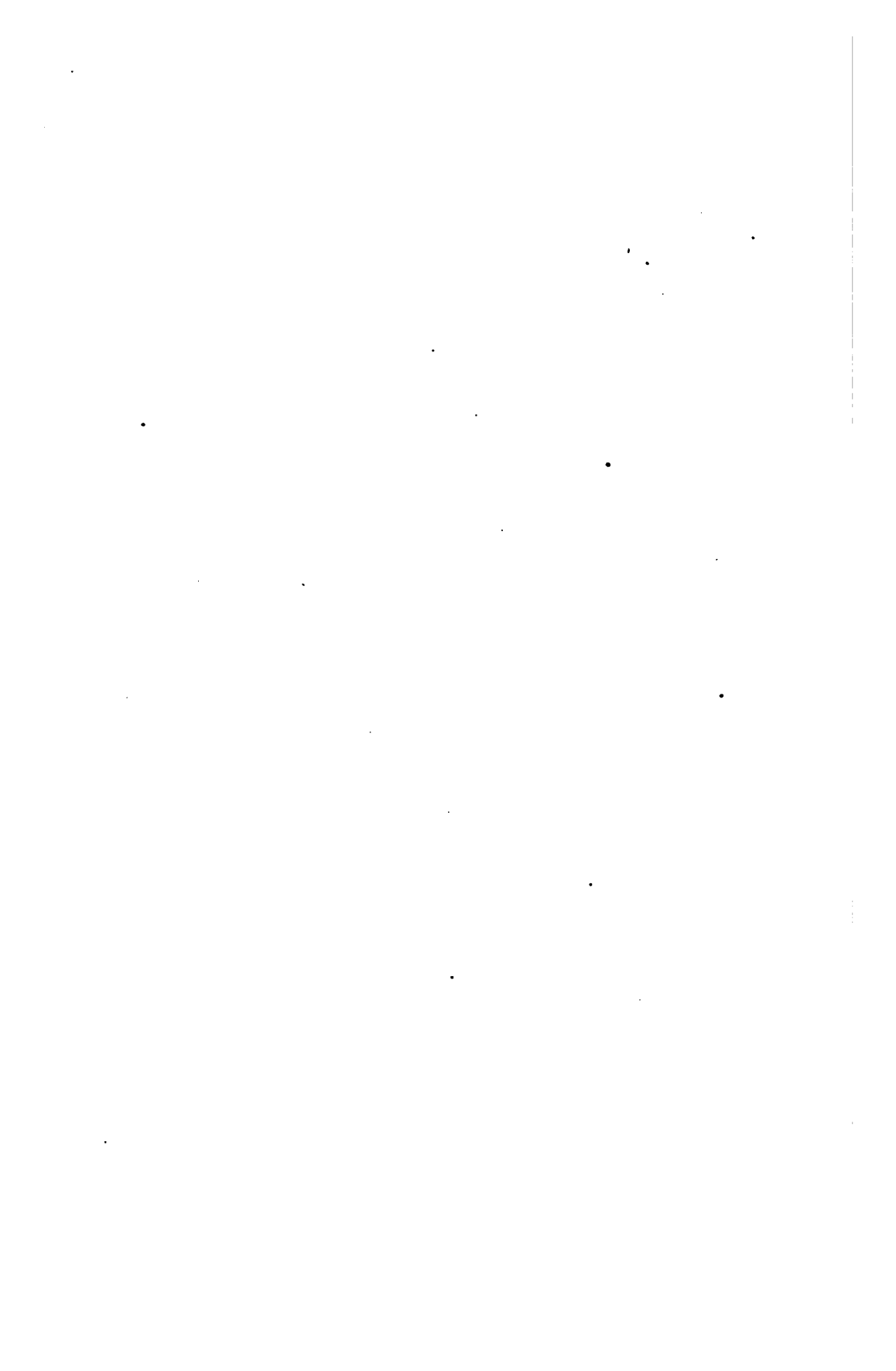

SECTION I.

REPORT

UPON THE CONDITION AND PROGRESS OF THE U. S. NATIONAL MUSEUM
DURING THE YEAR ENDING JUNE 30, 1889.

BY

G. BROWN GOODE,

Assistant Secretary of the Smithsonian Institution, in charge of U. S. National Museum.

H. Mis. 224, pt. 2—1

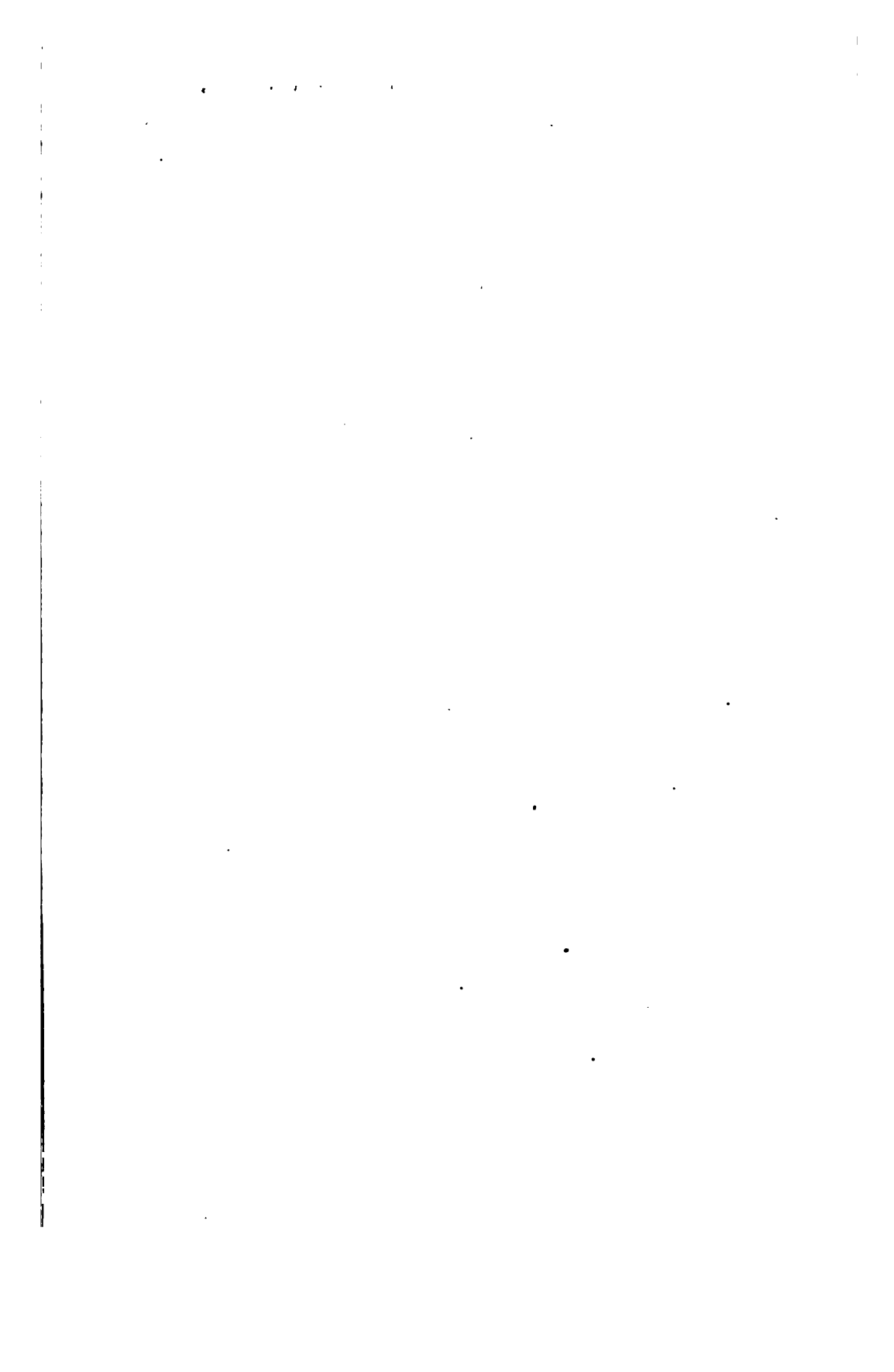

REPORT

UPON THE CONDITION AND PROGRESS OF THE U. S. NATIONAL MUSEUM
DURING THE FISCAL YEAR ENDING JUNE 30, 1889.

By G. BROWN GOODE,

Assistant Secretary Smithsonian Institution, in charge of U. S. National Museum.

A.—ORGANIZATION AND SCOPE OF THE MUSEUM.

The National Museum is under the charge of the Smithsonian Institution, and its operations are supervised by the Board of Regents of the Institution.

The Secretary of the Smithsonian Institution is by law the keeper of the collections.

In the act of Congress establishing the Smithsonian Institution are contained the following provisions concerning the scope of the museum to be placed under its charge :

(1) The law specifies certain classes of objects which shall come into the custody of the Institution, viz: All objects of art; all objects of foreign and curious research (*i. e.*, ethnological collections); all objects of natural history; all plants; all geological and mineralogical specimens belonging or hereafter to belong to the United States, which may be in the city of Washington—including the "National Cabinet of Curiosities," at that time in one of the halls of the Patent Office building—in whosoever custody they may be.

(2) It provides that in proportion as suitable arrangements can be made for their reception these objects shall be delivered to such persons as may be authorized by the Board of Regents to receive them.

(3) It provides that they shall be arranged in such order and so classed as best to facilitate their examination and study.

(4) It provides that they shall thus be arranged in the building to be inclosed for the institution.

(5) It authorizes the Regents to obtain new specimens, by exchange of duplicate specimens, and by gift, and directs that they shall be also appropriately classed and arranged.

(6) It constitutes the Secretary of the Smithsonian Institution the keeper of the museum.

PRINCIPAL SOURCES OF COLLECTIONS.

The collections of the Museum are made up, in large part, of the following materials:

(1) The natural history and anthropological collections accumulated since 1850 by the efforts of the officers and correspondents of the Smithsonian Institution.

(2) The collections of the Wilkes Exploring Expedition, the Perry expedition to Japan, and other naval expeditions.

(3) The collections of the scientific officers of the Pacific Railroad survey, the Mexican boundary survey, and of the surveys carried on by the Engineer Corps of the Army.

(4) The collections of the United States geological surveys under the direction of the United States geologists, Hayden, King, and Powell.

(5) The collections of the U. S. Fish Commission.

(6) The gifts by foreign Governments to the Museum or to the President or other public officers of the United States, who are forbidden by law to retain such gifts in their private possession.

(7) The collections made by the United States to illustrate the animal and mineral resources, the fisheries, and the ethnology of the native races of the country, on the occasion of the International Exhibition at Philadelphia in 1876, and the fishery collections displayed by the United States in the International Fisheries Exhibition at Berlin in 1880 and at London in 1883.

(8) The collections given by the Governments of the several foreign nations, thirty in number, which participated in the exhibition at Philadelphia.

(9) The industrial collections given by numerous manufacturing and commercial houses of Europe and America, at the time of the Philadelphia Exhibition and subsequently.

(10) The material received in exchange for duplicate specimens from the museums in Europe and America, at the time of the Philadelphia Exhibition and subsequently.

B.—SPECIAL TOPICS OF THE YEAR.

CLASSIFIED SERVICE OF THE MUSEUM.

A schedule representing the present actual needs of the service was, in response to a Senate resolution, submitted by the Secretary of the Smithsonian Institution. By this it was shown that the sum of \$200,000 at least was required to pay the salaries of the necessary scientific assistants, the clerical force, mechanics, and laborers, for the construction of suitable cases, and for the employés connected with the heating, lighting, electrical, and telephonic service.

A COLLECTION OF BUSTS OF STATE GOVERNORS IN 1860.

A collection of thirty-two busts, including one of James Buchanan, has been presented to the Museum by Mrs. Anna E. Douglass. The busts were executed by Mr. Henry Dexter, of Cambridge. After the series was completed in plaster, it was placed on exhibition in the Doric Hall of the State House at Boston. The lapse of time and the celebrity of several of the governors have made this collection of great value from an historical stand-point. It is also probable that the sculptor's efforts indicate the best work of the kind produced in the United States up to the year 1860.

AERONAUTIC COLLECTION.

It is intended to establish in the Museum a Department of Aeronautics, in which will be established (1) balloons and apparatus lighter than air, and (2) models of aerostats heavier than air. The co-operation of the Aeronautic Society of Great Britain has been invited by the Secretary of the Institution, who is especially interested in the subject.

INCREASE OF THE COLLECTIONS.

A careful estimate of the number of specimens in all the departments of the Museum places the total at 2,864,244. In 1882 the total was estimated at about 192,000. At that time, however, some of the largest collections in the Museum, such as the ethnological collection, had not been brought under control, and no estimate of their extent was then possible; so that the difference between the totals for 1882 and 1889 can not be accounted for solely by the number of specimens received during these years, but includes also the material which was already in the possession of the Museum, but which had not been classified at the time of the first census of the collections in 1882.

AMERICAN HISTORICAL ASSOCIATION.

The American Historical Association was founded in 1884 for the promotion of historical studies, for the collection and preservation of historical manuscripts, and for kindred purposes in the interest of American history. By an act of Congress approved January 4, 1889, the regents of the Smithsonian Institution are authorized to permit the American Historical Association to deposit its collections, manuscripts, books, etc., in the keeping of the Smithsonian Institution. Under this Act the American Historical Association reports annually to the Secretary of the Smithsonian Institution concerning its proceedings and the condition of historical study in America.

VISITORS DURING INAUGURATION SEASON.

On March 2 and 5 the Museum and Smithsonian buildings were visited by 106,075 people.

CINCINNATI EXPOSITION.

The Exposition closed on November 8, 1888. The appropriation available for the use of the Museum was \$40,000. The space occupied by the Museum exhibits was 12,000 square feet. Sixteen departments of the Museum prepared exhibits. The total attendance at the Exposition was 1,055,276, the daily average being 9,593.

TRANSFER OF DISBURSEMENT OF MUSEUM APPROPRIATIONS.

A statement relating to this matter is made on page 20 of the report for last year. Congress has sanctioned the proposed transfer, and the Museum appropriations will henceforth be disbursed under the direction of the Smithsonian Institution.

FORMATION OF A FORESTRY COLLECTION.

Through the courtesy of the Secretary of Agriculture Dr. B. E. Fernow, Chief of the Forestry Division of the Department of Agriculture, has accepted the charge of the Section of Forestry in the National Museum. The Section of Forestry was established in April, 1889.

C.—THE CONDITION OF THE COLLECTIONS.

INCREASE OF THE COLLECTIONS.

The total number of specimens as estimated in the appended table is now not far from three millions. The increase during this year is much smaller than in any previous year since the completion of the Museum building. At the close of 1882 there were about 192,000 specimens in the collections. The increase during 1883 was about 170,000; during 1884, more than 1,200,000. It was during this year that the extent of the ethnological collection was first estimated and also of the collections of mollusks, insects, aboriginal pottery, birds' eggs, reptiles and batrachians, and mesozoic fossils. During 1885 no estimate was made, this being the year when the fiscal year was adopted in place of the calendar year, and the report for 1885 covered only six months. In 1886 a careful estimate showed a further increase of about 950,000. In 1887 the increase was nearly 250,000, and in 1888 nearly 140,000. The increase during the fiscal year covered by this report is only 60,000. This may be accounted for to a large degree by the fact that, the exhibition halls and storage rooms being filled to their utmost capacity, it has become necessary to cease to a large degree the customary efforts for the increase of the collections.

In order that the tabulated results here presented may not be misleading, it is proper to repeat what has elsewhere been alluded to, namely, that the classification of some of the largest collections, such as

the ethnological collection, had not been made in 1882, and that therefore no figures appear under the head of ethnology for that year or for 1883, although the ethnological collection was at that time probably half as large as it is now. Some of the other collections had not been classified, and thus an increase in the collections more apparent than real appears to have taken place in 1885-'86.

CENSUS OF THE COLLECTIONS

Table showing the estimated number of specimens in the Museum in 1882 and each year since.

[No census of collection taken in 1885.]

Name of department.	1882.	1883.	1884.	1885-'86.	1886-'87.	1887-'88.	1888-'89.
Arts and industries:							
Materia medica.....		4,000	4,442	4,850	5,516	5,762	5,942
Foods.....		1,244	1,580	822	877	877	911
Textiles.....			2,000	3,063	3,144	3,144	3,222
Fisheries.....			5,000	9,870	10,078	10,078	10,078
Animal products.....			1,000	2,792	2,822	2,822	2,948
Naval architecture.....			600				600
Historical relics.....				1,002	} 13,634	14,640	14,990
Coins, medals, paper money, etc.....				1,005			
Musical instruments.....				400	417	427	427
Modern pottery, porcelain, and bronzes.....				2,278	2,238	3,011	3,011
Paints and dyes.....				77	100	100	109
"The Catlin Gallery".....				500	500	500	500
Physical apparatus.....				250	251	251	251
Oils and gums.....				197	198	198	213
Chemical product.....				659	661	661	688
Ethnology.....			200,000	500,000	503,764	505,464	506,324
American aboriginal pottery.....			12,000	25,000	26,023	27,122	28,222
Oriental antiquities.....							850
Prehistoric anthropology.....	35,512	40,491	45,252	65,314	101,669	108,631	116,472
Mammals (skins and alcoholics).....	4,660	4,920	5,604	7,451	7,811	8,058	8,275
Birds.....	44,354	47,246	50,350	55,945	54,987	56,484	57,974
Birds' eggs.....			40,072	44,163	48,173	50,055	50,173
Reptiles and batrachians.....			23,495	25,344	27,542	27,664	28,405
Fishes.....	50,000	65,000	68,000	75,000	100,000	101,350	107,350
Mollusks.....	33,375		400,000	460,000	425,000	455,000	468,000
Insects.....	1,000		151,000	500,000	585,000	593,000	603,000
Marine-invertebrates.....	11,781	14,825	200,000	350,000	450,000	515,000	515,300
Comparative anatomy:							
Osteology.....	3,535	3,640	4,214	} 10,210	11,022	11,558	11,753
Anatomy.....	70	103	3,000				
Paleozoic fossils.....		20,000	73,000	80,482	84,491	84,649	91,126
Mesozoic fossils.....			100,000	69,742	70,775	70,925	71,236
Cenozoic fossils.....			(Included with mollusks.)				
Fossil plants.....		4,624	7,291	7,429	8,462	10,000	10,178
Recent plants.....				30,000	32,000	38,000	38,459
Minerals.....		14,550	16,610	18,401	18,601	21,696	27,690
Lithology and physical geology.....	9,075	12,500	18,000	20,647	21,500	22,500	27,000
Metallurgy and economic geology.....		30,000	40,000	48,000	49,000	51,412	52,076
Living animals.....						220	491
Total.....	193,362	263,143	1,472,600	2,420,944	2,666,335	2,803,459	2,864,244

MUSEUM CATALOGUES.*

The following exhaustive account of the manuscript catalogues of the Museum has been prepared by Mr. Randolph I. Geare:

The catalogue system of the Museum was devised and commenced in April, 1839, by Professor Baird, at Carlisle, Pennsylvania, while engaged in work upon his private collection of birds. The book in which the specimens in this collection were recorded is now Vol. I of the Bird Catalogue, and is in the custody of Mr. Ridgway, Curator of Birds.

When Professor Baird became Assistant Secretary of the Smithsonian Institution in 1850, he brought with him and presented to the National Museum his private collection of birds, and a large general natural history collection, filling an entire baggage car. The bird collection was catalogued between 1839 and 1848.

After Professor Baird accepted the position of Assistant Secretary of the Smithsonian Institution, his system of cataloguing was adopted for the Government collections.

When the cataloguing of the Museum specimens was commenced, it was found more convenient to keep the records of the several collections in one book. For many years all objects other than specimens of natural history were entered in the "Ethnology" series. Vol. XI of this series is the first that was set apart for the entry of material of a specified character, and in it are recorded materia medica specimens. Musical instruments, fishery implements, foods, textiles, and other classes of specimens are also included in this volume. A catalogue for mineral and metallurgical specimens was opened in 1859, for fossils in 1859, for vertebrate specimens in 1840, for birds in 1839, for mammals in 1852, for mollusks in 1859. This early system of cataloguing was, although not entirely satisfactory, under the circumstances necessary; but during later years every special collection has been provided with its own catalogue book, and in some instances the curators have found it convenient to assign a different book to the several groups of objects under their custody. The total number of catalogue books in the Museum, entirely or partly filled, is 151, as shown in the following enumeration:

Series.	No. of catalogue books.	Series.	No. of catalogue books.
Ethnology	31	Marine invertebrates	12
Mineralogy and metallurgy	17	Reptiles and batrachians	4
Fossils	6	Recent plants	2
Birds	23	Insects	1
Vertebrates	7	Graphic arts	1
Mammals	4	Textiles and foods	2
Mollusks	24	Transportation and engineering	1
Birds' eggs	6	Living animals	1
Fishes	9		151

* Catalogue entries made later than June 30, 1889, are in many instances referred to, the preparation of this statement not having been completed until the end of the calendar year 1889.

The history of the system of cataloguing in the various departments is given in the following detailed statement:

CATALOGUES OF THE DEPARTMENTS IN THE NATIONAL MUSEUM.

ETHNOLOGICAL SERIES.

This series contains thirty-one volumes, with 150,400 entry spaces. The earlier volumes were devoted to the entry of all objects accruing to the Museum other than objects of natural history.

From time to time separate volumes or portions of volumes have been set apart for the entry of material of a specified character.

Vol. I, Nos. 1 to 3500.—The first material entered bears date of March 9, 1859, and is a collection of Japanese ethnological objects, presented by the Emperor of Japan, through Commodore Perry.

The last entry is dated February 4, 1867.*

Vol. II, Nos. 3501 to 8300.—This volume covers the period between February, 1867, and February, 1869. Many of its pages are devoted to the entry of material gathered by the Wilkes Exploring Expedition. The entries have not been carried beyond 8277, from 8278 to 8300, both inclusive, having been left for some reason blank.*

Vol. III, Nos. 8301 to 14100.—This volume covers the period between February, 1869, and June, 1874.*

Vol. IV, Nos. 14101 to 19825.—This volume covers the period between June, 1874, and March, 1875.*

Vol. V, Nos. 19826 to 24750.—This volume covers the period between March, 1875, and September, 1876.*

Vol. VI, Nos. 24751 to 29700.—The first entry in the volume is dated October, 1875—a year prior to the last entry in Vol. V, and the volume was completed a year subsequent to the opening of Vol. VII, the next of this series. This volume was probably set apart for the use of some collector in the field.*

Vol. VII, Nos. 29701 to 34600.—This volume covers the period between September, 1876, and January, 1879.*

Vol. VIII, Nos. 34601 to 39500.—This volume covers the period between January, 1879, and January, 1880.*

Vol. IX, Nos. 39501 to 44350.—This volume covers the period between January, 1880, and December, 1880.*

Vol. X, Nos. 44351 to 49225.—This volume covers the period between December, 1880, and January, 1881.*

In Vol. X is the following note:

The two succeeding volumes of record are devoted (1) to collections under the U. S. Fish Commission and (2) to chemical and other artificial products.

Vol. XI.—This volume, the first of the series set apart for the entry of material of a specified character, was assigned to Dr. Flint for the

* The original catalogue is in the Department of Prehistoric Anthropology, and a copy has been made for the Department of Ethnology.

entry of specimens of *materia medica*. It covers the period between May, 1881, and February, 1886. The entries in this volume have been carried as far as 54050, although the limit provided for is No. 53925; thus duplicating to the extent of about one hundred and twenty-five numbers the entries in Vol. XII. This volume is in the custody of the Section of *Materia Medica*.*

Vol. XII, Nos. 53926 to 57950.—From January, 1881, to February, 1883. Assigned as follows: From 53926 to 54750 is devoted to the entry of general ethnological objects except the following: Nos. 53926 to 54015. A collection of Japanese plants, from the University of Tokyo; entered in July, 1881. This portion of the catalogue has been used in the Section of Fisheries.

Nos. 54016 to 54079 embrace a collection of Chinese musical instruments from the Chinese Imperial Centennial Commission, and others. These entries were made in December, 1881. This portion of the catalogue has been used in the Section of Fisheries. The entry of musical instruments has been continued in Vol. XX of this series.

Nos. 54080 to 54302 are devoted to the entry of general ethnological objects. This portion of the catalogue has been used in the Section of Fisheries.

Nos. 54303 to 54525 are devoted to the entry of a large collection of fishing implements, models of fishing boats, etc. This material was entered in November, 1882, and was the nucleus of the fisheries collection. This portion of the catalogue has been used in the Section of Fisheries.

Nos. 54526 to 54750 are blank.

Nos. 54751 to 55550 are devoted to the entry of a collection of food-stuffs. This is the first entry of a collection of food-stuff of any considerable extent.

Nos. 55551 to 56425 are devoted to the entry of miscellaneous ethnological specimens, including fishing implements. (With the Section of Fisheries.)

Nos. 56426 to 56774. A collection of ethnological objects from the Alaskan Indians. (With the Section of Fisheries.)

Nos. 56775 to 56825 are blank.

Nos. 56826 to 57201 are used for the entry of a collection of ships

* In April, 1883, Vol. XVII of the "Ethnology series" was assigned to the curator of this section for the entry of such chemical specimens as could not be included under the head of *Materia Medica*. Vol. XVII was afterwards transferred to the custody of the Curator of Foods and Textiles, and Vol. XXX of the "Ethnology series" was assigned to the Section of *Materia Medica*. Vol. XVII has served the purpose of a general catalogue for this section from February, 1886—the date of completion of Vol. XI, to May, 1888—the date of the first entry in Vol. XXX. Such entries of *materia medica* specimens as had been made in Vol. XVII were transferred to Vol. XXX, which is still in use in this section. To the end of the last fiscal year 5502 catalogue numbers had been made use of, distributed as follows: In Vol. XI, 4825 numbers, from 49226 to 54051, in Vol. XXX, 677 numbers, from 141201 to 141878.

papers, fittings, and stores; fishing appliances; fishing products. (With the Section of Fisheries.)

Nos. 57201 to 57229. A small collection of fibers and textiles. (With the Section of Fisheries.)

Nos. 57230 to 57250 are blank.

Nos. 57251 to 57628. Food-stuffs, dyes, and textiles in the rough. (With the Section of Fisheries.)

Nos. 57629 to 57950. Fishing implements, including boat fittings, etc.

These several portions of Vol. XII are as yet unbound. A bound copy of this volume, comprising all these portions, is in the Department of Ethnology.

Vol. XIII, Nos. 57951 to 62750.—This volume covers the period between June, 1881, and February, 1884. It is devoted to the entry of archæological material with the exception of about 170 entries of ethnological specimens. A list of the ethnological material so entered has been appended to the copy of Vol. XII, in the Department of Ethnology. The original catalogue is in the Department of Prehistoric Anthropology.

Vol. XIV, Nos. 62751 to 67575.—This volume covers the period between December, 1881, and November, 1882, and is occupied with entries of pottery and stone implements exclusively.

The original catalogue is in the Department of Prehistoric Anthropology, and a copy is in the Department of Ethnology.

Vol. XV, Nos. 67576 to 72375.—This volume covers the period between November, 1882, and April, 1883, and is devoted to the entry of pottery, stone implements, and other archæological material.

The original catalogue is in the Department of Prehistoric Anthropology, and a copy is in the Department of Ethnology.

Vol. XVI, Nos. 72376 to 77350.—This volume covers the period between January, 1883, and March, 1887, and is devoted to the entry of general ethnological material, except the following numbers: 75001 to 75335 are set apart for the entry of a collection of historical relics, musical instruments, and modern ceramics.

Nos. 76001 to 76500 have been assigned for the use of the Curator of the Section of Naval Architecture.

Nos. 77245 to 77351 are left blank. The original catalogue is in the Department of Prehistoric Anthropology, and a copy has been made for the Department of Ethnology.

Vol. XVII, Nos. 77350 to 82325.—This volume covers the period between April, 1883, and June, 1889. Originally assigned to the Department of *Materia Medica* for the entry of chemicals. Used as a general catalogue of the Section of *Materia Medica*. Transferred to the Department of Foods and Textiles. Now in use, the entries having been carried as far as 78067. Upon its transfer the *Materia Medica* speci-

mens which had been entered in this volume, were transferred to Vol. XXX of this series.

Vol. XVIII, Nos. 82326 to 87300.—This volume covers the period between April, 1883, and October, 1883. Devoted to the entry of pottery, stone implements, and other archaeological material.

The original catalogue is in the Department of Prehistoric Anthropology, and a copy is in the Department of Ethnology.

Vol. XIX, Nos. 87301 to 92200.—This volume covers the period between October, 1883, and September, 1884. Devoted to the entry of pottery, prehistoric stone implements, etc.

The original catalogue is in the Department of Prehistoric Anthropology, and a copy is in the Department of Ethnology.

Vol. XX, Nos. 92201 to 97100.—Current catalogue of the section of musical instruments. Devoted to the entry of musical instruments, excepting Nos. 92335 to 92654, which are devoted to the entry of the "Washington relics" transferred from the Patent Office. The entries have been carried as far as 94658. This catalogue was commenced in May, 1883.

Vol. XXI, Nos. 97101 to 102000.—This volume covers the period between February, 1884, and April, 1887. Devoted to the entry of material assigned to the Department of Prehistoric Anthropology.

Vol. XXII, Nos. 102001 to 106900.—The current volume in use by the Section of Fisheries. Separate parts of this volume are assigned respectively to the Sections of Fisheries and Animal Products. The entries in the Section of Fisheries have been carried from 102001 to 103443; in the Section of Animal Products from 104501 to 105045. The first entry in the space assigned to the Section of Fisheries is dated March, 1884; the first in the space assigned to the Section of Animal Products is dated June, 1886.

Vol. XXIII, Nos. 106901 to 111800.—From September, 1884, to May, 1885. Devoted to the entry of specimens assigned to the Department of Prehistoric American Pottery.

Original catalogue in the Department of Prehistoric American Pottery; a partial copy in the Department of Prehistoric Anthropology.

Vol. XXIV, Nos. 111801 to 116700.—This catalogue covers the period between May, 1885, and June, 1886. Devoted to the entry of specimens assigned to the Department of Prehistoric American Pottery.

The original catalogue is in the Department of Prehistoric American Pottery and a partial copy in the Department of Prehistoric Anthropology.

Vol. XXV, Nos. 116701 to 121600.—This catalogue was assigned for the entry of a collection to illustrate the art of taxidermy. The first entry was made on February 9, 1886, and the last entry was made on March 9, 1886. The entries have only been carried as far as 116814.

Vol. XXVI, Nos. 121601 to 126500.—This volume was assigned for the

entry of historical collections and coins, and embraces the period from February, 1886, to October, 1889. The entries run as far as 126838, thus encroaching to the extent of about three hundred numbers on the entries of Vol. XXVII.

Vol. XXVII, Nos. 126501 to 131400.—The current volume in use in the Department of Ethnology. Commenced in March, 1886. In this volume 300 numbers, beginning with 130000, have been set apart for the entry of material assigned to the Section of Oriental Antiquities.

Vol. XXVIII, Nos. 131401 to 136300.—The current volume in use in the Department of Prehistoric American Pottery. Commenced in June, 1886.

Vol. XXIX, Nos. 136301 to 141200.—This volume is devoted to the entry of material assigned to the Department of Prehistoric Anthropology. From April, 1887, to October, 1889.

Vol. XXX, Nos. 141201 to 145900.—Current volume in use in the Section of Materia Medica. Commenced May, 1888.

Vol. XXXI, Nos. 145901 to 150400.—Current volume in use in the Department of Prehistoric Anthropology. Commenced in October, 1889.

MINERALOGICAL AND METALLURGICAL SERIES.

In the early volumes of this series are entered minerals, ores, lithological specimens, metallurgical products, and fossils. The first entry is dated April, 1859, and consists of a large collection of minerals, ores, rocks, and fossils; collected by Lieut. J. C. Ives. There are seventeen volumes included in this series. Vols. I, II, III, IV, and X are in the custody of the Department of Minerals, the other volumes of the series are in the Department of Geology.

Vol. I, Nos. 1 to 3500.—First entry April 29, 1859; the last entry noted is July, 1861, but there are many entries subsequent to this period. This volume contains many unused numbers.

Vol. II, Nos. 3501 to 9200.—First entry June 16, 1862; last entry December 23, 1874.

Vol. III, Nos. 9201 to 14,500.—First entry January 7, 1875; last entry February 25, 1884. On the title page is the following inscription:

Catalogue for minerals, rocks, fossils and metallurgical products, beginning with No. 9201, January, 1875.

Vol. IV, Nos. 14501 to 20300.—The first entry has no date; the last entry is dated June 10, 1883. There is a note at the end of this volume stating that Nos. 20301 to 25001 were assigned to "Mr. Keirigs (?) collection of rocks." On the title page is "A catalogue of the collection to illustrate the mineral resources of the United States, International Exhibition, 1876." There is an appendix containing many duplicate entries, together with additional entries made at a much later period than the date of completion of the volume.

Vol. V.—This volume is devoted to the entry of lithological material. Nos. 20301 to 25000. Entry has been made up to and including 25125, thus duplicating to the extent of one hundred and twenty-five numbers the entries of Vol. VI. Nos. 23399 to 24000, both inclusive, are blank.

Vol. VI, Nos. 25001 to 29649.—Devoted to the entry of lithological material. This book contains entries in 1881, 1882, 1883, and 1884.

Vol. VII, Nos. 29651 to 34650.—This book is devoted to the entry of ores and metallurgical appliances and products, etc. The entries in this volume duplicate those of Vol. VII to the extent of about one hundred and twenty-five numbers. First entry December 12, 1882; last entry May 10, 1884.

Vol. VIII, Nos. 34526 to 39400.—This volume is devoted to the entry of lithological material. First entry January 11, 1884; last entry May 12, 1888.

Vol. IX, Nos. 39401 to 44300.—This volume is devoted to the entry of ores, metallurgical appliances and products, etc. First entry March 24, 1884; last entry October 19, 1885.

Vol. X, Nos. 44301 to 49200.—This volume is devoted to the entry of mineralogical material. This catalogue is now in use in the Department of Minerals. First entry April 7, 1884. Up to the end of the last fiscal year, the last entry was 48468.

Vol. XI, Nos. 49201 to 54100.—This volume is devoted to the entry of ores and metallurgical appliances and products. Nos. 51674 to 54100, both inclusive, are left blank. The first entry in this book is dated May, 1884, but there are entries as late as November 11, 1889.

Vol. XII, Nos. 54101 to 59000.—This volume is devoted to the entry of ores and metallurgical appliances and products, etc. First entry August 8, 1884; last entry February 12, 1886.

Vol. XIII, Nos. 59001 to 63900.—Devoted to the entry of ores and metallurgical appliances and products. Nos. 59946 to 63900, both inclusive, are unused. First entry September 4, 1884; last entry October 4, 1889.

Vol. XIV, Nos. 63901 to 68800.—Devoted to the entry of ores and metallurgical appliances and products, etc. First entry October 19, 1885; last entry December 18, 1889. From 66651 to the end of the book the numbers are unused. Up to the end of June, 1889, the entries had proceeded as far as No. 66584.

Vol. XV, Nos. 68801 to 73500.—Devoted to the entry of lithological material. This catalogue is now in use in the Department of Geology. First entry January 20, 1888; last entry January 8, 1890. From 72890 to the end of the volume is unused. Nos. 70692 to 72889 are all entered under July 19, 1889.

Vols. XVI and XVII.—These two volumes are but partially filled by the re-entry of material already entered in some previous volume of

this series. Much material already entered in the earlier volumes of this series has been re-entered in the later volumes. In the Department of Metallurgy and Economic Geology an endeavor seems to have been made to enter all material of a like nature in separate catalogues; thus, in the year 1889 three catalogues (Vols. XI, XIII, and XIV) were in use in this department. All of these books are as yet unfilled.

INVERTEBRATE FOSSIL SERIES.

Vol. I.—The material constituting the nucleus of the Museum collection of fossils was gathered by the various Government Surveys of the country west of the Mississippi. The first entry, dated April 28, 1859, relates to a large collection of fossils gathered by Lieut. J. O. Ives, of the U. S. Army. The volume was completed in 1863. It contains numbers from 1 to 3500, both inclusive. The original is in the custody of the Department of Mesozoic Fossils, and a copy is with the Department of Paleozoic Fossils.

Vol. II, Nos. 3501 to 8890.—Original catalogue in the Department of Mesozoic Fossils, and copy with the Department of Paleozoic Fossils. First entry April 3, 1864; last entry March, 1880.

Vol. III, Nos. 8891 to 13575 to and including 12900.—Original with the Department of Mesozoic Fossils, and copy with the Department of Paleozoic Fossils. First entry April, 1880; last entry October, 1885.

Vol. IV, 13576 to 18500.—Devoted to the entry of Paleozoic Fossils exclusively. First entry June 9, 1883; last entry December 16, 1889.

Vol. V, Nos. 18501 to 23500.—This volume is now in use in the Department of Mesozoic Fossils. Up to the end of the last fiscal year the entries had been carried as far as 20262.

Vol. VI, Nos. 23501 to 28500.—Now in use in the Department of Paleozoic Fossils. The entries have been carried to 23657.

BIRD SERIES.

This catalogue is contained in twenty-three volumes of varying sizes, in which up to January, 1890, 117,445 entries had been made. The first volume of this series is a catalogue of the private collection of William M. and Spencer F. Baird. The first entry in this book is dated April, 1839, and there are entries as late as 1851. This volume includes numbers from 1 to 3696. This volume also contains a short list of quadrupeds.

Vol. II, Nos. 3697 to 7700.—There are no dates of entry, but this volume probably covers the period between 1851 and 1857.

Vol. III, Nos. 7901 to 13825.—From November, 1857, to December, 1860.

Vol. IV, Nos. 13826 to 23400.—From August, 1857, to January, 1862.

Vol. V, Nos. 23401 to 28400.—The title of this book is as follows: "Museum Catalogue of Birds from No. 23401 to 28400. Received during the years 1860 to 1863, A. D."

The entries are from December 30, 1860, to April 30, 1863.

Vol. VI, Nos. 28401 to 33200.—Title is as follows: "Museum Catalogue of Birds received during the years 1863 and 1864."

Vol. VII, Nos. 33201 to 38700.—From March 22, 1864, to June 12, 1865.

Vol. VIII, Nos. 38701 to 45500.—From June 12, 1865 to March 20, 1867.

Vol. IX, Nos. 45501 to 50400.—From February 19, 1867, to March 4, 1868.

Vol. X, Nos. 50401 to 56000.—From March 4, 1868, to January 15, 1869.

Vol. XI, Nos. 56001 to 61200.—From June, 1869, to May, 1871.

Vol. XII, Nos. 61201 to 66900.—The first entry is under the year 1872, the last is dated June 24, 1874.

Vol. XIII, Nos. 66901 to 72800.—From June 24, 1874, to February 15, 1877.

Vol. XIV, Nos. 72801 to 77700.—From April 6, 1877, to April, 1879.

Vol. XV, Nos. 77701 to 82500.—From April, 1879, to August, 1881.

Vol. XVI, Nos. 82501 to 87320.—From June 29, 1881, to June 12, 1882.

Vol. XVII, Nos. 87321 to 92300.—From June 12, 1882, to November 27, 1883.

Vol. XVIII, Nos. 92301 to 97300.—From November 20, 1883, to April 8, 1884.

Vol. XIX, Nos. 97301 to 102200.—From April 9, 1884, to January 31, 1885.

Vol. XX, Nos. 102201 to 107100.—From January 31, 1885, to January 10, 1886.

Vol. XXI, Nos. 107101 to 112050.—From January 10, 1886, to October 24, 1887.

Vol. XXII, Nos. 112051 to 117000. From October 24, 1887, to November 22, 1889.

Vol. XXIII.—Now in use. Commenced on November 22, 1889. On January 18, 1890, the entries had been carried as far as 117445.

VERTEBRATE SERIES (RECENT AND FOSSIL).

In the earlier volumes of this series were entered vertebrate fossils, recent and fossil. Subsequently entire volumes, or portions of volumes, were set apart for skeletons of a particular kind.

Vol. I, Nos. 1 to 3500.—Original and copy with the Department of Mammals. Covers the period between 1840 and 1859.

Vol. II, Nos. 3501 to 8850.—Original and copy with the Department of Mammals. From March 12, 1859, to May, 1869.

Vol. III, Nos. 8851 to 15800.—With the Department of Mammals. From May, 1869, to December, 1877.

Vol. IV.—The entries in this volume begin at 14501, thus duplicating

to the extent of about thirteen hundred numbers the entries of the preceding volume. This volume was closed on October 26, 1888, the entries having been carried as far as 18330.

Vol. V begins at *No. 20751*.—This volume is devoted exclusively to the entry of skeletons of mammals. Commenced March 14, 1882. The entries had been carried as far as 24951 on January 18, 1890.

Vol. VI.—Separate parts of this volume are set apart for the entry of skeletons of fishes and of reptiles. The entry of skeletons of fishes begins at 25751, dated March 4, 1883, and had been carried as far as 26084 on September 11, 1888. The entry of skeletons of reptiles begins at 29001, dated March 22, 1885, and had been carried as far as *No. 29266*, on August 31, 1889.

Vol. VII.—This is the current catalogue of the Department of Vertebrate Fossils. The entries begin at 30701 and on December 21, 1889, had been carried as far as 30950. This volume is in the custody of the Department of Comparative Anatomy. A card catalogue has been prepared of all vertebrate fossils belonging to the Museum collections, which have been entered in the earlier volumes of this series.

MAMMAL SERIES.

A separate series of books has been kept for the entry of mammal skins, with the exception of a few entries in *Vol. I* of the "Bird Series," made in 1840.

Vol. I, Nos. 1 to 2650.—Original and copy with the Department of Mammals. Commenced February 12, 1852, and closed prior to April, 1857.

Vol. II, Nos. 2651 to 7000.—Original and copy with the Department of Mammals. Covers the period between April, 1857, and October, 1863. The title of this volume is "Mammals from *No. 2651 to 7050* in the collection of the Smithsonian Institution, April, 1857 to October, 1863."

Vol. III, Nos. 7001 to 12250.—Original and copy with the Department of Mammals. Covers the period between October, 1863, and December, 1874.

Vol. IV.—Current volume in use in the Department of Mammals. On January 10, 1890, the entries had been carried as far as 18043.

MOLLUSK SERIES.

In the Report of the National Museum for 1885* Mr. W. H. Dall, Curator of the Department of Mollusks, presents a statement of the registration of specimens from 1859 to 1885, from which it appears that 42,440 entries had been made. During the fiscal year ending June 30, 1886, 18,638 entries were made. In the next fiscal year 10,530 entries were recorded, the latest being *No. 83534*, in *Vol. xviii*. On

* Page 110.

June 30, 1888, the catalogues show that 11,799 entries had been made, the last one being No. 98677, in Vol. XXI. From Mr. Dall's report for 1889 it appears that 6,323 entries had been made during the fiscal year ending June 30, 1889, the last number taken up being 102074, in Vol. XXI. Entries were also made during the same year in Vols. XVIII and XX. During the six months ending December 31, 1889, 1,159 additional entries had been made in Vol. XXII.

With a view to economy of time two other catalogue books are kept for the use of assistants working in other offices of the department. This series therefore comprises in all twenty-four volumes.

BIRDS' EGG SERIES.

This catalogue comprises six volumes, containing 23,908 entries.

Vol. I, Nos. 15 to 2300, 1858 to 1859; Vol. II, Nos. 2300 to 7900, 1859 to 1864; Vol. III, Nos. 7900 to 12900, 1864 to 1867; Vol. IV, Nos. 12900 to 17975, 1867 to 1878; Vol. V, Nos. 17975 to 22550; Vol. VI, Nos. 22551 to 27450. On January 15, 1890, the entries had been carried as far as 23908.

FISH SERIES.

This catalogue is contained in nine volumes. The title of the first volume is "Museum Catalogue of Foreign and Domestic Fish embraced in the collections of the Smithsonian Institution, from the years 1856 to 1861."

Vol. I, Nos. 1 to 3600, December 15, 1856 to 1861; Vol. II, Nos. 3601 to 8700, 1861 to 1872; Vol. III, Nos. 8701 to 16150, 1872 to 1876; Vol. IV, Nos. 16151 to 21100, 1876 to 1878; Vol. V, Nos. 21101 to 25925, 1878 to 1880; Vol. VI, Nos. 25926 to 30725, 1880 to 1882; Vol. VII, Nos. 30726 to 35700, 1882 to 1884; Vol. VIII, No. 35701. The last entry is dated April 13, 1889. Vol. IX begins at 40601. On December 10, 1889 (the last date of entry prior to January 20, 1890), the entries had been carried as far as 41594.

MARINE INVERTEBRATE SERIES.

In this department volumes or parts of volumes have been assigned to particular families or orders. The catalogue comprises about twelve volumes.

Porifera and Protozoa.—First entry February 28, 1881; last entry February 22, 1890. Number of entries, 6,193.

Crustacea.—The first volume of this series, containing Nos. 1 to 2000, was destroyed in the Chicago fire. The first entry in Vol. II is dated November 30, 1872, and is numbered 2001. On January 22, 1890, the entries had been carried as far as 14646.

Radiata.—First entry (No. 1) is dated November 19, 1880. On January 22, 1890, the entries had been carried as far as 17377.

Bryozoa and Ascidia.—First entry (No. 1) is dated February 11, 1882. On January 22, 1890, the entries had been carried as far as 2842.

Vermes.—First entry (No. 1) February 28, 1881. Number of entries up to January 22, 1890, 4780.

REPTILE AND BATRACHIAN SERIES.

Cataloguing in this department was commenced in 1856. This catalogue consists of four volumes.

Vol. I, from 1 to 2900, covers the period between January, 1856, and July, 1858.

Vol. II, from 2901 to 7875, covers the period between July, 1850, and March, 1873.

Vol. III, from 7876 to 13885, March, 1873, to October, 1884.

Vol. IV, is now in use. On January 20, 1890, the entries had been carried as far as 15619—to the end of June, 1889, to 15523.

INSECT SERIES.

The Department of Insects has a special catalogue in which are recorded all the additions to the collections since May 18, 1883. A single entry may include several hundred specimens. Up to the end of June, 1889, 486 entries had been made. No attempt has been made to affix catalogue numbers to the immense amount of material belonging to the Department of Agriculture. The material has been classified according to relationship, the several orders, families, genera, etc., being kept in separate trays. The force of this department is now engaged in the preparation of a catalogue based on relationship, in which will be indicated the number of examples of each species in the Museum collection.

BOTANICAL SERIES.

As has already been stated in connection with Vol. XII of the Ethnology series, Nos. 53926 to 54015 of that volume were taken up in cataloguing (July, 1881) a collection of Japanese plants received from the University of Tokyo. This is the first collection of plants entered under a consecutive series of numbers.

RECENT PLANT SERIES.

In 1868 the Herbarium of the Smithsonian Institution, already of great extent and value, which had for many years been under the care of Dr. John Torrey in New York City, was placed under the care of the Department of Agriculture, with the understanding that the appointment of the Botanist of the Department of Agriculture (to be charged with its administration) should be subject to the approval of the Secretary of the Smithsonian Institution. Constant additions have been made to the Herbarium since that time by the Smithsonian Institution, and the collection has been also greatly increased through special efforts made by the Botanist of the Department of Agriculture and his assistants.

In 1881, when Prof. Lester F. Ward took charge of the collection of fossil plants in the Museum, he found that the separation of the fossil plants from the recent plants caused him much inconvenience in connection with the identification of the former. Since that time, therefore, it has been customary to retain in the Museum such accessions of recent plants as were needed by Professor Ward and other students in connection with their paleo-botanical work. A second collection of recent plants has thus been formed in the Museum building. It became evident that the existence of two herbaria, each a part of the National Herbarium, and each entirely separate in administration from the other, was undesirable. Dr. George Vasey, Botanist of the Department of Agriculture, has therefore, at the request of the Secretary of the Smithsonian Institution, and with the consent of the Secretary of Agriculture, accepted the position of Honorary Curator of the National Herbarium. The Secretary of Agriculture has also agreed to the proposition of the Secretary of the Smithsonian Institution that, as soon as proper accommodation can be afforded to the National Herbarium in one of the buildings of the National Museum, the portion of the Herbarium now in the Department of Agriculture may be transferred and combined with the collection now in the Museum building.

In Dr. Vasey's report covering the remainder of the fiscal year (March 1 to June 30, 1889,) he states that no catalogue of the plants contained in the Herbarium has yet been made, but that they are properly arranged in orders, genera, and species, and are labeled so as to be readily accessible.

In March, 1889, the catalogue of recent plants received in the National Museum, contained 175 entries. No idea; however, of the extent of the collection can be formed by this statement, since the first two entries comprised 25,000 specimens, these representing the Ward and Joad collections. With the beginning of the fiscal year 1889-1890 a new catalogue will be opened by Dr. Vasey for the entry of recent plants.

FOSSIL PLANT SERIES.

The cataloguing of fossil plants was first systematically commenced in the year 1881 (?) by Prof. Leo Lesquereux, of Columbus, Ohio.

Several entries of fossil plants are found in the early volumes of the "Fossil Series" of catalogues.

There is an extra catalogue kept, in which is entered the material that had accumulated in the interval between the time at which Professor Lesquereux discontinued the work of cataloguing and the period at which it was resumed by Mr. Knowlton. This catalogue is only provisional, the specimens when identified being re-entered in the regular catalogue of the department.

GRAPHIC ART SERIES.

The Section of Graphic Arts has a special catalogue, in which up to January 7, 1890, 3,233 entries had been made.

FOOD AND TEXTILE SERIES.

In the custody of this department are two volumes of a special catalogue. In these, special series of numbers have been set apart for the various kinds of material placed in the department. The two volumes contain about 9,900 numbers, about two-thirds of which have thus far been utilized. It will be observed that a part of Vol. XII of the Ethnology series (Nos. 54751 to 55550) is devoted to the entry of a collection of foods and other specimens. This appears to have been the first set of numbers devoted to the cataloguing of this material.

TRANSPORTATION AND ENGINEERING SERIES.

To this section a special catalogue has been assigned. The first entry is dated March 10, 1885, and has reference to the locomotive "John Bull," the gift of the Pennsylvania Railroad Company. Up to the end of the fiscal year ending June 30, 1889, 125 entries had been made. In this section the work of cataloguing has never been carried on systematically, owing to the pressure of other work.

LIVING ANIMAL SERIES.

This department has a special catalogue. The first entry is in October, 1887. On June 30, 1889, 341 entries had been made.

FORESTRY SERIES.

The cataloguing of specimens in the forestry collection has not yet been commenced.

CATALOGUE ENTRIES DURING THE YEAR ENDING JUNE 30, 1889.

A catalogue entry, as explained in previous reports, may relate to a single specimen or to several hundred or even several thousand specimens, as frequently happens in regard to mollusks, plants, marine invertebrates, fossil and other groups of objects. The total number of entries made by the curators of the several departments in the Museum catalogue books during the year is 23,442, as shown in the accompanying table:

Table showing the number of catalogue entries made during the year.

Departments.	Total No. of entries.
Arts and Industries:	
Materia Medica.....	433
Foods.....	35
Textiles.....	78
Animal products.....	22
Coins, medals, paper money, etc.....	323

Table showing the number of catalogue of entries made during the year—Continued.

Departments.	Total No. of entries.
Ethnology.....	721
American Aboriginal Pottery	634
Prehistoric Anthropology	1,400
Mammals.....	635
Birds.....	2,971
Birds' Eggs.....	118
Reptiles and Batrachians.....	784
Fishes.....	1,476
Mollusks.....	6,323
Insects.....	78
Marine Invertebrates.....	3,214
Comparative Anatomy.....	1,054
Invertebrate Fossils:	
Paleozoic.....	583
Mesozoic.....	178
Fossil Plants.....	7
Recent Plants.....	24
Minerals.....	631
Lithology and Physical Geology.....	1,135
Metallurgy and Economic Geology.....	4132
Living Animals.....	17
Total.....	23,442

ARRANGEMENT OF COLLECTIONS AND ASSIGNMENT OF SPACE.

The development of the collection of objects illustrating the graphic arts has been so rapid that it has been found necessary to enlarge the limits of the space assigned for its display. In 1888 one-half of the northwest range was assigned to this collection. During the year it has been found necessary to devote the entire range to the Section of Graphic Arts, the casts of Mexican sculptures having been removed to the Smithsonian building. The east side of the northwest range is devoted to the technical collection, and on the west side are shown the methods of drawing and painting and the historical collection of relief engravings, intaglio engravings, and lithographs. Mr. Koehler in his report discusses at some length the need of additional space, in view of the fact that the space now provided is not sufficient for the installation of the material already on hand.

Mr. J. E. Watkins, Curator of Transportation and Engineering, has re-arranged the collection under the following classes: (1) Objects and implements for burthen-bearing by man and animals; (2) Objects and implements of human and animal traction (street railway cars excepted); (3) Originals, models, and drawings of stationary steam-engines; (4) Originals, models, and drawings of locomotives; (5) Models and drawings of passenger-freight cars; (6) Originals, models, and drawings illustrating the development of the American rail and track; (7) Models, relics, and drawings showing the beginnings of the steam-boats and

development of marine steam engineering; (8) Maps, showing the beginning and extension of the American railway system; (9) Electrical machine; (10) Air-ships, etc. In view of the progress which has been made in solving problems that have arisen in connection with electric propulsion, both on land and water, during the last few years, it would seem proper to begin to collect objects illustrating the early history of the devices which have gradually been developed into the motors, etc., now practically successful and in commercial use.

In February space was assigned to the Section of Oriental Antiquities on the north side of the west hall, and Dr. Cyrus Adler, Assistant Curator, has commenced the installation of specimens.

In April a section devoted to forestry collections was organized. Dr. B. E. Fernow, chief of the forestry division in the Department of Agriculture, has been appointed Honorary Curator. He has proposed the following classification for the exhibition series of specimens:

(1) Relation of forestry to other industries and conditions of life; (2) Description of the objects upon which forestry is to be applied, and of the raw material; (3) Methods of utilization and application; (4) Methods of production and management; (5) Bibliography. A few objects have already been placed on exhibition on a panel 12 feet by 14 feet. These are described in Dr. Fernow's report.*

The materia medica collection is installed in the southeast range of the Museum, and occupies a floor space of about 1,600 square feet.

The collection comprises the following exhibits:

(1) Medicinal forms; to illustrate the forms in which medicinal substances appear in commerce or are prepared for administration by the pharmacist.

(2) Official drugs. The crude medicinal articles, and their derivatives, authorized by the pharmacopœias, including non-official varieties of official drugs; the whole arranged under the following heads:

Animal Products. Vegetable Products. Organic Chemical Products. Inorganic Products. Mineral Waters and their constituents. Indigenous, or Domestic Drugs. Medicines of the North American Indians. Mexican Drugs. West Indian Drugs. South American Drugs. East Indian Drugs. Chinese, Japanese, and Korean Medicines.

In the Department of Ethnology has been organized a collection of charts, maps, lay figures, busts, portraits, and photographs, designed to illustrate the spread of various types of mankind. Professor Mason, the Curator of this department, has also prepared an ethnographical collection illustrating the arts and industries of the Koloshan, Haidan, and Tsimshian stocks of Indians, based upon the report of Ensign A. P. Niblack upon the Coast Indians of Alaska, published in the Museum report for 1888. Mr. Walter Hough, of this department, has brought

* Section II.

together and arranged in the exhibition hall a series of the fire-making tools of most of the American aborigines. The Curator has extended his studies on the subject of human transportation.*

Mr. Thomas Wilson, Curator of Prehistoric Anthropology, has proposed a re-arrangement of the exhibition hall on the second floor of the Smithsonian building. His plans are set forth in his report.†

Mr. True, Curator of Mammals, has continued the work of arranging the hall under his charge. Groups of prairie dogs and opossums have been thus treated during the year. Several special cases have been constructed for this department. Some important changes in the arrangement of the exhibition series have been effected. These are explained in detail in the report of the Curator.

The systematic arrangement of special bird exhibits has been accomplished by Mr. Robert Ridgway, Curator. These are described at length in his report.† The arrangement of the collection of skins is considered by Mr. Ridgway to be exceedingly unsatisfactory, on account of the lack of storage room. An apartment in the south tower has been assigned to this department.

Capt. Charles E. Bendire, Curator of Birds' Eggs, has continued the arrangement of the reserve series and also of the series of eggs of foreign birds.

A thorough re-arrangement of the entire collection of reptiles and batrachians has been found necessary, and Dr. Leonhard Stejneger, Curator, has already made a beginning with the reserve series of North American species. Lack of proper accommodations necessarily renders any work of this kind slow and difficult.

The collection of fishes is very inadequately provided for. Dr. T. H. Bean, Curator, states that it has become necessary to place the jars containing the specimens on the floor, thereby putting them in danger of being broken, and causing much extra labor and confusion.

Mr. William H. Dall, Curator of Mollusks, has arranged for exhibition the Lea collection of *Unionidæ*, and he hopes to be able to complete during the summer the arrangement of this magnificent collection of fresh water mussels.

In the Department of Insects there has been unusual activity in the arrangement and preparation of collections for exhibition. Work upon a general exhibition collection to be permanently placed in the Museum has been carried on. An additional laboratory has been completed for the use of this department by the construction of a room over the Public Comfort room. The arrangement of the reserve collection is progressing. The re-arrangement of the Coleoptera has been continued, and the family Carabidæ has been entirely re-arranged, occupying sixty-eight boxes in the reserve collection and eighteen double boxes in the duplicate series.

* See paper on this subject in the Museum report for 1887, p. 237.

† See section II.

Mr. Richard Rathbun, Curator of Marine Invertebrates, has carefully examined the alcoholic collection, and has arranged in systematic order the crustaceans, worms, holothurians, ophiurans, crinoids, hydroids, molluscoids, and sponges. It is his intention to bestow the same care upon the other groups during next year. He has also found time to revise the collection of duplicate specimens. Mr. Rathbun reports the entire collection to be in an excellent state of preservation, and available for reference or study.

Definite plans for the formation of an exhibition series of anatomical preparations of soft parts of specimens have been prepared by Mr. True, Acting Curator of Comparative Anatomy. It has, however, been found necessary to postpone the execution of this plan until next year. The large wall case in the exhibition hall of this department has been enlarged by the addition of a wing extending toward the west. This has made possible an improvement in the arrangement of the mounted skeletons of Primates and Carnivores. The arrangement of the collection of Vertebrate Fossils has occupied a considerable portion of the time of the Curator and of Mr. Lucas, Assistant Curator.

Mr. C. D. Walcott, Curator of Paleozoic Fossils, has, on account of his work as paleontologist of the Geological Survey, been unable to devote much time to the arrangement of the Museum collection. The space allotted to the exhibition series of this department is now nearly filled. The arrangement is, however, in a large measure provisional, and will require modification. Mr. R. R. Gurley has commenced the arrangement of the graptolites. It is Mr. Walcott's intention to arrange as soon as possible the large series of Lower and Middle Cambrian fossils which he has collected from Newfoundland.

Dr. C. A. White, Curator of Mesozoic Fossils, states that the collections under his care are in better shape than they have ever been before. Early in the year 1889 this department was furnished with ten glass top frames. These are now filled with specimens consisting chiefly of types of species, descriptions of which have been published in the reports of the U. S. Geological Survey.

The Herbarium is under the care of Dr. George Vasey, Botanist of the Department of Agriculture. He states in his report that the collection of herbarium specimens in the Department of Agriculture, forming a part of the National Herbarium, is exhibited in wall cases, occupying a space of about 85 running feet. This collection is mounted on 120,000 sheets. These are arranged according to orders, genera, and species, and are readily accessible. There are still a large quantity of specimens to be mounted and added to the collection, besides a great number of duplicates for distribution and exchange.

The collection of building and ornamental stones, as now installed, fills thirteen door screen cases, one wall case, two pyramids, and the tops of three table cases. The collections of rock and rock-forming minerals are arranged on one pier case and seven slope-top table-cases.

The systematic arrangement of the collections of dynamic and historical geology has not yet been commenced, owing to the lack of cases.

The entire southwest court is now reserved for the exhibition series of metals and ores. The space is still insufficient for the proper exhibition of the collection, and it has been found necessary to withdraw fully one-third of the specimens intended for exhibition, and divide them between the reserve and duplicate series.

The wooden structure adjoining the Smithsonian building on the south has become so overcrowded with specimens of living animals that numerous offers of additional specimens have necessarily been declined.

A room for tropical reptiles, quadrupeds, and other animals has been added.

The establishment of a National Zoological Park has been authorized by Congress, and the specimens now exhibited in this wooden shed will doubtless be removed to the park as soon as the necessary arrangements for their reception shall have been completed.

During the month of May the general storage room was removed from the Armory building, to make room for the offices of the U. S. Fish Commission, to the storage shed, west of the Armory building, and the storage separated into three sections.

D.—THE MUSEUM STAFF.

The staff of the National Museum includes two classes, scientific and administrative, the former consisting of curators, honorary curators, acting curators, assistant curators, assistants, aids; the latter consisting of chiefs of administrative departments, clerks, copyists, messengers, and the superintendent of buildings, with the watchmen, mechanics, and laborers under his supervision.

THE SCIENTIFIC STAFF.

There are now thirty-four organized departments and sections under the care of curators, or acting curators, and assistant curators.

DIVISION OF ANTHROPOLOGY.

DEPARTMENT OF ARTS AND INDUSTRIES: The Assistant Secretary acting as curator, with adjunct curatorships as follows:

GRAPHIC ARTS: S. R. Koeller, Acting Curator.

TEXTILE INDUSTRIES: Romyn Hitchcock, Acting Curator.

TRANSPORTATION AND ENGINEERING: J. Elfreth Watkins, Curator.

HISTORICAL COLLECTIONS: A. Howard Clark, Curator.

MATERIA MEDICA: Dr. J. M. Flint, U. S. Navy, Honorary Curator.

FISHERIES: R. Edward Earll, Acting Curator.

FOODS: W. O. Atwater, Honorary Curator.

ANIMAL PRODUCTS: R. Edward Earll, Acting Curator.

NAVAL ARCHITECTURE: J. W. Collins, U. S. Fish Commission, Honorary Curator.

FORESTRY: B. E. Fernow, Chief of the Division of Forestry, Department of Agriculture, Honorary Curator.

DEPARTMENT OF ETHNOLOGY: Otis T. Mason, Curator; Walter Hough, Aid.

SECTION OF ORIENTAL ANTIQUITIES: Paul Haupt, Johns Hopkins University, Honorary Curator; Cyrus Adler, Johns Hopkins University, Assistant Curator.
DEPARTMENT OF AMERICAN ABORIGINAL POTTERY: W. H. Holmes, Bureau of Ethnology, Honorary Curator.
DEPARTMENT OF PREHISTORIC ANTHROPOLOGY: Thomas Wilson, Curator.

DIVISION OF ZOOLOGY.

DEPARTMENT OF MAMMALS: F. W. True, Curator.
DEPARTMENT OF BIRDS: Robert Ridgway, Curator,
DEPARTMENT OF BIRDS' EGGS: Capt. Chas. E. Bendire, U. S. Army, Honorary Curator.
DEPARTMENT OF REPTILES AND BATRACHIANS: Leonhard Stejneger, Curator.
DEPARTMENT OF FISHES: Tarleton H. Bean, U. S. Fish Commission, Honorary Curator; Barton A. Bean, Aid.
DEPARTMENT OF VERTEBRATE FOSSILS: O. C. Marsh, U. S. Geological Survey, Honorary Curator.
DEPARTMENT OF MOLLUSKS: W. H. Dall, U. S. Geological Survey, Honorary Curator; R. E. C. Stearns, Adjunct Curator.
DEPARTMENT OF INSECTS: C. V. Riley, Department of Agriculture, Honorary Curator; Martin Linell, Aid.
DEPARTMENT OF INVERTEBRATES: Richard Rathbun, U. S. Fish Commission, Honorary Curator.
DEPARTMENT OF COMPARATIVE ANATOMY: F. W. True, Acting Curator; F. A. Lucas, Assistant Curator.
DEPARTMENT OF LIVING ANIMALS: William T. Hornaday, Curator.
DEPARTMENT OF INVERTEBRATE FOSSILS:
PALEOZOIC: C. D. Walcott, U. S. Geological Survey, Honorary Curator.
MESOZOIC: C. A. White, U. S. Geological Survey, Honorary Curator.
CENOZOIC: W. H. Dall, U. S. Geological Survey, Honorary Curator.

DIVISION OF BOTANY.

DEPARTMENT OF FOSSIL PLANTS: Lester F. Ward, U. S. Geological Survey, Honorary Curator.
DEPARTMENT OF RECENT PLANTS: George Vasey, Botanist of the Department of Agriculture, Honorary Curator.

DIVISION OF GEOLOGY.

DEPARTMENT OF MINERALS: F. W. Clarke, U. S. Geological Survey, Honorary Curator; William S. Yeates, Assistant Curator.
DEPARTMENT OF LITHOLOGY AND PHYSICAL GEOLOGY: George P. Merrill, Curator.
DEPARTMENT OF METALLURGY AND ECONOMIC GEOLOGY: Fred P. Dewey, Curator.

Of the curators and acting curators thirteen receive salaries from the Museum. Of the remainder, seven are officially connected with the U. S. Geological Survey, four with the Department of Agriculture, three with the U. S. Fish Commission, and one each with the U. S. Army, U. S. Navy, and Bureau of Ethnology.

PERSONNEL OF THE SCIENTIFIC DEPARTMENTS.

During the year a section of Forestry has been established, and with the consent of the Secretary of Agriculture, Dr. B. E. Fernow, chief of the Forestry Division of the Department of Agriculture has been appointed curator of the collection.

On April 5 Mr. L. O. Howard, of the Entomological Division of the Department of Agriculture, was appointed Acting Curator of insects during the absence of Professor Riley, Honorary Curator, in Europe.

On April 21 Mr. F. H. Knowlton, Assistant Curator of fossil plants, was furloughed for one year without pay, in order to enable him to prosecute some special botanical work, and to serve upon the editorial staff of the Century Dictionary. Mr. Knowlton has, however, kindly offered to continue assisting in the care of the collections until an appointment has been made.

Dr. H. C. Yarrow, who for many years has served as Honorary Curator of the Department of Reptiles, resigned on February 9, and Dr. Leonhard Stejneger, Assistant Curator of birds, was on March 1 appointed Curator of the Department of Reptiles.

Dr. George Vasey, botanist of the Department of Agriculture, was appointed honorary Curator of botany in March, and in that capacity controls the botanical collections in the National Museum and in the Department of Agriculture forming the National Herbarium. Prof. Paul Haupt, Honorary Curator of the Section of Oriental Antiquities, has been designated representative of the Smithsonian Institution at the Eighth International Congress of Orientalists, to meet in Stockholm and Christiania from September 2 to 13. Prof. Otis T. Mason has been detailed to visit the principal ethnological museums in France, Germany, Denmark, and England for the purpose of making arrangements for exchange of specimens and incidentally of studying the methods of installation adopted in them. Mr. Thomas Wilson will also visit the principal archæological museums in France for similar purposes, and will attend the meetings of the International Anthropological Congress.

Mr. J. B. Smith, Assistant Curator of the Department of Insects, resigned in April to accept a professorship in Rutgers College, New Brunswick, New Jersey, and the position of entomologist of the State Agricultural Experiment Station, and Mr. Martin Linell has been appointed aid in this Department.

THE ADMINISTRATIVE STAFF.

The administrative affairs of the Museum are under the direct charge of the Assistant Secretary. The arrangement of the administrative offices is as follows:

Department of accounts, W. V. Cox, chief clerk.

Department of correspondence and reports, R. I. Geare, executive clerk.

Department of registry and storage, S. C. Brown, registrar.

Department of property and supplies, J. Elfreth Watkins, engineer of property.

Department of publications, A. Howard Clark, editor of Proceedings and Bulletin.

The care of the buildings, the supervision of the mechanics, watchmen, laborers, and cleaners, and many related matters, are under the charge of Mr. Henry Horan, superintendent of buildings. Mr. C. A. Steuart is assistant superintendent.

The preparation and mounting of specimens for the exhibition series consumes the time of several skilled employes. Casts of specimens have often to be made, when

the original objects can not be retained in the Museum. Protographs of objects not infrequently supply the place of the object itself in the exhibition cases. The work incidental to such preparation is now of great importance and a department or preparation has been formed as here indicated :

Department of preparation: Taxidermists, W. T. Hornaday in charge, Joseph Palmer, William Palmer, Henry Marshall, George Marshall, A. J. Forney. Osteologist, F. A. Lucas. Photographer, T. W. Smillie. Draughtsmen, W. H. Chandlee and W. H. Burger. Modeler, J. W. Hendley. General preparators, E. H. Hawley and T. W. Sweeny.

Statements of the work accomplished in these departments during the year are given further on in this report.

CLASSIFIED SERVICE OF THE MUSEUM.

In response to a resolution* of the Senate asking for a schedule of the classified service of the officers and employes of the National Museum, the Secretary of the Smithsonian Institution addressed the following letter to the Hon. John J. Ingalls, president *pro tempore* of the Senate, transmitting a schedule which, upon very careful consideration, seemed to represent the actual needs of the service.

* U. S. SENATE, *October 9, 1888.*

THE NATIONAL MUSEUM.

* * *

Mr. WILSON, of Iowa. I offer the following resolution, and ask for its present consideration :

Resolved, That the Regents and Secretary of the Smithsonian Institution, and Director of the United States National Museum be, and hereby are, directed to formulate and transmit to the Senate at their earliest convenience, a schedule of classified service of the officers and employes of the National Museum, arranged according to duty and salary, as the same is required for the proper working of the Museum.

Mr. HOAR. From what committee does that come ?

Mr. WILSON, of Iowa. From none. It is a resolution that I introduced in order to get the information.

Mr. HOAR. I should like to inquire for information—I have no doubt it is all right—have we authority to impose directions on the Regents of the Smithsonian Institution and the Director of the National Museum ?

Mr. WILSON, of Iowa. The resolution relates mainly to the National Museum, which, I suppose, we have a right to call upon for information. It might be different as to the Smithsonian Institution, but as the resolution relates to the Museum, I presume we have that authority. There is no reason why we should not have it.

Mr. HOAR. We have authority to give such directions to the heads of Departments, which rests on unbroken usage from the beginning of the Government, but I am not aware that one House of Congress has a right to order an executive officer of the Government to do anything for its convenience, especially that we have such control over the Regents of the Smithsonian Institution. It may be there is such authority reserved by statute. I shall not interpose an objection to the resolution, because I know personally the officers referred to would be anxious to communicate the information, and it is the desire of the Senator from Iowa.

The PRESIDENT *pro tempore*. If there be no objection to the present consideration of the resolution, the question is on agreeing to the same.

The resolution was agreed to.

SMITHSONIAN INSTITUTION,
March 2, 1889.

SIR: In response to the Senate resolution asking for "a schedule of the classified service of the officers and employes of the National Museum," I have the honor to transmit the accompanying schedule, which represents the present actual necessities of the service.

The service for the fiscal year of 1887-'88 was reported upon in a letter to the Speaker of the House of Representatives, dated December 1, 1888 (H. R. Mis. Doc. No. 55, Fiftieth Congress, second session).

In this the aggregate expenditures for service were shown to have been \$122,750.47, of which sum \$97,493.32 was paid from the appropriation for preservation of collections, \$19,203.79 from that for furniture and fixtures, and \$6,053.36 from that for heating, lighting, and electrical and telephonic service.

A schedule of the number of persons employed in the various departments of the Museum was also given in this letter (pages 4, 9, 11). This schedule should, however, be regarded only as an approximate one, since many of the employes were actually engaged only a part of the year, and others were temporarily transferred to the pay-rolls of the Cincinnati Exhibition and were engaged in special work in connection with that exhibition.

It is estimated that the aggregate expenditures for services for the present fiscal year (1888-'89) will be \$129,710, of which amount \$103,000 will be paid from the appropriation for preservation of collections, \$20,000 from that for furniture and fixtures, and \$5,710 from that for heating, lighting, and electrical and telephone service.

In the schedule herewith transmitted it is shown that for the proper working of the Museum the amount required for services would be as follows:

For salaries of scientific assistants.....	\$56,300.00
For clerical forces.....	36,920.00
For services in preparing, mounting, and installing the collections.....	22,060.00
For services in policing, caring for, and cleaning the buildings.....	36,740.00
For services in repairing buildings, cases, and objects in the collections..	14,163.50
For salaries and wages in designing, making, and inspecting cases and other appliances for the exhibition and safe-keeping of the collections.	18,337.50
For services in connection with the heating, lighting, and electrical and telephonic service	6,620.00
For services of miscellaneous employes, including draughtsmen, messengers, etc.....	7,980.00
Total.....	199,121.00

The increase in the total expenditure, as indicated, is due partly to the addition of a number of officers to the scientific staff, and also to the necessity for a few additional clerks, and a considerable number of watchmen, laborers, cleaners, and messengers, whose services are essential to the safety of the collections, as well as to provide for the cleanliness and proper care of the buildings and for the comfort of visitors.

The rates of pay indicated are in most cases considerably lower than are customarily allowed for a similar service in the Executive Departments.

In the schedule now presented, expenditure for services only is taken into consideration.

No attempt has been made to present the needs of the Museum in regard to the purchase or collecting of specimens, the purchase of general supplies, preservatives, materials for mounting and installing col-

lections, books, exhibition cases, furniture, fuel and gas, the maintenance of the heating and lighting appliances, freight and cartage, traveling expenses of collectors and agents, etc.

For these various purposes the expenditure in the last fiscal year amounted to \$45,249.53, and that for the present fiscal year will, it is estimated, amount to about \$48,000, a sum very inadequate to the needs of the service.

It does not include the expenditures for printing the labels and blanks, and proceedings and bulletins of the Museum, for which the appropriation for many years past has been \$10,000, and for which I have asked \$15,000 for the coming fiscal year.

I must not omit to call your attention to the fact that owing to the peculiar constitution of the Museum as a scientific establishment, it has hitherto been possible to secure a special economy, owing to the fact that its officers and employés are not scheduled as in the Executive Departments.

In thus presenting, in obedience to the request of the Senate, a schedule of a durable organization of the service, I wish to remark, emphatically, that there are pressing needs in other directions—needs that merit the serious consideration of Congress, in order that the National Museum may be enabled to maintain a satisfactory position in comparison with those of European nations.

I have the honor to be, your most obedient servant,

S. P. LANGLEY,
Secretary.

Hon. JOHN J. INGALLS,
President pro tempore of the Senate.

Schedule of the classified service of the officers and employes of the United States National Museum, arranged according to duty and salary, as required for the proper working of the Museum.

Designation.	Compensation.
<i>Scientific staff.</i>	
Secretary Smithsonian Institution, director <i>ex officio</i>	
Assistant secretary Smithsonian Institution, in charge of National Museum	\$4, 000. 00
Curator and executive officer	3, 000. 00
Five curators, at \$2,400	12, 000. 00
Five curators, at \$2,100	10, 500. 00
Four assistant curators, at \$1,600	6, 400. 00
Four assistant curators, at \$1,400	5, 600. 00
Four aids, at \$1,200	4, 800. 00
Six aids, at \$1,000	6, 000. 00
Special service by contract	4, 000. 00
	56, 300. 00
<i>Clerical staff.</i>	
Chief clerk	2, 200. 00
Four chiefs of divisions: Correspondence; transportation, storage, and record; publications and labels; installation; at \$2,000	8, 000. 00
One disbursing clerk*	1, 200. 00
One clerk of class 4	1, 800. 00
Two clerks of class 3	3, 200. 00
Three clerks of class 2	4, 200. 00
Four clerks of class 1	4, 800. 00
Four copyists, at \$900	3, 600. 00
Four copyists, at \$720	2, 880. 00
Six copyists, at \$600	3, 600. 00
Three copyists, at \$480	1, 440. 00
	36, 920. 00
<i>Preparators.</i>	
Photographer	2, 000. 00
Assistant photographer	1, 000. 00
Artist	1, 320. 00
Chief taxidermist	2, 000. 00
One taxidermist	1, 500. 00
Two taxidermists, at \$1,000	2, 000. 00
Two taxidermists, at \$720	1, 440. 00
One modeler	2, 000. 00
One modeler	1, 200. 00
One general preparator	1, 200. 00
One general preparator	900. 00
Special service by contract	5, 500. 00
	22, 060. 00
<i>Buildings and labor.</i>	
One superintendent of buildings	1, 620. 00
Two assistant superintendents, at \$1,000	2, 000. 00
Four watchmen, at \$780	3, 120. 00
Twenty-four watchmen and door-keepers, at \$600	14, 400. 00
Twelve laborers, at \$480	5, 760. 00
Three attendants, at \$480	1, 440. 00
Ten attendants and cleaners, at \$360	3, 600. 00
Special service of laborers and cleaners to be paid by the hour	4, 800. 00
	36, 740. 00

* This officer receives pay also from the Smithsonian Institution for similar services.

Schedule of the classified service of the officers and employes, etc.—Continued.

Designation.	Compensation.
<i>Mechanics (repairing buildings, cases, and objects in the collections).</i>	
Cabinet-maker, at \$3.50 per day.....	1,095.50
Two painters, at \$2.50 per day.....	1,565.00
One tinner, at \$2 per day.....	626.00
One stone-cutter and mason, at \$2 per day.....	628.00
Six skilled laborers, at \$2.50 per day.....	4,695.00
Six skilled laborers, at \$2 per day.....	3,758.00
Special service by contract.....	1,800.00
	14,163.50
<i>Furniture and fixtures.</i>	
Engineer of property.....	2,000.00
One copyist.....	900.00
One copyist.....	720.00
One copyist.....	600.00
One copyist.....	480.00
Six carpenters and cabinet-makers, at \$3.....	5,634.00
Three painters, at \$2.....	1,978.00
Two skilled laborers, at \$2.50.....	1,565.00
Two skilled laborers, at \$2.....	1,252.00
Three laborers, at \$1.50.....	1,408.50
Special service by contract.....	1,800.00
	18,337.50
<i>Heating, lighting, and electrical service.</i>	
Engineer.....	1,400.00
One assistant engineer.....	900.00
Six firemen, at \$600.....	3,600.00
Telephone clerk.....	720.00
	6,620.00
<i>Miscellaneous.</i>	
Agent.....	1,200.00
One draughtsman.....	1,200.00
Two draughtsmen, at \$600.....	1,200.00
Two messengers, at \$600.....	1,200.00
One messenger.....	540.00
Two messengers, at \$480.....	960.00
Two messengers, at \$360.....	720.00
Four messengers, at \$240.....	960.00
	7,980.00

The rapid growth of the Museum renders a more definite classification of its employes and in some instances larger salaries desirable, and it is hoped that this schedule, or one similar in its general features, will be ultimately accepted by Congress. There are, however, so many other considerations for which money is needed, as for instance the purchase of specimens, that it seems doubtful whether it is wise to bring this matter yet to a final issue.

E.—REVIEW OF WORK IN THE SCIENTIFIC DEPARTMENTS.

Department of Ethnology.—Prof. O. T. Mason, Curator, mentions in his report nine collections, received during the year, as being of more than usual value. He has paid much attention during the year to the formation of several special exhibits, by which it is intended to bring before the eye of the visitor at a glance the entire collection from a definite locality, or to explain, within as limited a range as possible, a given art or industry of a particular tribe of Indians. This plan is in continuation of the method of installation of the Eskimo collection by Lieut. T. Dix Bolles in 1886. The subjects of fire making, heating, and lighting have been carefully studied by Mr. Walter Hough.

Special attention has also been paid to the study of transportation on the backs of men and women, to aboriginal hide dressing, to aboriginal cradles, and to the evolution of common tools, the knife, the hammer, the saw, etc. To interest the boys who visit the Museum a series of "jack-knives" has been arranged for public inspection, and the interest which such a case excites is shown by the gifts made constantly to the series.

In the latter part of the year the Curator commenced to collect for public reference a card catalogue of the resources of anthropology, to serve as a reference to the resources of the science, so that a special student, a lecturer, or a college professor can be put at once into communication with the chief sources of information.

Several exchanges of specimens have been effected during the year with other museums, notably the Peabody Museum at Cambridge, The Cincinnati Art Museum, and with Dr. Gosse, of Geneva, Switzerland, with the Royal Ethnological Museum in Berlin, and with Mr. Edward Lovett, of Croydon, England. The accessions of the year in this department were from sixty localities, and eight hundred and sixty specimens were received. The catalogue entries during the year were seven hundred and twenty-one in number.

Section of Oriental Antiquities.—Dr. Cyrus Adler, Assistant Curator, has devised an excellent plan for making copies of the smaller Assyro-Babylonian objects preserved in this country. These consist, for the most part, of seals, and are of much importance in the study of the history of Assyro-Babylonian religion and art. The primary object of the establishment of this section in the Museum was to collect copies of these seals and specimens of similar import. The history, archæology, languages, arts and religions of the peoples of Western Asia and Egypt are included in the scope of the section.

In common with several other departments in the Museum, this section was called upon to prepare an exhibit for the Cincinnati Exhibition. This work occupied several weeks, and a report upon the exhibit has been prepared by Dr. Adler and will be published in a future re-

port. Prof. Paul Haupt, Honorary Curator, has secured from the Royal Museum of Berlin and the British Museum several valuable casts of Assyrian and Egyptian objects. Labels have been prepared for the Assyro-Babylonian seals, and also for the Assyrian photographs from the British Museum, the Bonfils photographs, and the Assyrian and Egyptian objects from the Royal Museum of Berlin. Dr. C. Johnson, jr., of the Johns Hopkins University, has made an examination of an interesting Persian astrolabe, and has presented a paper entitled "The Chaldean Astronomy."

It may not be improper in this connection, to call attention to the proposed edition of the "Life and Writings of Edward Hincks," by the Semitic Seminary of the Johns Hopkins University. In July the Smithsonian Institution consented to make the Institution a depository for papers and manuscripts sent to this country to further the prosecution of the work. Prof. F. Max Müller, of the University of Oxford, under date of September 27, forwarded manuscript letters of Dr. Hincks in his possession; and under date of October 20 he kindly offered to permanently deposit these letters in the Smithsonian Institution.

Section of Transportation and Engineering.—Work in this section has been seriously interrupted by the necessary absence of the Curator, Mr. J. E. Watkins, at the Cincinnati Exposition, where a collection of objects was exhibited illustrating the development of the various systems of transportation. The exhibit was arranged in seven series, and is fully described in a special paper prepared by Mr. Watkins for publication in a future report.

Among the important accessions during the year may be specially noticed the following objects: A Japanese kago (or palanquin), obtained through Mr. Hieromich Shugio, made of wood, beautifully lacquered and elaborately ornamented; and a model of a Japanese jinrikisha. Several interesting relics have been received, as, for instance, the bell of the locomotive "Rahway," cast in 1838, and a section of the first heavy iron rail rolled in America, presented to the Museum by the Baltimore and Ohio Railway Company. A number of valuable drawings, illustrating the development of marine steam engineering, have been added to the collection.

A re-arrangement of the exhibition series has been commenced, and is described in detail in the report of the Curator.

Section of Graphic Arts.—Mr. S. R. Kochler, Curator, states in his report that his special aim is "to represent art as an industry." This may perhaps be more intelligibly rendered by the statement that art productions of all kinds, considered primarily from their technical side, are included in the scope of this section. The Section of Graphic Arts was organized in January, 1887, and, no report having yet been submitted by the Curator, the one now published in Section II of this report relates to the work accomplished since that date. The contributors of material to this collection number one hundred and six, some of whom had been

invited to assist the Curator in the preparation of a special exhibit for the Cincinnati Exposition. The catalogue of this section now contains 2,894 entries, of which 294 represent objects which were purchased for the collection, chiefly old prints, and such other material as could not be obtained by gift. On March 31, 1888, there had been made 936 entries in the catalogue. At this time the first arrangement of the collection in the Museum had just been completed.

The thanks of the National Museum are due especially to Mr. Peter Moran, Messrs. L. Prang & Co., the Photo-Engraving Company, W. H. Whitcomb & Co., Mr. John Durand, and Mrs. Ednah D. Cheney for their generous co-operation and contributions.

Mr. Koehler has prepared a catalogue of the collection prepared for exhibition at the Cincinnati Exposition. A full list of the names of all who have contributed to the collection since this section was organized may be found in the report of the Curator.*

Department of Prehistoric Anthropology.—The number of specimens added to the collection during the year has been 6,972, making a total number of 116,472 specimens in the collection. Mr. Thomas Wilson, Curator, states in his report that a great deal of his time has been consumed in examining and reporting upon objects sent for determination. The work of classifying and placing upon exhibition the specimens which were assigned to the exhibition series, has been rapidly pushed forward. A re-arrangement of the anthropological collection, which is still exhibited in the large hall on the second floor of the Smithsonian building, has been commenced, and Mr. Wilson's plan of re-arrangement is given in detail in his report.*

Fourteen of the collections received during the year have been considered by Mr. Wilson sufficiently valuable to receive special notice. The contributions of the U. S. Fish Commission from Patagonia, Straits of Magellan, Lower California, and California, have been numerous and of great importance. These collections were made by the steamer *Albaross* during the voyage from Virginia to California in 1887-1888.

Mr. Wilson has continued his researches in regard to the existence of paleolithic implements in the United States. There have been 14,000 entries made in the catalogue of the department. A special exhibit, intended to indicate the existence and geographic distribution of prehistoric man, as shown by the implements and objects which he manufactured and used, was prepared by the Curator for the Cincinnati Exposition. This exhibit is described by Mr. Wilson in a paper which will be published in a future report.

Section of Aboriginal Pottery.—Among the more important additions to this section may be mentioned a collection of pottery from a mound near Lake Apopka, Florida, made by Dr. Featherstonehaugh, and a collection from a mound near Perdido Bay, Alabama, made by Mr. F. H. Parsons.

* See Section II.

Mr. William H. Holmes, Honorary Curator, regards the latter collection as one of the most important yet received from the Gulf coast. Mr. Holmes has found time to make a study of the pottery of the Potomac tide-water region during the year, and has prepared a paper upon this subject, which will appear in the "American Anthropologist."

The number of specimens added to the collection during the year is 1,100, necessitating 634 entries in the catalogue.

The Forestry Collection.—This section was established in April, 1889. Dr. B. E. Fernow, chief of the Forestry Division in the Department of Agriculture, has been appointed Honorary Curator. It has not been possible to accomplish very much during the three months of the existence of this section before the close of the fiscal year, but Dr. Fernow has submitted a report,* in which he gives a brief outline of the scope of the collection which he hopes to make, and of the manner in which it may best be classified. A series of pictures illustrating the work of the French Forest Administration, and other objects, have already been placed on exhibition on a panel 14 by 12 feet. The Secretary of Agriculture has expressed his interest in the formation of this collection, and the Smithsonian Institution is greatly indebted to him for his co-operation in this branch of the Museum work.

Department of Mammals.—Special attention has been given in this department to providing better storage facilities for the study series of specimens, which has been largely increased by the collection of North American mammals deposited in the Museum by the Division of Economic Ornithology and Mammalogy in the Department of Agriculture. Groups of prairie-dogs and opossums have been mounted for exhibition and placed in new cases of special design.

The following contributors are mentioned in Mr. True's report as having presented material of especial value to the collection: Mr. William Wittfield, who presented two specimens of the Florida muskrat, *Neofiber alleni*; Mr. Loren W. Green, from whom was received a series of skins of the northern variety of *Tamias striatus*; Dr. R. W. Shufeldt, who presented a specimen of *Hesperomys truei*; Mr. James G. Swan, from whom was received a specimen of *Vespertilio longicrus*. Dr. Arthur Edwin Brown, of the Zoological Society of Philadelphia, contributed a small deer, probably of the species *Cariacus gymnotus*. The skin of a full-grown moose was obtained by Col. Cecil Clay for the Museum. Several exotic mammals were also secured by gift and purchase. Capt. J. L. Gaskell, keeper of the life-saving station at Atlantic City, forwarded to the Museum a specimen of Sowerby's whale, *Mesoplodon bidens*. Mr. True states in his report that this is the second specimen ever taken in American waters, and is the first fresh specimen ever seen by American naturalists. A few South American mammals were obtained by the naturalists of the U. S. Fish Commission steamer *Albatross*. The most important were the skeleton of a

*See Section II.

porpoise, *Prodelphinus longirostris*, obtained between Panama and the Galapagos Islands, and several skins of the sea-lions inhabiting those islands. During the year there were added to the collection of skins 192 specimens, and to the alcoholic series 35 specimens. The catalogue of the department has been increased by 633 entries.

A series representing all the existing families of mammals was prepared for exhibition at the Cincinnati Exposition, and a descriptive guide to the collection has been prepared for publication.

Department of Birds.—Mr. Robert Ridgway, Curator of this department, states in his report that the re-arrangement, labeling, and general improvement of the exhibition series has been actively continued. Nine special exhibits of birds and eggs have been completed. A considerable portion of the time of the Curator has been devoted to committee work in connection with the revision of the check-list of the American Ornithologist's Union. Special investigations have also been made by the Curator, on the genera *Psittacula*, *Accipiter*, *Xiphocolaptes*, and *Sclerurus*. A large collection from Costa Rica has been studied, and also the extensive collection made by the naturalists of the Fish Commission steamer *Albatross* in Alaska and in various portions of South America. Dr. Leonhard Stejneger has continued his work on Japanese ornithology.

Dr. J. A. Allen, of New York City, Dr. P. L. Sclater and Mr. Osbert Salvin, of London, England, Count von Berlepsch, of Münden, Germany, and several other active workers, have received material from the Museum to aid them in their studies of particular groups of American birds.

In March Dr. Stejneger severed his relations with this department, having been appointed Curator of the Department of Reptiles and Batrachians.

The accessions of the year number 1,490 specimens, of which 996 have been placed in the reserve series, 147 assigned to the duplicate series, while 347 specimens have been added to the exhibition collection. There are now 6,714 specimens on exhibition. Mr. Ridgway has made special mention in his report of 47 of the more important accessions received during the year.

Section of Birds' Eggs.—Capt. Charles E. Bendire, U. S. A., Hon. Curator, has continued the classification and arrangement of the new material, and has made considerable progress in re-labeling the reserve series of eggs in accordance with the revised check-list of the American Ornithologist's Union. He has also arranged a series of foreign eggs, of which there are now 4,913 specimens. Six collections of more than usual value have been received during the year. There are now more than 50,000 specimens in the collection. In the catalogue book 118 entries have been made.

Department of Reptiles and Batrachians.—Dr. H. C. Yarrow, U. S. A., who for several years has been in charge of this department,

having resigned, Dr. Leonhard Stejneger was in March appointed Curator of the department. He has commenced making a complete examination of the entire collection, and reports that at the close of the fiscal year he was still at work on the reserve series of North American species. The cataloguing of the new material and of specimens previously received but not catalogued, has been continued. The most important accession during the year was the collection made by the naturalists of the U. S. Fish Commission Steamer *Albatross*. It contains three hundred and nineteen specimens, which have been sent to Prof. E. D. Cope, of Philadelphia, for special report. Four other accessions are mentioned in the Curator's report as of especial interest.

The types of eight species have been identified and re-labeled. During the year Professor Cope has finished his work on the North American Batrachians, published as Bulletin 34 of the U. S. National Museum, and has commenced a study of North American snakes. Dr. G. Baur, of Yale College, has had for study a number of Chelonians, and some of the results of his studies are referred to in the Bibliography.*

Dr. Stejneger reports that the condition of the collection is good, but that the re-numbering and re-labeling of specimens is constantly found to be necessary. During the year 741 specimens have been added to the collection, and 784 entries made in the catalogue. The excess of the latter over the former is accounted for by the fact that some of the material received before this fiscal year had not been catalogued.

The Curator has been unable to devote much time to scientific study of the collection during the few months he has been in charge. What little he has been able to do has been in connection with an investigation of the status of the boiform snakes of North America, with special reference to individual variation.

Department of Fishes.—It has been necessary for Dr. Tarleton H. Bean, Honorary Curator of this department, to spend the greater part of the year on special work pertaining to the Fish Commission. Dr. Bean has recently taken charge of the editorial work of the Fish Commission, leaving very little time to be devoted to Museum matters. During his absence from the city Mr. Barton A. Bean, his assistant, was left in charge of the department. The entire collection of fishes has been overhauled and the jars supplied with fresh alcohol. In addition to the large and valuable collections received from the U. S. Fish Commission, several other important collections have been added to the collection. Ten of these are especially referred to in the report of the Curator.

During the last six months of the year Dr. Bean prepared and had published in various journals numerous papers upon the *Salmonidæ* and other species of fishes. A list of these papers is given in the Bibliography.*

* See Section IV.

The number of specimens received during the year was about 6,000, and 1,476 catalogue entries have been made. There are now, according to Dr. Bean's report, about 30,000 specimens in the exhibition series, 60,000 specimens in the reserve series, and 25,000 duplicates. The Curator calls attention in his report to the inadequacy of the case and storage room provided for the collection, and states that it has on this account become necessary to arrange the jars containing recent additions upon the floor.

Department of Mollusks.—The labeling, determining, and registration of old and new material has occupied a large share of the time of Mr. William H. Dall, Honorary Curator, and his assistants. Seven cases, containing a part of the Lea collection of *Unionida*, have been arranged for exhibition. Much progress has been made in cleaning and assorting the fossils. Considerable time has been devoted to the arrangement of the collection representing the fauna of the southeastern shores of the United States and adjacent waters. A check-list of this fauna is now being printed. The collection contains about fifteen thousand specimens. Dr. R. E. C. Stearns, Adjunct Curator, has devoted a portion of his time to the land and fresh water shells, especially of North America. He has also pushed forward the revision and labeling of old material. The Curator has supplied information of various kinds to forty-three correspondents, necessitating a large amount of labor and correspondence.

Mr. Dall has found time to finish his investigation of the Mollusca obtained by the United States steamer *Blake* under the supervision of Professor Agassiz in the Gulf of Mexico and the Caribbean Sea, and has continued work on the dredgings obtained by the U. S. Fish Commission in the same region, and also upon the collections obtained last year by the U. S. Fish Commission steamer *Albatross* during its voyage to California. He has also been occupied in a new systematic arrangement of the bivalve shells, and has studied the correlation of the tertiary fossils of the southeastern Atlantic coast with the recent fauna. Dr. Stearns has prepared for publication a paper on prehistoric shell money.

Next in importance to the accessions received from the Fish Commission during the year is a collection consisting of about five thousand specimens of shells from all parts of the world. This was presented by Messrs. F. B. and J. D. McGuire on behalf of the heirs of the late J. C. McGuire, of Washington. A collection containing about three hundred species was received from the Auckland Museum, New Zealand. Interesting series of specimens have been received from Messrs. E. W. Webster and J. J. White. Small though valuable collections have been presented by Mr. Henry Hemphill and Lieut. J. F. Moser, U. S. Navy. Large collections of fossil shells have been received from the U. S. Geological Survey, and of almost equal importance is the collection from the fossiliferous deposits of Florida, presented by Mr. Joseph

Willcox. The entries in the catalogues of this department during the year are 6,323 in number. About 13,000 specimens have been received, giving a total of 468,000 specimens in the entire collection.

Department of Insects.—More time than in any previous year has been devoted by Dr. C. V. Riley, Honorary Curator of this department, to the preparation of collections for exhibition. A special series, designed rather for educational use than for museum purposes, was prepared for the Cincinnati Exposition. The installation of a permanent exhibition series has been commenced in the southeast range. In April Mr. J. B. Smith, Assistant Curator, resigned his position to accept a chair in Rutgers College, New Brunswick. During the Curator's absence, from April to the close of the fiscal year, Mr. L. O. Howard, of the Department of Agriculture, took charge of the department, and the thanks of the Museum are due to him for his energetic administration of its affairs. Mr. Martin Linell has been appointed aid.

The work of naming specimens for collectors, the arrangement and selection of material to be sent to specialists for determination, the arrangement in permanent shape of the reserve series, and the preservation of the general collection, have received as much attention as opportunity would allow.

Several researches of a special character upon Museum material have been made during the year. These are nine in number, and are referred to in the report of the Curator.*

Twenty collections of more than ordinary interest have been received. About 8,000 specimens have been added to the collections during the year, and 78 catalogue entries have been made. The entire collection now contains, as estimated, 603,000 specimens.

Department of Marine Invertebrates.—Mr. Richard Rathbun, Honorary Curator, has been unable to devote much of his time during the year to the work of this department, owing to the pressing duties which have been placed upon him in connection with the work of the U. S. Fish Commission. The exhibition hall of this department, in the west end of the Smithsonian building, has been repaired and repainted, and is now open to visitors. The principal accessions have, as usual, been obtained from the Fish Commission, although these have been far less numerous than in any previous year, since the Fish Commission has lately retained its collections of marine animals with a view to their being studied and reported upon before being transferred to the Museum. For this reason probably not more than three hundred specimens have been added to the collection during the year. Interesting collections have been received from Lieut. J. F. Moser, U. S. Navy; Mr. Henry Hemphill; Dr. Louis F. H. Birt, of the Nicaragua Canal Construction Company; Mr. Rowyn Hitchcock, who presented a small collection of crustaceans and sponges from Japan, and from Mr. James G. Swan, of Port Townsend, Washington.

* See Section II.

A collection of marine specimens was prepared and transmitted to the Cincinnati Exposition. It consisted mainly of large specimens, and also contained examples of fish food and many microscopical preparations. Upon its return from Cincinnati the more interesting portions of the exhibit were placed in the exhibition hall.

Mr. Rathbun has found it impracticable to devote very much time to original research, but has given a limited amount of study to the Madreporarian corals, and particularly to those collected by the steamer *Albatross* in the Gulf of Mexico and on the voyage from Norfolk to San Francisco.

Prof. A. E. Verrill and Prof. S. I. Smith have continued their work upon the invertebrate collections of the Fish Commission. Prof. Edwin Linton is making a special study of internal parasites of fishes. Arrangements have been made with Prof. Walter Faxon to prepare a report upon the crayfishes added to the department since 1885, and Mr. J. Walter Fewkes has completed a paper on certain of the Medusæ obtained by the Fish Commission steamer *Albatross* in the region of the Gulf Stream. Several of the groups of marine invertebrates obtained by the *Albatross* during its voyage around South America have been assigned to specialists outside of Washington for study and report.

Nineteen sets of marine invertebrates have been distributed to schools and colleges during the year. Each set contained about one hundred and ten species, the greater part of which are preserved in alcohol.

Mr. Rathbun in his report briefly reviews the marine explorations of the steamers *Albatross* and *Fish Hawk* and of the schooner *Grampus*.

The number of catalogue entries has been 3,214.

Department of Comparative Anatomy.—Mr. F. W. True, Acting Curator of this department, reports that his activities have been principally directed towards reducing the accumulations of osteological material. A large number of skulls and skeletons have been cleaned and made available for use. The skulls of about five hundred specimens of small animals, deposited by the Department of Agriculture, have also been prepared. Mr. F. A. Lucas, Assistant Curator, has been occupied in the arrangement of the collection of vertebrate fossils, and in mounting a cast of the skeleton of *Dinoceras*, received from the Yale College Museum. Mr. Lucas also had charge of the preparation for shipment of the collection of mammals for exhibition at the Cincinnati Exposition.

The preparation of a card catalogue of alcoholic birds has been commenced, and is well advanced, and a large amount of work has been done in classifying and caring for this valuable portion of the collection.

Some work has been done in the preparation of specimens of soft anatomy and of the invertebrate material. The preparation and arrangement of the vertebrate fossils have also received some attention.

The principal accessions during the year were of mammals and birds.

No attempt has yet been made to acquire invertebrate specimens for this department. The most important addition to the exhibition series of skeletons was an Atlantic Right whale, *Balæna biscayensis*. This was purchased from Prof. H. A. Ward, of Rochester, N. Y. A skeleton of Sowerby's whale, *Mesoplodon bidens*, was prepared from the specimen obtained from Capt. J. L. Gaskell, keeper of the life-saving station at Atlantic City. The U. S. Fish Commission furnished skins of dolphins, a skeleton of the Fork-tailed gull, *Oreagus furcatus*, and a collection of birds and Elephant tortoises from the Galapagos Islands and the Straits of Magellan. An alcoholic collection of typical New Zealand birds was obtained from the Auckland Museum, and a similar collection of Australian birds was obtained from the Australian Museum at Sydney. In all 195 specimens have been added to the collection during the year. The number of catalogue entries during the same period has been 1,054. The excess of this number over the total number of specimens received is accounted for by the large amount of work accomplished upon accumulations of osteological material from past years.

Department of Paleozoic Fossils.—By far the larger portion of the accessions to this department has been obtained through the U. S. Geological Survey. Mr. C. D. Walcott, Honorary Curator, has contributed to the Museum collections, through his official connection with the Geological Survey, a large series of Lower Middle Cambrian fossils from Newfoundland. He reports that the Lower Cambrian genera and species have been worked over and named, and that a large quantity of new material has been added to the collection. From Newfoundland alone not less than 3,000 specimens have been transferred to the Museum during the year. Mr. Walcott in his report makes special mention of nine accessions. The material in the collection has been increased during the year by the addition of 6,477 specimens. The number of catalogue entries during the same period was 583.

Department of Mesozoic Fossils.—The official duties of Dr. C. A. White, Honorary Curator, in connection with the Geological Survey, has prevented him from devoting more than a small share of time to work upon the Museum collection. A great deal has, however, been accomplished, and the collection of Mesozoic Fossils is now in far better condition than it has ever been before. Numerous type specimens of species which have been published in various Government reports, have been installed and are now on exhibition in the south-east court. The principal accessions during the year have, as usual, been obtained through the U. S. Geological Survey. In addition, type specimens of twelve species of cretaceous fossils were transmitted to the Museum by President D. S. Jordan, of Indiana State University. From the Fish Commission has been received an interesting collection of cretaceous fossils from the Straits of Magellan. Altogether, 311 specimens have been added to the collection during the year, and 117 entries have been made in the catalogue.

Department of Botany.—Dr George Vasey, of the Department of Agriculture, has been appointed Honorary Curator of this department, and in that capacity has control of the collections both in the Department of Agriculture and in the National Museum. A brief statement of the early history of these collections, and of the resulting conditions which led to this combination of the two collections, is given on pp. 19 and 20. By this union of interests in the development of the National Herbarium, a great many good results will undoubtedly be effected.

There are already in the Department of Agriculture arranged on shelves, in wall cases, occupying altogether a wall space of about 85 running feet, not less than 120,000 sheets of botanical specimens. The general catalogue of the combined herbarium has not yet been made.

The Department of Agriculture has employed for a part of the year three agents to collect botanical specimens and information respecting the vegetation of little known regions. One of these agents has operated in western Texas, one in California (southern and lower), and one in Washington. From these agents we have received a large quantity of botanical specimens.

Among the additions to the herbarium received during the year through the Smithsonian Institution, have been a collection of plants from South America and Alaska, made by officers of the U. S. Fish Commission steamer *Albatross*. Several packages containing plants and pertified wood were collected by Lieut. Pond in Lower California and the adjacent islands. A valuable collection of four hundred species of Japanese plants has been received from the Tokyo Educational Museum. Five collections of duplicate specimens have been distributed to foreign herbaria. The number of specimens received during the year has been estimated at 459.

Fossil plants.—Prof. Lester F. Ward, Honorary Curator, has been able to devote but little time to the work of the department, owing to the pressure of his duties as paleontologist of the Geological Survey, but as far as his time permitted he has been engaged in the study of the fossil plants of the Laramie group. He is preparing a monograph of the flora of this group, and hopes to complete it before very long.

During the field season, between July and the latter part of October, Prof. F. H. Knowlton, Assistant Curator, visited the Yellowstone Park, where he made a collection of fossil plants and fossil woods which filled twenty-one boxes. After his return to Washington the boxes were opened, and the assortment of the collections was begun. Considerable time was spent in the study of this material, as well as upon the material obtained during the previous season from the same region.

Professor Lesquereux, of Columbus, Ohio, has completed the identification and elaboration of the large collection of fossil plants belonging to the National Museum, and collected by Capt. Charles E. Bendire in John Day Valley, Oregon. The material is very interesting, and contains many new species.

On account of the pressing nature of Professor Ward's duties in connection with the Geological Survey, he has not been able to prepare a report for this year, and this brief statement is therefore submitted in lieu of a formal report in Section II.

Department of Minerals.—The growth of the collection during the year has, through the energetic administration of its Curator, Prof. F. W. Clarke, been very satisfactory. The two most important accessions were received from the U. S. Geological Survey. These collections were made by Prof. S. F. Penfield and by Dr. W. F. Hillebrand, who visited Colorado and the adjacent States and Territories for the purpose of making mineralogical investigations and collections. A series of specimens of wood opal, collected by Dr. A. C. Peale in Montana, has also been contributed by the Geological Survey. Professor Clarke in his report* makes mention of eleven accessions as of especial interest.

It is to be deeply regretted that Mr. Joseph Willcox has found it necessary to withdraw his collection of minerals from the Museum, where it had been deposited for more than four years. Mr. Willcox had offered to sell this collection to the Museum for an exceedingly modest sum, but this offer could not be entertained, the Museum having no fund for the purchase of specimens, and thus the Museum has sustained an irreparable loss.

A series of specimens, illustrating the gems and precious stones of North America, was prepared for exhibition at the Cincinnati Exposition.

During the year 5,794 specimens were added to the collection, and 631 entries were made in the catalogue.

Department of Lithology and Physical Geology.—There has been unusual activity in the work of this department during the year. The Curator, Mr. George P. Merrill, has visited certain localities in North Carolina, New Hampshire, New York, Vermont, Massachusetts, and Maine, for the purpose of collecting specimens. These expeditions have resulted very advantageously to the Museum. Among the new material received sixteen collections have been selected as worthy of special mention in the report of the curator.*

One of the objects of the expeditions already alluded to was for the purpose of collecting material for distribution to educational establishments. It has been quite impossible to fill the numerous applications for lithological specimens from museums, colleges, and schools throughout the country. Mr. Merrill has succeeded in obtaining a very large quantity available for this purpose, and during the coming winter it is expected that a sufficient number of sets of specimens can be prepared to fill the applications now on file. From material on hand at the beginning of the year covered by this report, twenty-two sets of minerals were prepared and distributed. The determination of material sent for examination and report has occupied no inconsiderable portion of the

*See Section II.

Curator's time. During the year twenty-five "lots" of material have been forwarded for this purpose.

The collection of building and ornamental stones now fills thirteen door-screen cases, one wall case, two large pyramids, and the tops of three table cases. The collections of rocks and rock-forming minerals are now as extensive as can be taken care of in the limited space at the command of this department. These collections now comprise about two thousand specimens. The collections of dynamic and historical geology have received important additions during the year, but no attempt has yet been made to arrange them systematically. The total number of specimens received during the year has been 4,500, and 1,135 entries have been made in the catalogue.

Department of Metallurgy and Economic Geology.—The Curator, Mr. F. P. Dewey, has devoted his time chiefly to the preparation and arrangement of the exhibition material, which is now installed in the southwest court. During the year the Curator made a visit to Providence, R. I., for the purpose of examining a collection of petroleum specimens and related materials which had been prepared by Prof. S. F. Peckham in connection with his work for the Tenth Census. This collection numbers three hundred and sixty specimens, and illustrates very fully the occurrence of crude petroleum in this country. It is in the Museum, and will be placed upon exhibition as soon as practicable. Several valuable collections of ores have been added to the collection during the year, among which may be mentioned three series of foreign ores; one from the Australian Museum at Sidney, one from the Auckland Museum in New Zealand, and one forwarded by the Hon. Otto E. Reimer, United States consul at Santiago de Cuba.

During the year the Curator has made an examination of the production of pig-iron at the Muirkirk Furnace, near Washington, and nickel from Russel Springs, Kansas. This was undertaken at the request of the Hon. J. J. Ingalls.

The collection has been increased during the year by the addition of 664 specimens, and 413 catalogue entries have been made.

Department of Living Animals.—This department was organized in May, 1888, and Mr. William T. Hornaday, who has recently been appointed Superintendent of the National Zoological Park, retains charge of the collection. Owing to the limited space available for exhibiting these specimens, consisting of a wooden shed adjoining the Smithsonian building on the south, it has become necessary to decline several offers of valuable contributions to the collection. Mr. Hornaday has prepared, during the year, an exhaustive memoir relating to the discovery, life history, and extermination of the American Bison. Owing to the delay attending the printing of the Museum report, it was found possible to include this paper in the report for 1887, proof of which is now being received from the Printing Office. In order to emphasize the rapid extermination of this and several other animals indigenous to the United

States, a large collection of objects illustrating this subject was prepared for the Cincinnati Exposition. Amongst the animals which have become extinct were shown the buffalo, the Californian sea-elephant, and the West Indian seal. In the series of species which are likely to disappear very soon were the mountain sheep, mountain goat, elk, antelopes, moose, caribou, black-tail deer, beaver, otter, sea-otter, walrus, and grizzly bear.

Among the most important accessions received during the year were three specimens of the American elk, presented by the Hon. W. F. Cody; a young Gray wolf, presented by Mr. C. A. Dole, of Glendive, Montana; a collection of living tortoises from the Galapagos Islands, collected by the U. S. Fish Commission steamer *Albatross*; and four Angora goats, received from Misses Grace and Maude Parsons. Of especial interest is a young Rocky Mountain sheep, *Ovis montana*, forwarded to the Museum by Mr. George Bird Grinnell, editor of "Forest and Stream."

Special cages have been constructed on the reservation south of the Smithsonian building for the grizzly bear, puma, and the eagles. A buffalo-yard has also been completed on the same reservation, and from it sections have been cut off to afford protection for the deer, mountain sheep, and other animals.

In addition to Mr. Hornaday's other duties he has retained the supervision of the taxidermic work of the Museum. There are now 491 specimens in the collection of living animals, represented by 341 entries on the catalogue of the department.

F.—REVIEW OF THE ADMINISTRATIVE WORK.

PROGRESS OF GENERAL AND INCIDENTAL WORK.

LIBRARY.

Mr. John Murdoch, librarian, has furnished the following statement of the operations of the library during the year:

The total number of publications added to the library during the year is 6,052 (648 volumes of more than 100 pages, 903 pamphlets, 4,343 parts of regular serials, and 158 charts). Of these, 441 volumes, 617 pamphlets, and 3,752 parts of serials were retained for the use of the Museum from the accessions of the Smithsonian Institution.

The remainder were obtained as usual by gift, exchange, and purchase.

The most important accession to the library during the year was the gift of the heirs of the late Dr. Isaac Lea, of Philadelphia, consisting of 137 volumes, 276 parts and 693 pamphlets, selected from his scientific

library, and comprising many works of the greatest value. Another important accession is a nearly complete series of the "Proceedings of the Zoological Society of London." This gift was received so late in the fiscal year that it has been impossible to enter and catalogue the books. When this can be done, most of them will be assigned to the sectional library of Mollusks.

Apart from the regular exchanges, the following donations to the library are also worthy of notice:

From Dr. Paul Haupt, Baltimore, 44 pamphlets on oriental subjects; from Prof. P. H. Carpenter, Eton College, England, 19 pamphlets, scientific papers by his distinguished father; from Mr. John Murdoch, Washington, 18 volumes, 2 pamphlets; from Prof. Alpheus Hyatt, Boston, 12 pamphlets.

During the year 7,583 books were borrowed from the library.

Ninety-four persons are now authorized under the regulations to draw from the Museum library, and of these seventy-five are also authorized to obtain books from the library of Congress through the Museum library. During the year 245 orders were sent to the library of Congress.

The method of keeping the records of loans and returns of books, referred to in a previous report, has been used throughout the year with complete satisfaction.

The card-catalogue by authors has been continued, and 1,442 titles have been added to it during the year.

Through the kindness of the librarian of Congress, an order was obtained for binding 300 volumes of the books belonging to the Smithsonian deposit in the Museum library. These books were therefore sent to the Government bindery on June 20, 1889.

The work of covering and arranging the large collection of pamphlets has been continued, whenever the pressure of routine work would allow.

No material change has been made in the force employed in the library since the last report.

SECTIONAL LIBRARIES.

The regular inspection of the sectional libraries by the librarian was begun May 22 and completed June 7. Since the last report, the name of the section of archæology has been changed to Prehistoric Anthropology, and a new sectional library, that of Oriental Archæology, in charge of Dr. Cyrus Adler, Assistant Curator of the Section of Oriental Antiquities, has been established. The Assistant Secretary has commenced the organization of his sectional library, that of Administration.

The following is the result of the inspection:

Administration.—(In process of organization.) Inspected May 28. Contained 30 volumes and 1 pamphlet.

Birds.—Inspected May 23. Contains 480 volumes, 22 pamphlets, and 203 parts of serials. These are mostly in good condition, although the large volumes are necessarily exposed to dust for want of suitable cases. At least two additional standard book-cases with locks are required in this department.

Insects.—Inspected June 7, 1889. Contains 296 volumes, 169 pamphlets, and 538 parts of serials in excellent order, and suitably protected.

Editor, Smithsonian Institution.—Inspected May 7, 1889. Contains 809 volumes, 34 pamphlets, and 619 parts of serials, all in good order.

Ethnology.—Inspected May 31, 1889. Contains 55 volumes, 16 pamphlets, 225 parts of serials and 1 chart, all in good order.

Fishes.—Inspected May 23, 1889. Contains 78 volumes, 6 pamphlets, and 24 parts of serials, all in good order and suitably protected.

Lithology and Physical Geology.—Inspected June 3, 1889. Contains 184 volumes, 175 pamphlets, and 162 parts of serials and 5 charts, in good order and suitably protected.

Mammals.—Inspected June 6, 1889. Contains 183 volumes and 276 pamphlets, in good order.

Marine Invertebrates.—Inspected May 22, 1889. Contains 76 volumes, 41 pamphlets and 183 charts, all in good order and suitably protected.

Materia Medica.—Inspected May 29, 1889. Contains 202 volumes, 4 pamphlets and 181 parts of serials, all in good order.

Mesozoic Fossils.—Inspected June 25, 1889. Contains 34 volumes, 11 pamphlets, and 3 charts of serials, in good order.

Metallurgy and Economic Geology.—Inspected June 4, 1889. Contains 276 volumes, 139 pamphlets, 177 parts of serials and 1 chart, in excellent order.

Mineralogy.—(a) Inspected June 7, 1889. Contains 157 volumes, 9 pamphlets, and 511 parts of serials, all in good order.

Mineralogy.—(b) Inspected June 3, 1889. Contains 61 volumes, 50 pamphlets, 3 parts of serials and 1 chart, all in good order.

Mollusks and Cenozoic Fossils.—Inspected May 24, 1889. Contains 66 volumes, 9 pamphlets and 46 parts of serials, all in good order.

Oriental Archæology.—Inspected May 28, 1889. Contains 131 volumes, 66 pamphlets and 99 parts of serials, all in good order.

Plants, recent and fossil.—Inspected June 5, 1889. Contains 236 volumes, 224 pamphlets and 645 parts, in fair order.

Prehistoric Anthropology.—Inspected May 25, 1889. Contains 55 volumes, 13 pamphlets and 35 parts, in fair order, in addition to the Rau Memorial Library, which is still only partially catalogued.

Textiles and Foods.—The officer in charge of this department having returned to duty, the library is in process of reorganization. It was inspected June 7, 1889, and at that date contained 22 volumes and 11 pamphlets in good order.

TRANSPORTATION, STORAGE, AND DISTRIBUTION OF DUPLICATES.

The total number of boxes, packages, barrels, tanks, etc., received during the year is 16,625, of which 2,182 contained specimens for the Museum, the remainder being distributed to the Smithsonian Institution and the other persons addressed.

The registrar, Mr. S. C. Brown, has continued to act as transportation clerk for the Smithsonian Institution, and this has entailed a considerable addition to the routine work of his office.

During the fiscal year 261 packages were entered upon the storage records, and 203 packages were removed from storage and turned over to the curators for study, and to aid in making up sets for distribution.

Forty-eight boxes of duplicate and reserve material have been sent to general storage, and 57 specimens were sent out in exchange.

During the month of May the general storage room was removed from the "Old Armory" building to the storage shed west of the Armory building, and the storage separated into three sections.

First. General storage, which is now confined to the large shed proper, and is used for the storage of Museum specimens only.

Second. The south track of what is known as the "car shed" has been set aside for the accommodation of specimens collected by the U. S. Geological Survey and Bureau of Ethnology. All such specimens are entered in the Museum storage record, but are kept by themselves for convenience in handling.

Third. A new shed, 88 by 18 feet, has been erected west of the old one. The south end of it, 10 by 18 feet, is reserved for the department of Lithology and Physical Geology, for the storage of its duplicate material; the remainder of the new shed (78 by 18 feet) has been assigned to the property division of the Museum, for the storage of cases, drawers, etc.

The total number of packages sent out during the year is 2,552, of which 1,302 contained Museum material, transmitted as gifts or loans, or in exchange.

The Museum has continued to lend photographs of exhibition cases to all who have made formal application, and to send sample trays and boxes and copies of labels to applicants.

The distribution of specimens for the year, from the several departments of the Museum, is shown in the appended table.

Department.	No. of specimens.
Ethnology	268
American prehistoric pottery	33
Prehistoric anthropology	833
Mammals	42
Birds	226
Birds' eggs	3
Reptiles	47
Fishes	39
Mollusks	369
Insects	197
Marine invertebrates	2,072
Invertebrate fossils	508
Fossil and recent plants	2,945
Minerals	2,370
Lithology and physical geology	804
Metallurgy	58
Photographs and drawings	79
Total number of specimens sent out.....	11,382

Duplicate sets* of marine objects have been sent out, as in the past, in response to applications received from museums and educational institutions.

The distribution for the year was as follows :

	Specimens.
To domestic institutions.....	5,511
To foreign institutions	5,871
Total.....	11,382

This number added to the total number of specimens sent out from 1854 to June 30, 1888, which was 564,090, gives the grand total of 575,472 specimens distributed by the Smithsonian Institution up to June 30, 1889.

In addition to the regular sets of duplicates five special collections were also sent out.

Thirty-four applications for duplicate specimens other than marine invertebrates have been received during the year and entered upon the register. A majority of these have been favorably acted upon.

Mr. George P. Merrill has collected a large amount of material, which, together with duplicate specimens in the Museum, will be cut up and made into sets for distribution to educational establishments. Prof. F. W. Clarke has for a similar purpose made large collections of minerals.

Eight hundred specimens of minerals were sent out to over twenty establishments, and sixteen sets of duplicates were distributed to colleges and schools.

*Series IV. Each set in this series contains 108 species. Six universities, five colleges, five schools, and one society have each received a set during the year. A list of these is given in the report of the Curator of marine invertebrates. (Section II.)

It is probable that during the next fiscal year sets of bird-skins will also be prepared for distribution.

From the duplicate collections of the department of botany, distributions have been made to the Imperial Academy of Sciences, St. Petersburg, Russia; the Herbarium of the Jardin des Plantes, Paris, France; the Herbarium of the British Museum, London, England; the Royal Herbarium, Kew, England; and the Botanic Garden, Natal, South Africa.

Several special requests for material for study have been complied with. Among these were unmounted prints of photographs of the Charnay casts for the Bureau of Ethnology; pieces of the vertebral columns of *Chimæra* and *Gymnotus* for Prof. John A. Ryder; ethnological material for the Cincinnati Museum Association; cast of jade adze for Mr. Kunz; a loan of bird skeletons for Dr. J. L. Wortman, of the Army Medical Museum, to aid in the preparation of a monograph upon the anatomy of the fish hawk; two enlarged negatives and prints of the Red River Dam views for Commodore J. G. Walker, chief of the bureau of navigation, Navy Department; a collection of fishes for the College of the City of New York; skull of Flat Head Indian for Prof. E. de Bois Reymond, director of the Physiological Institute in Berlin.*

EXCHANGES.

The Museum has, as in past years, continued the exchange of duplicate specimens with museums, scientific establishments, and individuals at home and abroad. The domestic exchanges are indicated in the accession list (section v).

A classified statement of foreign exchanges is here presented.

Ethnology.—The Royal Ethnological Museum at Berlin, Germany, sent a series of casts of Egyptian and Assyrian antiquities. A list of these casts is given in the List of Accessions. The Museum of St. Germain, Paris, France, sent a collection of bronze implements (molds) in exchange for spears, plummets, and sinkers. The Musée d'Ethnologie of Geneva, Switzerland, sent in exchange, through Dr. H. J. Gosse, director, one hundred and twenty-seven specimens of pottery, bronzes, etc., from various localities in the Swiss lakes. Thirty-two ethnological specimens were sent to the Musée d'Ethnologie, Geneva, Switzerland, in exchange for a fine collection of pottery, bronzes, etc. Exchanges have been continued with Mr. Edward Lovett, of Croydon, England.

Prehistoric anthropology.—A collection of archæological specimens was sent to L. Guesde, Guadeloupe, in exchange for a collection of birds. A collection of thirty-four archæological specimens was sent to William Ranson, Fairfield, Hitchin, England; and similar material was received

* This skull was obtained by Dr. John S. Billings, curator of the Army Medical Museum, from the banks of Willamette River, Oregon, near its junction with the Clackamas.

in exchange. A collection of sixty-nine archæological specimens was sent to Signor Joseph Belucci, Perugia, Umbria, Italy. A collection of one hundred and four archæological specimens was sent to Prof. Henry H. Giglioli, Museum of Zoology, Florence, Italy. A collection of fifteen archæological specimens was sent to Louis Guesde, Pointe à Pitre, Guadeloupe, West Indies, and a collection of similar material was received in exchange. A collection of forty-nine archæological specimens was sent to Gustav Marty, Toulouse, France.

Mammals.—Skeletons of bisons and skulls of sea-lion and fur-seal were sent to Prof. T. F. Cheeseman, curator of the Auckland Museum, New Zealand, in exchange for a collection of birds, shells, minerals, rocks, and ores. A sea-lion and two fur-seals were sent to the Zoological Museum of the Royal University, Christiania, Norway, in part exchange for a Killer whale (*Orca gladiator*). The British Museum sent three casts of *Meiolans* from Lord Howe Island, England, in exchange for a skull of an American bison.

Birds.—From the Royal Zoological Museum, Florence, Italy, was received, in exchange, a collection of birds, fishes, reptiles, and mammals. Twenty-four bird-skins were received from Herr von Tschusi zu Schmidhoffen, of Salzburg, Austria.

Fishes.—An exchange of fishes has been made with the Australian Museum at Sydney. The Zoological Museum of Copenhagen, Denmark, sent sixty-seven specimens of fishes from northern seas. The Otago University Museum, Dunedin, New Zealand, sent in exchange a valuable collection of New Zealand fishes, containing forty-one species.

Mollusks.—A valuable collection of North European mussels and algæ was received from Dr. Rasch and C. Jensen, of Copenhagen, Denmark. A large collection of shells, three hundred and seventy-one specimens, was sent to the Albany Museum, Grahamstown, South Africa, in exchange.

Insects.—Specimens of Heteroptera were received from A. L. Montandon, Bucharest, Roumania.

Botany.—An exceedingly valuable collection of New Zealand woods was received from the Canterbury Museum, New Zealand, through F. W. Hutton, acting director. The Museum sent to Dr. Rasch, Copenhagen, and C. Jensen two hundred and fifty herbarium specimens. A collection of ferns from the Hawaiian Islands was received from G. W. Lichtenthaler, Bloomington, Ill., in exchange for ferns from Costa Rica. A collection of plants has been sent to the Imperial Academy of Sciences, St. Petersburg, Russia, and similar material has been received in exchange. A collection of plants has been sent to the Herbarium of the Jardin des Plantes, Paris, France. A collection of plants has been sent to the Herbarium of the British Museum, London, England. A collection of plants has been sent to the Royal Botanical Garden, Kew, England, and similar material has been received in exchange. A collection of plants has been sent to the Botanic Garden, Natal, South Africa.

Minerals.—The Imperial Roy. Natural History Museum, Vienna, sent in exchange three meteorites, through Dr. Aristides Brezina. Sixty-two specimens of miscellaneous minerals and forty-three specimens of miscellaneous rocks were sent to B. Sturtz, Bonn, Prussia, in exchange for rocks.

Geology.—An interesting and valuable series of meteorites and eruptive rocks of Brazil, comprising two hundred and sixty-nine specimens, was received from Prof. O. A. Derby, of Rio de Janeiro, in exchange for a series of rocks. A collection comprising about one hundred and eighty specimens of modern and antique marbles from Europe and Africa was received in exchange from the Museum of Natural History at Paris. A series consisting of one hundred and sixteen dressed specimens of building and ornamental stones and one hundred and two specimens of rocks, ores, and minerals, was sent to Dr. Aristides Brezina of the Imperial Royal Museum at Vienna, Austria, and a collection of one hundred and seventeen specimens of building stones was received in exchange. A series of one hundred and one specimens of building stones, many of them cut and polished, and a collection of eruptive and sedimentary rocks was sent to M. Meunier, of the Museum of Natural History, Paris, France. The National Museum of Brazil, at Rio de Janeiro, through Prof. O. A. Derby, sent a collection of Brazilian rocks and a meteorite, and one hundred and thirty-one specimens of American rocks sent in exchange. Rocks and minerals were sent to R. N. Worth, Plymouth, England, in exchange for serpentine rock. Five specimens of American rocks were sent to M. A. Lacroix, Paris, France.

A collection comprising sixty-four specimens of typical rocks and ores was sent to Rev. G. E. Post, Beirut, Syria.

PUBLICATIONS.

The publications of the National Museum consist of four series:

(1) The ANNUAL REPORT, submitted to the Secretary of the Smithsonian Institution, and by him transmitted to Congress as a part of the report of the Board of Regents of the Smithsonian Institution.

From 1850 to 1866 and from 1881 to 1883 the series was printed as an appendix to the report of the Secretary.

From 1867 to 1873 no report was published, except in passing reference in the Secretary's report on the Administrative work of the year.

From 1874 to 1877 the report of the Assistant Secretary on the Museum was quoted in the Secretary's report, and from 1878 to 1880 it was incorporated in the report of the Secretary.

Since 1884 the report on the Museum has been printed as a separate volume, constituting Part II of the report of the Smithsonian Institution, and the fifth volume of this series—that for 1887-'88—is now being printed. In the appendix of this report are printed each year certain

papers illustrative of the work of the Museum and descriptive of its collections, selected with reference to their general interests, as being suited for publication in a large edition and calculated to excite interest in the work of the Museum.

An edition of 7,000 copies of the Smithsonian Report, Part I and Part II, is placed in the hands of the Smithsonian Institution for distribution.

(2) The BULLETIN OF THE NATIONAL MUSEUM.—This series was begun in 1875, and thirty-seven numbers have been printed, Bulletin 38 being now in the hands of the printer.* The aggregate number of pages is 9,939+616 plate pages, in all 10,555 pages, or 659 $\frac{1}{2}$ signatures. The number, character, and size of these bulletins is given in the accompanying table.

Bulletins of the National Museum.†

No.	Title.	Author.
1	Cbeck-list of North American Batrachia and Reptilia	Edward D. Cope.
2	Contributions to the Natural History of Kerguelen Island.....	J. H. Kidder.
3	Contributions to the Natural History of Kerguelen Island.....	Do.
4	Birds of Southwestern Mexico.....	George N. Lawrence.
5	Catalogue of the Fishes of the Bermudas.....	G. Brown Goode.
6	Classification of the Collection to Illustrate the Animal Resources of the United States.	Do.
7	Contributions to the Natural History of the Hawaiian and Fanning Islands and Lower California.	Thos. H. Streets.
8	Index to the Names which have been Applied to the Subdivisions of the class Brachiopoda excluding the Rudistes previous to the year 1877.	W. H. Dall.
9	Contributions to North American Ichthyology	David S. Jordan.
10	do	Do.
11	Bibliography of the Fishes of the Pacific Coast of the United States.	Theodore Gill.
12	Contributions to North American Ichthyology.....	David S. Jordan.
13	The Flora of St. Croix and the Virgin Island.....	H. F. A. Eggers.
14	Catalogue of the Collection to Illustrate the Animal Resources and the Fisheries of the United States.	G. Brown Goode.
15	Contributions to the Natural History of Arctic America.....	Ludwig Kumlien.
16	Contributions to North American Ichthyology	David S. Jordan. Charles H. Gilbert.
17	On the Zoological Position of Texas.....	Edward D. Cope.
18	Exhibit of the Fisheries and Fish Culture of the United States of America, at the International Fischerei-Ausstellung, Berlin, April 20, 1890.	G. Brown Goode.
19	Nomenclator Zoologicus.....	Samuel H. Scudder.
20	The Writings of American Zoologists	G. Brown Goode.
21	Nomenclature of North American Birds.....	Robert Ridgway.
22	Guide to the Flora of Washington and Vicinity.....	Lester F. Ward.
23	Bibliography of the Publications of Isaac Lea, LL. D.....	N. P. Scudder.

* At the close of the fiscal year covered by this report, Bulletin 33 was the latest issued. Nos. 34, 35, 36, and 37 have since been published, and it seems proper to include them in this general statement of Museum publications.

† It may be found desirable to condense the series of bulletins into volumes, each containing three or four papers. Three such volumes have already been published.

Bulletins of the National Museum.—Continued.

No.	Title.	Author.
24	Check-list of North American Reptilia and Batrachia.....	H. C. Yarrow.
25	Contributions to the Natural History of the Bermudas	J. Matthew Jones. {G. Brown Goode.
26	Avifauna Columbiana.....	Cones and Prentiss.
27	Catalogue of the Collections Exhibited by the United States of America at the Great International Fisheries Exhibition, London, 1883.	
28	A Manual of American Land Shells	W. G. Binney.
29	Results of Ornithological Explorations in the Commander Islands and Kamschatka.	Leonhard Stejneger.
30	Bibliography of publications Relating to the Collection of Fossil Invertebrates in the U. S. National Museum.	John B. Marcou.
31	The North American species of Syrphidae	S. W. Williston.
32	Catalogue of Batrachians and Reptiles of Central America and Mexico.	E. D. Cope.
33	Catalogue of Minerals Alphabetically Arranged.....	Thomas Egleston.
34	Batrachia of North America	E. D. Cope.
35	Catalogue of the Described Transformations of North America Lepidoptera.	Henry Edwards.
36	A Review of the Species of Delphinidae	F. W. True.
37	Marine Mollusks of the Southeast coast of the United States	W. H. Dall.

The following bulletins were not published in the year covered by this report, but, having been issued before the report was in type, it is deemed desirable to include them in this statement:

Bulletin 34. The Batrachia of North America. By E. D. Cope.

Bulletin 35. Bibliographical Catalogue of the Described Transformations of North American Lepidoptera. By Henry Edwards.

Bulletin 36. Contributions to the Natural History of the Cetaceans; a review of the Family Delphinidæ. By Frederick W. True.

Bulletin 37. A Preliminary Catalogue of the Shell-bearing Mollusks and Brachiopods of the Southeastern Coast of the United States. By William Healey Dall.

The composition of these thirty-seven bulletins* is given in the following tables:

* The following arrangement is suggested for the convenience of those who may wish to bind the bulletins into volumes:

Bulletin Nos.		Bulletin Nos.	
Vol. I.....	1 to 10	Vol. VII.....	27
Vol. II.....	11 to 15	Vol. VIII.....	28, 29
Vol. III.....	16	Vol. IX.....	30, 31, 32
Vol. IV.....	17, 18, 19	Vol. X.....	33, 34
Vol. V.....	20, 21, 22, 23	Vol. XI.....	35, 36, 37
Vol. VI.....	24, 25, 26		

REPORT OF ASSISTANT SECRETARY.

57

Composition of bulletins of the National Museum, Nos. 1 to 37.

No. of Bulletin.	Date.	Ante.	Text.	Inter.	Post.	Plate pages.	Total.	Cuts.	Plates.	Maps.
1.....	1875	(4)	104				108			
2.....	1875	(10)	51		(1)		62			
3.....	1876	(2)	122				124			
4.....	1876		56				56			
5.....	1876	(2)	82				84			
6.....	1876	(12)	126				138			
7.....	1877		172				172			
8.....	1877		88				88			
9.....	1877		53		(1)		54			
10.....	1877	(4)	120			(90)	214		45	
11.....	1882	(4)	73		(1)		78			
12.....	1878		237		(1)		238			
13.....	1879	(6)	133		(1)		140			
14.....	1879	(16)	351		(1)		368			
15.....	1879		179		(1)		180			
16.....	1882	(56)	1,018				1,074			
17.....	1880	(4)	51		(1)		56			
18.....	1880	(16)	263		(1)		280			
19.....	1882	(22)	340				362			
20.....	1883	(18)	377		(1)	(4)	400		1	
21.....	1881		94				94			
22.....	1881		264		(2)		266			1
23.....	1883	(60)	278		(2)		340		1	
24.....	1882	(6)	249		(1)		256			
25.....	1884	(25)	353		(1)	(24)	403		12	
26.....	1883		133		(1)	(4)	138	100	2	4
27.....	1884	(54)	1,279	*(2)	(1)		1,336			
28.....	1885		528				528	515		
29.....	1885		382			(32)	414	7	8	1
30.....	1885		333		(1)		334			
31.....	1886	(32)	287		(1)	(48)	368		12	
32.....	1887		98				98			
33.....	1889		196	†(4)			202			
34.....	1889		525		(1)	(172)	698	120	86	
35.....	1889		147		(1)		148			
36.....	1889		191		(1)	(94)	286		47	
37.....	1889		221		(1)	(148)	370		74	
Total							10,555			

* Table of statistics.

† Abbreviations and errata.

Year.	No. of bulletins.	Pages.	Year.	No. of bulletins.	Pages.
1875.....	2 bulletins (1, 2).....	170	1883.....	2 bulletins (20, 26).....	538
1876.....	4 bulletins (3, 4, 5, 6).....	402	1884.....	2 bulletins (25, 27).....	1,789
1877.....	4 bulletins (7, 8, 9, 10).....	528	1885.....	4 bulletins (23, 28, 29, 30).....	1,616
1878.....	1 bulletin (12).....	238	1886.....	1 bulletin (31).....	368
1879.....	3 bulletins (13, 14, 15).....	688	1887.....	1 bulletin (32).....	98
1880.....	2 bulletins (17, 18).....	366	1889.....	5 bulletins (33, 34, 35, 36, 37).....	1,704
1881.....	2 bulletins (21, 22).....	360		Total	10,555
1882.....	4 bulletins (11, 16, 19, 24).....	1,770			

(3) The PROCEEDINGS OF THE NATIONAL MUSEUM.—This series was begun in 1878 and the twelfth annual volume—that for 1889—is now being printed.*

In the first eleven volumes were printed seven hundred and sixty scientific papers in addition to thirty-four administrative papers printed from time to time in the appendix.

The total of pages in the first ten volumes, excluding the appendices, is 6,112, 410 of plates, or 6,522 pages, constituting 406½ signatures.

Of Vol. XI there have been printed 671 pages of text with 60 plates. The total number of pages when the volume is complete will be about 725+120 plate pages.

In the table here introduced is shown the number of pages, text figures and plates, in Vols. I to X of the "Proceedings."

No.	Date.	Ante.	Text.	Inter.	Post.	Total.	Plate pages.	Grand total.	Text figures.	Appendix to volumes.		
										Plates.	Figures.	Pages.
I	1879	4	520	524	16	540	5	8
II	1880	4	499	4	1	508	20	528	7
III	1881	6	589	1	596	4	600	2
IV	1882	8	534	542	4	546	13	1	146
V	1883	12	703	1	716	24	740	52	12
VI	1884	8	461	1	470	56	526	6	14	4	68
VII	1885	8	591	1	600	8	608	2	70
VIII	1886	8	679	1	688	100	788	25	12	56
IX	1887	8	714	722	100	822	5	25
X	1888	8	737	1	746	78	824	11	39	34
		74	6,027	4	7	6,112	410	6,522	92	135	16	368

This series was established for the purpose of securing prompt publication of discoveries in the Museum, and in order to secure this, the printing has been done signature by signature as fast as matter was prepared, and a certain number of signatures have always been distributed, as soon as published, to scientific institutions and specialists, these being dated by stamp in the Smithsonian Institution. The number of signatures of each volume thus distributed has been in the neighborhood of two hundred.

This method of publication has seemed to be to some extent wasteful, and it is thought that good results may be secured by distributing a certain number of the advance copies in the form of authors' extras; consequently, in making the requisition for the printing of Vol. XII the following assignment was made: Out of an edition of 1,200 copies, 100 to be delivered in signatures as fast as printed, and 300 in extras or reprints, in paper covers, of which 50 are to be given to the authors and the remainder distributed to specialists, in the various departments to

* Vol. XI and twelve papers of Vol. XII have been published between the end of the fiscal and the calendar year.

which the papers relate, who are not otherwise provided with the publication. The 800 remaining volumes to be bound and distributed in this form.

In special instances, where a given paper in the "Proceedings" is believed to be of great general interest and to require a larger distribution, it has been customary to print from one hundred to one thousand extra copies.

(4) The MUSEUM CIRCULARS: Of these, forty-one have now been printed. The first thirty three numbers of the circulars were included as appendices to the Proceedings. Circulars 34 and 35 were printed in the report of the Museum. Circular 36 was issued only as a separate and what should be No. 37 was printed without a number in Vol. x of the "Proceedings" (page 701). It is believed that hereafter it will be more satisfactory to reprint them in the annual report of the Museum, since they are more of an administrative than of a scientific character. The object of printing them as appendices to the "Proceedings" was to provide for the expense out of the fund for printing the "Proceedings," but since the printing fund is now more directly under the control of the Museum, it is quite practicable to print such editions as may be needed of these administrative papers, and instead of having them electrotyped, they can be reset when the time comes for printing them in the report—a method which is rather less expensive to the Museum than the former one.

Following is a list of circulars 1 to 41, with titles and number of pages in each :

No.	Title.	No. of pages.
1	Plan of organization and regulations	58
2	Circular addressed to friends of the Museum	2
3	Circular in reference to petroleum collections	2
4	Circular concerning the department of insects	1
5	Establishment and officers	2
6	Classification and arrangement of the materia medica collections	2
7	A classification of the forms in which drugs and medicines appear and are administered.	7
8	Memoranda for collectors of drugs for the materia medica section of the National Museum.	2
9	Circular in reference to the building-stone collection	6
10	Two letters on the work of the National Museum	10
11	A professional classification of the food collections	22
12	Classification of the collection to illustrate the art of taxidermy	2
13	Outline of a scheme of Museum classification	4
14	Circular requesting material for the library	3
15	The organization and objects of the National Museum	4
16	Plans for the installation of collections	2
17	Contributions and their acknowledgements	1
18	List of publications of the United States National Museum	12
19	Classification of the materia medica collection of the U. S. National Museum and catalogue of specimens	45
20	Request for specimens of drugs and information concerning them	1
21	Circular relative to contributions of aboriginal antiquities to the U. S. National Museum.	5
22	Brief directions for removing and preserving the skins of mammals	7

No.	Title.	No. of pages.
23	Instructions for taking paper molds of inscriptions in stone, wood, bronze, etc.	5
24	Plan of a collection to illustrate the textile industries of the United States, to be exhibited at the World's Industrial and Cotton Centennial Exposition, 1884-'85 at New Orleans.	16
25	Preliminary plan for a collection of the building and ornamental stones and rocks of the United States, to be exhibited at the World's Industrial and Cotton Centennial Exposition, 1884-'85 at New Orleans.	2
26	Plan for a collection of the gems and precious stones of the United States, to be exhibited at the Cincinnati Industrial Exposition and the World's Industrial and Cotton Centennial Exposition, 1884-'85 at New Orleans.	2
27	Directions for collecting and preserving and transporting tortricids and other small moths.	3
28	Directions for mound exploration.	3
29	Provisional plan for a collection of mammals to be exhibited at the World's Industrial and Cotton Centennial Exposition of 1884-'85 at New Orleans.	27
30	A list of birds the eggs of which are wanted to complete the series in the National Museum, with instructions for collecting eggs.	4
31	Plan to illustrate the mineral resources of the United States and their utilization, at the World's Industrial and Cotton Centennial Exposition of 1884-'85 at New Orleans.	2
32	Classification of the materia medica collection of the U. S. National Museum, and catalogue of specimens.	39
33	Notes on the preparation of skeletons.	3
34	Circular for the guidance of persons desiring to make exchanges of birds or birds' eggs with the National Museum.	1
35	*Concerning the lending of type specimens.	1
36	Circular concerning Department of Antiquities, American Aboriginal Stone Relics.	6
137	‡Catalogue of the contributions of the section of graphic arts to the Ohio Valley Centennial Exposition, Cincinnati, 1888.	31
38	Contributions of the Department of Transportation and Engineering to the Ohio Valley Centennial Exhibition, 1888.	18
39	The contribution of the section of Oriental Antiquities to the Ohio Valley Centennial Exhibition.	7
40	Description of exhibit made by the Department of Prehistoric Anthropology in the National Museum at the Ohio Valley Central States Exposition in Cincinnati, Ohio, 1888.	33
41	Guide to a collection illustrating the families of mammals exhibited in the Ohio Valley Centennial Exhibition in 1888 by the U. S. National Museum.	26

* See Museum report 1886, p. 25.

† This and the following circulars were erroneously numbered.

‡ See "Proceedings," Vol. x, p. 701.

HISTORY OF THE MUSEUM PUBLICATION FUND.

The publication of the Proceedings and the Bulletin was at first paid for from the printing fund of the Interior Department, with which the Museum was at that time in close relations in respect to financial matters. Subsequently it was paid for from a fund for printing the labels of the Museum, estimates for which were annually submitted by the Secretary of the Interior at the request of the Secretary of the Institution. The amount asked for was usually \$10,000, but in 1882-'83 the estimate was for \$20,000, which sum, however, was not allowed. Although in the book of estimates, the Museum appears as asking a

certain sum for printing, no reference was made in making the appropriation for the Museum, but the money was given in the gross sum allotted to the Interior Department as a Printing Fund.

In 1888, however, a separate appropriation was made for the first time in these words: "For the National Museum, for printing labels and blanks and for the Bulletins and Annual Volumes of the Proceedings of the Museum, \$10,000."

In 1889 the appropriation for the fiscal year 1890 was made in the same words, but was not included as heretofore in the appropriations for the Department of the Interior.

The edition of the earlier volumes of the Proceedings and Bulletins was usually only 1,000, of which a portion was distributed by the Department of the Interior and a portion by the Museum, the number received being sometimes as many as 500, and sometimes as few as 250.* The edition placed at the disposal of the Museum being so small and withal so uncertain as to number, the distribution was always of necessity informal, and no effort was made, except in the case of the signatures of Proceedings, already referred to, to provide for supplying copies to a regular list of institutions and specialists. A considerable number were used up in the work of the Museum, and the others were sent to correspondents of the Museum in exchange for publications, for specimens, and incidentally to such institutions as might apply for copies, as well as to individuals, especially students who made it evident that they were in a position to make good use of the books.

In some cases, as, for instance, that of the catalogues of the Animal Products and Fisheries Collection at the Centennial Exhibition in 1876 (Bulletin 14); the catalogue of the Exhibit of the Fisheries and Fish Culture of the United States of America at the International Fishery Exhibition at Berlin in 1880 (Bulletin 18), and the catalogue of the collection exhibited by the United States at the International Fisheries Exhibition at London in 1883 (Bulletin 27), the entire edition, and indeed an extra large number of copies also, were entirely absorbed in special uses in connection with the exhibition work. In other instances, such as Coes and Prentiss's "Catalogue of the Birds of the District of Columbia" (Bulletin 26) and Ward's "Guide to the Flora of Washington and Vicinity" (Bulletin 22) the books were largely distributed to supply a local demand.

It was, in fact, not intended that formal publication of these documents should be made from the advance edition to which I have referred.

Formal publication was undertaken by the Smithsonian Institution, it being the intention that, the first cost of composition and electrotyping having been provided for by the special Congressional appropriation, the Smithsonian Institution should avail itself of the electrotype-plates

* The records show that of Bulletin 32, 250 copies were received; of Bulletin 29, 244; of Bulletin 25, 390; of Bulletins 27 and 30, 450.

and use them in making up certain volumes of the **Miscellaneous Collections**. The papers published in the "Proceedings" and "Bulletin" of the Museum were of precisely the same character which since 1862 had made up the great majority of the most important papers in the **Miscellaneous Collections**. The Institution then undertook to print an edition of 1,200 copies in the form of volumes of the **Miscellaneous Collections**, and to distribute them to the principal libraries of the world. This was at the time regarded as advantageous, since the cost of composition and electrotyping was always at least two-thirds of the cost of an edition of 1,200, and in addition to this the miscellaneous distribution, for which the Institution in the case of similar publications printed at its own expense had been accustomed to provide, was now already provided for out of the preliminary issue of several hundred copies paid for from the Museum fund.

The practice was in effect from 1878 to 1883, and five volumes of the **Miscellaneous Collections** were made up entirely of the "Proceedings" and "Bulletin" of the Museum, as is shown in the accompanying table.

Miscellaneous collections.	Date.	Contents.
Vol. XIII.....	1878	Bulletins 1, 2, 3, 4, 5, 6, 7, 8, 9, 10.
Vol. XIX.....	1880	Proceedings Vols. 1, and 2.
Vol. XXII.....	1882	Proceedings Vols. 3 and 4.
Vol. XXIII.....	1882	Bulletins 11, 12, 13, 14.
Vol. XXIV.....	1883	Bulletin 16.

In this manner the first four volumes of the "Proceedings" and the first sixteen numbers of the "Bulletin" were published, constituting in each instance about one-third of the entire series up to the present date.

Since 1883 no publication of the "Bulletin" has been made, and none has been made in the case of the "Proceedings" since 1882.

There remain unpublished, then, eleven volumes of the "Proceedings" and twenty-one numbers of the "Bulletin," in all sufficient to make ten thick volumes of the **Miscellaneous Collections**. Possibly, by condensation and omissions the number might be reduced to nine volumes.

If the Institution were to undertake to print the edition of 1,000, now customary in the case of the **Miscellaneous Collections**, the cost would be not less than \$9,000.

The same amount expended by the Institution in printing fresh matter would probably not produce one and a half volumes, or at most two volumes, of **Miscellaneous Collections**.

As a matter of fact, however, the publication of the edition of 1,000 copies by the Smithsonian Institution would not really meet the necessities of the case, since it would leave unsupplied a very large number of libraries quite as deserving as those already on the list.

In view of all these facts, it seems not desirable that the Institution should undertake hereafter the publication of the Museum "Bulletin" and "Proceedings," since it is evident that these will increase in bulk

from year to year, and that the demand upon the Institution would very soon become too burdensome.

The desired result could be attained by obtaining from Congress an increase in the appropriation for the Museum printing. It would then be practicable to publish an edition of 2,000 copies in addition. A volume of Proceedings not exceeding 800 pages could then be printed each year, and an indefinite number of bulletins, not to exceed in the aggregate 1,600 pages, with the necessary illustrations.

It is estimated that an edition of at least 3,000 copies is needed in order to place these publications in the hands of those libraries which ought to receive them.

Two tables are appended, one giving a list by States of the institutions to which it would seem proper that distribution should first be made, and another, giving a schedule of the number required to supply not only the institutions in the United States, but also scientific societies and specialists at home and abroad.

	State library.	State university.	State agricultural college and experimental station.	State historical societies.	State academies of science.	Colleges.	Normal schools.	Depositories, not otherwise supplied.	Total.
Alabama.....	1	1	1	1		4	8	1	17
Arizona.....	1	0	0	0	0	0	1	0	2
Arkansas.....	1	0	1	0	0	4	1	2	9
California.....	1	1	(1)	0	1	11	3	5	22
Colorado.....	1	1	2	0	1	2		1	8
Connecticut.....	1	1	2	1	1	2	3	4	15
North Dakota.....	1	1		0	0	2	2	0	9
South Dakota.....	1	1	1	0	0			0	
Delaware.....	1	1	(1)	1	0			3	6
Florida.....	1	0	1	0	0	2	0	2	6
Georgia.....	1	1	4	1	0	6	0	8	21
Idaho.....	1								1
Illinois.....	1	1	1	1	1	27	4	12	48
Indiana.....	1	1	1	1	1	14	5	6	30
Indian Territory.....	1	0	0	0	0	0	0	0	1
Iowa.....	1	1	1	1	1	22	6	7	40
Kansas.....	1	1	1	1	1	12	2	5	24
Kentucky.....	1	1	(1)	1	1	14	0	3	21
Louisiana.....	1	2	(1)	1	1	9	3	2	19
Maine.....	1	0	1	1	0	3	6	2	14
Maryland.....	1	1	1	1	1	12	2	2	21
Massachusetts.....	1	1	1	1	1	9	10	11	35
Michigan.....	1	1	1	1	0	9	2	10	25
Minnesota.....	1	1	1	1	1	6	3	2	16
Mississippi.....	1	1	2	1	0	5	3	4	17
Missouri.....	1	1	2	1	1	16	6	9	37
Montana.....	1	1	0	0	0	0	0	0	2
Nebraska.....	1	1	(1)	1	0	6	2	3	1

	State library.	State university.	State agricultural college and experimental station.	State historical societies.	State academies of science.	Colleges.	Normal schools.	Depositories, not otherwise supplied.	Total.
Nevada	1	1	(1)	0	0	1	1	3	7
New Hampshire	1	1	(1)	1	0	0	2	3	8
New Jersey	1	1	1	1	0	3	4	7	18
New Mexico	1	1	0	1	0	2	0	0	5
New York	1	0	2	1	1	22	13	24	64
North Carolina	1	1	1	0	0	8	4	5	20
Ohio	1	1	(1)	1	0	35	12	11	61
Oregon	1	1	1	1	0	6	3	1	14
Pennsylvania	1	1	1	1	1	25	14	18	62
Rhode Island	1	1	1	1	0	0	1	3	8
South Carolina	1	1	1	1	0	7	4	5	20
Tennessee	1	1	(1)	1	0	18	5	5	31
Texas	1	1	(1)	0	0	7	4	7	20
Utah	1	1	0	0	0	0	0	0	2
Vermont	1	1	(1)	1	0	1	3	2	9
Virginia	1	1	3	1	0	7	2	3	18
Washington	1	1	0	1	0	2	0	0	5
West Virginia	1	1	(1)	1	0	2	6	2	13
Wisconsin	1	1	(1)	1	1	8	7	4	23
Wyoming	1	1	0	0	1	0	0	0	3
Total	48	42	36	33	17	345	157	207	891

List by institutions and scientific societies.

State and territorial libraries	48
State universities	42
Agricultural and mechanical college and agricultural experimental stations not otherwise supplied	36
State historical societies	33
State academies of science	17
Colleges, institutions for superior industry, all in the United States	360
State normal schools	157
Public depositories, not otherwise supplied	207
Schools of science, not otherwise supplied	20
Scientific societies, museums, etc., in the United States	125
Reserve, to supply public institutions not yet established	300
Important libraries in the United States, not otherwise supplied	100
Foreign government universities, scientific societies abroad, and specialists...	500
Press and exchange government	150
Scientific specialists, exchanges for specimens, etc	600
For use of museums, special applications, contingencies, etc., and good of the Museum	305
Total	3,000

The issue of the enlarged edition would begin with Vol. XIII of the "Proceedings" and with Bulletin 40 or 41.

When the question of the publication of the back volumes is considered,

Vols. I to IV of the "Proceedings" and Bulletins 1 to 16 may be regarded as published; although not to the extent to which it would seem desirable in the way of supplying local institutions. Of the following there are in hand enough to make a very fair distribution, viz: "Proceedings" Vol. X and XI, and "Bulletins" Nos. 33 to 37. Of Vols. V to IX of "Proceedings" and of Bulletins 17 to 32, however, no systematic publication can be made without the printing of an additional number of copies.

There are, apparently, three ways in which the necessities of the case may be met.

(1) For the Smithsonian Institution to assume the publication in the Miscellaneous Collections of all the volumes of the Proceedings up to Vol. XII and of the Bulletins up to No. 40. Then to close the series and to begin the publication of two new series of "Proceedings" and "Bulletin" with a new set of numbers, in each instance to begin with No. 1.

(2) For the Smithsonian Institution to publish Vols. V to IX of the "Proceedings," and "Bulletins" 17 to 32, to make as judicious as possible a distribution of the subsequent volumes, and to begin with the year 1890 the publication of two series, as already suggested.

(3) To ask Congress in 1890 to appropriate a sum sufficient to complete the back sets of the "Proceedings" from Vol. I to XII, and in 1891 to make a similar request for the printing of back numbers of the "Bulletin;" in each case, if possible, securing an edition of 3,000 copies.

Appended to this part of the report are three lists of institutions, and foreign and domestic libraries to which it is desired to send the future publications of the Museum.

This is, of course, independent of the lists of special institutions and of specialists, who are provided with papers relating to their own peculiar lines of work, and also of institutions or individual specialists and correspondents of the Museum, with whom exchange is in progress, since such lists are constantly varying.

PUBLICATIONS DURING THE YEAR.

Proceedings of the U. S. National Museum.—Vol. X of this series, for 1887, was issued in December, 1888, and contains viii+771 pages and 39 plates. The first signature of the volume printed in this year was No. 32 (p. 497). In Vol. X are included seventy-eight papers* by twenty-nine authors, ten of whom are officers of the Museum; namely,

*Subject.	Number of papers.	Subject.	Number of papers.
Birds	34	Fossil plants	1
Fishes	18	Recent plants	1
Marine invertebrates	9	Mineralogy	1
Insects	3	Osteology	1
Mammals	3	General natural history	1
Oology	2	Total	78
Mollusks	2		
Reptiles	2		

Messrs. Bean, Beckham, Bendire, Knowlton, Lucas, Rathbun, Ridgway, J. B. Smith, Stejneger, and True. The other nineteen are Messrs. Bollmann, Call, Cope, Eigenmann, Gilbert, Gill, Hay, Jordan, Kunz, Lawrence, Lesquereux, Lilljeborg, Linton, McNeill, Shufeldt, Townsend, Vasey, Zeledon, and Mrs. Elizabeth G. Hughes.

The Appendix contains (pp. 701-731) the "Catalogue of the Contributions of the Section of Graphic Arts to the Ohio Valley Centennial Exposition, Cincinnati, 1889," by S. R. Koehler, Curator of the Section of Graphic Arts in the National Museum. Nineteen signatures of Vol. XI, Proceedings of the National Museum for 1888, were received between November 8 and March 26, from the Government Printing Office.

Papers descriptive of exhibits in the Cincinnati Exposition.—Special papers, prepared by Mr. Frederick W. True, Mr. Thomas Wilson, Dr. Cyrus Adler, Mr. S. R. Koehler, and Mr. J. E. Watkins, and describing the exhibits of their departments in the Cincinnati Exposition, were received from the Public Printer in October.

Bulletin of the U. S. National Museum.—No. 33 of this series, entitled "Catalogue of Minerals and Synonyms Alphabetically Arranged for the Use of Students," by T. Egleston, Ph. D., was issued in April, 1889. The preparation of the catalogue was first undertaken with a view to using it in the arrangement of the mineral collections of the School of Mines of Columbia College, New York City, but the rapid growth of the collections impressed the author with the desirability of enlarging the scope of his labors so that it could be used generally in museum work. The catalogue contains 198 pages, the names of minerals being printed in double columns. This is the last bulletin of the Museum printed by the authority of the Secretary of the Interior Department. After the close of this fiscal year the Museum will, in accordance with the sanction of Congress, superintend the printing of its own publications and pay for them out of the special appropriation for that purpose.

Mr. A. Howard Clark has continued his duties as editor of Proceedings and Bulletin. In April, 1889, he was granted leave of absence, the President having commissioned him Assistant to the United States Commissioner-General to the Paris Exposition, and Mr. R. E. Earll was appointed to act as editor in his absence.

The Public Printer has courteously expressed his interest in the matter of improving the appearance of the Museum publications, and has permitted the use of a better quality of paper and of new type.

The manuscript for the following bulletins of the National Museum has been transmitted to the Government Printing Office on the dates mentioned:

Bulletin 34, "The Batrachia of North America," by E. D. Cope: April 11, 1887.

Bulletin 35, "Bibliographical Catalogue of the described Transformations of North American Lepidoptera," by Henry Edwards: February 25, 1889.

Bulletin 36, "A Review of the Family Delphinidæ," by Frederick W. True: February 25, 1889.

Bulletin 37, "Marine Mollusks of the Southeast Coast of the United States," by Wm. H. Dall : March 23, 1889.

Bulletin 38, "Deep-Sea Fishes of the Atlantic Ocean," by G. Brown Goode and Tarleton H. Bean : October 18, 1888.

In Section IV of the report will be found a list of the publications of the Museum during the year, as also a bibliographical statement of papers by officers of the Museum and by others whose writings are based upon Museum material. The authors of these papers are eighty-nine in number, thirty-five of whom are connected with the Smithsonian Institution and the National Museum. The papers number four hundred and eighty, and are distributed under the following subjects :

Subjects.	By Museum officers.	By other investigators.	Total.
Textiles	1	0	1
Ethnology	14	6	20
Antiquities	2	0	2
Anthropology	3	0	3
Astronomy	3	0	3
Mammals	7	1	8
Birds	23	39	62
Birds' eggs	6	0	6
Reptiles and Batrachians	0	16	16
Fishes	23	20	43
Mollusks	7	3	10
Insects	138	15	153
Invertebrates	1	2	3
Fossils	9	1	10
Plants	24	2	26
Mineralogy	4	0	4
Lithology and Physical Geology	18	0	18
Exploration	1	0	1
Chemistry	4	0	4
Metallurgy	4	0	4
Assyriology	7	1	8
Transportation and engineering	4	0	4
Graphic arts	5	0	5
Agriculture	7	0	7
Forestry	3	0	3
History	1	0	1
Genealogy	1	0	1
Photography	4	0	4
Osteology	4	3	7
Biography	13	0	13
General	29	1	30
Total	370	110	480

VISITORS.

During the year the total number of visitors to the Museum building has been 374,843, showing an increase of more than 125,000 over the total for last year, or a little more than one-half of the total number for last year, which was 249,665.

The total number of visitors to the Smithsonian building has been 149,130, an increase of nearly 47,000, or, in other words, of about two-fifths of the total number for last year, which was 102,863.

The monthly register, as kept by the door-keepers, is here recorded.

	National Museum building.	Smithsonian building.
1888.		
July	19,242	8,388
August	20,361	8,343
September	21,270	8,321
October	20,844	7,765
November	17,231	6,179
December	23,143	6,970
1889.		
January	23,287	7,916
February	24,485	8,223
March	128,750	64,553
April	27,925	7,848
May	26,314	7,159
June	23,991	7,429
Total	374,843	149,130
Approximate daily average	1,201*	478*

* Counting 312 days to a year.

The Inauguration ceremonies in March brought large numbers of visitors to the Museum. On March 2 and 5 the Museum and Smithsonian buildings were visited by no less than 106,070 persons, the number on March 5, being 56,567. On these days the Museum building was kept open from 8 a. m. until 5.45 p. m.

Table showing the number of visitors to the Museum and Smithsonian buildings since the opening of the former in 1881.

Year.	Museum building.	Smithsonian building.	Total num- ber of visitors to both buildings.
1881	150,000	(?)	150,000
1882	167,445	152,744	320,189
1883	202,188	104,823	307,011
1884	195,322	91,130	286,452
1885 (January to June)	107,363	60,428	167,793
1885-'86	174,225	88,960	263,185
1886-'87	216,562	98,552	315,114
1887-'88	249,665	102,863	352,528
1888-'89	374,842	149,130	523,973
Total	1,837,615	848,620	2,686,235

LECTURES AND MEETINGS OF SOCIETIES.

Following the custom of previous years, the use of the lecture hall has been granted by the Regents of the Smithsonian Institution for a series of lectures delivered under the joint auspices of the Anthropological, Biological, Chemical, National, Geographic, and Philosophical Societies of Washington.* The programmes of the two parts of the course are as follows :

PROGRAMME OF THE FIRST HALF OF THE COURSE.

Saturday, March 9, 4.15 p. m.—Prof. DANIEL C. GILMAN: Recent Aspects of University Education in this Country.

Saturday, March 16, 4.15 p. m.—Prof. W. O. ATWATER: The Composition of Our Bodies and Our Food.

Saturday, March 23, 4.15 p. m.—Mr. JOHN MURDOCH: Hunting and Fishing Among the Eskimos of Point Barrow.

Saturday, March 30, 4.15 p. m.—Mr. HENRY WETHERBEE HENSHAW: Who are the American Indians?

Saturday, April 6, 4.15 p. m.—Mr. G. K. GILBERT: The History of Niagara Falls.

PROGRAMME OF THE SECOND HALF OF THE COURSE.

Saturday, April 13, 4.15 p. m.—Dr. WASHINGTON MATTHEWS: The Catlin Collection of Indian Paintings. (Illustrated by colored-lantern slides.)

Saturday, April 20, 4.15 p. m.—Prof. E. S. MORSE: Art Hand-Works of Japan.

Saturday, April 27, 4.15 p. m.—Mr. W. E. CURTIS: The United States of Colombia.

Saturday, May 4, 4.15 p. m.—Mr. EVERETT HAYDEN: Tropical Cyclones; with Special Reference to the Recent Hurricane at Samoa. (Illustrated by colored lantern-slides.)

Saturday, May 11, 4.15 p. m.—Prof. W. B. POWELL: First Steps in Education, Psychologically Considered.

The following table shows the number and dates of "Saturday lectures" delivered up to the close of the 1888-'89 course:

Year.	Date of first and last lecture.	No. of lectures.
1882	March 11, April 29	8
1883	January 13, March 31	12
1884	January 5, April 26	17
1885	February 7, May 2	12
1886	March 6, May 8	10
1887	March 12, May 7	12
1888	February 18, May 5	12
1889	March 9, May 11	10
Total	93

On May 29, upon the request of the trustees of the Toner fund, Prof. Harrison Allen delivered a lecture in connection with the Toner course in the lecture hall of the Museum. The subject of the lecture was

* The joint committee on lectures is as follows: Dr. Robert Fletcher, chairman; Marcus Baker, Henry Gannett, C. Hart Merriam, and H. W. Wiley.

"Clinical study of the skull undertaken in connection with the morbid conditions of the jaws and nasal chambers."

During the year the following-named societies have, by permission, held meetings in the Museum lecture hall:

The National Dental Association met on July 24, 25, and 26. On the evening of September 20 was held one of the meetings of the Medical Congress. The American Ornithologists' Union held its sixth congress on November 13, 14, and 15. Meetings of the Department of Superintendence of the National Educational Association were held on March 6, 7, and 8. The National Academy of Science held its meetings on April 16, 17, and 18. The council of the American Geological Congress held business meetings on April 19. The American Historical Association held its fifth meeting in Washington during Christmas week; the evening sessions being held at the Columbian University, the morning sessions at the Museum.

STUDENTS.

Free access has as usual been given to students in the various branches of natural history. The Museum has also received valuable assistance from the volunteered co-operation of several specialists. In several instances special groups of objects have been studied and identified by naturalists, and in this way both they and the Museum have received benefit.

Ensign A. P. Niblack was assigned by the Secretary of the Navy to duty in the Smithsonian Institution on October 3, for the purpose of preparing a report on the Coast Indians of Alaska and Northern British Columbia. The report was made chiefly from notes taken by Ensign Niblack, in connection with the survey of Alaska, 1885-1887. This report was completed in time to include it as one of the special papers in the Museum report for last year.

Dr. C. Johnston, jr., of the Johns Hopkins University, has undertaken the study of a Persian Astrolabe, obtained by the Museum, and at the May meeting of the American Oriental Society presented a study, suggested by this instrument, entitled "The Chaldean Astronomy."

Dr. C. Hart Merriam, of the Department of Agriculture, has made extensive studies of the arvicoline mice in the collection of mammals, as well as of other groups of North American mammals.

Prof. D. K. Shute, of the Medical Department of the Columbia University, was afforded facilities for study in the laboratory of the Department of Comparative Anatomy, and free access to the study series of specimens.

A portion of the collection of batrachians was lent to Prof. E. D. Cope to aid him in completing the illustrations for his work on the Batrachia of North America, since published as Bulletin 34 of the National Museum.

Dr. John A. Ryder, of the University of Pennsylvania, has been en-

gaged in a study of the vertebral column, and in this connection pieces of the vertebral column of *Chimaera* were lent to him. Dr. Ryder has, in a letter dated April 11, 1889, stated that every step can now be traced of the process by which the axial column of vertebrata has become what it is in the highest types.

Messrs. Frank Burns and Charles B. Greene have, by permission of the Director of the U. S. Geological Survey, rendered valuable assistance by their studies of the collections of Tertiary Mollusks.

The collection of *Materia Medica* has been studied by several students of medicine in the District of Columbia.

Dr. J. A. Allen, of New York, Dr. P. L. Sclater, and Mr. Osbert Salvin, of London, Count von Berlepsch, of Münden, Germany, and several other active ornithologists, have received from the National Museum material to aid them in their studies of particular groups of American birds.

Dr. G. Baur, of Yale College, New Haven, Connecticut, has had for study a number of the Chelonians belonging to the Museum. The results of his studies have been published in Vol. XI of "Zoologischer Anzeiger," Vol. XXII of the "American Naturalist," Vol. III of "Annals and Magazine of Natural History," Vol. IX of "Biologisches Centralblatt," and Vol. XI of "Proceedings of the U. S. National Museum."

The undetermined Myriapoda in the collection of insects were sent to Mr. C. H. Bollmann, of Bloomington, Illinois, for study. The material in the genera *Oediomychis* and *Disonycha* were sent to Dr. George H. Horn, of Philadelphia, who is engaged in working up the genera of the *Halticidæ*. Capt. T. L. Casey, of New York City, is studying the Staphylinid group of beetles, and the Museum material in certain genera was sent to him for examination.

Prof. A. E. Verrill and Prof. S. I. Smith have continued their work upon the collections made by the U. S. Fish Commission, and for the present stored at the Peabody Museum of Yale College. Prof. Edwin Linton is studying the internal parasites of fishes collected chiefly by himself at Wood's Holl. Prof. Walter Faxou, of the Museum of Comparative Zoology, Cambridge, Massachusetts, has promised to report upon the cray fishes received since 1885, and Mr. J. Walter Fewkes has completed a paper on some of the Medusæ collected by the Fish Commission steamer *Albatross* in the region of the Gulf Stream. Prof. Leslie A. Lee, chief naturalist of the Fish Commission steamer *Albatross*, has assorted the collections made by that vessel during the voyage around South America, and several groups of marine objects have been sent, for study and report, to different naturalists. These are referred to at greater length in the report* of Mr. Richard Rathbun, curator of the Department of Marine Invertebrates. Dr. T. H. Bean, curator of Fishes, has rendered assistance to several students of ichthyology in this and other cities.

* See Section II.

Several students of taxidermy have received instructions from Mr. W. T. Hornaday.

PROPERTY, SUPPLIES, AND ACCOUNTS.

The following statement relating to cases and other furniture, and to the supplies, and accounts of the Museum, together with a list of employés for the fiscal year 1888-'89, has been prepared by Mr. W. V. Cox, chief clerk.

At the time of submitting the last report upon the finances of the Museum, the unexpended balance of the appropriation for preservation of collections, 1888, was \$239.11. Since then \$60 has been expended for specimens; \$9.38 for books; \$46.36 for travel, and \$122 for freight and cartage, leaving, May 1, 1890, an unexpended balance \$1.37.

The appropriations received by the Museum for the year ending June 30, 1889, are as follows: for preservation of collections, \$125,000; for furniture and fixtures, \$40,000; for heating and lighting, \$13,000.

PRESERVATION OF COLLECTIONS.

The following disbursements were made from the appropriation for preservation of collections for this year: \$108,650.65 was paid for salaries, or compensation; \$4,792.61 for supplies; \$1,638.92 for stationery; \$4,803.82 for specimens; \$1,573.68 for books, periodicals, etc.; \$643.05 for travel; \$2,759.04 for freight and cartage; making a total expenditure of \$124,861.77 to May 1, 1890, and leaving an unexpended balance of \$138.23 to meet outstanding liabilities.

The average amount paid on the monthly roll for this year is \$9,054.22; the smallest number of employés in any month is 130 for November, 1888; the largest, 167, in March, 1889, when extra service was required on account of the crowds of strangers visiting the Museum; the average number employed is 140.

FURNITURE AND FIXTURES.

From the appropriation for furniture and fixtures for the fiscal year ending June 30, 1889, the following amounts have been disbursed: \$17,664.30 has been paid for services; for exhibition and storage cases, with designs and drawings for the same, cabinets and storage bases, book-cases, unit tables and boxes, \$8,460.34; for fire-proof safe for disbursing clerk, \$412.12; frames, stands, double folding-screens, and miscellaneous wood-work, \$2,155.67; drawers, trays, and boxes, \$1,518.33; glass, \$989.19; metal work (iron, tin, brass, etc.) \$1,652.58; office furniture and chairs for halls, \$549.55; cages for living animals, \$160.80; glass jars and containers for specimens, apparatus, etc., \$695.41; cloth, plush, etc. (linings for cases), \$167.65; altering and re-enforcing cases, \$45; lumber, \$2,153.67; tools, hardware, and appliances, \$1,517.67; paints, oils, varnish, brushes, etc., \$865.86; slate, brick, stone, and plaster, \$543.61; rubber goods, \$421.88; traveling expenses, \$21.47, making a total of expenditures to May 1, 1890, of \$39,995.10, and leaving a balance of \$4.90 to meet bills yet outstanding.

The average amount paid this year on the monthly roll for furniture and fixtures is \$1,472.02. The greatest number of employes in any one month is 33; the smallest, 20; the average, 27. The highest salary is \$150, paid to the Engineer of Property; the lowest pay on this roll, to a cleaner of glass, is \$30; the average being \$54.18.

STANDARD CASES AND OTHER MUSEUM FURNITURE.

Among the various items of standard museum furniture there are none, perhaps, that fill the purpose for which they were designed more satisfactorily than the unit-tables, storage cases and drawers for the storage of specimens.

The standard round columns, which support forty-eight wing-frames, are of great utility where space is limited, since they admit of the display of a large superficial area (480 square feet) of drawings and other illustrations upon 35 square feet of floor space.

These facts seem to be recognized, as we have frequent requests from persons interested in museum administration in this and other countries for drawings of these styles of cases. To comply with such requests, cyanotypes and specifications showing the details of construction have been prepared by Mr. J. E. Watkins, the engineer of property, for transmission to applicants.

The following is a detailed list of cases, bases, frames, stands, apparatus, general appliances, fittings, etc., made or furnished during the year by persons outside the Museum:

Designs and drawings for cases	\$235. 00
10 mahogany double Liverpool cases	2,360. 00
20 mahogany unit-tables	2,500. 00
10 mahogany dwarf unit-tables	1,200. 00
1 addition to wall-case, E. S. Range	335. 00
1 pair mahogany bases for Liverpool cases	170. 00
1 mahogany Kensington case, Gray pattern	82. 24
1 mahogany shade for Liverpool case	54. 50
2 insect cabinets, twenty drawers each	250. 00
12 pine card catalogue cases	234. 00
5 pine standard book-cases	112. 50
150 mahogany case-heading frames	75. 00
25 mahogany double-folding screens	68. 75
2 mahogany quarter unit-tables	84. 00
36 pine double unit-boxes	61. 00
2 tin storage cases (for small mammals)	72. 50
1 pine storage case (for drawings)	49. 85
Re-enforcing and altering unit-table and slide-screen cases	45. 00
1 mahogany case for Japanese Kago	228. 75
1 mahogany case for elephant	107. 00
1 mahogany case for opossum group	95. 00
1 mahogany case for prairie-dog group	80. 00
1 mahogany case for cave-bear skeleton	76. 00
1 mahogany case for horn-bill group	53. 00
1 frame for metal-covered case	45. 00
1 fire-proof safe for disbursing clerk	412. 10

2 cages for living animals	\$160. 80
Frames, stencils, miscellaneous wood-work	1, 966. 92
Drawers, trays, boxes.....	1, 518. 33
Apparatus and photographic instruments	615. 21
Glass jars and vials	80. 20
Office furniture	395. 05
Chairs (for halls)	154. 50
Tools, hardware, and appliances.....	1, 517. 67
Lumber	2, 153. 67
Glass	989. 19
Paints, oils, varnish, and brushes	865. 86
Metal-work (iron, brass, tin, etc).....	1, 652. 58
Slate, brick, stone, and plaster	543. 61
Cloth, plush, etc. (linings for cases)	167. 65
Rubber goods	421. 88
Traveling expenses	21. 47

A detailed list is here given of cases, furniture, etc., which have been made or remodeled in the Museum work-shops during the year ending June 30, 1889:

11 mahogany pier cases (remodeled).	43 bases.
6 mahogany unit cases (remodeled).	4 pedestals.
1 mahogany alcove case (remodeled).	2 shields.
1 mahogany wall case (remodeled).	48 mahogany frames.
1 mahogany wall case (extended).	24 mahogany label frames.
6 mahogany slide-screen cases (remodeled).	20 pine frames.
2 mahogany cases (repaired).	3 oak frames.
2 large oak cases for domestic fowls (re- modeled).	1 ash frame.
1 pine wall case (remodeled and extended).	1 oak counter, with drawers and railing.
3 pine cases (remodeled).	2 large, double storm-doors.
1 pair of storm doors (remodeled).	13 index boxes.
5 pedestals (remodeled).	13 panels (to go between columns).
1 walnut corner book-case.	8 screens.
2 oak book-cases.	4 stands.
1 pine book-case.	2 diaphragms.
1 oak case, with desk.	1 sample unit-drawer.
1 cherry glazed case.	1 shelf stack.
1 sample card-catalogue case.	2 heavy pine tubs for trees and plants.
7 pine storage cases.	5 cages for living animals.
3 pine wall cases.	1 pen for deer.
1 half unit-table, with drawers.	1, 000 blocks, beveled.
1 pine sample case for new style drawer slides.	1 table for circular saw.
11 mahogany table-tops for bent-wood legs.	35 copper tanks.
	20 tin insect-boxes.

During the first half of the year ending June 30, 1889, the time of the Museum carpenters was occupied to a considerable extent in making much needed and important changes in different parts of the building, whereby the number of rooms which could be used for office work was increased, and the space available for study series of specimens, storage of books, documents, etc., largely extended.

Partitions were built in the third floor, northwest pavilion, and extra ceilings were put in; in the southeast pavilion a ceiling with flooring

above was built, thus giving an additional room for the accommodation of the Entomological Department. Much new shelving was put up in the different departments, the stationery room was re-arranged, new files and book-cases were built for the Department of the Library, and a large number of cases, bases, frames, pedestals, etc., was built and remodeled.

In various places repairs have been found necessary in the flooring of the Museum, on account of the dry rot, which is becoming so extensive as to be a serious detriment. The bases of the cases standing directly upon the floor have also been found to be so much injured by the prevailing dry rot as to make it necessary to raise them upon blocks, pending the time when the bottoms of the cases can be repaired and strengthened, and, when practicable each article permanently raised upon casters. In order to prevent so far as possible any accumulation of dampness, which might cause this decay, the trenches below the building have been thoroughly cleaned, and have received several coats of whitewash, but the fact that the floors throughout the building were laid in the damp concrete renders this precaution of little avail. It has, however, been taken every year since the Museum has been occupied.

HEATING AND LIGHTING.

The appropriation for heating and lighting for the fiscal year ending June 30, 1889, was \$13,000.

The services of telephone clerk, engineer and firemen for this year amount to \$5,435; \$4,188.43 has been spent for coal and wood; \$1,188.37 for gas; \$625.24 for electric work; \$800.16 for telephones; \$120 for rental of call boxes; \$638.81 for heating repairs; making a total of \$12,996.01, which leaves, May 1, 1890, an unexpended balance of \$3.99.

The average amount paid this year on the monthly roll for heating and lighting is \$453. The greatest number of employés in any month is 9; the smallest, 6; the average, 8. The highest salary is \$120, paid to the engineer; the salaries of telephone clerk and firemen being uniformly \$50; the average salary is \$59.08.

The number of telephone calls made during the year is 31,377.

ELECTRICAL SERVICE.

A change, which proves satisfactory, has been made in the electrical service, by substituting for the clocks formerly used others which are run by the Gardiner system, and which, being connected with the U. S. Naval Observatory, are automatically regulated each day at noon.

An important improvement in the engine-room has been the repairing of the boiler, many of the tubes of which had become defective by long use. New ones were obtained, and put into position by the regular firemen, who, being practical mechanics, were able to accomplish these repairs at a saving of a considerable expense to the Museum.

LIST OF MUSEUM EMPLOYÉS.

The following is a list of the employés of the U. S. National Museum, June 30, 1889, classified under the appropriation from which paid :

EMPLOYÉS PAID FROM "PRESERVATION OF COLLECTIONS" APPROPRIATION.

Name.	Occupation.	Name.	Occupation.
Adler, Cyrus	Assistant curator.	Harris, J. T.	Laborer.
Anderson, M. D.	Laborer.	Harris, H. E.	Do.
Ashley, W. M.	Watchman.	Hawley, E. H.	Preparator.
Ashford, E. W.	Copyist.	Hendley, J. W.	Modeler.
Bannister, W. F.	Laborer.	Hess, A. V.	Cleaner.
Bean, B. A.	Aid.	Hill, R.	Laborer.
Beard, N. C.	Attendant.	Hitchcock, R.	Curator.
Becker, E. J.	Type writer.	Holmead, C. H.	Watchman.
Berrea, Joseph	Skilled laborer.	Horan, Henry	Superintendent.
Bond, J. H.	Laborer.	Horan, J. H.	Watchman.
Bond, S. H.	Messenger.	Hornaday, W. T.	Chief taxidermist.
Brelsford, W. H.	Watchman.	Hough, Walter	Aid.
Brockett, Paul	Messenger.	Irvine, A. C.	Messenger.
Brown, J. H.	Watchman.	James, C. H.	Clerk.
Brown, S. C.	Registrar.	Jouy, P. L.	Aid.
Brown, A. H.	Preparator.	Kalb, C. S.	Preparator.
Buckner, Benjamin	Laborer.	Karr, W. W.	Disbursing clerk.
Burger, W. H.	Draughtsman.	Kenyon, C. P.	Skilled laborer.
Burnside, H. W.	Clerk.	Kimball, W. H.	Clerk.
Cahill, John	Laborer.	Koehler, S. R.	Curator.
Calvert, R. A.	Watchman.	Latham, S. E.	Copyist.
Chandlee, W. H.	Draughtsman.	Laws, John	Laborer.
Chase, William	Laborer.	Linell, M. L.	Aid.
Clark, A. Howard	Curator.	Lucas, F. A.	Assistant curator.
Cook, N. S.	Laborer.	Luscombe, C. R.	Skilled laborer.
Cooper, W. B.	Skilled laborer.	Lyles, Isaac	Laborer.
Cornell, May	Copyist.	Maione, F. E.	Attendant.
Cox, W. V.	Chief clerk.	Marbury, E. M.	Copyist.
Coyle, A.	Cleaner.	Marron, Thomas	Do.
De Ronceray, M. E.	Copyist.	Marshall, George	Preparator.
Dewey, F. P.	Curator.	Marshall, Henry	Taxidermist.
Diggs, C. W.	Messenger.	Mason, O. T.	Curator.
Diggs, M. S.	Copyist.	Merrill, G. P.	Do.
Dorsey, James	Laborer.	Merrimon, W. B.	Copyist.
Dunne, Peter	Watchman.	Montis, E. C.	Do.
Durand, John	Agent.	Moore, G. C.	Messenger.
Earl, R. E.	Acting curator.	Neale, G. C.	Laborer.
Ford, Patrick	Laborer.	Nelligar, T. S.	Watchman.
Forney, A. H.	Preparator.	Newhall, W. H.	Clerk.
Gallaher, K. A.	Copyist.	Noah, J. M.	Do.
Gallaher, L. B.	Clerk.	Palmer, Joseph	Modeler.
Gant, James	Watchman.	Palmer, William	Preparator.
Gatton, J. F.	Laborer.	Peck, F. H.	Watchman.
Geare, R. I.	Executive clerk.	Perkins, H. S.	Copyist.
Goode, G. Brown	Assistant Secretary.	Phillips, B. L.	Laborer.
Graham, R. D.	Skilled laborer.	Piper, M. A.	Attendant.
Gurley, R. R.	Aid.	Pollock, M. B.	Watchman.
Hargrove, J. O.	Messenger.	Posey, Kate	Cleaner.

EMPLOYÉS PAID FROM "PRESERVATION OF COLLECTIONS" APPROPRIATION—Cont'd.

Name.	Occupation.	Name.	Occupation.
Proctor, J. C	Preparator.	Stimpson, W. G	Aid.
Queen, F. D	Watchman.	Sullivan, Roger	Laborer.
Rathbun, M. J	Copyist.	Sweeny, T. W	Preparator.
Redman, G. F	Laborer.	Tabler, L. D	Type-writer.
Rembert, Esau	Do.	True, F. W	Curator.
Rheem, E. S	Copyist.	Turnbull, T. R	Clerk.
Rhees, W. J	Clerk.	Twine, David	Messenger.
Ridgway, R.	Curator.	Upham, E. P	Clerk.
Roan, Oliver	Laborer.	Wassem, Harriet	Attendant.
Rosenbush, C	Copyist.	Weeden, W. C	Watchman.
Scollich, J. W	Taxidermist.	White, George	Laborer.
Seadler, N. P	Clerk.	Whiting, E. E	Clerk.
Searsford, J. S	Do.	Wilson, J. F	Copyist.
Shindler, A. Z	Artist.	Woltz, G. W	Watchman.
Skinner, A	Watchman.	Wood, N. R	Assistant taxidermist.
Smillie, T. W	Photographer.	Wright, Clifford	Messenger.
Stejneger, L	Acting curator.	Wynne, I. M	Copyist.
Stewart, C. A	Assistant superintendent.	Yeates, W. S	Assistant curator.
Stimpson, H. B	Copyist.	Yeatman, M. A	Copyist.

EMPLOYÉS PAID FROM "FURNITURE AND FIXTURES" APPROPRIATION.

Atkinson, S. S	Copyist.	Ofutt, F. I	Painter.
Branson, J. W	Laborer.	Rabbitt, Charles	Do.
Burger, Peter	Skilled laborer.	Reed, R. L	Carpenter.
Bueching, H	Cabinet-maker.	Ryan, R. W	Do.
Coleman, J. M	Carpenter.	Saunders, Robert	Laborer.
Deamond, J. J	Laborer.	Scott, Charles	Do.
Field, G. W	Carpenter.	Thorn, A. B	Do.
Goldsmith, J. S	Clerk.	Thomas, W. R	Do.
Gregory, M. J	Cleaner.	Taylor, H. C	Do.
Haney, W. H	Carpenter.	Todd, E. R	Clerk.
Holton, John	Laborer.	Wallingsford, W. W	Painter.
Hoover, J. E	Skilled laborer.	Watkins, J. E	Engineer of property.
McClain, G. C	Laborer.	Woltz, C. A. D	Painter.

EMPLOYÉS PAID FROM "HEATING AND LIGHTING" APPROPRIATION.

Bardine, B. W	Fireman.	Stone, M. L	Telephone clerk.
Duly, A. A	Engineer.	Thomas, William	Fireman.
Hughes, Britton	Fireman.	Wood, J. W. H.	Do.

DETAILED LIST OF VOUCHERS FOR EXPENDITURES FOR PRESERVATION OF COLLECTIONS, 1888-'89.

No.	Items of expenditure.	Amount.	No.	Items of expenditure.	Amount.
1	A. S. McClain, services	\$5. 16	8	L. M. Cornwall, supplies	\$58. 53
2	Clifford Wright, services	15. 00	9	M. B. Pollock, services	19. 35
3	F. H. Burns, services	5. 25	10	Pay-roll, July, services	7, 811. 16
4	G. B. Goode, services	300. 00	11	George F. Pollock, services	3. 87
5	Joseph Mace, freight	75. 00	12	O. S. Florence, services	25. 50
6	John Durand, services	100. 00	13	Wm. Butterworth, services	30. 65
7	S. R. Koehler, services	180. 00	14	George K. Cherrie, services	9. 68

DETAILED LIST OF VOUCHERS FOR EXPENDITURES FOR PRESERVATION OF COLLECTIONS, 1888-'89—Continued.

No.	Items of expenditure.	Amount.	No.	Items of expenditure.	Amount.
15	Great Falls Ice Co., supplies.....	\$59.36	66	John Akhurst, supplies.....	\$6.25
16	Wm. Ballantyne & Son, books.....	7.20	67	J. Wallace, specimens.....	24.00
17	J. T. Varnell & Son, supplies.....	52.08	68	Bangs & Co., specimens.....	5.50
18	M. E. Mann, books.....	72.00	69	Hensel, Bruckman & Lorbacker, freight.....	6.69
19	M. J. Geare, services.....	2.09	70	S. E. Latham, services.....	9.68
20	National Press Intelligence Co., books.....	1.10	71	H. Baumgarten, stationery.....	14.55
21	Thomas Rowland, specimens.....	7.00	72	Adams Express Co., freight.....	22.10
22	B. W. Mitchell, services.....	16.94	73	George W. Knox, freight.....	30.51
23	Henry A. Clarke & Son, station- ery.....	.75	74	S. R. Koehler, services.....	180.00
24	Emile Garet, services.....	10.00	75	N. D. C. Hodges, books.....	3.50
25	W. H. Lowdermilk & Co., books..	14.00	76	Garden & Forest Publishing Co., books.....	4.00
26	Joseph Mace, freight.....	75.00	77	Bowers & Loy, books.....	30.70
27	Pay-roll, August, 1888, services...	8,415.81	78	Leggatt Bros., books.....	2.00
28	G. B. Goode, services.....	300.00	79	A. L. Shipman's Sons, stationery..	8.40
29	U. S. Express Co., freight.....	6.00	80	John Durand, services.....	100.00
30	Adams Express Co., freight.....	26.45	81	John G. Mongel & Co., stationery..	6.40
31	James Mooney, specimens.....	2.25	82	Wm. Ballantyne & Son, stationery..	65.35
32	George W. Knox, freight.....	36.90	83	F. W. Clark, specimens.....	4.00
33	Z. D. Gilman, supplies.....	14.73	84	Poole & Brooke, supplies.....	5.61
34	C. K. Worthen, specimens.....	11.50	85	C. F. Hunt, specimens.....	5.00
35	S. R. Koehler, services.....	180.00	86	L. M. Cornwall, supplies.....	65.88
36	Clifford Wright, services.....	15.00	87	North Distillery Co., supplies....	102.35
37	E. J. Lewis, supplies.....	2.00	88	R. F. Downing & Co., freight.....	20.81
38	Edward Philpott, services.....	2.42	89	Adams Express Co., freight.....	82.90
39	E. J. Pullman, supplies.....	18.30	90	G. P. Merrill, travel.....	209.08
40	Chas. Baum, supplies.....	2.73	91	Samuel Bond, stationery.....	1.50
41	Otis T. Mason, travel.....	27.03	92	Joseph Mace, freight.....	75.00
42	Browning & Middleton, supplies..	1.50	93	G. B. Goode, services.....	333.33
43	J. Kannofsky & Co., specimens.....	6.98	94	J. H. Hickcox, books.....	5.00
44	C. H. Pennypacker, specimens....	14.50	95	Pay-roll, October, 1888, services...	8,535.69
45	Joseph Ross, supplies.....	3.50	96	Henry Marshall, supplies.....	1.00
46	W. A. Schieffelin & Co., supplies..	3.30	97	National Press Intelligence Co., books.....	2.45
47	Ed. G. Rose, services.....	6.67	98	S. R. Koehler, services.....	100.00
48	W. H. Claggett, supplies.....	10.54	99	U. S. Express Co., freight.....	19.20
49	Lorraine Tracy, services.....	24.00	100	do.....	19.65
50	Ella Olmstead, services.....	15.00	101	Brentano's, books.....	1.50
51	Marie L. Crusor, services.....	15.00	102	Davies, Turner & Co., freight.....	22.42
52	L. M. Cornwall, supplies.....	63.31	103	Leggatt Bros., books.....	12.25
53	Stephenson's Express, freight.....	8.65	104	Great Falls Ice Co., supplies.....	46.56
54	Olive R. Bendz, services.....	33.33	105	W. H. Lowdermilk & Co., books..	3.00
55	John F. Paret, stationery.....	4.00	106	Poole & Brooke, supplies.....	5.72
56	Joseph Mace, freight.....	75.90	107	Wm. Wesley & Son, books.....	35.15
57	G. B. Goode, services.....	300.00	108	D. K. Varzhabedian, specimens....	60.00
58	Pay-roll, September, services.....	8,114.65	109	M. C. Flannery, freight.....	2.50
59	John Durand, services.....	100.00	110	Trübner & Co., books.....	4.48
60	Fred A. Schmidt, services.....	40.00	111	Wm. Wesley & Son, books.....	4.00
61	Great Falls Ice Co., supplies.....	59.84	112	H. Baumgarten, stationery.....	7.75
62	John Boyle, supplies.....	9.80	113	W. P. Hayden, specimens.....	10.00
63	Wyckoff, Seamans & Benedict, stationery.....	40.95	114	Rider & Addison, stationery.....	14.00
64	John B. Smith, travel.....	82.30	115	Pennsylvania R. R. Co., travel....	22.00
65	F. P. May & Co., supplies.....	8.50	116	W. H. Lowdermilk & Co., books..	15.00

DETAILED LIST OF VOUCHERS FOR EXPENDITURES FOR PRESERVATION OF COLLECTIONS, 1888-'89—Continued.

No.	Items of expenditure,	Amount.	No.	Items of expenditure.	Amount.
117	George W. Knox, freight.....	\$112.19	165	Great Falls Ice Co., supplies.....	\$41.60
118	A. L. Shipman's Sons, stationery..	12.00	166	Leslie A. Lee, specimens.....	16.10
119	Patrick & Carter, supplies.....	2.50	167	John C. Parker, stationery.....	4.50
120	National Disinfectant and Manu- facturing Co., supplies.....	14.00	168	A. H. Young, supplies.....	4.25
121	G. B. Goode, services.....	333.33	169	S. F. Ware, supplies.....	7.65
122	Joseph Mace, freight.....	75.00	170	W. F. Hillebrand, specimens.....	50.00
123	Pay-roll November, 1888, serv ^{ices}	8,399.12	171	W. C. Willenbacher, books.....	18.00
124	John Durand, services.....	100.00	172	George Ryneal, jr., supplies.....	4.50
125	Mutual District Messenger Co., services.....	3.60	173	J. Frank Eline, supplies.....	6.00
126	Ginn & Co., books.....	9.00	174	Z. D. Gillman, supplies.....	11.00
127	S. R. Koehler, services.....	100.00	175	Leggatt Bros., books.....	4.81
128	E. Morrison, stationery.....	77.61	176	Mutual District Messenger Co., services.....	1.95
129	Edward L. Wilson, books.....	2.50	177	W. W. Davies, specimens.....	2.50
130	Singleton & Fletcher, supplies....	3.00	178	E. J. Pullman, supplies.....	5.50
131	J. H. Mills & Co., supplies.....	4.80	179	J. W. Boteler & Son, supplies.....	3.50
132	Leggatt Bros., books.....	2.36	180	Photo-Engraving Co., supplies.....	1.50
133	Henry J. Green, supplies.....	49.25	181	W. H. Cullina, specimens.....	9.50
134	Arthur Stafford, stationery.....	11.30	182	O. T. Mason, travel.....	14.50
135	Wm. Ballantyne & Son, stationery	125.25	183	Joseph Mace, freight.....	75.00
136	Z. D. Gilman, supplies.....	19.96	184	G. B. Goode, services.....	333.33
137	Z. D. Gilman, supplies.....	24.30	185	Pay-roll, December, 1888, services.	8,189.73
138	George Ryneal, jr., supplies.....	11.44	186	J. T. Walker's Sons, supplies.....	2.40
139	George Ryneal, jr., supplies.....	111.96	187	J. W. Howell, specimens.....	25.00
140	J. S. Topham, supplies.....	6.25	188	S. R. Koehler, services.....	100.00
141	Charles Baum, supplies.....	1.28	189	S. R. Koehler (E. W. Jenkins), services.....	2.25
142	John C. Parker, stationery, \$1.50; supplies, \$20.....	21.50	190	Thomas Wilson (E. R. Reynolds), specimens.....	62.50
143	R. Friedländer & Sohn, books.....	58.73	191	John Durand, services.....	100.00
144	Henry Romeike, books.....	7.75	192	J. G. & J. M. Waters, supplies.....	5.75
145	W. U. Telegraph Co., services.....	14.72	193	G. W. Knox, freight.....	145.82
146	G. B. Goodé, travel.....	22.35	194	Foreign Express Co., freight.....	.75
147	Japanese Fan Company, speci- mens.....	1.50	195	Mutual District Messenger Co., services.....	4.00
148	W. A. Stearns, freight.....	2.93	196	W. U. Telegraph Co., services.....	2.73
149	Garden & Forest Publishing Co., books.....	1.30	197	do.....	3.60
150	Loren W. Green, specimens.....	10.00	198	H. L. Cranford, supplies.....	5.00
151	H. M. Dexter & Co., services.....	14.78	199	Adams Express Co., freight.....	62.80
152	Pennsylvania R. R. Co., travel.....	13.00	200	E. Morrison, stationery.....	66.52
153	N. H. Perry, specimens.....	12.00	201	Seaton Perry, supplies.....	1.75
154	Francis Miller, supplies.....	5.33	202	L. Schmid & Sons, supplies.....	29.89
155	L. M. Cornwall, supplies.....	70.02	203	L. D. Wilson, freight.....	2.50
156	Lorraine Tracy, services.....	13.50	204	L. Tracy, services.....	9.00
157	L. M. Cornwall, supplies.....	82.65	205	M. Joyce, supplies.....	13.50
158	M. F. Talty, supplies.....	95.00	206	Thomas Lee, specimens.....	75.00
159	John Durand, services.....	100.00	207	L. M. Cornwall, supplies.....	73.92
160	Chas. H. Joy, services.....	3.60	208	W. O. Atwater, services.....	15.00
161	Wyckoff, Seamans & Benedict, stationery.....	46.80	209	Mrs. E. S. Brinton, specimens.....	12.00
162	W. E. Evans, services.....	32.26	210	Lansburgh & Bro., supplies.....	2.62
163	Thomas Marron, services.....	1.50	211	B. C. Towne, specimens.....	4.00
164	J. T. Varnell & Son, supplies.....	153.84	212	G. B. Grinnell, specimens.....	55.30
			213	Moss Engraving Co., specimens....	2.59
			214	Lillian T. Doane, services.....	2.00

DETAILED LIST OF VOUCHERS FOR EXPENDITURES FOR PRESERVATION OF COLLECTIONS, 1888-'89—Continued.

No.	Items of expenditure.	Amount.	No.	Items of expenditure.	Amount.
215	Atlas Steamship Co., freight.....	\$5.00	265	W. S. Yeates, books.....	\$1.86
216	W. L. Dudley, supplies.....	2.50	266	I. F. Hill, freight.....	4.80
217	W. Brenninger, supplies.....	3.00	267	James M. Southwick, specimens..	15.39
218	Eagle Chemical Co., supplies.....	12.00	268	Snowflake Marble Co., specimens..	5.00
219	David Bruce, specimens.....	50.00	269	Paul A. Garey & Co., supplies.....	48.00
220	D. B. Dearborn, freight.....	75.48	270	Northern Distilling Co., supplies..	109.02
221	Thomas Wilson, supplies.....	18.96	271	J. Karr, specimens.....	10.00
222	J. G. and J. M. Waters, supplies...	5.75	272	Evening Star Newspaper Co., supplies.....	17.22
223	J. E. Watkins, specimens.....	3.00	273	Thomas Wilson, travel.....	83.10
224	H. M. Dexter & Co., services.....	16.08	274	Theod. Schuchardt, specimens.....	14.45
225	Great Falls Ice Co., supplies.....	82.24	275	Church & Stephenson, supplies...	7.00
226	W. T. Hornaday, travel.....	2.30	276	Joseph Mace, freight.....	75.00
227	Joseph Mace, freight.....	75.00	277	G. Brown Goode, services.....	333.33
228	W. Wesley & Son, books.....	41.21	278	Pay-roll, February, services.....	8,287.56
229	W. Wesley & Son, books.....	14.73	279	J. T. Walker's Sons, supplies.....	2.95
230	Mutual District Messenger Co., services.....	1.00	280	J. C. Parker, stationery.....	105.69
231	Anthropological Society, books...	3.00	281	H. Rosendale, supplies.....	3.00
232	White Brothers, specimens.....	1.00	282	C. Fisher, supplies.....	11.91
233	U. S. Express Co., freight.....	27.95	283	H. Baumgarten, stationery.....	19.00
234	S. A. Scudder, books.....	50.00	284	Adams Express Co., freight.....	12.15
235	Henry Romeike, books.....	9.60	285	L. Tracy, services.....	12.00
236	Daniel Shanahan, supplies.....	.54	286	F. A. Schmidt, stationery.....	7.02
237	G. Brown Goode, services.....	333.33	287	G. W. Knox, freight.....	82.63
238	Pay-roll, January, services.....	5,161.75	288	Henry Romeike, services.....	7.05
239	Adams Express Co., freight.....	12.05	289	W. U. Telegraph Co., services.....	.70
240	W. A. Boyd, books.....	20.00	290	Munn & Co., books.....	10.50
241	Wm. C. Robinson & Son, supplies.	3.25	291	A. E. Foote, books.....	5.00
242	Francis Miller, supplies.....	14.65	292	A. T. Wayne, specimens.....	4.25
243	W. H. Clagett, supplies.....	10.54	293	S. R. Koehler, services.....	100.00
244	S. R. Koehler, services.....	100.00	294	A. L. Shipman's Sons, stationery..	2.70
245	John Durand, services.....	100.00	295	L. W. Morris & Son, freight.....	1.86
246	R. Hitchcock, services.....	58.06	296	M. L. Linell, services.....	50.89
247	U. S. Express Co., freight.....	21.70	297	U. S. Express Co., freight.....	214.65
248	Judd & Detweiler, supplies.....	10.00	298	R. Hitchcock, services.....	150.00
249	E. G. Weeeler, supplies.....	18.00	299	John Durand, services.....	100.00
250	Wyckoff, Seaman & Benedict, sta- tionery.....	2.50	300	First Japan Manufacturing and Trading Co., specimens.....	302.80
251	Stephenson's Express, freight.....	11.40	301	Z. D. Gilman, supplies.....	26.30
252	L. M. Cornwall, supplies.....	52.74	302	Ed. Maybridge, books.....	241.00
253	J. E. Lucas, services.....	36.00	303	C. Becker, supplies.....	6.00
254	A. E. Foote, specimens.....	48.00	304	G. Ryneal, jr., supplies.....	10.97
255	S. Raymond Roberts, books.....	30.00	305	E. L. Greene, books.....	2.50
256	F. W. Devoe & Co., stationery.....	17.88	306	Poole & Brooke, supplies.....	31.36
257	Edw. L. Wilson, books.....	2.50	307	Great Falls Ice Co., supplies.....	28.56
258	W. U. Telegraph Co., services.....	1.74	308	N. P. Scudder, books.....	3.75
259	Mutual District Messenger Co., services.....	1.65	309	J. F. Paret, stationery.....	2.20
260	Pitt & Scott's Foreign Express, freight.....	10.75	310	H. Hoffa, stationery.....	1.25
261	Raoul Heilbronner, specimens....	174.76	311	Pay-roll, part of March, services..	40.50
262	George W. Knox, freight.....	22.87	312	L. M. Cornwall, supplies.....	42.17
263	Great Falls Ice Co., supplies.....	29.60	313	Charles Becker, supplies.....	17.79
264	Ermanno Loescher, books.....	8.40	314	F. P. Dewey, travel.....	40.40
			315	F. W. Christern, books.....	28.75
			316	C. H. Roberts, supplies.....	12.50

DETAILED LIST OF VOUCHERS FOR EXPENDITURES FOR PRESERVATION OF COLLECTIONS, 1888-'89—Continued.

No.	Items of expenditure.	Amount.	No.	Items of expenditure.	Amount.
317	H. H. & C. S. Brimley, specimens ..	\$7. 10	369	Moss Engraving Co., books	\$3. 00
318	W. F. Murphy's Sons, stationery..	28. 00	370	Robert Boyd, supplies.....	1. 00
319	Northern Distilling Co., supplies..	103. 73	371	Goldborough & Co., specimens...	18. 00
320	J. G. & J. M. Waters, supplies.....	4. 00	372	S. D. Peet, books	4. 00
321	Pay-roll, part of March, services ..	58. 87	373	S. F. Denton, services	1. 50
322	Sunday Herald, supplies	5. 52	374	J. E. Lucas, services	7. 00
323	Hardy du Dreneuf, specimens ...	20. 00	375	Great Falls Ice Co., supplies	30. 18
324	H. A. Ward, specimens.....	23. 70	376	A. E. Cooke, supplies.....	10. 00
325	John B. Smith, specimens.....	500. 09	377	B. Mooney, services	15. 00
326	G. W. Knox, freight	33. 00	378	F. H. Knowlton, services.....	70. 00
327	C. W. Sisson, specimens.....	5. 00	379	George W. Knox, freight.....	21. 35
328	F. A. Brockhaus, books.....	35. 40	380	F. Keppel & Co., specimens.....	51. 00
329	W. Engelmann, books	8. 23	381	F. B. Webster, specimens 75
330	W. Wosley & Son, books.....	13. 87	382	C. Schoenhof, supplies	4. 35
331	Joseph Mace, freight	75. 00	383	Dennison Manufacturing Co., sta- tionery.....	74. 24
332	Robert Saunders, services	15. 00	384	John Durand, services.....	100. 00
333	J. W. Branson, services	15. 00	385	W. Ballantyne & Son, stationery ..	48. 73
334	G. B. Goode, services.....	333. 33	386	W. H. Lowdermilk & Co., books ..	4. 50
335	Pay-roll, March, services.....	8, 884. 58	387	George Ryneal, jr., supplies	15. 25
336	S. H. Bond, stationery	1. 00	388	W. H. Butler, supplies	7. 60
337	Easton & Rupp, stationery	80. 23	389	Z. D. Gilman, supplies.....	16. 83
338	Pay-roll, special, services	76. 50	390	Adams Express Co., freight	13. 95
339	C. D. Walcott, specimens.....	73. 50	391	do	24. 55
340	S. R. Koehler, services	100. 00	392	L. Schmid & Sons, supplies	15. 15
341	E. N. Andrus, specimens	20. 00	393	U. S. Express Co., freight	41. 50
342	W. F. Hewett, supplies	18. 64	394	G. Kohn, specimens	3. 00
343	Thomas Dowling, specimens.....	2. 00	395	Mutual District Messenger Co., services.....	2. 00
344	F. Miller, supplies	2. 80	396	do	1. 30
345	Z. D. Gilman, supplies	11. 80	397	Brodix Publishing Co., books	2. 00
346	William Ballantyne & Son, sta- tionery	242. 31	398	J. B. Smith, services.....	97. 78
347	Charles Willoughby, specimens...	7. 12	399	M. B. Pollock, services	20. 00
348	J. T. Varnell & Son, supplies.....	101. 34	400	Samuel Harrison, services	15. 00
349	Mutual District Messenger Co., services	1. 45	401	H. M. Dexter & Co., services	17. 92
351	A. L. Shipman's Sons, stationery..	9. 00	402	H. C. Taylor, supplies	28. 92
351	J. B. Clayton, services.....	10. 00	403	J. C. Parker, stationery	33. 00
352	E. G. Wheeler, supplies	3. 00	404	F. A. Brockhaus, books	15. 25
353	George Ryneal, jr., supplies	6. 50	405	C. Wunderlich & Co., specimens..	117. 00
354	W. U. Telegraph Co., services.....	5. 71	406	J. J. Desmond, services	29. 33
355	Leggett Bros, books	3. 70	407	F. Meder, specimens	5. 50
356	L. M. Cornwall, supplies	53. 88	408	G. B. Goode, services.....	333. 33
357	Robert Saunders, services	15. 00	409	Joseph Mace, freight	75. 00
358	J. W. Bronson, services	15. 00	410	Pay-roll, April, services.....	8, 838. 95
359	P. L. Jouy, specimens.....	125. 00	411	S. R. Koehler, services	100. 00
360	Browning & Middleton, supplies..	5. 20	412	F. W. True, travel	19. 30
361	James H. McGill, supplies	1. 50	413	Church & Stephenson, supplies...	6. 00
362	L. Moxley, supplies	10. 60	414	Wesley & Son, specimens.....	126. 69
363	W. F. Murphy's Sons, stationery..	12. 50	415	H. A. Clarke & Son, supplies.....	80. 00
364	L. S. Foster, books	\$ 3. 00	416	William Taylor, specimens.....	11. 00
365	Westermann & Co., books 71	417	The Capital, supplies	4. 37
366	G. L. English & Co., specimens.....	11. 00	418	W. F. Hewett, supplies.....	31. 48
367	Henry Romeike, books	13. 30	419	E. Morrison, stationery	113. 54
368	M. Knuedler & Co., specimens	7. 30	420	L. Tracy, services.....	9. 00

DETAILED LIST OF VOUCHERS FOR EXPENDITURES FOR PRESERVATION OF COLLECTIONS, 1868-'89—Continued.

No.	Items of expenditure.	Amount.	No.	Items of expenditure.	Amount.
421	J. Benjamin Clayton, services.....	\$20.00	475	C. S. Bement, specimens.....	\$100.00
422	C. S. Kalb, services.....	8.33	476	G. L. English & Co., specimens....	26.50
423	T. O. Weigel, books.....	88.03	477	J. Elias & Son, specimens.....	1.25
424	B. F. Stevens, books.....	21.25	478	W. W. Adams, specimens.....	15.00
425	E. Loescher, books.....	8.40	479	W. H. Butler, supplies.....	.30
426	W. Wesley & Son, books.....	8.37	480	W. Ballantyne & Son, stationery..	38.20
427	Taylor & Francis, books.....	2.54	481	W. U. Telegraph Co., services....	2.70
428	Emil Soeding, books.....	2.00	482	J. H. Mills & Co., supplies.....	80.90
429	W. Ballantyne & Son, books.....	9.54	483	U. S. Express Co., freight.....	19.15
430	Great Falls Ice Co., supplies.....	32.93	484do.....	68.00
431	E. Steiger & Co., books.....	5.00	485	Lansburgh & Bro., supplies.....	4.25
432	J. Benisch, services.....	.25	486	Dennison Manufacturing Co.,sup- plies.....	140.63
433	Evening Star, books.....	1.58	487	H. Wunderlich & Co., specimens..	40.00
434	S. Raymond Roberts, books.....	10.00	488	E. E. Thompson, specimens.....	10.00
435	J. Durand, services.....	100.00	489	George Ryneal, jr., supplies.....	7.14
436	Chas. H. Arnold, services.....	1.00	490	E. Morrison, stationery.....	5.00
437	L. M. Cornwall, supplies.....	53.23	491	Mutual District Messenger Co., services.....	.40
438	L. Amateis, specimens.....	40.00	492	Henry Romeyn, specimens.....	30.00
439	Ed. W. Ashford, services.....	20.52	493	C. H. Worthen, specimens.....	22.75
440	Joseph Mace, freight.....	75.00	494	Brentanos, books.....	10.60
441	G. Brown Goode, services.....	333.33	495	G. Kohn, specimens.....	5.10
442	Pay-roll, May, services.....	8,533.11	496	L. Amateis, specimens.....	50.00
443	Edward Philpitt, services.....	16.13	497	L. Tracy, services.....	6.00
444	John Durand, services.....	100.00	498	C. C. Carroll, supplies.....	111.00
445	J. E. Giles, services.....	25.50	499	E. J. Pullman, supplies.....	260.17
446	B. & O. R. R., freight.....	1.47	500	Wyckoff, Seamans & Benedict, stationery.....	29.40
447do.....	3.18	501	Robert Boyd, supplies.....	1.00
448	S. F. Ware, supplies.....	24.87	502	G. E. Kennedy & Son, supplies....	.50
449	W. E. Stockett & Co., supplies....	2.75	503	M. A. Tappan, supplies.....	102.00
450	W. S. Thompson, supplies.....	4.50	504	O. T. Mason, travel.....	31.75
451	E. J. Lewis, supplies.....	1.75	505	Easton & Rupp, stationery.....	4.74
452	T. W. Sweeney, travel.....	3.65	506	T. M. Stoughton, specimens.....	150.04
453	Walter Hough, travel.....	3.65	507	C. H. Hitchcock, travel.....	6.00
454	S. R. Koehler, services.....	100.00	508	L. E. Rickæcker, specimens.....	7.40
455	W. F. Hewett, supplies.....	33.68	509	Joseph Welch, specimens.....	35.00
456	J. H. McGill, supplies.....	3.50	510	L. M. Cornwall, supplies.....	56.00
457	W. H. Clagett, supplies.....	10.54	511	J. G. and J. M. Waters, supplies..	11.50
458	J. C. Parker, stationery.....	31.11	512	Mutual District Messenger Co., services.....	1.40
459	E. Morrison, stationery.....	118.00	513	W. Ballantyne & Son, stationery..	16.93
460	R. G. Campbell, supplies.....	5.10	514	L. Schmid & Sons, supplies.....	9.60
461	C. Schneider, supplies.....	10.00	515	Great Falls Ice Co., supplies.....	38.30
462	C. H. Joy, supplies.....	1.25	516	W. U. Telegraph Co., services....	8.50
463	M. Lindsay, supplies.....	4.75	517	J. F. Eline, supplies.....	4.00
464	Adams Express Co., freight.....	35.45	518	W. S. Thompson, supplies.....	6.25
465	T. H. McAllister, specimens.....	13.50	519	G. B. Goode, services.....	333.33
466	H. Benton, specimens.....	25.00	520	John Durand, services.....	100.00
467	L. S. Foeter, books.....	2.35	521	S. R. Koehler, services.....	100.00
468	E. E. Thompson, specimens.....	30.00	522	S. R. Koehler, specimens.....	1.00
469	W. F. Murphy's Sons, stationery..	28.80	523	W. H. Nalley, services.....	41.00
470	A. S. Clark, books.....	.35	524	Joseph Mace, freight.....	75.00
471	John Russell & Son, specimens....	11.50			
472	Geo. W. Knox, freight.....	77.99			
473	J. L. Potter, specimens.....	25.00			
474	J. B. Lippincott Co., books.....	5.35			

DETAILED LIST OF VOUCHERS FOR EXPENDITURES FOR PRESERVATION OF COLLECTIONS, 1888-'89—Continued.

No.	Items of expenditure.	Amount.	No.	Items of expenditure.	Amount.
525	George Ryneal, jr., supplies.....	\$30.25	578	A. Boncard, specimens.....	\$62.80
526	H. Romeike, books.....	9.50	579	Rob. Kirmees, specimens.....	70.04
527	H. Reid, specimens.....	3.00	580	Paul Klincksaleck, books.....	4.54
528	John Wilson & Son, supplies.....	4.00	581	Robert Boyd, supplies.....	1.00
529	Pay-roll, June, 1889, services.....	8,328.54	582	J. H. Mills & Co., supplies.....	8.70
530	B. & O. R. R., freight.....	7.87	583	E. J. Pullman, supplies.....	21.64
531	... do.....	.72	584	Easton & Rupp, stationery.....	32.35
532	Missouri Pacific R. R., freight.....	3.29	585	F. A. Schmid, stationery.....	3.15
533	Union Pacific R. R., freight.....	11.14	586	G. C. McLean, travel.....	3.70
534	... do.....	1.10	587	L. Schmid & Sons, supplies.....	7.80
535	Southern Pacific R. R., freight.....	.92	588	Great Falls Ice Co., supplies.....	42.72
536	... do.....	10.19	589	Wm. Ballantyne & Son, stationery.....	1.23
537	J. C. Ergood & Co., supplies.....	9.70	590	Z. D. Gilman, supplies.....	46.51
538	L. Moxley, supplies.....	12.60	591	Adams Express Co., freight.....	22.00
539	Stephenson's Express, freight.....	4.45	592	Geo. L. English & Co., specimens.....	74.10
540	B. F. Jackson, specimens.....	2.50	593	Brentanos, stationery.....	.90
541	G. Kohn, specimens.....	2.00	594	Charles Becker, supplies.....	13.88
542	J. Büttikofer, specimens.....	30.00	595	George W. Knox, freight.....	27.00
543	C. F. Adams, specimens.....	50.00	596	W. F. Hewett, supplies.....	30.12
544	W. F. Hewett, supplies.....	14.14	597	H. M. Dexter & Co., services.....	18.89
545	G. W. Knox, freight.....	28.13	598	E. Morrison, stationery.....	1.30
546	Pennsylvania R. R. Co., freight.....	27.50	599	J. W. Beath, specimens.....	40.75
547	L. Amateis, specimens.....	17.00	600	F. A. Schneider, supplies.....	4.75
548	I. M. Wynne, services.....	18.67	601	H. Baumgarten, stationery.....	1.00
549	Adams Express Co., freight.....	38.30	602	W. Englemann, books.....	1.42
550	W. U. Telegraph Co., services.....	2.38	603	Dulan & Co., books.....	4.24
551	F. Meder, books.....	9.00	604	Erdman & Schaus, specimens.....	2.41
552	U. S. Express Co., freight.....	108.20	605	Thomas Laurie, specimens.....	5.82
553	Woodward & Lothrop, supplies.....	42.79	606	Rollin & Fenardent, books.....	5.04
554	M. J. Geare, services.....	38.86	607	R. Friedlander & Sohn, books.....	2.54
555	L. Tracy, services.....	6.00	608	W. Wesley & Son, books.....	23.30
556	Washington Post, supplies.....	10.50	609	Edw. Gerrard, specimens.....	152.21
557	W. S. Yeates, travel.....	58.44	610	C. Fischer, supplies.....	2.05
558	N. F. Hines, supplies.....	12.00	611	S. F. Ware, supplies.....	16.00
559	Church & Stephenson, supplies.....	6.00	612	M. Lindsay, supplies.....	1.25
560	Mrs. E. A. Bruff, specimens.....	129.00	613	U. S. Express Co., freight.....	9.55
561	A. E. Cooke, supplies.....	8.00	614	J. F. Eline, supplies.....	1.50
562	J. J. Decker, stationery.....	2.00	615	W. H. Harrover, supplies.....	1.15
563	Moss Engraving Co., supplies.....	77.00	616	Church & Stephenson, supplies.....	2.00
564	Mutual District Messenger Co., services.....	1.45	617	W. U. Telegraph Co., services.....	2.74
565	Library Bureau, stationery.....	.60	618	William Niven, specimens.....	38.45
566	F. W. Christern, books.....	1.35	619	O. T. Barron, specimens.....	5.00
567	E. D. Cope, specimens.....	11.00	620	George Ryneal, jr., supplies.....	.70
568	M. A. Tappan, supplies.....	4.20	621	Shepherd & Hurly, services.....	4.50
569	W. J. Topley, specimens.....	3.75	622	Wyckoff, Seamans & Benedict, supplies.....	2.40
570	L. M. Cornwall, supplies.....	49.75	623	E. Koch, books.....	10.00
571	Brentanos, books.....	6.30	624	F. C. Brown, services.....	60.00
572	W. Nailor, freight.....	28.50	625	Mrs. E. A. Bruff, specimens.....	50.00
573	Bonfile & Co., specimens.....	10.00	626	C. C. Carroll, supplies.....	57.00
574	J. J. Deasmond, travel.....	3.50	627	S. E. Cassino, books.....	2.50
575	H. Romeyn, specimens.....	10.00	628	Washington Critic Co., supplies.....	10.40
576	W. Wesley & Son, books.....	7.13	629	J. C. Parker, stationery.....	14.86
577	J. & A. Churchill, specimens.....	11.92	630	Wood & Forsyth, specimens.....	1.50

DETAILED LIST OF VOUCHERS FOR EXPENDITURES FOR PRESERVATION OF COLLECTIONS, 1888-'89—Continued.

No.	Items of expenditure.	Amount.	No.	Items of expenditure.	Amount.
631	Photo-Engraving Co., supplies ..	\$61. 06	649	Southern Pacific R. R., freight ..	\$2. 12
632	Moss Engraving Co., stationery ..	1. 00	650	...do	2. 12
633	Evening Star Co., supplies ..	12. 50	651	B. & O. R. R., freight ..	2. 15
634	J. G. & J. M. Waters, supplies ..	4. 00	652	...do 72
635	J. B. Kendall, supplies ..	1. 50	653	Chicago, Rock Island & Pacific R.	
636	M. Joyce, supplies ..	12. 00		R., freight ..	. 91
637	H. Harkness, supplies ..	. 70	654	...do	1. 78
638	Chapman & Taylor, stationery ..	. 10	655	W. H. Lowdermilk & Co., books ..	9. 05
639	A. C. Bancroft, freight ..	10. 63	656	Leggatt Brothers, books ..	5. 00
640	E. Godey, supplies ..	. 90	657	A. S. Clark, books ..	2. 65
641	Alaska Commercial Co., supplies ..	100. 68	658	P. L. Jouy, specimens ..	349. 15
642	Alaska Commercial Co., specimens ..	30. 50	659	Ashton Todd, books ..	3. 30
643	S. F. Peckham, specimens ..	23. 03	660	R. Hitchcock, specimens ..	200. 00
644	J. T. Durney, specimens ..	2. 35	661	Émile Deyrolle, supplies ..	13. 91
645	E. Rey, specimens ..	15. 68	662	George Bird Grinnell, specimens ..	65. 00
646	W. Wesley & Son, specimens ..	75. 83	663	Émile Deyrolle, specimens ..	169. 29
647	S. R. Sturdevant, specimens ..	12. 06	664	William Wesley & Son, books ..	259. 66
648	Southern Pacific R. R., freight ..	34. 50			

DETAILED LIST OF VOUCHERS FOR EXPENDITURES FOR FURNITURE AND FIXTURES, 1888-'89.

No.	Items of expenditure.	Amount.	No.	Items of expenditure.	Amount.
1	Pay-roll, July, 1888, services ..	\$1, 130. 03	28	Patrick & Carter, repairing engine ..	\$3. 75
2	C. H. Darcy, services ..	42. 00	29	Wood & Forsyth, label frames ..	9. 00
3	J. W. Duval, services ..	9. 00	30	Pay-roll, November, services ..	1, 362. 66
4	Church & Stephenson, lumber ..	185. 93	31	W. Bruce Gray, drawings for cases ..	170. 00
5	Pay-roll, August, 1888, services ..	1, 499. 00	32	John C. Parker, letter-press ..	8. 50
6	R. L. Reed, services ..	49. 00	33	John A. Baker, crank-wheel ..	3. 50
7	R. W. Ryan, services ..	60. 00	34	Woodward & Lothrop, plush ..	17. 00
8	Melville Lindsay, rubber stopples ..	23. 04	35	George Ryneal, jr., putty ..	1. 90
9	Excelsior Varnish Works, varnish ..	3. 00	36	E. E. Jackson & Co., stands ..	50. 00
10	W. J. Walker, services ..	16. 00	37	W. E. Gavit, racks ..	19. 20
11	Pay-roll, September, 1888, services ..	1, 526. 50	38	Elmer & Amend, rubber stopples ..	207. 60
12	F. P. May & Co., hardware ..	11. 06	39	George P. Clark, rubber truck-wheel bands ..	10. 66
13	D. Ballauf, wooden cylinders ..	5. 00	40	Hayward & Hutchinson, fire-set ..	10. 50
14	Church & Stephenson, lumber ..	156. 84	41	E. F. Brooks, lamp ..	11. 00
15	G. B. Clark & Son, slate ..	22. 75	42	Church & Stephenson, lumber ..	371. 39
16	E. G. Wheeler, cage ..	10. 00	43	H. Rosendale, hammers ..	4. 50
17	Fritz Noebe, services ..	12. 00	44	W. B. Moses & Son, desk ..	33. 00
18	L. R. Trembly, glass ..	15. 00	45	F. P. May & Co., hardware ..	54. 61
19	C. J. Fanning, slate-roofing armory ..	112. 09	46	Excelsior Varnish Works, hard-oil finish ..	11. 50
20	W. H. H. eke, plush ..	3. 00	47	T. H. McAllister, stereopticon ..	225. 00
21	B. H. Shoemaker, plate glass ..	26. 50	48	F. W. Devoe & Co ..	76. 80
22	Pay-roll, October, services ..	1, 830. 66	49	G. Ryneal, jr., glue, white lead, etc ..	26. 20
23	Julius Lansburgh, chairs ..	4. 50	50	Ross & Co., leus ..	268. 62
24	F. A. Bolt, posts ..	2. 50	51	Thomas Wilson, desk, case, and chair ..	45. 00
25	W. H. Douglass, hinges ..	209. 88	52	Thonet Bros., stand legs ..	86. 35
26	W. B. Williams, folding chairs ..	150. 00	53	F. Miller, turpentine ..	11. 75
27	F. A. Schneider, hardware, glue, etc ..	34. 50			

DETAILED LIST OF VOUCHERS FOR EXPENDITURES FOR FURNITURE AND FIXTURES, 1888-'89—Continued.

No.	Items of expenditure.	Amount.	No.	Items of expenditure.	Amount.
54	F. A. Schmidt, instruments.....	\$3.20	102	Pay-roll, February, services.....	\$1,514.45
55	H. J. Brown, brass tags.....	125.00	103	F. P. May & Co., hardware.....	85.53
56	Pay-roll, December, 1888, services.....	1,316.08	104	George N. Garrett, hardware.....	15.00
57	Charles Woodington, pedestal.....	25.00	105	M. Lindsay, hose.....	177.98
58	John Schmitt, insect boxes.....	110.00	106	Albert Martin, services.....	27.00
59	C. A. Schneider's Sons, iron beams.....	422.64	107	George A. Mills, folding screens..	68.75
60	Church & Stephenson, lumber.....	56.45	108	Smith & Wardwell, mirror.....	1.89
61	Robert Boyd, iron work.....	33.33	109	Excelsior Varnish Works, paints.....	47.00
62	T. H. McAllister, cylinders, signal-bells, etc.....	69.92	110	F. W. DeVoe & Co., paints.....	14.00
63	W. H. Butler, paints.....	55.35	111	W. E. Gavit, racks.....	38.40
64	Excelsior Varnish Works, paints.....	3.00	112	L. Schmid & Sons, wire supports..	17.50
65	J. Carbutt, negative films.....	13.68	113	William Busching, services.....	9.00
66	J. M. Lloyd, brick work.....	201.36	114	Church & Stephenson, lumber.....	279.55
67	Eimer & Amend, chemicals.....	14.11	115	C. Schneider, locks.....	45.00
68	Lansburgh & Bro., velvet.....	57.88	116	J. E. Watkins, travel.....	0.77
69	Whitall, Tatum & Co., glass.....		117	Z. D. Gilman, paints.....	49.15
			118	George Ryneal, jr., paints.....	40.50
			119	W. B. Moses & Son, desk.....	36.00

87	I. CORNEVILLE & CURRIE, iron work.....	9.70		UNION.....	209.00
85	Herring & Co., fire-proof safe.....	412.12	137	W. B. Williams, mat and chairs....	35.00
86	William Fisher, brass work.....	64.33	138	L. H. Schneider's Son, hardware.....	163.17
87	James Hughes, plastering.....	59.00	139	Jacob Naylor, iron-work.....	109.46
88	R. McCormick, services.....	15.00	140	Cincinnati Corrugating Co., iron..	3.00
89	Wyckoff, Seamans & Benedict, type-writer.....	85.00	141	E. G. Wheeler, lead.....	1.00
90	L. H. Schneider's Son, hardware.....	37.30	142	George Ryneal, jr., paints.....	37.75
91	F. W. De Voe & Co., paints.....	118.80	143	E. E. Jackson & Co., frames and blocks.....	45.00
92	Edw. Burroughs, services.....	42.00	144	E. E. Jackson & Co., blocks.....	6.00
93	Fritz Noebe, services.....	42.00	145	Wood Brothers, drawers.....	18.02
94	Charles Bergmann, services.....	9.00	146	F. W. DeVoe & Co., paints.....	6.75
95	L. H. Hopkins, pins.....	6.75	147	Robert Boyd, iron and tin.....	18.85
96	Charles Woodington, label frames.....	50.00	148	H. Hollander, spittoons.....	3.19
97	Curry & Burchette, wall case.....	235.00	149	F. P. May & Co., hardware.....	128.30
98	Church & Stephenson, lumber.....	270.10	150	G. A. Mills, mahogany tables.....	1,250.00
99	William Busching, services.....	42.00	151	Wood Brothers, drawers.....	154.50
100	Fritz Noebe, services.....	9.00	152	F. P. May & Co., hardware.....	25.16
101	V. E. Bardick, ladder.....	15.00	153	B. H. Shoemaker, plate-glass.....	172.72

DETAILED LIST OF VOUCHERS FOR EXPENDITURES FOR PRESERVATION OF COLLECTIONS, 1888-'89—Continued.

No.	Items of expenditure.	Amount.	No.	Items of expenditure.	Amount.
631	Photo-Engraving Co., supplies ..	\$61.06	649	Southern Pacific R. R., freight ...	\$2.12
632	Moss Engraving Co., stationery ..	1.00	650	do	2.12
633	Evening Star Co., supplies	12.50	651	B. & O. R. R., freight	2.15
634	J. G. & J. M. Waters, supplies	4.00	652	do72
635	J. B. Kendall, supplies	1.50	653	Chicago, Rock Island & Pacific R.	
636	M. Joyce, supplies	12.00		R., freight91
637	H. Harkness, supplies70	654	do	1.78
638	Chapman & Taylor, stationery ..	.10	655	W. H. Lowdermilk & Co., books ..	9.05
639	A. C. Bancroft, freight	10.63	656	Leggatt Brothers, books	5.00
640	E. Godey, supplies90	657	A. S. Clark, books	2.65
641	Alaska Commercial Co., supplies ..	100.68	658	P. L. Jouy, specimens	349.15
642	Alaska Commercial Co., specimens ..	30.50	659	Ashton Todd, books	3.30
643	S. F. Peckham, specimens	23.03	660	R. Hitchcock, specimens	200.00
644	J. T. Durney, specimens	2.35	661	Émile Deyrolle, supplies	13.91
645	E. Rey, specimens	15.68	662	George Bird Grinnell, specimens ..	65.00
646	W. Wesley & Son, specimens	75.83	663	Émile Deyrolle, specimens	169.20
647	S. R. Sturdevant, specimens	12.00	664	William Wesley & Son, books	259.66
648	Southern Pacific R. R., freight ..	34.50			

DETAILED LIST OF VOUCHERS FOR EXPENDITURES FOR PRESERVATION OF COLLECTIONS, 1888-'89—Continued.

No.	Items of expenditure.	Amount.	No.	Items of expenditure.	Amount.
665	Gustav E. Stechert, books	\$3.00	671	Ferris Bros., books	\$1.80
666	Gurney & Jackson, books	7.41	672	Gloucester Net and Twine Co.,	
667	Washington Post Co., supplies ..	11.00		supplies	60.50
668	E. Koch, books	4.83	673	F. A. Brockhaus, books	112.57
669	Alaska Commercial Co., specimens ..	180.00	674	A. Nacet, supplies	235.82
670	Wash. Nailor, services	1.50			
12	F. P. May & Co., hardware	1,526.50	39	George P. Clark, rubber truck-	
13	D. Ballauf, wooden cylinders	11.06		wheel bands	10.00
14	Church & Stephenson, lumber	5.00	40	Hayward & Hutchinson, fire-set ..	10.50
15	G. B. Clark & Son, slato	156.84	41	E. F. Brooks, lamp	11.00
16	E. G. Wheeler, cage	22.75	42	Church & Stephenson, lumber	371.39
17	Fritz Noebe, services	10.00	43	H. Rosendale, hammers	4.50
18	L. R. Trembly, glass	12.00	44	W. B. Moses & Son, desk	33.00
19	C. J. Fanning, slate-roofing armory ..	15.00	45	F. P. May & Co., hardware	54.61
20	W. H. Hueke, plush	112.00	46	Excelsior Varnish Works, hard-	
21	B. H. Shoemaker, plate glass	3.00		oil finish	11.50
22	Pay-roll, October, services	26.50	47	T. H. McAllister, stereopticon ..	225.00
23	Julius Lausburgh, chairs	1,830.66	48	F. W. Devos & Co	76.80
24	F. A. Belt, posts	4.50	49	G. Ryneal, jr., glue, white lead, etc	26.20
25	W. H. Douglass, hinges	2.50	50	Ross & Co., lens	268.62
26	W. B. Williams, folding chairs	209.88	51	Thomas Wilson, desk, case, and	
27	F. A. Schneider, hardware, glue,	150.00		chair	45.00
	etc	34.50	52	Thonet Bros., stand legs	86.35
			53	F. Miller, turpentine	11.75

REPORT OF ASSISTANT SECRETARY.

85

DETAILED LIST OF VOUCHERS FOR EXPENDITURES FOR FURNITURE AND FIXTURES, 1888-'89—Continued.

No.	Items of expenditure.	Amount.	No.	Items of expenditure.	Amount.
54	F. A. Schmidt, instruments.....	\$1.20	102	Pay-roll, February, services.....	\$1,514.45
55	H. J. Brown, brass tags.....	125.00	103	F. P. May & Co., hardware.....	85.53
56	Pay-roll, December, 1888, services.....	1,316.08	104	George N. Garrett, hardware.....	15.00
57	Charles Woodington, pedestal.....	25.00	105	M. Lindsay, hose.....	177.98
58	John Schmitt, insect boxes.....	110.00	106	Albert Martin, services.....	27.00
58	C. A. Schneider's Sons, iron beams.....	422.64	107	George A. Mills, folding screens.....	68.75
60	Church & Stephenson, lumber.....	56.45	108	Smith & Wardwell, mirror.....	1.89
61	Robert Boyd, iron work.....	33.33	109	Excelsior Varnish Works, paints.....	47.00
62	T. H. McAllister, cylinders, signal-bells, etc.....	69.92	110	F. W. DeVoe & Co., paints.....	14.00
63	W. H. Butler, paints.....	55.35	111	W. E. Gavit, racks.....	38.40
64	Excelsior Varnish Works, paints.....	3.00	112	L. Schmid & Sons, wire supports.....	17.50
65	J. Carbutt, negative films.....	13.68	113	William Busching, services.....	9.00
66	J. M. Lloyd, brick work.....	201.36	114	Church & Stephenson, lumber.....	279.55
67	Eimer & Amend, chemicals.....	14.11	115	C. Schneider, locks.....	45.00
68	Lansburgh & Bro., velvet.....	57.88	116	J. E. Watkins, travel.....	6.77
69	Whitall, Tatum & Co., glass bottles.....	17.70	117	Z. D. Gilman, paints.....	49.15
70	Melville Lindsay, rubber packing.....	2.60	118	George Ryneal, jr., paints.....	40.50
71	George P. Clark, casters.....	5.60	119	W. B. Moses & Son, desk.....	36.00
72	W. E. Gavit, brackets.....	29.50	120	F. P. May & Co., hardware.....	8.71
73	E. E. Jackson & Co., walnut rods.....	53.50	121	F. A. Schneider, hardware.....	45.22
74	Daniel Shanahan, paints.....	5.95	122	N. V. Randolph & Co., trays.....	518.12
75	Franklin & Co., lens.....	2.50	123	Charles Woodington, case.....	75.00
76	Pay-roll, January, services.....	1,516.60	124	Charles Becker, paints.....	20.71
77	F. A. Schneider, hardware.....	10.88	125	J. Lansburgh, desk, mats, etc.....	50.38
78	De Witt Wire Cloth Co., brass work.....	32.00	126	A. W. Martin, services.....	30.00
79	J. W. Barker, copper-tanks.....	62.50	127	Barber & Co., hardware.....	2.91
80	Francis Miller, paints.....	14.75	128	T. Somerville & Son, brass-work.....	4.04
81	E. E. Jackson & Co., blocks and pedestals.....	67.10	129	Pennsylvania R. R. Co., travel.....	2.00
82	Smith & Wardwell, mirror.....	1.89	130	J. T. Armstrong & Co., iron-work.....	77.95
83	George A. Mills, trays.....	128.10	131	H. P. Gilbert, paints.....	86.62
84	T. Somerville & Sons, iron work.....	3.46	132	Edward Burroughs, services.....	42.00
85	Herring & Co., fire-proof safe.....	412.12	133do.....	33.00
86	William Fisher, brass work.....	64.33	134	Pay-roll, March, services.....	1,593.58
87	James Hughes, plastering.....	59.00	135	F. Peterson, mat.....	4.00
88	R. McCormick, services.....	15.00	136	Curry & Burchette, catalogue cases.....	234.00
89	Wyckoff, Seamans & Benedict, type-writer.....	85.00	137	W. B. Williams, mat and chairs.....	35.00
90	L. H. Schneider's Son, hardware.....	37.30	138	L. H. Schneider's Son, hardware.....	163.17
91	F. W. De Voe & Co., paints.....	118.80	139	Jacob Naylor, iron-work.....	109.46
92	Edw. Burroughs, services.....	42.00	140	Cincinnati Corrugating Co., iron.....	3.00
93	Fritz Noebe, services.....	42.00	141	E. G. Wheeler, lead.....	1.00
94	Charles Bergmann, services.....	9.00	142	George Ryneal, jr., paints.....	37.75
95	L. H. Hopkins, pine.....	6.75	143	E. E. Jackson & Co., frames and blocks.....	45.00
96	Charles Woodington, label frames.....	50.00	144	E. E. Jackson & Co., blocks.....	6.00
97	Curry & Burchette, wall case.....	235.00	145	Wood Brothers, drawers.....	18.02
98	Church & Stephenson, lumber.....	270.10	146	F. W. DeVoe & Co., paints.....	6.75
99	William Busching, services.....	42.00	147	Robert Boyd, iron and tin.....	18.85
100	Fritz Noebe, services.....	9.00	148	H. Hollander, spittoons.....	8.19
101	V. E. Burdick, ladder.....	15.00	149	F. P. May & Co., hardware.....	128.30
			150	G. A. Mills, mahogany tables.....	1,250.00
			151	Wood Brothers, drawers.....	154.50
			152	F. P. May & Co., hardware.....	25.16
			153	B. H. Shoemaker, plate-glass.....	172.72

DETAILED LIST OF VOUCHERS FOR EXPENDITURES FOR FURNITURE AND FIXTURES, 1888-'89—Continued.

No.	Items of expenditure.	Amount.	No.	Items of expenditure.	Amount.
154	J. W. Barker, copper tanks	\$87. 50	200	George Rynceal, jr., white lead	\$20. 25
155	L. H. Schneider's Son, hardware	13. 17	201	Pay-roll, June, 1889, services	1, 351. 33
156	Wm. H. Butler, oils and brushes	48. 25	202	M. G. Copeland, awnings	24. 00
157	N. V. Randolph & Co., paper-trays	75. 81	203	James Hughes, plastering	125. 00
158	B. & P. R. R. Co., travel	7. 25	204	Chester Steel Casting Co., steel	100. 36
159	Pay-roll, April, 1889, services	1, 231. 08	205	F. H. Ganter, metal frame	20. 00
160	Church & Stephenson, lumber	333. 94	206	L. H. Schneider's Son, hardware	140. 95
161	Curry & Burchette, mahogany columns	950. 40	207	Woodward & Lothrop, cloth, sheet- ing, etc	69. 11
162	D. Shannahan, brushes	17. 51	208	Franklin & Co., engravers' loops	2. 50
163	G. A. Mills, mahogany tables	1, 250. 00	209	H. Rosendale & Co., tools	6. 75
164	Wood Brothers, unit drawers	429. 55	210	F. W. Pilling, cages	160. 80
165	Holbrook Brothers, plate glass	353. 09	211	H. Hoffa, stand	2. 00
166	Geo. A. Mills, mahogany cases	1, 200. 00	212	F. A. Belt, walnut	48. 75
167	J. B. Hammond, unit boxes	81. 00	213	George W. Dant, brick-work	23. 50
168	Pay-roll, May, 1889, services	1, 304. 33	214	The F. F. Adams Co., traps	9. 00
169	Church & Stephenson, lumber	92. 10	215	W. E. Gavit, brackets	306. 63
170	C. F. Carter & Co., hardware	12. 55	216	L. Schmid & Sons, wire frames	13. 00
171	F. A. Schneider, hardware	32. 03	217	Church & Stephenson, lumber	138. 09
172	F. P. May & Co., hardware	12. 50	218	Robert Boyd, metal work	118. 42
173	T. Somerville & Sons, brass	20. 81	219	E. J. Pullman, hawk-eye camera	25. 00
174	S. Corbett, tin storage cases	72. 50	220	L. H. Schneider's Son, hardware	28. 52
175	L. H. Schneider's Son, hardware	50. 93	221	W. Bruce Gray, drawings	65. 00
176	John Schmitt, insect cabinets	250. 00	222	Charles Becker, paint	4. 25
177	Wood Bros., book-cases	112. 50	223	M. W. Beveridge, pitchers, dusters, etc	13. 73
178	M. W. Beveridge, brushes, buck- ets, etc	118. 62	224	Barber & Ross, wire and tacks 70
179	Lansburgh & Bro., sheeting, etc	20. 66	225	Wood Bros., pine drawers	273. 90
180	William H. Butler, glazier's dia- mond and turpentine	23. 00	226	George White & Sons, machinists	10. 00
181	E. G. Wheeler, lead	4. 00	227	F. P. May & Co., hardware and metal	55. 74
182	G. A. Mills, mahogany table cases	84. 00	228	George Watts, dusters 75
183	S. Bache & Co., plate glass	247. 50	229	Thomas Somerville & Sons, brass- work	4. 10
184	E. J. Pullman, photo-outfit	49. 98	230	Belt & Dyer, walnut bird-stands	34. 10
185	Robert Boyd, hardware	3. 25	231	Wood Bros., pine drawers	140. 30
186	L. Eisinger, painting	4. 00	232	E. E. Jackson & Co., pine storage boxes	31. 00
187	Barber & Ross, tools	1. 95	233	E. G. Wheeler, old lead	2. 50
188	Yale and Towne Manufacturing Co., locks	8. 06	234	L. H. Schneider's Son, hardware	1. 55
189	E. E. Jackson & Co., mahogany case and pine case	156. 85	235	do	1. 65
190	B. H. Shoemaker, crystal and plate glass	157. 10	236	J. E. Watkins, travel	5. 45
191	Brock Bros, tin case	9. 55	237	F. P. May & Co., hardware	2. 00
192	J. Lansburgh, walnut desk	35. 00	238	Wood Bros., trays and drawers	205. 00
193	T. H. McAllister, photo-supplies	13. 13	239	W. Fisher, book-fasteners	14. 48
194	E. Miller, crystal glass	13. 50	240	J. M. Queen & Co., glass vials	42. 50
195	E. E. Jackson & Co., mahogany cases	2, 360. 00	241	E. E. Jackson & Co., cases	345. 50
196	E. E. Jackson & Co., mahogany cases	403. 75	242	E. E. Jackson & Co., case	45. 00
197	Church & Stephenson, lumber	220. 53	243	Thomas W. Smith, case	53. 00
198	G. A. Mills, repairs to irons and cases	20. 60	244	Chas. T. Carter & Co., solder	1. 50
199	W. H. Douglass, brass-work	8. 70	245	James W. Queen & Co., vials	20. 00
			246	George A. Mills, case	82. 24
				Total	39, 995. 10

DETAILED LIST OF VOUCHERS FOR EXPENDITURES FOR HEATING AND LIGHTING, 1888-'89.

No.	Items of expenditure.	Amount.	No.	Items of expenditure.	Amount.
1	Pay-roll, July, 1888, services	\$530.00	38	C. K. Ditto, services	\$15.00
2	Gas Company, gas	65.51	39	Pay-roll, March, services	425.00
3	Pay-roll, August, 1888, services	530.00	40	Wm. E. Hodge, coal	24.85
4	Gas Company, gas	70.64	41	Royce & Marean, electric work	7.24
5	Pay-roll, September, services	465.00	42	Mutual District Messenger Co., box rent	10.00
6	B. Brown, telephones	6.00	43	Gas Company, gas	109.13
7	Wm. E. Hodge, coal	2,930.15	44	A. H. Young, heating repairs	1.00
8	Gas Company, gas	80.88	45	Kennedy Bros., wood	13.00
9	T. Somerville & Sons, heating re- pairs	4.95	46	Samuel Emery, coal	2.00
10	W. C. Robinson & Son, oil	3.23	47	M. E. Pierce, telephones	4.00
11	A. H. Young, heating repairs	4.00	48	Chesapeake and Potomac Tele- phone Co., telephones	207.70
12	Pay-roll, October, services	465.00	49	Mutual District Messenger Co., box rent	10.00
13	Chesapeake and Potomac Tele- phone Co. telephones	178.86	50	do	10.00
14	Gas Company, gas	93.64	51	Pay-roll, April, services	425.00
15	Pay-roll, November, services	465.00	52	Gas Company, gas	102.26
16	Mutual District Messenger Co., box rent	20.00	53	William E. Hodge, coal	998.35
17	W. E. Hodge, coal	51.39	54	A. B. Smith, wood	6.20
18	A. B. Smith, wood	12.00	55	Pay-roll, May, 1889, services	425.00
19	Royce & Marean, electric work	40.00	56	T. Somerville & Sons, heating re- pairs85
20	Mutual District Messenger Co., box rent	10.00	57	Gas Company, gas	79.14
21	Gas Company, gas	107.88	58	Mutual District Messenger Co., box rent	10.00
22	Pay-roll, December, services	465.00	59	John K. Ward, heating repairs	153.05
23	Mutual District Messenger Co., box rent	10.00	60	Mutual District Messenger Co., box rent	10.00
24	Gas-Light Company, gas	123.88	61	F. Miller, heating repairs	1.25
25	Mutual District Messenger Co., box rent	10.00	62	W. W. Tupper & Co., heating re- pairs	200.00
26	Pay-roll, January services	425.00	63	Pay-roll, June, 1889, services	375.00
27	T. Somerville & Sons, heating re- pairs	20.87	64	J. C. Ergood & Co., oil	5.04
28	Arthur B. Smith, wood	40.00	65	Gas Company, gas	77.26
29	Gas-Light Company, gas	145.89	66	Mutual District Messenger Co., box rent	10.00
30	Chesapeake and Potomac Tele- phone Co., telephones	201.60	67	Chesapeake and Potomac Tele- phone Co., telephones	200.00
31	Mutual District Messenger Co., box rent	10.00	68	Browning & Middleton, candles	1.10
32	W. C. Lewis & Co., heating repairs	22.75	69	Royce & Marean, electric bell, etc.	11.00
33	W. E. Hodge, coal	110.49	70	T. Somerville & Sons, heating re- pairs	19.61
34	Pay-roll, February, services	425.00	71	Jno. K. Ward, heating repairs	183.33
35	Gas Light Company, gas	132.26	72	E. F. Brooks, glass globes, etc.	11.00
36	M. E. Pierce, telephones	2.00	73	Royce & Marean, electric work	567.00
37	T. Somerville & Sons, heating re- pairs	6.76		Total	12,996.01

CORRESPONDENCE AND REPORTS.

This department of the administrative work is under the charge of Mr. R. I. Geare, executive clerk.

The office force includes a stenographer, a type-writer, an indexer, a record clerk, and a messenger.

There has been prepared for the signature of the Secretary of the Smithsonian Institution and of the Assistant Secretary in charge of the Museum, 5,349 official papers, including 2,323 letters on miscellaneous Museum matters; 263 reports on material transmitted for examination; 1,138 acknowledgments of specimens given or lent to the Museum; 374 letters transmitting specimens to museums, colleges, schools, and individual investigators. In addition, nearly a thousand letters in regard to Museum publications have been written.

A special feature of the Museum correspondence is in connection with requests for technical information upon various subjects. The letters prepared in reply usually embody data supplied by the curators to whom the letters have been referred.

For the benefit of persons interested in the details of the administrative work of the Museum, as well as for the purpose of placing them on record for reference in future years, the following statement of the contents of letters asking for information, received during the year, has been prepared by Mr. Geare. It is needless to say that the publication of the details of office business in such minuteness will not form a regular feature of the Museum report.

STATEMENT OF LETTERS ASKING FOR INFORMATION.

- ABBOTT, Dr. C. C. (Trenton, New Jersey), having found the young of the genus *Tylosurus* in the Delaware River, desires to know if their occurrence in those waters is common.
- ADAIR, J. M. (Glen Ella, Louisiana), sends description of a coin and desires information concerning it, also an opinion as to its value.
- ALGER, Mrs. C. J. (Burlington, Vermont), desires information regarding the occurrence of rust on small fruits.
- ALLEN, J. C. (White Gate, Virginia), sends description of a fossil for determination of the species.
- ALLEN, RICHARD (Hartford City, Virginia), desires information concerning the bibliography of the Stone Age in New Jersey.
- AMERICAN CARBONATE COMPANY (New York City), makes inquiry regarding the occurrence of magnesite in large masses.
- ANDERSON, Dr. JOHN J. (Brooklyn, New York), desires to be informed where photographs of certain ruins in Arizona may be obtained; also as to the origin of the name "Montana" as applied to the Territory.
- ARNETTE, A. R. (Gaylord, Virginia), makes inquiry in reference to the bibliography of Herpetology.
- AUSTIN, W. W. (Palmyra, New York), desires information regarding the publications of the International Congress of Anthropology, held in June, 1888.
- BALDWIN, Miss ANNIE F. (Cincinnati, Ohio), desires to be informed as to the commercial value of certain minerals, and where they may be obtained.

- BANGS, C.** (Wolverton, Minnesota), sends sketch of a stone implement concerning which he desires information.
- BARTOW, Miss EMILY** (Rock Creek, Wyoming), asks for information concerning the Yellowstone National Park.
- BATEMAN, GEORGE W.** (Cincinnati, Ohio), makes inquiry regarding the bibliography of African exploration.
- BELELING, A. H.** (Florence, Alabama), desires a determination of a fossil plant from a description of the same which he sends.
- BENEDICT, W. H.** (Port Henry, New York), desires information regarding crustacean tracks in Potsdam sandstone.
- BENZON, HANS** (Indianapolis, Indiana), desires to know where he may sell to the best advantage a collection of bird eggs, also an opinion as to the value of the same.
- BIBB, W. C.** (Montgomery, Alabama), seeks information concerning the technology of petroleum and the petroleum products.
- BLACKMAR, F. W.** (Johns Hopkins University, Baltimore, Maryland), desires reference to a book treating of the scope and finances of the Smithsonian Institution.
- BLANKINSHIP, J. W.** (Drury College, Springfield, Missouri), seeks information regarding mounds and "Mound Builders."
- BODECKER, J. K.** (Williamsport, Pennsylvania), makes certain inquiries concerning Government publications.
- BORS, CHRISTIAN** (Royal Swedish and Norwegian Consulate, New York City), inquires where skins of the Musk Ox may be obtained.
- BOURNE, GEORGE S.** (South Hutchison, Kansas), seeks information in reference to mushrooms.
- BOYER, H. S.** (Sunbury, Pennsylvania), desires information regarding a two-headed snake.
- BROWN, C. A.** (Honolulu, Hawaiian Islands), desires reference to an account of a species of mullet occurring in the Gulf of Mexico; also sends photograph of a fish for determination of the species.
- BROWN, Rev. H. M.** (East Aurora, New York), desires information regarding a coin, an electrotype copy of which he sends.
- BROWN, M. E.** (Orange, New Jersey), makes inquiries regarding musical instruments.
- BROWNE, F. C.** (Framingham, Massachusetts), desires information concerning a prehistoric stone implement, a plaster cast of which he sends.
- BRUMBAUGH, G. M.** (Normal College, Huntingdon, Pennsylvania), makes inquiry concerning cases and boxes used in the Museum for the display of mineralogical collections.
- BUGBEE, EDWARD B.** (Los Angeles, California), desires reference to a work on Ornithology that will assist him in determining the birds of his locality.
- BURROWS, D. B.** (Malvern, Arkansas), asks the title of a publication relating to the birds of Arkansas.
- BURT, R. C.** (Chatham, Ontario), makes inquiries concerning Government publications.
- BUTTON, Miss SUSAN S.** (Litchfield, Ohio), seeks information regarding the value of coins and other currency.
- CALLENDER, ALEXANDER** (Eureka, Illinois), desires information concerning a coin, a description of which he sends.
- CANTWELL, Lieut. JOHN O.** (U. S. Revenue Marine Service), makes inquiry regarding the composition of certain specimens of supposed jade.
- CHAMBERS, WARREN** (Chicago, Illinois), asks questions regarding the longevity of toads and as to the credibility of accounts of their having been found alive incased in solid rock.
- CHITTENDEN, C. E.** (Scranton, Pennsylvania), asks an opinion as to the use of a stone implement, a sketch of which he transmits.

- CHRISTIAN, THOMAS** (Richmond, Virginia), makes inquiry as to the most effectual method of arranging arrow-heads for purposes of exhibition.
- CLARKE, T. D.** (Seattle, Washington), asks for information regarding the cultivation of oysters.
- COCKERELL, THEODORE D. A.** (West Cliff, Colorado), sends an impression of markings upon a knife found near West Cliff, with a request that they be deciphered.
- COOPER, B., Jr.** (Wheeling, West Virginia), desires information regarding a colonial note, a description of which he sends.
- COOPER, BARKLEY** (Wheeling, West Virginia), desires information concerning organization of Museum work in connection with the Smithsonian Institution.
- COWLES, Rev. SYLVESTER** (Randolph, New York), asks information concerning a stone implement, a sketch of which he transmits.
- COX, PHILIP** (Newcastle, New Brunswick), makes inquiry as to the most effectual method of collecting and preserving fish, and concerning the bibliography of Ichthyology.
- CURTIN, PATRICK** (Grangeville, Idaho), seeks information regarding certain impressions on rocks, a description of which he sends.
- DAVIS, J. A.** (Eureka, Illinois), desires information regarding a coin, a photograph of which he transmits.
- DECKER & BONITZ** (Philadelphia, Pennsylvania) desire to be informed where pure gypsum may be obtained in large quantities.
- DENISON, H. R.** (Platteville, Wisconsin), desires information regarding a stone implement, a photograph of which he sends.
- DEVVAULT, J. J.** (Seattle, Washington), transmits a coin for determination.
- DEVRON, Dr. G.** (New Orleans, Louisiana), desires a translation of an inscription on a tombstone, a photograph of which he transmits.
- DOBLE, ARTHUR** (Toronto, Canada), desires reference to a book relating to Alaska.
- DODGE, CHARLES K.** (Port Huron, New York), desires reference to some work on the grasses and sedges of the United States.
- DRESSER, WILLIAM** (Santa Ana, California), desires information regarding the phenomena of putrefaction.
- DUMBLE, Dr. E. T.** (Austin, Texas), desires information as to the cost of cases used for exhibition and storage purposes in the Museum.
- DUNN, W. S.** (Washington, District of Columbia), inquires as to the rapidity of growth in turtles.
- DYER, Lieut. G. L., U. S. Navy** (Hydrographic Office, Navy Department), inquires as to the density of water in certain harbors, and as to the surface tension of certain liquids.
- EARLE, EDWARD M.** (Malvern P. O., Jamaica), makes inquiry regarding the preservation of fish for purposes of study.
- EDGERTON, Hon. A. P.** (Hicksville, Ohio), for D. W. H. Howard, of Winameg, Ohio, makes inquiries regarding prehistoric stone implements.
- EMERSON, Mrs. ELIZABETH** (Palma Sola, Florida), desires the determination of a shell from a description which she sends, also an opinion as to its value.
- FAIN, W. J.** (Dallas, Georgia), sends description of a stone, and inquires as to the probability of its containing diamonds.
- FOOTE, KATE** (Guilford, Connecticut), desires information regarding the looms used by the Indians of Alaska in weaving blankets.
- FRASER, W. LEWIS** (Century Company, New York City), makes inquiry regarding the existence of structures analogous to the Irish round towers in the cañons of the western United States.
- FULFORD, R. H.** (Cincinnati, Ohio), seeks information regarding the domestication and hybridization of the American bison.
- GALLINAN, GUSTAVE W.** (Columbus, Ohio), desires information in reference to cork and pins for mounting insects for purposes of exhibition.

- GARNER, J. P.** (Linwood, Maryland), makes inquiry regarding the geological characteristics of Maryland.
- GARNER, R. L.** (Norfolk, Virginia), desires information regarding certain archaeological objects in the Museum.
- GIBBS, Dr. MORRIS** (Kalamazoo, Michigan), desires information regarding a tooth, a sketch of which he transmits.
- GILFRY, HENRY H.** (Washington, District of Columbia), makes inquiries regarding locked elk-horns.
- GNIFFKE, HENRY B.** (Florence, Alabama), desires information regarding the production of asphalt in the United States.
- GOINS, ALFORD** (Prides P. O., Alabama), desires information regarding rocks, sketches of which he sends.
- GOODE, JAMES S.** (Springfield, Ohio), asks for information regarding the cultivation of fish.
- GOODHUE, F. D.** (Cincinnati, Ohio), desires information regarding basket work among the American Indians.
- GOULD, A. C.** (Boston, Massachusetts), desires certain information regarding fish and game laws in the District of Columbia.
- GRADY, W. C.** (Richmond, Virginia), asks for the determination of a bird from a description which he sends.
- GRAVES, W. H.** (Kingman, Kansas), desires information regarding the technology of the salt, sugar, paper, and linseed-oil industries.
- GREEN, LOREN W.** (Charlestown, New Hampshire), makes inquiry regarding the skinning of small mammals.
- GRINNAN, A. G.** (Madison Mills, Virginia), desires the address of some specialist in cryptogamous botany.
- GROW, Mrs. GEORGE** (Plainsfield, Wisconsin), makes inquiry regarding the varieties of Asiatic, or so-called "German," carp.
- GUESDE, Mons. L.** (Point-a-Pitre, Guadeloupe), inquires where specimens of *Scarabeus hercules* may be obtained.
- HAFELFINGER, FRED.** (Washington, District of Columbia), desires information regarding an old guitar in his possession.
- HAYDEN, H. B.** (Raton, New Mexico), inquires as to the commercial value of agatized bone.
- HEDRICK, Rev. JOHN T., S. J.** (Woodstock College, Howard County, Maryland), desires certain information for his guidance in making exchanges of entomological material.
- HICKMAN, THOMAS** (Mount Jackson, Virginia,) desires information regarding a coin, a description of which he sends.
- HIGHT, JAMES L.** (Dallas, Georgia), requests an opinion as to the value of a stone implement, which he describes.
- HILL, JOHN W.** (Symsonia, Kentucky), requests an opinion as to the value of certain coins.
- HISS, P. H., jr.** (Baltimore, Maryland), asks information regarding the preservation of fish for purposes of study.
- HOLMES, Prof. J. A.** (University of North Carolina, Chapel Hill, North Carolina), asks what methods have been adopted by the Museum in labeling its exhibition series of minerals.
- HOPKINS, G. F.** (Minneapolis, Minnesota), makes inquiry regarding the genealogy of the Hopkins family.
- HOWARD, D. W. H.** (Winameg, Ohio), through Hon. A. P. Edgerton, of Hicksville, Ohio, makes inquiries regarding prehistoric stone implements.
- HULCEE, Dr. H. J.** (Louisville, Kentucky), desires the name of a fish, a description of which he sends.
- HUNT, A.** (Knickerbocker Ice Company, Philadelphia, Pennsylvania), desires information regarding asbestos.

- HUTSON, GEORGE (Morganfield, Kentucky), desires information regarding a rock supposed to contain fossil remains, a description of which he sends.
- JACKSON, WILLIAM H. (Pigeon Cove, Massachusetts), sends drawing of a skull, probably of a species of whale, regarding which he desires information.
- JARDIN, E. (Brest, France), makes inquiries regarding the flora of the Arctic regions of America; also in regard to Arctic explorations.
- JARRETT, W. E. (Edwards Station, Kentucky), desires information in regard to a coin, a description of which he sends.
- JOHNSON, H. D. (Collegiate Institute, Strathroy, Ontario), desires information regarding a plant which he describes.
- JUILLERAT, CHARLES E. (New York City), desires an opinion as to the value of a book which he describes.
- KEKNEY, HOSIER (Breckenridge, Missouri), desires information regarding the coloring of beverages.
- KELLEY, GEORGE (Santa Ana, California), makes inquiry regarding the Museum system of labeling shells.
- KING, Rev. JOSEPH E., D. D. (Fort Edward, New York), desires information regarding fish-culture.
- KNOX, JOSEPH J. (Philadelphia, Pennsylvania), desires information regarding an albino bird which he describes.
- KOHLER, A. (Elgin, Illinois), makes inquiries in regard to the bibliography of Euto-mology.
- KONOPAK, C. R. (Toledo, Ohio), makes inquiry regarding the value of certain paper currency.
- KUBBEL, S. S. (Philadelphia, Pennsylvania), desires certain information in regard to lubricating oils.
- KURTZ, WILLIAM C. (Harrisburg, Pennsylvania), inquires as to the value of certain mementos, examples of the so-called "Washington buttons."
- LAIRD, Hon. JAMES (United States House of Representatives), desires information in regard to certain guns exhibited in the Museum.
- LERCH, Dr. OTTO (San Angelo, Texas), desires to know if the Smithsonian Institution will identify certain material for him.
- LESTER, Mrs. EULALIA (Kinsley, Kansas), desires information in regard to the flora of western Kansas.
- LESTER, J. ERASTUS (Providence, Rhode Island), desires the address of some reliable antiquarian book-seller in Washington.
- LIMBERGER, W. B. (Randolph, New York), requests a description of certain bird eggs, to aid him in the determination of some specimens.
- LISMAN, Dr. W. A. (Carlisle, Indiana), asks information regarding a metal ring said to have been found embedded in a block of bituminous coal.
- LOGAN, Rev. JOHN A. (Acadia Mines, Nova Scotia), makes inquiries in regard to the mythology of the aborigines of North America.
- LOSIER, JOSEPH J. (Fulton, Kentucky), requests information as to the best methods of collecting and preserving natural history objects.
- LOWNDES, W. C. (Baltimore, Maryland), requests an opinion as to the value of a medal which he describes.
- LUCAS, F. A. (Trenton, New Jersey), desires certain information regarding snakes.
- LUNAN, J. H. (Terre Haute, Indiana), desires to know if a reward has been offered for a practical method of welding copper.
- LYNN, J. C. (Kearney, Nebraska), describes certain bones concerning which he desires information.
- MCLAIN BROTHERS (Wheeling, West Virginia) desire a determination of a reptile which they describe.
- MANN, B. PICKMAN (Washington, District of Columbia), desires certain information in reference to mollusca of the genus *Psyche*.

- MASTERS, MARK** (Gibbon, Nebraska), requests certain information regarding the Incas of Peru.
- MATHESON, WILLIAM J., & Co.** (New York City), desire the determination of a snake from a description sent.
- MAYO, GEORGE W.** (Richmond, Virginia), requests certain data in regard to zoological gardens in the United States.
- MEIGS, General M. C., U. S. Army** (Washington, District of Columbia), requests an opinion as to the genuineness of a whistle, supposed to have been taken from an Indian mound near Columbus, Georgia.
- MILLER, C. B.** (Prescott, Arizona), requests certain information regarding vanadinate of lead.
- MILLS, Hon. R. Q.** (United States House of Representatives), requests information regarding a colonial note of the State of Maryland.
- MILLS, W. C.** (Newcomerstown, Ohio), desires information regarding aboriginal sculpture in America.
- MONROE, J. P.** (Ringgold, Tennessee), sends sketch of a chain said to have been taken from an Indian mound, and requests an opinion as to its genuineness.
- MOORE, C. R.** (Birdsneat P. O., Virginia), desires information regarding the publications of the Smithsonian Institution relating to prehistoric anthropology.
- MORTON, Mrs. ELIZA H.** (Portland, Maine), makes inquiry regarding the government of Alaska; also regarding the "American Geographical Society."
- MURFIT, A. C., jr.** (Red Bank, New Jersey), requests certain information regarding a coin.
- MYER, Mrs. A. B.** (Newportville, Pennsylvania), desires information as to the rights of a discoverer of mineral wealth on lands other than his own.
- NORTHROP, GEORGE J.** (Marquette, Michigan), makes inquiry as to the occurrence of intestinal worms in fish.
- O'HARE, DANIEL** (Washington, District of Columbia), incloses a copper coin concerning which he desires information.
- OLIVER, CHARLES** (Under Secretary, Department of Lands, New South Wales), makes inquiry regarding the existence of epidemics among wild rabbits in the North-western United States.
- OSTRANDER, CHARLES F.** (Rye, New York), makes inquiry regarding the ravages of insects on elm and on apple trees; also as to the best liquid for the preservation of insects for purposes of study.
- PARSONS, FRANCIS H.** (U. S. Coast and Geodetic Survey), asks for information regarding an Indian mound.
- PHILLIPS, BARNET** (Brooklyn, New York), desires information regarding the occurrence of luminous beetles in the vicinity of New York City.
- PHILLIPS, Miss E. J.** (Chagrin Falls, Ohio), desires information regarding publications of the Museum.
- PIERCE, THOMAS H. B.** (Dexter, Maine), makes inquiry regarding Indian mounds.
- PILLING, J. C.** (Washington, District of Columbia), desires information regarding the internal administration of the Smithsonian Institution.
- PLEAS, E.** (Dunreith, Indiana), desires information regarding prehistoric stone implements; also in reference to the bibliography of the Mollusca.
- RAGSDALE, G. H.** (Gainesville, Texas), desires information regarding the coloration of certain species of *Aucistrodon*; as to the depth to which meteorites usually penetrate; and regarding the superstitions in connection with the so-called "mad-stone."
- RANSON, ROBERT** (Cadauval, Florida), inquires as to the proper method of making plaster casts; and desires to know if sharks are viviparous.
- REYMERSHOFFER'S SONS, J.** (Galveston, Texas), transmit an analysis of the water from their artesian well and desire an opinion as to its suitability for refining sugar.

- RICHARDS**, President J. **HAVENS** (University of Georgetown, District of Columbia), makes inquiry regarding the form of cases in use in the Museum.
- RICKERTSON**, F. A. (Allen, Michigan), makes inquiry regarding mounds and "mound builders."
- RILEY**, A. T. (Santa Monica, California), desires information regarding supposed bones, a description of which he sends.
- RITCHIE**, W. W. (Punta Gorda, Florida), makes certain inquiries in regard to the removal of the remains of Washington.
- ROBERT**, Dr. T. (St. Charles, Iowa), wishes an identification of a coral which he transmits.
- ROGAN**, JAMES W. (Rogersville, Tennessee), asks for information regarding certain rocks which he describes.
- ROMAIN**, CHARLES E. (Crockett, Texas), desires information regarding the Marsupialia.
- ROMERO**, SENOR DON **MATIAS** (Mexican Legation, Washington, District of Columbia), desires information regarding a plant, a description of which he sends.
- ROUSER**, GEORGE A. (Georgetown, Texas), desires information regarding a coin and a Colonial note in his possession; also regarding the dating of coins.
- ROWLANDS**, WALTER (Boston, Massachusetts), makes inquiry regarding works of art in the Museum.
- RUNNALLS**, Dr. H. B. (Arkansas City, Kansas), desires information regarding the bibliography of Ornithology.
- RUST**, H. N. (South Pasadena, California), desires information regarding the manner of grooving stone implements.
- SAVAGE**, JOHN W. (Philadelphia, Pennsylvania), desires to know what kind of wood is best adapted to the manufacture of spools.
- SAVAGE**, M. F. (New York City), wishes to know where Santa Barbara arrowheads may be obtained in exchange.
- SAWYER**, C. M. (Mechanics Falls, Maine), asks for name of some work on the birds of New England.
- SCHIEL**, WILLIAM H. (New York City), desires information regarding mineral rubber.
- SHARP**, CLARENCE S. (National City, California), makes inquiry regarding the bibliography of Ornithology.
- SHEM WELL**, R. L. (Oak Level, Kentucky), asks the value of certain old coins which he describes.
- SKINNER**, E. S. (Lake Forest, Illinois), desires information regarding mermaids.
- SLEVIN**, T. E. (San Francisco, California), makes inquiry regarding certain papers published by the Smithsonian Institution.
- SLOUGH**, Rev. J. S. (Pioneer, Ohio), desires information regarding stone implements, sketches of which he sends.
- SMITH**, J. T. (Hazelhurst, Georgia), desires information in regard to a reputed antidote for snake-bite.
- SMITH**, L. H. (Strathroy, Ontario), transmits a plant for determination.
- SPEEL**, FRED. (Philadelphia, Pennsylvania), desires an identification of a fish from a description which he sends.
- SPRAY**, SAMUEL J. (Salida, Colorado), wants reference to a book on the birds of North America; also to know where he may sell to the best advantage certain mammal skins.
- SPRINGER**, Mrs. R. M. (Forest City, Dakota), desires information regarding certain impressions in limestone, a description of which is sent.
- STERNS**, FREDERICK & Co. (Detroit, Michigan), makes inquiry regarding the chemical composition and therapeutic uses of *Cascara amarga*.
- STEPHENS** F. V. (Marco, Florida), makes inquiry regarding the occurrence of the crocodile in Florida.
- STIZENBERGER**, Dr. ERNST (Konstanz, Germany), desires information regarding the distribution of lichens.

- STONE, DR. SOLON B., U. S. Army (Fort Shaw, Montana), makes inquiry regarding the formation of septa in native carbonate of iron.
- STONEBRAKER, JOSEPH R. (Baltimore, Maryland), desires information regarding fish-culture, and the construction of fish-weirs.
- STUEHCK, RUDOLF (Goldendale, Washington), desires to be informed as to the best means of preventing the ravages of certain insects, specimens of which he transmits.
- SUCHETET, M. A. (Bréauté, Seine-Inférieure, France), makes inquiry regarding a directory of American naturalists.
- TANNER, W. W. (Worcester, Massachusetts), makes inquiry regarding the bibliography of Indian dialects.
- TAPPEY, E. P. (Bridgeton, New Jersey), desires directions for the preparation of whitewash such as is used on light-houses in the United States.
- TEED, C. F. (Elmira, New York), desires information regarding a slate implement, a description of which he sends.
- TEETOR, HENRY DUDLEY (Public Library, Cincinnati, Ohio), makes inquiry regarding certain astronomical instruments; also in reference to a portrait of the Indian chief "Little Turtle."
- TILFORD, H. J. (Louisville, Kentucky), desires information regarding a petrified oyster, a description of which he sends.
- TODD, JOHN F. (Gove City, Kansas), desires an opinion as to the probability of minerals being found on certain lands which he describes.
- VAISZ, ARANKA (Buda-Pesth, Hungary), asks general questions regarding entomological matters in the United States.
- VAN ANTWERP, BRAGG & CO. (Cincinnati, Ohio), desires information regarding analyses of foods.
- VANCE, HON. ROBERT B. (Washington, District of Columbia), makes inquiry regarding a mint token, a medal of the "Indian Peace" series.
- VAN HYATT, P. (Fall River, Kansas), desires information regarding fossil plants.
- VOICE, The, Editor of (New York City), desires information regarding the use of spirituous liquors as an antidote for snake-bite.
- WASHINGTON, WILLIAM HERBERT (Bar Harbor, Maine), makes inquiry regarding the dialect of the Passamaquoddy Indians.
- WATTS, B. F. (Lakeland, Kansas), requests information regarding a deposit of graphite.
- WEIDEMEYER, J. W. (New York City), inquires whether the Museum possesses certain photographs and autographs.
- WELSH, W. W. (San Bernardino, California), desires information regarding slabs of stone with characters engraved thereon.
- WERNSE, E. A. (St. Louis, Missouri), makes inquiry regarding the value of certain Egyptian coins.
- WHEELER, MRS. S. A. P. (Avalon, California), desires reference to a work on the birds of the Pacific coast, especially of California.
- WHITE, JAMES J. (Palm Beach, Florida), desires reference to some comprehensive work on Conchology.
- WHITE, T. ARTHUR (Navasota, Texas), desires information regarding a coin, an impression of which he sends.
- WHITSON, Prof. B. F. (Barneville, Ohio), desires reference to a work on American birds.
- WILDER, Rev. S. P. (Janesville, Wisconsin), desires information regarding the "buffalo bug," and suggestions as to the best means of preventing its ravages.
- WILLIAMSON, C. W. (Los Angeles, California), desires information regarding Smithsonian publications.
- WINCHELL, Prof. N. H. (Geological and Natural History Survey of Minnesota, Minneapolis, Minnesota), desires to know where a copy of Catlin's painting "The Falls of St. Anthony" may be obtained.

WISE, WILLIAM F. (Pittsburgh, Pennsylvania), asks for information regarding a supposed fossil which he describes.

WOOD, J. P. (Valentine, Nebraska), desires information regarding a tooth and a bone which he describes.

WOODS, Miss EVA H. (Pinckneyville, Kentucky), desires information in regard to a coin, a description of which is sent.

WRIGHT, Prof. RAMSAY (University of Toronto, Canada), makes inquiry regarding State Museums in the United States.

YOUNG, M. J. (St. Clair, Missouri), makes inquiries regarding a check-list of the birds of North America.

Statement of technical letters prepared during the year, arranged geographically.

Locality.	Number of letters written.	Locality.	Number of letters written.
Alabama.....	4	New Hampshire.....	2
Arizona.....	3	New Mexico.....	4
Arkansas.....	6	New York.....	41
California.....	14	North Carolina.....	5
Colorado.....	10	Ohio.....	20
Connecticut.....	3	Oregon.....	2
Dakota.....	4	Pennsylvania.....	36
District of Columbia.....	37	Rhode Island.....	2
Florida.....	7	South Carolina.....	2
Georgia.....	6	Tennessee.....	13
Idaho.....	2	Texas.....	25
Illinois.....	11	Utah.....	6
Indian Territory.....	1	Vermont.....	2
Indiana.....	4	Virginia.....	29
Iowa.....	6	Washington.....	8
Kansas.....	19	West Virginia.....	16
Kentucky.....	12	Wisconsin.....	5
Louisiana.....	5	Wyoming.....	3
Maine.....	4	Australia.....	1
Maryland.....	10	Canada.....	7
Massachusetts.....	7	France.....	2
Michigan.....	9	Germany.....	4
Minnesota.....	5	Hawaiian Islands.....	1
Mississippi.....	2	Hungary.....	1
Missouri.....	12	Mexico.....	1
Montana.....	6	Scotland.....	1
Nebraska.....	5	West Indies.....	2
Nevada.....	1	Total.....	456

One of the reasons for the great increase in this branch of the Museum work is, that the letters addressed to the Smithsonian Institution relating to anthropological and zoological subjects are, almost without exception, referred to the Museum. Letters of this class are received daily from the Secretary, and the majority of the letters in reply are prepared for the Secretary's signature.

The Museum receives a large number of offers to make explorations in various parts of the world, and to collect specimens for the collec-

tions. Thirty-five offers of this kind, each of which necessitates considerable correspondence, have been received during the year, and are briefly shown in the following statement:

MAX BAUDELLOT (261 West Madison street, Chicago, Illinois) offers "to make a study of every subject concerning the history and civilization of the Republic of Honduras."

Miss FAUSTINE BUTLER, A. M. (1620 Rush street, San Francisco, California), desires to make explorations and collect specimens along the Pacific coast from Mexico to Alaska.

Dr. JOHN M. CRAWFORD (registrar of the Pulte Medical College, Cincinnati, Ohio, and now United States consul at St. Petersburg, Russia), has kindly consented to make special ethnological researches in Finland, and to collect specimens, particularly musical instruments.

Mr. J. CRAWFORD (through the Department of State) offers to collect from the Department of Nueva Segovia in Nicaragua, mineralogical and other specimens, and to procure for the Museum such portions of the exhibit made by the Nicaraguan Government at the Paris Exposition as may be desirable.

Mr. JEREMIAH CURTIN (through Maj. J. W. Powell, Bureau of Ethnology) offers to collect ethnological specimens in connection with an expedition to the Hupa Valley.

VINAL N. EDWARDS (Wood's Holl, Massachusetts) offers to collect sea birds.

L. L. FROST (Susanville, California) offers to collect ethnological and archaeological specimens.

E. C. GREENWOOD (Brownville, Texas) offers to collect birds in Texas.

B. M. HAYWARD (Weybridge, Vermont) offers to continue his explorations in northern Mexico, and to collect birds for the Museum.

Dr. A. E. HEIGHWAY (Cincinnati, Ohio) offers to make explorations and collections in Central and South America.

Ensign W. L. HOWARD, U. S. N. (Office of Naval Intelligence) offers to collect in Alaska mammals, fishes, and ethnological objects.

Prof. O. B. JENKINS (De Pauw University, Greencastle, Indiana) offers to collect and present to the Museum a series of fishes from the Hawaiian Islands.

F. M. LAMB (Nestockton, Oregon) offers to collect minerals.

JAMES LISLE (Gordon, Nebraska) offers to collect ethnological specimens.

GEORGE W. MCGLUMPHY, A. B. (professor of Zoology, Botany and Geology at Ozark College, Greenfield, Missouri) offers to make explorations in southwestern Missouri, and to send specimens of the fauna and flora of that section.

E. W. MARTIN (Medina, Ohio) offers to collect bird skins in his vicinity.

C. S. MASON (Engineer's Office, Lake Shore and Michigan Southern Railroad Company, Toledo, Ohio), offers to collect iron ores in his vicinity.

A. J. MILLER (Evansville, Indiana) offers to collect specimens of natural history geology, and archaeology in Central America.

S. CLAIR MITCHELL (Dolores, Colorado) offers to continue his explorations in Colorado and Arizona.

SOLOM ORR (Melrose, Silver Bow County, Montana) offers to collect specimens from the lava beds of Idaho.

HENRY DU R. PHELAN (11 Van Ness Avenue, San Francisco, California) offers to make general explorations and collections.

Rev. STEPHEN D. PERT (Mendon, Illinois) proposes to make mound explorations in his vicinity.

THOMAS H. B. PIERCE (Dexter, Maine) offers assistance in the exploration of mounds in his vicinity.

- Rev. Fred. H. H. Post (313 Church Street, Salem, Oregon) proposes to make explorations, etc., near Anvik on the Yukon river, Alaska, and to transmit collections to the Museum.
- W. W. ROCKHILL (Peking, China) offers to secure ethnological specimens in China and Thibet.
- CHARLES RUBY (acting steward, U. S. Army, Fort Assiniboine, Montana Territory) offers to collect specimens of birds and mammals in his vicinity.
- EDWIN RUSS offers to make collections in southwestern Oregon.
- Prof. ISRAEL C. RUSSEL (U. S. Geological Survey) offers to make collections in Alaska of zoological, botanical, and ethnological specimens.
- JAMES A. SINGLEY (Giddings, Texas) informs the Smithsonian Institution of his intention to spend the spring months in southwestern Texas, for the purpose of collecting shells, birds, and eggs.
- H. L. SCAVLEM (176 Prospect Avenue, Janesville, Wis.) offers to collect mammals in the vicinity of Janesville.
- VIX SMITH (Lyon Post-office, Madison County, Montana) offers to collect specimens of living animals for the National Zoological Park.
- Dr. JOHN SUNBERG (405 Montgomery street, San Francisco) desires to act as agent of the Smithsonian Institution for the purpose of collecting specimens in the regions of the Persian Gulf, and the Euphrates Valley.
- Lieut. E. H. TAUNT, U. S. Navy (909 Sixteenth street northwest, Washington, District of Columbia) offers to continue his work of collecting material for the Museum in the Congo Valley, South Africa.
- TALCOTT WILLIAMS (1833 Spruce street, Philadelphia, Pennsylvania) informs the Smithsonian Institution of his proposed trip to Morocco, and offers to make scientific researches in botany, geology, and ethnology.

It has been found impracticable to accept several of these offers. Among those which have been accepted, and which have resulted most favorably to the Museum, may be mentioned the explorations of Mr. Talcott Williams, Dr. John M. Crawford, Mr. Jeremiah Curtin, Mr. W. W. Rockhill, Prof. I. C. Russell, and Lieut. E. H. Taunt.

Special reference to the results of their work is made under the head of "Exploration."

A special feature of the routine work of this department is the method of indexing letters written. A card has been prepared on which is written the name and address of each correspondent, together with the number of the letter-books and pages in which all letters to a given person have been copied, including the date of each letter. By this means can be ascertained at a glance the amount of correspondence with any person. This has been found exceedingly convenient. More than five thousand of these cards have been filled up during the year relating to letters written since 1887. These cards are arranged alphabetically and kept in long boxes divided into compartments, one or more of which are devoted, as required, to a single letter of the alphabet. Cross references are made under the name of the Government department or private establishment with which the person addressed may be connected. For instance, all letters written to any official in the Treasury Department are recorded on cards headed "Treasury Department," and another card is filed under the name of the person addressed. This is particularly convenient in the case of the Government departments where changes of officials are more or less frequently occurring.

The principal records kept in this department may be classified under the following headings :

- | | |
|--|---|
| 1. Card index of letters written. | 6. Museum record of events of special moment. |
| 2. Index of letter-books. | 7. Index of applications for scientific work. |
| 3. Offers for sale, gift, and exchange of specimens. | 8. Requisitions for publications. |
| 4. Offers for collection and exploration. | 9. List of publications promised when issued. |
| 5. Index of requests for information. | |

In this office is prepared for publication in the annual report (as Section V) a complete list of accessions to the Museum during the year. This is now arranged alphabetically under the name of the sender. Two indexes are furnished; the one by Museum departments showing at a glance the number of accessions to each department during the year; the other by locality, indicating what material has been received from each locality both in this and in foreign countries.

A similar list with corresponding indexes is prepared of the material submitted for examination and report. This is published in another part of the annual report.

The bibliography of papers published during the year by the officers and collaborators of the Museum is prepared in this office and forms Section IV of the annual report.

The data required for the preparation of Section I of the annual report is compiled in this office.

In addition, the general preparation of the annual report, as well as the supervision of the proof, has also been made a part of the work of this office.

PREPARATION OF LABELS.

There were received from the Government Printing Office 3,188 forms of labels, classified as follows:

Materia medica	741	Oriental antiquities	182
Metallurgical	842	Botanical	267
Birds	615	Living animals	19
Foods and textiles	111	Archæological	5
Mammals	79		
Ethnological	206	Total	3,188
Building stones	121		

Of each form, twelve copies are printed on proof paper for catalogue purposes and twelve copies on colored board. This gives the total number of copies of labels printed, 96,512.

In addition to this there have been printed on the small press at the National Museum 803 forms of labels, classified as follows:

Materia medica	3	Transportation	21
Foods and textiles	2	Mollusca	39
Mammals	246	Forestry	7
Ethnological	145	Graphic Arts	135
Building stones	166		
Oriental antiquities	19	Total	803
Living animals	20		

This places the total number of label forms printed for the National Museum during the year at 3,991.

BUILDINGS AND LABOR.—POLICE AND PUBLIC COMFORT.

The staff employed for police and inspection has remained under the charge of Henry Horan, superintendent of buildings.

From the reports of the superintendent are quoted in brief the following statements, which will serve to show in part the character of the work accomplished by the laboring force during the year :

1888.

July.—During the first part of the month the mechanics and laborers were occupied in making preparations for the shipment of exhibits to the Cincinnati Exposition, which were finally shipped in twelve car-loads. Later in the month twenty-two boxes, containing the photographic exhibit, were forwarded by freight. This completed the work of packing and shipping the exhibit from the Smithsonian Institution.

On July 9, the work of preparing material, packing and shipping an exhibit to the Marietta exposition was begun. This was completed on July 14.

On July 16, additional mechanics and laborers, who had been hired for work in connection with the Cincinnati exposition, were discharged. In order to afford better light in the main hall of the Smithsonian building, one end of each of the galleries was cut off. The fence inclosing the buffalo yard was painted. New steps were made and placed in the annex east entrance leading to the basement.

Storage-cases for specimens were built for the Department of Ethnology ; two card-catalogue boxes for the executive clerk's office, and two cases for the metallurgical department.

August.—Scaffolding was erected in the main hall of the Smithsonian building to facilitate the preparation of the walls and ceiling for painting. The painting of the exhibition hall of the Department of Fishes was finished. In the carpenter and paint shops, the following work has been completed: Construction of one large storage-case for unit trays, one frame for mounting tiles, cutting and fitting glass for cable-frames, putting mahogany casing around plaster casts; making pedestals for the department of mammals; construction of two large tubs for holding trees in the rotunda. New mahogany label-frames were made. Mahogany panel ends have been put in four door-screen cases in the department of lithology.

The alteration of the galleries in the main hall of the Smithsonian building has been continued this month.

The following work has also been completed: Putting new floor in the café; shel-lacing and painting wall cases; extending wall-cases and polishing specimen blocks for the department of comparative anatomy; repairing broken cases and making frames for the department of ethnology. For the executive clerk's office there has been made one case of drawers with shelving, and one case for letter-books. The refitting of doors to cases in several departments has been continued from day to day.

September.—Several repairs in different parts of the Museum building and in the Armory building were rendered necessary by the results of a severe storm which occurred on September 10. The cases formerly occupying the wall space at the south entrance of the Smithsonian building, were removed to the northeast court of the Museum building. A great many blocks for specimens have been painted and ebonized for the various departments, and the work of fitting shelves to cases has been continued.

The platform in the lecture room has been repaired, and a large book-case made for the Department of Buildings and Labor. Five pier upright cases have been remodeled for the Department of Ethnology, and several catalogue boxes have been made for the executive clerk's office. Oak frames for transparencies have been made. The office of the engineer of property has been furnished with a brass wire screen. The extension and remodeling of the bird cases still continue.

October.—The stained glass in the circle over the south entrance of the Smithsonian building has been removed and replaced with plain glass. The radiators in the southeast court were removed from the walls to make room for wall cases, and were placed further back towards the center of the hall. This work necessitated some excavating in connection with the fitting of the steam-pipes. A new shed was built for the collection of living turtles and other specimens. Repairs were made to the floor in the southeast court. One of the upper rooms of the north tower in the Smith-

sonian building has been assigned to the Department of Mollusks, and shelving has been erected therein for the storage of trays, etc., belonging to that department. The halls and galleries in the Smithsonian building have been scoured and cleaned, and the furniture placed in order after the confusion incident to the painting of the walls. The mechanics have also been occupied on the following work: making five hundred blocks for the exhibition of medals; making frames for Assyrian slabs, and mahogany shelves for the Department of Mammals; remodeling pier cases, and fitting them with shelves; fitting drawers and locks to cases; making drawers for storage cases; fitting mahogany table tops to wooden pedestals; constructing a platform for the steam-steering machine in the Department of Transportation and Engineering; making one case of pigeon-holes for the section of fisheries; fitting shelves to a chart case; beveling one thousand blocks for the Department of Minerals; making a desk and case of pigeon-holes for the registrar's office; making frames for plaster casts; painting the window frames of the Museum building; painting walls in the lecture room; kalsomining the east front of the annex building; ebonizing blocks for the Department of Minerals.

November.—Early in the month the Superintendent left Washington with six skilled laborers for Cincinnati for the purpose of packing and returning to the Museum the exhibits and cases sent to the Exposition. A force of men has been engaged in cleaning out the sheds at the Armory and re-arranging the vast amount of material there stored. The tender belonging to the engine "John Bull" was brought over from the Armory and placed at the east entrance of the Museum building. The lecture hall was cleared to make room for the return of the exhibits from Cincinnati, which began to arrive on the 26th. On December 15, all this material was safely housed, and the superintendent with his men returned to their duties in the Museum. The work of unpacking and returning the exhibits to their proper departments occupied the time of the entire laboring force for many days. After most of the above work was completed, the Graphic Art exhibit, recently returned from Cincinnati, was installed in the lecture hall. During the latter part of this month many of the cases in the Anthropological hall were re-arranged. The carpenters completed remodeling pier cases for use in the Department of Arts and Industries. The following work was also accomplished: One book-case, with shelves, was made for the Department of Botany; changing doors in unit tables in the Department of Botany; making two oak book-cases for the Executive Department; constructing pigeon-holes for the Department of Building Stones; also counter, drawers, and pigeon-holes for the office of the engineer of property; adjusting locks and doors in floor cases in the southwest hall. The painters have been engaged in covering and painting diaphragms, lettering screens, and varnishing picture frames; painting tubs for plants in the rotunda; painting the walls of the public comfort room; glazing windows in the Smithsonian and Museum buildings; painting walls over the stairway in the east pavilion; finishing in hard oil a large book-case for the executive clerk's office; painting cases for the Department of Property and Supplies.

December.—Ashscreens to be placed on the top of the cases in the southwest court have been made. The west hall has been re-arranged and the lecture hall put in order for the meetings of the American Historical Association. Eleven door screen cases have been furnished to the curator of birds. These will take the place of the old white cases in the center of the hall, which will be condemned as soon as the specimens have been removed. The old storm door at the north entrance to the Museum building has been removed to the east entrance, and larger and more serviceable ones have been placed at the north entrance. The following work has also been accomplished: Construction of base for statues; painting trays; repairing Japanese clock; construction of card catalogue shelves for cases; putting strips in case for medals; painting bases; making two large walnut bases; setting glass in the antelope case, and finishing and shellacing pedestals; painting pedestals and putting locks on cases in the Department of Botany. The fence around a part of the Armory building has been repaired and the sash glazed and painted. The windows and screens in the lecture hall have been glazed and painted. For the Department of Ethnology a large oak frame for a map of Asia has been made. A Kensington case has been polished; frames for plaster casts have been made; a skeleton frame for the west hall has been constructed; four boxes have been made for the library; cases for the models of the Zoological Park have been made, and a card catalogue case was constructed for the office of the engineer of property. The work on the bird cases in the Smithsonian building still continues. The upright cases have been extended back as far as the wall.

1889.

January.—The work of constructing an additional room for the entomological laboratory over the ladies' reception room was begun the latter part of December. This work was continued during this month and completed in the early part of February. For the Department of Prehistoric Anthropology a number of wing frames have been

glazed and trays painted. Several cases in the exhibition hall of this Department have been painted, and ten mahogany table frames have been made for the various sections in the Department of Arts and Industries. Trays have been repaired and label frames made for the Department of Botany. A large number of wooden blocks have been ebonized, one book-case made, and one case altered in some of its details. For the Department of Lithology mahogany table frames have been made and wing frames glazed. The old storm doors have been placed at the east entrance. The walls on the stairway leading to the basement of the Smithsonian building have been painted. The floor in the ladies' retiring room has been repaired. The walls at the north entrance to the Smithsonian building have been painted. Cases have been painted and glazed for the Department of Anatomy. The floor in one alcove case in the Department of Ethnology was lowered. Frames for maps were made. For the Department of Engineering a case with sliding drawers has been made. Boxes for copper tanks were made for the Department of Fishes. A base for a memorial stone transmitted by the Washington Monument Commission was made. In the Department of Insects a sky-light was made. The floor and wall cases in the Department of Metallurgy were painted, and several shelves fitted. Frames for glass to cover models, and storage cases for use in the south west pavilion were made. For the Department of Mesozoic Fossils several slope-top cases and frames were made and drawers fitted to the cases. A number of blocks were ebonized for the Department of Minerals. The alteration of the old doors and hanging new doors to bird cases was attended to. A large number of picture frames were painted and cleaned. Frames for maps were made. Glass was put in bird cases, and the inside and outside of the cases were painted. For the Department of Paleozoic Fossils a number of shelves were painted.

February.—The removal of the office of the curator of textiles from the third to the second floor was completed, and the office of the curator of naval architecture was removed from the second to the ground floor in the east tower. The removal and rearrangement of cases stored in the Armory building was completed. A wire fence to inclose the large mineral masses on the west side of the Museum building was constructed. Two skylights were placed in the roof over the entomological laboratory. Painting the walls and ceiling in the ladies' retiring room was begun. The rearrangement of the cases in the north and west halls has occupied a great deal of time. The skeletons of whales, one of which was returned from the Cincinnati Exposition, have been hung in the osteological hall. Other work accomplished this month is as follows: Several shelves for wall cases were made, and two hundred and forty-seven trays painted for use in the anthropological hall. Bases for the walrus and sea-lion were made for the Department of Mammals. An iron bracket for the whale skeleton in the Department of Comparative Anatomy was painted. For the Department of Ethnology several screens and cases were painted. A base was made for the Japanese Buddha, a slope base for Assyrian slabs, and one for totem posts were made. Glass for label frames for the Engineer of Property was cut. A base for four ash screens for the exhibition of a collection of busts was made. A wall case in the entomological laboratory was constructed. Several screens to be placed at the entrance to exhibition halls, and screens and shelves to go behind and over radiators were made. Glass was put in bird cases in the main hall of the Smithsonian building. Diaphragms and strips were made and placed in door-screen cases, and a number of cases were painted. For the Department of Paleozoic Fossils four boxes were made and a desk repainted.

March.—During the early part of this month almost the entire force was required to remain after the regular hours in order to complete the re-arrangement of cases in the exhibition halls. On March 2, eight of the force were sworn in as special policemen, this being thought advisable for the better protection of the collections during the inauguration season. Several of the laborers, carpenters, and painters were required to do duty as watchmen on this occasion. The arrangement of the Lorillard collection of casts, recently removed to the Smithsonian building was begun. This work occupied a considerable force of laborers for several days. In the Department of Ethnology a base with high back to accommodate plaster casts was made. Sample drawers for unit cases were made. Label frames were made for the Department of Botany, and a platform placed over the stairway in the south balcony. In the Department of building stones a number of partitions were placed in paper boxes, and a file case and drawers made to hold them. The wall in the north hall of the National Museum was painted. The collection of Mexican casts was moved from the Museum building to the Smithsonian building. The interior of the long wall case in the southeast range was painted, the wall case was glazed and label frames made. Locks were put on cases and doors for the Department of Ethnology. Two sample unit drawers were made and partitions put in drawers in the Executive Department. Stretches were made for some of the Washington relics. For the Department of Marine Invertebrates locks and keepers were put on a book-case. The cases in the hallway of the northwest pavilion were painted. Locks were fitted to doors and cases in the Department of Metallurgy. Piers and frames were painted, and several cases glazed. A

small case was made for the Department of Birds, and the inside and outside of several cases in the bird hall were painted. Shelves to slope cases were made for the Department of Paleozoic Fossils.

April.—The ledges of a large number of windows were lined with tin to prevent the rain from beating in. In the Department of Antiquities, pedestals and shelves were constructed and two hundred thirty-seven trays were painted. Locks were put on cases in the Department of Mammals. One end of the wall case in the south hall was made moth proof. A tin collecting case was made for use in the Department of Botany. Locks were put on chart cases in the Department of Building Stones. For the Department of Buildings and Labor a mail box was made for the Superintendent's office. The walls in the northwest pavilion and in the lecture hall were painted. The third floor of the northwest pavilion was fitted up for the offices of the executive clerk. Glass was reset in a case for the Department of Anatomy. In the Department of Ethnology packing boxes were made, and mahogany tables for specimens of Japanese lacquer were constructed. Shelving was constructed around a portion of the executive clerk's office. Two copper tanks were made for the engineer of property. Locks were fitted to several unit cases. Blocks were ebonized for the display of food specimens. A base and screen for an exhibit of woods was made. In the section of Historical Relics a frame was made for a portrait of Washington. A number of screens in the Department of Metallurgy were strengthened and painted. For the Department of Minerals two tanks were made, a number of blocks ebonized, casters put on ten unit-table cases, and doors and trays eased. A number of blocks were painted for the section of Materia Medica. For the Department of Ornithology tanks boxes were made; the inside of cases in the bird hall were painted, and a small mahogany case made for a group of birds. Several floor cases were fitted up, and old book-cases repaired. For the Section of Graphic Arts 36 double boxes were finished.

May.—The northwest basement has been thoroughly cleaned, and several coats of whitewash have been put on the walls. Awnings have been fitted to the windows in both buildings. For the collection of Animal Products a storage case was built; this holds about one hundred and fifty trays. Case drawers and trays have been planed and eased. In the Department of Antiquities casters were put on a large walnut case; fifteen heavy bases made. Wing frames for use in the Section of Oriental Antiquities were repaired, four pedestals cut down, and the inside of cases painted. For the Department of Mammals a stand for porpoise casts was made, and casters were put on unit table cases. The prairie-dog and elephant cases were glazed and the bases of table cases made moth-proof. One hundred and seventy-six trays were made for the Department of Botany. A number of relief maps were lettered for the Department of Building Stones. The sky-lights in the carpenter's shop and leaks in the roof were repaired. Twelve label-frames were made and sectional covering put on steam-pipe in the exhibition hall of the Department of Comparative Anatomy. Six pine shelves for storage were made, and several pamphlet boxes repaired. Twelve copper tanks and twenty tin insect-boxes were made for the Engineer of Property. Twenty drawers were fitted to storage cases in the Department of Metallurgy. Casters were put on two unit cases in the Department of Minerals, and a number of wooden blocks for specimens were planed. Three sliding screen cases in the Section of Materia Medica were reduced to half their original thickness. Door screen cases were glazed. Cases in the exhibition hall of the Department of Birds were painted, and shelving and floor cases fitted up in the south tower of the Smithsonian building. Drawers and locks were fitted on two unit cases, and one box made for the Department of Birds' Eggs. For the Section of Textiles three label-frames were made, one hundred blocks painted, and one hundred and forty-two trays eased. In the Department of Ethnology casters were put on ten mahogany cases, one map lettered, and twenty-seven trays eased.

June.—The basement rooms under the north entrance have been thoroughly cleaned.

On June 6, four extra laborers were engaged to help in clearing the storage rooms at the Armory building for the use of the Fish Commission. This occupied the time of six to eight laborers for many days.

The installation of the collection of prints and engraving has occupied the time of several carpenters, painters, and laborers. A window was cut in the wall in the third floor of the northwest pavilion. The east window in the second floor of the natural history laboratory was enlarged. The painting of exhibition cases, shelves, drawers, and trays in the halls of the Department of Birds and Prehistoric Anthropology has continued from month to month, owing to many changes in the original plans. Shelving was placed in the shed in the Armory building, and doors and trays to cases eased in the Department of Building Stones. Repairs were made in the roof of the Museum building. The walls and stairway at the north front of the Smithsonian building were painted. The roof of this building was repaired. Nineteen French ventilators were painted. Two hundred and six trays were eased and three lights of glass 60x90 inches were fitted in slope cases for the Department of Ethnology.

Eighty-five trays were eased for use in the Department of Metallurgy. Three old sliding screen cases were changed into three door screen cases for the Section of Materia Medica.

In the Department of Birds the interiors of several cases were painted light buff, thirty-two new shelves for mahogany floor cases were fitted up, and locks were put on unit cases. In the Department of Paleozoic Fossils thirty-nine trays and two hundred and thirty-one new drawers to unit table cases were eased. A large number of shelves for cases were repaired for the Section of Textiles.

THE WORK OF THE MUSEUM PREPARATORS.

The preparation of specimens for exhibition in the Museum and for the study series has been satisfactorily continued. The work of modeling is in charge of Mr. W. T. Hornaday, chief taxidermist.

TAXIDERMISTS AND MODELERS.

The operations of the department in preparing groups of mammals have been greatly hampered by the vast amount of other necessary routine work, but considerable progress has been made with several groups which it is expected will be completed during the coming year.

These groups are:

Gray Squirrels.—Part of this group was completed for the Cincinnati Exposition, but owing to lack of space it was not sent. It has now been decided to increase its size, incorporating in it all that it is possible to exhibit of the life history of the squirrels, thus making it more comprehensive and instructive.

Red Squirrels.—What is stated of the gray-squirrel group applies to this group also.

Red and Gray Foxes.—Some work has been done on these groups, but more material has yet to be collected.

Rabbits.—Material has been collected for this group, and it will be one of the first finished.

Moose.—Considerable work has been done on this large and important group. The manikins for three of the six animals of which this group will be composed, have been made, and it is the intention to bring it to completion at an early date. The group will occupy a special case of the same dimensions as that containing the group of buffaloes.

In addition to the work mentioned above, a portion of the necessary materials for several other groups have been collected and designs drawn. These groups will include the Rocky Mountain Goat, Rocky Mountain Sheep, Musk-ox, Beaver, Raccoon, and Woodchuck.

The Opossum and Prairie-Dog groups have been put in their new cases and the Orang-outang group retouched. The Antelope group was sent to the Cincinnati Exposition. When a new case for this group has been made, it is intended to add several specimens of different ages, and to rearrange it for exhibition.

The following is a list of specimens mounted during the year :

<p style="text-align: center;"><i>Primates.</i></p> <p>16166. <i>Semnopithecus siamensis.</i> 16167. <i>Cercocebus aethiops.</i> 13499. <i>Jacchus vulgaris.</i> 16170. <i>Lemur flavifrons.</i></p> <p style="text-align: center;"><i>Carnivora.</i></p> <p>16177. <i>Felis minuta.</i> 16176. <i>Felis marmoratus.</i> 16324. <i>Felis domesticus (angora).</i> 16121. <i>Lynx maculatus.</i> 16179. <i>Melivora ratel.</i> 16288. <i>Bassaris astuta.</i> 16238. <i>Urocyon virginianus.</i> 16175. <i>Nandina binotata.</i> 16171. <i>Otogale crassicaudata.</i> 16174. <i>Hemigalea hardwicki.</i></p> <p style="text-align: center;"><i>Ungulata.</i></p> <p>16075. <i>Cariacus clavatus.</i> Male. 16076. <i>Cariacus clavatus.</i> Female.</p>	<p style="text-align: center;"><i>Chiroptera.</i></p> <p>13251. <i>Rhinolphus hipposideros.</i></p> <p style="text-align: center;"><i>Rodentia.</i></p> <p>15325. <i>Dasyprocta aethmica.</i> 16228. <i>Lepus campestris.</i> 16359. <i>Lepus campestris.</i> 16235. <i>Mus decumanus.</i> 16182. <i>Sciurus macrourus.</i> 16183. <i>Sciurus maximus.</i> 16184. <i>Sciurus punctatissimus.</i> 15980. <i>Sciurus bicolor.</i> 14685. <i>Sciurus niger.</i> 16316. <i>Sciurus hudsonius hudsonius.</i> 14433. <i>Sciurus hudsonius douglassi.</i></p> <p style="text-align: center;"><i>Marsupialia.</i></p> <p>12881. <i>Didelphys myosurus.</i> 16187. <i>Dendrolagus ureinus.</i></p> <p style="text-align: center;"><i>Miscellaneous.</i></p> <p>Three Ptarmigans. One Crow.</p>
---	---

Sixty fresh specimens of mammals received during the year and fifty alcoholic specimens were skinned and preserved. Of the sixty fresh animals skinned, thirty-three were collected by the taxidermists, fifteen were received from the Department of Living Animals, and twelve from the Mammal Department. Thirty-eight skins were also received, dry and alcoholic. There has been some progress in making up into good dry skins the duplicate material on hand. A beginning has also been made in reducing the number of alcoholic specimens by working them over into dry skins for the reserve collection.

The following statement relates to dry skins which have been made during the year :

<p>Primates 7 Carnivora 33 Ungulata 2 Chiroptera 14 Rodentia 109</p>	<p>Edentata 2 Marsupialia 4 Total 174</p>
--	---

A number of porpoise casts sent to the Cincinnati Exposition having been returned more or less injured, it was decided to put them in good condition, and also to overhaul others on exhibition and in storage. This work has been done almost entirely by Mr. Joseph Palmer and Mr. A. H. Forney. A list of these is as follows, about a dozen remaining to be completed another year :

cast of the Siloom inscription, and made a cast of the memorial medalion of Prof. Joseph Henry. Only a few molds of animals have been made during the year, but these have been very important.

A Bottle-nosed whale (*Mesoplodon bidens*) was received whole, and a complete mold of both sides was made, as also a separate mold of the head with the mouth open. The largest of the specimens of the Galapagos tortoises, collected by the Fish Commission steamer *Albatross*, died in the Department of Living Animals, and a mold was made from it. These molds are stored with others, and will be cast in due time.

OSTEOLOGICAL PREPARATOR.

Mr. F. A. Lucas, Assistant Curator in the Department of Comparative Anatomy, reports that the work of the past year has been very largely devoted to the preparation of material, and to the care of that already in the collection.

The enlargement of the large exhibition case in the osteological hall, and necessary alterations in the small case, have necessitated the moving of the entire series of specimens on exhibition and their complete re-arrangement.

The preparation of a much-needed card catalogue of alcoholic birds has been commenced and is well advanced, and a large amount of work has been done in classifying and caring for this valuable portion of the collection.

Some work has been done in the preparation of specimens of soft anatomy, and some on invertebrate material, while the greater portion of one month was passed in arranging vertebrate fossils, and in preparing them for exhibition.

The cast of a skeleton of *Dinoceras*, received from the Yale College Museum has been mouted.

At the close of the Cincinnati Exposition the entire labor of packing all the zoological material there exhibited by the Departments of Mammals, Birds, Insects, and Comparative Anatomy was performed under Mr. Lucas's direction, and the collections reached Washington in good condition.

The skeleton of a whale exhibited at Cincinnati was, on its return, again hung from the ceiling of the Museum. Another whale skeleton acquired by the Museum has also been put in place, and a third has been moved to a new location in the osteological hall, and there suspended from the wall on a plan devised by Mr. Lucas.

The following table gives a summary of the material received and of the work of preparation during the year:

	Mammals.			Birds.			Reptiles and Batrachians.			Fishes.		Total.
	Skulls.	Skeletons.	Portions of skeletons.	Skulls.	Skeletons.	Portions of skeletons.	Skulls.	Skeletons.	Portions of skeletons.	Skulls.	Skeletons.	
Received fresh.....		11			25			10			2	48
Cleaned.....	519	12	9	5	47	1	7	3		1	2	606
Mounted.....	10	6			4			1	5			26
Total.....	529	29	9	5	76	1	7	14	5	1	4	680

PHOTOGRAPHER.

Mr. T. W. Smillie reports that 253 negatives have been added to the permanent files. Of these, 88 related to ethnology; 116 to prehistoric anthropology, 11 to mammals, 3 to osteology, 21 to transportation, 10 to graphic arts, and 181 to miscellaneous subjects. Thirty-nine transparencies were also made.

The number of prints made during the year is 2,199, distributed as follows: ethnological, 190; anthropological, 138; mammals, 22; osteological, 3; transparencies, 77; graphic arts, 10; miscellaneous, 1,759. In addition to this 23 enlargements have been made; 39 cyanotypes have been printed, and a collection of miscellaneous photographs, 113 in number, have been mounted.

The following special work for the U. S. Fish Commission has also been performed: Negatives made, 22; silver albumen prints, 22; cyanotypes, 476.

The usual routine work of numbering and filing negatives, making up outfits for expeditions, etc., has been continued.

By request of the Postmaster-General and by order of the Assistant Secretary, a number of samples of canceling inks have been tested for the Post-Office Department.

The illustrating of the lectures given in the National Museum has been conducted by means of the stereopticon operated by the photographer and his assistants.

A collection intended to show the uses of photography was prepared for exhibition at the Cincinnati Exposition. This collection included valuable contributions of photographs from Prof. E. C. Pickering, of Harvard University, Mr. J. W. Osborne, of Washington, and from several officers connected with the Government service, notably, the Geodetic and Coast Survey; the Light-House Board; the Army Medical Museum, and the proving ground at Annapolis. At the close of the Exposition this collection was returned to the Museum and is now being prepared, in connection with additional material which has since been received, for permanent exhibition. It is intended that the scope of this exhibit shall be enlarged so as to take the form of an

historical collection in which shall be shown examples of every photographic process that has been invented, together with the appliances used, beginning with the photograph of the solar spectrum, as made by Scheele in 1777, and showing each step in the evolution of photography from that time to the present day. Considerable material has already been gathered which will be incorporated in this collection.

The first camera made in the United States has been acquired by purchase. A stereoscope, containing daguerreotypes and transparencies by the old albumen process on glass, was presented by Mrs. E. J. Stone. The Scoville Manufacturing Company of New York, presented a series of cameras showing the latest improvements, and from the Eastman Dry-Plate Company of Rochester, New York, has been received a Kodak camera, together with a series of enlarged photographs, illustrating its use.

The following students have been instructed in photography: Lieut. E. H. Taant, U. S. N., Mr. W. H. Perry, Miss Frances B. Johnston, Dr. T. H. Bean, Mr. Howard, and Professor J. B. Daish.

In the year 1887, Mr. Smillie was transferred from the U. S. Fish Commission to the National Museum as chief photographer. From that time the photographic work of the Fish Commission has been done in the Museum on the following conditions:

The Commissioner furnishes an assistant, as well as the material and apparatus necessary for the work of the Commission. The work of the assistant is under the supervision of the photographer of the Museum, who makes the requisitions for material, and keeps a record of the work done. In return, the assistant paid by the Fish Commission is expected to assist in work for the Museum, when not occupied in the interest of the Commission.

COLORIST.

Mr. A. Zeno Shindler has spent a considerable part of the year in repainting a collection of fish casts for the Cincinnati Exposition. He has painted for use in the Department of Birds two maps, representing the two hemispheres. For the Ethnological Department he has painted eighty-five photographs of Indians, and also sixty-four photographs of Indians and negroes of Surinam, from the collection of Prince Roland Bonaparte. Life-size busts of the King of Siam, King Kalakaua of the Sandwich Islands and Miss Fairchild, have also been painted.

In connection with the formation of a collection of oil paintings representing the races of man, the following types have been finished: Eskimo Dyak of Borneo; Apache (Arizona); Niam Niam (Africa); Chief of the Clallam Indians, Washington; Aborigine of Australia; portrait of the Secretary of the Chinese Legation in Washington.

DRAUGHTSMEN.

Beginning with the year 1884, the report of the National Museum has consisted of a separate volume, and a section of each report has, since and including that year, been devoted to the publication of papers illustrative of collections in the National Museum. Many of these papers have been illustrated by both photographs and drawings. The former have been made by Mr. T. W. Smillie, photographer. It has been more satisfactory in certain cases to have drawings of the objects prepared in the Museum, especially in connection with the illustration of the following papers: In Report for 1884: "Throwing-sticks in the National Museum," by Otis T. Mason (17 plates); "Basket-work of the North American Aborigines," by Otis T. Mason (64 plates); "A study of the Eskimo bows in the U. S. National Museum," by John Murdoch (12 plates); "The West Indian Seal," by Frederick W. True and F. A. Lucas (3 plates). In Report for 1886: "How to collect Mammal skins for purposes of study and for mounting," by William T. Hornaday (9 figures). In Report for 1887: "Cradles of the American Aborigines," by Otis T. Mason (45 figures); "The Human Beast of Burden," by Otis T. Mason (54 figures); "Ethno-Conchology—A Study of Primitive Money," by Robert E. C. Stearns (9 plates and 22 text figures); "The Extermination of the American Bison," by William T. Hornaday (12 plates and 1 map). In the Report for 1888: "The Indians of the Northwest Coast," by Ensign A. P. Niblack (70 plates and 48 text figures); "Fire-making apparatus in the National Museum," by Walter Hough (8 plates and 60 text figures).

Illustrations for papers on "Eskimo Strike-a-Light," by Walter Hough; "Skin Scrapers," by Otis T. Mason; and "Easter Island," by Paymaster William J. Thomson, U. S. Navy, are now being prepared.

The drawings for the greater part of these illustrations have been made by Mr. W. H. Chandlee and Mr. W. H. Burger, both of whom are in the employ of the Museum, and have been especially assigned to the Department of Ethnology, from which department have emanated the larger proportion of illustrated papers.

A great deal of time has been occupied in piece work connected with general administration and covering the entire field of draughting, embracing topographical and architectural work, tracings and sketch maps, engrossing, lettering, table designing, sketching of articles temporarily in the Museum, coloring of maps and charts, and artistic color work. For these purposes the following mediums were required; oil-colors and water-colors (transparent and opaque), pens and ink, lead pencils, crayons (Conté and lithographic), charcoal, and lamp-black.

G.—ACCESSIONS.

The total number of accessions to the Museum during the year was 1347.

A table showing the number of accessions to the Museum each year,

beginning with 1881 (the first year of occupancy of the Museum building), is here given :

Year.	Accession numbers (inclusive.)	Accessions.
1881.....	9890-11000	1111
1882.....	11001-12500	1500
1883.....	12501-13900	1400
1884.....	13901-15550	1650
1885 (January to June).....	15551-16208	658
1885-'86.....	16209-17704	1496
1886-'87.....	17705-19350	1646
1887-'88.....	19351-20831	1481
1888-'89.....	20832-22178	1347
Total since 1881.....		12299

The decrease in the number of the accessions this year may be accounted for in part by refusals of collections which have been necessitated owing to lack of both storage and exhibition room.

A geographical statement has been prepared, showing the sources of the more important accessions.

GEOGRAPHICAL REVIEW OF THE MORE IMPORTANT ACCESSIONS.

During the year, material has been received from nearly every part of the world, although as usual the greater number of the accessions have come from the United States. The following statement has reference to the most important accessions. These have, as far as possible, been arranged under the localities from which they were gathered rather than the place of residence of the sender.

AFRICA.

Madagascar.—Two linen table-covers, a silver watch-chain, a gold breast-pin, an ivory carving, and a small basket were deposited in the National Museum by President Cleveland, to whom they had been presented by the Queen of Madagascar.

Egypt.—Miss Alene Solomon, of Washington, District of Columbia, gave two Egyptian scarabs.

Dr. James Grant-Bey, of Cairo, Egypt, sent several water-color sketches of ancient lamps, two fragments of leather cover (fac-simile) of the catafalque of Isi-Em-Kheh, a queen of the twenty-first dynasty, 1000 B. C., and a fragment of mummy cloth, with characters of the "Ritual of the dead."

A series of casts of Assyrian and Egyptian antiquities were transmitted by the Royal Museum at Berlin.

Oberlin College, at Oberlin, Ohio, presented seventeen bird-skins chiefly from Africa, many of them new to the collection.

AMERICA.

BRITISH AMERICA.

British Columbia.—A collection of ethnological objects from Vancouver and Queen Charlotte Islands, was purchased by the Museum from Mr. James G. Swan, of Port Townsend, Washington.

Nova Scotia.—Mr. George P. Merrill, of the National Museum, collected and transmitted to the Museum specimens of gypsum obtained at Hopewell.

New Brunswick.—A collection of Middle Cambrian fossils from the St. John formation, was purchased from Mr. G. F. Matthew, of St. John.

Canada.—Mr. H. H. Lyman, of Montreal, sent rare specimens of lepidoptera.

CENTRAL AMERICA.

Costa Rica.—The Museo Nacional de Costa Rica sent two valuable specimens of birds, through Señor José C. Zeledon. A large collection of bird-skins was sent through the same source, for study and comparison, a portion of which were donated to the Museum.

MEXICO.

Chihuahua.—Mr. E. Wilkinson, of Mansfield, Ohio, sent an egg of the Cactus wren.

Two living Mexican wild-cats and three living chachalacas were received from Capt. Henry Romeyn, of Fort Ringgold, Texas.

UNITED STATES.

Alabama.—Dr. J. S. Taylor, of Mobile, sent fragments of pottery from Baldwin County.

A number of birds, birds'-nests and birds'-eggs were presented by Dr. William C. Avery, of Greensborough.

The Shelby Iron Company sent a variety of minerals.

Alaska.—The Alaska Commercial Company, of San Francisco, California, presented a bidarka.

From Lieut. George M. Stony, U. S. N., were received a deer-skin coat, trowsers, boots, skull-cap and sleeping-bag, from Kotzebue Sound, Alaska.

A picture of a crab caught at Sitka was sent by Commander L. A. Beardslee, U. S. N., of Little Falls, New York.

Arizona.—A collection of pottery, stone and vegetable fiber objects, gathered at Flagstaff, and pottery from Moqui, were presented by Col. James Stevenson, of the Bureau of Ethnology.

Mr. William W. Price, of Tombstone, sent a set of eggs of the Sulphur-bellied fly-catcher; also four birds'-eggs, new to the Museum collection.

A collection of fishes, reptiles, and batrachians was received from Dr. Edgar A. Mearns, of Fort Snelling.

The Drake Company, of Sioux Falls, Dakota, presented four slabs of agatized wood from Chalcedony Park.

California.—Prof. J. S. Diller, of the U. S. Geological Survey, collected rock specimens which were transmitted to the Museum by the survey. He also presented a White-footed field mouse from Mount Shasta.

A medicine stone was received from Mr. H. W. Henshaw, of the Bureau of Ethnology.

Dr. H. C. Yarrow, U. S. A., Washington, District of Columbia, sent an ancient bowl found in Deep Creek Valley.

Mollusks, crustacea and sponges from San Diego, were given by Mr. Henry Hemphill.

Eighteen new species of fishes from the Gulf of California were received from Profs. O. P. Jenkins and B. W. Evermann, of Greencastle, Indiana.

Mr. C. R. Orcutt of San Diego, sent shells from Lower California.

Stone relics were presented by Mr. Stephen Bowers, of San Buenaventura.

Colorado.—The U. S. Geological Survey transmitted one hundred and sixty-nine mineral specimens collected in Colorado by Messrs. Cross and Hillebrand, of the Survey.

Rocks, minerals and petrified wood were received from Lieut. Charles F. Pond, U. S. N.

Mr. Henry Zahn, of Denver, sent a piece of geyserite.

Messrs. D. R. C. Brown and Elmer T. Butler, of Aspen, presented a miniature model of Aspen Mountain.

A fine collection of birds, nests, and eggs was received from Mr. Denis Gale, of Gold Hill.

Connecticut.—Prof. O. C. Marsh, of Yale College, sent the skeleton of a cormorant for study and comparison.

Minerals were received from Prof. C. H. Hitchcock, of Hanover, New Hampshire, and from O. C. Farrington, of New Haven.

Miss Ellen Oakford, of New Haven, lent seven etchings for exhibition at the Cincinnati Exposition.

Delaware.—The Jackson & Sharp Company, of Wilmington, sent cyanotype prints of different classes of railway cars.

District of Columbia.—Numerous campaign and Grand Army badges were received from various residents of the District.

Mr. A. C. Winslow, of Washington, presented the original key to the Treasury of the United States when organized under General Washington's administration.

Mrs. E. J. Stone, of Washington, sent a map of the city engraved in 1818, and a fac-simile of the original Declaration of Independence.

Two Indian arrow-heads were given by Mr. David Fitzgerald, librarian of the War Department.

Illustrations of various military and naval uniforms were received from Mr. Paul Beckwith, of the National Museum.

Mr. Robert Ridgway, of the National Museum, presented a collection of bird-skins.

The U. S. Geological Survey transmitted fossil fish through Mr. H. W. Turner, by whom they had been collected.

M. Celeste Moritz, of Washington, presented two living White rats. Two living Prairie dogs were given by Lowell C. Williams, of Washington.

Mr. Walter Hough, of the National Museum, presented a set of waffle-irons and a wooden lock.

The U. S. Coast and Geodetic Survey sent, at the request of the Smithsonian Institution, photographs illustrating the method used in mounting photographic prints, for exhibition at the Cincinnati Exposition.

A Sparrow-hawk and a Wood thrush were received from Mr. B. W. Mitchell, of the National Museum.

Mr. George H. Boehmer, of the Smithsonian Institution, gave a bronze medal, commemorative of the centenary celebration of the Royal Batavian Society of the Academy of Sciences.

Mr. D. Ballauf, of Washington, sent a model of a locomotive for exhibition at the Cincinnati Exposition.

Dr. G. Brown Goode, assistant secretary of the Smithsonian Institution, presented six campaign metallic badges, four lithographs of army hospitals in existence from 1862 to 1869, two silhouettes and eight engravings.

An interesting addition to the photographic exhibit prepared for the Cincinnati Exposition was a collection of cyanotype prints, showing the lights and flames used in the light-houses on the American coast. These were contributed by the U. S. Light-House Board.

Dr. J. L. Wortman, of the U. S. Army Medical Museum, presented four living rattlesnakes.

A cast of the head of President Lincoln, taken sixty days before his death, by Clark Mills, was received from Theodore A. Mills, of Washington.

A collection of land, marine, and fresh-water shells was presented by Messrs. J. D. and F. B. McGuire, being a part of the collection of the late J. C. McGuire.

Mr. John Graham, warden of the city jail, gave a collection of knives, razors, tweezers and a sand-bag, made by prisoners in the District jail.

Mrs. Thomas C. Cox, of Washington, deposited General George Washington's shaving table. This table was presented to General Washington by the first French minister accredited to the United States.

The Department of Agriculture sent a collection of animal parasites.

A Secchi meteorograph was deposited in the Museum by the Chief Signal Officer.

Madame Veuve A. Collin presented a bust of the late President Garfield.

Florida.—Lieut. J. F. Moser, of the U. S. Coast and Geodetic Survey, sent birds, shells, insects, snakes, and fishes collected at Cape Sable.

Dr. J. C. Neal, of Archer, presented a collection of ethnological objects.

Shells were received from General F. E. Spinner, Pablo Beach.

Mr. Frederick W. True, of the National Museum, gave field mice, muskrats, snakes, and insects.

Three living rattlesnakes were received from Mr. James Bell, of Gainesville.

Georgia.—A large corundum crystal was sent by Mr. N. P. Pratt, of Atlanta.

Mr. M. Hamilton, of Savannah, sent, for experimental purposes, a plant supposed to be antidote for snake bites.

Pottery fragments, from Stalling's Island, were received from Mr. C. C. Jones, of Augusta.

Mr. Alfred Chisolm, of Savannah, presented an albino Red-wing black-bird.

Illinois.—Mr. A. J. W. Copelin, of Chicago, sent photographs of locomotives.

Stone implements were received from Mr. W. S. Strode, of Bernadotte.

Mr. Otho C. Poling, of Quincy, gave specimens of birds' eggs.

Mr. C. K. Worthen, of Warsaw, presented three specimens of *Ochetodon* and twelve mammal skins and skulls.

Indiana.—Prof. B. W. Evermann, of Greencastle, presented a collection of thirty species of fishes from Deer Creek and the Tippecanoe and Wabash Rivers.

Mr. Robert Ridgway, of the National Museum, collected several specimens of bird skins.

Twenty leaf-shaped implements were sent by Dr. E. C. Black, of Wheatland.

Stone implements, taken from mounds south of Cherokee, were received from Mr. J. V. Ward, of Cherokee.

Iowa.—Mr. C. R. Keys, of Burlington, sent specimens of land and fresh-water shells.

A collection of Devonian fossils were received from Prof. A. H. Conrad, of Shenandoah.

Kansas.—A collection of invertebrate fossils was received from Dr. W. S. Newlon, of Oswego.

Mr. B. F. Cannon, of Russell Springs, sent specimens of nickel ore.

A skull of a Flathead Indian was presented by Mr. W. Meinhold, of Paola.

Kentucky.—Specimens of limonite and iron ore were sent by Mr. T. W. MacGill, of Franklin.

Mr. C. F. Very, of New Albany, Indiana, presented ethnological objects from Grayson County.

Louisiana.—Mr. G. Kohn, of New Orleans, presented several specimens of terrapin.

Fifty rude stone implements were received from Mr. George Williamson, of Grand Cane.

Maine.—Mr. George P. Merrill, of the National Museum, collected specimens of granite from Red Bank, pebbles from Cape Elizabeth, and diabese from Tenant's Harbor.

A collection of minerals was sent by Mr. N. H. Perry, of South Paris.

Dr. H. C. Yarrow, U. S. A., Washington, District of Columbia, gave a sword-fish head.

Mineral specimens were purchased from Mr. W. P. Hayden, of Raymond.

Maryland.—Mr. James A. Millholland, of Cumberland, sent a drawing of the boiler-plate bridge, constructed in 1846 for the Baltimore and Susquehanna Railroad Company.

A broad-winged hawk was presented by Mr. Harold P. Stabler, of Sandy Spring.

Mr. Robert Ridgway, of the National Museum, sent a collection of birdskins.

A living tortoise was received from Mr. Howard Tabler, of Seabrook.

Mr. George Marshall, of Laurel, contributed birds.

A ground dove from Broad Creek and three snake-eggs from the Potomac River were donated by Mr. Thomas Marron, of the National Museum.

Rear-Admiral Daniel Ammen, of Ammendale, deposited a carriage used by General U. S. Grant, in Washington, prior to his election to the Presidency of the United States, and by him presented to Rear-Admiral Ammen in the summer of 1870.

Massachusetts.—Rock specimens from Newbury were collected by Mr. George P. Merrill, of the National Museum.

A series of albertypes (seventy-four) were presented by the Forbes Lithographic Manufacturing Company, of Boston.

Eighteen phototypes were received from the Boston Photogravure Company and eleven heliotypes were presented by the Heliotype Printing Company, of Boston.

Mr. G. W. Field, of Brockton, donated an Ibis and two Snake-birds.

Silver prints and lantern slides were sent by the Harvard College Observatory, Cambridge.

Mr. James P. Tilton, of Newburyport, sent fragments of pottery from Plum Island.

A mink was presented by Mr. Vinal N. Edwards, of Wood's Holl.

A whale skull was received from Mr. William H. Jackson, of Pigeon Cove.

Mrs. Anne E. Douglass, of Cambridgeport, presented plaster busts of governors of all States in office January 1, 1860, with the exception of Oregon and California.

Michigan.—A collection of bird skins, containing several species new to the Museum collection, was purchased from Mr. W. H. Collins, of Detroit.

Mr. C. A. Thompson, of Quincy, sent a specimen of stone carving from a mound near Coldwater.

Minnesota.—Mr. C. Bangs, of Wolverton, sent specimens of copper implements found in Wilkin County.

Mr. James Rigby, of Minneapolis, presented a model of a car-wheel.

The State Normal School, at Winona, sent insects, crustacea, plants, and shells.

Mississippi.—A collection of Indian pottery and several stone objects, from Prentiss County, were transmitted by the U. S. Geological Survey.

Mr. Charles E. Chidsey, of Scranton, sent sixty-eight specimens of pottery.

Missouri.—Mr. J. E. Callaway, of Ravenna, sent an interesting specimen known as a hair ball. These balls are found in the fourth compartment of the stomachs of cattle, and are composed of hairs licked from the surface of the body.

Rocks were received from Mr. Erasmus Haworth, of Oskaloosa, Iowa.

Mrs. Clara B. Davidson, of St. Louis, donated a saber presented to General J. W. Davidson, U. S. Army, for gallant conduct during the capture of Little Rock, Arkansas, in 1863.

Montana.—Col. J. I. Allen, of Stillwater, sent photographs of Crow Indians.

Among the most important acquisitions from Montana were two buffalo skins purchased from W. T. Hornaday, of the National Museum, on his return from the buffalo expedition to Montana.

Mr. Ellingson Knute sent samples of ore.

Dr. Thomas J. Reed, of Great Falls, presented two living Sparrow-hawks.

A fine living wolf was received from Mr. C. A. Dole, of Glendire.

Nevada.—A large collection of rocks (embracing about two thousand specimens) of the Comstock Lode and Washoe District, Nevada, collected by Messrs. S. F. Emmons and G. F. Decker, was received from the U. S. Geological Survey.

New Hampshire.—Four mammal skins, two insects, a turtle, and a woodchuck, were presented by Mr. Loren W. Green, of Charlestown.

Mr. G. P. Merrill, of the National Museum, collected for the Museum granite from West Concord.

Minerals and rocks were received from Prof. C. H. Hitchcock, of Hanover.

New Jersey.—Three arrow-heads were received from Mr. Charles Mead, of Sayreville.

Mr. G. P. Merrill, of the National Museum, collected for the Museum serpentine and associated minerals.

A specimen of Sowerby's whale was sent by Capt. J. L. Gaskill, keeper of the U. S. Life-Saving Station at Absecon, New Jersey.

New Mexico.—Maj. J. W. Powell, Director of the U. S. Geological Survey, transmitted fragments of pottery from Jemes Valley, also pottery and stone objects from Abiquiu.

Large collections of pottery and stone objects from various parts of New Mexico, were sent by Messrs. James Mooney, James Stevenson, W. H. Holmes, Arthur P. Davis, Dr. Washington Matthews, and Mr. Victor Mindeleff, of the Bureau of Ethnology.

Dr. R. W. Shufeldt presented a hawk, a living rattlesnake, a Long-billed Marsh wren, field mice and pocket mice, and the skin of a Red-tailed Hawk, from Fort Wingate. Eight batrachians were collected by Dr. Shufeldt and John G. Morse, of Fort Wingate.

H. W. Bremen, of Silver City, sent a root supposed to be an antidote for snake bites.

New York.—The Central Park Menagerie sent a stork and three eggs of the Black swan.

W. W. Worthington, of Shelter Island, sent specimens of arrow-heads and flakes.

A valuable and interesting collection of photographic apparatus and prints was received from the Eastman Dry Plate and Film Company, of Rochester.

W. W. Adams, of Union Springs, sent shell beads.

From William A. Hakes, of Binghamton, were received pottery fragments and stone objects from Broom County.

Rocks were collected by G. P. Merrill, of the National Museum, from Keeseville and Stony Point.

Fred Mather, of Cold Spring Harbor, presented two Mandarin ducks. Harper Brothers, of New York City, donated illustrations of the railway passenger-car.

The skeleton of a Black whale was purchased from H. A. Ward, of Rochester.

The Scovill Manufacturing Company, New York City, donated five photographic cameras and one extension tripod.

Miss Anna Randall Diehl, New York City, deposited a collection of oriental seals.

Eight watches of different designs were purchased from Tiffany & Co., New York City.

Dr. Sanderson Smith, of New York City, presented seven rare minerals.

Two specimens of Algean marble were sent by E. Fritsch, of New York City.

An important and interesting contribution to the Department of Graphic Arts, was the gift of 137 engravings, illustrating the various mechanical engraving processes, from Prof. C. F. Chandler, of Columbia College, New York City.

Photographs of street cars were received from the John Stephenson Company, New York City.

E. M. Lewis, of Bedloe's Island, presented birds which had been killed by flying against the statue "Goddess of Liberty," in New York Harbor.

J. M. Falconer, of Brooklyn, gave an engraving, "The Building of Brooklyn Bridge."

A lithograph of a landscape by Tudot was received from S. P. Avery, New York City.

A large collection of minerals, containing 1,371 specimens, collected by S. L. Penfield in Jefferson, Louis, and St. Lawrence Counties, was transmitted by the U. S. Geological Survey.

North Carolina.—J. M. Spainhour, of Lenoir, presented a specimen of asbestos.

G. P. Merrill, of the National Museum, collected peridotite, chromide, and nickel ores from Webster. He also presented photographic negatives of views taken at Webster.

The observer of the U. S. Signal Service at Charlotte sent flexible sandstone.

E. S. Bowers, of Webster, presented amethysts, two sapphire corundums, and a brown star sapphire.

Several fine mineral specimens were sent by D. A. Bolman, of Bakersville.

William H. Gaskill, keeper of the Life-Saving Station, Cape Lookout, sent a sunfish.

Ohio.—From the Cincinnati Society of Natural History was received a collection of bone, shell, and stone implements gathered from graves in Madisonville.

William H. McGinnis, Member of Congress, of Youngstown, sent stone implements, flakes, arrow and spear heads.

Coleoptera and lepidoptera were donated by Charles Dury, of Cincinnati.

A large collection of stone objects and pottery, containing 4,710 specimens, was deposited by Warren K. Moorehead, of Xenia.

Thomas Wilson, of the National Museum, presented a collection of bone, shell, and stone implements from Anderson Township and Clermont County.

Selenite crystals were received from C. S. Mason, of Toledo.

Carey Bell, of Utica, sent a stone axe.

Oregon.—Livingston Stone, sent a specimen of fungus which was found growing in a fir log near Clackamas Station.

Three water lizards from Fort Klamath were received from Capt. G. S. Carpenter, U. S. Army.

Pennsylvania.—A specimen of stone pestle from Cohocksink Creek was received from George W. Haig, of Philadelphia.

The Zoological Society of Philadelphia presented a Sheath Bill and a Cockatoo.

E. L. Pintard, of Philadelphia, deposited a file of the "Philadelphia Photographer", 1867-1887.

Two stone implements found near New Brighton, were given by Thomas Wilson, of the National Museum.

Fred Speel, of Philadelphia, sent a Toad-fish.

Four ethnological objects were received from George C. Fryer, of Philadelphia.

James D. Middleton collected and transmitted through the U. S. Geological Survey, pottery fragments from Irvine, Warren County, Pennsylvania.

A cast of a supposed human face found in the Hamilton sand-rock was received from F. W. Gibson, of Falling Springs.

E. F. Schafirt, of Media, presented a skeleton of a Rose-breasted Cock-stoo.

George P. Merrill, of the National Museum, collected copper and serpentine rock, from Cornwall, and slate from Franklin and Bangor.

The Baldwin Locomotive works, of Philadelphia, presented several photographs of modern locomotives.

Several silver prints from negatives taken in an anthracite coal mine were received from E. B. Harden, of Philadelphia.

William Bell, of Philadelphia, presented two photographic cameras.

Rhode Island.—A valuable collection of petroleum and related materials was received from Prof. S. F. Peckham, of Providence. This collection was made in connection with Professor Peckham's work for the Tenth Census, by a special arrangement with Professor Baird.

Silas Carr, of Providence, sent a collection of minerals.

Eight etchings were received from Samuel Coleman, of Newport.

Miss M. Francis, of Newport, sent a type-writer invented by the late Dr. Samuel Ward Francis in 1857.

George A. Lewis, of Wickford, presented fishes.

South Carolina.—A metal copy of the original memorial tablet designed to commemorate the services of the Charleston Relief Committee during the earthquake in 1886, was presented by Tiffany & Company, of New York.

Tennessee.—W. D. Dreher, of Knoxville, sent an Indian axe.

A. S. Oldham presented two sets of buckhorns found in Lauderdale County.

Pottery fragments were received from General G. P. Thurston, of Nashville.

Campbell Brown, of Spring Hill, presented flint implements from that place.

Texas.—G. H. Ragsdale, of Gainesville, sent a collection of fossil shells and bird skins, also a Pouched rat.

A living Civet cat was received from E. N. Hasbrouck, of Brownwood.

William Taylor, of San Diego, sent a stone implement from that place.

Vermont.—A collection of stone objects was received from Prof. G. H. Perkins, of Burlington.

G. P. Merrill, of the National Museum, collected granite in Craftsburg.

Prof. H. M. Seely, of Middlebury, sent specimens of calciferous fossils.

Virginia.—Thomas H. Tolson, of Shamrock, presented a White-headed Eagle.

Two living Black bears, captured in Virginia, were presented by the Hon. J. S. Miller, Commissioner of Internal Revenue.

M. M. Wakefield, of Annandale, sent a Great-horned owl.

Four living Angora goats were presented by the Misses Grace and Maud Parsons, of Natural Bridge.

Robert Ridgway, of the National Museum, collected bird-skins in Virginia.

Stone objects from Chain Bridge were sent by Dr. L. W. Gill.

Four living rabbits were presented by C. Edgar Uber, of Falls Church.

Millard Burch, of Ballston, donated six living Night herons.

Alexander Hunter, of Washington, gave a confederate army jacket.

A Hog-nosed snake was received from Col. W. Shutt, of Hillsboro.

Dr. Hugh M. Smith, of the National Museum, sent four birds from Back River.

Rev. R. Ryland, of Richmond, sent samples of light wood from Richmond, and a living miuk from Langley.

The following objects, formerly the property of General Washington, were received from Lawrence Washington, of Marshall:

1 pitcher portrait of Washington (china-ware).	1 colored picture in frame, view of old church near Limerick.
1 statuette of Necker.	1 colored picture in frame.
1 journal of household and personal expenses of Washington, March, 1793, to March, 1797, in writing of secretary or steward.	1 portrait in frame, "Madonna with Book."
1 sword-blade.	1 portrait in frame, "St. John."
1 spy-glass.	1 engraving, "Louis XVI."
4 engravings in circular frames.	1 picture in frame, "Fall of the Bastile."
	1 mirror.

Washington.—From the U. S. Geological Survey were received specimens of native platinum.

Five eggs of the Short-nosed owl were received from Godfrey Koenig, of Sassin.

West Virginia.—A peculiarly colored duck egg, laid the night after the duck was seen eating the shells of dyed Easter eggs, was received from W. H. Lewis, of Jefferson County.

Greenland Thomson, of Morgantown, sent several ethnological objects.

A canteen of 1863 was received from Col. Frank Thomson, of Morgantown.

Edward P. Whites, of Alderson, presented a memorial medal of George Washington.

A flint-lock pistol and lantern were received from Col. Ashbel Fairchild, of Morgantown.

Mrs. L. I. Hough, of Morgantown, sent a basket formerly used in making bread.

A coffee-biggins was donated by Mrs. Casselberry, of Morgantown.

Two living vipers were sent by Alexander McVeigh Miller, of Alderson.

A Dutch oven and an old brass candlestick were sent by Miss Emma Protzman, of Morgantown.

Wisconsin.—A medallion of General Lucius Fairchild, commander-in-chief of the Grand Army of the Republic, 1887, was presented by F. L. Phillips, of Madison.

H. P. Hamilton, of Three Rivers, sent pottery fragments.

Pottery from Yellow Lake was sent by Gerard Fowke.

H. Eggers, of Milwaukee, presented two patent boomerangs.

Wyoming Territory.—Two fine living elk were received from Hon. W. F. Cody (Buffalo Bill), of North Platte, Nebraska.

Emile Granier, of Atlantic, deposited a polished agate.

A Western porcupine from Fort Bridges, was received from Dr. C. Hart Merriam, of the Department of Agriculture.

WEST INDIES.

Cuba.—A collection of ores, forming a valuable addition to the metallurgical exhibit in the Museum, was received from Hon. Otto E. Reimer, United States consul to Santiago de Cuba, through the Department of State.

Guadeloupe.—The Museum of Comparative Zoology, Cambridge, Massachusetts, sent a collection of fishes.

A collection of bird-skins was received from L. Guesde, Point-à-Pitre.

SOUTH AMERICA.

Argentine Republic.—Walter B. Barrows, of the Department of Agriculture, presented a collection of reptiles, insects, and land shells.

Brazil.—A collection of bird-skins, comprising one hundred and eighty-seven specimens from Bahia, were purchased from Prof. Leslie A. Lee, Thomas Lee, and Charles H. Townsend, of the U. S. Fish Commission. Prof. Orville A. Derby, National Museum, Rio de Janeiro, sent, in exchange, several specimens of ores and one meteoric specimen.

Specimens of iron ore, coal and coke, from Rio Grande de Sul, were received through the Department of State.

Peru.—Woven fabrics from Ancon were presented by G. H. Hurlbut.

Uruguay.—Thomas H. Brooks, of Montevideo, sent the skin and bones of a Sea-lion from the coast of Uruguay.

Venezuela.—A valuable collection of beetles collected in Venezuela, were sent by Ernst C. Colby, of Curaçoa.

Photographs of Indians of the Goajira Peninsula were received from the Department of State, through the Hon. T. F. Bayard.

The Zoological Society of Philadelphia presented a deer, in the flesh, from South America.

The Museum of Comparative Zoology, Cambridge, Massachusetts, sent a collection of fishes from South America.

Maj. J. W. Powell, Director U. S. Geological Survey, presented two feet of a Harpy eagle.

ASIA.

China.—The Chinese Minister, at Washington, sent a beautifully mounted, carved, temple urn, of the Shang dynasty, B. C. 1762, and an ancient jade audience-ring.

A very valuable collection of religious objects from northern China and Thibet used by the Lama priests in their religious ceremonies was deposited by W. W. Rockhill. These consist of prayer wheels, Buddhist books, libation bowl, prayer beads, images of gods, etc. He also presented a scroll picture, in colors, of life in Chinese Turkestan.

P. L. Jouy, of the National Museum, presented a Chinese bow and five arrows.

Corea.—A large and valuable collection of Corean birds, comprising five hundred and forty-seven specimens, was purchased from P. L. Jouy of the National Museum.

India.—Mrs. W. Scott, of London, England, presented specimens of Tusser silk cocoons from Sadra.

The Royal Botanical Garden, Seebpore, sent in exchange an exceedingly valuable collection of mounted plants from India.

Persia.—Rev. J. L. Potter, of Drakesville, New Hampshire, sent a complete suit of a Persian Mohammedan priest, from Teheran, Persia.

A cast of a seal of Darius, King of Persia, and two casts of Babylonian seals were presented by Isaac Myer, of Philadelphia.

Japan.—A very interesting collection of Japanese birds, containing one hundred and nine specimens and seventy-four species, from southern Japan, was presented by T. Ringer, of Nagasaki. Among them was a fine male specimen of the true Sommering's Pheasant (*Phasianus serritillans*) and a Spoon-billed sandpiper (*Eurynorhynchus pygmaeus*).

A collection of ivory figures was purchased from Tiffany & Company, New York City.

A collection of bronze and wooden figures was purchased from Edward Greey, New York City.

A Buddhist rosary and two birds were received from P. L. Jouy, of the National Museum.

Harry V. Henson, of Yokohama, sent a bird from Hakodate.

Japanese musical instruments, two Japanese masks, porcelain ware, and a palanquin were purchased from the First Japanese Trading Company, New York City.

The Tokyo Library and Tokyo Educational Museum presented a very fine collection of Japanese plants.

Jerusalem.—A shofar, or ancient Jewish trumpet, made of ram's horn, was presented by David Sulzberger, of Philadelphia.

An alabaster model of a Mosque in Jerusalem was deposited by the Rev. J. P. Newman, of New York.

EUROPE.

Austria.—The Royal Imperial Natural History Museum, of Vienna, sent, through Dr. Aristides Brezina, a collection of meteorites, and also sent in exchange one hundred and seventeen specimens of building stones.

Three meteorites were received, in exchange, from Baron Braun, of Vienna.

A collection of twenty-four bird skins was received, in exchange, from Victor Ritter von Tschusi zu Schmidhoffen, of Salzburg.

Chevalier Schmit von Tavera, minister from Austro-Hungary, presented an ethnological map of Hungary.

Denmark.—A collection of fishes representing sixty-seven species, from northern seas, was received, in exchange, from the Zoological Museum of the University of Copenhagen.

A silver cross of the "Order of Danenborg" was presented by Paul Beckwith, of the National Museum.

France.—The Musée d'Histoire Naturelle, Paris, sent, in exchange, one hundred and ninety-five specimens of modern and antique marbles from Europe and Africa.

The Musée de St. Germain, Paris, sent, in exchange, molds of bronze implements.

Thomas Wilson, of the National Museum, presented minerals from Brittany.

A collection of five hundred specimens of stone implements from various localities of France was purchased from E. R. Reynolds, of Washington, District of Columbia.

Germany.—C. Kickhoff, of New York, sent samples of alloys from Germany.

A collection of bird-skins was purchased from Dr. E. Rey, of Leipsic.

Great Britain.—From the Royal Botanical Gardens at Kew, was received a collection of vegetable economic products, including textiles, foods, gums, materia medica, botanical and ethnological specimens.

F. W. Webb, locomotive superintendent of the London and North-western Railway Company, Crewe, sent photographs of Trevithick's engine and boiler.

The State Department sent a collection, made by W. F. Grinnel, United States consul at Bradford, England, of woolen, worsted, silk, and cotton fabrics.

Three casts of *Meiolonia* from Lord Howe Island, was sent by the British Museum.

A collection of ethnological objects was received from Edward Lovett, of Croydon, near London.

Italy.—The Royal Museum, Florence, sent, in exchange, through Prof. Henry H. Giglioli, one hundred and fifty fishes, two hundred and thirty-four birds, thirty-two reptiles, and twenty-four mammals.

Seven European bats were received from Angelo Senna, of Pavia.

A. A. Blair, of Philadelphia, sent crystallized hematite from the Island of Elba.

Norway.—A complete model of a Viking ship was purchased for exhibition at the Cincinnati Exposition, from Albert Cammermeyer, of Christiania.

A Killer whale was received, in exchange, from the Zoological Museum, Royal University, Christiania.

Roumania.—A. L. Montandon, of Bucarest, sent, in exchange, specimens of coleoptera and hemiptera from eastern Europe.

Russia.—A military medal from the Crimea was received, in exchange, from Paul Beckwith, of the National Museum.

The Museum of Natural History, at Tiflis, sent through Dr. Gustave Radde, a collection of Caucasian and Transcaspian bird-skins.

Scotland.—D. Bruce Peebles, of Edinburgh, sent pith of the rush used as a lamp wick.

Switzerland.—The Musée d'Ethnologie, Geneva, sent, in exchange, a very fine collection of Lacustrian pottery, vase, bronzes, bracelets, and collars.

OCEANICA.

AUSTRALASIA.

Australia.—Baron Ferdinand von Mueller, of Melbourne, sent a collection of Australian plants.

New Zealand.—A collection of fishes, representing forty-one species, was received from the Otago University Museum, Dunedin, through Dr. T. Jeffery Parker.

An interesting collection of birds, rocks, minerals, shells, and ores was received from Prof. T. F. Cheeseman, curator of the Auckland Museum.

A valuable collection of New Zealand woods was received, in exchange, from the Canterbury Museum, Christchurch.

New South Wales.—The Department of State presented a case containing samples of Australian wools collected by the United States consul at Sydney.

POLYNESIA.

Hawaiian Islands.—A collection of ferns containing one hundred and ten species, from the Hawaiian Islands, was received from G. W. Lichenthaler, Bloomington, Illinois, in exchange for ferns from Costa Rica. Valdemar Knudsen, of Waia, presented two petrels.

H.—SPECIMENS SENT FOR EXAMINATION AND REPORT.

A large number of specimens are received each year for examination and report. A separate record of these is kept. When specimens thus received are worthy of addition to the collections, they are entered on the accession record, and receive a number in the accession series. No less than three hundred and forty-seven lots of specimens of this kind were received during the year. In each case the specimens are examined by the curator to whose department they relate, and he submits a formal report upon them. A copy of this is transmitted to the sender. A list* of these specimens received is here given together with an index arranged by localities. It should be stated, perhaps, that the object of printing this list is the same as for printing the list of letters asking for information, which has been already explained on p. 88.

- ADAMS, WILLIAM W., Mapleton, New York. Fragment of supposed meteorite. 306, '88 (xvi); copper spear-heads, from Michigan and New York. (Purchased.) 147 (22229), '88 (iii.)
- AIKEN, J. CHAP., Jonesborough, Tennessee. Larva of insect. (Returned.) 140 '88 (x).
- AINSWORTH, W. P. H., Taylorsville, Mississippi. Minerals. 182, '88 (xvi).
- ALBA, A., Norwalk, Florida. Larva of insect. 244, '88 (x).
- ALLEN, J. A., American Museum of Natural History, New York City, New York. Birds, from Brazil. (Borrowed for study and returned.) 406, '89 (v, a).
- ALLEN, J. C., White Gate, Giles County, Virginia. Chart from Virginia. (Returned.) 203, '88 (xvii). Bird skins. (Borrowed for study and returned.) 289, '88 (v, a).
- ALTSCHUL, M., Hampton, Virginia. Rock. 183, '88 (xvii). Fossil shark teeth (two specimens). 183, '89 (xii). Cenozoic fossil (fragment). 183, '88 (xiii, b).
- AMERICAN MUSEUM OF NATURAL HISTORY, New York City, New York. Bird skins from Brazil. (Returned.) 363, '89 (v, a). Birds. (Borrowed for study and returned.) 468, '89 (v, a). Birds (12). (Borrowed for study and returned.) 474, '89 (v, a).
- AMES, FISHER, Lakeside, Michigan. Fossil coral. 301, '88 (xvi).
- APPLETON, JNO. W. M., Salt Sulphur Springs, West Virginia. Insect. 460, '89 (x).
- ASHLEY, GEORGE, New Flat Fork, Virginia. Ore. 298, '88 (xviii).
- ASKEW, H. G., Tyler, Texas. Shells, from Texas. 473, '89 (ix).
- AT LEE, W. YORK, Washington, District of Columbia. Tripoli. (Returned.) 238, '88 (xviii).
- AVERY, Dr. WILLIAM C., Greensborough, Alabama. Bird skins. 449, '89 (v, a).

* Entries having double numbers indicate that the specimen was first sent for examination and report, and was afterwards added to the collections.

- AYRES, Col. E. W., Washington, District of Columbia. Bog-ore. 197, '88 (xviii).
- BABCOCK, Dr. S. E., Chester, South Carolina. Limonite; oxide of iron. 262, '88 (xvi).
- BACON, N., Talcott, West Virginia. Argillaceous sandstone. 404, '89 (xviii).
- BAKER, DANIEL, Buckeystown, Maryland. Specimens of building stone. 342 (21671), '89 (xvii).
- BARBOUR, THOMAS P.; San Antonio, Texas. Mineral. 282, '88 (xvi).
- BASINSKI, J. & BROTHERS, Miles City, Montana. Plant, 164, '88 (xv).
- BAXTER, R. F., Glen's Falls, New York. Rock. 319, '88 (xvii); ore. 339, '89 (xviii).
- BEAUCHAMP, W. M., Baldwinsville, New York. Stone implements. (Returned.) 469, '89 (iii).
- BERRY, Hon. J. H., United States Senate. Iron ore. 185, '88 (xviii); copper ores. 256, '88 (xviii).
- BEWERTHEIM, A. T. & SONS, San Louis Potosi, Mexico. Topaz crystal. 456, '89 (xvi).
- BIBIKOV, N. A., Albuquerque, New Mexico. Ores. 314, '88 (xviii).
- BILLET, GEORGE, Shocks Mills, Pennsylvania. Iron pyrites. 278, '88 (xvi); minerals. 297, '88 (xvi).
- BISSIG, FRANK, Payson, Arizona. Ore. 169 (21089), '88 (xviii).
- BLUME, EDWARD L., Mount Savage, Maryland. Quartz and limestone concretion. 356, '89 (xvii).
- BOARD, A., Jackson Court-House, West Virginia. Silver ore. 152, '88 (xviii).
- BRUFF, Mrs. J. G., Washington, District of Columbia. A collection of ethnological material. 458, '89 (ii, a).
- BOND, WARREN E., Custer, Dakota. Ore. 326, '89 (xviii).
- BOWMAN, D. A., Bakersville, North Carolina. Sample of supposed mineral water. 154, '88 (xvi).
- BOWMAN, N. W., Taylor Springs, Virginia. Calcite. 216, '88 (xvi).
- BRADSTREET, E. C., Gold Hill, Colorado. Quartz. 285, '88 (xvi).
- BRENNING, G. F., Fort Collins, Colorado. Pine Grosbeak. (Returned.) 384, '89 (v, a).
- BREWSTER, WILLIAM, Cambridge, Massachusetts. Birds from Chihuahua, Mexico. (Returned.) 192, '88 (v, a); birds from Chihuahua, Mexico. (Borrowed for study and returned.) 181, '88 (v, a).
- BRIGGS, S. M., Washington, District of Columbia. Ore. 241, '88 (xviii).
- BRUCE, DAVID, Brockport, New York. Insects, principally from Colorado. 280 (21679), '88 (x).
- BRUCE, GEORGE A., Worsham, Virginia. Mineral. 365, '89 (xvi).
- BRUCE, Miss M. W., New York City. Six Babylonian Tablets and three Cylinders. (Borrowed for study and returned.) 408, '89 (i).
- BRYANT, WALTER E., San Francisco, California. Bird skins, from Lower California. (Returned.) 295, '88 (v, a); bird skins. (Borrowed for study and returned.) 172, '88 (v, a).
- BUIE, D. M., Burgaw, North Carolina. Insects. 457, '89 (x).
- BULL, AMOS, Page, Kansas. Ores containing iron and nickel. 251, '88 (xviii).
- BULLOCK, JAMES A., Pittard, North Carolina. Tree cricket. 243, '88 (x).
- CAMPBELL, W. M., Texarkana, Texas. Ore, 283, '88 (xviii).
- CANNON, B. F., Russell Springs, Kansas. Iron ore. 211, '88 (xviii); ore. 196, '88 (xviii).
- CANTRELL, GEORGE G., Minneapolis, Minnesota. Bird skins. (Returned.) 381, '89 (v, a).
- CARTER, F. L., Cleveland, Ohio. May fly (*Palengonia bilineata*). 139, '88 (x).
- CASE, S. J., Traverse City, Michigan. Flowers. 167, '88 (xv).
- CHASE, JAMES H., Ironton, Missouri. Three specimens of minerals. 371, '89 (xvi).
- CHASE, Miss SUSIE F., Takoma Park, District of Columbia. Ferns. 141, '88 (xv).
- CHESNEY, H., New Orleans, Louisiana. Insects. 229, '88 (x).

- CHESNEY, J. C., Northumberland, Pennsylvania. Ores. (Returned.) 332, '89 (XVIII).
- CHRISTOPHER, M. J., Richmond, Virginia. Brain coral, from the West Indies. (Returned.) 268, '88 (XI).
- CHURCH, I. S., Kelly, New Mexico. Copper. 348, '89 (XVII).
- Cincinnati Society of Natural History, Cincinnati, Ohio. Vertebra (portion) of Mastodon. (Returned.) 480, '89 (XII).
- CLARK, WALDO J., Mullen, Idaho. Mineral. 415 (22,095), '89 (XVI).
- COALE, H. R., Chicago, Illinois. Bird skins. (Returned.) 171, '88 (V, A).
- COCHRAN, J. P., New York City, New York. Babylonian cylinder. (Returned.) 1887, '88 (I).
- COLEMAN, JOHN B., Baker City, Oregon. Mineral. 439, '89 (XVI).
- COLLETT, Prof. R., University of Christiania, Christiania, Norway. Bird skins. 217, '88 (V, A).
- Colorado Biological Association (through Theodore D. A. Cockerell, secretary), West Cliff, Colorado. Cretaceous fossils. (Returned.) 331, '89 (XIII, B).
- COMBS, J., Beaver, West Virginia. Mineral. 467, '89 (XVI).
- COOK, T. M., Jackson, Cherokee County, Texas. Limonite, from Texas. 403, '89 (XVIII); ore, from Texas. 545, '89 (XVIII).
- Copake Iron Works, Columbia county, New York (through Fred. P. Miles). Wrought iron. 346, '89 (XVIII).
- CORDER, JONATHAN O., Guest's Station, Virginia. Clay. 320, '88 (XVIII).
- COTMAN, A. J., Cedar Glades, Arkansas. Lead and zinc ores. 227, '88 (XVIII).
- CURTIS, W. E., Washington, D. C. Stone carving, representing a llama. (Lent by request and returned.) 323, '89 (III).
- DALLAS, JOHN, Fairfield, Connecticut. Lepidoptera. (Returned.) 399, '89 (X); Lepidoptera. 423, '89 (X).
- DALY, P. C., Chattanooga, Tennessee. Ores. (Returned.) 329, '89 (XVIII).
- DANIELS, O. E., Pecatonica, Illinois. Red bat. 233, '88 (IV).
- DAVIS, JOHN M., Fayette Court-House, Alabama. Insects. 478, '89 (X).
- DAVIS, Hon. H. G., Baltimore, Maryland. Cannel coal, from West Virginia. 337, '89. (XVIII).
- DECKER, C. L., Dayton, Wyoming. Plant from Wyoming. 419, '89 (XV).
- DIBBLE, DAVID D., Springfield, Utah. Petroleum. 325, '89 (XVIII).
- EASTWOOD, Miss ALICE, Denver, Colorado. Plants. 261, '88 (XV).
- ELAM, W. C., Trevilian's, Virginia. Mole cricket, *Gryllotalpa longipennis*. 194, '88 (X).
- ELLINGSON, K., Virginia City, Montana. Oxide of iron. 146 (20,960), (XVIII).
- ELLS, R. T., Grimm's Landing, West Virginia. Impure limestone and clay marl. 367, '89 (XVII).
- EMERSON, Mrs. ELIZABETH, Palma Sola, Florida. Shell, *Voluta junonia*. 409, '89 (IX). (Returned).
- ENGLISH, GEORGE L. & Co., Philadelphia, Pennsylvania. Mineral. 272, '88 (XVI); mineral. 327, '89 (XVI); crystals. 396, '89 (XVI); crystals. 397, '89 (XVI). Minerals. (Part returned). 421 (22,099), '89 (XVI).
- EVANS, EVAN M., Princeton, New Jersey. Bird. (Returned.) 374, '89 (V, A).
- EVANS, FRANK H., San Bernardino, California. Minerals, rocks, and ores. 443, '89 (XVI).
- FAUNTLEROY, T. T., Staunton, Virginia. Stone implements. 221, '88 (III).
- FIELD & GREENWOOD, Brownsville, Texas. Bird skins. 343, '89, (V, A); birds. (Returned.) 398 '89, (V, A). Birds (five specimens) from Brownsville, Texas. 448, '89, (V, A). Eggs of Western Night-hawk (two specimens) and one bird skin. 476, '89 (V, A).
- FISHER, EMORY, Phoenix, Arizona. Ore. 465, '89 (XVIII).
- FOOTE, GEORGE B., Helena, Montana. Minerals. (Returned.) 416, '89 (XVI).
- FORCE, HOUSTON T., St. Louis, Missouri. Vertebrae of fossil animal, found in Clark County, Arkansas. 420, '89 (IV).

- FOY, ALFRED D., Lookout Mountain, Tennessee. Indian-pipe plant (Corpse plant) 219, '88 (xv).
- FULLER, IRA C., Brookville, Pennsylvania. Ore. 379, '89 (xviii); minerals from Kentucky. 385, '89 (xvi).
- FRENCH, CLARENCE E., Jacksonville, Cherokee County, Texas. Galena. 341, '89 (xviii); iron pyrites. 387, '89 (xvi); minerals. 425, '89 (xvi); ore from Texas. 431, '89 (xviii).
- FRENCH, G. H., Carbondale, Illinois. Insects. (Returned.) 357, '89 (x).
- FRY, F. G., New Orleans, Louisiana. Amazonian figures. 445, '89 (ii, a).
- GAWTHROP, J. E., Huttonsville, Randolph County, West Virginia. Ochre. 153, '88 (xvi).
- GAY, W. H., New York City. Carbon in stick. 392, '89 (xviii).
- Geological Survey of Canada, Ottawa, Canada. Fossils. 369, '89 (xiii, a).
- GERMAIN, W. H., Glendora, California. Coal. 180, '88 (xviii).
- GILBERT, J. F., Abbeville County, South Carolina (through Hon. J. S. Cothran, House of Representatives). Gold ore. 271, '88 (xviii).
- GILLETTE, Prof. E. P., Iowa Agricultural Experiment Station. Insects (fifteen specimens). (Returned.) 267, '88 (x).
- GILLILAN, Rev. J. D., Beaver, Utah. Clay. 376, '89 (iii).
- GOAN, W. R., Hot Springs, North Carolina. Insect. 479, '89 (x).
- GOFF, Hon. N., House of Representatives, Washington, District of Columbia. Quartz. 322, '89 (xvi).
- GOSS, N. S., Topeka, Kansas. Humming-birds (eight specimens) from Central America. (Returned.) 215, '88 (v, a); birds from Mexico. (Returned.) 471, '89 (v, a).
- GRIGSBY, W. T., Union City Tennessee. Mole cricket. 265, '88 (x).
- GROVER, J. T., Tampa, Florida. Root. 277, '88 (i, a).
- GUERNSEY, Rev. J. W., Rutland, Vermont. Carpet-bag. 393, '89 (x).
- HALLOCK, CHARLES, Plainfield, Massachusetts. Rock. 220 (21,273) '88 (xvii).
- HANCOCK, Dr. JOSEPH L., Chicago, Illinois. Bird skin. (Returned.) 429, '89 (v, a).
- HANNON, V. T., Texarkana, Texas. Lead and zinc ores, 269, '83 (xviii).
- HARLAN, JAMES, Navajoe, Indian Territory. Insect. 472, '89 (x).
- HARLOW, WILLIAM H., Sewanee, Tennessee. Fern. 441, '89 (xv).
- HARRIS, GEO. E., Cassville, Missouri. Plants. 432, '89 (xv); plants. 455 (xv); plants, 470, '89 (xv).
- HARRIS, JONAH, Pence, Kansas. Ore, 230, '88 (xviii).
- HART, WILLIAM R., Silverton, Colorado. Insects (four specimens). 179, '88 (x).
- HAVENS, Capt. JOHN G. W., Point Pleasant, New Jersey. Fish. 302, '88 (vii).
- HAZEN, FRED. K., Goffstown, New Hampshire. Stone implement. 149, '88 (xvi).
- HAZEN, WILLIAM, Covello, Columbia County, Washington. Pyrite crystals, sulphide of iron. 228, '88 (xviii).
- HEAD, W. H., jr., Cane River, Van Buren County, Tennessee. Iron pyrites in calcite. 214, '88 (xvi).
- HENRY, JAMES, Shingle, White County, Tennessee. Ores. 349, '89 (xviii).
- HERRON, Dr., Washington, District of Columbia. Tourmaline in quartz, from Maryland. 160, '88 (xviii).
- HIGHT, JAMES L., jr., Dallas, Georgia. Spear head. 422, '89 (iii).
- HIMROD, W. G., Havre de Grace, Maryland. Ore. 438, '89 (xviii).
- HINDE, HARRY H., Fort Smith, Arkansas. Insects. 193, '88 (x).
- HOLBERTON, WAKEMAN, New York City, New York. Painting, representing Black-spotted trout (male and female) and a Dolly Varden trout. (Returned.) 426, '89 (vii).
- HOOPER, JOSEPH, West Chester, Pennsylvania. Bird skin. (Borrowed for study and returned.) 161, '88 (v, a).
- HOVEY, GEORGE U. S., White Church, Kansas. Mineral. 459, '89 (xvi).
- HOY, Dr. P. R., Racine, Wisconsin. Plant. 255, '88 (xv); fresh-water sponge, 276 (22167), '88 (xi).

- HUNTINGTON, OLIVER B., Springfield, Utah. Minerals. 335, '89 (xvi).
- HURST, General H. P., Washington, District of Columbia. Plate of wrought iron penetrated by a bullet. 173, '88 (xviii).
- JACKSON, B. F., Athelstan, Arkansas. Stone pipe. 359 (21953), '89 (iii).
- JACKSON, W. R., Memphis, Tennessee. Ore from Polk County, Arkansas. 373, '89 (xviii).
- JARRETT, W. E., Edwards, Kentucky. Silver coin, Mexican, 8 reals, year 1818. 157, '88 (1).
- JESURUM, MORTIMER, Douglas, Wyoming. Fossil shell. 279, '88 (xiii, b).
- JOAB, C. W., Albany, New York. Minerals. 332, '89 (xvi); stone and flint implements, and human skull from a mound near Newark, Ohio. 382, '89 (iii); ethnological objects. 382, '89 (ii, a); palmated elk horns and leg of a panther. (Returned.) 332, '89 (iv); minerals. 395, '89 (xvi).
- JOHNSON, BEN, Stockton, Tooele County, Utah. Sand. 411, '89 (xviii).
- JOHNSON, F., Riverside, California. Bird skins. (Returned.) 394, '89, (v, a). Illinois State Laboratory of Natural History, Champaign, Illinois. Insects. (Returned.) 312, '88 (x).
- INGALLS, Hon. J. J., United States Senate, Washington, District of Columbia. Nickel ore. 207, '88 (xviii).
- KEESE, A. E. L., Washington, District of Columbia. Gold, silver, and copper coins and medals. (Returned.) 209, '88 (1).
- KELLER, C. E., Keller, West Virginia. Impure graphite. (Returned.) 239, '88 (xviii).
- KENNEDY, M., Amicus, Virginia. Ore. 317, '88 (xviii).
- KIDWELL, F., Harpers Ferry, West Virginia. Calcite. 364, '89 (xvii).
- KLOBBER, CHARLES E., jr., Washington, District Columbia. Siliceous hematite from Roanoke, Virginia. 247, '88 (xviii).
- KNAPP, L., Outcut, New York. Bird skin. (Returned.) 137, '88 (v, a).
- LANSING, Prof. J. G., Theological Seminary, New Brunswick, New Jersey. Egyptian gold coin. (Returned.) 254, '88 (1).
- LAUREDALE, A. N., Lampasas, Texas. Gnano. 358, '89 (xvii).
- LAWRENCE, GEORGE N., New York. Birds (three specimens), from Mexico. (Returned.) 377, '89 (v, a).
- LAWRENCE, Messrs. W. H. & Co., Denver, Colorado. Shellbark hickory nuts. 263, '88 (xv).
- LEARY, J. L., Thoroughfare, Virginia. Decomposed rock. 405, '89 (xviii).
- LEON, Dr. NICOLAS, Morelia, Mexico. Plant. 288, '88 (xv).
- LONG, VERNON, Paul Smith's, Franklin county, New York. Iron ore. 155, '88 (xvi).
- LE NOED, Dr. L. D., Mineral Springs, Arkansas. Fiber. 353, '89 (1).
- LERCH, Dr. OTTO, San Angelo, Texas. Iron ore, from Texas. 274, '88 (xviii).
- LOCKE, GEORGE, Libertyville, Illinois. Mineral, 191, '88 (xvi).
- LOOMIS, LOVERETT M., Chester, South Carolina. Raven. (Returned.) 375, '89 (v, a); bird skins. 315, '88 (v, a).
- LOUCKS, CASPER, York, Pennsylvania. Stone implements. (Returned.) 447, '89 (iii).
- LUCAS, Dr. H. S., Pine Mountain, Georgia. Rock. 307, '88 (xvii).
- LYNCH, JOHN, North Yakima, Washington. Ore. 312, '89 (xviii).
- MCBRIDE, W. S., Marshalltown, Iowa, fragment of a skull. (Returned.) 413, '89 (iii).
- MCCAIN, I. G. & Co., Hot Springs, Washington. Water (for analysis). 204, '88 (xvi).
- MCCARTHY, JOHN, Hermosa, Dakota. Mineral. 412, '89 (xvi).
- MCCLELLAND, Dr. J. B., Pittsburgh, Pennsylvania. Pottery, from a well near Powhatan, Virginia. 245, '88 (ii, b).
- MCCONVILLE, D., Sixth Auditor, Treasury Department. Chert containing calcite. (Returned.) 234, '88 (xviii); iron ore, 213, '88 (xviii).
- MCDONALD, A. W., Berryville, Clarke County, Virginia. Ore from Blue Ridge mountains. 400, '89 (xviii).

- MCGINNIS, WILLIAM H., Youngstown, Ohio. Stone implements. 208 (21212), '88 (III); plant. 208 (21212), '88 (xv).
 MCLWRAITH, T., Cairnbrae, Hamilton, Ontario, Canada. Bird skins. (Returned.) 351, '89 (v, A).
 MCSPEIDEN, T. G., Baltimore, Maryland. Ore, supposed to contain nickel. 281, '88 (xviii).
 MACGILL, T. W., Franklin, Kentucky. Bog-ore, from Kentucky. 175 (21075), '88 (xviii).
 MANGUM, Mrs. WILLIE, Washington, District of Columbia. Japanese coins. 303, '88 (1); Japanese coins. (Returned.) 303, '88 (II, A); Chinese copper coins. 303, '88 (1).
 MARQUETTE, PETER J., West Fort Ann, New York. Minerals. 444, '89 (xvi).
 MILLER, F. S., Chillicothe, Missouri. Insect. 391, '89 (x).
 MIRICK, Miss NELLIE, Oneida, New York. Plant. 225, '88 (xv).
 MITCHELL, C. W., Lynchburgh, Virginia. Clays, colored by oxides of iron. 178, '88 (xvii).
 MOONEY, JAMES, Cherokee, North Carolina. Garnet. (Specimens sent for report as to value per ton.) 163, '88 (xvi); feldspar. 380, '89 (xvii).
 MORGAN, H. DE, New York City, New York. Collection of prehistoric antiquities, from America. 435, '89 (22,264) (III).
 MAY, W. R., Nephi, Utah. Bituminous carbonate of lime. (Borrowed for study.) 134, '88 (xvi).
 MAYOR, Mrs. MINNIE, Austin, Minnesota. Shell snicker. (Returned.) 366, '89 (III).
 MEAD, ALBERT D., Middlebury, Vermont. Black-throated warbler (skin); *Dendroica caerulescens* (Returned). 159, '88 (v, A). Bird skins and eggs. (Returned.) 324, '89 (v, A).
 MEDER, FRED., New York City, New York. Prints. (37), 446 (22 074), '89 (1).
 MEREDITH, JOSEPH, Rico, Colorado. Radius of a deer. 260, '88 (xii).
 MERRILL, Dr. J. C., U. S. Army, Frankfort Arsenal, Philadelphia, Pennsylvania. Rocks (three specimens) from the Boulder mining district of Montana. 222, '88 (xvii).
 MURRAY, JOHN, Sing Sing, New York. Rock. 248, '88 (xvii).
 MURRAY, R. R., Camp Supply, Indian Territory. Lava. 440, '89 (xvii).
 NEHRLING, H., Milwaukee, Wisconsin. Bird skin. (Returned.) 410, '89 (v, A).
 NELSON CHRISTIAN, Virginia City, Montana. Minerals. 150, '88 (xvi).
 NEMEGUEI, B. M. DE, Independence, West Virginia. Larvæ of caterpillar. 198 (21211), '88 (x).
 NEWBERRY, Prof. J. S., Columbia College, New York. Cretaceous invertebrate fossil, from Weld County, Colorado. 186, '88 (xiii, B).
 NICKELL, L. A., Union, West Virginia. Iron pyrite, 366. '88 (xviii).
 NICKERSON, GEORGE A., Plymouth, Massachusetts. Fish. 370, '89 (xii).
 NICKERSON SALT COMPANY, Nickerson, Kansas. Salt. 240, '88 [xviii].
 NIVEN, WILLIAM, New York City, New York. Minerals and cut stones. 463, '89 (xvi).
 NOLTING, AUGUST H. jr., Brooklyn, New York. Beetle, *Monohammus confusor*. 156, (21094), '88 (x).
 OATES, M. T., and MORRIS, B. L., Rhome, Texas. Siliceous limestone. 166, '88 (xviii).
 OBENDERF, JOHN L., Downeyville, Nye County, Nevada. Ore (two specimens). 184, '88 (xviii).
 OTEY, PETER J., Lynchburgh, Virginia. Mole cricket. (Returned.) 318, '88 (x).
 PARKHILL, C. H., Cornwall, Vermont. Bird skins. (Returned.) 434, '89 (v, A).
 PARKS, HIRAM, McDonald, Tennessee. Iron ores. 212, '88. (xviii).
 PATTERSON, Capt. J. H., U. S. Army, Fort McGinnis, Montana. Insect. 257, '88 (x).
 PATTON, W., Osceola, Missouri. Ore. 237, '88 (xviii).
 PENDLETON, Dr. E. B., Berkeley Springs, West Virginia. False spikenard. (Borrowed for study.) 151, '88 (xv).

- PENNYPACKER, C. H., West Chester, Pennsylvania. Mineral. (Returned.) 190, '88 (xvi).
- PERRY, J. W., Kansas City, Missouri. Iron ores. 466, '89 (xviii).
- PETERSON, G. H., Denver, Colorado. Plaster cast of a bronze coin of Augustus Cæsar, Emperor of Rome. (Returned.) 286, '88 (i).
- PETTEBONE, PAYNE & SON, Wyoming, Pennsylvania. Worm-eaten ash handle. 433, '89 (x).
- PHILLIPS, JOHN W., South Oil City, Pennsylvania. Minerals. 378, '89 (xvi).
- PIKE, E. BERTRAM, Boston, Massachusetts. Siliceous sand. 340, '89 (xvii).
- POLING, OTHO C., Quincy, Illinois. Bird skins. (Returned.) 291, '88 (v, a.); bird skins. (Returned.) 311, '88 (v, a.)
- POLKINHORN, H. B., Charlottesville, Virginia. Galena. 293, '88 (xvi).
- PRICE, THOMAS H., Hyattstown, Maryland. Ores. 482, '89 (xviii).
- PRINTUP, JOHN C., Rome, Georgia. Tripoli. 218, '88 (xviii).
- PROCK, A. B., Osceola, Missouri. Hematite iron ore. 388, '89 (xvi).
- PUTNAM, Professor F. W., Peabody Museum, Cambridge, Massachusetts. Fire sticks of the Ainos, Bushmen, and Somalis. (Lent for drawing.) 145, '88 (II, A); fragments of bones of mammals. (Returned.) 294, '88 (xii).
- PRATT, N. P., Atlanta, Georgia. Corundum crystal. 407, '89 (29934).
- PRATT, W. E., Lake Forest, Illinois. Birds' eggs (three specimens). (Returned.) 345, '89 (v, b).
- PRESTON, E. D., U. S. Coast and Geodetic Survey. Lava from the Sandwich Islands. 360 (21704) '89 (xvii).
- PRICE, C. W., Chrome, Colorado. Fossil. 442, '89 (xiii, b).
- RABB, R. I., Paducah, Kentucky. Horny covering of lower jaw of a Loggerhead turtle. 242, '88 (xii).
- RAGSDALE, G. H., Gainesville, Texas. Bird skins (4 specimens). (Returned.) 148, '88 (v, a). Cretaceous fossils. (Returned.) 231, '89 (xiii, b.); skulls of Mole. 390, '89 (iv.); copper-head snake. 424, '89 (vi).
- RALSTON, THOMAS C., Fairbury, Nebraska. Ores. 195 '88 (xviii).
- RANKIN, E. P., Jacksonville, Texas. Larva of moth. 224, '88 (x).
- RAWLINGS, L. A., Box-Elder, Colorado. Ores. 361, '89 (xviii).
- RAY, MICA COMPANY, The G. D., Burnsville, North Carolina. Mica. 249, '88 (xvi).
- REDMAN, AMOS, Wellington, Virginia. Red hematite; an oxide of iron. 162, '88 (xviii).
- REICHSTEIN, JACOB, Pittsburgh, Pennsylvania. Ore. 206, '88 (xviii).
- REMUS, E., Acton, California. Plant. 304, '88 (xv).
- RICHARDSON, MAX B., Oswego, New York. Indian clothing. 208 (21596), '89 (II, A).
- RICHARDSON, URIAH, Oakley, Logan County, Kansas. Magnetic iron sand. 226, '88 (xvi).
- RIDENOUR, WILLIAM B., Brooklyn, New York. Plant. 223, '88 (xvi).
- RINGHARTZ, THEO. VON, Middletown, Virginia. Quartz. 296, '88 (xvi).
- ROGAN, JAMES W., Rogersville, Tennessee. Insect. 452, '89 (x).
- ROGERS, DR. C. F., Braunbury, Texas. Teeth of fossil Ganoid fish. 352, '89 (vii).
- ROGERS, O. F., Kingston, New Mexico. Ore. 309, '88 (xviii); ore. 323, '89 (xviii).
- ROTCHFORD, Mrs. H. J., Woodland, New York. Larvæ of insects. 136, '88 (x).
- SAGAR, ANDREW J., Saunsville, Virginia. Mineral. 475, '89 (xvi); minerals. 427, '89 (xvi).
- SALT E. M. Bath, New York. Plant. 355, '89 (xv).
- SANDOS, Mr. W. A., Opelousas, Louisiana. Insect. 401, '89 (x).
- SAUNDERS, JOHN P., Elizabeth, West Virginia. Iron ore. 389, '89 (xviii).
- SCOTT, MARY P., Sioux City, Iowa. Clay marl, from Iowa. 201, '88 (xvii).
- SCOTT, W. W., Canal Dover, Ohio. Stone with carving of human face. (Returned.) 436, '89 (iii).
- SEARCY, F. D., Seattle, Washington. Photographs of deer. 310, '88 (iv).

- SECRET SERVICE DIVISION, Treasury Department. Photographs (Fifty) of counterfeiters. 143, '88 (20,926), (1).
- SENNETT, GEORGE B., American Museum of Natural History, New York. Birds (three specimens), from Mexico. (Returned). 316, '88 (v, A); bird. (Returned.) 430, '89 (v, A).
- SHEDD, Rev. J. H., Marietta, Ohio. Oriental seals, gems, and coins. 344, '89 (1).
- SHERIDAN, JOHN, Pioche, Nevada. Samples of rock and mineral. 414, '89 (xvi).
- SHERRATT, W. J., Philadelphia, Pennsylvania. Cape May Warbler. (Returned.) 330, '89 (v, A).
- SHIPLEY, A. B. & Son, Philadelphia, Pennsylvania. Insect. 176, '88 (x).
- SMALLEY, C. W., Russell Springs, Kansas. Slag. 235, '88 (xviii); lignite. 402, '89 (xviii).
- SMILLIE, Miss L. E., Washington, District of Columbia. Doilies (twelve), decorated by platinotype. 142, '88 (20925), (1).
- SMITH, H. G., Jr., Denver, Colorado. Reptiles, from Colorado. (Returned.) 368, '89 (vi).
- SMOCK, Prof. J. C., State Museum, Albany, New York. Serpentine. (Returned.) 347, '89, (xvii).
- SNEED, S. G., Austin Texas. Swallow-tailed butterfly. 259, '88 (x).
- SNOW, Prof. F. H., Lawrence, Kansas. Insects. 253, '88 (x).
- STEELE, JOHN G., Rook Hill, South Carolina. Mineral. 423, '89 (xvi).
- STRANAHAN, J. J., Chargin Falls, Ohio. Catfish. 275, '88 (xii).
- STOLL & THAYER, Los Angeles, California. Plant. 481, '89 (xv).
- STOLLEY, OTTO, Double Horn, Texas. Insects. 372, '89 (x).
- STRONG, J. E. P., Castanea, Clinton County, Pennsylvania. Wood and seed-pods. 418, '89 (xv).
- STRONG, W. F., Washington, District of Columbia. Bronzite. 174, '88 (xviii).
- SUMMERLIN, M. C., Lowell, Georgia. Glass. (Returned.) 158, '88 (xvi).
- SWAN, JAMES G., Boston, Massachusetts. Fungus. 170, '88 (xv).
- TAYLOR, F. W., Kingston, New Mexico. Rock specimens. 333, '89 (xvii).
- THOMPSON S. S., Denison, Texas. Crude petroleum. 187, '88 (xviii).
- THORN, E. P., Youngstown, Ohio. String of beads, from the Sandwich Islands. 250, (21315), '88 (ii, A).
- TIBBITS, J. H., San Diego, California. Ore. 461, '89 (xviii).
- TODD, JOHN F., Gove City, Kansas. Gravel. 386, '89 (xvi).
- TOMASON, THOMAS, Presidio, Texas. Desert horned lark. 257, '88 (v, A).
- TOMLINSON, I. J., Battle Creek, Michigan. Wild corn, from Idaho. (Returned.) 168, '88 (xv).
- TOWNSEND, CHARLES H., U. S. Fish Commission steamer *Albatross*. Mexican spider-monkey: *Ateles vellerosus* (living specimens). 144, '88 (20927) (xix).
- TREAKLE, E. M., Versailles, Missouri. Siliceous limestone. 264, '88 (xvii).
- TRISTRAM, Rev. H. B., The College, Durham, England. Bird skins. (Returned.) 334, '89 (v, A).
- VANCE, Hon. R. B., Assistant Commissioner of Patents, Department of the Interior, Washington, District of Columbia. Crystallized quartz (2). 273, '88 (xvi).
- VERY, C. F., New Albany, Indiana. Stone implements. 313 (21518) '88 (iii).
- VILAS, J. C., Livingston, Park County, Montana. Minerals. 477, '89 (xvi); minerals. 450, '89 (xvi).
- VOORHEES, J., Wolverton, Minnesota. Limestone. 362, '89 (xvii).
- WALKER, ADAM S., St. John, Utah. Bituminous shale. 292, '88 (xvi).
- WALKER, JOHN, Muldon, Mississippi. Bird. 462, '89 (xii).
- WARD, Dr. W. S., Plantsville, Connecticut. Arrow-points (8 specimens). (Returned.) 200, '88 (iii).
- WARREN, Dr. B. H., West Chester, Pennsylvania. Bird skins from Florida and Pennsylvania. (Returned.) 290, '88 (v, A).

- WATKINS, GEORGE W., Moriah, Essex County, New York. Mineral. 437, '89 (xvi).
 WEBB, JOHN S., Disputanta, Virginia. Molar tooth of a Mastodon. 232, '88 (iv).
 WERTH, J. M., Stockton, Henry County, Virginia. Metal. 354, '89 (xviii).
 WESTCOTT, O. I., Maywood, Illinois. Insects, (borrowed for study and returned).
 246, '88 (x).
 WETMORE, J. F., Albany, New York. Shrub. 177, '88 (xv).
 WHEELER, M. V., Clayton, West Virginia. Blue limestone. 189, '88 (xvii).
 WHEELER, WILLIAM M., secretary Public Museum, Milwaukee, Wisconsin. Bird.
 (Returned.) 336, '89 (v, a).
 WHITE, JOHN C., Brisbee, Arizona. Obsidian. 305, '89 (xviii).
 WHITTEN, Dr. W. A., Moline, Mississippi. Carbonate of lime. 165, '88 (xvi).
 WILLCOX, JOSEPH, Philadelphia, Pennsylvania. Fossil shells, from Florida. 453, '89
 (ix).
 WILLIAMS, W. C., Batesville, Arkansas. Plant. 252, '88 (xv).
 WILLIAMS, W. W., Washington, District of Columbia. Quartz stained by iron, from
 Montgomery County, Maryland. 205, '88 (xviii); iron ores. 210, '88 (xviii).
 WILVERT, EMIL, Sunbury, Pennsylvania. Ore. 258, '88 (xviii); zinc ore. 270, '88
 (xviii); White pig-iron. 284, '88 (xviii).
 WINCHESTER, B. F., Frederick City, Maryland. Plant. 464, '89 (xv).
 WITHERS, J. E., Henderson, Kentucky. Magnetite sand. 417, '89 (xviii).
 WOFFORD, J. L., Nashville, Tennessee. Clay. 202, '88 (xviii).
 WORTHEN, CHARLES K., Warsaw, Illinois. Mammal skins. (Part returned.) 350
 (21868), '89 (iv); mammal skins. (Nine; three retained, six returned.) 383
 (21863), '89 (iv); mammal skins and skulls. 451, '89 (iv).
 YOUNGLOVE, JOHN E., Bowling Green, Kentucky (through Tiffany & Co., New York).
 Carving of a head and hand in stone. 236 (21402), '88 (iii).

The index appended shows the geographical sources of the material sent to the National Museum for examination and report.

AMERICA.

	Number of lot.	Total.
North America:		
Canada	351, 369	2
Mexico	288, 456	2
United States:		
Alabama	449, 478	2
Arizona	169, 305, 465	3
Arkansas	185, 193, 227, 252, 256, 353, 359	7
California	172, 180, 295, 304, 443, 461, 481	7
Colorado	179, 280, 261, 263, 272, 280, 285, 286, 331, 368, 334, 442	12
Connecticut	200, 300, 399, 428	4
Dakota	328, 412	2
District of Columbia	141, 173, 174, 209, 210, 238, 303, 328	8
Florida	244, 277, 409	3
Georgia	158, 218, 307, 407, 422	5
Idaho	415	1
Illinois	171, 191, 233, 246, 291, 311, 312, 345, 350, 357, 383, 429, 451	13
Indiana	213, 313	2
Indian Territory	440, 470	2
Iowa	201, 267, 413	3
Kansas	196, 197, 207, 211, 215, 226, 230, 235, 240, 251, 253, 396, 402, 450, 471	15

AMERICA—Continued.

	Number of lot.	Total.
United States:—Continued.		
Kentucky	157, 175, 242, 285, 417	5
Louisiana	229, 401, 445	3
Maryland	160, 205, 281, 337, 342, 356, 438, 464, 482	9
Massachusetts	145, 181, 192, 220, 294, 340, 370	7
Michigan	167, 168, 301, 394	4
Minnesota	366, 381	2
Mississippi	165, 182, 462	3
Missouri	237, 264, 371, 388, 391, 420, 432, 455, 466, 470	10
Montana	146, 150, 164, 222, 257, 416, 450, 477	8
Nebraska	195	1
Nevada	184, 414	2
New Hampshire	149	1
New Jersey	254, 302, 374	3
New Mexico	309, 314, 323, 333, 348	5
New York	136, 137, 147, 155, 156, 163, 177, 186, 188, 223, 225, 248, 289, 306, 308, 310, 319, 339, 346, 347, 355, 377, 380, 392, 395, 408, 426, 430, 433, 435, 437, 444, 446, 463, 468, 469, 474	37
North Carolina	154, 199, 241, 243, 249, 273, 457, 479	8
Ohio	139, 208, 234, 250, 275, 344, 436, 480	8
Oregon	439	1
Pennsylvania	161, 176, 190, 206, 245, 258, 270, 278, 284, 290, 297, 299, 327, 330, 332, 378, 379, 396, 397, 412-418, 447, 453	23
South Carolina	262, 271, 315, 375, 423	5
Tennessee	140, 202, 212, 214, 219, 236, 265, 329, 349, 373, 441, 452, 458	13
Texas	148, 166, 187, 224, 231, 241, 259, 269, 274, 282, 283, 287, 343, 352, 358, 372, 387, 390, 398, 403, 424, 425, 431, 448, 454, 473, 476	27
Utah	138, 292, 325, 335, 376, 411	6
Vermont	159, 324, 393, 434	4
Virginia	162, 178, 183, 184, 194, 203, 216, 221, 232, 247, 293, 296, 317, 318, 320, 354, 365, 400, 405, 427, 475	21
Washington	170, 204, 228, 310, 321	5
West Virginia	151, 152, 153, 189, 198, 239, 266, 298, 322, 364, 367, 389, 404, 460, 467	15
Wisconsin	255, 276, 336, 410	4
Wyoming Territory	279, 419	2
West Indies	268	1
South America:		
Brazil	363, 406	2

EUROPE.

England	334	1
Norway	217	1

OCEANICA.

Polynesia:		
Sandwich Islands	360	1

I.—CO-OPERATION OF THE DEPARTMENTS AND BUREAUS OF THE GOVERNMENT.

The National Museum has continued to enjoy the friendly co operation of the departments and bureaus of the Government, and many of them have contributed very liberally to the collections of the Museum during the year. In addition to the contribution of specimens, a wide interest in the affairs of the Museum has been manifested. The most extensive aid to the Museum, as far as the receipt of collections is concerned, has been rendered by the U. S. Geological Survey, whose work is in many ways closely allied to that of the Museum. The co-operation of officers of the War and Navy Departments has been especially conspicuous and gratifying, and the Department of State, particularly through the agency of its consuls, has contributed largely to the interesting material received during the year.

DEPARTMENT OF STATE.

Hon. T. F. Bayard, Secretary of State, sent photographs of Indians of the Goajira Peninsula, which forms the extreme northwestern part of Venezuela.

Hon. A. L. Rives, First Assistant Secretary of State, sent a collection of water-color sketches and photographs of Samoan scenery and life.

Iron ore, coal, coke, and specimens of shale from Brazil were received through Hon. A. A. Adee, Assistant Secretary of State.

A valuable and interesting collection of textile fabrics of wool, worsted, silk, cotton, mohair, and alpaca was received through Hon. William Grinnell, United States consul, at Bradford, England.

Twenty-four specimens of ores were transmitted by Hon. Otto E. Reimer, United States consul at Santiago de Cuba.

Consul Mason, at Marseilles, sent an interesting series of samples of ramie.

The United States consul at Sydney, New South Wales, sent samples of Australian wool.

A package of engravings illustrating the breeds of foreign cattle, sheep, and swine, were received from Mr. J. Fenner Lee, chief clerk.

Through the courtesy of the Department facilities have been extended to collectors for the National Museum by means of letters of introduction to ministers and other officials in the countries to be visited, and in other ways.

TREASURY DEPARTMENT.

The Treasury Department has bestowed the usual courtesies in passing, free of entry, material sent from abroad and intended for the Smithsonian Institution and the National Museum. The thanks of the

Museum are due to the Department for its friendly offices in affording facilities to collectors and explorers in behalf of the Museum. The Light-House Board, the Life-Saving Service, the U. S. Coast and Geodetic Survey, and the Revenue Marine Division have each contributed interesting specimens to the Museum, and have in various ways facilitated the work of some one or more of the departments in the Museum.

Life-Saving Service.—Hon. S. I. Kimball, Superintendent of the Life-Saving Service, has aided the Museum by giving instructions to the keepers of Life-Saving stations to forward to the Museum any marine specimens captured in their vicinity which might be desired. As a result of this co-operation the following material has been received: A fresh specimen of Sowerby's whale (*Mesoplodon bidens*), from Capt. J. L. Gaskill, keeper of the Absecom Life-Saving station, Atlantic City. William H. Gaskill, keeper of the Cape Lookout Life-Saving station, North Carolina, transmitted a fresh specimen of Sunfish (*Mola mola*).

Light-House Board.—A collection of blue prints of lamps and flames, illustrating the illuminating system of the Light-House Service, was sent, at the request of the Museum, for exhibition at the Cincinnati Exposition, and formed an important feature of the photographic exhibit of the Museum on that occasion. W. M. Quinn, keeper of the Cape Sanblas Light-House station, Florida, sent a collection of turtles.

Revenue Marine Division.—A valuable and interesting collection of photographs of the natives and scenery of Alaska, taken by the officers of the revenue steamer *Bear*, was lent to the Museum by Mr. Peter Bonnett, chief of the division.

Secret Service Division.—A collection of photographs of counterfeiters was, through the kindness of Mr. John S. Bell, chief of the division, lent to the Museum for exhibition at Cincinnati, for the purpose of illustrating the uses to which photography had been applied in connection with the requirements of the Government service.

The Commissioner of Internal Revenue, Mr. J. S. Miller, presented two living Black bears from West Virginia.

Dr. J. W. Jewett, examiner of drugs, Custom-House, New York City, sent a collection of drugs.

U. S. Coast and Geodetic Survey presented a series of photographs, showing the methods of mounting photographic exhibits. Specimens of marine invertebrates, fishes, mollusks, and insects collected at Cape Sable, Florida, were transmitted to the Museum.

Several specialists engaged in making collections for the Museum have, through the courtesy of the Superintendent of the Coast Survey, been supplied with charts of the regions along the coast to be explored.

WAR DEPARTMENT.

The Museum has received valuable aid from this Department in many ways, especially through the Quartermaster's Department of the Army.

Through its medium collections of living animals and other objects intended for the Museum have been promptly forwarded, which might have been injured by the ordinary methods of transportation.

Six photographs of Hell Gate explosion were sent by Maj. W. R. King, Willetts Point, New York, for exhibition at the Cincinnati Exposition.

Dr. Edgar A. Mearns, U. S. Army, Fort Snelling, Minn., sent a small collection of reptiles, fishes, and batrachians from Arizona.

Dr. J. L. Wortman, U. S. Army Medical Museum, presented four living rattlesnakes and a Bee-eating buzzard.

Lieut.-Col. S. C. Kellogg, U. S. Army, deposited a buffalo robe.

Dr. John S. Billings, Curator of the Army Medical Museum, presented specimens of pottery and stone implements from old graves in the mountains near Lima, Peru, and three pieces of pottery from Ancon, Peru.

Dr. E. W. Shufeldt, U. S. Army, stationed at Fort Wingate, New Mexico, presented the following specimens: a hawk, a long-billed marsh wren, a living rattlesnake, a pigeon hawk, field mice and pocket mice, two bird skins, eight batrachians, and a skin of a western red-tailed hawk.

Capt. Charles E. Bendire, U. S. Army, has continued his valuable service as Honorary Curator of the collection of birds' eggs.

U. S. Signal Office.—General A. W. Greely, Chief Signal Officer, sent a specimen of flexible sandstone, collected by the signal observer at Charlotte, North Carolina. A Secchi meteorograph and two sections of Beck's pantograph, and Myers' autograph telegraphic instrument were deposited in the Museum, and have been added to the collection of scientific apparatus. Photographs of meteorological records were contributed to the exhibit of photography prepared by the Museum in connection with the Cincinnati Exposition. Through the kindness of the Chief Signal Officer a large number of correspondents and collaborators of the Museum have been supplied with Mr. Lucian M. Turner's "Contributions to the Natural History of Alaska."

NAVY DEPARTMENT.

The principal accession has been a collection of fifty-nine mounted birds, transmitted by the U. S. Naval Academy, at Annapolis, Md.

Several pieces of bronze and copper from the Washington Navy-Yard were obtained through the kindness of Commodore M. Sicard, Chief of the Bureau of Ordnance.

The Ordnance Office of the Naval Academy sent, through Lieut. Albert Gleaves, several photographs of a projectile in flight from a Hotchkiss magazine-rifle.

Through the courtesy of Commander C. F. Goodrich, several photographs of torpedo experimental work were obtained.

At the request of the Museum, Lieut. George L. Dyer, hydrographer, furnished a copy of the British admiralty chart, and also charts of Queen Charlotte Islands, Hecate Straits, and Dixon Entrance, for use in the Ethnological Department of the Museum.

Dr. J. M. Flint, U. S. Navy, has contributed valuable services as Honorary Curator of the section of *Materia Medica*.

DEPARTMENT OF THE INTERIOR.

U. S. Geological Survey.—The Museum acknowledges with gratitude and pleasure the valuable assistance of the Survey, whose operations are in many respects closely related to the work of the Museum. The researches of the geologists connected with the Survey are of especial value by reason of the large collections which are made, and which after being worked over and described are transferred to the Museum collections. The past year has been, perhaps, as notable as any in the acquirement by the Museum of valuable and interesting collections from this source, as will be seen from the appended statement.

The U. S. Geological Survey presented several pieces of Indian pottery, and a number of stone relics found in Prentiss County, Mississippi; a specimen of native platinum from Washington Territory; rock specimens from California, collected by J. S. Diller; a large collection of rocks (comprising about 2,000 specimens) of the Comstock Lode and Washoe District, Nevada, gathered by S. F. Emmons and G. F. Becker. This collection is more fully described in Mr. Becker's report of the geology of this region (Monograph III, U. S. Geological Survey), and also in Messrs. Hague and Iddings's paper on the Development of Crystallization in Igneous Rocks (Bulletin U. S. Geological Survey, No. 17); a collection of minerals, made by Dr. W. F. Hillebrand from various localities; a mineral from Yellowstone National Park, Wyoming, collected by Walter H. Weed; a collection of 1,371 minerals, collected by S. L. Penfield in St. Lawrence, Lewis, and Jefferson Counties, New York, embracing fluorite, pink tremolite, blue calcite, graphite, tourmaline, talc, pyrite, etc.; minerals from Bisbee, Arizona, collected by Dr. W. F. Hillebrand; mineral specimens collected by Dr. W. F. Hillebrand in Arizona, Dakota, and New Mexico; mineral specimens (87) from Las Cruces, New Mexico, collected by Dr. W. F. Hillebrand; minerals from Utah and New Mexico; minerals from Colorado; specimens of Oriskany (drift) fossils from Potomac River, below Washington, District of Columbia; rocks and soils from various localities; a large collection of geological specimens from Arizona, Utah, and California, collected by Mr. J. S. Diller; a specimen of gutermanite containing zunyite, from Silverton, California, sent through Dr. W. F. Hillebrand; specimens of the trachyte body near Rosita, in the Silver Cliff region of Colorado, collected by S. F. Emmons; specimens (37) of wood opal from the Madison River, Montana, collected by Dr. A. C. Peale; specimens (804) of Lower Cambrian fossils, from Conception Bay, Newfoundland, collected by C. D. Walcott; specimens (3) of Lower Cambrian fossils from New York, Nevada, and Vermont, collected by C. D. Walcott; minerals from Colorado, collected by L. G. Eakins; specimens (3,240) of Middle Cambrian fossils from Conception Bay, Newfoundland; minerals from Montana, collected by Dr. A. C. Peale; specimens (39) of trimmed rocks from the Trias of the New Jersey region, collected by Nelson H. Darton; mineral specimens (139) collected in Colorado by Messrs. Cross and Hillebrand; Miocene fossils from New Jersey marls; specimens (24) of crystallized trona, from Dr. T. M. Chatard; a specimen of infusorial earth from Patuxent River, near Dunkirk, Maryland.

The Director of the Geological Survey has, on several occasions, extended very important assistance to the geological departments of the Museum, and has inspired the geologists of the Survey in the matter of advancing the interests of the Museum in every possible way, both in connection with their field-work and while on duty in Washington.

Several officers of the Geological Survey are officially connected with the Museum in the capacity of honorary curators of collections. These are Dr. C. A. White, in charge of Mesozoic fossils; Mr. C. D. Walcott, in charge of Paleozoic fossils; Mr. William H. Dall, in charge of mollusks and tertiary fossils, with Dr. R. E. C. Stearns as adjunct curator; Prof. O. C. Marsh, in charge of vertebrate fossils; Mr. Lester F. Ward, in charge of fossil plants; Prof. F. W. Clarke, in charge of minerals. To all of these gentlemen the National Museum offers its sincere thanks for their services during the year.

U. S. Patent Office.—Through the Commissioner of Patents were received specifications and patents illustrating the development of photography and the graphic arts in the United States and in Germany.

Bureau of Education.—Hon. N. H. B. Dawson, Commissioner, presented to the Museum a series of very interesting publications relating to the subject of American educational history.

DEPARTMENT OF JUSTICE.

Col. Cecil Clay, chief clerk, collected in Canada and presented to the Museum the skin and skeleton of a full-grown moose.

POST-OFFICE DEPARTMENT.

By the direction of the Postmaster-General, the Superintendent of the Dead-Letter Office has been requested to inform the Museum of the receipt in his office of specimens which might be of value to the Museum collections.

DEPARTMENT OF AGRICULTURE.

Four departments of the Museum are under the charge of specialists connected with the Department of Agriculture; namely, the Section of Forestry, Dr. B. E. Fernow, Honorary Curator; Department of Insects, Prof. C. V. Riley, Honorary Curator; Department of Botany, Dr. George Vasey, Honorary Curator; and the Section of Foods, Prof. W. O. Atwater, Honorary Curator.

The Division of Entomology sent, through Prof. C. V. Riley, a collection of insects, principally coleoptera from Michigan.

The Bureau of Animal Industry transmitted, through D. E. Salmon, chief of Bureau, a collection of parasites prepared by Dr. Cooper Curtice.

The Division of Ornithology and Mammalogy sent, through Dr. C. Hart Merriam, collections of mammal skins and skulls, from Florida

and California. Dr. Merriam also presented a valuable collection of birds' skins from the old world.

The Secretary of Agriculture has expressed his willingness to co-operate with the Museum in the establishment of a Department of Forestry, and, as already stated, the collection will be under the charge of Dr. B. E. Fernow.

The Department purchased from Dr. Taylor Townsend a large series of insects. This has been incorporated in the Museum collection.

Through the courtesy of the Secretary of Agriculture, Dr. George Vasey has been appointed Honorary Curator of the Department of Botany in the National Museum, in connection with his duties as botanist of the Department of Agriculture.

UNITED STATES FISH COMMISSION.

The chief source of material contributed during the year by the Fish Commission has been from the cruise of the U. S. Fish Commission steamer *Albatross* in the West Indies and on the Pacific coast. The most important accessions to the Museum resulting from the expedition are: a large collection of geological and archæological specimens, coins, mammals, reptiles, batrachians, insects, arachnids and myriopods, birds' eggs, skeletons of birds, mammals, fossils, plants, lichens, mosses, fungi, and fossil woods. These were collected during the voyage from Norfolk, Virginia, to California, in 1887 and 1888. A collection of birds, reptiles, stone implements, plants, ethnological objects, and fossil woods was gathered in Alaskan waters. Several reports on these collections are being prepared by curators in the Museum and will be published as separate papers, forming parts of Vol. XII, Proceedings of the National Museum. These will be issued in advance of the bound volume.

The Commission also transmitted to the Museum twelve living elephant tortoises from the Galapagos Islands, seven living amblystomas, three painted terrapins, and three specimens of sting-ray fish (*Trygon centura*) from Chesapeake Bay; a collection of fishes made by Prof. C. H. Gilbert and Dr. J. A. Heushall, from the tributaries of the Ohio River; three Marble cat-fish, collected by Mr. Rogan, of Russellville, Tennessee, through Col. Marshall McDonald, U. S. Commissioner, two living opossums, and six living turtles; a skin and skeleton of Spotted porpoise, collected by the Fish Commission schooner *Grampus*.

Mr. J. Frank Ellis presented four living alligators from Tampa, Florida.

The valuable services of Mr. Richard Rathbun, as Honorary Curator of Marine Invertebrates; Dr. T. H. Bean, as Honorary Curator of Fishes; and Capt. J. W. Collins, as Honorary Curator of Naval Architecture, have been continued through the courtesy of the Commissioner, and a grateful acknowledgment of the same is here made.

Bureau of Ethnology.—Through the courtesy of the Director, Maj. J. W. Powell, the Department of American Prehistoric Pottery in the National Museum, which was established several years ago, was placed under the direction of Mr. W. H. Holmes, who has since acted as Honorary Curator. Through his efforts this department has attained a prominent place in the development of the work of the National Museum.

During the year the following collections of pottery, stone implements, woven fabrics, shells-beads, etc., were transferred to the Museum by the Bureau of Ethnology:

W. W. Adams sent shell beads from Union Springs, New York; E. Bohan, pottery from Mexico; Arthur P. Davis, pottery from Pueblo Alto, New Mexico; Gerard Fowke, pottery from Yellow Lake, Wisconsin; Dr. L. W. Gill, stone objects from Chain Bridge, Virginia; William A. Hakes, pottery fragments and stone objects from Susquehanna Valley, New York; H. P. Hamilton, pottery fragments from Two Rivers, Wisconsin; H. W. Henshaw, one medicine stone collected by L. L. Frost, Susanville, California; W. H. Holmes, pottery and stone objects from New Mexico; G. H. Hurlbut, woven fabrics from Ancon, Peru; C. C. Jones, pottery fragments from Stallings Island, Georgia; James D. Middleton, pottery fragments from Irvineton, Pennsylvania; Maj. J. W. Powell, pottery and stone objects from near Abiquiu, Mexico; James Stevenson, pottery from Moki, Arizona, eight hundred and fifty-one specimens of pottery, stone, and other objects from New Mexico, sixty-eight specimens of stone, implements from Moki, Arizona, one stone ball from James Springs, New Mexico, thirty-two specimens from Flagstaff, Arizona; Dr. Taylor, pottery fragments from near Mobile, Alabama; General G. P. Thurston, pottery fragments from suburb of Nashville, Tennessee; James P. Tilton, pottery fragments from Newburyport, Massachusetts; Charles L. R. Wheeler, one cast of stone knife from Westchester County, New York. Through James Mooney, a collection of ethnological specimens from the East Cherokee Reservation, North Carolina; fragments of pottery from New Mexico, collected by Maj. J. W. Powell; pottery from James Valley New Mexico, collected by W. H. Holmes; pottery from Irvington, Warren County, Pennsylvania, collected by James D. Middleton; fragment of pottery from Yellow Lake, Burnet County, Wisconsin, collected by Gerard Fowke; pottery and modern Cherokee work from the East Cherokee Reservation, North Carolina, collected by James Mooney; fragments of pottery from Pueblo Alto, New Mexico, collected by Arthur P. Davis; pottery from Oraibi Moki, Arizona, collected by Victor Mindeleff.

J.—EXPLORATIONS.

The collections of the National Museum have received valuable additions through the co-operation of several gentlemen who have offered

to make special researches in its behalf, or who have allowed the Museum to share the results of their explorations. The most important of these are here briefly referred to.

Early in the present year Mr. Talcott Williams, of Philadelphia, visited the northern part of Africa, and kindly offered in behalf of the Smithsonian Institution to make special inquiries in regard to the civilization of the modern Arab and the natural history of the region; also to collect linguistic specimens. His plan was to go direct to Tangiers, thence to Fez and Mequinez, continuing, if possible, as far as Mogador and Morocco. Mr. Williams's knowledge of the Arabic language aided him greatly in his investigations in the country, and through his endeavors the Institution will no doubt obtain collections, as well as information, of extreme value. Botany, geology, and archæology are the special studies to which Mr. Williams intends to devote himself. At the time of his arrival the North African flora was in flower, and, as his plan was to travel for two or three weeks on horseback, his opportunities in the first direction were excellent. The geology of north Africa is imperfectly represented in the National Museum, therefore characteristic rocks and photographs of features of physical geology will be of great value. The archæology of this region is, however, the subject of the highest importance to the Smithsonian Institution, and to which Mr. Williams has promised chiefly to direct his attention. He hopes to visit El Kutel, one of the most striking monolithic remains in north Africa, and other interesting ruins. He has been furnished with a photographic outfit, photographs and measurements being particularly desired. He has been provided with a complete outfit of instruments for taking observations of temperature and altitudes. A preliminary report of the work accomplished has been received in the form of a letter to the Secretary of the Smithsonian Institution, and is here printed:

TANGIERS, MOROCCO, *June 17, 1889.*

SIR: I have the honor to make a preliminary report upon the commission intrusted to me in Morocco.

(1) The collection of musical instruments of north Morocco is, I trust, complete. It includes every instrument in use, making six stringed instruments, six wind, and four of percussion, with varieties of each ranging from the rudest bayi whistle to stringed instruments which require the utmost skill in manufacture. In each instrument the native name and the native names of all its parts have been noted, the pitch of each string in the stringed and the range of each wind instrument, as tuned and played by professional native musicians, has been taken and the air and melody of a native tune played on each instrument has been noted by a competent musician in our own musical notation.

Aside from this incidental contribution to folk music I know no instance where a museum catalogue or label gives the particulars I have mentioned of Oriental musical instruments.

(2) With reference to the Arab tent, I found, after careful examination, that the Arab tribes whom I visited have been so altered by a semi-sedentary life, living half and sometimes all the year in one place, and raising grain, that a tent would be misleading and reflect only the current agricultural life of this country. I therefore did

not procure one. The fringe of unsettled region which separates the true Arab from settled regions is here a wide one, and this plan of the Museum, which is altogether feasible, can only be carried out at some point like Aden and the upper Nile, say at Wady Halfa-Tripoli or near the present work of the Babylonian Expedition, of Pennsylvania University, where the true nomad Arab is within a few hours of an American agent. Modification in this type is in rapid progress, and in a few years it will be too late.

(3) I have been able to find but one book in the Berber language in the possession of an European. Nearly every one, including native scholars and European residents of long standing, have told me that they have never heard of one. The utmost I have been able to secure is a leaf or two of an old Berber manuscript on Moslem law, which is, I think, unique.

(4) A large share of my purchases has therefore been of "simple utensils." A full list, giving in each case the native name of each article, will be transmitted later. The chief objects I have sought to illustrate are, in brief—

The lamp in ordinary use here is the "Roman lamp" form, and I have this from a rude metal up through a series of elaborate brass forms.

Fires are built in small pots. These range from earthenware shaped by hand, through successive additions to a tall iron stove.

The preparation of food is illustrated among other phases by a complete set with samples of the plant used in making cooscoosn, the national dish.

The ground palm, *Chamerops humile*, plays a most important part in domestic economy, nowhere noted, and this is illustrated in all stages of its leaf and fiber.

Comb manufactures, giving carpenter's tools, form a single compact exhibit with photographs, and this is supplemented by a primitive lathe.

The Fry pottery offers an unusual instance of a local pottery unaffected by modern methods, and a full set of its patterns are included.

There are also a number of lesser articles, of which an interesting one is the survival of the wooden sword, unnoticed by any previous traveler.

Three costumes have been purchased: (1) Fry woman; (2) mountaineer man; (3) mountaineer woman.

In each case the native name of each article is noted, an omission which robs many museum costumes of an important linguistic value.

I send in addition three hundred species of flowering plants and fossils from three localities, from none of which have they been collected before.

A small shipment was made from Teheran and another from here will be sent later of seven boxes and one bundle, the invoice", etc., of which I have transmitted to Mr. G. Brown Goode.

*Invoice No. 7.—Shipped to Smithsonian Institution, Washington, D. C., U. S. A.

From Teheran—

1 Hat.....	\$0.60
1 Snuff-box.....	1.00
1 Palmetto prayer-mat.....	.15
1 Ood. musical instrument.....	2.00
1 Giubrede.....	.40
1 Giubrede.....	.60
1 Rabab and parts of Giubrede.....	2.00
2 Snuff-boxes.....	.10
Duboga-folley drum.....	.25
2 Candle-sticks.....	.04
1 Plow-yoke.....	3.00

10.14

The list which I will also send later will give careful notes on each article. The notes on the musical instruments may not be sent until I return.

When transportation, etc., is paid, the sum in my hands will be exhausted, and an account of the same will be duly transmitted.

I am, very respectfully, yours truly,

TALCOTT WILLIAMS.

Hon. S. P. LANGLEY,
Secretary of the Smithsonian Institution.

At the request of Mr. Williams the examination of the contents of his collections will be deferred until he arrives. In the next report a complete list of the collection will probably be published.

Mr. W. W. Rockhill, formerly of the American Legation of Peking, has recently undertaken a journey through Thibet, with a view to making a special study of the ethnology of that region, having already made himself familiar with the customs of the natives. The Smithsonian Institution has supplied him with a barometer and other instruments desired by him for his journey. His previous investigations have resulted in an exceedingly valuable collection of objects, illustrating the religious occupations and amusements of the various peoples in different parts of China, Thibet, and Turkestan. Among those from Thibet are a number of prayer-wheels, a divination bowl made from a human skull, a sprinkler for holy water, a Lama's drum, a bell and score-book used in religious worship, an exercising flute made from a human femur, a rosary of one hundred and eight beads made from bones of human skulls, a charm box and sacred books, images and scroll pictures of gods. From Western China and Mongolia are carved rosaries, and figures of gods supposed to preside over medicines, riches, etc. From Northern Turkestan is a scroll picture showing the occupations and sports of the people.

Dr. James Grant Bey, who some years ago established a sanitarium at Cairo, Egypt, attended the International Medical Congress held in Washington in 1887, and was much interested in the work of the National Museum. He has, since his return to Egypt, devoted his leisure time to special studies of the arts of the ancient Egyptians. Several very valuable collections have been received from him, among which are the following objects: Fifteen fragments of the Egyptian "Book of the Dead" in Hieratic, seven water-color sketches of ancient lamps, many ancient coins of various sorts, a modern Arabic almanac for the year Hegira 1300, containing autograph, two gold ornaments of Thothmes III, flower of the *Nymphaea cerulea*, the lotos of Upper Egypt, a beetle from Thebes, and many other objects of value and interest.

Mr. Jeremiah Curtin was sent, during the summer, by the Bureau of Ethnology to the Hupa Reservation in California, in order to study the languages and mythology of the tribes of Indians inhabiting the reservation. The Smithsonian Institution was fortunate enough to secure the assistance of Mr. Curtin in investigating their arts and industries

as well. A small sum of money was placed in his hands for the purchase of objects to complete the series of the Museum collection from this region.

Dr. John M. Crawford, United States Consul-General at St. Petersburg, expects to make extensive ethnological researches in Russia and Finland, and has generously offered to allow the National Museum to participate in the results. Dr. Crawford is well known as the author of the English translation of the Finnish epic "The Kalevala," as a philologist and a student of Scandinavian antiquities. His acquirements in these directions led to his being appointed Consul-General at St. Petersburg, from which place he would be able to carry on his studies of the Finnish race, and related peoples. Letters of introduction to several correspondents in Russia and Finland, have been furnished by the Smithsonian Institution in order to facilitate his work.

Rev. Frederick H. Post, late rector of St. Paul's Church, Salem, Oregon, has recently assumed charge of the mission of the Episcopal Church at Anvik on the Yukon River, Alaska. He is very much interested in the study of natural science and history, and has offered to serve the Smithsonian Institution in collecting information relating to the tribes of the Upper Yukon, and also in transmitting to the Museum specimens of the mammals and birds of that region. It is probable that Mr. Post will, next year, be furnished with an outfit of alcohol, guns, and ammunition.

Lieut. J. F. Moser, commanding the U. S. Coast Survey steamer *Bache*, has continued his explorations for the Museum and has sent a collection of fishes, mollusks, insects, and marine invertebrates from the vicinity of Cape Sable, Florida.

Prof. O. P. Jenkins, of De Pauw University, Indiana, proposes to visit the Hawaiian Islands during the summer for the purpose of collecting fishes, and has kindly offered to present a duplicate series of specimens to the Museum. To aid him in this undertaking the Smithsonian Institution has supplied him with seines, giving him also a letter of introduction to the curator of the National Museum in Honolulu.

During the summer of 1888, Mr. George P. Merrill, Curator of Geology, made a collecting trip to North Carolina, Pennsylvania, New York, Vermont, New Hampshire, Massachusetts, and Maine. Large collections of rock were obtained for the Museum.

Mr. Thomas Wilson, Curator of Prehistoric Anthropology, visited mounds in Ohio, and made interesting collections.

In August Dr. W. F. Hillebrand, of the U. S. Geological Survey, visited some of the Western States and Territories, partly with a view to making collections of minerals. These will eventually be incorporated with the Museum collections.

In order to further the work of those who have expressed their willingness to collect specimens for the Museum, as well as those who have been sent out as collectors by the Museum, outfits of apparatus, tanks, al-

cohol, etc., have been supplied. During the year the outfits here indicated have been furnished to the following-named collectors:

1888.

August 3.—Mr. W. A. Stearns, of Cambridgeport, Massachusetts, was supplied with a large outfit of tanks, dredge-nets, tin tags, pig bladders, bottles, vials, cheese-cloth, heavy paper, and a double-barrel shot-gun, for use in collecting natural history specimens for the National Museum in northern Labrador. It has been found necessary to postpone this expedition until next summer.

December 19.—Lieut. J. F. Moser, commanding the U. S. Coast Survey steamer *Bache*, has been furnished with tanks, packing-boxes, jars, etc. He has transmitted a collection of fishes, mollusks, insects, and marine invertebrates to the National Museum from the vicinity of Cape Sable, Florida, and has kindly signified his willingness to make additional collections, as opportunity may offer.

1889.

January 15.—Capt. W. L. Carpenter, who for many years has sent to the Smithsonian Institution collections of natural history specimens, is now stationed at Prescott, Arizona. He has kindly promised to continue his efforts in behalf of the Museum, in collecting fishes, reptiles, marine invertebrates, etc., for the preservation of which tanks and alcohol have been furnished.

January 18.—Lieut. E. H. Taunt, of Washington, District of Columbia, has offered to collect mineral specimens in connection with his cruise to the Congo River, South Africa. He has been supplied with a photographic apparatus by the Smithsonian Institution.

February 4.—Dr. L. F. H. Birt, of Greytown, Nicaragua, Central America, having in the past sent large collections of mammals, reptiles, fishes, birds, etc., to the National Museum, has been supplied with tanks and alcohol for the continuance of his services. Dr. Birt proposes to direct his attention later to the fishes and crustacea of the Atlantic and Pacific Coasts of this country, the results of which he will share with the Smithsonian Institution.

March 28.—Lieut. W. J. Howard, of San Francisco, California, offered to collect fishes and ethnological objects in Alaska for the Smithsonian Institution. To aid him in this undertaking the Institution has supplied him with tanks, alcohol and trade-supplies.

May 22.—An outfit of alcohol, a gun, and ammunition was supplied to Mr. I. C. Russell, of San Francisco, California, to aid him in his Alaska Expedition. The Alaska Commercial Company also afforded facilities to Mr. Russell, introducing him to its agent at St. Michael.

May 27.—Hon. Charles Bartlett, United States consul at Guadaloupe, West Indies, sent a number of brilliantly luminous insects, among them the "Cuenjo" (*Pyrophorus noctilucus*) for purposes of analysis. A number of insect-boxes were sent to him, and also to Señor José C. Zeledon of San José, Costa Rica, and Señor Ferrari Perez, City of Mexico, for the same purpose.

June 8.—Tanks and alcohol were sent to Dr. R. W. Shufeldt, of Tacoma, District of Columbia, in which place, he states, the opportunity is excellent to collect a number of embryo birds, many of which will greatly assist him in working out the morphology of the group. Dr. Shufeldt kindly offers to collect specimens for the National Museum.

June 11.—An outfit of tanks, alcohol, and shellac was sent to Mr. Frank Burns, of the U. S. Geological Survey.

James Mooney, of Cherokee, North Carolina, was supplied with tanks and alcohol. No collections have as yet been received.

Mr. C. R. Orcutt, of San Diego, California, has, from time to time, transmitted to the National Museum valuable collections of fishes, reptiles, fossils, marine invertebrates, etc., from California. During the past year he has been supplied with tanks, alcohol, jars, and a seine for this purpose.

Mr. W. Harvey Brown, of the National Museum, was appointed naturalist to accompany the United States Eclipse Expedition to South Africa. Being in the employ of the Smithsonian Institution he was furnished with a large outfit of tanks, alcohol, jars, oil, linen, and tools. It is probable that the next report will contain an account of the results of this expedition.

June 13.—Prof. O. P. Jenkins, of De Pauw University, Indiana, intends to visit the Hawaiian Islands, and has been supplied with seines to aid him in collecting fishes, a duplicate set of which he has expressed his intention of presenting to the National Museum.

December 29.—Dr. John I. Northrup received an outfit of tanks and alcohol to use during his visit to the Bahama Islands, where he expects to collect plants and animals, especially marine invertebrates and fishes. He offers to present a duplicate set of specimens to the Smithsonian Institution.

K.—REPORTS UPON THE PARTICIPATION OF THE SMITHSONIAN INSTITUTION AND THE NATIONAL MUSEUM IN THE EXPOSITIONS HELD AT CINCINNATI AND MARIETTA IN 1888.

Letter from the Assistant Secretary to the Secretary of the Smithsonian Institution, relating to the participation of the Institution in the Cincinnati Exposition.

MAY 7, 1889.

SIR: I have the honor to report that all work in connection with the participation of the Smithsonian Institution and the National Museum in the Centennial Exposition of the Ohio Valley and Central States, held in Cincinnati in 1888, has now been completed. All objects sent to Cincinnati have been returned to their proper places and damages suffered by specimens and furniture have been repaired to as great an extent as has been found practicable under the arbitrary and unusually stringent rulings of the Treasury officials in charge of the disbursements and account.

I transmit herewith a report (Appendix A) upon the Smithsonian participation in the Exposition, which has been prepared by Mr. R. Edward Earll, who was placed in charge of the administrative work at Cincinnati, it having been impossible for me to be absent from Washington during the continuance of the Exposition, and who performed the responsible and difficult duties of his position in an exceedingly efficient and faithful manner.

In his report a history of our work is given, and also a history of what was done by the various departments of the Museum and by the Bureau of Ethnology. In addition to what is stated in this report, reference should be made to the willing and efficient aid rendered by the curators of the Museum, who prepared a very instructive and impressive collection in a remarkably short time, notwithstanding the fact

that the work was done in the hottest part of the summer. Prof. Otis T. Mason contributed a comprehensive ethnological collection, Mr. Thomas Wilson a synoptical series of objects, illustrating prehistoric anthropology, the remains of primitive man in the new world and the old being shown side by side. Mr. Cosmos Mindeloff, who was detailed for this work by the director of the Bureau of Ethnology, prepared a display of the arts and architectures of the Pueblo Indians of the southwest. Dr. Cyrus Adler selected from the treasures of the section of Oriental Antiquities an exhibit of Biblical archæology.

The history of transportation by land and water was happily and successfully shown by Mr. J. E. Watkins, who received most important aid from the Baltimore and Ohio and Pennsylvania Railroad Companies, and a supplementary display of models of ships and boats was arranged by Capt. J. W. Collins. Mr. S. R. Koehler, with great energy and enthusiasm, brought together a most instructive collection, illustrating the history and methods of the graphic arts, supplementing the collections already in the Museum by loans from his private collection and from those of his friends and correspondents. Mr. T. W. Smillie gathered a similar collection to illustrate the history and present condition of the art of photography. Mr. F. W. True, assisted by Mr. F. A. Lucas, prepared a collection showing the classification of mammals. Mr. W. T. Hornaday, by means of specimens and pictures, preached a sermon upon the extermination of the native animals of North America. Mr. Robert Ridgway exhibited an attractive collection of birds; Prof. C. V. Riley, aided by Mr. John B. Smith, prepared a collection showing the classification of North American insects. Dr. R. E. C. Stearns and Mr. Rathbun contributed a few cases from the departments of Mollusks and Marine Invertebrates. Mr. F. H. Knowlton prepared an exhibit from the botanical collections, and Mr. W. S. Yeates, under the supervision of Professor Clarke, arranged a case of North American gems and precious stones. All of these contributions are, as I have said, somewhat fully described in Mr. Earll's report, and this passing reference is made solely for the sake of making proper acknowledgment to those to whom the success of our work at Cincinnati is entirely due.

Special reference should be made to the work of Mr. W. V. Cox, who in addition to his regular duties in the Museum, undertook the financial administration of the work and carried through without a single disallowance from the Treasury the complicated and perplexing expenditures of the exposition's service. This was a task of much difficulty owing to the loose wording of the Congressional act providing for the participation of the Government departments, and still more to the capricious and unprecedented decisions of the special auditor appointed by the President to audit the exposition accounts. In this work Mr. W. W. Karr, who also rendered volunteer service, and Mr. W. H. Kimball, were exceedingly faithful coadjutors.

Mr. Cox was also charged with the preparation of a special display to

be sent to the Exposition at Marietta, Ohio, a report upon which, prepared by him, is hereto appended (Appendix B).

In conclusion I submit a brief review of the financial history of the work.

The entire appropriation for the Smithsonian Institution, National Museum, and U. S. Commission of Fish and Fisheries, for the Centennial Exposition of the Ohio Valley and Central States, as mentioned in the act of Congress authorizing the same, was \$50,000. Of this amount the sum of \$10,000, by agreement between the Secretary of the Smithsonian Institution and the Commissioner of Fish and Fisheries, was set apart for the use of the Commission, leaving \$40,000 to cover all expenditures of the Smithsonian and Museum for the purchase of new material to complete series as well as all charges for services, and for the transportation and subsistence of employes sent to Cincinnati and Marietta for the preparation, installation, and maintenance of exhibit.

The first step was the preparation of an estimate of probable expenditures, leaving a general contingent fund of about \$4,000, which was set aside to be drawn upon when necessary.

The act of Congress making the appropriation did not become a law until May 28, and the exposition was to be opened on the 4th of July. It therefore became necessary to make our selections and purchases with all possible haste. The Museum schedule rates were, however, taken advantage of when practicable. In cases where this could not be done, and where the amount involved was considerable, when the articles were such as are usually found in the market, competitive bids were obtained. The expense of this hurried work was proportionately great, and a considerable waste of time and effort was inevitable.

This extra exposition work crowded into the hot summer months made it necessary for the chief clerk and his assistants to be at their desks early and late, a demand which they cheerfully complied with, giving up their much needed vacations in order to keep up their regular and extra duties.

Vouchers had to be prepared in quadruplicate, one copy for the Smithsonian files, one for the special auditor, one for the disbursing officer, and one for the Treasury Department. This involved much clerical work, as the number of original vouchers was over three hundred, making it necessary, in order to fulfill all requirements, to prepare a total of more than twelve hundred copies of vouchers.

While the nature and amount of the disbursements could not be exactly determined in advance, it is gratifying to be able to report that a provisional schedule of classified expenditures, which was prepared in the beginning, was at least approximately correct, and would have been still more accurate but for the postponement of the time of closing the Exposition. As it is, the contingent fund of \$4,000 more than covers all differences between estimated and actual expenditures.

Although the Exposition was closed as long ago as November 8, 1888,

our accounts only became ready for final settlement on April 15, 1889. This delay was in part due to the fact that the regular routine of forwarding, signing, and returning the vouchers for articles purchased in foreign countries, necessarily consumed much time. Delay has also been caused by the retention and questioning of many vouchers in the office of the special auditor of Cincinnati accounts at the Treasury Department, although in every case his objections have been finally withdrawn, and all vouchers have, after protracted delays, been approved by that official. These delays, which seemed to us quite unnecessary, caused us much annoyance, as many of those who had furnished materials or labor, almost daily, either in person or by letter, urged upon us their need of funds and the great inconvenience they were compelled to undergo by the delays which were entirely beyond our control, but for which they were disposed to hold us responsible.

The Auditor raised many trivial points, which necessitated the writing of numerous letters in answer to uncalled for questions. This, together with long waiting for replies, which were usually transmitted verbally by a clerk, has greatly impeded action. In view of this experience it is urged that, should Congress decide to have the Smithsonian Institution and National Museum participate in future expositions, the law be so framed as to require the appointment of an auditing officer familiar with the demands of exhibition work, in order to prevent the unnecessary retardment of public business, and the consequent incurring of extra expense by the Government.

If such a course be not adopted, responsibility of selecting and deciding upon exhibits should be understood to rest entirely with the representatives of the various departments, and the auditor's province limited to the careful examination of accounts, which, of course, should be sufficiently detailed to prevent errors. Experience has proved that only by some similar division of responsibility can successful results be obtained.

Another fruitful cause of delay in our work has been the payment of all the accounts by a disbursing officer stationed at Newport, Kentucky, instead of Washington, where, as is always the case, nine-tenths of the bills are contracted. The paymaster drew checks upon the Cincinnati depository only, a method very unjust to employés and workmen, who were obliged to wait many days before receiving their checks, and then to lose something of their hard earned money by the refusal of the Treasury in Washington to honor the same. The only alternative for them was to present the checks to local banks, paying the usual discount rates.

Statement showing condition of appropriation for Centennial Exposition of Ohio Valley and Central States, April 15, 1889.

Appropriation	\$50,000.00
Fish Commission allotment.....	10,000.00
	<hr/>
Net appropriation	40,000.00

ESTIMATE OF EXPENDITURES.

(a) Services of assistants, clerks, laborers, etc	\$16,752.00
(b) Fittings, materials, cases, travel, freight, storage, etc....	13,300.00
(c) New material completing series, specimens, models, etc.	5,750.00
(d) General contingent fund.....	4,198.00
	<hr/>
	40,000.00

ACTUAL EXPENDITURES.

(a) Services of assistants, clerks, laborers, etc.....	20,305.41
(b) Fittings, materials, cases, travel, freight, storage, etc....	13,841.33
(c) New materials completing series, specimens, models, etc.	4,542.62
(d) Unexpended balance.....	1,310.64
	<hr/>
	40,000.00

I recommend that the balance to the credit of the Institution, amounting to \$1,310.64, be covered into the Treasury according to law.

Very respectfully,

G. BROWN GOODE,
Assistant Secretary.

Prof. S. P. LANGLEY, LL. D.,
Secretary of the Smithsonian Institution.

APPENDIX A.

REPORT UPON THE EXHIBIT OF THE SMITHSONIAN INSTITUTION, INCLUDING THE U. S. NATIONAL MUSEUM, AT THE CENTENNIAL EXPOSITION OF THE OHIO VALLEY AND CENTRAL STATES, HELD AT CINCINNATI, OHIO, IN 1888.

By R. EDWARD EARLL.

1. HISTORY OF THE MOVEMENT.

The series of industrial exhibitions which culminated in the recent Centennial Exposition at Cincinnati had their origin in the annual fairs of the Ohio Mechanics' Institute. These fairs, though limited in scope, and depending largely both for their exhibits and patronage on the immediate vicinity, were very successful. They were held regularly for about twenty years prior to the war of the rebellion, but owing to the nearness of the city to hostile territory it became necessary to temporarily abandon them during this period. When revived in 1868 it was decided to greatly enlarge their scope. The Mechanics' Institute invited the co-operation of both the Chamber of Commerce and the Board of Trade, the result being the Cincinnati Annual Industrial Exposition, with a board of fifteen directors consisting of five representatives from each of the bodies named. The expositions, which from that date were held almost yearly, met with much encouragement, not only from the local population, but from residents of other portions of Ohio and of the adjoining States. This encouragement led to the erection of permanent buildings in the center of the city at a cost of more than a million dollars.

As early as 1883 it was decided that the exposition for the centennial year (1888) should exceed any of those previously held, and that an attempt should be made to show the progress "of art, science, and industry" in the States comprising the original Northwest Territory during the first century of their occupation by civilized man. This was in accord with the action taken at the semi-centennial celebration of the settlement of Cincinnati in 1838, when a committee was appointed to see that "the one-hundredth anniversary of the settlement of Cincinnati, occurring in 1888, be properly celebrated." An organization was soon perfected and plans developed for holding "the Centennial Exposition of the Ohio Valley and Central States," including "the States of the Northwest Territory and those which border upon the Ohio and even farther to the south." After considerable discussion it was decided, in view of the central location of the permanent buildings, that

these should be used as a nucleus, and that additional space be secured for the erection of other buildings. Application was made to the board of public affairs, which granted the use of Washington Park on the east, and of certain streets bordering the Miami Canal on the west. In this way floor space aggregating 400,000 square feet, with 142,500 additional feet of wall space, was secured in the heart of the city. To place the project on a sound financial basis a guaranty fund of \$1,050,000 was raised among the citizens of Cincinnati.

The movement was indorsed by the city councils of Cincinnati, Covington, and Newport, and by the Ohio State legislature, which authorized the appointment of honorary commissioners, voted a small sum of money for State representation, and directed the governor, in behalf of the State, to invite "the assistance and co-operation of the Federal Government, our sister States, and especially the Central States of West Virginia, Pennsylvania, Kentucky, Tennessee, Indiana, Illinois, and Michigan, and that they be requested to appoint five honorary commissioners each to assist in the organization and carrying on of this Centennial Exposition." These States passed formal resolutions of acceptance and appointed honorary commissioners, but, as a rule, little was attempted in the way of preparing State exhibits.

Copies of the resolutions extending an invitation to the Federal Government were sent to the President and to Congress; and after considerable delay the initiative was taken by the Appropriations Committee of the House of Representatives, the chairman of which addressed letters to the heads of the several Departments with a view to ascertaining what could be done, and the amount of money needed by each for making a suitable display. This correspondence resulted in the draughting of a bill by members of said committee, which, after slight amendment, passed both Houses of Congress and received the President's signature. The bill as passed read as follows:

AN ACT making an appropriation to enable the several Executive Departments of the Government and the Bureau of Agriculture and the Smithsonian Institution, including the National Museum and Commission of Fish and Fisheries, to participate in the Centennial Exposition of the Ohio Valley and Central States, to be held at Cincinnati, Ohio, from July fourth to October twenty-seventh, eighteen hundred and eighty-eight.

Whereas the States which comprise the Northwest Territory and the adjacent States will hold at Cincinnati, Ohio, from July fourth to October twenty-seventh, eighteen hundred and eighty-eight, a centennial exposition commemorative of the organization of the Northwest Territory under the ordinance of seventeen hundred and eighty-seven, in which exposition all the States and Territories of the United States and the General Government have been invited to participate, the object being in said exposition to present a panorama of the nation's resources and present state of progressive development, by an exhibition of the products of agriculture, of the various industries and fine arts; also the results of advancement made in the sciences; the whole illustrating the opportunities secured to and the possibilities which wait upon the citizens of this Republic; and

Whereas the citizens of the Ohio Valley and the several States adjacent thereto have made suitable and adequate preparation and arrangements for holding said exposition, and are desirous, and it being fit and proper, that the several Executive Departments of the Government, the Department of Agriculture, the Smithsonian

Institution, including the National Museum and Commission of Fish and Fisheries, should participate in said exhibition: Therefore,

Be it enacted by the Senate and House of Representatives of the United States of America in Congress assembled, That the head of each of the several Executive Departments of the Government, the Commissioner of Agriculture, and the Smithsonian Institution, including the National Museum, and Commission of Fish and Fisheries, under the direction of the President of the United States, be, and they are hereby, authorized and directed to prepare and make suitable exhibits at the said Centennial Exposition of the Ohio Valley and Central States to be held at Cincinnati, beginning on the fourth of July, and closing October twenty-seventh, eighteen hundred and eighty-eight.

That there shall be appointed a committee of Congress composed of ten members, five to be appointed by the President of the Senate and five by the Speaker of the House of Representatives. Said committee is authorized and directed to visit said exposition, and make such report to Congress in that behalf as they may deem needful and proper: *Provided,* That the President may, in the exercise of his discretion, allow such documents and exhibits as relate to early settlement at Marietta, Ohio, and the establishment of civil government in the Territory Northwest of the Ohio River, to be taken to Marietta and exhibited during the time from July fifteenth to nineteenth, eighteen hundred and eighty-eight, inclusive, under such restrictions and custody as he may direct.

That to enable the several Executive Departments of the Government, the Department of Agriculture, and the Smithsonian Institution, including the National Museum and the Commission of Fish and Fisheries, to participate in said exposition to be held as aforesaid, there is hereby appropriated out of any money in the Treasury not otherwise appropriated one hundred and forty-seven thousand seven hundred and fifty dollars, apportioned as follows:

For the War Department, seven thousand one hundred and fifty dollars

For the Navy Department, fifteen thousand dollars.

For the State Department, two thousand five hundred dollars.

For the Treasury Department, seven thousand five hundred dollars.

For the Interior Department, thirty-six thousand one hundred dollars.

For the Department of Agriculture, twenty thousand dollars.

For the Post-Office Department, five thousand dollars.

For the Department of Justice, two thousand dollars.

For the Smithsonian Institution, including the Commission of Fish and Fisheries, fifty thousand dollars.

For the expenses of the committee of Congress, two thousand five hundred dollars.

That the President may, if in his judgment it shall be deemed necessary and expedient in order to secure the best results with greatest economy, transfer a part of the fund hereby apportioned to one Department or Bureau to another Department or Bureau. The term Bureau wherever used herein shall be construed to include the Agricultural Department, the Smithsonian Institution, and Commission of Fish and Fisheries.

That the President of the United States is hereby authorized to detail an officer of the pay department of the Army or Navy to disburse the fund appropriated by this act.

The payments on account of the expenses incurred in carrying out and into effect the provisions hereof shall be made on itemized vouchers approved by the representative of the Department incurring the liability, and a person to be designated by the President to make final audit of said accounts: *Provided,* That payment of the expenses incurred by the committee of Congress shall be made on vouchers approved by the chairman of said committee.

That the head of each of said Executive Departments and of the Department of Agriculture, Smithsonian Institution, and Commission of Fish and Fisheries shall, among the officers or employees thereof, appoint a suitable person to act as rep-

representative of such Department or Bureau, and said representative shall, under the direction and control of the head of the Department or Bureau, supervise the preparation and conduct of the exhibits herein provided for.

That no officer or employee appointed as aforesaid shall be paid extra or additional compensation by reason of services rendered in virtue of such employment; but nothing herein shall be so construed as to prevent the payment of the just and reasonable expenses of any committee, officer, or employee appointed or employed under or by virtue of the provisions of this act.

That all articles imported from the Republic of Mexico or the Dominion of Canada for the purpose of being exhibited at said exposition shall be admitted free of duty, subject, however, to such conditions and regulations as the Secretary of the Treasury may impose and prescribe.

Approved May 28, 1888.

Shortly after the passage of the above bill the President, in accordance with its requirements, designated one of the officials of the Treasury Department as special auditor. This gentleman at the outset questioned the right of the various Departments under the act to purchase any specimens for the completion of their exhibits, claiming that the collections must be made up of materials already on hand. This necessitated further action on the part of Congress which took the shape of a joint resolution declaring the meaning of the act. The resolution read as follows :

JOINT RESOLUTION declaring the true intent and meaning of the act approved May twenty-eighth, eighteen hundred and eighty-eight.

Resolved by the Senate and House of Representatives of the United States of America in Congress assembled, That it is the true intent and meaning of the act of Congress approved May twenty-eighth, eighteen hundred and eighty-eight, by the President of the United States, entitled "An act making appropriation to enable the several Executive Departments of the Government, and the Bureau of Agriculture, and the Smithsonian Institution, including the National Museum, and the Commission of Fish and Fisheries, to participate in the Centennial Exposition of the Ohio Valley and Central States to be held at Cincinnati, Ohio, from July fourth, to October twenty-seventh, eighteen hundred and eighty-eight," that the President of the United States may, in his discretion make an order directing that any documents, papers, maps, not original, books or other exhibits which properly and pertinently relate to the establishment of civil government in the territory northwest of the Ohio River, may be sent upon an Executive order from any of the several Departments in said act named, or from the exhibits now at Cincinnati; and that the appropriation of money in said act to defray the expenses of such exhibits, may be made applicable, in so far as the President of the United States may direct, to the payment of the expenses, of the care, transportation to, and return of, such exhibits from Marietta. And the same shall be paid from such fund heretofore set apart for each Department as the President may order. Nor shall anything in said act be so construed as to prevent the purchase of suitable materials, and the employment of proper persons, to complete or modify series of objects, and classes of specimens, when in the judgment of the head of any Department, such purchase or employment or both is necessary in the proper preparation and conduct of an exhibit. Nor to authorize the removal from their places of deposit in Washington of any original paper or document or laws or ordinances whatever.

Approved, July 16, 1888.

The original bill received the President's approval May 28th and on the following day in accordance with its requirements the Secretary of

the Smithsonian Institution appointed Dr. G. Brown Goode the Assistant Secretary in charge of the U. S. National Museum, as its representative.

The item of \$50,000, appropriated for the Smithsonian Institution in the bill, included the U. S. Fish Commission, and, by an agreement with the Commissioner of Fisheries, \$10,000 was set apart for the use of said Commission, leaving \$40,000 to be expended under the direction of the Institution. As little more than a month remained before the exposition was to open, it was impossible for the Smithsonian, or, in fact, for any of the Departments to prepare suitable exhibits, ship them to Cincinnati, and have them properly installed by the opening day. However, as no time was to be lost, a meeting of the representatives of the various Departments was called with a view to the organization of a board, and the settlement of questions relating to the amount and location of the space to be assigned to each Department. At the first conference it was found that at least 100,000 square feet of floor space would be required to accommodate the exhibits which the several representatives proposed sending, but upon inquiry it was learned that the exposition officials, owing to the delay in the passage of the bill, and to the uncertainty as to the final action upon it, as well as to their lack of information concerning the amount of space required by the Government, had reserved only one short wing of the park building, aggregating about 13,000 square feet, for its use, the remainder having already been assigned to private exhibitors. As this amount was wholly inadequate, they at once consented to erect additional buildings in the park adjacent to, and communicating with, the wing already reserved. But as the unoccupied space in the park was limited, it was impossible, notwithstanding their very generous disposition, to find room for new buildings of sufficient size to furnish the additional accommodations desired. It was finally decided to erect two annexes, one on either side of the Government wing of the main building, and in this way 29,000 feet additional were secured making a total of about 42,000 square feet available for the use of the Government.

This space was divided approximately as follows:

	Feet.
War Department.....	4,000
Navy Department.....	4,750
State Department.....	750
Treasury Department.....	4,250
Interior Department.....	6,000
Agricultural Department.....	4,000
Post-Office Department.....	2,500
Department of Justice.....	750
Smithsonian Institution.....	12,000
Commission of Fish and Fisheries.....	3,000
Total	42,000

It will thus be seen that the space occupied by each Department was very much less than that desired, in some cases only a little more than one-third of the amount asked being assigned.

2. PREPARATION AND INSTALLATION OF THE SMITHSONIAN EXHIBIT.

Immediately on his appointment Dr. Goode commenced active operations. He soon outlined an exhibit which would require at least 20,000 feet of floor space, and it was not until the work was well under way that it became known that only 12,000 feet could be secured. This necessitated considerable change in the plans, and it was finally decided to omit entirely certain subjects and to substitute pictures and models for the more bulky specimens in other groups, in order to bring the exhibit within the space assigned.

In deciding upon the general character of the exhibit and the subjects to be represented, he was governed largely by the objects of the exposition as set forth in the preamble to the bill—viz: "To present a panorama of the nation's resources and present state of progressive development, by an exhibition of the products of agriculture, of the various industries and fine arts; also the results of advancement made in the sciences; the whole illustrating the opportunities secured to and the possibilities which wait upon the citizens of this Republic."

As the National Museum has an average attendance of about 300,000 visitors yearly, it was necessary that its interests also should be considered; and it was decided to interfere as little as possible with those departments, the exhibits of which were fairly complete and properly arranged, but in so far as might be practicable, to select the specimens for Cincinnati from the newer departments, and from the duplicate materials, and to secure from other sources such additional articles as might be necessary to complete the exhibits. By this plan the educational value of the Museum was largely preserved, and its most interesting series were left intact for comparison and study by its numerous visitors.

Having outlined, in a general way, the plan of the exhibit, Dr. Goode called to his aid the curators of the several Museum departments which were to be represented. These officials were charged with the responsibility of preparing the necessary collections for their respective departments; and, as only four weeks remained before the opening of the exposition, they were obliged to neglect their regular museum duties and to devote their entire time and energies to the Cincinnati work. A large force of laborers and mechanics was at once employed in packing such articles as were ready for shipment, and in mounting specimens, making models, cases, and other necessary articles, while the curators busied themselves with the selection and arrangement of the available museum specimens, and in securing such new material as was required for completing the collections under their charge.

The first car-load of exhibits left on June 22, and others followed in rapid succession, so that by the 30th of the month eight of the twelve car-loads had been forwarded, all of the remainder, with the exception of the photographic exhibit, which was of necessity considerably delayed, leaving by the 12th of July.

To save time, articles obtained from other parts of the country and from abroad, were sent direct to Cincinnati without coming to Washington at all.

Owing to the departure of Professor Langley for Europe, in June, for an absence of some months, the duties of Acting Secretary of the Smithsonian Institution devolved upon Dr. Goode. This rendered it quite impossible for him to go to Cincinnati, and the writer was designated deputy representative. He left Washington in company with Mr. James S. Morrill, who was to act as clerk, on the 26th of June, arriving in Cincinnati the following day. He was soon joined by a number of the Museum curators who came on to superintend the installation of their respective exhibits. About the same time Mr. Henry Horan arrived with several skilled mechanics and laborers to assist in the general work.

The space assigned to the Smithsonian was located in the northern annex to the park building near the Race street entrance. It consisted of a rectangular space 125 feet long by 95 feet wide, an uninterrupted wall space 13 feet high, extending along one entire side, this being practically continued around the remainder of the area by means of partitions which were built to separate it from the adjoining departments. This gave a floor space of 11,875 square feet with about 6,000 additional feet of wall space, the latter being increased to over 10,000 feet by means of screens and partition, which it was found desirable to put up. After setting off a strip 17½ feet wide through the center of the space in its longest direction for a main aisle or thoroughfare, the remainder was assigned to the sectional exhibits as follows:

	Square feet.
Prehistoric Anthropology.....	600
General Ethnology.....	1,120
Bureau of Ethnology.....	1,425
Biblical Archaeology.....	280
Transportation.....	600
Naval Architecture.....	312½
Graphic Arts.....	1,500
Photography.....	925
Mammals (systematic exhibit).....	953
Mammals (extermination series).....	884
Birds.....	325
Insects.....	238
Mollusks.....	250
Marine Invertebrates.....	125
Botany.....	90
Mineralogy.....	60

The first four car-loads of exhibits reached the exposition on the 28th of June, but, as the annex in which they were to be placed was not completed, they were temporarily stored on adjoining space in the main building. Two days later the workmen completed the annex and the boxes were at once moved into it. Forty-five men, including the Washington party, were soon at work unpacking and arranging the exhibits,

and while it was wholly impossible to have everything ready for the opening day an effort was made to have the installation as far advanced as possible, and by working early and late the work was rapidly advanced, so that by 10.30 on the morning of July 4, when at the request of the Commissioners work was temporarily suspended, enough had been accomplished to give the visitor an idea of the character of the exhibit, and of what might be expected when finally completed. Equal activity prevailed in the other departments, and though none had their collections permanently installed, the progress made was very gratifying. After the opening ceremonies were over, work was resumed, and as the articles arrived, they were rapidly put in place, but owing to soot which filled the air and settled upon the exhibits in such quantities as to seriously injure them, and also to the tendency of the visitors to handle the specimens, it became necessary to put many articles under glass, which otherwise would have remained uncovered. In this way the work of installation was somewhat prolonged, and it was more than four weeks before it was fully completed, though the public was admitted to all of the Government departments during the progress of the work.

The private exhibits in the various classes were as a rule in place on the opening day, and all of the available space was occupied.

The Exposition, while in every way creditable to the management, did not receive that support from the public which its merits justified. The attendance during the first two months, possibly owing somewhat to the warm weather and the demands upon the time of the agricultural classes during the harvest season, was very light. However, as the weeks passed, it gradually improved, and during the months of September and October was fairly satisfactory; but the lack of co-operation on the part of the railroads unquestionably had a marked influence on the attendance of people residing at a distance. Thinking that possibly the high price of admission had kept many away, it was decided to continue the exposition for a few days beyond the 27th of October, which was the time set for closing, and to reduce the entrance fee to 25 cents, thus giving all classes the opportunity of seeing and studying the exhibits. But this did not result in any marked increase in the number of visitors, and when the doors were finally closed to the public on November 8, the turnstiles showed a total attendance of only 1,055,276, or an average of 9,593 daily, as against a daily attendance of 55,061 at Philadelphia in 1876. It was, however, considerably in excess of the daily attendance at New Orleans in 1885, which averaged (Sundays included) only 6,438. When it is remembered that Cincinnati is in the center of a very prosperous country, with a population of nearly five millions of people within easy access, the figures are certainly far below what might reasonably have been expected. Yet it should not be inferred that the Exposition was a failure, for the visitors as a rule appeared to be greatly interested, and the collections were studied with very great

care by various classes, notably by students from the institutions of learning in Ohio and adjoining States, and the educational influence upon these can not be overestimated.

Governmental participation in the expositions of the past has usually been urged on the ground of the great educational value of such undertakings to the intelligent visitors. No one who has given the slightest thought to this subject or who has observed the crowds in their examination of the collections, will for a moment deny this, nor will they fail to discover that the exhibits of the General Government attract by far the most attention. If these departmental exhibits, when properly installed in Washington, were accessible to all, there would certainly be no excuse for ever sending them to other localities; but as such a vast majority of the people of the country never visit the National Capital, the practice of sending educational collections to the larger centers of population is perhaps justifiable.

On November 8, the day set for closing, a party of eight arrived from Washington to assist in the work of packing the exhibits. It consisted of Mr. F. A. Lucas, who was to superintend the packing of the natural history collections, and Mr. Horan, who, with six skilled workmen, was to assist in the general work. A number of local mechanics and laborers were also employed and the work of packing was vigorously pushed. Five car-loads of exhibits were ready for shipment on the 20th of the month, and others were forwarded at intervals during the next two weeks, the last starting on December 4. They arrived with less than the usual amount of breakage, and by the middle of the following February, a very large percentage of them had been unpacked, repaired, and returned to their places in the Museum collections.

In accordance with the provision of the law, the President on July 11, authorized the sending of an exhibit to Marietta, Ohio. Most of the material for this exhibit was sent direct from Washington, though a few articles were forwarded from the collections at Cincinnati. This collection was under the direction of Mr. W. V. Cox, chief clerk of the Museum, who has prepared a detailed report on the subject.

3. REVIEW OF THE SMITHSONIAN EXHIBIT.

The collective exhibit of the Smithsonian was, as already intimated, made up of separate collections prepared by the curators of several of the departments of the Museum. The general display may be divided into three groups, namely: Anthropological exhibits, natural history collections, and series belonging to the department of arts and industries. A detailed description of the separate exhibits, or in fact, even a list of the objects exhibited, would extend this paper far beyond the proper limit. It, however, seems desirable to give a brief statement of the general character of the exhibits of the various sections. Such a statement will be found in the following pages. When fuller informa-



GENERAL VIEW OF THE SMITHSONIAN EXHIBIT, LOOKING NORTH.



GENERAL VIEW OF THE SMITHSONIAN EXHIBIT, LOOKING SOUTH.

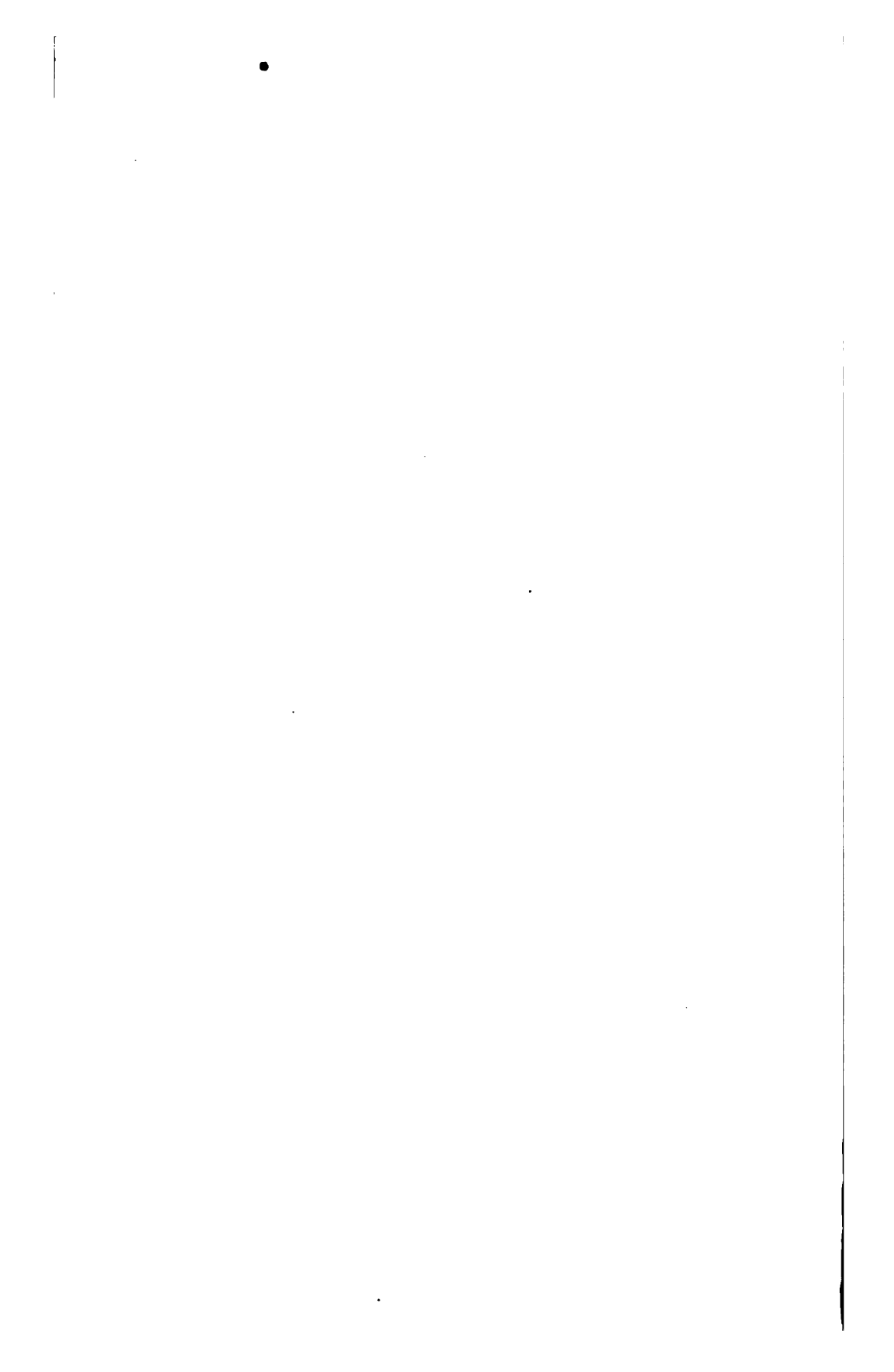

tion is desired, it can be found in the reports of the curators, under whose direction the separate exhibits were prepared.

SECTION OF PREHISTORIC ANTHROPOLOGY.

Mr. Thomas Wilson, Curator of Prehistoric Anthropology, was requested to prepare an exhibit which should illustrate the methods employed in the study of prehistoric man, and the present state of our knowledge of his manners and customs, and of his geographical distribution during the different periods. To accomplish this purpose, he selected about two thousand specimens which would best represent man's progress during the early centuries of his existence. These included objects from all parts of the world. They were arranged in continuous series in cases placed end to end to represent the stream of time during the prehistoric ages. The entire series of cases was divided longitudinally, each separate division being devoted to a different country or group of countries. At the top was Great Britain, next below came France and Belgium, then Italy, Switzerland, the Scandinavian countries, Asia, Africa, Oceanica, and at the bottom the United States. Perpendicular divisions were also made to represent the various epochs of prehistoric civilization. By this arrangement it was easy to compare the progress of man in the different countries, and to show the variations in the implements used in each. Special attention was given to demonstrating that our own country was inhabited during the earliest periods. This was done by the exhibition of large series of specimens similar in all important particulars to those belonging to the earlier epochs from the Old World.

The collection began with the Chellian epoch, when man used but one implement, a crudely chipped stone, and followed down through the different divisions of the stone age, then through the age of bronze to that of iron, showing clearly the steps in human progress from a lower to a higher civilization. Charts showing the distribution of prehistoric man and the location of his settlements during different epochs were exhibited; also drawings and models of the Swiss Lake dwellings; a skeleton of the cave bear; and a series of crude stone, ivory, bone, and metal implements, used by Indians of modern times, to illustrate the various methods of fastening them to handles.

SECTION OF ETHNOLOGY.

The Curator of Ethnology, Prof. O. T. Mason, was asked to prepare an exhibit to illustrate in a general way the leading characteristics of the different races of men; and to show the tribal relations of the North American Indians and the progress made by them in civilization. His exhibit occupied more than 1,100 square feet of floor space, and attracted much attention. It was divided into two series, namely: the general ethnological exhibit, which included all of the principal races of men, and the collections illustrating the life and habits of the various

Indian tribes. The first series contained diagrams showing the classification of mankind into races, and maps indicating, by colored areas, the distribution of the various races over the face of the earth. These were followed by models in plaster of the heads of many of the semi-civilized people of the Old World, and by full-sized figures showing the characteristic costumes of the various nationalities.

The exhibit relating to the North American Indians was naturally more extensive. It included a large number of hand-colored photographs showing both profile and front views of prominent members of each of the more important tribes. The life and habits of these Indians were illustrated by means of carefully selected collections of their implements, utensils and costumes. Among the specimens shown were war-clubs, bows, arrows, spears, tomahawks, scalping-knives, cooking utensils, samples of weaving, dressed skins and agricultural implements. Collections illustrating the art, religion, and pastimes of the Indians were also exhibited.

In the center of the space occupied by this department was a collection showing the chemical composition of the human body. The series was based upon a man weighing 154 pounds, the exact quantity of each of the various solids, liquids, and gases being represented. On the opposite side of the same case were series showing the daily income and expenditure of the human body, and the amount of food required during a day of twenty-four hours by a man of moderate work, based upon the latest investigations by physiological chemists; also a series showing the chemical constituents of a pound of wheat bread.

Adjoining the general ethnological exhibit was a collection prepared by Mr. Walter Hough, to show the development of the lamp. It was not limited to the United States, but contained objects from various other countries as well. The series began with the fire-fly cage from the West Indies and the candle-fish of the Eskimo, and included the more interesting forms of torches, candles, lanterns, and the various stone, metal, and glass lamps adapted to both animal and mineral oils and to electricity.

EXHIBIT OF THE BUREAU OF ETHNOLOGY.

In addition to the exhibit made by the department of ethnology in the National Museum, already referred to, the Director of the Bureau of Ethnology, Maj. J. W. Powell, was requested to furnish a supplemental exhibit which should illustrate the methods employed by said Bureau in the study of the North American Indians. This exhibit, which was prepared by Mr. Cosmos Mindeleff, related chiefly to the Pueblo Indians and the mound-builders. It contained plaster models from life, by Theo. A. Mills, of six of the leading members of the Zuñi tribe. These were dressed in their characteristic costumes, including the ornaments worn by them. In an adjoining case was a relief map of a section of the Zuñi country showing the location of their settlements. Next came a series of scale models and photographs of many of their

dwellings, both ancient and modern. Among these were some of the most noted ruins as well as several of their most populous villages. The largest model, which was about 15 feet square, represented the village of Zuñi on a scale of 1 to 60, all of the important details being carefully reproduced. The arts and industries of these people were represented by cases containing large collections of their textiles, basketry, pottery, agricultural implements, and household utensils. The mound-builders were represented by several carefully prepared models of noted mounds from different parts of the country; among these were the Great Elephant Mound of Grant County, Wisconsin, and the Large and Small Etowah Mounds of Bartow County, Georgia, with samples of pottery and other articles taken from them.

EXHIBIT OF BIBLICAL ARCHÆOLOGY.

Owing to the wide-spread interest in biblical studies, Dr. Cyrus Adler, Assistant Curator of the Section of Oriental Antiquities, was called upon to prepare an exhibit which should enable Bible students (of whom it is estimated that there are already more than four millions in the Sunday-schools of the United States) to see something of the results of the work of the numerous specialists who have devoted their time and energies to the study of the people of Bible lands, and to become familiar with some of the interesting objects which have been collected and studied, with a view to the better understanding of the language, history, art, social life, and religion of these people. Nearly all of the most interesting objects secured by archæologists are in foreign museums, and the time was too short to have casts of them made and forwarded; but by the co-operation of a number of people in this country who had articles in their possession, and by the liberal use of photography, it became possible to get together considerable material, which with the articles already in the possession of the Museum made a very instructive exhibit. The collection was not confined to the Israelites, but included all of the people with whom they came in contact. "Owing to the unparalleled conservatism of these people," says Dr. Adler, "proper names, dialectic forms, architecture, costumes, and, what is more surprising, considering the changes of faith, even religious practices have persisted in the East through thousands of years," and the collections therefore properly included many objects still in use. The exhibits were arranged by countries, including Assyria and Babylonia, Egypt, Elam, and Palestine. They contained objects from a period beginning 3800 years B. C., and continuing to the present time, including royal seals and impressions of same, casts of obelisks and tablets containing pictorial and historical inscriptions, photographs of the Egyptian pyramids, sphinxes, sculptures, mummies of noted kings, with specimens of plants, shells, lamps, and costumes collected in the several countries named. Among the more interesting objects were the casts of the Black Obelisk of Shalmaneser II, the Rosetta Stone, the Moabite Stone, and the Siloam Inscription.

SECTION OF MAMMALS.

The Curator of the Department of Mammals, Mr. F. W. True, was asked to prepare an exhibit which should illustrate the principles on which the present classification of mammals was based. The family was selected as the division which would best represent the general theory of classification, and it was decided to send a collection which should include one or more characteristic specimens of every known family. As quite a number of the families were not represented in the museum collection it became necessary to secure specimens from other sources, and when such could not be obtained, to represent the family by means of pictures. Owing to the fact that classification rests partly on external and partly on internal characters, both skeletons and stuffed specimens were included. The families, excepting only a few of the largest forms, which from their size had to be separated from the systematic series, were arranged in zoological order in one continuous case 140 feet long, beginning with the highest order, man, and ending with the lowest or egg-laying mammals, thus affording excellent opportunities for study and comparison. The collection naturally included many animals with which the public had thus far had little opportunity for becoming acquainted. Among these were the gorilla, chimpanzee, aye-aye, panda, walrus, coney, tapir, saiga, antelope, almiqui, shrew, tana, chinchilla, coypu, whale, porpoise, manatee, aard-vark, pangolin, armadillo, ant-eater, duck-bill, and many other forms seldom found in expositions in this or any other country.

MAMMAL EXTERMINATION SERIES.

Adjoining the systematic mammal collection was a special exhibit prepared by Mr. W. T. Hornaday, Curator of Living Animals, to direct the attention of the public to the rapid destruction of many of the larger animals which are fast disappearing from the country, and are already in great danger of extermination. The series included the bison, or American buffalo, moose, elk, antelope, mountain goat, mountain sheep, walrus, elephant-seal, and the beaver. The bison was the object of special attention, and a large series of pictures were shown to illustrate the numerous methods employed by both Indians and whites in its destruction. In the center of the exhibit, upon a sod-covered pedestal, was a skeleton of a bison from which the hide had been removed, showing the condition in which the carcasses are left upon the plains by the hide-hunters; and on adjoining screens were specimens of the various grades of commercial hides, with a schedule of their past and present market values. There was also on exhibition a very instructive map of North America, showing by colored areas the original territory covered by the buffalo, and its narrowing range from time to time during the past quarter of a century, due to the destructive agency of man. In the rear of the exhibit was a case containing samples of the hides of



MAMMAL EXTERMINATION SERIES, SMITHSONIAN EXHIBIT.



other animals which have been eagerly sought by the hide-hunter, and an exhibit of the different weapons used in the destruction of the various species.

SECTION OF BIRDS.

An instructive exhibit of birds was prepared by the Curator of Birds, Mr. Robert Ridgway. It consisted of an extensive collection of finely mounted and carefully labeled specimens of the birds of North America, and of smaller series of the principal birds of foreign countries.

The collection of North American birds was very complete, including examples of every known genus excepting only a few of the larger water birds and birds of prey, which were omitted for lack of space. They were arranged in proper sequence, thus affording an excellent opportunity for the study of the latest scientific classification. In a few instances, where the birds were too rare and valuable to warrant the sending of specimens, they were represented by means of original water-color paintings by the curator. The collection of foreign birds, though much smaller, consisted of the characteristic types of various countries selected for the purpose of showing something of the bird fauna of the principal zoo-geographical regions of the earth. Among those represented were the Australian, Indo-Malayan, and Ethiopian regions, and the principal birds of Europe. Another series which attracted much attention from the exposition visitors was a collection of the principal birds of literature, with the names by which they are known in poetry and appropriate quotations from the leading authors regarding them. A collection of birds' eggs and casts of same to represent the various sizes, from the egg of the extinct *epyorius* or giant ostrich of Madagascar, with a capacity of two gallons, to that of the humming-bird, and a set of facsimile reproductions of the plates of Audubon's books on the birds of North America were also exhibited.

SECTION OF INSECTS.

This exhibit was prepared by Dr. C. V. Riley and Mr. John B. Smith. It consisted of a systematic collection illustrating the various families of insects, and economic series showing separately the species injurious to agriculture and to forests. The systematic series represented, either by specimens or detailed drawings, all of the families of American insects. Where practicable, care was taken to select large and showy specimens to represent the different families, thus attracting the attention of the public as well as that of the specialist to the exhibit. This was notably true in the case of the *Coleoptera* and *Lepidoptera*, which contained many attractive forms. Each family was accompanied by a descriptive label calling attention to its peculiar characters, and in many instances was illustrated by several species. This series contained several thousand specimens, and was much admired both by the

public and by students interested in this branch of natural history. The economic exhibit contained separate series, each being devoted to a particular species, including insects that feed upon the different grains, the cotton plant, the apple, the grape, and the various species of ornamental and forest trees. It was prepared for the benefit of the agricultural classes, and contained specimens and drawings illustrating the development of the various species, their methods of feeding, and samples of roots, stalks, branches, leaves, flowers, and fruits that had been injured by them. The descriptive label accompanying each specimen contained information of practical value to the farmer and fruit-grower, and suggested methods by which they could to a greater or less degree protect their crops from the ravages of these pests.

SECTION OF MOLLUSKS.

The Department of Mollusks in the Museum forwarded a collection, prepared by Dr. W. H. Dall and Prof. R. E. C. Stearns. The object, as in the case of the other natural history collections, was to illustrate the principles on which the present system of classification was based. The exhibit, though occupying only about 250 feet of floor space, was very complete, and contained specimens representing all of the important families of marine mollusks not only of this country, but of other parts of the world. No attempt was made to show the land shells, as the time was too short to get up a collection, and there was not sufficient space for displaying the same, even if it had been prepared.

SECTION OF MARINE INVERTEBRATES.

A collection of marine invertebrates was prepared by Mr. F. A. Lucas, osteologist of the Museum. It consisted of a carefully selected series of typical representatives of the various families of sponges, corals, jelly-fishes, echinoderms, and star-fishes. As a rule, the species were represented by dried and carefully mounted specimens of the animals themselves; but such groups as could not be preserved in this way were shown by means of glass models obtained from Europe. The collection of sponges contained full series of both the ornamental and commercial species of our own country and a number of the more important commercial species from the Mediterranean Sea. The families of corals were represented by numerous species from the off-shore banks of the North Atlantic, by a number of the more attractive forms from the Gulf of Mexico, and by a collection of the typical forms from Polynesia. The growth of the red or precious coral of commerce was shown by means of models. The exhibit illustrating the families of jelly-fishes was made up exclusively of glass models, by means of which a number of the more delicate forms, including the Portuguese man-of-war, were represented.

SECTION OF BOTANY.

The botanical exhibit was prepared by Mr. F. H. Knowlton, Assistant Curator of Botany. It consisted of a collection of chromo-lithographs of the flowering plants and ferns of the country, and of an ex-

hibit of specimens of marine algæ. The series illustrating the flowering plants included about two hundred and fifty plates, each representing a different species. It contained examples of all the principal orders, the specimens selected being such as, on account of their beauty or curious form, would be most likely to attract the attention of the public. In many of these plates all of the parts of the plant were represented, and in some instances the parts of the flower were enlarged to show the important characters of the species.

The collection of ferns was more complete. It contained eighty-one plates, on which one hundred and fifty, out of one hundred and sixty species of North American ferns were represented. These plates were taken largely from the published works of Eaton, Meehan, Sprague, and Goodale.

The collection of algæ included nearly all of the species known to occur on the Atlantic coast of the United States and many of the common species from the Pacific. It was originally intended, in addition to the above, to show separate collections of the flowers and ferns of the Ohio Valley, and also to prepare a comprehensive forestry exhibit, which should include sample woods and herbarium specimens of the principal trees of the Ohio Valley, photographs of the forest trees of the United States, and maps locating the present forest areas of the country; but the delay in the passage of the bill authorizing the exhibit and the lack of space made it impossible to do so. A collection of fossil plants to show the progress made in the study of paleontological botany was omitted for a similar reason.

SECTION OF MINERALOGY.

This exhibit was prepared by Prof. F. W. Clarke, Honorary Curator of the Department of Minerals, with the aid of the Assistant Curator, Mr. W. S. Yeates. It was at first intended to send a complete collection of the minerals of North America, the floor space required being estimated at 1,200 square feet, and negotiations were begun for the purchase of a collection, valued at \$5,500, belonging to Mr. Joseph Willcox, of Philadelphia, which was especially rich in North American materials, to serve as a nucleus of the exhibit. The auditing officer for the Government, however, objected to the proposed expenditure, and the plan of making a systematic exhibit was therefore of necessity abandoned. The exhibit as finally sent consisted of a single case, containing such gems and ornamental stones as were available from the collections already in possession of the Museum, with the addition of a small amount of gem material from other sources. It was limited almost exclusively to North American specimens.

SECTION OF TRANSPORTATION.

Some months prior to the passage of the exposition bill, Mr. J. E. Watkins, formerly with the Pennsylvania Railroad Company, was appointed curator of a newly-formed section of transportation in the Na-

tional Museum, and considerable interest was already manifested by the public in the small collection which he had succeeded in getting together. He was requested to secure additional material to supplement this collection, and to send to Cincinnati a comprehensive exhibit which should illustrate so far as practicable, the development of the principal systems of transportation in the various countries of the world.

He outlined a scheme based on the different motive powers, including man, the various animals, wind, steam, and electricity. In the division of steam transportation, special attention was given to the development of the railroad, and numerous models were secured illustrating the growth of the locomotive, the car, and the track, including rail, road-bed, and bridge. These were supplemented by a map, showing by decades the progress of railroad construction in the United States. The track exhibit was especially complete, containing scale models of nearly every style used in this country since the introduction of railroads, and also much interesting material from foreign lands. The collection contained many articles of historic interest, including models or drawings of many of the earliest locomotives and steam-boats, chief among which were Murdock's high-pressure locomotive, 1784; Trevithick's locomotive, 1804; Stevens's experimental locomotive, 1825; "Rocket" and "Stour-bridge Lion," both of 1829; Hull's steam-boat, 1739; Rumsey's steam-boat, 1787; steamer "F. R. Stockton," 1839; also, the original papers, signed by Louis XVI of France in 1791, granting a patent to John Fitch for steam-boat propellers.

The systematic exhibit already referred to was supplemented by an independent series showing the early methods of transportation in the original Northwest Territory. This collection, as was expected, proved of special interest to the exposition visitors, a majority of whom were residents of Ohio and adjoining States. It included a model of the "Sandusky," 1837—the first locomotive in the State of Ohio, and of the "Orleans," 1812—the first steam-boat on the Ohio River.

While numerous collections had previously been prepared to illustrate the progress of one or another of the various systems of transportation, this was, so far as we know, the first attempt ever made to bring them all together, and to treat them systematically in one comprehensive series.

Much assistance was rendered by the Baltimore and Ohio, and Pennsylvania Railroad Companies, both of which furnished valuable collections showing the progress made on their respective lines; and by the officers of the Stevens Institute at Hoboken, N. J., who loaned various objects of historical interest and allowed photographs and models of others to be made.

SECTION OF NAVAL ARCHITECTURE.

This exhibit was sent for the purpose of showing the various types of vessels of the world, especially those of North America. It was prepared by Capt. J. W. Collins, Curator of the Section of Naval Archi-

ture, and was arranged in such a way as to direct attention to the improvements in vessels of modern times over those of earlier years. The exhibit consisted chiefly of rigged models, builders' models, and pictures. It contained many objects of historic interest which attracted much attention. The historical series began with the viking ship, dating back to 800 A. D., and included the famous Columbus fleet of 1492, the Car-rack of the Sixteenth century, the Spanish Galleon of the Sixteenth and Seventeenth centuries, the "Sally Constant" (the "Mayflower" of the Virginia Colony), the "Mayflower" of 1620, and the "Cumberland", sunk at Hampton Roads during the late war. The other series contained models of the kyack or skin-boat of the Eskimo, the various types of fishing vessels of different periods, the principal kinds of merchant ves-sels and other sailing craft, and both river and ocean steamers of mod-ern pattern.

SECTION OF PHOTOGRAPHY.

The photographic exhibit was prepared by Mr. T. W. Smillie, the photographer of the National Museum. The original plan was very comprehensive, the intention being to show, in so far as practicable, the origin and growth of the science, the various processes and appliances, the different uses of photography, and the literature of the subject; but the limited time remaining after the passage of the bill made it im-possible to fully carry out the scheme. The representation of origin and growth was therefore practically neglected, and the collection of appliances was of necessity somewhat limited, Mr. Smillie's attention being devoted chiefly to showing the more important processes and the various uses of the science. The collection of apparatus included por-trait and landscape cameras of former years, both single and stereo-scopic, a complete daguerreotypers' outfit, and a number of the more satisfactory portrait, enlarging, landscape, and detective cameras of the present day. The series of processes included the Daguerreotype, Tal-botype, albumen, collodion, and gelatine negative processes; also series showing samples of plain, albumen, bromide, and other silver prints, as well as prints by the platinum, carbon, uranium, asphalt, and the nu-merous iron processes. Enlarged prints by the use of whey, platinum, and bromide, the collodion transparency, and transferotypes on paper, canvas, and porcelain were also exhibited.

In addition to the ordinary uses to which photography is applied, at-tention was directed to its great value in other directions. One series of photographs illustrated its use, in connection with the microscope, in the study of disease germs, embryology, lithology, mineralogy, etc.; and another in connection with the telescope, in making astral charts, in studying eclipses, stellar spectra, and the like. Examples were also displayed showing its value for other purposes, such as the study of botany, zoölogy, architecture, lamp flames, explosives, in the detection of criminals, in map and chart making, in recording the fluctuations in

various scientific instruments, as thermometers, barometers, and magnetic needles, in the study of special industries, in the illustration of books, and as an aid to the artist and engraver. The literature of the science was represented by a series of photographs of the title-pages of more than three hundred books and pamphlets relating to photography.

A small collection of photographs, forwarded by Mr. A. Howard Clark, curator of the section of personal and historical relics, was exhibited in this space. It consisted of a series of photographs of Washington and Grant relics in the possession of the Museum, and a collection of portraits of men prominent in the various branches of science during the past three centuries.

SECTION OF GRAPHIC ARTS.

This exhibit, prepared by Mr. S. R. Koehler, Curator of the Section of Graphic Arts, was intended to illustrate the various methods employed in the preparation of blocks and plates for pictorial printing. It was divided into four groups as follows :

(1) The various processes of engraving and printing from the beginning of the Sixteenth century to the present time, exclusive of the modern photo-mechanical processes; (2) The history of wood-engraving in the United States; (3) The history of etching in the United States; (4) The modern photo-mechanical processes. The first group contained prints illustrating all of the most important processes of this division, twenty-four in number, and in the case of the principal ones an attempt was made to give some idea of their history by the exhibition of carefully selected series showing the progress made in several of the leading countries including England, Germany, France, the Netherlands, and Italy, during different periods.

As both wood-engraving and etching owe much of their present popularity to American artists either by nativity or adoption, and as the Exposition was largely for the purpose of showing the progress made in the arts and sciences, it was thought desirable to prepare extensive exhibits showing separately the growth of these processes in the United States. Considerable space was given to these collections in which specimens of the work of all prominent artists in either branch were displayed. The series of wood-engravings began with samples of the earliest work of Dr. Alexander Anderson, 1818, and included engravings by no less than sixty different artists. The earliest etchings shown were those by Chapman in 1852, the bulk of the collection being made up of work executed within the past ten years. "Special stress" says Mr. Koehler was "laid upon the painter etchings (*i. e.* original work), and the smaller reproductive plates made from about 1877 to about a year or two ago, while the large plates of a more commercial character which have appeared lately were represented only by a few selected specimens." In this collection over fifty of the leading etchers of the country were represented, thirteen of them being women.

The fourth group was devoted to the modern photo-mechanical proc-



SECTION OF PHOTOGRAPHY, SMITHSONIAN EXHIBIT.

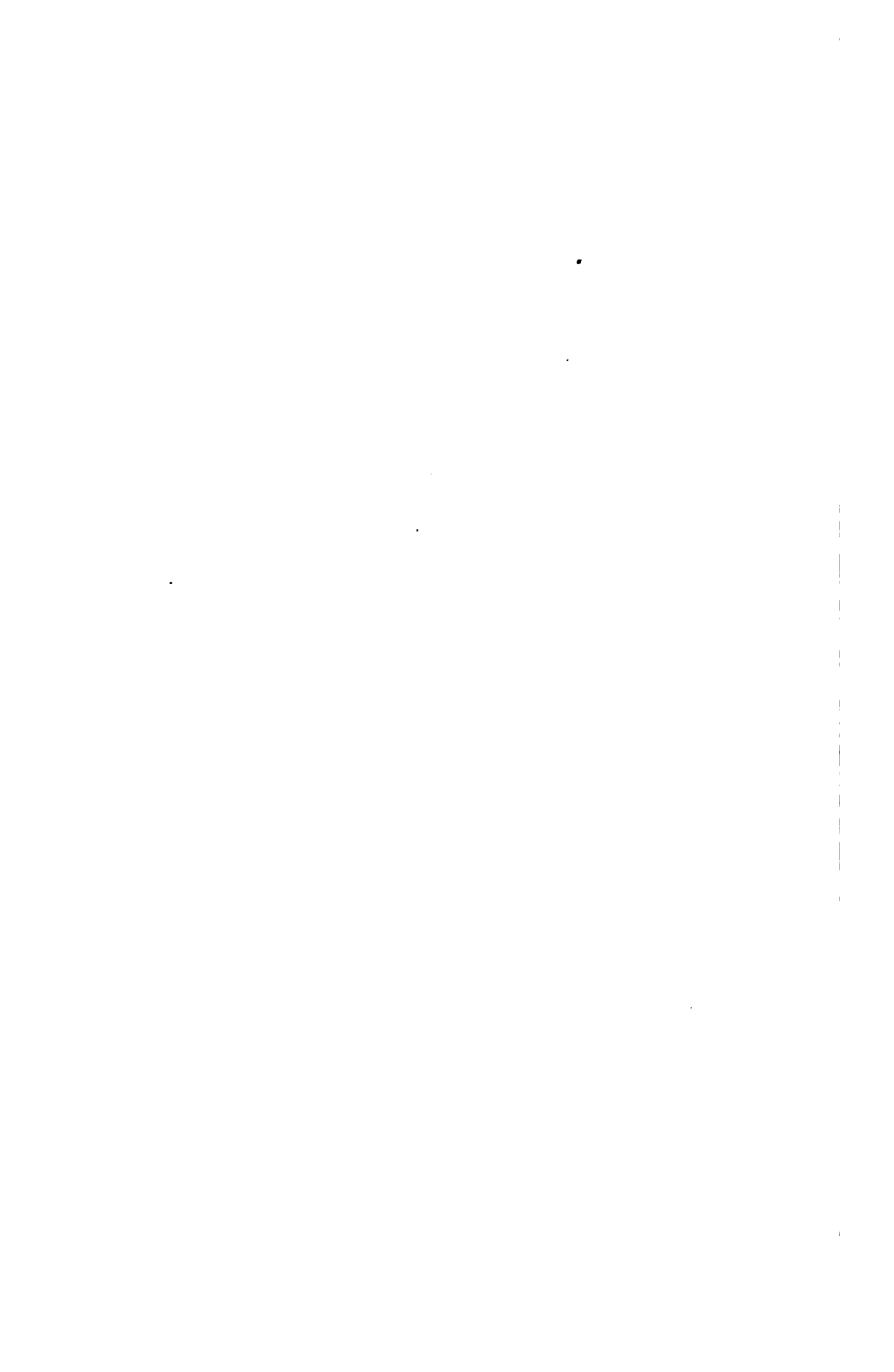

esses which are playing so important a part in the pictorial printing of the present time. Photography proper, being a photo-chemical process in which the print is made by the action of the sun's rays, was excluded, the exhibit being limited to those processes in which the printing-press is necessary to the manifolding of the picture, even though the block or plate may have been made wholly or in part by the chemical action of light. The various relief, photo-lithographic, zincographic, calographic, and intaglio processes were grouped separately, and an effort was made to show, by means of prints, the improvement made in each since its discovery; though, as the processes are usually either wholly or in part secret, no attempt was made to illustrate the methods by which the blocks were produced. Mr. Koehler has prepared a detailed catalogue of the exhibit, in which the various processes are briefly described and much valuable information regarding their history is given.

4. REVIEW OF THE EXHIBITS OF THE OTHER DEPARTMENTS OF THE GOVERNMENT.

State Department.—The State Department exhibit was under the direction of Mr. Haughwout Howe. It was prepared for the purpose of illustrating the work of that Department. It contained many papers and other objects of great historical interest. The series of diplomatic papers included the letter addressed by Benjamin Franklin to the premier of France in December, 1776 (this being the first official communication ever sent to a foreign court by an officer of our Government) and many other equally interesting papers, among which were letters bearing the signature of many of the leading sovereigns of the world during the past century, and of almost every one now in power. The original treaty of 1782 with Great Britain, which secured to us our independence, was exhibited, as were also a number of other treaties with Great Britain, France, The Netherlands, and Turkey, each bearing the seal of its respective government, and a whale's tooth sent as a treaty by the King of the Fiji Islands. There was also a complete series of portraits of the Presidents of the United States, and another of the Secretaries of State from the time of Jefferson; also photographs of the principal Government buildings of Washington, and of certain of our foreign offices, with maps showing the location of our diplomatic and consular stations in all parts of the world. To the above were added many interesting historical relics from the library of the department, series of medals awarded to the United States, to officers of the Army and Navy, and to private citizens, and a full set of the department publications, including United States laws, diplomatic correspondence, foreign relations, consular reports, consular regulations, commercial relations, and reports on various expositions.

War Department.—The exhibits of this Department, prepared by Capt. H. A. Russell, Bureau of Ordnance, assisted by Lieut. E. S. Benton, Third Artillery, were among the most interesting of the Govern-

ment exhibits. They occupied a floor space of about 4,000 square feet in the eastern part of the south annex adjoining the space occupied by the Navy Department. The collections were made up of materials obtained from different sources to show the various implements of war and the improvements in the same during recent years. The older forms consisted chiefly of war relics from different parts of the world, the greater part of them being objects captured from, or surrendered by the enemy during the wars with Great Britain, Mexico, the various Indian wars, and the War of the Rebellion. These were supplemented by a large series showing many of the older styles of weapons used by our own army during the earlier years of its existence. The series of war relics contained a great variety of objects from all parts of the world, including spears, pikes, lances, bayonets, halberds, daggers, creeses, sabers, swords, scimeters, shields, armors, small-arms, and mounted and unmounted guns of various kinds. The collections showing the modern war implements were furnished in large part by the Bureau of Ordnance, and contained a sufficient number of primitive forms to show the origin and development of many of the implements of the present day. The series of small-arms began with the old match-lock, which was in turn followed by the wheel-lock, flint-lock, percussion-lock, and the breech-loading rifle. The series of larger guns contained mounted and unmounted specimens of various forms, including the muzzle-loading cannon, Napoleon gun, breech-loading steel field-piece, Gatling gun, volley gun, Krupp gun, Hotchkiss gun, and numerous other forms. There was also a large series of projectiles of various styles, a collection of fuses, and samples of the uniforms worn by soldiers of different rank in the various branches of the Army.

Navy Department.—The Naval exhibits, prepared under the direction of Lieut. Richard Rush, assisted by Ensigns E. A. Clements and John Gibson, occupied about 4,750 square feet of floor-space fronting on the main aisle of the Government wing of the Park building, and extending backward for some distance into the south annex. They consisted of separate collections forwarded by the Bureau of Ordnance, Bureau of Construction and Repairs, Bureau of Navigation (including the Hydrographic Office, Office of Compasses and Naval Observatory), and by the U. S. Naval Academy.

The exhibit of the Bureau of Ordnance consisted of steel breech-loading rifle guns of various sizes, Parrot rifle gun with fittings, howitzers, Gatling guns, small-arms of different patterns, specimens of projectiles and fuses, and a fully equipped torpedo-boat. The Bureau of Construction and Repair sent a very valuable collection of models of our largest and most modern war vessels, including several now building. The Bureau of Navigation exhibited a complete set of day and night signals, and the flags of all nations. The Hydrographic Office forwarded a series of instruments used in its survey work, a portable observatory with the necessary equipment for the telegraphic determination of longitude, a collection illustrating the methods of chart construction from the first

rough survey plottings to the completed chart, relief models in plaster showing the contour of the ocean-bed in various localities, and wind, current, thermal and other charts issued by this office as aids to navigation. The Office of Compasses sent a full set of mariner's compasses and other instruments for determining magnetism. The Naval Observatory exhibited a complete outfit of apparatus for astronomical work, photographs of the heavenly bodies, and a set of instruments and electric apparatus to illustrate the operations of the Observatory time system, and to show its relation to the various commercial interests of the country. During the continuance of the Exposition this department, through its Washington office, operated a time-ball by means of which the correct time was furnished daily.

Treasury Department.—The exhibits of this Department were made up of separate collections by several bureaus, including the Department proper, the Coast and Geodetic Survey, the Bureau of Printing and Engraving, and the Life-Saving Service. The collective exhibit, which occupied an area of 4,250 square feet at the farther end of the south annex, was under the general direction of Maj. Herman Kretz, representative, assisted by Lieut. C. H. McClellan of the Life-Saving Service, and Capt. C. O. Boutelle and Dr. J. H. Clark of the Coast and Geodetic Survey.

The exhibit of the Treasury proper consisted of a complete collection of portraits in oil of the Secretaries of the Treasury from the organization of the Department. The exhibit of the Coast and Geodetic Survey was composed in large part of the scientific instruments and other apparatus used in its magnetic, hydrographic, geodetic, and topographic work, with a full set of the maps, charts, and publications of the survey, and a set of standard weights and measures, and of the weights and measures of the metric system.

The Bureau of Printing and Engraving sent an exhibit illustrating the various kinds of work done by its employés, including the different styles of engraving, and samples of printing by both hand and steam presses. The objects selected for showing the processes were United States bonds varying in size from \$100 to \$50,000, currency notes and silver and gold certificates ranging from \$1 to \$10,000, internal revenue certificates and a collection of vignette portraits of two hundred of the leading American statesmen and inventors.

The collections sent by the Life-Saving Service consisted of a carefully selected series, illustrating by means of pictures, apparatus, and models, the methods employed by it in the saving of both life and property. It contained a complete station outfit, including self-bailing life-boat and carriage, cannon, projectile, shot-line, life-car, breeches-buoy, and a complete set of lines, ropes, blocks, and signals; also a beach wagon fully equipped for service, samples of the life-jackets and swimming-suits worn by the crew, and statistical summaries of the work accomplished during the past few years.

Department of the Interior.—The exhibits of this Department occupied the east front of the park building and the eastern side of the north annex. They were made up of separate collections from the Patent Office, General Land Office, Census Office, Geological Survey, Bureau of Education, Indian Bureau, Railroad Bureau, and Pension Office. The representative of this Department was the late Marcellus Gardner, who died after a brief illness while the exposition was still in progress, Prof. F. W. Clarke being designated as his successor. The bulk of the collections were sent by the Patent Office and the Geological Survey. The former sent upwards of two thousand five hundred models, which were arranged systematically by classes of inventions. Among the number were several of historic interest, including the original models of the Howe sewing-machine, the Morse electric telegraph, and the Whitney cotton-gin. This office also exhibited enlarged photographs of the public buildings of Washington, portraits of all ex-Commissioners of Patents, and of prominent inventors. The Geological Survey exhibited a series of interesting geological maps and relief models, an educational series of rocks, and an extensive collection of specimens of rocks and minerals from Yellowstone Park; also sketches in water color illustrating the different kinds of erosion, and a large collection of both plain and colored photographic transparencies of natural scenery in different parts of the country. The Land Office exhibited maps and charts of the United States, and paintings in oil relating to gold, silver, and coal mining and to oil-wells. The Bureau of Education sent collections to illustrate the methods employed in educational work among the Japanese, in schools for the blind in our own country, and the latest kitchen and kindergarten methods. It also sent models of ancient implements, portraits of ex-Commissioners and prominent American and foreign educators, with statistics of schools and colleges. The Indian Bureau forwarded a collection illustrating the methods employed by it in the education of Indian children at the Government schools, with samples of the work done by the pupils. The Census Office displayed, by means of maps, the results of the Tenth Census of the United States; and the Railroad Bureau exhibited maps showing the development of our present railroad system, with photographs of the most noted railroad bridges of the country.

Department of Agriculture.—The exhibits of this Department occupied about 4,000 square feet of space fronting on the main aisle of the Government wing of the Park building, opposite the Post-Office exhibit, and extending back a short distance into the northern annex. They consisted of separate collections prepared by several bureaus of the Department under the general direction of Mr. William Saunders, representative. The Botanical Division sent about two hundred species of grasses, all carefully identified, with the locality from which they came, and other information regarding them. The Forestry Division exhibited sections of the wood of about one hundred of the commercially im-

portant forest trees of the United States, with samples of their seeds. These were accompanied by maps showing the location of forests, prairies and other treeless regions of the country, and the farmer's interest in forest property. The same division sent a series of photographs illustrating the effects of deforestation, another to show the methods adopted in France for restoring the forests, and a third to direct attention to the results of tree planting in the city of Washington. The Pomological Division sent a series of colored drawings of the principal American and English fruits. The Mycological Division prepared a collection to show the various diseases of plants and the methods of treating them. The Ornithological Division sent a very interesting collection of the birds which are either directly or indirectly beneficial or injurious to agriculture, with a list of the various animals and plants upon which they feed. The Division of Animal Industries forwarded specimens illustrating the diseases of animals, their distribution, and the apparatus and methods employed in their study and treatment. The Chemical Division established a laboratory for practical work in agricultural chemistry, under the supervision of Mr. G. L. Spencer, who was in attendance at the Exposition to explain the details of the various methods. The Statistical Division sent several series of maps and charts to show, first, the distribution of the different food plants and other plants of economic interest; second, the area devoted to the cultivation of each, with statistics of production at different periods; third, the effect of price upon production; and fourth, the yearly export of agricultural products to different countries.

Post-Office Department.—The exhibits of this Department occupied about 2,500 square feet in the east wing of the Park building at the end adjoining the central fountain. They were prepared under the direction of Maj. R. D. S. Tyler, representative of the Department. The main feature of the exhibit was a working post-office, complete in every particular, which, through the co-operation of the postmaster at Cincinnati, supplied the necessary mail facilities for the Exposition. Adjoining this was an exhibit consisting of objects, models, and pictures illustrating the work of the several branches of the postal service. These included representations of the various methods of carrying the mails, such as the mounted carrier, sled, stage-coach, postal-car, and both river and ocean steamers, maps showing the post routes with the frequency of service and the location of the various offices, photographs of the principal post-office buildings of the United States and of several European countries, portraits of the leading post-office officials, copies of postmasters' appointments, and the uniforms worn by post-office employes of this and other countries. It contained also publications relating to the history and growth of the postal service, copies of postal treaties, collections of stamps, both domestic and foreign, samples of American and international postal cards, postal notes, and money-

orders, historical series of stamping tools, mail-bags, letter-boxes, locks, and other articles. There was also an exhibit showing the work of the Dead-Letter Office, and, in addition, full statistics of the work of the Post-Office Department in its various branches. A very interesting addition to the exhibit was a machine for the manufacture of stamped envelopes, forwarded and operated by the owners. This machine automatically gummed, stamped, folded, counted, and bunched envelopes at the rate of about 4,500 per hour.

Department of Justice.—The exhibits of this Department occupied about 750 square feet of floor space to the right of the Department of State in the south annex. They were under the direction of Col. Cecil Clay, representative, who prepared several series of pictures to illustrate the work of the Department. One of the features of the exhibit was a collection of large portraits in oil of all the Attorneys-General from the establishment of the Government. Another series of pictures showed the principal court buildings, with a list of the court officers in each judicial district, statistics of the work of the United States courts from 1883 to 1887, inclusive, and statistics of the legal business of the United States Supreme Court and the Court of Claims. A full set of the publications of the Department was also exhibited.

The United States Fish Commission.—A very popular and instructive display was made by this Department under the direction of Capt. J. W. Collins and Dr. T. H. Bean. It occupied a space of about 3,000 square feet at the extreme end of the north annex. The exhibit consisted of collections illustrating the methods employed by the Commission in its scientific investigations, in its fish-cultural work, and in its study of the commercial fisheries. One of the most attractive features was a series of aquaria containing live fishes and other aquatic animals and plants. Among the fishes were many of the economic species of the Ohio River basin and a number of interesting forms from other parts of the country. The Division of Scientific Inquiry was represented by photographs of its zoological stations, models of its vessels for exploration, and by samples of its apparatus for biological and physical research, such as nets, dredges, sounding apparatus, thermometers, etc. It also exhibited a large series of marine animals from various localities and different depths. The Division of Fish-culture showed, by means of models, the method adopted by the Commission in taking the eggs from the parent fish for purposes of artificial propagation, and by apparatus supplied with live eggs of different species the methods employed in hatching them and in rearing the fry. This exhibit was supplemented by a complete fish-cultural outfit, including apparatus for collecting and transporting the eggs, hatching-troughs, boxes and jars suitable for developing eggs of the various species, models of cars and samples of tanks, cans, and pails used in the transportation of fry, rearing and feeding troughs, samples of fish-food, and models and pho-

tographs of the more important fish-cultural stations. The Division of Fisheries exhibited plaster casts of all of the principal food fishes, papier-maché casts of the porpoises, the oil and bone whales, specimens of the edible mollusks of the country, and maps showing the distribution of the fishes of greatest commercial importance. It also sent photographs of fishermen engaged in different branches of the sea and river fisheries, as well as pictures of their homes and villages, and, in addition, a series of pictures showing the various forms of fishing-vessels and boats, and the apparatus and methods employed in the cod, halibut, herring, mackerel, and other fisheries, and statistical charts showing the yield in different years.

APPENDIX B.

REPORT UPON THE EXHIBIT OF THE SMITHSONIAN INSTITUTION, INCLUDING THE UNITED STATES NATIONAL MUSEUM, AT THE CENTENNIAL EXPOSITION, MARIETTA, OHIO, JULY 16 TO 21, 1888.

BY W. V. COX.

The Smithsonian Institution and the National Museum participated in the Centennial Exposition at Marietta, in conformity with the President's order of July 11, 1888, which permitted the head of any Department to send such exhibits to Marietta, as, in his discretion, it was proper and expedient to remove.

The executive order, together with a letter from the Hon. John Eaton, former Commissioner of Education, and Public Resolution No. 26, are given herewith.

EXECUTIVE MANSION, *July 11, 1888.*

The action of the State Department, as indicated in the extract from the order issued by the said Department submitted to me, is approved to the extent of permitting the head of any Department to determine what, if any, of the exhibits from his Department should be sent to Marietta, pursuant to the provisions of the act, and to cause the removal of the same to Marietta, in charge of some careful and discreet person, if the appropriation allowed his Department is sufficient, and if in the discretion of the head of said Department such removal is proper and expedient.

GROVER CLEVELAND.

WASHINGTON, D. C., *July 11, 1888.*

SIR.—I have the honor to invite your attention to the provision in the act relating to the Exhibition in Cincinnati, placing within your discretion the approval of an exhibit of certain articles at Marietta, Ohio, during the Centennial celebration there. The time for the Exhibition is short, only a few days now intervening. Would it be in accordance with your judgment to provide the action of the State Department already taken for the guidance of the other Departments in the exercise of the discretion committed to you by law?

Very respectfully, your most obedient servant,

JOHN EATON.

The PRESIDENT.

[Public Resolution No. 26.]

JOINT RESOLUTION declaring the true intent and meaning of the act approved May 28, 1888.

Resolved by the Senate and House of Representatives of the United States of America in Congress assembled, That it is the true intent and meaning of the act of Congress approved May 28, 1888, by the President of the United States, entitled "An act making appropriation to enable the several Executive Departments of the Government, and the Bureau of Agriculture, and the Smithsonian Institution, including the National Museum and the Commission of Fish and Fisheries, to participate in the Centennial Exposition of the Ohio Valley and Central States, to be held at Cincinnati, Ohio, from July 4 to October 7, 1888," that the President of the United States may, in his discretion, make an order directing that any documents, papers, maps, not original, books, or other exhibits which properly and pertinently relate to the establishment of civil government in the territory northwest of the Ohio River, may be sent upon an Executive order from any of the several Departments in said act named, or from the exhibits now at Cincinnati; and that the appropriation of money in said act to defray the expenses of such exhibits may be made applicable, in so far as the President of the United States may direct, to the payment of the expenses of the care and transportation to and return of such exhibits from Marietta; and the same shall be paid from such fund heretofore set apart for each Department, as the President may order. Nor shall anything in this act be so construed as to prevent the purchase of suitable materials and the employment of proper persons to complete or modify series of objects and classes of specimens, when, in the judgment of the head of any Department, such purchase or employment, or both, is necessary in the proper preparation and conduct of an exhibit. Nor to authorize the removal from their places of deposit in Washington of any original paper or document, or laws or ordinances whatever.

Approved, July 16, 1888.

Owing to the absence in Europe of Professor Langley, the secretary of the Smithsonian Institution, Mr. G. Brown Goode, the acting secretary and representative to the Exposition, was unable to leave his official post in Washington. I was therefore delegated to represent Professor Goode at the Marietta Centennial Exposition.

The executive order permitting the sending of exhibits to Marietta was not received until noon of July 14, the day before the opening of the Centennial, and at 9.40 p. m. of that day, I, together with Mr. Paul Brockett, took the first express train at Washington, with thirty-one boxes, containing 7,327 pounds of exhibits in charge.

Arriving about noon of the 15th, these exhibits were conveyed to the City Hall, and by 2.30 a. m. the following day, the centennial anniversary of the inauguration at Marietta of General St. Clair as the governor of the "Northwest Territory," the display of the Smithsonian Institution and the National Museum was in order and ready for examination.

It was thought that students of Marietta and the archæologists would be interested in a collection illustrative of the arts of the Haida Indians of Queen Charlotte Archipelago, British America, as these Indians are in the same condition of culture as the builders of the earthworks at Marietta, and so, to give a general idea of the arts of the ancient mound-

builders, a collection composed of the following objects was brought from the National Museum.

Haida boxes.	Ammunition bag.	Medicine-man's clapper.
Carved canes.	Horn spoon.	Whale-oil dish.
Slate totem posts.	Gambling sticks.	Food dish.
Stone knife.	Baskets.	Carved images.
Slate knives.	Carved dishes.	Carved masks.
Slate plate.	Carved wooden spoon.	Model of Haida house.
Carved slate box.	Carved horn spoons.	Model of Haida boat.
Slate dish.	Rattles.	Mask.
Carved war club.	Wooden dipper.	Stone maul.
Horn dishes.	Mask, Bilhula.	Stone maul-head.
Carved dipper.	Fish hook.	Bottle covered with woven grass.
Painted hat.	Wooden spoon.	Unit boxes of Haida carvings, dishes, etc.
Chief's wooden hat.	Wooden fork.	
Stone pipe.	Papoose cradle.	

One of the original Audubon plates, from which was printed "Birds of North America," was exhibited, as were also eighteen lithographs from Goode and Kilbourne's work, "The Game Fishes of the United States." These lithographs, the list of which is appended, were greatly admired:

Grayling, *Thymallus tricolor*.
Perch, *Perca americana*.
Weakfish, *Cynoscion regale*.
Red snapper, *Lutjanus blackfordi*.
Sea bass, *Serranus atrarius*.
Lake trout, *Salvelinus namaycush*.
Salmon, *Salmo salar*.
King-fish, *Menticirrus nebulosus*.
Mackerel, *Scomber scombrus*.
Bonito, *Sarda sarda*.

Brook trout, *Salvelinus fontinalis*.
Blue-fish, *Pomatomus saltator*.
Sheep's-head, *Archosargus probatocephalus*.
Pompauo, *Trachynotus carolinus*.
Rockfish, *Roccus lineatus*.
Spanish mackerel, *Scomberomorus maculatus*.
Channel bass, *Scianops ocellata*.
California salmon, *Onchorynchus chonicha*.

The following medals, made of copper at the mint from the original dies, were on exhibition. These medals are of great historic interest, the originals, of gold and silver, having been struck by order of Congress in commemoration of national events, or in recognition of heroic actions in the history of our country, thus furnishing an enduring record, and a means of familiarizing future generations with the features of American heroes of every class of events, military, naval, civil, and scientific.

MILITARY AND NAVAL MEDALS.

General Washington, siege of Boston.
General Gates, Saratoga.
Maj. Harry Lee, Powles Hook.
General Morgan, Cowpens.
Col. J. E. Howard, Cowpens.
Col. De Fleury, Stony Point.
Capt. Paul Jones, naval victory.
Captain Truxton, naval victory.
Capt. Isaac Hull, naval victory.
Commodore Preble, naval victory.
Col. W. A. Washington, Cowpens.

Col. George Croghan, Fort Stephenson.
General Harrison, the Thames.
Governor Isaac Shelby, the Thames.
General Winfield Scott, Chippewa and Niagara.
Capt. Stephen Decatur, naval victory.
Captain Bainbridge, naval victory.
Capt. Jacob Jones, naval victory.
Captain Lawrence, naval victory.
General P. B. Porter, Chippewa, Niagara, Erie.

General Jacob Brown, Chippewa, Niagara, Erie.
 General James Miller, Chippewa, Niagara, Erie.
 General E. W. Ripley, Chippewa, Niagara, Erie.
 Lieut. E. R. McCall, naval victory.
 Capt. O. H. Perry, Lake Erie (three medals).
 General Jackson, New Orleans.
 Lieutenant Burrows, naval victory.
 General Zachary Taylor (three medals), Monterey, Buena Vista, Rio Grande.
 Capt. J. D. Elliott, Lake Erie.

Capt. Warrington, naval victory.
 Capt. Blakely, naval victory.
 Captain Macdonough, Lake Champlain.
 General Winfield Scott (two medals), Mexico.
 General Ulysses S. Grant, Fort Donelson, Vicksburg, Chattanooga.
 General Alex. Macomb, Plattsburg.
 Capt. R. Henley, Lake Champlain.
 Lieutenant Cassin, Lake Champlain.
 Capt. J. Biddle, naval victory.
 Capt. C. Stewart, naval victory.
 General E. P. Gaines, Lake Erie.

MISCELLANEOUS MEDALS.

Diplomatic medal.
 Loss of brig *Somers*.
 Wreck of steam-ship *San Francisco*.
 Commander D. N. Ingraham, release of *Cozta*.
 Two shipwreck medals.
 Japanese embassy.
 Dr. Fred. Rose, heroic conduct.
 Colonel Armstrong, Kittanning.
 Cornelius Vanderbilt, patriotism.
 John Horn, jr., heroic conduct.
 G. F. Robinson, heroic conduct.
 Commodore M. C. Perry, treaty with Japan.
 Loss of steam-ship *Metis*.
 Emancipation proclamation.
 Prof. Louis Agassiz, scientific medal.
 Coast survey.
 Pacific Railway, the oceans united.
 "Let us have Peace," U. S. Grant.
 Cyrus W. Field, completion of Atlantic cable.

President J. Adams, Indian peace medal.
 President Thomas Jefferson, Indian peace medal.
 President Madison, Indian peace medal.
 President Monroe, Indian peace medal.
 President J. Q. Adams, Indian peace medal.
 President Jackson, Indian peace medal.
 President Van Buren, Indian peace medal.
 President Tyler, Indian peace medal.
 President Polk, Indian peace medal.
 President Taylor, Indian peace medal.
 President Fillmore, Indian peace medal.
 President Pierce, Indian peace medal.
 President Buchanan, Indian peace medal.
 President Lincoln, Indian peace medal.
 President Johnson, Indian peace medal.
 President Grant, Indian peace medal.
 President Hayes, Indian peace medal.
 President Garfield, Indian peace medal.
 President Arthur, Indian peace medal.

A large survey map, which showed the geological formation of North America through the area of the United States, was exhibited, as were also fine photographs of the Smithsonian Institution, National Museum, State, War, and Navy Departments, Patent Office, and Executive Mansion. These photographs were enlargements, $4\frac{1}{2}$ by 7 feet in size, made by the photographer of the National Museum, by means of the electric light, and are among the largest ever made.

Many autotypes of pictures by the old masters, and by the most famous modern painters, were shown on the walls of the exposition room. These pictures, the list of which is given here, were constantly surrounded by appreciative groups.

Group of Saints, Orcagna.
 Procession of Saints, Fra Angelico.
 The Crucifixion, Fra Angelico.
 Pieta, Van der Weyden.

The Virgin and St. Elizabeth, Lippi.
 St. Michael, Perugino.
 St. Bernard and the Virgin, Perugino.
 Infant Jesus, Virgin and Saints, Perugino.

- The London Madonna, Perugino.
 The Coronation of the Virgin, Botticelli.
 Portrait, Francia.
 The Nativity, Memling.
 Christ preaching to the Apostles, Leonardo da Vinci.
 A portrait, Leonardo da Vinci.
 Virgin and Child, Albertinelli.
 The Erythrean Sibyl, Michael Angelo.
 The Delphic Sibyl, Michael Angelo.
 The Prophet Jeremiah, Michael Angelo.
 The Prophet Zacharias, Michael Angelo.
 Four Frescoes from the Sistine Chapel, Michael Angelo.
 The Manchester Madonna, Michael Angelo.
 Entombment of Christ, Titian.
 The Virgin with a Rabbit, Titian.
 St. Sebastian, Sodoma-Bazzi.
 The Sistine Madonna, Raphael.
 Madonna della Sedia, Raphael.
 The Miraculous Draught of Fishes, Raphael.
 Dispute Concerning the Sacrament, Raphael.
 La belle Jardinière, Raphael.
 Holy Family, with Catharine, Elizabeth, and the Infant Jesus, Andrea del Sarto.
 The Madonna of St. Francis, Andrea del Sarto.
 Innocence, Romano.
 Ecce Homo, Correggio.
 Die heilige Nacht, Correggio.
 Picture from the Exposition du Palais Bourbon, Palma.
 Descent from the Cross, Carracci.
 Nude figure seated, Carracci.
 The Annunciation, Guido Reni.
 Deianira and Nessus, Guido Reni.
 The Little Princess, Moreelse.
 Descent from the Cross, Rubens.
 Henri IV installing Marie de Medici as Regent, Rubens.
 The Triumph of Youth, Rubens.
 The Rape of Antiope, Rubens.
 Fish Woman, Hals.
 Saint Cecelia, Domenichino.
 Victorious Love, Domenichino.
 Theseus finding his father's sword, Poussin.
 Madonna, Van Dyck.
 Portrait, Van Dyck.
 The Good Shepherd, Champaigne.
 The Three Ages of Man, Sassoferrato.
 The Abbess, Rembrandt.
 Portrait of Himself, Rembrandt.
 The Temptation of St. Anthony, Teniers.
 Village Festival, Teniers.
 Old Woman at a Window, Gerard Dow.
 Winter Scene in Holland, Van Ostade.
 War, Salvator Rosa.
 Christ appearing before Mary Magdalene, Le Sueur.
 The Field, Potter.
 Group of Sheep, Potter.
 Cows and Sheep, Potter.
 Wandering Musician, Jan Steen.
 Study from Nature, Metzcu.
 A Dead Calm, Van de Velde.
 Marine View, Van de Velde.
 Louis XIV, Rigaud.
 "Gilles" or "Pierrot," Watteau.
 The Chocolate Girl, Liotard.
 Pastoral Subject, Boucher.
 The Village Groom, Greuze.
 A Portrait, Greuze.
 Portrait of M. Rabuti, Greuze.
 Picture from the Musée du Louvre, Grenze.
 The Horatii, David.
 Madame Recamier, David.
 The Marquise d'Orvilliers, David.
 Portrait of the Artist and her Daughter, Vigée Le Brun.
 The Burial of Atala, Girodet.
 Daphnis and Chloe, Gerard.
 Oedipus and the Sphinx, Ingres.
 Joan of Arc, Ingres.
 Arab Hunter, Vernet.
 The Wreck of the Medusa, Gericault.
 Willows at Marseilles, near Beauvais, Corot.
 The Princes in the Tower, Paul Delaroche.
 The Forest at Fontainebleau, Sunset, Rousseau.
 The Shore at Antibes, Meissonier.
 Napoleon, Meissonier.
 A Shepherd, Millet.
 The Reaper's Repast, Bida.
 The Return of the Gleaners, Breton.
 Tobit and the Angel, Doré.

The composition of the human body, its daily income and expenditure, and casts, in plaster, of the articles of food ordinarily used as a day's rations, were shown, as well as specimens of the different chemi-

cal elements and compounds of the body, so far as possible to science to obtain or represent them. This exhibit, which is explained by the accompanying list of objects shown, and by copies of the large descriptive labels, attracted perhaps more attention than any other sent by the Museum, curious and interested crowds being seen at all times examining it.

In addition to the collections from Washington, Mr. J. E. Watkins, Curator of the Department of Transportation in the National Museum, who was in attendance at the Cincinnati Exposition, was telegraphed to bring from his department at that Exposition such models, engravings, and paintings as could be spared, illustrative of the methods of transportation adopted by the early settlers in America, and of the early navigation of the Ohio River, together with the means of reaching the Ohio Valley from the sea-board, from aboriginal times to the introduction of the locomotive.

This exhibit, which was placed in the center of the hall and directly in front of the entrance, proved very attractive, so much so, in fact, that it was found necessary to protect it with a railing from eager but not unfriendly hands, that frequently took the birch-bark canoe on impromptu journeys around the room, and sometimes tried to set the machinery to work in the models of the antiquated steam-boats on exhibition.

The transportation exhibit may be briefly described as follows :

(1) Type of birch-bark canoe used on the Ohio River by the Indians.
(2) Engraving of ship *Sally Constant*, which brought the first settlers in Virginia to Jamestown, among whom were many of the ancestors of the pioneers of the "Northwest Territory."

(3) Boat similar in construction to that built by Captain Devoll in 1787, and known as the *Mayflower of the Ohio*. Captain Devoll having been a constructor of whaling ships in Massachusetts, the lines of the hull are similar to boats of that time constructed in the east.

(4) The *Orleans*, 1812, the first steam-boat on the Ohio River; constructed in 1811 at Pittsburgh. Fulton and Livingstone, having met with success in introducing the steam-boat on the Hudson, four years later transferred their sphere of labor to the western waters. This boat was on her way to New Orleans during the earthquake of 1812, and, reaching there safely, continued to run between that point and Natchez until July 14, 1814, when she was sunk off Baton Rouge. Her machinery, however, was saved, and with a new boiler was transferred to another boat, which was called the *New Orleans*.

The Baltimore and Ohio Railway in 1828 began to lay its tracks from Baltimore toward the Ohio River. The steam locomotive at that time was not in successful operation, and many experiments were made in the construction of cars and in the application of power. Models illustrating these experiments were also shown.

(5) Closed passenger-car with weather-boarded sides, and windows similar to those in dwelling-houses; built to be drawn by horses.

- (6) Double-deck, stage-body car, also to be drawn by horses.
- (7) Horse-power tread-mill car. This car was driven at the rate of 12 miles per hour by a single horse in the tread-mill, which was geared to the wheels by a band.
- (8) Sail-car, with which experiments were made with a view to utilize the power of the wind, as in boats.
- (9) First car drawn by a locomotive on the Baltimore and Ohio Railway.
- (10) Engraving of first train of cars drawn by a locomotive in the State of New York, on the line of communication between Boston and New York.
- (11) Engraving of the first passenger-car on the Camden and Amboy Railway; used on the route from New York to Philadelphia.
- (12) Model of canal packet-boat; used on the Pennsylvania Canal on the through route from Philadelphia to Pittsburgh.
- (13) Model of canoe used by the Haida Indians.
- (14) Indian of the Northwest returning from the hunt with a bunch of ptarmigan. The full-sized figure illustrates the manner in which snow-shoes are used to aid individual movement.

In the Exposition Hall, besides the exhibits sent by the Smithsonian Institution and the National Museum, was the interesting display of the State Department. This embraced copies of the most important treaties made by the United States, a fac-simile of the Declaration of Independence, photographs of several historical pictures of much interest, and pictures of most of the Presidents of the United States.

The U. S. Geological Survey had an attractive exhibit of photographs and transparencies, one of the finest of the latter being a view of the Grand Cañon of Colorado, looking west. The photographs of dwellings in the Zuñi villages, showing the mode of entrance to the houses, and giving an accurate idea of many features in the life of a people just now the object of so much interesting research, attracted the attention of ethnologists and others.

In the armory building of Marietta the local display proper was to be seen. Here one could find relics of the mound-builders and of the Indian tribes who disappeared at the coming of the white man. Then there were precious heirlooms of the first families of the Northwest territory, in the shape of antique furniture, clocks, books, deeds, pictures, needle-work, old china, silver, pewter, spinning-wheels, and watches.

There were Washington relics, there were La Fayette relics, there were many articles that had belonged to General Israel Putnam, and to his grandson, the Israel Putnam who was one of the pioneers of Ohio, and there were relics of many other of Ohio's most distinguished children, civil and military; there were also many articles that had been the property of Burr and of Blennerhassett. The historian and the relic hunter alike were attracted by this remarkable collection.

APPENDIX C.

BIOGRAPHICAL NOTICE OF JAMES STEVENSON.

James Stevenson was born in Maysville, Ky., December 24, 1840. His father, who settled in Kentucky early in the century, was a Virginian, and, it is believed, probably of that hardy Scotch-Irish family of Indian fighters and riflemen to which belonged Col. Hugh Stevenson, of the Berkeley Riflemen, and his brothers, Col. Richard and Col. Valentine Stevenson, all soldiers of the Revolution. He was a vigorous, active boy, and at an early period showed an enthusiasm to explore the Rocky Mountain region and to see the Indian in his home. He read all the books of travel and adventure he could borrow, and at the age of thirteen he ran away from home and joined a party of the Hudson Bay Fur Company's traders, bound up the Missouri River. Dr. F. V. Hayden was a passenger on the same packet, on his way to explore the fossiliferous regions of the Upper Missouri and Yellowstone. He noticed that Stevenson had taste for natural history, and invited him to join him in his work.

The boy showed tireless energy in collecting objects of natural history and ethnology along the buttes, mesas, and river benches of the *Mauvais Terres*, and in time became an explorer of intrepid courage and indefatigable zeal.

He remained in the region of the Upper Missouri and the Yellowstone mouth for three years, and became acquainted with the Crows, Blackfeet, Gros Ventres, and other Indians, up to that time little changed by intercourse with white men, and acquired a knowledge of their customs and characteristics.

In 1857 the Pacific Railroad surveys of the Government having been fairly begun, Stevenson, still an assistant of Professor Hayden, was attached to Lieut. G. K. Warren's party, and subsequently to that of Lieut. F. W. Reynolds. At this time he made a useful collection of fossil mammals and reptiles, and another illustrating the zoology and botany of the "Bad Lands." The labor and exposure incident to exploration at that time can not be properly appreciated in these days of rapid and luxurious travel.

In 1861 James Stevenson enlisted as a private soldier in the Thirtieth Regiment, New York Volunteers, and remained in the service until 1865. He took part in all the heavy battles of the Army of the

Potomac and won an officer's commission. After the war **he again** joined Professor Hayden in his exploration of the Upper **Missouri**, under the auspices of the Philadelphia Academy of Natural **Sciences**.

Soon after the return of peace, the Pacific Railroad project **was taken** up by Congress. Among the Western members of the House **who be-** came its advocates was General John A. Logan, who took the **lead** in combating the statement that the Territories had no coal. **He main-** tained that coal existed in abundance, and that it could be **located** by a proper geological survey of the region. Stevenson was his **principal** authority for his statements, and urged upon him the necessity **for such** surveying works. After consultation with Professor Baird, **General** Logan, in the winter of 1867, proposed an amendment to the **sundry** civil bill authorizing the organization of a geological survey **under the** direction of Professor Hayden, and by a vigorous effort secured its passage.

The legislation of 1867 was the beginning of the geological and geographical survey of the Territories. Stevenson was made the **executive** officer of the new organization, and retained this position during its entire existence.

His tastes were rather toward ethnology than geology, and his winters among the Blackfoot and Sioux Indians were occupied in **part** in studying their customs and their dialects.

From 1868 to 1878 he took part in all the adventures of the **Hayden** survey; with it he explored almost all of the Territories, and had a share in bringing to light the hidden marvels of Yellowstone Park, and in urging its retention as a public reservation. He followed the great rivers of the continent to their sources, and discovered a new **path** across the Rocky Mountains. He ascended the Great Teton, and verified an Indian tradition of the presence of a stone altar upon its top.

His frontier experience fitted him for understanding thoroughly the requirements of explorers in the field. He was a good judge of character and showed much tact in planning and expediting the operations of the mixed trains engaged in the survey work. He led working parties of experts trained in topography, geology, and natural history over the unexplored regions of Nebraska, Colorado, New Mexico, Montana, Wyoming, Idaho, Utah, and Dakota.*

When the various geological and geographical surveys were consolidated in 1879, Mr. Stevenson became associated with the operations of the Bureau of Ethnology, under Major Powell, and continued his investigations of the Indians. When Clarence King resigned the directorship of the new geological survey and Major Powell was selected to succeed him, Mr. Stevenson was appointed the executive officer of the latter organization. In this new trust he had charge of outfitting and

* His work was chiefly in the following regions: 1851-'53, Upper Missouri. 1859-'60, Wyoming and Montana (then Nebraska), with Reynolds. 1866, Bad Lands in Dakota, with Hayden. 1867, Nebraska, with Hayden. 1868, Wyoming, with Hay-

supplying its parties in the field and of its business operations in the East. His relations with the members of both Houses of Congress, during the many years he appeared before that body in the interests of the U. S. Geological Survey and other scientific organizations, were always pleasant, and the members of Congress, of both parties, had faith in his integrity. Senator Edmunds once declared on the floor of the Senate, when some Senator proposed a reduction in the salaries of the director and executive officer of the Geological Survey, that Mr. Stevenson was "one of the best workers in the world."

In 1879 he began the exploration of the prehistoric cliff and cave dwellings of Arizona and New Mexico, unearthing an extended series of buried ruins and making a large invaluable collection of ancient pottery, costumes, weapons, and ceremonial and industrial utensils, now in the National Museum. He made a study of the religious practices of the Zuñi tribe of Indians and the history and folk lore of the Navajos and the Moquis. In this latter work he had a faithful assistant in Mrs. Stevenson, who made an especial study of the domestic and religious side of the Indian character. It was a source of regret to Mr. Stevenson that his duties with the Survey prevented him from completely publishing the investigation he had planned, and it remains for his widow to complete for publication the results of the work which they began together.

In 1886, while exploring some of the highest mesas of Arizona and New Mexico, he was attacked by that singular disease of those regions known as "mountain fever," from which he partially recovered after his return to the East. In spite of the remonstrances of his friends he spent the season of 1887 among the ruins in the Tewan Mountains of New Mexico and at the pueblo of Sia, where he found a rich field for study. He discovered that the Sia, like the Moki, hold ceremonials with the rattlesnake (a secret most jealously guarded by these Indians), and he succeeded in obtaining one of the ancient vases in which the snakes are each year gathered. His collection of idols and fetishes from Sia is the rarest yet obtained from any pueblo.

When he came East in November he was suffering from valvular heart trouble, and, after a brave fight for life, died in New York City July 25, 1888.

The full story of his useful life would fill a book. His resources when leading a party through a wild district were limitless, and he was always ready to meet, by quick action and apt understanding, any accident or miscarriage in the field. One of his associates tells the following incident, which illustrates the readiness of his faculties:

den. 1869, Colorado and New Mexico, with Hayden. 1870, Wyoming and Utah, with Hayden. 1871, parts of Utah, Idaho, Montana, and Yellowstone Park. 1872, parts of Idaho, Wyoming, and Yellowstone Park. 1873-76, Colorado, under Hayden. 1877, Wyoming and Utah, with Hayden. 1878, Yellowstone National Park, with Hayden. 1879-'87, among the Navajos and Pueblos of New Mexico and Arizona and Mission Indians of Southern California, under Major Powell.

In July, 1871, the Hayden survey reached the shores of the Yellowstone Lake, and as it came into camp for the first time on its banks, the beautiful sheet of water courted navigation. No provision whatever had been made for building a boat—the thought had not entered the minds of Dr. Hayden or Mr. Stevenson when they outfitted for the exploration, and nothing therefore was taken into the luggage of the party and its pack-train for such a contingency. As the members of the party gazed with delighted eyes upon the broad expanse of this big mountain lake, a general desire to sail out to the islands upon its waters was loudly expressed, coupled with regret that no fit means for so doing was available, rafting being wholly inadequate. Stevenson said nothing, but quietly took the cook's axe, called two of the packers and went with them into a thicket of young birch and spruce trees, where he speedily trimmed out the ribs and gunwales of a double-ended and skiff-shaped boat. He lashed these into place and then took one of the cargo covers—a large square sheet of heavy canvas—with which he neatly covered this rude frame. A small mast was stepped, and a pair of oars adjusted as they were hewn out, together with a large steering sweep. He began this work about 2 o'clock in the afternoon; just before nightfall or dark (about 9 o'clock then and at that place) the little boat, some 13 feet in length, was launched, and Mr. Stevenson pushed out from the shore for a brief trial trip. The boat was a perfect success, and by its aid a complete hydrographic survey was made before the party left that region.

In ways like this he overcame the many unforeseen obstacles which arise in the path of a scientific exploring party. Climbing mountains, winding through forests and cañons, crossing ugly, treacherous streams and arid plains, in heat or in cold, in rain or in sunshine, or meeting hostile savages, Mr. Stevenson was always in the front, always ready, and always genial, and always the quiet and resolute master of the situation.

Three descriptive and illustrated catalogues of archæological and pueblo collections were prepared by Mr. Stevenson and were published by the Bureau of Ethnology. He also prepared for publication papers relating to the myths, ceremonials, and sand paintings of the Navajo Indians, and to the archæological remains of the southwest.

The death of James Stevenson was a positive loss to the institutions to which he devoted his life, viz, the U. S. Geological Survey, National Museum, and Bureau of Ethnology, and to scientific explorations. No offers however flattering could allure him from his life's work. He labored from a love for truth, and was ever ready to lend his aid to any movement for the advancement of science. His modesty and unselfishness won for him the esteem of all who knew him.

APPENDIX D.

**LISTS OF INSTITUTIONS AND FOREIGN AND DOMESTIC
LIBRARIES TO WHICH IT IS DESIRED TO SEND
FUTURE PUBLICATIONS OF THE
NATIONAL MUSEUM.**

I.—LIST OF INSTITUTIONS UNDER STATE CONTROL, AND OF COLLEGES OF LIBERAL ARTS, TO WHICH IT IS DESIRED TO SEND FUTURE PUBLICATIONS OF THE NATIONAL MUSEUM.

[The Reports of the Commissioner of Education are, as a rule, the authority for the official name of an institution, and for the number of volumes in a library. Libraries the names of which are printed in *italics* contain more than 10,000 volumes. The figure [i] after a name indicates that it already receives regularly the *Smithsonian Report*; [ii] that it receives the *Report* and the *Smithsonian Miscellaneous Collections*; [iii] that it receives the two preceding and the *Smithsonian Contributions to Knowledge*. The letter D after a name indicates that it is one of the 400 libraries known as depositories of public documents, and thus receives regularly all public documents published by the Government. The letter X after a name indicates that it is one of the 800 libraries officially designated to receive certain classes of documents, including the publications of the U. S. Geological Survey.]

Note: This list is not intended to indicate the distribution of Smithsonian publications, but shows incidentally what publications of the Institution are sent to the libraries mentioned.

ALABAMA.

STATE LIBRARIES.

Alabama State and Supreme Court Library. Montgomery. D

STATE HISTORICAL AND SCIENTIFIC SOCIETIES.

Alabama Historical Society (1851). Tuscaloosa. [i]

STATE UNIVERSITIES AND TECHNICAL SCHOOLS.

Alabama Agricultural and Mechanical College (1872). Auburn. [ii] D
Agricultural Experiment Station (Agricultural and Mechanical College), Auburn.

Canebrake Agricultural Experiment Station (Agricultural and Mechanical College), Uniontown.

University of Alabama (1819-'21). (University P. O.) Tuscaloosa. [iii] D

Law Department, University of Alabama. Tuscaloosa.

COLLEGES AND UNIVERSITIES.

Howard College. (East Lake P. O.) Birmingham. [iii] D

Selma University. Selma.

Southern University. Greensborough. [iii] D

Spring Hill College. (Spring Hill P. O.) Mobile. [ii] D

STATE NORMAL SCHOOLS.

Alabama Normal College for Girls. (White.) Livingston. [i]

Florence State Normal School. (White.) Florence. X

Huntsville State Normal and Industrial School. (Colored.) Huntsville. [i]

Jacksonville State Normal School. (White.) Jacksonville. D

Montgomery State Normal University. Montgomery.

Troy Normal School Troy. X

Tuskegee State Normal School. (Colored.) Tuskegee. [i]

ARIZONA.

STATE LIBRARIES.

Territorial Library. Phoenix. [i] D

STATE UNIVERSITIES AND TECHNICAL SCHOOLS.

University of Arizona (1889). Tucson.

College of Agriculture (University of Arizona). Tucson.

STATE NORMAL SCHOOLS.

Territorial Normal School. Tempe.

ARKANSAS.

STATE LIBRARIES.

Arkansas State Library. Little Rock. [iii] D

STATE HISTORICAL AND SCIENTIFIC SOCIETIES.

Arkansas Historical Society. Little Rock.

STATE UNIVERSITIES AND TECHNICAL SCHOOLS.

Arkansas Industrial University. (1868-'72.) Fayetteville. [ii] D

Arkansas Agricultural Experiment Station (Arkansas Industrial University). Fayetteville.

Substation Arkansas Agricultural Experiment Station (Arkansas Industrial University). Newport.

Substation Arkansas Agricultural Experiment Station (Arkansas Industrial University). Texarkana.

Substation Arkansas Agricultural Experiment Station (Arkansas Industrial University). Pine Bluff.

COLLEGES AND UNIVERSITIES.

Arkansas College. Batesville. X

Cane Hill College. Boonsborough. [i] X

Little Rock University. Little Rock. [i]

Philander Smith College. Little Rock.

STATE NORMAL SCHOOLS.

Branch Normal College of Arkansas, Industrial University. Pine Bluff. D

CALIFORNIA.

STATE LIBRARIES.

California State Library. Sacramento. [iii] D

STATE HISTORICAL AND SCIENTIFIC SOCIETIES.

California Historical Society. San Francisco.

California Academy of Science. (1854.) San Francisco. [iii]

STATE UNIVERSITIES AND TECHNICAL SCHOOLS.

University of California. (1868-'69.) (Berkeley P. O.). San Francisco. [iii] D

Lick Observatory (Astronomical Department, University of California). Mount Hamilton. [iii]

College of Agriculture of the University of California (1866-'68.) (Berkeley P. O.). San Francisco.

Agricultural Experiment Station of College of Agriculture (Berkeley P. O.). San Francisco.

COLLEGES AND UNIVERSITIES.

Hesperian College. Woodland.

Napa College. Napa City. [i]

Pacific Methodist College. Santa Rosa.

Pierce Christian College. College City. [i]

Saint Augustine, College of. Benicia.

Saint Ignatius College. San Francisco. [ii]

Saint Vincent's College. Los Angeles.

San Joaquin Valley College. Woodbridge.

Santa Clara College. Santa Clara. [iii]

University of the Pacific. San José. [ii]

University of Southern California. Los Angeles.

STATE NORMAL SCHOOLS.

Chico State Normal School.	Chico.	
Los Angeles State Normal School.	Los Angeles.	
Normal Department of Girls' High School.	San Francisco.	
State Normal School of California.	San José.	[i]

COLORADO.

STATE LIBRARIES.

Colorado State Library.	Denver.	[iii]	D
Colorado Supreme Court Law Library.	Denver.		

STATE HISTORICAL AND SCIENTIFIC SOCIETIES.

Colorado State Historical Society.	Denver.	
Colorado Scientific Society.	Denver.	[i]

STATE UNIVERSITIES AND TECHNICAL SCHOOLS.

University of Colorado (1875-'77),	Boulder.	[i]	D
State Agricultural College of Colorado (1879).	Fort Collins.	[i]	X
Agricultural Experiment Station (State Agricultural College).	Fort Collins.		
State School of Mines (1874).	Golden.	[i]	X

COLLEGES AND UNIVERSITIES.

Colorado College.	Colorado Springs.	[i]	D
University of Denver.	Denver.	[ii]	X

CONNECTICUT.

STATE LIBRARIES.

<i>State Library of Connecticut.</i>	Hartford.	[iii]	D
--------------------------------------	-----------	-------	---

STATE HISTORICAL AND SCIENTIFIC SOCIETIES.

<i>Connecticut Historical Society</i> (1825).	Hartford.	[iii]
Connecticut Academy of Arts and Sciences. (1799.) (Yale University.)		
New Haven. (No library.)		

STATE UNIVERSITIES AND TECHNICAL SCHOOLS.

<i>Yale University</i> (1700).	New Haven.	[iii]	D
Divinity School of Yale University.	New Haven.		
Law School of Yale University.	New Haven.		
Medical Department of Yale University.	New Haven.		
Sheffield Scientific School of Yale University (1847 and 1864).	New Haven.	[ii]	X
Connecticut Agricultural Experiment Station.	New Haven.	[i]	
Storrs Agricultural School (1881).	Mansfield.	[i]	
Storrs School, Agricultural Experiment Station.	Storrs.	[i]	

COLLEGES AND UNIVERSITIES.

<i>Trinity College.</i>	Hartford.	[iii]	
<i>Wesleyan University.</i>	Middletown.	[iii]	X

STATE NORMAL SCHOOLS.

Cedar Street Training School.	New Haven.	
Connecticut State Normal School.	New Britain.	[iii]
Welch Training School.	New Haven.	

DELAWARE.

Delaware State Library. Dover. [iii] D

STATE HISTORICAL AND SCIENTIFIC SOCIETIES.

Historical Society of Delaware (1884). Wilmington. [i]

STATE UNIVERSITIES AND TECHNICAL SCHOOLS.

Delaware College (1834). Newark. [iii] X
Agricultural Experiment Station (Delaware College). Newark. [i]

DISTRICT OF COLUMBIA.

NATIONAL LIBRARY.

Congressional Library (1800). Washington.

NATIONAL HISTORICAL AND SCIENTIFIC SOCIETIES.

Smithsonian Institution. Washington.
American Historical Society. Washington.
National Academy of Sciences. Washington.

COLLEGES AND UNIVERSITIES.

Catholic University of America. Washington.
Columbian University. Washington.
Georgetown University (Georgetown P. O.). Washington.
Howard University. Washington.

NORMAL SCHOOLS.

Miner Normal School. Washington.
Washington Normal School. Washington.

FLORIDA.

STATE LIBRARIES.

Florida State Library. Tallahassee. D

STATE HISTORICAL AND SCIENTIFIC SOCIETIES.

Historical Society of Florida. Saint Augustine.

STATE UNIVERSITIES AND TECHNICAL SCHOOLS.

Florida State Agricultural and Mechanical College (1884). Lake City.
Agricultural Experiment Station (State Agricultural and Mechanical College). Lake City.

COLLEGES AND UNIVERSITIES.

Rollins' College. Winter Park.

NORMAL SCHOOL.

Florida State Normal College. De Funiak Springs.
Florida State Normal School. Tallahassee.

GEORGIA.

STATE LIBRARIES.

Georgia State Library. Atlanta. [iii] D

STATE HISTORICAL AND SCIENTIFIC SOCIETIES.

Georgia Historical Society (1839). Savannah. [iii] D

STATE UNIVERSITIES AND TECHNICAL SCHOOLS.

<i>University of Georgia</i> ([1784], 1801).	Athens.	[iii]	D
Medical Department (University of Georgia).	Augusta.		
Atlanta University (colored) (1869).	Atlanta.		
Georgia State College of Agricultural and Mechanic Arts (the University of Georgia) (1872).	Athens.		
Georgia Agricultural Experiment Station. (State College of Agriculture and Mechanic Arts).	Athens.		
Middle Georgia Military and Agricultural College (1880.)	Milledgeville.		X
North Georgia Agricultural College (1873.)	Dahlonega.	[i]	D
South Georgia Agricultural College.	Thomasville.		X
Southwest Georgia Agricultural College (1879).	Cuthbert.		
West Georgia Agricultural and Mechanical College (1892).	Hamilton.		

COLLEGES AND UNIVERSITIES.

Bowdon College.	Bowdon.	[i]	
Clark University.	Atlanta.		
Emory College.	Oxford.	[iii]	X
<i>Mercer University.</i>	Macon.	[iii]	X
Pio Nono College.	Macon.		

IDAHO.

STATE LIBRARIES.

Idaho State Library.	Boisé City.		D
----------------------	-------------	--	---

ILLINOIS.

STATE LIBRARIES.

<i>Illinois State Library.</i>	Springfield.	[iii]	D
--------------------------------	--------------	-------	---

STATE HISTORICAL AND SCIENTIFIC SOCIETIES.

Illinois State Historical Society and Natural History Museum.	Springfield.	[i]	
---	--------------	-----	--

STATE UNIVERSITIES AND TECHNICAL SCHOOLS.

<i>University of Illinois</i> (1868).	Urbana.	[iii]	D
State Laboratory of Natrual History (University of Illinois) Normal.			
College of Agriculture of the University of Illinois (1867).	Champaign.		
Agricultural Experiment Station of the University of Illinois.	Champaign.		

COLLEGES AND UNIVERSITIES.

Augustana College.	Rock Island.	[i]	X
Carthage College.	Carthage.	[i]	
Chaddock College.	Quincy.		
Eureka College.	Eureka.	[ii]	
Ewing College. (Ewing College P. O.)	Ewing.	[i]	X
Hedding College.	Abingdon.	[i]	
German-English College.	Galena.		
Illinois College.	Jacksonville.	[iii]	X
Illinois Wesleyan University.	Bloomington.	[iii]	D
Knox College.	Galesburgh.	[iii]	
Lake Forest University.	Lake Forest.	[i]	X
Lincoln University.	Lincoln.	[i]	

Lombard University.	Galesburgh.	[ii]	
McKendree College.	Lebanon.	[iii]	
Monmouth College.	Monmouth.	[i]	D
Northwestern College.	Naperville.		
<i>Northwestern University.</i>	Evanston.	[iii]	D
Shurtleff College.	Upper Alton.	[i]	
Saint Francis Solanus College.	Quincy.		
<i>Saint Ignatius College.</i>	Chicago.	[i]	
Saint Joseph's Diocesan College.	Teutopolis.		
Saint Viateur's College.	Bourbonnais Grove.	[i]	
Westfield College.	Westfield.	[ii]	X
Wheaton College.	Wheaton.	[iii]	

STATE NORMAL SCHOOLS.

Cook County Normal School. (Englewood P. O.)	Chicago.	[i]	D
Illinois State Normal University.	Normal.	[i]	D
Southern Illinois Normal University.	Carbondale.	[ii]	D

INDIANA.

STATE LIBRARIES.

<i>Indiana State Library.</i>	Indianapolis.	[iii]	D
<i>Indiana State Law Library.</i>	Indianapolis.		

STATE HISTORICAL AND SCIENTIFIC SOCIETIES.

Indiana Historical Society (1832).	Indianapolis.		
State Academy of Science (1885). (Unlocalized.)			

STATE UNIVERSITIES AND TECHNICAL SCHOOLS.

Indiana University (1820-'26).	Bloomington.	[iii]	D
Department of Geology and Natural History (Indiana State University). Indianapolis.		[i]	
Purdue University (1874).	La Fayette.	[iii]	
School of Agriculture, Horticulture, and Veterinary Science (Purdue University). La Fayette.			
Agricultural Experiment Station of Indiana (Purdue University). La Fayette.			

COLLEGES AND UNIVERSITIES.

Butler University. (Irvington P. O.)	Indianapolis.	[iii]	D
Concordia College.	Fort Wayne.	[ii]	X
<i>De Pauw University.</i>	Greencastle.	[iii]	D
Theological School (De Pauw University). Greencastle.			
Earlham College.	Richmond.	[i]	X
Franklin College.	Franklin.	[i]	D
Hanover College.	Hanover.	[iii]	
Hartsville.	Hartsville.	[i]	
Moore's Hill College.	Moore's Hill.	[ii]	X
Ridgeville College.	Ridgeville.	[i]	
Rose Polytechnic Institute.	Terre Haute.	[iii]	
Saint Meinrad's College and Abbey.	Saint Meinrad.	[ii]	X
Union Christian College.	Merom.	[ii]	
<i>University of Notre Dame du Lac.</i>	Notre Dame.	[iii]	D
<i>Wabash College.</i>	Crawfordsville.	[iii]	D

STATE NORMAL SCHOOLS.

Indiana Normal College.	Covington.		
Indianapolis Normal School.	Indianapolis.		
Indiana State Normal School.	Terre Haute.	[ii]	X

INDIAN TERRITORY.

STATE LIBRARIES.

Cherokee National Council Library. Tahlequah.

STATE UNIVERSITIES AND TECHNICAL SCHOOLS.

Cherokee National Female Seminary. Tahlequah. [i]
Cherokee National Male Seminary. Tahlequah. [i]

IOWA.

STATE LIBRARIES.

Iowa State Library. Des Moines. [iii] D

STATE HISTORICAL AND SCIENTIFIC SOCIETIES.

State Historical Society of Iowa. Iowa City. [iii]
Iowa Academy of Sciences (1875). Iowa City.

STATE UNIVERSITIES AND TECHNICAL SCHOOLS.

State University of Iowa (1847-'60). Iowa City. [iii] D
Law Department (State University of Iowa). Iowa City.
Iowa State College of Agriculture and Mechanic Arts (1858). Ames. [ii]
Iowa Agricultural Experiment Station. Ames.

COLLEGES AND UNIVERSITIES.

Amity College.	College Springs.	[i]	X
Central University of Iowa.	Pella.		
Cornell College.	Mount Vernon.	[iii]	X
Drake University.	Des Moines.	[i]	X
German College.	Mount Pleasant.		
Griswold College.	Davenport.	[iii]	
Iowa College.	Grinnell.	[iii]	D
Iowa Wesleyan University.	Mount Pleasant.	[iii]	D
Lenox College.	Hopkinton.		
Norwegian Luther College.	Decorah.	[i]	X
Oskaloosa College.	Oskaloosa.	[iii]	
Parsons College.	Fairfield.	[i]	X
Penn College.	Oskaloosa.	[i]	X
Simpson College.	Indianola.	[ii]	X
Saint Joseph's College.	Dubuque.		
Tabor College.	Tabor.	[i]	
University of Des Moines.	Des Moines.		
Upper Iowa University.	Fayette.	[iii]	D
Western College.	Toledo.		

STATE NORMAL SCHOOLS.

Iowa State Normal School. Cedar Falls. [i]
West Des Moines Training School. Des Moines.

KANSAS.

STATE LIBRARIES.

Kansas State Library. Topeka. [iii] D

STATE HISTORICAL AND SCIENTIFIC SOCIETIES.

Kansas State Historical Society. Topeka. [ii] D
Kansas Academy of Sciences (1868). Topeka. [ii]

STATE UNIVERSITIES AND TECHNICAL SCHOOLS.

<i>University of Kansas</i> (1861-'66).	Lawrence.	[iii]	D
Kansas State Agricultural College (1863).	Manhattan.	[iii]	D
Kansas Agricultural Experiment Station.	Manhattan.		

COLLEGES AND UNIVERSITIES.

Baker University.	Baldwin City.	[i]	
College of Emporia.	Emporia.		
Highland University.	Highland.		
Kansas Wesleyan University.	Salina.	[i]	X
Lane University.	Lecompton.		
Ottawa University.	Ottawa.	[i]	
Saint Benedict's College.	Atchison.	[i]	
Saint Mary's College.	Saint Mary's.		X
Washburn College.	Topeka.	[ii]	

STATE NORMAL SCHOOLS.

Kansas State Normal School.	Emporia.	[i]	X
-----------------------------	----------	-----	---

KENTUCKY.

STATE LIBRARIES.

<i>Kentucky State Library.</i>	Frankfort.	[i]	D
--------------------------------	------------	-----	---

STATE HISTORICAL AND SCIENTIFIC SOCIETIES.

Kentucky Historical Society.	Frankfort.		
------------------------------	------------	--	--

STATE UNIVERSITIES AND TECHNICAL SCHOOLS.

<i>Kentucky University.</i>	Lexington.	[iii]	D
Agricultural and Mechanical College of Kentucky (1865).	Lexington.	[i]	
Kentucky Agricultural Experiment Station (Agricultural and Mechanical College).	Lexington.		

COLLEGES AND UNIVERSITIES.

Berea College.	Berea.		X
Bethel College.	Russellville.	[iii]	X
Central University.	Richmond.	[ii]	X
Centre College.	Danville.	[iii]	D
Eminence College.	Eminence.	[i]	
Georgetown College.	Georgetown.	[iii]	D
Kentucky Classical and Business College.	North Middletown.		
Kentucky Wesleyan College.	Millersburgh.		
Murray Male and Female Institute and Western Kentucky Normal School.	Murray.		
Ogden College.	Bowling Green.	[i]	D
Saint Mary's College.	Saint Mary's.		X
South Kentucky College.	Hopkinsville.		

LOUISIANA.

STATE LIBRARIES.

<i>State Library of Louisiana.</i>	New Orleans.	[iii]	D
------------------------------------	--------------	-------	---

STATE HISTORICAL AND SCIENTIFIC SOCIETIES.

Louisiana State Historical Society.	Baton Rouge.	[i]	
-------------------------------------	--------------	-----	--

STATE UNIVERSITIES AND TECHNICAL SCHOOLS.

<i>Tulane University</i> (1847).	New Orleans.	[iii]	D
Fisk Library of Tulane University.	New Orleans.		
New Orleans Academy of Science (Tulane University).	New Orleans.		
Southern University (colored) (1880).	New Orleans.		
<i>Louisiana State University and Agricultural and Mechanical College</i> (1873).	Baton Rouge.	[iii]	D
North Louisiana Experiment Station (Agricultural and Mechanical College).	Calhoun.		
State Experiment Station (Agricultural and Mechanical College).	Baton Rouge.		
Sugar Experiment Station (Agricultural and Mechanical College).	Kenner.		

COLLEGES AND UNIVERSITIES.

Jefferson College. (Saint Mary's.)	Convent.	[i]	X
Saint Charles College.	Grand Coteau.	[iii]	X
Centenary College of Louisiana.	Jackson.	[i]	X
Keachi College.	Keachi.		X
College of the Immaculate Conception.	New Orleans.		
New Orleans University.	New Orleans.		D
Straight University.	New Orleans.		
Thatcher Institute.	Shreveport.		

STATE NORMAL SCHOOLS.

New Orleans Normal School.	New Orleans.		
Louisiana State Normal School.	Natchitoches.		D

MAINE.

STATE LIBRARIES.

<i>Maine State Library.</i>	Augusta.	[iii]	D
-----------------------------	----------	-------	---

STATE HISTORICAL AND SCIENTIFIC SOCIETIES.

<i>Maine Historical Society</i> (1822).	Portland.	[iii]	D
---	-----------	-------	---

STATE UNIVERSITIES AND TECHNICAL SCHOOLS.

Maine State College of Agriculture and the Mechanic Arts (1865).	Orono.	[iii]	X
Maine State College Agricultural Experiment Station.	Orono.		

COLLEGES AND UNIVERSITIES.

<i>Burdoin College.</i>	Brunswick.	[iii]	D
Bates College.	Lewiston.	[i]	D
<i>Colby University.</i>	Waterville.	[iii]	D

STATE NORMAL SCHOOLS.

Eastern State Normal School.	Castine.		
Madawaaka Training School.	Grand Isle and Fort Kent.		
Normal Training and Practice Class.	Portland.		
State Normal and Training School.	Farmington.		
State Normal School.	Gorham.		

MARYLAND.

STATE LIBRARIES.

<i>Maryland State Library.</i>	Annapolis.	[iii]	D
--------------------------------	------------	-------	---

STATE HISTORICAL AND SCIENTIFIC SOCIETIES.

<i>Maryland Historical Society.</i>	Baltimore.	[iii]	D
Maryland Academy of Sciences (1822).	Baltimore.	[ii]	

STATE UNIVERSITIES AND TECHNICAL SCHOOLS.

Maryland Agricultural College ([1856], 1859).	Agricultural College P. O.	[iii]	
Maryland Agricultural Experiment Station (Agricultural College).	Agricultural College P. O.		

COLLEGES AND UNIVERSITIES.

Baltimore City College.	Baltimore.		
<i>Johns Hopkins University.</i>	Baltimore.	[iii]	D
Mount Saint Mary's College.	Emmitsburg.	[iii]	
New Windsor College and Windsor Female College.	New Windsor.		
Rock Hill College.	Ellicott City.	[i]	X
Saint Charles College.	Ellicott City.		
Saint John's College.	Annapolis.	[iii]	D
Washington College.	Chestertown.	[iii]	X
Western Maryland College.	Westminster.	[ii]	D

STATE NORMAL SCHOOLS.

Maryland State Normal School.	Baltimore.	[ii]	
-------------------------------	------------	------	--

MASSACHUSETTS.

STATE LIBRARIES.

<i>Massachusetts State Library.</i>	Boston.	[iii]	D
-------------------------------------	---------	-------	---

STATE HISTORICAL AND SCIENTIFIC SOCIETIES.

<i>Massachusetts Historical Society.</i>	Boston.	[iii]	D
<i>American Academy of Arts and Sciences (1780).</i>	Boston.	[iii]	

STATE UNIVERSITIES AND TECHNICAL SCHOOLS.

<i>Harvard University (1636).</i>	Cambridge.	[iii]	D
Astronomical Observatory, Phillips Library.	Cambridge.		
Botanic Garden and Herbarium (Harvard University).	Cambridge.	[i]	
Bussey Institution, Agricultural and Horticultural.	Jamaica Plains.	[ii]	
<i>Harvard Divinity School.</i>	Cambridge.		
Harvard Medical School (Harvard University).	Boston.		
Episcopal Theological School of Harvard University.	Cambridge.	[i]	
Lawrence Scientific School of Harvard University.	Cambridge.	[i]	
<i>Law School,</i> Harvard (Harvard University).	Cambridge.		
<i>Museum of Comparative Zoology,</i> Harvard (Harvard University).	Cambridge.	[iii]	
Natural History Society, Harvard (Harvard University).	Cambridge.		
Peabody Museum of American Archaeology and Ethnology.	Cambridge.	[iii]	
Massachusetts Institute of Technology (1863-'65).	Boston.	[iii]	
Massachusetts Agricultural College (1856).	Amherst.	[ii]	
Massachusetts State Agricultural Experiment Station.	Amherst.		
Hatch Experiment Station.	Amherst.		

COLLEGES AND UNIVERSITIES.

<i>Amherst College.</i>	Amherst.	[iii]	D
Lawrence Observatory.	Amherst [i].		
<i>Boston College.</i>	Boston.	[ii]	X
<i>Boston University.</i>	Boston.	[ii]	
Clark University.	Worcester.	[iii]	
Smith College.	Northampton.	[ii]	X
<i>Tufts' College.</i>	College Hill.	[iii]	X
<i>Wellesley College.</i>	Wellesley.	[iii]	

<i>Williams College.</i>	Williamstown.	[iii]	D
Observatory (Williams College).	Williamstown.		
Lyceum of Natural History (Williams College).	Williamstown.		
Museum of Williams College.	Williamstown.		
<i>College of the Holy Cross.</i>	Worcester.	[iii]	

STATE NORMAL SCHOOLS.

Boston Normal School.	Boston.		
Fall River Training School.	Fall River.		
Haverhill Training School.	Haverhill.		
Lawrence Training School.	Lawrence.		
Massachusetts Normal Art School.	Boston.		
Massachusetts State Normal School.	Worcester.	[i]	
State Normal School.	Bridgewater.	[ii]	
State Normal School.	Framingham.		
State Normal School.	Salem.		
Westfield State Normal School.	Westfield.		

MICHIGAN.

STATE LIBRARIES.

<i>Michigan State Library.</i>	Lansing.	[iii]	D
--------------------------------	----------	-------	---

STATE HISTORICAL AND SCIENTIFIC SOCIETIES.

Historical Society of Michigan.	Detroit.	[i]	
---------------------------------	----------	-----	--

STATE UNIVERSITIES AND TECHNICAL SCHOOLS.

<i>University of Michigan.</i>	Ann Arbor.	[iii]	D
Dental Department (University of Michigan).	Ann Arbor.		
Law Department (University of Michigan).	Ann Arbor.		
Medical Department (University of Michigan).	Ann Arbor.		
Observatory (University of Michigan).	Ann Arbor.		
Michigan Agricultural College.	Agricultural College.	[iii]	
Experiment Station of Michigan Agricultural College.	Agricultural College.		

COLLEGES AND UNIVERSITIES.

Adrian College.*	Adrian.	[iii]	
Albion College.	Albion.	[iii]	X
Battle Creek College.	Battle Creek.	[i]	
Grand Traverse College.	Benzonia.		
Hillsdale College.	Hillsdale.	[iii]	X
<i>Hope College.</i>	Holland.		X
Kalamazoo College.	Kalamazoo.	[iii]	
<i>Olivet College.</i>	Olivet.	[ii]	

STATE NORMAL SCHOOLS.

Training School for Teachers.	Adrian.		
State Normal School.	Ypsilanti.	[i]	X

MINNESOTA.

STATE LIBRARIES.

<i>Minnesota State Library.</i>	St. Paul.	[iii]	D
---------------------------------	-----------	-------	---

STATE HISTORICAL AND SCIENTIFIC SOCIETIES.

<i>Minnesota Historical Society.</i>	St. Paul.	[iii]	D
Minnesota Academy of Natural Science (1873).	Minneapolis.	[i]	

STATE UNIVERSITIES AND TECHNICAL SCHOOLS.

<i>University of Minnesota.</i>	Minneapolis.	[iii]	D
College of Agriculture of the University of Minnesota (1868). (St. Anthony Park P. O.)	Minneapolis.		
State School of Agriculture of the University of Minnesota. (St. Anthony Park P. O.)	Minneapolis.		
Agricultural Experiment Station of the University of Minnesota. St. Anthony Park.			

COLLEGES AND UNIVERSITIES.

Augsburg Seminary.	Minneapolis.		
Carleton College.	Northfield.	[ii]	X
Hamline University.	Hamline.	[i]	X
Saint John's University.	Collegetown.		

STATE NORMAL SCHOOLS.

State Normal School.	Mankato.	[i]	D
State Normal School.	Moorhead.		
State Normal School.	Saint Cloud.	[ii]	D
State Normal School.	Winona.	[i]	D

MISSISSIPPI.

STATE LIBRARIES.

<i>Mississippi State Library.</i> (Smithsonian publications transferred to the Agricultural and Mechanical College.)	Jackson.		D
--	----------	--	---

STATE HISTORICAL AND SCIENTIFIC SOCIETIES.

Mississippi Historical Society.	Jackson.	[i]	.
---------------------------------	----------	-----	---

STATE UNIVERSITIES AND TECHNICAL SCHOOLS.

<i>University of Mississippi</i> (1874). (University P. O.)	Oxford.	[iii]	D
Agricultural and Mechanical College of Mississippi (1880). (Agricultural College P. O.)	Starkville.	[iii]	D
Mississippi Agricultural Experiment Station. (Agricultural College P. O.)	Starkville.	[i]	
Alcorn Agricultural and Mechanical College (colored).	Rodney.	[i]	

COLLEGES AND UNIVERSITIES.

Kavanaugh College.	Holmesville.		
Mississippi College.	Clinton.	[i]	D
Rust University.	Holly Springs.		

STATE NORMAL SCHOOLS.

State Normal School.	Holly Springs.		D
Tougaloo University.	Tougaloo.		

MISSOURI.

STATE LIBRARIES.

<i>Missouri State Library.</i>	Jefferson City.	[iii]	D
--------------------------------	-----------------	-------	---

STATE HISTORICAL AND SCIENTIFIC SOCIETIES.

Missouri Historical Society.	St. Louis.	[i]	D
<i>Saint Louis Academy of Sciences</i> (1857).	St. Louis.	[iii]	

STATE UNIVERSITIES AND TECHNICAL SCHOOLS.

<i>University of Missouri.</i>	Columbia.	[iii]	D
Law Library of University of Missouri.	Columbia.		
Missouri School of Mines and Metallurgy (1870). (University of Missouri).	Rolla.	[i]	X
Agricultural and Mechanical College of the University of Missouri (1870).	Columbia.		
Missouri Agricultural Experiment Station of the University of Missouri.	Columbia.		

COLLEGES AND UNIVERSITIES.

Central College.	Fayette.	[ii]	
Central Wesleyan College.	Warrenton.	[i]	
Christian University.	Canton.		
Colleges of the Christian Brothers.	St. Louis.		D
<i>Drury College.</i>	Springfield.	[iii]	D
Grand River College.	Edinburgh.	[i]	
La Grange College.	La Grange.	[i]	
Lewis College.	Glasgow.		
Morrisville College.	Morrisville.		
Pritchett School Institute.	Glasgow.	[i]	
<i>Saint Louis University.</i>	St. Louis.	[iii]	D
<i>Saint Vincent's College.</i>	Cape Girardeau.		D
Southwest Baptist College.	Bolivar.		
Washington University.	St. Louis.	[iii]	
Westminster College.	Fulton.		D
William Jewell College.	Liberty.	[ii]	

STATE NORMAL SCHOOLS.

Missouri State Normal School (1st District).	Kirksville.	[iii]	D
Missouri State Normal School (2d District).	Warrensburg.	[ii]	
Missouri State Normal School (3d District).	Cape Girardeau.		X
Saint Louis Normal School.	St. Louis.		

MONTANA.

STATE LIBRARIES.

<i>Montana State Library.</i>	Helena.	[i]	D
-------------------------------	---------	-----	---

STATE HISTORICAL AND SCIENTIFIC SOCIETIES.

Historical Society of Montana.	Helena.	[ii]	D
--------------------------------	---------	------	---

COLLEGES AND UNIVERSITIES.

College of Montana (1883).	Deer Lodge.		X
----------------------------	-------------	--	---

NEBRASKA.

STATE LIBRARIES.

<i>Nebraska State Library</i> (1851).	Lincoln.	[iii]	D
---------------------------------------	----------	-------	---

STATE HISTORICAL AND SCIENTIFIC SOCIETIES.

State Historical Society of Nebraska (1878).	Lincoln.	[i]	
--	----------	-----	--

STATE UNIVERSITIES AND TECHNICAL SCHOOLS.

University of Nebraska (1869).	Lincoln.	[i]	D
Industrial College of the University of Nebraska (1869).	Lincoln.		
Agricultural Experiment Station (University of Nebraska, Lincoln).			

COLLEGES AND UNIVERSITIES.

Creighton College.	Omaha.	[i]	X
Doane Collégé.	Crete.	[ii]	X
Gatea College.	Neligh.	[i]	X
Methodist Episcopal College of Nebraska.	York.		
Nebraska Central College.	Central City.		

STATE NORMAL SCHOOLS.

Nebraska State Normal School.	Peru.	[ii]	X
-------------------------------	-------	------	---

NEVADA.

STATE LIBRARIES.

<i>State Library of Nevada.</i>	Carson City.	[i]	D
---------------------------------	--------------	-----	---

STATE UNIVERSITIES AND TECHNICAL SCHOOLS.

State University of Nevada.	Reno.	[i]	D
School of Agriculture of the Nevada State University (1887).	Reno.		
Nevada State Agricultural Experiment Station (University of Nebraska).	Reno.		

NEW HAMPSHIRE.

STATE LIBRARIES.

<i>New Hampshire State Library.</i>	Concord.	[iii]	
-------------------------------------	----------	-------	--

STATE HISTORICAL AND SCIENTIFIC SOCIETIES.

<i>New Hampshire Historical Society (1823).</i>	Concord.	[iii]	
---	----------	-------	--

STATE UNIVERSITIES AND TECHNICAL SCHOOLS.

<i>Dartmouth College.</i>	Hanover.	[iii]	D
Chandler Scientific Department of Dartmouth College.	Hanover.		
Thayer School of Civil Engineering of Dartmouth College.	Hanover.		
Shattuck Observatory (Dartmouth College).	Hanover.		
New Hampshire College of Agriculture and the Mechanic Arts.	Hanover.	[ii]	
New Hampshire Agricultural Experiment Station.	Hanover.		

STATE NORMAL SCHOOLS.

City Training School.	Manchester.		
New Hampshire State Normal School.	Plymouth.		

NEW JERSEY.

STATE LIBRARIES.

<i>State Library of New Jersey.</i>	Trenton.	[iii]	D
-------------------------------------	----------	-------	---

STATE HISTORICAL AND SCIENTIFIC SOCIETIES.

New Jersey Historical Society (1845).	Newark.	[iii]	
---------------------------------------	---------	-------	--

STATE UNIVERSITIES AND TECHNICAL SCHOOLS.

<i>College of New Jersey (1746).</i>	Princeton.	[iii]	D
Green, J. C., School of Science (College of New Jersey).	Princeton.	[i]	
Halstead Observatory (College of New Jersey).	Princeton.	[i]	
Museum, E. M., of Geology and Archæology of the College of New Jersey.	Princeton.	[ii]	
<i>Theological Seminary of the Presbyterian Church.</i>	Princeton.	[iii]	
Rutgers Scientific School of Rutgers College.	New Brunswick.	[i]	
New Jersey Agricultural College Experiment Station (Rutgers College).	New Brunswick.		
New Jersey State Agricultural Experiment Station (Rutgers College).	New Brunswick.		

COLLEGES AND UNIVERSITIES.

<i>Rutgers College.</i>	New Brunswick.	[iii]	D
College of the Sacred Heart.	Vineland.		
Saint Benedict's College.	Newark.		

STATE NORMAL SCHOOLS.

New Jersey State Normal School.	Trenton.	[ii]	
Newark Normal School.	Newark.		
Patterson Normal Training School.	Patterson.		

NEW MEXICO.

STATE LIBRARIES.

Territorial Library of New Mexico.	Santa Fé.	[i]	D
------------------------------------	-----------	-----	---

STATE HISTORICAL AND SCIENTIFIC SOCIETIES.

Historical Society of New Mexico. Santa Fé. [i]

STATE UNIVERSITIES AND TECHNICAL SCHOOLS.

University of New Mexico (1881). Santa Fé. [ii]
 Agricultural College of New Mexico. Las Cruces.

NEW YORK.

STATE LIBRARIES.

New York State Library. Albany. [iii] D
 New York State Law Library (New York State Library). Albany. D

STATE HISTORICAL AND SCIENTIFIC SOCIETIES.

New York Historical Society (1804). New York. [iii] D
 New York Academy of Science (1817). New York. [iii]

STATE UNIVERSITIES AND TECHNICAL SCHOOLS.

Cornell University. Ithaca. [iii] D
 Cornell University Agricultural Experiment Station. Ithaca.
 College of Agriculture of Cornell University (1888). Ithaca.
 New York Agricultural Experiment Station. Geneva. [i]

COLLEGES AND UNIVERSITIES.

Alfred University. Alfred Centre. [ii]
 Observatory, Alfred University. Alfred Centre.
 Brooklyn Collegiate and Polytechnic Institute. Brooklyn. X
Canisius College. Buffalo. [ii]
College of St. Francis Xavier. New York. [iii]
College of the City of New York. New York. [iii] D
Columbia College. New York. [iii] D
 Observatory, Columbia College. New York.
 School of Mines, Columbia College. New York. [ii]
Hamilton College. Clinton. [iii] X
 Litchfield Observatory, Hamilton College. Clinton.
Hobart College. Geneva. [iii] X
Madison University. Hamilton. [iii]
Manhattan College. New York. [i]
 Niagara University. (Niagara University P. O.) Suspension Bridge. [i]
 Saint Bonaventure's College and Seminary. Allegany. [i]
 Saint Francis College. Brooklyn.
Saint John's College (formerly Fordham). Tremont. [iii] D
 Saint Lawrence University. Canton. [ii] D
 Saint Stephen's College. Annandale. [ii]
Syracuse University. Syracuse. [iii] D
Union College. Schenectady. [iii] D
University of Rochester. Rochester. [iii] D
University of the City of New York. New York. [iii]
 Scientific Department (of the University of the City of New York).
 New York.
 Vassar College. Poughkeepsie. [iii] X
 Wells College. Aurora. [i]

STATE NORMAL SCHOOLS.

Brooklyn Training School. Brooklyn.
 Female Normal School. New York.
 State Normal school. Albany. [iii] X
 State Normal and Training School. Brockport. [i] -X
 State Normal and Training School. Buffalo.

State Normal and Training School.	Cortland.	[ii]	
State Normal and Training School.	Fredonia.	[i]	
State Normal and Training School.	Geneseo.		
State Normal and Training School.	New Paltz.	[i]	X
State Normal and Training School.	Oswego.	[i]	X
State Normal and Training School.	Potdam.		X
Syracuse Training School.	Syracuse.		
Teachers' Normal Training Class.	Rochester.		
Teachers' Training Class of Albany.	Albany.		

NORTH CAROLINA.

STATE LIBRARIES.

<i>North Carolina State Library.</i>	Raleigh.	[iii]	D
--------------------------------------	----------	-------	---

STATE UNIVERSITIES AND TECHNICAL SCHOOLS.

University of North Carolina.	Chapel Hill.	[iii]	D
Elisha Mitchell Science Society (University of North Carolina).	Chapel Hill.	[i]	X
Law Department of the University of North Carolina.	Chapel Hill.		
Medical School of the University of North Carolina.	Chapel Hill.		
College of Agricultural and Mechanic Arts of North Carolina.	Chapel Hill.		
North Carolina Agricultural Experiment Station.	Raleigh.	[i]	

STATE UNIVERSITIES AND TECHNICAL SCHOOLS.

Biddle University.	Charlotte.		
Davidson College.	Davidson College.	[iii]	
North Carolina College.	Mt. Pleasant.		
Rutherford College.	Rutherford.		
Shaw University.	Raleigh.		
Trinity College.	Trinity College.	[iii]	
Wake Forest College.	Wake Forest.	[ii]	X
Weaverville College.	Weaverville.		

STATE NORMAL SCHOOLS.

New Berne State Normal School.	New Berne.		
Plymouth State Colored Normal School.	Plymouth.		
State Colored Normal School.	Fayetteville.		
State Colored Normal School.	Salisbury.		

NORTH DAKOTA.

STATE LIBRARIES.

North Dakota State Library.	Bismarck.	[i]	D
-----------------------------	-----------	-----	---

STATE UNIVERSITIES AND TECHNICAL SCHOOLS.

University of North Dakota (1883-'84).	Grand Forks.		D
North Dakota Agricultural College (1890).	Fargo.		

OHIO.

STATE LIBRARIES.

<i>Ohio State Library.</i>	Columbus.	[iii]	D
<i>Ohio State Law Library.</i>	Columbus.		

STATE HISTORICAL AND SCIENTIFIC SOCIETIES.

Historical and Philosophical Society of Ohio.	Cincinnati.	[iii]	
---	-------------	-------	--

STATE UNIVERSITIES AND TECHNICAL SCHOOLS.

Ohio State University (1873).	Columbus.	[ii]	
Ohio Agricultural Experiment Station (Ohio State University).	Columbus.		

COLLEGES AND UNIVERSITIES.

<i>Adelbert College of Western Reserve University.</i>	Cleveland.	X
Antioch College.	Yellow Springs. [iii]	
Ashland College.	Ashland. [i]	
Baldwin University.	Berea.	
Belmont College.	College Hill. [iii]	X
Buchtel College.	Akron. [i]	D
Observatory (Buchtel College). Akron.		
Calvin College. (Brooklyn Village P. O.)	Cleveland.	
Capital University.	Columbus.	
<i>Denison University.</i>	Granville. [iii]	D
German Wallace College.	Berea.	
Heidelberg College.	Tiffin. [iii]	X
Hiram College.	Hiram. [ii]	D
<i>Kenson College.</i>	Gambier. [iii]	D
<i>Marietta College.</i>	Marietta. [iii]	D
Miami University.	Oxford. [iii]	D
Mount Union College. (Mount Union P. O.)	Alliance. [ii]	D
Muskingum College.	New Concord. [i]	
<i>Oberlin College.</i>	Oberlin. [ii]	D
Ohio University.	Athens. [iii]	D
Normal Department of the Ohio University.	Athens.	
<i>Ohio Wesleyan University.</i>	Delaware. [iii]	D
Otterbein University.	Westerville. [iii]	
Rio Grande College.	Rio Grande.	
Scio College.	Scio. [i]	
Saint Joseph's College.	Cincinnati.	
<i>Saint Xavier's College.</i>	Cincinnati.	
Twin Valley College.	Germantown. [i]	
University of Cincinnati.	Cincinnati. [iii]	X
<i>University of Wooster.</i>	Wooster. [iii]	X
Urbana University.	Urbana. [ii]	
Wilberforce University.	Wilberforce. [x]	X
Wilmington College.	Wilmington. [i]	
<i>Wittenberg College.</i>	Springfield. [iii]	

STATE NORMAL SCHOOLS.

Cincinnati Normal School.	Cincinnati.
Cleveland Normal School.	Cleveland.
Dayton Normal School.	Dayton.
Geneva Normal School.	Geneva.

OREGON.

STATE LIBRARIES.

<i>Oregon State Library.</i>	Salem. [iii]	D
------------------------------	--------------	---

STATE HISTORICAL AND SCIENTIFIC SOCIETIES.

Oregon Pioneer and Historical Society.	Astoria.
--	----------

STATE UNIVERSITIES AND TECHNICAL SCHOOLS.

University of Oregon.	Eugene City. [iii]	D
Oregon State Agricultural College (1888).	Corvallis.	D
Oregon Experiment Station. (Oregon State Agricultural College.)		
Corvallis.		

COLLEGES AND UNIVERSITIES.

Christian College.	Monmouth.
Corvallis College.	Corvallis.

McMinnville College.	McMinnville.	X
Tualatin Academy and Pacific University.	Forest Grove. [iii]	X
Philomath College.	Philomath. [i]	
Willamette University.	Salem.	

STATE NORMAL SCHOOLS.

Ashland College and Normal School.	Ashland.	
Oregon State Normal School.	Monmouth.	
State Normal School.	Drain.	X

PENNSYLVANIA.

STATE LIBRARIES.

<i>Pennsylvania State Library.</i>	Harrisburg. [iii]	D
------------------------------------	-------------------	---

STATE HISTORICAL AND SCIENTIFIC SOCIETIES.

<i>Historical Society of Pennsylvania (1824).</i>	Philadelphia. [iii]	D
<i>Academy of Natural Sciences.</i>	Philadelphia. [iii]	

STATE UNIVERSITIES AND TECHNICAL SCHOOLS.

<i>University of Pennsylvania (1751).</i>	Philadelphia. [iii]	D
Stillé Medical Library.	Philadelphia.	
Pennsylvania State College.	State College. [ii]	D
Pennsylvania State College Agricultural Experiment Station (Pennsylvania State College).	State College.	

COLLEGES AND UNIVERSITIES.

<i>Allegheny College.</i>	Meadville. [iii]	D
Observatory of Allegheny College.	Allegheny.	
Bryn Mawr College.	Bryn Mawr.	
<i>Bucknell University.</i>	Lewisburg. [iii]	
Catholic College of the Holy Ghost.	Pittsburg. [i]	
Dickinson College.	Carlisle. [iii]	
Franklin and Marshall College.	Lancaster. [iii]	X
Geneva College.	Beaver Falls. [i]	X
Grove City College.	Grove City.	
<i>Haverford College.</i>	Haverford. [iii]	
Observatory, Haverford College.	Haverford.	
<i>Lafayette College.</i>	Easton. [iii]	X
Pardee Scientific Department. (Lafayette College.)	Easton.	
La Salle College.	Philadelphia. [i]	
Lebanon Valley College.	Annville. [i]	
<i>Lehigh University.</i>	South Bethlehem. [iii]	D
Sayer Observatory. (Lehigh University.)	South Bethlehem.	
Lincoln University. (Lincoln University P. O.)	Oxford. [iii]	
Muhlenberg College.	Allentown.	X
Pennsylvania College.	Gettysburg. [iii]	D
Pennsylvania Military Academy.	Chester.	
<i>Saint Vincent's Abbey and College.</i>	Beatty. [i]	
<i>Swarthmore College.</i>	Swarthmore. [iii]	
Theil College.	Greenville. [i]	
Ursinus College. (Collegeville P. O.)	Freeland. [i]	
Villanova College.	Villanova.	
Washington and Jefferson College.	Washington. [iii]	
Westminster College.	New Wilmington. [iii]	
Western University of Pennsylvania.	Allegheny. [ii]	

STATE NORMAL SCHOOLS.

• Cumberland Valley State Normal School.	Shippensburg.	
Central State Normal School.	Lock Haven. [i]	D

Keystone State Normal School.	Kutztown.	[i]	D
Pennsylvania State Normal School of the Fifth District.	Mansfield.	[ii]	D
Pennsylvania State Normal School of the Second District.	Millersville.	[i]	
Pennsylvania State Normal School of the Sixth District.	Bloomsburg.		
Philadelphia Normal School for Girls.	Philadelphia.		
Southwestern State Normal School.	California.	[i]	
State Normal School of Clarion.	Clarion.	[i]	
State Normal School, Edinborough.	Edinborough.	[i]	
State Normal School.	Indiana.		
Teachers' Training School.	Erie.		
Teachers' Training School.	Reading.		
West Chester State Normal School.	West Chester.	[iii]	

RHODE ISLAND.

STATE LIBRARIES.

<i>Rhode Island State Library.</i>	Providence.		D
------------------------------------	-------------	--	---

STATE HISTORICAL AND SCIENTIFIC SOCIETIES.

<i>Rhode Island Historical Society.</i>	Providence.	[iii]	
---	-------------	-------	--

STATE UNIVERSITIES AND TECHNICAL SCHOOLS.

<i>Brown University</i> (1764).	Providence.	[iii]	D
Agricultural and Scientific Department of Brown University.	Providence.		

<i>Rhode Island State Agricultural School</i> (1888).	Kingston.		
Rhode Island State Agricultural Experiment Station.	Kingston.		

STATE NORMAL SCHOOLS.

<i>Rhode Island State Normal School.</i>	Providence.	[ii]	
--	-------------	------	--

SOUTH CAROLINA.

STATE LIBRARIES.

<i>South Carolina State Library.</i>	Columbia.	[iii]	D
--------------------------------------	-----------	-------	---

STATE HISTORICAL AND SCIENTIFIC SOCIETIES.

<i>South Carolina Historical Society.</i>	Charleston.	[i]	
---	-------------	-----	--

STATE UNIVERSITIES AND TECHNICAL SCHOOLS.

<i>University of South Carolina</i> (1801).	Columbia.		D
College of Agriculture and Mechanic Arts of the University of South Carolina (1879).	Columbia.	[iii]	

South Carolina Agricultural Experiment Station (University of South Carolina). Columbia.

<i>Cladin University and South Carolina Agricultural College and Mechanics' Institute</i> (1872).	Orangeburg.	[i]	
---	-------------	-----	--

COLLEGES AND UNIVERSITIES.

Adger College.	Walhalla.		
Allen University.	Columbia.		
<i>College of Charleston.</i>	Charleston.	[iii]	D
Erskine College.	Due West.	[ii]	
Astronomical Observatory of Erskine College.	Due West.		
Furman University.	Greenville.	[iii]	
Newberry College.	Newberry.	[i]	X
<i>South Carolina College.</i>	Columbia.		
Wofford College.	Spartanburg.		D

STATE NORMAL SCHOOLS.

<i>Winthrop Training School for Teachers.</i>	Columbia.		
---	-----------	--	--

SOUTH DAKOTA.

STATE LIBRARIES.

South Dakota State Library.	Pierre.	D
-----------------------------	---------	---

STATE UNIVERSITIES AND TECHNICAL SCHOOLS.

University of South Dakota (1863).	Vermillion.	[ii]	D
South Dakota Agricultural College (1889).	Brookings.	[i]	D
South Dakota Agricultural Experiment Station.	Brookings.		
South Dakota School of Mines (1886).	Rapid City.		

COLLEGES AND UNIVERSITIES.

Pierre University. (East Pierre P. O.)	Pierre.	[ii]	D
--	---------	------	---

STATE NORMAL SCHOOLS.

South Dakota Normal School.	Madison.		
State Normal School.	Spearfish.		D

TENNESSEE.

STATE LIBRARIES.

Tennessee State Library.	ashville.	[iii]	D
--------------------------	-----------	-------	---

STATE HISTORICAL AND SCIENTIFIC SOCIETIES.

Tennessee Historical Society,	Nashville.	[i]	
-------------------------------	------------	-----	--

STATE UNIVERSITIES AND TECHNICAL SCHOOLS.

University of Tennessee (1806).	Knoxville.	[iii]	D
Nashville Medical College (University of Tennessee).	Nashville.	[i]	
State Agricultural and Mechanical College of the University of Tennessee (1869).	Knoxville.		
Tennessee Agricultural Experiment Station (University of Tennessee).	Knoxville.		

COLLEGES AND UNIVERSITIES.

Bethel College.	McKenzie.		X
Carson College.	Mossy Creek.		
Central Tennessee College.	Nashville.	[i]	
Chattanooga University.	Chattanooga.		
Christian Brothers' College.	Memphis.	[ii]	X
Cumberland University.	Lebanon.	[iii]	D
Fisk University.	Nashville.		
Grant Memorial University.	Athens.		
Greeneville and Tusculum College.	Tusculum.	[ii]	D
Hiwassee College.	Hiwassee.	[ii]	X
King College.	Bristol.		
Maryville College.	Maryville.	[iii]	
Milligan College.	Milligan.		X
Roger Williams University.	Nashville.		
Southwestern Baptist University.	Jackson.	[ii]	D
Southwestern Presbyterian University.	Clarksville.	[i]	X
University of the South.	Sewanee.	[iii]	D
Vanderbilt University.	Nashville.	[iii]	D
Observatory of Vanderbilt University.	Nashville.		

STATE NORMAL SCHOOL.

State Normal College, University of Nashville.	Nashville.	[iii]	X
--	------------	-------	---

TEXAS.

STATE LIBRARIES.

Texas State Library. Austin. [iii] D

STATE UNIVERSITIES AND TECHNICAL SCHOOLS.

University of Texas. Austin. [iii] D

Agricultural and Mechanical College of Texas. College Station. [ii] D

Texas Agricultural Experiment Station. College Station.

COLLEGES AND UNIVERSITIES.

Austin College. Sherman. [i]

Baylor University. Waco. D

Hope Institute. Italy.

Mansfield Male and Female College. Mansfield.

Salado College. Salado.

Southwestern University. Georgetown. [i] X

Trinity University. Tehuacana. [i] X

STATE NORMAL SCHOOLS.

Prairie View Normal Institute. Hempstead.

Sam Houston Normal Institute. Huntsville. X

UTAH TERRITORY.

STATE LIBRARIES.

Utah Territorial Library. Salt Lake City. [iii] D

STATE UNIVERSITIES AND TECHNICAL SCHOOLS.

University of Deseret (1850). Salt Lake City. [iii] X

Utah Agricultural College (1888). Logan City.

VERMONT.

STATE LIBRARIES.

Vermont State Library. Montpelier. [iii] D

STATE HISTORICAL AND SCIENTIFIC SOCIETIES.

Vermont Historical Society. Montpelier. [iii]

State Cabinet of Natural History (with State Library). Montpelier. [i]

STATE UNIVERSITIES AND TECHNICAL SCHOOLS.

University of Vermont and State Agricultural College. Burlington. [iii] D

Vermont State Agricultural Experiment Station. Burlington.

COLLEGES AND UNIVERSITIES.

Middlebury College. Middlebury. [iii] D

STATE NORMAL SCHOOLS.

Johnson State Normal School. Johnson. [i]

Castleton State Normal School. Castleton. [iii]

Randolph State Normal School. Randolph. [i]

VIRGINIA.

STATE LIBRARIES.

Virginia State Library. Richmond. [iii] D

Virginia State Law Library. Richmond.

STATE HISTORICAL AND SCIENTIFIC SOCIETIES.

Virginia Historical Society (1831). Richmond. [iii] D

STATE UNIVERSITIES AND TECHNICAL SCHOOLS.

University of Virginia (1819). (University P. O.) Charlottesville. [iii] D

Leander McCormick Observatory (University of Virginia). University P. O.

Virginia Military Institute (University of Virginia). Lexington. [iii] D

Virginia Agricultural and Mechanical College (1872).	Blacksburg.	[ii]	
Virginia Agricultural Experiment Station.	Blacksburg.		
Hampton Normal and Agricultural Institute (1868).	Hampton.	[i]	

COLLEGES AND UNIVERSITIES.

Emory and Henry College.	Emory.	[iii]	D
Hampden-Sidney College.	Hampden-Sidney.	[iii]	
Randolph Macon College.	Ashland.	[iii]	
Richmond College.	Richmond.	[iii]	X
Roanoke College.	Salem.	[iii]	D
Washington and Lee University.	Lexington.	[iii]	X
School of Civil Engineering and Mining (Washington and Lee University).	Lexington.		
William and Mary College.	Williamsburgh.		

STATE NORMAL SCHOOLS.

State Normal School of Virginia.	Farmville.		X
Virginia Normal and Collegiate Institute.	Petersburg.	[i]	D

WASHINGTON.

STATE LIBRARIES.

Washington State Library.	Olympia.	[iii]	D
---------------------------	----------	-------	---

STATE UNIVERSITIES AND TECHNICAL SCHOOLS.

University of Washington (1862).	Seattle.	[ii]	
----------------------------------	----------	------	--

COLLEGES AND UNIVERSITIES.

Whitman College.	Walla Walla.	[ii]	
Washington College.	Tacoma.		

WEST VIRGINIA.

STATE LIBRARIES.

West Virginia State Library.	Charleston.	[iii]	D
------------------------------	-------------	-------	---

STATE HISTORICAL AND SCIENTIFIC SOCIETIES.

West Virginia Historical Society.	Morgantown.		
-----------------------------------	-------------	--	--

STATE UNIVERSITIES AND TECHNICAL SCHOOLS.

West Virginia University and Agricultural College.	Morgantown.	[iii]	D
West Virginia Experiment Station. (University of West Virginia.)	Morgantown.		

COLLEGES AND UNIVERSITIES.

Bethany College.	Bethany.	[iii]	X
West Virginia College.	Flemington.	[ii]	

STATE NORMAL SCHOOLS.

Fairmont State Normal School.	Fairmont.		D
Glenville State Normal School.	Glenville.		D
Marshall College State Normal School.	Huntington.	[i]	X
Shepherd College State Normal School.	Shepherdstown.	[ii]	X
Storer College.	Harper's Ferry.		
West Liberty State Normal School.	West Liberty.		

WISCONSIN.

STATE LIBRARIES.

State Library of Wisconsin.	Madison.		D
-----------------------------	----------	--	---

STATE HISTORICAL AND SCIENTIFIC SOCIETIES.

State Historical Society of Wisconsin. Madison. [iii] D

STATE UNIVERSITIES AND TECHNICAL SCHOOLS.

University of Wisconsin. Madison. [iii] X

Washburn Observatory of the University of Wisconsin. Madison.
Department of Agriculture of the University of Wisconsin (1866). Madison.

Agricultural Experiment Station of the University of Wisconsin.
Madison.

COLLEGES AND UNIVERSITIES.

Beloit College. Beloit. [iii] D

Smith's Observatory, Beloit College. Beloit.

Galesville University. Galesville. [i] D

Laurence University. Appleton. [iii] D

Milton College. Milton. X

Northwestern University. Watertown. [i]

Racine College. Racine. [iii] D

Ripon College. Ripon. [i] X

Seminary of Saint Francis of Sales. (St. Francis P. O.) Milwaukee.

STATE NORMAL SCHOOLS.

Oshkosh State Normal School. Oshkosh. [i]

River Falls State Normal School. River Falls. [i] X

Whitewater State Normal School. Whitewater. [i] X

Wisconsin State Normal School. Platteville. [iii]

Wisconsin State Normal School. Milwaukee.

WYOMING.

STATE LIBRARIES.

Wyoming State Library. Cheyenne. [ii] D

STATE HISTORICAL AND SCIENTIFIC SOCIETIES.

Wyoming Academy of Art, Science, and Letters. Cheyenne. [i]

STATE UNIVERSITIES AND TECHNICAL SCHOOLS.

University of Wyoming. Laramie City. [iii] X

II.—LIST OF THE PRINCIPAL LIBRARIES IN THE UNITED STATES TO WHICH IT IS DESIRED TO SEND FUTURE PUBLICATIONS OF THE NATIONAL MUSEUM.

[This list includes all libraries known as Government depositories, all libraries officially designated to receive certain classes of publications, including those of the U. S. Geological Survey, all additional libraries of over 10,000 volumes, a representative library in every city of over 10,000 inhabitants not otherwise supplied, and, in brackets, the State institutions, colleges of liberal arts, and State normal schools mentioned in the preceding list, all being arranged alphabetically by States and towns. In use of small capitals in the names of towns signifies that the population was more than 10,000 by the census of 1880. The figures at the right of an institution indicate the number of volumes in its library, compiled chiefly from the published reports of the Commissioner of Education. The names of all libraries containing more than 10,000 volumes are printed in italics. As in the preceding list, D indicates that the library is a Government depository; X, that it receives the publications of the U. S. Geological Survey; [i], that it receives regularly the *Smithsonian Report*; [ii], that it receives the *Report* and the *Smithsonian Miscellaneous Collections*; [iii], that it receives the two preceding and in addition the *Smithsonian Contributions to Knowledge*.]

NOTE.—This list is not intended to indicate the distribution of Smithsonian publications, but shows incidentally what publications of the Institution are sent to the libraries mentioned.

ALABAMA.

Abbeville.

[South East Alabama Agricultural School.]

Athens.

[North Alabama Agricultural School.]

Auburn.

[Alabama Agricultural and Mechanical College.] 1,500 [ii] D

Birmingham.

Alabama Club. X

[Howard College.] (East Lake P. O.) 5,000 [iii] D

Young Men's Christian Association. X

Courtland.

Public Literary and Law Library Association. D

Demopolis.

Marengo Institute Library. X

East Lake (see Birmingham).

Florence.

[State Normal School.] (White.) 1,000 X

Greensborough.

[Southern University.] 1,470 [iii] D

Huntsville.

[State Normal and Industrial School.] (Colored.) 800 [i]

Jacksonville.

[Jacksonville State Normal School.] (White.) 500 D

Livingston.

[Alabama Normal College for Girls.] (White.) 250 [i]

Marion.

Judson Female Institute. 3,000 X

MOBILE.

[Spring Hill College.] (Spring Hill P. O.) 25,000 [ii] D

MONTGOMERY.

[State and Supreme Court Library.] 17,626 D

[Montgomery State Normal University] (formerly at Marion). 400

State Board of Health. 3,000 [i] D

Young Men's Christian Association. X

Selma.

[Selma University.] 400

Young Men's Christian Association. 1,000 X

Spring Hill (see Mobile.)			
Troy.			
Troy Normal School.	50		X
Tuscaloosa.			
[Alabama Historical Society.]	500	[i]	
Pierson Library.	1,500		X
[University of Alabama.] (University P. O.)	7,000	[iii]	D
Tuskegee.			
[Tuskegee State Normal School.] (Colored.)	3,000	[i]	
Uniontown.			
[Canebrake Agricultural Experiment Station.] (Agricultural and Mechanical College.)			
Wetumpka.			
Public Library of Wetumpka Academy.			D
ARIZONA.			
Phoenix.			
Phoenix Public Library.			X
[Territorial Library.]	5,000	[i]	D
Tempe.			
[Territorial Normal School.]			
Tombstone.			
Tombstone Public Library.	400		X
Tucson.			
Free Public Library.	800		D
[University of Arizona.]			
[College of Agriculture of the University of Arizona.]			
ARKANSAS.			
Altus.			
Central College Institute.			X
Arkadelphia.			
Ouachita College Library.			X
Batesville.			
[Arkansas College.]	800		X
Boonsborough.			
[Cane Hill College.]		[i]	X
Conway.			
Public Library.			X
Young Men's Christian Association.			X
Evening Shade.			
Evening Shade High School.			X
Fayetteville.			
[Arkansas Industrial University.]	6,000	[ii]	D
Fort Smith.			
Public School Library.			D
La Crosse.			
La Crosse Academy.			X
LITTLE ROCK.			
Architects' Society of Architects and Surveyors.			X
[Arkansas Historical Society.]			
[Arkansas State Library.]	20,000	[iii]	D
[Little Rock University.]	1,000	[i]	
[Philander Smith College.]	500		
Pine Bluff.			
[Branch Normal College of Arkansas Industrial University.]	739		D

CALIFORNIA.

Alameda.			
Alameda Free Library and Reading Room.	5,150	[i]	X
Benicia.			
[College of St. Augustine.]	3,700		
Berkeley (see San Francisco).			
Biggs.			
Public School Library.			X
Chico.			
Chico State Normal School.			
College City.			
[Pierce Christian College.]	200	[i]	
Gredley.			
Public School Library.			X
LOS ANGELES.			
Los Angeles Public Library.	3,964		X
[Saint Vincent's College.]	3,000		
[State Normal School.]	1,300		
[University of Southern California.]	1,000		
Marysville.			
Marysville City Library.	4,000	[iii]	
Monterey.			
Monterey Library Association.		[iii]	
Napa City.			
[Napa College.]	700		
OAKLAND.			
<i>Free Public Library.</i>	10,738	[i]	X
Petaluma.			
Petaluma Public Library.	3,500		X
SACRAMENTO.			
[California State Library.]	61,612	[iii]	D
<i>Sacramento Free Library.</i>	11,778	[iii]	D
San Buenaventura.			
Ventura Public Library.	2,500		X
San Diego.			
San Diego Public Library.	1,600	[i]	X
San Diego Society of Natural History.	458	[i]	
SAN FRANCISCO.			
<i>Bancroft Library (Pacific Library).</i>	45,000	[iii]	
<i>Bibliothèque de la Ligue Nationale Française.</i>	13,000	[iii]	
[California Academy of Sciences.]	10,000	[iii]	
[California Historical Society.]			
<i>Mechanics' Institute.</i>	40,000	[iii]	X D
<i>Mercantile Library Association.</i>	55,000	[iii]	X
[Normal Department, Girls' High School.]			
<i>Odd Fellows' Library Association.</i>	40,131	[iii]	X
[Saint Ignatius College.]	10,000	[ii]	
<i>San Francisco Free Public Library.</i>	65,000	[iii]	D
<i>San Francisco Law Library.</i>	25,500	[i]	
<i>Sutro Library.</i>	110,000	[iii]	
<i>Theological Seminary of San Francisco.</i>	16,000		
[University of California.] (Berkeley P. O.)	33,170	[iii]	D
[College of Agriculture of the University of California.] (Berkeley P. O.)			

SAN JOSÉ.			
[California State Normal School.]	3,000	[i]	
San José Free Public Library.	6,500	[i]	D
[University of the Pacific.]	2,800	[ii]	
San Mateo.			
San Mateo Public Library.			X
Santa Barbara.			
Santa Barbara Free Public Library.	4,500	[ii]	
Santa Barbara Society of Natural History.	2,600	[i]	D
Santa Clara.			
[Santa Clara College.]	12,000	[iii]	
Santa Cruz.			
Free Library.	3,000	[i]	X
Santa Rosa.			
[Pacific Methodist College.]	1,000		
Free Library.	1,200		X
STOCKTON.			
Free Public Library.	8,147	[i]	D
Vacaville.			
California Normal College.	2,500		X
Woodbridge.			
[San Joaquin Valley College.]	1,000		
Woodland.			
[Hesperian College.]	400		
COLORADO.			
Boulder.			
[University of Colorado.]	2,100	[i]	D
Colorado Springs.			
[Colorado College.]	6,000	[i]	D
DENVER.			
Chamber of Commerce.			X
[Colorado Scientific Society.]		[i]	
[Colorado State Historical Society.]			
Denver Public Library.		[i]	D
[State Library.]	8,000	[iii]	D
High School Library.		[ii]	X
[University of Denver.]	1,000	[ii]	X
Durango.			
Durango Club Library.			X
Fort Collins.			
[State Agricultural College of Colorado.]	900	[i]	X
Golden.			
[State School of Mines.]	1,000	[i]	X
LEADVILLE.			
Young Men's Christian Association.	600		
CONNECTICUT.			
BRIDGEPORT.			
Bridgeport Public Library and Reading Room.	16,550	[iii]	D
Canaan.			
Douglas Library.	2,028		X
DANBURY.			
Danbury Library.	7,500		X
Danielsonville.			
Peoples' Library Association.	2,000		X
DERBY. (No library.)			

HARTFORD.

[<i>Connecticut Historical Society.</i>]	21,000	[iii]	
Hartford High School.	1,500		X
<i>Hartford Library Association.</i>	36,500	[iii]	X
<i>Hartford Theological Seminary.</i>	42,000	[iii]	
<i>State Library of Connecticut.</i>	15,000	[iii]	D
[<i>Trinity College.</i>]	28,000	[iii]	
<i>Watkinson Library of Reference.</i>	40,000		

Mansfield.

[<i>Storr's Agricultural School.</i>] (State.) (Storrs P. O.)	939	[i]	
---	-----	-------	--

MERIDEN.

Young Men's Christian Association.	4,800		
------------------------------------	-------	--	--

Middletown.

<i>Berkeley Divinity School.</i>	17,387		
[<i>Wesleyan University.</i>]	35,000	[iii]	X

NEW BRITAIN.

Public High School.	420	[i]	X
[<i>State Normal School.</i>]	4,000	[iii]	

NEW HAVEN.

American Oriental Society.	3,000	[iii]	
[<i>Cedar Street Normal Training School.</i>]	168		
[<i>Connecticut Academy of Arts and Sciences.</i>] (No library.)			
<i>Linonian and Brother's Library.</i>	28,000		
<i>New Haven Young Men's Institute.</i>	12,000	[iii]	
New Haven Public Library.			X
Peabody Museum. (Yale University.)		[i]	
[<i>Sheffield Scientific School of Yale University.</i>]	6,000	[ii]	X
[<i>Welch Normal Training School.</i>]	400		
[<i>Yale University.</i>]	130,000	iii	D

NEW LONDON.

New London Public Library.			D
----------------------------	--	--	---

NORWALK.

Library Corporation.	1,800		X
----------------------	-------	--	---

NORWICH.

<i>Otis Library.</i>	15,640	[ii]	D
----------------------	--------	--------	---

STAMFORD.

Ferguson Library.	5,000		X
-------------------	-------	--	---

Storrs (see Mansfield.)

WATERBURY.

<i>Silas Bronson Library.</i>	36,500	[iii]	D
-------------------------------	--------	---------	---

Willimantic.

Dunham Hall.	2,000		X
--------------	-------	--	---

DELAWARE.

Dover.

[<i>Delaware State Library.</i>]	15,000	[iii]	D
Dover Library.	1,890		X
Scott Library.	1,600		D

Milford.

Milford Library Association.	800		X
------------------------------	-----	--	---

Newark.

[<i>Delaware College.</i>]	8,000	[iii]	X
------------------------------	-------	---------	---

New Castle.

New Castle Library Company.	4,000	[iii]	D
-----------------------------	-------	---------	---

Seaford.

Seaford Public School.			X
------------------------	--	--	---

WILMINGTON.

[Historical Society of Delaware.]	6,500	[i]	
Shields Library Association.	758		X
Wilmington Institute.	15,632	[iii]	D

DISTRICT OF COLUMBIA.**WASHINGTON.**

[American Historical Society.]			
Army Medical Museum.	76,733	[i]	
Bureau of Education.	17,000	[ii]	
Bureau of Ethnology.		[iii]	
[Catholic University of America.]		[iii]	
Columbian Institution for the Deaf and Dumb.	3,000	[iii]	
[Columbian University.]	8,000	[iii]	
[Congressional Library.]	565,134	[iii]	
Cosmos Club.		[i]	
Department of Agriculture.	18,000	[iii]	
Department of State.	22,625	[iii]	
Engineer Department, U. S. Army (Office Chief of Engineers).		[iii]	
[Georgetown University.]	35,000	[iii]	
[House of Representatives.]	125,000	[i]	
[Howard University.]	13,000	[ii]	
Interior Department Library.	8,000	[iii]	
Metropolitan Club.		[i]	
[Miner Normal School.]	75		
[National Academy of Sciences.]			
Navy Department Library.	17,000	[iii]	
Quartermaster-General's Office.		[ii]	
Rotunda of United States National Museum.		[i]	
Signal Office Library.	10,540	[ii]	
[Smithsonian Institution.] (Books deposited in Congressional Library.)		[iii]	
Surgeon-General's Office.	76,733	[iii]	
Treasury Department Library.	18,000	[ii]	
United States Coast and Geodetic Survey.	4,500	[i]	
United States Commission of Fish and Fisheries.		[iii]	
United States Geological Survey.	17,255	[iii]	
United States National Museum.	13,000	[iii]	
United States Naval Observatory.	12,000	[iii]	
United States Patent Office (Scientific Library).	50,000	[iii]	
United States Senate.	30,000		
War Department Library.	17,500	[iii]	
Washington High School Library.		[iii]	
[Washington Normal School.]			

FLORIDA.

De Funiak Springs (Lake De Funiak).			
De Funiak Springs Library.	500	[i]	X
[Florida State Normal College.]	480		
De Land.			
John B. Stetson University.			D
Jacksonville.			
Jacksonville Library Association.	500	[ii]	D
Lake City.			
[Florida State Agricultural and Mechanical College.]			

Milton.			
Santa Rosa Academy Public Library.	4,000	[ii]	D
Pensacola.			
Pensacola Public School Library.			X
Saint Augustine.			
[Historical Society of Florida.]			
Tallahassee.			
[Florida State Library.]	12,500		D
[Florida State Normal School.]			
Florida University.	2,200	[i]	X
Winter Park.			
[Rollins College.]	1,500		

GEORGIA.

Acworth.			
Acworth Literary and Library Association.	484		X
Americus.			
Americus Library Association.	1,909		D
Athens.			
[University of Georgia.]	18,000	[iii]	D
ATLANTA.			
[Atlanta University.]	6,000		
[Clark University.]	2,000		
[Georgia State Library.]	45,000	[iii]	D
Young Men's Library Association.	11,343	[ii]	D
AUGUSTA.			
Young Men's Library Association.	5,769	[ii]	D
Bowdon.			
[Bowdon College.]	350	[i]	
Cave Spring.			
Georgia Institution for the Deaf and Dumb.	1,200	[ii]	
Cedartown.			
Cedartown Library.			X
COLUMBUS.			
Columbus Public Library.	6,000	[i]	X
Conyers.			
Rockdale Library.			X
Crawfordsville.			
Stephens' High School.			X
Cuthbert.			
[Southwest Georgia Agricultural College.]			
Dahlonega.			
[North Georgia Agricultural College.]	500	[i]	D
Gainesville.			
Gainesville College Library.			D
Young Men's Library Association.			X
Griffin.			
Granthier Club Library.			X
Hamilton.			
[West Georgia Agricultural and Mechanical College.]			
Hawkinsville.			
Hawkinsville Library and Literary Association.	1,400		X
Jefferson.			
Martin Institute.			X

MACON.			
[<i>Mercer University.</i>]	10,000		X
[<i>Pio Nono College.</i>]	600		
<i>Public Library and Historical Society.</i>	10,000	[iii]	D
<i>Wesleyan Female College.</i>	2,500	[i]	X
Milledgeville.			
[<i>Middle Georgia Military and Agricultural College.</i>]			X
Newnan.			
<i>College Temple.</i>	15,000		
Oxford.			
[<i>Emory College.</i>]	5,000	[iii]	X
Perry.			
<i>Perry Public Academy.</i>			X
Quitman.			
<i>Brook County Library.</i>			X
Rome.			
<i>Young Men's Library Association.</i>			D
SAVANNAH.			
[<i>Georgia Historical Society.</i>]	15,250	[iii]	D
Thomasville.			
<i>Thomasville Library Association.</i>	300		X
[<i>South Georgia Agricultural College.</i>]			X
Waynesboro.			
<i>Waynesboro Library Association.</i>			X
West Point.			
<i>Young Men's Library Association.</i>	1,800	[i]	D
IDAHO.			
Boisé City.			
[<i>Idaho State Library.</i>]	5,000		D
Camas.			
<i>Camas Library.</i>			X
Lewiston.			
<i>Lewiston Public School Library.</i>			D
Murray.			
<i>Murray Library.</i>			X
ILLINOIS.			
Abingdon.			
[<i>Hedding College.</i>]	1,800		
Alton.			
<i>Alton Public Library.</i>	6,000		X
AURORA.			
<i>Aurora Free Public Library.</i>	6,333		X
BELLEVILLE.			
<i>Belleville Public Library.</i>	9,702		D
BLOOMINGTON.			
<i>Bloomington Library Association.</i>	9,661	[ii]	X
[<i>Illinois Wesleyan University.</i>]	3,408	[iii]	D
Bourbonnais Grove.			
[<i>Saint Viator's College.</i>]	2,000		
Cairo.			
<i>Cairo Public Library.</i>	2,650	[i]	X
Carbondale.			
[<i>Southern Illinois Normal University.</i>]	8,260	[ii]	D
Carrollton.			
<i>Carrollton Library Association.</i>		[i]	D

Carthage.		
[Carthage College.]	3,000	[i]
Champaign (see Urbana).		
[Agricultural Experiment Station of the University of Illinois.]		
CHICAGO.		
Chicago Academy of Sciences.	4,500	[iii]
<i>Chicago Historical Society.</i>	12,024	[iii] D
<i>Chicago Law Institute.</i>	19,000	
<i>Chicago Public Library.</i>	119,570	[iii] D
Chicago Theological Seminary.	7,500	[iii]
[Cook County Normal School.] (Englewood P. O.)	5,000	[i] D
Englewood High School Library. (Englewood P. O.)	1,300	X
Married Men's Sodality and Railroad Library.		X
Newberry Library.		[iii] D
[<i>Saint Ignatius College.</i>]	12,000	[i]
Young Men's Literary Association.		X
Young Men's Christian Association.	3,500	[ii]
Colden.		
Cobden Library Association.	1,796	X
Danville.		
Danville High School.		[ii]
Danville Public Library.	4,000	[i] X
Decatur.		
Free Public Library.	7,322	[i] X
Elgin.		
Elgin Public Library.	8,223	[i] D
Englewood (see Chicago).		
Eureka.		
[Eureka College.]	4,500	[ii]
Evanston.		
[<i>Northwestern University.</i>]	26,000	[iii] D
Ewing.		
[Ewing College.]	1,000	[i] X
Freeport.		
Freeport Young Men's Christian Association.		X
Galena.		
[German English College.]	500	
GALESBURG.		
<i>Galesburg Public Library.</i>	12,571	
[Knox College.]	6,600	[i, i]
[Lombard University.]	6,000	[ii]
Gnothantic Library.		X
Greenville.		
Greenville Public Library.		X
Hillsborough.		
Hillsborough Public Library.		X
Hyde Park.		
Hyde Park High School Library.	400	X
JACKSONVILLE.		
[Illinois College.]	9,000	[iii] X
Illinois Institution for the Education of the Deaf and Dumb.	7,284	[ii] D
JOLIET.		
<i>Joliet Business College.</i>	11,000	

Kankakee.			
Kankakee Ladies Library Association.	2,000		X
Knoxville.			
Saint Mary's School.	900	[1]	X
Lake Forest.			
[Lake Forest University.]	5,672	[1]	X
Lebanon.			
[McKendree College.]	6,500	[iii]	
Lincoln.			
[Lincoln University.]	3,000	[1]	
Macomb.			
Macomb City Free Public Library.	2,059	[1]	X
Monmouth.			
[Monmouth College.]	2,000	[1]	D
<i>Warren County Library and Reading Room.</i>	11,196	[iii]	
Morgan Park.			
<i>Baptist Union Theological Seminary.</i>	25,000		
Mount Carroll.			
Mount Carroll Seminary.	5,000		D
Mount Morris.			
<i>Mount Morris College (Cassel Library).</i>	12,000	[iii]	X
Mount Sterling.			
Mount Sterling Library Association.			X
Mount Vernon.			
Mount Vernon Supreme Court Library.	7,000		D
Naperville.			
[Northwestern College.]	1,200		
Normal.			
[<i>Illinois Museum of Natural History.</i>] (University of Illinois.)		[iii]	
[<i>Illinois State Normal University.</i>]	3,000	[1]	D
Oak Park.			
Scoville Institute.			X
Olney.			
Olney Public Library.	2,500	[1]	D
Ottawa.			
Ottawa City High School.	1,100	[ii]	X
Paxton.			
Paxton Library.			X
PEORIA.			
<i>Peoria Public Library.</i>	25,350	[iii]	D
QUINCY.			
[Chaddock College.]	300		
Quincy Library.	6,400	[1]	X
[<i>Saint Francis Solanus College.</i>]	2,235		
Rantoul.			
Rantoul Literary Society.	800	[1]	X
Ravenswood.			
Ravenswood Public Library.			X
ROCKFORD.			
<i>Public Library of Rockford.</i>	13,100	[iii]	X
ROCK ISLAND.			
[<i>Augustana College.</i>]	7,900	[1]	X
Rock Island Public Library.	8,057	[ii]	X
Shawneetown.			
Shawneetown Public Reading Room.			X

Shelbyville.			
Shelbyville Public School Library.	600		D
SPRINGFIELD.			
[<i>Illinois State Historical Society and Natural History Museum.</i>]		[i]	
[<i>Illinois State Library.</i>]	40,000	[iii]	D
Springfield Public Library	8,000	[ii]	X
Streator.			
Streator High School.			X
Sycamore.			
Sycamore Public Library.			X
Teutopolis.			
[<i>Saint Joseph's Diocesan College.</i>]	2,000		
Upper Alton.			
[<i>Shurtleff College.</i>]	6,300	[i]	
Urbana (see Champaign).			
[<i>University of Illinois.</i>]	15,539	[iii]	D
Vandalia.			
Vandalia Public Library.			X
Westfield.			
[<i>Westfield College.</i>]	2,500	[ii]	X
Wheaton.			
[<i>Wheaton College.</i>]	2,500	[iii]	
INDIANA.			
Aurora.			
Aurora Public Library Association.	2,000		X
Bloomington.			
[<i>Indiana University.</i>]	5,000	[iii]	D
Brookville.			
Brookville Society of Natural History.	2,000	[i]	D
Covington.			
[<i>Indiana Normal College.</i>]	1,200		
Crawfordsville.			
[<i>Wabash College.</i>]	23,000	[iii]	D
Crown Point.			
Crown Point Public School Library.	500	[i]	X
Dauville.			
Central Normal College.	1,300	[i]	X
EVANSVILLE.			
[<i>Willard Library.</i>]	10,000	[iii]	D
FORT WAYNE.			
Catholic Library Association.	4,700	[i]	D
[<i>Concordia College.</i>]	2,000	[ii]	X
Fort Wayne Public School Library.	5,500	[i]	X
Frankfort.			
Frankfort Public Library.	1,200		X
Franklin.			
[<i>Franklin College.</i>]	5,000	[i]	D
Greencastle.			
[<i>De Pauw University.</i>] (Formerly Asbury University.)	13,000	[iii]	D
Hanover.			
[<i>Hanover College.</i>]	6,000	[iii]	
Hartsville.			
[<i>Hartsville College.</i>]	1,000	[i]	
Huntingburg.			
Petoka Township Library	634		X

Huntington.				
Public School Library.	5,000	[i]		D
INDIANAPOLIS.				
[Butler University.] (Irvington P. O.)	3,000	[iii]		D
[Indiana Historical Society.]	1,200			
<i>Indiana State Law Library.</i>	14,500			
[<i>Indiana State Library.</i>]	23,000	[iii]		D
Indianapolis High School Library.				X
[Indianapolis Normal School.]	200			
<i>Indianapolis Public Library.</i>	39,500	[iii]		X
Medical College of Indiana.	2,000	[ii]		
Irvington (see Indianapolis).				
Kokomo.				
Kokomo Free Library.				X
LA FAYETTE.				
La Fayette Public Library.	8,600			D
[Purdue University.]	2,300	[ii]		
[School of Agriculture, Horticulture, and Veterinary Science.] (Purdue University.)				
La Porte.				
High School Library.				X
La Porte City Library.				X
Public Library and Natural History Society.		[ii]		
LOGANSPORT.				
American Normal College.	820			X
Marion.				
Marion Public School Library.				X
Merom.				
[Union Christian College.]	700	[ii]		
Moore's Hill.				
[Moore's Hill College.]	1,200	[ii]		X
Muncie.				
Muncie Public Library.	6,111			D
NEW ALBANY.				
New Albany High School.		[iii]		
New Harmony.				
New Harmony Working Men's Institute.	8,000	[i]		X
Notre Dame.				
[<i>University of Notre Dame du Lac.</i>]	25,000	[iii]		D
Plainfield.				
Plainfield Central Academy.				X
RICHMOND.				
[Earlham College.]	5,000	[i]		X
<i>Morrison Library.</i>	13,500	[i]		
Ridgeville.				
[Ridgeville College.]	250	[i]		
Rising Sun.				
Natural History Club.	429	[i]		X
Rockville.				
Rockville High School Library.				X
Saint Mary's.				
Saint Mary's Institute.				X
Saint Meinrad.				
[<i>Saint Meinrad's College and Abbey.</i>]	12,508	[ii]		X

SOUTH BEND.			
Young Men's Christian Association.	1,000	[i]	
Spiceland.			
Spiceland Academy Library Association.	1,200		X
TERRE HAUTE.			
[Indiana State Normal School.]	4,000	[ii]	X
[Rose Polytechnic Institute.]	4,212	[iii]	
Valparaiso.			
Northern Indiana Normal School.	5,000	[i]	D
Vincennes.			
Vincennes University.	4,000	[i]	D
Wabash.			
Noble Township Library.	650		X
Washington.			
Washington Public School Library.			X

INDIAN TERRITORY.

Tahlequah.			
[Cherokee National Council Library.]	2,100		
[Cherokee National Female Seminary.]	600	[i]	
[Cherokee National Male Seminary.]	1,000	[i]	

IOWA.

Ames.			
[Iowa State College of Agricultural and Mechanical Arts.]	800	[ii]	
Audubon.			
Audubon High School Library.			X
Bloomfield.			
Bloomfield Library.	400		X
Boone.			
Public Library Association.		[i]	D
BURLINGTON.			
Burlington University.	3,500	[iii]	
Cedar Falls.			
Public Library.	2,600	[i]	X
[Iowa State Normal School.]	1,760	[i]	
CEDAR RAPIDS.			
<i>Grand Lodge of Masons of Iowa.</i>	10,000	[iii]	X
Charles City.			
Charles City Free Public Library.			X
Clarinda.			
Clarinda Young Men's Christian Association.			D
Clinton.			
Clinton Public School Library.	2,800		X
College Springs.			
[Amity College.]	1,000	[i]	X
COUNCIL BLUFFS.			
Free Public Library.	5,300	[i]	D
DAVENPORT.			
<i>Davenport Academy of Natural Sciences.</i>	10,000	[iii]	
[Griswold College.]	8,000	[iii]	
<i>Library Association.</i>	10,500		D
Decorah.			
[Norwegian Lutheran College.]	4,300	[i]	X

DES MOINES.				
[Drake University.]	22,000	[i]		X
[Iowa State Library.]	22,554	[iii]		D
[University of Des Moines.]	2,000			
[West Des Moines Training School.]	40			
Public Library.	5,800			D
DEBUQUE.				
[Saint Joseph's College.]	2,000			
Young Men's Library Association.	13,000			D
Fairfield.				
Jefferson County Library Association.	8,500	[ii]		D
[Parsons College.]	2,400	[i]		X
Fayette.				
[Upper Iowa University.]	2,500	[iii]		D
Grinnell.				
[Iowa College.]	12,250	[iii]		D
Hopkinton.				
[Lenox College.]	800			
Hull.				
Pattersonville Institute.				X
Humboldt.				
Humboldt College.		[iii]		
Independence.				
Independence Free Public Library.	2,414	[i]		X
Indianola.				
[Simpson College.]	1,500	[ii]		X
Iowa City.				
[Iowa Academy of Sciences.]				
[State Historical Society of Iowa.]	11,000	[iii]		
[State University of Iowa.]	18,000	[iii]		D
KEOKUK.				
Keokuk Library Association.	7,500	[iii]		X
Le Mars.				
Northwestern Normal Institute and Business College.				D
Missouri Valley.				
Missouri Valley High School Library.				X
Mount Pleasant.				
[German College.]	585			
[Iowa Wesleyan University.]	2,000	[iii]		D
Mount Pleasant Public Library.	4,030	[i]		X
Mount Vernon.				
[Cornell College.]	7,500	[iii]		X
Osage.				
Cedar Valley Seminary.	650	[ii]		
Oskaloosa.				
[Oskaloosa College.]	2,000	[iii]		
[Penn College.]	2,000	[i]		X
Pella.				
[Central University of Iowa.]	2,000			
Shenandoah.				
Western Normal College and Shenandoah Commercial Institute. (Private.)	3,000	[i]		X
Tabor.				
[Tabor College.]	5,000	[i]		

Toledo.			
[Western College.]	3,200		
Washington.			
Washington Public Library.			X
Waterloo.			
Waterloo Library Association.	1,500		D
KANSAS.			
ATCHISON.			
Atchison Public Library.	2,894		X
[Saint Benedict's College.]	5,000	[i]	
Baldwin City.			
[Baker University.]	3,000	[i]	
Dodge City.			
Dodge City Library.			X
Emporia.			
[College of Emporia.]	700		
[Kansas State Normal School.]	2,000	[i]	X
Garnett.			
Garnett Library Association.	455		X
Harlan.			
Gould College.	350		D
Hiawatha.			
Morrill Library.			D
Highland.			
[Highland University.]	5,000		
Holton.			
Campbell University.	780	[ii]	X
Independence.			
Independence Ladies' Library Association.	603		X
Lawrence.			
[University of Kansas.]	10,000	[iii]	D
Lawrence City Library.	4,000	[ii]	D
LEAVENWORTH.			
Public Reading Room.		[i]	
Lecompton.			
[Lane University.]			
Manhattan.			
[Kansas State Agricultural College.]	5,559	[iii]	D
Mankato.			
Mankato High School Library.			X
McPherson.			
McPherson City Library.			X
Newton.			
Newton Library.	751		D
Oswego.			
Oswego College for Young Ladies.			X
Oswego Public Library.			D
Ottawa.			
[Ottawa University.]	1,160	[i]	
Paola.			
Paola City Library.	3,100	[i]	X
Saint Mary's.			
[Saint Mary's College.]	8,000		X
Salina.			
[Kansas Wesleyan University.]	150	[i]	X

TOPEKA.

[<i>Kansas Academy of Science.</i>]		[ii]	
[<i>Kansas State Historical Society.</i>]	24,121	[ii]	D
[<i>Kansas State Library.</i>]	23,988	[iii]	D
Topeka Free Public Library.			D
[<i>Washburn College.</i>]	5,000	[ii]	X

Troy.

Troy Public Library.			X
----------------------	--	--	---

Wichita.

Garfield College.			X
-------------------	--	--	---

KENTUCKY.

Ashland.

Ashland Reading Room Association.			D
-----------------------------------	--	--	---

Bardstown.

Saint Joseph's College.	800		D
-------------------------	-----	--	---

Berea.

[<i>Berea College.</i>]	4,000		X
---------------------------	-------	--	---

Bowling Green.

[<i>Ogden College.</i>]	600	[i]	D
---------------------------	-----	-----	---

Barkeville.

Alexander College.	1,000		X
--------------------	-------	--	---

Cecilian.

Cecilian College.	2,000		X
-------------------	-------	--	---

Clinton.

Clinton College Reference Library.	522		X
------------------------------------	-----	--	---

Columbia.

Columbia Christian College.			X
-----------------------------	--	--	---

COVINGTON.

Covington High School Library.	2,000		D
--------------------------------	-------	--	---

Covington Law Library Association.			X
------------------------------------	--	--	---

Danville.

[<i>Center College.</i>]	5,000	[iii]	D
----------------------------	-------	-------	---

<i>Danville Theological Seminary.</i>	10,000		
---------------------------------------	--------	--	--

Earlington.

Catholic School Library at Saint Bernards.			X
--	--	--	---

Eminence.

[<i>Eminence College.</i>]	2,000	[i]	
------------------------------	-------	-----	--

Farmdale.

Kentucky Military Institute.	5,000	[ii]	
------------------------------	-------	------	--

Frankfort.

Kentucky Geological Survey.	1,050	[fii]	
-----------------------------	-------	-------	--

[<i>Kentucky Historical Society.</i>]	400		
---	-----	--	--

[<i>Kentucky State Library.</i>]	33,900	[i]	D
------------------------------------	--------	-----	---

Frenchburg.

Frenchburg High School Library.			X
---------------------------------	--	--	---

Georgetown.

[<i>Georgetown College.</i>]	8,000	[iii]	D
--------------------------------	-------	-------	---

Georgetown Public Library.			X
----------------------------	--	--	---

Glasgow.

Glasgow Normal School.	1,500	[i]	X
------------------------	-------	-----	---

Hartford.

Hartford College.			X
-------------------	--	--	---

Hopkinsville.

[<i>South Kentucky College.</i>]	1,000		
------------------------------------	-------	--	--

Jackson.

Jackson Academy Library.	1,000		X
--------------------------	-------	--	---

LEXINGTON.			
[State College of Kentucky.] (Agricultural and Mechanical.)		[i]	
Hamilton Female College.	500		X
[Kentucky University.]	13,400	[iii]	D
Lexington Library.	15,000		
LOUISVILLE.			
Louisville Library Association.	10,000	[ii]	
Louisville Trade and Labor Assembly.			D
Male High School.		[i]	X
Polytechnic Society of Kentucky.	40,533	[iii]	D
Southern Baptist Theological Seminary.	8,500	[ii]	X
Madisonville.			
National Institute Library.			X
Mayfield.			
Western Kentucky College.		[i]	X
Maysville.			
Limestone Lodge Knights of Pythias.			X
Millersburg.			
[Kentucky Wesleyan College.]	1,500		
Murray.			
[Murray Male and Female Institute and West Kentucky Normal School.]	45		
NEWPORT.			
Odd Fellows' Library.	3,600		X
North Middletown.			
[Kentucky Classical and Business College.]	200		
Princeton.			
Princeton Collegiate Institute.	800		X
Richmond.			
[Central University.]	7,000	[ii]	X
Russellville.			
[Bethel College.]	2,000	[iii]	X
Saint Mary's.			
[Saint Mary's College.]	5,000		X
Vanceburgh.			
Riverside Seminary.			X
Versailles.			
Versailles Public Library.			X
LOUISIANA.			
Baton Rouge.			
College Institute.			X
[Louisiana State Historical Society.]		[i]	
[Louisiana State University and Agricultural and Mechanical College.]	18,085	[iii]	D
Calhoun.			
[North Louisiana Experiment Station.] (Agricultural and Mechanical College.)			
Convent.			
[Jefferson College.] (Saint Mary's.)		[i]	X
Grand Coteau.			
[Saint Charles College.]	8,000	[iii]	X
Jackson.			
[Centenary College of Louisiana.]	2,000	[i]	X
Keachi.			
[Keachi College.]	200		X

Kenner.

[Sugar Experiment Station.] (Agricultural and Mechanical College.)

Monroe.

Monroe Public Library. D

Mount Lebanon.

Mount Lebanon College Library. 400 X

Natchitoches.

[Louisiana State Normal College.] 500 D

NEW ORLEANS.

City Public School and Lyceum Library. 17,000 [iii] D

[College of the Immaculate Conception.] 13,000

Howard Memorial Library. X

[New Orleans Normal School.] 200

New Orleans Law Association. 10,000

New Orleans Public School and Lyceum Library. 17,000

[New Orleans University.] 2,000 D

Soulé Commercial College and Literary Institute. 1,964 [i] X

[Southern University.] (Colored.) 225

[State Library of Louisiana.] 21,000 [iii] D

[Straight University.] 400

[Tulane University of Louisiana.] 15,500 [iii] D

Shreveport.

[Thatcher Institute.] 250

Winsted.

Gilbert Seminary. D

MAINE.

Augusta.

[Maine State Library.] 41,000 [iii] D

BANGOR.

Bangor Public Library. 23,255 [iii] D

Bangor Theological Seminary. 17,000 [iii]

BIDDEFORD.

Biddeford Public Library. 4,000

Brunswick.

[Bowdoin College.] 35,000 [iii] D

Bucksport.

East Maine Conference Seminary. 3,200 [i] X

Calais.

Saint Croix Library. 4,000 X

Castine.

[Eastern State Normal School.] 1,300

Dexter.

Dexter Town Library. 2,300 X

Ellsworth.

Ellsworth City Library. 2,560 X

Farmington.

[State Normal Training School.] 1,712

Gorham.

[State Normal School.] 1,687

Grant Isle and Fort Kent.

[Madawaska Training School.] 200

Hebron.

Hebron Academy (Hamlin Library.) 600 [ii]

Kent's Hill.			
Maine Wesleyan Seminary and Female College.	4,515		X
Kittery.			
Rice Public Library.	2,700	[i]	X
LEWISTON.			
[Bates College.]	9,237	[i]	D
Manufacturers and Mechanics' Library Association.	9,085	[ii]	X
Norway.			
Norway Public Library.	1,200		X
Orono.			
[Maine State College of Agriculture and the Mechanic Arts.]	6,500	[iii]	X
PORTLAND.			
[<i>Maine Historical Society.</i>]	10,000	[iii]	D
[Normal Training and Practice Class.]	216		
Portland Public Library.	31,000	[iii]	D
Portland Society of Natural History.	1,300	[iii]	
Saco.			
York Institute.	1,100	[ii]	X
Waterville.			
[<i>Colby University.</i>]	21,000	[iii]	D
MARYLAND.			
Agricultural College.			
[Maryland Agricultural College.]	2,000	[iii]	
Annapolis.			
[<i>Maryland State Library.</i>]	75,000	[iii]	D
[Saint John's College.]	6,000	[iii]	D
United States Naval Academy.	26,893	[iii]	
BALTIMORE.			
Archiepiscopal Library.	15,000		
[Baltimore City College.]	5,000		
Calumet Club.			X
Enoch Pratt Free Library of Baltimore City.	40,888	[iii]	D
[<i>Johns Hopkins University.</i>]	30,000	[iii]	D
Library Company of the Baltimore Bar.	10,000		
Loyola College.	12,000	[ii]	X
[Maryland Academy of Sciences.]	800	[ii]	
Maryland Historical Society.	20,000	[iii]	D
Maryland Institute for the Promotion of Mechanic Arts.	20,515	[iii]	
[Maryland State Normal School.]	2,516	[ii]	
Mercantile Library Association of Baltimore.	40,000	[iii]	
Mount Clare Library.			X
Odd Fellows' Library.	21,952		
Peabody Institute.	83,000	[iii]	D
Saint Mary's University and Theological Seminary of Saint Sulpice.	26,000	[iii]	
Catonsville.			
Catonsville Library Association.	3,000		X
Charlotte Hall.			
Charlotte Hall School Library.	1,000		X
Chestertown.			
[Washington College.]	2,000	[iii]	X
College of Saint James.			
College of Saint James (High School).	8,000	[iii]	
CUMBERLAND. (No public library.)			
Easton.			
Easton High School.			X

Ellicott City.			
[Rock Hill College.]	6,300	[i]	X
[Saint Charles College.]	9,900		
Emmitsburg.			
[Mount Saint Mary's College.]	8,000	[iii]	
Hagerstown.			
Hagerstown Library Association.			X
Ilchester.			
<i>Mount Saint Clement's College.</i>	10,600		
New Windsor.			
[New Windsor College and Windsor Female College.]	3,000		
Reisterstown.			
Hannah Moore Academy.			X
Sandy Springs.			
Sandy Springs Library.			X
Westminster.			
[Western Maryland College.]	1,000	[ii]	D
Westminster Library.			X
Woodstock.			
<i>Woodstock College.</i>	67,000	[iii]	

MASSACHUSETTS.

Amherst.			
[<i>Amherst College.</i>]	40,000	[iii]	D
[Massachusetts Agricultural College.]	4,400	[ii]	
Andover.			
<i>Andover Theological Seminary.</i>	42,938	[iii]	
ATTLEBOROUGH.			
Attleborough Free Public Library.	2,400		
Beverly.			
Public Library.	10,211	[i]	
BOSTON.			
[<i>American Academy of Arts and Sciences.</i>]	18,000	[iii]	
American Board of Commissioners for Foreign Missions.	7,273	[iii]	
<i>American Congregational Association.</i>	25,450	[i]	X
American Statistical Association.		[iii]	
<i>Boston Athenaeum.</i>	150,261	[iii]	D
Boston Chamber of Commerce.			D
[<i>Boston College.</i>]	10,000	[ii]	X
<i>Boston General Theological Society.</i>	15,000		
<i>Boston Library Society.</i>	26,000	[iii]	
<i>Boston Medical Library Association.</i>	15,000	[ii]	
[Boston Normal School.]			
<i>Boston Public Library.</i>	434,837	[iii]	D
<i>Boston Social Law Library.</i>	19,500		
<i>Boston Society of Natural History.</i>	30,000	[iii]	
[<i>Boston University.</i>]	12,000	[ii]	
[<i>Massachusetts Historical Society.</i>]	31,000	[iii]	D
[<i>Massachusetts Institute of Technology.</i>]	4,117	[iii]	
[<i>Massachusetts Normal Art School.</i>]	300		
Naval Library and Institute (United States).	2,390	[iii]	
<i>New England Historic-Genealogical Society.</i>	20,778	[iii]	
[<i>State Library of Massachusetts.</i>]	60,000	[iii]	D
Bridgewater.			
[<i>State Normal School.</i>]	4,000	[ii]	

Brockton.			
<i>Brockton Public Library.</i>	10,341	[i]	
Brookline.			
<i>Brookline Public Library.</i>	30,842	[ii]	
CAMBRIDGE.			
<i>Cambridge Public Library.</i>	18,000		
[<i>Divinity School, Harvard.</i>] (Harvard College.)	17,400		
[<i>Harvard University.</i>]	239,500	[iii]	D
[<i>Law School, Harvard.</i>] (Harvard College.)	21,600		
[<i>Museum of Comparative Zoology.</i>] (Harvard College.)	17,600	[iii]	
<i>Porcelain Club.</i> (Harvard College.)	10,000		
[<i>Peabody Museum of American Archæology and Ethnology.</i>] (Harvard College.)	795	[iii]	
Cambridgeport.			
Cambridge Public Library.		[ii]	
CHELSEA.			
Chelsea Public Library.	8,646		X
CHICOPEE.			
Chicopee Town Library.	8,300		
Clinton.			
<i>Bigelow Free Public Library.</i>	13,000		
College Hill.			
[<i>Tuft's College.</i>]	22,000	[iii]	X
Concord.			
<i>Concord Free Public Library.</i>	19,643	[iii]	X
Cummington.			
Bryant Free Library.	5,300		X
Danvers.			
<i>Peabody Institute and Library.</i>	12,000	[ii]	
Dedham.			
Dedham Public Library.	8,920		D
FALL RIVER.			
Fall River Public Library.		[iii]	X
[<i>Fall River Training School.</i>]	300		
FITCHBURG.			
<i>Fitchburg Public Library.</i>	17,000		X
Framingham.			
<i>Framingham Town Library.</i>	12,000		X
[<i>State Normal School.</i>]	2,000		
GLOUCESTER.			
Sawyer Free Library.	7,000	[iii]	
HAVERTHILL.			
<i>Haverhill Public Library.</i>	39,268	[iii]	X
[<i>Haverhill Training School.</i>]	50		
Hingham.			
Hingham Public Library.	5,800		X
Hingham Centre.			
Hingham Public Library.	5,800	[iii]	
HOLYOKE.			
<i>Holyoke Public Library.</i>	11,000		X
Ipswich.			
<i>Ipswich Public Library.</i>	10,000	[ii]	
Jamaica Plains.			
[<i>Bussey Institution.</i> (Harvard University.) Agricultural and Horticultural.]	2,700	[ii]	

Lancaster.			
<i>Lancaster Town Library.</i>	16,281	[iii]	
LAWRENCE.			
<i>Lawrence Public Library.</i>	27,322	[iii]	X
[Lawrence Training School.]	125		
Leominster.			
<i>Public Library.</i>	10,800	[i]	
Lexington.			
<i>Carey Memorial Library.</i>	10,000	[ii]	
LOWELL.			
<i>Lowell City Library.</i>	30,000	[iii]	X
<i>Middlesex Mechanics' Association.</i>	20,000	[iii]	D
LYNN.			
<i>Lynn Free Public Library.</i>	34,411	[ii]	D
MALDEN.			
<i>Malden Public Library.</i>	10,724	[i]	X
MARLBOROUGH.			
<i>Marlborough Free Public Library.</i>	8,600		X
Medford.			
<i>Medford Public Library.</i>	10,260		
Middleborough.			
<i>Middleborough Public Library.</i>	3,955		X
Milton.			
<i>Milton Public Library.</i>	10,000		X
Nantucket.			
<i>Nantucket Athenæum.</i>	6,500	[iii]	
Natick.			
<i>Morse Institute.</i>	13,647		
NEW BEDFORD.			
<i>Free Public Library of New Bedford.</i>	50,000	[iii]	D
NEWBURYPORT.			
<i>Newburyport Public Library.</i>	23,282	[iii]	X
NEWTON.			
<i>Newton Free Library.</i>	23,309	[ii]	X
Newton Centre.			
<i>Newton Theological Institution.</i>	18,000	[iii]	
NORTH ADAMS.			
<i>North Adams Public Library.</i>	5,777		
NORTHAMPTON.			
<i>Northampton Free Public Library.</i>	20,000	[iii]	
[Smith College.]	5,000	[ii]	X
North Easton.			
<i>Ames Free Library.</i>	11,059		
Peabody.			
<i>Peabody Institute.</i>	25,507	[iii]	
PITTSFIELD.			
<i>Berkshire Athenæum.</i>	16,000	[i]	X
QUINCY.			
<i>Thomas Crane Public Library.</i>	14,000	[ii]	X
Randolph.			
<i>Turner Free Library.</i>	10,000		
Roxbury.			
<i>Fellows' Athenæum (formerly Roxbury Athenæum).</i>		[iii]	
SALEM.			
<i>Essex Institute.</i>	37,000	[iii]	D
<i>Peabody Academy of Science.</i>	5,000	[iii]	

SALEM—Continued.			
<i>Salem Athenæum.</i>	19,000	[iii]	
[Salem State Normal School.]	5,000		
SOMERVILLE.			
<i>Somerville Public Library.</i>	12,637		
Southbridge.			
<i>Southbridge Public Library.</i>	10,180	[i]	X
South Hadley.			
<i>Mount Holyoke Female Seminary.</i>	11,000	[ii]	
South Natick.			
Historical and Natural History and Library Society.	965	[ii]	
Spencer.			
Spencer Public Library.	6,000		X
SPRINGFIELD.			
<i>City Library Association.</i>	55,000	[iii]	X
TAUNTON.			
<i>Public Library.</i>	24,434	[iii]	D
WALTHAM.			
<i>Waltham Public Library.</i>	13,000	[ii]	
Watertown.			
<i>Free Public Library.</i>	15,791	[iii]	
Wayland.			
<i>Wayland Free Public Library.</i>	10,000	[i]	
Wellesley.			
[<i>Wellesley College.</i>]	30,321	[iii]	
Westfield.			
<i>Westfield Athenæum.</i>	14,000		
[Westfield State Normal School.]	2,000		
WEYMOUTH.			
Tuft's Library.	9,114	[i]	
Williamstown.			
[<i>Williams College.</i>]	34,000	[iii]	D
Winchester.			
Winchester Public Library.	6,300	[ii]	
WOBURN.			
<i>Woburn Public Library.</i>	23,789	[iii]	X
WORCESTER.			
<i>American Antiquarian Society.</i>	80,000	[iii]	D
[Clark University.]		[iii]	
<i>Free Public Library of the City of Worcester.</i>	63,941	[iii]	D
[<i>College of the Holy Cross.</i>]	14,000	[iii]	
[Massachusetts State Normal School.]	6,329	[i]	
Worcester County Free Institute of Industrial Sciences.	1,200	[ii]	
<i>Worcester Society of Antiquity.</i>	10,000	[i]	

MICHIGAN.

Ads:			
[Adrian City Training School for Teachers.]			
[Adrian College.]	4,000	[iii]	
Agricultural College.	5,000		
[Michigan Agricultural College.]	7,474	[iii]	X
Albion.			
[Albion College.]	5,621	[iii]	X
Alma.			
Alma College.			X

Ann Arbor.				
[<i>University of Michigan.</i>]	60,201	[iii]		D
Battle Creek.				
[<i>Battle Creek College.</i>]	1,300	[i]		
<i>Battle Creek Public School Library.</i>	7,000	[i]		D
BAY CITY.				
<i>Bay City Public Library.</i>	10,000			D
Benzonia.				
[<i>Grand Traverse College.</i>]				
Big Rapids.				
<i>Big Rapids Public School Library.</i>	1,665			X
Cassopolis.				
<i>Cassopolis Public School Library.</i>				X
DETROIT.				
<i>Detroit College.</i>	4,550	[i]		D
<i>Detroit Scientific Association.</i>	750	[i]		X
[<i>Historical Society of Michigan.</i>]		[i]		
<i>Public Library of the City of Detroit.</i>	59,653	[iii]		D
EAST SAGANAW.				
<i>Hoyt Public Library.</i>	6,531			X
EsCANABA.				
<i>EsCANABA High School Library.</i>	800			X
Grand Haven.				
<i>Akley College.</i>				X
GRAND RAPIDS.				
<i>Grand Rapids Public Library.</i>	17,000	[ii]		D
Hillsdale.				
[<i>Hillsdale College.</i>]	7,060	[iii]		X
Holland.				
[<i>Hope College.</i>]	6,923			X
Houghton.				
<i>Houghton Historical Society and Mining Institute.</i>	500			D
IONIA.				
<i>IONIA Public School Library.</i>	500			X
JACKSON.				
<i>JACKSON Public Library.</i>	5,338	[i]		D
Kalamazoo.				
[<i>Kalamazoo College.</i>]	3,376	[iii]		
<i>Kalamazoo Public Library.</i>	11,419	[i]		D
<i>Ladies' Library Association.</i>	3,290	[ii]		
LaSING.				
[<i>Michigan State Library.</i>]	46,000	[iii]		D
Lapeer.				
<i>Lapeer High School Library.</i>	500			X
Manistee.				
<i>Manistee Public School Library.</i>				D
MUSKEGON.				
<i>Muskegon Public School Library.</i>	4,007	[i]		X
Olivet.				
[<i>Olivet College.</i>]	14,700	[ii]		
Orchard Lake.				
<i>Michigan Military Academy.</i>	650	[i]		D
Petoskey.				
<i>Ladies' Library Association.</i>	335			X

Pontiac.			
Ladies' Library Association.	925		X
Port Huron.			
Ladies' Library Association of Port Huron.	3,000	[ii]	D
SAGINAW.			
Saginaw Public and Union School Library.	4,000		
St. Clair.			
Union School Library.	300		F
Sault de Ste. Marie.			
Sault de Ste. Marie Public School Library.			X
West Bay City.			
<i>Sage Public Library.</i>	12,000	[i]	X
Wyandotte.			
Wyandotte Public Library.	1,000		X
Ypsilanti.			
[State Normal School.]	7,938	[i]	X
MINNESOTA.			
Albert Lea.			
Albert Lea College for Young Ladies.		[i]	X
Alexandria.			
Alexandria Public Library.	1,025	[i]	X
Collegeville.			
[Saint John's University.]	9,500		
Duluth.			
Duluth Chamber of Commerce.			X
Duluth Public Library.			X
Young Men's Christian Association Reading Room.		[ii]	
Faribault.			
Faribault Public Library.			D
Hamline.			
[Hamline University.]	3,500	[i]	X
Mankato.			
[State Normal School.]	2,500	[i]	D
MINNEAPOLIS.			
[College of Agriculture of the University of Minnesota.]			
<i>Minneapolis Public Library.</i>	31,000	[iii]	
[Minnesota Academy of Natural Sciences.]		[i]	
[<i>University of Minnesota.</i>]	21,000	[iii]	D
[Augsburg Seminary.]	1,000		
Moorhead.			
[Moorhead State Normal School.]			
New Ulm.			
New Ulm Turnerverein Library.	1,064		X
Northfield.			
[Carleton College.]	8,000	[ii]	X
Saint Anthony Park. (See Minneapolis.)			
Saint Cloud.			
Saint Cloud City Library.	1,600		X
[State Normal School.]	6,000	[ii]	D
SAINT PAUL.			
[<i>Minnesota Historical Society.</i>]	12,338	[iii]	D
<i>Saint Paul Public Library.</i>	11,500	[ii]	X
[<i>State Library.</i>]	14,142	[iii]	D
Saint Peter.			
Gustavus Adolphus College.	2,000		X

Stillwater.			
Stillwater Library Association.	2,600	[iii]	D
WINONA.			
[State Normal School.]	5,000	[i]	D
Winona Free Library.	3,000	[i]	X

MISSISSIPPI.

Agricultural College. (See Starkville.)			
Blue Mountain.			
Blue Mountain Female College.	443	[i]	X
Brookham.			
Whitworth Female College.	600		X
Buena Vista.			
Buena Vista Normal College.			X
Carrolton.			
Carrolton Female College.	700		X
Carthage.			
Carthage High School Public Library.			X
Clinton.			
Central Female Institute.	2,000		X
[Mississippi College.]	2,000	[i]	D
Columbus.			
Columbus Public Library.	1,895	[i]	D
Female Industrial College.		[ii]	
Daleville.			
Cooper Normal College.	3,500	[ii]	
Giltsborough.			
Giltsborough College.			X
Greenville.			
Greenville Public Library.	2,200		D
Grenada.			
Grenada Female College.			X
Harpersville.			
Harpersville Public Library.			X
Holly Springs.			
[Mississippi State Normal School.]	3,000		D
[Rust University.]	1,000		
Holmesville.			
[Kavanaugh College.]			
Jackson.			
[Mississippi Historical Society.]		[i]	
[State Library.] (Smithsonian publications transferred to Agricultural and Mechanical College.)	40,000		D
Jefferson.			
Jefferson Academy.			X
Natchez.			
Natchez Library Association.	3,100	[i]	D
Oxford.			
[University of Mississippi.] (University P. O.)	12,000	[iii]	D
Rodney.			
[Alcorn Agricultural and Mechanical College.] (Colored.)	1,353	[i]	
Starkville.			
[Agricultural and Mechanical College of Mississippi.]	2,342	[iii]	D
Summit.			
Lea Female College.	300	[i]	X

Tougaloo.			
[Tougaloo University.]	500		
VICKSBURG. (No public library.)			
Washington.			
Jefferson College. (Academy.)	2,000	[ii]	X
West Point.			
West Point Male and Female Academy.			X
MISSOURI.			
Albany.			
Albany Public School.			X
Avalon.			
Avalon College of the United Brethren in Christ.	500	[i]	X
Bolivar.			
[Southwest Baptist College.]	600	[i]	
Boonville.			
Kemper Family School.	1,200		X
Cameron.			
Cameron Library.	422		X
Canton.			
[Christian University.]	600		
Cape Girardeau.			
[Missouri State Normal School.] (Third District.)	1,800		X
[<i>St. Vincent's College.</i>]	10,000		D
Carthage.			
Public School Library.	527		D
Chillicothe.			
Chillicothe High School Library.			D
Clinton.			
Baird College.			X
Columbia.			
[Agricultural and Mechanical College.]	1,000		
[<i>University of Missouri.</i>]	14,520	[iii]	D
Denver.			
Denver Public Library.			X
Edinburgh.			
[Grand River College.]	450	[i]	
Fayette.			
[Central College.]	4,300	[ii]	
Howard Female College.	600		X
Fulton.			
[Westminster College.]	2,500		D
Gallatin.			
Gallatin Public School Library.			D
Glasgow.			
[Lewis College.]	5,000		
[Pritchett School Institute.]	300	[i]	
HANNIBAL.			
Hannibal Public Library.			
Independence.			
Independence Young Men's Christian Association.			X
Jefferson City.			
[Lincoln Institute.]	850		X
[<i>Missouri State Library.</i>]	18,000	[iii]	D
KANSAS CITY.			
Kansas City Public Library.	12,000	[ii]	D

Keytesville.				
Keytesville Library.				X
Kirkville.				
[Missouri State Normal School.] (First District.)	1,127	[iii]		D
La Grange.				
[La Grange College.]	1,800	[i]		
Liberty.				
[William Jewell College.]	4,000	[ii]		
Marionville.				
Marionville Collegiate Institute.	350			X
Morrisville.				
[Morrisville College.]	600			
Nevada.				
Nevada Public School Library.	400			X
Parkville.				
Parkville College.	1,500	[i]		X
Rolla.				
[Missouri School of Mines and Metallurgy, University of Missouri.]		[i]		X
SAINT JOSEPH.				
Mechanical and Scientific Library Association.				D
SAINT LOUIS.				
[College of the Christian Brothers.]	5,000			D
Law Library Association of St. Louis.	14,320			
Missouri Botanical Gardens.	3,000	[ii]		
[Missouri Historical Society.]	4,000	[i]		D
[Saint Louis Academy of Sciences.]	10,000	[iii]		
Saint Louis Labor Library.				X
Saint Louis Mercantile Library.	65,657	[iii]		D
[Saint Louis Normal School.]	500			
Saint Louis Public Library.	60,000	[iii]		D
[Saint Louis University.]	25,000	[iii]		D
Saint Theresa's School.				X
[Washington University.]	8,000	[iii]		
Sedalia.				
Sedalia Natural History Society.	500	[i]		X
Young Men's Christian Association.	600			X
Springfield.				
[Drury College.]	20,000	[iii]		D
Knights of Labor Library.				X
Warrensburgh.				
[State Normal School.] (Second District.)	1,500	[ii]		
Warrenton.				
[Central Wesleyan College.]	3,600	[i]		
MONTANA.				
Deer Lodge.				
[College of Montana.]	1,000			X
Helena.				
[Historical Society of Montana.]	5,000	[ii]		D
[Montana State Library.]	4,000	[i]		D
NEBRASKA.				
Beatrice.				
Beatrice Public Library.				X
Central City.				
[Nebraska Central College.]	300			

Crete.				
[Doane College.]	3,350	[ii]	X	
Franklin.				
Franklin Academy.	550	[i]	X	
Fremont.				
Fremont Normal School Library.			X	
Fremont Reading Room Library.			D	
Hastings.				
Hastings College.	1,200		D	
Humboldt.				
Brunn Memorial Public Library.	2,000		X	
LINCOLN.				
Industrial College of the University of Nebraska.				
[State Historical Society of Nebraska.]	349	[i]		
[Nebraska State Library.]	24,398	[iii]	D	
[University of Nebraska.]	8,382	[i]	D	
Nebraska City.				
Ladies' Library Association.	1,743		D	
Nebraska Institute for the Blind.	400		X	
Neligh.				
[Gates College.]	3,000	[i]	X	
Norfolk.				
Norfolk Public Library.			X	
Omaha.				
[Creighton College.]	5,300	[i]	X	
Omaha Public Library.	14,237	[iii]	D	
Peru.				
[State Normal School.]	3,250	[ii]	X	
York.				
[Methodist Episcopal College of Nebraska.]				
NEVADA.				
Carlin.				
Carlin Library Association.	1,777		X	
Carson City.				
[State Library of Nevada.]	18,000	[i]	D	
Paradise.				
Paradise Public School Library.			X	
Reno.				
Reno Library Association.			X	
[School of Agriculture of the Nevada State University.]				
[State University of Nevada.]	1,000	[i]	D	
VIRGINIA CITY.				
Miners' Union Library of Virginia City.	4,000		D	
Wadsworth.				
Nevada Engineers and Mechanics' Library.			X	
NEW HAMPSHIRE.				
Claremont.				
Fiske Free Library.	4,857	[i]	X	
CONCORD.				
Concord Public Library.	11,300		X	
[New Hampshire Historical Society.]	10,300	[iii]		
[New Hampshire State Library.]	20,000	[iii]	D	
DOVER.				
Dover Public Library.	7,153		X	

Great Falls.			
Great Falls Manufacturers and Village Library.	7,500	[i]	X
Hanover.			
[<i>Dartmouth College.</i>]	67,000	[iii]	D
[<i>New Hampshire College of Agriculture.</i>]		[ii]	
Keene.			
Keene Public Library.	6,000	[i]	X
MANCHESTER.			
<i>Manchester City Library.</i>	28,660	[iii]	D
[<i>Manchester City Training School.</i>]	140		
NASHUA.			
Nashua Public Library.	8,500		X
Plymouth.			
[<i>New Hampshire State Normal School.</i>]	450		
Portsmouth.			
<i>Portsmouth Athenæum.</i>	15,133	[iii]	D
Portsmouth Free Public Library.	7,245	[ii]	
Rochester.			
Rochester Public Library.			X
NEW JERSEY.			
Burlington.			
<i>Burlington Library.</i>	10,000	[iii]	
CAMDEN.			
Microscopical Society of Camden.	340		
Delanco.			
Delanco Library.			X
ELIZABETH.			
Elizabeth Public Library and Reading Room.	4,500		
Hightstown.			
Peddie Institute.	1,200		X
HOBOKEN.			
German Academy of Hoboken.			X
Stevens Institute of Technology.	5,000	[iii]	
JERSEY CITY.			
Jersey City Public School Free Library.	5,000		D
St. Peter's College.		[i]	X
Long Branch.			
Long Branch Free Reading Room and Library.	1,600		X
Lakewood.			
Lakewood Public Library.	1,450		X
Lawrenceville.			
Lawrenceville High School.			X
Madison.			
<i>Drew Theological Seminary.</i>	18,000	[iii]	X
Morristown.			
<i>Morristown Library and Lyceum.</i>	11,000	[ii]	D
Mount Holly.			
Burlington County Lyceum of History and Natural Science.	4,800	[i]	D
NEWARK.			
<i>Newark Library Association.</i>	27,523	[iii]	D
[<i>Newark Normal School.</i>]	140		
[<i>New Jersey Historical Society.</i>]	8,114	[iii]	
[<i>St. Benedict's College.</i>]	2,930		
NEW BRUNSWICK.			
[<i>Rutgers College.</i>]	19,000	[iii]	D
[<i>Rutgers Scientific School of Rutgers College.</i>]		[i]	
<i>Theological Seminary of the Reformed Church in America.</i>	38,000		

Newton.				
Dennis Library.	6,445	[ii]	D	
ORANGE.				
New England Society of Orange.	705			
Passaic.				
Passaic Free Public Library.			X	
PATERSON.				
[Paterson Normal Training School.]	1,200			
Paterson Free Public Library.	7,000	[ii]	D	
Princeton.				
[College of New Jersey.]	60,000	[iii]	D	
E. M. Museum of Geology and Archæology of the College of New Jersey.		[ii]		
Theological Seminary of the Presbyterian Church.	48,000	[iii]		
Rahway.				
Rahway Library Association.	9,043	[ii]		
Salem.				
Salem Library Company.	9,000	[i]	D	
TRENTON.				
[New Jersey State Normal School.]	500	[ii]		
[State Library of New Jersey.]	31,000	[iii]	D	
Vineland.				
[College of the Sacred Heart.]	5,000			
Vineland Public Library.	1,500		X	
NEW MEXICO.				
Las Cruces.				
[Agricultural College of New Mexico.]				
Las Vegas.				
Las Vegas College.	3,500		X	
Santa Fé.				
[Historical Society of New Mexico.]		[i]		
St. Michael's College.	1,300		X	
[Territorial Library of New Mexico.]	7,570	[i]	D	
[University of New Mexico.]	300	[ii]		
NEW YORK.				
ALBANY.				
Albany Catholic Union.			X	
New York State Agricultural Society.		[iii]		
New York State Library. (See New York State Library.)	37,300		D	
[New York State Library.]	128,871	[iii]	D	
New York State Museum of Natural History.	1,000	[iii]		
[New York State Normal School.]	5,000	[iii]	X	
[Teachers' Training Class of Albany.]				
Young Men's Association.	17,000			
Albion.				
Albion Union School.	625	[i]	X	
Alfred Centre.				
[Alfred University.]	5,000	[ii]		
Allegany.				
[St. Bonaventure's College and Seminary.]	6,358	[i]		
Annandale.				
[St. Stephen's College.]	5,500	[ii]		
AUBURN.				
Seymour Library Association.	9,439	[ii]	D	
Theological Seminary of Auburn.	16,417	[ii]		

Aurora.			
[Wells College.]	2,600	[i]	
Bath.			
Bath Library Association.	5,500	[ii]	D
BINGHAMTON.			
Binghamton Library Association.	3,000		D
Brockport.			
[State Normal and Training School.]	7,000	[i]	D
BROOKLYN.			
Adelphi Academy.	1,846	[i]	X
[Brooklyn Collegiate and Polytechnic Institute.]	3,000		X
Brooklyn Institute. (Yonths' Free Library.)		[iii]	
<i>Brooklyn Library.</i>	90,000	[iii]	D
[Brooklyn Training School.]			
Columbian Club.	789		X
<i>Eastern District School Library.</i>	17,000		
<i>Long Island Historical Society.</i>	41,000	[iii]	D
Packer Collegiate Institute.	4,929	[ii]	X
Saint Augustine Mechanical Library.			X
Saint Francis's College.]	3,000		
Saint Peter's Library.			X
Young Men's Christian Association.	7,854		D
BUFFALO.			
Buffalo Catholic Institute.	4,000		X
Buffalo Historical Society.	8,237	[i]	
<i>Buffalo Library.</i>	53,000	[iii]	X
Buffalo Mechanics' Institute.	6,000		X
Buffalo Society of National Sciences.	3,300	[iii]	
[Buffalo State Normal and Training School.]			
[<i>Canisius College.</i>]	14,500	[ii]	
<i>Grosvener Library.</i>	31,000	[iii]	D
Canastota.			
Union School and Academy. (District No. 9.)	500		X
Canton.			
[St. Lawrence University.]	9,400	[ii]	D
Catskill.			
Catskill School Library. (District No. 1.)	1,672		X
Cattaraugus.			
Cattaraugus Union Free School.			X
Cazenovia.			
Cazenovia Seminary.	3,000		X
Clinton.			
[<i>Hamilton College.</i>]	20,000	[iii]	X
Coblekill.			
Union School Library.			D
COHOES.			
Cohoes City Library.	2,000		
Corning.			
Corning Library Association.	8,600	[ii]	
Cortland.			
Franklin Hatch Library Association.			X
[State Normal and Training School.]	2,220	[ii]	
Dausville.			
Union School Library.	1,000		X
Ellicottville.			
Ellicottville Union Free School.			X

ELMIRA.			
Young Men's Christian Association.	3,890	[ii]	X
Fordham (see Tremont.)			
FREDONIA.			
[State Normal and Training School.]	2,500	[i]	
GENESEO.			
[State Normal and Training School.]	4,000		
<i>Wadsworth Library.</i>	10,000		D
GENEVA.			
[<i>Hobart College.</i>]	18,000	[iii]	X
GLENS FALLS.			
Union Free School Library.	796		D
HAMILTON.			
[<i>Madison University.</i>]	17,821	[iii]	
HAVANA.			
Cook Academy.	1,200	[iii]	X
HERKIMER.			
Union Free School.			X
HORNELLVILLE.			
Hornell Library Association.	7,300	[ii]	X
HOOSICK FALLS.			
High School Library.			X
HUDSON.			
Franklin Library.	4,674		X
ITHACA.			
[<i>Cornell University.</i>]	54,840	[iii]	D
[<i>College of Agriculture of Cornell University.</i>]			
<i>Cornell Library.</i>	13,851		X
JAMESTOWN.			
City Public School Library.			D
KINGSTON.			
Kingston Academy.	1,145		X
LIMA.			
Genesee Wesleyan Seminary (formerly Genesee College).		[iii]	
LOCKPORT.			
Lockport Union School Library.	4,100		D
LONG ISLAND CITY.			
Fourth Ward School Library. (Astoria P. O.)	600		
Macedon Centre.			
Macedon Academy.	320		X
MALONE.			
Mead Library (District School Building).			X
MONTICELLO.			
Monticello Free School Library.			X
NEW BRIGHTON			
Natural Science Association of Staten Island.		[i]	
NEWBURGH.			
<i>Newburgh Free Library.</i>	15,229	[iii]	D
New Palz.			
[State Normal and Training School.]	1,508	[i]	
NEW YORK CITY.			
<i>American Geographical Society.</i>	18,000	[iii]	
<i>American Institute of the City of New York.</i>	13,000	[iii]	
American Institute of Mining Engineers.	2,000	[i]	
American Museum of Natural History.	6,094	[iii]	
American Numismatic and Archaeological Society.	1,000	[i]	

NEW YORK CITY—Continued.

<i>American Seamen's Friend Society.</i>	38,592		
<i>American Society of Civil Engineers.</i>	16,375	[i]	
<i>Apprentices' Library.</i>	69,537		X
<i>Astor Library.</i>	223,284	[iii]	D
<i>Bar Association of the City of New York.</i>	27,237		
Board of Foreign Missions of the Presbyterian Church.		[iii]	
Central Park Menagerie.		[ii]	
Century Club.	4,536	[i]	
Chamber of Commerce.			D
[<i>College of the City of New York.</i>]	23,878	[iii]	D
College of Pharmacy of the City of New York.	3,500	[ii]	
[<i>College of St. Francis Xavier.</i>]	22,000	[iii]	
[<i>Columbia College.</i>]	93,144	[iii]	D
School of Mines of Columbia College.		[ii]	
<i>Cooper Union for the Advancement of Science and Art.</i>	20,000	[iii]	D
<i>Free Circulating Library and Ottendorfer Branch.</i>	21,624	[i]	X
<i>General Theological Seminary of the Protestant Episcopal Church.</i>	19,000	[iii]	
<i>Grand Lodge Free and Accepted Masons.</i>	10,000		
<i>Harlem Library.</i>	12,000	[i]	D
<i>Harmonic Social Club.</i>	10,000		
<i>Lenox Library.</i>	25,000	[iii]	D
<i>Maimonides Library, L. O. B. B.</i>	26,840	[iii]	
[<i>Manhattan College.</i>]	10,000	[i]	
<i>Maritime Library Association.</i>	210,431	[iii]	D
Metropolitan Museum of Art (Central Park).	1,371	[iii]	
<i>New York Academy of Medicine.</i>	30,000	[ii]	
[<i>New York Academy of Sciences.</i>]	8,000	[iii]	
<i>New York Apprentices' Library.</i>	69,537	[iii]	
[<i>New York Female Normal School.</i>]			
[<i>New York Historical Society.</i>]	75,000	[iii]	D
<i>New York Hospital.</i>	16,000	[i]	
<i>New York Law Institute.</i>	34,000	[i]	
<i>New York Press Club.</i>	2,000		X
<i>New York Society Library.</i>	80,000	[iii]	X
<i>New York Turnverein Bibliothek.</i>	4,860		X
School of Mines. (See Columbia College.)			
<i>Union Theological Seminary.</i>	50,000	[iii]	
University Club Library.	2,907	[i]	X
[<i>University of the City of New York.</i>]	10,000	[iii]	
Saint James' Library.			X
Saint Mary's Library.			X
<i>Xavier Union of the City of New York.</i>	13,746	[i]	
<i>Young Men's Christian Association.</i>	33,111	[iii]	D
Niagara University (see Suspension Bridge).			
OGDENSBURGH.			
Ogdensburg Educational Institute.	7,350		
Oneonta.			
Union School (District No. 5).	600		X
OSWEGO.			
Oswego City Library.	8,634	[ii]	
[<i>Oswego State Normal and Training School.</i>]	1,475	[i]	X
Peekskill.			
Field Library.			X

Plattsburgh.			
Railroad Young Men's Christian Association.			X
Potsdam.			
[State Normal and Training School.]			X
POUGHKEEPSIE.			
<i>Poughkeepsie City Library.</i>	14,240	[ii]	D
<i>Vassar College.</i>	15,000	[iii]	X
ROCHESTER.			
<i>Court of Appeals.</i>	12,000		
<i>Public School Central Library.</i>	14,249	[i]	
<i>Reynolds Library.</i>	14,000	[iii]	X
[Teachers' Normal Training Class.]			
<i>Rochester Theological Seminary.</i>	20,590	[iii]	
[<i>University of Rochester.</i>]	21,790	[iii]	D
ROME.			
Central New York Institution for Deaf Mutes.			
SCHENECTADY.			
[<i>Union College.</i>]	24,038	[iii]	D
Sing Sing.			
<i>Mount Pleasant Military Academy.</i>	12,000		
Skaeateles.			
Skaneateles Library Association.		[i]	X
Springville.			
Griffith Institute.	497	[i]	X
Suspension Bridge.			
De Veaux College.		[iii]	
[Niagara University] (Niagara University P. O.)	9,000	[i]	
SYRACUSE.			
<i>Central Library.</i>	15,889	[iii]	X
<i>Court of Appeals.</i>	10,420		
[Syracuse Training School.]			
[<i>Syracuse University.</i>]	10,714	[iii]	D
Tremont.			
[<i>St. John's College</i>] (formerly Fordham).	24,800	[iii]	D
TROY.			
Rensselaer Polytechnic Institute.	4,600	[ii]	
Troy Female Seminary.	1,664	[iii]	
Troy High School Library.	691		X
<i>Troy Young Men's Association.</i>	27,210	[iii]	D
UTICA.			
Oneida Historical Society.	1,441	[i]	X
State Lunatic Asylum.	3,500	[iii]	
<i>Utica City Library.</i>	10,479	[ii]	D
WATERTOWN.			
Watertown Public School Library.	5,000		X
West Point.			
<i>United States Military Academy.</i>	30,827	[iii]	
Whitestone.			
Engineer School of Application of United States Army.		[iii]	
YONKERS.			
Yonkers Public Library.	4,600	[i]	
NORTH CAROLINA.			
Chapel Hill.			
Elisha Mitchell Science Society. (University of North Carolina.)		[i]	X
[North Carolina College of Agriculture and Mechanic Arts.]	2,000		
[University of North Carolina.]	8,000	[iii]	D

Charlotte.			
[Biddle University.]	3,120		
Clinton.			
Clinton Female Seminary.			X
Conover.			
Conover College.		[i]	X
Davidson College.			
[Davidson College.]	3,000	[iii]	
Fayetteville.			
Fayetteville Library Association.			D
[Fayetteville State Normal School.]	760		
Goldaborough.			
Goldaborough Graded School.			X
Greensborough.			
Greensborough Graded School.			D
Haysville..			
Haysville High School.			X
Ledger.			
Goodwill Free Library.			X
Lenoir.			
Davenport Female College.		[ii]	
Pioneer Library of North Carolina.	1,100	[i]	D
Mount Airy.			
Mount Airy Library.			X
Mount Pleasant.			
[North Carolina College.]	920		
New Berne.			
[New Berne State Normal School.]			
New Berne Young Men's Christian Association.			X
Plymouth.			
[Plymouth State Colored Normal School.]	125		
Raleigh.			
[North Carolina Agricultural Experiment Station.]		[i]	
[North Carolina State Library.]	45,000	[iii]	D
[Shaw University.]	3,000		
Rutherford.			
[Rutherford College.]	4,000		
Salisbury.			
[Salisbury State Colored Normal School.]	800		
Trinity College.			
[Trinity College.]	3,900	[iii]	
Wake Forest.			
[Wake Forest College.]	8,400	[ii]	X
Warrenton.			
Warrenton Female Collegiate Institute.	1,500	[ii]	
Weaverville.			
[Weaverville College.]	113		
WILMINGTON.			
Historical and Scientific Society.		[i]	
Wilson.			
Wilson High School.			X
Winston.			
Winston Graded School Library.	2,500		X

NORTH DAKOTA.

Bismarck.			
[North Dakota State Library.]			D
Fargo.			
[North Dakota Agricultural College.]			
Grand Forks.			
[University of North Dakota.]	1,000		D

OHIO.

Ada.			
Ohio Normal University.	4,000		X
AKRON.			
Akron Public Library.	8,000		X
[Buchtel College.]	3,500	[i]	D
Alliance.			
[Mount Union College]. (Mount Union P. O.)	6,000	[i]	D
Ashland.			
[Ashland College.]		[i]	
Athens.			
[Ohio University.]	6,000	[iii]	D
Berea.			
[Baldwin University.]	713		
[German Wallace College.]	3,000		
Bluffton.			
Bluffton Public Library.			X
Brooklyn Village.			
[Calvin College.]			
Bryan.			
Bryan Library.	1,100	[i]	X
Cambridge.			
Cambridge Public School Library.			X
CANTON.			
Canton Public School Library.	1,881		X
Cuyahoga Falls.			
Cuyahoga Falls Public Library.			X
CHILLICOTHE.			
Chillicothe Public Library.	10,000		D
CINCINNATI.			
Cincinnati Law Library.	10,000		
[Cincinnati Normal School.]	100		
Cincinnati Society of Natural History.	2,800	[iii]	X
[Cincinnati University.]		[iii]	X
Cincinnati Wesleyan College.	1,000	[ii]	
[Historical and Philosophical Society of Ohio.]	9,720	[iii]	
[Industrial and Art School of Ohio Mechanical Institute.]	2,000		
Lane Theological Seminary.	13,090	[iii]	X
Public Library of Cincinnati.	142,853	[iii]	D
[Saint Joseph's College.]	3,000		
[Saint Xavier's College.]	15,300		
Young Men's Mercantile Library Association.	50,000	[iii]	D
Circleville.			
Circleville Public Library.	3,800		X
CLEVELAND.			
[Adelbert College of Western Reserve University.]	9,000		X
Case Library.	20,000	[iii]	D
Case School of Applied Sciences.		[ii]	
Cleveland Law Library.	7,141		X

CLEVELAND—Continued.			
[Cleveland Normal School.]			
<i>Cleveland Public Library.</i>	45,905	[iii]	D
Socialar Turnverein.			X
Western Reserve University.		[iii]	
College Hill.			
[Belmont College.]	1,500	[iii]	X
COLUMBUS.			
[Capital University.]	3,781		
Ohio State Board of Agriculture.	1,500	[i-i]	
<i>Ohio State Law Library (Ohio State Library).</i>	18,000		
[<i>Ohio State Library.</i>]	53,500	[iii]	D
[Ohio State University.]	5,500	[ii]	
<i>Public Library and Reading Room of the City of Columbus.</i>	18,500	[ii]	D
DAYTON.			
[Dayton Normal School.]	256		
<i>Public Library.</i>	21,232	[iii]	D
Defiance.			
Defiance Library Association.	1,300		X
Delaware.			
[<i>Ohio Wesleyan University.</i>]	13,786	[iii]	D
Fremont.			
Birchard Library.	9,000	[ii]	X
Gallipolis.			
Union School Library.	700		X
Gambia.			
[<i>Kenyon College.</i>]	20,000	[iii]	D
Geneva.			
[Geneva Normal School.]	100		
Germantown.			
Germantown Public Library.			X
[Twin Valley College.]		[i]	
Granville.			
[Denison University.]	9,000	[iii]	D
HAMILTON.			
Lane Free Library.	4,500		X
Hillsborough.			
Public Library.	5,250	[i]	X
Hiram.			
[Hiram College.]	5,000	[ii]	D
Ironton.			
Briggs Library Institute.	514		X
Lancaster.			
Lancaster Free Library and Reading Room.	3,500		X
Lebanon.			
Mechanics' Institute.	600	[ii]	
National Normal University.	5,000	[i]	X
Lee.			
Wells Library.	1,625	[i]	X
Leipsic.			
Union School.			X
Lima.			
Citizens' Library.	500		X
Mansfield.			
Mansfield Memorial Library.	3,500	[i]	X

Marietta.				
[<i>Marietta College.</i>]	20,130	[iii]	D	
Mount Vernon.				
Mount Vernon Public Library.		[i]	X	
New Concord.				
[<i>Muskingum College.</i>]	500	[i]		
New Lexington.				
New Lexington High School Library.	300		X	
Norwalk.				
Young Men's Library and Reading Room Association.	5,000	[i]	X	
Oberlin.				
[<i>Oberlin College.</i>]	13,819	[iii]	D	
Oxford.				
[<i>Miami University.</i>]	7,000	[iii]	D	
Painesville.				
Lake Erie Female Seminary.	2,500	[ii]		
Temperance Society and Young Men's Christian Association.	2,000		X	
Piqua.				
Piqua High School Library.	600		X	
PORTSMOUTH.				
Portsmouth Public Library.	7,180	[i]	D	
Rio Grande.				
[<i>Rio Grande College.</i>]	570			
SANDUSKY.				
Sandusky Public School Library.			X	
Scio.				
[<i>Scio College.</i>]		[i]		
Scio College Libraries.	1,000		X	
Sidney.				
Sidney Public Library.			D	
SPRINGFIELD.				
<i>Public Library.</i>	12,037	[iii]	D	
[<i>Wittenberg College.</i>]	8,000	[iii]		
STUEBENVILLE.				
Odd Fellows' Library.	3,000	[i]		
Syracuse.				
Carleton College.			X	
Tiffin.				
[<i>Heidelberg College.</i>]	6,000	[iii]	X	
TOLEDO.				
<i>Public Library of Toledo.</i>	23,000	[iii]	D	
Urbana.				
Urbana Library Association.			X	
[<i>Urbana University.</i>]	6,000	[ii]		
Washington.				
Washington Public Library.			X	
Westerville.				
[<i>Otterbein University.</i>]	4,000	[iii]		
Wilberforce.				
[<i>Wilberforce University.</i>]	4,000	[ii]	X	
Wilmington.				
[<i>Wilmington College.</i>]	1,130	[i]		
Wooster.				
[<i>University of Wooster.</i>]	10,300	[iii]	X	

Yellow Springs.			
[Antioch College.]	6,000	[iii]	
YOUNGSTOWN.			
Youngstown Young Men's Christian Association.			X
ZANESVILLE.			
Zanesville Athenæum.	9,000		X

OREGON.

Ashland.			
[Ashland College and Normal School.]	200		
Astoria.			
[Oregon Pioneer and Historical Society.]			
Corvallis.			
[Corvallis College.]	1,000		
[Oregon State Agricultural College.]			D
Drain.			
[State Normal School.]			X
Eugene City.			
[University of Oregon.]	1,256	[iii]	D
Forest Grove.			
[Pacific University and Tualatin Academy.]	5,400	[iii]	X
McMinnville.			
[McMinnville College.]	600		X
Monmouth.			
[Christian College.]			
[Oregon State Normal School.]			
Philomath.			
[Philomath College.]	600	[i]	
PORTLAND.			
Alpine Club.			X
Bishop Scott Grammar and Divinity School.	1,500	[ii]	
<i>Library Association of Portland.</i>	13,436	[iii]	D
Odd Fellows' Hall.			X
Roseburgh.			
Roseburgh Academy.			X
Salem.			
[Oregon State Library.]	12,000	[iii]	D
[Willamette University.]	3,000		

PENNSYLVANIA.

ALLEGHENY.			
Lincoln School.			X
Theological Seminary of the United Presbyterian Church.	3,100		X
<i>Public School Library.</i>	10,000	[i]	D
Western Pennsylvania Theological Seminary.		[iii]	
<i>Western Theological Seminary of the Presbyterian Church.</i>	25,000		
[Western University of Pennsylvania.]	5,600	[ii]	
ALLENTOWN.			
Allentown High School Library.			X
[Muhlenberg College.]	3,000		X
ALTOONA.			
Mechanics' Library and Reading Room Association.	6,000		X
Andalusia.			
Kingdale Library.			X
Annville.			
[Lebanon Valley College.]	2,150	[i]	

Beatty.			
[<i>St. Vincent's Abbey and College.</i>]	24,000	[i]	
Beaver Falls.			
[Geneva College.]	1,000	[i]	X
Blairsville.			
Blairsville Library Association.			X
Bloomsburg.			
Columbia County Law Library.	710		Y
[Pennsylvania State Normal School of the Sixth District.]	1,160		
Bryn Mawr.			
[Bryn Mawr College.]	3,000	[ii]	
California.			
[Southwestern State Normal School.]	800	[i]	
Carlisle.			
[Dickinson College.]	8,485	[iii]	
<i>Belles Lettres Society (Dickinson College).</i>	10,611		
<i>Union Philosophical Society (Dickinson College).</i>	10,681		
Chambersburg.			
Wilson Female College.	2,000		X
CHESTER.			
[Pennsylvania Military Academy.]	1,200		
<i>Crozer Theological Seminary.</i>	10,000		
Clarion.			
[Clarion State Normal School.]	1,500		
Collegeville.			
[Ursinus College.]	6,000	[i]	
Columbia.			
Schock's Library.			X
Curwensville.			
Curwensville Public School Library.			X
Danville.			
Thomas Bearer Library.			X
EASTON.			
Easton Library.	5,700	[ii]	
[<i>Lafayette College.</i>]	19,946	[iii]	X
Edinborough.			
[State Normal School.]	6,500	[i]	
ERIE.			
Law Library of the City of Erie.			X
Germantown.			
<i>Friends' Free Library and Reading Room.</i>	13,000	[ii]	X
Germantown Library Association.		[ii]	
Workingmen's Club of Germantown.	2,600	[i]	D
Gettysburg.			
[Pennsylvania College.]	9,000	[iii]	D
<i>Theological Seminary of the General Synod of the Evangelical Lutheran Church.</i>	12,000	[iii]	
Greenville.			
[Thiel College.]	5,000	[i]	
Grove City.			
[Grove City College.]	2,000		
HARRISBURG.			
[<i>Pennsylvania State Library.</i>]	60,000	[iii]	D
Young Men's Christian Association.	2,350		D
Hatborough.			
<i>Union Library.</i>	10,164	[i]	

Haverford.			
[<i>Haverford College.</i>]	15,530	[iii]	
Hazleton.			
Young Men's Christian Association.	1,000		X
Honesdale.			
Honesdale School Library.	7,298	[ii]	D
Huntingdon.			
Normal College.	1,524	[i]	D
Indiana.			
[State Normal School.]	1,300		
Jefferson.			
[<i>Monongahela College.</i>]	310	[i]	
Jenkintown.			
Friends' Library, of Abington.	400		X
Jersey Shore.			
<i>Eclectic Institute.</i>	10,000		
Johnstown.			
Cambria Library Association.	6,029		D
Kutztown.			
[Keystone State Normal School.]	1,843	[i]	D
LANCASTER.			
[<i>Franklin and Marshall College.</i>]	3,556	[iii]	X
<i>Theological Seminary (German Reformed).</i>	10,000		
Young Men's Christian Association of Lancaster.	5,763		D
Lewisburg.			
[<i>Bucknell University.</i>]	12,000	[iii]	
Lincoln University.			
[<i>Lincoln University.</i>]	9,000	[iii]	
Lock Haven.			
[<i>Central State Normal School.</i>]	850	[i]	D
Mansfield.			
[<i>Pennsylvania State Normal School.</i>]	4,500	[ii]	D
Manch Chunk.			
Dimmick Memorial Library.			D
Meadville.			
[<i>Allegheny College.</i>]	12,000	[iii]	D
Library, Art and Historical Association.	4,000	[ii]	X
<i>Meadville Theological School.</i>	18,000	[iii]	
Media.			
Delaware County Institute of Science.	2,500	[iii]	
Millersville.			
[<i>Pennsylvania State Normal School of Second District.</i>]	2,000	[i]	
Minersville.			
Minersville Lyceum.			X
Montrose.			
Montrose School Library.			X
New Castle.			
Young Men's Christian Association.			D
New Wilmington.			
[<i>Westminster College.</i>]	4,500	[iii]	
NORRISTOWN.			
Norristown Library Company.	8,000		D
Overbrook.			
<i>Theological Seminary of St. Charles Borromeo.</i>	16,500	[iii]	

Patterson.

Melford Grange.

PHILADELPHIA.

[<i>Academy of Natural Sciences.</i>]	40,000	[iii]
American Baptist Historical Society.	7,100	
American Baptist Publication Society.	3,000	[iii]
[<i>American Philosophical Society.</i>]	50,000	[iii]
<i>American Sunday School Union (Editorial Library).</i>	10,000	
<i>Apprentices' Library Company.</i>	18,000	[iii]
<i>Athenæum of Philadelphia.</i>	25,000	[iii]
[Central High School.]		[ii]
<i>College of Physicians of Philadelphia.</i>	37,048	[i]
<i>Franklin Institute.</i>	24,240	[iii]
George Institute.	5,000	
<i>German Society of Pennsylvania.</i>	22,000	[iii]
Girard College for Orphans.	8,512	[iii]
[<i>Historical Society of Pennsylvania.</i>]	28,162	[iii]
Home for F. and A. Masons (Masonic Temple).		[ii]
[La Salle College.]	4,000	[i]
Library Association of Friends.	9,951	[iii]
<i>Library Company of Philadelphia.</i>	150,000	[iii]
<i>Mercantile Library Company of Philadelphia.</i>	152,000	[iii]
<i>Mutual Library Company of Philadelphia.</i>	43,400	
<i>Odd Fellows' Library.</i>	12,000	
<i>Pennsylvania Hospital.</i>	15,000	[iii]
Philadelphia Club.	2,000	[i]
Philadelphia College of Pharmacy.	4,000	[iii]
<i>Philadelphia Law Association.</i>	19,112	
[Philadelphia Normal School for Girls.]	1,600	
Presbyterian Board of Publication.	3,000	[iii]
<i>Presbyterian Historical Society.</i>	20,000	[i]
Southwark Library.	9,746	[iii]
<i>Spring Garden Institute.</i>	13,000	
<i>Theological Seminary (Evangelical Lutheran).</i>	17,000	
[<i>University of Pennsylvania.</i>]	28,000	[iii]
Wagner Free Institute of Science.	6,000	[iii]
West Philadelphia Institute.	6,000	
Young Men's Christian Association.	5,600	[ii]
Zoological Society of Philadelphia.	300	[i]

PITTSBURGH.

<i>Allegheny County Law Library.</i>	15,000	
<i>Bishop Bowman Institute.</i>	15,000	
[Catholic College of the Holy Ghost.]	3,000	
Iron City Microscopical Society.		X
Pennsylvania Female College.		[ii]
Pittsburgh Female College.	1,100	[ii]
<i>Pittsburgh Library Association.</i>	19,000	[iii]

POTTSVILLE.

Law Library of Schuylkill County.	2,702	D
Pottsville Athenæum.	3,500	X

READING.

Reading Library.	7,000	[iii]	X
------------------	-------	-------	---

SCRANTON.

Lackawanna Institute.	1,800	[ii]	X
-----------------------	-------	------	---

Sewickley.

Sewickley Public Library.	2,500	[i]	X
---------------------------	-------	-----	---

Sharon.			
Sharon Public School Library.	867		X
SHENANDOAH.			
Shenandoah High School.			
Shippensburg.			
[Cumberland Valley State Normal School.]	325		
Somerset.			
Somerset County Law Library.	500		X
South Bethlehem.			
[Lehigh University.]	61,000	[iii]	D
State College.			
[Pennsylvania State College.]	3,500	[ii]	D
Swarthmore.			
[Swarthmore College.]	7,415	[iii]	
Tunkhannock.			
Tunkhannock School Library.			X
Van Dyke.			
Center Library Society.			X
Villa Nova.			
[Villa Nova College.]			
Warren.			
Warren Library Association.	4,800		
Washington.			
[Washington and Jefferson College.]	5,200	[iii]	
Waynesburg.			
Waynesburg College.	2,000	[i]	D
West Chester.			
Chester County Law and Miscellaneous Library.	1,940		D
[State Normal School.]	3,600	[iii]	
West Chester Library Association.	2,050		X
West Grove.			
West Grove Free Library.	1,100		X
WILKES BARRE.			
Ely Post, Grand Army of the Republic.			X
Wyoming Historical and Geological Society.	5,200	[iii]	D
Wilkesburg.			
WILLIAMSPORT.			
Dickinson Seminary.	2,500	[i]	X
Williamsport School District Library.	1,263		X
YORK.			
United Library Association of York.	3,600	[i]	
RHODE ISLAND.			
Bristol.			
Rogers Free Library.	8,432		X
East Greenwich.			
East Greenwich Academy.	2,500		D
Kingston.			
[Rhode Island State Agricultural School.]			
LINCOLN. (No public library.)			
NEWPORT.			
Naval Institute.		[ii]	
People's Library.	25,650		X
Redwood Library and Athenæum.	31,700	[iii]	D
PAWTUCKET.			
Pawtucket Free Public Library.	9,313	[i]	X

PROVIDENCE.			
[<i>Brown University.</i>]	62,800	[iii]	D
Franklin Lyceum.	9,000		D
Friends' Boarding School.	6,300	[ii]	
<i>Providence Athenæum.</i>	44,582	[iii]	
<i>Providence Public Library.</i>	33,047	[ii]	X
Public School Library.	2,200		X
[<i>Rhode Island Historical Society.</i>]	16,000	[iii]	
[<i>Rhode Island State Library.</i>]	12,000		D
[Rhode Island State Normal School.]	1,200	[ii]	
WARWICK.			
Crompton Free Library.	3,091		
Westerly.			
Pawcatuck Library.	4,000	[i]	X
WOONSOCKET.			
Harris Institute Library.	9,166	[ii]	X
SOUTH CAROLINA.			
Aiken.			
Aiken Library.		[i]	D
CHARLESTON.			
Charleston High School.			X
<i>Charleston Library Society.</i>	19,000	[iii]	D
Citadel Academy.			X
[<i>College of Charleston.</i>]	10,000	[iii]	D
[South Carolina Historical Society.]		[i]	
Medical College of the State of South Carolina.	4,000	[iii]	
South Carolina Military Academy.			X
Young Men's Christian Association.	840		X
Cheraw.			
Cheraw Lyceum.	1,000		X
Clinton.			
Thornwell Orphanage.	1,816	[i]	X
COLUMBIA.			
[Allen University.]			
[College of Agricultural and Mechanical Arts of the University of South Carolina.]			
[<i>South Carolina College.</i>]	27,000		
[<i>South Carolina State Library.</i>]	36,000	[iii]	D
[<i>Presbyterian Theological Seminary.</i>]	22,000	[i]	X
[<i>University of South Carolina.</i>]	27,000	[iii]	D
[Winthrop Training School for Teachers.]	50		
Due West.			
[Erskine College.]	1,500	[ii]	
Edgefield Court House.			
Edgefield Public Library.			X
Florence.			
Florence Library Association.	2,000		D
Gaffney City.			
Cooper Limestone Institute.			X
Greenville.			
[Furman University.]	2,500	[iii]	
Marion.			
Young Men's Club.			X
Newberry.			
[Newberry College.]	6,000	[i]	X

Oats.			
Oats Library.			X
Orangeburg.			
[Clafin University and College of Agriculture.]	1,500	[i]	
Spartanburg.			
[Wofford College.]	6,000		D
Walhalla.			
[Adger College.]			
Wahalla Female College.	300		X
Yorkville.			
King's Mountain Military Institute.	800		X

SOUTH DAKOTA.

Brookings.			
[South Dakota Agricultural College.]	500	[i]	D
East Pierre. (See Pierre.)			
Madison.			
[South Dakota Normal School.]	650		
Pierre.			
[Pierre University.] (East Pierre P. O.)	1,200	[ii]	D
[South Dakota State Library.]			D
Rapid City.			
[South Dakota School of Mines.]			
Spearfish.			
[State Normal School.]	2,600		D
Vermillion.			
[University of South Dakota.]	2,000	[ii]	D

TENNESSEE.

Athens.			
[Grant Memorial University.]	2,250		
Bellbuckle.			
Webb School.			X
Bristol.			
[King College.]	756		
Brownsville.			
Brownsville Female College.			X
CHATTANOOGA.			
Chattanooga Public Library.			X
[Chattanooga University.]	644		
Chuckey City.			
Warren College.			X
Clarksville.			
[Southwestern Presbyterian University.]	3,500	[i]	X
Columbia.			
Columbia Athenæum.	5,000	[ii]	X
Columbia Institute.			X
Hiwassee College.			
[Hiwassee College.]	2,300	[ii]	X
Jackson.			
Jackson Free Public Library.	1,100		X
[Southwestern Baptist University.]	3,000	[ii]	D
Knoxville.			
Public Library of Knoxville.	3,729	[i]	X
[University of Tennessee.]	7,000	[iii]	D

Lebanon.				
[<i>Cumberland University.</i>]	10,000	[iii]		D
Lewisburg.				
Lewisburg Institute Library.	1,000	[i]		D
Maryville.				
[Maryville College.]	6,000	[iii]		
McKenzie.				
[Bethel College.]	700			X
McMinnville.				
McMinnville Library Association.	1,500	[i]		D
MEMPHIS.				
Bar and Law Library Association.	6,630			X
[Christian Brothers' College.]	3,500	[ii]		X
Cossett Library.				X
Cotton Exchange.				D
Young Men's Hebrew Library.				X
Milligan.				
[Milligan College.]	400			X
Mossy Creek.				
[Carson College.]	320			
NASHVILLE.				
[Central Tennessee College.]	2,150	[i]		
[Fisk University.]	3,125			
[Roger Williams University.]	3,000			
[State Normal College, University of Nashville.]	500	[iii]		X
[Tennessee Historical Society.]		[i]		
[Tennessee State Library.]	30,000	[ii]		D
[Vanderbilt University.]	10,000	[iii]		D
Watkins Institute.				D
Pulaski.				
Martin College.				D
Ripley.				
Wesleyan Methodist Academy.				X
Rugby.				
Hughes' Free Public Library.	6,195	[ii]		X
Sewanee.				
[<i>University of the South.</i>]	16,000	[iii]		D
Tusculum.				
[Greeneville and Tusculum College.]	5,820	[ii]		D
Union City.				
Union City College.				D
Winchester.				
Winchester Normal School.				X
TEXAS.				
Athens.				
Athens Public School Library.				X
AUSTIN.				
Austin Public Library.				X
[Texas State Library.]		[iii]		D
[University of Texas.]	5,000	[iii]		D
Belton.				
Baylor Female College.	1,000			X

Bonham.			
Carlton Library.			X
Cisco.			
Cisco Public School Library.			X
College Station.			
[Agricultural and Mechanical College of Texas.]	2,051	[ii]	D
DALLAS.			
Public Library and Reading Room.	800		D
Fairfield.			
Fairfield Public School Library.			X
Fort Worth.			
Commercial Exchange Library.			X
GALVESTON.			
Free Public Library.	5,600	[1]	D
St. Mary's University.	500		X
Georgetown.			
[Southwestern University.]	1,000	[i]	X
Hempstead.			
[Prairie View Normal Institute.]	375		
Hillsboro.			
Hillsboro Public Library.			X
HOUSTON.			
Houston Lyceum Library.	2,500		D
Huntsville.			
[Sam Houston Normal Institute.]	3,500		X
Italy.			
[Hope Institute.]	100		
Mansfield.			
[Mansfield Male and Female College.]			
Palestine.			
[Academy of Science of Texas.]		[1]	
Public Library Association of Palestine.			D
Prairie Lea.			
The Grange Library.	385		D
Salado.			
[Salado College.]			
SAN ANTONIO.			
San Antonio Literary and Scientific Association.	3,000		
Savoy.			
Platonian Literary Society.			D
Sherman.			
[Austin College.]	3,000	[i]	
Sulphur Springs.			
Central College.	400		X
Tehuacana.			
[Trinity University.]	1,000	[i]	X
Terrell.			
Terrell Public Library.			X
Waco.			
[Baylor University.]	3,500		D
Waxahachie.			
Marvin College.	800		D
Weatherford.			
High School Library.			D

UTAH TERRITORY.

Logan City.			
[Utah Agricultural College.]			
SALT LAKE CITY.			
[Utah Territorial Library.]		[iii]	D
[University of Deseret.]	3,621	[iii]	X

VERMONT.

Bellows Falls.			
Bellows Falls Lyceum.			X
BURLINGTON.			
<i>Fletcher Free Library.</i>	18,600	[iii]	D
<i>University of Vermont and State Agricultural College.</i>	35,000	[iii]	D
Vermont Episcopal Institute.	4,000	[i]	X
Castleton.			
[Castleton State Normal School.]		[iii]	
Johnson.			
[Johnson State Normal School.]	900	[i]	
Lunenburg.			
<i>Cutting's Public Library and Museum.</i>	14,000	[i]	
Middlebury.			
[Middlebury College.]	1,600	[iii]	D
Montpelier.			
[State Cabinet of Natural History.] (Merged with State Library.)			
[Vermont Historical Society.]		[iii]	
[<i>Vermont State Library.</i>]	18,600	[iii]	D
Randolph.			
[State Normal School.]	1,000	[i]	
Richmond.			
Richmond Lyceum.			X
RUTLAND.			
Rutland High School.			
St. Johnsbury.			
<i>St. Johnsbury Athenæum.</i>	12,000	[iii]	D
Strafford.			
Harris Library (Public Library).	2,062	[ii]	
<i>Vergennes Library.</i>	22,220		
Windsor.			
Windsor Library Association.	4,480	[i]	X
Woodstock.			
Normal Williams Public Library.	4,400		X

VIRGINIA.

ALEXANDRIA.			
Alexandria Library.	5,000		
Ashland.			
[<i>Randolph Macon College.</i>]	10,000	[iii]	
Blacksburg.			
[Virginia Agricultural and Mechanical College.]	1,200	[ii]	
Charlottesville.			
[<i>University of Virginia.</i>]	47,000	[iii]	D
Emory.			
[Emory and Henry College.]	4,580	[iii]	D
Farmville.			
[State Normal School of Virginia.]	500		X

Fortress Monroe.				
United States Artillery School.	5,900	[i]	X	
Hampden-Sidney.				
[Hampden-Sidney College.]	2,200	[iii]		
<i>Union Theological Seminary.</i>	12,400			
Hampton.				
[Hampton Normal and Agricultural Institute.]	3,500	[i]		
Jonesville.				
Jonesville Town Library.			X	
Lexington.				
[Virginia Military Institute.]	8,800	[iii]	D	
[<i>Washington and Lee University.</i>]	18,000	[iii]	X	
LYNCHBURG.				
Young Men's Christian Association.	450		X	
Newmarket.				
Polytechnic Institute.	500	[ii]		
Norfolk.				
Norfolk Library Association.			D	
Young Men's Christian Association.			X	
PETERSBURG.				
[Virginia Normal and Collegiate Institute.]	625	[i]	D	
Young Men's Christian Association.	2,000		X	
PORTSMOUTH. (No public library.)				
RICHMOND.				
Richmond Academy of Science.				
[Richmond College.]	8,000	[iii]	X	
Richmond Mechanics' Institute.	3,200		X	
[<i>Virginia Historical Society.</i>]	13,883	[iii]	D	
[<i>Virginia State Library.</i>]	45,000	[iii]	D	
Young Men's Christian Association.	3,300	[i]	D	
Roanoke City.				
Young Men's Christian Association of Roanoke.			X	
Salem.				
[<i>Roanoke College.</i>]	16,000	[iii]	D	
Staunton.				
Young Men's Christian Association.	1,426	[i]	X	
Theological Seminary.				
<i>Protestant Episcopal Theological Seminary.</i>	12,000	[iii]		
University of Virginia (see Charlottesville.)				
Wytheville.				
Wytheville Library Association.	600		X	
WASHINGTON.				
Olympia.				
[State Library.]	1,200	[i]	D	
Seattle.				
[University of Washington.]	2,260	[ii]		
Tacoma.				
[Washington College.]		[ii]		
Walla Walla.				
[Whitman College and Seminary.]	1,976	[ii]		
WEST VIRGINIA.				
Bethany College.				
[Bethany College.]	2,000	[iii]	X	
Buchanan.				
Buchanan Academy Library.			X	

Charleston.				
[State Library.]	6,000	[iii]	D	
Clarksburg.				
Clarksburg Academy.			X	
Concord.				
Concord Normal School.			X	
Fairmont.				
[Fairmont State Normal School.]	800		D	
Farmington.				
Farmington High School.			X	
Flemington.				
[West Virginia College.]	200	[ii]		
Glenville.				
[Glenville State Normal School.]	950		D	
Harper's Ferry.				
[Storer College.]	3,500			
Huntington.				
[Marshall College State Normal School.]	700	[i]	X	
Martinsburg.				
Grammar School Library.			X	
Morgantown.				
[West Virginia Historical Society.]	500			
[West Virginia University.]	8,000	[iii]	D	
Romney.				
Literary Society of Romney.	2,000		X	
West Virginia Institute for the Deaf, Dumb, and Blind.	734	[i]	X	
Shepherdstown.				
[Shepherd College State Normal School.]	300	[ii]	X	
West Liberty.				
[West Liberty State Normal School.]	350			
WHEELING.				
Wheeling Public Library.	8,500	[i]	D	
WISCONSIN.				
Appleton.				
[Lawrence University.]	10,740	[iii]	D	
Ashland.				
Vaugh Library.			X	
Beloit.				
[Beloit College.]	12,840	[iii]	D	
EAU CLAIRE.				
Eau Claire Free Library.	3,000		X	
FOND DU LAC.				
Free Library of Fond du Lac.	7,500		D	
Galesville.				
[Galesville University.]	3,000	[iii]	D	
Green Bay.				
Green Bay Business Men's Association.			X	
LA CROSSE.				
Public Library of La Crosse.			D	
MADISON.				
[College of Agriculture of the University of Wisconsin.]				
[State Historical Society of Wisconsin.]	116,750	[iii]	D	
[State Library of Wisconsin.]	18,954		D	
[University of Wisconsin.]	14,436	[iii]	X	
[Wisconsin Society of Science, Art, and Letters.]				

Marinette.			
Marinette Library.			X
MILWAUKEE.			
<i>Milwaukee Public Library.</i>	34,687	[iii]	D
Public School Libraries (6).	4,137		X
Public Museum of the City of Milwaukee.	788	[i]	X
[<i>Seminary of Saint Francis of Sales.</i>]	11,000		
Wisconsin Natural History Society.		[i]	
[<i>Wisconsin Normal School.</i>]	720		
Milton.			
[<i>Milton College.</i>]	3,316		X
Nashotah.			
<i>Nashotah Theological Seminary.</i>	10,500		X
Neenah.			
Neenah High School.			X
OSHKOSH.			
Oshkosh High School Library.			X
[<i>Oshkosh State Normal School.</i>]	1,600	[i]	
Platteville.			
[<i>Wisconsin State Normal School.</i>]	700	[iii]	
Portage.			
Portage High School.			X
Prairie du Chien.			
College of the Sacred Heart.	4,000		D
RACINE.			
[<i>Racine College.</i>]	8,200	[iii]	D
Ripon.			
[<i>Ripon College.</i>]	5,800	[i]	X
River Falls.			
[<i>State Normal School.</i>]	1,498	[i]	X
Saint Francis (see Milwaukee.)			
Sheboygan.			
Business Men's Association.	1,205		X
Watertown.			
[<i>Northwestern University.</i>]	3,200	[i]	
Waukesha.			
Waukesha Free Library.			X
Waupun.			
Waupun Library Association.	4,000	[i]	X
Whitewater.			
[<i>State Normal School.</i>]	1,586	[i]	X

WYOMING.

Cheyenne.			
[<i>State Library.</i>]	10,000	[ii]	D
[<i>Wyoming Academy of Art, Science, and Letters.</i>]		[i]	
Laramie City.			
[<i>University of Wyoming.</i>]		[iii]	X

III.—LIST OF FOREIGN LIBRARIES TO WHICH IT IS DESIRED TO SEND FUTURE PUBLICATIONS OF THE NATIONAL MUSEUM.

[As in the preceding lists, [i] indicates that the library receives regularly the *Smithsonian Report*; [ii] that it receives the *Report* and the *Smithsonian Miscellaneous Collections*; [iii] that it receives the two preceding and the *Smithsonian Contributions to Knowledge*.]

NOTE.—This list is not intended to indicate the distribution of Smithsonian publications, but shows incidentally what publications of the Institution are sent to the libraries mentioned.

AFRICA.

Société Algérienne de Climatologie, Sciences Physiques et Naturelles.	Algiers, Algeria.	[i]
South African Museum.	Cape Town, Cape of Good Hope.	[i]
South African Philosophical Society.	Cape Town, Cape of Good Hope.	[i]
Musée de Boulaq.	Cairo, Egypt.	[i]
Société d'Histoire Naturelle.	Port Louis, Mauritius.	

AMERICA (NORTH).

Le Naturaliste Canadien.	Cape Rouge, Quebec.	[i]
McGill University.	Montreal, Quebec.	[iii]
Natural History Society.	Montreal, Quebec.	[i]
Geological and Natural History Survey of Canada.	Ottawa, Ontario.	[iii]
Royal Society of Canada.	Ottawa, Ontario.	[i]
Université Laval.	Quebec, Quebec.	[iii]
Canadian Institute.	Toronto, Ontario.	[iii]
Natural History Society of Toronto.	Toronto, Ontario.	[i]
Provincial Museum.	Victoria, British Columbia.	
Manitoba Historical and Scientific Society.	Winnipeg, Manitoba.	[iii]
University of New Brunswick.	Fredericton, New Brunswick.	[iii]
Natural History Society.	St. John's, New Brunswick.	[i]
Geological Survey of Newfoundland.	St. John's, Newfoundland.	[i]
Nova Scotia Institute of Natural Sciences.	Halifax, Nova Scotia.	[i]
Museo Nacional.	San José, Costa Rica.	
Museo de Historia Natural.	Guatemala, Guatemala.	
Museo Nacional.	San Salvador, San Salvador.	
El Museo Nacional.	Mexico, Mexico.	[iii]
Mexican Geographical Exploring Expedition.	Mexico, Mexico.	
Sociedad Mexicana de Historia Natural.	Mexico, Mexico.	[iii]
Bermuda Library.	Hamilton, Bermudas, West Indies.	[i]
Real Universidad de la Habana.	Habana, Cuba.	[i]
Musée l'Herminier.	Point-à-Pitre, Guadeloupe.	[i]
Public Museum.	Kingston, Jamaica.	

AMERICA (SOUTH).

Museo Público de Buenos Ayres.	Buenos Ayres, Argentine Republic.	[iii]
Sociedad Zoológica Argentina.	Buenos Ayres, Argentine Republic.	
Academia Nacional de Ciencias Exactes.	Corboha, Argentine Republic.	[i]
Museo Nacional.	Rio Janeiro, Brazil.	[i]
Public Museum.	Georgetown, British Guiana.	
Museo Nacional.	Santiago, Chile.	[i]
Sociedad de Historia Natural.	Santiago, Chile.	
National Library.	Bogota, Colombia.	[iii]
Museo Nacional.	Bogota, Colombia.	
National Library.	Lima, Peru.	[iii]
Academia de Ciencias Naturales.	Lima, Peru.	
Museo Nacional.	Caracas, Venezuela.	

ASIA.

Royal Asiatic Society (China branch). (Care James Bairn, Haymarket, London, England.)	Shanghai, China.	[iii]
Bombay Natural History Society.	Bombay, India.	[i]
Government Central Museum (now Victoria and Albert Museum).	Bombay, India.	[i]
Asiatic Society of Bengal.	Calcutta, India.	[iii]
Geological Survey of India.	Calcutta, India.	[iii]
Indian Museum.	Calcutta, India.	[i]
Municipal Library and Museum.	Kurrachee, India.	[i]
Government Central Museum and Library.	Madras, India.	[i]
Trevandrum Museum.	Trevandrum, India.	
Museum of Natural History.	Hakodadi, Japan.	
Asiatic Society of Japan (formerly in Yokohama).	Tokio, Japan.	[i]
Deutsche Gesellschaft für Natur- und Völkerkunde Ost-Asiens.	Tokio, Japan.	[i]
Mombusho Museum.	Tokio, Japan.	[iii]
Tokio Daigaku (formerly Kaisei Gakko).	Tokio, Japan.	[iii]
Koninklijke Naturkundige Vereeniging in Nederlandsch-Indië.	Batavia, Java.	[iii]
Raffles Library and Museum.	Singapore, Straits Settlements.	[i]
Perak Government Museum.	Perak, Straits Settlements.	

AUSTRALASIA.

AUSTRALIA.

Australian Museum.	Sydney, New South Wales.	[i]
Linnean Society of New South Wales.	Sydney, New South Wales.	[i]
Natural History Society.	Sydney, New South Wales.	
Queensland Museum of Natural History.	Queensland, Australia.	
Royal Society of South Australia.	Adelaide, South Australia.	[i]
Royal Society of Tasmania. (Packages sent through G. W. Wheatly & Co., 165 Leadenhall street, London, E. C.)	Hobarton, Tasmania.	[iii]
Melbourne Museum.	Melbourne, Victoria.	
National Museum of Victoria.	Melbourne, Victoria.	[i]
Natural History Society.	Melbourne, Victoria.	[i]
Public Library, Museum, and National Gallery.	Melbourne, Victoria.	[iii]
Zoological and Acclimatization Society.	Melbourne, Victoria.	[i]

NEW ZEALAND.

Auckland Museum.	Auckland, New Zealand.	
Canterbury Museum.	Christchurch, New Zealand.	[i]
Otago Museum.	Dunedin, New Zealand.	[i]
Colonial Museum and Geological Survey Department.	Wellington, New Zealand.	[i]
New Zealand Institute.	Wellington, New Zealand.	[ii]

POLYNESIA.

Department of Foreign Affairs.	Honolulu, Sandwich Islands.	[i]
--------------------------------	-----------------------------	-----

EUROPE.

AUSTRIA-HUNGARY.

National Museum.	Agram (Zagreb), Croatia.	[i]
Vorarlberger Museums-Verein.	Bregenz, Austria.	[i]

Naturforschender Verein.	Brinn, Austria.	[iii]
K. Magyar Tudományos Egylet.	Budapest, Hungary.	[ii]
K. Magyar Természettudományi Társulat.	Budapest, Hungary.	[iii]
Magyar Nemzeti Museum.	Budapest, Hungary.	[i]
Musée d'Anthropologie de l'Université.	Budapest, Hungary.	
Naturforschender Verein.	Budapest, Hungary.	
Zoologisch-Zootomisches Institut.	Gratz, Styria.	
Edelyi Museum Egylet.	Klausenburg, Transylvania.	[i]
Akademija Umiejetności.	Krakau, Galicia.	[i]
Landes-Museum.	Laibach, Illyria.	[i]
Museum Francisco Carolinum.	Linz, Austria.	[i]
Comité für naturwissenschaftliche Landesdurchforschung.	Prag, Austria.	[i]
K. böhmisches Museum.	Prag, Bohemia.	[iii]
Verein für Natur- und-Heil kunde.	Presburg, Hungary.	[i]
Verein der Naturfreunde.	Reichenberg, Bohemia.	
Städtisches Museum Carolino-Augusteum.	Salzburg, Austria.	[i]
Civico Museo di Storia Naturale Ferdinando-Massimiliano.		
	Trieste, Illyria.	[i]
Anthropologische Gesellschaft.	Wien, Austria.	[i]
Kaiserliche Akademie der Wissenschaften (Universitäts-Platz 2).		
	Wien, Austria.	[iii]
K. K. Botanisches Hof-Cabinet.	Wien, Austria.	
K. K. Naturhistorisches Hof-Museum.	Wien, Austria.	[ii]
K. K. Oesterr. Museum für Kunst und Industrie.	Wien, Austria.	[i]
K. K. Zoologisch-Botanische Gesellschaft.	Wien, Austria.	[ii]
K. K. Zoologisches Hof-Cabinet.	Wien, Austria.	
K. K. Handels Museum.	Wien, Austria.	[i]

BELGIUM.

Société Royale de Zoologie.	Amvers (Belgium).	
Académie Royale des Sciences, des Lettres et des Beaux-Arts de Belgique.		
	Bruxelles (Belgium).	[iii]
Musée Royal d'Histoire Naturelle de Belgique.	Bruxelles (Belgium).	[ii]
Société Entomologique de Belgique.	Bruxelles (Belgium).	[ii]
Société des Naturalistes Dinantais.	Dinant, Belgium.	
Société d'Histoire Naturelle.	Gand (Belgium).	
Muséum Commercial et Industriel.	Melle, near Ghent (Belgium).	

DENMARK.

Kongelige Danske Videnskaberne Selskab.	Kjöbenhavn (Denmark).	[iii]
Kongelige Danske Selskab for Fædrelandets Historie og Sprog.		
	Kjöbenhavn (Denmark).	
Naturhistoriske Forening.	Kjöbenhavn (Denmark).	[i]
Universitets Bibliotheket.	Kjöbenhavn (Denmark).	[i]
Universitets Zoologiske Museum.	Kjöbenhavn (Denmark).	[i]

FRANCE.

Muséum d'Histoire Naturelle.	Bordeaux, France.	[i]
Société Linnéenne de Bordeaux.	Bordeaux, France.	[iii]
Société Linnéenne de Normandie.	Caen, France.	[iii]
Musée d'Histoire Naturelle.	Caen, France.	[i]
Société d'Histoire Naturelle de Savoie.	Chambéry, France.	
Société Nationale des Sciences Naturelles et Mathématiques de Cherbourg.	Cherbourg, France.	[iii]

Musée d'Histoire Naturelle.	Douai (Nord), France.	[i]
Musée d'Histoire Naturelle.	Laval, France.	
Musée d'Histoire Naturelle.	Lille, France.	[i]
Société des Sciences, de l'Agriculture et des Arts.	Lille, France.	[iii]
Musée d'Histoire Naturelle de Lyon.	Lyon, France.	[i]
Société d'Agriculture, Histoire Naturelle et Arts Utiles de Lyon.	Lyon, France.	[iii]
Muséum d'Histoire Naturelle.	Marseilles, France.	[i]
Société d'Horticulture et d'Histoire Naturelle de l'Hérault.	Montpellier, France.	[i]
Société de la Loire inferieure.	Nantes, France.	[i]
Bibliothèque Nationale	Paris, France.	[iii]
Académie des Sciences.	Paris, France.	[i]
"La Nature" (120 Boulevard St. Germain).	Paris, France.	
L'Anthropologie.	Paris, France.	
Musée Guimet, Ministère de l'Instruction, etc.	Paris, France.	[i]
Musée d'Ethnographie (Trocadero).	Paris, France.	
Musée d'Histoire Naturelle.	Paris, France.	[i]
Musée du Louvre.	Paris, France.	
Société d'Acclimatation (11 rue de Lille).	Paris, France.	[i]
Société Entomologique de France (à la Mairie du VI ^e Arrondissement).	Paris, France.	[i]
Société Zoologique de France.	Paris, France.	[i]
Musée d'Histoire Naturelle de Rheims.	Rheims, France.	
Académie des Sciences, Belles-Lettres et Arts de Rouen.	Rouen, France.	[iii]
Société d'Histoire et d'Archéologie et d' Histoire Naturelle de la Manche.	Saint Lô, France.	
Musée de Saint-Germain.	Saint-Germain-en-Laye, France.	
Matériaux pour l'Histoire Primitive et Naturelle de l'Homme.	Toulouse, France.	[i]
Société d'Histoire Naturelle de Toulouse.	Toulouse, France.	[i]

GERMANY.

Naturforschende Gesellschaft des Osterlandes.	Altenburg, Saxe-Weimar.	[iii]
Annaberg-Buchholzer-Verein für Naturkunde.	Annaberg, Saxony.	
Naturhistorischer Verein.	Augsburg, Bavaria.	[i]
Archiv für Naturgeschichte.	Berlin, Prussia.	
Berliner Gesellschaft für Anthropologie, Ethnologie und Urgeschichte.	Berlin, Prussia.	[i]
Benth-Schinckel Museum.	Berlin, Prussia.	
Deutsche Zoologische Gesellschaft.	Berlin, Prussia.	
Gesellschaft Naturforschender Freunde.	Berlin, Prussia.	[i]
Königliche (Preussische) Akademie der Wissenschaften.	Berlin, Prussia.	[iii]
Königliche (Preussische) Museen, General-Direction.	Berlin, Prussia.	[iii]
Märkisches Provinzial-Museum.	Berlin, Prussia.	
Mineralien-Cabinet Mineralogisch Petrographisches Institut der Universität.	Berlin, Prussia.	
Rauch Museum.	Berlin, Prussia.	
Societatum Litteraræ.	Frankfurt, Prussia.	[i]
Zoologisches Museum der Universität.	Berlin, Prussia.	[i]
Museum Ludwig Salvator.	Meissen, Saxony.	[i]
Mineralogisches Museum und Institut der Universität.	Bonn, Prussia.	
Naturhistorischer Verein der Preussischen Rheinlande und Westfalens.	Bonn, Prussia.	[iii]

Herzogliches Naturhistorisches Museum.	Braunschweig (Germany).	[i]
Naturwissenschaftlicher Verein.	Bremen, Germany.	[i]
Universitäts-Bibliothek.	Breslau, Prussia.	[iii]
Société d'Histoire Naturelle de Colmar.	Colmar, Alsace.	
Naturforschende Gesellschaft.	Danzig, Prussia.	[iii]
West-Preussisches Provinzial-Museum.	Danzig, Prussia.	
Grossherzogliches Museum.	Darmstadt, Hesse.	[i]
Naturhistorischer Verein.	Dessau, Anhalt.	[i]
Verein für Geschichte und Naturgeschichte der Baar.	Donaueschingen, Baden.	[i]
Königliches Mineralogisch-Geologisch und Prähistorisches Museum.)	Dresden, Saxony.	[i]
Königliches Zoologisches und Anthropologisch-Ethnographisches Museum.	Dresden, Saxony.	[i]
Naturforschende Gesellschaft.	Emden, Prussia.	[iii]
Universitäts-Bibliothek.	Erlangen, Bavaria.	[iii]
Deutsche Malakozologische Gesellechaft.	Frankfurt-am-Main, Prussia.	[i]
Neue Zoologische Gesellschaft.	Frankfurt-am-Main, Prussia.	[i]
Senckenbergische Naturforschende Gesellschaft.	Frankfurt-am-Main, Prussia.	[iii]
Zoologischer Garten (Redaktion).	Frankfurt-am-Main, Prussia.	
Naturforschende Gesellschaft.	Freiburg-im-Breisgau, Baden.	[i]
Verein für Naturkunde.	Fulda, Prussia.	
Universitäts-Bibliothek.	Giessen, Hesse.	[iii]
Zoologisches Museum.	Giessen, Hesse.	[i]
Naturforschende Gesellschaft.	Görlitz, Prussia.	[iii]
Königliche Societät der Wissenschaften.	Göttingen, Prussia.	
Zeitschrift für Wissenschaftliche Zoologie.	Göttingen, Prussia.	[i]
Zoologisches Museum.	Göttingen, Prussia.	
Geographische Anstalt (Justus Perthes).	Gotha, Saxe-Goburg.	[iii]
Verein der Freunde der Naturgeschichte in Mecklenburg. (Care of Opitz & Co.)	Güstrow, Mecklenburg.	[i]
Universitäts-Bibliothek.	Greifswald, Prussia.	[iii]
Kaiserliche Leopoldina Carolina Akademie der Deutschen Naturforscher.	Halle-an-der-Saale, Prussia.	[i]
Die Natur Redaktion : (Dr. Karl Müller).	Halle-an-der-Saale, Prussia.	[iii]
Naturhistorisches Museum (Dr. Pagenstecher).	Hamburg, Germany.	
Naturwissenschaftlicher Verein Hamburg-Altona.	Hamburg, Germany.	[iii]
Königliche Oeffentliche Bibliothek.	Hannover, Prussia.	[iii]
Naturhistorische Gesellschaft.	Hannover, Prussia.	
Universitäts-Bibliothek.	Heidelberg, Baden.	[iii]
Medicinisch-Naturwissenschaftliche Gesellschaft.	Jena, Saxe-Weimar.	[i]
Verein für Naturkunde.	Kassel, Prussia.	[i]
Universitäts-Bibliothek.	Kiel, Prussia.	[iii]
Naturhistorischer Verein.	Koblentz, Prussia.	
Museum für Völkerkunde.	Leipzig, Saxony.	[i]
Königlich-Sächsische Gesellschaft der Wissenschaften.	Leipzig, Saxony.	[iii]
Naturforschende Gesellschaft.	Leipzig, Saxony.	[i]
Zoologischer Anzeiger.	Leipzig, Saxony.	[i]
Naturhistorisches Museum.	Lübeck, Germany.	[i]
Museum-Verein. (United with the Naturwissenschaftlicher Verein.)	Lüneburg, Prussia.	[i]
Naturforschender Verein.	Meiningen, Saxe-Meiningen.	
Société d'Histoire Naturelle de Metz.	Metz, Lorraine.	[i]
Universitäts-Bibliothek.	München, Bavaria.	[iii]

Provinzial-Verein für Wissenschaft und Kunst.	Münster, Prussia.	[i]
Naturhistorische Gesellschaft.	Nürnberg, Bavaria.	[iii]
Naturhistorischer Verein.	Passau, Bavaria.	[i]
Kaiserliche Universitäts- und Lander-Bibliothek.	Strassburg, Alsace.	[iii]
Musée d'Histoire Naturelle.	Strassburg, Alsace.	[i]
Königliche Oeffentliche Bibliothek.	Stuttgart, Württemberg.	[iii]
Verein für vaterländische Naturkunde in Württemberg.	Stuttgart, Württemberg.	[iii]
Königliche Universitäts-Bibliothek.	Tübingen, Württemberg.	[iii]
Von Malzan'sches Naturhistorisches Museum.	Waren, Mecklenburg.	[i]
Verein für Naturkunde.	Wiesbaden, Prussia.	[iii]
Naturhistorischer Verein.	Zweibrücken, Bavaria.	

ENGLAND.

Bath Natural History and Antiquarian Field Club.	Bath, England.	[i]
Birmingham Free Libraries (J. D. Mullins, Librarian, Radcliffe Place).	Birmingham, England.	[iii]
Birmingham Natural History and Microscopical Society. (Care of Mason College of Science.)	Birmingham, England.	[i]
Brighton and Sussex Natural History Society.	Brighton, England.	[i]
Bristol Museum and Library.	Bristol, England.	[i]
Suffolk Institute of Archæology and Natural History.	Bury St. Edmunds, England.	[i]
Morphological Laboratory, New Museum.	Cambridge, England.	
Museum of Zoology and Comparative Anatomy (Downing Street).	Cambridge, England.	
University Library.	Cambridge, England.	[iii]
East Kent Natural History Society. (Care of W. H. Housley, St. Stephen's Lodge, Canterbury, formerly in Dover.)	Canterbury, England.	[i]
Wiltshire Archæological and Natural History Society.	Devizes, England.	[i]
Devon and Exeter Albert Memorial Museum, School of Science and Art, and Free Library.	Exeter, England.	[iii]
Natural History Society.	Folkestone, England.	
Natural History and Antiquarian Society.	Isle of Man, England.	
Royal Botanic Gardens.	Kew, England.	[i]
Leeds Philosophical and Literary Society.	Leeds, England.	[iii]
Leicester Town Museum.	Leicester, England.	[i]
Free Public Library, Museum, and Walker Gallery of Art of the town of Liverpool.	Liverpool, England.	[iii]
Liverpool Marine Biological Station.	Puffin Island, Liverpool, England.	
Annals and Magazine of Natural History. (Care of Taylor & Francis, Red Lion Court, Fleet Street, E. C.)	London, England.	
Anthropological Institute of Great Britain and Ireland (3 Hanover Square, W.).	London, England.	[iii]
"Athenæum" (20 Wellington Street, Strand, W. C.).	London, England.	[i]
British Museum (Great Russell Street, Bloomsbury, W. C.).	London, England.	[iii]
British Museum, Natural History Division (Cromwell Road, South Kensington, S. W.).	London, England.	[iii]
Entomological Society (11 Chandos Street, Cavendish Square, W.).	London, England.	[iii]
Geological Society of London (Burlington House, W.).	London, England.	[iii]
Linnæan Society (Burlington House, W.).	London, England.	[iii]
Quekett Microscopical Club (University College, Gower Street, W. C.).	London, England.	

Royal Geographical Society of London (1 Savile Row, W.).	London, England.	[iii]
Royal Microscopical Society (King's College, Strand, W. C.).	London, England.	[iii]
Royal Society of London (Burlington House, W.).	London, England.	[iii]
South Kensington Museum.	London, England.	[i]
Victoria Institute (or Philosophical Society of Great Britain, 8 Adelphi Terrace, W. C.).	London, England.	
Zoological Society of London (1 Hanover Square, W.).	London, England.	[iii]
'Zoologist.' (Care of Van Voorst, 1 Paternoster Row, E. C.)	London, England.	
Manchester Public Free Library (formerly "and Museum.")	Manchester, England.	[iii]
Natural History Society of Northumberland, Durham, and Newcastle-upon-Tyne (Museum, Newcastle).	Newcastle-upon-Tyne, England.	[iii]
Norfolk and Norwich Museum.	Norwich, England.	[i]
Free Library and Museum of the Borough of Nottingham.	Nottingham, England.	
Bodleian Library.	Oxford, England.	[iii]
Museum of Natural History.	Oxford, England.	[i]
Radcliffe Library (Museum).	Oxford, England.	[i]
Natural History and Antiquarian Society.	Penzance, England.	[i]
Marine Biological Association of the United Kingdom.	Plymouth, England.	[i]
Plymouth Institution and Devon and Cornwall Natural History Society.	Plymouth, England.	[i]
Natural History Society of Rugby School.	Rugby, England.	
Salford Royal Museum and Library.	Salford, England.	[i]
Shropshire Archæological and Natural History Society.	Shrewsbury, England.	
Somersetshire Archæological and Natural History Society.	Taunton, England.	[i]
Natural History Society.	Torquay, England.	[i]
Royal Institution of Cornwall.	Truro, England.	[i]
Warwickshire Natural History and Archæological Society.	Warwick, England.	[i]

IRELAND.

Natural History and Philosophical Society.	Belfast, Ireland.	[iii]
Royal Dublin Society (Kildare Street).	Dublin, Ireland.	[ii]
Royal Irish Academy.	Dublin, Ireland.	[iii]
Science and Art Museum.	Dublin, Ireland.	[i]

SCOTLAND.

Aberdeen University.	Aberdeen, Scotland.	[iii]
University College.	Dundee, Scotland.	[ii]
Museum of Science and Arts.	Edinburg, Scotland.	[iii]
Royal Physical Society.	Edinburg, Scotland.	[i]
University Library.	Edinburg, Scotland.	[iii]
Glasgow University. (Care of Mr. Macle hose, Glasgow, per Mr. Billing, Ave Maria Lane, London, E. C.)	Glasgow, Scotland.	[iii]
Natural History Society of Glasgow (207 Bath Street).	Glasgow, Scotland.	[i]
Montrose Natural History and Antiquarian Society.	Montrose, Scotland.	[i]

WALES.

Free Library and Museum.	Cardiff, Wales.
Naturalists' Society.	Cardiff, Wales.

GREECE.

Natural History Museum of the National Library. Athens, Greece. [i]

GREENLAND (South).

Syd Grönlande Inspektorat. Godthaab, Greenland.

ICELAND.

National Library of Iceland. Reykjavik, Iceland. [i]

ITALY.

Accademia delle Scienze dell' Istituto di Bologna. Bologna, Italy. [iii]
 Museo Civico di Archeologia. Bologna, Italy.
 Reale Museo di Fisica e Storia Naturale. Firenze, Italy. [iii]
 Museo Civico di Storia Naturale. Geneva, Italy. [i]
 Museo Civico di Storia Naturale. Milano, Italy.
 Reale Istituto Lombardo di Scienze e Lettere. Milano, Italy. [iii]
 Società Italiana di Scienze Naturali. Milano, Italy.
 Società di Naturalisti in Modena. Modena, Italy.
 Biblioteca Nazionale. Napoli, Italy. [iii]
 Museo Nazionale di Napoli. Napoli, Italy. [i]
 Stazione Zoologica di Napoli. Napoli, Italy.
 Reale Accademia di Scienze, Lettere ed Arti di Padova. Padova, Italy. [iii]
 "Il Naturalista Siciliano." Palermo, Italy. [i]
 Museo di Storia Naturale. Parma, Italy.
 Reale Università. Pavia, Italy. [i]
 Università. Pisa, Italy. [iii]
 Biblioteca Nazionale Vittorio Emanuele. Rome, Italy. [iii]
 Reale Accademia dei Lincei. Rome, Italy. [iii]
 Reale Museo Industriale Italiano. Rome, Italy.
 Società Italiana delle Scienze. Rome, Italy. [iii]
 Accademia Reale delle Scienze. Torino, Italy. [iii]
 Direzione di "Cosmos" (Guido Cora) Torino, Italy. [i]
 Reale Museo di Storia Naturale. Torino, Italy. [i]
 Reale Museo Zoologico di Torino. Torino, Italy. [i]
 Musei di Zoologia ed Anatomia comparata della R. Università di Torino. Torino, Italy.
 Archives Italiannes di Biologie. Torino, Italy.
 Reale Istituto Veneto di Scienze, Lettere ed Arti. Venezia, Italy. [iii]

NETHERLANDS.

Koninklijke Akademie van Wetenschappen. Amsterdam, Netherlands. [iii]
 Koninklijke Zoologisch Genootschap "Natura Artis Magistra." Amsterdam, Netherlands. [iii]
 Koninklijk Zoologisch-Botanische Genootschap te 'S Gravenhage (Holland). 'S Gravenhage (The Hague). [i]
 Naturkundig Genootschap. Groningen, Netherlands. [i]
 Rijks Universiteit (formerly Academia Groningana). Groningen, Netherlands. [i]
 Hollandsche Maatschappij van Wetenschappen. Haarlem, Netherlands. [iii]
 Rijks Museum van Natuurlijke Historie. Leiden, Netherlands. [i]
 Rijks Ethnographisch Museum. Leiden, Netherlands. [i]
 Rijks Universiteit. Leiden, Netherlands. [iii]
 Société Néerlandaise de Zoologie. Rotterdam, Netherlands.
 Rijks Universiteit. Utrecht, Netherlands. [iii]

NORWAY.

Arendals Skoles offentlige Bibliothek og Museum.	Arendal, Norway.	[i]
Bergen Museum.	Bergen, Norway.	[iii]
Library of the University. (Det Kongelige Norske Frederiks.)	Christiania, Norway.	[iii]
Museum of Zoology. (Det Kongelige Norske Frederiks.)	Christiania, Norway.	[iii]
Videnskabs Selskabet.	Christiania, Norway.	[i]
Stavanger Museum.	Stavanger, Norway.	
Det Kongelige Norske Videnskabernes Selskab.	Trondhjem, Norway.	[iii]
Tromsø Museum.	Tromsø, Norway.	[i]

PORTUGAL.

Academia Real des Sciencias.	Lisbon, Portugal.	[iii]
Museo de Lisboa (Lisbon).	Lisbon, Portugal.	[i]
Museo de Historia Natural da Camara Municipal do Porto.	Oporto, Portugal.	

RUSSIA.

Derptskoie Obshchestvo Iestestvo-Ispytalelei.	Derpt, Russia.	[i]
Fiinskoie Uchonoie Obshchestvo (Societas, Scientiarum Fennica, Finska Vetenskaps-Societets).	Helsingfors, Russia.	[iii]
Obshchestvo dla izsledovania Iaroslafskoi gubernii v iestestvenno-istorichesk om otnoshenii.	Iaroslavl, (Yaroslav) Russia.	[i]
Imperial Kazanskii Universitet.	Kazan, Russia.	[iii]
Imper. Kharkofskii Universitet.	Kharkof, Russia.	[i]
Imper. Universitet Sviatovo Vladimira.	Kief, Russia.	[i]
Imper. Moskofskoie Obshchestvo Iestestvo-Ispytalelei.	Moskva (Moscow), Russia.	[iii]
Imper. Obshchestvo Lubitelei Iestestvoznania, Antropologii i Etnografii.	Moscow, Russia.	[i]
Moskofskii Publichnyi i Rumiantsefskii Muzei.	Moscow, Russia.	[i]
Novo-Rossiiskoie Obshchestvo Iestestvo-Ispytalelei.	Odessa, Russia.	
(The library of this society is inseparably connected with the university.)		
Obshchestvo Iestestvo-Ispytalelei (Naturforscherverein).	Riga, Russia.	[iii]
Imper. Akademia Nauk.	Sankt-Peterburg (St. Petersburg), Russia.	[iii]
Imper. Sankt-Peterburgskii Universitet.	St. Petersburg, Russia.	[i]
Sankt-Peterburgskoie Obshchestvo Iestestvo-Ispytalelei.	St. Petersburg, Russia.	[i]
Kavkazskii Muzei.	Tiflis, Russia.	
Imper. Varshafskii Universitet.	Varshava (Warsaw), Russia.	[i]
Vilenskaia Publichnaia Biblioteka i Muzei Drevnostei.	Vilna, Russia.	[i]

SPAIN.

Sociedad Española de Historia Natural.	Madrid, Spain.	[i]
--	----------------	-----

SWEDEN.

Götheborg Museum.	Götheborg, Sweden.	
Kongliga Universitet.	Lund, Sweden.	[iii]
Kongliga Svenska Vetenskaps Akademien.	Stockholm, Sweden.	[iii]
Nordiska Museet.	Stockholm, Sweden.	
Royal Museum of Natural History.	Stockholm, Sweden.	
Kongliga Universitet.	Upsala, Sweden.	[i]

SWITZERLAND.

Aargauische Naturforschende Gesellschaft.	Aarau, Switzerland.	[i]
Naturforschende Gesellschaft.	Basel, Switzerland.	[iii]
Universitäts-Bibliothek.	Basel, Switzerland.	[i]
Naturforschende Gesellschaft.	Bern, Switzerland.	[iii]
Universitäts-Bibliothek.	Bern, Switzerland.	[iii]
Thurgauische Naturforschende Gesellschaft.	Frauenfeld, Switzerland.	[i]
"Bibliothèque Universelle."	Genève, Switzerland.	
Musée Zoologique.	Genève, Switzerland.	
Société de Physique et d'Histoire Naturelle.	Genève, Switzerland.	[iii]
Société Vaudoise des Sciences Naturelles.	Lausanne, Switzerland.	[i]
Société des Sciences Naturelles.	Neuchâtel, Switzerland.	[iii]
Naturforschende Gesellschaft Graubündens.	Olten, Switzerland.	
Naturhistorische Gesellschaft.	Rheinfelden, Switzerland.	[i]
Naturforschende Gesellschaft.	Solothurn, Switzerland.	
Naturforschende Gesellschaft.	Zurich, Switzerland.	[iii]
Zoologisches Museum.	Zurich, Switzerland.	

TURKEY.

Robert College.	Constantinople, Turkey.	[iii]
-----------------	-------------------------	-------

SECTION II.

**REPORTS OF THE CURATORS OF THE U. S. NATIONAL MUSEUM
UPON THE PROGRESS OF WORK DURING THE FISCAL
YEAR ENDING JUNE 30, 1889.**

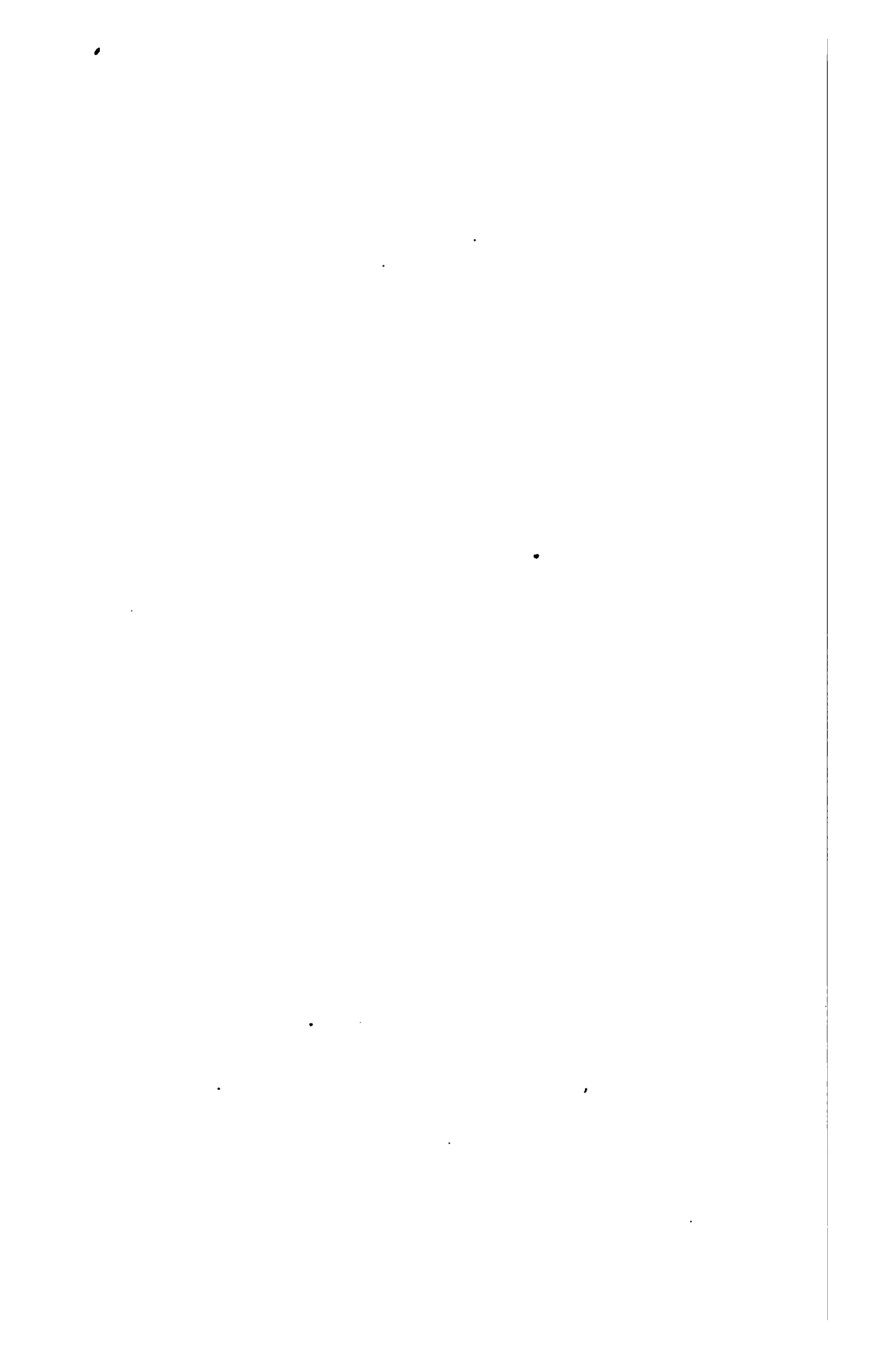

REPORT ON THE DEPARTMENT OF ETHNOLOGY
IN THE U. S. NATIONAL MUSEUM, 1889.

By OTIS T. MASON, *Curator.*

Among the collections secured during the year, the following are worthy of especial mention :

Dr. Washington Matthews's type set of Navajo blankets upon which his paper published in the third annual report of the Bureau of Ethnology is based.

A small lot of specimens from the Klyoquot Indians well authenticated by James G. Swan, to be used in labeling older objects from the same locality.

Antiquities and sketches from Egypt, by Dr. James Grant Bey, of Cairo, Egypt, accompanied by letter giving full information.

The entire contents of an Indian grave, presumably Choctaw, by Dr. W. A. Whitten, Moline, Mississippi, to be exhibited as a polyorganic museum unit.

A valuable series of religious objects from Thibet, collected by Mr. W. W. Rockhill. Each specimen was secured by Mr. Rockhill himself and is well authenticated.

A lot of objects from Mr. Edward Lovett, in England, especially useful in the illustration of the first steps in our modern inventions.

Mr. James Mooney, having spent two summers among the Cherokees, in western North Carolina, studying their dances and ceremonies, contributes excellent series of dance paraphernalia, with full information.

From Mrs. Col. James Stevenson the Museum has secured some rare pieces of old Pueblo pottery, and her own private collection of Zuñi arts, with detailed instructions for labeling and mounting.

Col. J. I. Allen, of Stillwater, Montana, has sent a rare collection from that almost inaccessible region.

Special mention is made of these accessions, because they fulfill the requirement of the curator with regard to accurate information.

During the year new sections have been organized in the exhibition series. In order to interest a large number of scholars not hitherto specially attached to the institution, efforts were made to gather in the National Museum fac-similes of all the inscriptions, seals, etc., in the country, relating to what is called in England "Biblical Archæology," or

the study of countries lying within an 800-mile radius around Palestine. So rapidly has this plan developed that a new section was formed under the curatorship of Dr. Paul Haupt, with Dr. Cyrus Adler, as assistant curator. Both of these gentlemen are connected with the Johns Hopkins University, Baltimore. A report of this section will be made by Dr. Adler.

Another exhibit organized may be called the ethnic series. In it by means of charts, colored maps, life-size lay figures, busts, miniature lay figures, painted portraits, and colored photographs, it is designed to teach the visitor the spread of various types of mankind, and to show just how these types appear. Great care has been bestowed upon this section. From Paris have come M. Hebert's reproductions. Many pieces have been prepared by our own workmen. The Bureau of Ethnology contributes photographs of all Indian delegations visiting the city. The Austrian minister has given a set of maps. This series is so installed that a public-school teacher may bring her class to the Museum and give to them a practical lesson in ethnology.

In another section of ethnic installation the curator is enabled to express his renewed obligation to the U. S. Navy. In a former report mention was made of the great help rendered by Lieut. T. Dix Bolles, U. S. Navy, in the installation of the Eskimo collections. During the last year the curator was aided by Ensign Albert P. Niblack, U. S. Navy, in arranging the specimens from the strip of our continent lying between Mt. St. Elias and Vancouver Island, along the Pacific coast, partly in British Columbia and partly in Alaska. This region is sometimes called the Northwest coast of America. The only objection to this title is the fact that in the Wilkes' narrative the same term is applied to the strip from San Francisco Bay to the Straits of San Juan de Fuca. There are several distinct linguistic stocks here, the Koloshan, the Haidan, Tsimsian, Haeltzukan, and Salishan, but the region forms one of these unique areas in which the arts, the modes of life, even the philosophical and religious conceptions have been guided and molded by surroundings.

Ensign Niblack was on duty in the Museum from October 3 to March 22. He was ordered to the Smithsonian to prepare a report on the Coast Indians of Alaska and Northern British Columbia from notes made in connection with the survey of Alaska in 1885, 1886, and 1887, such orders being in pursuance of a plan formed by the Navy Department in 1831, to further the progress of scientific research by enlisting the interest of naval officers on their cruises in making such collections and notes as might prove of value. The ethnological material in the National Museum from southern Alaska offered a fine field for illustrating the ethnographic character of these Indians, and in connection with the photographs and sketches taken in the field, form the basis of the illustrations of the report. Two charts also accompany the report, one representing the Indian stocks, as defined.

by the most recent investigations in British Columbia, and the other the location of the different tribes of the Koloshan and Haidan stocks about Dixon Entrance, which arm of the sea forms the natural boundary between Alaska and British Columbia. In connection with this latter chart it may be well to state that it outlines the hunting and fishing grounds of the different tribes as far as obtainable by the writer. The report itself does not deal with the linguistic characteristics, the religious beliefs, or superstitions and traditions of the Indians. Otherwise it aims at a somewhat systematic general exposition of the habits, customs, arts, industries, and characters of the Indians composing the Koloshan, Haidan and Tsimshian stocks and in connection with the accompanying illustrations will serve as a descriptive catalogue of the collection in the National Museum from this region. In the selection of the material for illustrations from the Museum collections, characteristic specimens were formed into an ethnographic collection illustrative of these Indian stocks, similar to the Eskimo collection now so graphically arranged in the Museum. General descriptive cards were written to temporarily explain the significance of the collections until such time as the individual cards may be prepared from the report. From the narrative of early voyages the primitive customs and characteristics of these natives are contrasted with those of the different periods in the past century. Much new material is presented, notably the illustrations of ancient wooden and leather armor, the preparation of tobacco, details of house and canoe construction, several methods of hunting and fishing, the significance of totemism, the steps in the development of the arts of painting and carving and outline of their principal ceremonial institutions. This report will undoubtedly form the basis of any further ethnological research in that region, and the section will be an object lesson to explain the report.

Another series of objects arranged for public inspection in the Museum is designed to teach the history and elaboration of a single group of industries, namely, those connected with the protection and manipulation of fire. Mr. Walter Hough, my assistant, has devoted much time to this study, and has been able to gather the fire-making tools of nearly all the tribes of our aborigines from the farthest north to Cape Horn. By study and correspondence he has also found out the methods of applying these, until he can, with the simplest savage device, himself create fire. Collections have also been made of tinder-boxes, tinder-wheels, strike-a-lights, stick-matches or "spunks," early friction matches, lighters, etc., and the series is now nearly complete for this country. Mr. Hough has also devoted much time to the arrangement of the illumination collection, with a view to filling up the lacunæ and showing the elaboration of lighting apparatus. While the collection and installation of ancient and foreign lamps has been attended to, special attention has been given to procuring the earlier forms in our own country

from colonial times down to the era of kerosene. Study has been made of the ancestry of the older American lamps, and the forms have been traced to Germany, England, Scotland, and other countries—the shapes of lamps in the different sections of the United States depending on the country from which the immigration came.

Models have been made of candle-dipping apparatus and other objects that could not be procured, or were unsuitable for exhibition.

Germane to this subject is that of heating. This collection, though smaller, has been exhibited and has received several important additions within the past year.

A series to illustrate this whole subject, both by countries and in its elaboration, was sent to the Cincinnati Exposition of 1888. A series of antique lamps was contributed to the exhibition of Biblical Archaeology, also shown at Cincinnati.

The curator has given especial attention to the study of transportation on the backs of men and women, to aboriginal hide dressing, to aboriginal cradles, and to the evolution of common tools, the knife, the hammer, the saw, etc. To interest the boys who visit the Museum, a series of "jack-knives" has been arranged for public inspection, and the interest which such a case excites is shown by the gifts made constantly to the series.

In the latter part of the year the curator commenced to collect for public reference a card catalogue of the resources of anthropology. By this is meant not a bibliography of anthropology, but a guide catalogue to the resources of the science, so that a special student, a lecturer, or a college professor can be put at once into communication with the chief sources of information. For this work a student at the National Deaf Mute College, who has spent his leisure and his holidays with me, has been specially detailed. By this means the literary resources of the department will be made as useful and instructive as the material.

For the purpose of educating people in correct methods of anthropological study great care was taken in the preparation of exhibits for the expositions at Cincinnati and Marietta.

At the former place were shown a series of charts giving the classification of the human species by Hæckel, Topinard, Friedrich Müller, Welcker, de Quatrefages, and W. H. Flower, a map of the world painted to show the distribution of the chief types of humanity, large glass cases fitted up with groups of Zuni and Ute Indians in costume, and three hundred painted portraits of individuals belonging to the various races of men have been prepared by Mr. A. Z. Shindler.

Another series to which great attention was paid was a set of vitrines, each devoted to the natural history of a separate art or a separate thing. All the tools and specimens of partly finished work belonging to the basket-maker, mat-weaver, root-digger, bread-maker, tanner, shoe-maker, bow and arrow maker, etc., were so mounted and illustrated as to teach the process of the art.

Another series was made to teach the lesson of geographical distribution. For instance, three hundred arrows were so mounted and labeled as to help the visitor to trace the effect of environment on the arrow. In the same way were treated other implements. At Marietta another lesson entirely was taught. Here the object was to make the ethnic concept supreme. The Makah Indians, living at the northwest corner of Washington, were selected, and specimens of their handiwork so arranged as to show their homes, dress, handicrafts, arts, social life, and religion. The life history of a single group was made manifest.

The curator has during the year, at the request of the Director of the Museum, made three tours of inspection, to examine the Valentine collection in Richmond, the Western Reserve collection in Cleveland, and to study the public and private museums in the vicinity of Boston.

The first named is an enormous private gallery in the vicinity of Richmond illustrating the aboriginal life on the James River. It is worthy of a more public installation. In the same collection are about one thousand articles from North Carolina made in soft micaceous material absolutely *sui generis*. The curator was greatly interested in the ingenuity manifested in the design and fabrication of these pieces.

The Western Reserve collection at Cleveland is located in the upper story of a building, and should be more attractively exhibited. There are in this hall many pieces of great value. It is especially rich in the archæology of Ohio.

The Peabody Museum at Cambridge exhibits in every room the training in anatomy of its two distinguished curators. If we omit the National Museum, there is no other place in our country where archæology is more richly illustrated. In the shell heaps of the whole Atlantic coast, the palæolithic relics of New Jersey, the results of careful dissection of mounds and graves in the Ohio drainage, this museum leaves little to be desired and presents a great deal worthy of imitation.

From these tours of inspection the curator returns impressed with the great service which may be rendered to science by the co-operation of great museums and by friendly assistance rendered to local collections, and would recommend the preparation of a directory of anthropological and archæological resources in America.

In lieu of costly expenditures for the purpose of collecting, the curator has found it convenient to have in various out-of-the-way places local agents and referees, from whom, by patient questioning and careful collecting, he has been able to gather material under circumstances which confer great value upon it. In this way a cradle, a bow and arrow, a weaving-stick, a fire-drill, and so forth, may be followed up until the student has received complete information from reliable source. Especial mention may be here made of Col. J. I. Allen, Montana; Charles Willoughby, Quinaielt; J. G. Swan, Port Townsend, Washington; L. Frost, and N. J. Purcell, California; Lieut. T. Dix Bolles,

U. S. Navy; John Durand, Paris; Dr. James Grant Bey, Egypt; Lady Edith Blake, Nova Scotia.

Another method adopted for enriching the department of ethnology has been a number of exchanges with museums. During the year a large series of objects from our modern Indian tribes was sent to the Peabody Museum in Cambridge, for which our collection will receive accessions from the explorations of Professor Putnam.

Exchanges have also been conducted with the Cincinnati Art Museum, with Dr. Gosse, of Geneva, Switzerland, with the Royal Ethnological Museum in Berlin, and with Mr. Edward Lovett, in England.

ADDITIONS TO THE DEPARTMENT OF ETHNOLOGY.

- Greenland*.—Snow shovel, 4 arrow points, fid, comb; Dr. C. Hart Merriam (21589).
Water tube, harpoon head, belaying pin, kayak scraper, ice knife or kayak, throwing stick, knife. Theodore Holm (21418).
- Sitka*.—Caribou-skin jerkin, buckskin ceremonial shirt, deer-skin shirt, buckskin shirt ornamented with bear's claws. Max B. Richardson (21596).
- Queen Charlotte Island*.—Dancing shirt of bear skin, very fine; design, the totem of the bear. J. G. Swan (20957).
- Fort Rupert, British Columbia*.—Nimkish Indians. Jointed sword (dancer's), powder bags (3), wythe of cedar (rope), spoons (4), salmon gaff hook, knife for carving (4), prepared kelp, seal spear heads and leaders (2). J. G. Swan (20957).
- Vancouver Island*.—(Kuyouquats.) Basket of spruce root, cloak, blanket or cloak, cedar bark mat, prepared cedar bark. J. G. Swan (20957).
- Vancouver Island*.—Brass bracelets. Dr. F. Boas (21890).
- Washington Territory*.—Colispe Indians. Camas roots. Dr. E. L. Morgan, (20945).
- Alaska*.—Woman's knife. Dr. Cyrus Adler (22145).
- Rattle, food dish, trap. U. S. Fish Commission (21734).
- Montana*.—Stillwater photos of two Crow Indians (20979). Child's moccasins (21549).
Crow Indian medicine shield, medicine case, bone breaker, robe fletcher, lariat, sheep-skin robe, peace pipe and case, arrow with two scalps, girl's deerskin dress, parfleche wallet, broken sword from Custer's battle-field. Col. J. I. Allen (21553).
Bow made by Yellow Belly. Capt. Charles Bendire, U. S. Army.
- New Mexico*.—Zufii sacred blanket, blue blanket, eagle fetish, medicine stone, red paint, grooved axes (3), celt, sacred paint mortars (3), rubbing stones (2), hafted axes ground and chipped (2) (Moki); sacred meal trays (27), tray baskets (10), bowl-shaped baskets (2), basket materials, wooden images (3), dance sticks (1 pair), wooden bird, head dress, rattle, dance armlets (2 pairs); (Pueblos), Arrow heads, spear heads, knives, awls used as amulets in dance, and for drills, etc. (25); (Apaches), baskets (3); Mrs. T. E. Stevenson (21665). Arrows, Apaches (2); D. Fitz Gerald (21110).
- Arizona*.—Apaches, part of fire drill, Capt. John G. Bourke, U. S. Army (22093); Navajos, Cap holder and powder charger, silver chain, spindles, blankets (5), the large blanket, blankets of coarse and fine diagonal weaving and fine and coarse straight weaving (types used to illustrate Dr. Matthews's paper on Navajo weaving in the third annual report of the Bureau of Ethnology, 1885, p. 335); Dr. Washington Matthews, U. S. Army (20888).
- California*.—San Luis Obispo, charm stone; H. W. Henshaw (21792).
- Maine*.—Swedish wooden shoes; William Bartlett (21523).
- Massachusetts*.—Salem, earliest friction match; F. W. Putnam (20904).
- Niagara Falls*.—Basket; W. H. Chandler (21749).
- New York*.—Foot stove; F. S. Hawley (21741).
- New York*.—Broadalbin; glass camphene lamp, wheel tinder box and pistol cartridge box; F. S. Hawley (21276).

- Wisconsin*.—Milwaukee; Patent boomerangs, H. Eggers (20974).
- Pennsylvania*.—Philadelphia; Shaving and splint matches; Geo. G. Fryer (21108).
- Maryland*.—Russian lamps (2), whale oil lamps (2), Camphene lamp, J. T. Durney (21960). Globe candlesticks (2), cut-glass camphene lamp, flat candlestick and extinguisher, student lamp, Diacon lamp, James Russel & Son (21959). Foot stove, Joseph Elias & Son (21958). Candle snuffers; T. W. Sweeney (20973). Stone with socket; E. P. Valentine (21486).
- Washington*.—Camp candlesticks; Paul E. Beckwith (21313). Flint-lock pistol, (21535). Old balances; Peter Burger (20972). Gas-lighting attachment; C. A. Stewart (21558). Sand bag, knives (6), tweezers and razor; John Graham (21270). Luminous match safe, pair of old bellows, pocket match box, model of candle-dipping apparatus, model of "endless," or "Confederate candle," used in South during the war; W. Hough (21731). Bust of Geronimo; Theo. A. Mills (21729).
- Virginia*.—Plantation hoe; Frank Burns (21372). Light-wood; Rev. R. Ryland (21851).
- West Virginia*.—Waffle tongs (21131), wooden lock (21131), pottery lamp for burning grease; Walter Hough (21459). Bread raising basket; Mrs. L. S. Hough (21137). Coffee biggin; Mrs. Dr. Casselberry (21132). Dutch oven and brass candlestick; Miss Emma Protzman (21134). Muffin rings (3), cake patty and wooden lock; Greenland Thompson (21135). Canteen of 1863; Col. Frank Thompson (21134). Horse pistol and old lantern; Col. Ashbel Fairchild (21136).
- North Carolina*.—Photographs of houses and of the inhabitants of North Carolina; G. P. Merrill (21246). Cherokee baskets (3), moccasins, stone for polishing pottery, scratchers used in ball play (2), cupping horn, glass lancet, arrow heads and stone knife (3), conjuring stones (3), ball uniforms (4), masks (2), rattles worn on the knee (1 pair), bullet molds, spoon, pipes, Bureau of Ethnology; James Mooney (21449-21450).
- Georgia*.—Brass hammer, iron chisel and hatchet, Henry Horan (21381).
- Mississippi*.—Objects found in a Creek or Seminole grave, bottles (3), cups (2), saucers (2), iron spoons (5), pewter spoon, brass kettle, bits (2), scissors, semi-lunar breast ornaments (4), silver crosses (3), silver amulets (2), silver wristlets (3), silver open-work brooches (15), gorgets (3), glass beads, small buckles, trinkets (10), brass padlock, silver earrings (1 pair), ear-drops (11); Dr. W. A. Whitten (20377).
- Mexico*.—Pottery owl; Mrs. T. E. Stevenson (21664). Aztec idols (3); W. H. Doane (20647). Photos of Caribs, "Les Habitants de Suriname;" Prince Roland Bonaparte.
- Bohemia*.—Rice sieve; Royal Gardens, Kew, England (20488).
- South America*.—Venezuela, photos of Goajiro Indians (4); Hon. T. F. Bayard (21344). Rio Negro, quiver of poisoned arrows for bow-gun, basket; Royal Gardens, Kew, England (20488). Patagonia, horse bolas and guanaco bolas; Thomas Lee (21468).
- England*.—Toaster and warming-pan one hundred and twenty years old; Mrs. E. J. Stone (21419). Spring candlestick; Goldsborough & Co. Snuffers, tinder-box, early English cup, liquor pot and base of cup, rush dipped candle, horn lantern; E. Lovett (21292).
- Scotland*.—Iron lamp, "Crusie" (3); E. Lovett (21292). Cruisgean or iron lamp; Charles Stewart (21706).
- Belgium, Antwerp*. Hanging lamp (old style), Flemish tinder box; E. Lovett (21292).
- Germany, Nurnburg*. Box of night-light tapers (old original); George G. Fryer (21108). Meerscham pipe; L. Luchs (21891).
- Italy*.—Etruscan pottery lamp, oil lamp seventeenth century; Goldsborough & Co.
- Egypt*.—Fragments of leather cover (fac-simile) of the catafalque of Isi-em-kheb, a queen of the twenty-first dynasty 1000 B. C. (21417). Water colors of ancient

- lamps (7) (20975). Piece of mummy cloth with ritual of the dead; Dr. James Grant Bey (20730). Small pottery figures and scarabs (26), shubti or respondents (2), stucco mask from female mummy; S. Prentiss Knut (21919). Wreathes from mummies, Royal Gardens, Kew, England (20488).
- Morocco*.—Knife; Henry Horan (21146).
- East Central Africa*.—Spoon, Royal Gardens, Kew, England (20488).
- Africa*.—Fire drill, South Africa, fire stick (Bushman); F. W. Putnam (145).
- Persia*.—Teheran, suit of a Persian Mohammedan priest (12 pieces); Rev. J. L. Potter (21866).
- Afghanistan*.—Pulley, Royal Gardens, Kew, England (20488).
- East Turkey*.—Complete costumes Koordish soldier (18 pieces); Rev. A. N. Adrus (21666).
- India*.—Model of the Taj Mahal, (tomb of Nourmahal); Bishop J. P. Newman (21043). Madras. Sling; Royal Gardens, Kew, England (20488). Cup; E. Lovett (21292).
- Ceylon*.—Betel nut for chewing; R. Hitchcock (21689). Rice strainer; Royal Gardens, Kew, England (20488).
- Assam*.—Tinder; Royal Gardens, Kew, England (20488).
- Turkestan*.—Scroll picture giving scenes in city life in Chinese Turkestan; W. W. Rockhill (21260).
- Mongolia*.—Mongol Buddhist manuscript book; W. W. Rockhill.
- Thibet*.—Lama's score book, book with pictures of Buddhist pantheon; *mani-Kandun*. Thibetan religious books (2), almanacs, burial service, skull libation bowl, priest's drum, exorcising flute, prayer beads, priest's bell, charm box, hand prayer wheel, table prayer wheel, gift handkerchief, images of Dolma (*Jam-by-ang*), Lok-yo-ma god of medicine, *Kun-kar-yi-jin-norbu* god of riches, Wupamed Thibetan form of Buddha, picture of Pal-dan-hlamo one of the chief protectors of Thibet, picture of the five gods of hell, picture of the three chief gods of Thibet, picture of Tsong-ka-pa, the founder of Lamaism and of the chief Lamas, picture of the Mongol Lamaist pantheon, aspergill, inkstand, photo of Lama priest, photos in western China (3); W. W. Rockhill (21251).
- China*.—Rosary of nuts, rosary of carved seeds, Chinese Buddhist book; W. W. Rockhill (20261). *Kin* or moon guitar, *Ur-heen* and bow, flute, tambourine, *San-hee* or banjo, mandolin (21317). Woman's costume; Mrs. W. W. Rockhill (21318). Canton, compound bow and arrows (5); P. L. Jouy (21264). Jade audience ring, Chang Yen Hoon (21964). Strike-a-light, G. G. Fryer (21108).
- Corea*.—School book, writing book, and tract on western innovations; Ensign J. B. Bernadou, U. S. Navy (21599).
- Japan*.—Bronze Buddha, bows and arrows in holder, fire engine (20852). Seated figures (3), Nio; Daikohu, god of wealth, foxes called man's servants (2), shoki, the demon slayer; Ed. Greey (21176). Head of royal arrow, Hieromich Shugio (21737). Scepter of Indra; W. W. Rockhill (21261). Buddhist rosary, P. L. Jouy (21264).
- Yesso*.—Fire-making set (*Ainos*); F. W. Putnam (145).
- Siam*.—Bamboo pipe-stems (2); Royal Gardens, Kew, England (21488).
- Borneo*.—Sandals; Royal Gardens, Kew, England (20488).
- New Zealand*.—Sandal; Royal Gardens, Kew, England (20488).
- Sandwich Islands*.—Necklace; E. P. Thorn (21315). Hawaii or Oahu, adze blades (2); Mrs. T. E. Stevenson (21664).
- Admiralty Islands*.—Spear heads of obsidian; Mrs. T. E. Stevenson (21664).
- Solomon Island*.—Adze blades (2); Mrs. T. E. Stevenson (21664).
- New Guinea*.—Jade celt; Mrs. T. E. Stevenson (21664). Motu Group, net bag, necklace, Royal Gardens, Kew, England (20488).
- Australia*.—Hatchet; Mrs. T. E. Stevenson (21664).
- Orkney Islands*.—Rush pith wicks; D. Bruce Peebles (20965).

REPORT ON THE SECTION OF ORIENTAL ANTIQUITIES
IN THE U. S. NATIONAL MUSEUM, 1889.

By CYRUS ADLER, *Assistant Curator.*

The word "oriental," as usually understood in museum administration or in philological or archæological circles, covers a broad field. India, China, Japan, Siam, Armenia, Persia, Phœnicia, and Cyprus, Palestine and the Jews, the Samaritans, Arabia and Mohammedanism, Syria and Egypt are included within the range of the American Oriental Society, or of the Royal Asiatic Society. The scope of the International Congress of Orientalists, held in 1889, is indicated by the following division into sections:

First. Semitic and Islam:

a. Languages and literatures of Islam.

b. Semitic languages, other than Arabic; cuneiform texts and inscriptions, etc.

Second. Aryan.

Third. African, including Egyptology.

Fourth. Central Asia and the Far East.

Fifth. Malay and Polynesia.

Much of the material which would find place in a department established with such a scope, had been collected for the Museum and installed in other departments before the organization of a section especially devoted to Oriental Antiquities was contemplated.

The establishment of this section was due originally to a desire to collect in the National Museum copies of the smaller Assyro-Babylonian objects preserved in this country. These objects (principally seals) are of much importance in connection with the history of the Assyro-Babylonian religion and art, and the Museum has devised a plan for copying them which facilitates their study and exhibition. It is hoped that among other results there will grow from this work a catalogue of all the Assyro-Babylonian objects preserved in this country.

The Section of Oriental Antiquities, in view of the limitations upon its scope and resources, is practically devoted to Biblical Archæology—to the history, archæology, languages, arts and religions of the peoples of Western Asia and Egypt. Material is chosen which especially illustrates Biblical history, and labels are prepared from this point of view.

The first six weeks of the fiscal year (which included a stay of two weeks in Cincinnati) were devoted to the arrangement and labeling of the exhibit of Biblical Archæology for the Centennial Exposition of the Ohio Valley. The last two weeks of August, as much time as could be spared from the work at the Johns Hopkins University during the winter, and the latter part of May and June were spent in arranging, labeling and putting on exhibition specimens acquired, in conducting correspondence with a view to increasing the collection, in gathering a working library for the use of the Section and of properly accredited Orientalists visiting Washington, in the preparation of a report on the progress of oriental science in America during 1888, and in the transaction of the business connected with the meeting of the Eighth International Congress of Orientalists at Stockholm.

The collection of casts of Babylonian and Assyrian seals has grown satisfactorily during the year.

While attending the exhibition at Marietta, Ohio, in July 1888, Mr. W. V. Cox, chief clerk of the Museum, and Mr. J. Elfreth Watkins, Curator of the Section of Transportation and Engineering, noticed a Persian seal; they secured an impression of this object, which was forwarded along with the name of its owner, Maj. E. C. Dawes. The correspondence which followed, resulted in Major Dawes offering his small collection for copy, accompanied by the information of the expected return to this country of their collector, the Rev. Dr. J. H. Shedd. Dr. Shedd also sent a small collection for copy and gave information of the existence of a collection made by himself, but sold some time since; through the instrumentality of Mr. A. Van Name, Librarian of Yale College, this collection was traced to the hands of Prof. O. C. Marsh, of New Haven, who placed it at the disposal of the Museum for copy.

The small but valuable collection of Miss M. W. Bruce, of New York, to which attention was first called by Madame Zenaide A. Ragozin,* was secured for copy through the instrumentality of Madame Ragozin. It includes three cylinder seals and six contract tablets.

President D. C. Gilman, of the Johns Hopkins University called attention to a communication from Prof. Spencer F. Baird, under date of January 29, 1864, in which he referred to objects "collected at Babylon and Nineveh, by my old pupil, Rev. Israel S. Diehl." A careful search revealed no trace of their whereabouts, but with the assistance of Bishop Newman, it was found that they were in possession of Mrs. Anna Randall Diehl, of New York, who deposited the collection of seals in the Museum.

The manner of obtaining these small objects has been dwelt upon to show how they are scattered throughout the country, and how the kind assistance of friends of learning is necessary to rescue them from their hiding places.

* *Media*, in the *Story of the Nations* series, page 251.

Prof. Paul Haupt, Honorary Curator of the Section, spent the summer of 1888 abroad, and visited the Royal Museum of Berlin, and the British Museum. From the former he made a selection of casts of Assyrian and Egyptian objects, illustrating the collections in the Royal Museum of Berlin, the Museum of Egyptian Antiquities at Turin, Italy, the Louvre at Paris, the Boulak Museum at Cairo, Egypt, and the British Museum. The National Museum is indebted to the officers of the Royal Museum of Berlin for courtesies in its transmission, and for excellent packing, whereby the entire collection arrived in good condition.

Two Egyptian scarabei, the gift of Miss Aline E. Solomons, Washington, a series of Egyptian photographs, and the Egyptian ethnographic series prepared by Mr. W. Flinders Petrie, have also been added to the collection.

Labels have been prepared for all the Assyro-Babylonian seals mentioned above, as well as for those received during the previous year. Only a portion of these objects has thus far been placed on exhibition. The labels included a statement of the material of the original when known, a history of the original, translation of the inscription, and signification of the representation where it could be determined. Labels were also prepared for the series of Assyrian photographs from the British Museum, the Bonfils photographs, and the Assyrian and Egyptian objects from the Royal Museum of Berlin. In February space was assigned the section in the west hall, and on March 2 the collection was installed, the larger slabs on frames especially constructed for the purpose.

There have been no published researches on the specimens collected, though the collection of casts of Assyrian and Babylonian seals has been studied with a view to future publication. It may not be improper in this connection to call attention to the proposed edition of the "Life and Writings of Edward Hincks" by the Semitic Seminary of the Johns Hopkins University. In July the Acting Secretary of the Smithsonian Institution consented to make the Institution a depository for papers and manuscripts sent to this country to further the prosecution of the work. Prof. F. Max Müller, of the University of Oxford, under date of September 27, forwarded manuscript letters of Dr. Hincks in his possession; and under date of October 29, he kindly offered to permanently deposit these letters in the Smithsonian Institution.*

The Museum secured an interesting Persian astrolabe. After a preliminary examination it was submitted to Dr. C. Johnson, jr., Fellow-elect in Semitic languages, of the Johns Hopkins University. He is now engaged upon it, and presented a study, suggested by this instrument, at the May meeting of the American Oriental Society, entitled, "The Chaldean Astronomy."

*Cf. Dr. Cyrus Adler. Note on the proposed edition of the life and writings of Edward Hincks, *Amer. Orient. Soc. Proc.*, October, 1888, p. 61.

The catalogue of the section is kept by the Department of Ethnology. The number of specimens on exhibition (including one hundred and fifty photographs) is about four hundred and twenty-five, with an equal number in the reserve and study collections, which include a collection of paper squeezes from the Boulak Museum.

We are indebted for co-operation and assistance, in addition to the persons already named, to the Hon. Oscar Straus, ex-United States minister at Constantinople; Prof. Howard Osgood, of Rochester, New York; Dr. James Grant Bey, of Cairo, Egypt; and Prof. D. G. Lyon, of Harvard University.

REPORT ON THE SECTION OF TRANSPORTATION AND ENGINEERING
IN THE U. S. NATIONAL MUSEUM, 1889.

By J. ELPRETH WATKINS, *Curator.*

The routine work in the Section of Transportation and Engineering during the fiscal year 1888-'89, was interrupted by my absence from the Museum during almost the whole month of July, at the Ohio Valley Centennial Exposition, at Cincinnati, where several series of models, photographs and drawings were placed upon exhibition, to illustrate the successive stages in the development of the art of transportation from aboriginal times to the present era of the steam-ship and the locomotive.

It is believed that this was the first attempt in the history of expositions, to present an object-lesson of the development, step by step, of our great systems of transportation.

While this first effort must be regarded as an experiment, it is gratifying to know that it met the approval of those interested in preserving the history of engineering science. This is particularly true of the objects in the fourth series alluded to below.

The exhibit was arranged in seven series.

The first was intended to show the methods adopted by the aborigines and early settlers, and contained objects of special local interest to the residents of the Ohio Valley and of the old Northwest Territory.

The second contained only objects illustrating the development of (1) the American; and (2) the English locomotive. It is believed that this series contained a larger number of objects than had ever before been assembled to show the history of the locomotive.

In the third, illustrating the development of the American passenger car, the objects were arranged according to dates, rather than as a series showing the progress of development. This arrangement was made necessary owing to the large number of experiments that were made before the present type of American car* came into general use.

*Many of the objects in this series were illustrated in "The Evolution of the Railway Passenger Car," by J. Elfreth Watkins, *Harper's Weekly*, August 25, 1888.

In the fourth series were exhibited forty-five models,* illustrating the development of the American rail and track. In addition to these models several rail sections that had been in service prior to 1835 were shown, attached by the original fastening to the stone blocks which were used by early railway constructors.

In selecting objects for the fifth series, devoted to the development of the American steam-boat and modern steam-ship, many illustrations of early attempts at invention, which may be regarded as chimerical, were omitted. This series was intended to show the beginnings of marine steam engineering, together with a very few types of modern steamships.

The sixth series contained maps, showing the beginning and extension of the American railway system from 1830 to 1888; and in the seventh, palanquins, sledges, elephant howdahs, etc., illustrating methods of transportation in foreign lands, were assembled.

The arrangement of objects in the alcove assigned to the Department of Transportation and Engineering at Cincinnati was completed about the last of July, when, upon returning to Washington, my attention was directed to the rearrangement of the few objects which remained upon the floor of the Museum.

Late in November, 1888, many of the objects in the exhibit alluded to above were returned from Cincinnati, requiring a rearrangement of the exhibition series, which was completed early in March. Since that date the work of correspondence and the care of the objects which have been added to the collection have engrossed as much of my attention and time as could be spared from other duties in the Department of Property and Supplies, the present organization of which, I trust, will permit me to devote more effort to the extension of the Section.

At the annual convention of the American Society of Civil Engineers held at Seabright, New Jersey, June 20-26, 1889, the following preamble and resolutions were unanimously adopted:

Whereas the authorities of the Smithsonian Institution have established in the National Museum at Washington a department devoted to the preservation of the history of American Engineering science:

Resolved, That the American Society of Civil Engineers hereby expresses its gratification at the establishment by the Smithsonian Institution, with the authority of the General Government, of a department in the National Museum for the preservation of objects of interest bearing upon the history of American engineering, and recommends that American engineers co-operate with the Smithsonian Institution in furthering the objects for which the Department of Engineering has been established.

Resolved, That copies of this resolution be sent to the Secretary of the Smithsonian Institution, and to the Curator of the Engineering Department of the National Museum.

JOHN BOGART,

Secretary American Society Civil Engineers.

* Illustrations of these models may be found in the "Development of the American Rail and Track," by J. Elfreth Watkins, read before the annual convention of the American Society of Civil Engineers, Seabright, New Jersey, June 21, 1889.

Among the important accessions received during the year the following may be noted :

A handsome Japanese kago, presented by Tokugawa Iyenari, eleventh Taikun of Japan to his daughter, upon her betrothal to Prince Hosokawa a Daimio of Higo, 1835, obtained through Hieromich Shugio. This kago is made of wood, beautifully lacquered and elaborately embellished with crests of the Tokugawa and Hosokawa families. The interior is handsomely upholstered and decorated.

A model of a Japanese jinrikisha (light-covered vehicle with two wheels, drawn by a man or boy), together with the small painting which accompanies it, gives an excellent idea of the manner in which this popular conveyance of Japan, which takes the place of the London cab is used.

Among the objects especially prepared for the Cincinnati Exposition which have found a permanent place in the collection, is a series illustrative of the history of transportation before the advent of the locomotive, of which the following are worthy of note :

Apache squaw with carrying basket (full-size figure), illustrating an aboriginal form of burden bearing, since known as "toting" by the negroes of the Southern States.

Pack-mule (mounted specimen), illustrating means adopted by early settlers to transport freight across the Alleghany Mountains, the pack-saddle and manner of packing being in accordance with prevailing methods among the mountain "packers."

Ohio River flat-boat (model), *The Mayflower of the Ohio*. It was upon a similar boat that the earliest settlers journeyed down the Ohio River and disembarked at Marietta.

Steam-boat *Orleans*, 1812 (model), the first steam-boat on the Ohio River. This boat was built under the direction of Robert Fulton and Nicholas Roosevelt.

Conestoga wagon, 1785-1830 (model). Wagons of this type were used in the transportation of emigrants and freight from the East across the Alleghanies to the Ohio and Mississippi Valley.

Stage coach (model). Type in use between Pittsburgh and Philadelphia in 1825.

Canal passenger packet-boat, 1846 (model). Type used on the Pennsylvania Canal, Columbia to Hollidaysburg, on the through line, Philadelphia to Pittsburgh. Through the courtesy of Mr. William J. Latta, general agent, and Mr. F. W. Webb, foreman of the Pennsylvania Railroad Company, at Philadelphia, the last three models noted above were constructed at the Philadelphia shops, being a reproduction in miniature of the vehicles and canal packet-boat exhibited by the Pennsylvania Railroad Company in the trades' parade at the Celebration of the Centennial Anniversary of the Adoption of the Constitution, in Philadelphia, October, 1887.

The series illustrating the history of the American locomotive has

been very materially strengthened by the addition of several valuable models, among them being :

Trevithick's locomotive, 1804 (model). This was the first steam locomotive to help man, and was designed and constructed by Richard Trevithick. It ran for several months in 1804 between Pandyarren Works and the Glamorgan Canal, near Aberdare Junction, Wales, hauling cars laden with coal and pig iron.

John Stevens's experimental locomotive, 1825 (model.) The first locomotive built in America of which there is a reliable record. The original locomotive built by John Stevens had a multi-tubular boiler,* and was experimented with on a circular track at Hoboken, New Jersey, during the years 1825, 1826, 1827, and 1828. This model was constructed in the National Museum workshops, from information furnished by Mr. Francis B. Stevens (a grandson of John Stevens), a distinguished mechanical engineer of Hoboken, New Jersey, who rode upon the locomotive when he was a boy, and who was thoroughly familiar with its construction.

Locomotive *Best Friend*, 1830 (model). The first locomotive constructed in America for actual service on a railroad. Built at West Point Foundry, New York, for the South Carolina Railroad. Made trial trip January 15, 1831. This model is constructed from the original drawings in possession of the American Society of Civil Engineers.

Locomotive *John Bull*. Camden and Amboy Railroad. India ink drawing (on mat 30 by 40) from tracings of the original working drawings which accompanied the locomotive from Stephenson's Works, New Castle-on-Tyne, showing how the locomotive appeared when set up at Bordentown, New Jersey, August, 1831. The tender built at Bordentown shortly afterward, was improvised from a small four-wheel construction car, a whisky hogshead being used for a water-tank. The connecting-rods shown were never used, owing to sharp curves in the road.

Locomotive *Sandusky* (model). Driving wheels, 4 feet 6 inches; cylinders, 11 by 16 inches. The first locomotive in the State of Ohio, 1837. This, the first locomotive built by Rogers & Co. (then Rogers, Ketchum & Grosvenor), at Paterson, New Jersey, was originally built for the New Jersey Railroad and Transportation Company, but, not being accepted by them, was purchased by J. H. James, of Urbana, Ohio, president of the Mad River and Lake Erie Railroad. It was shipped by canal October 14, 1837, and when it arrived in Sandusky, November 17, 1837, not a foot of railroad had been laid in the State. The gauge of the wheels of *Sandusky*, 4 feet 10 inches, thus became the established gauge in the State of Ohio. This model was also constructed in the Museum workshops.

* The original multi-tubular locomotive boiler, constructed by John Stevens in 1825, for this experimental locomotive, was deposited in the U. S. National Museum by the authorities of the Stevens' Institute, Hoboken, New Jersey, in the last fiscal year, and is referred to in my annual report for 1887-'88.

The handsome model of the locomotive *Old Ironsides*, built by Matthias Baldwin in 1832, constructed at considerable expense by the Baldwin Locomotive Works, and presented by them to the Museum, is one of the most valuable accessions of the year. This model, accurate in every detail, a faithful miniature of the early handiwork of the founder of the company which has sent locomotives to every quarter of the globe, will be a great aid to the future historians who may wish to place upon record the facts connected with the beginnings of locomotive building in America. The original "*Ironsides*" hauled the first passenger train in the State of Pennsylvania.

Through the courtesy of the Steel Street Railway Company of Johnstown, Pennsylvania, who presented the Museum with fourteen sections of street rails, and three sets of joint fixtures, it has become the possessor of a nucleus of a collection, which it is to be hoped may soon be expanded until it shall illustrate the history of the street railway—pre-eminently an American invention in the beginning, which has since been carried to every part of the globe. It is highly important that the history of a system which has had so much to do with the growth of every American city should be preserved.

It is to be desired that other friends of the Museum will add to this nucleus by collecting early forms of street rails and track appliances.

Through the kindness of Mr. F. W. Webb, of the London and North-western Railway, of England, whose numerous contributions have been acknowledged in previous reports, the Section has been enriched by a series of graphic photographs of the exterior and interior views of the railway carriages occupied by the Queen of England, and other members of the royal family, in their journeyings by rail, to different parts of the kingdom. The arrangement and decorations of these carriages, especially that reserved for H. R. H. the Prince of Wales, are in marked contrast to the palatial "Special" cars used by American railway officials and men of wealth.

Among the railroad relics received is the bell of the old locomotive *Rahway*, cast in 1838. This bell was one of the first alarm-bells ever placed upon a locomotive, the bells which preceded it being generally used to communicate signals to the engineer by the conductor or brakeman. For this bell, as well as for a section of track, consisting of rails and wooden joint blocks, in use for many years on the New Jersey Railroad between Jersey City and New Brunswick, the Museum is indebted to Mr. James R. Smith, of Newark, New Jersey, one of the oldest supervisors on the Pennsylvania Railroad system.

Another valuable relic is a section of the first heavy iron rail rolled in America, a gift of the Baltimore and Ohio Railroad. This rail is \cap shaped in section and was rolled for the Baltimore and Ohio Railroad Company, in 1844, by the Mount Savage Rolling Mill in Alleghany County, Maryland. To commemorate this event the Franklin Institute of Philadelphia awarded a silver medal in October, 1844, to the pro-

prietors of the Mount Savage Rolling Mill. A duplicate of this medal has been promised by that Institute for the collection.

A number of valuable drawings illustrating the development of marine steam-engineering have been added to that series, among them being :

Print of Jonathan Hull's steam-boat, 1737, from draught published according to act of Parliament, 1737. This is the first feasible proposition for navigating boats by steam on record.

Rumsey's steam-boat, 1787. This is the boat in regard to the construction of which General Washington wrote to Rumsey after seeing his boat driven by the tide against the stream, and of which there is a piece of the original chain-gearing in the collection.

Steam-boat constructed by John Fitch, 1787. This boat carried passengers, who paid fare, between Philadelphia and Burlington, on the Delaware River.

Engine and propeller wheels of steam-boat constructed by John Stevens, with twin screws, in 1804 ; on mat 30 by 40 inches, made from the original engine in the Museum of the Stevens Institute, Hoboken, New Jersey.

The *Clermont*, Fulton's first American steam-boat. This steam-boat made the first trip from New York to Albany in August, 1807, and remained in continuous service for several years.

Steam-boat *Phoenix*, the first steam-boat to navigate the ocean and the first vessel built with wave lines. The engine and hull were constructed under the direction of John Stevens, at Hoboken, New Jersey. This vessel was launched about fifteen days after the *Clermont*, and made the ocean trip from Sandy Hook to Cape May, on the way from New York to Philadelphia, early in 1808.

Fulton's first ferry system, being an enlarged fac-simile of original drawing made by Robert Fulton, 1812. This was the system in use at Fulton Ferry, New York City, for many years.

Steam-ship *Savannah*, the first steam-ship to cross the Atlantic, 1819. This vessel sailed from Savannah May 22, 1819, under command of Capt. Moses Rogers, and arrived in Liverpool, June 20, 1819.

The original log of this voyage in the handwriting of Sailing-Master Steven Rogers is also preserved in the collection.

Among the relics relating to early steam-boats which have recently been obtained, may be noted : Fac-simile of draught of letter from John Stevens, of Hoboken, New Jersey, to Robert Hare, jr., of Philadelphia, written November 16, 1805, describing the steam-boat with twin screws, which is illustrated in the drawing alluded to above.

Also an original copy of the Philadelphia "Federal Gazette and Daily Advertiser," published Monday, July 26, 1790. This paper contains an advertisement of the time-table of Fitch's steam-boat, showing the leaving and arriving time at Philadelphia, Bristol, Burlington, and Bordentown. Deposited by Richard G. Stevens.

During the year an entire re-arrangement of the exhibition series was attempted, under the following temporary classification :

- (1) Objects and implements for burthen-bearing by man and animals.
- (2) Objects and implements of human and animal traction (street-railway cars excepted).
- (3) Originals, models, and drawings of stationary steam-engines.
- (4) Originals, models, and drawings of locomotives.
- (5) Models and drawings of passenger and freight cars.
- (6) Originals, models, and drawings illustrating the development of the American rail and track (steam railways and horse railways.)
- (7) Models, relics, and drawings showing the beginning of the steam-boat and development of marine steam-engineering.
- (8) Maps showing beginning and extension of the American railway systems.
- (9) Electrical machines (telegraph and motors).
- (10) Air-ships, etc.

Owing to the nature of things, the study series is composed almost entirely of drawings and other graphic illustrations, in arranging which the same general classification has been temporarily adopted as prevails in the exhibition series.

I cannot close this report without calling attention to the necessity for additional space, in order to accommodate the normal growth of the Section.

From personal intercourse and correspondence with a number of prominent engineers and railway constructors, I feel satisfied that the collection could be rapidly increased by the addition of valuable objects, if the space could be found to exhibit them. In no country in the world has there been such a revolution in the methods of constructing bridges as in America, yet we are compelled to refuse to exhibit models of the early structures, now rapidly going out of use, owing to the crowded condition of the exhibition series. And the same statement holds good in regard to historic locomotives, cars, and other bulky objects, it being possible to devote only 600 square feet of floor space to the locomotive and railway car.

So much progress has been made in solving problems that have arisen in connection with electric propulsion, both on land and water, during the last few years, that it would seem proper to begin to collect objects illustrating the early history of the devices which have gradually been developed into the motors, etc., now practically successful and in commercial use.

Such a collection, if properly made, would also require considerable space for exhibition, and must therefore be delayed for the present.

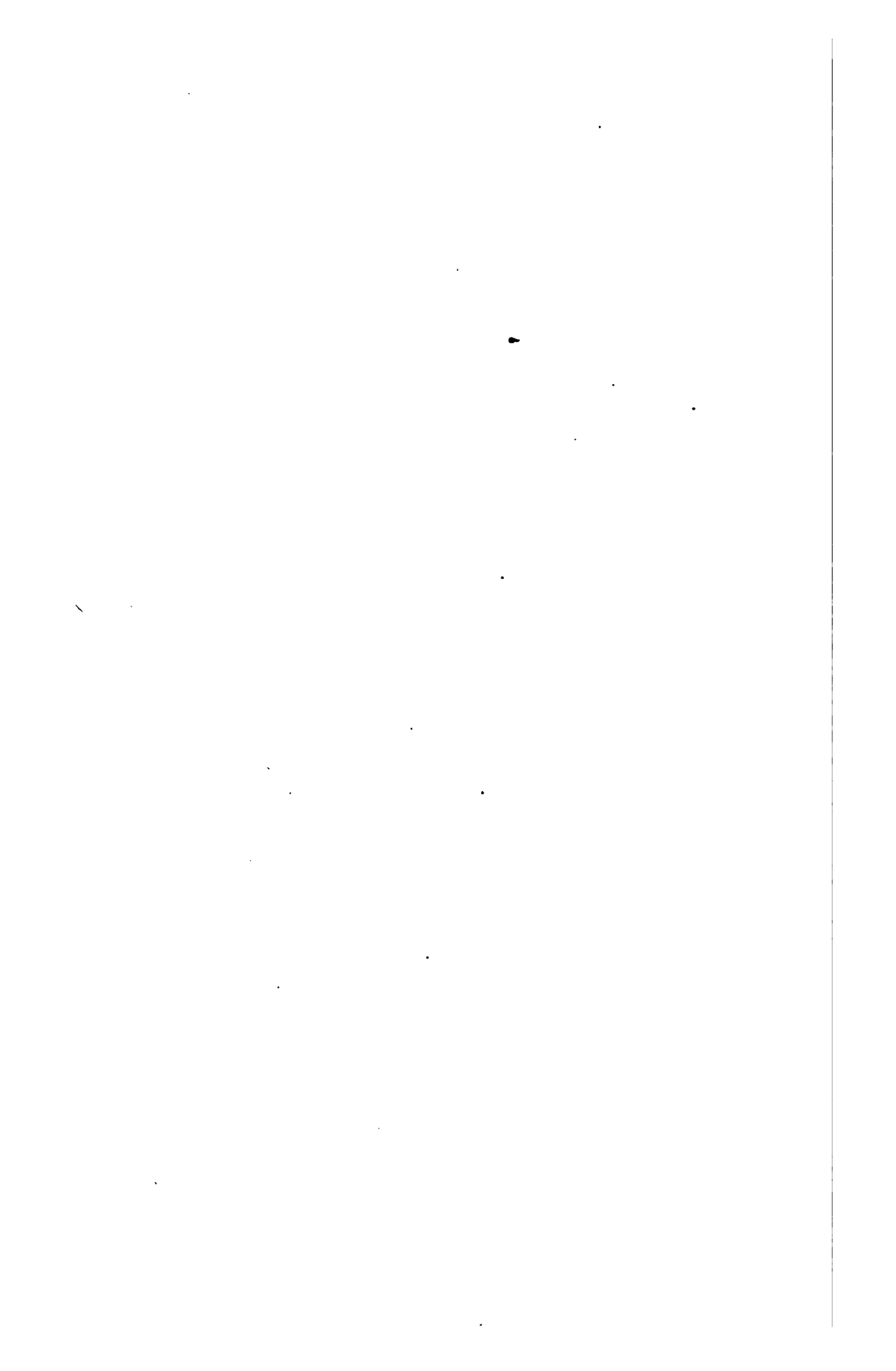

REPORT ON THE SECTION OF GRAPHIC ARTS
IN THE U. S. NATIONAL MUSEUM, 1889.

By S. R. KOEHLER, *Curator.*

Although this section was organized in January, 1887, no official report has as yet been made. The report now submitted embraces, therefore, the period between January 1, 1887, and June 30, 1889.

It will be advisable to preface the general review of the work done within this period by some remarks explanatory of the principal aim which has been kept constantly in view in the formation of the collections of the section of graphic arts, in consonance with the general plan laid out for this section, from the beginning of the present organization of the Museum. This aim being of a peculiar character, on the one hand, and the notions held by the mass of the people concerning the nature and functions of art being, on the other, of the vaguest kind, it is often found difficult, even by persons interested in art, to grasp it. The concisest way of stating it will be to say, that the aim of the section of graphic arts is to represent *art as an industry*. This must not, however, be understood as implying the application of art to industry. The expression must be taken in its literal sense, as conveying the idea that art productions of all kinds, from the great frescoes of the most distinguished painters to the slightest illustration produced by the latest photo-mechanical process, are here to be considered, primarily, from their material, that is to say, their technical side. Art thus takes its place in the scheme of the Museum, side by side, and on terms of equality, with the other great industries,—agriculture, the fisheries, mining, transportation, etc.—and the artist is recognized, not merely as an ornamental appendage, whose useless labors may be ignored with impunity, but as a valuable member in the social organization of mankind, whose creations answer to a human want, and whose material necessities it is quite as important to understand and minister to as those of the farmer, the wool-grower, the fisher, the engineer, the weaver, and so on. This view of the matter does not in the least degrade art, as those are apt to think who approach it exclusively from the æsthetic side. It simply recognizes the fact that art stands upon a material basis, in common with all other branches of human activity.

It appears from what has thus far been said that the ultimate aim

of all art—the expression of ideas by artistic means—is not considered directly in the scheme of the section of graphic arts. These ideas and their development in the progress of time, are, nevertheless, also illustrated, or eventually will be, for, in pursuing the study of the technical means employed in the graphic arts, it is necessary to inquire into their historical evolution, and this can not be done by a mere bringing together of the tools and materials used at different times. It unavoidably involves an examination of the results, and these latter tend to show that the tools and materials themselves were influenced by the ideas which sought expression. An historical collection of specimens illustrating the progress of the graphic arts is, therefore, quite as much a necessity as a collection of tools and materials, and it is obvious that such a collection will furnish the opportunity also for the study of the intellectual aspect of art. The apparently purely material and unintellectual starting point of the scheme laid out for the section of graphic arts, thus leads in the end to a much broader, as well as profounder, illustration of the subject in hand than can possibly be provided in ordinary museums of art which ignore means and deal with results only. Naturally, in endeavoring to bring together a series of examples illustrating the technical activity of the artist, it is found much easier to acquire prints of all kinds than drawings and paintings. This difficulty it has been sought to overcome in a measure by adding a collection of photographs from paintings, etc. These, however, can give but a very inadequate idea of technical peculiarities, while, on the other hand, they add largely to the illustration of the progress of ideas as expressed in art.

For the sake of completeness it may be well to state here that the section of graphic arts confines itself strictly within the limits indicated by its name, that is to say, to drawing and painting and the various methods of producing pictures to be multiplied in the press, or, in other words, to the various methods of delineation on surfaces.

As comparatively but little material (308 numbers in all) had been collected at the time when I took charge of the section, the first thing to be done, in the almost total absence of means wherewith to make purchases, was to solicit contributions from artists, publishers, and private persons. The measure of success attained is shown by the list of donors and depositors printed as Appendix A. Of the 2,894 entries in the catalogue up to June 30, 1889, only 294 represent objects purchased, at a cost of \$2,368.23,*—mostly old prints and such tools, etc., as could not be obtained as gifts. Among these purchases (occasioned principally by the Ohio Valley Centennial Exposition, at which the section of graphic arts was represented by a special exhibition) there are some very fine and important examples of engraving and etching, such as Rembrandt's "Christ Preaching," known as "Le petit

*In this statement the collection of photographs acquired before I was appointed, is not included, as it has not yet been registered.

La Tombe," B 67, certainly one of the most beautiful impressions of this admirable plate in existence; very good impressions of Dürer's "St. Jerome in his Chamber," B 60, and "The Great Horse," B 97; a fine proof of Nanteuil's "Pompone de Bellière," R-D 37; a splendid proof, before the coat-of-arms, of Wille's "Satin Gown," Le Bl 55; a subscriber's impression, before any of the later retouches, of Müller's "Madonna di S. Sisto," after Raphael, etc. It will be quite impossible to speak here at length of the many valuable gifts received during the period under review. Some idea of their importance may be gathered from the details given in the list of donors and depositors, which includes also the material received previous to my official connection with the Museum, such as the collection illustrating the etching process, given by Mr. Peter Moran; the collection illustrating the technical processes of lithography and chromo-lithography, given by Messrs. L. Prang & Co.; the exhibit of the Photo-Engraving Company, and that illustrating the process of electrotyping made by Messrs. W. H. Whitcomb & Co. Two items must, however, be emphasized here as being of special importance and fitness in the U. S. National Museum. I allude to the plate, with a set of trial proofs, of Asher Brown Durand's "Ariadne," after Vanderlyn, given by his son, Mr. John Durand, and to the collection of proofs from plates engraved by John Cheney, given by his sister-in-law, Mrs. Ednah D. Cheney. Generally speaking, special stress has been laid, in the historical division, upon a good representation of American art, and the list of donors again will show that these efforts have been liberally seconded by artists, publishers, and other friends of the Museum.

The time from January, 1887, to February, 1888, was given up wholly to the collecting of specimens and the preparation of cases. During the months of February and March, 1888, these specimens were placed on exhibition on the western side of the northwest range. The extent of the collection at that time, and the arrangement adopted, are shown by the placard which was prepared for display in the hall, a copy of which is annexed to this report as Appendix B.

Part of the month of May, the month of June, and part of July of the same year were devoted to the preparation and installation of the exhibition of the section of graphic arts at the Ohio Valley Centennial Exposition at Cincinnati. To avoid the almost total depletion of the exhibition cases at the Museum, the greater part of the specimens shown at this exhibition was borrowed for the purpose, and the lack of specimens, representative of the work of the past, necessitated the purchases above alluded to, which were paid for out of the special appropriation made by Congress to defray the expenses of the Smithsonian Institution arising out of its participation in the Exposition. A more detailed account of this exhibition will be found in the catalogue, printed in the "Proceedings United States National Museum, Vol. x., Appendix." The rapid growth of the collection, from 936 entries in the cata-

logue on March 31, 1888, the time when the first arrangement of specimens in the Museum was completed, to 2894 on June 30, 1889, making necessary a re-arrangement and expansion, the whole of the northwest range was given up to the section of graphic arts, the casts from Mexican sculptures, etc., which had occupied its eastern half having been removed to the Smithsonian building, and the exhibition as it stands at this writing was put into place during the months of May and June, 1889. As arranged at present, the eastern side of the hall is occupied by the technical exhibition, illustrating the older processes of producing pictures for multiplication in the press (relief engraving, intaglio engraving, lithography, and the substitutes devised to take the place of these processes), aids in drawing used by engravers and by draughtsmen for photo-mechanical processes, methods of reducing and enlarging, and the modern photo-mechanical processes (phototyping, photogravure, photolithography, collographic processes, Woodburytype, etc.). On the western side are shown the specimens illustrating the various methods of drawing and painting, with the monotype, and the historical collection of relief engravings, intaglio engravings, lithography, and color printing. As an appendix there have been added some specimens showing the industrial applications of printing. The collection of photographs, illustrating the history of painting, is also displayed on this side of the hall. The arrangement adopted has already, however, shown itself inadequate, and a re-arrangement and filling up of gaps is impending, although the lack of space will preclude any considerable further expansion.

It has been impossible, of course, to place on exhibition all the material collected, and the large number of specimens left over has been roughly arranged, under technical headings, in two storage cases. As the collection grows, it is to be hoped that this mass of interesting and valuable material may be made available to students. For the present, all that can be done is to provide for its safe-keeping. The culling and arrangement of duplicates, to be used for exchanging, also remains to be attended to. It is not to be expected, however, that this feature will attain the same proportions in the section of graphic arts which it has attained in other departments of the Museum, dealing with the products of nature. During the period covered by this report only one specimen has been obtained by exchange.

A most valuable subdivision of the section, specially important from its practical bearings, is that devoted to patents relating to all the graphic arts, including the modern photo-mechanical processes. Under the direction of Mr. J. W. Osborne, of Washington, who has given his advice and time gratuitously, lists of such patents issued in all countries are now being made, and many of them have already been procured. But the completion of this work and its utilization by the public must be deferred to the future.

A pressing necessity, finally, is the labeling of the specimens ex-

hibited and the preparation of an elementary manual for the use of visitors, without which the collection is practically useless. All that can be said concerning this matter is that a number of essays have been made which, it is hoped, will lead to a result before long.

The present state of the collection, so far as the number of entries on the catalogue shows it, has already been alluded to. On June 30, 1888, there were 1,671 entries, showing that the additions during the fiscal year just ended were 1,223, making a total of 2,894 on June 30, 1889. Of these entries 26 were loans which have been returned. These are more than offset, however, by the entries which represent series consisting of several specimens, so that the number of specimens actually constituting the collection may safely be said to be considerably over 3,000. How many of these are on exhibition and how many in the reserve collection it is impossible to say, as the specimens on exhibition have not yet been numbered. The varied character of the collection can in a measure be ascertained from the list of donors and depositors which accompanies this report.*

Unfortunately this list does not include one of the most important gifts received during the year, the collection, namely, of Mr. J. W. Osborne, which has not yet been registered, although many of the most important specimens in it have already been placed on exhibition. This collection contains, besides a very full record of the development of Mr. Osborne's own photolithographic process, specimens by many of the earliest experimenters in the same and similar directions, such as Fox Talbot, Paul Pretsch, Poitevin, Asser, etc., together with fine examples of lithography, engraving, etc.

The condition and extent of the section of graphic arts has been thus far, and still is, such as to preclude the possibility of special researches upon the material belonging to it, and it is to be feared that it will be a long while before the opportunity for such researches can be offered. Papers by collaborators there are none, since there are no collaborators. My own activity as a student and with the pen during the period embraced by this report has necessarily been quite limited, as my time has been taken up almost entirely by the routine work and the purely manual labor which my position in this museum and as curator of the print department at the Museum of Fine Arts in Boston have forced upon me. A list of the few papers, etc., that I have published during the year will be found in the Bibliography (Section IV). Several papers were published during the time of my connection with the Museum previous to the fiscal year of 1887-'89. These are noticed in the Museum report for 1887-'88.

To the preceding report upon the administration of the collection up

* The accessions to this collection, mentioned in the List of Accessions (Section V of the report), refer to those only which were received during the fiscal year ending June 30, 1889. A complete list of donors and depositors, from January 1, 1887, to June 30, 1889, is given in the Appendix.

to June 30, 1889, I beg leave to add some suggestions concerning the future.

The first and most important point to be kept in view, if the growth of the section of graphic arts is not to be arrested, and if it is the desire to build it up normally and properly proportioned in all its parts, is the necessity of an adequate yearly appropriation. The appeal to artists, publishers, and others has, indeed, been liberally responded to, but it goes without saying that a collection depending almost wholly upon gifts can not possibly attain to the logical development, the completeness, and the superlative quality which alone would answer the ends sought, and be worthy of a great nation claiming to occupy the first rank in material welfare and in intellectual attainments. An even cursory examination of the collection as it now stands will show that it is deficient in many respects, and that in a number of cases specimens have been admitted without regard to quality simply because they illustrated some technical point and could be had for nothing. It is vain to expect gifts of valuable drawings, paintings, and old prints, except upon rare occasions and at long intervals. Such specimens must be bought, and it is, moreover, necessary that the curator should be in a position to secure them whenever and wherever they offer. Really desirable specimens rarely have to wait for a purchaser, and such opportunities must therefore be quickly seized when they occur.

While, as has been pointed out, the principal aim of the section of graphic arts is to represent art as an industry, there are yet other possibilities within its grasp that should not be lost sight of, and of which it may, indeed, be said that they are the natural outgrowth of its activity. The attempt to illustrate the technical processes of graphic art and the historical development of these processes unavoidably leads, as has already been shown, to the formation of a collection embodying the results reached, that is to say, to a collection of drawings, paintings, and prints. It will probably be advisable to restrict the acquisition of drawings and paintings, for the present at least, to only such examples as are absolutely necessary for the elucidation of strictly technical details. There is less call, however, for such a restrictive policy in the case of prints. A print collection is very far from being simply a means of ministering to æsthetic desires. It may be put to almost unlimited practical uses, and is quite as much an educational apparatus as a collection of books. Indeed, it might be claimed that it is often a much more powerful educational instrument, since prints present to the eye what books endeavor merely to construct in the mind. A print collection, therefore, is not only strictly within the province of the Smithsonian Institution; it is, indeed, one of the means of instruction which it is in duty bound to provide as an institution for the dissemination of learning. This universal value of print collections, the artistic aspect of which is only a subordinate feature, has long been recognized in Europe, and it is about time that their importance should

be realized also on this side of the water. It will, of course, be a long time before we can hope to equal such great national collections as that of the British Museum with its uncounted treasures, the French collection with its more than two millions of specimens, or the Print Cabinet at Berlin with over a million and a half, but this conviction ought all the more to spur us on to make at least a beginning as soon as possible, more especially as the prices of prints are going up with unpleasant rapidity, and as a most favorable opportunity for such a beginning is just now offering. In saying this I have in mind the Sewall collection, which is for sale in New York, and which can be bought at a figure representing about one-third of what would be its value if the specimens composing it had to be bought in open market. The collection contains about eighteen thousand prints, representing all periods and schools, and is the result of forty years' collecting. I would respectfully recommend that a special appeal be made to Congress to secure this collection for the U. S. National Museum. I would furthermore suggest that what is left of the Marsh collection, bought by Congress in 1849, be definitely turned over to the Section of Graphic Arts. Unfortunately the largest and most desirable parts of this collection, including all the fine Dürers, Rembrandts, etc., which the original inventory enumerates, have unaccountably disappeared, but there still remain several volumes of single prints, and, presumably, the various gallery works, etc., belonging to it, which, if added to the present collections of the section, would considerably increase their interest. The prints in question ought, however, to be taken out of the volumes into which they have been pasted, and ought to be carefully examined and mounted on separate sheets, so that they can be classified scientifically. As at present arranged; these volumes are not much more than picture books for the gratification of idle curiosity.

In a print collection, the property of the people of the United States, America ought, as a matter of course, to receive the fullest share of attention. It has been my constant endeavor, as before stated, to give due prominence to American art in the collection in my charge, and in these efforts I have been liberally seconded by artists, publishers, and others. But again, by mere reliance upon gifts, the aim to be followed cannot be reached, and this aim ought not to be less than to make the division of Americana the first of its kind among the institutions of the United States, so that all investigators may in the future turn to it with the just expectation that here they will find the best and richest material for their researches. It would seem possible to take an important step towards the attainment of this end without cost to the nation as represented through government. Under the copyright law two copies of each copyrighted print, book, etc., are deposited in the Congressional Library. I would respectfully recommend that Congress be asked to pass a law directing that one copy of each copyrighted print, illustrated book, etc., now in the Congressional Library be turned over to

the U. S. National Museum, to be there deposited in the section of graphic arts, and that all similar matter henceforth received be similarly divided between the Congressional Library and the U. S. National Museum.

Another need of the section of graphic arts is a special library. Even in the present embryonic condition of its collections, books of reference are often wanted which ought to be at hand for immediate use if they are to be of any use at all. The Marsh collection again offers a nucleus of great value, and I would venture the further suggestion that the books belonging to it be turned over to this section. Thus placed they will do good service, whereas at present they do little or none. The attention given to such a special library ought not, however, to stop here. In accordance with the original aim of the section, it is quite indispensable that it should collect all technical and historical treatises relating to the graphic arts, and more especially the former. So far as American productions of this kind are concerned, the direct aid of Congress might again be invoked here. It is desirable also, and indeed necessary, that a number at least of the journals dealing with the graphic arts should be kept, including those in which the developments of the modern photo-mechanical processes are recorded.

It stands to reason that the plans for the future so far outlined can not be carried out, unless considerably more room can be devoted to the collections, and unless the service can be provided which will make it possible to throw them open for the use of students. It will be quite impossible, and, indeed, would not be desirable if it were possible, to exhibit all the material collected and to be collected. Rooms will, therefore, have to be set apart in which the portfolios and cases containing the reserves can be kept, with the possibility of expansion in the future, and providing also the necessary space for tables for visitors, and, in connection with these, public rooms, special workrooms not accessible to ordinary visitors, in which mounting, restoring, classifying, etc., can be carried on. Before a definite plan is adopted for the arrangement of these rooms, it would of course be necessary to make a thorough study of similar institutions in Europe, so as to assure the adoption of the system which actual experience has shown to be the best.

That such collections, liberally administered, might be made of the greatest use, both educationally and practically, does not admit of the slightest doubt. Their educational value has already been dwelled upon, and I may, therefore, confine myself to a few closing remarks upon their practical use to the busy portion of mankind to whom art really is an industry. To these workers the section of graphic arts might easily be made a central bureau of reference. It is already beginning to assume the character of an archive, in which are deposited the records of the labors of inventors within its sphere. Thus it has in its keeping the original Saxton engraving machine, and its collections com-

prise as full records as it will ever be possible to gather of the development of the Osborne photo-lithographic and of the original Ives half-tone process, while several other inventors have promised to prepare similar records of their achievements. That such material, together with the patents now collecting, must be of inestimable value to future inventors is self-evident. With a view to the further extension of the practical utility of the section, all makers of machinery and tools, and manufacturers and dealers in materials used in the graphic arts are encouraged to send not only specimens of their wares, but also their circulars and catalogues, and the latter are given or sent to applicants for information to whom they promise to be of interest. Few such applications have, indeed, been received so far, but it is to be hoped that as the character and aims of the section of graphic arts become more widely known, the facilities which it offers, or hopes to be able to offer, will be utilized more freely.

It will, I think, need no further argument to show that the section of graphic arts may be made not only a valuable institution for the scholar and the student, but that it may become practically useful to the large body of men and women who depend upon the graphic arts as a pursuit, quite as much as the Bureau of Education, the Department of Agriculture, or the Fish Commission are helpful to the teacher, the farmer, and the fisherman.

APPENDIX A.

LIST OF DONORS AND DEPOSITORS, SECTION OF GRAPHIC ARTS.

- AIR BRUSH COMPANY, THE, Rockford, Illinois.—Specimens of work done by the air-brush; 2 numbers.
- ANDREW, JOHN & SON, Boston, Massachusetts.—Proofs from wood-engravings, executed by the donors, or in their establishment; 21 numbers.
- AVERY, S. P., New York.—Engravings, etchings, lithograph, process prints, books, catalogues, etc.; 31 numbers.
- BALDWIN & GLEASON COMPANY (LIMITED), New York.—Specimens of printing on celluloid, executed in the establishment of the donors; 20 numbers.
- BIERSTADT, A., N. A., New York.—Proof of an engraving by James Smillie, from a painting by the donor.
- BOBBETT, ALFRED, Brooklyn, New York.—Relief engravings printed in colors, executed by the donor; 5 numbers.
- BOBBETT, WALTER, Brooklyn, New York.—A series of proofs of a relief engraving in colors, showing the various stages, etc., by Albert Bobbett; 23 numbers.
- BOSTON BOXWOOD COMPANY, Boston, Massachusetts.—A rough section of boxwood.
- BOSTON PHOTOGRAVURE COMPANY, THE, Boston, Massachusetts.—Gelatine prints, executed in the establishment of the donors; 18 numbers.
- BOUSSOD, VALADON & COMPANY, Paris and New York.—Process prints of various kinds, executed in the establishment of the donors; 15 numbers.
- BROWN, MISS H. LOUISA, Boston, Massachusetts.—Lead pencil, India ink, sepia and water color drawings, soft-ground etchings, lithographs, etc., by various artists; 12 numbers.
- BUEHRING, FRED., president of the Lithographer Publishing Company, New York.—India rubber reducing and enlarging machine, invented by the donor, with specimens of work done by its means; 5 numbers.

- BUREAU, THE, OF ENGRAVING AND PRINTING, Washington, District of Columbia (depositor).—Illustrations of the process of engraving and transferring bank-notes, including plates and a steel roller; 6 numbers.
- CASSELL & COMPANY (LIMITED), London and New York.—Wood-engravings, after Gustave Doré; 12 numbers.
- CASTLE, DR. FRED. A., New York.—Proofs from wood blocks, engraved by Dr. Alex. Anderson, in the possession of the donor; 6 numbers (37 specimens).
- CENTURY COMPANY, THE, New York (depositor).—Drawings, proofs of wood-engravings, and process prints made for the Century Magazine, and wood-engravers' tools and materials; 94 numbers.
- CHANDLER, PROF. CHARLES F., Columbia College, New York.—Process prints of various kinds; 137 numbers.
- CHENEY, MRS. EDNAH D., Jamaica Plain, Massachusetts.—Proofs and prints, mostly from plates engraved by John Cheney; Memoir of John Cheney, written by the donor; 28 numbers.
- CHURCH, F. S., N. A., New York.—Drawings, proofs from etchings, and an oil sketch by the donor; 8 numbers.
- CLOSSON, WILLIAM B., Lancaster, Massachusetts.—Proofs of wood-engravings by the donor; 6 numbers.
- CROSSCUP & WEST.—(See Ives, F. E.)
- DANA, WILLIAM JAY, Boston, Massachusetts.—Proofs of wood-engravings by the donor; 10 numbers.
- DAY, BENJAMIN, New York.—Apparatus for using Day's Rapid Shading Mediums, with specimens of work done by its means; 7 numbers.
- DE VINNE, THEO. L., The De Vinne Press, New York.—Tableau, illustrating the overlaying of wood-engravings.
- DONALDSON, THOMAS, Philadelphia, Pennsylvania.—Etchings by American artists, from the "American Art Review"; 17 numbers.
- DOUGAL, W. H., Washington, District of Columbia.—Proofs and prints from plates engraved by the donor; 8 numbers.
- DURAND, JOHN, Paris, France.—Copperplate, "Ariadne," after Vanderlyn, engraved by the late Asher Brown Durand, N. A., and working proofs from the same; 10 numbers.
- FALCONER, J. M., Brooklyn, New York.—Proofs from original plates by the donor (etching, dry point, roulette work); Baxter oil prints; 5 numbers.
- FARRER, HENRY, New York.—Proofs of etchings by the donor; catalogue of New York Etching Club, 1888, with illustrations; 18 numbers.
- FILLEBROWN, F. E., Boston, Massachusetts.—Proofs of wood-engravings executed by the donor; 8 numbers.
- FORBES LITHOGRAPH MANUFACTURING COMPANY, THE, Boston, Massachusetts.—Albertypes, executed in the establishment of the donors; 74 numbers.
- GEBBIE & Co., Philadelphia, Pennsylvania.—Photogravures, executed in the establishment of the donors; 11 numbers.
- GIFFORD, R. SWAIN, N. A., New York.—Proofs of etchings by the donor; 14 numbers.
- GOODE, PROF. G. BROWN, Washington, District of Columbia.—Wood-engravings, process work, silhouettes, etc.; 68 numbers. Engraving by Claude Mellan (deposited).
- GUTEKUNST, F., Philadelphia, Pennsylvania.—Illustrations of the process of gelatine printing, including negative, film, etc., executed in the establishment of the donor; 10 numbers.
- HAIGHT & DUDLEY, Poughkeepsie, New York.—Specimens of color printing executed in the establishment of the donors; 17 numbers.
- HARPER & BROTHERS, New York.—Proofs of wood-engravings executed for Harper's Monthly, Harper's Weekly, and Harper's Bazar; 35 numbers.
- HART, CHARLES HENRY, Philadelphia, Pennsylvania.—Engravings, etchings, lithographs, mezzotints, and aquatint; 33 numbers.

- HEINEMANN, E., New York.—Proofs of wood-engravings by the donor; 10 numbers.
- HELIOTYPE PRINTING COMPANY, THE, Boston, Massachusetts.—Heliotypes, heliochromes, photolithographs, etc., executed in the establishment of the donors; 48 numbers.
- HILL, JOHN HENRY, Nyack Turnpike, New York.—Etchings by the donor; aquatints by John Hill; 4 numbers.
- HITCHCOCK, PROF. ROMYN, Washington, District of Columbia.—Photo-collotypes; 6 numbers.
- HOF, ROBERT, & CO., New York.—Illustrations of presses built by them; 3 numbers.
- HOSKIN, ROBERT, Brooklyn, New York.—Proofs from wood-engravings by the donor; 11 numbers.
- HOGGH, WALTER, Washington, District of Columbia.—Old German etchings; 2 numbers.
- HOVENDEN, THOMAS, N. A.—Proofs of etchings by the donor; 2 numbers.
- IVES, FREDERICK E., (Crosscup & West), Philadelphia, Pennsylvania.—Illustrations of the original "Ives Process," including models of machinery, etc.; book: "A New Principle in Heliochromy;" 69 numbers.
- JUENGLING, F., New York.—Proofs of wood-engravings by the donor; 27 numbers.
- KAPPEL, ALFRED, A. N. A., New York.—Charcoal-drawing by the donor.
- KETTERLINUS PRINTING HOUSE, Philadelphia, Pennsylvania.—Illustrations of ruling and etching on lithographic stone, including a stone; 16 numbers.
- KIMMEL & VOIGT, New York.—Illustrations of the printing of intaglio plates (etchings, etc.), including tools and materials; 41 numbers.
- KLACKNER, C., New York.—Proofs of etchings and engravings published by the donor; 5 numbers.
- KOEHLER, S. R., Roxbury, Massachusetts.—Etchings, engravings, lithographs, process work, etc.; 107 numbers.
- KURTZ, WILLIAM, New York.—Specimens of half-tone process work by the donor; gelatine prints by Tessié du Motay; 20 numbers.
- LINTON, W. J., New Haven, Connecticut.—Illustrations of the history of wood-engraving, in originals and in photographs; proofs from wood-engravings by the donor; 122 numbers (202 specimens).
- LOWELL, JOHN A., & CO., Boston, Massachusetts.—Proof of an engraving by S. A. Schoff, published by the donors.
- Marsh Collection. U. S. National Museum. (Depositor.) Wood-cuts and mezzotints; 8 numbers.
- MAURER, LOUIS, New York.—Drawing by the donor.
- MILLER, CHAS. H., N. A., New York.—Drawings, sketches, and proofs of etchings by the donor; 13 numbers.
- MILLER, WILLIAM, New York.—Proofs of wood-engravings by the donor; 22 numbers.
- MORAN, MRS. EMILY K., Philadelphia, Pennsylvania.—Proofs of etchings by the donor; 10 numbers.
- MORAN, MRS. M. NIMMO, New York.—Proofs of etchings by the donor; 4 numbers.
- MORAN, PETER, Philadelphia.—An etched plate in its various stages, etching tools and proofs of etchings by the donor; 55 numbers.
- MORAN, THOMAS, N. A., New York.—Proofs of etchings by the donor; 6 numbers.
- NICHOLSON, W. L., Washington, District of Columbia.—Etchings by William Nicholson, R. S. A.; 2 numbers.
- NICOLL, J. C., N. A., New York.—Proofs of etchings by the donor; 5 numbers.
- NIEMEYER, PROF. JOHN H., New Haven, Connecticut.—Water-color sketch by the donor.
- O'NEILL, JOHN A., Washington, District of Columbia.—Engraving by S. A. Schoff.
- OSBORNE, J. W., Washington, District of Columbia.—Specimen of printing on metal. (Also a large collection of process work, etc., not yet registered.)
- PARRISH, STEPHEN, Philadelphia, Pennsylvania.—Proofs of etchings and dry points by the donor; 12 numbers.

- PARSONS, CHARLES, New York.—Wood-cut by Dr. Alex. Anderson.
- PENDLETON, J. S., New York. (Depositor.)—The Saxton Engraving Machine, invented by the grandfather of the depositor, together with plates, specimens, etc.; 6 numbers (most of them including several specimens).
- PHOTO-ENGRAVING COMPANY, THE, New York.—Illustrations of the process of photo-engraving, including plates, etc.; specimens of the work done in the establishment of the donors; 63 numbers.
- PHOTOGRAVURE COMPANY, THE, New York.—A photo-gravure plate, and photo-gravures executed in the establishment of the donors; 9 numbers (including series of six and more specimens each).
- Portrait Collection of the U. S. National Museum. (Depositor.)—Engravings, mezzotints, etc.; 8 numbers.
- PRANG, L., & Co., Roxbury, Massachusetts.—Illustrations of the processes and history of lithography and chromolithography; wood-engravings; a drawing; specimens of steno-chromy; 473 numbers.
- RADTKE, LAUCKNER, & Co., New York.—Proof of a dry-point by William H. Lippincott, published by them.
- ROSS, CHARLES J., Burlington, New Jersey.—Specimens of the papers for process-drawing made by the donor, with drawings upon them, and impressions from the blocks made from these drawings; 23 numbers (49 specimens).
- ROWLANDS, WALTER, Allston, Massachusetts.—Engravings of various kinds; 24 numbers.
- ROYLE, JOHN, & SONS, Patterson, New Jersey.—Photographs of routing-machines made by the donors; 2 numbers.
- RUSSELL & RICHARDSON, Boston, Massachusetts.—Proofs of wood-engravings made by and in the establishment of the donors; 20 numbers.
- SARONY, NAPOLEON, New York.—Lithograph made by the donor.
- SARTAIN, JOHN, Philadelphia, Pennsylvania.—Illustrations of the process of mezzotinting, including a plate and tools; proofs of mezzotints by the donor; 16 numbers.
- SCHOFF, S. A., Newtonville, Massachusetts.—Proof of an engraving by the donor.
- School of Drawing and Painting, Museum of Fine Arts, Boston, Massachusetts.—Drawings by pupils of the school in lead pencil, crayon, charcoal, etc.; 12 numbers.
- SCHRAUBSTADTER, C. JR., St. Louis, Missouri.—“Star Engraving Plates,” with tools, etc.; 9 numbers.
- SELLERS, JOHN & SON, New York.—Engravers' tools and materials; 8 numbers.
- SHARP, GEORGE B., New York.—Plates of various metals for the use of engravers and etchers; 4 numbers.
- SHIRLAW, WALTER, A. N. A., New York.—Drawings and proof of an etching by the donor; 4 numbers.
- SMILLIE, GEORGE H., N. A., New York.—Pencil drawings by the donor; trial proof of an engraving by James Smillie; 3 numbers.
- SMILLIE, JAMES D., N. A., New York.—Drawings, sketches in oil and in water-colors, and proofs of etchings by the donor; 10 numbers.
- SMILLIE, T. W., Washington, District of Columbia.—Specimens of medal-ruling over fossils; 3 numbers.
- SOMERS BROTHERS, Brooklyn, New York.—Specimens of lithographic printing on metal executed in the establishment of the donors; 17 numbers.
- STEARNS, PROF. R. E. C., Washington, District of Columbia.—Specimens of color-printing; 15 numbers.
- STRUTHERS, JOSEPH, & Co., New York.—Proofs from blocks made by the wax process in the establishment of the donors; 6 numbers. (Each number consisting of a series of specimens.)
- STUART, FREDERIC T., Boston, Massachusetts.—Set of working proofs from a plate engraved by the donor; 8 numbers.

- TUCHFARBER COMPANY, THE F.**, Cincinnati, Ohio.—Specimens of lithographic printing transferred to metal and to glass, made in the establishment of the donors; 3 numbers.
- Unknown donors or depositors.**—Two engraved plates and a Japanese wood-block, with impressions from them; 7 numbers.
- VAN ELTEN, KRUSEMAN, N. A.**, New York.—Lead-pencil drawings and proofs from etchings by the donor; 9 numbers.
- WALKER, CHARLES A.**, Boston, Massachusetts.—Monotypes and proofs from etchings by the donor; trial proofs and finished impressions of engravings by various engravers; 30 numbers.
- WHIPPLE, H. C.**, Philadelphia, Pennsylvania.—Phototypes from "etchings on glass" by Hamilton; 25 numbers.
- WHITCOMB, W. H., & Co.**, Boston, Massachusetts.—Illustrations of the process of electrotyping, including plates, materials, etc; 15 numbers.
- WHITNEY, E. J.**, Brooklyn, New York.—Proofs of wood-engravings by the donor and by other American engravers, from Dr. Alex. Anderson to the present time; 150 numbers (318 specimens).
- WILSON, JOHN, & SON**, The University Press, Cambridge, Massachusetts.—Impressions from a wood-engraving to illustrate certain technical points; 2 numbers.
- WILSON, THOMAS**, Washington, District of Columbia. (Depositor.)—Drawings by old artists; miniatures on ivory; chromolithographs; 35 numbers.
- WOLFF, M.**, Dayton, Ohio.—Fine-line plates for half-tone process made by the donor, and impressions from blocks made with their aid; 9 numbers.
- YEATES, WILLIAM S.**, Washington, District of Columbia.—Engraving.

TEMPORARY LOANS FOR THE OHIO VALLEY CENTENNIAL EXPOSITION.

- E. J. WHITNEY**, Brooklyn, New York.—4 specimens.
- THE CENTURY COMPANY**, New York.—5 specimens.
- Miss M. LOUISE McLAUGHLIN**, Cincinnati, Ohio.—2 specimens.
- Miss E. D. HALE**, Boston, Massachusetts.—2 specimens.
- S. P. AVERY**, New York.—8 specimens.
- GEORGE R. HALM**, New York.—1 specimen.
- JOHN SARTAIN**, Philadelphia.—2 specimens.
- H. WUNDERLICH & Co.**, New York.—2 specimens.
- C. KLACKNER**, New York.—4 specimens.
- CHARLES A. WALKER**, Boston, Massachusetts.—7 specimens.
- H. DESPARD**, New York.—6 specimens.
- CHARLES H. MILLER, N. A.**, New York.—6 specimens.
- Miss BLANCHE DILLAYE**, Philadelphia, Pennsylvania.—7 specimens.
- SAMUEL COLMAN, N. A.**, Newport, Rhode Island.—8 specimens.
- Miss ELLEN OAKFORD**, New Haven, Connecticut.—7 specimens.
- Mrs. M. S. TWACHTMAN**, Cincinnati, Ohio.—4 specimens.
- Mrs. E. L. GETCHELL**, Worcester, Massachusetts.—6 specimens.
- Miss G. D. CLEMENTS**, Philadelphia, Pennsylvania.—4 specimens.
- Miss H. FRANCES OSBORNE**, Salem, Massachusetts.—5 specimens.
- WILLIAM KURTZ**, New York.—15 specimens.
- F. GUTEKUNST**, Philadelphia, Pennsylvania.—5 specimens.
- CROSSCUP & WEST**, Philadelphia, Pennsylvania.—6 specimens.
- THE PHOTO-ENGRAVING COMPANY**, New York.—24 specimens.
- THE PHOTOGRAVURE COMPANY**, New York.—22 specimens.
- H. E. SYLVESTER**, Boston, Massachusetts.—8 specimens.
- S. E. KOEHLER**, Roxbury, Massachusetts.—445 specimens.

APPENDIX B.

DESCRIPTIVE LABEL SHOWING THE ARRANGEMENT OF THE COLLECTION ILLUSTRATING THE GRAPHIC ARTS.

It is the aim of the Section of Graphic Arts to illustrate all the methods and processes ever used for the expression, graphically upon plane surfaces, of artistic ideas, or for the representation of natural and other objects. It therefore embraces drawing and painting, as well as the various methods of engraving, so far as the latter have been used for the production of prints. The field is a vast one, and the present collection must be looked upon as only a fragmentary attempt to illustrate the main points in the scheme. The collection is arranged as follows:

FIRST ALCOVE.—*Drawing, painting, and the monotype.*

- Case 1.—Drawing in lead-pencil. Case 4.—Pen and ink. India ink. Water-color.
 2.—Drawing in crayon (chalk).
 3.—Drawing in charcoal. 5.—Oil-painting. The monotype.
 Swinging screens placed against the wall: Drawings by artists of the seventeenth century, etc.

SECOND ALCOVE.—*Engraving in relief on wood (and on metal).*

- Case 6.—Tools and materials used by the modern wood-engraver. Electrotyping. Overlaying. Positive and negative impressions. Original drawings, with the engravings made from them.
 7.—Original drawings; with the engravings made from them, continued.
 8.—Some specimens of old relief engraving down to end of eighteenth century. (Knife work, black line, on wood. Graver work on metal).
 9.—English relief engraving on wood (and on metal?), from Bewick and his predecessors and followers to the middle of the nineteenth century. (Mainly white-line work.)
 10.—Modern English wood-engraving. Some specimens of modern German and French work.
 11.—Wood-engraving in America from Anderson to the present time.
 Swinging screens placed against the wall: Wood-engravings by American engravers.

THIRD ALCOVE.—*Intaglio engraving on metal.*

- Case 12.—The tools and materials used for etching and engraving, mezzotinting excepted. (Illustrations of printing and electrotyping metal plates to be added.) Some specimens of old engraving.
 13.—A set of progressive proofs from an engraved plate forwarded by etching, with the plate.
 14.—Engravings by American engravers.
 15.—Engravings by American engravers, continued. Bank-note engraving and the transfer process.
 16.—Stippling. Mezzotint. Rouletting used to produce tints.
 17.—Modern mixed methods of engraving. Machine ruling. Machine engraving.
 Placed against the wall: The Saxton engraving machine.

FOURTH ALCOVE.—*Intaglio engraving on metal by means of mordants, i. e., etching.*

- Case 18.—An etched plate in its various stages. A set of working proofs from an etched plate finished with the graver. Positive and negative impressions from an etched plate. The printing of etchings. The materials on which etchings are printed.

- 19.—Some specimens of old etched work. Original etchings by American painters.
- 20.—Original etchings by American painters, continued.
- 21.—Original etchings by American painters, continued.
- 22.—Original etchings by American painters, continued. Reproductive etchings by American etchers.
- 23.—Soft ground etching. Aquatinting. Dry-pointing.
- Swinging screens placed against the wall: Original etchings by American painters.

FIFTH ALCOVE.—*Lithography.*

- Case 24.—Tools and materials.
- 25.—Lithographic machinery. Papers used for printing in lithography. The principal styles of lithography.
- 26.—The principal styles of lithography, continued.
- 27.—
- 28.— } Illustrations of the history of lithography. (To be supplied later.)
- 29.— }
- Swinging screens and frames on the wall: A series of impressions showing the progressive stages of a chromo-lithograph (chromo).

SIXTH ALCOVE.—*Mechanical and photographic engraving processes.*

- Case 30.—Mechanical processes.
- 31.—Photo-engraving processes producing relief plates.
- 32.—Photo-engraving in intaglio (photogravure).
- Nearly all the tools, specimens, etc., shown were given by artists, publishers, and other friends of the Museum. Labels giving concise technical descriptions, with titles and names of donors, will be added as soon as they can be prepared.

THE HISTORY OF PAINTING.

A collection of photographs, autotypes, etc., illustrating the history of painting, is displayed in the swinging screens on the table cases in the northern part of the hall. The collection is as yet neither complete nor definitely arranged.

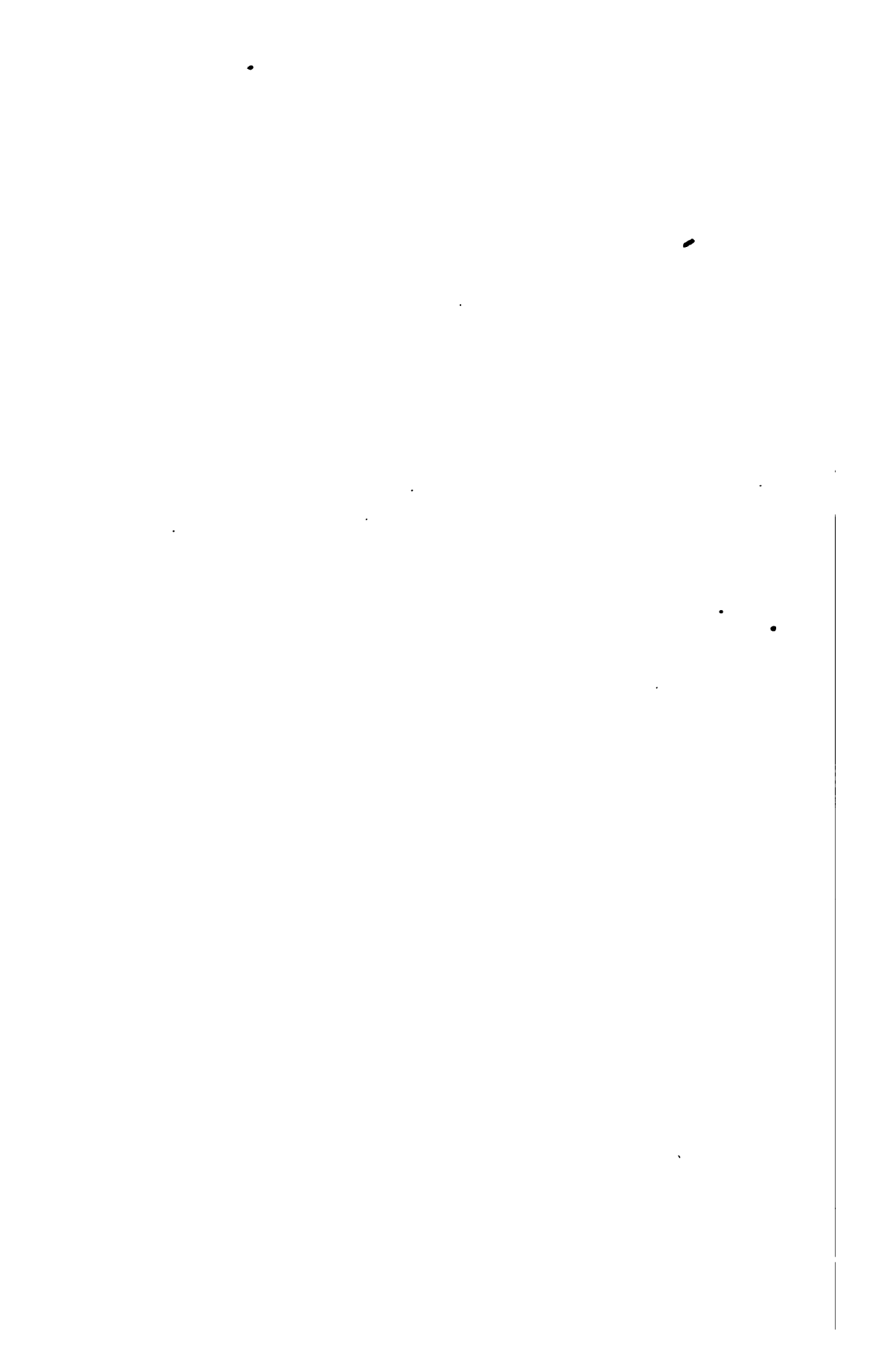

REPORT ON THE DEPARTMENT OF PREHISTORIC ANTHROPOLOGY
IN THE U. S. NATIONAL MUSEUM, 1889.

By THOMAS WILSON, *Honorary Curator.*

The general character of the work for the year ending June 30, 1889, has been much the same as in former years, although there have been changes and much extra work. Implements of the usual character have been received and have been examined, classified, arranged, entered and numbered, as formerly. To this customary routine were the added duties incident to the Cincinnati Exposition (which opened July 4, 1888, and closed November 15, 1888), the investigation of paleolithic implements and of rude notched axes, and other matters, involving a great increase of the clerical work of the office. The number of implements received, to be catalogued and displayed, has been largely increased, and likewise the number of objects sent for examination and report.

The reception of three hundred new trays during the year gave an opportunity long desired, to place specimens in trays instead of loosely upon the shelves and bottoms of the cases. In November 1888, the work of repainting the trays and cases was begun, requiring the removal and changing of position from case to case of every tray and specimen in the entire collection. This work has been continued until the present time. It is now almost finished.

During the last two and a half months of the year, carpenters and laborers have been at work putting new shelves in the cases, wherever possible, to utilize vacant space (this work is not completed); placing shelves in the window-seats for the reception of the stone images from Central America and the West Indies, twenty of which are thus displayed; and placing casters under the tall upright cases, seventeen of which are thus arranged. This has been preparatory to the proposed re-arrangement of the cases in the Museum, placing four rows of cases instead of three, as before, and making three aisles, one of which is the center, instead of four aisles as heretofore. By this arrangement much space is gained. The cases which before approached the center of the hall, and so nearly covered it, are now retired towards either end of the hall, leaving a large space in the center which affords room for re-arrangement and better display of the Pueblo village models and the Mexican architectural sculptures (Lorillard and Abadiano

collections) which have heretofore been so much crowded as to do them injustice. The main aisles among the cases are slightly narrower than before, but by the substitution of single for double cases, as heretofore employed, the lateral aisles have been widened so as to afford ample relief against any crowd, however large. I am satisfied that we could manage without crowding the 29,000 persons who visited the museum on the 5th day of March 1889, and that this arrangement of cases is an improvement.

IMPORTANCE OF THE SCIENCE OF PREHISTORIC ANTHROPOLOGY.

Prehistoric anthropology is a new science. During the past eighteen hundred years the Christian, and, consequently, the civilized world, has, until the beginning of the nineteenth century, lived on in the belief that man's appearance upon earth dated no more than 4,000 years before the commencement of our era, and was without knowledge of prehistoric man, nor did it have a suspicion of his existence.

The wise men of Denmark in the early part of the nineteenth century, while investigating and studying the Runic characters and legends engraved upon their ruined stones, and in their sagas, discovered evidences of a human occupation of their country earlier than any of which they had heretofore known or suspected. This occurred about 1806, and in 1836 Mr. Thompson the renowned Danish archæologist (who founded, and for fifty years directed, the prehistoric museums at Copenhagen) published his first memoir in regard to prehistoric civilization, which he named after the material principally employed for cutting implements, "The Ages of Stone, Bronze, and Iron." These divisions have ever since been universally accepted.

In 1854 Dr. Ferdinand Keller recognized at Meilen on Lake Zurich, Switzerland, certain evidences which developed into our present knowledge of the Swiss Lake-dwellers, although it has since been proved that lake-dwellings existed in many other countries of Europe.

Beginning with 1841, M. Boucher de Perthes, residing at Abbeville, on the river Somme, discovered certain flint implements rudely chipped in the shape of an almond or peach-stone, with the cutting edge at the point. He found them deep in the gravelly terraces of the river Somme, and in such position and association as to force the conclusion that they were the handiwork of man and of an antiquity before unsuspected. His labors were continued with varying success in the gaining of converts until the year 1859, when, by agreement, a committee of fifteen gentlemen, supposed to be best qualified for the task, and in their departments certainly the most learned men of France and England, met on the ground for the purpose of making personal investigations. After discussion, dispute, and difference of opinion, of which I need not speak here, it was finally decided that M. Boucher de Perthes was correct in his theory, and that these implements were the work of man and of an antiquity heretofore unknown.

Here was born the new science of prehistoric anthropology, and since then it has not only been recognized as a science, but whenever and wherever it has been studied and understood, it has increased in dignity and importance.

KNOWLEDGE OF PREHISTORIC MAN EARLIER IN AMERICA THAN EUROPE.

I have said that the civilized world had, until the beginning of the nineteenth century, lived without knowledge of prehistoric man, and without even a suspicion of his existence. This is more true in Europe than in America. The knowledge of prehistoric man began on this continent several hundred years before it did in Europe. Columbus formed his acquaintance on the discovery of America. The white man upon arriving beheld the prehistoric man face to face, and had ample opportunities for knowing, studying, and finding out everything that was discoverable from contact with him. Though many books have been written about the prehistoric man of America, and their authors have described him as they saw him, yet we know but little of his true nature. The scientific study of this subject has begun only of late years, and we are still ignorant concerning his history or life prior to the discovery of America in 1492; whence he came, to what race he belonged, or what were his habits, customs, or monuments. We are even wanting in knowledge of those things peculiar to him since that time, and which have been manifested to us in every period of our contact with him. The study of his language, sociology, religion, mythology, has but just commenced. Many have written descriptions of their visits to the Red Man of North America, have given histories of their travels, and have written entertaining books on the subject. But these have largely been fugitive, isolated, and without connection with any other than the tribe visited, the voyage described, or the travel undertaken. Nor was there any connection proposed between those writers who might have taken up the same line of investigation with other tribes or in other parts of the country. I would not dwarf or belittle the labors or discoveries of our pioneers; but, conceding for them all that their friends can claim, they have done but little toward giving an accurate or comprehensive anthropologic and ethnologic history of the North American Indians. As to their history in prehistoric times, before Columbus, no attempt was made by these historians. Collections have been made of the implements of the North American Indian, and large prehistoric museums established in nearly all parts of the United States, beginning back a hundred years or more, which are and will be of great interest and value in writing such a history. But in the majority of these cases the work has been that of collectors, sometimes for commerce, but more often to gratify that thirst for things of antiquity which seems a part of the second nature of mankind. A study of anthropology will be scarcely claimed by any one as the motive on which these collections were based. So, while we have had an earlier knowledge in America

of prehistoric man, it has not attained to the dignity and importance, as a science, which it has in Europe.

The Smithsonian Institution, National Museum, Bureau of Ethnology, Peabody Museum, and several other institutions whose names will occur to the reader, are exceptions to this statement. There are many private persons who should also be excepted, and the number, I am gratified to say, who are giving serious attention to this matter and are doing faithful and valuable work in this connection, is increasing each year.

I have considered, as part of my duty, the endeavor to awaken and elevate the public mind to the importance of the new science of prehistoric anthropology, and, so far as possible, prevent the search for Indian relics as a matter of commerce, and cause collectors to regard these objects in their true light as aids to science; not as gewgaws and trinkets.

In the performance of this duty I have, during the past year, delivered ten public lectures; distributed from my office several hundred copies of circular No. 47, descriptive of the prehistoric exhibit at the Cincinnati Exposition, that has a bearing in this direction, and have written (not yet published) a study of prehistoric anthropology which, being intended for general distribution, it is hoped will not be without its effect. There has been also prepared a circular (No. 49) containing information for the guidance of explorers and collectors.

IMPORTANCE OF THE SCIENCE OF PREHISTORIC ANTHROPOLOGY BETTER RECOGNIZED IN EUROPE THAN IN AMERICA.

Despite the fact that the discovery of prehistoric man in Europe was so many years, possibly so many hundreds of years, later than his discovery in America, I am compelled by the facts to declare that Europeans, because of their interest in the new science, have established prehistoric anthropology on a broader basis and a firmer foundation, and have given to it more thorough and scientific treatment than has been done in the United States. If I make a comparison in this regard between the two countries to the detriment of our own, it will only be that we may benefit thereby, may take warning and so redouble and direct our efforts, using the opportunity and material which we have in such improved methods and increased endeavors that in future years the difference will not be to our disadvantage. If the following statements will direct the attention and increase the energy of our scientists to proper exertions in this regard, I shall feel amply repaid for my labor.

Our acquaintance with the aborigines of this country began with Columbus in 1492, but the real history and our first actual knowledge of them began no earlier than 1600, probably 1604 or 1608—now only two hundred and eighty years ago. Americans, therefore, of the present day are removed from the prehistoric man of the whole country only by that period, nor is it even so long, for this was the commencement of

our knowledge. The authors at that time saw him face to face, and were thus enabled to describe him and write his history. He has continued with us ever since, and we have from that time to the present had full and ample opportunity to increase our information concerning him by investigation, examination, and personal contact.

In France and England, in fact over all Western Europe, the period when the last possible contact with prehistoric man could have taken place, the time when all our knowledge concerning him, acquired from observation, was gained, ended with the invasion by Cæsar. So that, while the American goes back no further than two hundred and eighty years to study the prehistoric man of his country, and has had him present ever since, the Frenchman, the European, has to go back nigh two thousand years, and his opportunities of personal contact ended at that time, if it had not done so before; for it is not at all certain that the Gaul of that epoch is to be considered as prehistoric. He may have been related to him, possibly his descendant, but it appears certain that the prehistoric bronze age had ended in that country, and the iron age begun, from four hundred to nine hundred years before the advent of Cæsar.

I have said this much to show the difference in the respective opportunities for the study of prehistoric man between Europeans and Americans. The territory of France is about 200,000 square miles; that of the United States is about 3,600,000—eighteen times larger than France. Mile for mile and acre for acre, the United States will yield as much to the student of prehistoric archæology as will that of France; yet with this difference in area of equal fruitfulness, the United States Government is far behind that of France in its interest and assistance given to this science. Compare the National Museum of France, to wit, that of St. Germain, with the department of the National Museum of the United States. The St. Germain Museum is installed at St. Germain-en-Laye, a few miles out of Paris—the palace of that name, built by Francis I. I have not the exact dimensions, but it is in the form of a triangle; the front or shortest line is, I should say, 400 feet long. It is given up entirely to the officers of the institution and to the chambers and living apartments of the officers. The other line of the right angle has been fire-proofed throughout and completely restored, and is now occupied with the halls of exhibition. This restoration is being continued upon the other wing. The work began in 1879 and is not yet completed. The building is four stories high, and there are now twenty-five halls filled with prehistoric objects and open to the public. One entire story is devoted each to the paleolithic and neolithic periods of the stone age and one to the bronze age, while the basement contains the heavy stone, principally architectural monuments, of the Roman occupation. Except the latter, the display made, the objects shown, the epochs, periods, or ages represented, are the same as those now crowded into my hall. With all her wealth of antiquity eighteen times greater than

that of France, the United States devotes to the objects and implements of her prehistoric races less than one-eighteenth part of the museum space occupied by France.

In the management and direction of this museum and of matters pertaining to this new science there exists about the same difference. The director of the museum is a member of the institute and approximates in the dignity and importance of his position to that of the Secretary and the Director of our entire National Museum. The work of the Bureau of Ethnology is committed into the hands of a commission of savants of which M. Henry Martin, the great French historian, was, and M. Gabriel de Mortillet, Député, is, the chief.

I shall not attempt to compare the work of this commission with its representative in the United States, but I may indicate the difference when I say that the monuments belonging to the prehistoric age, which are attached to the soil and part of the real estate which have been purchased, restored, and are now owned by the Government of France, are to be numbered by the score, if not by the hundred.

The department of prehistoric anthropology in the British Museum has for its curator an eminent man of science, who receives a salary of £1,500 per annum, equal to \$7,500.

The Museum of the Irish Academy of Dublin possesses a greater value in prehistoric gold ornaments alone than it has cost the United States for our entire Museum, with all its specimens, services, management, and furniture.

The Prehistoric Museum of Antiquities at Edinburgh, Scotland, is also extensive. It is devoted exclusively to the antiquities of its own country, and forms a complete museum in itself. It has at its head for curator, and for assistant and secretary, Professor Anderson and Dr. Arthur Mitchell, names which stand as high in their science as do any others of their country in any science.

The Prehistoric Museum at Copenhagen is so extensive and so rich that it might be classed as one of the wonders of the world. It occupies the entire palace of the Prince, has eight exhibition halls, with a full corps of professors, curators, etc., who occupy the highest ranks in science. The riches of this museum are almost beyond computation; 10,000 polished stone hatchets and axes, the contents of 11 workshops, one alone of which furnished 200 hatchets, 58 perçoirs, 4,000 scrapers, 1,426 arrow-heads, *trenchant transversal*; 51 cases of bronze implements and ornaments; and gold objects so numerous and valuable that, though kept on exhibition during the day (under lock and key, of course), are taken out each night and stored for safety in an immense steel safe.

Stockholm has a national museum devoted entirely to prehistorics, for which the government has organized a bureau and erected a fine museum building, with Messrs. M. M. Hildebrand and Montelius as professors

The University of Lund devotes the basement story to its prehistoric museum, with Professor Soderberg for its professor and lecturer.

The university at Upsala, one of the oldest and finest in all Europe, is engaged in the same direction.

The university at Christiania, Norway, has also the same kind of arrangement. Rygh and Undset are its professors. An idea can be had of the importance with which prehistoric science is viewed in this country, when I say that the numismatic museum of Christiania possesses a finer collection of United States coins and medals than does our National Museum, and still their desire to keep their own antiquities is so great that they refuse to exchange them for those of any foreign country.

The mention of these Scandinavian museums with the names of some of their professors will give but a faint idea of the dignity which has been accorded to the science of prehistoric anthropology in those countries and the attention which it has there received. These countries are entitled to and they have maintained a leading place in the science. So much so that he who was its acknowledged head in Europe and the world, Worsaae, was taken into the King's cabinet and served the later years of his life as minister of public instruction.

I need not mention the great prehistoric museums of Germany: that at Berlin with Virchow, probably the leading anthropologist of the world, at its head; that at Munich under the direction of Dr. Johannes Ranke, and so on; dotted over the country in every city from the Baltic to the Alps.

Much might be expected from Switzerland, for it is the land of the prehistoric lake-dwellers; and she has not disappointed our expectations. Berne, the capital, has no less than three governmental prehistoric museums; one, belonging to the republic, was purchased by it lately from Dr. Gross, of Neuveville, for the sum of 60,000 francs. The canton and the city each own a museum of no mean extent, where are gathered and displayed all objects found in the neighborhood. The other cities and cantons of Switzerland are equally alive to the importance of this science and equally active in its study and pursuit. Geneva, with Dr. Gosse at its head, Lausanne, with Morel-Fatio, Yverdon, Neuchatel, Bienville, Steen, Constance, Zurich, are all active, energetic, and industrious in gathering the objects in their vicinity and in the general increase and diffusion of knowledge concerning their prehistoric ancestors and people.

The same story may be told with regard to Italy. Genoa, Pisa, Turin, Milan, Verona, Vicezza, Parma, Regio, Bologna, Imola, Marzobotta, Florence, Arrezzo, Cortona, Perugia, Chiusi, Corneto, all possess extensive museums, and Rome has three or four great governmental establishments, organized with presidents and professors, and approaching the dignity of institutes and colleges, with museums attached, all devoted to the study of antiquities almost if not quite prehistoric.

This list might be extended indefinitely. Austria, Hungary, Poland, Russia, are all interested in this new science, and are devoting themselves to the spread of its knowledge and to the increase of the museums.

I have failed largely in my purpose if before this time I have not convinced the reader that the United States, both government and people, have not been aroused to an appreciation of this new science, and have not attached to it the importance to which it is entitled and which it receives in other countries.

The International Congress of Anthropology and Prehistoric Archaeology holds its tenth session in Paris during August (1889). These congresses were organized and have been holding their regular meetings since 1865 or 1867. They have had members, delegates, from all adjoining countries; they have usually met in the capital of the country, and never twice consecutively in the same country, with a number of members varying from 500 to 1,500, according to the contiguity of the place of meeting. Their bulletins formed volumes of several hundred pages, that at Stockholm over a thousand, yet no scientific organization from the United States has ever had any representative, and since the meeting at Paris in 1878 there has not been a single American present, in any capacity, at any of the meetings. The same comparison, continued with regard to the means of instruction in the different countries, America and Europe, would make about the same showing. Each of the countries of Europe may, I think, fairly claim that they are equal to, if not ahead of, the United States in their appreciation of and assistance to the science of prehistoric anthropology; even little Switzerland, with a territory of 16,000 square miles, would say she was not behind us. France, with her area of 204,000 square miles, would undoubtedly claim superiority over the United States. The area of the United States is greater by far than that of all Europe, and its archaeological area, acre for acre, is equally rich in specimens, and would afford a proportionate number and a proportionately good opportunity for the study of the history of the prehistoric man; and yet, I repeat, every country in Europe, if it but knew the exact status in the United States, would claim that it was superior in interest and study of the science of prehistoric anthropology.

In the means of education in this new science the same comparison holds good between Europe and the United States. In the societies of the different countries, established for the advancement of science, a section is devoted to anthropology, as is done in the United States. But the ten different countries of Europe make ten different societies there against one in America. In France, Germany, Italy, Denmark, Sweden, Scotland, and possibly in England, though I can not say certainly, there have been courses of lectures organized and conducted in connection with the societies of anthropology and the museums (such as comprise my department) in nearly all the principal cities. I may men-

tion that of Paris as the most extensive and complete, yet the others are of no mean proportion. In Paris the organization comprises seven lecturers, and they provide one lecture each day during the entire college session, from October until June, each being on the subject of anthropology. The lecturers are paid for their services, and they carry on their work with an earnest diligence for which we can find no parallel in the United States. The good effects of these lectures and of this education is manifest in the interest taken in the society, which numbers at Paris near seven hundred members, with an annual income of 20,000 or more francs, and with a capital of over 50,000 francs.

Enlarging upon this question of the comparative want of interest on the part of the United States Government and people, I might remark the number of scientific missions which have been sent out by these European governments in pursuit of this science. In 1834-'85 France sent Dr. Pousie to Australia and India to make studies in ethnology, Le Bon to India to study primitive architecture, Jules Monsier to make archæological researches in the Caucasus, Monsieur Brau to Malacca and Sumatra to make ethnologic collections, Gauthier to Turkey and Persia for researches in natural history and anthropology. Ernest Chantre, curator of the prehistoric museum at Lyons, was sent by the government to make anthropological researches in the Caucasus. He has just published his report in five large volumes, quarto, with 440 figures and 140 chromo-lithographic or heliographic full-page plates. M. Cartailhac was sent on a like mission to Spain and Portugal. His report is published in one large volume, with 450 engravings and four plates. The most extensive and complete works, with the finest illustrations concerning our own country, do sometimes come from the hands of these foreigners thus sent out. Wiener reports Peru, Lucien Briart the Aztecs, while the most comprehensive work on the subject, entitled "Prehistoric America," is written by a Frenchman, the Marquis Nadaillac.

The curators of European museums are being continually sent to visit and examine other prehistoric museums than their own. In a report just received, published by the keeper of the National Museum of Antiquities at Edinburgh, Dr. Anderson, and his assistant, Mr. Black, is to be found a note of some of these visits. "In connection with most of the principal archæological museums on the Continent provision has been made for enabling the officers and attachés of the museum (who had been at their occupation as experts) to enlarge their knowledge in the lines of their specialties by travel and research." In 1842-'45 Worsaae was sent from Copenhagen through Sweden, Norway, North Germany, and Russia; in 1846-'47 to Great Britain; and the result was the publication of his "Danes and Northmen in Britain," which is still the standard work. Mr. Undset, a young attaché of the Christiania Museum, was sent to Sweden, Denmark, Germany, France, and Britain, as a result of which he published his Norse Antiquities. Since then he has traveled

over Europe and published his report, "The Iron Age in Europe," the standard book on that subject. In 1878-'79 Dr. Sophus Müller, a young attaché of the Prehistoric Museum at Copenhagen, was sent through Germany, Austria, and Italy, returning through France and Britain. He studied the zoomorphic ornament in Europe, and he has published the most complete monograph on the subject which has yet appeared. Dr. Montelius, keeper of the National Museum at Stockholm, was sent throughout Europe to study the fibula of the bronze and iron ages. Sweden and Norway each set aside \$560 annually for similar purposes. The report of Dr. Anderson, which I have just mentioned, was the result of sundry voyages made throughout Scotland, visiting the local archæologic museums, for the expenses of which an annual appropriation of \$200 has been made.

The closer we examine and study the policy of the European governments and compare their achievements and those of their people and institutions with those of the government and kindred institutions of the United States, the greater the contrast. Take the laws of the various European governments for the preservation of, by obtaining title to, mounds, earth-works, caves, dolmens, and other prehistoric monuments. The most of the European countries have passed such laws. In England Stonehenge belongs to the government, and Abury is now in the same line, if the transfer has not been actually completed. Denmark, Sweden, and Norway own great numbers of prehistoric monuments. In France they are to be counted by the hundreds, while Italy probably surpasses all others. In Italy these matters have received most serious consideration at the hands of the government, and a complete system of laws are now in force providing for the proper investigation of these monuments, their preservation, and the conservation of the objects found therein. Any person in the kingdom making a discovery of archæological objects is required to make it known to the proper department of the government at Rome. If he would excavate, he must also notify the Government, and it will send an inspector, who will supervise the excavation, keep a diary of all work done and a register of all objects found. This he does from actual observation, for he is required to be on the ground every day during the progress of the work. At Corneto-Tarquini the excavations have been continued practically for twelve years past by the same band of workmen under pay of the town, with a permanent Government inspector. Antiquities discovered in Italy can not be removed from the Kingdom, certainly not from the Roman provinces, without first submitting to the inspection of the Government officers, who claim the first right of purchase. Not until after they have declined to purchase will a permit be given for exportation.

I do but state it fairly when I say that the United States, so far from having any such governmental control over or interest in any of the prehistoric antiquities, whether monuments or otherwise, has no serious thought of such control. Neither the Government nor any of its officers

or institutions have ever, to my knowledge, even considered a proposition for the purchase of any of these prehistoric monuments; and if they or any of them have ever supervised an excavation, it certainly has not been with a view to purchase the objects that they might be displayed in any of the museums. By our law no officer or institution has either power or authority to purchase real estate, whether it be a prehistoric monument or not. No such power has ever been proposed to be given by Congress, and we stand to-day in this position upon this subject, that the Smithsonian Institution, which may fairly claim to be the representative scientific institution of the Government, can not purchase any one of our numerous prehistoric monuments for the purpose of its preservation (as was done in the case of the Serpent Mound in Ohio) for want of the necessary legal authority. More than that, it can not accept and hold the title of any such monument, however great its value and necessity of preservation, even if such monument shall be presented as a gift.*

I will not attempt to complete the comparison of labors performed and interest taken in the science of prehistoric anthropology between the two countries Europe and America. That will be known by American readers without citations. I make two remarks concerning American investigations and publications that, with a few exceptions, are easily recognized. The work has been done by piecemeal, a little here and a little there, devoted to a single locality or a single view of the subject, isolated, divided, without connection or harmony either in investigation, publication, or comparison, without any comprehensive or general system by which the workers, each performing his own labor, should assist.

The duty of investigating prehistoric man in the United States clearly belongs to the scientists of our own country. It is the history of our own people and country, depending upon investigations made upon our own soil; a studying, and, if need be, the excavation of monuments erected upon territory belonging to us. If it is to be done at all, it should be done by us. True, there is no law nor any legal obligation by which we can be required to make these investigations or perform this labor, and naught but national pride and our own self-respect will compel it. We should apply to science the Monroe doctrine of politics. We should recognize and declare our ability to do this work and our intention to perform it, that we may contribute to the science of the world, a history of our prehistoric people. If the work is not done by us, or insufficiently performed, it should not be because the matter was neglected or forgotten by either our Government or people, but for the reason that we decided it was not worth the effort, and in this we must justify ourselves in the eyes of the world. The sciences of astronomy, chemistry, metallurgy zoology, and paleontology may have certain demands for recognition, but their claims rest upon other countries with equal weight as upon ours. Our country is under no greater obligation

* Since the above was written the legislature of Ohio has authorized the purchase of the prehistoric earthwork of Fort Ancient, Warren County.

in respect of these and similar sciences than are other countries of the world. But in respect of the prehistoric anthropology of this country it is different. The duty weighs heavier and solely upon us.

The Smithsonian Institution and National Museum stand as beacon lights to the American people in respect to science, and are the great representative scientific institutions of our country. In this regard they represent the United States Government; they stand for it and speak for it. They have the ear of its Executive and of its legislature, and exercise an influence with the Government not possessed by private individuals or organizations, and therefore a certain responsibility rests upon them whether they will or not.

As a means of correcting the defect mentioned, I would respectfully suggest the giving of greater attention to the dissemination of information among the people. This can be done through publications, by means of lectures, and by the organization in kindred societies for concert of action and more extensive preparation at their meetings for the presentation of this subject in its proper light. I also suggest the preparation of series of specimens illustrating the science of Prehistoric Anthropology, accompanied with descriptive letter-press and catalogue; these to be distributed to all institutions of learning in the United States, receiving in exchange such implements and objects as are possible. Perhaps the most important factor of all would be the endeavor to increase the knowledge and interest of the executive and legislative officers of our Government, so that the science of Prehistoric Anthropology could be certain to receive in the future their countenance, support, and assistance.

IMPORTANT ACCESSIONS DURING THE YEAR.

Dr. E. C. Black, Wheatland, Indiana, sent twenty leaf-shaped implements from a *cache* or deposit. He states that they were found while plowing the side of a clay hill in an old field in Harrison Township, Knox County, Indiana. The land had been in cultivation eighteen years, and its being a hill-side indicates that the implements were buried in the ground for a purpose. (Accession 21076.)

The Cincinnati Society of Natural History (through Horace P. Smith, 108 Broadway, Cincinnati, Ohio), forwarded a collection from the cemetery at Madisonville, Ohio, consisting of flint knife, drills and scrapers, rude and fine spear and arrow-points, chisel and gouges, perforators, scrapers made from the leg-bones of deer (peculiar to Madisonville), bone beads and needles, animal teeth such as bear, beaver, porcupine, woodchuck, elk, lynx, and raccoon. Also perforated unio valves, carbonized maize and ashes from altar mound number 3; 203 specimens. (Accession 21206.)

C. T. Wiltheiss, Piqua, Ohio. Six flint flakes and points, 1 perforator, 17 rude implements more or less leaf-shaped (flint), 14 disk-like implements of slate (Plate V), 11 polished stone hatchets, 2 grooved axes, 1

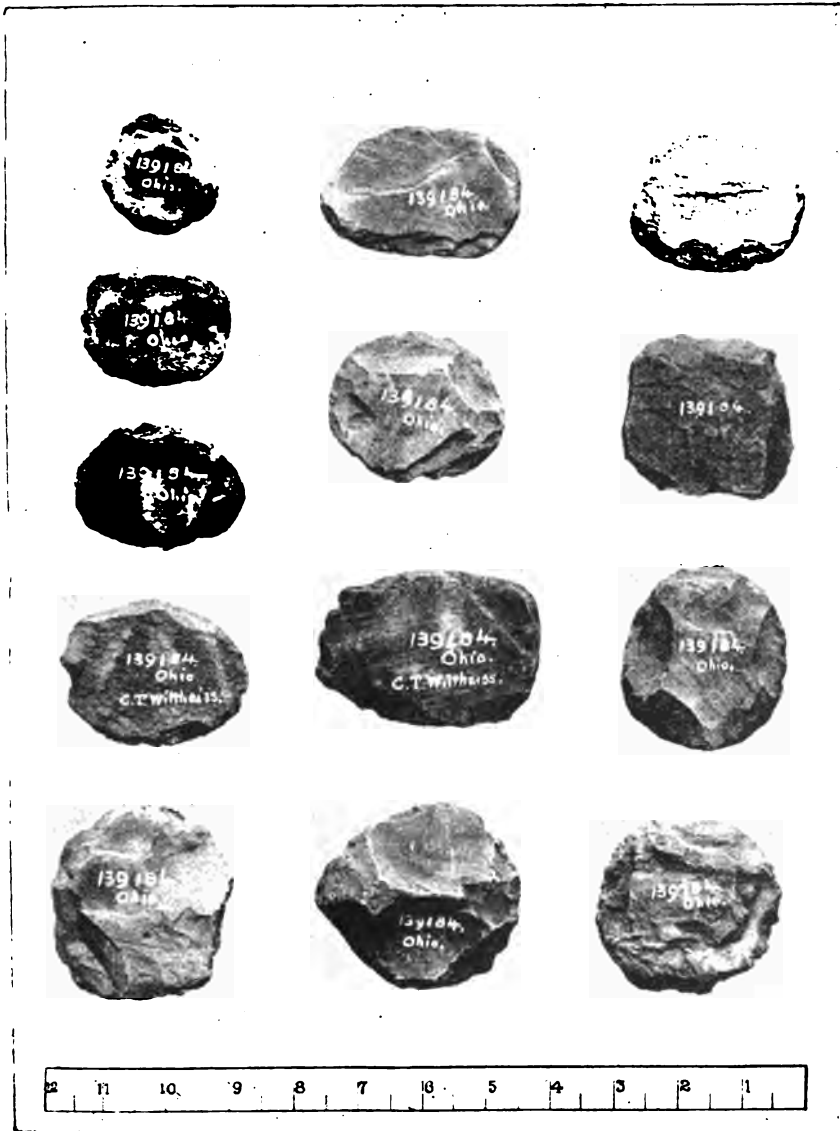

DISC-LIKE IMPLEMENTS OF SLATE.

(Cat. No. 139184, U. S. N. M. Piqua, Ohio. Collected by C. T. Wiltheiss.)

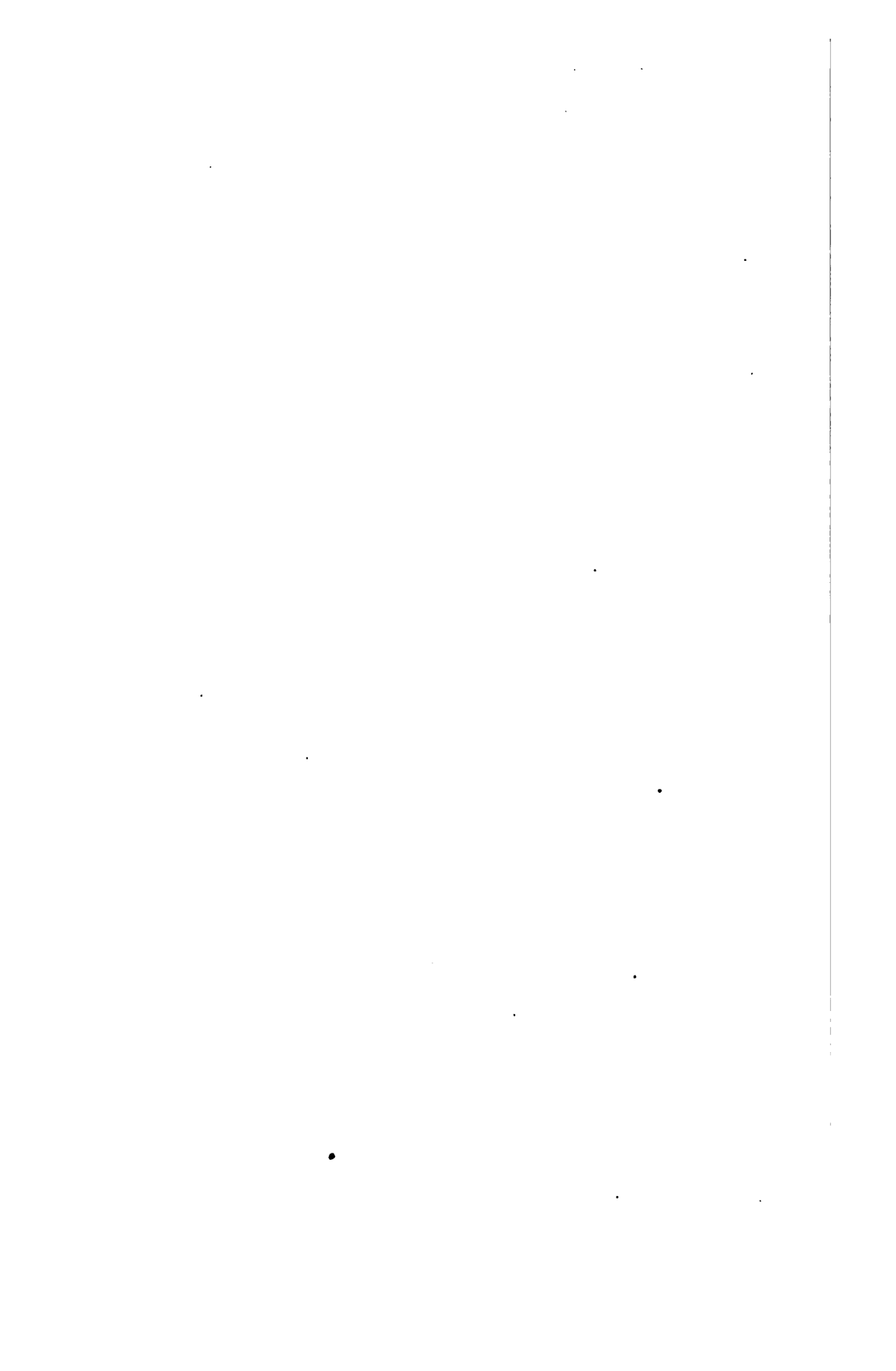

notched ax (granite), 3 pieces of slate rudely worked, and 2 unfinished ceremonial objects of slate; 56 specimens.

He says, "The implements wash out of the east bank of the Miami River, on the bottom-lands, from a stratum of yellow clay covered by a layer of black loam 3 or 4 feet in thickness."

The thirteen disks are so well shown in the plate as to render description needless, except to say that they are the same on both sides, are quite flat and thin. Their edges are not defined nor sharp enough for them to have served in their present condition as a cutting implement. and there is no trace of service by which their purpose can be surmised. One has a slight notch in its edge, but it appears to have been accidental. Others (not shown) are of different forms, one with a rude hammered or chipped edge, another with a rude notch indicating a possible handle, but the entire series is unusual. (Accession 20311.)

G. B. Frazar (West Medford, Massachusetts) sent a collection of hammers, paleolithic implements, arrow and spear points, knives, etc., found on the Mystic, in Medford, West Medford, and Arlington; also at Spy Pond, Arlington, Massachusetts. This collection is quite interesting, and important from the fact that there were but very few specimens of the paleolithic class from Massachusetts in the Museum. (Accession 21781.)

Mr. P. L. Jouy, U. S. National Museum, contributed a collection from the prehistoric graves in Corea, in which are included stone daggers, arrow and spear heads, knives, chipped and polished hatchets, polished jade, Megatama or curved jewels, amber heads, and a polished stone ornament. These objects are rare and unique, and are the only specimens of prehistoric stone implements that have been received from Corea. They are a valuable contribution to prehistoric archæology. (Plate VI.) (Accession 21859.)

From W. D. Dreher, Knoxville, Tennessee, was received a grooved ax found between Loudon and Kingston, eastern Tennessee. This is one of the finest specimens ever received by the Museum. (Accession 22057.)

Mr. Warren K. Moorehead, Xenia, Ohio, forwarded a large and valuable collection of prehistoric antiquities, mostly from the Ohio River Valley, for exhibition in the Museum. The collection deserves special mention. It is the result of years of work in the field, and when the specimens were obtained from other sources he has the exact locality where found given, so that the identity of each specimen is secured. It would be impossible to give a complete catalogue of the collection in this report, but it contains examples of almost every object known to American archæologists in the localities which he has investigated. The objects from mounds are mounted separately. Each specimen is numbered, and Mr. Moorehead has a complete catalogue to which reference can be made at any time; 4710 specimens. (Accession 21695.)

The Musée d'Ethnologie, Geneva (through Dr. H. J. Gosse, director),

sent a collection of Lacustrien pottery and bronzes, including vases, weights, etc., of clay; bronze bracelets, buttons, pins, rings, instruments, ear-rings, collars, fish-hooks, razor, hatchet, lance-head, sickles, knives, and pieces of wire. (Accession 28577.)

From Halbert Rust (Jeffersonville, Indiana) was received a large collection of stone and bone implements, etc., embracing nuclei, paleolithic implements, notched axes, hammers, scrapers, perforators, arrow or spear points, polished hatchets, grooved axes, pestles, fragments of pottery, bone implements, fragment of human skull, bones and teeth of animals, jaw-bones of drum-fish, awls or needles made of fish-spines, fresh-water shells, and an encrinite bead; 756 specimens. (Accession 21498.)

He states that the largest number and most desirable of the specimens were found in a burial place near Clarksville, Indiana, evidently deposited with the bodies of the owners. Some were on the surface and at various depths below it, while others were taken from the graves or gathered on the slope of the shore line after heavy rains or high waters. I have never found a whole vessel of pottery or fragments larger than those sent. Many of the stone implements have been little changed from the stone as it was created, while others have been skillfully wrought and smoothly finished. Nearly all the pieces of bone have been worked. The shells are part of such as I found quite plentifully with the human skeletons.

Dr. F. A. Steinmeyer (Bonaparte, Van Buren County, Iowa), sent five paleolithic implements, which were found in the vicinity of Bonaparte at a depth ranging from 2 to 5 feet under the soil, which was clay. They were in their original position, and the deposit appeared to be accidental. (Accession 20684.)

Livingston Stone (Baird, California) sent two rude stone axes, which he says were formerly used by the Win-ni-inim Wintum Indians, McCloud River, California. They were—i. e., this kind of ax—in actual use among these Indians during the life-time of the older members of the tribe, and were the only axes used by them before the advent of the white man 40 or 50 years ago. The larger one was employed to cut down large trees, and the smaller one for brush and small trees. They are simply pieces of stone so cloven as to leave a comparatively sharp edge. (Accession 21035).

One of the earliest, possibly the very earliest announced principle having a bearing upon the discovery of prehistoric man, was that by the three Scandinavian savants Nilson, Thomson and Forchammer, in the early part of the nineteenth century, wherein they declared that rude implements belonged to an earlier civilization than those more highly finished. The ruder the implements, the greater their antiquity. It was in the application of this principle by these three wise men that the discovery of prehistoric man was made. I will not deny the correctness of the principle—but it has been misapplied and misconstrued—



STONE DAGGERS, ARROW AND SPEAR HEADS, KNIVES, ORNAMENTS, ETC.
(Cat. Nos. 140902-140913, U. S. N. M. Prehistoric graves in Corea Collected by P. L. Jouy.)

until I know of none which has been productive of greater error in the study of prehistoric civilization. Correct enough if applied to a whole people or to a series of their arts and industries, but it has been distorted by superficial investigators who apply it to a single object. These investigators passing upon an implement, especially one of stone and rude in construction, declare it to be of great antiquity, simply because it is rude, and this without regard to the locality in which it was found or the objects associated therewith. This has resulted in the propagation of great errors in regard to ancient civilization. If one wanted a common illustration of this error, let him consider tools of different trades—say carpenters, blacksmiths, tanners—and compare those used by workers in a complete establishment with those of a country workman who did only rough work.

I am impelled to make these observations in studying these two rude stone axes received from Mr. Stone (Catalogue Nos. 139793, 139794). Only one, the largest, is illustrated; from it one can easily understand what the smaller one is like. (Plate VII.)

Now these implements were made with less work and in a shorter time than probably any other. They are of the extremest type of simplicity and rudeness, and yet they are probably the most modern of any implement of similar type in the Museum. The one illustrated appears to have been a part of a large solid bowlder projecting from the earth with a worn and rounded edge at the top. A heavy blow projected against the side of this rounded edge would knock off a large spawl, which became at once the completed ax. The rounded edge of the bowlder served for a grip, while the opposite side was the edge. It is 8 inches long, $6\frac{1}{2}$ wide, and 2 thick, and weighs $4\frac{1}{2}$ pounds. Its material is diorite. The smaller one is 4 inches long, $2\frac{1}{2}$ wide, 2 thick, and weighs one-half pound. Its material is indurated shale. Thus we have a veritable ax actually used for cutting trees so rude and simple as to be made at a single blow, and is withal quite modern.

This implement, for all its rudeness, has no relation to paleolithic implements. The paleolithic age or period has sometimes been called the age of chipped stone, because its stone implements were made by chipping, and in contradistinction of the neolithic age or period wherein most of the implements of stone were smoothed or polished. But these descriptions are only fortuitous. The term "paleolithic" in connection with prehistoric archæology means the ancient stone age; "neolithic" means the recent stone age, while the term "eolithic" has been given to the dawn of the stone age, said to belong to the tertiary geologic period. These prefixes *eo*, *paleo*, and *neo* are Greek, and refer to comparative periods of time, and not to the implements, nor their kind or manner of making. While the principal implements of the paleolithic age were of stone, yet all were not so. Important implements of that age have been found in great numbers made of horn and bone. Har-

poons, fish spears, all manner of points, needles, spoons, etc., were thus made, and they were all smoothed and polished; yet they belonged to the paleolithic age quite as much as did the rude chipped stone implements.

The rude stone axes sent by Mr. Stone are not paleolithic, do not belong to that age, and have no relation with or resemblance to any paleolithic implements. They belong no more to the paleolithic age than would a split boulder or piece of stone chipped to an edge by a hunter who, loaded and armed with all the scientific appliances of the nineteenth century, having lost his hatchet, and being overtaken by night, should improvise and make such an implement to cut the needed brush for his fire or boughs for his bed.

This implement, rude and simple as it is, has no resemblance to the true paleolithic implements—not in form, shape, mode of manufacture, kind of chipping, nor the formation or sharpening of its edge. Any one acquainted with them would recognize the difference at once and could not be deceived.

From William Taylor (San Diego, Duval County, Texas) was received a rude flint implement, found near top of *Equus* beds, one-half mile from San Diego, where species of *Myiodon*, *Glyptodon*, and three species of *Equus* and *Elephas* have been found. (Accession 21181).

From the U. S. Fish Commission (Washington, District of Columbia) was received archæological specimens from Patagonia, Straits of Magellan, Lower California, and California, collected by the Fish Commission steamer *Albatross* during her voyage from Virginia to California in 1887-88.

The localities from which the specimens were obtained are as follows: Port Churruca, Elizabeth Island, Saint Martas Island, and Gregory Bay, Straits of Magellan, Pichilingue Bay, Gulf of California, Margarita Island, Lower California, and San Celmente Island, California.

The greatest number of objects collected at any one point was at the Kitchen Midden, Elizabeth Island, Straits of Magellan.

The stone implements of flint and obsidian number four hundred and forty-five and include hammers, rude implements of paleolithic type, leaf-shaped implements, scrapers or knives, arrow and spear points, pitted stones, pebbles slightly worked, and a large number of chips and flakes. Bone implements were also found, such as perforators, knives, etc. The bones of animals and birds received have been identified as follows: Whale (species not identified), Sea Lion, *Otaria jubata*; Sea Bear, *Arctocephalus*; Penguin, two species, *Aptenodytes* and *Spheniscus*; Cormorant, two species, *Phalacrocorax albiventris*; and *Phalacrocorax magellanicus*; Steamer Duck, *Tachyeres cinereus* and Gull, *Larus*.

A large number of bones are in such a fragmentary condition that it is almost impossible to identify them with any degree of accuracy.

The shells (426) belong to the following species: *Patella*, *Mytilus*, and *Voluta*. The specimens obtained at the other localities mentioned are perhaps of equal importance, and should, in the future, be made the subject of a more elaborate report. (Accession 21699.)



RUDE STONE AXE—SIDE AND EDGE VIEW.

(Cat. No. 139793, U. S. N. M. McCloud River Indians, California. Collected by Livingston Stone.)

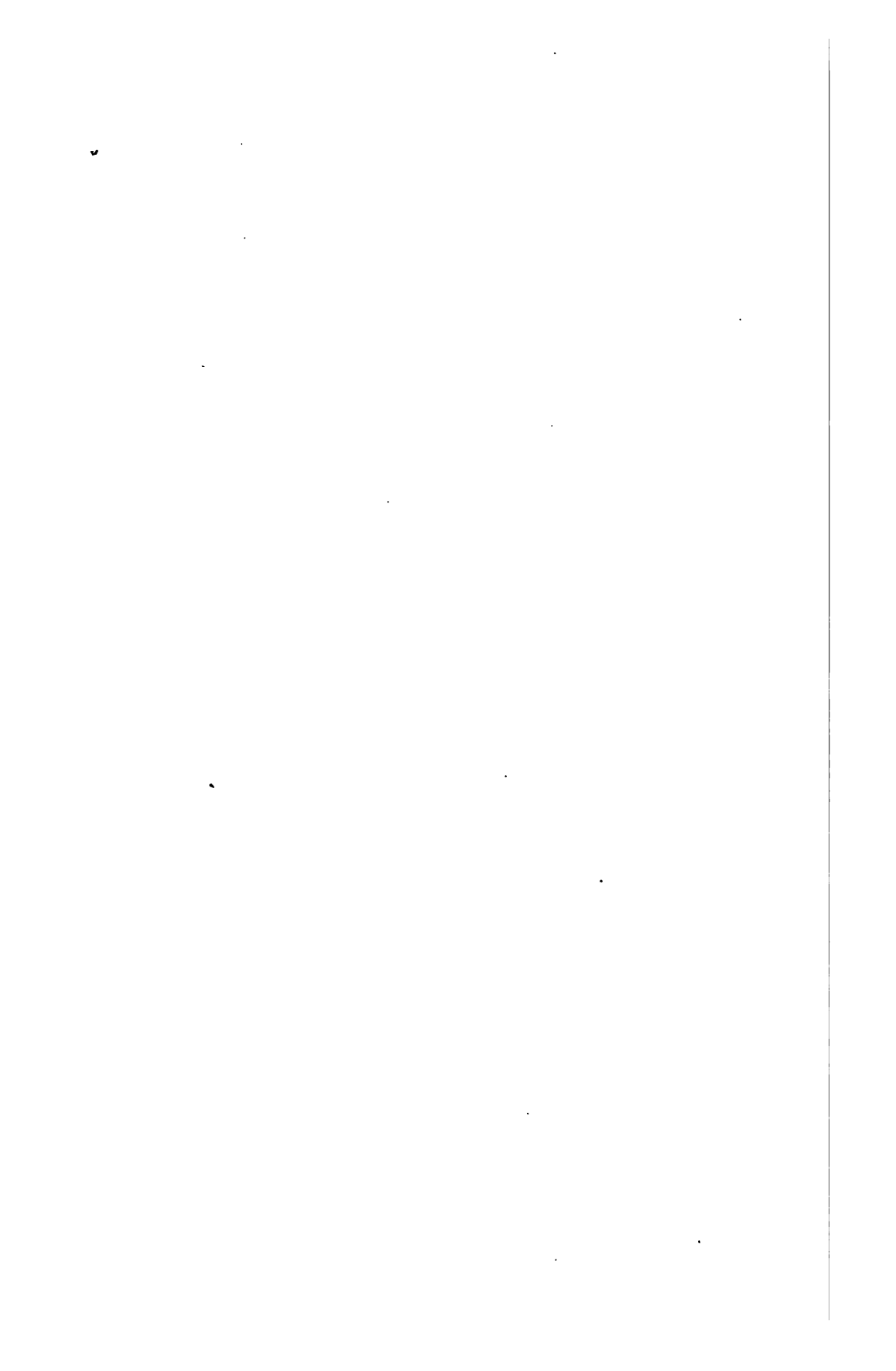

Thomas Wilson (U. S. National Museum) gave a collection of bone, stone, and shell implements, embracing hammers, rude pieces of worked flint, chips and flakes, leaf-shaped implements, scrapers, arrow-points, perforators of stone and bone, fragments of pottery, and valves of *unios* from Hahn's field, one mile east of Newton, Anderson Township, Ohio, on site of mounds 1, 2, 3, and 4, Group C, Metz Exploration; 64 specimens. A rude chipped implement, found in the surface of an ancient cemetery at Sand Ridge, Anderson Township, Ohio; five rude chipped implements, found 12 to 20 feet below the surface in the gravel drift of the Little Miami River, at Loveland, Clermont County, Ohio. (Accession 21238.)

Also a large collection from Flint Ridge, Licking County, Ohio, consisting of flint cores, flakes, rude implements (so-called turtle-backs), small leaf-shaped implements, arrow and spear points, hammers, a rude maul, polished stone hatchets, notched implement, flakes retouched with intent to deceive, and a number of specimens showing crystals; 1029 specimens in all. (Accession 21351.)

Mr. James C. Wright, of Fredonia, Licking County, Ohio, an enthusiastic but careful collector of prehistoric archæologic specimens, was reported to me as being the owner of a statue of a bear, found at the city of Newark. I wrote to him a letter of inquiry, and our correspondence resulted in the following letter:

I send you by mail to day a cast of the stone bear, as requested. It is owned by me and has been in my possession ever since it was found. The stone bear was taken from a mound in the city of Newark, this county, in the year 1881, being found 4 feet below the surface, associated with human bones. There is no doubt of the genuineness of this relic, as there are a number of persons who saw it at the time it was found. Mr. Jacob Holler, a day laborer, was the finder, and I purchased it of him soon after.

I had heard of this find while on a visit to the city of Newark, and had seen a cast. It was then called the stone bear, and was continually spoken of as such. Upon receipt of the cast I recognized at a single glance that it was not the statue of a bear, but intended to represent a human form clad in bear's skin, the head being brought over the crown and serving as a sort of head dress, after the fashion of a lion's skin of Hercules and Alexander. In the illustration (Plate VIII), the photograph has been taken of the cast, showing front and profile views. The subject has been conventionally treated. The entire head of the bear is represented on the top of the head of the man in such way as to show the entire skull of the bear and not the skin alone, while the arms of the man appear inserted within the skin of the fore legs of the bear.

The appropriation of the skin of the beast which had been slain by the hunter who had slain it, as a trophy of his skill and prowess, is a custom prevailing in all countries and ages, the beginning of which is lost in antiquity. Its survival into modern times and in civilized society is shown by the same use of the brush of the fox, the scalp of the

wolf, and the skin of the lion and tiger. It probably existed in prehistoric times, and while no direct evidence has been found of such a custom in the eastern hemisphere, the object herewith figured is evidence of its existence, and the use of the skin of the slain beast, either as a garment or a fetich, or both, among the prehistoric peoples of America. The custom is found in the times of earliest given history. Hercules stands in the Grecian mythology as the earliest and most notable representative of this custom. Hercules having slain his music teacher Linos, was banished by his putative father Amphytriton. At the age of eighteen he slew a lion that infested Mount Kythaeron and preyed upon the flocks of his father. Returning to Thebes he wore the lion's skin hanging from his shoulders as a sign of his success, and from this one may suppose that it was already a custom and that he was not the first to inaugurate it. But the skin with which Hercules is generally represented was not that of this lion. Of the twelve great labors put upon him by Eurystheus the first was the destruction of the Nemean lion. Its skin was known to be impenetrable, proof even against the arrows of Hercules. He entered the cave where was its lair, closed the entrance behind him, grappled the monster in his arms and strangled him. He tore off the skin and resolved to wear it in his own defense, and thus he came to be represented with the lion's skin, either carrying it across his arms or wearing it down his back, with the skin of its head fitting to his crown like a cap, and the fore legs knotted or crossed under his chin.

The early coins give us some insight into this matter. Beginning with 700 B. C., the coins bore the type of the various animals—lion, bull, horse, boar, etc.—also the creatures of mythology, as the Chimera, Gorgon, etc., while they early began with types of the gods—Aphrodite, Poseidon, Pegasus, Minotaur, Apollo, etc. Among these early appeared Hercules. On a coin from Termera, dating probably about 480 B. C., Hercules is represented kneeling, with the lion skin about him and its head drawn over his crown. On two coins of Cyprus, Hercules is represented with his bow in his left hand, his club in his right, and wearing the lion skin. A coin of Thasos, about 411 B. C., represents Hercules in the act of drawing the bow and wearing the lion skin. In the foregoing the hero is represented at full length, and, consequently, the lion's skin is extremely small and somewhat indistinct. But on a coin from Camarina, which was destroyed 405 B. C., is the type of the head of young Hercules, which shows the lion's skin with great detail and beauty. The fore paws are drawn together and crossed on his neck under the chin. The under jaw of this lion is conventionally treated, and is shown as laid upon the under jaw of the god, the lion's open mouth encircling his ear.

A gold coin from Syracuse, about 412 B. C., shows the head of Hercules again with the lion's skin, and others from Cos Cyprus and other places, so that they cease to be rare.



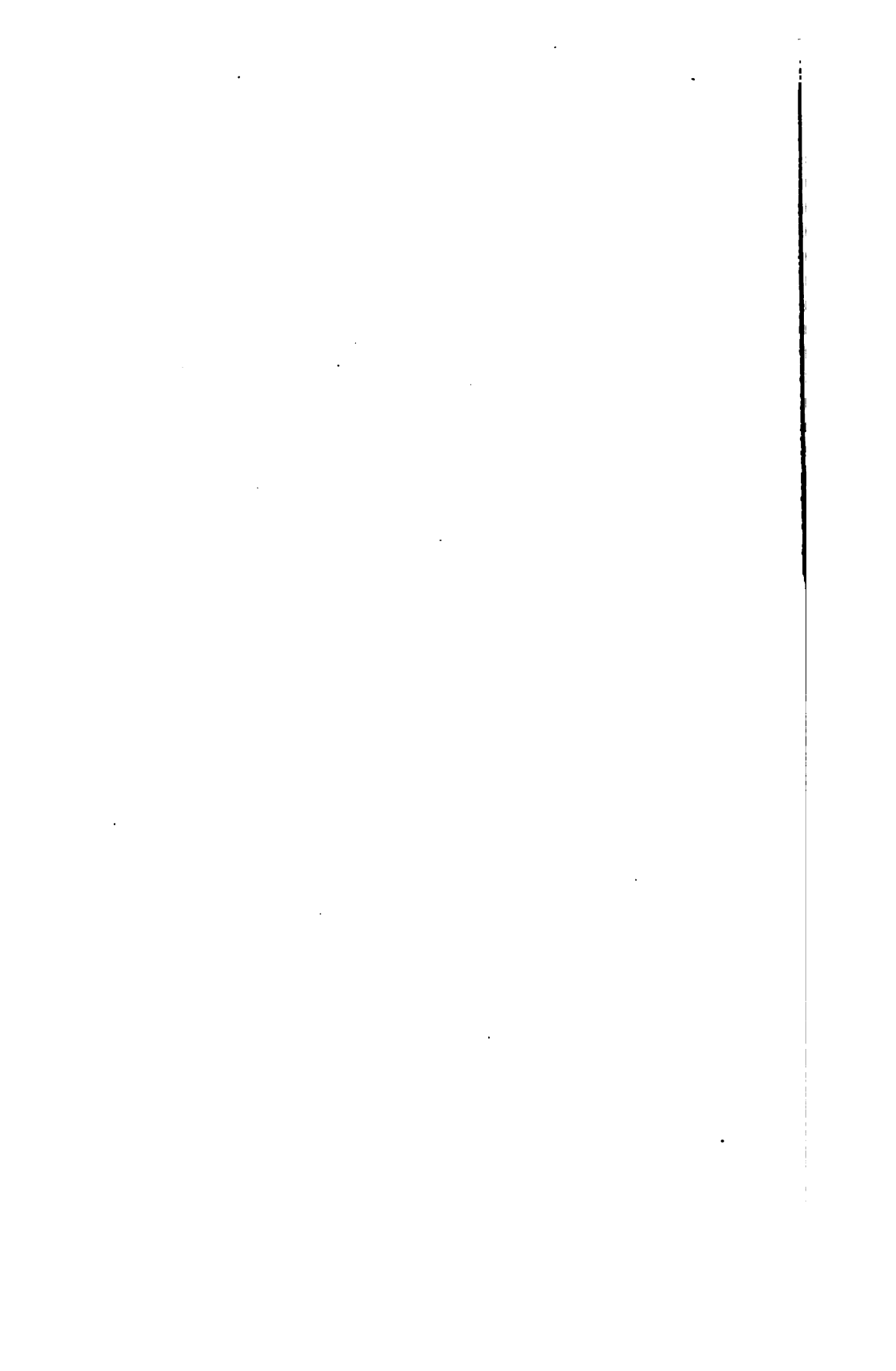

Alexander the Great adopted the lion's skin head-dress, and in a large proportion of his coins, especially the tetradrachm, he is thus represented. It was at that period and in this coinage that Hercules began to be represented with his club, his effigy being usually upon the reverse, while on the obverse was depicted Alexander with the lion-skin.

On some of the coins, instead of the lion skin, Alexander is represented with his head covered by the front portion of the skin of an elephant, showing the tusks; this was adopted, as is supposed by some, after his victories in India.

It is probable that this object is unique in the locality in which it has been found. The Indians of that locality, and possibly all over North America, were in the habit of employing skins of beasts to cover themselves, whether for protection against cold or enemies, but more probably during their dances and ceremonies, in which they may have represented the animal whose skin they wore. Numerous cases of this kind can be found. The buffalo dance among the Mandans is one of this kind. It is described in the Smithsonian Report, 1885, Part II, page 309. It is there said that this dance was to make the buffalo come when the Indians are likely to starve for want of food. Their song was to the Great Spirit, imploring him to send the buffalo, and promising to cook the best of it for him.

It is not improbable that in this way the skins of various animals thus worn, and which in other countries served as the coat of arms of the individual or family and became the foundation of heraldry, here found their counterpart in the different clans of various tribes, as the bear, the wolf, the fox, etc., or in other localities it may have served as the totem of the individual or his clan or tribe.

It is to be remarked that the physiognomy of the individual is not at all Indian. He holds in his right hand, as it were by the neck, the amputated head of another individual, which can be best seen by turning the front view upside down, which brings that head into a natural position. The hair of this head is strained tight away from the head, and drawn together and held at the foot of the statue. The features of this head bear no greater resemblance to that of the Indian than does the first. There are also ear ornaments in both figures, which have a resemblance to those from the farther south, Mexico and Central America, rather than to anything pertaining to the Indian.

In fact, all the peculiarities of the human portions of this figure point to such a resemblance rather than to the North American Indian.

Another floating straw of evidence in this direction is to be found in Figs. 1 and 2 of Plate IX. Fig. 1 is a stone object, in form of the llama, and was brought from Peru by Mr. W. E. Curtis during his late visit to that country, the result of which he has just published. Fig. 2 is a cast of an object bearing a great resemblance to the llama, and in fact to nothing else, the original of which is in the possession of Dr. Snyder, and which was found in a mound in Miama County, Ohio. It has been

known that the llama belongs to South America and to the southern part of North America. Among the discoveries of Mr. Cushing, in charge of the Hemenway expedition on the Salado River, were rude pictures and outlines of animals which can only be likened to the llama if they represented any living animal. Dr. Washington Matthews has made an investigation into this matter, and his report with these figures is in train for publication. It was, I believe, his opinion that no trace or evidence of the existence of the llama in North America farther north than the Salado River had ever been found. It is not intended by these observations to make any assertion with regard to the truth of these matters, but only to offer them in the way of suggestion, affording subject for consideration. (Accession 21794.)

REVIEW OF SPECIAL RESEARCHES.

The continuation of researches as to the existence and frequency of occurrence of paleolithic implements in the United States has been continued, and the department is still in receipt of letters from persons whose attention was called to the subject by Circular No. 36.

During the year 14 accessions, numbering in all 3031, were received in this department for examination and report.

On December 10, 1888, a circular letter in regard to a rude chipped stone ax or adze was sent to a large number of contributors to this department, and responses have been received from fifty-two persons, which will be given in a future report, when fuller information has been received. (Plate X.)

The examination of steatite bowls, trays, and plates affords an interesting study.

They have been investigated on the Pacific better than on the Atlantic slope, though some ardent, intelligent seekers have made discoveries which unfortunately have not been published. The most common form is oval, boat-shaped, with handle at the ends. They are blocked out rudely at the quarries and then carried away to be finished leisurely. The marks of pecking and cutting are shown in Fig. 1, Plate XI, as is the partly wrought handle at the end. This specimen is broken, as are nearly all found in the quarries. Fig. 2 is a rude notched ax, said to have been found in a quarry along with Figs. 3 and 4, all from Goochland County, Virginia, and presented by G. W. Reed. The latter are an adaptation of the common polished grooved stone ax (No. 4), being more pointed than usual. They were evidently to be used with a handle, and may have served to fashion either the inside or outside of the bowl. Figs. 2 and 3 may have been used in quarrying. These, with the many others of the same type and the numberless other industrial and art objects of the same culture, seem to fix the epoch of the steatite implements as neolithic and late Indian. The two implements, Figs. 5, Pennsylvania, 6 District of Columbia, have no groove, and probably were held in the hand. Their points are peculiar, and with Fig. 4 may



1



2

STONE CARVINGS REPRESENTING THE LLAMA.

Fig. 1. PLASTER CAST. (Cat. No. 140897, U. S. N. M. Original from Peru. Collected by W. E. Curtis.)

Fig. 2. PLASTER CAST. (Cat. No. 30046, U. S. N. M. Original from a mound in Miami County, Ohio. Collected by Dr. J. F. Snyder.)

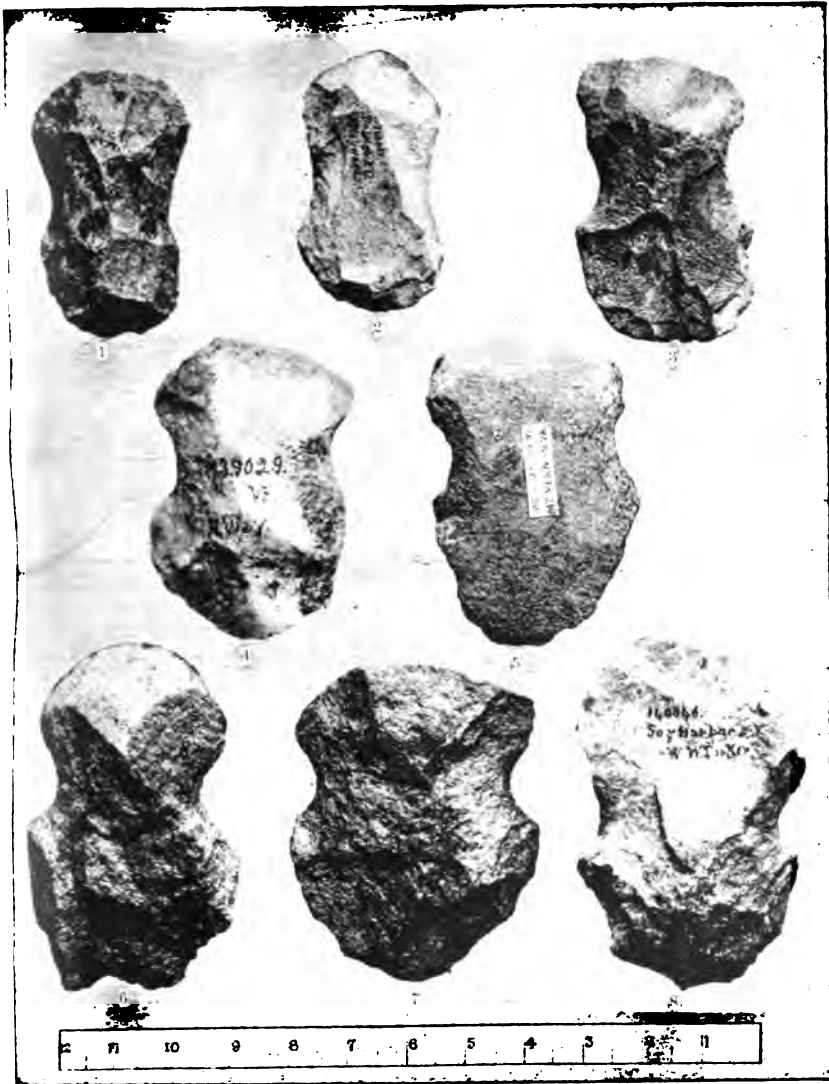

RUDE NOTCHED AXES.

1. From Georgia. (Cat. No. 19225, U. S. N. M.)
2. From North Carolina. (Cat. No. 140057, U. S. N. M.)
3. From Tennessee. (Cat. No. 65725, U. S. N. M.)
4. From Virginia. (Cat. No. 139029, U. S. N. M.)
5. From Virginia. (Cat. No. 137502, U. S. N. M.)
6. From Virginia. (Cat. No. 1073, U. S. N. M.)
7. From Virginia. (Cat. No. 1073, U. S. N. M.)
8. From New York. (Cat. No. 140046, U. S. N. M.)

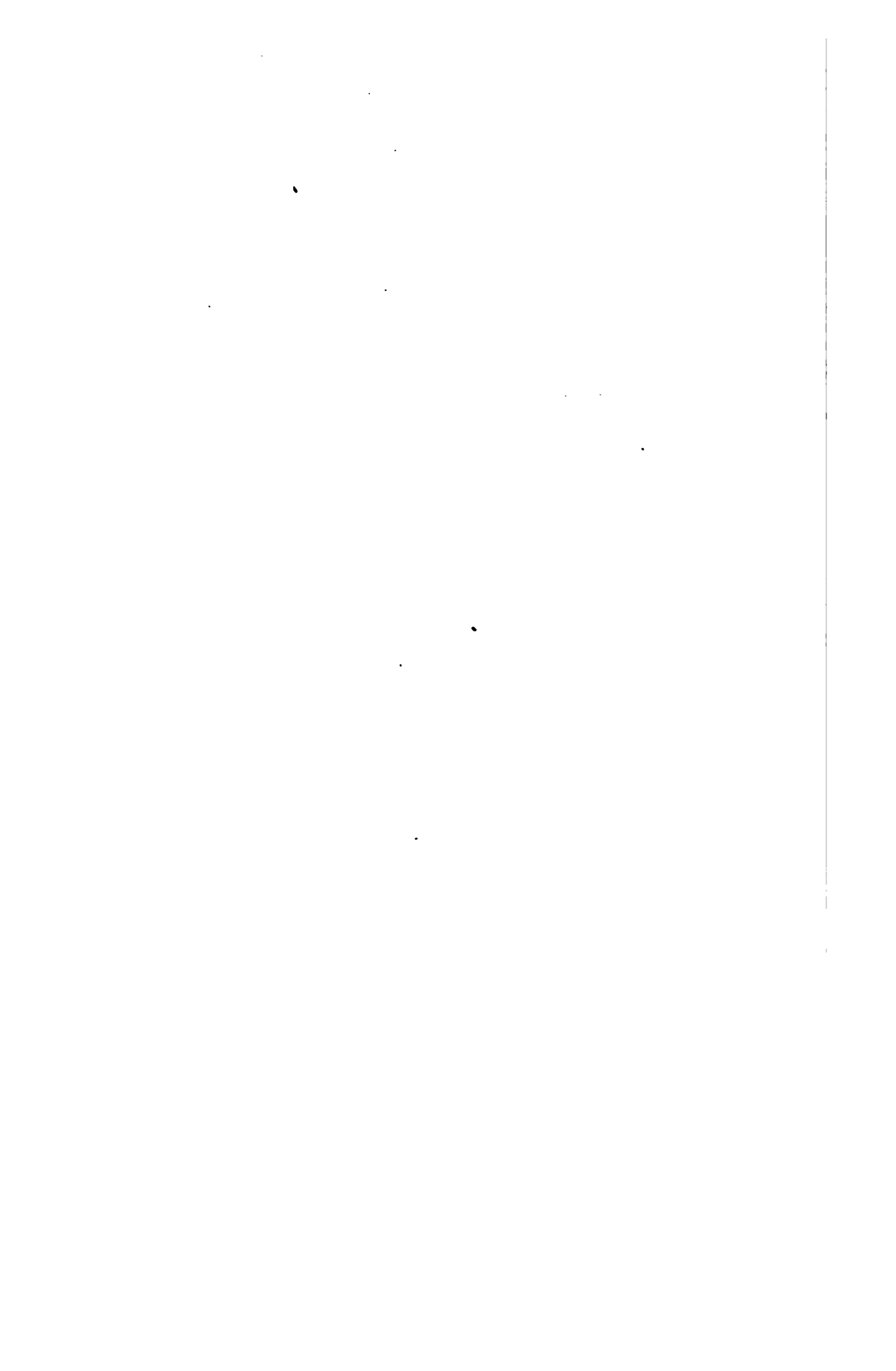

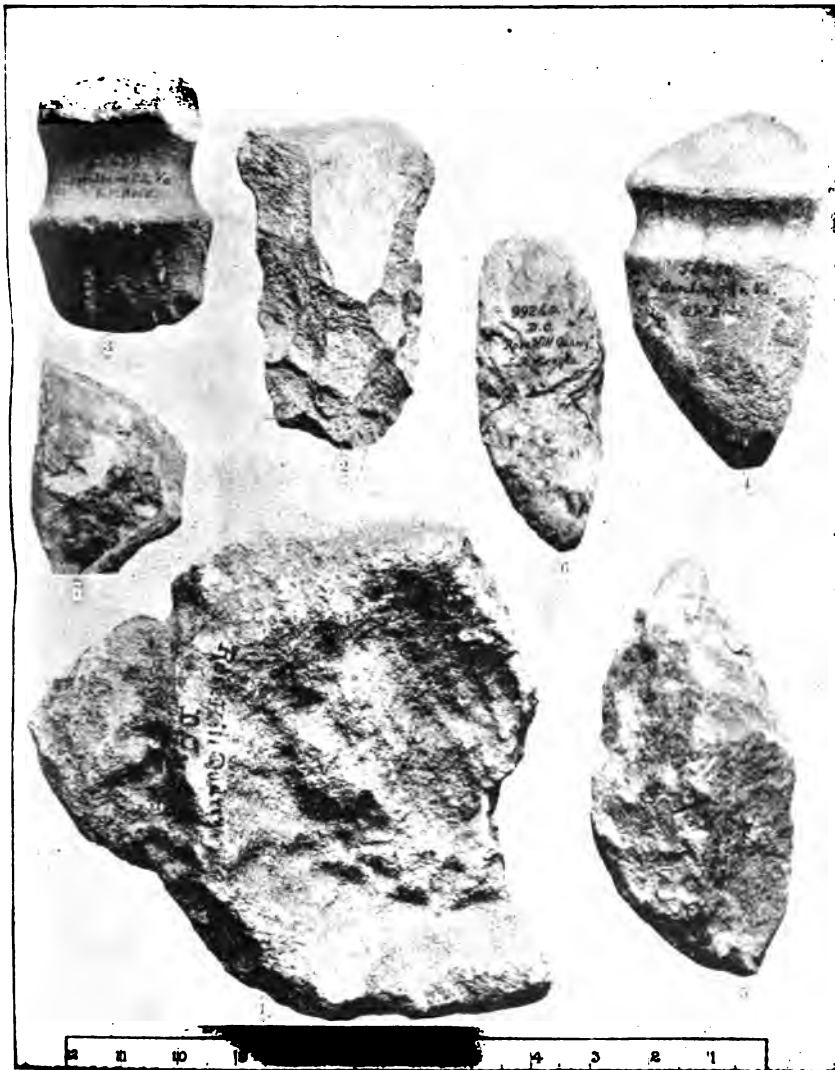

FRAGMENT OF POT-STONE VESSEL AND SPECIMENS OF TOOLS
FOUND IN ABORIGINAL QUARRIES.

1. From District of Columbia. (Cat. No. 99245, U. S. N. M.)
2. From Virginia. (Cat. No. 58426, U. S. N. M.)
3. From Virginia. (Cat. No. 58429, U. S. N. M.)
4. From Virginia. (Cat. No. 58430, U. S. N. M.)
5. From Pennsylvania. (Cat. No. 35485, U. S. N. M.)
6. From District of Columbia. (Cat. No. 99240, U. S. N. M.)

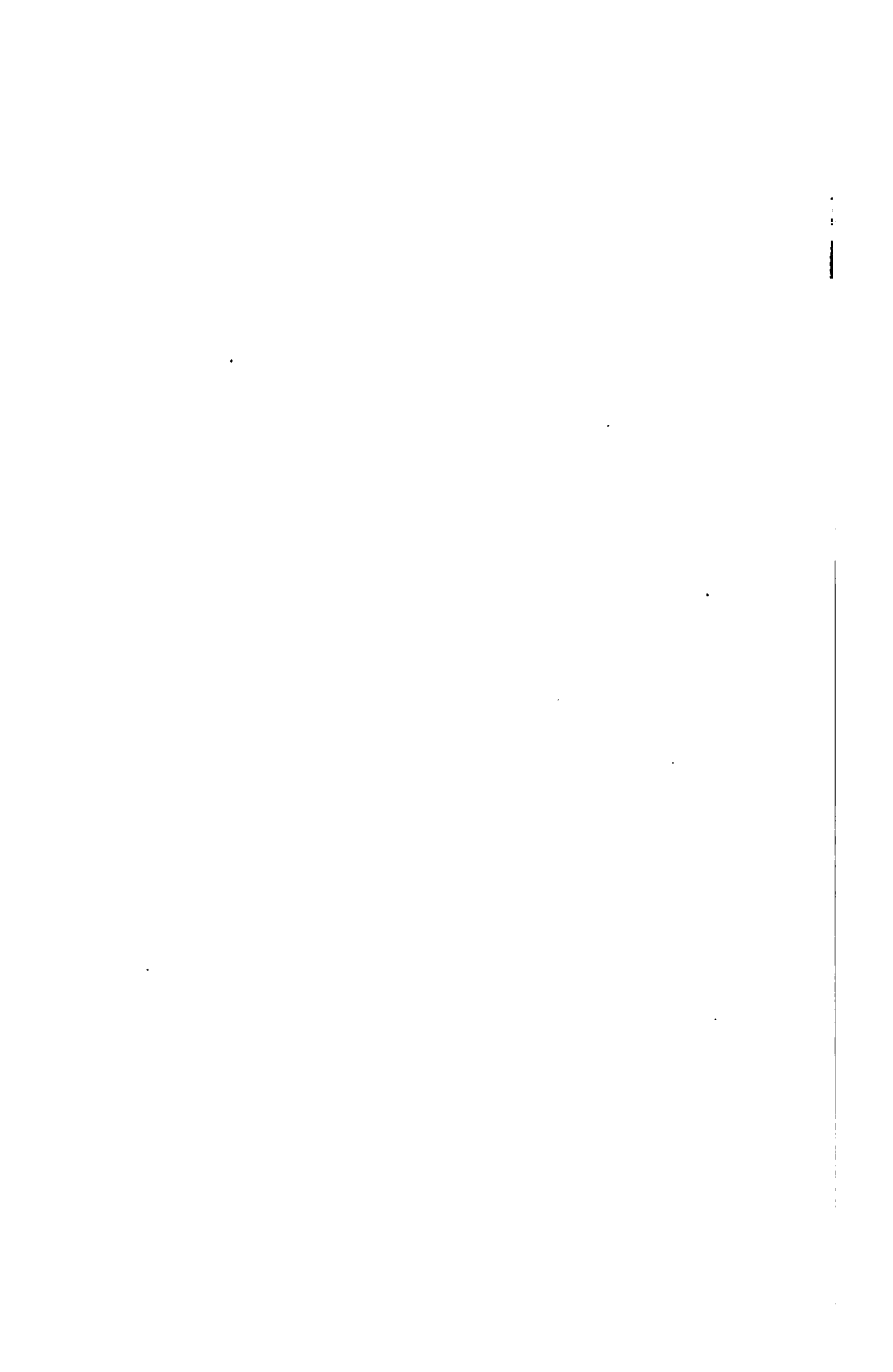

have served to dig out the inside of the bowl, to which they seem adapted, and which the marks shown on Fig. 1 would seem to identify.

Steatite has been found in quarries on the Atlantic slope from Massachusetts to Georgia, while in the interior only the completed utensils have been found and no quarries.

PRESENT STATE OF THE COLLECTION.

Brought forward from last year	107,810
Specimens received during the year.....	8,369
Specimens sent in exchange	529
	7,841
Total number of specimens in the collection	115,651
Last entry June 30, 1888, catalogue number	139,619
Last entry June 30, 1889, catalogue number	141,016

ARCHÆOLOGICAL SPECIMENS SENT FROM THE U. S. NATIONAL MUSEUM IN EXCHANGE DURING THE YEAR ENDING JUNE 30, 1889.

To Signor Joseph Belucci, Perugia, Umbria, Italy.

Character of specimens.	Number of specimens.
Arrow and spear points.....	57
Diak-shaped implement.....	1
Polished celt.....	1
Grooved ax	1
Hammer-stones	2
Pitted stone.....	1
Mortar, from California	1
Pestle, from California	1
Shell beads, from California..... strings..	3
Glass beads, from California	1
	69

To the Cincinnati Museum of Natural History, Cincinnati, Ohio.

Mortar, from California	1
Pestle, from California	1
Rubbing-stone for metate, from California	1
Pierced club-head, from California	1
Small bowl (serpentine), from California	1
Shell and glass beads, from California	2
Glass beads, from California	1
Shell beads, from California	5
Shell beads, from California	1
Shell pendants (Haliotis), from California.....	3
Metate and rubbing-stone, from Pueblo Indians in New Mexico and Arizona	3
Grooved hammer-stones, from Pueblo Indians in New Mexico and Arizona	4
Paint mortar, from Pueblo Indians in New Mexico and Arizona	1
Stone used in smoothing pottery, from Pueblo Indians in New Mexico and Arizona.....	2
Grooved hammer-stone, from Pueblo Indians in New Mexico and Arizona.....	1
	28

To A. E. Douglas, American Museum of Natural History, Central Park, New York City.

Character of specimens.	Number of specimens.
Rude implements (paleolithic)	1

To Prof. Henry H. Giglioli, Royal Zoological Museum, Florence, Italy.

Arrow and spear points	50
Hammer-stone	1
Pestles	2
Pitted stone	1
Polished celts	4
Grooved axes	3
Notched slinkers	2
Gaming disk	1
Scrapers	4
Perforators	2
Knives, etc.	6
Mortar, from California	1
Pestle, from California	1
Rubbing-stone, from California	1
Pierced club-head, from California	1
Shell beads, from California	3 strings
Glass beads, from California	1 do.
Pot-stone vessel, from California	1
Metate, from pueblos in New Mexico and Arizona	1
Rubbing-stone, from pueblos in New Mexico and Arizona	2
Grooved hammer, from pueblos in New Mexico and Arizona	2
Stone for smoothing pottery, from pueblos in New Mexico and Arizona	4
Grooved maul, from pueblos in New Mexico and Arizona	1
	104

To Louis Guesde, Pointe-à-Pitre, Guadeloupe, West Indies.

Arrow or spear points	12
Grooved ax	1
Polished stone hatchet	1
Pestle	1
	15

To T. G. Jones, St. Clair, Pennsylvania.

Arrow or spear points	25
-----------------------------	----

To Wm. H. McGinnis, Youngstown, Mohoning County, Ohio.

Arrow or spear points	34
-----------------------------	----

To Dr. T. Millspaugh, Kendall Creek, McKene County, Pennsylvania.

Character of specimens.	Number of specimens.
Arrow or spear points	6

To William Ranson, Fairfield, Hitchin, Hartfordshire, England.

Arrow or spear points	24
Hammer-stone	1
Grooved ax	1
Polished celt	1
Notched sinker	1
Pestle	1
Rubbing-stones	2
Paint mortar	1
Scraper	1
Shell beads	1
..... string	1
	<hr/> 34

To W. W. Worthington, Shelter Island, New York.

Arrow or spear points	25
Pestle	1
Polished stone hatchet	1
Rubbing-stone	1
Grooved hammer	1
	<hr/> 29

To S. H. Zahm, Lancaster, Pennsylvania.

Rude implements	20
-----------------------	----

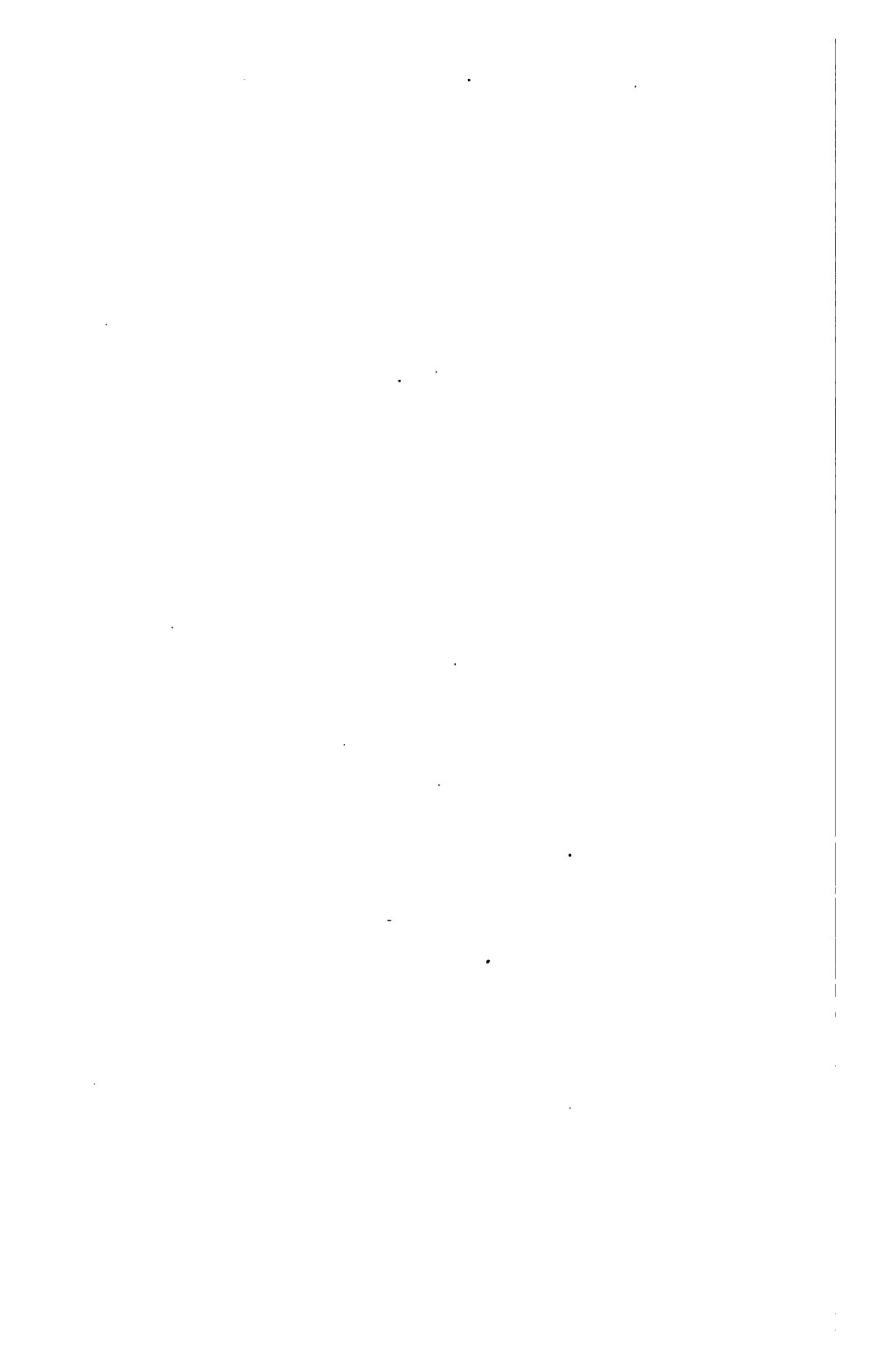

REPORT ON THE SECTION OF AMERICAN ABORIGINAL POTTERY
IN THE U. S. NATIONAL MUSEUM, 1889.

By WILLIAM H. HOLMES, *Honorary Curator.*

Little work has been required in this section beyond the reception and installation of new accessions. The collections and additions for the year fall considerably short of those of preceding years. Through our official collectors, chiefly agents of the Bureau of Ethnology, 532 specimens have been received. Through purchase we have 151, and through donation 355.

Among the more important collections are donations of pottery from a mound near Lake Apopka, Florida, by Dr. Featherstonehaugh, and of pottery from a mound on Perdido Bay, Alabama, by Mr. F. H. Parsons. The latter collection is one of the most important ever received from the Gulf coast.

Researches connected with this section made by the curator were limited to a study of the pottery of the Potomac tide-water region. A paper upon this subject will appear in the July number of the *American Anthropologist*.

The last catalogue number in June, 1888, is 134497, in June, 1889, 135131.

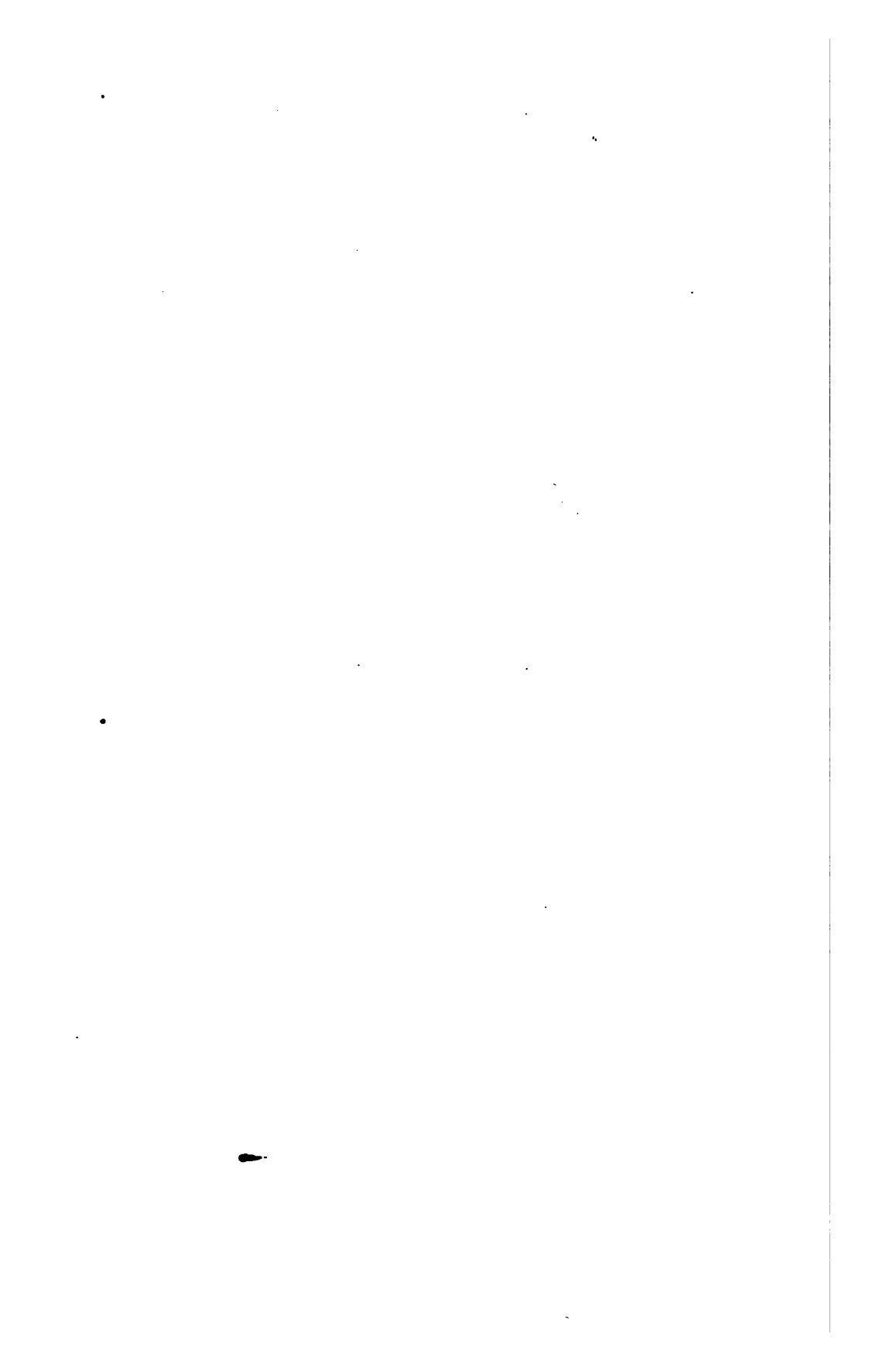

REPORT ON THE SECTION OF FORESTRY COLLECTIONS
IN THE U. S. NATIONAL MUSEUM, 1889.

By B. E. FERNOW, *Honorary Curator.*

The establishment in April of this year of a section of forestry collections in the National Museum is an event, significant in so far as it recognizes the existence of forestry as an art worthy of representation in a museum. I believe that there is no such special section to be found in any other great museum of the world, and my report may therefore properly consist in the justification of this new branch of museum work, a brief outline of what such forestry collections should contain, and how they are to be classified.

Forestry is an art in the same sense as agriculture, and comprises all that part of human activity which concerns itself with the production of timber and the management of the artificial or natural forest as a crop, or for its beneficial influences upon other conditions of life.

The basis of all forestry is of course the growth of trees. Yet its sphere must not be confounded or mixed up with that of the horticulturist, or the orchardist, or the landscape gardener, who use trees for ornamental purposes or for their fruit. The aim as well as the methods of the forester are distinct from those of these other branches of arboriculture, and the scope of forestry is as distinctive.

Forestry may be said to be the latest art invented by human intelligence, and practiced only by fully civilized people with reference to the use of the soil; and its development and extent of application may be fairly considered as a measure, if not of the intellectual, yet, of the cultural development of a country.

With the growth of population grow the demands on the products of the soil, and the most profitable use of soils for the production of food and for other necessities—the relegation of the soil to proper uses—becomes the problem of a nation which lives and progresses intelligently.

We find, therefore, in the most densely populated regions the cultural arts most highly developed; and in a country like Germany, it is only wise and providential policy with regard to the use of the soil, which makes the subsistence of an ever-increasing population on a con-

fined and naturally not overproductive area possible. Agriculture and forestry are practiced there on the most scientific methods.

Besides the production of useful material for the arts, there has been more or less distinctly recognized from olden times, a certain connection of forest growth with climatic, water, and soil conditions. Lately this assumed or observed connection has been subjected to scientific scrutiny, and while in some respects the claimed influences have not yet been quantitatively determined, or as in the case of the influence on rain-fall even qualitatively defined, yet the most advanced students of the question of forest influences are agreed upon the existence of certain mechanical influences which a forest cover may exercise upon the seasonal flow of water, upon local conditions of atmospheric and soil humidity, and upon all local and climatic hygienic conditions which are determined by the atmospheric movements in the lower strata, and upon which the mechanical barrier of a forest belt must naturally bear.

The forest, then, has an interest to man both for the valuable material it furnishes and for its bearing upon conditions of life hydrologic, climatic, cultural, hygienic, and ethical; this last influence is by no means to be underrated in the life of a nation.

In our own country the recognition of the value of this natural resource, the forest, is only just dawning. We are only just realizing that under the clearing for agricultural land, and under the drain for wood and lumber—which now represent an annual product valued at over one billion dollars—and under careless destruction by fire, and the absence of all application of the art of forestry, the natural forests are being decimated at a rapid rate; no regard being paid to future requirements, no regard to the disturbances which begin to make themselves felt here and there in water-flow, and to other conditions produced by the removal of their protecting cover.

The tree-planting on the Western wind-swept plains, scanty indeed when compared with the large area in need of such protection, is almost the only sign of intelligent appreciation of the value of forest growth. A beginning has been made to remedy matters, which in a country with our institutions, must consist mainly, in the first place, in educating the masses.

This educational work is carried on by associations, by the press, by the Forestry Division in the United States Department of Agriculture; and now the National Museum, which with its object lessons is the great educator of the people, joins these forces by making the subject of forestry a part of its exhibits. The reasons, then, for forestry exhibits and the justification of instituting a separate branch of forestry collections in the Museum are:

(1) The importance and singleness of the art of forestry being separate in its aims and methods from all other arts and industries:

(2) The absence of an appreciation of the value and character of forestry in our country, which calls for the education of the people ;

(3) The value of object lessons in educating the people, which is the main function of the Museum.

While other art exhibits of the Museum are more in the nature of a record of that which has been accomplished, and serve to show the progress of the art through the various stages of its development, and incidentally to serve the educational object of furthering general and special knowledge in the respective branches, I conceive the object of forestry collections at present to be principally educational. Forestry, as an art, being hardly yet known in our country, the exhibits will have to lead up to the art by making known its aims and needs, and by facilitating an acquaintance with the objects upon which it is to be exercised—the forest and its component parts ; also by exhibiting the experiences and practices of other countries, in order to stimulate the application of the art in our own country. The sequence in which, therefore, the exhibits are to be secured, will have to be with reference to their educational value in the direction outlined.

RANGE OF FORESTRY COLLECTIONS.

To define and circumscribe the range within which forestry collections ought to be kept, it will be well to find the fields on which it borders, from which it borrows, and upon which it works.

Other museums, like that at Kew, have a branch of economic botany ; a part of this field must be occupied by forestry collections. Forest botany is a branch of economic botany, and forms naturally also an object of forestry collections ; and such branches of physiological botany as apply to tree-growth belong also in its sphere of representation.

Technology and chemistry, as far as these bear upon the application of wood in the arts, upon the derivation of by-products from wood, upon increasing the durability of wood-material, etc., come under the consideration of the forestry collector, only, however, in so far as they exhibit or influence the quality of the raw material, to produce which, the art of forestry is called into requisition.

While the application of wood in all branches of human art would furnish an endless array of manufactured objects for exhibit, it seems expedient to make use of such exhibits in forestry collections, only so far as they illustrate the capability of the material for a certain class of manufactures.

Machinery and engineering find application in the exercise of the art, and as far as they are used exclusively in the transformation of the raw material of the forest, in the production of the forest crop, or bear upon forestry work in general, they must find representation in forestry collections.

With these limitations in mind, we may propose a preliminary classification of exhibits under the following sections :

A. Relation of forestry to other industries and conditions of life in general.

B. Description of the objects upon which forestry is to be applied and of the raw material.

C. Methods of utilization and application.

D. Methods of production and management.

E. Bibliography and miscellaneous.

Section *A* would serve, so to speak, as an introduction to the subject of forestry. Under it would be classified such exhibits as represent the importance of forests to the industrial and cultural life of the nation, their influence upon soil, water, and climatic conditions, and their ethical value, forest conditions of this and other countries, statistics of supply and demand. The value of the application of forestry upon the natural forest areas, the history of the development of the art in other nations and our own, methods of education, may be exhibited in statistical tables, charts, maps, etc.

Section *B* would represent not only the nature of the material of which our forests are composed, describing the forest trees by botanical specimens, wood-sections, and illustrations (forest-botany), and more especially the economically valuable timbers by slabs and otherwise, but also by maps, charts, and illustrations, the distribution, location, and condition of forest-areas and the distribution of species (forest geography). Photomicrographs and veneer sections will show the structure of the various woods; peculiarities of growth and characteristics of the living tree will be made clear by suitable specimens.

The aim in this section will have to be not to expand too much in the direction of general botany, but to keep in view that forestry deals with vegetable products for a special purpose mainly, and this purpose must guide in the selection and limitation of the exhibit.

The timbers of foreign countries may also be exhibited as far as their knowledge is of interest, as bearing upon the forestal development of our country, or as aiding to make us appreciate our own forest wealth.

Section *C* admits of the greatest expansion, and the limitations above mentioned will have to be specially kept in view in selecting the material for exhibit. Besides the raw material in shape for manufacture and partly manufactured, there may be exhibited such complete manufactures as show the adaptability of certain woods to special uses.

Here will also be exhibited the tools and machinery (in models, etc.) of the lumberman and the wood-worker, as far as they belong to the history of harvesting the crop and shaping it for the market.

The methods of obtaining the so-called by-products of the forest, such as tan bark, turpentine, charcoal, and the various products of distillation, also cellulose and wood-pulp manufacture; processes for seasoning and preserving timber, etc., must be represented in this section.

The exhibits for Section *D* represent forestry proper, and, since forestry is hardly yet practiced in this country, will at first have to be

largely composed of material obtained from foreign countries where the art of forestry is practised, representing the tools used in forest planting, the maps and plans used in forest management, graphic illustrations of rates of growth, and the methods and instruments employed to measure them; instruments used in thinning, pruning, and the results of these operations on the growth. Methods of protecting against insects, methods of reforestation as used to guard against landslides and torrents; a seed collection, specimens of plant material, a root herbarium belong also in this exhibit.

Section *E* would contain whatever of passing interest and curiosity, not at present otherwise classified, may fall into the province of forestry, and, further, such collection of reference literature, reports, maps, charts, photographs, as will aid the student to understand the relation of forests and forestry to human life, and show its history and development as an art.

The short time since my appointment and other duties have prevented the installation of any exhibits, excepting one. This consists of a series of thirty photolithographs from the work of the French forest administration, illustrating the effects of deforestation in the Alpine districts of southeastern France, and the methods applied to counteract the torrential action thus produced; two statistical tables give in briefest manner an idea of the forestry interests of the United States; two half-sections of Sitka Spruce from the northwest (228 years old and 7 feet in diameter) show the rapidity and immense dimensions of the growth in that section; while a historic chart adapted to a section of Tulip Poplar (5 feet in diameter) from the Mississippi Valley brings to the mind of the beholder by referring the annual ring-growth to historical data, the long periods of time which are required to produce our forest giants in the East and which form the basis of calculation in the art of the forester. The whole exhibit, placed on one panel 14 by 12 feet, is designed to create in the mind of the visitor the first interest in the subject of forestry and in the forestry collections to come.

The material on hand has not yet been classified, except superficially. It consists of parts of exhibits which have served in various expositions, and, while forming a valuable nucleus for the collections, is far from being exhaustive in any one direction. Through the co-operation of the Department of Agriculture, and especially of its Forestry Division, it is hoped that the collections will soon be sufficiently ample to justify their installation.

REPORT ON THE DEPARTMENT OF MAMMALS
IN THE U. S. NATIONAL MUSEUM, 1889.

By FREDERICK W. TRUE, *Curator.*

At the opening of the last fiscal year the preparations for the Ohio Valley Centennial Exposition, which had occupied the month of June, were nearly completed. A number of matters, however, still demanded attention, and the exposition work was not entirely off our hands until a month later. Early in the fall the Curator was called upon to assist in the routine work of the Assistant Secretary's office. For this reason, and also because for a considerable part of the time the Chief Taxidermist was occupied by special work, outside of his regular duties, the progress made in the department during the year was not so great as it would have been under more favorable conditions.

The exhibition series received more important additions than, perhaps, during any other year. The collection contains representatives of a larger number of families of mammals than ever before. A portion of these specimens were received in exchange, others were purchased, and the remainder originally formed a part of the series exhibited in the Cincinnati Exposition.

The groups of prairie dogs and opossums, the first of a series intended to represent the smaller forms peculiar to North America, were placed in new, specially designed, cases. The series of casts of Cetaceans, which forms a special feature of the collection of the Museum, was renovated and completed.

Attention was directed afresh to the matter of providing better storage-cases for the study-series. New arrangements were made necessary, especially by the fact that the Bureau of Economic Ornithology and Mammalogy of the Department of Agriculture, had agreed to deposit in the Museum its valuable collection of North American mammals. The new cases are not completed at this date, but it is expected that they will be in use within a few months.

Among the accessions of the year are many interesting specimens. Two specimens of the rare Florida muskrat, *Neofiber alleni*, were presented by William Wittfield, esq. Mr. Loren W. Green presented a series of excellent skins of the northern variety of *Tamias striatus*, col-

lected at Charlestown, New Hampshire. A second specimen of *Vespertilio longicrus* was received from Judge J. G. Swan. Col. Cecil Clay obtained after much exertion, and presented to the Museum, the skin of a full-grown male moose. It is intended that this individual shall be included in the group of moose now in course of preparation. A small male deer, believed to be *Cariacus gymnotus*, was presented by the Philadelphia Zoological Society, through Dr. A. E. Brown. This is the third individual of this species received from the Society.

Of exotic mammals the most important, so far as the exhibition series is concerned, were the monkeys and lemurs, twenty-nine in number, purchased from Messrs. H. A. Ward, E. Gerrard, and Dr. J. Büttikoper. The species were all new to the collection. Among the lemurs were several of the most important and most attractive species of *Propithecus*. A considerable collection of European bats, *Vesperugo kuhlii*, *Vespertilio nattereri*, etc., were received from Dr. Senna Angelo in exchange for American species.

From the Royal Zoological Museum, Florence, were received in exchange a skin of *Ovis musimon*, a skeleton of *Monachus albiventer*, and a number of European bats.

Dr. Birt collected in Graytown, Nicaragua, a number of interesting specimens, including the Spiny rat, *Echinomys semispinosus*, a form not hitherto obtained in Central America. It is a representative of the *Octodontidæ*, a family usually considered strictly South American.

Of aquatic mammals the most important accession during the year was a fresh male specimen of Sowerby's whale, *Mesoplodon bidens*, which was captured by the crew of the U. S. life-saving station at Atlantic City, New Jersey (Capt. J. L. Gaskell, keeper). This is the second specimen ever taken in American waters and the first fresh specimen ever seen by American naturalists.

Among the collections made by the naturalists of the U. S. Fish Commission Steamer *Albatross*, during a cruise around Cape Horn, were a few South American mammals. The most important specimens received were the skeleton of a porpoise, *Prodelphinus longirostris*, obtained between Panama and the Galapagos Islands, and several skins of the sea-lions of the Galapagos Islands. Two mounted skins of the West Indian seal, *Monachus tropicalis*, were received from Prof. H. A. Ward in exchange.

As must necessarily be the case each year, the routine work which occupied the most time was the identification, cataloguing, and labeling of accessions. A new card-catalogue was made of the skins which have accumulated in the tanks in the taxidermist's shop. When specimens are mounted or distributed the cards corresponding to them are removed from the catalogue, and it is always possible therefore to determine what material is really in the hands of the taxidermist. A large number of alcoholic specimens were measured preparatory to being converted into dry skins, but for the reasons already given the taxidermists were unable to begin work upon them.

The matter of providing new storage-cases for the study-series was brought to a head by the offer on the part of the Bureau of Economic Ornithology and Mammalogy of the Department of Agriculture, to deposit its collections of North American mammals in the Museum, if suitable cases for their reception were provided. It was finally decided to adopt metallic cases for the entire study series. Two large zinc-storage cases and a smaller tin case were obtained in Cambridge, Massachusetts, for trial. As a further experiment one compartment in the large storage base in the Osteological hall was lined with zinc and furnished with a dust-tight front, and one of the three-quarter unit tables in the south hall was also made dust-proof. These have proved very satisfactory during the short time that they have been in use, and the Curator has recommended that all the bases in the exhibition hall of the department be remodeled in the same manner. The drawers in the large metal-lined compartment already referred to are four times as large as the ordinary unit drawers in general use in the Museum, and are admirably suited for the storage of large skins.

Considerable attention has been paid to the matter of providing a substitute for the large tin-lined copper tanks which have hitherto been used for the storage of alcoholic specimens of large size. These tanks, besides being expensive, are constantly deteriorating, on account of the fact that the acetic acid and other impurities in the alcohol dissolve the tin linings and attack the copper walls of the tanks. As a result, the tanks soon begin to leak, and the hair and bones of the specimens preserved in them are dyed green by the salts of copper in the alcohol. Inquiries have been made as to whether earthenware jars of suitable form and size could not be obtained in the market. Thus far, however, nothing suitable has been found, some of the jars offered being of too heavy weight, others too expensive, and others still coated with glazes which might be dissolved by alcohol. It will probably be found necessary to have jars manufactured, which shall be of a form and quality especially adapted for the uses of the Museum.

A considerable amount of re-arrangement was made necessary in the exhibition hall after the return of the collection exhibited in Cincinnati. The cases now in the hall are not sufficient for the exhibition of the entire collection, and a small number of new ones are greatly needed. Special cases for the groups of opossums and prairie-dogs were made during the year, and the groups were placed in them. Temporary bases for Steller's sea-lion and the walrus were made prior to the 4th of March, in order to secure these specimens from injury at the hands of the crowds of visitors who were in the Museum at that date. A new case for the elephant "Mungo" was placed in the hall, but has not yet been brought into use. I regret to state that this case was considerably injured by visitors on the 4th of March, in spite of the efforts of the watchmen to protect it. Plans were made for arranging the collection of deers' antlers on the tiers at the north end of the exhi-

bition hall, but after due consideration the scheme was abandoned on account of the expense involved.

The series of cetacean casts, a considerable number of which had been more or less damaged by being moved from place to place and shipped to different exhibitions, was entirely renovated, and, except in the case of two large species, new casts were made from all the molds that had not previously been used. The series as thus completed consists of twenty-seven casts. Casts of the Grampus and of Sowerby's whale remain to be added. It is intended that large painted labels shall be provided for the series in the immediate future.

As already stated, a large number of important species were added to the exhibition series during the year. No list of additions was given in last year's report, and the present one has, therefore, been made to cover the past two years.

- Gorilla, *Gorilla savagei*.
 Chimpanzee, *Anthropopithecus troglodytes*.
 Siamang, *Hylobates syndactylus*.
 Hoonuman Monkey, *Semnopithecus entellus*.
 Siam Monkey, *S. siamensis*.
 Ashy Monkey, *S. albocinctus*.
 White-throated Capuchin Monkey, *Cebus capucinus*.
 Black-eared Marmoset, *Hapale penicillatus*.
 Pinche Marmoset *Midas edipus*.
 Ruffed Lemur, *Lemur varia*.
 Slow Lemur, *Nycticebus tardigradus*.
 Short-tailed Lemur, *Indris brevicauda*.
 Smith's Dwarf Lemur, *Chirogaleus smithii*.
 Weasel Lemur *Lepilemur mustelinus*.
 Edwards' Lemur, *Propithecus edwardsii*.
 Black Lemur, *Propithecus holomelas*.
 Diadem Lemur, *Propithecus diademata*.
 Decken's Lemur, *Propithecus deckenii*.
 Thick-tailed Galago, *Galago crassicaudatus*.
 Rufous Lemur, *Lemur collaris rufus*.
 Woolly Lemur, *Arahis laniger*.
 Aye Aye, *Chiromys madagascariensis*.
 Marbled Cat, *Felis marmorata*.
 Tigine Cat, *Felis mitis*.
 Javan Cat, *Felis javanensis*.
 Spotted Bay Lynx, *Lynx maculatus*.
 African Genet, *Genetta poensis*.
 Binturong, *Arctictis binturong*.
 Hardwick's Hemigale, *Hemigalea hardwickii*.
 Goudot's Eupleres, *Eupleres goudoti*.
 Two-spotted Paradoxure, *Nandinia binotata*.
 Levallant's Cynictis, *Cynictis penicillata*.
 Aard Wolf, *Proteles cristatus*.
 Cape Hunting-Dog, *Lycan picta*.
 Coyote, *Canis latrans* (group of three specimens).
 African Ratel, *Mellivora capensis*.
 Cat-squirrel, *Bassaris astuta*.
 Panda, *Ailurus fulgens*.
 West Indian Seal, *Monachus tropicalis* (two specimens).
 Tree Coney, *Dendrohyrax arboreus*.
 Indian Rhinoceros, *Rhinoceros indicus*.
 Bison, *Bison americanus* (Group of six specimens).
 Ibez, *Capra ibex*.
 Rocky Mountain Sheep, *Ovis canadensis*.
 Rocky Mountain Goat, *Mazama montana* (three specimens).
 Prong-horned Antelope, *Antilocapra americana* (group of four specimens).
 Water Buck, *Kobus vingsing*.
 Harnessed Antelope, *Tragelaphus scriptus*.
 Bontebok, *Alcelaphus pygargus*.
 Equine Antelope, *Hippotragus equinus*.
 Japanese Goat Antelope, *Nemorhedus crispus*.
 Beisa Antelope, *Oryx beisa*. (Head.)
 Spike-horned Deer, *Cariacus claratus* (two specimens; types).
 Naked-eared Deer, *Cariacus gymnotis*.
 Red Deer, *Cervus elaphus*.
 Barren Ground Caribou, *Rangifer tarandus caribou*.
 Llama, *Auchenia glama*.
 Indian Chevrotain, *Memmina indica*.
 Golden Mole, *Chrysochloris* sp.
 Tenrec, *Centetes caudatus*.
 Spiny Ericulus, *Ericulus setonus*.
 Jumping Shrew, *Rhynchocydon cirnei*.
 Tuna, *Tupaia tuna*.
 Horseshoe Bat, *Rhinolophus hipposideros*.

Patagonian Cavy, <i>Dolichotis patagonicus</i> .	Borneo Flying Squirrel, <i>Pteromys nitidus</i> .
Chinchilla, <i>Chinchilla laniger</i> .	Red Squirrel, <i>Sciurus hudsonius</i> .
Visacha, <i>Lagostomus trichodactylus</i> .	Malabar Squirrel, <i>Sciurus maximus</i> .
Cuvier's Chinchilla, <i>Lagidium cuvieri</i> .	Indian Hill-Squirrel, <i>Sciurus macrurus</i> .
African Porcupine, <i>Hystrix cristata</i> .	Jeleraug Squirrel, <i>Sciurus bicolor</i> .
Coypu, <i>Myopotamus coypu</i> .	Grizzled Squirrel, <i>S. punctissimus</i> .
Cape Jumping Hare, <i>Pedetes caffer</i> .	Fox Squirrel, <i>Sciurus niger</i> .
Great Rodent Mole, <i>Bathyergus maritimus</i> .	Prairie-Dogs, <i>Cynomys ludovicianus</i> (group of four specimens).
Norway Rat, <i>Mus decumanus</i> .	Common Dolphin, <i>Delphinus delphis</i> .
White-tailed Rat, <i>Brachytaromys albicauda</i> .	Spotted Dolphin, <i>Prodelphinus plagiodon</i> .
South African Dormouse, <i>Graphiurus capensis</i> .	Aard Vark, <i>Orycteropus capensis</i> .
Common Dormouse, <i>Myozus glis</i> .	Giant Armadillo, <i>Priodon gigas</i> .
Taguan Flying Squirrel, <i>Pteromys petaurista</i> .	Tree Kangaroo, <i>Dendrolagus ursinus</i> .
	Opossum, <i>Didelphys marsupialis</i> (group of seven specimens).

As no statement of the character of exhibits prepared by this department for the Cincinnati exhibition was included in last year's report, it is perhaps, desirable that a brief account of the same should be given in this connection. After a number of plans had been considered, it was decided that a series representing all the existing families of mammals would be of more general interest, and would indicate more nearly the educational side of the work of the department, than any other collection which could be prepared in the time allotted. A number of families were unrepresented in the regular exhibition series of the Museum, but it was found possible to purchase representatives of many of them from the dealers in natural history specimens. A few were unrepresented, except by pictures. The real excellence of the collection as a whole is indicated by the fact that out of the eighty-eight families recognized, seventy-five were represented by from one to fourteen typical species. The whole number of mounted skins exhibited was one hundred and twenty-two, and of skeletons fifty-nine, making a total of one hundred and eighty one. Among these were some of the largest species, such as the fin-back whale, rhinoceros, elephant, tapir, gorilla, narwhal, walrus, black bear, etc. The Prong-horn antelope was represented by the admirable group executed by Mr. Hornaday, and now in the Museum. Specimens of two important forms, the Fur-seal and the Saiga antelope were loaned respectively by Prof. H. A. Ward and Dr. G. E. Manigault. The families of which representatives could not be obtained, such as those including the Ganges dolphin, the fousa, the giraffe, etc., were represented by pictures.

The collection was installed in a special case 145 feet long, 3 feet wide, and 6 feet high (without the base), which was constructed in Washington and transported to Cincinnati for the exhibition. The rhinoceros and the group of Prong-horn antelopes were placed in special cases, while the skeleton of the finback whale and the narwhal were, after much labor, suspended from the roof of the building. The collection was arranged by the Curator, who went to Cincinnati for that pur-

pose. He was assisted by Mr. W. Harvey Brown. All the specimens were labeled in the same manner as in the Museum, and the family-divisions were also indicated by large labels. At the request of the Director of the Museum, a special guide to the collection was furnished by the Curator, in which a brief account of the zoological affinities, habits, and geographical distribution of all the species was given.

The Curator has completed during the year his preliminary examination of the species of dolphins, and has read the proofs of a review of that group, forming Bulletin No. 36 of the Museum series. He has examined all the species of *Cariacus* and *Coassus* in the collection, in the hope of finding trenchant characters whereby to distinguish these two groups of deer. In this connection he has prepared for publication a description of a new species of spike-horned deer from Central America, *Cariacus clavatus*, a number of specimens of which were detected in the Museum collection. He has also prepared for publication an account of the collections of mammals made by Mr. Charles H. Townsend in Honduras, and by Doctor Birt in Nicaragua. The former collection contained an undescribed subspecies of *Capromys*, *C. brachyurus thorcatus*, from Little Swan Island.

The Curator furnished a greater or less amount of technical information on a variety of subjects, to a considerable number of correspondents of the Museum. He corresponded with A. H. Cocks, Esq., of Thames Bank, England, and Mr. E. Pierce, of New Bedford, regarding a harpoon of American manufacture taken from a whale captured on the coast of Finmarken. To Mr. C. L. Richardson, of the Soldiers' Home, Kansas, he communicated such facts as are at command regarding breeds of solid-hoofed hogs. Mr. George H. Ragsdale, of Gainesville, Tex., received certain information regarding the mammals of that region, and Dr. R. W. Shufeldt, regarding the mammals of New Mexico.

Correspondence was also had with Dr. W. L. Abbott, who has forwarded to the Museum a considerable collection of mammals made by himself in the vicinity of Mount Kilima-njaro, East Africa.

The receipt of a skull of a narwhal with two tusks, and of a fresh specimen of Sowerby's whale, was the occasion of an examination of the literature relating to those two species of whales. The facts regarding both were communicated to the Biological Society of Washington by the Curator.

Dr. C. H. Merriam has made extensive studies of the arvicoline mice in the collection of the department, as well as of other groups of North American mammals.

The general condition of the collection as regards preservation, may be considered on the whole satisfactory; that of the exhibition series is entirely so. The mounted specimens have not suffered in the least from the attacks of insects for a number of years. The exhibition cases, if not absolutely dust-proof, are approximately so, and can undoubtedly be made perfectly tight after a little more experimentation.

The same, unfortunately, can not be said of the storage cases. As stated in previous reports they are neither sufficient in number nor satisfactory in kind. As arrangements have now been made, however, for providing better cases, it is unnecessary to repeat the previous recommendations regarding this very important matter.

The condition of the collection of specimens in alcohol is fairly satisfactory. The specimens deteriorate to a certain extent in spite of our best efforts. For perfect preservation they should be placed in bottles which can be sealed with paraffine or wax. It is best that the collection should be reduced in size, but in order to convert a portion of the series into dry skins it would be necessary to divert the attention of the taxidermists from the work of mounting groups, which would be inadvisable. The skins might perhaps be made at the least expense by contract with outside parties.

The number of specimens in the different series on June 30, 1889, was as follows :

Number of mounted skins in the exhibition series.....	745
Number of skins in the study and duplicate series.....	4557
Number of specimens in alcohol	3084
Received during the year :	
Skins *	192
Specimens in alcohol.....	35
Skeletons	44
Skulls	151

The first entry made in the catalogue of skins on July 1, 1888, was under No. 16,237; the last on July 30, 1889, was under No. 16,870.

In the catalogue of skeletons and skulls the first entry, July 1, 1888, was under No. 22,999; the last, No. 23,781.

Of the mammals deposited by the Bureau of Economic Ornithology and Mammalogy, Department of Agriculture, the number of skins and alcoholic specimens entered was 382; of skulls, 358.

* All the skins received during the year, one hundred and ninety-two in number, were accompanied by skulls. The total number of skulls received therefore was 343.

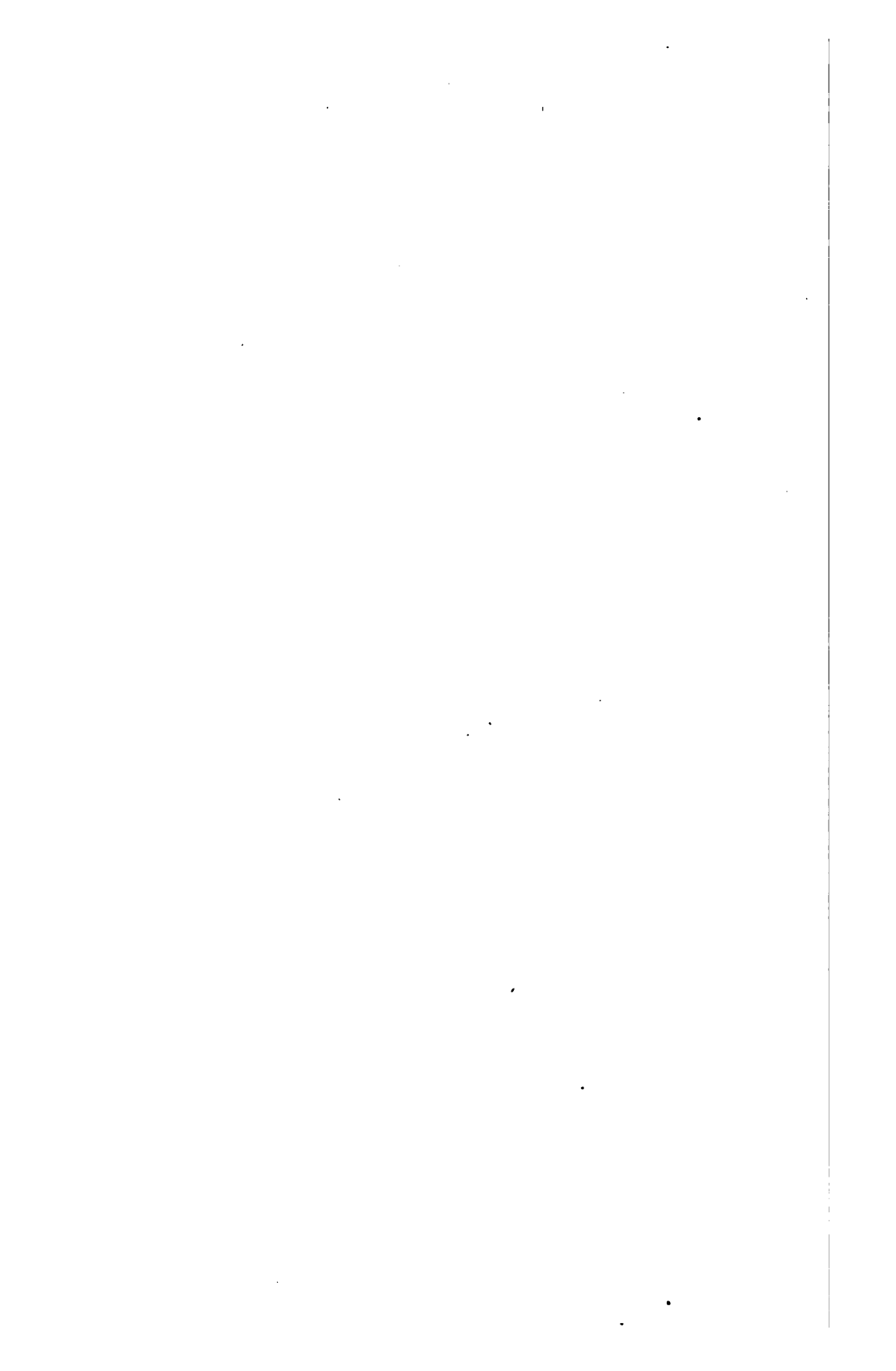

REPORT ON THE DEPARTMENT OF BIRDS
IN THE U. S. NATIONAL MUSEUM. 1889.

By ROBERT RIDGWAY, Curator.

The year's work has not differed materially in its character or scope from that of preceding years, except that the rearrangement, labeling, and general improvement of the exhibition collection was more actively and continuously prosecuted.

There has been an increase over the year 1887-'88 in the number of specimens received and distributed, in correspondence, and in the number of specimens mounted. Owing to progress in the remodeling of the cases, a far greater amount of work has been done in the way of rearranging and labeling the exhibition collection.

The number of entries made in the register of the bird department during the year is 2,971, the principal accessions being as follows:

Auckland Museum, New Zealand, through I. F. Cheeseman.—One *Apteryx oweni*, one *Puffinus carneipes* and a pair of *Hymenolaimus malacorhynchus*, all from New Zealand, the latter species new to the Museum collection. (Exchanged.)

O. T. Baron, Elk, Mendocino County, California.—One Doubleday's humming bird, *Iache doubledayi*, from Mexico. (Purchased.)

A. Boucard, Paris.—8 specimens, 7 species, from various parts of the world, mostly new to the collection. (Purchased.)

George K. Cherrie, New York City.—72 specimens, 29 species, from the neighborhood of New York City. A very acceptable collection of good skins. (Gift.)

W. H. Collins, Detroit, Michigan.—38 specimens, 8 species of water birds in the downy stage, from St. Clair Flats. A very interesting accession, since this plumage of several of these species has hitherto been unrepresented in our collection, some of them being in fact undescribed. (Purchased.)

C. B. Cory, Boston, Massachusetts.—6 specimens, 4 species, from Grand Cayman, and Cayman Brac, West Indies. (Exchanged.)

Costa Rica National Museum, San José, Costa Rica, through Mr. José C. Zeledon.—A male of *Acanthidops bairdi*, from Costa Rica. This species was described by Mr. Ridgway only a few years ago from a single female specimen, and the male has remained unknown until now. But three specimens of this rare bird have been taken as yet. (Gift.)

Costa Rica National Museum, San José, Costa Rica.—56 specimens, 30 species, from Costa Rica. A very valuable accession, including the types of two new species (one a new genus and perhaps new family), besides plumages new to the collection. (Gift.)

Costa Rica National Museum, San José, Costa Rica.—6 specimens, 6 species from

Costa Rica, 5 of which are types of new species, while the sixth, a typical specimen of a recently described species, presented with usual liberality by the National Museum of Costa Rica. (Gift.)

M. Hardy de Dreneuf, Rio Janeiro, Brazil.—3 specimens of the rare Giant Snipe (*Gallinago gigantea*,) from Brazil. (Purchased.)

Royal Zoological Museum, Florence, Italy, through Prof. E. H. Giglioli.—235 specimens, 156 species, all from Italy; a valuable accession, as our collection has been rather poor in Italian specimens. They are moreover carefully labeled. (Exchanged.)

A. Guesde, Guadeloupe, West Indies.—31 specimens, 26 species, from Guadeloupe. (Exchange.)

H. W. Henshaw, Washington, District of Columbia.—196 specimens, 120 species, from North America. (Exchange.)

H. W. Henshaw, Washington, District of Columbia.—23 specimens, 5 species, chiefly from California and Oregon. (Exchange.)

H. W. Henshaw, Washington, District of Columbia.—4 specimens, 4 species, from North America, among them a specimen of *Puffinus puffinus*, from New Brunswick (Exchange.)

Harry V. Henson, Yokohama, Japan.—The type specimen of *Parus palustris hensoni* Stejn. (Gift.)

A. H. Jennings, Baltimore, Maryland.—One specimen Kirtland's Warbler, (*Dendroica kirtlandi*) adult male, from the Bahamas. (Gift.)

P. L. Jouy, Washington, District of Columbia.—651 specimens, 172 species, from Korea, and Tshu-Shima, Japan. This is one of the most valuable and interesting collections ever acquired by the Museum, being, as it is, the result of several years of intelligent collecting in hitherto ornithologically entirely unexplored country. Besides some undescribed forms, the collection contains a number of very rare species represented in but few museums, as for instance *Platalea minor*, *Herodias eulophotes*, *Lanius sphenocercus*, *Otis dybowskii*, *Ciconia boyciiana*, *Puffinus leucomelas*, *Urosphena squamiceps*, *Xanthopygia xanthopygia*, *Erithacus sibilans*, *Galerida corensis*, etc., and last, but not least, a pair of *Pitta nympha*, the first specimens found since Schlegel and Temminck described the species from a Japanese drawing. (Purchased.)

Charles E. Kern, Washington, District of Columbia.—20 specimens, 16 species, from Nicaragua. (Gift.)

Waldemar Knudsen, Kauai, Hawaiian Islands.—2 petrels from Kauai. (Gift.)

Leslie A. Lee, *Thomas Lee*, and *C. H. Townsend*.—187 specimens, 114 species, from Bahia, Brazil; a very valuable and interesting addition to our collection. (Purchased.)

Thomas Marron, National Museum, Washington, District of Columbia.—A Ground Dove (*Columbigallina passerina*) shot at Broad Creek, Maryland, near Washington, October 14, 1888. (Gift.)

Fred. Mather, Cold Spring Harbor, New Brunswick.—Young male and adult female Mandarin Duck, bred in captivity. (Gift.)

Dr. C. Hart Merriam, Washington, District of Columbia.—194 specimens, 127 species, nearly exclusively from the Old World. A very important and valuable collection of well preserved skins, containing many varieties and species new to the Museum. (Exchange.)

Dr. C. Hart Merriam, Washington, District of Columbia.—27 specimens, 14 species, chiefly from the West. (Gift.)

Dr. C. Hart Merriam, Washington, District of Columbia.—2 specimens (male and female) of Bachman's Warbler (*Helminthophila bachmani*) from Sombrero Key, Florida. (Gift.)

G. Frean Morcom, Chicago, Illinois.—A curious goose in the flesh, supposed to be a hybrid between *Chen caerulescens* and *Branta hutchinsi*. (Gift.)

Lieut. J. F. Moser, U. S. Navy, Coast Survey Steamer *Blake*.—10 specimens, 8 species, mostly water birds, from South Florida. (Gift.)

Museum of Oberlin College, Oberlin, Ohio (through L. M. McCormick).—16 specimens, 16 species, chiefly from Africa, and nearly all new to the collection. (Exchange.)

Dr. E. Rey, Leipzig, Germany.—20 specimens, 20 species, from various countries; a very valuable collection containing many species hitherto unrepresented in the Museum, among them the curious terrestrial Jay, *Podoces hendersoni*, from Central Asia, and the large pale *Bubo sibiricus*, from the Altai Mountains in Southern Siberia. (Purchased.)

R. Ridgway, Laurel, Maryland.—11 specimens, 8 species, from Laurel, Maryland. (Gift.)

R. Ridgway, Laurel, Maryland.—86 specimens, 34 species, from Maryland, Virginia, Illinois, and Indiana. (Gift.)

R. Ridgway, Laurel, Maryland.—43 specimens, 33 species, (two accessions) chiefly from Laurel, Maryland. (Gift.)

T. Ringer, Nagasaki, Japan.—109 specimens, 74 species, from Southern Japan. A very interesting addition to the collection of Japanese birds now in the Museum. Among the chief attractions is a fine male of the true Sommering's Pheasant, proving that all the specimens in the Museum believed to be this bird in reality belong to a distinct species, *Phasianus scintillans*. There is also a specimen of the Spoon-billed Sandpiper (*Eurinyornis pygmaeus*). (Gift.)

Lieut. Wirt Robinson, U. S. Army, Fort Adams, Rhode Island.—12 specimens, 7 species, albino Birds from Virginia. (Gift.)

Phs. Rowland, New York City.—9 specimens, 3 species, from North America, viz, 4 Passenger Pigeons, 2 Great Gray Owls, and 3 Arctic Horned Owls, one of the latter mounted. (Purchased.)

Dr. E. W. Shufeldt, Fort Wingate, New Mexico.—One specimen *Cistothorus palustris paludicola*, from Fort Wingate. (Gift.)

Tokio Educational Museum, through Mr. Namiye, Tokio, Japan.—Adult female and young male of *Dryobates namiyei*, the first ones known of this species and yet undescribed. (Exchange.)

Victor Ritter von Tschui zu Schmidhoffen, Hallerie, Salzburg, Austria.—24 specimens, 19 species, from Austria, nicely filling important gaps in our series of European birds; preparation excellent. (Exchange.)

U. S. Fish Commission, (through Col. M. McDonald, Commissioner).—256 specimens, about 112 species, from Santa Lucia, West Indies, and various parts of South America. A very valuable accession, especially as regards the collection made on the Galapagos Islands, some of which not previously visited by naturalists being represented. Among the birds which may be especially mentioned in this connection are the rare Swallow-tailed Gull (*Croagrus furcatus*), of which two fine adults were collected at Dalrymple Rock, these being, respectively, the fourth and fifth examples known to naturalists.

U. S. Fish Commission (through Col. M. McDonald, Commissioner)—96 specimens, 35 species, from Alaska.

U. S. Naval Academy, Annapolis, Maryland—63 specimens, 41 species, of mounted birds, chiefly from Maryland. (Gift.)

Provincial Museum, Victoria, British Columbia (through John Fannin, esq., curator)—27 specimens, 9 species, from British Columbia. (Exchange.)

J. Wallace, New York City—6 specimens, 6 species, nearly all new to the collection, among which is a very rare and interesting parrot (*Dasyptilus pequetii*) from New Guinea. (Purchased.)

Dr. B. H. Warren, West Chester, Pennsylvania—A series of 24 specimens of *Quiscalus quiscula*. (Gift.)

Arthur T. Wayne, Charleston, South Carolina—17 Cross-bills, from McPhersonville, South Carolina. (Purchased.)

J. Grant Wells, Grenada, West Indies—3 specimens, 2 species, of water birds. (Gift.)

Routine work in arrangement and classification of the collection, and in the preparation of the exhibition and study series, has not differed materially in its character from that of the preceding year, but has been prosecuted on a much more extensive scale, owing to the greater facilities provided in the way of new cases, additional labels, etc.

Specimens have been systematically arranged and labeled in twelve "door-screen" cases, two wall cases and adjoining sides of two adjacent cases. These cases include the following exhibits:

- (1) Birds of literature (European) with appropriate special labels.
- (2) A corresponding series of North American birds, as yet unprovided with special labels.
- (3) A series of eggs, illustrating extremes of size, represented by a cast of the egg of the Giant ostrich of Madagascar on the one side, and the Humming bird on the other, connected by a series of eggs of different birds, including the ostrich, goose, domestic fowl, pigeon, etc., to show a gradation between the extremes.
- (4) The smallest known bird and its nest.
- (5) Specimens illustrating protective mimicry.
- (6) A selection of the more remarkable birds of the world (including the Lyre bird, Bell bird, Umbrella bird, Apteryx, Bird of Paradise, etc.).
- (7) The Great Auk and a cast of its egg.
- (8) A small collection explaining confusion of popular nomenclature in the case of certain American birds, to which have been applied names properly belonging to totally different European birds.
- (9) Parts of the general systematic or faunal exhibits, including the *Corvidæ*, and the orders *Picariæ*, *Psittaci*, *Striges*, *Columbæ*, and *Pterocletes* of the general systematic series and the following families of North American birds: Thrushes, Warblers, Dippers, Creepers, Titmice and Nuthatches, Wrens, Mocking-Thrushes, Wagtails and Pipits, Wood-Warblers, Vireos, Honey Creepers, Shrikes, Waxwings, Tanagers, and Finches.

Among special researches prosecuted upon material belonging to the department may be mentioned, first, the work of a committee of the American Ornithologists' Union, having charge of the matter of the revised official check-list and supplement thereto. This committee held numerous meetings in the office of the Curator of the department, and based its decisions, affecting something near one hundred species and subspecies which were candidates for admission into the official list, almost exclusively upon the collection belonging to the department. In addition to this matter, special investigations were made by the curator in the genera *Psittacula*, *Accipiter*, *Xiphocolaptes*, and *Sclerurus*, while much work of similar character was done in connection with a large collection from Costa Rica, and a still more extensive one made by the naturalists of the U. S. S. *Albatross* in Alaska, and various portions of South America, including the Galapagos archipelago. Dr. Leonhard Stejneger has continued his researches in Japanese orni-

thology, while Mr. J. A. Allen, of New York City, Dr. P. L. Selater, and Mr. Osbert Salvin, of London, England, Count von Berlepsch, of Müinden, Germany, and several other active workers, have been sent many specimens to aid them in their studies of particular groups of American birds.

The present state of the collection is, so far as preservation of the specimens is concerned, as nearly perfect as is possible under existing circumstances, but a portion of the duplicate series and the mounted collection is yet liable to the attacks of insects, an unfortunate condition of affairs which it is not possible to prevent until suitable cabinets are provided for the former and the cases containing the latter made practically air-tight or dust-proof. So far as its *arrangement* is concerned, the condition of the skin collection (which is several times more extensive and valuable than the mounted collection) is extremely unsatisfactory. Not only are all the cabinets so crowded as in many cases to admit no additional specimens, but the general facilities for storage and proper arrangement are so inadequate as to prevent easy access to the specimens for study, and practically put a stop to the making of exchanges or distribution of duplicates. Indeed, it may truly be said that no other need of the department of birds can be compared in importance or urgency with that of suitable cases for the skin collection.

The number of specimens in the bird collection at the end of June, 1889, can be only approximately stated, but the following careful estimate is believed to be very nearly correct.

	1887-88.	1888-89.	Increase.
Reserve skin series	43,454	45,450	996
Duplicates, skin series	6,609	6,756	147
Exhibition	6,421	*6,768	347
Total	56,484	58,974	1,490

*An actual count of the exhibition collection since the above estimate was made shows a total of 6,714 specimens.

The last entry in the catalogue in June 1888, is 113659; in June, 1889, 116630.

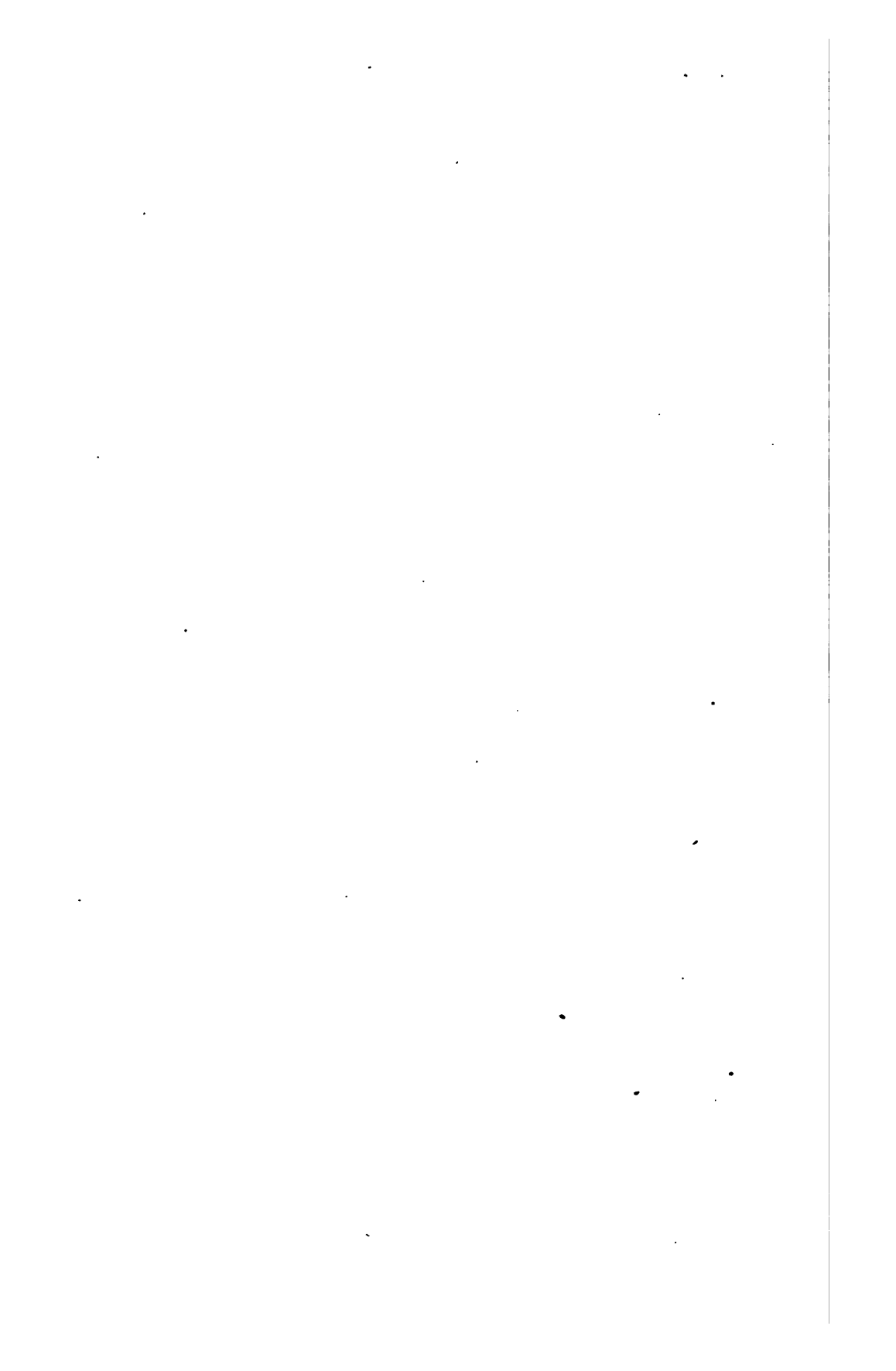

REPORT ON THE SECTION OF BIRDS' EGGS IN THE U. S. NATIONAL MUSEUM, 1889.

By CHARLES E. BENDIRE, U. S. A., *Honorary Curator.*

The following important additions have been made to the Oological collection during the year :

From Dr. William C. Avery, Greensborough, Alabama. (Gift.) Nest and four eggs of *Peuceea aestivalis bachmanii*.

From William W. Price, Tombstone, Arizona. (Gift.) Four eggs of *Cardellina rubrifrons*. New to the collection and to science.

From J. C. Davidson, Lockport, New York. (Gift.) Nest and three eggs of *Dendroica cerulea*. New to the collection.

From Denis Gale, Gold Hill, Boulder County, Colorado. (Gift.) An exceedingly valuable and interesting collection of nests and eggs, among them those of *Picicorvus columbianus*, *Myadestes townsendii*, *Dendroica auduboni*, *Regulus calendula*, *Turdus aonalaschka auduboni*, and *Empidonax hammondi*. This is the finest collection received for some time from any source.

From the U. S. Fish Commission. (Gift.) An interesting collection of eggs, made during the cruise of the U. S. steamer *Albatross*, from December, 1887, to April, 1888 in the Galapagos Archipelago and coast of Brazil.

Fifty-three nests have been received during the year, of which some of the rarer species have been mentioned.

The character of the routine work for the fiscal year has been as follows :

Taking the measurements, numbering, classifying, and arranging 369 new specimens ; relabeling and arranging part of the reserve collection of eggs after the new American Ornithologists' Union check list, besides arranging a series of foreign eggs, of which there are 4,193 specimens.

Last entry in June, 1888	23, 647
Last entry in June, 1889	23, 765
Total number of entries	118
Number of specimens, North American, in reserve series.....	30, 548
Number of specimens, North American, in duplicate series.....	11, 548
Number of specimens, North American, on exhibition	1, 491
Total.....	43, 587

Number of species and subspecies in the North American series	749
Number of specimens in foreign reserve series	4,133
Number of specimens in foreign duplicate series	241
Total	4,424
Number of species of eggs in foreign series	611
Number of nests in reserve series.....	2,157
Number of nests on exhibition	235
Total	2,392

REPORT ON THE DEPARTMENT OF REPTILES
IN THE U. S. NATIONAL MUSEUM, 1889.

By LEONHARD STEJNEGER, *Acting Curator.*

Up to the time when the present Curator was appointed and assumed control of the department, the work performed during the year consisted chiefly in the ordinary routine. Upon assuming his new duties he found that before any other work could be properly undertaken, a thorough overhauling of the entire collection would be necessary, in order to ascertain just what specimens the collection contained, and to arrange them—so far as the space allotted to the department would allow—in such a manner that it would be possible at any time to lay hand on any specimen desired. A beginning was made with the reserve series of North American species, and this work was still progressing at the end of the year covered by this report. At the same time a large number of specimens, which previously had not been catalogued, were entered upon the Museum register.

The most important accession received during the year is the collection made by the naturalists of the U. S. Fish Commission steamer *Albatross*, during the circumnavigation of South America, and particularly during the stay at the Galapagos Islands. The collection contains three hundred and nineteen specimens, which have been sent to Prof. E. D. Cope, in Philadelphia, for special report.

From Mr. J. F. Le Baron, in charge of the survey of the proposed canal through the Isthmus of Nicaragua, an interesting collection of forty-four specimens, brought together by Dr. L. F. H. Birt, the surgeon of the surveying party, was received in good condition. The Curator, by press of routine work, was prevented from working it up immediately, but he hopes to be able to report more fully upon it later on.

The Royal Zoological Museum, of Florence, Italy, sent in exchange a small but very interesting collection from that country, especially from the islands surrounding it.

Mr. H. W. Henshaw, of the Bureau of Ethnology, presented quite a number of specimens, chiefly batrachians, from the eastern United States, among which were numerous specimens of *Chorophilus triseriatus corporalis*.

Through the kind offices of Mr. Gustave Kohn, of New Orleans, Louisiana, the department secured by purchase, a number of rare chelonians from that state, thus filling serious gaps in the North American reserve series.

A great deal of the routine work has consisted in entering on the record book material accumulated during previous years. The Curator has instituted a change in cataloguing accessions, so that now each specimen receives a separate number. Formerly all the specimens of the same species in each accession were entered collectively under the same number. Under the old system it was very difficult to properly designate each individual specimen when it became necessary to mention it separately, either in treating of it scientifically or in the ordinary museum routine, for instance, when any single individual of a collective number had to be picked out as a duplicate for exchange.

Special care has been exercised in identifying and properly labeling type specimens. When assuming control the Curator found quite a number of specimens collected by the famous "Exploring Expedition" with labels which, from exposure and neglect, had become nearly illegible. They had not been entered upon the record books, and on cataloguing them, great care was taken in deciphering the labels to prevent possible mistakes. This work was of necessity very slow, as it involved considerable research besides the mere deciphering of the faded labels; but the Curator was rewarded by rescuing in this way the types of no less than eight species.

It often happens that specimens destined for this department are received alive. Whenever practicable such specimens have been deposited in the department of living animals, to be returned when they die. It has been found impracticable to do so with rare or specially valuable specimens, because in the vivarium they easily lose their identity, while, on the other hand, it often happens that their death is only discovered after putrefaction has set in, rendering them unfit for preservation in alcohol.

During the present year Prof. E. D. Cope has finished his work on the North American batrachians, based upon the collections of this department, and has commenced a similar study of the North American snakes in the Museum.

Dr. G. Baur, of Yale College, New Haven, Connecticut, has had for study a number of chelonians belonging to the Museum, especially the soft-shelled turtles. Some of the results of these studies will be found indicated in the bibliography of the year, forming Section IV of the report.

The Curator has been unable to devote much time to scientific study of the collection during the few months he has been in charge. What little he has been able to do has been to investigate the status of the boiform snakes of North America, with special reference to individual variation. One paper has been handed in to the editor of the Museum

"Proceedings," while another more extensive article was in preparation at the end of the year covered by this report.

As stated above, a complete overhauling of the whole collection has been commenced and is still in progress, in order to ascertain the state of the collection, including the number of specimens contained in the various "series." On account of the cramped condition of the collection and lack of assistance, this work will still consume months before completion. The following table is therefore simply based upon the one furnished by my predecessor for the year 1887-'88, by adding the number of entries catalogued during the present year and deducting the number of specimens which are known to have been destroyed, or disposed of in exchange. By a calculation of this nature, the status of the collection on June 30, 1889, would be as follows :

	Specimens.
Reserve series	13, 469
Duplicate series.....	8, 802
Unassorted and exotics	6, 134
Total.....	28, 405

The state of preservation of the collection may be said, on the whole, to be tolerably good, but errors in numbering and labeling are constantly discovered. In most cases it has been possible to correct them by a diligent search through the records and the literature, a work involving considerable labor and consuming much time, though the results have well paid for the trouble. The greatest need of the collection, however, is additional room, since the great majority of the specimens with the present facilities are wholly inaccessible, while the handling of those more or less accessible is attended with difficulty, and exposes them to great danger of being destroyed or lost. The office of the department is now so crowded that a great many of the largest and most valuable specimens have to be placed on the floor, leaving but little room for the occupants to move about, and exposing the jars to the danger of being broken.

The number of the last catalogue entry in June, 1888, was 14,739; in June, 1889, 15,523.

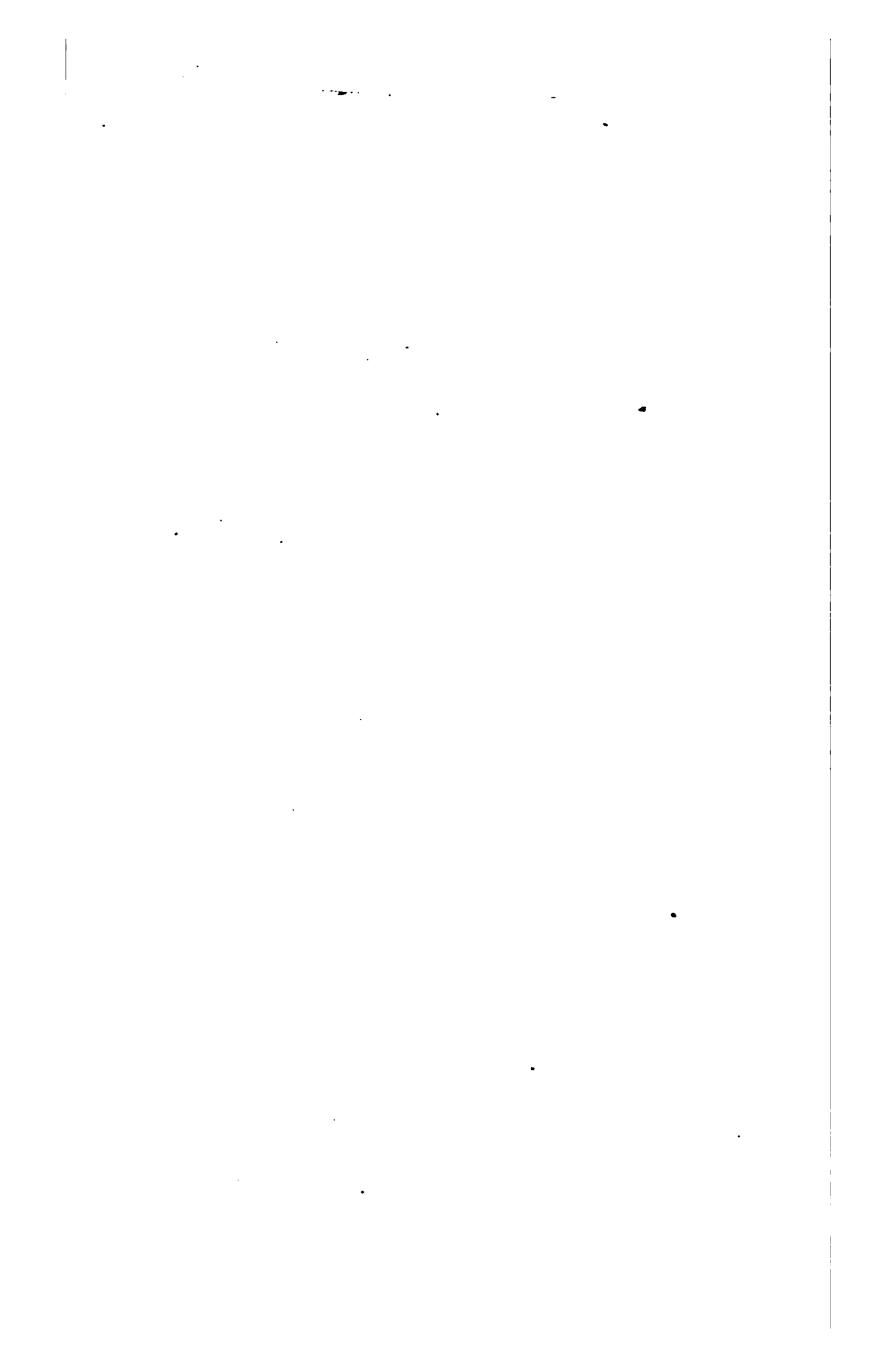

REPORT ON THE DEPARTMENT OF FISHES
IN THE U. S. NATIONAL MUSEUM, 1889.

By TARLETON H. BEAN, *Honorary Curator.*

It having been necessary for me to be absent from the Museum during July, August, September, and October, on duty connected with the U. S. Fish Commission, the department was, during those months, left in charge of my assistant, Mr. Barton A. Bean, who received and cared for the specimens sent to the Museum. He also overhauled the entire collections of fishes. Considerable time was spent in the arrangement of papers relating to fishes. Upon my return to Washington, I was occupied for a time with accumulated correspondence, accessions, etc., which had come in during my absence. Soon after this I was put in charge of the editorial work of the Fish Commission, which left me but little time to devote to Museum work. During the last six months of the year I prepared and had published in various journals numerous papers upon the *Salmonidæ* and other species of fishes. A list of these papers is given in Section IV of this report. Fifty-three accessions were received during the year, of which the following are the most important:

Accession 20952, containing eighteen new species of fishes, collected in the Gulf of California, by O. P. Jenkins and B. W. Evermann. The descriptions of these have been published in the Proceedings U. S. National Museum, 1888.

Accession 21065, containing sixty-seven species of fish from northern seas; given in exchange by the Zoological Museum, University of Copenhagen.

Accession 21074, forty-one species of New Zealand fishes; in exchange, Otago University Museum, Dunedin, New Zealand.

Accession 21228, a collection of fishes from all parts of the world, including Europe, the Pacific Ocean, North, Central, and South America; in exchange, Museum of Comp. Zool., Cambridge, Mass.

Accession 21285, nine new species of fishes, collected in Virginia and North Carolina, by Prof. D. S. Jordan and party. A paper containing descriptions of these new forms has been published in the Proceedings U. S. National Museum.

Accession 21302, a specimen of *Merluccius bilinearis*, collected at Point Pleasant, New Jersey, by Capt. John G. W. Havens, and interesting on account of its range.

Accession 21483, a collection of fishes made in Nicaragua, Central America, by Dr. Louis F. H. Birt.

Accession 21620, a large collection from the Mediterranean; exchange from Royal Zoological Museum, Florence, Italy.

Accession 21651, a collection of fishes, principally Selachians, from Australia; exchange from the Australian Museum, Sidney.

Accession 21752, types of new species, *Gobius townsendi* and *Lepidogobius gilberti*, collected at San Diego, California, by C. H. Eigenmann.

Large and valuable collections have been received from the U. S. Fish Commission, made by Prof. D. S. Jordan and party in Virginia, North Carolina, and Tennessee.

The routine work has consisted, for the most part, in receiving and caring for accessions, preparing papers for publication, attending to correspondence, bottling, labeling, and preserving the collections. Some attention has been shown students of ichthyology from this and other cities. The duties of the Curator, as Ichthyologist and Editor of the Fish Commission, have been such as to allow little time for Museum work during this year.

Exchanges have been made with the Otago University, New Zealand, and the Australian Museum, Sydney.

The state of the collection has been improved; numbers of specimens have been transferred from tanks to jars, thereby insuring their better preservation.

The number of specimens added to this department during the year was about 6,000. There are at least 25,000 duplicate specimens, 60,000 reserve specimens, and 30,000 specimens in the exhibition series. A collection of this magnitude is very difficult to handle and care for. The case and shelf room is inadequate, making it necessary to stand the jars containing the specimens upon the floor, thereby causing much extra labor and confusion.

REPORT ON THE DEPARTMENT OF MOLLUSKS*
IN THE U. S. NATIONAL MUSEUM, 1889.

By WM. H. DALL, *Honorary Curator.*

The force of the Department of Mollusks for the period reported on has consisted, in addition to the Curator, of Dr. R. E. C. Stearns, Adjunct Curator, and Mr. Pierre Louis Jouy, Aid.

Assistance in the work on the fossils collected by the Geological Survey and other donors has been rendered from time to time by Messrs. Frank Burns and Charles B. Greene, of the U. S. Geological Survey, by the permission of the Director of the Survey.

The need of the department for a person who might be entitled to the designation of an elegant penman, to write labels for exhibition and other purposes, increases annually. The clerical force of the department is wholly inadequate to conquer the arrears of labeling and registration, a fact which will not seem extraordinary when it is realized that the collection contains at least twice as many specimens as any other department of the Museum, that of these not exceeding one-half are registered and labeled according to the Museum requirements, and that at any time we are liable to receive an accession large enough to employ our entire time for a whole year.

The work, as in previous years, has consisted largely of the labeling, determination, and registration of new and old material. This branch of our work, owing to greater demands on our time from other directions, has not progressed as far as in the previous year. Still, under the circumstances, I believe that as much has been done as our opportunities would allow, and it has been done in a thorough and efficient manner. A considerable amount of time has been spent in putting in order the Lea collection of *Unionida* for exhibition. Seven cases have been arranged, but the work has been brought to a temporary cessation pending the substitution of new and more presentable cases for those hitherto in use. It is hoped that early in the present summer these may be far enough advanced to permit of arranging the whole of this unequalled collection of fresh-water mussels of the world.

* Including tertiary fossils.

Good progress has also been made in cleaning and assorting the fossils contained in the Lea collection, mostly fine specimens from the European Tertiaries.

ACCESSIONS DURING THE YEAR.

The total number of accessions during the year is forty-six, a number somewhat less than the preceding year. The amount of material received under the head of these accessions is also less. It would have been wonderful had it been otherwise, since last year's list included the sixty-three boxes of the Lea collection.

The most important accession of the year was the collection of Mollusca and Tertiary fossils made by the U. S. Fish Commission party on the *Albatross* during the voyage from Chesapeake Bay, through the western Atlantic, the Strait of Magellan, and the eastern Pacific to the Galapagos Islands and San Francisco, California. This contains a small but precious collection of deep-sea forms, and a large number of shallow-water species of the coasts visited. The latter were particularly important on the eastern coast of South America, where the distribution of the Mollusca is little known. The *Albatross* collections show that some of the Patagonian species reach as far north as the Amazon, and that some of the Antillean species extend southward to Rio Janeiro and even farther south. A special report on this collection is being prepared for the U. S. Commissioner of Fisheries.

The accession next in importance was received from Messrs. F. B. and J. D. McGuire, of Washington, who presented on behalf of the heirs of the late J. C. McGuire, of Washington, a collection estimated to comprise about two thousand species and perhaps five thousand specimens of shells, marine and terrestrial, from various parts of the world. This generous donation has been retained temporarily in the packages in which it was received until the material now in hand shall have been administered upon; but, when time shall favor, it will doubtless add materially to our series.

An invaluable faunal collection was received from the Auckland Museum, Auckland, New Zealand, and contains about three hundred species, with exact labels of locality, mostly named. These, with the very full collection received in former years from the Otago Museum, and other material derived directly or indirectly from private collections, makes the New Zealand collection of our department extremely full and nearly exhaustive for the marine forms. Our chief deficiencies from a faunal stand-point are, and have for some years been, among the African and Chinese forms and those of southern Japan.

Among the smaller collections received, which are worthy of particular remark, are a small collection from our constant friend and correspondent, Henry Hemphill, representing a picked series of certain Californian species; a small lot containing some very nice things from Cape Sable, Florida, from Lieut. J. F. Moser, U. S. Navy, and two series each

from Messrs. G. W. Webster and J. J. White, collected in southeastern Florida. These materially enlarge our knowledge of the geographical distribution of many Southern species heretofore only known from the Antilles and the Keys.

Among fossils the largest contributor, as usual, has been the U. S. Geological Survey, closely followed by Mr. Joseph Willcox, of Philadelphia, whose energy in exploring the fossiliferous deposits of Florida has been most untiring.

ROUTINE WORK.

The routine work of the past year has been largely devoted to the collection representing the fauna of the southeastern shores of the United States and adjacent waters. This part of the collection is now wholly registered, fully labeled, and arranged systematically. A checklist of this fauna is now in process of printing, and when completed will serve as an index to this part of our molluscan collection. From a rough estimate this fauna may be regarded as represented in our collection by about fifteen thousand specimens divided among some two thousand nominal species. This is probably the fullest and best exhibit of these forms brought together anywhere in the world, though the very completeness of the arrangement shows that it is not without its deficiencies.

Dr. Stearns reports that his time has been largely devoted to the land and fresh-water shells, especially of North America, and to the revision and labeling of material heretofore not administered upon. The collection of North American land and fresh-water shells is in complete order for reference, and the forms belonging to the South American and Antillean fauna are to a great extent available also. The material in both these sections of the collection, as well as in the matter of exotic land shells, will be largely augmented when the Lea collection shall be administered upon and in a state for study. Constant small additions are being made by correspondents of the Museum in different parts of the country.

As soon as storage room in the new cases becomes available, a large proportion of the material now piled up for want of space to put it away will be provided for, and work on the remaining arrears be greatly facilitated. A proper series for exhibition purposes will be available at the same time, and for the first time in its history the Department of Mollusks will be able to bear its proper share in interesting the public by the contents of suitable table-cases.

Information or assistance of more or less importance, chiefly in the identification of specimens or supplying data for investigators, has been furnished to the following persons, among others, the work often requiring in a single instance the available part of several days of labor and the writing of several letters.

The recipients of this assistance are scattered over the whole country, but, as might be expected, reside chiefly in those localities where libraries and collections are least accessible.

Prof. Alex. Agassiz.	George F. Kunz.	Prof. N. S. Shaler.
S. Arnheim.	J. B. La Penotiere.	Dr. R. W. Shufeldt.
H. G. Askew.	Col. M. McDonald.	C. T. Simpson.
W. B. Barrows.	W. G. Mazyck.	E. A. Smith.
Dr. Stephen Bowers.	Thomas Morgan.	Dr. V. Sterki.
Theo. D. A. Cockerell.	Lient. J. F. Moser.	George J. Streator.
Dr. A. K. Fisher.	Hon. J. B. Moore.	M. A. Suchetet.
S. S. Greeley.	C. R. Orcutt.	Prof. J. B. Tilton.
General A. W. Greeley.	Prof. A. S. Packard, jr.	G. W. Webster.
Dr. W. B. Hartman.	F. M. Phillips.	W. W. Westgate.
Henry Hemphill.	H. A. Pilabry.	J. J. White.
Capt. E. P. Herendeen.	G. H. Ragsdale.	Prof. R. P. Whitfield.
Prof. A. Heilprin.	W. J. Raymond.	Joseph Willcox.
C. S. Hill.	J. M. Rogers.	
Dr. W. Kobelt.	I. C. Russell.	

SPECIAL RESEARCHES.

The limited time for research has been employed by the Curator partly in concluding the investigation of the mollusca of the expedition on the U. S. S. *Blake*, under the supervision of Professor Agassiz, in the Gulf of Mexico and the Caribbean Sea. The second and concluding part of this report, including the Gastropoda and Scaphapoda, is now printed and forms a volume of about 800 pages with thirty-one plates. Work has also been done on the dredgings of the U. S. Fish Commission in the same region, and on the voyage of the *Albatross* to California, a report of which is nearly finished. A new systematic arrangement of the bivalve shells or pelecypoda has occupied the Curator's attention, and the correlation of the Tertiary, especially the Pliocene, fossils of our southeastern Atlantic coast, with the recent fauna of that coast, is in progress, with a prospect of publication during the coming year. Dr. Stearns has prepared for publication a paper, which is now in press, on Shell Money, Prehistoric and Historic,* a subject upon which he has made long-continued investigations.

STATE OF THE COLLECTION.

In previous reports I have stated why it is impossible to give the exact number of specimens, species, duplicates, etc., contained in the collection. In my last report I estimated that the collection contained 455,000 specimens of all sorts. Since then about 13,000 have been received.

The total number of entries in the Museum register, or catalogue for 1887-'88, was 11,803; the number for 1888-'89 is 6,323. The discrepancy is entirely accounted for by the interruptions to our work already

* Report of National Museum, 1887, pp. 297-334. Nine plates.

mentioned. The total number of registrations to date, omitting duplicates and numbers assigned to but not yet reported, as used by Professor Verrill on the Fish Commission collections, is 88,234, which represents about 265,000 specimens administered upon and available for use.

The schedule of registration follows, the number of workers requiring the simultaneous use of several registration books.

Volume.	From	To	Total.	Remarks.
XVIII.....	87,302	87,512	210	Volume not filled.
XX.....	94,585	97,300	2,715	Do.
XXI.....	98,677	102,074	3,398	Do.
Total.....			6,323	

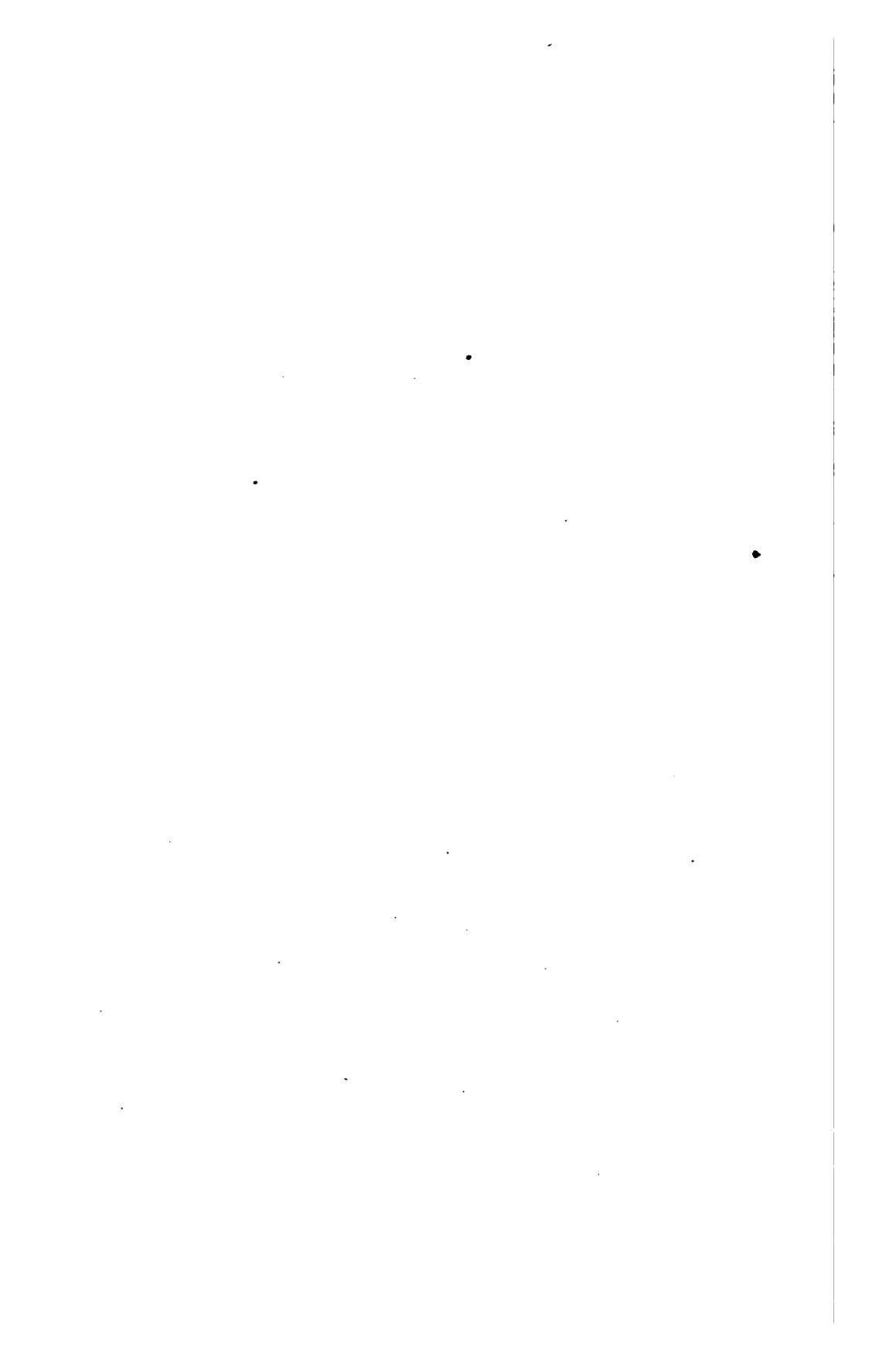

REPORT ON THE DEPARTMENT OF INSECTS
IN THE U. S. NATIONAL MUSEUM, 1889.

By C. V. RILEY, *Honorary Curator.*

The past fiscal year has been rather a busier one than usual in this department, and has been signalized particularly by the preparation of exhibit collections. During the early part of the year the educational collection for exhibition at the Cincinnati Exposition was completed and sent to Cincinnati, where it remained until December.

In August the Assistant Curator was sent North, and examined a number of private collections at New York City, Brooklyn, Albany, Brockport, and Buffalo for the purpose of obtaining exchange material for the Museum. During October and November, work upon a general exhibit collection to be permanently placed on the lower floor of the Museum, was begun and carried on. In December, work on additional laboratory space was begun, and was completed in May. A large additional room has thus been added to the much needed conveniences of the department. During December work was also begun upon an exhibit collection devoted mainly to the economic aspects of entomology to be sent to Paris, as a part of the exhibit at the Exposition. As additional help was needed upon this work, Mr. Martin L. Linell, of Brooklyn, was engaged temporarily for this purpose. The work of preparing this exhibit continued assiduously to the end of March, when it was shipped to Paris.

April 1 the Assistant Curator, Mr. John B. Smith, resigned, to accept the more lucrative position of entomologist of the Agricultural Experiment Station at New Brunswick, N. J., and Mr. M. L. Linell was appointed Aid.

On April 1 I went to Paris as one of the expert Commissioners, and as representative of the Secretary of Agriculture to the Paris Exposition, and during my absence of five months in those capacities Mr. L. O. Howard was Acting Curator, and I would here acknowledge my indebtedness to him in that connection.

The number of accessions during the year have been about as usual, but the following more important ones may be mentioned :

A series of named Coleoptera and Lepidoptera from Charles Drury, of Cincinnati, Ohio. This lot contains a large lot of species wanting in the collection. A considerable lot of good material in Lepidoptera, collected in California by D. W. Coquillett, was turned over to the Museum by Professor Riley, from the Department of Agriculture. Acc. 21256.

Twenty-nine specimens of 16 species of Mexican Coleoptera, collected at Guerrero, Mexico, and purchased from L. E. Ricksecker, Sauta Rosa, California. Acc. 21347.

Miscellaneous lot of alcoholic insects, collected by Walter B. Barrows at Concepcion del Uruguay, Argentine Republic, South America. Acc. 21385.

Collection of insects, chiefly Coleoptera, mostly from Michigan and Louisiana (about 1,200 species and 5,500 specimens), purchased by the Department of Agriculture from Mr. Tyler Townsend, and turned over to the Museum by Professor Riley. Acc. 21391.

A series of 5 species of 30 specimens, of Lepidoptera, from David Bruce, Brockett, Monroe County, New York. All desiderata. Acc. 21389.

Miscellaneous lot of insects, from R. P. Speer, Ames, Iowa. Acc. 21464.

A series of Coleoptera in alcohol, from E. Van Dyke, Los Angeles, California. Acc. 21557.

A miscellaneous lot of insects, mostly Coleoptera, from J. M. Holtzinger, Winona, Minnesota. Acc. 21542.

A series of named Coleoptera, from Mr. Henry Ulke, of Washington, District of Columbia. Acc. 21670.

A series of alcoholic specimens from Japan, from Mr. Romyn Hitchcock, U. S. National Museum. Acc. 21649.

A series of Lepidoptera, from G. H. French, Carbondale, Illinois. Acc. 357.

A large lot of dried Coleoptera, from G. W. J. Angell, New York; collected in Venezuela. These were too much mutilated for scientific study, but a number of the most conspicuous forms are useful for exhibit purposes. Acc. 21743.

Twelve specimens of spiders, from Dr. Edward Palmer; collected at San Pedro, Martin Island, Gulf of California. Acc. 11751.

A large series of North American Myriapods, from C. H. Bollman, of Bloomington, Indiana. Acc. 21787.

Thirty-five species of Coleoptera and 22 species of Hemiptera, from A. L. Montandon, Bucharest, Roumania; collected in Eastern Europe; through Prof. C. V. Riley. Acc. 21846.

A number of specimens of the "Aweto," a fungus growing from the body of a caterpillar in New Zealand; through Prof. C. V. Riley. Acc. 21864.

A number of miscellaneous alcoholic insects, from C. Carlos, Cape Gracias, Nicaragua. Acc. 21593.

Eighty-four specimens (30 species) of Heteroptera, from A. L. Montandon, Bucharest, Roumania; through Prof. C. V. Riley. Acc. 21992.

A lot of alcoholic insects, mostly Coleoptera, through C. E. Orcutt, San Diego, California. Among these were several really desirable species, especially a fine series of *Schizopus sallei*. Acc. 22108.

Four species of rare Lepidoptera, collected in Florida, from W. E. Longley, 117 Wabash avenue, Chicago. Acc. 21112.

The routine work during the year, in addition to the special work upon the preparation of insect collections mentioned in the general review, has been:

(1) The naming of specimens for collectors: Among the most important tasks of this kind have been the naming of seventy species of insects from photographic plates for H. G. Dyar, of Rhinebeck, New York; determinations for Prof. O. Lugger, of the Minnesota Experiment Station; Prof. S. A. Forbes, State Entomologist of Illinois; Prof. F. M.

Webster, of the Indiana Experiment Station; David Bruce, of Brockport, New York; John Dallas, of Fairfield, Connecticut, and C. R. Orcutt, of San Diego, California.

(2) The arrangement and selection of material to be sent to specialists for determination. This is a very important item in the routine work of the department and occupies a great deal of time. It has been the policy to assist both specialists and the Museum itself by sending collections in particular groups to specialists who happen to be just at the time working upon them. Thus the entire undetermined material in the Myriapoda was selected out, carefully listed, and sent to Mr. C. H. Bollman, of Bloomington, Illinois, during August. A large portion of the month of October was also spent in collating the Curator's notes on the lepidopterous family Pyralidæ, in collecting the biological material in this family, and in selecting a nearly complete series for Prof. H. C. Fernald, of Amherst, Massachusetts. The material in the Halticid genera *Edionychis* and *Disonycha* was brought together and sent to Dr. George H. Horn, of Philadelphia, who is working up the genera of the Halticidæ. Advantage was taken of the occasion to look over and rearrange the material in other genera of the family. Again, during April the Staphylinid material in certain genera was carefully selected out and forwarded to Capt. T. L. Casey, of New York City, for study, as he is engaging himself with this group of beetles.

(3) The work of arranging in permanent shape all the reference or reserve collection. This is a matter of extremely slow accomplishment. The re-arrangement of the Coleoptera mentioned in the last annual report of this department has been continued, and, proceeding from the family Cicindelidæ there mentioned as having been completed, the very large family Carabidæ has been entirely re-arranged, occupying sixty-eight boxes in the reserve collection and eighteen double boxes in the duplicate series. A beginning has been made with the succeeding families of water beetles, beginning with the Dytiscidæ. In addition to this work, which has occupied most of Mr. Linell's time, Mr. Lawrence Bruner, entomologist to the Nebraska Experiment Station, during a visit to Washington in November, spent a number of days in working over the Orthoptera of the collection, naming many of the heretofore-undetermined species and adding a number of his type species. Dr. S. W. Williston, of New Haven, also visited Washington during May, and devoted some little time to work upon the Diptera in the collection.

(4) The actual care of the collection; its disinfection and preservation from insect pests. This is a matter of considerable time. Twice or three times a year every box of the hundreds now upon the shelves must be carefully examined, disinfected with bisulphide of carbon or benzine in case the work of museum pests is discovered, and the naphthaline cones used as preventives renewed. The entire collection was thus carefully gone over twice during the past year and was found in most admirable condition.

Among the special researches based upon material belonging to the Department should be mentioned the following:

(1) A monograph of the Sphingidæ of North America, by John B. Smith, which has been published during the year by the American Entomological Society of Philadelphia.

(2) A paper upon the Acridiidæ of North America, by Lawrence Bruner, which has been submitted for publication in the Proceedings of the Museum.

(3) A paper entitled Notes and Descriptions of Braconidæ, by William H. Ashmead, to be published in the Proceedings of the Museum.

(4) A paper to be entitled Notes and Descriptions of Ichneumonidæ, by William H. Ashmead, now nearly completed and to be published in the Proceedings of the Museum.

(5) Two papers, with titles corresponding to those by Mr. Ashmead, just mentioned, are in preparation by myself, and include the new material in the Museum collection in these two families of parasitic Hymenoptera not treated by Mr. Ashmead.

(6) Several papers by C. H. Bollman, of Bloomington, Illinois, upon Myriopoda, which have been submitted for publication in the Proceedings of the Museum.

(7) A report upon the Insects, Arachnids, and Myriapods collected by the U. S. Fish Commission steamer *Albatross* during 1887 and 1888, submitted to the assistant secretary in charge of the Museum in June, by Mr. L. O. Howard.

It will be very difficult at the present time to draw up a table showing the present state of the collection, indicating the number of specimens in all orders. This was carefully done in the report of the Department for 1886-'87, and in the report for 1887-'88 the statement was made that some 10,000 specimens had been added. During the present year, while several thousand specimens have been added to the collection, the work of rearrangement, except upon exhibit collections, has been so slow that a definite tabulated statement at the present time is impracticable. The work may be said to be just now in a transition state. The most urgent need of the department at the present time is additional help, to permit me to keep the rapid accumulations properly worked up.

REPORT ON THE DEPARTMENT OF MARINE INVERTEBRATES
IN THE U. S. NATIONAL MUSEUM, 1889.

By RICHARD RATHBUN, *Honorary Curator.*

The duties of the Curator in connection with the Fish Commission have prevented his giving much personal attention to his department during the past year. The exhibition hall, which has been closed for two or three years on account of the extensive repairs made to the Smithsonian building, has been thoroughly renovated and prepared for the use of the public. All of the collections have received constant care, and their condition in the several store-rooms has been greatly improved. But few accessions were received, owing chiefly to the fact that the Fish Commission, which has been its principal contributor ever since the department was reorganized in 1880, has made arrangements to care for its own collections of marine animals until they shall have been studied and reported upon. This will, in a measure, benefit the department by relieving it of the routine work incidental to the preservation and assorting of the large unworked collections sent in by the vessels and field parties of the Commission, while eventually it will become the recipient of valuable type series, representing the labors of recognized authorities in systematic zoology. It is expected, moreover, that these collections will be turned over to the Museum from time to time, as the work on the different groups is completed.

The total number of accessions recorded is thirteen, none of which were of large size. Lieut. J. F. Moser, U. S. Navy, commanding the Coast Survey steamer *Bache*, has contributed a small assortment of miscellaneous specimens dredged off Cape Sable, Florida, during the winter of 1887-'88. Mr. Henry Hemphill has sent in a number of specimens of crustaceans and sponges, obtained from kelp roots, off San Diego, California. Several fresh-water crabs and shrimps have been received from Dr. Louis F. H. Birt, of the Nicaragua Canal Construction Company. They were collected near Greytown, Nicaragua. Mr. Romyn Hitchcock has presented a small collection of crustaceans and sponges from Japan; and Judge James G. Swan, several echini and crustaceans from Port Townsend, Washington. The remaining accessions do not require special mention.

During the greater part of the year, the west hall in the Smithsonian building, assigned to this department for exhibition purposes, was used for storing the general dried collection, pending the renovation of the bird hall, in one of the galleries of which it is regularly kept. This work being finished in the spring, the exhibition hall was again made ready for the public, the cases being newly painted on the inside, and the display collections re-arranged by the curator. The alcoholic specimens in the basement store-rooms were all gone over during the year, and the following groups, including both the identified and unidentified specimens, were arranged in systematic order, namely: the crustaceans, worms, holothurians, ophiurans, crinoids, hydroids, molluscoids, and sponges. This places the collection in better shape for reference than ever before, and the remaining groups will be taken up in the same manner during the next fiscal year. The collection of duplicate specimens was also revised and the card catalogue of the same completed.

A collection of marine forms representing some of the investigations of the Fish Commission was prepared and transmitted to the Cincinnati Exposition during the summer of 1888, as a part of the exhibit accredited to the Commission. It consisted mainly of large showy specimens, but also contained examples of fish food and many microscopic preparations. After its return to Washington, in the autumn, the more interesting portions were added to the display series in the exhibition hall. When the collections of natural history, made during the cruise of the steamer *Albatross* from Norfolk to San Francisco, were received at Washington, in the winter of 1888-'89, the new Fish Commission laboratory had not been constructed, and these collections were largely assorted and prepared for study in the work-rooms of this department, with such assistance as we were able to render. The curator has had but one assistant during the year, Miss M. J. Rathbun, on whom have devolved not only the care and preservation of the collections, but also, for the most part, the general supervision of the department, and its excellent condition at the present time is due chiefly to her conscientious labors.

The Curator has given a limited amount of time to the study of the Madreporarian corals, and particularly those collected by the steamer *Albatross* in the Gulf of Mexico and on the voyage from Norfolk to San Francisco. Otherwise no special researches have been carried on in the department. Prof. A. E. Verrill and Prof. S. I. Smith are still continuing their work upon the Fish Commission collections stored at the Peabody Museum of Yale College, the same being now the property of the National Museum. Prof. Edwin Liuton is also giving his attention to the large series of internal parasites of fishes collected chiefly by himself at the Wood's Holl station of the Fish Commission. Arrangements have been made with Prof. Walter Faxon, of the Museum of Comparative Zoology, Cambridge, Massachusetts, to report upon the crayfishes added to the department since his memoir published in 1885; and Mr. J. Walter Fewkes has completed a paper on certain of the *Albatross* medusæ obtained in the region of the Gulf Stream.

The collections made by the *Albatross* on the voyage around South America, were, as before explained, partly assorted in the laboratory of this department by Prof. Leslie A. Lee, the chief naturalist of the steamer during that cruise, with the assistance of Miss Rathbun. Subsequently several of the groups of marine invertebrates were assigned to different naturalists for study and report, as follows: The echini and stalked crinoids, to Mr. Alexander Agassiz; the mollusca in general, to Mr. William H. Dall; the pteropods and heteropods, to Mr. James I. Peck; the brachyura and isopoda, to Prof. Leslie A. Lee; the stomatopods and free medusæ, to Prof. W. K. Brooks; the hydroids to Mr. J. Walter Fewkes; the actinians, to Prof. J. P. McMurrich; the larval cephalopods, to Mr. S. Watase; the internal parasites of fishes, to Prof. Edwin Linton; the Madreporarian corals and starfishes to the curator.

Notwithstanding the fact that so little special work has been placed upon the collections during the past year, the specimens have been retained in an exceptionally good state of preservation, and they are now so well arranged as to be available for reference or study without loss of time in finding all the representatives of each group, although the entire collection occupies the space of five good-sized store-rooms. Over three thousand entries have been made in the catalogue books, as explained in the following table:

STATEMENT OF CATALOGUING DURING THE FISCAL YEAR ENDING JUNE 30, 1889.

	Entries to June 30, 1888.	Entries to June 30, 1889.	Number of entries made during year.
Crustaceans	13, 110	14, 385	1, 275
Worms	4, 173	4, 728	555
Bryozoans and Ascidians	{ 960	1, 000	} 209
	{ 2, 549	2, 778	
Echinoderms and Coelenterates	16, 400	16, 885	476
Sponges and Protozoans	{ 4, 973	5, 000	} 639
	{ 5, 444	6, 056	
Total			3, 214

The following institutions have been supplied with duplicate sets of marine invertebrates from series No. IV, the character of which has been described in previous reports. Each set contains about one hundred and ten species, the most of which are preserved in alcohol. The varied character of the material comprising these sets makes them of great value for educational purposes:

State Normal School, Terre Haute, Indiana; University of Georgia, Athens, Georgia; The Free Academy, Elmira, New York; W. A. McMullen, Wellsville, York County, Pennsylvania; Brattleboro Society of Natural History, Brattleboro, Vermont; Racine College, Racine, Wisconsin; Ohio University, Athens, Ohio; Straight University, New Orleans, Louisiana; University of Dakota, Vermillion, Dakota; Lombard

University, Galesburg, Illinois; Virginia Agricultural and Mechanical College, Blacksburg, Virginia; East Maine Conference Seminary, Bucksport, Maine; Rutgers College, New Brunswick, New Jersey; High School, Stamford, Connecticut; High School, Galesburg, Illinois; Marietta College, Marietta, Ohio; Fisk University, Nashville, Tennessee; Baird College, Clinton, Missouri; Simpson College, Indianola, Iowa.

In addition to the regular sets of duplicates, special collections were sent out as follows: Small lots of unmounted foraminifera to Hillsdale College, Hillsdale, Michigan; to E. H. Galway, Washington, District of Columbia; and to George S. Lewis, jr., Springfield, Massachusetts; one specimen of *Geryon quinquedens* Smith to A. Milne-Edwards, Paris, France; specimens of seven species of Atlantic coast actinians to Prof. J. Playfair McMurrich for special study.

No field work yielding results of interest to this department was conducted during the year under the auspices of the Museum, but it seems advisable to refer briefly to the marine explorations of the Fish Commission, as has been done in previous reports, for the reason that the materials obtained by that means will sooner or later be represented in the Museum. The *Albatross* left San Francisco July 4, 1888, on her first cruise to the Alaskan fishing grounds. Work was begun in the vicinity of the island of Unalashka, at the eastern end of the Aleutian chain, and carried thence eastward to the reported position of Pamplona Rocks, south of Prince William's Sound. Five principal fishing banks were developed in that region, all lying on the submerged continental plateau, and extending to its abrupt outer edge. The names of the banks are as follows: Davidson Bank, Sannakh Bank, Shumagin Bank, Albatross Bank, and Portlock Bank. Many dredge hauls, chiefly with the beam-trawl, were made over this area in different depths of water, and much shore collecting was also done on the adjacent islands and main-land. Leaving this region, a line of sounding and dredging stations was carried down the coast to the northern end of Vancouver's Island, whence the steamer proceeded through the inland passage to Puget Sound, dredging at intervals on the way. A month was subsequently spent on the outer coast of Washington and Oregon, the cruise terminating at San Francisco in October. The total number of hauls made with the dredge and beam-trawl was fifty, the depth of water ranging from 21 to 1,569 fathoms. In January, the *Albatross* started on a second cruise, this time to the coast of southern and Lower California, and the Gulf of California. Several months were spent in this region, and one hundred and fifty-five dredgings were made in depths of 5 to 1,005 fathoms. The collections obtained on these two trips are very large; they have been received in Washington by the Fish Commission, and are partly in course of elaboration. Lieut. Commander Z. L. Tanner has continued in command of the steamer during the year, with Mr. Charles H. Townsend as naturalist and Mr. A. B. Alexander as fishery expert. On the second cruise, Prof. Charles H. Gilbert, of the Univer-

sity of Indiana, was placed temporarily in charge of the natural history work.

During the summer of 1888, the steamer *Fish Hawk* made an investigation of the oyster beds of Providence River, and of New Haven, Connecticut, and during the following winter both the steamer *Fish Hawk* and the schooner *Grampus* were at work on the western and southern coast of Florida, the former in the interest of the mullet fishery, the latter making an investigation of the red snapper and grouper fishing grounds. On all of these cruises important natural history collections were obtained.

H. Mis. 224, pt. 2—25

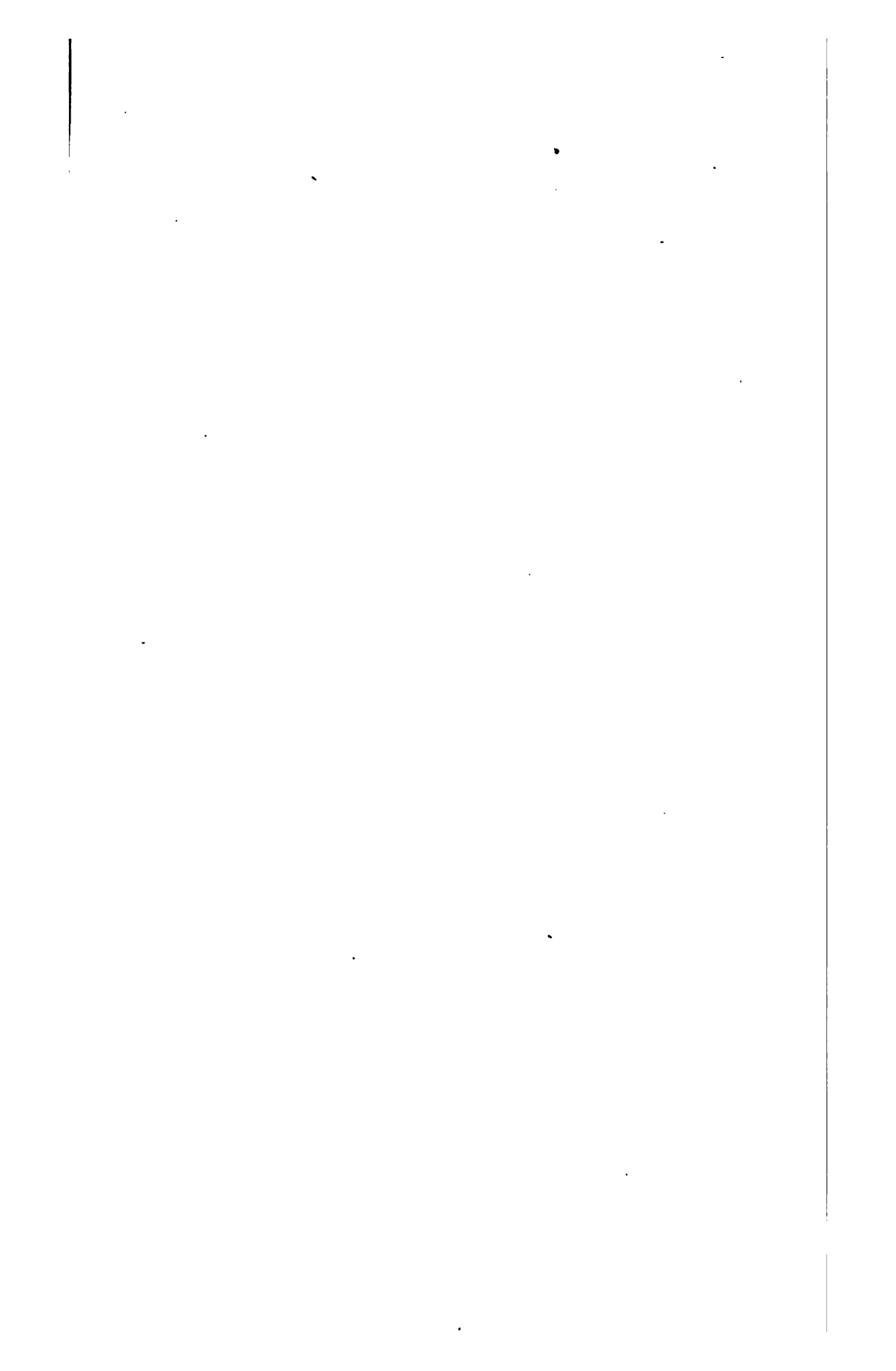

REPORT ON THE DEPARTMENT OF COMPARATIVE ANATOMY
IN THE U. S. NATIONAL MUSEUM, 1889.

By FREDERICK W. TRUE, *Acting Curator.*

The activities of the past year were exerted chiefly in the direction of reducing the accumulations of osteological material in the preparators' workshops and storage rooms. A large number of skulls and skeletons were cleaned and made available for students or for exhibition purposes.

Definite plans were made for the beginning of an exhibition series of anatomical preparations of soft parts, but at the last moment the preparator to whom this work was to be entrusted was detached from the force to accompany the astronomical expedition to Angola. It has been found necessary, therefore, to postpone the commencement of this undertaking.

The most important accessions during the year belonged to the classes of mammals and birds. The total number of the vertebrates received was small. As regards invertebrates it may be said that no attempt has thus far been made to acquire specimens for this department. The material received by the Museum is, of course, divided among the departments that have to do with the invertebrates. When the exhibition series of soft parts is begun, it is to be presumed that the necessary material will be drawn from the collections of these departments.

The most important and striking addition to the exhibition series of skeletons was the skeleton of an Atlantic Right whale, *Balaena biscayensis*. This was purchased from Prof. H. A. Ward, of Rochester, New York, who procured it from Amagansett, Long Island. The skeleton, as now mounted, is about 43 feet long. The skeletons of several other important cetaceans were added to the collection during the year. Most prominent among these is Sowerby's whale, *Mesoplodon bidens*, a male specimen of which was obtained through the crew of the U. S. Life-Saving Station at Atlantic City, New Jersey (Capt. J. L. Gaskell, keeper). Further mention of this specimen will be found in the report of the department of mammals, (p. 350.)

The skull of a female Narwhal, bearing two equally-developed horns 41 inches long, was purchased from Robert Kinnes, of Dundee, Scotland. It was obtained by Capt. James Fairweather, of the steamship *Aurora*, of Dundee, in Prince Regent's Inlet, Lancaster Sound, in July, 1887. From the U. S. Fish Commission were obtained a skeleton of a small Spotted dolphin, *Prodelphinus longirostris*, and one of the large spotted species, *Prodelphinus plagiodon*. The skeleton of a young Killer whale was obtained from Prof. Robert Collett, director of the Zoological Museum of Christiania, Norway, in exchange for other specimens. Skulls of *Balenoptera rostrata*, *Delphinus delphis*, and *Phocena communis* were also received.

The authorities of the Australian Museum presented skeletons of a number of Marsupials, including *Cuscus orientalis* and *Belideus ariel*. Of much importance for comparison with the West Indian seal is the skeleton of the Mediterranean seal, *Monachus albiventer*, presented by Prof. H. H. Giglioli, director of the Royal Zoological Museum of Florence, Italy, in exchange for other specimens.

The Museum purchased from Capt. F. G. Fry, a remarkably large and well-developed skeleton of a male Gorilla.

One of the most interesting accessions during the year was the skeleton of the Fork-tailed Gull, *Creagrus furcatus*, which, so far as known, is the only skeleton of this species of bird in any museum. It was obtained by the naturalists of the U. S. Fish Commission steamer *Albatross*. The Commissioner also presented a collection of birds of the Galapagos Islands, and of the Straits of Magellan.

The authorities of the Auckland Museum presented a collection of typical New Zealand birds, preserved in alcohol. Among the specimens were representatives of the genera *Stringops* and *Apteryx*.

A similar alcoholic collection of Australian birds, including species of various characteristic genera, such as *Ocydromus*, *Calenias*, and *Megapodius*, was received from the Australian Museum, Sydney, New South Wales.

Among the collections made by Dr. L. F. H. Birt, at Greytown, Nicaragua, were considerable numbers of birds in alcohol, including certain Trogons and Toucans, which had been among our desiderata. Six Elephant Tortoises, brought alive from the Galapagos Islands by the U. S. Fish Commission, died in captivity, and their skeletons were acquired by this department. The skeletons of two Boas were obtained.

The most important change in the exhibition hall was the enlargement of the large wall case on the north side of the hall by the addition of a west wing. The wing agrees in design with the remainder of the case, but is somewhat deeper. Its length is 21 feet; depth, 3 feet. On account of the additional space afforded it has been possible to improve the arrangement of the mounted skeletons of Primates and Carnivores.

The purchase of the large skeleton of a Right Whale, already referred to, made it necessary to change the position of all the large whalebone

whales, previously on exhibition. After the consideration it was thought best to hang the skeleton of the Humpback Whale, which is somewhat lighter than the others, from large iron brackets at the east side of the hall. A suitable design was made by Mr. Lucas, assistant curator, and the brackets were made by the People's Iron Works, Philadelphia. The skeleton was hung without difficulty, and the plan proved entirely satisfactory. It is improbable that we shall be able to suspend any more large skeletons from the roof of this hall, and in the future must resort to other methods of installation. Skeletons of the Great Bowhead and the Sperm Whale, which are still among our desiderata, would be much heavier than any of the skeletons now in position.

Each of the series represented in the exhibition collection has received more or less important additions during the year. The number of specimens in each series at the end of the year was as follows:

Mammals—	No. of specimens.
Skeletons	192
Skulls	32
Birds—	
Skeletons	41
Reptiles and Batrachians—	
Skeletons	37
Fishes—	
Skeletons	23
Invertebrates	88
Anatomical models and preparations	4
Series illustrating the growth and replacement of teeth	59
Series representing the morphology of limbs	37
Series illustrating the structure of horns	16
Casts of skulls showing brain capacity	14
Miscellaneous	43
Total number of specimens on exhibition	606

As already stated, the preparators were engaged chiefly in cleaning and preparing for the exhibition and study series a portion of the material that had accumulated in the workshops and storagerooms. One preparator was engaged almost exclusively in cleaning the skulls of small species of mammals deposited by the Department of Agriculture. About five hundred of these skulls were cleaned during the year.

A considerable part of the time of the chief preparator was occupied by the arrangement of the collection of vertebrate fossils, and in mounting a cast of the skeleton of *Dinoceros*, which work, though very necessary, was not connected with this Department. Mr. Lucas was also detailed to pack the collection of mammals exhibited in the Cincinnati Exposition.

The amount of work done by the preparators during the year is indicated by the subjoined table, which was prepared by Mr. Lucas :

	Skulls		Skeletons.		Portions of skeletons.		Rough specimens prepared from fresh specimens.
	Cleaned.	Mounted.	Cleaned.	Mounted.	Cleaned.	Mounted.	
Mammals.....	519	10	12	6	9		11
Birds.....	5		47	4	1		25
Reptiles and batrachians.....	7		3	1		5	10
Fishes.....	1		2				2
Total.....	532	10	64	11	10	5	48

The preparation of a much-needed card-catalogue of birds preserved in alcohol was begun, and a large amount of work in classifying and caring for this material was carried out.

The numbers of the last entries in the different catalogues in June, 1889, and those for the previous year, are given in the following table:

Class.	Last entry recorded in catalogue.		Increase.
	June 30, 1888.	June 30, 1889.	
Mammals.....	22,998	23,781	783
Birds.....	18,256	18,508	252
Reptiles and batrachians.....	29,247	29,261	14
Fishes.....	26,079	26,084	5
Total.....			1,054

REPORT ON THE DEPARTMENT OF PALEOZOIC FOSSILS
IN THE U. S. NATIONAL MUSEUM, 1889.

BY C. D. WALCOTT, *Honorary Curator.*

In the annual report for the last fiscal year, I stated that 10,955 specimens had been placed in the exhibition cases. During the first six months of the present fiscal year Dr. R. R. Gurley was engaged in rewriting the labels of the exhibition series and in incorporating the new material which he had worked over in the laboratory. I had anticipated adding quite largely to the collections from the material belonging to the Geological Survey now stored in the laboratory, but owing to a long absence in the field and a subsequent determination to publish a paper on the fauna of the Olenellus zone, little opportunity has occurred to work on the collections.

Dr. Gurley began, about March 1 last, a study and arrangement of the graptolites contained in the Museum collection. During the months of May and June he was engaged in collecting graptolites in the Hudson River valley of New York, and it is expected that the specimens there obtained will be incorporated in the Museum collections during the present fiscal year. My own field and office work during the past year has contributed to the Museum collections a large series of Lower and Middle Cambrian fossils from Newfoundland. The Lower Cambrian genera and species have been worked out and named, and a number of new genera and species added to the collections. From Newfoundland alone, some three thousand specimens have been transferred to the Museum. The collection of fossils from the Silurian (Ordovician) rocks has not been materially enlarged, owing to lack of time to transfer the collections made by the Geological Survey and now stored in the laboratory of this department in the Museum building. During the year large collections were made from the Silurian (Ordovician) rocks of New York which will ultimately be transferred to the Museum.

A report on "The Fauna of the Olenellus Zone" is now completed and will be published by the U. S. Geological Survey. A paper containing the descriptions of the new genera and species was transmitted for publication in the Proceedings of the National Museum.

The more important accessions received during the year are:

Accession 19689.—This accession includes the type and figured specimens of Dr. D. D. Owen, which were used in his pioneer work in the Upper Mississippi Valley.

This collection is of historic value, and is a most interesting addition to the Museum collections, although many types are missing.

Accession 20525.—The Lea collection, which contains a number of fine specimens that are suitable for the exhibition series, and a large number for the student collection.

Accession 21650 is of value in affording the means of comparison between the Cambrian fauna of Sweden and that of North America. There are a number of species illustrating genera that are not known from North American strata.

Accession 21716 is a small but very welcome addition to the Museum collections, as the fauna of the Calciferous terrane of New York is very meager and but poorly represented in the collections.

Accession 21838 adds materially to the series of graptolites and, with accession 21887, gives the Museum a fair representation of that fauna from Canada.

Accession 21855 gives the data for comparison of an extensive group of problematical fossils from the Silurian (Ordovician) strata of Portugal with somewhat similar forms from Great Britain and North America.

Accession 21861 contains the types of thirteen species, and the collection is of interest and value from its having been the means of settling a most important geologic question in relation to North American geology. United with accession 21914 it gives the largest series of Cambrian fossils yet obtained from Newfoundland.

Accessions 21904 and 21869 add to the means of comparison of the European Cambrian fauna with that of North America, and also give a representation of several genera not hitherto known to the Museum collections.

RECAPITULATION OF ACCESSIONS RECEIVED DURING THE YEAR.

Accession No.	No. of genera.	No. of species.	No. of specimens.
20956.....	8	8	19
21130.....	8	3	16
21286*.....			
21352†.....	3	5	
21521.....	3	3	19
21629.....	9	12	69
21630.....	10	13	95
21639.....	13	22	682
21650.....	24	46	431
21654.....	12	13	17
21656.....	5	5	6
21657.....	2	2	3
21716.....	6	7	21
21720.....	1	1	1
21738‡.....			
21838.....	9	12	37
21845.....	2	2	3
21855.....	2	4	13
21861.....	16	26	125
21869.....	9	12	36
21876.....	7	8	33
21887§.....			
21963.....	3	3	6
21904.....	10	12	315
21914.....	15	19	3,241
22046§.....			
Total.....	172	238	5,179

* In process of study and identification.

† Not yet identified.

‡ For reference to Department of Lithology.

§ Not yet examined.

A complete list of the accessions for the year will be found in Section V of the report. A number of accessions which had been received before this year, but which it has not been possible to open up before the present year, are here noted :

Accession No. 12157. From Albert I. Phelps, Damariscotta, Maine. Material from shell-heaps. Referred to Department of Ethnology.

Accession No. 12464. From U. S. Geological Survey, Washington, District of Columbia.

Accession No. 19395, from F. H. Knowlton, U. S. National Museum, Washington, District of Columbia, of no palaeontological value, and destroyed.

Accession No. 19689, from the Indiana State University, Bloomington, Indiana, through Prof. D. S. Jordan, as follows :

Character of specimens.	No. of specimens.	
Pre-Cambrian :		
Mud-markings	1	Figured.
Facoids	3	Do.
Potadam formation of the Upper Cambrian :		
<i>Lingula ampla</i> , Owen	2	Type.
<i>Lingulepis pinniformis</i> , Owen	4	Do.
<i>Obolella polita</i> , Hall	2	Do.
<i>Ditrocephalus minnesotensis</i> , Owen	21	Do.
<i>pepinensis</i> , Owen	8	Do.
<i>Ptychoparia minor</i>	1	Do.
<i>Crepicephalus iowensis</i> , Owen	3	Do.
<i>Ptychaspis miniskensis</i> , Owen	1	Do.
Lower Silurian (Ordovician) :		
<i>Lingula quadrata</i> , Eichwald?	1	Figured.
sp. undetermined	1	Do.
<i>Strophomena (Leptæna) trilobata</i> , Owen	1	Type.
<i>Leptæna sericea</i> , Sowerby?	2	Do.
<i>Orthis bifurcata</i> , Schlotheim	3	
<i>dentata</i> , Pander	15	
<i>borealis</i> , Billings	6	
<i>testudinaria</i> , Dalman	150	
<i>occidentalis</i> , Hall	2	Figured.
<i>subquadrata</i> , Hall	3	
<i>disparilis</i> , Conrad	1	
<i>ella</i> , Hall	6	
<i>plicatella</i> , Hall	4	
sp. undetermined	2	Do.
<i>Zygospira modesta</i> , Say	30	
<i>cincinnatiensis</i> , James	20	
<i>Rhynchonella</i>	3	
<i>Ambonychia bellistriata</i> , Hall	2	Do.
<i>Conocardium antiquum</i> , Owen	1	Type.
<i>Cyrtolites ornatus</i> , Conrad?	1	Figured.
<i>Bucania</i> , n. sp.	2	Do.
<i>Pleurotomaria muralis</i> , Owen	1	Type.
<i>subconica</i> , Hall	4	
sp. undetermined	1	Figured.
<i>Murchisonia bellisincta</i> , Hall	4	Do.
<i>Trochonema umbilicatum</i> , Hall	1	
<i>Oytherina</i> sp. undetermined	1	Do.
<i>Asaphus (Isotelus) iowensis</i> , Owen	12	Type.
<i>cornigerus</i> , Brongniat	12	

Character of specimens.	No. of specimens.	
Niagara formation of the Silurian :		
<i>Strophomena</i>	2	Figured.
<i>Atrypa reticularis</i> , Linnæus	2	
<i>Leperditia baltica</i> , Hisinger	2	
Devonian :		
<i>Zaphrentis gigantea</i> , Rafinesque	1	
<i>Fenestella milleri</i> , Lonsdale?	1	Do.
<i>Gorgonia</i> (allied to <i>G. repisteria</i>)	1	Do.
<i>Chonetes</i> sp. undetermined	1	Do.
<i>Strophodonta demissa</i> , Conrad	1	Do.
<i>Orthis lentiformis</i> , Vanuxem?	1	Do.
<i>Spirifera atwaterana</i> , Miller (the <i>S. pennata</i> , Owen, preoccupied	2	Type.
<i>liga</i> , Owen	1	Do.
var	1	Figured.
<i>cedarensis</i> , Owen	1	Type.
<i>euruleines</i> , Owen	3	Do.
<i>iowensis</i> , Owen	1	Do.
n. sp.?	1	Figured.
<i>Atrypa</i> n. sp.?	1	
<i>Pentamerus conis</i> , Owen	1	Type.
n. sp.?	1	Figured.
<i>Pleurotomaria lucina</i> , Hall	2	
<i>Euomphalus</i>	1	
<i>Homalonotus</i>	1	
<i>Phacops</i>	1	
Lower Carboniferous :		
<i>Cyathophyllum fungites</i> , Fleming?	1	Do.
<i>Campophyllum torquium</i> , Owen	1	Type.
<i>Agassizocrinus conicus</i> , Owen	1	Do.
Annelid trails	1	
<i>Archimedes</i>	2	Figured.
Productal limestone	3	Do.
<i>Productus prattenianus</i> , Norwood	1	
<i>Chonetes iowensis</i> , Owen	1	Type.
<i>granulifera</i> , Owen	8	Do.
<i>Streptorhynchus crenistria</i> , Phillips	1	Figured.
<i>Spirifera camerata</i> , Morton	1	Do.
<i>striata?</i> var. <i>attenuata?</i> Vern. & De Kon	1	Do.
<i>Terebratula serpentina?</i>	1	Do.
<i>Entolium</i>	1	Do.
<i>Allorisma regularis</i> , D'Orbigny?	1	Do.
<i>Bellerophon hiuleus</i> , Sowerby?	1	
<i>Nautilus burlingtonensis</i> , Owen	1	Type.
<i>Discites tuberculatus</i> , Owen	1	Do.
<i>Phillipsia</i>	1	
Unidentified	2	
Upper Coal Measures of the Carboniferous :		
<i>Lophophyllum proliferum</i> , McChesney	12	
<i>Lingula mytiloides</i> , Sowerby	3	
<i>Productus longispinus</i> , Sowerby	12	
<i>pertenuis</i> , Meek	1	
<i>cora</i> , D'Orbigny	5	
<i>Chonetes mesoloba</i> , Nor. & Prat	1	
<i>granulifera</i> , Owen	6	
<i>Streptorhynchus</i>	7	

Character of specimens.	No. of specimens.
Upper Coal Measures of the Carboniferous—Continued.	
<i>Orthis pecosi</i> , Marcon	2
<i>Spirifera camerata</i> , Morton	2
<i>planocoveza</i> , Shumard	12
<i>Spiriferina kentuckiensis</i> , Shumard	3
<i>R. tzia</i>	8
<i>Athyris</i>	9
<i>Rhynchonella</i>	9
<i>Schizodus</i>	9
<i>Clinopistha radiata</i> , Hall	1
<i>Edmondia</i>	2
<i>Bellerophon</i>	12
<i>Pleurotomaria spironema</i> , M. & W	4
sp. undetermined	15
<i>Naticopsis wheeleri</i> , Swallow	11
sp. undetermined	1
<i>Acisina robusta</i> , Stevens	2
<i>Orthonema conicum</i> , M. & W	1
<i>Macrochitina altonensis</i> , M. & W	3
sp. undetermined	5
<i>Nautilus planovoleis</i> , Shumard	1
<i>Orthoceras</i>	1
Unidentified	4

The collection contains five hundred and sixty-one specimens, representing 62 genera and 111 species. Those marked "Type" or "Figured" are described or illustrated in Dr. D. D. Owen's "Report on Wisconsin, Iowa, and Minnesota."

Accession No. 20.525. From Dr. Isaac Lea (deceased), through Mrs. M. J. Chase, Philadelphia, Pennsylvania, as follows:

No.	No.
Pre-Cambrian—	Lower Silurian (Ordovician)—Continued.
<i>Palaeotrochus minor</i> , Emmons	<i>Glyptocystites multiporus</i> , Billings
Lower Cambrian—	<i>Glyptocystites</i>
<i>Olenellus thompsoni</i> , Hall	<i>Stictopora elegantula</i> , Hall
Middle Cambrian—	<i>Monticulipora</i>
<i>Hyolithes shaleri</i>	<i>Strophomena</i>
<i>Paradoxides harlani</i> , Green	<i>Orthis biforata</i> , Schlotheim
Upper Cambrian—	<i>testudinaria</i> , Dalman
Unidentified	<i>occidentalis</i> , Hall
Lower Silurian (Ordovician)—	<i>subquadrata</i> , Hall
<i>Receptaculites neptuni</i> , De France	<i>Orthis</i>
<i>Zaphrentis canadensis</i> , Billings	<i>Zygospira</i>
<i>Calceola</i>	<i>Rhynchonella</i>
<i>Glyptocrinus decadactylus</i> , Hall	<i>Pterinea</i>
<i>Amygdalocystites radiatus</i> , Billings	<i>Ambonychia bellistriata</i> , Hall
<i>Agelaerinus</i>	<i>Tellinomya nasuta</i> , Hall
<i>Comarocystites punctatus</i> , Billings	<i>logani</i> , Salter
<i>Pleurocystites filixtus</i> , Billings	<i>Bellerophon bilobatus</i> , Sowerby
sp. undescribed	<i>Bellerophon</i>
<i>Pleurocystites</i>	<i>Raphistoma lenticulare</i> , Emmons

Character of specimens.	No. of specimens.	
Niagara formation of the Silurian :		
<i>Strophomena</i>	2	Figured.
<i>Atrypa reticularis</i> , Linnaeus	2	
<i>Leperditia baltica</i> , Hisinger	2	
Devonian :		
<i>Zaphrentis gigantea</i> , Rafinesque	1	
<i>Fenestella milleri</i> , Lonsdale?	1	Do.
<i>Gorgonia</i> (allied to <i>G. repisteria</i>)	1	Do.
<i>Chonetes</i> sp. undetermined	1	Do.
<i>Strophodonta demissa</i> , Conrad	1	Do.
<i>Orthis lentiformis</i> , Vanuxem?	1	Do.
<i>Spirifera atwaterana</i> , Miller (the <i>S. pennata</i> , Owen, preoccupied	2	Type.
<i>liga</i> , Owen	1	Do.
var	1	Figured.
<i>cedarensis</i> , Owen	1	Type.
<i>euruleines</i> , Owen	3	Do.
<i>iowensis</i> , Owen	1	Do.
n. sp. ?	1	Figured.
<i>Atrypa</i> n. sp. ?	1	
<i>Pentamerus comis</i> , Owen	1	Type.
n. sp. ?	1	Figured.
<i>Pleurotomaria lucina</i> , Hall	2	
<i>Euomphalus</i>	1	
<i>Homalonotus</i>	1	
<i>Phacops</i>	1	
Lower Carboniferous :		
<i>Cyathophyllum fungites</i> , Fleming?	1	Do.
<i>Campophyllum torquium</i> , Owen	1	Type.
<i>Agassizocrinus conicus</i> , Owen	1	Do.
Annelid trails	1	
<i>Archimedes</i>	2	Figured.
Productal limestone	3	Do.
<i>Productus prattenianus</i> , Norwood	1	
<i>Chonetes iowensis</i> , Owen	1	Type.
<i>granulifera</i> , Owen	8	Do.
<i>Streptorhynchus crenistria</i> , Phillips	1	Figured.
<i>Spirifera camerata</i> , Morton	1	Do.
<i>striata</i> ? var. <i>attenuata</i> ? Vern. & De Kon	1	Do.
<i>Terebratula serpentina</i> ?	1	Do.
<i>Entolium</i>	1	Do.
<i>Allorisma regularis</i> , D'Orbigny?	1	Do.
<i>Bellerophon hiulcus</i> , Sowerby?	1	
<i>Nautilus burlingtonensis</i> , Owen	1	Type.
<i>Discites tuberculatus</i> , Owen	1	Do.
<i>Phillipsia</i>	1	
Unidentified	2	
Upper Coal Measures of the Carboniferous :		
<i>Lophophyllum proliferum</i> , McCheaney	12	
<i>Lingula mytiloides</i> , Sowerby	3	
<i>Productus longispinus</i> , Sowerby	12	
<i>pertenuis</i> , Meek	1	
<i>cora</i> , D'Orbigny	5	
<i>Chonetes mesoloba</i> , Nor. & Prat	1	
<i>granulifera</i> , Owen	6	
<i>Streptorhynchus</i>	7	

Character of specimens.	No. of specimens.
Upper Coal Measures of the Carboniferous—Continued.	
<i>Orthis pecosi</i> , Marcon	2
<i>Spirifera camerata</i> , Morton	2
<i>planoconvexa</i> , Shumard	12
<i>Spiriferina kentuckiensis</i> , Shumard	3
<i>R-tzia</i>	8
<i>Athyris</i>	9
<i>Rhynchonella</i>	9
<i>Schizodus</i>	9
<i>Clinopistha radiata</i> , Hall	1
<i>Edmondia</i>	2
<i>Bellerophon</i>	12
<i>Pleurotomaria spironema</i> , M. & W	4
sp. undetermined	15
<i>Naticopsis wheeleri</i> , Swallow	11
sp. undetermined	1
<i>Aclisina robusta</i> , Stevens	2
<i>Orthonema conicum</i> , M. & W	1
<i>Macrochilina altonensis</i> , M. & W	3
sp. undetermined	5
<i>Nautilus planovoleis</i> , Shumard	1
<i>Orthoceras</i>	1
Unidentified	4

The collection contains five hundred and sixty-one specimens, representing 62 genera and 111 species. Those marked "Type" or "Figured" are described or illustrated in Dr. D. D. Owen's "Report on Wisconsin, Iowa, and Minnesota."

Accession No. 20.525. From Dr. Isaac Lea (deceased), through Mrs. M. J. Chase, Philadelphia, Pennsylvania, as follows:

	No.		No.
Pre-Cambrian—		Lower Silurian (Ordovician)—Continued.	
<i>Palaotrochus minor</i> , Emmons	25	<i>Glyptocystites multiporus</i> , Billings	55
Lower Cambrian—		<i>Glyptocystites</i>	1
<i>Olenellus thompsoni</i> , Hall	1	<i>Stictopora elegantula</i> , Hall	10
Middle Cambrian—		<i>Monticulipora</i>	61
<i>Hyolithes shaleri</i>	1	<i>Strophomena</i>	15
<i>Paradoxides harlani</i> , Green	4	<i>Orthis biforata</i> , Schlotheim	50
Upper Cambrian—		<i>testudinaria</i> , Dalman	85
Unidentified	4	<i>occidentalis</i> , Hall	40
Lower Silurian (Ordovician)—		<i>subquadrata</i> , Hall	7
<i>Receptaculites neptuni</i> , De Franco	1	<i>Orthis</i>	12
<i>Zaphrentis canadensis</i> , Billings	5	<i>Zygospira</i>	60
<i>Calceola</i>	1	<i>Rhynchonella</i>	6
<i>Glyptocrinus decadaelytus</i> , Hall	10	<i>Pterinea</i>	1
<i>Amygdalocystites radiatus</i> , Billings	1	<i>Ambonychia bellistriata</i> , Hall	1
<i>Agelaerinus</i>	1	<i>Tellinomya nasuta</i> , Hall	2
<i>Comarocystites punctatus</i> , Billings	1	<i>logani</i> , Salter	1
<i>Pleurocystites flitczus</i> , Billings	11	<i>Bellerophon bilobatus</i> , Sowerby	1
sp. undescribed	22	<i>Bellerophon</i>	1
<i>Pleurocystites</i>	2	<i>Raphistoma lenticulare</i> , Emmons	3

	No.		No.
Lower Silurian (Ordovician)—Continued.		Upper Silurian—Continued.	
<i>Murchisonia bellicincta</i> , Hall	2	<i>Illanus</i>	1
<i>Murchisonia</i>	21	<i>Dalmanites caudatus</i> , Green	4
<i>Cyclonema biliz</i> , Conrad	19	<i>Dalmanites</i>	3
<i>Maclurea logani</i> , Salter	2	Miscellaneous	24
<i>Subulites elongatus</i> , Conrad	2	Devonian—	
<i>Oncoceras constrictum</i> , Hall	1	<i>Cyatiphyllum americanum</i> , E. & H.	1
<i>Orthoceras strigatum</i> , Hall	1	<i>plicatum</i> , Goldfuss	1
<i>Trinucleus concentricus</i> , Eaton	14	<i>Cyatiphyllum</i>	3
<i>Asaphus platycephalus</i> , Stokes	4	<i>Favosites hemisphericus</i> , Y. & Sh	2
<i>Asaphus</i>	1	<i>tuberosus</i> , Rominger	1
<i>Illanus</i>	1	Annelid trails	1
<i>Dalmanites callicephalus</i> , Green	1	<i>Spirifera euruteines</i> , Owen	2
<i>Ceraurus pleurexanthemus</i> , Green	1	<i>Spirifera</i>	4
Unidentified	8	<i>Atrypa reticularis</i> , Linnæus	4
Upper Silurian—		<i>aspera</i> , Schlothheim	3
<i>Halsites catenulatus</i> , Linnæus	6	<i>Conocardium</i>	2
<i>Helolites</i>	2	<i>Pleurotomaria</i>	1
<i>Amplexus shumardi</i> , Edw	1	<i>Lozonema</i>	1
<i>Calceola sandalina</i> , Lamarck	1	<i>Homalonotus dekayi</i> , Green	2
<i>Favosites favosus</i> , Goldfuss	4	<i>Phacops</i>	1
<i>Favosites</i>	6	Carboniferous—	
<i>Actinocrinus moniliformis</i> , Miller (†)	1	<i>Pentremites</i>	12
<i>Cornulites</i>	1	<i>Productus longispinus</i> , Sowerby	7
<i>Strophomena rhomboidalis</i> , Wilckens	5	<i>cora</i> , D'Orbigny	2
<i>Strophomena</i>	1	<i>semireticulatus</i> , Martin	1
<i>Spirifera arenosa</i> , Conrad	0	<i>Spirifera camerata</i> , Morton	2
<i>Athyris</i>	2	<i>lateralis</i> , Hall	1
<i>Atrypa reticularis</i> , Linnæus	6	<i>Spirifera</i>	1
<i>Pentamerus oblongus</i> , Sowerby	0	<i>Athyris subtilita</i> , Hall	20
<i>galeatus</i> , Dalman	4	<i>Terebratula bovidens</i> , Morton	6
<i>Pentamerus</i>	2	<i>Nucula</i>	1
<i>Leptocælia hemispherica</i> , Sowerby	1	<i>Nuculana bellistriata</i> , Stevens	5
<i>Megalomus canadensis</i> , Hall	1	<i>Bellerophon carbonarius</i> , Cox	12
<i>Tentaculites</i>	1	<i>Bellerophon</i>	4
<i>Huronia vertebralis</i> , Stokes	2	<i>Pleurotomaria spironema</i> , M. & W	2
<i>Calymene blumenbachii</i> , Brongniart	5	<i>Pleurotomaria</i>	12
<i>macrophthalmus</i>	3	<i>Leaia tricarinata</i> , M. & W	2
<i>Calymene</i>	11		

The collection contains seven hundred and thirty-seven specimens, representing 64 genera and 103 species.

As a whole, the accessions for the year are a valuable addition to the exhibition and study series of the Museum.

The material in the collections has been increased during the year by the addition of 6,477 specimens.

The catalogue numbers taken up during the year are from 17,847 to 18,430, both inclusive.

I respectfully repeat the recommendation, urged in my previous annual reports, that a sum be reserved, annually, for increasing the Museum collection by the purchase of small collections of type specimens, which can not be obtained in any other way.

REPORT ON THE DEPARTMENT OF MESOZOIC FOSSILS
IN THE U. S. NATIONAL MUSEUM, 1889.

By C. A. WHITE, *Honorary Curator.*

Although the time which could be devoted to the work of the department has been very limited, owing to the official duties devolving upon me and my assistants in connection with the U. S. Geological Survey, the fossil collections in the Museum have been put into better and more accessible shape than they have ever been in before. The ordinary routine work of the division has also been performed as usual.

Aside from important collections of fossils which have been both formally and informally turned over from the U. S. Geological Survey to the Museum, the accessions have not been numerous during the year; the number in all being only thirteen. The most important of these last named accessions are the type specimens of twelve species of Cretaceous fossils which were published in the Geological report of Dr. David Owen on Iowa, Wisconsin, and Minnesota, and which were transmitted to the Museum by President D. S. Jordan, of the Indiana State University. Besides these a small but interesting collection of Cretaceous fossils from St. Paul's and St. Peter's Islands in the Straits of Magellan were received through the U. S. Fish Commission. They were collected by members of the Commission upon the cruise of the Steamer *Albatross* of 1888-'89.

Up to the beginning of the past year none of the fossils of this division had been properly installed for exhibition. Early in the present calendar year the Director of the Museum assigned ten glass top-frames to ten of the fifteen cases which had been previously assigned to this division in the southeast court. He also detailed Dr. R. R. Gurley to aid in the work of installing selections of fossils in the cases mentioned, and the work was accomplished by him and my assistant, Mr. C. B. Boyle, jointly, who were assisted for a month by a temporary assistant, Mr. C. W. Hayes, of the Geological Survey.

The collections which now fill the glass covered cases consist mainly of the numerous type specimens of the species which have been published in the various Government reports.

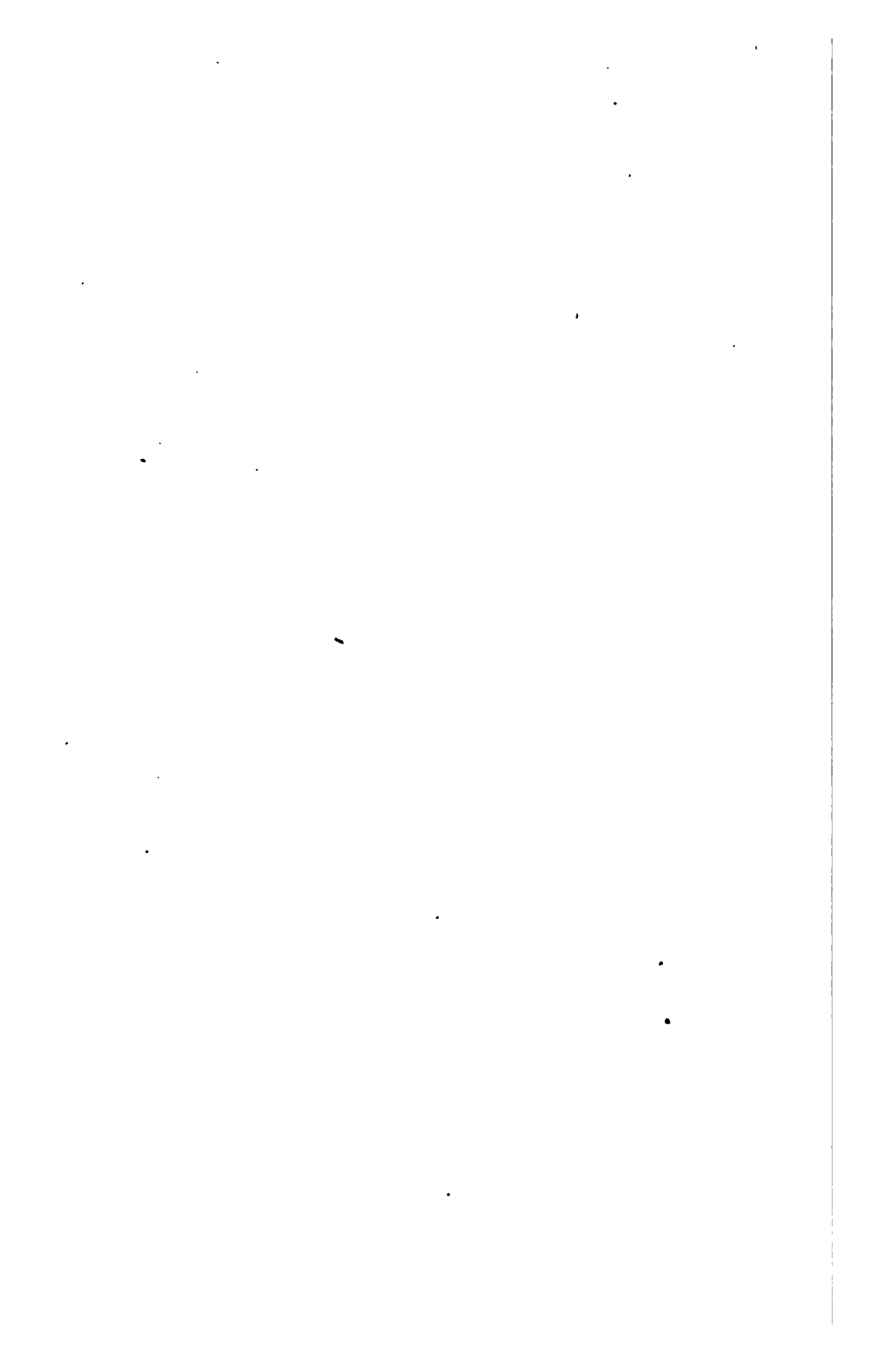

REPORT ON THE DEPARTMENT OF BOTANY
IN THE U. S. NATIONAL MUSEUM, 1889.

By GEORGE VASEY, *Honorary Curator.*

In view of the great amount of current work, I have not been able to make a catalogue of the plants contained in the Herbarium, but am only able to state in general, that that part of the Herbarium which is in the Department of Agriculture is disposed in cases which are arranged against the walls of three rooms, occupying in all a wall-space of about 85 running feet; that the cases are 8 feet high and divided into spaces about 6 inches high, 13 inches wide, and 18 inches deep; and that of such spaces there are about 16 in each row, making a total of more than 1,300 spaces or shelves. We estimate that the shelves each contain, on an average, about one hundred sheets, or altogether more than one hundred and twenty thousand sheets. These are properly arranged in orders, genera, and species, and labeled so as to be readily accessible. We have a large quantity yet to be mounted and added to the collection, besides a great number of duplicates for distribution and exchange.

The Department of Agriculture has employed for a part of the year three agents to collect botanical specimens and information respecting the vegetation of little known regions. One of these agents has operated in western Texas, one in California (Southern and Lower), and one in Washington. From these agents we have received a large quantity of botanical specimens.

We have received as additions to the Herbarium through the Smithsonian Institution a valuable set of plants collected by officers of the U. S. Fish Commission steamer *Albatross* in South America and Alaska; also several packages collected by Lieutenant Pond of the U. S. Navy, in Lower California and the islands adjacent. We have also received through the Smithsonian Institution, a collection of four hundred species of the plants of Japan, collected by Mr. S. Tegima of the Tokyo Educational Museum, Tokyo, Japan.

We have made from our duplicate collections distributions to the following societies:

- To the Imperial Academy of Sciences, St. Petersburg, Russia.
- To the Herbarium of the Jardin des Plantes, Paris, France.
- To the Herbarium of the British Museum, London, England.
- To the Royal Herbarium, Kew, England.
- To the Botanic Garden, Natal, South Africa.

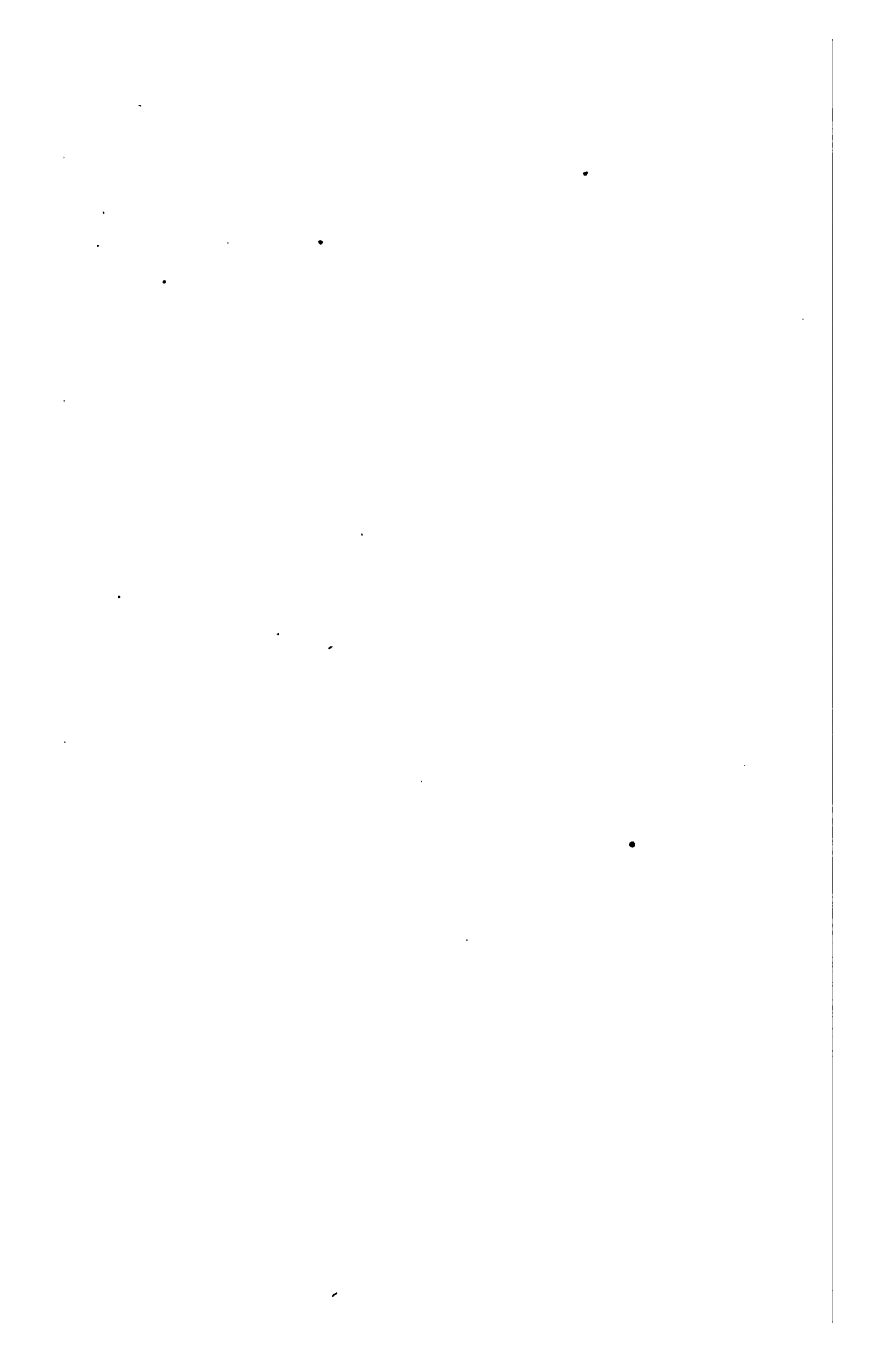

REPORT ON THE DEPARTMENT OF MINERALS
IN THE U. S. NATIONAL MUSEUM, 1889.

By F. W. CLARKE, *Honorary Curator.*

In general the work of the year has followed the usual lines with little variation. The only notable divergence was in the matter of the exhibit at the Cincinnati Centennial Exposition, in which the Department was represented merely by a single case of specimens, to illustrate the gems and precious stones of North America. In the preparation of that exhibit a few very choice gems were added to the collection.

The growth of the collection during the year has been highly satisfactory, and especially so as regards the quality of the material obtained. The two most important accessions were received from the U. S. Geological Survey, in collections made by Profs. S. L. Penfield and W. F. Hillebrand, respectively. The Penfield collection was obtained in two seasons of field work in and near St. Lawrence County, New York, and numbers 1,366 specimens, of which a considerable number are duplicates. It is exceedingly rich in black, brown, and white tourmaline, white and green phlogopite, diopside, calcite, albite crystals, oligoclase, danburite, wollastonite, tremolite, etc., and it contained several almost unique specimens. Of the latter I may mention a huge mass of green fluorite, superbly crystallized, a large pyrite crystal, a radiated brown tourmaline, and a series of most brilliant peristerite feldspars. Dr. Hillebrand's collection was made during a six weeks trip to the Far West, in which he visited the cryolite locality near Pike's Peak; the Tintic District in Utah: Silver City, Georgetown, and Las Cruces, New Mexico; and the Copper Queen Mine in Arizona. The collection embraces the cryolite groups of minerals, a magnificent series of mixite, tyrolite, erinite, and clinoclase; some very brilliant and unusual descloizite, finely crystallized wulfenites, and some extraordinary azurites and fibrous malachite. On his journey Dr. Hillebrand also made some purchases for the Museum, securing among other things a lot of turquoise from Los Cerillos, New Mexico, numbering 363 specimens, mostly duplicates. The descloizite from Georgetown, New Mexico, was a new discovery, and Mr. Alex. McGregor, manager of the mine in which it occurs, has since sent the Museum a superb series of 81 specimens, in-

cluding several choice examples of vanadinite. Both of these species are rare. Dr. Hillebrand also secured valuable gifts of specimens for the Museum from Mr. Richard Pearce, of Denver, and from Messrs. J. W. Howell and B. Williams, of Bisbee, Arizona. In addition to the Penfield and Hillebrand collections, the Geological Survey has also contributed 37 specimens of wood-opal, collected by Dr. A. C. Peale in Montana.

Important gifts of minerals were received from the following donors:

From the Australian Museum at Sidney, fifteen specimens of phacolite, emboelite, etc.

From W. H. Beck, of Washington, fourteen specimens of a new variety of cleizite from Montana.

From Mrs. A. C. Bidwell, of Clip, Arizona, five specimens of dumortierite.

From D. A. Bowman, of Bakersville, North Carolina, specimens of kyanite, beryl, and transparent oligoclase. From one of the kyanites a fine gem has been cut.

From W. G. Clark and G. M. Wilson, of Mullan, Idaho, specimens of plattnerite. This rare species has been lost sight of for nearly fifty years, and its new occurrence is quite noteworthy.

From the Drake Company, Sioux Falls, Dakota, four polished slabs of the Arizona agatized wood.

From H. G. Hanks, of San Francisco, four large crystals of hanksite, the types of a published article.

From J. A. Lucas, of Silver City, New Mexico, eight pseudomorphs of native copper after azurite.

From S. Scott, of Rapid City, Dakota, fifty-nine specimens of minerals from the Black Hills.

From Hon. John Sherman, a large mass of polydymite from Canada. This rare ore of nickel contained traces of platinum.

From Prof. H. L. Wells, of Yale University, a specimen of the new mineral sperrylite.

By exchange the collection has been moderately increased. Nineteen specimens were thus obtained from G. L. English & Co., of Philadelphia; 85 specimens from the museum at Auckland, New Zealand; 327 specimens from C. W. Kesler, of North Carolina, and 128 specimens from Joseph Willcox.

In addition to the specimens already mentioned, a number of choice minerals were secured by purchase. From J. W. Beath, of Philadelphia, forty-seven specimens of gems were bought, including one diamond in the gangue. From C. S. Bement, a large mass of crystallized azurite, probably the finest specimen in existence. From F. H. Butler, of London, two choice crystals of the Egremont calcite. From Dr. F. E. Chatard, a specimen of native silver from Chili weighing eighteen ounces. From G. L. English & Co., eighteen miscellaneous specimens, including the new species beryllonite, and a unique crystal of galena. From A. E. Foote, three remarkable azurites, a specimen of opal agate, and a choice calcite twin. From Tiffany & Co., four cut specimens of agatized wood, two disks of concentric azurite and malachite, and a fine Siberian tablet representing various small fruits carved in different ornamental stones.

These accessions represent the greater part of the material received during the year. On the debit side, the Museum was impoverished by the withdrawal of the Willcox collection, which had been a feature of the mineral exhibit for over four years. Eight hundred specimens were sent out to complete more than twenty exchanges, and sixteen sets of duplicates were distributed to colleges and schools.

The last catalogue number in June, 1888, was 47,837; in June 1889, 48,468. During the year 5,794 individual specimens were catalogued. The routine work of the department has been performed as usual by the Assistant Curator, W. S. Yeates, with characteristic faithfulness and efficiency.

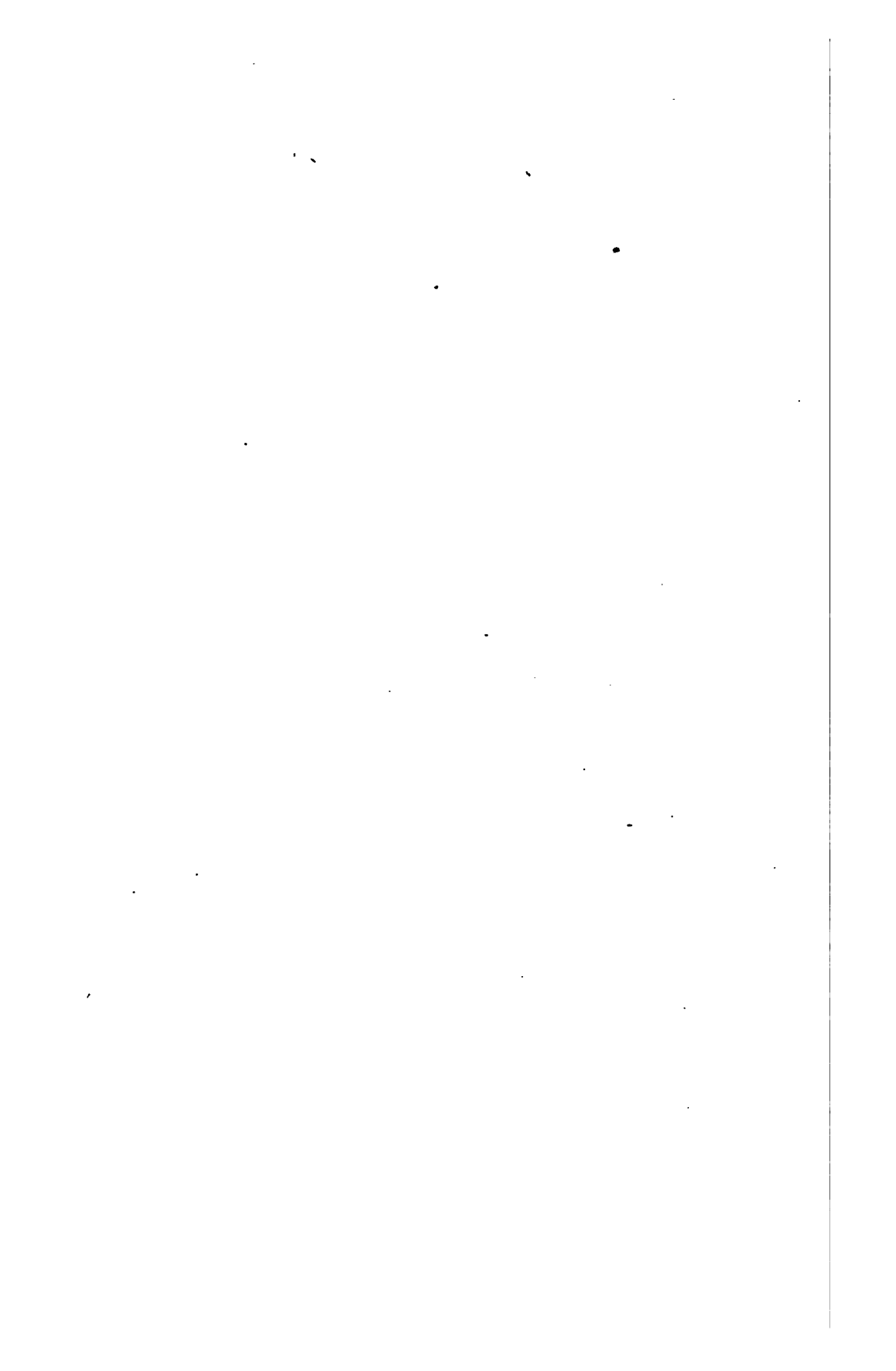

REPORT ON THE DEPARTMENT OF LITHOLOGY AND PHYSICAL GEOLOGY
IN THE U. S. NATIONAL MUSEUM, 1889.

By GEORGE P. MERRILL. *Curator.*

So far as is to be judged from the mere acquisition of materials, the year just closed has been one of unprecedented activity and progress in this department. This may be accounted for by the fact that (1) the Curator has been enabled to visit in person sundry localities and obtain thence desirable materials, and that (2) the department having become fairly established and with a fair amount of duplicate material, we have been enabled to make a series of profitable exchanges. The U. S. Geological Survey has also furnished much valuable matter, as will be noted later.

On July 17 the Curator left on a collecting trip into southwestern North Carolina, returning on the 29th. The main points visited were Webster, Jackson County, and the corundum mines at Cullasaja, Macon County. From these localities were obtained several hundred pounds of necessary material, consisting chiefly of rocks of the peridotite and pyroxenite groups. On August 4 a second trip was made into Pennsylvania, followed during the summer vacation by excursions into northern New York, Vermont, New Hampshire, eastern Massachusetts, and as far east as Eastport, Maine.

The material collected during these trips will be noted under the head of accessions, but mention may be made here of a fine series of slates from Lehigh and Northampton Counties, which were selected with a view to illustrating the efficacy of pressure in the production of slaty cleavage. Blocks were obtained, showing very plainly the eminent cleavage at a sharp angle with the bedding, and also blocks which through lack of homogeneity in various layers, yielded unequally to the compressive force, the finer grained and more uniform portions becoming evenly and finely fissile, while the coarser layers were crimped, crushed, or repeatedly faulted in a very instructive manner.

A series of photographs was also obtained to illustrate certain physical phenomena, such as could not be illustrated by means of specimens.

NOTES ON THE MORE IMPORTANT ACCESSIONS.

The more important accessions of the year are included in the following list:

(1) A large polished block (22 by 21 by 15 inches) of serpentinous limestone (ophiolite or ophicalcite) from Thurman, Warren County, N. Y. Gift of R. T. Baxter, of Glens Falls. The specimen is of value not only on account of its beauty as an ornamental stone, but also as showing the various stages of alteration from pyroxene into serpentine. This stone has been the subject of a special investigation by the Curator. (See bibliography.)

(2) Two samples of Algerian marble, showing fracturing and faulting. Gift of E. Fritsch, 515 and 517 West Twentieth Street, New York City.

(3) A collection comprising some one hundred and eighty specimens modern and antique marbles from European and African localities, received in exchange from the Museum of Natural History in Paris.

(4) An interesting and valuable series of metamorphic and eruptive rocks of Brazil (269 specimens), received in exchange for other materials from Prof. O. A. Derby, of Rio de Janiero.

(5) A series of serpentines and associated rocks from various localities in New York State, received from G. F. Kunz.

(6) A series of peridotites and serpentines from Clickertor and the Cadgwith district, England, in exchange from Mr. R. N. Worth, of Plymouth, England.

(7) A series of rocks and general geological material, including spherulitic felsite, serpentine, geodes, graphite, fossil footprints, infusorial earth, etc., from various localities, received from Prof. W. O. Crosby, of the Boston Society of Natural History, in exchange for other materials.

(8) A polished slab (12 by 14 inches) of green marble from Loudoun County, Virginia. Gift of Mr. G. W. Carter, Washington, D. C.

(9) A series of ninety-two specimens European eruptive rocks, received in exchange for other material from B. Sturtz, of Boun, Prussia.

(10) Some forty specimens of siliceous sinters and eruptive rocks from New Zealand, received in exchange from Prof. T. F. Cheeseman, of the Auckland Museum.

(11) Some sixty-five eruptive and metamorphic rocks from Norway, Sweden, and Scotland, received in exchange for other material from Dr. G. H. Williams, of Johns Hopkins University, Baltimore, Maryland.

(12) A series comprising one hundred and seventeen dressed 4-inch cubes of building and ornamental stones of Austria, received in exchange from Dr. A. Brezina, of the Imperial Museum in Vienna.

(13) Twelve characteristic specimens lavas from the Hawaiian volcanoes. Gift of Mr. E. D. Preston, of the U. S. Coast Survey.

(14) The U. S. Geological Survey has furnished much interesting and valuable material, among which should be mentioned (1) some one hundred and fifty specimens of rocks from Utah, Montana, California, and Oregon, collected under the direction of Mr. J. S. Diller, and comprising theralites, dacites, quartz basalts, and saxonites, as well as fine examples of rain-eroded limestones, jointed shales, and volcanic bombs with large inclosures of granular olivine; (2) some one hundred specimens of trachyte from near Rosita, in the Silver Cliff region, Colorado, collected by Mr. C. Whitman Cross; (3) a series of sixty-four photographs illustrating the topography of lake shores, glacial geology, the tufa deposits of Lake Lahontan, etc., prepared under the direction of Mr. I. C. Russell; (4) specimens of clay baked by burning lignite beds, and other rocks and concretions from Dakota and Montana, collected by Dr. A. C. Peale; (5) the entire collection comprising some two thousand specimens, of the rocks of the Comstock lode and Washoe district, Nevada, from the study of which were prepared the results embodied by Mr. Becker in his report of the geology of this region (Monograph III, U. S. Geological Survey), and also in Messrs. Hague and Iddings' paper on the Development of Crystallization in Igneous Rocks (Bull. U. S. Geological Survey, No. 17), and (6) an instructive series of decomposed rocks, soils, and residual clays, collected under the direction of Mr. I. C. Russell.

(15) A large slab (29 by 77 inches) of Triassic sandstone from Turner's Falls, Massachusetts, with fossil footprints. Selected for the Museum by Prof. C. H. Hitchcock, of Hanover, and obtained from Mr. T. M. Stoughton, of Turner's Falls.

(16) The following materials collected by the Curator, as above alluded to, may also be mentioned: The peridotites and pyroxenites from near Webster and Cullasaja, North Carolina; peridotite, serpentines, vermiculites, and crushed and faulted slates from Pennsylvania; weathered talcose schists from Maine; serpentines from Massachusetts; granite from Concord, New Hampshire; orbicular granite from Craftsbury, Vermont; norite from Keeseville, New York; serpentines and ophiolites from Essex County, New York; all the above being collected in quantity to furnish material not only for our own exhibition series, but also for duplicates.

ROUTINE WORK.

Since the death of Mr. A. J. Forney, which took place October 30, 1888, the department has been without a preparator skilled in stone-cutting and polishing, and hence but little work of this nature has been done. Mr. J. O. Hargrove, who was appointed as a temporary assistant on September 25, has rendered very satisfactory service in trimming and specimens for the exhibition and study series, and has rendered valuable assistance in the work of re-arranging the exhibition series. The clerical work of the department has been carried on, as during the pre-

vious year, in a very satisfactory manner by Mr. W. B. Merrimon. Work was begun early in the fall of 1888 with a view to preparing one hundred sets of rocks, of fifty specimens each, to meet the numerous demands from educational institutions, and it was hoped that the entire series might be made ready for distribution before the close of the year. That it is not as yet ready, is due in a large degree to the lack of satisfactory storage space, though there are also lacking certain materials that are essential to the completion of the series. It is hoped that we may be able to obtain these during the coming summer. A re-assignment of storage space, it should be noted, has necessitated once more a moving of the entire collection of duplicates and unassorted materials.

Twenty-three sets of duplicates, mostly in the way of exchanges, were sent out during the year. They are as follows:

July 11.—To Dr. Stephen Bowers, Ventura, California, two specimens of serpentine from Montville, New Jersey.

July 30.—To Dr. H. S. Lucas, Cullasaja, North Carolina, two specimens of serpentine from Montville, New Jersey.

August 3.—To Mr. W. H. Schreiber, Webster, North Carolina, one specimen of chryome iron ore.

October 4.—To Prof. W. O. Crosby, Boston, Massachusetts, 100 pounds dunite and pyroxenite, from Webster, North Carolina.

October 5.—To O. C. Farrington, New Haven, Connecticut, two specimens serpentine from Montville, New Jersey.

October 15.—To M. A. Lacroix, Paris, France, five specimens of American rocks.

November 8.—B. Sturtz, of Bonn, Prussia, forty-three specimens of miscellaneous rocks from the United States.

November 27.—To M. Meunier, Museum of Natural History, Paris, France, a series of one hundred and one specimens, many of them cut and comprising a variety of building and ornamental stones and eruptive and sedimentary rocks.

December 6.—To Prof. O. A. Derby, Rio Janeiro, Brazil, a series of one hundred and thirty-one specimens American rocks, mainly eruptive.

December 8.—To Prof. E. Haworth, Penn College, Oskaloosa, Iowa, a series of seventy-two specimens miscellaneous rocks, mainly eruptive.

December 12.—To Prof. C. C. Nutting, Iowa City, Iowa, a series comprising twenty-six specimens cut and polished marbles.

February 8, 1889.—To the Maine State College, Orono, Maine (Prof. F. L. Harvey), a series of sixty-one specimens rocks, ores, and minerals from various sources.

February 25.—To the U. S. Geological Survey (loaned for study), six specimens obsidian, from various sources.

March 14.—Transferred to department of animal products, four specimens rock, composed mainly of organic remains.

April 8.—To Dr. A. Brezina, Imperial Royal Museum at Vienna, Austria, a series comprising one hundred and sixteen dressed specimens building and ornamental stones in sizes about 4 by 4 by $\frac{1}{4}$ -inch, and also one hundred and two specimens miscellaneous rocks, ores, and minerals in sizes about 4 by 4 by 1 inch.

May 4.—To Dr. George H. Williams, Johns Hopkins University, Baltimore, Maryland, eleven specimens miscellaneous rocks.

May 4.—To Prof. C. H. Hitchcock, Dartmouth College, Hanover, New Hampshire, sixteen specimens miscellaneous rocks.

May 23.—To Prof. W. S. Bayley, Colby University, Waterville, Maine, six specimens miscellaneous rocks.

May 28.—To Professor J. F. Kemp, Cornell University, Ithaca, New York, five specimens andesites.

June 1.—To Prof. O. A. Derby, four specimens rocks from Montana, Colorado, and California.

July 17.—To Rev. G. E. Post, Beirut, Syria, a collection comprising sixty-four specimens typical rocks and ores.

July 18.—To Prof. W. O. Crosby, Boston, Massachusetts (Boston Society Natural History), a collection comprising nineteen specimens rocks and geological materials.

Special reports on material received for examination and report, and from persons as a rule in no way connected with the Museum, have been prepared as follows:

On Accession 183.—A clay ironstone concretion received from M. Altschul, Hampton, Virginia.

On Accession 178.—Clays received from C. W. Mitchell, Lynchburgh, Virginia.

On Accession 189.—Limestone and pyrite received from M. V. Wheeler, Clayton, West Virginia.

On Accession 166.—Supposed ore received from M. T. Oates and B. L. Morris, Rhome, Texas.

On Accession 201.—Clay marl received from Mary P. Scott, Sioux City, Iowa.

On Accession 203.—Chert nodule received from J. C. Allen, White Gate, Giles County, Virginia.

On Accession 222.—Rocks and ores received from Dr. J. C. Merrill, Frankford Arsenal, Philadelphia, Pennsylvania.

On Accession 220.—Weathered rock received from Mr. Charles Hallock.

On Accession 248.—Received from Mr. John Murray, Sing Sing, New York.

On Accession 264.—A siliceous limestone received from E. M. Treakle, Versailles, Maine.

On Accession 20678.—A supposed fossil egg received from Dr. E. G. Shellack, Allen, Kansas.

On Accession 307.—Rock received from Dr. H. S. Lucas, Cullasaja, North Carolina.

On Accession 333.—Rocks received from Dr. F. W. Taylor, Kingston, New Mexico.

On Accession 340.—Abrading material received from E. B. Pike, Boston, Massachusetts.

On Accession 342.—Carbonaceous limestone received from Daniel Baker, Buckeys-town, Maryland.

On Accession 356.—Quartz and septarian nodules received from E. L. Blume, Mount Savage, Maryland.

On Accession 358.—Fertilizer (?) received from A. N. Lauderdale, Lampasas, Texas.

On Accession 362.—Crinoidal limestone received from J. Voorhees, Wolverton, Minnesota.

On Accession 364.—Calcite received from F. Kidweiler, Harper's Ferry, West Virginia.

On Accession 360.—On lavas from the Hawaiian Islands received from Mr. E. D. Preston, U. S. Coast Survey.

On Accession 367.—Impure limestone and clay marl received from Mr. R. T. Ellis, Grimm's Landing, West Virginia.

On Accession 380.—Feldspar received from F. A. Morey, Keeseville, New York.

On rock from D. W. Brunton, Leadville, Colorado, and referred by F. P. Dewey, of the Museum.

On Accession 404.—Argillaceous sandstone received from M. W. Bacon, Talcott, West Virginia.

On a sample of sandstone (building stone) submitted by Mr. Schureman, of Ohio.

PRESENT STATE OF THE COLLECTION.

Concerning the present state of the collection little can be said that would not be a repetition of what has been given in my previous reports. The collection of building and ornamental stones, as now installed, fills thirteen door screen cases, one wall case, two large pyramids, and the tops of three table cases. The systematic collections illustrating the composition of the earth's crust in its least altered form, that is, the collections of rocks and rock-forming minerals, are now, so far as mere number of specimens is concerned, as large as seems advisable with our present limited amount of space. They still need, however, more or less sifting out and replacement as new and, for the purposes, better material is obtained. In this rock-collection, it should be stated, an attempt is made not merely to show all the kinds of rocks which go to make up any appreciable amount of the earth's crust, but also to a certain extent their geographical distribution. It is deemed of more importance, for instance, to show basalts from America, Europe, and Australia, even though they may closely resemble one another, than to show an equal number of varieties all from one region. These collections now comprise some 2,000 specimens, and are arranged in one pier-case and seven slope-top table-cases on the south side of the exhibition hall. The collections of dynamic and historical geology have both received important accessions, but, owing to a lack of proper cases as well as necessary materials to fill important gaps in the series, no attempt has been made to arrange them systematically. In the historical series, I may say, it is not the intention to show rocks of any particular region arranged according to their geological sequence, but to show rather that the various processes of rock formation are not as a rule confined to any particular geological epoch, but, though particularly active at certain periods, have been carried on more or less intermittently from the earliest times to the most recent. The preparation of such a collection involves a great amount of time and care in its selection, even under the most favorable circumstances.

The figures given below regarding the actual number of specimens are to be regarded as only approximate. As has been mentioned in previous reports, the practice of bringing in material in bulk and breaking or cutting up as occasion demands, renders it impossible to give exact figures, excepting in the cases of the approximately complete exhibition series and the monograph collections of the study series.

Number of specimens in reserve series	23,500
Number of specimens in duplicate series.....	3,500
Total	27,000

The reserve series is distributed as follows:

On exhibition.....	7,500
In drawers for study and comparison	16,000

The exhibition series comprises :

General lithology	2,500
Economic series (building and ornamental stones and stones used in sharp- ening edge-tools).....	3,245
General geology	1,755
Last catalogue entry in June, 1888	69,556
Last catalogue entry in June, 1889	70,691

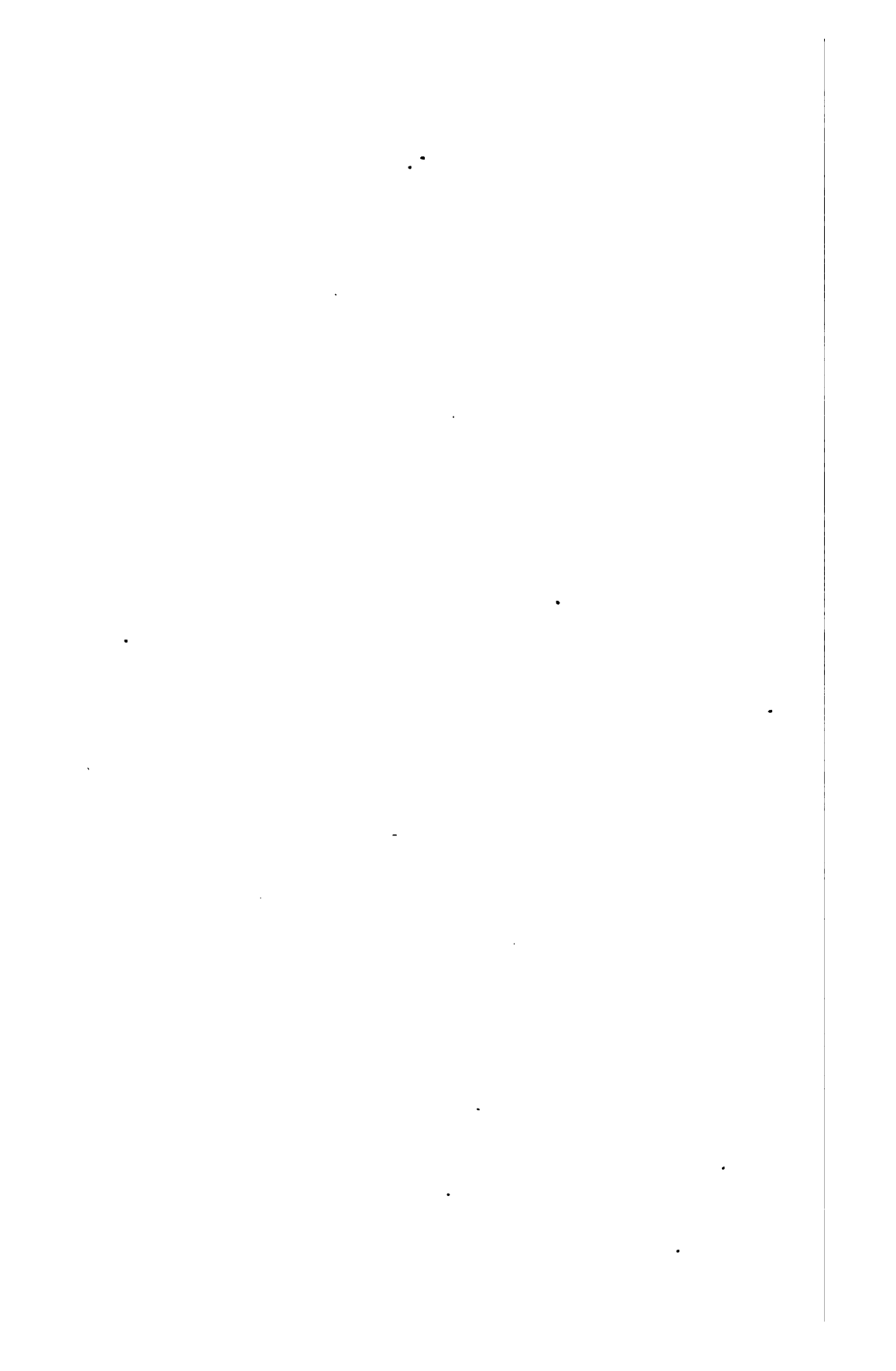

REPORT ON THE DEPARTMENT OF METALLURGY
IN THE U. S. NATIONAL MUSEUM, 1889.

By F. P. DEWEY, *Curator.*

The chief work of the department for the year has been the preparation and arrangement of the material for exhibition in the southwest court upon the plan which was commenced during the previous year.

At first it was contemplated to prepare only one-half of the court for exhibition and then throw it open to the public, but afterwards it was decided to prepare the whole court before any portion was thrown open. This necessitated some changes in the plan of the work, and especially as regards the disposition of duplicate and reserve material. It also increased the labor of handling the specimens, owing to the crowded condition of both the exhibition and storage spaces. The work was pushed forward as rapidly as possible, and the court was thrown open to the public about the middle of April.

In this work of condensing the exhibits to fit the restricted space, it was necessary to remove a large number of specimens from the exhibition series for want of space. Although the cases are even now overcrowded, fully one-third of the exhibition series, as it stood when this work of transfer began, has been removed and divided between the reserve and duplicate series.

In February the Curator made a visit to Providence, Rhode Island, to examine a very valuable collection of petroleum and related materials which had been made for the Museum by Prof. S. F. Peckham. Arrangements were made for sending the collection to Washington in such shape that a portion of it could be immediately placed upon exhibition, in order to continue and complete the collection illustrating the subject of carbon in the systematic series.

The latter part of May the Curator joined the party of American engineers which visited Europe at the invitation of the English, French, and German Engineering societies, and was absent from Washington during the balance of the year. On this trip the Curator visited the museums of London and Paris and also spent considerable time at the exposition in Paris.

The most important accession received during the year was the collection of petroleums mentioned above. This collection was made for

the Museum by Prof. S. F. Peckham, of Providence, Rhode Island, who also prepared the Tenth Census report upon the same subject, and by the connections formed while making this report, he was enabled to gather many specimens, especially those of historical value, which otherwise it would have been impossible to obtain. The collection contains three hundred and fifty specimens, and illustrates very fully the occurrence of crude petroleum in this country, and also contains some representatives of foreign petroleums. A very complete illustration of the technology of the subject, numbering one hundred and fifty-four specimens and donated by Mr. T. G. McMasters, Pittsburgh, Pennsylvania, is included in this collection.

The illustrations of petroleums have been further enriched by a collection of one hundred and twenty-nine specimens received from Prof. J. J. Stevenson, of New York, in exchange for a collection of ores. While the specimens in this collection are mostly small, it fills several gaps in the Peckham collection and is a valuable addition.

Among the collections received during the year which are especially valuable, should also be mentioned a complete illustration of the quicksilver industry at New Almaden, California. The collection shows a complete series of the different characters of ores, together with the associates and rocks of the deposit, a complete illustration of the process of extracting the metal, a very extensive and interesting series of views in and about the mines and works, including a few underground pictures which are especially valuable, a large number of publications relating to the history and development of the mines, and a very interesting and instructive glass model of the mine, showing the contour of the surface and the excavations made underground in working the mine.

A series representing the smelting of pig-iron, by the Shelby Iron Company at Shelby, Alabama. This collection was made upon the general plan adopted for the collections at the New Orleans Exposition.

An interesting series of photographs of the Jones and Laughlin Works at Pittsburgh, Pennsylvania, including a view of the Bessemer converter, taken at night by the light of its own flame, presented by Gretton Bros.

A series of iron oxides from New Hampshire, which are used for paints, obtained from Prof. C. H. Hitchcock, in exchange.

A large model of Aspen Mountain, Colorado, prepared for use in a celebrated law-suit to determine the ownership of very valuable mines. It shows the contour and geology of the surface, and, by means of sections, the underground geology and mining work.

Three series of foreign ores, one from the Australian Museum, one from the Auckland Museum, in New Zealand, and the third, representing the occurrence of manganese ores at Santiago de Cuba, presented by Tirso Roca y Agusti, and forwarded by Consul Otto E. Reimer.

Two researches have been carried on during the year by the Curator. The first was an examination of the production of remarkably strong

pig-iron at the Muirkirk Furnace, 14 miles from Washington. The second was an examination of the nickel from Russell's Springs, Kansas, undertaken at the request of the Hon. J. J. Ingalls.

The total number of specimens in the department remains about the same as at the end of last year, 51,000, the additions during the year being counterbalanced by the removal of worthless material; 12,000 specimens are on exhibition; 15,000 are duplicates, and 12,000 are in the reserve series. The balance consists of unclassified material which is at present considered as reserve material.

One hundred and six accessions have been received during the year, of which 69, containing 111 specimens, were for examination and report. Five special reports were made in answer to questions submitted.

In cataloguing the collection, 505 entries, covering 664 specimens, have been made; and 5,459 card catalogue cards have been written.

First entry in July, 1888.....	51,540	59,465	66,432	68,493
Last entry in June, 1889	51,662	59,601	66,584	68,554

Forty-eight boxes of duplicate and reserve material have been placed in general storage, and fifty-seven specimens have been sent out in exchange.

During the year the Curator has published three articles. The first entitled *Pig Iron of Unusual Strength*, in the *Transactions of the American Institute of Mining Engineers*,* gives the result of the research into the operation of the Muirkirk Furnace. The second, relating to the nickel ore of Russell's Springs, Logan County, Kansas, was a preliminary note on the subject, published in the *Engineering and Mining Journal*,† and the third, on the same subject, published in the *Transactions of the American Institute of Mining Engineers*,‡ gives the result of the examination of this nickel ore.

The clerical work of the department has been ably performed during the year by Mr. W. H. Newhall, assisted during a portion of the time by Mr. T. R. Turnbull.

* Vol. xvii, p. 460.

† Vol. xlvi, p. 213, September 15, 1888.

‡ Vol. xvii, p. 636.

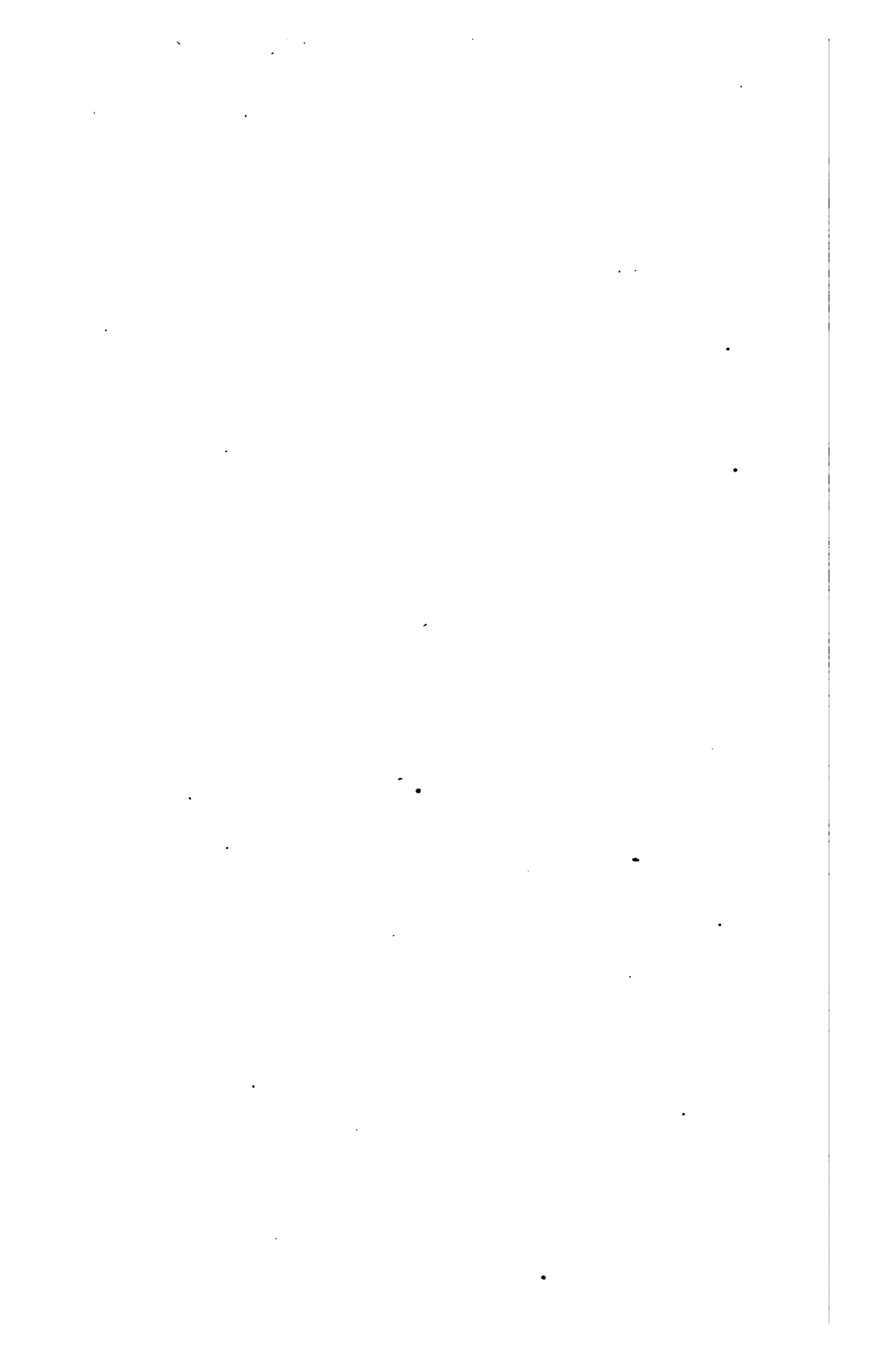

REPORT ON THE DEPARTMENT OF LIVING ANIMALS
IN THE U. S. NATIONAL MUSEUM, 1889.

By W. T. HORNADAY, *Honorary Curator.*

The collection of living animals has increased during the year to the utmost limit under the circumstances which now regulate its existence. The building in which the animals are exhibited, has for months been filled to its utmost capacity, and the crowds of visitors which daily visited the collection were often so great as to cause general discomfort. The open yards were so completely filled with large animals that it was only by the greatest difficulty that all the specimens were finally accommodated.

Under such conditions, when the accommodations for the collections had been expanded to their utmost limits, it was found necessary to check the increase of the number of specimens, both by declining gifts when possible to do so, and by discontinuing entirely the purchase of specimens.

Although the collection of living animals has attracted its full share of attention from visitors to the Museum, everything else accomplished by the department during the year becomes of small importance in comparison with the work accomplished in connection with the establishment by Congress of the National Zoological Park. In the belief that in no other way could the Curator render more valuable service to the public, he devoted much of his time, during both sessions of the Fiftieth Congress, to efforts calculated to induce Congress to establish at once a national zoological garden on a liberal scale. In this, the collection of living animals played an important part. The crowds of visitors which daily thronged a small, illy ventilated and highly uncomfortable temporary building, furnished abundant testimony to the eagerness of American people generally to learn more about our American fauna.

The valuable gifts of living creatures which came in from all parts of the United States, even faster than accommodations could be provided for them, proved conclusively the readiness of the public to contribute liberally and generally to a national collection of living animals. The demand for ample room and for the best facilities for the care and dis-

play of the collection thus commenced, became very general. In the end it proved to be irresistible; and in comparison with the great result finally reached on March 2, 1889, all other work accomplished by this department during the year becomes of small importance.

On the part of the Curator there was no opportunity for any special researches upon material belonging to the department. The time and effort which it was necessary for him to devote to the plan for a Zoological Park, and also to the department of taxidermy, rendered it impossible to accomplish for the collection of living animals anything but the routine work necessary to its existence; and, but for the valuable and energetic service rendered by Keeper Weedon, and the practical responsibilities assumed by him, more important work would have been compelled to suffer neglect.

The only work accomplished by the Curator, which in any way partook of the character of investigation and research, was the preparation of an extended memoir on the extermination of the American bison, with a sketch of its discovery and life history. This publication, which appeared in the annual report of the National Museum for 1887, was rendered necessary by reason of the fact that the fate of almost total extinction, which has befallen the buffalo, is now threatening all our most valuable quadrupeds, and unless public attention is drawn to the great undesirability of the policy of extermination, our most interesting quadrupeds will before long be swept out of existence.

In order to still further direct public attention to this universal war of extermination which is now being prosecuted against all our best game animals, the Curator, by direction of the Assistant Secretary, brought together a large collection of objects illustrating this subject in a graphic manner. This collection was prepared especially for display at the Ohio Valley Centennial Exposition, held at Cincinnati, to which it was duly forwarded for exhibition. The following editorial description of this exhibit, from *Forest and Stream*, of September 22, 1888, may properly be reproduced here for the purpose of still further carrying out the object for which the exhibit was made, viz: to draw attention to a subject of national importance:

“In the Smithsonian department of the Cincinnati Exposition there is now to be seen a startling exhibit. It is a collection of objects which have been brought together by Mr. W. T. Hornaday, to illustrate and impress upon the mind of the observer the fact that nearly all of our most conspicuous and interesting game quadrupeds are rapidly being exterminated, and will soon disappear forever. The lesson it teaches is both impressive and saddening to every lover of animated nature, and like all the lessons taught by the National Museum collections, it is strictly true.

“The most prominent feature of the exhibit is a series of mounted specimens representing the species of American mammals which have become extinct (in a wild state, at least), and also those which are now approaching extinction. The buffalo, Californian sea elephant, and West Indian seal are represented as having become extinct in a wild state, with the exception of perhaps a score of stragglers which the hunters have not yet found. In the series of species threatened with speedy extirpation are found the mountain sheep, mountain goat, elk, a fine group of antelopes of

various ages, the moose, caribou, black tail deer, beaver, otter, sea otter, walrus and grizzly bear.

"The story of the great buffalo slaughter is very graphically told. A mounted specimen and a series of superb photographic enlargements of the various specimens composing the large mounted group in the National Museum, represent the species as it once flourished. Opposite these hang another series of pictures, three of which are large oil paintings, illustrating the methods employed in the destruction of the buffalo. The first is a representation of the 'Chase on Horseback,' which the label declares to have been the only fair and sportsmanlike mode of hunting ever practiced by either reds or whites. Next to this hangs a magnificent oil painting, executed by special order, by J. H. Moser, of Washington, entitled 'The Still Hunt.' This represents the typical still-hunter, who killed buffalo by the hundred for hides, worth a dollar each. The hunter is lying flat on the ground at the top of the ridge 'pumping' bullets from a Sharp's rifle at a bunch of buffalo, on which he has "got a stand." A dozen or more have fallen, but the stupid brutes stand there in wonder, while the remorseless butcher pours in the bullets of death. In the distance a snowy plain, backed by snow-clad mountains, is 'black with buffalo,' to the number of ten thousand or more. The picture is a very striking and truthful representation of the method by which the destruction of seven or eight million buffalo was accomplished in a few short years.

"Other pictures in this series represent the other methods employed in killing buffalo, chiefly by Indians, such as impounding, hunting on snowshoes, hunting in disguise, 'the surround,' etc. On three large flat screens are shown samples of 'the objects for which the buffalo was exterminated.' One is a skin of a large buffalo bull, and another is a cowskin, both in a raw state, just as they came from 'the range,' where the former sold for the insignificant sum of \$1.25 and the latter brought even less. A third specimen is a bull hide, taken in the summer when almost bare of hair, for use as leather, and having only about half the value of the robe. The label attached to this specimen fitly characterizes the hunters who killed buffaloes in summer for hides as 'greedy wretches.'

"Last come two objects to show what remains of our most valuable American quadruped. On a section of Montana prairie, 8 feet by 10, lies the complete skeleton of a large buffalo bull, just as it was found bleaching on the range, and just as ten thousand others lie to-day. The powerful action of the weather has stripped every particle of flesh from the bones, and left them clean and white, but still attached to each other by their dried-up ligaments, the legs in position precisely as the animal fell. It is a ghastly object, and surely must awaken a feeling of remorse in the breast of every old buffalo hunter who comes face to face with it as he passes along the main aisle. Hanging near it is another large oil painting by Moser, entitled "Where the Millions Have Gone." It represents a scene on the Montana buffalo range as it is to-day. A wide plain is covered with bleaching buffalo skeletons, similar to the actual skeleton already mentioned, as weird and ghastly a scene as could be found anywhere outside a charnel-house.

"One of the most startling features of this strange display is a lot of seventy tanned skins of the rare and little-known Rocky Mountain goat, which the label explains were purchased in New York, fully tanned and dressed, at \$1.50 each, and originally sold in Denver at 50 cents each, to be made into cheap rugs and mats. This shows what railroads and breech-loaders are doing for the game in the West. When it is possible for the pot-hunters to get at even the mountain goat in its remote and dangerous fastnesses, kill them by the score and sell their hides at 50 cents each, we can count on our fingers the number of years within which the total extinction of this rare and interesting quadruped is likely to be accomplished, in this country at least. Western newspapers occasionally report hunters as hauling in a wagon load of mountain goats at a time. The Cincinnati lot includes the pelts of adult males and females and young of all ages, even to kids. If the members of State and Territorial

legislatures in the West could see this lot of skins and read the descriptive label attached to it, they might be induced to pass a protective law that would really protect these animals, and others also, from such purposeless and wanton destruction.

"The final feature of this unique exhibit is a collection of 'weapons of destruction,' which includes specimens of nearly all of the sporting rifles that have been used against American game, from the old Harper's Ferry flintlock down to the latest and deadliest patterns of repeating breech-loaders."

The more important accessions received during the year were the following:

Three American elk, or Wapiti (*Cervus canadensis*), a female and two males, presented by the Hon. W. F. Cody ("Buffalo Bill"). All three are adult, and in very fine condition. On June 8, 1889, the cow gave birth to a calf, which is doing finely and attracts much attention.

Two young black bears, from Virginia, were received from Mr. J. S. Miller, Commissioner of Internal Revenue, and placed in the large hexagonal cage in the center of the closed building, where their playful antics have furnished a constant source of amusement to visitors.

A fine young gray wolf (*Canis lupus griseo-albus*) was received from Mr. C. A. Dole, Glendive, Montana, and its death during the winter was the most serious loss the collection sustained during the year. It is hoped that it may soon be replaced by another specimen of the same species.

A very important accession, from the U. S. Fish Commissioner, consisted of twelve elephant tortoises (*Testudo elephantopus*), of various sizes, from the Galapagos Islands, collected by the U. S. Fish Commission steamer *Albatross*. A warm room for the special accommodation of these interesting reptiles was immediately built as an addition to the animal house, and heated by a stove; but in spite of the utmost care and attention a number of the tortoises died.

Five very interesting monkeys were received during the year from various friends of the Museum, as follows: One Mexican spider monkey (*Ateles vellerosus*) from Mr. C. H. Townsend, one White-throated Capuchin (*Cebus hypoleucus*) from Mrs. H. D. Cook, jr., one White-fronted Cebus (*Cebus albifrons*) from Dr. S. P. Murray, one specimen of *Cebus hypoleucus* from Mr. Hubbard T. Smith, and another species of *Cebus*, from Uruguay, the gift of Senator J. T. Morgan.

Four beautiful Angora goats were received from Misses Grace and Maude Parsons, Natural Bridge, Virginia, two of which have given birth to young.

A young Prong-horned antelope, from Texas, was received from Senator Leland Stanford, but before it had fully recovered from the effects of its long journey it became alarmed at the presence of a stray dog close to the yard-fence, and in springing about the yard its head received an injury, from the effects of which it died a few days later, in spite of the best medical care.

Two young Red foxes were received from Mr. R. B. L. Fleming, The Plains, Virginia; a large swan (*Cygnus columbianus*) was presented by

Masters Frank and Charles Drew; several species of turtles and terrapins were received from the Yale College Museum, through Dr. G. Baur.

Among the rare and specially interesting objects received, the most valuable prize was a young Rocky Mountain sheep, or Big Horn (*Ovis montana*), female, from Mr. George Bird Grinnell, editor of the New York *Forest and Stream*. This interesting animal was captured in the mountains of northwestern Montana, by a Piegan Indian, in June, 1888, and was procured from him by Mr. Grinnell, who conveyed it to the nearest railway, at very considerable trouble, in October of the same year. It arrived at the Museum in good condition, and has thriven as satisfactorily, and with as much rapidity, as any domestic lamb. Inasmuch as there is, so far as known, only one other specimen of *Ovis montana* in captivity, this individual is particularly interesting. It has been weighed, photographed, and measured at intervals, and its development carefully watched. In the issue of *Forest and Stream* for June 6, 1884, there appeared a very interesting biographical sketch of this animal, by Mr. Grinnell, illustrated by a fine engraving from an instantaneous photograph by Mr. T. W. Smillie. It is confidently believed that the Mountain sheep can be quite successfully acclimated and bred in the climate of Washington, and experiments in that direction will be made as soon as the Zoological Park is ready to accommodate specimens.

Among the other interesting rarities received were a Cacomistle, or "Civet Cat" (*Bassaris astuta*), from Mr. E. M. Hasbrouck; two Mexican quails (*Cyrtonyx*) from Mr. B. J. Jones, Columbus, Ohio; a Wood rat (*Neotoma floridana*) from Mr. George W. Shutt; a Black-footed ferret (*Putorius nigripes*) from Mr. A. B. Baker, Wa Keeney, Kansas; three Mexican guans (*Ortalis vetula macalli*) from Capt. Henry Romeyn, Fort Ringgold, Texas, and three Monkey-faced owls (*Strix pratincola*) from Mr. John T. Ward, Washington, District of Columbia.

Several objects were received which, owing to their aquatic habits, it was found impossible to care for successfully in the absence of proper facilities for the care of aquatic birds. They were two Great northern divers (*Colymbus torquatus*), one swan (*Cygnus columbianus*), one widgeon (*Mareca americana*), and a Ruffed grouse (*Bonasa umbellus*). In the autumn of 1889, the Hon. W. F. Cody offered to the Museum his entire herd of eighteen buffalos as a deposit, but it was impossible to accept them. In the same manner the Museum was offered, by Mr. W. A. Conklin, of New York, a camel, an aoudad, lioness, ibex, black leopard, and ostrich, all of which had to be declined.

During the year a number of valuable American mammals were offered to the Museum at nominal prices, and although all of them would have been most welcome additions to the collections, it was absolutely necessary to decline them. They were the following: Two specimens of manatee from Florida; three specimens of moose from Maine, Canada, and Minnesota; a Caribou from Maine, and three specimens of

Prong-horned antelope from Dakota. The loss of the manatee, moose, and caribon, all very rare in captivity, was sincerely regretted.

During the year the increase of the collection rendered it necessary to provide additional accommodations for animals of various kinds. A room 30 by 14 feet for tropical reptiles and quadrupeds was built on the north of the animal building as an addition to the latter. In this, which was heated by a stove, were accommodated the elephant tortoises, monkeys, turtles, terrapins, and alligators, and but for its warmth the monkeys could not have survived the winter. The limited space for visitors in this room has from the first been a serious drawback, inasmuch as there is nearly always a crowd around the cages containing the monkeys, and the passage-way is very often completely blocked.

On several occasions the crowd in the side room became so dense and the press so great, that it became necessary to clear the room and close it for a time.

The grizzly bear and puma outgrew their in-door quarters, and a large outdoor cage 8 feet square was made for each and placed at the edge of the lawn in front of the animal-house. In these the grizzly and puma are quite comfortable, and are in much better health than they have been before. Another large outdoor cage was made for the eagles and placed on the lawn near the deer-yards, and for the first time since the organization of the department these interesting birds are cared for under proper conditions. The buffalo-yard has been subdivided by cutting off a small section at one side to afford a yard for the Columbian black-tail deer, which, during the rutting season, became so vicious and dangerous that it was necessary to isolate him entirely. One of the deer-yards was also divided into two, to furnish a separate yard for the Mountain sheep.

Owing to the small size of all the yards, great difficulty was experienced during the rutting season in so isolating the bucks of all species as to prevent their fighting and seriously injuring each other. Of the large animals, the buffalos have proven to be the easiest to manage, and the most satisfactory of all the ruminants. It is also to be noted that they are in fine condition.

Several new and more comfortable cages were fitted up in the closed building for the raccoons, opossums, snakes, owls, etc. Printed labels were provided to accompany specimens as soon as possible after their receipt, and while the general system of labeling has been far short of what it should be, and has not been even a suggestion of the possibilities in that direction, it was the best that could be done under the circumstances. In the matter of routine work in the care of the collections, it would be impossible to speak too highly in praise of Mr. W. C. Weedon, keeper, and Mr. Selmon Cook, assistant, both of whom have always been untiring in their efforts to keep the animals in good condition and to make the entire collection as attractive as possible, even though laboring under the serious disadvantages of temporary and very

limited accommodations. They have been on duty every holiday in order to keep the collection open to the crowds of visitors always in attendance on such occasions, and are always on duty part of the day on Sunday to look after the comfort of the animals in their charge.

Unlike all the other departments of the Museum, this contains neither a reserve nor duplicate series of specimens, but an exhibition series only, which embraces all the living creatures on hand at any given time. Specimens lost by death are immediately transferred to the other departments of the Museum, according to their respective wants, being divided between the departments of comparative anatomy, mammals, birds, and reptiles.

The total number of living specimens received during the year was 271, of which 126 were gifts, 37 were deposited, and 8 were purchased. The last catalogue entry on June 30, 1889, was 341, which represents the total number of specimens received since the collection was begun.

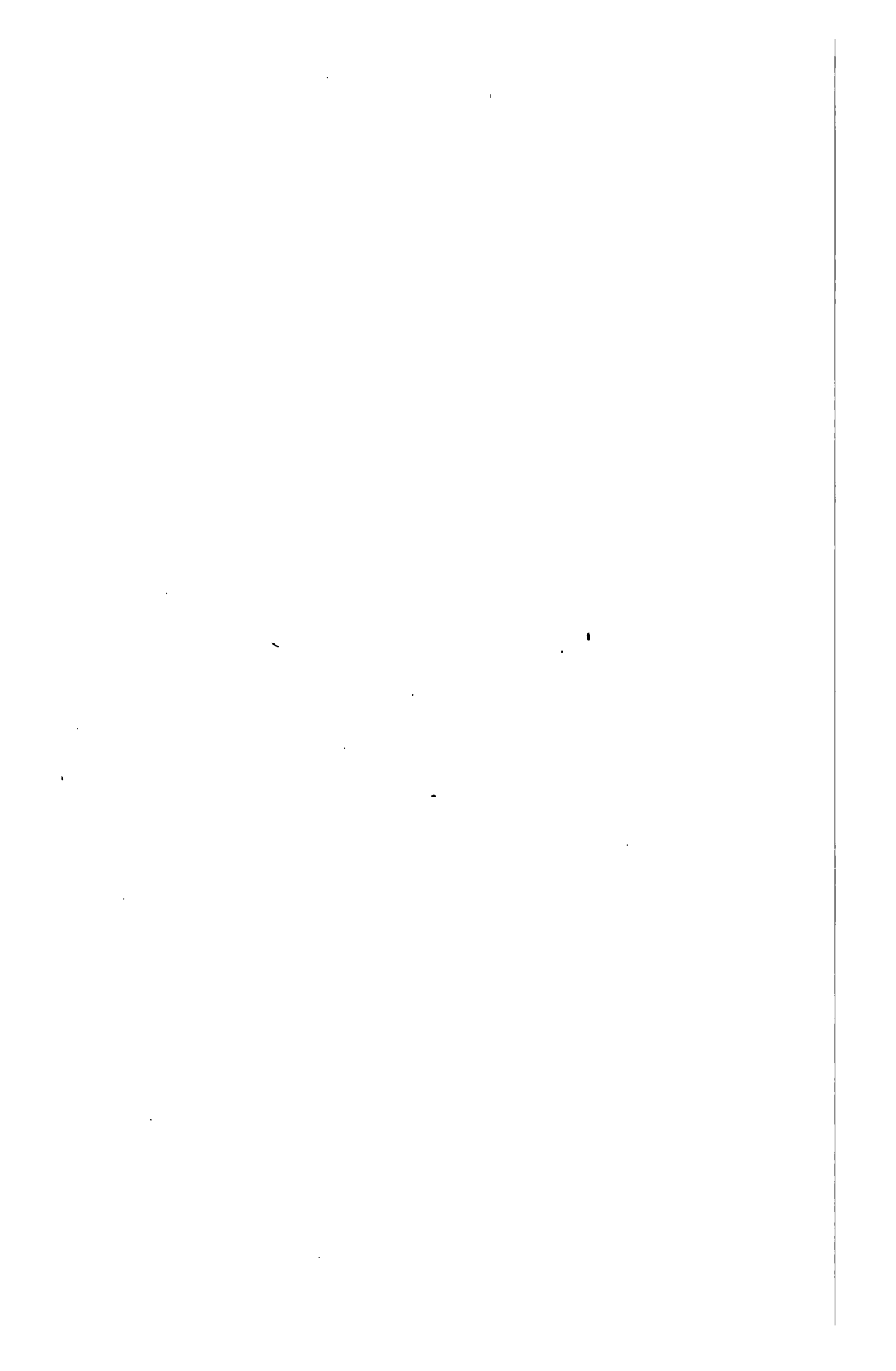

SECTION III.

PAPERS DESCRIBING AND ILLUSTRATING THE COLLECTIONS IN THE U. S. NATIONAL MUSEUM.

1. The Museums of the Future. By G. BROWN GOODE.
2. Te Pito Te Henua, or Easter Island. By WILLIAM J. THOMSON, Paymaster, U. S. Navy.
3. Aboriginal Skin-Dressing; a Study Based on Material in the U. S. National Museum. By OTIS T. MASON.
4. The Puma, or American Lion (*Felis concolor* of Linnæus). By FREDERICK W. TRUE.
5. Animals Recently Extinct or Threatened with Extermination, as represented in the Collections of the U. S. National Museum. By FREDERIC A. LUCAS.
6. The Development of the American Rail and Track, as illustrated by the Collection in the U. S. National Museum. By J. ELFRETH WATKINS.
7. Explorations in Newfoundland and Labrador in 1887, made in Connection with the Cruise of the U. S. Fish Commission Schooner *Grampus*. By FREDERIC A. LUCAS.
8. On a Bronze Buddha in the U. S. National Museum. By CHARLES DE KAY. (Reprint.)

•

THE UNIVERSITY OF CHICAGO

THE MUSEUMS OF THE FUTURE.*

By G. BROWN GOODE, LL. D.

There is an Oriental saying that the distance between ear and eye is small, but the difference between hearing and seeing very great.

More terse and not less forcible is our own proverb, "To see is to know," which expresses a growing tendency in the human mind.

In this busy, critical, and skeptical age, each man is seeking to know all things, and life is too short for many words. The eye is used more and more, the ear less and less, and in the use of the eye, descriptive writing is set aside for pictures, and pictures in their turn are replaced by actual objects. In the school-room the diagram, the blackboard, and the object-lesson, unknown thirty years ago, are universally employed. The public lecturer uses the stereopticon to re-enforce his words, the editor illustrates his journals and magazines with engravings a hundred-fold more numerous and elaborate than his predecessor thought needful, and the merchant and manufacturer recommend their wares by means of vivid pictographs. The local fair of old has grown into the great exposition, often international and always under some governmental patronage, and thousands of such have taken place within forty years, from Japan to Tasmania, and from Norway to Brazil.

Amid such tendencies, the museum, it would seem, should find congenial place, for it is the most powerful and useful auxiliary of all systems of teaching by means of object lessons.

The work of organizing museums has not kept pace with the times. The United States is far behind the spirit of its own people, and less progressive than England, Germany, France, Italy, or Japan. We have, it is true, two or three centers of great activity in museum work, but there have been few new ones established within twenty years, and many of the old are in a state of torpor. This can not long continue. The museum of the past must be set aside, reconstructed, transformed from a cemetery of bric-a-brac into a nursery of living thoughts. The museum of the future must stand side by side with the library and the laboratory, as a part of the teaching equipment of the college and university, and in the great cities co-operate with the public library as one of the principal agencies for the enlightenment of the people.

* A lecture delivered before the Brooklyn Institute, February 28, 1889.

The true significance of the word museum may best be appreciated through an allusion to the ages which preceded its origin—when our ancestors, hundreds of generations removed, were in the midst of those great migrations which peopled Europe with races originally seated in Central Asia.

It has been well said that the early history of Greece is the first chapter in the political and intellectual life of Europe. To the history of Greece let us go for the origin of the museum idea, which, in its present form, seems to have found its only congenial home among the European off-shoots of the great Indo-Germanic or Aryan division of the world's inhabitants. Long centuries before the invention of written languages there lived along the borders of northern Greece, upon the slopes of Mount Olympus and Helicon, a people whom the later Greeks called "Thracians," a half-mythical race, whose language even has perished. They survived in memory, we are told, as a race of bards, associated with that peculiar legendary poetry of pre-Homeric date, in which the powers of nature were first definitely personified. This poetry belonged, presumably, to an age when the ancestors of the Greeks had left their Indo-European home, but had not yet taken full possession of the lands which were afterward Hellenic. The spirits of nature sang to their sensitive souls with the voice of brook and tree and bird, and each agency or form which their senses perceived was personified in connection with a system of worship. There were spirits in every forest or mountain, but in Thrace alone dwelt the Muses—the spirits who know and who remember, who are the guardians of all wisdom, and who impart to their disciples the knowledge and the skill to write.

Museums, in the language of Ancient Greece, were the homes of the Muses. The first were in the groves of Parnassus and Helicon, and later they were temples in various parts of Helles. Soon, however, the meaning of the word changed, and it was used to describe a place of study, or a school. Athenæus in the second century described Athens as "the museum of Greece," and the name was applied to that portion of the palace of Alexandria which was set apart for the study of the sciences and which contained the famous Alexandrian library. The museum of Alexandria was a great university, the abiding place of men of science and letters, who were divided into many companies or colleges, for the support of each of which a handsome revenue was allotted.

The Alexandrian museum was burned in the days of Cæsar and Aurelian, and the term museum, as applied to a great public institution, dropped out of use from the fourth to the seventeenth century. The disappearance of a word is an indication that the idea for which it stood had also fallen into disfavor, and such, indeed, was the fact.

The history of museum and library runs in parallel lines. It is not until the development of the arts and sciences has taken place, until an extensive written literature has grown up, and a distinct literary and

scientific class has been developed, that it is possible for the modern library and museum to come into existence. The museum of the present is more unlike its old-time representative, than is our library unlike its prototype.

There were, in the remote past, galleries of pictures and sculpture as well as museums, so-called. Public collections of paintings and statuary were founded in Greece and Rome at a very early day. There was a gallery of paintings (Pinacotheca) in one of the marble halls of the Propylæum at Athens, and in Rome there was a lavish public display of works of art.

M. Dezobry, in his brilliant work upon "Rome in the time of Augustus" (*Rome au siècle d'Auguste*), described this phase of the Latin civilization in the first century before Christ.

"For many years," remarks one of his characters, "the taste for paintings has been extending in a most extraordinary manner. In former times they were only to be found in the temples, where they were placed, less for purposes of ornament than as an act of homage to the gods; now they are everywhere, not only in temples, in private houses, and in public halls, but also on outside walls, exposed freely to air and sunlight. Rome is one great picture gallery; the Forum of Augustus is gorgeous with paintings, and they may be seen also in the Forum of Cæsar, in the Roman Forum, under the peristyles of many of the temples, and especially in the porticoes used for public promenades, some of which are literally filled with them. Thus everybody is enabled to enjoy them, and to enjoy them at all hours of the day."

The public men of Rome at a later period in its history were no less mindful of the claims of art. They believed that the metropolis of a great nation should be adorned with all the best products of civilization. We are told by Pliny that when Cæsar was dictator, he purchased for 300,000 deniers two Greek paintings, which he caused to be publicly displayed, and that Agrippa placed many costly works of art in a hall which he built and bequeathed to the Roman people. Constantine gathered together in Constantinople the paintings and sculptures of the great masters, so that the city before its destruction became a great museum like Rome.

The taste for works of art was in the days of the ancient civilizations generally prevalent throughout the whole Mediterranean region, and there is abundant reason to believe that there were prototypes of the modern museum in Persia, Assyria, Babylonia, and Egypt, as well as in Rome.

Collections in natural history also undoubtedly existed, though we have no positive descriptions of them. Natural curiosities, of course, found their way into the private collections of monarchs, and were doubtless also in use for study among the savants in the Alexandrian museums. Aristotle, in the fourth century before Christ, had, it is said, an enormous grant of money for use in his scientific researches, and

Alexander the Great, his patron, "took care to send to him a great variety of zoölogical specimens, collected in the countries which he had subdued," and also "placed at his disposal several thousand persons, who were occupied in hunting, fishing, and making the observations which were necessary for completing his History of Animals." If human nature has not changed more than we suppose, Aristotle must have had a great museum of natural history.

When the Roman capital was removed to Byzantium, the arts and letters of Europe began to decline. The Church was unpropitious, and the invasions of the northern barbarians destroyed everything. In 476, with the close of the Western Empire, began a period of intellectual torpidity which was to last for a thousand years. It was in Bagdad and Cordova that science and letters were next to be revived, and Africa was to surpass Europe in the exhibit of its libraries.

With the Renaissance came a period of new life for collectors. The churches of southern Europe became art galleries, and monarchs and noblemen and ecclesiastical dignitaries collected books, manuscripts, sculptures, pottery, and gems, forming the beginnings of collections which have since grown into public museums. Some of these collections doubtless had their first beginnings in the midst of the Dark Ages within the walls of feudal castles or the larger monasteries, but their number was small, and they must have consisted chiefly of those objects so nearly akin to literature as especially to command the attention of bookish men.

The idea of a great national museum of science and art was first worked out by Lord Bacon in his "New Atlantis," a philosophical romance published at the close of the seventeenth century.

The first scientific museum actually founded was that begun at Oxford, in 1667, by Elias Ashmole, still known as the Ashmolean Museum, composed chiefly of natural history specimens collected by the botanists Tradescant, father and son, in Virginia and in the north of Africa. Soon after, in 1753, the British Museum was established by act of Parliament, inspired by the will of Sir Hans Sloane, who, dying in 1749, left to the nation his invaluable collection of books, manuscripts, and curiosities.

Many of the great national museums of Europe had their origin in the private collections of monarchs. France claims the honor of having been the first to change a royal into a national museum, when in 1789, the Louvre came into the possession of a republican government.

It is very clear, however, that democratic England stands several decades in advance—its act, moreover, being one of deliberate founding rather than a species of conquest. A century before this, when Charles the First was beheaded by order of Parliament, his magnificent private collection was dispersed. What a blessing it would be to England to-day if the idea of founding a national museum had been suggested to the Cromwellians. The intellectual life of America is so closely bound to

that of England, that the revival of interest in museums, and in popular education, at the middle of the present century, is especially significant to us.

The Great Exhibition of 1851 was one of the most striking features of the industrial revolution in England, that great transformation which, following closely upon the introduction of railroads, turned England feudal and agricultural, into England democratic and commercial. This Exhibition marked an epoch in the intellectual progress of English speaking peoples. "The Great Exhibition," writes a popular novelist—a social philosopher as well—"did one great service for country people: It taught them how easy it is to get to London, and what a mine of wealth, especially for after-memory and purposes of conversation, exists in that great place."

Our own Centennial Exhibition in 1876 was almost as great a revelation to the people of the United States. The thoughts of the country were opened to many things before undreamed of. One thing we may regret—that we have no such wide-spread system of museums as that which has developed in the motherland, with South Kensington as its administrative center.

Under the wise administration of the South Kensington staff, an outgrowth of the events of 1851, a great system of educational museums has been developed all through the United Kingdom. A similar extension of public museums in this country would be quite in harmony with the spirit of the times, as shown in the present efforts toward university extensions.

England has had nearly forty years in which to develop these tendencies, and we but thirteen since our Exhibition. May we not hope that within a like period of time and before the year 1914, the United States may have attained the position which England now occupies, at least in the respect of popular interest and substantial governmental support.

There are now over one hundred and fifty public museums in the United Kingdom, all active and useful. The museum systems of Great Britain are, it seems to me, much closer to the ideal which America should follow than are those of either France or Germany. They are designed more thoughtfully to meet the needs of the people, and are more intimately intertwined with the policy of national, popular education. Sir Henry Cole, the founder of the "Department of Science and Art," speaking of the purpose of the museum under his care, said to the people of Birmingham in 1874: "If you wish your schools of science and art to be effective, your health, the air, and your food to be wholesome, your life to be long, your manufactures to improve, your trade to increase, and your people to be civilized, you must have museums of science and art, to illustrate the principles of life, health, nature, science, art, and beauty.

Again, in words as applicable to America of to-day as to Britain

in 1874, said he: "A thorough education and a knowledge of science and art are vital to the nation and to the place it holds at present in the civilized world. Science and art are the life-blood of successful production. All civilized nations are running a race with us, and our national decline will date from the period when we go to sleep over the work of education, science, and art. What has been done is at the mere threshold of the work yet to be done."

The museums of the future in this democratic land should be adapted to the needs of the mechanic, the factory operator, the day laborer, the salesman, and the clerk, as much as to those of the professional man and the man of leisure. It is proper that there be laboratories and professional libraries for the development of the experts who are to organize, arrange and explain the museums. It is proper that the laboratories be utilized to the fullest extent for the credit of the institution to which they belong. No museum can grow and be respected which does not each year give additional proofs of its claims to be considered a center of learning.

On the other hand the public have a right to ask that much shall be done directly in their interest. They will gladly allow the museum officer to use part of his time in study and experiment. They will take pride in the possession by the museum of tens of thousands of specimens, interesting only to the specialists, hidden away perpetually from public view, but necessary for purpose of scientific research. These are foundations of the intellectual superstructure which gives the institution its standing.

Still no pains must be spared in the presentation of the material in the exhibition halls. The specimens must be prepared in the most careful and artistic manner, and arranged attractively in well-designed cases and behind the clearest of glass. Each object must bear a label, giving its name and history so fully that all the probable questions of the visitor are answered in advance. Books of reference must be kept in convenient places. Colors of walls, cases, and labels must be restful and quiet, and comfortable seats should be everywhere accessible, for the task of the museum visitor is a weary one at best.

In short, the public museum is, first of all, for the benefit of the public. When the officers are few in number, each must of necessity devote a considerable portion of his time to the public halls. When the staff becomes larger, it is possible by specialization of work to arrange that certain men may devote their time uninterruptedly to laboratory work, while others are engaged in the increase of the collections and their installation.

I hope and firmly believe that every American community with inhabitants to the number of five thousand or more will within the next half century have a public library, under the management of a trained librarian. Be it ever so small, its influence upon the people would be of untold value. One of the saddest things in this life is to realize

that in the death of the elder members of a community, so much that is precious in the way of knowledge and experience is lost to the world. It is through the agency of books that mankind benefits by the toil of past generations and is able to avoid their errors.

In these days, when printing is cheap and authors are countless, that which is good and true in human thought is in danger of being entirely overlooked. The daily papers, and above all the overgrown and uncanny Sunday papers, are like weeds in a garden whose rank leaves not only consume the resources of the soil but hide from view the more modest and more useful plants of slower growth.

Most suggestive may we find an essay on "Capital and Culture in America" which recently appeared in one of the English reviews. The author, a well known Anglo-American astronomer, boldly asserts that year by year it becomes clearer that despite the large increase in the number of men and women of culture in America, the nation is deteriorating in regard to culture. Among five hundred towns where formerly courses of varied entertainments worthy of civilized communities—concerts, readings, lectures on artistic, literary, and scientific subjects, and so forth were successfully arranged season after season, scarcely fifty now feel justified in continuing their efforts in the cause of culture, knowing that the community will not support them. Scientific, literary, and artistic societies, formerly flourishing, are now dying or dead in many cities which have in the meantime increased in wealth and population." He instances Chicago as typical of an important portion of America, and cites evidences of decided deterioration within sixteen years.

The people's museum should be much more than a house full of specimens in glass cases. It should be a house full of ideas, arranged with the strictest attention to system.

I once tried to express this thought by saying "*An efficient educational museum may be described as a collection of instructive labels, each illustrated by a well-selected specimen.*"

The museum, let me add, should be more than a collection of specimens well arranged and well labeled. Like the library, it should be under the constant supervision of one or more men well informed, scholarly and withal practical, and fitted by tastes and training to aid in the educational work.

I should not organize the museum primarily for the use of the people in their larval or school-going stage of existence. The public school teacher with the illustrated text-book, diagrams, and other appliances, is in these days a professional outfit which is usually quite sufficient to enable him to teach his pupils. School days last at the most only from five to fifteen years, and they end with the majority of mankind before their minds have reached the stage of growth most favorable for the reception and assimilation of the best and most useful thought. Why should we be crammed in the times of infancy and kept in a state of

mental starvation during the period which follows, from maturity to old age, a state which is disheartening and unnatural, all the more because of the intellectual tastes which have been stimulated and partially formed by school life.

The boundary line between the library and the museum is neither straight nor plain. The former, if its scope be rightly indicated by its name, is primarily a place for books. The latter is a depository for objects of every kind, books not excepted.

The British Museum, with its libraries, its pictures, its archaeological galleries, its anthropological, geological, botanical, and zoölogical collections, is an example of the most comprehensive interpretation of the term.

Professor Huxley has described the museum as "a consultative library of objects." This definition is suggestive but unsatisfactory. It relates only to the contents of the museum, as distinguished from those of the library, and makes no reference to the differences in the methods of their administration. The treasures of the library must be examined one at a time and by one person at a time; their use requires long-continued attention, and their removal from their proper places in the system of arrangement. Those of the museum are displayed to public view, in groups, in systematic sequence, so that they have a collective as well as an individual significance. Furthermore, much of their meaning may be read at a glance.

The museum cultivates the powers of observation, and the casual visitor even makes discoveries for himself and under the guidance of the labels forms his own impressions. In the library one studies the impressions of others. The library is most useful to the educated, the museum to educated and uneducated alike, to the masses as well as to the few, and is a powerful stimulant to intellectual activity in either class. The influence of the museum upon a community is not so deep as that of the library, but extends to a much larger number of people.

The National Museum has 300,000 visitors a year, each of whom carries away a certain number of new thoughts.

The two ideas may be carried out, side by side, in the same building, and if need be under the same management, not only without antagonism, but with advantage.

That the proximity of a good library is absolutely essential to the usefulness of a museum will be admitted by every one.

I am confident also that a museum, wisely organized and properly arranged, is certain to benefit the library near which it stands in many ways through its power to stimulate interest in books, thus increasing the general popularity of the library and enlarging its endowment.

Many books and valuable ones would be required in the first kind of museum work, but it is not intended to enter into competition with the library. (When necessary, volumes could be duplicated.) It is very often the case, however, that books are more useful and safer in the

museum than on the library shelves, for in the museum they may be seen daily by thousands, while in the library their very existence is forgotten by all except their custodian.

Audubon's "Birds of North America" is a book which every one has heard of and which every one wants to see at least once in his lifetime. In a library, it probably is not examined by ten persons in a year; in a museum, the volumes exposed to view in a glass case, a few of the most striking plates attractively framed and hung upon the wall near at hand, it teaches a lesson to every passer-by.

The library may be called upon for aid by the museum in many directions. Pictures are often better than specimens to illustrate certain ideas. The races of man and their distribution can only be shown by pictures and maps. Atlases of ethnological portraits and maps are out of place in a library if there is a museum near by in which they can be displayed. They are not even members of the class described by Lamb as "books which are not books". They are not books, but museum specimens masquerading in the dress of books.

There is another kind of depository which, though in external features so similar to the museum, and often confused with it in name as well as in thought, is really very unlike it. This is the art gallery. The scientific tendencies of modern thought have permeated every department of human activity, even influencing the artist. Many art galleries are now called museums, and the assumption of the name usually tends toward the adoption in some degree of a scientific method of installation. The difference between a museum and a gallery is solely one of method of management. The Musée des Thermes, the Cluny Museum in Paris is, notwithstanding its name, simply a gallery of curious objects. Its contents are arranged primarily with reference to their effect. The old monastery in which they are placed, affords a magnificent example of the interior decorative art of the Middle Ages.

The Cluny Museum is a most fascinating and instructive place. I would not have it otherwise than it is, but it will always be unique, the sole representative of its kind. The features which render it attractive would be ruinous to any museum. It is, more than any other that I know, a collection arranged from the stand-point of the artist. The same material, in the hands of a Klemm or a Pitt Rivers, arranged to show the history of human thought, would, however, be much more interesting, and, if the work were judiciously done, would lose none of its æsthetic allurements.

Another collection of the same general character as the one just described is the Soane Museum in London. Another, the famous collection of crown jewels and metal work in the Green Vaults at Dresden, a counterpart of which may be cited in the collection in the Tower of London. The Museum of the Hohenzollerns in Berlin and the Museum of the City of Paris are of necessity unique. Such collections can not

be created. They grow in obedience to the action of natural law, just as a tree or a sponge may grow.

The city which is in the possession of such an heirloom is blessed just as is the possessor of an historic surname, or he who inherits the cumulative genius of generations of gifted forefathers. The possession of one or a score of such shrines does not, however, free any community from the obligation to form a museum for purposes of education and scientific research.

The founding of a public museum in a city like Brooklyn, is a work whose importance can scarcely be overestimated. The founders of institutions of this character do not often realize how much they are doing for the future. Opportunity such as that which is now open to the members of the Brooklyn Institute occur only once in the lifetime of a nation. It is by no means improbable that the persons now in this room have it in their power to decide whether in the future intellectual progress of this nation, Brooklyn is to lead or to follow far in the rear.

Many of my hearers are doubtless familiar with that densely populated wilderness, the east end of London, twice as large as Brooklyn, yet with scarce an intellectual oasis in its midst. Who can say how different might have been its condition to-day if Walter Besant's apostolic labors had begun a century sooner, and if the People's Palace, that wonderful materialization of a poet's dream, had been for three generations brightening the lives of the citizens of the Lower Hamlets and Hackney.

Libraries and museums do not necessarily spring up where they are needed. Our governments, Federal, State, and municipal, are not "paternal" in spirit. They are less so even in practical working than in England, when, notwithstanding the theory that all should be left to private effort, the government, under the leadership of the late Prince Consort and of the Prince of Wales, has done wonderful things for all the provincial cities, as well as for London, in the encouragement of libraries, museums, art, and industrial education.

However much the state may help, the private individual must lead, organize, and prepare the way. "It is universally admitted," said the Marquis of Lansdowne in 1847, "that governments are the worst of cultivators, the worst of manufacturers, the worst of traders," and Sir Robert Peel said in similar strain that "the action of government is torpid at best."

In beginning a museum the endowment is of course the most essential thing, especially in a great city like Brooklyn, which has a high ideal of what is due to the intelligence of its populace and to the civic dignity.

Unremunerated service in museum administration, though it may be enthusiastically offered and conscientiously performed, will in the end fail to be satisfactory. Still more is it impossible for a respectable

museum to grow up without liberal expenditure for the acquisition of collections and their installation.

Good administration is not to be had for nothing. As to the qualification of a museum administrator, whether it be for a museum of science or a museum of art, it is perhaps superfluous to say that he should be the very best obtainable; a man of ability, enthusiasm, and withal of experience, for the administration of museums and exhibitions has become of late years a profession, and careful study of methods of administration is indispensable. If the new administrator has not had experience he must needs gain it at the expense of the establishment which employes him—an expense of which delay, waste, and needless experiment form considerable elements.

No investment is more profitable to a museum than that in the salary fund. Around a nucleus of men of established reputation and administrative tact, will naturally grow up a staff of volunteer assistants, whose work, assisted and directed in the best channels, will be of infinite value.

The sinews and brains of the organism being first provided, the development of its body still remains. The outer covering, the dress, can wait. It is much better to hire buildings for temporary use, or to build rude fire-proof sheds, than to put up a permanent museum building before at least a provisional idea of its *personnel* and contents has been acquired.

As has been already said, a museum must spend money in the acquisition of collections, and a great deal of money. The British Museum has already cost the nation for establishment and maintenance not far from \$30,000,000. Up to 1882 over \$1,500,000 had been expended in *purchase of objects* for the art collections at South Kensington alone.

Such expenditures are usually good investments of national funds, however. In 1882, after about twenty-five years of experience, the buildings and contents of the South Kensington Museum had cost the nation about \$5,000,000, but competent authorities were satisfied that an auction on the premises could not bring less than \$100,000,000. For every dollar spent, however, gifts will come in to the value of many dollars. In this connection it may not be amiss to quote the words of one of the most experienced of English museum administrators (presumably Sir Philip Cunliffe Owen) when asked many years ago whether Americans might not develop great public institutions on the plan of those at Kensington:

“Let them plant the thing,” he said, “and it can’t help growing, and most likely beyond their powers—as it has been almost beyond ours—to keep up with it. What is wanted first of all is one or two good brains, with the means of erecting a good building on a piece of ground considerably larger than is required for that building. Where there have been secured substantial, luminous galleries for exhibition, in a fire-proof building, and these are known to be carefully guarded by night and day, there can be no need to wait long for treasures to flow

into it. Above all, let your men take care of the interior and not set out wasting their strength and money on external grandeur and decoration. The inward built up rightly, the outward will be added in due season.*

Much will, of course, be given to any museum which has the confidence of the public—much that is of great value, and much that is useless.

The Trojans of old distrusted the Greeks when they came bearing gifts. The museum administrator must be on his guard against every one who proffers gifts. An unconditional donation may be usually accepted without hesitation, but a gift coupled with conditions is, except in very extraordinary cases, far from a benefaction.

A donor demands that his collection shall be exhibited as a whole, and kept separate from all others. When his collection is monographic in character and very complete, it is sometimes desirable to accept it on such conditions. As a rule, however, it is best to try to induce the donor to allow his collections to be merged in the general series—each object being separately and distinctively labeled. I would not be understood to say that the gift of collections is not, under careful management, a most beneficial source of increase to a public collection. I simply wish to call attention to the fact that a museum which accepts without reserve gifts of every description, and fails to re-enforce these gifts by extensive and judicious purchasing, is certain to develop in an unsystematical and ill-balanced way.

Furthermore, unless a museum be supported by liberal and constantly increasing grants from some State or municipal treasury, it will ultimately become suffocated. It is essential that every museum, whether of science or art should from the start make provision for laboratories and storage galleries as well as for exhibition halls.

All intellectual work may be divided into two classes, the one tending towards the increase of knowledge, the other towards its diffusion—the one toward investigation and discovery, the other toward the education of the people and the application of known facts to promoting their material welfare. The efforts of learned men are sometimes applied solely to one of these departments of effort—sometimes to both, and it is generally admitted by the most advanced teachers, that for their students as well as for themselves, the happiest results are reached by investigation and instruction simultaneously. Still more is this true of institutions of learning. The college which imparts only second-hand knowledge to its students belongs to a stage of civilization which is fast being left behind. The museum likewise must, in order to perform its proper functions, contribute to the advancement of learning through the increase as well as through the diffusion of knowledge.

We speak of educational museums and of the educational method of installation so frequently that there may be danger of inconsistency in the use of the term. An educational museum, as it is usually spoken

* Conway : Travels in South Kensington, 26.

of, is one in which an attempt is made to teach the unprofessional visitor; an institution for popular education by means of labeled collections, and it may be also by popular lectures. A college museum, although used as an aid to advanced instruction, is not an "educational museum" in the ordinary sense; nor does a museum of research, like the Museum of Comparative Zoology at Cambridge, Mass., belong to this class, although to a limited extent it attempts and performs popular educational work in addition to its other functions.

In the National Museum in Washington the collections are divided into two great classes. The exhibition series, which constitutes the educational portion of the Museum, and is exposed to public view with all possible accessions for public entertainment and instruction, and the study series, which is kept in the scientific laboratories, and is scarcely examined except by professional investigators.

In every properly conducted museum the collections must from the very beginning divide themselves into these two classes, and in planning for its administration provision should be made not only for the exhibition of objects in glass cases, but for the preservation of large collections not available for exhibition, to be used for the studies of a very limited number of specialists.

Lord Bacon, who, as we have noticed, was the first to whom occurred the idea of a great museum of science and art, complained three centuries ago, in his book "On the Advancement of Learning," that up to that time the means for intellectual progress had been used exclusively for "amusement" and "teaching," and not for the "augmentation of science."

It will undoubtedly be found desirable for certain museums, founded for local effect, to specialize mainly in the direction of popular education. If they can not also provide for a certain amount of scholarly endeavor in connection with the other advantages, it would be of the utmost importance that they should be assorted by a system of administrative co-operation with some institution which is in the position of being a center of original work.

The general character of museums should be clearly determined at its very inception. Specialization and division of labor are essential for institutions as well as for individuals. It is only a great national museum which can hope to include all departments, and which can with safety encourage growth in every direction.

A city museum, even in a great metropolis like Brooklyn, should, if possible, select certain special lines of activity, and pursue them with the intention of excelling. If there are already beginnings in many directions, it is equally necessary to decide which lines of development are to be favored, in preference to all others. Many museums fail to make this choice at the start, and instead of steering toward some definite point, drift hither and thither, and, it may be, are foundered in mid-ocean.

There is no reason why the museum of the Brooklyn Institute may not in time attain to world-wide fame, and attract students and visitors from afar. It would be wise perhaps in shaping its policy to remember that in the twin city of New York are two admirable museums which may be met more advantageously in co-operation than in rivalry. Brooklyn may appropriately have its own museum of art and its museum of natural history, but they should avoid the repetition of collections already so near at hand.

In selecting courses for the development of a museum, it may be useful to consider what are the fields open to museum work.

As a matter of convenience museums are commonly classed in two groups—those of science and those of art, and in Great Britain the great national system is mainly under the control of “The Science and Art Department of the Committee of Council on Education.”

The classification is not entirely satisfactory since it is based upon methods of arrangement, rather than upon the nature of the objects to be arranged, and since it leaves a middle territory (only partially occupied by the English museum men of either department), a great mass of museum material of the greatest moment both in regard to its interest and its adaptability for purposes of public instruction.

On the one side stand the natural history collections, undoubtedly best to be administrated by the geologist, botanist, and zoologist. On the other side are the fine art collections, best to be arranged from an æsthetic standpoint, by artists. Between is a territory which no English word can adequately describe—which the Germans call *Culturgeschichte*—the natural history of cult, or civilization, of man and his ideas and achievements. The museums of science and art have not yet learned how to partition this territory. An exact classification of museums is not at present practicable, nor will it be, until there has been some redistribution of the collections which they contain. It may be instructive however, to pass in review the principal museums of the world, indicating briefly their chief characteristics.

Every great nation has its museum of nature. The natural history department of the British Museum, recently removed from the heart of London to palatial quarters in South Kensington, is probably the most extensive—with its three great divisions, zoological, botanical, and geological. The Musée d'Histoire Naturelle, in the garden of plants in Paris, founded in 1795, with its galleries of anatomy, anthropology, zoology, botany, mineralogy, and geology, is one of the most extensive, but far less potent in science now than in the days of Cuvier, Lamarck, St. Hilaire, Jussieu, and Brongniart. In Washington, again, there is a National Museum with anthropological, zoological, botanical, mineralogical, and geological collections in one organization, together with a large additional department of arts and industries, or technology.

Passing to specialized natural history collections, perhaps the most

noteworthy are those devoted to zoology, and chief among them that in our own American Cambridge. The Museum of Comparative Zoology, founded by the Agassiz's, "to illustrate the history of creation, as far as the present state of knowledge reveals that history," was in 1887, pronounced by the English naturalist, Alfred Russell Wallace, "to be far in advance of similar institutions in Europe as an educational institution, whether as regards the general public, the private student, or the specialist."

Next to Cambridge, after the zoological section of the museums of London and Paris, stands the collections in the Imperial Cabinet in Vienna, and those of the zoological museums in Berlin, Leyden, Copenhagen, and Christiania.

Among botanical museums, that in the Royal Gardens at Kew, near London, is pre-eminent, with its colossal herbarium containing the finest collection in the world, and its special museum of economic botany founded in 1847, both standing in the midst of a collection of living plants. There is also in Berlin the Royal Botanical Museum, founded in 1818 as the Royal Herbarium; in St. Petersburg, the Herbaria of the Imperial Botanical Garden.

Among the geological and mineralogical collections the mineral cabinet in Vienna, arranged in the imperial castle, is among the first.

The Museum of Practical Geology in London, which is attached to the Geological Survey of the United Kingdom, was founded in 1837, to exhibit the collections of the survey, in order to "show the applications of geology to the useful purposes of life." Like every other healthy museum, it soon had investigations in progress in connection with its educational work, and many very important discoveries have been made in its laboratories. It stands in the very first rank of museums for popular instruction, the arrangement of the exhibition halls being most admirable. Of museums of anatomy there are thirty of considerable magnitude, all of which have grown up in connection with schools of medicine and surgery, except the magnificent Army Medical Museum in Washington.

The Medical Museum of the Royal College of Surgeons in London is probably first in importance. The collections of St. Thomas's, Guy's, St. George's, and other hospitals are very rich in anatomical and pathological specimens. The oldest public anatomical museum in London is that of St. Bartholomew's.

Paris, Edinburgh, and Dublin have large anatomical and materia-medica collections. As a rule, the medical museums of Europe are connected with universities. Dr. Billings, Curator of the Army Medical museum in Washington, has traced accurately the growth of medical collections both at home and abroad, and from his address upon medical museums, as president of the Congress of American Physicians and Surgeons, delivered in 1888, the facts here stated relating to this class of museums have been gathered. The Army Medical Museum appar-

ently owes its establishment to Dr. William A. Hammond, in 1862. The museum contained in 1888 more than 15,000 specimens, besides those contained in the microscopical department. "An ideal medical museum," says Dr. Billings, "should be very complete in the department of preventive medicine or hygiene. It is a wide field, covering, as it does, air, water, food, clothing, habitations, geology, meteorology, occupations, etc., in their relations to the production or prevention of disease, and thus far has had little place in medical museums, being taken up as a specialty in the half dozen museums of hygiene which now exist."

William Hunter formed the great Glasgow collection between the years 1770 and 1800, and John Hunter, in 1787, opened the famous Hunterian Museum in London, bought by the English Government soon after (1799), and now known as the Museum of the Royal College of Surgeons.

Paris is proud of the two collections at the School of Medicine, the Musée Orfila and the Musée Dupuytren, devoted, the one to normal, the other to pathological anatomy.

Ethnographic museums are especially numerous and fine in the northern part of continental Europe. They were proposed more than half a century ago by the French geographer Jomard, and the idea was first carried into effect about 1840 in the establishment of the Danish Ethnographical Museum, which long remained the best in Europe. Within the past twenty years there has been an extraordinary activity in this direction.

In Germany, besides the museums in Berlin, Dresden, and Leipzig, considerable collections have been founded in Hamburg and Munich. Austria has in Vienna two for ethnography, the Court Museum (Hof-Museum) and the Oriental (Orientalisches) Museum. Holland has reorganized the National Ethnographical Museum (Rijks Ethnographisch Museum) in Leyden, and there are smaller collections in Amsterdam, Rotterdam, and The Hague. France has founded the Trocadero (Musée de Trocadero). In Italy there is the important Prehistoric and Ethnographic Museum (Museo preistorico ed etnografico) in Rome, as well as the collection of the Propagando, and there are museums in Florence and Venice.

Ethnographical museums have also been founded in Christiania and Stockholm, the latter of which will include the rich material collection by Dr. Stolpe on the voyage of the frigate *Vanadis* around the world. In England there is less attention to the subject—the Christy collection in the British Museum being the only one specially devoted to ethnography, unless we include also the local Blackmore Museum at Salisbury.

In the United States the principal establishments arranged on the ethnographic plan are the Peabody Museum of Archæology in Cambridge, and the collections in the Peabody Academy of Sciences at Salem, and the American Museum of Natural History in New York.

The ethnological collections in Washington are classified on a double system, in one of its features corresponding to that of the European, in the other, like the famous Pitt Rivers collection at Oxford, arranged to show the evolution of culture and civilization without regard to race. This broader plan admits much material excluded by the advocates of ethnographic museums, who devote their attention almost exclusively to the primitive or non-European peoples.

In close relation to the ethnographic museums are those which are devoted to some special field of human thought and interest. Most remarkable among these perhaps is the Musée Guimet, recently removed from Lyons to Paris, which is intended to illustrate the history of religious ceremonial among all races of men. Other good examples of this class are some of those in Paris, such as the Musée de Marine, which shows not only the development of the merchant and naval marines of the country, but also, by trophies and other historical souvenirs, the history of the naval battles of the nation. The Musée d'Artillerie does for war, but less thoroughly, what the Marine Museum does in its own department, and there are similar museums in other countries. Of musical museums perhaps the most important is the Musée Instrumental founded by Clapisson, attached to the Conservatory of Music in Paris. There is a magnificent collection of musical instruments at South Kensington, but its contents are selected in reference to their suggestiveness in decorative art. There are also large collections in the National Museum in Washington and the Conservatory of Music in Boston, and the Metropolitan Museum in New York has recently been given a very full collection by Mrs. John Crosby Brown, of that city.

There is a Theatrical Museum at the Academie Française in Paris, a Museum of Journalism at Antwerp, a Museum of Pedagogy in Paris, which has its counterpart in South Kensington. These are professional, rather than scientific or educational, as are perhaps also the Museum of Practical Fish Culture at South Kensington and the Museums of Hygiene in London and Washington.

Archæological collections are of two classes, those of prehistoric and historic archæology. The former are usually absorbed by the ethnographic museums, the latter by the art museums. The value to the historian of archæological collections, both historic and pre-historic, has long been understood. The museums of London, Paris, Berlin, and Rome need no comment. In Cambridge, New York, and Washington are immense collections of the remains of man in America in the pre-Columbian period, collections which are yearly growing in significance, as they are made the subject of investigation, and there is an immense amount of material of this kind in the hands of institutions and private collectors in all parts of the United States.

The museum at Naples shows, so far as a museum can, the history of Pompeii at one period. The museum of St. Germain, near Paris, exhibits the history of France in the time of the Gauls and of the Roman

occupation. In Switzerland, especially at Neuchatel, the history of the inhabitants of the Lake Dwellings is shown. The Assyrian and Egyptian galleries in the British Museums are museums of themselves.

Historical museums are manifold in character, and of necessity local in interest. Some relate to the history of provinces or cities. One of the oldest and best of these is the Märkisch Provinzial Museum in Berlin; another is the museum of the city of Paris, recently opened in the Hotel Canaveral. Many historical societies have collections of this character. Some historical museums relate to a dynasty, as the Museum of the Hohenzollerns in Berlin.

The cathedrals of southern Europe, and St. Paul's, in London, are in some degrees national or civic museums. The Galileo Museum in Florence, the Shakespeare Museum at Stratford, are good examples of the museums devoted to the memory of representative men, and the Monastery of St. Mark, in Florence, does as much as could be expected of any museum for the life of Savonarola. The Sloane Museum in London, the Thorvaldsen Museum in Copenhagen, are similar in purpose and result, but they are rather biographical than historical. There are also others which illustrate the history of a race, as the Bavarian National Museum in Nuremberg.

The Museums of Fine Art are the most costly and precious of all—since they contain the master-pieces of the world's greatest painters and sculptors. In Rome, Florence, Venice, Naples, Bologna, Parma, Milan, Nurn, Modena, Padua, Ferrara, Brescia, Sienna and Pisa; in Munich, Berlin, Dresden, Vienna, and Prague; in Paris, and many provincial cities of France; in London, St. Petersburg, Madrid, Copenhagen, Brussels, Antwerp, and the Hague, are great collections, whose names are familiar to us all, each the depository of priceless treasures of art. Many of these are remarkable only for their pictures and statuary, and might with equal right be called picture galleries; others abound in the minor products of artists, and are museums in the broader sense.

Chief among them is the Louvre, in Paris, with its treasures worth a voyage many times around the world to see; the Vatican, in Rome, with its three halls of antique sculptures, its Etruscan, Egyptian, Pagan, and Christian museums, its Byzantine gallery and its collection of medals; the Naples Museum (*Musée di Studii*) with its marvelous Pompeiian series; the Uffizi Museum in Florence, overflowing with paintings and sculptures, ancient and modern, drawings, engraved gems, enamels, ivories, tapestries, medals, and works of decorative art of every description.

There are special collections on the boundary line between art and ethnology, the manner of best installation for which has scarcely yet been determined. The Louvre admits within its walls a museum of ship models (*Musée de Marine*). South Kensington includes musical instruments, and many other objects equally appropriate in an ethnological collection. Other art museums take up arms and armor, selected costumes, shoes, and articles of household use. Such objects, like por-

celains, laces, medals, and metal work, appeal to the art museum administrator through their decorations and graceful forms. For their uses he cares presumably nothing. As a consequence of this feeling, only articles of artistic excellence have been saved, and much has gone to destruction which would be of the utmost importance to those who are now studying the history of human thought in the past.

On the other hand, there is much in art museums which might to much better purpose be delivered to the ethnologist for use in his exhibition cases. There is also much which the art-museums, tied as it often is to traditionary methods of installation, might learn from the scientific museums.

Many of the arrangements in the European art collections are calculated to send cold shivers down the back of a sensitive visitor. The defects of these arrangements have been well described by a German critic, W. Bürger. "Our museums," he writes, "are the veritable grave-yards of art in which have been heaped up, with a tumultous-like promiscuousness, the remains which have been carried thither. A Venus is placed side by side with a Madonna, a satyr next to a saint. Luther is in close proximity to a Pope, a painting of a lady's chamber next to that of a church. Pieces executed for churches, palaces, city halls, for a particular edifice, to teach some moral or historic truth, designed for some especial light, for some well studied surrounding, all are hung pell-mell upon the walls of some non-committal gallery—a kind of posthumous asylum, where a people, no longer capable of producing works of art, come to admire this magnificent gallery of débris."

When a museum building has been provided, and the nucleus of a collection and an administrative staff are at hand, the work of museum-building begins, and this work, it is to be hoped, will not soon reach an end. *A finished museum is a dead museum, and a dead museum is a useless museum.* One thing should be kept prominently in mind by any organization which intends to found and maintain a museum, that the work will never be finished, that when the collections cease to grow, they begin to decay. A friend relating an experience in South Kensington, said: "I applied to a man who sells photographs of such edifices for pictures of the main building. He had none. 'What, no photographs of the South Kensington Museum!' I exclaimed; with some impatience. 'Why, sir,' replied the man, mildly, 'you see the museum doesn't stand still long enough to be photographed.' And so indeed it seems," continued Mr. Conway, "and this constant erection of new buildings and of new decorations on those already erected, is the physiognomical expression of the new intellectual and æsthetic epoch which called the institution into existence, and is through it gradually climbing to results which no man can foresee."

My prayer for the museums of the United States and for all other similar agencies of enlightenment is this—that they may never cease to increase.

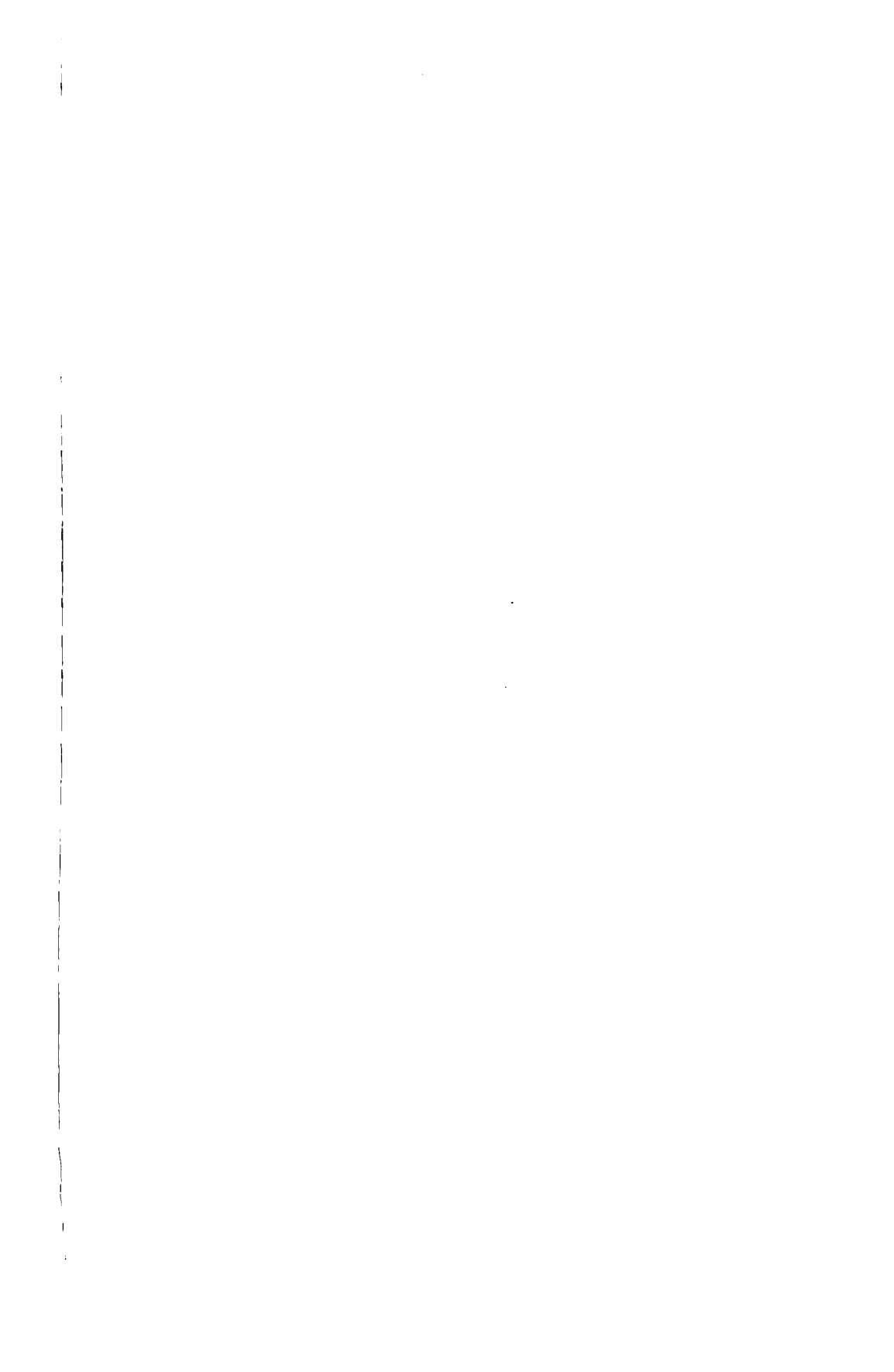

TE PITO TE HENUA, OR EASTER ISLAND.

By Paymaster WILLIAM J. THOMSON, U. S. Navy.

THE DISCOVERY OF EASTER ISLAND.

The honor of the discovery of Easter Island is contested by several of the earlier voyagers in the Pacific. Spanish writers claim that the island was sighted by Mendana in 1566, but the account is by no means authenticated, and the records preserved are not sufficiently accurate to determine the exact track sailed over by that ancient mariner. Captain Davis is credited by Capt. William Dampier with being the first to sight the island, and Lionel Wafer, who cruised with that bold navigator, on board of the *Batchelor's Delight*, gives the following account of the discovery in the year 1687:

Bound to the southward, in latitude 12 degrees 30 minutes and about 150 leagues off the coast, experienced a shock of earthquake, that was afterwards found to correspond with the destruction of Callao by earthquake. Having recovered from our fright we kept on to the southward. We steered south-and-by-east-half-easterly, until we came to latitude 27 degrees 20 minutes south, when about two hours before day we fell in with a small low, sandy island and heard a great roaring noise, like that of the sea beating upon the shore, right ahead of the ship. Whereupon the sailors, fearing to fall foul upon the shore before day, desired the captain to put the ship about, and to stand off until the day appeared; to which the captain gave his consent. So we plied off till day and then stood in again with the land, which proved to be a small flat island, without any guard of rocks. We stood in within a quarter of a mile of the shore and could see it plainly, for it was a clear morning, not foggy or hazy. To the westward about 12 leagues, by judgment, we saw a range of high land, which we took to be islands, for there were several partitions in the prospect.

This land seemed to reach about 14 or 16 leagues in a range, and there came great flocks of fowls. I and many more of our men would have made this land and have gone ashore on it, but the captain would not permit us. The small island bears from Copiapó almost due east 500 leagues, and from the Galapagos, under the line, 600 leagues.

Unfortunately, none of the voyagers on board of the *Batchelor's Delight* were permitted to land upon this unknown island, nor is mentioned in the narratives of monoliths or unusual structures that might have been observed from the short distance in which it is claimed they approached the shore. The apparent inaccuracy in the description of the appearance of the land may have been due to the peculiar bearing of the vessel, but it gives foundation to the claim of Admiral Rogge-

veen, that Davis's island was not identical with the one discovered by him on April 7, 1722, and named Easter Island in commemoration of the day upon which the land was sighted. Roggeveen says:

When we approached nearer the land we saw distinctly from a short distance that the description of the sandy and low island did not accord in the least with our discovery. Furthermore, it could not be the same land which the aforesaid voyagers claim to have seen stretching 14 to 16 leagues in front of them, and near the highland which Dampier judged to be the coast-line of the unknown south. That Easter Island can not be the sandy island described by Davis is clear, because that was small and low, while on the contrary Easter Island is high and towers above the sea, having also two elevations rising above the level part. It would not be possible to mistake, even at the dry season of the year, the grass and verdure that covers the hill-sides for barren sand. After the Dutch custom of the day, the admiral assembled the commanders of the three vessels composing his fleet—the *Arend*, the *African Galley*, and the *Thienhoven*—in council to pass formal resolutions claiming the discovery of the land. The proceedings of the assembly state that on Easter day land was sighted about 9 miles distant, of moderate height, and containing an area of about 6 Dutch miles. The weather being calm the vessels were not able to secure an anchorage near the land until the next day. The island was found to be destitute of trees, but with a fertile soil producing bananas, potatoes, and sugar-cane of extraordinary thickness. It was unanimously agreed that both from the difference in the location as well as the appearance of the land seen by Davis, the fact was established beyond doubt that the island just discovered could not be the same. These proceedings, being drawn up, were formally signed by Jacob Roggeveen, Jan Koster, Cornelius Bonman, and Roelof Rosendaal. After sailing from Easter Island the vessels spent a number of days in a search for the low sandy island described by Davis, but not with success.

The unreliable Behrens mentions in the "Two Years' Voyage" the discovery of Easter Island by Roggeveen on the day celebrated as the resurrection of the Lord (April 6, 1722), in latitude 27 degrees south and longitude 268 degrees west.

Capt. F. W. Beechey, R. N., commanding H. M. S. *Blossom* (November, 1825), referring to the discovery of Easter Island, finds the credit due to Davis, giving the following reasons for the conclusions drawn:

Had such an island been in existence answering to the description of that seen by Davis, geographers would not have been long in reconciling their opinions on the subject of his discovery, as in all probability they would have waived their objections to its distance from Copiapó in consideration of its identity. The subject of the supposed discovery has been often discussed; and when the data are so unsatisfactory as to allow one party to choose the islands of Felix and Ambrose for the land in question, and the other Easter Island, two places nearly 1,600 miles apart, they are not likely to be speedily reconciled unless two islands exactly answering the description given by Davis, and situated in the proper latitude, shall be found.

Without entering upon a question which presents so many difficulties, I shall merely observe that, considering the rapid current that exists in the vicinity of the Galapagos, and extends, though with diminished force, throughout the trade-wind, the error in Davis's reckoning is not more than might have happened to any dull sailing vessel circumstanced as he was. In a short run from Juan Fernandez to Easter Island, Behrens, who was with Roggeveen, was drifted 318 geographical miles to the westward of his supposed situation. H. M. S. *Blossom* in passing over the same ground experienced a set of 270 miles in the short space of 18 days. M. La Pérouse on his arrival at Sandwich Islands from Concepcion, touching at Easter Island on his way,

found a similar error of 300 miles in the course of that passage. It is fair to presume that Davis was longer in crossing from the Galapagos to Easter Island than either of those vessels or, at least, than the *Blossom*; and it is consequently but reasonable to allow him a greater error, particularly as the first part of his route was through a much stronger current. But taking the error in the *Blossom's* reckoning as a fair amount, and applying it to the distance given by Wafer, there will remain only 204 miles unaccounted for between it and the real position of Easter Island, which, from the foregoing considerations, added to the manner in which reckonings were formerly kept, does not appear to me to exceed the limit that might reasonably be ascribed to those causes.

M. La Pérouse was of the opinion that the islands of Felix and Ambrose were those under discussion, and in order to reconcile their distance from Capiapo with that given by Wafer, has imputed to him a mistake of a figure in his text, without considering that it would have been next to impossible for Davis to have pursued a direct course from the Galapagos to those islands (especially at the season in which his voyage was made), but on the contrary that he would be compelled to make a circuit which would have brought him much nearer to Easter Island, and that Davis acquainted Dampier with the situation of his discovery, which agreed with that contained in Wafer's account.

The alteration of a figure, it must be admitted, is rather arbitrary, as it has nothing to support it but the circumstance of the number of islands being the same. A mistake certainly might have occurred, but in the admission of it either party may claim it as an advantage by interpreting the presumed error in a way which would support his own opinion.

Cook and Pérouse differ in a very trifling degree from each other, and also from us, in the geographical position of Easter Island. The longitude is, by Cook, 109 degrees 46 minutes 20 seconds, and deducting 18 minutes 30 seconds, in consequence of certain corrections made at Fetegn Island, leaves 109 degrees, 27 minutes, 50 seconds west. That by Pérouse, allowing the longitude of Concepcion to be 72 degrees 56 minutes 30 seconds west, is 109 degrees 32 minutes 10 seconds west, and our own is 109 degrees 24 minutes 54 seconds west.

Admitting that the land was first sighted by Davis, the fact is beyond question that the Dutchmen under Roggeveen were the first Europeans to land on the island. From the unfortunate termination of his cruise, and the suppression of his official journal for so many years, but little has been handed down to us in the way of description of the island as it then appeared.

The Spaniards sighted the island in 1770, and gave it the name of St. Carlos. Captain Cook called it Easter Island in March, 1774, and sent an expedition on shore, but his log affords little in regard to its general appearance beyond the fact that it was parched and desolate, and of no value as a place of refreshment.

M. Bernizet, geographical engineer, who visited the island in April, 1786, with the La Pérouse expedition, describes its appearance with care, and after the lapse of a century his notes are found to be sufficiently accurate for ordinary purposes.

Amasa Delauro, Kotzebue, Lisiansky, and many other voyagers made brief calls at the island, and their journals afford little information. The recent French, Spanish, and English charts are sufficiently accurate in the main features, but some of the coast lines were evidently established from running surveys, and are incorrect. During the stay of the

Mohican Lieut. F. M. Symonds, with Naval Cadet C. M. McCormick as assistant, made a careful survey of the island, and their chart, herewith appended, will be found accurate and replete with interest. (Plate XII.)

SAILING DIRECTIONS.

Vessels anchoring on this unprotected coast must be guided entirely by the direction of the wind at the time. The *Mohican* anchored in the roadstead of Hanga Roa (Cook's Bay on the English charts) on the morning of December 19, 1886, and afterwards moved to a position off Anakena Bay (La Pérouse Bay), for convenience in shipping the stone image, now in the National Museum.

• On the south coast there are good anchorages during northerly and westerly winds, but there is usually a heavy swell from the southwest, making the boat-landings at Vaihu both difficult and dangerous. With easterly winds a good anchorage will be found just outside of Hanga Pico Bay, with sandy bottom, in about 26 fathoms of water, and the boat-landing will be found safe. The best boat-landing on the island is at Anakena Bay; the beach is comparatively free from stones, and even with northerly winds the landing would be no more difficult than is usual at Funchal.

The rise and fall of the tide at Easter Island is about 2 feet. The northerly and westerly winds do not produce a high sea, but generally bring rain, and are usually confined to the winter season. These winds are known to the natives as "papakino" (ill-force). The northeast wind is called "tongariki;" it is variable, and frequent in summer. The southeast wind, known as "anoraro" (wide expanse), is the prevailing wind in summer. The south wind, called "motu-rauri" (dark leaf rock), blows in winter. The southwest wind blows strong in winter, and brings rain and a high sea. Vaitara (cut-water) is a winter wind from the west. The prevailing winds are from an easterly direction, and all others are of short duration. Light airs that frequently shift direction are usually accompanied by rain, and are called by the natives "tepuhanga" (blows drift on shore), the reason for which is obvious.

GEOLOGICAL FEATURES.

The geological features of the island are replete with interest. The formation is purely of a volcanic character and embraces every variety pertaining to that structure. Basaltic, cellular, and tufaceous lavas abound in diversified forms. The basaltic is generally porous and scoriiform, but on the slope of the hills the substrata are frequently as compact and dense as that of the coast-line. Near Anakena may be seen hills composed of scoria quite as cellular as pumice, and in close proximity compact beds having a dark blue basis, composed of crystals of glassy feldspar and olivine.

The cellular formation is mixed pumice and slag, in some cases simi-

lar to volcanic cinder, having the lightness and qualities of coke. In some of the varieties the cavities are filled with olivine crystals partly decomposed, but generally the cavities are empty. This lava when mixed with feldspar is sometimes of gray color; not unfrequently several tints of red may be seen, though the most common is a dark, lusterless brown.

The tufaceous lavas are extremely interesting, because they form the most prominent feature in the physiognomy of the island. To this geological structure, with the incessant action of the trade-winds and heavy rains, is due the fact that the island is surrounded by precipitous cliffs, rising in some cases to a thousand feet in height. The formation is extremely friable, and by the action of the elements, enormous masses are continually disappearing beneath the waves of the sea that beat upon this unprotected shore. These tufas differ considerably in consistency at the eastern end of the island. The species is a fine light-red dust that is blown about by the wind and is destitute of vegetation; towards the southwest end the basis is a compact mud-like red clay, while the colossal crowns, intended to adorn the gigantic statues, are carved out of a variety that has been scorified in one of the craters, and is of a dull reddish color.

The ordinary rules for estimating the age of rocks by compactness can be applied at Easter Island only hypothetically, because the scoriform and more dense specimens are found immediately contiguous to one another. In places they are quite conglomerated, as though older formations had been disturbed by volcanic convulsions, while a new flow of lava enveloped and sealed the whole into a heterogeneous mass. During our short stay on the islands there was no opportunity to measure the lava flow or to make investigations of that nature.

Natural caves are numerous, both on the coast-line and in the interior of the island. Some of them are of undoubted antiquity and bear evidence of having been used by the early inhabitants as dwellings and as burial places. It is reported that small images, inscribed tablets, and other objects of interest have been hidden away in such caves and finally lost through land-slides.

The numerous hills on this island have gently sloping sides, except where they approach the coast, falling at this point precipitously to the sea. The plains are irregularly shaped, and some of the smaller ones rise to a considerable height. The physical character of the soil is alluvial. The substratum is volcanic ash and stones, and the upper formation is composed of decayed vegetable matter mingled with a rich deposit of decomposed lava washed down from hills by the frequent rains. These plains being formed by the periodical eruptions of the volcanoes, some difference may be noted in the quantity of the soil, varying according to location.

After the successive discharges of lava from the craters of Rana Roraka and Rana-kao had prescribed the limits of the island and when

this flow had ceased, there was a heavy deposit of mud, covering deeply both hill and dale. This condensed earth, after the lapse of centuries, has formed a soil that produces a natural grass affording an excellent pasture for flocks and herds. The expiring energy of the volcanic power appears to have been directed, long after the formation of this soil, to sprinkling thickly the entire surface of the island with stones and small bowlders, thus providing the means of attraction and holding the moisture, nature's substitute, as it were, for trees. The natives have distinct names for the following varieties: Black and red tufa with volcanic cinder and pumice are called "Maea-Haue-haue," "maea" being the generic term applied to all stone. A soft gray tufa is ground down with the juice of the sugar-cane and used as a paint. This is known as "Kiri-kiri Teu." Hard slates, black, red, and gray, are used for stone axes and called "Maea-Toke." Granite used for the same purpose is known as "Maea-Nevhive. The hardest and finest stone implements are made of the flinty beach pebble known as "Maea-Reng-rengo." The hard cellular stones from which the majority of the platforms are built are called "Maea-Pupura." The material from which images were constructed is called "Maea-Matariki," and the obsidian from which spear-heads were made is known as "Maea-Mataa."

VARIOUS NAMES OF THE ISLAND.

Previous to the general recognition of the name bestowed by Admiral Roggeveen in commemoration of the day upon which the land was discovered, it had not been regularly christened by either of the earlier navigators who claimed to have sighted it. The Spaniards afterwards gave it the name of San Carlos, but the Dutchman's title of Easter Island was preferred by the chart-makers and was adopted by the world in general.

The island is known to the natives as "Te Pito te Henua," the literal interpretation of the words signifying the "navel and uterus." This singular name was given to the land, according to the ancient traditions, by Hotu Metua immediately after its discovery, and has been handed down through succeeding generations unchanged. To the simple-minded Polynesian this name is suggestive, appropriate, and beautiful. The child of nature recognizing the volcanic origin of the island can see in the great volcano, Rana Roraka, a resemblance to the human "te pito" in relation to its shape and gently sloping sides surrounding the shallow crater. The same association of ideas would picture the majestic volcano, Rana Kao, at the southwest end, as "te henua," in whose womb was conceived the embryo and whose vitals brought forth the rocks and earth from which the island was formed.

"Kiti te eiranga" is stated by an English writer of some note to be the native name for the island, but we could not find any authority for it, nor did the natives with whom we came in contact recognize the name.

Throughout southeastern Polynesia this island is known as Rapa Nui, but the name is of accidental origin and only traces back about twenty years. When the islanders, kidnaped by the Peruvians, were being returned to their homes, there was for a time a question as to the identity of those from Easter Island. The native name of "Te Pito te Henua" was not recognized by the French officials, and finding certain fellow-sufferers hailing from Oparo, an island lying 2,000 miles to the westward, were more successful under the local appellation of Rapa iti (Little Rapa), the euphonious title was dropped and Rapa nui (Great Rapa) substituted. Teapy, Waihu, and various other names have been given to the island, but clearly without warrant. Waihu was the name of a district and was occupied by the most powerful clan in the days of Cook and La Pérouse, but it was never applied to the entire island.

CLIMATE.

The climate is not unlike that of Madeira, with one wet and one dry season. From April to October the rainfall is copious, and in summer it is limited to passing showers. The mean temperature at the time of our visit (midsummer), in the shade, at 2 o'clock p. m., was between 78° and 80° Fah., and at 2 o'clock a. m. there was a fall of about 6 degrees. The southeast trades blow fresh at the beginning and end of the season, and make the climate salubrious and healthful. Our long fatiguing marches, while making the exploration of the island, were not accompanied with inconvenience from exposure to the direct rays of the sun, the constant breezes making the sensible temperature always appear lower than that recorded by the thermometer. Violent exercise induced profuse perspiration, but evaporation was always free and rapid. Electric storms are unknown.

VILLAGES AND HABITATIONS.

The Catholic missionaries built at Waihu, on the south coast, near Cape Koe Koe, a commodious and substantial church, a parsonage containing three rooms, and several outbuildings. The house is now the residence of Mr. Salmon, the outbuildings are occupied by his employés, and the church has degenerated into a storehouse for wool. The principal native settlement is at Mataveri, on the southwest coast, and about a mile distant, at Hanga Roa, a small neat church has been erected. Here the islanders assemble on Sundays and other occasions to hear the service read by one of their number, who was ordained especially to take charge of this congregation upon the departure of the French missionaries. At the southwest end of the island, and near the base of Rana Kas, is the residence of Mr. Brander.

The house is of modern structure, with large and convenient rooms, but is in a state of bad repair, and is more attractive when viewed from a distance, surrounded by the shrubbery and vines that have been planted about it, than it is upon close inspection.

The native priest and a few of his connections reside at Hanga Roa, only those in the employ of Mr. Salmon live at Vaihu, and the only settlement on the island that may be termed a village is the one at Mata-veri. The primitive huts formerly used by the natives (Fig. 1) have

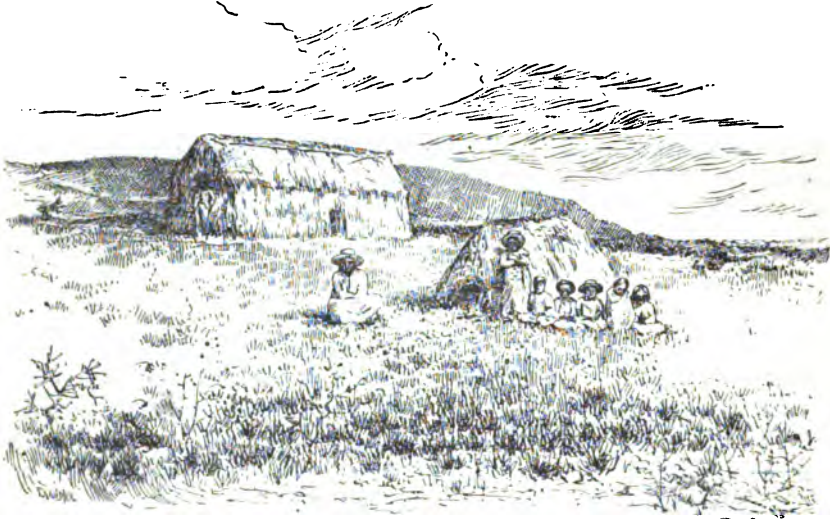

FIG. 1.
NATIVE HOUSES BUILT OF BULRUSHES.

been abandoned for more comfortable dwellings constructed under the direction of a Danish carpenter out of material obtained from the wreckage of several vessels loaded with Oregon lumber. These buildings are of a style of architecture commonly met with in small cheap barns and stables, but to the simple-minded islanders they supply all the comforts that could be desired.

These houses are usually about 25 feet long and 15 feet wide with undressed weather-boards and roofed with the same material. Hinged doors open in the center and admit light and ventilation, though a few of the more pretentious buildings are furnished with small glazed windows. The floors are of bare earth strewn with a litter of dried grass, filthy and vermin-infested from long use. Mats made of bulrushes are spread out for sleeping; several rough bedsteads and chests were seen, but the majority of the houses are destitute of furniture or ornament. Several families occupy the same dwelling; men, women, and children lie down together like dogs in a kennel, and with about the same ideas of what constitutes the comforts of life.

FLORA.

The native traditions agree in the statement that the discoverers of the island found it destitute of trees and all vegetation except grasses and a creeping vine bearing a dehiscent fruit to which the name Moki-oo-ne

was given. Hotu-Matua and his followers are believed to have brought with them potatoes, yams, bananas, sugar-cane, and the seed of various plants, including the paper-mulberry and toromiro trees. The newly discovered species of legume, together with fish and turtle, enabled the first settlers to exist while the first crop was being planted and cultivated.

Nothing could be more contradictory than the description which the different voyagers have given of Easter Island. Roggeveen states that it was destitute of trees, but the land was found to be exceptionally fertile, producing bananas, potatoes, and sugar-cane of extraordinary thickness, and concludes by saying that the island, by virtue of its productive soil and salubrious climate, could be made an earthly paradise by careful cultivation. Behrens speaks of trees on the island, but to his romantic eyes the clusters of banana and paper-mulberries were magnified into forests. Captain Cook expresses great disappointment in the expectation that he had formed of this island as a place of refreshment. The only articles of importance obtained were potatoes and yams, and these were only sufficient to serve for a few meals; while the fowls, bananas, and sugar-cane were in such inconsiderable quantities that they were deemed hardly worth mentioning. George Foster writes:

The island is so very barren that the whole number of plants growing upon it does not exceed twenty species, of which the far greater part is cultivated, though the space which the platforms occupy is inconsiderable compared with what lies waste. The soil is altogether stony and parched by the sun, and the water is so scarce that the inhabitants drink it out of wells which have a strong admixture of brine, and some of our people really saw them drink of the sea water when they were thirsty.

Mr. Foster devoted considerable attention to the investigation of indigenous plants, and his report embraces all of the most important varieties. He found the paper-mulberry carefully cultivated for the purpose of making cloth. The stems were from 2 to 4 feet high, and they were planted in rows among the rocks where the rains had washed a little soil together. The *Thespesia populnea* Carr. (*Hibiscus populneus* Linn.), was cultivated in the same manner, and likewise a *Mimosa*, which is referred to as the only shrub that affords the natives sticks for their clubs and pattoo-pattoos, and wood sufficient to patch up a canoe. Wild celery and a few other small plants were identified as the same species as that which he had found growing in abundance on the shores of New Zealand. He also discovered a variety of night-shade, which the Tahitians use as a vulnerary remedy (*Solanum nigrum*), and speculates as to whether it was used here for the same purpose.

La Pérouse, impressed with a desire to relieve to some extent the destitute condition in which he found the islanders and of contributing essentially and lastingly to their welfare, had ground prepared in which he sowed various kinds of pulse. Peaches, plums, and cherries were planted, also pips of oranges and lemons. The natives were instructed

as fully as possible in the care and attention the new plants would require, and made to understand the value of this addition to their resources. Not a trace can be found of the things planted by this generous Frenchman, but whether they were suffered to die out through the ignorance or indolence of the natives may never be known.

We found the lapse of a century had made but little improvement in the resources of the islanders. Trees have been planted around the house of Mr. Brander, at the southwest end of the island, but, with the exception of the fig, acacia, and paper-mulberry, they do not appear to thrive. At various places throughout this land we found small clumps of *Edwardsia*, *Broussonetia*, and *Hibiscus*, but all were dead, having been stripped of their bark by the flocks of sheep, which roam at will over the island. None of these trees were over 10 feet high, and the largest trunk we found would measure about 5 inches in diameter.

The natives are not altogether ignorant of husbandry, though they practice it spasmodically and at a great expense of time and labor, differing in no respect from the customs of their forefathers hundreds of years ago. In the cultivation of yams, potatoes, and taro, the young plants are protected from the fierce heat of the sun by a mulching of dried grass gathered from the uncultivated ground. Bananas are grown in holes a foot or more deep and with sloping sides, designed to catch and hold the rain-water as long as possible about the roots of the plant. Sugar cane is grown in protected spots, and attains the height of about 10 feet. During our peregrinations this succulent plant was extensively used in lieu of something to drink, and proved exceedingly valuable in preventing a parched condition of the throat. The natives have no knowledge of the art of extracting the juice of the cane for the purpose of making sugar.

The sweet potatoes are large and remarkably good. The natives eat them both raw and cooked. Experiments have been made recently with imported white potatoes, but they have been tried in various situations and at different seasons without success. After the first growth they appear like new potatoes, and when planted again they are invariably soft and sweet, and are much less palatable than the indigenous variety. We saw tobacco plants growing in secluded spots, but were unable to determine by whom or when they were introduced. The natives maintain that the seed was included among that which was brought to the island by the first settlers. Tomato plants were also found growing wild, and on several occasions proved a valuable addition to our limited fare.

A wild gourd is common, and constituted the only water-jar and domestic utensil known to the natives. Suitable clay abounds, but the potter's art seems never to have been known on the island. There are two varieties of indigenous hemp.

We saw no flowering plants that are indigenous to the soil. Vervain,

Verbena officinalis, and a few others grow in great profusion, but they grew from cuttings obtained from a French vessel of war.

Ferns of many varieties are common, and grow in profusion in the craters of the volcanoes. Except in a few exposed places, the slopes of the hills and the valleys are covered with a perennial grass. It strongly resembles the Jamaica grass (*Paspalum*) and grows in bunches or tufts, which in the dry season become so slippery as to make the walking both difficult and dangerous. This natural growth supplies ample pasturage for the numerous cattle and sheep owned by Messrs. Salmon and Brander.

To avoid the depredations of the sheep that wander over the island without restraint, the natives are compelled to protect their cultivated patches by stone walls. The volcanic stones furnish the only available material for these barriers, and are thrown loosely together to a height of 5 or 6 feet, and inclose gardens from a few feet square to several acres. The deeply rooted prejudice existing in the native mind against physical exertion that might be avoided, has developed a happy expedient to save labor and at the same time to escape the ravages of the animals lately imported by the foreign residents. Ruins of houses, cairns, platforms, and tombs are thickly scattered over the island; many of the standing walls are sufficiently well preserved and others require but little repair. Within these ancient foundation walls are raised their limited crops of fruit and vegetables; the only disadvantage being the contracted area available for each plot.

MAMMALS.

There are no quadrupeds peculiar to the island except several varieties of rodents. The ancient traditions claim that a goat-like animal was found here by the first colonists, with wide-spreading horns and giving six young at a birth. It is difficult to imagine the foundation for this fancy. We found no representation of such an animal either in the mural paintings or outlined on the sculptured rocks, and diligent search of the débris of the caves failed to disclose any of the bones or traces of mammals.

La Pérouse found the islanders without domestic animals, and left with them two ewes, a she-goat, and a sow, with the male of each species. Their native names indicate the recent addition to the language.

In the caves and among the ruins we saw many rats of great size. The examination of the tombs disclosed the fact that the bones had been frequently gnawed by these rodents, and their nests were sometimes found inside the crania.

There are on the island a few cats as wild as though they had never seen the face of man, though they are descended from feline pets landed by some passing vessel. They have grown to an immense size, and upon several occasions when encountered in the dark recesses of a cave

or tomb presented a formidable appearance. Messrs. Salmon & Brander have a herd of 600 cattle, and a flock of sheep numbering 18,000. The cattle are from Chilian stock, are small, averaging only about 400 pounds, and possess no dairy qualities; the cows giving barely enough milk to rear their calves. The sheep were also imported from Chili. The wool is coarse and scant, the average being only about 2 pounds per animal. The export of last year in wool was 16 tons, and was shipped to Europe *via* Tahiti. An effort will be made next year to improve the breed of sheep by introducing blooded rams from Australia. A few tough little horses have been introduced from the island breed of Tahiti, but it is doubtful whether this will ever become an important industry.

BIRDS.

Small birds are altogether absent and, except the ordinary domestic fowl, we found only the tropic or man-of-war bird, petrels, gulls, and a variety of aquatic birds. George Foster observed noddies so tame as to settle on the shoulders of the natives, but he did not conclude that they kept a regular breed of them. The common domestic fowl was found on the island by the early navigators, and it is claimed that they were brought there by the first colonists. They are of the same kind as the common chickens reared at home; their bodies are small, and the legs long, but this is no doubt the result of long in-breeding. The natives all have tame fowls about their dwellings, but there are others in a wild state. We shot some of the wild fowls and found them tough and inferior in taste to those that were domesticated.

FISHES.

Fish has always been the principal means of support for the islanders, and the natives are exceedingly expert in the various methods of capturing them. The bonito, albicore, ray, dolphin, and porpoise are the off-shore fish most highly esteemed, but the swordfish and shark are also eaten. Rock-fish are caught in abundance and are remarkably sweet and good. Small fish of many varieties are caught along the shore, and the flying-fish are common. Eels of immense size are caught in the cavities and crevices of the rock-bound coast. Fresh-water fish are reported to exist in the lakes inside of the craters, but we did not see any of them.

Turtles are plentiful and are highly esteemed; at certain seasons a watch for them is constantly maintained on the sand beach. The turtle occupies a prominent place in the traditions, and it is frequently represented in the hieroglyphics and also appears on the sculptured rocks. A species of crayfish classified by Dr. Philippi, of Chili, as "*papar-chalu*," is abundant. These are caught by the natives by diving into the pools among the rocks, and form an important article of food.

Shell-fish are plentiful. Remains of several varieties of univalves were found in the stone houses at Orongo, and frequently met with in the débris of the caves throughout the island.

REPTILES AND INSECTS.

Small lizards are frequently seen among the rocks; the natives claim that a large variety is not uncommon, but we saw nothing of it. No snakes exist, but there are centipedes whose bite is said to be extremely painful, though not attended with serious consequences. Several varieties of butterflies were observed. Myriads of flies infest every part of the island. Vliegen Island was the name given to Riroa, in the Pamotu group, or Low Archipelago, by Schouten in 1616, but we were tormented here by hundreds where we saw tens on the Attol. From the earliest dawn of day to the close of the short twilight, hordes of flies annoyed us; it made no difference whether we skirted the cliffs to windward, climbed the breeze-swept hills, or burrowed in the musty caves and tombs, swarms of flies met us, prepared to dispute every foot of the ground. Whatever may have been the parent stock of the Polynesians, we came to the unanimous conclusion that we had discovered here the lineal descendants of the flies that composed the Egyptian plague, and can testify that they have not degenerated in the lapse of time.

Fleas occasioned us more annoyance than the flies, because this industrious little insect was untiring in its attentions by day and night. They were found in numbers in all the camping places, and we seemed to get a fresh supply every time a halt was called.

There are fifteen or twenty mangy dogs of a mongrel breed on the island whose hides were literally alive with jumping insects. They had long ago given up all hope of relief, and made no ineffectual efforts in that direction, but they plainly expressed in their mute way the conviction that life in this flea-bitten state was not worth the living.

It was said that there were no mosquitoes on the island until cisterns were built by Messrs. Salmon and Brander to catch the rain-water. We saw none elsewhere.

Cockroaches about 2 inches long, with antennæ to correspond, infest every dwelling on the island, from the humble thatched hut to the comparatively comfortable residences of the foreigners. They partook of our food at meal-times with a freedom which showed that the presence of the stranger caused no restraint; while at night they made themselves familiar with our garments in whatever time could be spared from their gastronomic researches.

A peculiar variety of snapping beetle made its appearance every evening just before sundown, appearing suddenly and vanishing with daylight.

NETS AND ROPES.

Various forms of fishing nets were manufactured, from the hand net to the long seine called "kupenga maito," which was supported by poles at the extremities, weighted with stone sinkers on the submerged edge and floated by billets of wood on the surface (Plate XIII). Their

light casting-nets were used with great dexterity as they waded along the beach, and when a shoal of small fish appeared, the net was thrown with the right hand. These nets were remarkably made, and in the manufacture a netting-needle of bone or wood was used, much after the fashion in more civilized countries. The coarse nets and cordage was made from the twisted bark of the *hibiscus*, and the fine ones from the fiber of the indigenous hemp. From the strong heavy ropes used in raising and transporting the colossal images to the light but durable fish-lines, the threads were all twisted by hand, across the knee, into even strands, which were multiplied according to the size and strength required.

NATIVES.

The population of Easter Island is not stated in actual figures by any of the traditions or legends, but all agree in the statement that the different districts were peopled by numerous and powerful clans who were constantly at war with each other. The immense amount of work performed by the image-makers and platform-builders would indicate the employment of a great many persons, if accomplished within a reasonable limit of time, or the extension over several centuries, if the undertaking was carried out by successive generations. The ruins of extensive settlements near Tahai Bay Kotatake plains, around Puka Manga-Manga mountain, the Rana-Hana-Kana coast, the vicinity of Anakena, the shores of La Pérouse Bay, and extending along the coast from Tongariki to Vinapu in an almost unbroken line, would prove either the presence of numerous inhabitants, or a frequent change of location. The limited area of the 32 square miles of surface available for cultivation precludes the idea of any very dense population, and many reasons might be assigned for a frequent change of habitation. We know that the stone houses at Orango were only occupied during the feast of "bird eggs." The image-builders engaged in the quarries of Rana Roraka probably lived at Tongariki, and entire communities may have changed location at different seasons of the year from failure of water supply, or some equally sufficient reason.

The early Spanish voyagers estimated the population at between 2,000 and 3,000. Admiral Roggeveen states that he was surrounded by several thousand natives before he opened fire upon them. Captain Cook, fifty-two years later, placed the number at between 600 and 700, and Foster, who was with him, estimated them at 900. Twelve years later (1786) La Pérouse placed the population at 2,000. Bushey (1825) puts the number at about 1,500. Kotzebue and Lisiansky make more liberal estimates. Equally chimerical and irreconcilable deductions are made by recent writers. Mr. A. A. Salmon, after many years' residence on the island, estimates the population between 1850 and 1860 at nearly 20,000. The diminution of the actual number of inhabitants progressed rapidly from 1863, when the majority of the able-bodied men were kidnaped by the Peruvians, and carried away to work in the guano deposits of the Chincha Islands, and plantations in Peru. Only



FISH-NET.

(Cat. No. 129748, U. S. N. M. Easter Island. Collected by Paymaster W. J. Thomson, U. S. N.)



a few of these unfortunates were released, and all but two of them died upon the return voyage, from small-pox. The disease was introduced on the shore and nearly decimated the island in a short time. An old man called Pakomeo is at present the only survivor of those returned from slavery, and he is eloquent in the description of the barbarous treatment received from the hands of the Peruvians. In 1864 a Jesuit mission was established on the island, and through the teachings of Frère Eugene, the ancient customs and mode of life were replaced by habits of more civilized practice.

H. M. S. *Topaze* visited the island in 1868. At that time the population was about 900, one-third of the number being females. In 1875 about 500 persons were removed to Tahiti under contract to work in the sugar plantations of that island. In 1878 the mission station was abandoned, and about 300 people followed the missionaries to the Gambier Archipelago.

Mr. Salmon took a complete census of the people just before the arrival of the *Mohican*, and we were furnished with a list containing the names of every man, woman, and child on the island. The total number of natives is at present 155. Of these 68 are men, 43 women, 17 boys under fifteen years of age, and 27 girls of corresponding age. The population has been for several years at a standstill, the births and deaths being about equal in numbers. The longevity of the islanders appears to compare favorably with the natives of more favored lands. The oldest man among them is a chief called Matí; his actual age is not known, but he must be upwards of ninety, and his wife is nearly of the same age.

The last king was kidnaped by the Peruvians and died in captivity, but his nearest descendant is a sturdy old fellow (Fig. 2) called Kaitae,



FIG. 2.

KAITAE, NEAREST DESCENDANT OF THE LAST KING OF EASTER ISLAND.

about eighty years of age. The simple mode of life, frugal diet, freedom from care and anxiety, with regular habits, are favorable to the longevity of the race.

PERSONAL APPEARANCE OF THE NATIVES.

In describing the personal appearance of the islanders (Plate XIV) the early writers give us a pleasing variety to choose from. Behrens solemnly states that a boat came off to the ship steered by a single man, a giant 12 feet high, etc. He afterwards observes, "with truth, I might say that these savages are all of more than gigantic size. The men are tall and broad in proportion, averaging 12 feet in height. Surprising as it may appear, the tallest men on board of our ship could pass between the legs of these children of Goliath without bending the head. The women can not compare (Fig. 3) in stature with the men, as they are

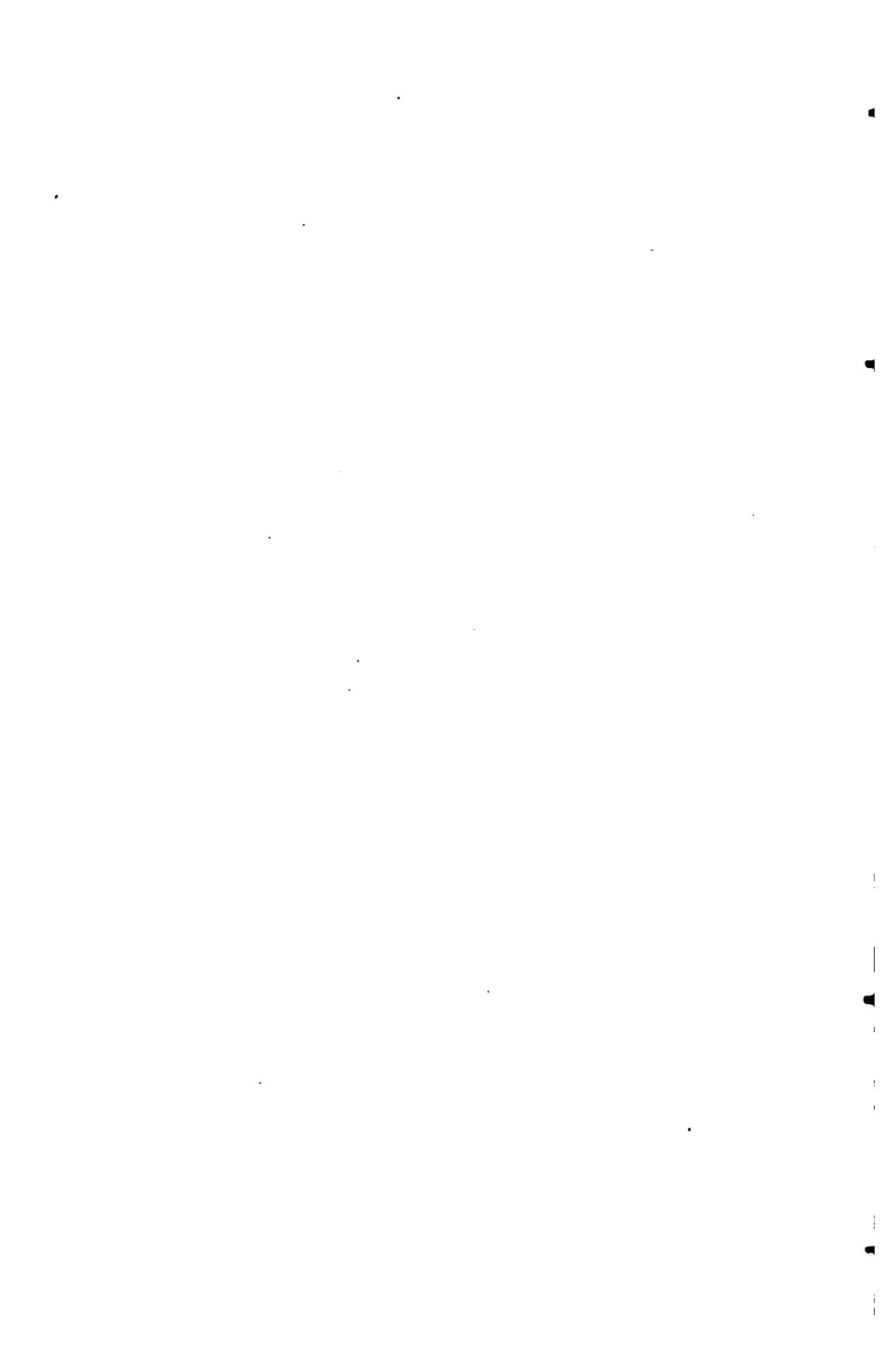

FIG. 3.
NATIVE WOMEN.

commonly not above 10 feet high." Roggeveen does not commit himself to a measurement, but states "the people are well proportioned of limb, having large and strong muscles, and are great in stature. They have snow-white teeth, which are uncommonly strong; indeed, even among the aged and gray we were surprised to see them crack large hard nuts whose shells were thicker than those of our peach seeds." La Pérouse contradicts the account as to their enormous height and praises the beauty of the women, who, he says, resemble Europeans in color and features. M. Rollin states that the females were more liberally endowed with grace and beauty than any which were afterwards



GROUP OF NATIVES IN EMPLOY OF MR. BRANDER.



met with. The natives are not of large stature; a few of the men are tall, but they are of spare build, stand erect with straight carriage, and appear taller than they really are.

Great care was taken to measure accurately the human remains found in the oldest tombs excavated on the island. These proved the ancient islanders to have been of medium size, and the largest skeleton found measured a little short of 6 feet. The men are strong, active, and capable of standing great fatigue—a fact demonstrated to our satisfaction during the exploration of the island. The women are shorter and of smaller bone than the men, as is usually the case throughout Polynesia.

Mendana states that the islanders are nearly white and have red hair. They resemble the Marquesans more than any other Polynesians, and considerable variety prevails in their complexions. The children are not much darker than Europeans, but the skin assumes a brown hue as they grow up and are exposed to the sun and trade-winds. The parts of the body that are covered retain the light color, and the females, who are usually protected from the sun, are much fairer than the men. Bronze complexions are believed to indicate strength, and a dark skin is considered a mark of beauty. The eyes are dark-brown, bright, and full, with black brows and lashes not very heavy. The countenance is usually open, modest, and pleasing. The facial angle is slightly receding, the nose aquiline and well proportioned; the prominent chin with thin lips gives somewhat the appearance of resolution to the countenance.

The native character and disposition has naturally improved as compared with the accounts given by the early navigators. They were then savages wearing no clothes, but with bodies painted in bright colors. The women are said to have been the most bold and licentious in Polynesia, if the reports are correctly stated, but we found them modest and retiring and of higher moral character than any of the islanders. The repulsive habit of piercing the lobe of the ear and distending the hole until it could contain bone or wooden ornaments of great size is no longer practiced, but there are still on the island persons with ear-lobes so long that they hang pendent upon the shoulders. In disposition the natives are cheerful and contented. Our guides were continually joking with each other, and we saw no quarreling or fighting. They are said to be brave and fearless of danger, but revengeful and savage when aroused. They are fond of dress and ornaments. Very little tappa cloth is now worn, the people being pretty well equipped with more comfortable garments, obtained from the vessels that have called at the island. (Plate XV). Straw hats are neatly braided by the women and worn by both sexes. The women wear the hair in long plaits down the back, the men cut the hair short and never discolor it with lime as is the custom in many of the islands of Polynesia. The hair is coarse, black, and straight, sometimes wavy, but never in the kinky stage. The beard is thin and sparse. Gray hair is common among those beyond middle life and baldness is very rare.

Kava is not grown upon the island and the drink made from the kava-root, common throughout the South Sea, is not known to these people. The diminution of the inhabitants can not be ascribed to the introduction of intoxicating drinks, or indeed any of the factors usually advanced in such cases. The decadence was no doubt accelerated by the introduction of the small-pox, and by the deportation of large numbers, but it is earnestly hoped that the small remnant of the people will increase and multiply under the comforts and protection acquired from contact with civilization.

BRUTAL TREATMENT OF NATIVES BY EARLY VOYAGERS.

The brutal treatment that the islanders received from the hands of their early visitors was not calculated to impress them favorably. Usually the strangers were met upon their arrival by a crowd of noisy, restless, impetuous people, as curious as children and as peaceable and friendly with all their boisterousness. The greatest fault they committed was theft, and in return numbers were shot down and innocent persons murdered. Roggeveen plainly states that his boats approached the island well armed and in great fear of the natives. The men were formed in line of battle as they disembarked, and before all were landed, some one in the rear fired a shot, and immediately a fusilade began by these cowardly ruffians upon the unfortunate islanders, ten or twelve of whom were killed outright and as many were wounded. The admiral quietly shifts the responsibility for this outrage upon the shoulders of the second mate of the *Thienhoven*, who offers as an excuse that some of the natives were observed to take up stones and make threatening gestures. As soon as the astonishment and terror of the inhabitants had subsided, they sued for mercy, and everything they possessed in the way of fruits and vegetables, poultry, etc., was procured and laid as a peace offering at the feet of the Dutchman. Captain Cook afterwards received the most friendly reception possible from the same people, but he observed their great dread of fire-arms, the deadly effects of which were thoroughly understood. The landing party conducted a brisk trade, and were highly amused to witness the small thefts committed upon one another in order to obtain articles for barter, yet Lieutenant Edgecomb did not hesitate to immediately shoot with his musket a poor unfortunate who picked up a little bag of botanical specimens.

Captain Beechey was received with friendly demonstrations and his boats, sent on shore for supplies, obtained bananas, yams, potatoes, sugar-cane, nets, etc., in trade, and some were thrown into the boats, leaving the strangers to make what return they chose. His journal dwells at great length upon the thieving propensity of the natives. His boats were surrounded by native swimmers, who made off with small articles that came within reach of them, and among them were women who were not the actual plunderers, but who procured the opportunity for others by engrossing the attention of the seamen.

To reach the landing-place the boats had to pass a small isolated rock upon which many persons had congregated, and who sang a song of welcome, accompanied by gestures showing that the visit was acceptable. On shore the party was surrounded by a crowd clamorous to obtain something from the strangers, the few presents offered were accepted, and then everything that came handy appropriated in the most open manner. This led to a scuffle, in which sticks and stones were freely used, resulting in a fight in which the native chief was shot and killed. The punishment of the natives, according to European ideas, was both cruel, and unnecessary. La Pérouse judged the same crimes more leniently, and did not feel justified in committing murder to avenge petty thefts. The outrages perpetrated upon the defenseless people by Captain Rugg, of the *Friend*, and other freebooters, including the Peruvian slavers, require no comment.

THIEVING.

The natives did not attach any moral delinquency to the practice of thieving. They had a god of thieving, and successful operations were believed to be accomplished under his patronage, and only detected when not sanctioned by that spirit. The detected thief was made to suffer for his crime by an established system of retaliation peculiar to themselves, but the individual never lost caste or the respect of his friends. Thieves caught in the act might be beaten, knocked about, and the aggressor was permitted to offer no resistance in the efforts to escape, although he might be the largest and most powerful. Before the retaliation could be enforced, the theft had to be proven and fixed beyond question, then the plundered individual was at liberty to recover the value of the loss from any property available belonging to the robber, and in the event of the value not being recovered, articles of value could be destroyed to equalize the amount. Retaliation for theft could be enforced by the weak and feeble against the strong and powerful, and any resistance would call to their aid the entire community.

The rite of circumcision, so common throughout Polynesia, is unknown here, and their language contains no equivalent word for it. At the present time, all the natives have professed Christianity, and the ancient customs have been replaced by the ceremonies of the church to a great extent, but since the departure of the missionaries there has been a tendency to return to the old ideas, and many superstitions and practices are mingled with their religion. The marriage ceremony is performed by the acting priest in the church, but the practice is permitted with children who have not reached the age of puberty, and the betrothal is conducted by parents, the relations of the female paying a stipulated amount, generally in food to be consumed by the friends at the feast given to celebrate the event. It is not certain that polygamy ever existed, but an ancient custom permitted the husband to sell or lease his wife to another for a stated term. On account of the disproportion in the number of the sexes, celibacy was a matter of necessity, and

probably originated this custom. Love of family is a strong trait in their character; children are fondly cared for, and the desire for offspring is general.

TATTOOING.

Tattooing is not practiced at the present time, none being observed upon children and young persons. But all those advanced in life are ornamented on all parts of the body. Unlike the Samoans and other islanders, where a standard pattern is adhered to, the designs were only limited by the fancy and ability of the artist. Both sexes were tattooed (Figs. 4, *a* and *b*), but the women to a greater extent and with more elaborate designs than the men. The material used in tattooing is obtained by burning the leaf of an indigenous plant called "ti," which is moistened with the juice of a berry called "poporo." A tattoo comb is made of bone or fish bones fastened to a stick, which is held in position and struck with a sharp blow.



FIG. 4, a.

TATTOOING ON NATIVE WOMAN (FRONT VIEW).

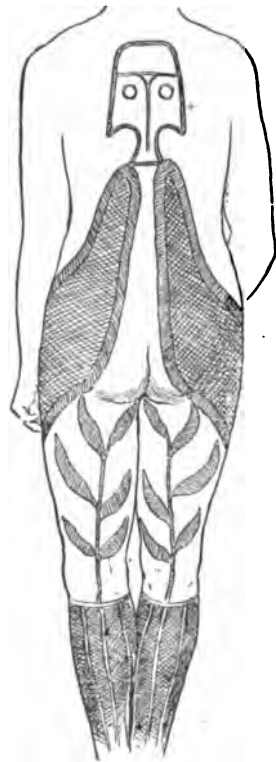

FIG. 4, b.

TATTOOING ON NATIVE WOMAN (BACK VIEW).

The highest ornamentation was as follows: A narrow band around the upper part of the forehead, at the edge of the roots of hair, with little circles extending down upon the forehead and joined to the band

by a stem. From the coronet, a line extended around the outside edge of the ear, with a circle on the lobe. The lips were freely tattooed, after the manner of the Maoris, with lines curving around the chin and extending towards the cheek-bones; the entire neck and throat covered with oblique or wavy lines, with occasional patches of solid coloring; a broad, wide girdle (Fig. 4, *a*) about the waist, from which bands rise in front and behind, representing trees and foliage, surmounted by large faces on the breast and back, and smaller ones on each side of the body. Below the waist belt the lines were fine, like lace-work, and from the thigh to the knee the appearance was that of silk tights with variegated pattern. Below the knee there were various designs. terminating in a point at the feet.

SALUTATION.

The form of salutation is "Kohomai," literally interpreted, "Come to me." This is always heartily expressed, and parties meeting often shout out the kohomai while some distance apart. The greeting is varied by the addition of a word of respect when addressed to a superior in rank, or a stranger, and by a term of endearment, when to a child or to a relation.

DRESS.

The costume of the natives is at present made up of the cast-off clothing obtained from ships of all nations that have called at the island, but principally old uniforms of the French, Spanish, and English vessels of war. Brass buttons appeal strongly to the native love for adornment, and many were made happy by the liberal contributions from the *Mohican*. Very little tappa cloth is made on the island at present, but specimens of the ancient handiwork are treasured up in every family. The mode of manufacture is quite similar to that practiced on the various groups of the South Sea, but the patterns are much less elaborate. The bark is stripped from the branches of the *Hibiscus*, in a manner to obtain the greatest possible length, and rolled into coils with the inner bark outside, in order to make it flat and smooth. It is then scraped with a piece of obsidian to remove the bark, the coils being occasionally soaked in water to remove the resinous substances. The strips are laid across a log and beaten for many hours with a heavy mallet. The mallets are made of the heaviest and hardest wood that can be obtained (*toromiro*), about a foot long and 3 inches on each face, some of which are smooth and others carved into grooves or ribs, to suit the different stages in the process of manufacture. Several strips of bark are beaten into one thickness of cloth, according to the purpose for which it was intended, some being made quite fine and others coarse and heavy. No gum is used except that naturally contained in the bark, and the fibers adhere closely when kept dry. The fabrication of the tappa speaks well for the native

invention and industry, but it is not very durable when compared with woven goods. The colors with which the decorations are made are procured from roots, leaves, and berries of indigenous plants and are prepared with considerable skill. Several kinds of earth are used for the dark colors, the pigment being ground down and boiled in the juice of the sugar-cane.

MATS.

The natives excel in the manufacture of fine mats, specimens of which will be found in our collection. They are made of bulrushes obtained from the craters in the vicinity of the lakes formed by the collection of the rain-water. They are woven by hand, and fine specimens are highly prized.

AMUSEMENTS.

The amusements of the people were reduced to a minimum when the customs of their heathen forefathers were abandoned, and at present there is no general assemblage for the purpose of enjoyment except an occasional marriage feast or some accidental occasion, such as the arrival of a foreign ship. Prominent among the ancient customs were feasts to celebrate the return of the different seasons and various anniversaries in their history, such as the landing of Hotu-Metua at Anakena Bay. Upon the latter occasion the ancient traditions were repeated by recognized orators, and a prominent feature of all fetes was athletic sports, such as running, spear-throwing, and feats of skill and dexterity. Dancing was the most common of all amusements and there was no assemblage without its appropriate dance.

THE NATIVE DANCE.

Just as the traditions are cherished and repeated from father to son, the native dances are remembered and held in esteem, although never publicly practiced. Mr. Salmon secured the services of the "star performers" and we were fortunately enabled to witness the peculiarities of the native dance at his house at Viahu, on the eve of our departure from the island. The music was furnished by three persons seated upon the floor, who accompanied their discordant voices by thumps upon a tom-tom improvised from old cracker-boxes, and the dance was performed by an old woman and a young girl, the latter possessing some claim to symmetry of figure. The dancers wore a single loose garment, short enough to expose the bare ankles and sun-browned feet. Over the head and shoulders was thrown a white cloak, composed of a few yards of cotton cloth, which was sometimes spread open and occasionally made to hide the whole figure as they went through the various evolutions of the dance. This mantle was not managed with any particular skill or grace and seemed to be identified with one particular

dance, after which it was discarded for the small dancing-paddle or wand. The weird songs related the achievements and exploits of their ancestors in war, fishing, and love, and the gestures of the dancers were upon this occasion perfectly proper and modest. Some of the movements were suggestive of a rude relationship to the dances performed by the geisha girls of Japan in their odori, and consisted of movements and attitudes calculated to display the elegance and grace of the performers. The peculiar feature of the native dancing is the absence of violent motion; there is no jumping or elaborate piquettes, no extravagant contortions, and nothing that might be called a precision of step. The lower limbs play a part of secondary importance to the arms and the dancers indulge in no dizzy gyrations. The feet and hands are kept moving in unison with the slow, monotonous music, while the dancers endeavor to act out the words of the song by pantomime. These islanders, like their sisters throughout Polynesia, have their hula-hula, or dances that partake of passion and abandon, and portray the old story of coquetry, jealousy, and ultimate surrender of the maiden. Soft swaying movements, a gentle turning away, timid glances, and startled gestures, gradually giving place to more rapturous passion, speak plainly enough the theme of the song, though the movements are less graceful and elegant than those which characterize the nautch dances of India. Among the diversified dances, some are performed by men and others by women, but the sexes rarely if ever dance together. Wands are usually held in each hand, but occasionally one and sometimes both are discarded. Feather hats and other ornaments are worn in portraying characters and some of the dances are said to be of obscene tendencies.

BELIGION.

Like most savage nations, the Easter Islanders had numerous superstitious and resorted to charms, prayers, incantations, and amulets to bring good luck and ward off evil. A thorough delineation of these superstitious might be instructive in the light of showing the real depth of the religious feeling of those who now profess Christianity as well as the capacity of the native mind for entertaining a higher form of civilization; but, unfortunately, our brief stay on the island did not afford time to thoroughly investigate the subject.

The belief in a future state was a prominent feature in the religion. After death the soul was supposed to depart to the "place of departed spirits" to be rewarded by the gods or tormented by the demons. With this idea in view a small hole was invariably built in the wall near the top of all tombs, cairns, and other receptacles for the dead, by which the spirit of the deceased was supposed to find egress. Deified spirits were believed to be constantly wandering about the earth and to have more or less influence over the human affairs. Spirits were supposed to appear to sleeping persons and to communicate with them through visions or dreams.

Gnomes, ghouls, and goblins were believed to inhabit inaccessible caves and niches in the rock and to have the power of prowling about after dark. The small wooden and stone images known as "household gods," were made to represent certain spirits and belong to a different order from the gods, though accredited with many of the same attributes. They occupied a prominent place in every dwelling and were regarded as the medium through which communications might be made with the spirits, but were never worshiped. The Great Spirit Meke-Meke is represented by a bird-like animal as referred to in the description of sculptured rocks and paintings at Orongo.

SUPERSTITIONS.

The islanders were superstitious to an extent that was extraordinary, and they were constantly under the influence of dread from demons or supernatural beings. Fish-hooks were made of bones of deceased fishermen, which were thought to exert a mysterious influence over the denizens of the deep. Fishermen were always provided with the stone god that was supposed to be emblematic of the spirit having cognizance of the fish. Rocks in certain localities were believed to be under spirit taboo, and persons who walked over them were punished with sore feet. The leaves of several harmless plants were regarded as prophylactic against disease. Stones were buried beneath the doorways of houses to guard against evil influences. The native priests were simply wizards and sorcerers who professed to have influence with evil spirits sufficient to secure by incantations their co-operation in the destruction of an enemy, or by occult means gain their aid and good-will for the protection of property, crops, etc. The system of taboo corresponds with the same thing practiced throughout the islands of the South Sea, and included a prohibition in regard to persons as well as property. The symbol of the taboo on crops properly consisted of a small pile of stone placed in the form of a pyramid, or piled one on top of the other. The natives have a way of divining the future by means of a flower, common enough in more civilized countries but not observed before in Polynesia. "Ae" and "Aita" are repeated as the petals are thrown away, and the signification appears to be equivalent to the "yes," and "no" of Goethe's Marguerite.

SACRIFICIAL STONES.

In the rear of some of the best-preserved platforms are stones said to have been erected for sacrificial purposes. These altars consist of a single shaft, generally of vesicular lava, but in some cases cut from the material of which the images and crowns were made. They range in height from 5 to 10 feet, squared to $3\frac{1}{2}$ or 4 feet on each face, and stand in the center of a terrace paved with smooth boulders. The sides and plinth were covered with figures sculptured in low relief, but are now too much weather-worn to be traced. These altars are said to have

been designed and used for human sacrifices, but of this a reasonable doubt may be expressed. The form is inconveniently adapted to the purpose and the stones differ in all respects from those used for the same purpose in the other islands. Evidences of fire on top of stones were plain enough, but no charred bones were found except those of recent date belonging to sheep and cattle.

DISEASES AND THEIR TREATMENT.

The practice of relieving pain by manipulation of the body was the effective movement cure resorted to by the islanders years before the Swedish or massage treatment assumed its present prominence. Without entering upon the question of how valuable the practice of lomi-lomi may be as a cure for ailments, I may testify to the physical regeneration of this titillant manipulation. On more than one occasion I have thrown myself upon the ground, completely exhausted by over-exertion, and yielded to the dexterous kneadings and frictions and palmings and pinchings of those skilled in the treatment. The hard-fisted native is by no means gentle in the operation, but with palms and knuckles vigorously tests every muscle and tendon, as well as every joint of the vertebræ, until the exhausted patient sinks into a state of oblivious somnolence.

Several of the plants indigenous to the island were considered valuable remedies for certain ailments, but the chief therapeutic art of the native practitioner was the pretended exercise of powers of divination. The application of herbs, simples, and the practice of lomi-lomi were perhaps not sufficient distinction, and therefore a claim was made for occult knowledge and supernatural power.

The native pharmacopœia is extremely limited in its scope. The thistle is bruised and applied to sores and ulcers, arrowroot for burns, and a species of nightshade is used as a vulnerary remedy. On this breeze-swept island diseases of a paludal nature are unknown.

A mild type of remittent fever is common during the rainy season from April to October, but nature is left to fight its battles without assistance. Rheumatism and pulmonary complaints occasionally result from long exposure to inclement weather, but as a rule no medical treatment is attempted.

The natives believe that a disease called "kino," or cracked feet, results from walking over the rocks along the shore at Tahai. Probably the trouble arises from cuts and abrasions coming in contact with a succulent vine that grows at this place.

FIRE.

The method of obtaining fire requires considerable preparation of material and patience on the part of the operator. A pointed stick of hard wood is rubbed against a piece of dry paper-mulberry until a groove is formed, which finally becomes hot from the friction and ignites the lint

or fiber thrown up at the end of the groove. This is blown into a flame, and dried grass added to it until the fire is sufficiently established. The difficulty of preserving suitable material in a perfectly dry state led to the custom of keeping up a perpetual fire in each community. These vestal fires were kept up by persons appointed for that purpose, though it does not appear that they were vestal virgins. Caves affording ample protection from the weather were selected for the location of these permanent fires, and although they had no religious significance, the flames were as carefully watched and attended as the celestial fire of the followers of Zoroaster.

CANNIBALISM.

The traditions abound with instances of anthropophagism, and in all Polynesia there were no more confirmed cannibals than these islanders. The practice is said to have originated with a band of natives who were defeated in war and besieged in their stronghold until reduced to the borders of starvation. From this time the loathsome custom of devouring prisoners, captured in war, grew in popular favor. Cannibalism may have originated in a spirit of revenge, but it grew beyond those limits, and not only were prisoners of war and enemies slain in battle eaten, but every unfortunate against whom trivial charges were made met that fate. Instances are related in the legends of children being devoured by their parents, not from any other motive than to satisfy the cravings of their depraved and vitiated appetites. Cannibalism was practiced until a comparatively recent period. Several of the older natives acknowledge that they had frequently eaten human flesh in their youth, and described the process of cooking and preparing "long-pig" for the feast.

GOVERNMENT.

The ancient government of Easter Island was an arbitrary monarchy. The supreme authority was vested in a king and was hereditary in his family. The person of the king was held sacred. Clan fights and internecine struggles were common, but the royal person and family were unmolested. The king reigned over the entire island and was not disturbed by the defeat or the victory of any of the clans. The island was divided into districts having distinct names and governed by chiefs, all of whom acknowledged the supremacy of the king. The title of chief was also hereditary, and descended from father to son, but the king reserved the right to remove or put to death any of them and of naming a successor from the people of the clan.

There was no confederation, each clan being independent of all the rest, except as the powerful are naturally dominant over the weak. The chiefs wore peculiar feather hats to denote their rank, and they presided at feasts and councils in the absence of the king. Other grades of rank were recognized, such as that required by feats of valor, public

service rendered, such as image making, etc., but this privileged class had no authority vested in them over their fellows. Personal security and the rights of private property were little regarded, and disputes were settled by king or chief without regard to law or justice. There was no code of laws, the people avenged their own injuries, and persons who incurred the displeasure of the ruler were marked as victims for sacrifice. It does not appear that any great homage was paid the king, and no tax was exacted of the people. Long-continued custom was accepted as law, and defined the few duties and privileges of the private citizen.

Maurata, the last of a long line of kings, together with all of the principal chiefs of the islands was kidnapped by the Peruvians and died in slavery. Since that time there has been no recognized authority among the natives; every man is his own master, and looks out for his own interests.

In 1863-'64 the natives were converted to Christianity by Frère Eugène, a Jesuit missionary. A Frenchman called Dutrou-Bornier had settled upon the island and started an extensive farm, and a conflict of authority sprang up between the two foreigners, which led to bitter feuds between the natives. Dutrou-Bornier lived with a common woman, who had been the wife of a chief, and he succeeded in having her proclaimed queen of the island, under the name of Korato. A system of espionage and intrigue was instituted by Queen Korato, guided by the Frenchman's instructions, which resulted in an open rebellion against the ecclesiastical authority. The missionary was finally compelled to leave the island, and he removed to Gambier Archipelago with about three hundred of his followers, giving Dutrou-Bornier and Queen Korato a clear field. The Frenchman was killed in August, 1876, by being thrown from his horse while drunk, and Queen Korato and her two children survived him only a few years. Mr. Salmon found upon his arrival that none of the natives had assumed authority over his fellows, and in due course that gentleman became to all intents and purposes the king of the island, ruling the people with kindness and wisdom and thus securing their unbounded respect and esteem.

BURIAL OF THE DEAD.

Hundreds of tombs, cairns, platforms, and catacombs were examined during our stay on the island, and in all cases the bodies were lying at full length. In a vault beneath platform No. 11 are a number of skulls packed together in sufficient quantity to completely fill the compartment—trophies of war perhaps, in view of the fact that the skulls were those of adults; but in no single instance did we discover the remains doubled up as the Incas and other American aborigines were in the habit of burying their dead. In the early ages it was the custom to wrap the corpse in dried grass, bound together by a mat made of sedge, and whether laid in platform, cairn, or cave, the body was

usually laid with the head towards the sea. Succeeding generations substituted tappa or native cloth for the sedge mat, and the present people are sufficiently civilized to prefer rude coffins when the material can be obtained. Cemeteries were located by the missionaries near the churches at Vaihu and Mateveri, and strong efforts made to discourage the burial of converted natives with their heathen ancestors, but they were never able to overcome their aversion to promiscuous interment.

BOATS.

Hotu-Matua is said to have landed upon the island with three hundred followers in two canoes, which are described in the traditions as 90 feet in length and 6 feet deep (draught of water). From the description given of these boats and the representations found of them among the mural paintings and sculptures in certain caves, the canoes of the original settlers were quite similar to the Fiji war-canoes. They were constructed of many pieces of wood neatly fitted together and held in place by thongs or lashings; high and sharp at both ends and balanced by an outrigger or smaller canoe. Such boats are in use at the present time in many of the Polynesian islands and are quite capable of making long voyages at sea. The boats built by succeeding generations were few in number and small in size, on account of the scarcity of material to be found on the island. Many of the early navigators refer to the scarcity of boats belonging to the natives. Captain Cook saw several canoes, 10 or 12 feet long, built of pieces 4 or 5 inches wide, and not more than 2 or 3 feet long, but the majority of his native visitors swam off to his ship. Captain Beechey saw three canoes on the beach, but they were not launched. Von Kotzebue saw three canoes each containing two men. At the time of our visit the only boats on the island were two large ones, belonging to Messrs. Salmon and Brander, built of material obtained from the wrecks on the coast. There are no canoes in use at the present time, but we found two very old ones in a cave on the west coast, having long ago passed their days of usefulness on the water and now serving as burial-cases. They were a patchwork of several kinds of wood sewed together, and though in an advanced stage of dry-rot the material was sufficiently well preserved to prove that it never grew on Easter Island, but had been obtained from the drift-wood on the beach.

WEAPONS AND WAR.

The native weapons in offensive and defensive operations were limited to obsidian-pointed spears, short clubs, and the throwing-stones, but these were handled with remarkable skill and dexterity. The history of the simple weapons in the hands of people who became pre-eminent in their use has been repeated in all ages and countries, and is fully exemplified in these islanders; though their primitive spear,

lacking the metal-piercing medium, could never aspire to the fame of the gladiator's trident, the Homeric javelin, the Roman pilum, the Turkish jereed, the Landsknecht's halberd, the Polish lance, the Zulu assagai, or even the knoberry of the Amazulu. The formidable weapon of the ancient Parthian, still wielded by the dexterous Turcoman, was not known to these islanders. Arrows might have been improvised, but there was no wood in their possession suitable for the manufacture of bows.

Unlike the Fijians and other Polynesians to the westward, who did great execution with their long war-clubs, these natives used in fighting only the patoopatoo, or the *meré*, like that of the Maori, except that they were invariably made of wood. They possessed a long club, a little expanded and flattened at one end, and the other carved into a head with a double face with eyes made of obsidian and bone; but this was carried as a baton of office before the chiefs and used only for that purpose.

Stones were thrown with great precision and accuracy from the hand, and the use of a sling, such as made David more than a match for the gigantic Philistine, appears to have been unknown. Slings were common among the Incas and other races of South America from the earliest times, but no traces of such an appliance could be found on Easter Island, either in the tombs or mentioned by the ancient traditions.

A want of practice has probably made the natives of to-day less proficient in stone-throwing than their forefathers, but if the stories may be believed, the time was when their truculent address could only have been surpassed by Runjeet Singh's Akalis in flinging the chuckkra.

Several of the ancient traditions speak of a net being used in fighting, and men were especially trained in its use, but whether they resembled the old Roman *retiarius* can not be discovered, the custom having long since died out. It is unknown to the natives of to-day.

Two kinds of spears were used, one about 6 feet long for throwing and the other a shorter one; a heavier stabbing pike was only fit for use at close quarters. In its original form the spear was essentially a missile, and the traditions speak of the adoption of the thrusting weapon in the desperate engagements that resulted in the extermination of the "long-eared race." The shafts were made of *pourou Hibiscus* sp. and *tu Dracæna terminalis*, and the various forms of obsidian points were secured by a lashing made from the indigenous hemp. The javelins were thrown underhanded with the little finger foremost, but they did not have that peculiar vibratory motion that distinguished the Zulu assagai.

Nothing was known of a retrieving weapon, such as the boomerang of the Australians, or even the throwing-sticks of the Eskimo tribes on the coast of Alaska.

There was no class of professional fighters or soldiers; every able-bodied man was supposed to be a warrior and compelled to do duty in time of war. Fighting men were not trained or drilled, except that

throwing stones and darting the spear were favorite amusements and always a prominent feature of all feasts. The clans were always led to battle by the chief, but there was no particular formation. Every man acted in accordance with his individual fancy, or as occasion demanded, relying upon skill and strength alone. No shields were used and no particular efforts were made to parry the weapons of the enemy.

In view of the fact that the islanders all acknowledged the authority of one king, their wars were surprisingly numerous, barbarous, and unrelenting. The traditions are filled with accounts of sanguinary conflicts originating from trivial causes and continued through generations, until one party or the other were entirely exterminated. The slaughter on the field of battle was never very great, but in the event of a general defeat, the vanquished party was pursued by the victors to the hiding places, their habitations destroyed, females captured, children and infirm persons brutally murdered. The defenseless unfortunates who fell victims to their merciless captors, accepted their fate, whether it was slavery, torture, or butchery, with remarkable fortitude, seldom if ever making any show of resistance.

EXPLORATION OF THE ISLAND.

The *Mohican* came to anchor in the roadstead of Hanga Roa (Plate XVI) on the morning of Saturday, December 18, 1886. The individuals most interested in the exploration of the island went on shore without delay, and the work was pushed forward as rigorously as possible until the hour appointed for the sailing of the ship for Valparaiso on the evening of the last day of the year.

Messrs. Salmon and Brander boarded the ship upon her arrival and extended the hospitalities of Easter Island, placing their limited resources entirely at our command with a heartiness that won our immediate esteem, and which ripened into sincere friendship before our departure. These gentlemen are closely connected with the royal family of Tahiti, and we had been intrusted with letters and various articles from relatives and friends who desired to embrace the opportunity for communication offered by the *Mohican*.

Upon landing at Hanga Roa we found nearly all of the natives on the island congregated to receive their unknown visitors. The men inspected us closely and were profuse in friendly demonstrations, while their wives and daughters gazed curiously from a little distance, and the children's manner plainly showed the enjoyment of an occasion of infrequent occurrence in their quiet lives. Surrounded by this crowd we walked about a mile to the house of Mr. Brander, where the baggage, tools, and impedimenta in general were deposited. During the afternoon a reconnaissance was made to the crater of Rana Kao and the ancient stone-houses in the vicinity, and in the evening we crossed the island in a light wagon with Mr. Salmon to his residence at Vaihu. That gentleman has, during his long residence on the island, accumu-

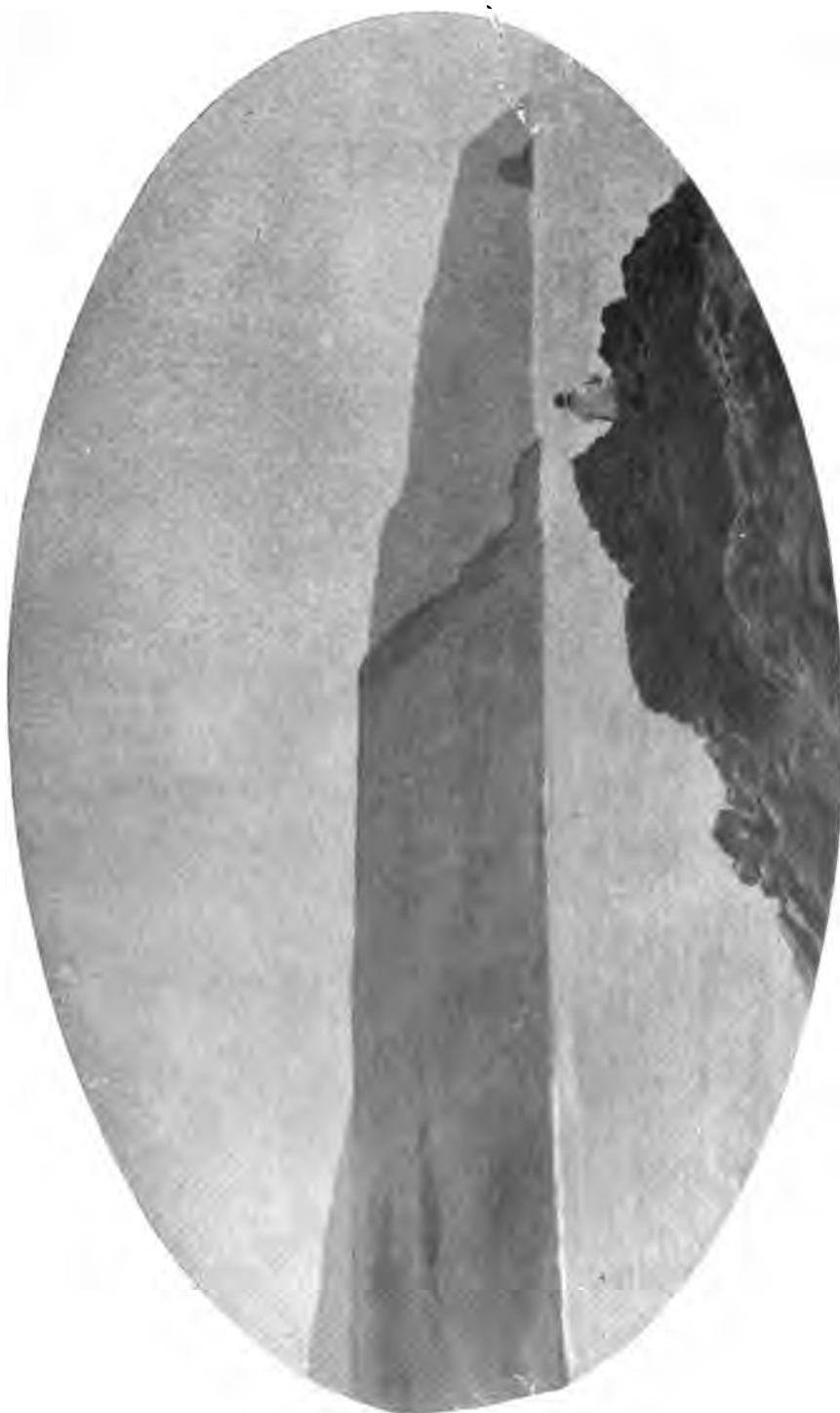

APPEARANCE OF EASTER ISLAND FROM THE ROADSTEAD OF HANGA-ROA.





CRATER OF RANA KAO.

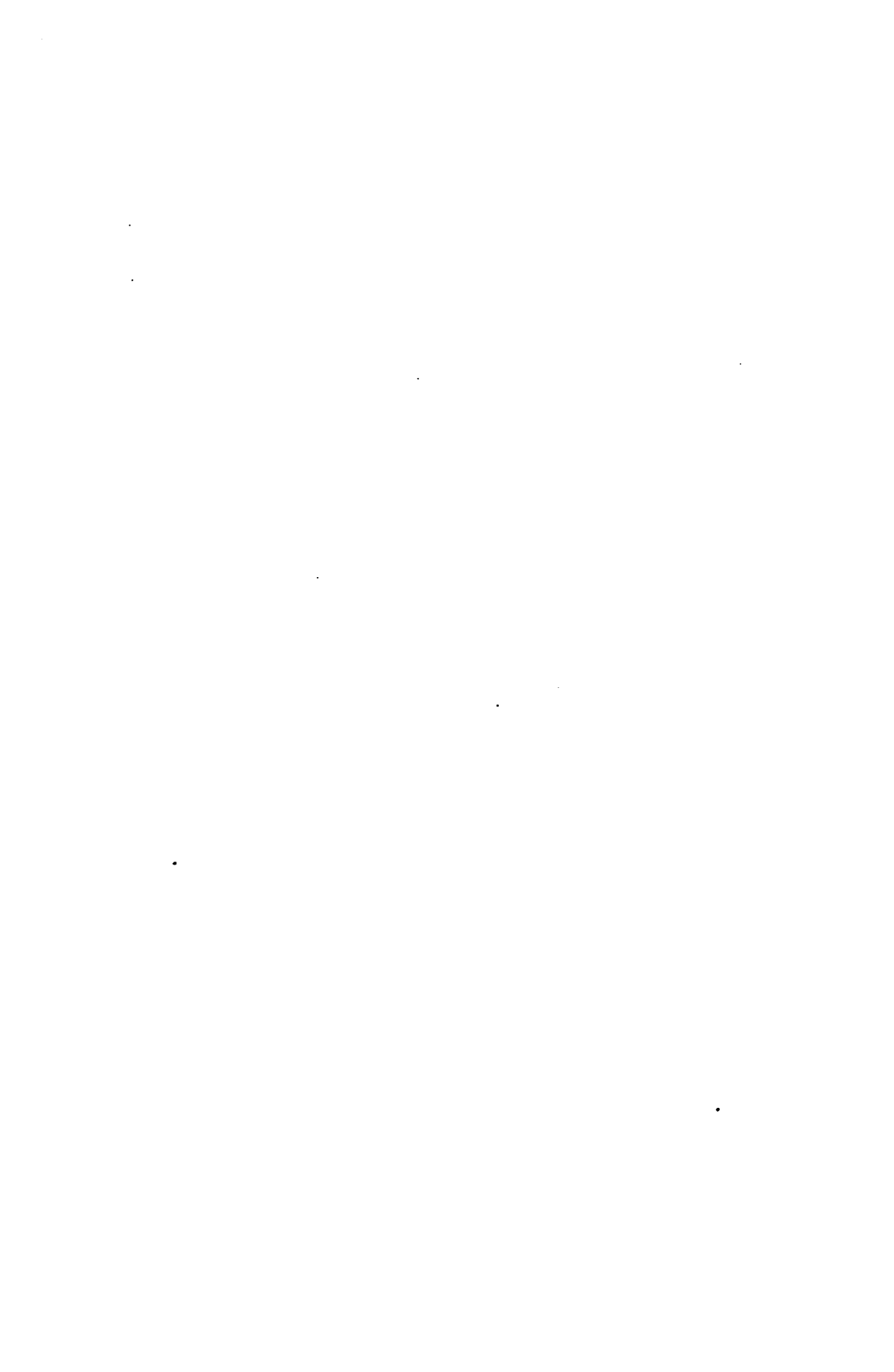



ANCIENT STONE-HOUSES AT ORONGO, FROM WHICH PICTURED SLABS WERE PROCURED.

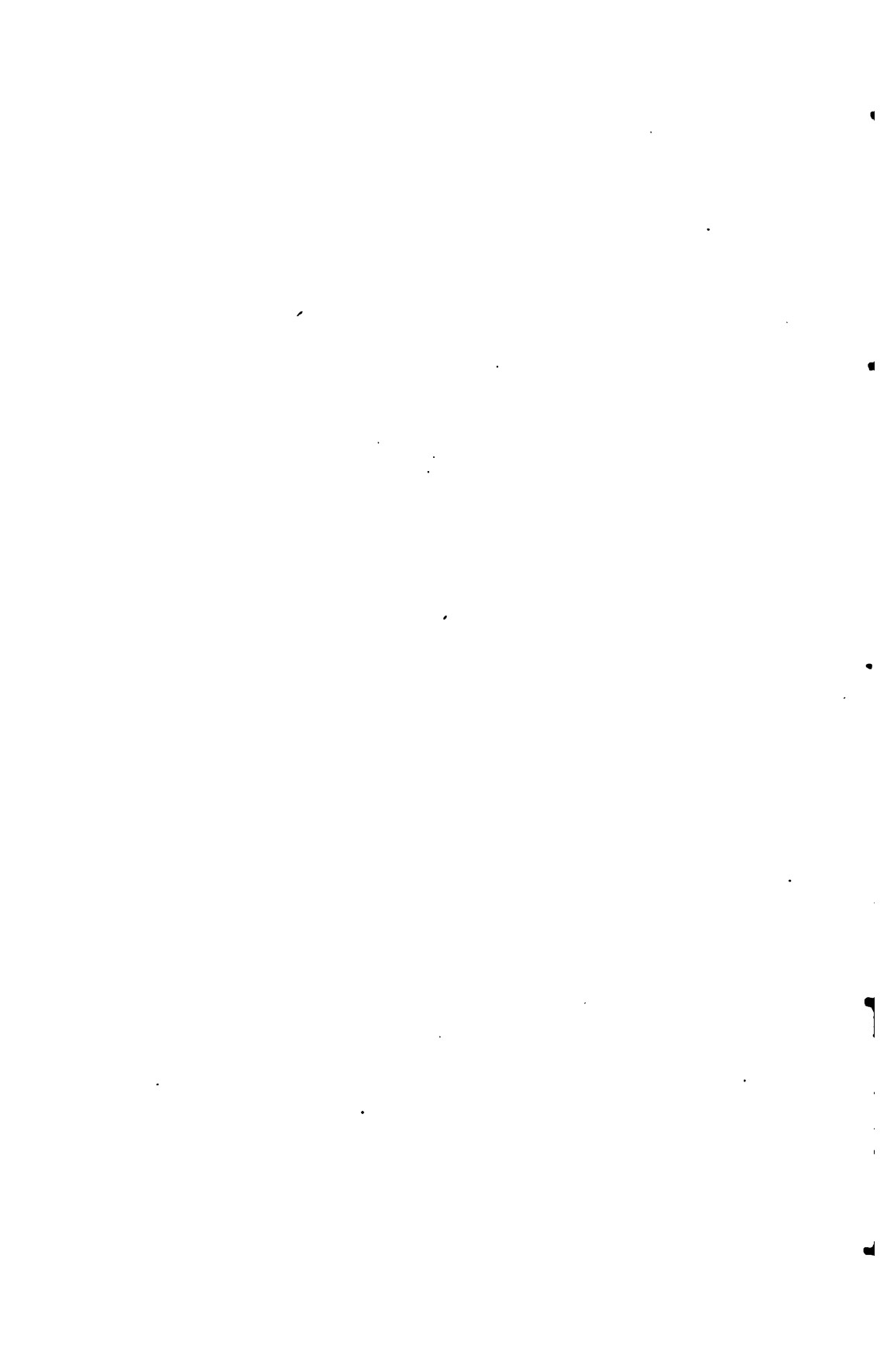

lated a valuable collection of curios and relics of the former inhabitants. Nearly all of our first night on shore was devoted to the purchase and cataloguing of specimens from Mr. Salmon's collection, all of which will be referred to and described elsewhere. Duplicates were obtained of all articles furnished Lieut. Commander Geisler, of the *Hyane*, for the museum at Berlin, and of those collected by the *Topaze* for the British Museum, together with original tablets and other relics of great interest and value that had escaped the attention of former collectors.

RECONNAISSANCE TO RANA KAO.

Sunday, December 19.—Made an early start from Vaihu and rode to the central elevations called Mount Teraai, Mount Punapau, and Mount Tuatapu and inspected the quarries from whence the red tufa was obtained which formed the crowns or head-dresses that ornamented all the huge images. Following the road to the southwest we made the ascent of Rana Kao. The crater is nearly circular and about a mile in diameter (Plate XVII), with steep jagged sides, or walls, except on the south, where the lava-flow escaped to the sea. A lake fills the bottom of what was once the volcanic caldron; the water is of great depth and the surface covered with a coat of peat, so dense and strong that cattle range over it, finding food at irregular intervals. The surface of the lake is about 700 feet from the top, but the cattle have made a path by which the descent can be made with safety.

Skirting the edge of the crater to the southward the ridge becomes narrower, falling precipitously a thousand feet to the sea on one side, and descending abruptly into the crater on the other until it terminates in an elongated wall of rock rising to a sharp, jagged edge impassable to either man or beast. Just where this elevated edge contracts rapidly towards the south are located the ancient stone-houses of Orongo. (Plate XVIII). These burrow-like dwellings were built with little regard to streets, avenues, etc., but were regulated by the contour of the land. Piles of débris in one or two spots marked the destroying hand of former investigators, but the large majority of the houses were intact, and in some instances the openings had been sealed up with stone, making it difficult to outline the original entrances. These dwellings were constructed without windows or other openings except a door-way so low and narrow that an entrance could only be effected by crawling upon the hands and knees, while in many cases it was necessary to creep serpent-like through the contracted confines. Many interiors were inspected by the light of candles provided for the purpose and houses marked for thorough investigation on the morrow.

While tracing and sketching the sculptured rocks in the vicinity of Orongo, the declining sun hastened the departure for Vaihu, where the hours after our evening meal were devoted to making notes of the native traditions as translated by Mr. Salmon, until that good-natured gentle-

man could be kept awake no longer. It had been proposed that we should occupy one of the ancient stone houses for the night, in order to be near the scene of operations planned for the next day, but they were damp and ill-smelling and the work accomplished on the traditions more than repaid the time lost in recrossing the island.

THE ANCIENT STONE HOUSE AT ORONGO.

December 20.—Leaving Vaihu at early daylight we arrived at Hanga Roa in time to meet the detachment of eight selected men sent on shore from the ship with proper tools and implements for making a thorough exploration of Orongo and vicinity. (Plate XIX). The blue-jackets scampered up the slope of Rana Kao with the buoyant spirits of school-boys out for a holiday, and arriving at the spot were anxious to lend the assistance of willing hands and plenty of brawn to the prosecution of the work.

Every house was entered and inspected, though occasionally a miscalculation was made in the dimensions of a narrow passage-way and it became necessary to rescue a prisoner by dragging him back by the heels. Once inside the building, the interior could be easily inspected and sketches made of frescoes and sculptured figures. (Plate XX).

These remarkable habitations were built against a terrace of earth or rock, which in some cases formed the back wall of the dwelling (Fig. 5). From this starting point a wall was constructed of small slabs of stratified basaltic rock, piled together without cement and of a thickness varying from about 3 feet to a massive rampart of 7 feet in width.



FIG. 5.

VIEW OF STONE HUT IN ORONGO.

The outer entrance is formed by short stone posts planted in the ground and crossed by a basaltic slab. The passage-way was in all cases unpaved and usually lined on the top and both sides with flat stones. This important feature added materially to our comfort while forcing an entrance through some of the narrow openings, and saved the necessity for adding to our already bountiful supply of bruises and abrasions. No regularity of plan is shown in the construction of the majority of the houses; some are parallelogram in shape, others elliptical, and many are immethodical, showing a total absence of design, the builder being guided by the conformation of the ground, the amount of material available, and other chance circumstances. These houses



REMOVING SLABS FROM HOUSE AT ORONGO.

|

•

•

|



ANCIENT HOUSE AT ORONGO

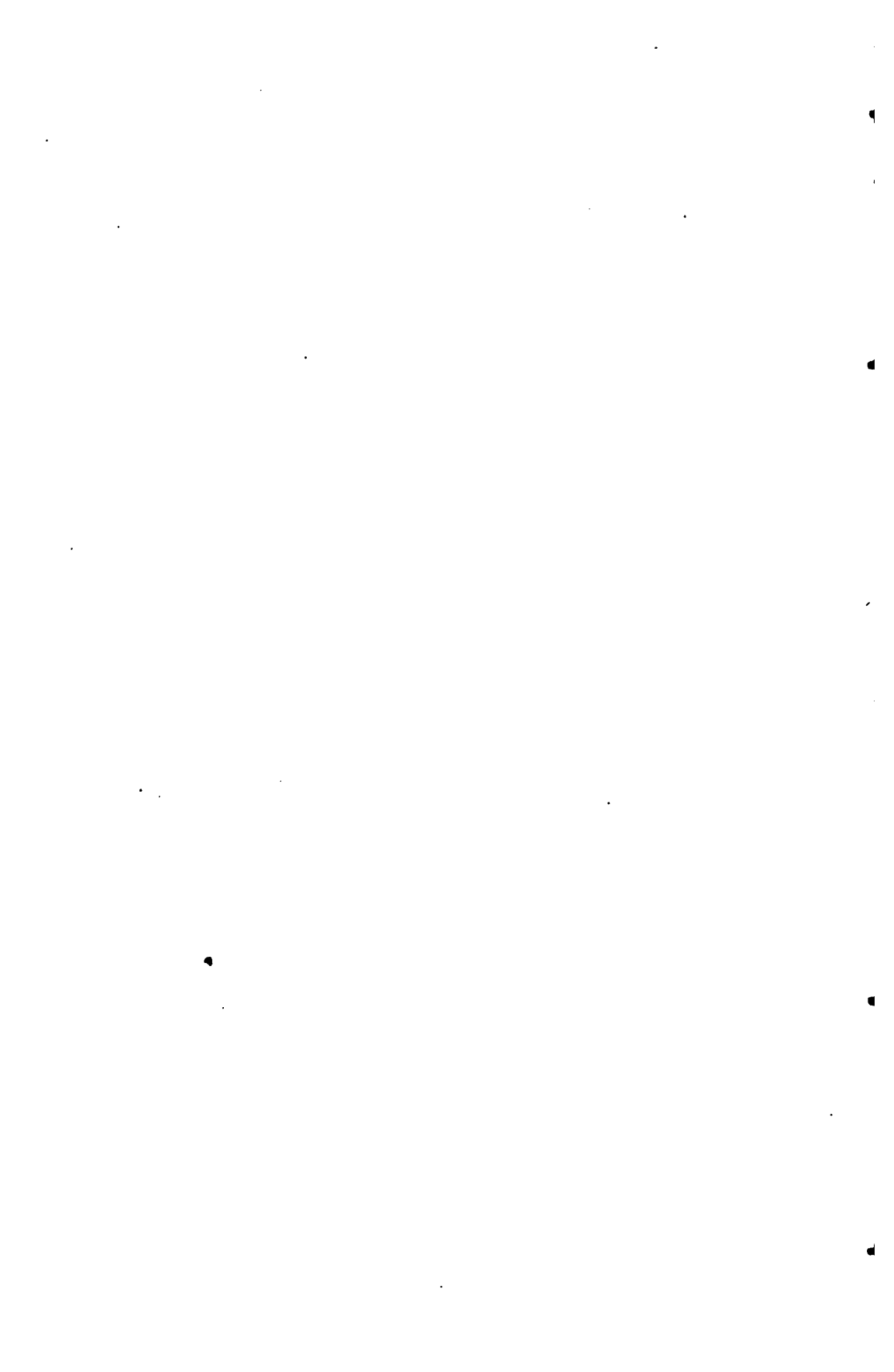

are roofed with slabs of rock of sufficient length to span the side walls, showing that no particular care had been exercised to form close joints. Over this stone ceiling the earth was piled in mound-shape, reaching a depth in the center of from 4 to 6 feet, and covered by a sod that afforded ample protection from rain. The floors were the bare earth, and the interiors were damp and moldy from insufficient ventilation afforded by the single contracted opening.

An accurate measurement of these remarkable structures gave the average height from floor to ceiling 4 feet 6 inches; thickness of walls, 4 feet to 10 inches; width of rooms, 4 feet 6 inches; length of rooms, 12 feet 9 inches; average size of door-ways, height 20 inches, width 19 inches. In making the survey of Orongo the houses were

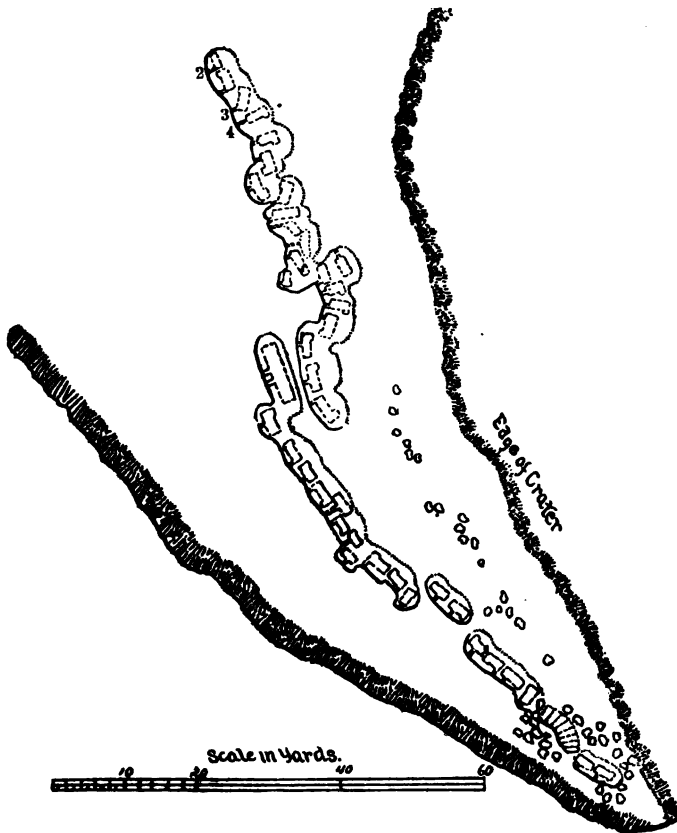

FIG. 6.
ORONGO.

numbered from 1 to 49, inclusive, commencing at the inshore extremity (Fig. 6). While in the majority of instances the interior dimensions were considerably below the average given above, several of the houses exceeded those limits, particularly in the length of the rooms. The

largest house contained a single chamber nearly 40 feet long; three were over 30 feet, and eight measured over 20 feet in length, with other dimensions approximately the same as the general average. These rude dwellings were not in all cases confined to a single apartment; some have one and a few have two or three recess chambers opening out of the main room; but they were dark little dens, having no separate light or ventilation.

Near the center of this assemblage of houses there is a sort of square court with eight door-ways opening upon it. These might be considered separate and distinct dwellings, though the apartments are connected by interior passage-ways, making it possible to pass from one to the other. At the extreme end of the point a similar collection of houses opens upon a circular court, and the interiors are also connected.

In front of each house and about 10 feet from the door-way, small excavations lined with slabs of stone, making holes about a foot wide and 2 feet long and about 20 inches deep, indicated the culinary arrangements of the former inhabitants. The *modus operandi* of preparing the food was primitive in the extreme; a fire was built in the rude oven and removed when the stones were sufficiently heated, a covering of damp earth being placed over the oven to retard the radiation of heat.

Thorough examination demonstrated the fact that these peculiar houses were not precisely alike in all respects, though the same general characteristics prevailed. Those at the extreme point of the ridge (Plate XXI) bear evidence of great antiquity, and much excavation was necessary before a satisfactory examination could be made of the door-posts or stone supports to the entrances, which were covered with hieroglyphics and rudely carved figures. From houses numbered 2, 3, and 4 (Fig. 6) on Lieutenant Symond's chart of Orongo, were taken samples of these sculptures for the National Museum. The large beach pebbles were obtained by digging to a depth of 2 feet below the door-posts, and are of considerable interest both from the dense nature of the material and the fact that these carvings were found frequently repeated throughout the island.

The majority of the houses at Orongo are in a fair state of preservation and bear evidence of having been occupied at no very remote period. The result of the investigation here showed very little of carving on stone, but the smooth slabs lining the walls and ceilings were ornamented with mythological figures and rude designs painted in white, red, and black pigments. Houses marked 1, 5, and 6 on Lieutenant Symond's chart were demolished at the expense of great labor and the frescoed slabs obtained. Digging beneath the door-posts and under the floors produced nothing beyond a few stone implements.

The houses in this vicinity occupy such a prominent position that they were naturally robbed of everything in the way of relics by the natives, who were beginning to appreciate the value of such things through the importance placed upon them by the foreign vessels that



GROUP OF VERY ANCIENT HOUSES AT THE EXTREME END OF RIDGE AT ORONGO, SHOWING SCULPTURED
DOOR-POSTS.





SCULPTURED ROCKS AT ORONGO.



have called at the island. A niche in the wall of each of these dwellings was evidently designed to receive the household god and the various valuables which were possessed by the inhabitants. Whatever treasures they may have held in former years, we found them empty, and our search revealed nothing of importance.

Attention was directed to one of the buildings in this assemblage that apparently had no entrance way. One wall was demolished, disclosing a rude coffin containing the remains of a native recently deceased. The unoccupied house had been utilized as a tomb, and sealed up with the material of which the walls were built.

SCULPTURED ROCKS.

The most important sculptured rocks on this island (Plate XXII) are in the immediate vicinity of the stone houses at Orongo (Fig. 7). As



FIG. 7.
SCULPTURED ROCKS NEAR ORONGO.

much time as possible was devoted to examining and sketching these curious relics. The hard volcanic rock is covered by carvings intended to represent human faces, birds, fishes, and mythical animals, all very much defaced by the ravages of time and the elements (Plate XXIII). The apparent age of some of the rock-carvings antedates the neighboring stone houses, the images, and other relics of the island except the ruined village on the bluff west of Kotatake Mountain. Fishes and turtles appear frequently among these sculptures, but the most common figure is a mythical animal, half human in form, with bowed back and long claw-like legs and arms. According to the natives, this symbol was

intended to represent the god "Meke-Meke," the great spirit of the sea (Fig. 8). The general outline of this figure rudely carved upon the

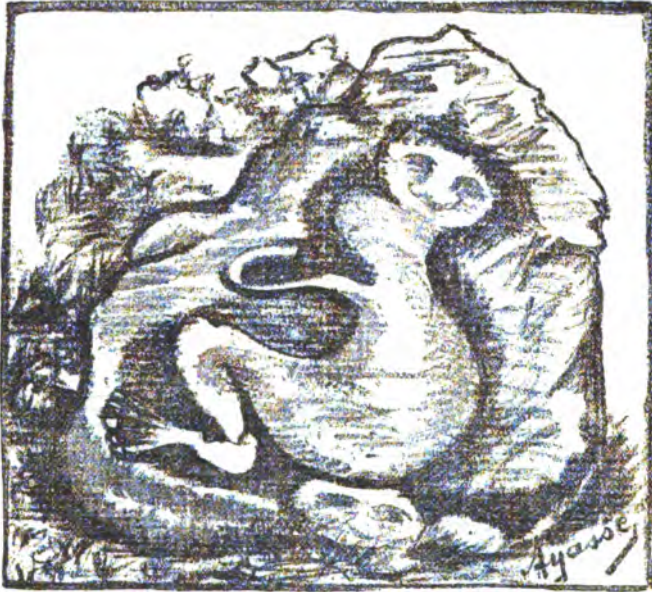

FIG. 8.

SCULPTURED FIGURES OFTEN REPRODUCED ON ROCKS AT ORONGO: "MEKE-MEKE."

rocks, bore a striking resemblance to the decoration on a piece of pottery which I once dug up in Peru, while making excavations among the graves of the Incas. The form is nearly identical, but, except in this instance, no similarity was discovered between the relics of Easter Island and the coast of South America.

ANCIENT CUSTOMS IN RELATION TO GATHERING THE SEA-BIRDS EGGS.

From the most reliable information that could be obtained, the stone houses at Orongo were built for the accommodation of the natives while celebrating the festival of the "sea-birds eggs," from a remote period until the advent of the most important ceremonies.

During the winter months, sea-birds in great numbers visit the Island to lay their eggs and to bring forth their young. The nests are made among the ledges and cliffs of the inaccessible rocks, but a favorite spot for these birds has always been the tiny islands Mutu RauKau and Mutu Nui, lying a few hundred yards from the southwest point of the island (Plate XXIV). Here the first eggs of the season are laid, and therefore Orongo was selected as a convenient point to watch for the coming of the birds. According to the ancient custom, the fortunate individual who obtained possession of the first egg and returned with it unbroken to the expectant crowd, became entitled to certain privileges and rights during the following year. No especial authority was



PICTURED SLABS TAKEN FROM THE ANCIENT STONE-HOUSES AT ORONGO.
(Cat. No. 128573-128576, U. S. N. M. Easter Island. Collected by Commander B. F. Day, U. S. N.)

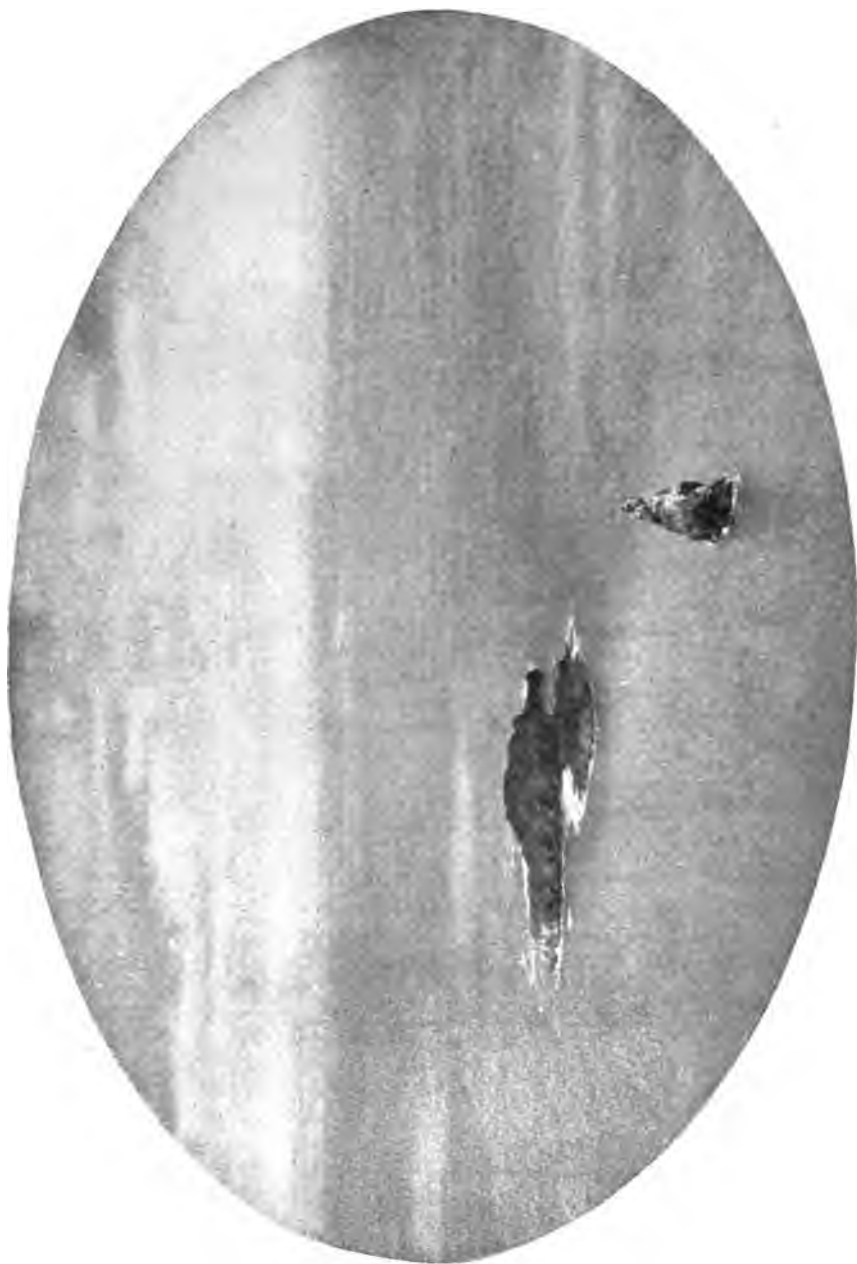

MUTU RAUKAU AND MUTU NUI; ISLANDS NEAR RAPA NUI, WHERE BIRDS' EGGS WERE GATHERED.

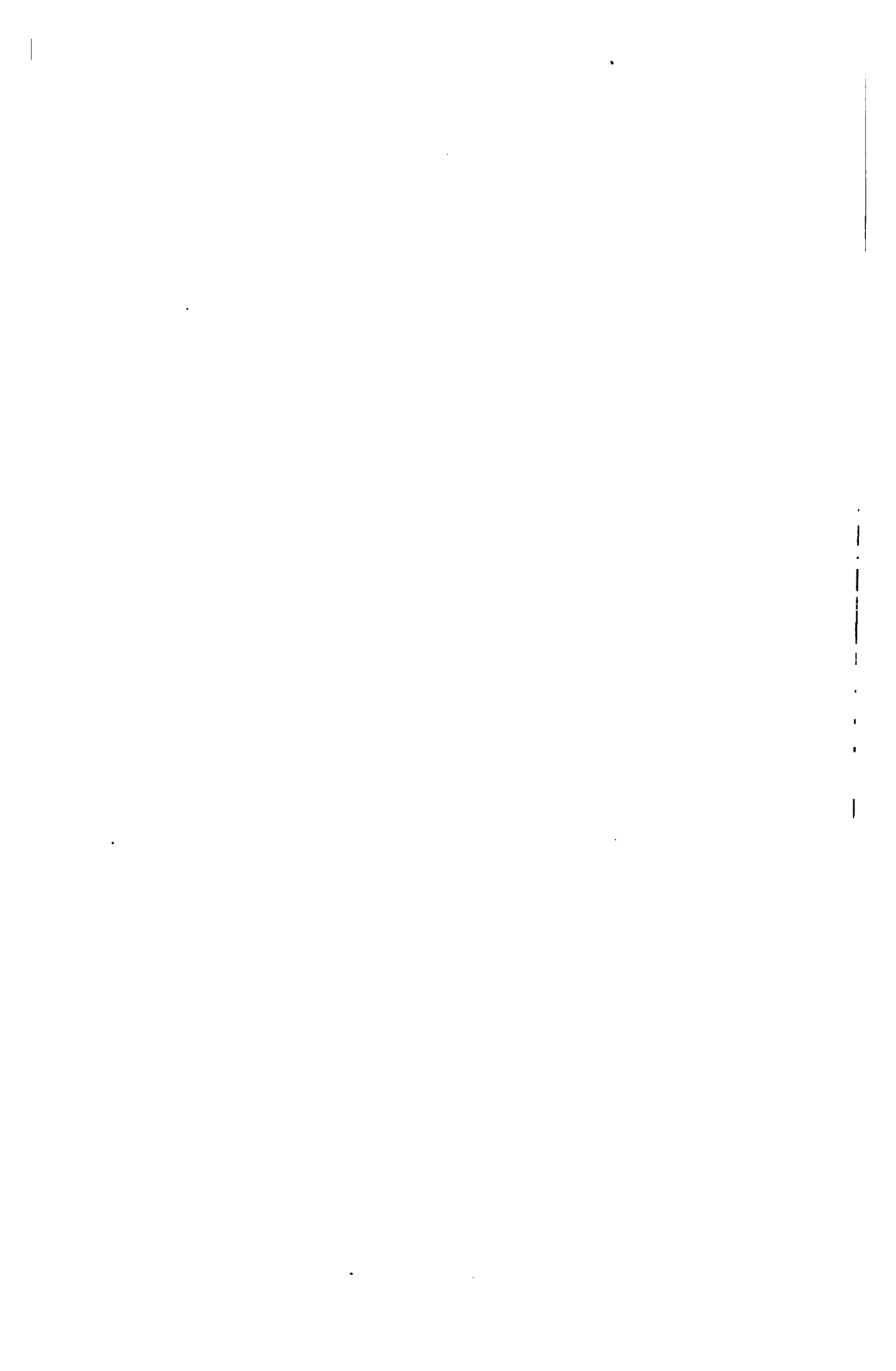

vested in him, but it was supposed that he had won the approval of the great spirit "Meke Meke" and was entitled to receive contributions of food and other considerations from his fellows. The race for the distinguished honor of bearing off the first egg was an occasion of intense excitement. The contestants were held in check at Orongo until the auspicious moment arrived, and the scramble commenced at the word "go," pronounced by the king, who was about the only able-bodied man on the island who did not participate. It was decidedly a go-as-you-please race, every man selecting his route to the sea by the circuitous paths or directly over the face of the cliff, and many fatal falls are recorded as the result.

The swim to Mutu Rau Kau was a trifling matter, the chief difficulty being to return with an egg unbroken through the general scramble.

The houses at Orongo were probably unoccupied except for a short period in July of each year while awaiting the coming of the sea-birds. The peculiarity of their construction might be accounted for by the fact that the thatched hut, common to the plains, could not be used to advantage on this exposed bluff. The low, contracted entrances, were used here as well as elsewhere for defense. Factional fights were common, and it was necessary that every house should be guarded against surprise and easily defended. Another reason might be found for making the openings as small as possible, in the absence of doors to shut out the storms. The sculptured rocks in the vicinity of Orongo bear record of the grateful contestants in the egg-races to the great spirit "Meke Meke" for his benign influence and protection, much after the manner in which boats, pictures, and other objects are dedicated to certain patron saints in more civilized portions of the earth.

EMPLOYMENT OF NATIVES.

The investigations in the vicinity of Orongo having been finished, a contract was made with Mr. Brauder for removing from the excavations and transporting to the landing-place the frescoed slabs, inscribed door-posts, and objects collected, and the evening was devoted to the native traditions until exhausted nature demanded a few hours rest. With a view of propitiating the natives and securing their good-will and cooperation in prosecuting the work with the utmost dispatch, a number of men were employed to assist in the excavations made at Orongo, but the experiment proved a failure. They constituted themselves an appreciative audience, and could not be induced to work. They evinced a lively interest in all that was going on, and performed astounding gastronomic feats at meal-time. We concluded to dispense with their services after a demonstration of their dexterity in causing the disappearance of every small object that remained unprotected for a moment. Several of the head-men, afterwards employed as guides to accompany the expedition around the island, and stimulated with the hope of bounti-

ful rewards, performed valuable service in the way of locating water-holes, identifying localities, naming objects of interest, etc.

December 21.—Preparations were made for an early start on the expedition already planned. The native contingent was dispatched about daylight with camp equipage and instructions to form Camp Mohican at a spot where it was reported good water could be found in abundance. We were somewhat handicapped for the march by the fatigue of the last few days, added to the want of rest. The hospitality of the Brander establishment had been cordially extended, but such a large and varied assortment of insects and noxious animals had possession of the premises, that we preferred the open air, though there were several passing showers during the night. A working party from the ship, consisting of nine men, including a boatswain's mate and quartermaster, landed at an early hour, each man equipped with knapsack, canteen, shovel and pick. The expedition took the road passing through the villages of Mataveri and Hanga Roa to the coast, followed by almost every man, woman, and child on the island. The interest displayed by the natives in our movements gradually died out after a few hours of hard walking, and towards noon the last party returned to their homes, leaving us a clear field.

Following the coast-line to the northwest, every part of the ground was carefully examined, platforms measured and plotted, excavations made, and objects of interest collected and catalogued.

Near Anahoirangaroa Point, on some ledges of hard volcanic rock we found numerous depressions that evidently were made at the cost of great labor. Some are elliptical in shape, others perfectly circular, averaging about 3 feet in diameter and 2 feet deep. The majority are above high-water line and others just awash when the tide is full. No explanation could be obtained in regard to these holes, and it was concluded that they were originally intended as live-boxes for the preservation of fish.

The natives have a superstition to the effect that any one who walks over these rocks will be afflicted with sore feet, and we received many solemn warnings in regard to it. If there is any foundation for it at all, it is probably due to a succulent vine that grows here, coming in contact with the wounds caused by the sharp rocks. A short distance farther on stands a round tower 12 feet in diameter and 20 feet high (Fig. 9), said to have been erected as a lookout station from whence the movements of turtles could be watched. We found here, as well as under every other pile of stones of any description on the island, tombs and receptacles for the dead, all filled with human remains in various stages of decay, from freshly interred bodies to the bones that crumbled into dust upon exposure to the air. The entire island seems to be one vast necropolis, and the platforms along the sea-coast appear to have been the favorite burial places in all ages. Natural caves were utilized as places of deposit for the dead.

Considerable time was devoted to the examination of the platforms,

and in numerous instances interesting catacombs and tombs were discovered, containing remains of great antiquity. In this connection a peculiar trait in the native character was developed. Towards evening one of the native guides returned to pilot the working party to the place selected for the camp, just at the time a particularly old tomb had been uncovered and the crania were being removed from their former resting place. This the unsophisticated native took in at a glance, and with the announcement that we were desecrating the burial place of his forefathers, he set up a howl of despair, and became prostrated with grief at the sight of a skull which he claimed to recognize as that of his great-grandfather. Notwithstanding the absurdity of the statement, the anguish displayed induced us to return the bones to their ancient resting place. The afflicted youth quickly dried his eyes, and intimated that for a suitable reward he would be willing to dispose of the remains of his ancestors, and he thought that a consideration of about \$2 would assuage his grief. That settled it. The skulls were gathered into the collection, and the sorrowing native left to mourn the loss both of the money and of the bones of his forefathers.

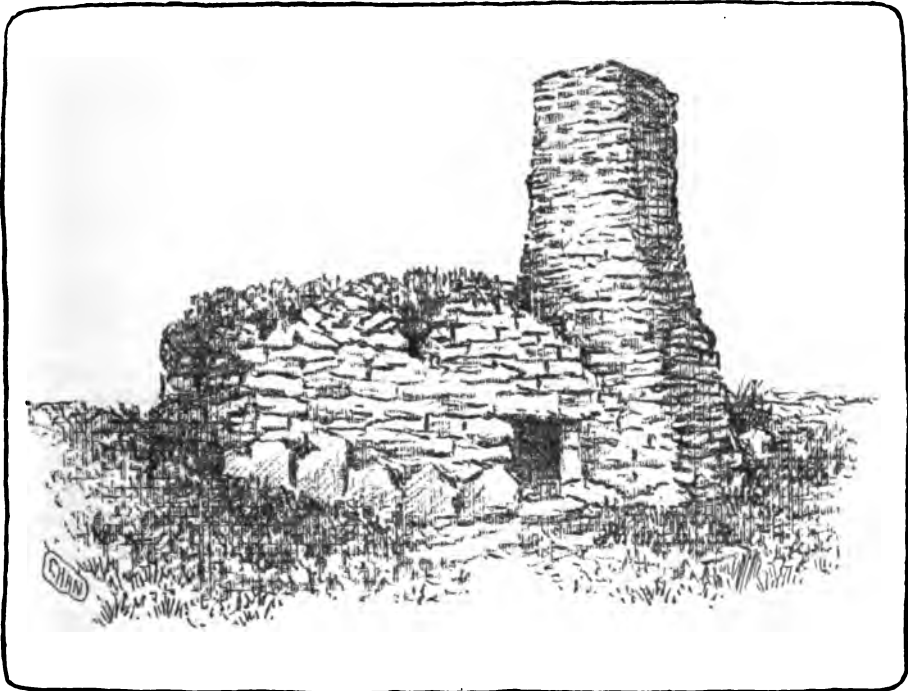

FIG. 9.
OBSERVATION TOWER ON BLUFF NEAR ANHOIRANGAROA POINT.

Many of the stone bases upon which the images stood still remain in their original positions upon the platforms. Generally they are irregular in shape, a few have been squared, and on platform No. 5 we

found one of octagon shape that stood the test of measurement very well. Between platforms 4 and 5 the land falls away gently to the sea, and this slope is paved regularly with small round bowlders, having every appearance of having been constructed as a way for hauling out boats. The coast in this vicinity is perfectly rock-bound, but a narrow channel extends from the paved way out to sea. Boats might land here at any time. With the wind southeast, or in any direction except west, the landing would be perfectly smooth. The place is admirably adapted to the landing of heavy weights, but, as far as known, the images were never transported by sea, nor did the islanders possess boats sufficiently large to float them, or material from which they could be constructed.

CAVE AND TOMB NEAR AHUAKAPU POINT.

On the face of the cliff near the point, Ahuakapu, a large and interesting cave, was visited. Many of the recesses and angles had been walled up and contained human remains. Fossiliferous specimens of marine animals were obtained by digging up the floor of the cave. The igneous rocks in the vicinity show evidences of rude sculptures, among which could be traced canoes, fishes, and men in various attitudes. Upon the extreme point we found another one of those round towers, built for the purpose of observing the movements of turtles on the beach. The shaft measures $24\frac{1}{2}$ feet, and stands in the center of a narrow platform 67 feet long, filled with tombs containing human remains that had long been undisturbed, as evidenced by a luxuriant growth of lichens on the rough rocks.

RUINS OF THE OLDEST HABITATION ON THE ISLAND.

On the high bluff west of Kotatake Mountain we discovered the ruins of a settlement extending more than a mile along the coast-line and inland to the base of the hill. These remains bear unmistakable evidences of being the oldest habitations on the island. The houses are elliptical in shape, with door-ways facing the sea, and were built of uncut stone. Some of the walls are standing, but the majority are scattered about in the utmost confusion. An extremely interesting feature of these ancient ruins is the fact that each dwelling was provided with a small cave or niche at the rear end, built of loose lava stones, which was in a number of instances covered by an arch supported by a fairly shaped key-stone. The recesses were undoubtedly designed to contain the household gods, and the key-stone, although extremely rough in construction, is unmistakable in its application. Our guides had no knowledge of this locality and knew no distinctive name for it.

Messrs. Salmon and Brander had not visited the spot, because the location is bleak and desolate and, as far as they had heard, was a trackless waste, devoid of all interest.

Camp Mohican was formed a few hundred yards in the rear of platform No. 7. We reached the spot just as the shades of night were closing in, foot-sore and weary from the hard day's march. The camp was not more than 5 miles in a direct line from our starting point in the morning, but we had traveled many times the distance in making a thorough inspection of the ground. A narrow pathway follows the coast-line for a part of the distance, which affords safe footing for the natives; everywhere else the ground is covered with volcanic rocks of every conceivable size and shape, making the walking both difficult and dangerous. The site for the camp was selected because of the proximity of a water-hole, the only one to be found in this neighborhood. It proved to be a shallow cave where the rain-water collected from the drainage of the surrounding hills; the fluid was full of both animal and vegetable matter and decidedly unpleasant to taste and smell. A shelter-tent was improvised by suspending a blanket at the ends from boarding pikes planted in the ground, and after a hasty meal all hands sought the much needed rest. About midnight ominous looking clouds rolled up from the southeast, and it rained in heavy squalls until morning. Wet and unrefreshed, we turned out at daylight to resume the march with everything completely saturated from underclothing to note-books, but with undaunted resolution to continue the work in spite of the elements.

Platforms 7 and 8 are within a few hundred yards of each other and close to the edge of the bluff, which is at this point 390 feet above the sea level. From beneath these ancient piles many interesting specimens of crania were obtained, together with obsidian spear-heads and stone implements. An extensive settlement must have been located here at a comparatively recent period. Narrow curbing stones indicated the position of the houses. These stones had been squared, with 2-inch holes sunk in the upper face at short intervals to receive the ends of the poles that supported the thatched roof. These dwellings had been built upon terraces descending towards the sea, and though they differed greatly in size, the same characteristics were preserved in all cases. The style of architecture must have been suggested by an inverted canoe. The curbing walls of the house in the center of this collection measured 124 feet in length, 12 feet wide in the center, and converging to 15 inches at the ends.

NATURAL CAVES.

Among some outcropping rocks near by, a cave was accidentally discovered, with a mouth so small that an entrance was effected with difficulty. Once inside, however, it branched out into spacious chambers that could shelter thousands of people with comfort. It bore evidences of having been used in former years as a dwelling-place, and probably had other entrances and extensions which we failed to penetrate for the

want of time. Human remains were found in this cave, but all very old.

The caves of Easter Island are numerous and extremely interesting in character. They may be divided into two classes: those worn by the action of the waves, and those due to the expansion of gases in the molten lava and other volcanic action. The process of attrition is in constant progress around the entire coast-line, and the weaker portions of the rock are being undermined by the incessant beating of the ocean. Some of these sea-worn caves are of considerable extent, but generally difficult of access and affording little of interest except to the geologist. The caverns produced by volcanic agencies are found throughout this island, and some were traced through subterranean windings to an outlet on the bluffs overlooking the sea. They are generally quite dry; the rain-water falling upon the surface occasionally finds its way between the cracks or joints in the solid rock, but these gloomy passages and chambers lack grandeur from the entire absence of stalactites and deposits of carbonate of lime. No glistening and fantastical forms of stalagmitic decorations exist here to excite the fancy and create in the imagination scenes of fairy-like splendor. The feeble rays of our candles were quickly absorbed by the somber surroundings, heightening the apparent extent and gloom of the recesses. Careful investigation proved that all of the caves visited had been used as dwelling-places by the early inhabitants.

Platform 18 deserved more attention than we were able to give to it, the facing-stones having been torn from their original position in the structure and lying scattered about as though thrown down by some great convulsion of nature. Some of them show evidences of having been ornamented with rude figures carved on the hard rocks; but the approach of sundown hastened our steps toward Motukau Point, where we could see the flags flying over our camp. The day's march had been exceedingly fatiguing on account of the rugged nature of the ground and the absence of water, but the last mile or so was accomplished at a swinging pace in view of the fact that the camp could not be reached after darkness had closed in. Our course had been around Cape North, and covering the territory between the coast and the base of Rana Hana Kana. Loose bowlders of every imaginable shape and size cover the ground, threatening sprained limbs and broken bones at every incautious step, as though the expiring energy of the volcanoes had been expended in creating this natural barrier.

Camp Day, named in honor of our commanding officer, was located in a district known as Vai-mait-tai (good water), but it was decidedly a misnomer, the supply being ample, but brackish and ill-smelling. After a hearty meal of mutton, prepared by our guides in true island style, we sought shelter under the lee of an outcropping rock, fatigued enough to sleep through the attacks of myriads of noxious insects and regardless of the passing showers of rain.

ANAKENA BAY.

December 23.—A dip in the sea at daylight, and a breakfast of mutton which had been slowly roasting all night on hot stones placed in the ground and covered with earth to prevent the escape of heat, put us in prime condition for the work in hand. Our route lay along the north coast of the island and around Anakena Bay, the place where Hotu-Matua and his followers landed when they arrived from the unknown and much-disputed locality from which they migrated. On the sand beach of this bay we found the small univalve, the remains of which were noticed in all the caves and ruins on the island and which are still highly esteemed by the natives as an article of food. Jelly-fish, such as are known to the sailors as "Portuguese men-of-war," also abound, and are esteemed a delicacy by the natives. The entire plain back of Anakena (La Pérouse) Bay is covered with small platforms, cairns, tombs, and the ruins of dwellings of various sorts. Houses built of loose stones, nearly circular in shape, are plentiful; but they belong to a comparatively recent date, as is indicated by the fact that the stones, of which they are constructed, have been taken from the platforms and from the foundations of the thatched tents. Any sort of material that came handy appears to have been freely used by the builders of these houses. In several we found well-cut heads that had formerly ornamented image platforms, built in the walls, some facing inside and others in the opposite direction. The ruins in the vicinity show that this had been the site of a large settlement, and that it continued to be a place of importance through many generations; but the greatest mystery is how such a number of people obtained a sufficient supply of fresh water.

Near Anakena is a large image in the best state of preservation of any found about the platforms of the island. The traditions assert that this was intended to represent a female, and that it was the last image completed and set up in place. Our guides informed us that it was only thrown down about twenty-four years ago, and previous to that time it had remained for many years the only statue standing upon a platform on the island. Camp Whitney was located at Hangaone Bay, where we found shelter in a bug-infested cave. The water supply was obtained from an ancient tomb near by, and was both scant in quantity and nasty in quality. We were, however, in such an indifferent state of mind that anything wet was acceptable.

December 24.—With the knowledge that we had a particularly hard march before us, we struck camp early and got under way before it was fairly light in the morning. Around Cape Pokokoria the rugged nature of the ground passed over was extremely exhausting. The slopes of Mount Puakalika are in places covered with coarse hummock-grass and flowering vines, which look green and attractive during the rainy season of the year, but which were at this time almost as dry and parched as though scorched by fire. The toilsome march of this day was heightened by the absence of water, and all suffered severely from thirst.

Starting out in the morning with empty canteens, our throats soon became dry and painful. A small quantity of water was found in the afternoon in Mount Puakalika crater, thick and unpleasant to look upon, but affording valuable relief to our sufferings.

THE POIKE PLAINS.

The Poike Plains are extensive tracts of fine red volcanic sand and dust with occasional patches of hummock-grass struggling for existence in this barren waste. Manga Tea-tea (White Mountains), so called from the grayish appearance of the rocks, furnished the stone implements of the natives. The material was chipped as nearly as possible into the desired shape and then ground down to a point or edge by friction upon a hard surface with sand and water. At Anakena and other points convenient to the sand beach we found grinding-stones, together with unfinished and broken implements.

The traditions assert that the island was in former ages densely populated, and the legends are supported by the gigantic works of the image and platform builders and the ruins of various sorts scattered about. While the accounts are probably greatly exaggerated in regard to the number of inhabitants at one time, there is every reason to believe that the people were numerous enough to severely tax for their support the limited area of ground available for cultivation. The Incas of Peru usually selected for burial-places the rocky and steep slopes of the hills or the low sandy plains, where cultivation was impossible, and presuming that a similar economy might have been practiced here, much time was devoted to a thorough examination of the sand-wastes at the eastern extremity of the island. Excavations were made at the expense of great labor in several places where the indications were most promising, but with barren results. Digging to a depth of 9 feet in a depression near Cape Anataavanui we found several flat stones of large size, such as were used for facing the platforms, but the loose, shifting nature of the sand made it impossible with our small force to thoroughly investigate them. The trade-winds freely sweep these elevated plains, blowing the sand about, and creating ridges that may be leveled again by stronger currents at some other season. Hills and depressions simply represent the force and direction of the wind at the time.

TONGARIKI.

Camp Baird was delightfully located in a commodious cave called Ana Havea, on the bay of Hanga Nui, near Point Onetea, and its proximity to Rana Roraka where all the monoliths on the island had been quarried. Tongariki with its rich remains of platforms, images, cairns, and tombs, and Vaihu and other points not yet explored, were sufficient to induce a permanent establishment during the remainder of our stay at Easter Island. The cave was dry, with spacious entrance exposed to the full force of the trade-winds, and we were comfortable a degree, after dried grass and bulrushes had been collected to

sleep upon. Successive generations of natives probably occupied this ancient cavern; an extensive corral has been built near by, and Messrs. Salmon and Brander sleep here while rounding up their cattle. Drinking-water, the great desideratum on the island, obtained from sources that form the crater of Rana Roraka, was, owing to its animal and vegetable impurities, unpalatable, while the supply from the springs was more so, but afforded a pleasing variety, which enabled us to exercise a preference for some other, whenever either kind was used. The so-called springs are holes into which the sea-water percolates, and are as salt as the ocean, at high tide, and decidedly brackish at all other stages.

December 25.—The forenoon was devoted to the exploration of the face of the bluff to the eastward of Tama Point. Many caves were reached after difficult and dangerous climbing, and were found to contain nothing of interest, while others of traditional importance were inaccessible from below, and we were not provided with ropes and the necessary appliances for reaching them from above. No doubt there are caves in this vicinity with contracted entrances that have been covered by loose rocks and intentionally concealed. One such cavern was found by accident. It contained a small image about 3 feet high, carved out of hard gray rock. It was a splendid specimen of the work and could be easily removed to the boat-landing at Tongariki. Retracing our steps toward the camp, the ground between Puakalika elevation and Rana Roraka was thoroughly examined during the afternoon. The plain is completely covered with cairns, tombs, and platforms. Many of the most promising were completely demolished and the foundations dug up to a depth of six feet. All contained human remains in various stages of decay, and the earth upon which they were built proved to be a rich loam filled with sea-shells of minute size, free of stones, while outside of the foundation-walls the composition was composed of bowlders of all sizes with very little earth. Among the vast ruins are many fragments of images and crowns scattered about, and it is evident that platforms were erected and destroyed by succeeding generations. The traditions assert, and appearances indicate, that this plain had from the earliest times been one of the most densely populated districts on the island. Only the remains of walls and cisterns were found here. They were generally small, the largest being 9 feet in diameter, 14 feet deep, and surrounded by a sloping bank paved with small stones to facilitate the collection of rain-water.

In honor of the day, work was suspended earlier than usual, and we returned to camp a couple of hours before sundown, but we found that our Christmas cheer had been reduced to "hard-tack" and island mutton by the leger-de-main of our native assistants, though ample stores had been provided for the entire expedition. With no indulgence in indigestible Christmas luxuries, we were enabled to retire to an undisturbed rest at an earlier hour than would have been probable in a more civilized land and with different surroundings.

December 26.—Our native contingent deserted in a body at daylight on the plea that their religious convictions would not permit them to work on Sunday. Remonstrances and arguments were in vain, and we had to permit them to depart after exacting a promise that they would return early the next morning. Luka, the chief guide, lingered a while to state that his family burial place was beneath the great platform of Tongariki, and that he had a decided aversion to having the skulls of his ancestors added to our collection.

Sunday inspection and its attendant functions has through long custom become second nature with the men who have been long in the service, and through the desire to thus mark the day, the most valuable of our geological specimens were lost. The boatswain's mate took advantage of our temporary absence to clean up the cave and make it more presentable, and, in doing so, threw all the stones and "trash" into the sea. Nothing could be said, in view of the fact that it was done with the best possible intentions, but he was greatly chagrined to find that those same stones had been carried over many a weary mile to be lost now, when it was impossible to obtain duplicates or other specimens of some of the peculiar formations met with on the first days of the trip.

RANA RORAKA.

The day was devoted to the examination of the inside of the crater of Rana Roraka. The walls of the crater are very abrupt except on the west side, where the lava-flow escaped to the sea, and here the cattle and horses find easy access to the pool of water that has collected in the bottom. High up on the southern side are the workshops of the image-builders, extending in irregular terraces quite to the top. Here we found images in all stages of incompleteness (Fig. 10), from the rude

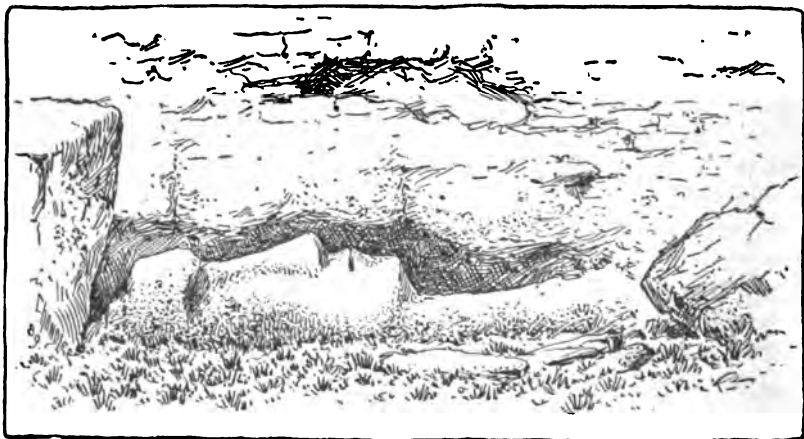

FIG. 10.
UNFINISHED IMAGE, CRATER OF RANA RORAKA.

outline drawing to the finished statue ready to be cut loose from its original rock and launched down the steep incline. The *modus operandi*

appears to have been to select a suitable rock upon which the image was sketched in a reclining position. The upper surface having been carved into shape and entirely finished, the last work was to cut the back loose from the rock. This necessitated the exercise of great care to prevent the breaking off of exposed portions, and was accomplished by building piles of stones to sustain the weight while it was being undermined.

Ninety-three statues in all, similar to those shown in Figs. 11 and 12, were counted inside the crater, and of these forty are standing up, completed and ready to be transported to the platforms for which they were

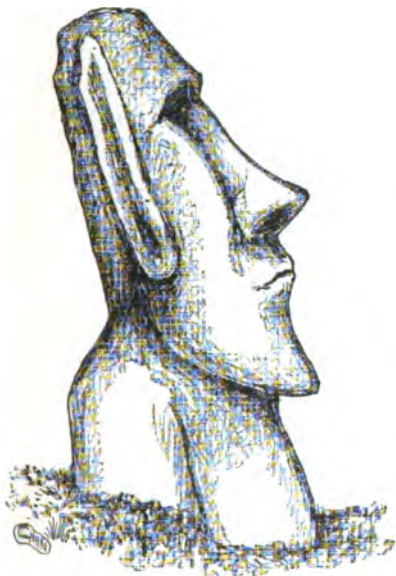

FIG. 11.

IMAGE: RANA RORAKA (front view.)

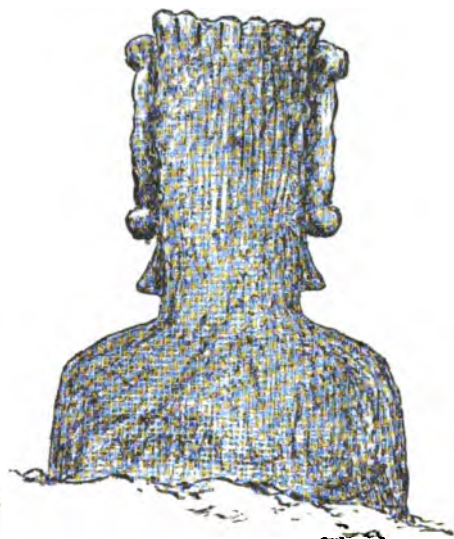

FIG. 12.

IMAGE: RANA RORAKA (back view).

intended. They stand well down towards the bottom of the slope, and are more or less buried in the earth by the washings from above, as shown in Figs. 13 and 14.

The work of lowering the huge images from the upper terraces to the bottom of the crater and thence over the wall and down into the plain below, was of great magnitude, and we are lost in wonder that so much could be accomplished by rude savages ignorant of everything in the way of mechanical appliances. The average weight of these statues would be something between 10 and 12 tons, but some are very large and would weigh over 40 tons. It is possible that a slide was made, upon which the images were launched to the level ground below; a number of broken and damaged figures lie in a position to suggest that idea, but from the bottom of the crater they were transported up and over the wall and thence over hill and dale to various points all over the island. Excavations were made at different points inside the

crater, but nothing was found of interest beyond a few broken stone implements that had no doubt been used by the image-builders.

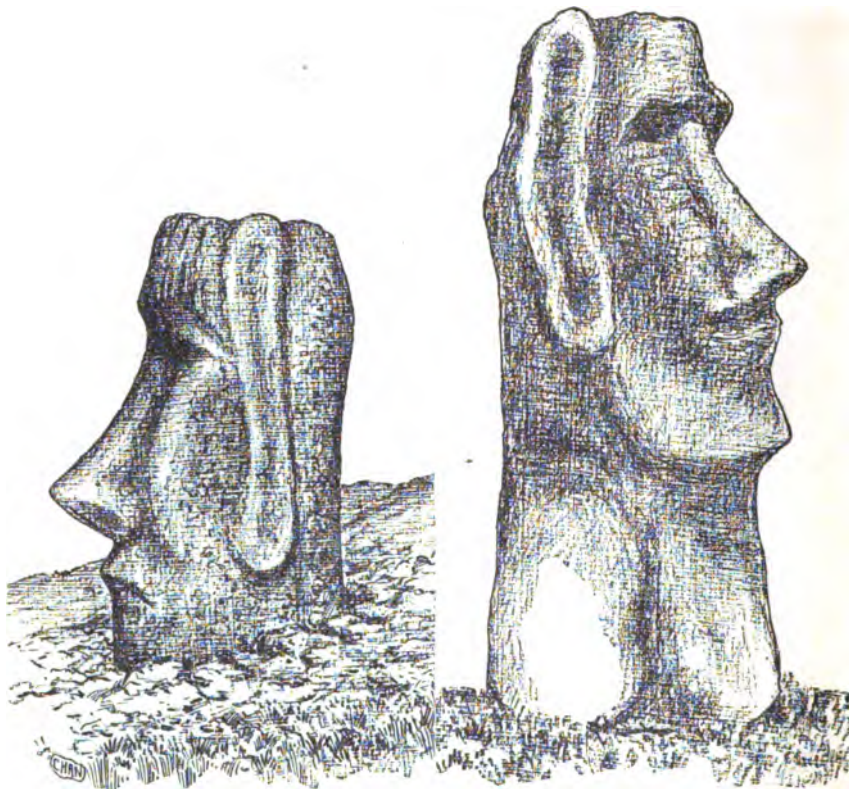

FIG. 13.
BURIED IMAGE: CRATER OF RANA RORAKA.

FIG. 14.
IMAGE STANDING INSIDE THE CRATER OF
RANA RORAKA.

December 27.—We made an early start and visited the image-builders' workshops on the west side of Rana Roraka, which are much more extensive than those on the inside of the crater. These workshops commence well up on the side of the mountain and extend quite to the summit by irregular terraces. In places these terraces extend one above another with unfinished images upon each, and the configuration of the land is such as to preclude all idea of launching the statues by means of a slide. We were unable to arrive at any satisfactory conclusion as to how the immense statues on the upper tier of works could be moved to the plain below, passing over the underlying cavities where similar works had been quarried. We know the natives had ropes made of hemp, two kinds of which are indigenous to the island, but it is difficult to conjecture how these heavy weights were handled without mechanical appliances. One hundred and fifty-five images were counted upon this slope in various stages, including those standing at the base of the mountain finished and complete, ready for removal

to the platforms. Many of the images in the workshops are of huge proportions, but the largest one on the island lies on one of the central terraces in an unfinished condition and measures 70 feet in length, 14½ feet across the body; the head being 28½ feet long. Some of the standing statues are in as perfect condition as the day they were finished.

One (Fig. 15) is noticeable from the fact that the head is slightly turned to one side and is known as the "wry-neck," but whether it is the result of accident or design could not be determined.

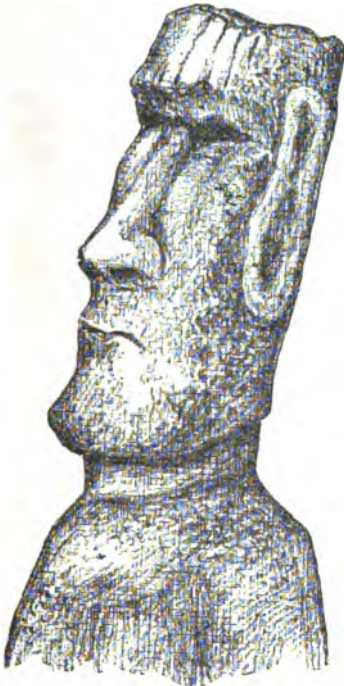

FIG. 15.
"WRY-NECK" IMAGE, RANA RORAKA.



FIG. 16.
THE MUTILATED IMAGE "HIARA," OUTSIDE OF
CRATER OF RANA RORAKA.

Another excellent specimen (Fig. 16) of these remarkable figures stands near the last mentioned and shows tool-marks around the neck as though an effort had been made to cut the head off. The natives call this "hiara" and have a tradition to the effect that it belonged to a powerful clan who were finally defeated in war, and that their enemies had made an attempt to destroy the statue by cutting off the head. The story may be based only upon the mutilation, but the chances are that it is founded upon fact.

Nothing of importance was found by digging about the images or in the workshops except broken stone implements which had been used by the builders. In one of the quarries we found the only trace of sculptured figures in the vicinity.

These emblems were carved upon a smooth rock over a half-finished image.

December 28.—Shortly after daylight the entire force started making excavations under the foundations of the image-builders houses, the ruins of which extend towards Rana Roraka from Tongariki Bay, on regular terraces. These peculiar ruins are to be found here in great numbers both inside and outside of the crater, but do not differ from those already described. A custom obtained among the islanders, similar to that practiced by the tribes of Alaska and other Indians of America, of burying something of interest or value beneath the door-posts of their dwellings. Usually it was a smooth beach pebble which was supposed to have some fetish qualities to bring good luck or ward off evil influences.

One of the largest of these ruins has an extensively paved terrace in front. At a depth of about three feet below the surface of the central door-way, we found a rough angular flinty stone with a rudely carved face upon it. A prominent ruin of the same description inside of the crater, and another near the workshop on the outside, yielded a hard stone upon which marks had been carved very similar to those on the rocks at Orongo.

SKULLS SHOWING PECULIAR MARKS.

One of our guides produced from a hiding place three ancient skulls, described elsewhere, upon the top of which these same mystical figures had been cut. They were not shown until a reward had been promised, and the guide claimed to have obtained them in their present condition from the King's platform.

On the outside of the crater of Rana Roraka, near the top and looking towards the southwest, we found a workshop containing fifteen small images. These had been overlooked in our former trips to this place.

Scattered over the plains extending towards Vaihu are a large number of images, all lying face downward. The indications are that they were being removed to their respective platforms when the work was suddenly arrested. These heavy weights were evidently moved by main strength, but why they were dragged over the ground face downward instead of upon their backs, thus protecting their features, is a mystery yet unsolved. One statue in a group of three is that of a female; the face and breast is covered with lichen, which at a short distance gives it the appearance of being whitewashed.

December 29.—We continued the work of exploration from Vaihu around the southwest points of the island. Excavations were made wherever the indications were good, but the results did not differ from those already described. Mount Orito was visited, from whence the obsidian was obtained for spear-heads, and also the quarries that produce the red pigment from which the natives make a red paint by rubbing it down with the juice of the sugar-cane. The remainder of the stay on Easter Island was devoted to the collection of traditions, translations of tablets, and similar matters of interest.

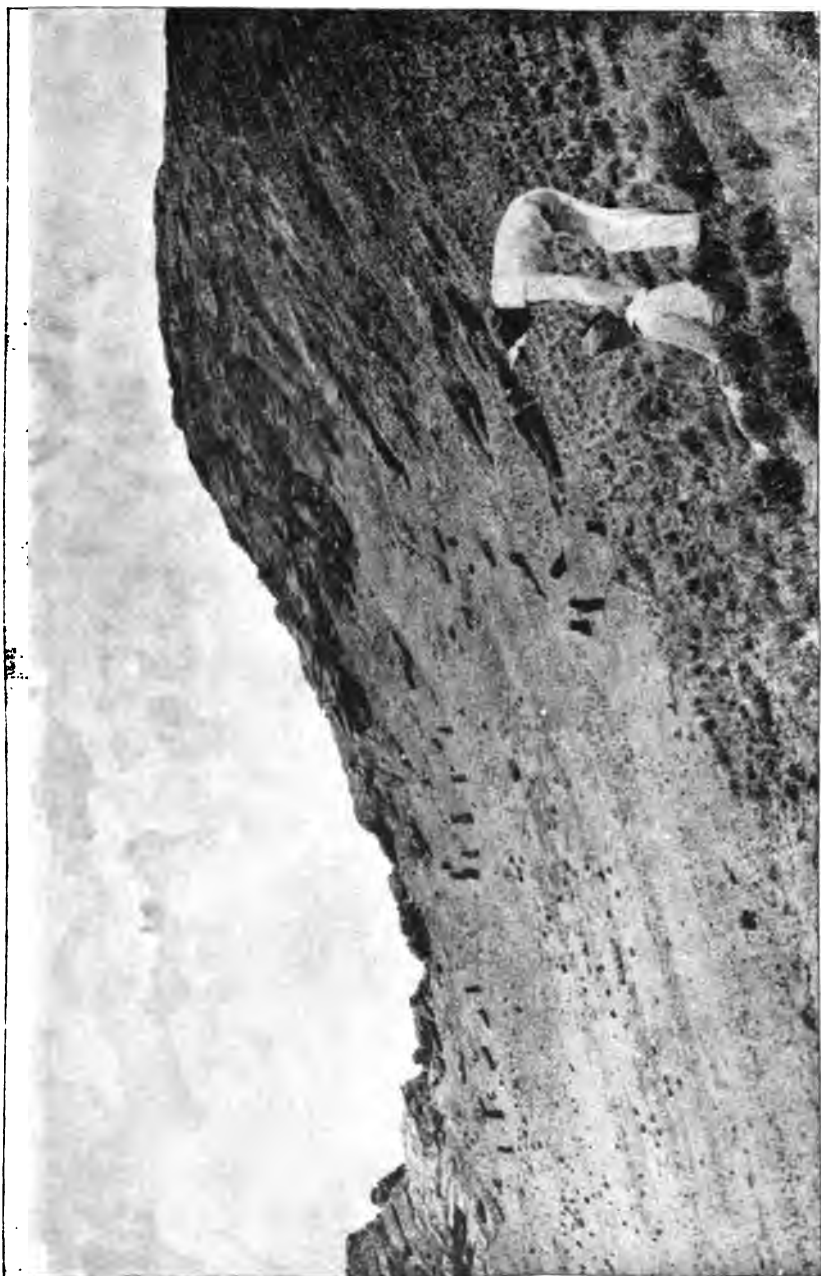

INSIDE THE CRATER OF RANA RORAKA, ON SLOPE BELOW THE ANCIENT WORKSHOPS.

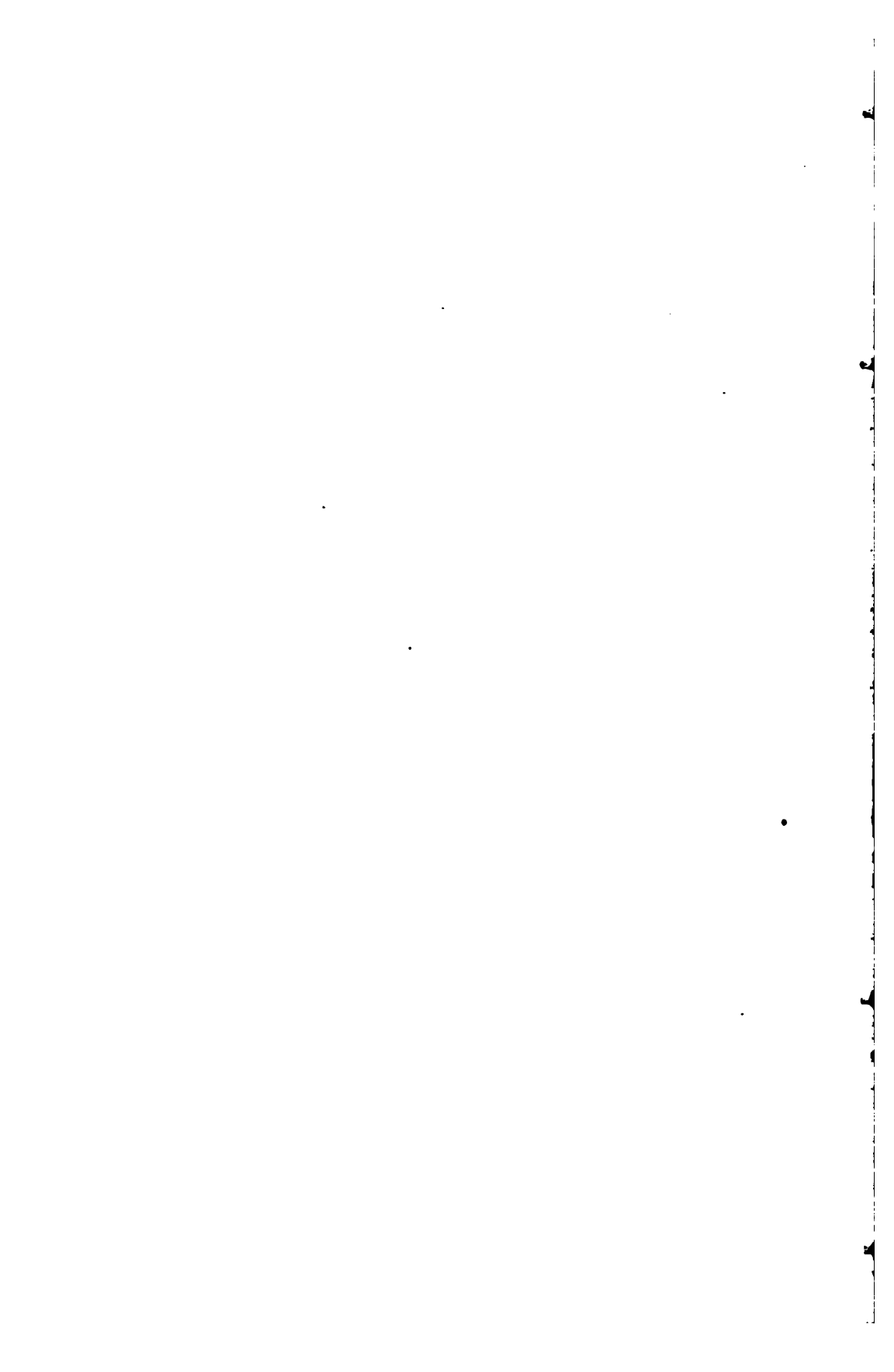

LATFORMS AND IMAGES.

In order to form an estimate of the magnitude of the work performed by the image-makers, every one on the island was carefully counted, and the list shows a total of five hundred and fifty-five images (Plates XXV and XXVI). Of this number forty are standing inside of the crater and nearly as many more on the outside of Rana Roraka (Plate XXVII), at the foot of the slope where they were placed as finished and ready for removal to the different platforms for which they were designed; some finished statues lie scattered over the plains (Plate XXVIII) as though they were being dragged toward a particular locality but were suddenly abandoned. The large majority of the images, however, are lying near the platforms all around the coast, all more or less mutilated and some reduced to a mere shapeless fragment. Not one stands in its original position upon a platform. The largest image is in one of the workshops in an unfinished state and measures 70 feet in length; the smallest was found in one of the caves and is a little short of 3 feet in length. One of the largest images that has been in position lies near the platform which it ornamented, near Ovahe; it is 32 feet long and weighs 50 tons.

Images representing females were found. One at Anakena is called "Viri-viri Moai-a-Taka" and is apparently as perfect as the day it was finished; another, on the plain west of Rana Roraka is called "Moai Putu," and is in a fair state of preservation. The natives have names for every one of the images. The designation of images and platforms as obtained from the guides during the exploration was afterwards checked off in company with other individuals without confusion in the record. The coarse gray trachytic lava of which the images were made, is found only in the vicinity of Rana Roraka and was selected because the conglomerate character of the material made it easily worked with the rude stone implements that constituted the only tools possessed by the natives. The disintegration of the material when exposed to the action of the elements is about equivalent to that of sandstone under similar conditions, and admits of an estimate in regard to the probable age. The traditions in regard to the images are numerous, but relate principally to impossible occurrences, such as being endowed with power to walk about in the darkness, assisting certain clans by subtle means in contests, and delivering oracular judgments. The legends state that a son of King Mahuta Ariiki, named Tro Kaiho, designed the first image, but it is difficult to arrive at an estimation of the period. The journals of the early navigators throw but little light upon the subject. The workshops must have been in operation at the time of Captain Cook's visit, but unfortunately his exploration of the island was not directed towards the crater of Rana Roraka.

Although the images range in size from the colossus of 70 feet down to the pigmy of 3 feet, they are clearly all of the same type and general

characteristics. The head is long, the eyes close under the heavy brows, the nose long, low-bridged, and expanded at the nostrils, the upper lip short and the lips pouting. The aspect is slightly upwards, and the expression is firm and profoundly solemn. Careful investigation failed to detect the slightest evidence that the sockets had ever been fitted with artificial eyes, made of bone and obsidian, such as are placed in the wooden images.

The head was in all cases cut flat on top to accommodate the red tufa crowns with which they were ornamented, but the images standing on the outside of the crater had flatter heads and bodies than those found around the coast. The images represent the human body only from the head to the hips, where it is cut squarely off to afford a good polygon of support when standing. The artists seem to have exhausted their talents in executing the features, very little work being done below the shoulders, and the arms being merely cut in low relief. The ears are only rectangular projections, but the lobes are represented longer in the older statues than in those of more recent date.

The images were designed as effigies of distinguished persons and intended as monuments to perpetuate their memory. They were never regarded as idols, and were not venerated or worshiped in any manner. The natives had their tutelary genii, gods, and goddesses, but they were represented by small wooden or stone idols, which bore no relation to the images that ornamented the burial platforms. The image-makers were a privileged class, and the profession descended from father to son. Some of the natives still claim a descent from the image-makers, and refer to their ancestors with as much pride as to the royal family. One of our guides never missed an opportunity of stating that one of his forefathers was Unrautahui, the distinguished image-maker.

The work of carving the image into shape and detaching it from the rock of which it was a part, did not consume a great deal of time, but the chief difficulty was, in the absence of mechanical contrivances, to launch it safely down the slope of the mountain and transport it to a distant point. It was lowered to the plain by a system of chocks and wedges, and the rest was a dead drag accomplished by main strength. A roadway was constructed, over which the images were dragged by means of ropes made of indigenous hemp, and sea-weed and grass made excellent lubricants. The platforms were all built with sloping terraces in the rear, and up this incline a temporary road-way was constructed of a suitable height, upon which the statue could be rolled until the base was over its proper resting-place. The earth was then dug away to allow the image to settle down into position, the ropes being used to steady it in the mean time. It was a work of great magnitude, but we can clearly see how it was accomplished with a large force of able-bodied men.

The crowns, or head ornaments, were made of red vesicular tufa, quarried in the Teraai Hills, where many finished specimens are still standing.



IMAGES STANDING AT THE BASE OF OUTER SLOPE OF RANA RORAKA.

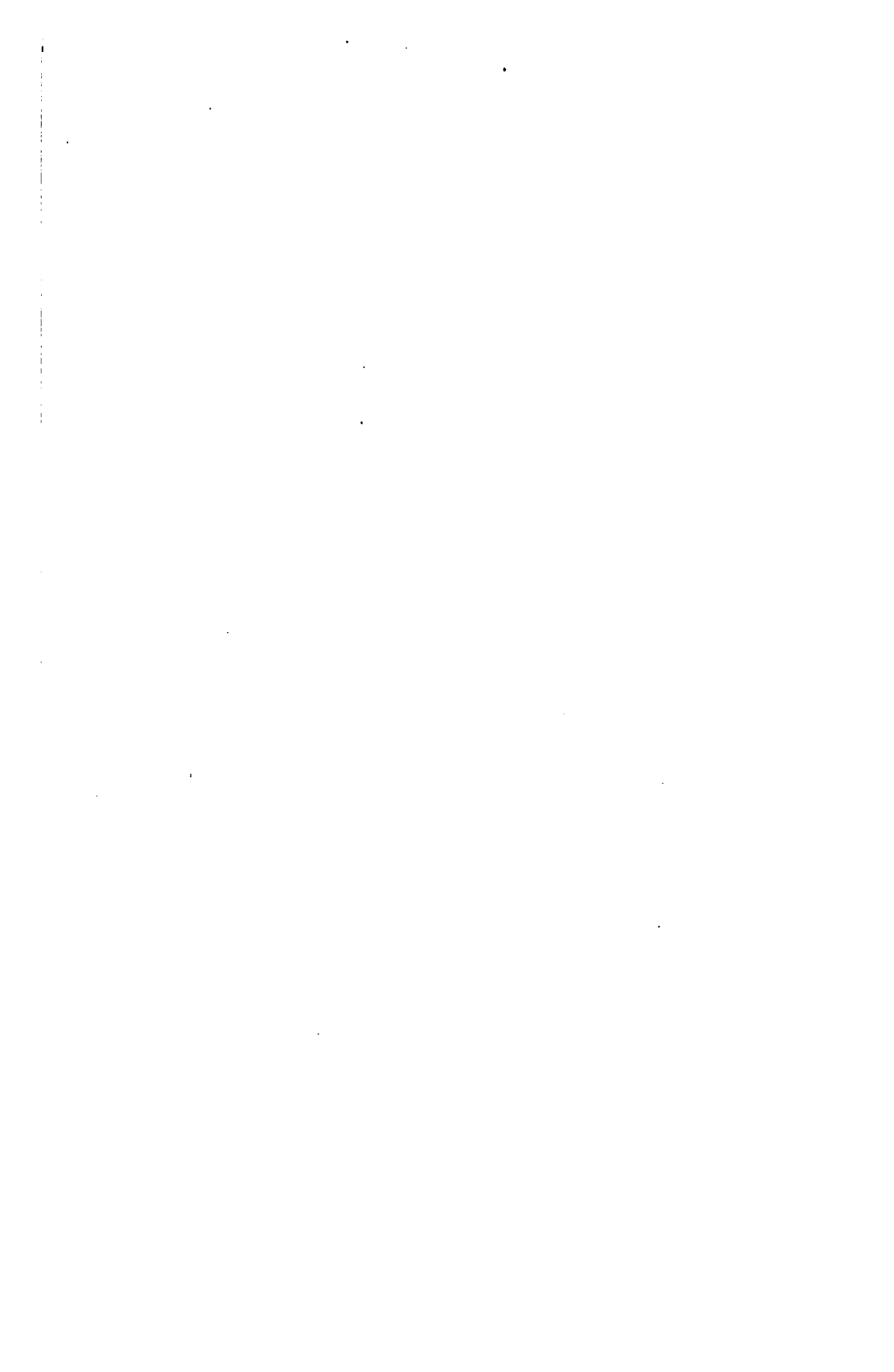

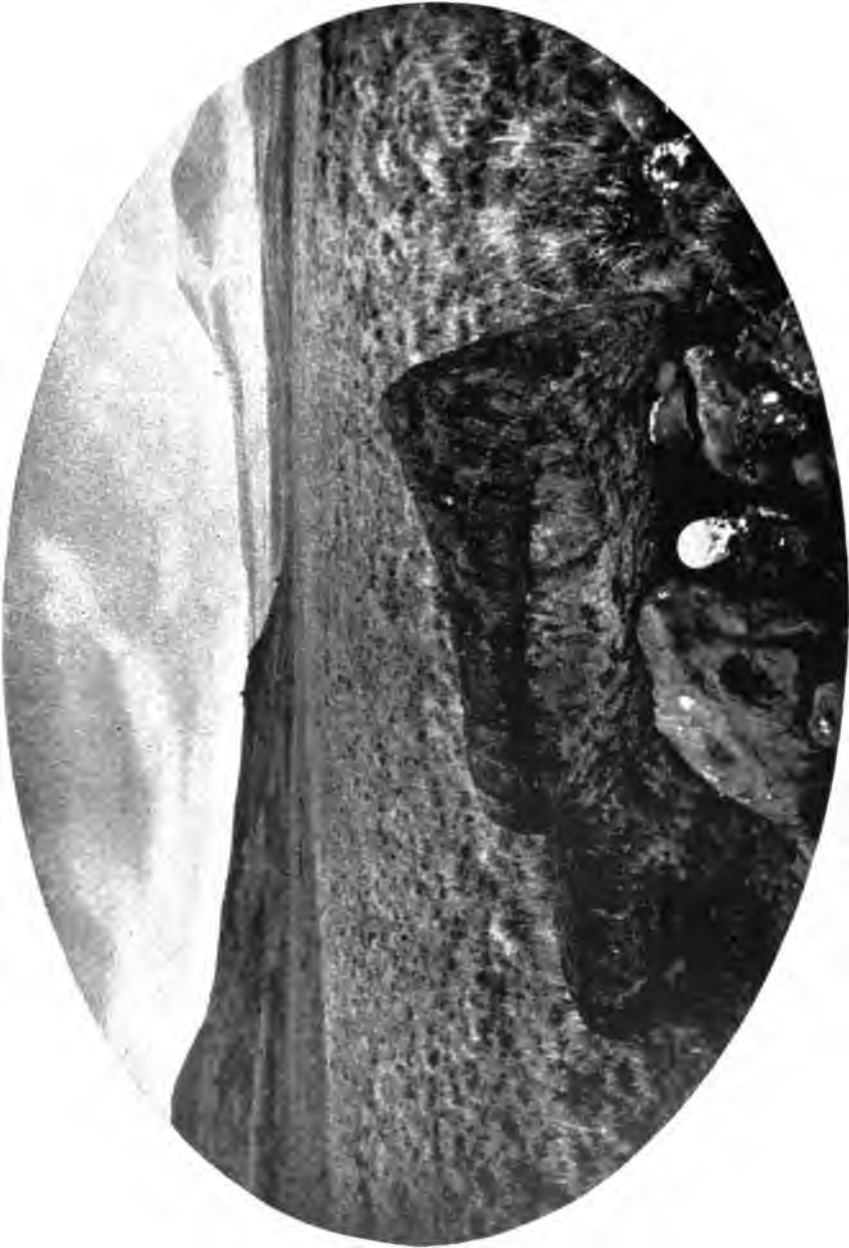

PLAIN OF ANAKENA.

The image in the foreground is now in the National Museum.
(Cat. No. 138308, U. S. N. M. Easter Island. Collected by Paymaster W. J. Thomson, U. S. N.)

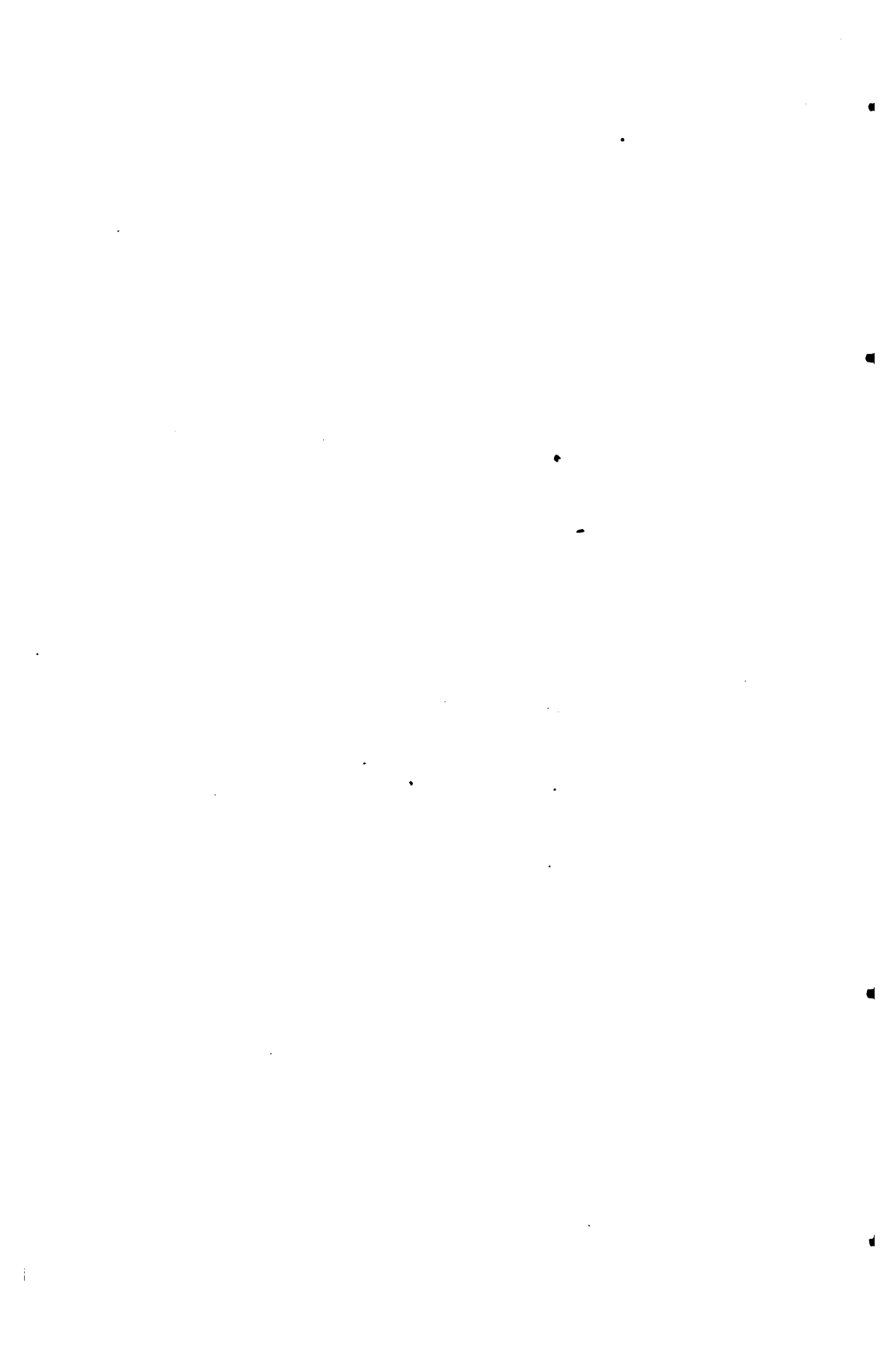

These truncated cones, nearly cylindrical in shape, were easily transported. The material is readily quarried and fashioned, being light, only about 1.4 times heavier than water, while the average density of the image-stone is about 2.1.

The largest crown measured was $12\frac{1}{2}$ feet in diameter, but of those that had actually been placed in position the average weight would not be more than 3 tons. The crowns were placed in position upon the heads of the standing images by building a road-way upon which they could be rolled to the proper spot. The clearing away of the incline was the final act. The earth which formed the surface was utilized as garden-patches, and the stones which formed the foundation of the road-way were disposed of in building the wing-extensions of the platform. The platforms differ greatly in dimensions, but the general plan and characteristics are invariably the same. Many of them are in a fair state of preservation, except that the images have been thrown down and the terraces in the rear obliterated or strewn with rubbish, while others have been reduced to a state of complete ruin. The platforms are usually located near the beach, and on the high bluff some of them are quite near the edge, overlooking the sea. The general plan consists of a front elevation composed of blocks of stone fairly well squared and neatly fitted together without cement, a parallel wall forming the inside boundary, built of uncut stone, inclosing small chambers or tombs placed at irregular intervals. Loose bowlders fill the spaces between the tombs and form the horizontal plane of the platform, into which are set the rectangular stones which constituted the base upon which the images stood. The façade stones are large and heavy, and in some cases the smooth surface presented could not well be attributed to the rude implements at the command of the builders, and must have been produced by friction or grinding. Long wings composed of uncut stone extend from the platform proper, built up to the summit at the line of junction and sloping away to the surface of the ground at the ends. In the rear of the platform a few steps descend to a gently sloping terrace, which terminates in a low wall and is bounded by a squarely built wall raised above the ground so as to join the top of the platform. Human remains fill the inner chambers, and bones lie scattered about among the loose bowlders of the platform and its extensions. The ruined condition of these solid specimens of architecture, with the overthrown images and immense deposit of loose bowlders on the surface of the ground, are strongly suggestive of earthquakes and volcanic eruption. The images in all stages of incompleteness in the workshops, and abandoned *en route* to the coast in various directions, indicate that the work was suddenly arrested, and not gradually brought to an end; but the traditions are silent upon the subject, and no record has been handed down of the disturbance of any of the volcanoes on the island.

Platform No. 1.—Known to the natives as “Hanga Roa”. Only the base remains, measuring 59 feet long by 7 feet wide. This pile was demolished to obtain material for the construction of a house for one of the Catholic missionaries formerly stationed on the island.

Platform No. 2.—Called “Ana Koiroraroa”; 160 feet long by $12\frac{1}{2}$ feet wide and 10 feet high. The facing-stones on the front line remain intact, but the body of the platform is a mere mass of loose stones, probably torn up by the natives in recent years for the purpose of depositing their dead in these ancient structures. The three statues that formerly adorned this pile are lying immediately in the rear, and show from their positions that they had faced inboard, with their backs to the sea. These images are much weather-worn and defaced: one is entire; another has the head lying close by, probably broken off in the fall; and the third is minus the head and with the neck showing saw-marks. We afterwards found out that a French vessel of war visited the island a few years ago and the head of this image was cut off by them and taken to Europe.

Platform No. 3 (See Fig. 17).—Called “Hanga Varevare”; 50 feet long and 8 feet wide. This has the appearance of an unfinished pile and is merely a burial place covered with loose rocks and without the usual smoothly faced stones in front. We found the catacombs or tombs underneath this platform had been robbed of the most ancient skulls, and concluded that the Frenchmen had taken everything of interest away.

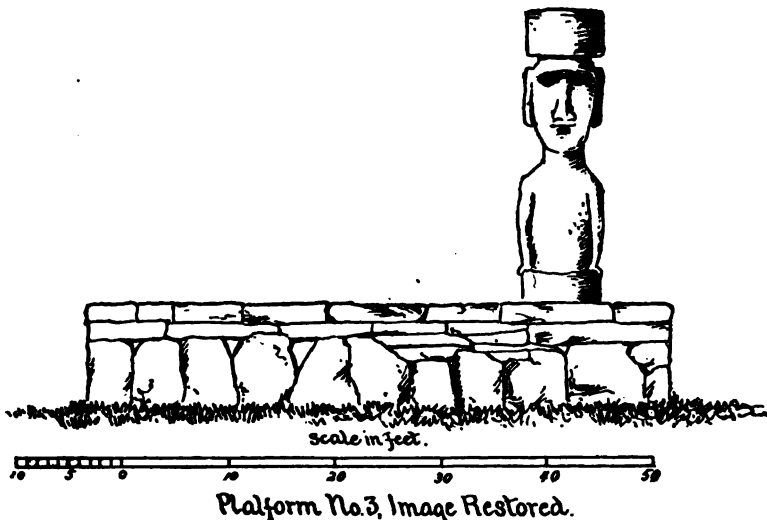

FIG. 17.
HANGA VAREVARE.

Platform No. 4.—Called “Tahai”; 160 feet long, $7\frac{1}{2}$ feet wide, and 7 feet high. In a bad state of preservation, but the facing-stones on the front are sufficiently plain, while the rest of the pile is a mass of loose

stones. Five large flat stones at regular intervals along the platform, show where the images once stood. The statues have fallen face downward on the inshore side, and are much broken and dilapidated. The one on the north end is of gigantic size, and much larger than the others. The red tufa crown that adorned this image lies near it, and measures 7 feet 9 inches wide; 5 feet 9 inches in ellipse; and 4 feet 9 inches high, and the top is ornamented by sculptured lines that have the appearance of geometrical figures, but are too much obliterated to decipher.

Platform No. 5.—Called by the same name as the last, only a few yards distant, is shaped like a right angle, and it is possible that these two platforms may have been originally designed for one of huge proportions. The stones of which it is composed have been thrown about in such disorder that the original design can not be followed, but the flat base stones indicate where the images once stood. At one end of this platform a statue 14 feet high and 9 feet across the hips, lies face downward on the inboard side, and at the other end, one measuring 15 feet long and 6 feet wide, lies face downward toward the sea, being one of the few images on the island found in that position, admitting the possibility of having faced outboard.

Platform No. 6.—Called "Anotai"; 120 feet long, 17½ feet wide, and 7½ feet high. In a bad state of preservation, though the faced stones on the front may be traced. The remains of one image lies on the inboard side, but minus the head. A large cavity in the center of the back of this image attracted attention, but could not be explained. The red tufa crown belonging to this statue lies half-buried in the earth, about 100 feet distant. Under the center of this platform were obtained some interesting relics, and the tombs bore evidence of great antiquity.

Platform No. 7.—Called "Ahuakapu"; 101 feet long, 9 feet wide, and 8 feet high. In a bad state of preservation. Three images lying on the front side with the appearance of having been pulled over backwards, and one upon the inshore side down upon its face. All four statues are in good condition, except that the heads have been broken off at the neck by the fall. One of these detached heads measured 5 feet 3 inches in length by 3 feet 2 inches from ear to ear. The four pedestal stones are still in place on the platform and average 4 feet long and 3 feet 8 inches wide, and are composed of hard volcanic rock, roughly squared.

Platform No. 8.—Called "Anaoraka"; 95 feet long and 8 feet wide and 7 feet high. Remarkable for the large stones that support the sea face, the largest of which measures 6 feet 9 inches high and 4 feet 7 inches wide. Four images have fallen upon their faces upon the inboard side. Only a pedestal stone remains in position, which is 5 feet 2 inches square by 2 feet 2 inches thick. (Fig. 18).

Platform No. 9.—Called "Kibikihiraumea"; 186 feet long, 8 feet 10 inches wide, and 7 feet 5 inches thick. The central section of this structure contains stones so remarkably well cut and fitted together that it

merits the accompanying sketch. Four images were found, which had been thrown down on their faces on the inboard side. These are in a fair state of preservation. From this ruin we obtained skulls, obsidian spear-heads, and stone tools.

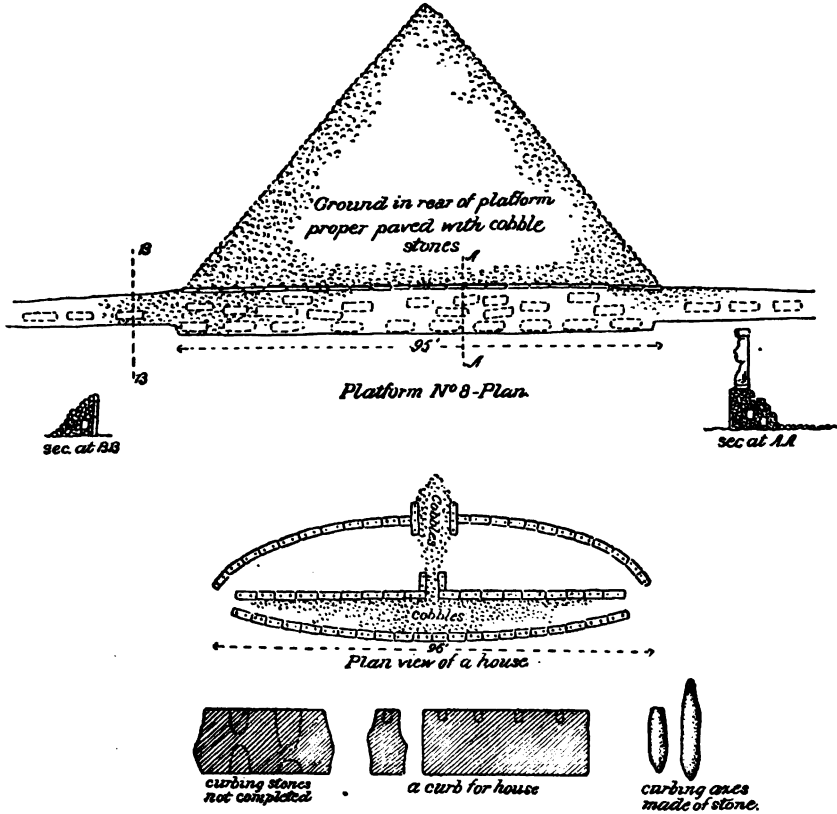
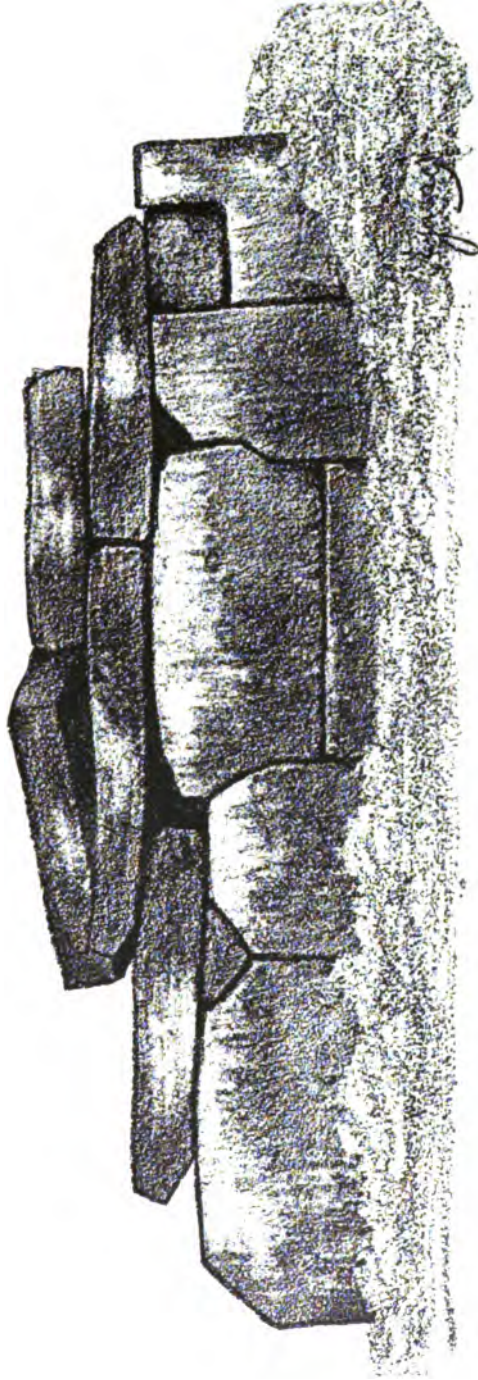

FIG. 18.
SHOWING GENERAL PLAN OF CONSTRUCTION OF PLATFORM. ALSO PLAN OF HOUSE CONSTRUCTION WITH DETAILS.

Platform No. 10.—Called “Ahutepu”. Is in such a state of dilapidation that it was impossible to obtain accurate measurements. Portions of an image are here, but it looks as though others might have been rolled over the edge of the cliff, which is only a few feet distant and about 450 feet high, and against the base of which the sea dashes incessantly.

Platform No. 11.—Called “Hananakou”. Central sections 48 feet long, 12 feet wide, and 9 feet high; total length, with wings, 248 feet. This is an exceedingly fine platform, and contains some remarkably large stones. In the face of the main structure are huge blocks of igneous rock that appear to have once been fashioned into faces and figures, but now so destroyed by the action of the elements and perhaps by the hand of the iconoclast that the features can only be dimly traced. Hard work with



"OHOU" PLATFORM, No. 12, SHOWING PECULIARLY FITTED STONES. CENTER STONE WEIGHS 6 TONS; CIRCULAR PEDESTAL STONE, 5½ FEET IN DIAMETER.

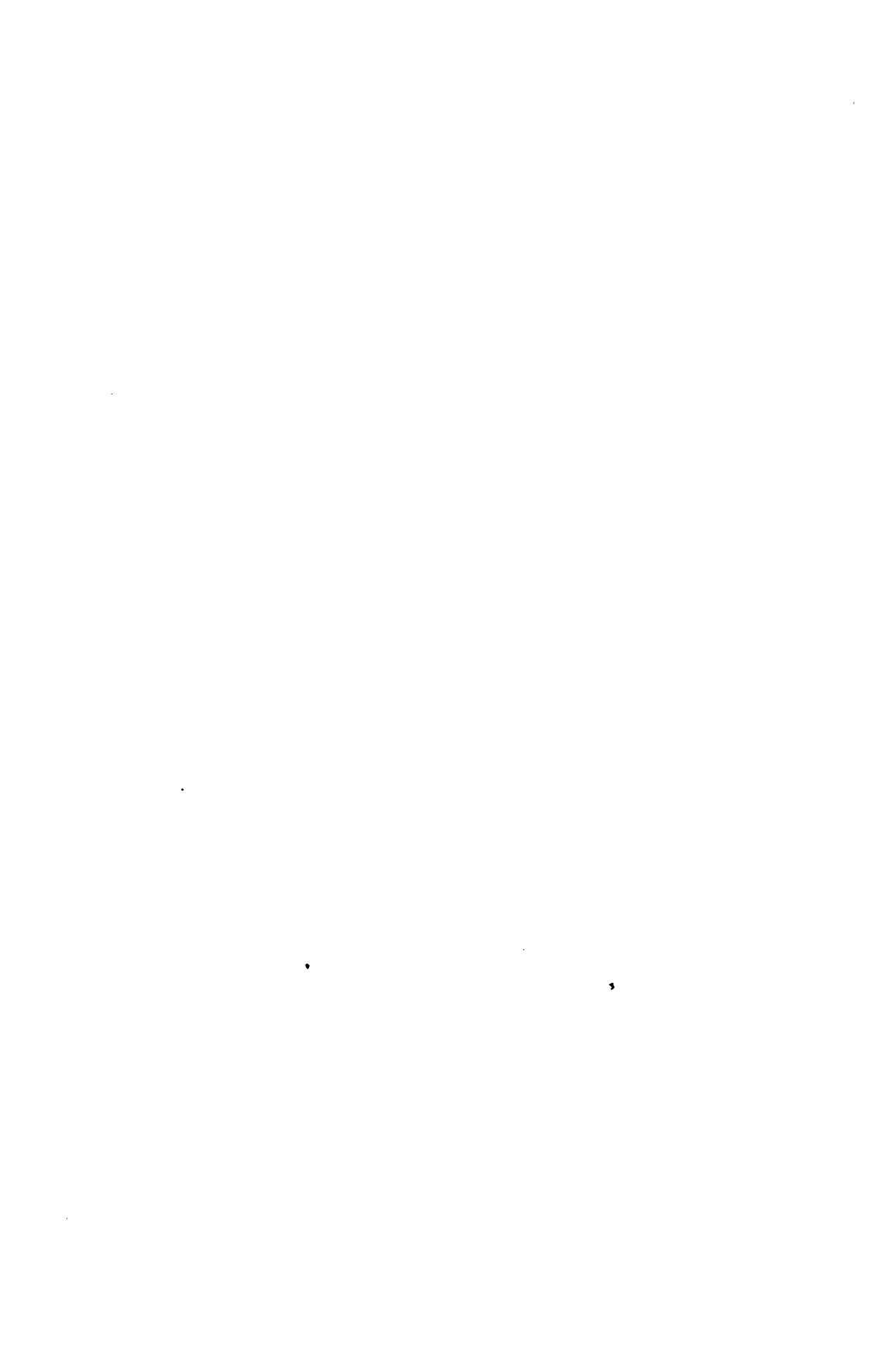

our entire force disclosed beneath this platform well constructed catacombs and tombs, containing human remains so old that they crumbled into dust upon exposure to the air. The removal of one of the facing-stones revealed a lot of skulls with remarkably broad, heavy underjaws. These were generally too brittle to be handled, and a peculiar feature about the find was the fact that these heads had been entombed together, and the surroundings excluded the idea of any other portions of the bodies having been interred with them. Only one image is in sight, and the proximity of the platform to the edge of the bluff suggests the possibility that other statues may have been thrown into the sea. From the size and character of the work on the structure it is not reasonable to suppose that it was designed to support the one insignificant statue that lies near it:

Platform No. 12.—Called "Ohaus". Central section 18 feet long, 9 feet wide, and 6 feet high. One image thrown down upon its face on the inboard side, 8 feet 4 inches long; extreme width of body 5 feet; length of head 4 feet; and width from ear to ear, 3 feet 3 inches. Good state of preservation. (Plate XXIX).

Platform No. 13.—Called "Ahukinokino". In such a state of ruin that measurements were not obtainable. Situated close to the edge of the high cliff.

Platform No. 14.—Called "Ahutoretore". Has been so completely destroyed that nothing can be determined about its original size and importance. Excavations in this vicinity produced nothing but a few stray spear heads of obsidian.

Platform No. 15.—Called "Hangatariri"; 103 feet long, 11 feet wide; and 6 feet high. In very bad condition, but some of the large cut facing-stones are in position. Four images lie face downward on the island side, and two more have fallen on their backs toward the sea. A few yards back of this structure is a tomb 50 feet long and 6 feet wide, built of stones taken from the platform and those peculiarly cut stones that form the foundations of the image-builders' houses. At one end is a hard stone slab that appears to have been covered with hieroglyphics, but they are too nearly obliterated to be accurately traced. After a thorough investigation we concluded that it was of comparatively recent date and had no distinctive features of its own. On the plain, a few hundred yards distant, is an image of gigantic proportions lying upon its face with the head toward the sea. The indications are that it was designed for this platform and was being moved into position when from some sudden emergency it had to be abandoned. The ground underneath the statue has been dug out by later generations in such a manner that the body of the image forms the roof of the cave. The base of the statue shows traces of rudely sculptured figures, nearly obliterated. In this vicinity are several large caves, with the narrow entrances completely blocked up with loose stones, which were not investigated for the want of time.

Platform No. 16.—Called "Haugaoteo"; 70 feet long and 12 feet wide. Has the appearance of having been in process of construction when the work was suddenly suspended.

Platform No. 17.—Called "Tumuheipara"; 40 feet long, 8 feet wide, and 8 feet high. This structure also appears to have been abandoned before completion. The chances are that several days could have been spent upon the extensive plain, back of these images, to great advantage and it is regretted that the limited time at our disposal did not allow a more-thorough investigation.

Platform No. 18.—Called "Haahuroa". Central section 40 feet long, 12 feet wide, and 7 feet high, with wings 145 feet in length. One image lying on the inboard side measures 7 feet 5 inches long and 3 feet 5 inches wide; length of head to shoulders 3 feet 4 inches, and width from ear to ear 3 feet 5 inches. The fragments of two other images lie in front of the platform. The huge facing-stones of this structure have been thrown about as though by some great convulsion of nature, and some of them bear evidences of having been ornamented with sculptured figures.

Platform No. 19.—Called "Akane". Seems to have been abandoned while in the process of construction. A few faced stones intended for the front of the central section are lying about, but were never placed in position.

Platform No. 20.—Called "Ahuroa". Is a mere mass of loose rocks, said to have been destroyed in the tribal wars, but it has the appearance of having never been completed.

Platform No. 21.—Called "Vaiavangarenga". In the same condition as the last. No images.

Platform No. 22.—Called "Maiki". Same as the last; merely a pile of loose stones covering human remains. These platforms may have been robbed to supply the material for the construction of the numerous houses and cairns, the ruins of which cover the hills in this vicinity.

Platform No. 23.—Called "Tauka". Central section 38 feet long, 48 feet wide, and 12 feet high, the extreme length with wings 120 feet. In very bad condition. One small image lies face-upward toward the sea, much broken. Facing and other suitable stones have been removed from this platform for the construction of tombs and houses. Near at hand is one of those peculiar ways, made by paving the sloping bank with regular lines of smooth, round boulders, as though intended for hauling up heavy boats or weights.

Platform No. 24.—Called "Punamuta". In its incipient stage, and important only from the fact that it shows the manner of laying the foundation of the work.

Platform No. 25.—Called "Koteva". This has been an important structure and was built in the shape of a right angle 60 feet long, 11 feet wide, and 20 feet high. Portions of the walls have been thrown down, and no images could be found.

Platform No. 26.—Called "Tetonga". Similar in shape and structure to the last, but of smaller size. From these piles we obtained relics in the shape of obsidian spear-heads, stone implements, and skulls.

Platform No. 27.—Called "Hanghaogio"; 150 feet long, 8 feet wide, and 10 feet high. Three small images have been thrown down and much broken.

Platform No. 28.—Called "Huarero". Very similar to the last, but located on the hill-side about three-quarters of a mile back of the bay. The facing-stones show traces of carving, but so nearly obliterated that only these figures could be made out: , and they seemed to be often repeated. The fragments of two images lie behind the platform.

Platform No. 29.—Called "Anakena"; 75 feet long, 8 feet wide, and 10 feet high. An image lies upon its face upon the inboard side, 13 feet long and 9 feet across the hips; length of head, to shoulders, 5 feet, and width, from ear to ear, 6 feet 6 inches. This image is in the best state of preservation of any found about the platforms of the island. The traditions state that it was the last statue finished and set up in place. Our guides maintained that this is the statue of a female, and that it was only thrown down about twenty-four years ago. Its size, and proximity to the perfectly smooth landing place at Anakena Bay, would insure its easy removal to a vessel. From the sand beach at Anakena Bay we passed over hills composed of volcanic cinder as light as coke, but very hard. Beyond this are numerous ruins of houses, each with a small stone building connected that was evidently designed for fowls. The largest of these was about 8 feet square, and the only opening was a small hole for the chickens to pass through.

Platform No. 30.—Called "Ahutrature". Central section 30 feet long, 10 feet wide, and 6 feet high. Extreme length 80 feet. In ruins, with no images.

Platform No. 31.—Called "Anateka"; 30 feet long, 12 feet wide, and 7 feet high. Extreme length 100 feet. In a very bad condition. Small fragments are all that remain of two images and two crowns.

Platform No. 32.—Called "Ahupuapatetea". Merely a shapeless mass of uncut stones remain to indicate the site of the structure.

Platform No. 33.—Called "Ahangakihikihi"; 20 feet long, 10 feet wide, and 9 feet high. In ruins. One small image lies on the inboard side in a bad condition.

Platform No. 34.—Called "Punahoa". Although in ruins, this has evidently been a structure of some importance; 175 feet long, 8 feet wide, with the central section projecting 6 feet forward of the main line. The facing-stones are from 6 feet to 9 feet in length by 5 feet and 1 foot in thickness. An image lies upon its face on the inboard side, and measures 32 feet long, 10 feet 3 inches wide; length of head, to shoulders, 12 feet and 6 inches. Near this platform we found a peculiar stone nearly buried in the earth. After much digging it proved to be

nearly spherical in shape and about 8 feet 4 inches in circumference. The natives called it "Petakula", and we could only make out that it was a grinding stone of some sort.

Platform No. 35.—Called "Puapau"; 150 feet long, 10 feet wide, and 8 feet high, with a small platform in front of it. The building of this elaborate structure must have furnished employment for a large number of people. The foundation stones are of hard rock of immense size, all smoothly faced. Four images have been thrown down, two on each side, and all much broken.

Platform No. 36.—Called "Hangakouri". Central section 70 feet long, 7 feet wide, and 8 feet high. Extreme length 300 feet. In a state of absolute ruin and no images.

Platform No. 37.—Called "Hangahoonu". Completely in ruins and with one image in a bad condition. Between these last two platforms is a paved way leading to a small channel through the rocks that affords a safe and convenient landing for small boats.

Platform No. 38.—Called "Mari". Central section 80 feet long, 12 feet wide, and 7 feet high. Extreme length 300 feet, situated very close to edge of the bluff.

Platform No. 39.—Called "Ahurai". Very large; but, like the last, in a state of ruin.

Platform No. 40.—Called "Tehahitunukiolaira". Of great size; but, like the last, in a state of absolute ruin; covering human remains.

Platform No. 41.—Called "Narnaanga". Small and inferior; also in ruins and no images.

Platform No. 42.—Called "Hangaopuna"; 100 feet long and 10 feet wide. Has two layers of roughly cut stones in the front face, and appears to have been left in an unfinished state.

Platform No. 43.—Called "Tumatuma"; 25 feet long, 7 feet wide, and 7 feet high. Poorly constructed, and contains nothing of interest but one small image.

Platform No. 44.—Called "Tokaie". Larger than the last, but in a bad condition. A much battered head lies just behind the pile, but the rest of the image can not be found.

Platform No. 45.—Called "Vaimangeo"; 50 feet long, 8 feet wide, and 15 feet high. Extreme length, including wings, 150 feet. In a state of ruin, and has one large image thrown down on the inboard side.

Platform No. 46.—Called "Moukuhoi"; 20 feet long, 7 feet wide, and 5 feet high. Extreme length, including wings, 60 feet. Situated very close to the edge of the bluff, and looks as if the destroyers of the structure might have tossed the most of it into the sea.

Platform No. 47.—Called "Moukuroa". In all respects a duplicate of the last one.

Platform No. 48.—Called "Motuariki"; 20 feet long, 7 feet wide, and 5 feet high. Extreme length, including wings, 260 feet. This has been a large and imposing structure. The central section, upon which the im-



CENTRAL SECTION OF THE GREAT PLATFORM OF TONGARIKI.



RIGHT WING OF PLATFORM OF TONGARIKI. BROKEN IMAGE ON PEDESTAL; THE ONLY ONE ON THE ISLAND FOUND IN ITS ORIGINAL POSITION ON A PLATFORM.





LEFT WING OF PLATFORM OF TONGARIKI.

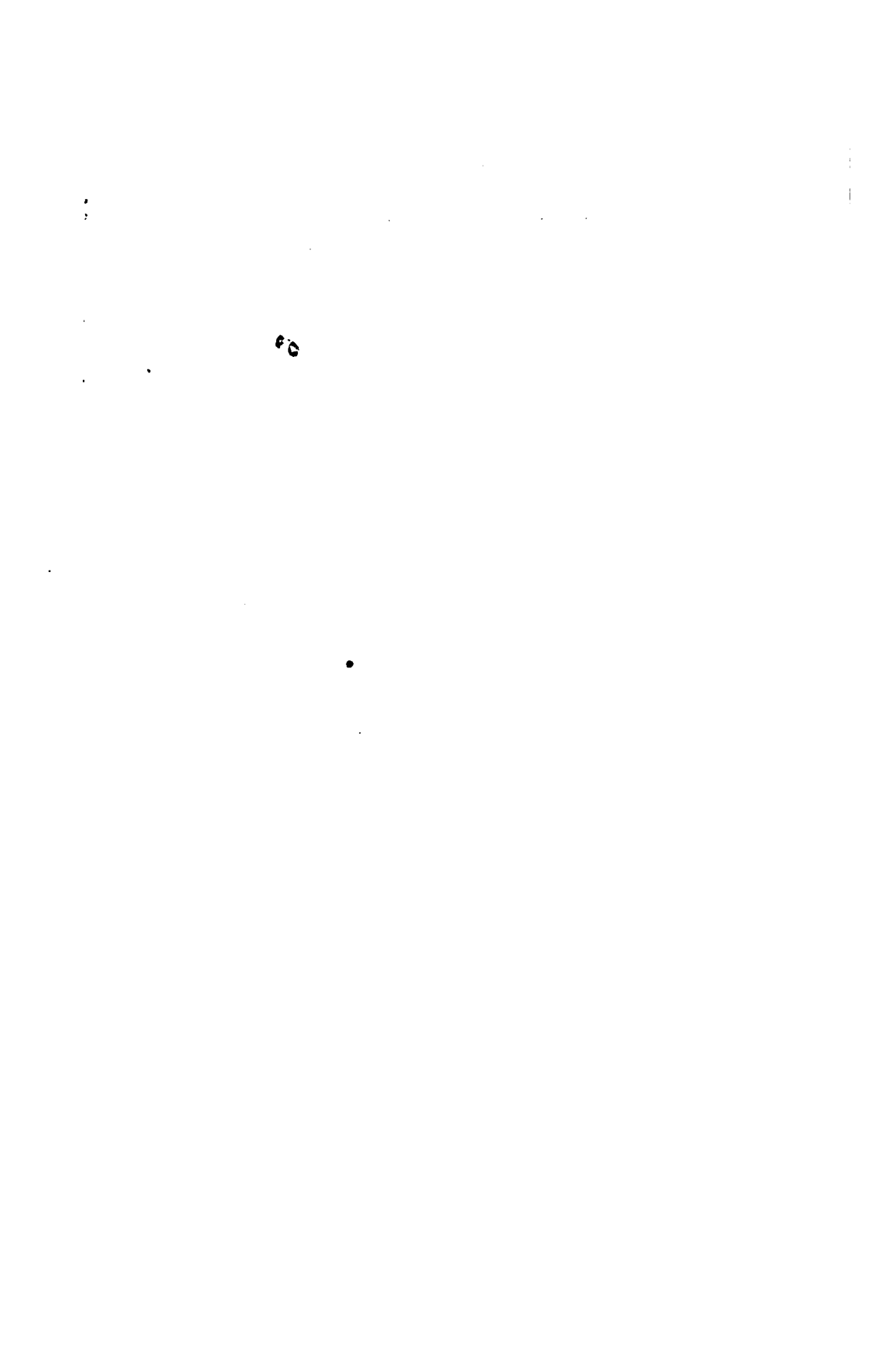



REAR VIEW OF RIGHT WING OF PLATFORM OF TONGARIKI, SHOWING FALLEN IMAGES.



REAR VIEW OF CENTRAL SECTION OF PLATFORM OF TONGARIKI, WITH FALLEN IMAGES.



age stood projects beyond the line of the platform, and was higher. In the rear, and extending the entire length of the pile, is a broad terrace, neatly paved with smooth round boulders. The fragments of three images lie upon the terrace.

Platform No. 49.—Called "Oneonepuhea". Central section is about 45 feet long by 6 feet high. This is a crescent-shaped structure, and the only one of the kind that we saw on the island. It is situated on the extreme edge of the cliff, which at this point has a straight-away fall of over 500 feet to the sea, which dashes against its wall-like base. There is no image in sight, but a large pedestal stone, inclined at a sharp angle towards the sea, shows where one has stood and suggests what became of it.

Platform No. 50.—Called "Ahutakaure". Located on Poike cliff, facing westward; is small and unimportant and in a state of complete ruin. On the east slope of the mountain we found an image, the head of which had been broken off, but it lies near by. There is no platform here and no indications that one was intended to be built in the vicinity; so we concluded that the statue was being moved to some distant locality when it was broken and abandoned.

Platform No. 51.—Called "Hangaiti"; 30 feet long and 8 feet wide and 5 feet high. In a bad condition and one small image broken.

Platform No. 52.—Called "Tongariki"; 150 feet long, 9 feet wide, and 8 feet high (Plates XXX-XXXIV). Extreme length, including original wings, 540 feet. This is the largest platform on the island, and was ornamented with fifteen gigantic statues. These have been thrown down upon their faces on the inshore side, and the most of these are broken, the one on the south end being fractured across the middle of the body, leaving the lower section still standing. The red tufa crowns are lying a short distance away and are also much broken. The hard stones of which the sea-front of this platform is constructed are of immense size, faced and neatly joined together. One of the foundation-stones in the center of this wall is of red tufa and represents a human head.

Our investigations were commenced at this point by throwing down the facing-stones and working straight backwards through the platform. The labor was great, and occupied the most of our force for nearly two days, but the catacombs and tombs underlying the structure were thoroughly examined. Under the central section are small, narrow passages forming a part of the original design, having been built up while the platform was in process of construction, and containing human remains. The oldest of these tombs appear to have been sealed up before the structure was completed, and the probability is that they were not intended to be opened, from the fact that there is nothing to indicate their exact locality. The pedestal-stones, all of which are still in place, show that the images were put up at equal distances and with a view to symmetry, and without regard to the position of the tombs; though

it is pretty well established that they were intended as effigies of chiefs or distinguished persons. The terrace behind the platform was also used as a burial-place, and contained remains of an ancient date. Succeeding generations have utilized the same places for the same purposes, but there are passages under the platform that have never been opened since the structure was built. The entire plain back of Tongariki Bay is one vast cemetery, containing the decaying remains of thousands of people. Every pile of stones, cave or ruined platform, house or cairn, has been used as a tomb. The christianized natives of to-day still regard this as a favorite burial-place. They have neither the ambition nor the industry to construct tombs for themselves, but are content to place their dead in receptacles filled with the remains of their ancestors. The recess-angles between the bodies of the fallen images, and the platforms upon which the base rests, are filled with remains of a recent date.

Platform No. 53.—Called "One-tea". Completely in ruins. Three images much broken. Foundation proper about 100 feet long.

Platform No. 54.—Called "Opaariounga". Small and unimportant. Central section 20 feet long, 6 feet wide, and 7 feet high. Remains of one small image.

Platform No. 55.—Called "Hangatufata"; 125 feet long, 8 feet wide, and 7 feet high. Five images thrown down, broken and in bad condition.

Platform No. 56.—Called "Onemakihī". Central section 40 feet long, 7 feet wide, and 7 feet high. Extreme length, including wings, 100 feet. One image much mutilated.

Platform No. 57.—Called "Punakape". Central section 40 feet long, 6 feet wide, and 6 feet high. Extreme length 80 feet. In ruins, and no images.

Platform No. 58.—Called "Moaitutahi". Central section 150 feet long, 7 feet wide, and 7 feet high. Extreme length 250 feet. Only two images remain, but appearances indicate that others have been destroyed. Upon terraces sloping towards the sea from the front are numerous remains of image-builders' houses. From the back of the structure a nicely paved way, 10 feet wide, extends inland for a distance of 200 yards.

Platform No. 59.—Called "Hanga-mahibiku". A mere mass of ruins, and almost devoid of shape. No images.

Platform No. 60.—Called "Ahuakoi". Central section 75 feet long, 7 feet wide, and 6 feet high. Extreme length, 160 feet. In a bad condition, and no images.

Platform No. 61.—Called "Hanga-tutuki". A mere mass of ruins covering human remains.

Platform No. 62.—Called "Ahupoepoe". In same condition as the last and without images.

Platform No. 63.—Called "Vaimoai". Central section 40 feet long, 6 feet wide, and 8 feet high. Extreme length, 90 feet. In bad condition, and no images.



AKAHANGA (KING'S PLATFORM), No. 80, REAR VIEW.

Platform No. 64.—Called “Kai”. Same dimensions and general appearance as the last, but has one broken image.

Platform No. 65.—Called “Ruruoa”. Central section 150 feet long, 7 feet wide, and 6 feet high. Extreme length, including wings, 275 feet. Two large images, each 33 feet in length by 5 wide. Length of head, to shoulders, 10 feet, and width, from ear to ear, 4 feet. The stones on the front wall of the structure are neatly squared and smoothly faced.

Platform No. 66.—Called “Mahatua”. Central section 30 feet long, 7 feet wide, and 6 feet high. Extreme length, 100 feet. Two images, much defaced, lie on the inboard side on their faces. Between this platform and the last there is a nicely graded and paved road, with gentle slope from the cliff to the water-edge.

Platform No. 67.—Called “Ahukirirera”. Has been pretty well demolished. No images.

Platform No. 68.—Called “Tehangakiri”. Central section 40 feet long, 7 feet wide, and 7 feet high. Extreme length, 250 feet. Here are seven images, three large ones and four small-sized, all in a damaged condition.

Platform No. 69.—Called “Kirikiriroa”. Has been pretty thoroughly demolished, and has the fragments of one image.

Platform No. 70.—Called “Onepuheua”. A duplicate of the last one in all respects.

Platform No. 71.—Called “Hanga-tetera”; 60 feet long, 6 feet wide, and 7 feet high, and has no wings. The main stones of sea-face average in size $5\frac{1}{2}$ feet long and $1\frac{1}{2}$ feet wide. No images.

Platform No. 72.—Called “Hanga-rea”. Has been completely demolished and the fragments of two images lie among the ruins.

Platform No. 73.—Called “Oteu”. Has a small foundation and seems to have been abandoned in an unfinished condition.

Platform No. 74.—Called “Tahureue”. Has been destroyed, and the fragments of two images lie in the ruins.

Platform No. 75.—Called “Oroi”. Central section 40 feet long, 6 feet wide, and 6 feet high. Extreme length, 140 feet. In a bad condition and no images.

Platform No. 76.—Called “Ahukinokino”. Somewhat smaller than the last, but destitute of all interest.

Platform No. 77.—Called “Papaturei”. A duplicate of the last, and in a demolished condition.

Platform No. 78.—Called “Tutuirā”. A mere mass of ruins, and with no images.

Platform No. 79.—Called “Ue”. Central section 30 feet long, 6 feet wide, 6 feet high. Extreme length, 120 feet. Two images in a bad condition.

Platform No. 80.—Called “Akahanga” (Plate XXXV). Two hundred and fifty feet long, 10 feet wide, and 7 feet high, with no wings.

Thirteen colossal images that once ornamented this remarkable structure have been thrown down and more or less damaged. Their red tufa crowns, also considerably broken, lie near at hand. On the inland facing-wall there is a ground tier of gray volcanic stone finely dressed, and on this is a tier of tufa stones $4\frac{1}{2}$ feet long, $2\frac{1}{2}$ feet high, and 8 inches thick each, and these are covered with hieroglyphics. This is known as the King's platform, and is regarded as one of the most important on the island, on account of the finished work on the structure as well as the numerous sculptures (Fig. 19). The tradition

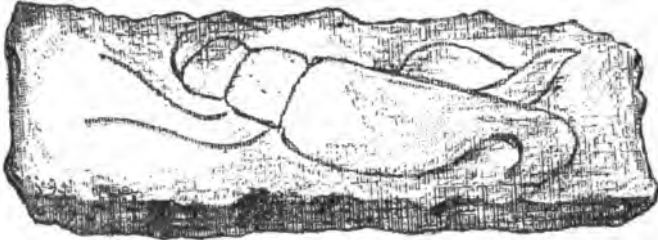

FIG. 19.
SCULPTURED ROCK: KING'S PLATFORM.

asserts that this was the burial place of Hotu-Matua, the first king, and a long line of his descendants. Our excavations in the vicinity produced nothing of interest beyond a few ancient skulls with lower jaws of extraordinary size and width. From the foundation of image-builders' houses we obtained fine stone implements and carving tools.

Platform No. 81.—Called "Harerora". Small and unimportant. One image, much broken.

Platform No. 82.—Called "Motuopope". Central section 252 feet long, 10 feet wide, and 7 feet high. Extreme length, 375 feet. Six images in rather bad condition. This structure is important from the fact that the statues have short ears, the only ones of the kind we found on the island. The sketches will show that on all the platforms, as well as the images in the workshops as those left in an unfinished state were all carved with long ears. Why there was an exception made to the general rule in the images that adorned this structure, could not be determined.

Platform No. 83.—Called "Anaonero". Consisting of foundation stones only, showing that the work was abandoned shortly after being commenced.

Platform No. 84.—Called "Huareva". A mere mass of ruins.

Platform No. 85.—Called "Hoekoe". Has been completely demolished and shows fragments of two large images.

Platform No. 86.—Called "Pakaea". Central section 45 feet long, 8 feet wide, and 7 feet high, with wings extending 250 feet on either side. One image, in a bad condition.

Platform No. 87.—Called “Manumea”. A mere mass of ruins.

Platform No. 88.—Called “Hanga-tee”. Same condition as the last.

Platform No. 89.—Called “Kope-iti”. Only the foundation-stones in place; probably never finished.

Platform No. 90.—Called “Runga-vae”. Same condition as last.

Platform No. 91.—Called “Kote-one”. In same unfinished state.

Platform No. 92.—Called “Renga-havini”. A mere mass of ruins.

Platform No. 93.—Called “Kote-ara-ara”. In a complete state of ruin.

Platform No. 94.—Called “Puepau”. In same condition as the last.

Platform No. 95.—Called “Kiraau”. A shapeless ruin.

Platform No. 96.—Called “Taroe”. Central section 200 feet long, 8 feet wide, and 6½ feet high. Extreme length, 350 feet. Eleven images, all mutilated.

Platform No. 97.—Called “Ariki-iki”. A shapeless ruin.

Platform No. 98.—Called “Kone-iti”. Same condition as the last.

Platform No. 99.—Called “Koturara”. In a very bad condition, with one broken image.

Platform No. 100.—Called “Moturea”. In a state of absolute ruin.

Platform No. 101.—Called “Hanga-paukura”. Shows that it was originally well built, and has six images lying behind it.

Platform No. 102.—In a very bad condition, and the name could not be ascertained.

Platform No. 103.—Called “Mataakira”. A shapeless mass of ruins.

Platform No. 104.—Called “Anokahi”. Similar to the last.

Platform No. 105.—Called “Hanga-hahue”. In a bad condition, but has been an extensive structure with long wings. Four images.

Platform No. 106.—Called “Tehuteaheru”. A mass of ruins.

Platform No. 107.—Called “Ahumeamea”. Small and irregular construction. One image much damaged.

Platform No. 108.—Called “Ahumata-iti”. This structure has been pretty thoroughly demolished and shows the fragments of one image.

Platform No. 109.—Called “Tahiri”. The dimensions of the structure are not great, but it is remarkable on account of the finished workmanship. The sea front is built of immense blocks of hard heavy volcanic rock, smoothly faced and neatly joined together. In places, small stones have been mortised into the larger ones. It is surprising that such results could be produced by the rude stone implements that are known to have been the only tools at the command of the natives. Finished surfaces might be the result of grinding with sand and water, but the joints and fittings could only be accomplished by long and patient labor. Some of the facing-stones were estimated at a weight of upwards of 5 tons. Under the impression that the superior character of the work indicated a platform of more than usual importance, it was thoroughly investigated at the expense of great labor and time. A section of the front wall was thrown down and the stones removed

until an opening was made clear through the structure. No results having been obtained except a knowledge of how the pile was constructed from the foundation up, additional efforts were directed towards the two ends. To our great disappointment, we had nothing to show for the great labor expended upon this platform. The only human remains about the place are those of recent date, in shallow tombs on the rear side of the pile. There is a tradition to the effect that this was the last platform built on the island and was intended for the colossal image (70 feet) lying in the workshops on the west side of the crater of Rana Roraka. The legend asserts that when the work upon the platform and images had arrived at a certain stage, a great feast was held in honor of the event by the powerful tribe of Vinapu. The wife of the chief was of the Tongariki clan and during the ceremonies this "lady" was slighted in the division of "long pig," but whether intentionally or otherwise does not appear. Cannibalism was practiced on the island down to the advent of the first missionaries, and was always an important feature of the ancient feasts. The bodies were roasted in ovens made of hot stones covered with earth, after the manner practiced all through Polynesia, and certain portions were awarded to prominent individuals. Upon this particular occasion the rib-roast, "tenderloin" steak, or whatever the favorite morsel was which belonged to the aforesaid female by reason of her rank, was given to another. The insulted individual immediately sought the protection of her own clan, who arose *en masse* to vindicate the Tongariki honor. Long and bloody wars followed. Image-builders and platform-makers were drawn into the conflict from all parts of the island and, in a spirit of revenge, platforms were destroyed and images thrown down whenever opportunity offered. This is believed to have been the origin of the trouble which has laid waste the extraordinary works of this island.

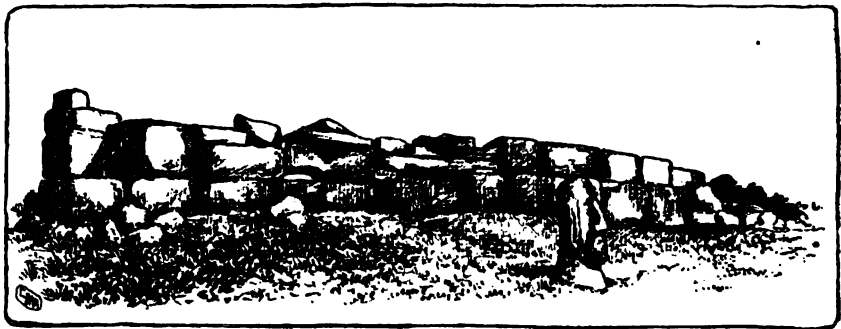

FIG. 20.
PLATFORM 110. "VINAPU."

Platform No. 110.—Called "Vinapu" (Fig. 20). A large structure with six mutilated images, and of the same general character and appearance as those already described. Immediately behind this platform a wall of earth incloses a piece of ground about 225 feet in

diameter and circular in shape. This is believed to have been the theater of the native ceremonies, and perhaps the spot where the feasts were held. We made excavations in the center and around the sides, but without a "find."

Platform No. 111.—Called "Ahutupai." Has been pretty thoroughly demolished. Six images in a bad condition lie on the top of the pile.

Platform No. 112.—Called "Ahurikiriki." Situated on the extreme southwestern end of the island, and remarkable from its position on the face of a perpendicular cliff nearly 1,000 feet high and midway between the sea and the top. Sixteen small images are lying on this platform and many of them seem to be in excellent condition. We could find no way of reaching the narrow ledge upon which this platform stands. No road leads down from the top; it can not be approached from either side, and from below it is a straight up and down wall against which the sea dashes continually. It is hardly probable that the images were lowered from the top by ropes, and the natural conclusion is, that a roadway once existed, which has been undermined by the waves and has fallen into the sea.

Platform No. 113.—Called "Kaokaoe." This was originally a large structure, but has been completely demolished by Mr. Brander to obtain material for the construction of stone-fences about his place.

LANGUAGE.

The principal feature of interest, connected with Easter Island, is the written language by which the ancient traditions and legends were perpetuated. The existence of the incised tablets was not known until the missionaries settled upon the island. Numerous specimens were found in the possession of the natives, but no especial attention appears to have been directed towards them. Several persons, belonging to vessels that were wrecked at Easter Island, report having seen these tablets, but they were so highly prized by the natives, that they could not be induced to part with them. The three hundred islanders who emigrated to Tahiti had in their possession a number of these tablets; they created some attention on account of the remarkable skill with which the figures were executed, but they were highly prized by the owners and no effort was made to secure them because their real value was not discovered. The Chilian corvette *O'Higgins* visited Easter Island in January, 1870, and Captain Gana secured three tablets, two of which are on deposit in the national museum at Santiago de Chili and the third was sent to France, but does not appear to have reached its destination. Paper impressions and casts were taken from the Chilian tablets for the various museums of Europe. Those sent to the English Ethnological Society created some interest after a time, but others sent to Berlin were regarded as stamps for marking native cloth (Mittheilungen, July, 1871). Seven of these tablets are now in the possession of Tepano Jansser, bishop of Axieri, all in excellent state of preservation.

While the *Mohican* was at Tahiti, the bishop kindly permitted us to examine these tablets and take photographs of them. These tablets were obtained from the missionaries who had been stationed on Easter Island, and they ranged in size from $5\frac{1}{2}$ inches in length by 4 inches broad, to $5\frac{1}{2}$ feet in length and 7 inches wide. Diligent search was made for specimens of these tablets during our visit to Easter Island. At first the natives denied having any, but Mr. Salmon knew of the existence of two, and these were finally purchased after a great deal of trouble and at considerable expense. The tablets obtained are in a fair state of preservation. The large one is a piece of drift-wood that from its peculiar shape is supposed to have been used as a portion of a canoe. The other is made of the toromiro wood indigenous to the island. In explanation of the disappearance of these tablets, the natives stated that the missionaries had ordered all that could be found to be burned, with a view to destroying the ancient records, and getting rid of everything that would have a tendency to attach them to their heathenism, and prevent their thorough conversion to Christianity. The loss to the science of philology by this destruction of valuable relics is too great to be estimated. The native traditions in regard to the incised tablets simply assert that Hotu-Matua, the first king, possessed the knowledge of this written language, and brought with him to the island sixty-seven tablets containing allegories, traditions, genealogical tables, and proverbs relating to the land from which he had migrated. A knowledge of the written characters was confined to the royal family, the chiefs of the six districts into which the island was divided, sons of those chiefs, and certain priests or teachers, but the people were assembled at Anekena Bay once each year to hear all of the tablets read. The feast of the tablets was regarded as their most important fête day, and not even war was allowed to interfere with it.

The combination of circumstances that caused the sudden arrest of image-making, and resulted in the abandonment of all such work on the island, never to be again revived, may have had its effect upon the art of writing. The tablets that have been found in the best stage of preservation would correspond very nearly with the age of the unfinished images in the workshops. The ability to read the characters may have continued until 1864, when the Peruvian slavers captured a large number of the inhabitants, and among those kidnapped, were all of the officials and persons in authority. After this outrage, the traditions, etc., embraced by the tablets, seem to have been repeated on particular occasions, but the value of the characters was not understood and was lost to the natives. A man called Ure Vaeiko, one of the patriarchs of the island, professes to have been under instructions in the art of hieroglyphic reading at the time of the Peruvian visit, and claims to understand most of the characters. Negotiations were opened with him for a translation of the two tablets purchased; but he declined to furnish any information, on the ground that it had been forbidden by the priests. Presents of money and



OBVERSE OF EASTER ISLAND TABLET, "APAI."
(Original in possession of Bishop of Axtiert.)





REVERSE OF EASTER ISLAND TABLET, "APAI."
(Original in possession of Bishop of Axiari.)

valuables were sent him from time to time, but he invariably replied to all overtures that he was now old and feeble and had but a short time to live, and declined most positively to ruin his chances for salvation by doing what his Christian instructors had forbidden. Finally the old fellow, to avoid temptation, took to the hills with the determination to remain in hiding until after the departure of the *Mohican*. It was a matter of the utmost importance that the subject should be thoroughly investigated before leaving the island, and unscrupulous strategy was the only resource after fair means had failed. Just before sundown one evening, shortly before the day appointed for our sailing, heavy clouds rolled up from the southwest and indications pointed to bad weather. In a heavy down-pour of rain we crossed the island from Vinapu to Mataverí with Mr. Salmon, and found, as had been expected, that old Ure Vaeiko had sought the shelter of his own home on this rough night. He was asleep when we entered and took charge of the establishment. When he found escape impossible he became sullen, and refused to look at or touch a tablet. As a compromise it was proposed that he should relate some of the ancient traditions. This was readily acceded to, because the opportunity of relating the legends to an interested audience did not often occur, and the positive pleasure to be derived from such an occasion could not be neglected. During the recital certain stimulants that had been provided for such an emergency were produced, and though not pressed upon our ancient friend, were kept prominently before him until, as the night grew old and the narrator weary, he was included as the "cup that cheers" made its occasional rounds. A judicious indulgence in present comforts dispelled all fears in regard to the future state, and at an auspicious moment the photographs of the tablets owned by the bishop were produced for inspection. Old Ure Vaeiko had never seen a photograph before, and was surprised to find how faithfully they reproduced the tablets which he had known in his young days. A tablet would have met with opposition, but no objection could be urged against a photograph, especially something possessed by the good bishop, whom he had been instructed to reverence. The photographs were recognized immediately, and the appropriate legend related with fluency and without hesitation from beginning to end. The story of all the tablets of which we had a knowledge was finally obtained, the words of the native being written down by Mr. Salmon as they were uttered, and afterwards translated into English.

A casual glance at the Easter Island tablets is sufficient to note the fact that they differ materially from other kyriologic writings. The pictorial symbols are engraved in regular lines on depressed channels, separated by slight ridges intended to protect the hieroglyphics from injury by rubbing. In some cases the characters are smaller, and the tablets contain a greater number of lines, but in all cases the hieroglyphics are incised and cover both sides as well as the beveled edges and hollows of the board upon which they are engraved. The symbols

on each line are alternately reversed; those on the first stand upright, and those on the next line are upside down, and so on by regular alternation.

This unique plan makes it necessary for the reader to turn the tablet and change its position at the end of every line; by this means the characters will be found to follow in regular procession. The reading should commence at the lower left-hand corner, on the particular side that will bring the figures erect, and followed as the characters face in the procession, turning the tablet at the end of each line, as indicated. Arriving at the top of the first face, the reading is continued over the edge to the nearest line, at the top of the other side, and the descent continues in the same manner until the end is reached. The Boustrophedon method is supposed to have been adopted in order to avoid the possibility of missing a line of hieroglyphics.

Ure Vaeiko's fluent interpretation of the tablet was not interrupted, though it became evident that he was not actually reading the characters. It was noticed that the shifting of position did not accord with the number of symbols on the lines, and afterwards when the photograph of another tablet was substituted, the same story was continued without the change being discovered. The old fellow was quite discomposed when charged with fraud at the close of an all-night session, and at first maintained that the characters were all understood, but he could not give the signification of hieroglyphics copied indiscriminately from tablets already marked. He explained at great length that the actual value and significance of the symbols had been forgotten, but the tablets were recognized by unmistakable features and the interpretation of them was beyond question; just as a person might recognize a book in a foreign language and be perfectly sure of the contents without being able to actually read it.

Beyond doubt certain legends are ascribed to particular tablets, all of which are named, and a reference to those names will recall the appropriate story from those who do not profess to understand the hieroglyphics. An old man called Kaitae, who claims relationship to the last king, Maurata, afterwards recognized several of the tablets from the photographs and related the same story exactly as that given previously by Ure Vaeiko.

The writing is composed of pictorial symbols carrying their signification in the image they represent. The execution would be a creditable production with the assistance of the best etching tools, and is a truly wonderful result of patience and industry to be accomplished by means of obsidian points. The minute size of the hieroglyphics made it impossible to convey anything more than the general appearance of the objects delineated, but the figures may be recognized by their form in the outline drawing after the manner of some of the Egyptian hieroglyphics. The study of the tablets is chiefly difficult on account of the way in which actual objects are conventionally treated, and in order to

preserve symmetry and effect, men, canoes, fish, etc., are represented of the same size throughout the lines.

A careful study of the hieroglyphics of Easter Island is being made with the hope that valuable information may be obtained in regard to the early history and origin of the people. Results of an extremely interesting nature are barely outlined at present and not in shape to be presented herewith. It is not considered expedient to attempt an explanation of the symbols until the subject can be treated exhaustively. As an example of the ideographic character of the signs, the tablet containing the genealogical tables shows a frequent repetition of the symbol of the great spirit Meke-Meke in connection with that of the female vulva. The signification is the birth of a person. The position of the figures shows whether the child was the result of marriage, or intrigue, and the following figures indicate the date of the birth, the seasons and the approximate time. An important feature, in connection with the tablets, is the fact that forms have been discovered which have no types on Easter Island, and which may lead to an identification of the locality from whence the first settlers migrated. The hieroglyphics include, besides the representation of actual objects, figures used by the chiefs, and each clan had its distinctive mark. Samples are given in different treaties made with the islanders of the sign-manual of some of the chiefs. (See Plates XXXVI-XLIX.)

TRANSLATION OF EASTER ISLAND TABLETS.

APAI.

(Plates XXXVI and XXXVII.)

Timo te kakaha piki apai te roria aruki e tangata Mohonákuta mōhonga matangi eri apai ia ra Techo i te ika mahoi rua matangi apai tirori mahoi rua matangi tahoi te tūa tahoi hakavirri ia tapui rurenga tahri te ika tahoi te ata e tau ira tau na mimi hara rau kina ata rangi no no tupa kan k maka reva atea e tau ira matuku hara atarungi no no tapairu renga ava ki hoato.

Houa kata-kata hura matini rau hanga tamaru kia tun ama tavake toto tunmakeuka tantan mea te kura. Ki hi hongā te kura e aku tapaini kari mao aku hoa-hoa tae kote kura mata ki rei aaku tapa iru nei kairi mai aku hora-hora tae kote kura.

Mata ki rei mata ku haka iri marai matairi maru matai maru ka irira tapui rei tapui ranga muku kiri mai aku hoa-hoa tae kote kura. Mata ki rei mata ku haka iri maru matai maru matai rara ku uira tapui rei tapui rei tapu ranga muku kāiri mai aku hora-hora kapainga mai. E. tangaroa te mare kura hapai e haka ihi mo topa rei kura taku tapo rei huu atu arua tae haath rangi ura rangi hara-tua oaku matua oaku ma teuga otae ahiri noa ranga ki te rangi no te munniri a rua hiru te hetu takiri ko mumu ana kia kake mao-mao ake. Haka tau Era a Nuku te atua. Atara kahiria a uka hopua. Tun haka maua kura. Tun te ha hei kura. Tun te tieuitairi kura. Tun te matangi e ria a mangaro.

Tun tahake oi taura te herunga taku ohu tutuhinga tanku mato kapi-piri te hetun tan aranga noi ruga vake noi runga.

Maruaua ha heire mana mahahine mauaira taake. Te herunga taku oho te tuhinga taku mata mata ka pipiri te hetu tau avanga no iringa vake-vake. No iri uga vake rei manana halinie E te mai ran o tun e katan, râ, ka piapiri râ e te maraloturi e kakapura e kahakpiri e kaho-notake mate aa tapu onote ariiki no Manana hahiue no Mananatake a niramai te rangi kai a ku ia umika uri te hainu tokotokona to rau e nui a tapu te tai nate ariiki. E. hopu a ia e tapu te tai no te tapa iru e kore kaukau â ia haharua tau kapa tau kaiugoh i te an mata heuna, mariunga te hou i te an mataheune mariunga te houga ma tau arapeka hoa mai ia keho iti hiti aura hiti apauoko hue taka haahaarua tau kape tau hai ugoto piria tamu ara te uaua na Heke i kai te hunue kura te nahoapu, pue hatataka i te an mata mo tara haieka i te peka akatau o mirunga te hounga mo tara haieka. Panga tiorei nuku horo papa tara naeaki i te pou tuu. Panga te orei nuku horo papa hoake mataue uake tahau te nauai e oho te nauai e rai te nauau nauai kino noho avava tauake te kete irnuga te niu ei ia hoa ko ni ni ei ia hoa o Rionou tona koake matone uake te nauai e oho te nauai e rai te nauai nauai nauai kino nobi ava ava taua kate kete iringa te niu haamatua nauai kino katangi te moko-moko uri katangi te moko-moko tea kohao kopi-pi-rienta moko-moko uri ua moko-moko tea takaia rangi kakae hoki i te atua. Mohao haruru vai e kahihinga ma te tougakapitia rangi moko-moko uri moko moko tea kohao kopiri e atua mamairi kauaha itu atimo eae aruarua vori kahihina mo te Tonga kahuhinga ma te Tonga nui kahinga i tongarou kapitia rangi moko moko uri moko-moko tea pruhou kauaha uri korueiha Hangaroa a Timeo eae e te Raki ete roroe taua erua aaku manu.

Hakarongo noa i te reo o te moa e vai-vai mahau ia ure roroi renga aha iho nei e te ahiue ariikie onku ika na kio i varimariaria hopue hara koe e rara a eau i te taura hiku raverave a hiro kai te teri hepo e tao koe hoki uapa te ingoa taua ika ko mumu maranga ugaiatu ko pephu ko pepetangi. ko pepetangi taravi tavi. ko pepetangi tava taravi tava e hakanui koe ki te ehu koe ki te kapua. Tun hitu hare ka more koe kapai tue.

ENGLISH TRANSLATION OF APAI TRADITION.

Mohouakuta, the chief of a powerful clan, when about to make war to revenge the death of one of his relatives, who had been killed by treachery, summoned Timo, the builder of fowl-houses, and ordered him to construct on the windward side of the house of Techo, the fisherman, a fowl-house of one hundred crescent-shaped stakes. It was ordered that of the fowls captured in the war those with long tail-feathers, and the white ones, should be reserved and sent to this house for safe-keeping.

The warriors of the clan assembled promptly at the council-fire with

their faces brilliantly painted and wearing their distinctive shell necklaces.

The solemn ceremonies, attendant upon the declaration of war, were performed by the assembled braves, in accordance with the ancient customs handed down by their forefathers. Obeisance was first made to the sky, each warrior repeating the prayer, "May we be killed in battle if we neglect to worship the Great Spirit." The ceremonies concluded with obeisance to the god of feathers, each warrior wearing the feather-hat of his clan—Era Nuku, the god of feathers, whose costume consists of feathers for the head, feathers for the neck, and feathers to be waved by the wind. He who brings good luck when feathers are worn that are tied by a string of hair. He who protects the yams and potato plantations when feathers are tied upon a stick, and placed close together between the hills. He who keeps off the evil spirit when feathers are planted over the burial-places.

The god of feathers, whose wife is Manana. Manana Take came from the skies. She once visited the land in the shape of a fish, which was captured and given to the king on account of its size and beauty. Recognizing the divine nature of the fish, the king was thereafter debarred from swimming in the sea.

(The next hieroglyphics on the tablet are supposed to have been written in some ancient language, the key to which has long ago been lost. After this unknown section the translation is continued as follows):

When the island was first created and became known to our forefathers, the land was crossed with roads beautifully paved with flat stones. The stones were laid close together so artistically that no rough edges were exposed. Coffee-trees were growing close together along the borders of the road, that met overhead, and the branches were laced together like muscles. Heke was the builder of these roads, and it was he, who sat in the place of honor in the middle where the roads branched away in every direction. These roads were cunningly contrived to represent the plan of the web of the gray and black-pointed spider, and no man could discover the beginning or the end thereof.

(Here again are some sections of the tablet written in the characters that are not understood, after which the following translation is made:)

In that happy land, that beautiful land where Romaha formerly lived with his beloved Hangaroa, and where Turaki used to listen to the voice of the fowl, and feed them with watery food. In that beautiful land that was governed by gods from heaven, and who lived in the water when it was cold. Where the black and white-pointed spider would have mounted to heaven, but was prevented by the bitterness of the cold.

Where is our ancient queen? It is known that she was transformed into a fish that was finally caught in the still waters. A fish that had to be tied by the rope of Heros to be captured. Away, away, if you can not name the fish. That lovely fish with the short gills that was brought for food to our Great King, and was laid upon a dish that rocked this way and that. The same that afterwards formed the corner of the stone walk that led to the house of the Great Chief.

TRANSLATION OF THE EASTER ISLAND TABLETS.

ATUA MATARIRI.

(Plates XXXVIII and XXXIX.)

Atua Matariri; Ki ai Kiroto, Kia Taporo, Kapu te Poporo.
Ahimahima Marao; Ki ai Kiroto, Takibi Tupufema, Kapu te Kihikehi.

Aoevai; Ki ai Kiroto, Kava Kohe Koe Kapu te Koe.

Matua anua; Ki ai Kiroto, Kappipiri Haitau, Kapu te Miro.

Angingieai; Ki ai Kiroto, Kia Humutoti, Kapu te Maluta.

Hiti; Ki ai Kiroto, Kia Heta Kapu te Ti.

Atura; Ki ai Kiroto, Katei, Kapu te Monku Uta.

Ahan; Ki ai Kiroto, Vava, Kapu te Tureme.

Ahekai; Ki ai Kiroto, Hepeue, Kapu te Mataa.

Viri Koue; Ki ai Kiroto, Ariugarehe Urubarero, Kapu te Runa.

Atua Metua; Ki ai Kiroto, Kariritunarai, Kapu te Niu.

Atua Metua; Ki ai Kiroto, Kite Vuhi o Atua, Kapu te Toromiro.

Atua Metua; Ki ai Kiroto, Tapuhavaoatua, Kapu te Moana.

A Heuru; Ki ai Kiroto, Hetomu, Kapu te Marikuru.

A Taveke; Ki ai Kiroto, Pouhutuhututerevaimangaro, Kapu te Veke.

A Hahamea; Ki ai Kiroto, Hohio Kapu te Takure.

Aukia Ki ai Kiroto; Moremanga, Kapu te Ngarava.

Avia Moko; Ki ai Kiroto, Viatea, Kapu te Kena.

Tereheue; Ki ai Kiroto, Viaraupa, Kapu te Kaupa.

A Heroe; Ki ai Kiroto, Unhipura, Mapu te Ro.

Tahatoi; Ki ai Kiroto, Kateapiairororo, Kapu te To.

Irapupue; Ki ai Kiroto, Irakaka, Kapu te Pia.

Mangeongeoe; Ki ai Kiroto, Herakiraki Kapu te Kape.

A Hen; Ki ai Kiroto Pana Kapu te Hue.

Heima; Ki ai Kiroto Kairui Kairui-Hakamarui Kapu te Raa.

Huruan; Ki ai Kiroto Hiuaioi Kapu te Moa.

A Hikua; Ki ai Kiroto Hiuaioi Kapu te Uruara.

Tingahae; Ki ai Kiroto Parararahikutea Kapu te Niuki.

A Hikue; Ki ai Kiroto Hiuaioi Kapu te Tabraha.



OBVERSE OF EASTER ISLAND WOODEN TABLET, "A TUA MATARIRI."
U. S. N. M. Easter Island. Collected and deposited by Paymaster W. J. Thomson, U. S. N.)



REVERSE OF EASTER ISLAND WOODEN TABLET, "ATUA MATARIRI."
(Cat. No. 12973, U. S. N. M. Easter Island. Collected and deposited by Paymaster W. J. Thomson, U. S. N.)

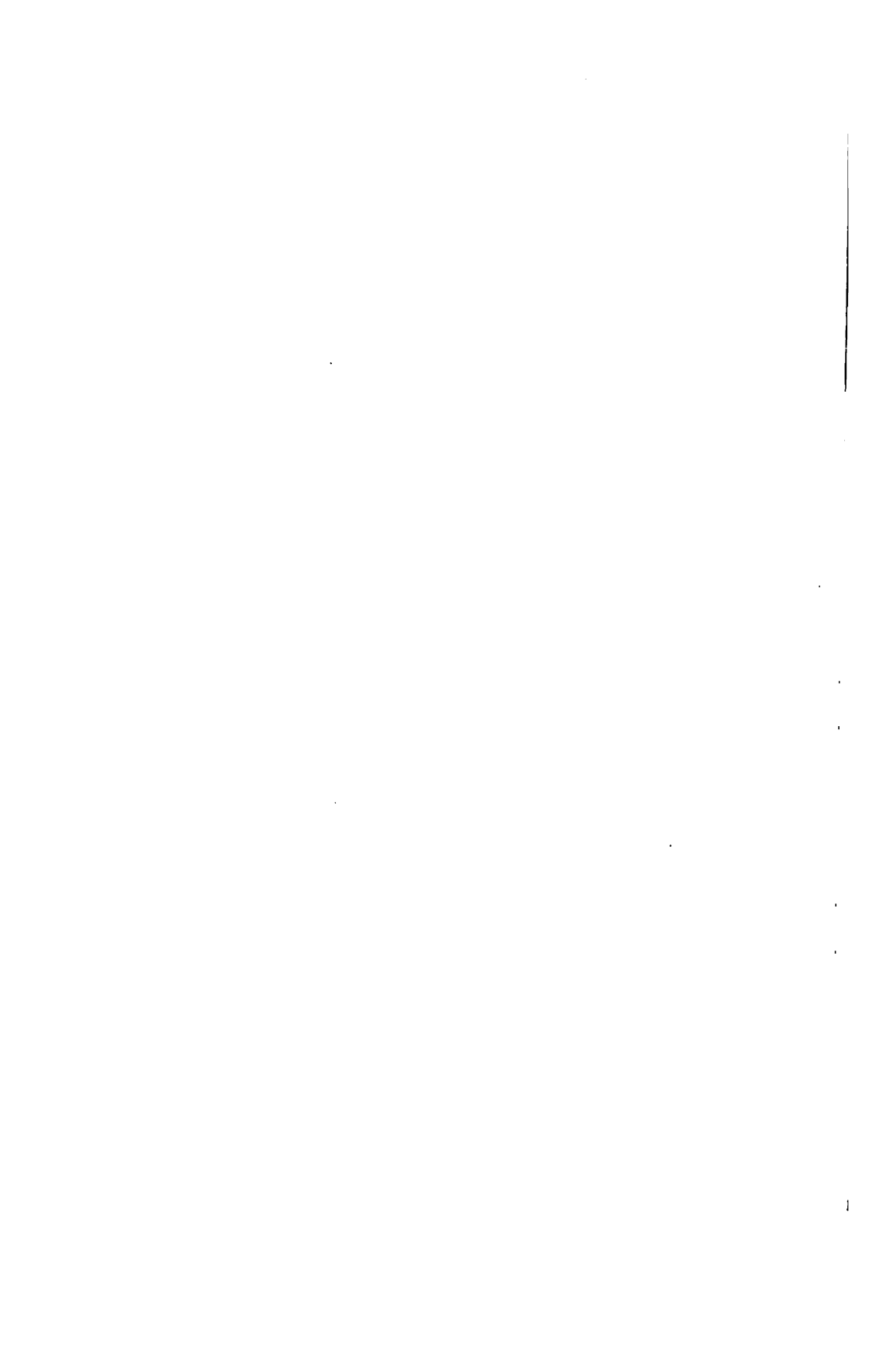

Tikitehatu: Ki ai Kiroto Hibohihokiteturu Kapu te Paroko.

Tikitehatu: Ki ai Kiroto Hiuapopoia Kapu te Hiuakuhara.

Tikitehatu: Ki ai Kiroto Maea Kapu te Heraherakitomea.

Tikitehatu: Ki ai Kiroto Rurutikitehatu Kapu te Teririkatea.

Atimoteræ: mea a mura i hiki te alu mo tannu o te ita. mo hangai ite ariiki.

Takoua: Ki ai Kiroto Tukouo, Kapu te Poopoo.

E. Toto te Efi no Kino no naroko no ngaoreno no nga tokutoko ruapapa.

Epuoko te nuika no tupa iti no tupa nui.

Uku Ki ai Kiroto, Karori Kapu te Ngaatu.

Kuhikia Ki ai Kiroto Taurari Kapu te Ngaatu.

Kuhikia Ki ai Kiroto Ruperoa Kapu to Turi.

Taaria Ki ai Kiroto Taaria, Kapu te Tauehu.

Haiuge Ki ai Kiroto hatukuti, Kapu te Evea.

Pauaroroko Ki ai Kiroto Hakukuti, Kapu te Taerongovetave.

Hiiitirerire Ki ai Kiroto Kanohotatataporo Kapu te Boporo.

Numia a Tangaire Turuhirohero te toto o te o korare.

Kamanu te Korare taratara te Korare.

Turuki te Ua Maanau Manavai roa.

Kaunuku raituahea auakihorou eaa e to e tua tanu to tana moko eaha Uaugai e to e ufi e Kumara.

ENGLISH TRANSLATION OF THE ABOVE TABLET.

EASTER ISLAND TRADITION.

The origin of inanimate things is believed to be the result of the marriage of certain gods and goddesses in accordance with the following table.

God Atua Matariri and goddess Taporo produced thistle.

God Ahimahima Marao and goddess Takihi Tupufema produced rocks.

God Aoevai and goddess Kava Kohekoe produced medicine.

God Matua anua and goddess Kappipiri Aaitau produced the Miro tree.

God Angingieai and goddess Kia Humutoti produced the paper-mulberry tree.

God Hiti and goddess Kia heta produced the tea plant.

God Atura and goddess Katei produced bunch grass.

God Ahen and goddess Vana produced fine grass.

God Agekai and goddess Hepene produced obsidian.

God Viri Koue and goddess Ariugarehe Uruharero produced the morning-glory plant.

God Atua Metua and goddess Kariritunaria produced cocoanuts.

God Atua Metua and goddess Ki te Vuhi o Atua produced the toro-miro tree.

God Atua Metua and goddess Tapuhavaoatua produced Hibiscus.

God A Heuru and goddess Hetomu produced the blue leaf plant.

God A Taveke and goddess Pouhutihututerevaimangaro, produced the white ash.

God A Hahamea and goddess Hohio produced flies.

God Aukia and goddess Moremanga produced roaches.

God A Via Moko and goddess Viatea produced boobies.

God Tereheue and goddess Viaraupa produced leaves.

God A Heroe and goddess Unhipura produced ants.

God Tahatoi and goddess Kateapiairororo produced sugar-cane.

God Irapupue and goddess Irakaka produced arrowroot.

God Mangeonge and goddess Herakiraki produced yams.

God Ahen and goddess Pana produced calabash.

God Heima and goddess Kairui-hakamarui produced stars.

God Huruan and goddess Hinaoioi produced fowls.

God A Hikua and goddess Hinaoioi produced vermilion.

God Tingahae and goddess Pararahikutea produced sharks.

God A Hikue and goddess Hinaoioi produced porpoise.

God Tikitehatu and goddess Hihohihokiteturu produced rock-fish.

God Tikitehatu and goddess Hinapopoi produced life.

God Tikitehatu and goddess Maea produced luck.

God Tikitehatu and goddess Rurutikitehatu produced man.

Atimoterae created brook-fish and established them as the chosen food of the gods.

God Takoua and goddess Tukouo produced milk-thistle.

E Toto discovered the sweet taste of the yam and made it the principal food of the people.

Epuoko created the delicious banana food for the kings.

God Uku and goddess Karori produced bullrushes.

God Kuhikia and goddess Taurari produced small birds.

God Kuhikia and goddess Ruperoa produced sea-gulls.

God Taaria and goddess Taaria produced white gulls.

God Haiuge and goddess Hatukuti produced wind.

God Pauaroroko and goddess Hakukuti produced pain.

God Hinitirerire and goddess Kanohotatataporo produced creeping vines.

Numia a Tangaire Turuhirohero was the founder of all things unpleasant and bad smells.

Turuki was the first builder of rock fences and barriers.

Kuanuku created death by drowning, death in warfare, death by accident, and death by disease.

TRANSLATION OF EASTER ISLAND TABLETS.

EAHA TO RAN ARIIKI KETE.

(Plates XL and XLI.)

1. Eaha to ran ariiki kete mahua i uta nei ?
E tupu tomo a mata mea e rangi ran e tuatea to ran ariiki kete mahua i uta nei.
Ane rato mani rata karata te tuatea, karata te rangi ran karata te tupua.
2. Eaha to ran ariiki kete mahua i uta nei ?
E ura e poopoo e koiro e nohoe e to ran ariiki kete mahua i uta nei.
Ane rato mani rata karata te ura ki kara te poopoo e nehe e riku e kava-kava atu.
3. Eaha to ran ariiki kete mahua i uta nei ?
E nehe e riku e kava atua to ran ariiki kete mahua i uta nei.
Ane rato mani rata karata te nehe karata riku karata rain kava atua.
4. Eaha to ran ariiki kete mahua i uta nei ?
E a hao nei e kahi e atu e ature.
Ane rato mani rata karata te kahi kaharta ahi rarata te ature ane rato.
5. Eaha to ran ariiki kete mahua i uta nei ?
E ufi e tra e kumaro to ran ariiki mahua i uta nei.
Ane rato karata te ufi kumara toa e mahua i uta nei, ane rato maru.
6. Eaha to ran ariiki kete mahua i uta nei ?
E honu e kea e pane te ran ariiki kete mahua i uta nei.
Ane rato karata te honu te kea te pane.
7. Eaha to ran ariiki kete mahua i uta nei ?
E hetu e range e han e na e raa e mahua te ran ariiki kete mahua i irunga nei.
Ane rato karata te rangi e hon e na e raa e mahua.
8. Eaha to ran ariiki kete mahua i uta nei ?
E anuga nei karata te hehun rangi han na raa mahua.
Ane rato karata te hehuu rangi han na raa mahua.
9. Eaha to ran ariiki kete mahua i uta nei ?
E ariiki e tapairu to ran ariiki kete i mahua i mua nei.
Ane rato karata to ariiki te tapairu.
10. Eaha to ran ariiki kete mahua i uta nei ?
E oi e potupotu e ugarara e hata to ran ariiki kete mahua i uta nei.
Ane rato karata main rata e oi e potupotu e ugarara e hata to ran ariiki kete mahua i uta nei.

ENGLISH TRANSLATION OF TABLET.

EASTER ISLAND ANTHEM.

What power has the Great King on the land ?
He has power to make the plants grow and to change the sky to different colors.
All hail the power of the Great King who makes us lenient to the

young plants, to admire the skies of different colors, and to behold the clouds that rise.

What power has the Great King on the land ?

He has the power to create the lobsters, white-bait, eels, ape-fish, and everything in the sea.

All hail the power of the Great King who gives us the knowledge of how to catch the lobsters, white-bait, eels, ape-fish, and all marine animals.

What power has the Great King on the land ?

He has the power to produce the ferns, creeping plants, grass, bushes, and all vegetation.

All hail the power of the Great King who has taught us to love the ferns, creeping plants, and all green things.

What power has the Great King over the sea ?

He has the power to create the mighty fish that swim in the deep water.

All hail the power of the Great King who has given us the strength and skill to catch the fish of the mighty deep.

What power has the Great King on the land ?

He has the power to produce the yams, potatoes, and sugar-cane.

All hail the power of the Great King who enables us to use as food yams, potatoes, and sugar-cane.

What power has the Great King on the land ?

He has the power to clothe the turtles in hard shell, the fish with scales, and protects every living thing.

All hail the power of the Great King who enables us to overcome the defense of the turtles, fish, and all reptiles.

What power has the Great King in the universe ?

He has the power to create the stars, the clouds, the dew, the rain, the sun, and the moon.

All hail the power of the Great King who enables us to appreciate the blessings of the bright stars, the lowering clouds, the gentle dew, the falling rain, and the light of the sun and moon.

What power has the Great King upon the land ?

He has the power to populate the earth, to create both kings and subjects.

All hail the power of the Great King who has created the human beings, given authority to kings, and created loyal subjects.

What power has the Great King upon the land ?

He has the power to create maggots, flies, worms, fleas, and all creeping and flying insects.

All hail the power of the Great King who enables us to withstand the attacks of the maggots, flies, worms, fleas, and all manner of insects.

What power has the Great King ?

All hail the unlimited power of the Great King.



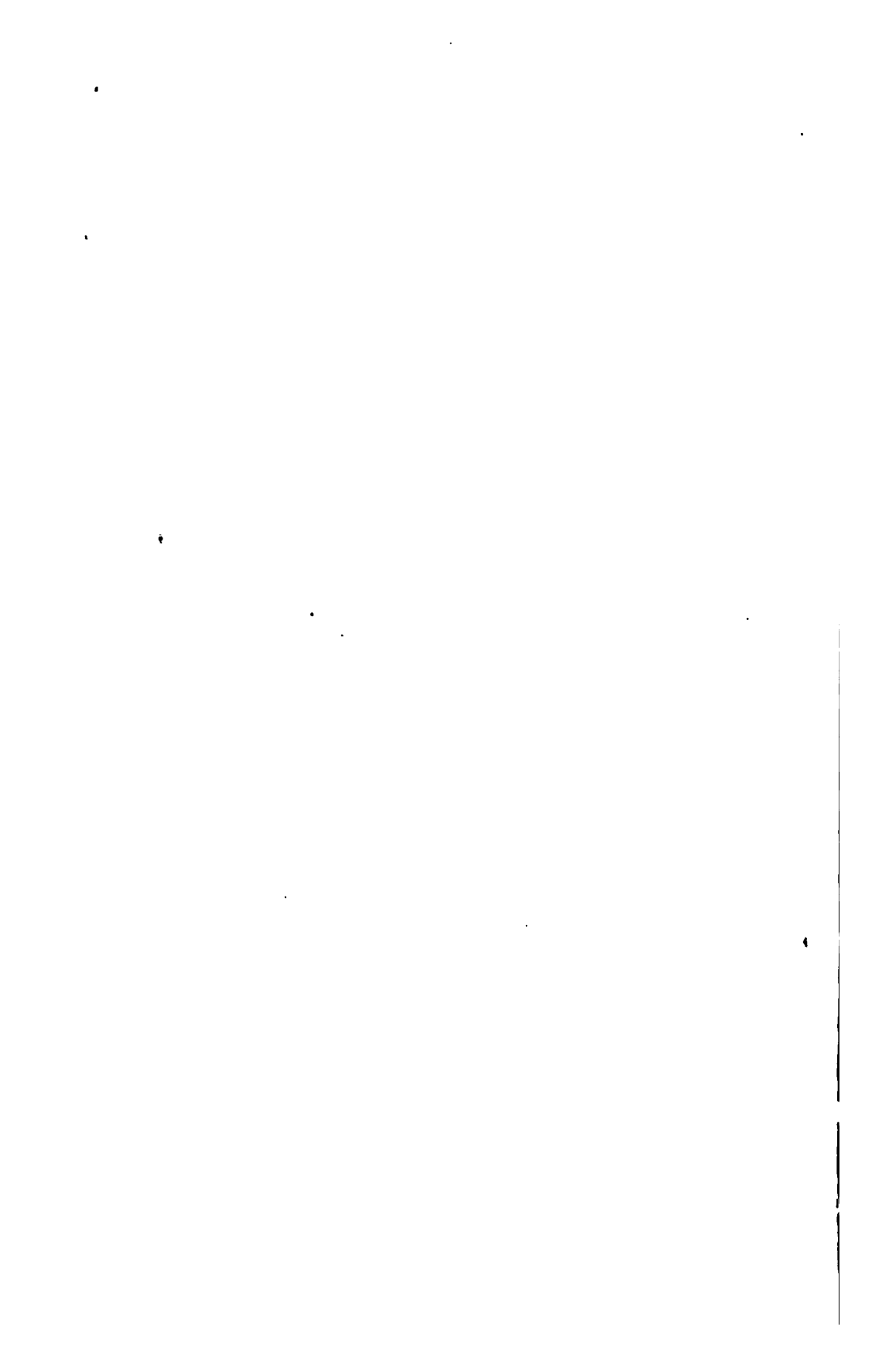

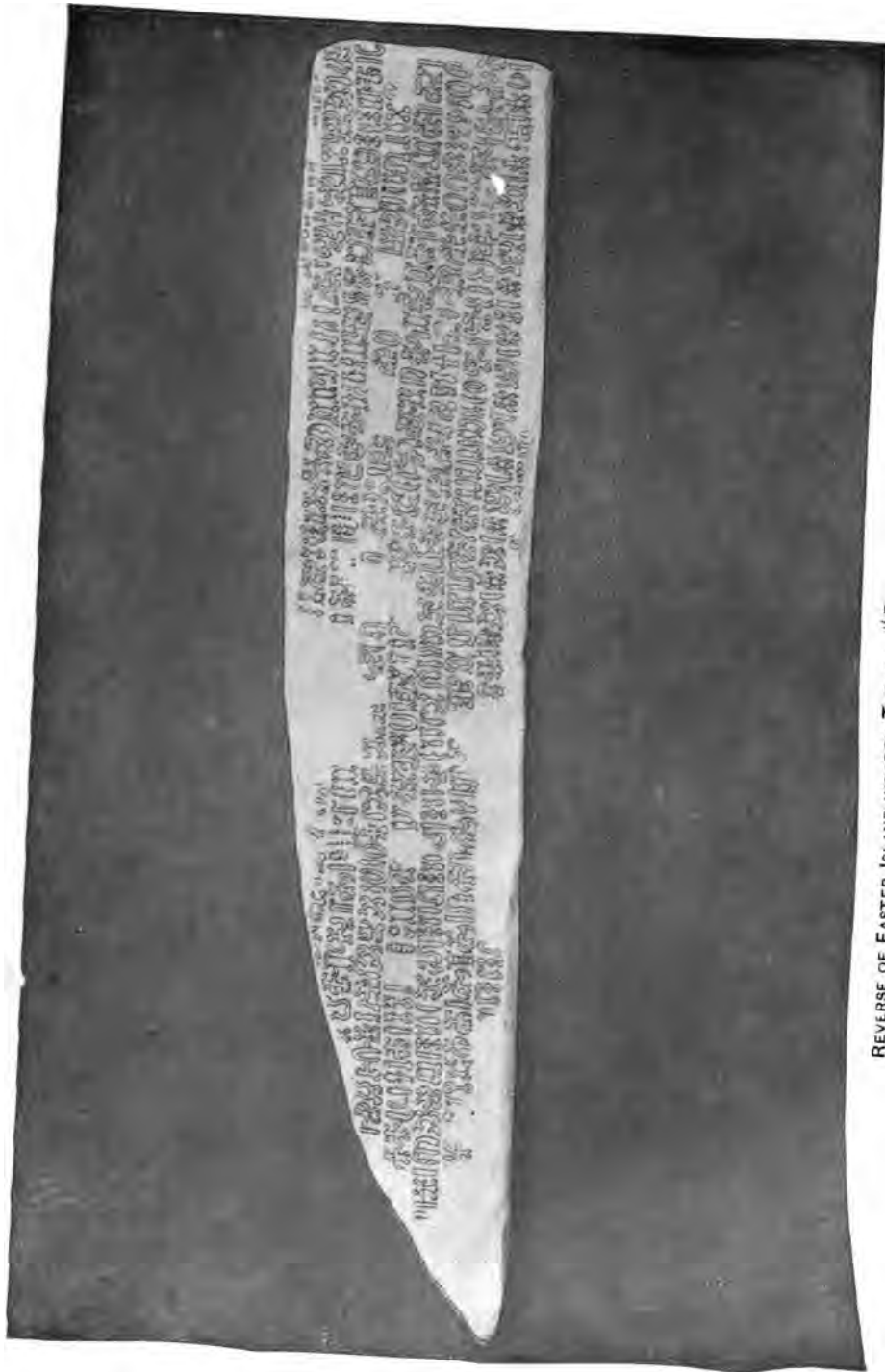

REVERSE OF EASTER ISLAND WOODEN TABLET. "EAHA TO RAN ARIKI KETE."
(Cat. No. 120774, U. S. N. M. Easter Island. Collected and deposited by Paymaster W. J. Thomson, U. S. N.)

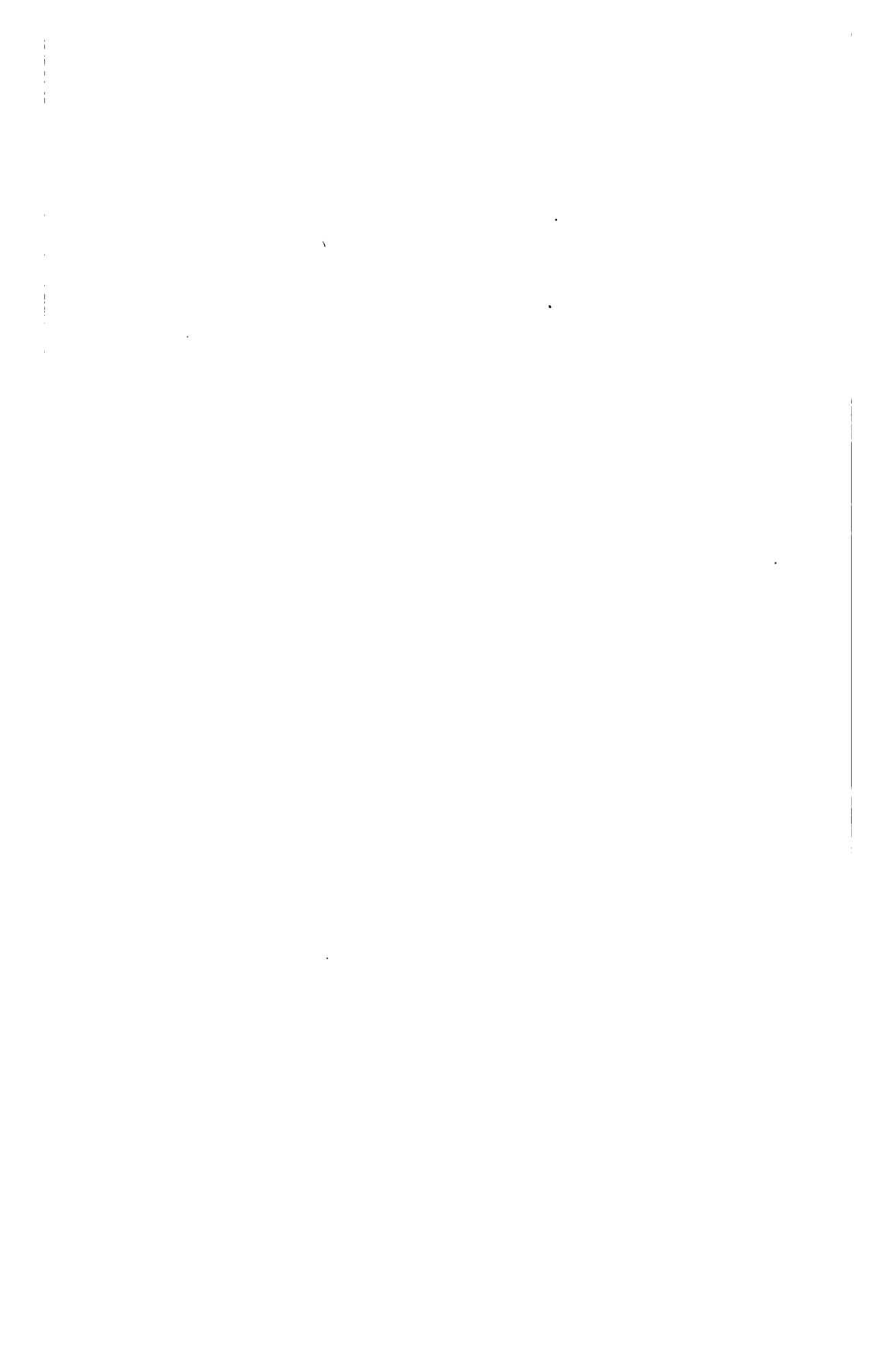

TRANSLATION OF EASTER ISLAND TABLETS.

FATHER MOURNING THE LOSS OF HIS CHILD.

(Plates XLII and XLIII.)

Ka ihi uiga — te ki ati —
 Auwe te poki, e —
 Ite maki tana — Rii te hiva ina.
 Ka ihi uiga — mai.

2.

Ka ihi uiga — te ki ati —
 Auwe te poki, e —
 Ite maki tana — Honiti ina.
 Ka ihi uiga — moa mai.

3.

Ha imn, — poki — e —;
 Ta auwe rai — e;
 Viviri rai, inage — o;
 I — ruga — i;
 Te papare hinua
 Viviri rai — inage — o!

4.

Haki — e!
 Avahinua — ki tagu atu.
 Auwe poki — e!
 Ava rai —
 Ava mata — Ina hiva
 Auwe poki — e!
 Ite renia o parapa moni
 Auwe poki — e!

This is an old song, supposed to have descended from the time the first inhabitants arrived on the island. The father is believed to mourn for his child left in that eastern land, from which tradition states the people migrated.

ENGLISH TRANSLATION.

The sail of my daughter,
 Never broken by the force of foreign clans!
 The sail of my daughter,
 Unbroken by the conspiracy of Honiti!
 Ever victorious in all her fights
 She could not be enticed to drink poison waters
 In the cup of obsidian glass.
 Can my sorrow ever be appeased
 While we are divided by the mighty seas?
 Oh my daughter, oh my daughter!
 It is a vast and watery road
 Over which I look toward the horizon,
 My daughter, oh my daughter!
 I'll swim over the deep to meet you,
 My daughter, oh my daughter!

TRANSLATION OF EASTER ISLAND TABLET.

"Ate-a-renga-hokan iti poheraa."

LOVE SONG.

(Plates XLIV and XLV.)

Ka tagi, Renga-a-manu — hakaopa;
 Chiu ruurame a ita metua.
 Ka ketu te nairo lihi — O te hoa!
 Eaha ton tiena — e te hoa — e!

Ita haga ta poapatu — O te hoa!
 Kahii te riva forau — O te hoa — e!
 Auwe ka tagi ati — u — a — iti iti.
 Eha ton tiena — e ta hoa — e.

Ta hi tiena ita have.
 Horoa ita have.
 Horoa moni e fahiti;
 Ita ori miro;
 Ana piri atu;
 Ana piri atu;
 Ana taga atu.

ENGLISH TRANSLATION.

NATIVE LOVE SONG,

Who is sorrowing? It is Renga-a-manu Hakopa!
 A red branch descended from her father.
 Open thine eyelids, my true love.
 Where is your brother, my love?
 At the feast in the Bay of Salutation
 We will meet under the feathers of your clan.
 She has long been yearning after you.
 Send your brother as a mediator of love between us,
 Your brother who is now at the house of my father.
 O, where is the messenger of love between us?
 When the feast of drift-wood is commemorated
 There we will meet in loving embrace.

TRADITION IN REGARD TO THE ORIGIN OF THE ISLANDERS.

The island was discovered by King Hotu-Matua, who came from the land in the direction of the rising sun, with two large double canoes and three hundred chosen followers. They brought with them potatoes, yams, bananas, tobacco, sugar-cane, and the seeds of various plants, including the paper mulberry and the toromiro trees. The first landing was made on the islet of Motu Nui, on the north coast, and there the first food was cooked that had been tasted for one hundred and twenty days. The next day the queen started in one of the canoes to explore the coast to the northwest, while the other canoe, in charge of the king, rounded the island to the southeast. At Anekena Bay the



OBVERSE OF WOODEN TABLET FROM EASTER ISLAND. "KA IHI UIGA."
(From photographs presented by George Davidson to the California Academy of Sciences.)



REVERSE OF WOODEN TABLET FROM EASTER ISLAND. "KA IHI UIGA."
(From photographs presented by George Davidson to the California Academy of Sciences.)





OBVERSE OF WOODEN TABLET FROM EASTER ISLAND. "ATE-A-RENGA-HOKAN ITI POHERAA."
(Original in possession of Bishop of Axtieri. From photograph by Paymaster W. J. Thomson, U. S. N.)

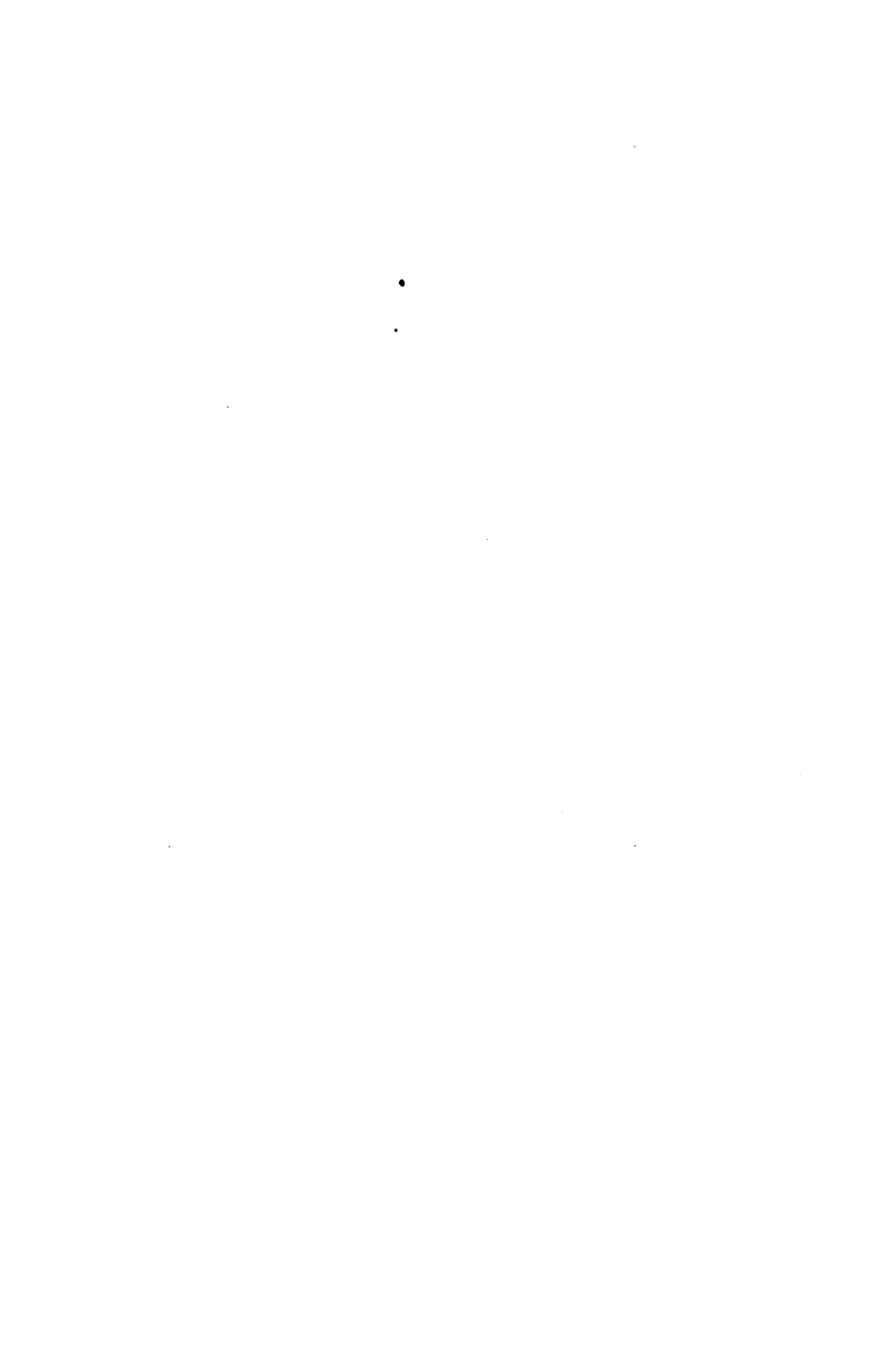



REVERSE OF WOODEN TABLET FROM EASTER ISLAND. "ATE-A-RENGA-HOKAN ITI POHERAA."
(Original in possession of Bishop of Axtleri. From photograph by Paymaster W. J. Thomson, U. S. N.)



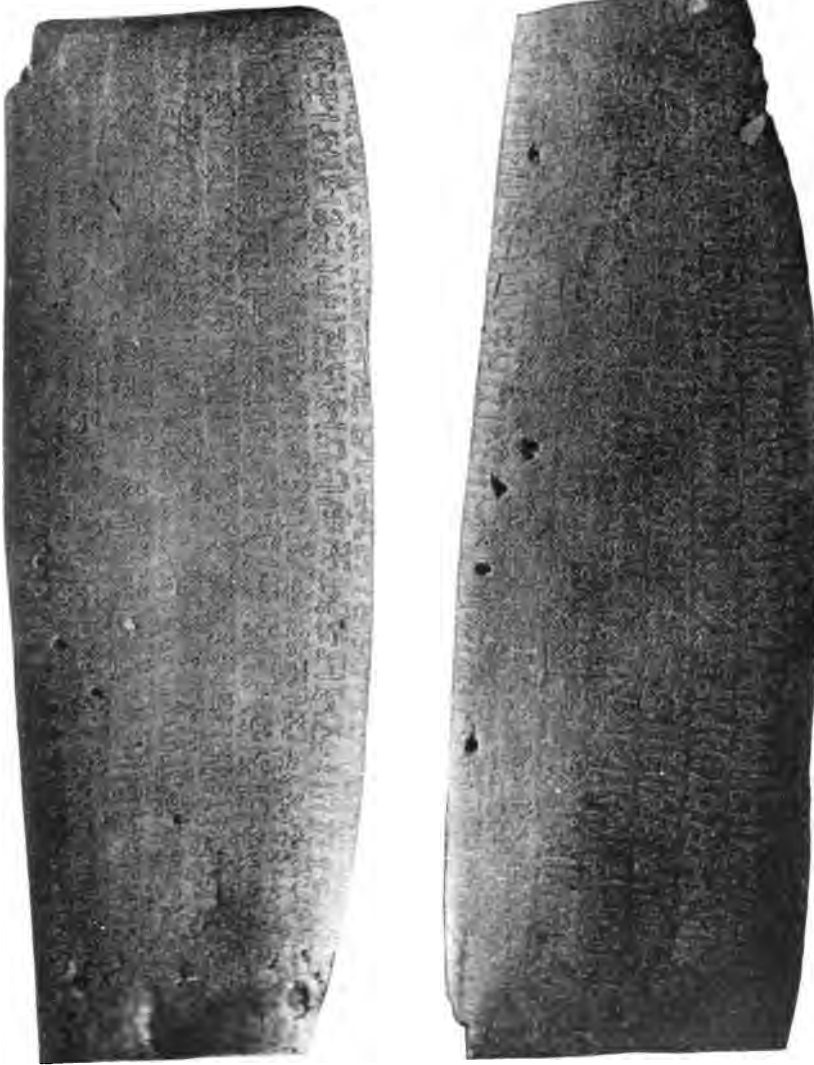

OBVERSE AND REVERSE OF EASTER ISLAND TABLET.
(From a cast lent by Parke, Davis & Co.)





REVERSE OF EASTER ISLAND TABLET, OBTAINED BY THE CHILIAN CORVETTE "O'HIGGINS."
(Original in Santiago Museum, Chili.)





OBVERSE OF EASTER ISLAND TABLET, OBTAINED BY THE CHILIAN CORVETTE "O'HIGGINS."
(Original in Santiago Museum, Chili.)

|

|

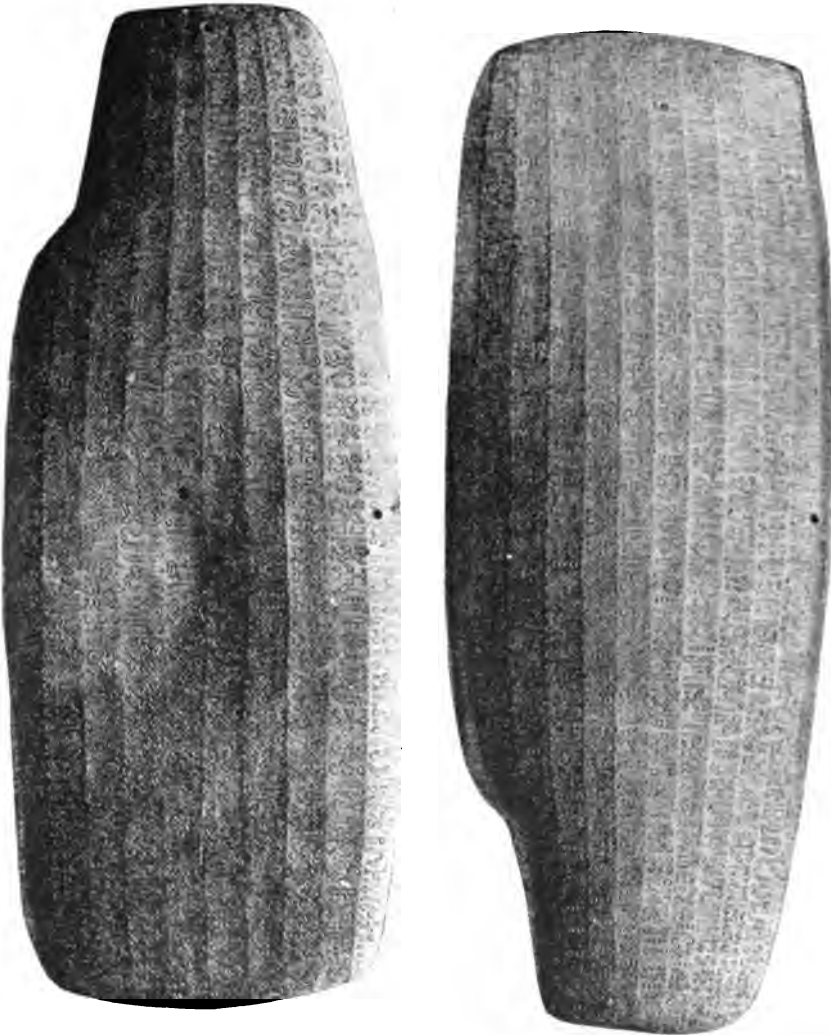

OBVERSE AND REVERSE OF EASTER ISLAND TABLET, OBTAINED BY THE CHILIAN CORVETTE "O'HIGGINS."
(Original in Santiago Museum, Chili.)

two canoes met and, attracted by the smooth sand-beach, Hotu-Matua landed and named the island "Te-pito te-henua" or "the navel of the deep." The queen landed, and immediately afterwards, gave birth to a boy, who was named Tuumae-Keke. The landing place was named Anekena in honor of the month of August, in which the island was discovered. All the plants landed from the canoes were appropriated for seed, and the people immediately began the cultivation of the ground. For the first three months they subsisted entirely upon fish, turtle, and the nuts of a creeping-plant found growing along the ground, which was named "moki-oo-ne." After the lapse of a number of unrecorded years, during which the island had been made to produce an abundance of food, and the people had increased and multiplied in numbers, Hotu-Matua at an advanced age was stricken with a mortal illness. Before his end drew near, the chief men were summoned to meet in council. The king nominated his eldest son as his successor (Tuumae-Heke), and it was ordained that the descent of the kings should always be through the eldest son. This important matter having been settled, the island was divided up into districts and portioned out to the children of the king as follows: To Tuumae-Heke, the eldest, were given the royal establishment and lands extending from Anekena to the northwest as far as Mounga Tea-tea. To Meru, the second son, were given the lands between Anekena and Hanga-roa. To Marama, the third son, were given the lands between Akahanga and Vinapu. The land lying to the northward and westward of Mounga Tea-tea was the portion of the fourth son, Raa, and was called Hanga-Toe. To the fifth son, Korona-ronga, were allotted the lands between Anekena and the crater of Rana-Roraku. To the sixth and the last son were given the lands on the east side of the island. His name was Hotu-iti.

The tradition here goes back before the advent of the people on the island, and states that Hotu-Matua and his followers came from a group of islands lying towards the rising sun, and the name of the land was Marae-toe-hau, the literal meaning of which is "the burial place." In this land, the climate was so intensely hot that the people sometimes died from the effects of the heat, and at certain seasons plants and growing things were scorched and shriveled up by the burning sun.

The circumstances that led to the migration are related as follows: Hotu-Matua succeeded his father, who was a powerful chief, but his reign in the land of his birth, owing to a combination of circumstances over which he had no control, was limited to a very few years. His brother, Machaa, fell in love with a maiden famed for her beauty and grace, but a rival appeared upon the scene in the person of Oroï, the powerful chief of a neighboring clan. After the manner of the sex in all ages and climes, this dusky beauty trifled with the affections of her suitors and proved fickle-minded. When pressed to make a choice between the two, she announced that she would marry Oroï, provided he would prove his love by making a pilgrimage around the island,

and it was specified that he should walk continually without stopping to eat, or to rest by day or night, until the tour of the island was completed. Retainers were selected to carry food to be eaten on the route, and Oroï started upon his journey, accompanied for the first few miles by his affianced bride, who promised upon parting, to permit her thoughts to dwell upon nothing but him until his return. The inconstant female eloped with her other lover, Machaa, on the same evening. Oroï did not hear this news until he had arrived at the farther end of the island; then he returned directly to his home, where he prepared a great feast to which he summoned all the warriors of his clan. The indignity that had been put upon him was related, and all present registered a vow that they would never rest until Hotu-Matua and his entire family had been put to death.

It appears that Machaa was a man of prudence, and seeing that a desperate conflict was imminent, he embarked with six chosen followers and his bride, in a large double canoe, and with plenty of provisions sailed in the night for some more genial clime. The great spirit "Meke-Meke" is supposed to have appeared to him and made it known that a large uninhabited island could be found by steering towards the setting sun. The land was sighted after they had been out two months, and the canoe was beached on the south side of the island. On the second day after their arrival they found a turtle on the beach near Auekena, and one of the men was killed by a blow of its flipper in trying to turn it over. Two months after they had landed on the island, the two canoes with Hotu-Matua and his followers, three hundred in number, arrived.

The desertion of Machaa did not appease the wrath of Oroï, and war to the death was carried on until Hotu-Matua, after being defeated in three great battles, was driven to the last extremity. Discouraged by his misfortune, and convinced that his ultimate capture and death were certain, he determined to flee from the island of Marae-toe-hau, and accordingly had two large canoes, 90 feet long and 6 feet deep, provisioned and prepared for a long voyage. In the night, and on the eve of another battle, they sailed away, with the understanding that the setting sun was to be their compass.

It appears that the intended flight of Hotu-Matua was discovered by Oroï at the last moment, and that energetic individual smuggled himself on board of one of the canoes, disguised as a servant. After arriving upon the island, he hid himself among the rocks at Orougo, and continued to seek his revenge by murdering every unprotected person who came in his way. This interesting state of affairs continued for several years, but Oroï was finally captured in a net thrown by Hotu-Matua and was pounded to death. The tradition continues by a sudden jump into the following extraordinary condition of affairs: Many years after the death of Hotu-Matua, the island was about equally divided between his descendants and the "long-eared race," and between them

a deadly feud raged. Long and bloody wars were kept up, and great distress prevailed on account of the destruction and neglect of the crops. This unsatisfactory state of affairs was brought to an end, after many years' fighting, by a desperate battle, in which the "long ears" had planned the utter annihilation of their enemies. A long and deep ditch was dug across Hoto-iti and covered with brush-wood, and into this the "long ears" arranged to drive their enemies, when the brush-wood was to be set on fire and every man exterminated. The trap was found out, and the plan circumvented by opening the battle prematurely and in the night. The "long ears" were driven into the ditch they had built, and murdered to a man.

After the defeat and utter annihilation of the "long-eared race," the tradition goes on to state that peace reigned on the island, and the people increased in numbers and prosperity. In the course of time dissensions arose between the different families or clans, which led to open hostilities. Kaina, the chief of the Hotu-iti clan, and a descendant of the sixth son of the first king, proved himself a valiant warrior, and his possessions were increased by encroachments upon the domain of his neighbors. He died and was succeeded by his son, Huriavai, who inaugurated his introduction into the office by a three days' engagement, in which the chiefs of two neighboring clans were killed. Several clans now combined forces, and after desperate fighting the Hotu-iti people were defeated, half of them taking refuge in a cave on the face of the cliff on the northeast side of the island, and the rest on the islet of Marotiri.

The besieged parties were watched night and day by their vigilant enemies, and were finally reduced to the verge of starvation. A chief, named Poya, had just finished a large double canoe at Hanga-roa, which he called Tuapoi. This was dragged across the island and launched at Anahava. Every day this canoe, filled with fighting men, cruised around the islet of Maroiri, making attacks upon the besieged Hotu-iti people whenever opportunity offered. As the people were reduced by privations, the number of prisoners captured increased day by day. The captives were taken to a place called Hanga-wi-aihi-toke-rau and portioned out to the different clans, and were immediately cooked and eaten. This is said to be the origin of cannibalism on the island, and is supposed to have been prompted by revenge.

Cannibalism, however, proved a double-pointed sword that caused dissensions in the ranks, and finally resulted in the liberation of a part of the besieged people. A chief named Oho-taka-tore happened to be absent upon one occasion, and upon his return found the bodies had all been distributed and his claims completely ignored. He demanded his share of the spoils, and was informed that "a man who sleeps late in the morning can not expect to see the sun rise." Feeling degraded by the slight, Oho-taka-tore turned his feather-hat hind-side before, to

indicate that the alliance was broken, and with his men marched off the field.

On the road he stopped at Vaka-pikō, at the house of his daughter-in-law, to inquire after his son. The "lady" received him with demonstrations of respect, and while listening to the story of his wrongs, stood behind him and picked fleas out of his head, which, in accordance with the native customs, was the most delicate compliment that one individual could show another.

Upon the return of her husband, whose name was Moa, the woman related the particulars of the visit of his father. Moa said nothing about the state of his feelings, but arose at sunrise and dug up a lot of potatoes and yams, which he baked in an oven. Towards evening he brought out his fish-net and employed himself in arranging the floats and sinkers. After dark he wrapped up his potatoes and yams in sugar-cane and leaves, shouldered his net, and started off, after informing his wife that he was going fishing. He hid his net in the rocks at Kahiherea and then went to Mounga-tea-tea, where a palm tree was growing, from which he cut and trimmed eight large branches. At Ngana Moa he found the camp of the men who guarded the cliff overlooking the cave where the Hotu-iti people were imprisoned, so he turned and went down by the sea-shore. The men stationed there to guard the approach were all asleep, and Moa managed by great caution to pass them without being discovered. Having arrived near the cave he was challenged, and replied, "I am Moa, who seeks revenge while helping you." One of the besieged men, named Tokihai, descended from the cave and received the grip of friendship by being clasped around the belly. Moa took his food into the cave and distributed it among the thirty famished and thoroughly discouraged men who remained alive.

While the great canoe was making its predatory excursions to the islet, the combined forces had not neglected the people who had taken refuge in the cave. Every day a large net filled with men was lowered from the top of the cliff, and from it stones were hurled into the cave, killing and maiming the defenseless people. Moa produced his palm branches and instructed his friends how to make hooks from pieces of human bone, which could be fastened to the poles and used as grapples.

Before daylight everything was in readiness, and when the net was lowered abreast of the opening, it was caught by the hooks and drawn in the cave, and the men in it dispatched almost without resistance. The prisoners got into the net and were hoisted to the top, where by reason of the surprise and the fierceness of their fighting their enemies were defeated and put to flight.

It happened that on the night of Moa's visit to the cave, Huriarai and a man named Vaha, who were with the party on the small island of Marori, became desperate from hunger and made an effort to capture one of the men guarding the sea-beach. The sentry saw one of the men

swimming towards him ; it proved to be the chief Huriarai, who was so much exhausted that he was clubbed to death without making much resistance. Vaha, however, landed some distance off, and creeping upon the sentry killed him while he was bending over the body of his victim. Vaha hastily buried the body of his chief among the rocks and taking his victim upon his back swam back to his companions on the islet. The people there were without means of making a fire and the body had to be eaten raw. In the morning, when they saw the escape of their comrades from the cave and the desperate fighting on the cliff, they all swam ashore and joined forces.

The traditions, from this point, are a record of tribal wars, abounding in feats of personal bravery and extraordinary occurrences, but of little value to the history of the island. The discovery of the island by Hotu-Matua and his band of three hundred, together with the landing already referred to, is probably correct and seems natural enough down to the division of the land and the death of the first king. The wars and causes that led to the migration of the people from that unknown land, called Marae-toe-hau, are no doubt based upon a foundation of facts. There is no good reason for doubting the description of the climate of their former home, which would, if accepted, locate it somewhere about the equator, or at all events in the tropics. The heat could not be the effect of volcanic action, or their legends would not state that the crops were burned up by the sun at certain seasons.

The improbable, not to say impossible, part of the story comes in, where Machaa steals away and lands upon the same island which his brother's party reach two months later, by simply steering towards the setting sun. There is not one chance in a million, that two canoes could sail for thousands of miles, steering by such an uncertain and indefinite course, and strike the same little island. The tradition states that Hotu-Matua found the island uninhabited, and immediately contradicts this, by the ridiculous story of his brother and his followers having been there two months. It is not unlikely that the natives, anxious to maintain the credit of the discovery of the island, attempt to account for the presence of an earlier people in this way. This might account for the killing of one of Machaa's men by the turtle, for it has no possible bearing upon the story, beyond the fact that it would account for Hotu-Matua finding a tomb or burial-place on the beach at Anekena, when he first landed.

The story of Oroï disguising himself as a servant and sailing for months in an open canoe, filled with naked savages, without his identity being discovered, is too absurd to be considered, beyond ascribing an origin to the enemy or enemies who murdered Hotu-Matua's people, and whose stronghold was on the rocky cliffs near Orongo. One peculiar feature of the tradition is the allusion to the fighting-net, which must have been something after the fashion of those used in old Roman times. These nets are represented to have been square and weighted at the

corners with stones. A lanyard was fastened to the center, and the net was thrown over an antagonist, who was beaten to death while entangled in its meshes. It is worthy of remark that nothing of this sort has been discovered among the Polynesians or their contemporaries on the coast of America.

The suddenness with which the tradition jumps into the warfare between the descendants of the first king and the "long-eared race" is startling, because no previous reference has been made to such a race on the island. It is hardly possible that the "long-ears" were descended from people who landed with them on the island, for those that came with Hotu-Matua were of the same clan, and it is fair to presume that the same customs obtained among them all. Besides, the legends all make a distinction between the "long-eared" race and the descendants of the first king. The "long-ears" appear to have been a power in the land at an early period in the history of the island, though they were eventually defeated and exterminated by the others.

It is possible that there has been more than one migration of people to the island, and that their traditions have been mingled together, but there can be no reasonable doubt about the progenitors of the present islanders being of the Malayo-Polynesian stock. It is difficult to account for the statement, so frequently repeated throughout the legends, that Hotu-Matua came from the eastward and discovered the land by steering towards the setting sun, because the chart shows no islands in that direction which would answer the description of "Marae-toe-hau."

TRADITION REGARDING OBSIDIAN SPEAR-POINTS.

The implements of warfare brought to the island by King Hotu-Matua and his followers were few in number, and in the course of time became broken, lost, or destroyed. The clans were continually at war with each other, but from the want of proper weapons the most desperate encounters resulted in little loss of life. Spears were improvised with heads made of the sharp edges of the calabash, but they proved inefficient weapons and did little execution. During the reign of Aturaugi, the sixth king, a man living near the crater of the Rana Kau, while returning to his home after sundown from Temanevai, where he and his companions had been engaged in a useless struggle, stepped in the darkness upon a sharp stone that cut his foot like a knife. He carried the stone home with him, and in the morning found it to be black volcanic glass, which upon being broken showed vitreous edges such as had cut his foot. Believing he had discovered an effective material for the manufacture of spear-heads, he substituted the obsidian for the calabash points and went forth to meet his enemies. The new weapon proved more puissant than he had hoped for, and havoc was created in the ranks of his opponents. Armed with spear-heads obtained from the obsidian mountain Orito, the discoverer and his clan swept everything before them until the new material became known to all the

people. Since the time of this discovery the encounters of the islanders are characterized as more sanguinary.

TRADITION REGARDING FISH HOOKS.

In the time of Atua Ure Rangi, the seventeenth king, the image-makers were exempt from all other kinds of work, and the fishermen were taxed for their chief support. The fish-hooks in use were made of stone, so hard that many months of chipping and grinding were required to fashion one fit for service, and the most perfect hooks, even in the hands of expert fishermen, permitted the escape of a large proportion of the fish. A youth named Urevaiaus, who was descended from a long line of fishermen, living at Hanga Pico, became prominent as one of the most skillful fishermen on the island. His outfit contained hooks bequeathed to him by his forefathers, but he became discouraged by the want of success which he thought his labors demanded, and much time was devoted to a consideration of the subject. One day, after a number of large and choice fish had escaped from his hooks, he determined to spend the entire night in the worship of the god Mea Kabi. About midnight, while he was still at his devotions, the spirit of an ancient fisherman named Tirakoka appeared, and made known the fact that his want of success was due to the inefficiency of the hooks. The spirit directed him to go to the cave in which his father's remains had been interred, and secure a piece of the thigh-bone, out of which a proper hook might be constructed. Urevaiaus became so much frightened by his interview with the spirit, that he failed to remember fully all the instructions that had been given, but he went to the cave the next day and secured the thigh-bone of his paternal parent. For many days he went out in his canoe regularly, but instead of fishing, his entire attention was devoted to the manufacture of an improved hook. During this period his boat returned empty every evening, and his want of success excited the open ridicule of his companions and the concern of his friends, but he persevered until he had fashioned a bone-hook with barbed point.

When ready to test his new invention, a place was selected at a distance from his companions, and his boat was quickly filled with the finest fish. The extraordinary success of the young fisherman, in time excited the envy and jealousy of his companions, and his persistent refusal of all inducements to part with the secret led to a serious quarrel and bitter enmity. A sudden attack was finally planned upon Urevaiaus while at work upon the fishing-grounds; in the effort to preserve his secret the youth lost his life, but the new form of hooks was found in his boat and the invention became known to the fraternity.

GENEALOGY OF THE KINGS OF EASTER ISLAND.

Hotu-Matua, driven from his kingdom to the eastward by the rebellion of his subjects, landed with a chosen band of followers at Easter

Islands, in the month of August (Anekena), in two canoes, each 15 fathoms long and 1 fathom deep.

First. Hotu Matua.	Thirtieth. Kote Kura Tahoua.
Second. Tuunaaheke.	Thirty-first. Taoraha Kaihahaanga.
Third. Nuku.	Thirty-second. Tukuma.
Fourth. Miru.	Thirty-third. Tekahui te Hunga.
Fifth. Hiuariru.	Thirty-fourth. Tetuu Hunga Nui.
Sixth. Aturaugi.	Thirty-fifth. Tetun Hunga Roa.
Seventh. Raa.	Thirty-sixth. Tetu Hunga Mare Kapeau.†
Eighth. Ataranga.	Thirty-seventh. Toati Rangi Habei.
Ninth. Hakapuna.	Thirty-eighth. Tagaroa Tatarara.
Tenth. Oihu.	Thirty-ninth. Hariui Koro.
Eleventh. Ruhoi.	Fortieth. Punahako.
Twelfth. Tukanga te Mamaru.	Forty-first. Puna Ate Tuu.
Thirteenth. Takahita.	Forty-second. Puna Kai te Vaa.
Fourteenth. Ouaraa.	Forty-third. Teriri Katea.
Fifteenth. Koroharua.	Forty-fourth. Haumoana.
Sixteenth. Mahuta Ariiki.*	Forty-fifth. Tupaarii Ki.
Seventeenth. Atua Ure Rangi.	Forty-sixth. Mahiki Tapuakiti.
Eighteenth. Teriri Turkura.	Forty-seventh. Tuu Koiho.
Nineteenth. Korua-Rougo.	Forty-eighth. Anekena.
Twentieth. Tiki-Tehatu.	Forty-ninth. Nui Tupahotu.
Twenty-first. Urukenu.	Fiftieth. Re Kaun.
Twenty-second. Teruruatiki te Hatu.	Fifty-first. Terava Rara.
Twenty-third. Nau Ta Mahiki.	Fifty-second. Tehitehuke.
Twenty-fourth. Terika Tea.	Fifty-third. Terahai.
Twenty-fifth. Teria Kautahito.	Fifty-fourth. Kaimokoi.
Twenty-sixth. Kotepu Ite Toki.	Fifty-fifth. Ngaara.
Twenty-seventh. Kote Hiti Ruauea.	Fifty-sixth. Kaimakoi Iti.
Twenty-eighth. Turna Ki Keua.	Fifty-seventh. Maurata.
Twenty-ninth. Tuterkimanara.	

Maurata, the last king, only reigned three years. He was carried away by the Peruvians in 1864, and it is supposed to have died in the guano mines of the Chinchí Islands.

LIST OF ETHNOGRAPHIC SPECIMENS OBTAINED AT EASTER ISLAND.

Wooden image.—Called Moai Tangata. Male figure made of toro-miro wood, with eyes of bone and obsidian. (Plate L, fig. 1.)

Wooden image.—Called Moai Kva-kva. Male figure made of toro-miro wood, with eyes of bone and obsidian, and breast-bone and ribs sharply defined. (Plate L, fig. 2.)

Wooden image.—Called Moai Papaa. Female figure made of toro-miro wood, with eyes of bone and obsidian. (Plate L, fig. 3.)

These figures have been called household gods, and were never worshipped, though they were regarded as the representations of certain spirits. Similar figures were made to represent deceased chiefs and

* Mahuta Ariiki had a son named Tuu-Koiho, who made the first stone image on the Island. This son died before his father.

† These two kings reigned at the same time. The son rebelled against his father, and finally killed him.

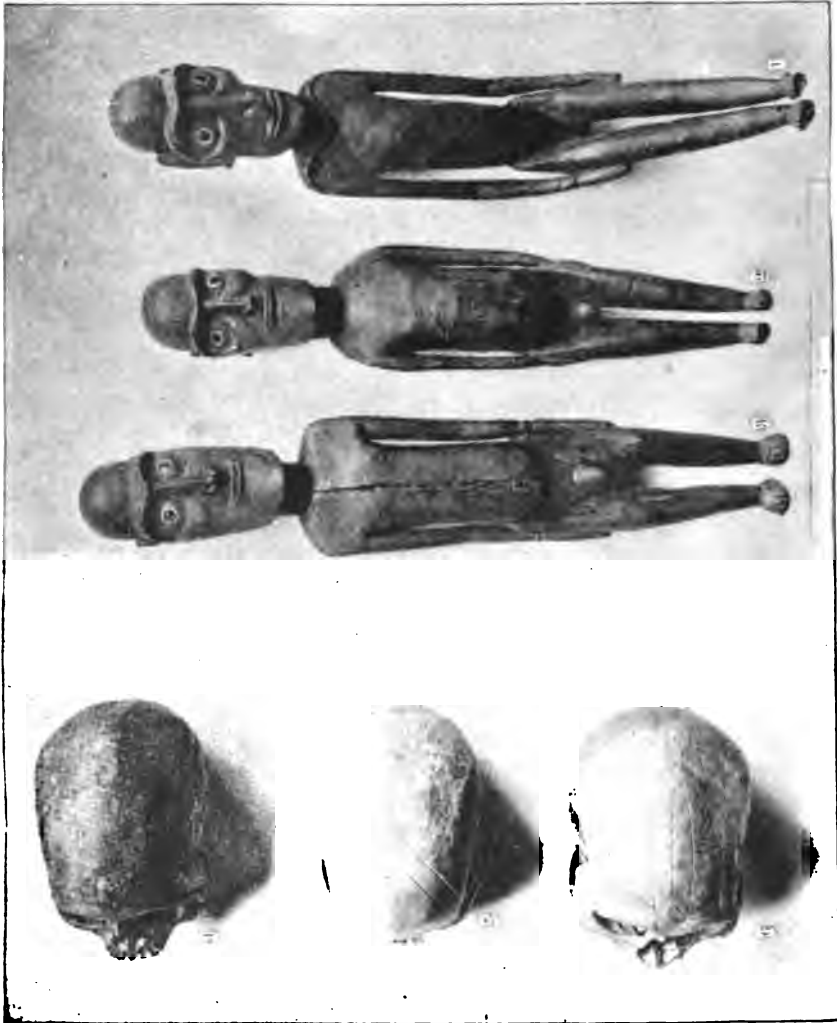

WOODEN IMAGES AND HUMAN SKULLS.

Figs. 1, 2, 3. WOODEN IMAGES. (Cat. Nos. 126743-126745, U. S. N. M. Easter Island. Collected by Paymaster W. J. Thomson, U. S. N.)
Figs. 4, 5, 6. HUMAN SKULLS. (Cat. No. 126759, U. S. N. M. Easter Island. Collected by Paymaster W. J. Thomson, U. S. N.)





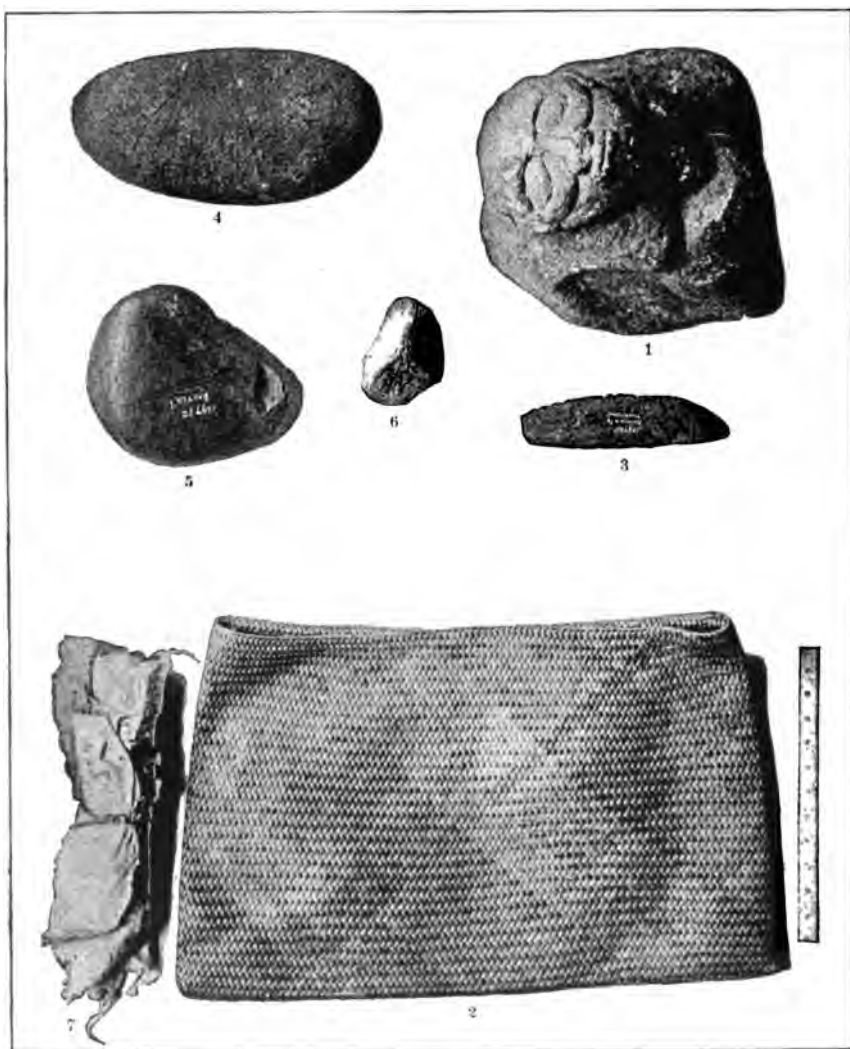

STONE GODS, BULRUSH WALLET, ETC.

- Figs. 1, 4, 5, 6. **STONE GODS.** (Cat. Nos. 129770-129773, U. S. N. M. Easter Island. Collected by Paymaster W. J. Thomson, U. S. N.)
- Fig. 2. **BULRUSH WALLET.** (Cat. No. 129760, U. S. N. M. Easter Island. Collected by Paymaster W. J. Thomson, U. S. N.)
- Fig. 3. **KNIFE.** (Cat. No. 129735, U. S. N. M. Easter Island. Collected by Paymaster W. J. Thomson, U. S. N.)
- Fig. 7. **TAPOA-CLOTH.** (Cat. No. 129739, U. S. N. M. Easter Island. Collected by Paymaster W. J. Thomson, U. S. N.)

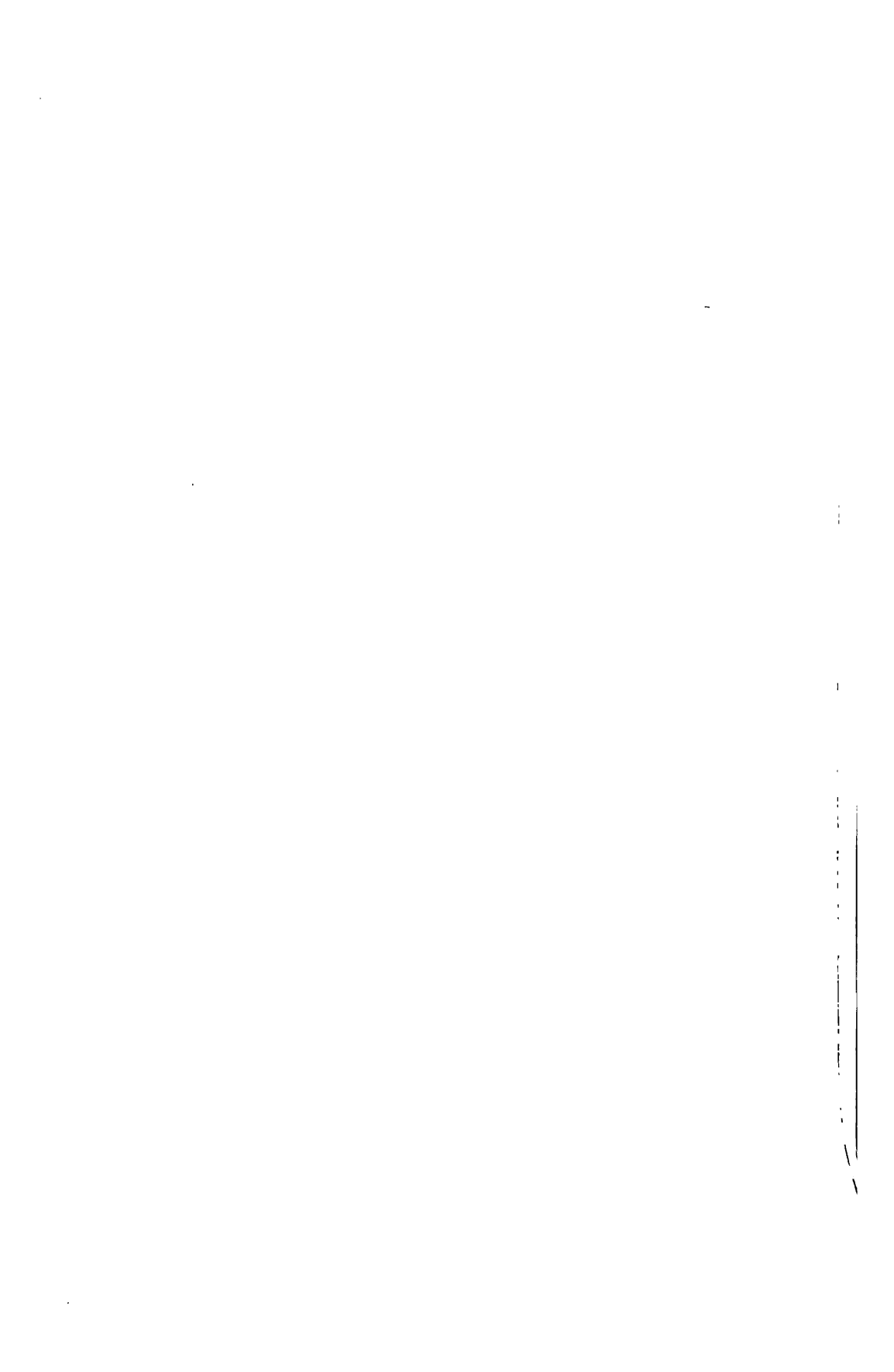

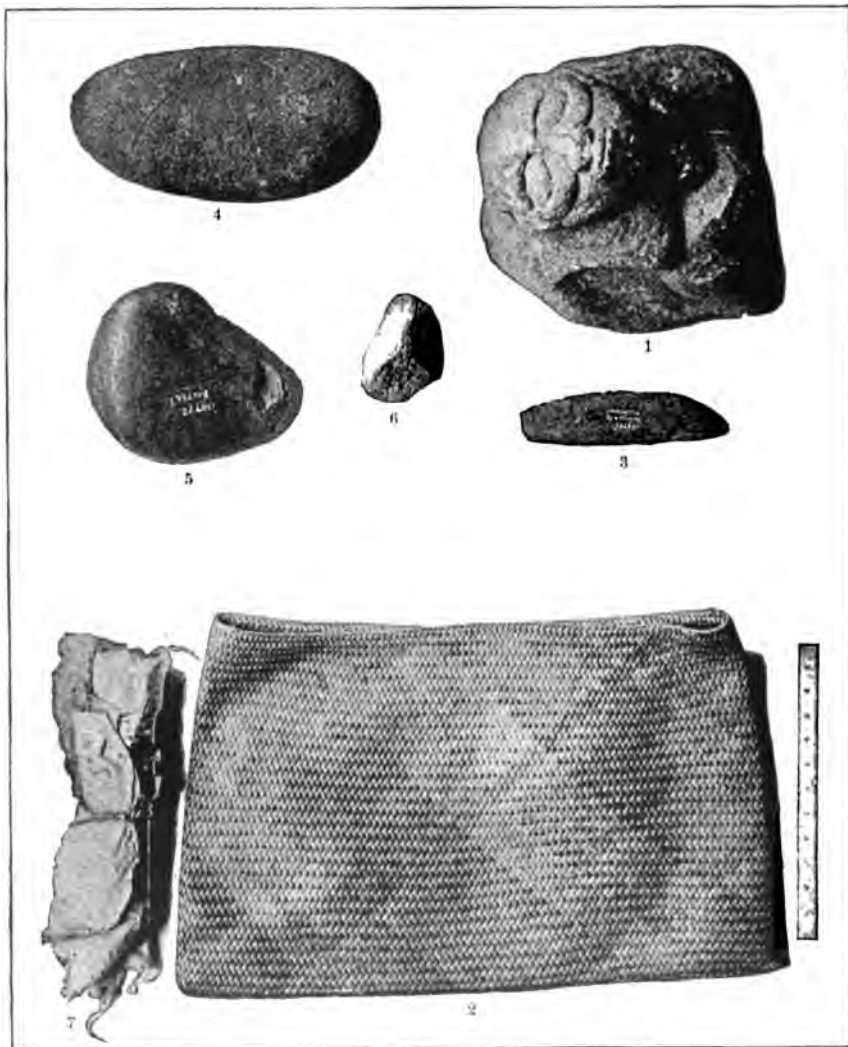

STONE GODS, BULRUSH WALLET, ETC.

- Figs. 1, 4, 5, 6. STONE GODS.** (Cat. Nos. 129770-129773, U. S. N. M. Easter Island. Collected by Paymaster W. J. Thomson, U. S. N.)
- Fig. 2. BULRUSH WALLET.** (Cat. No. 129760, U. S. N. M. Easter Island. Collected by Paymaster W. J. Thomson, U. S. N.)
- Fig. 3. KNIFE.** (Cat. No. 129735, U. S. N. M. Easter Island. Collected by Paymaster W. J. Thomson, U. S. N.)
- Fig. 7. TAPOA-CLOTH.** (Cat. No. 129739, U. S. N. M. Easter Island. Collected by Paymaster W. J. Thomson, U. S. N.)

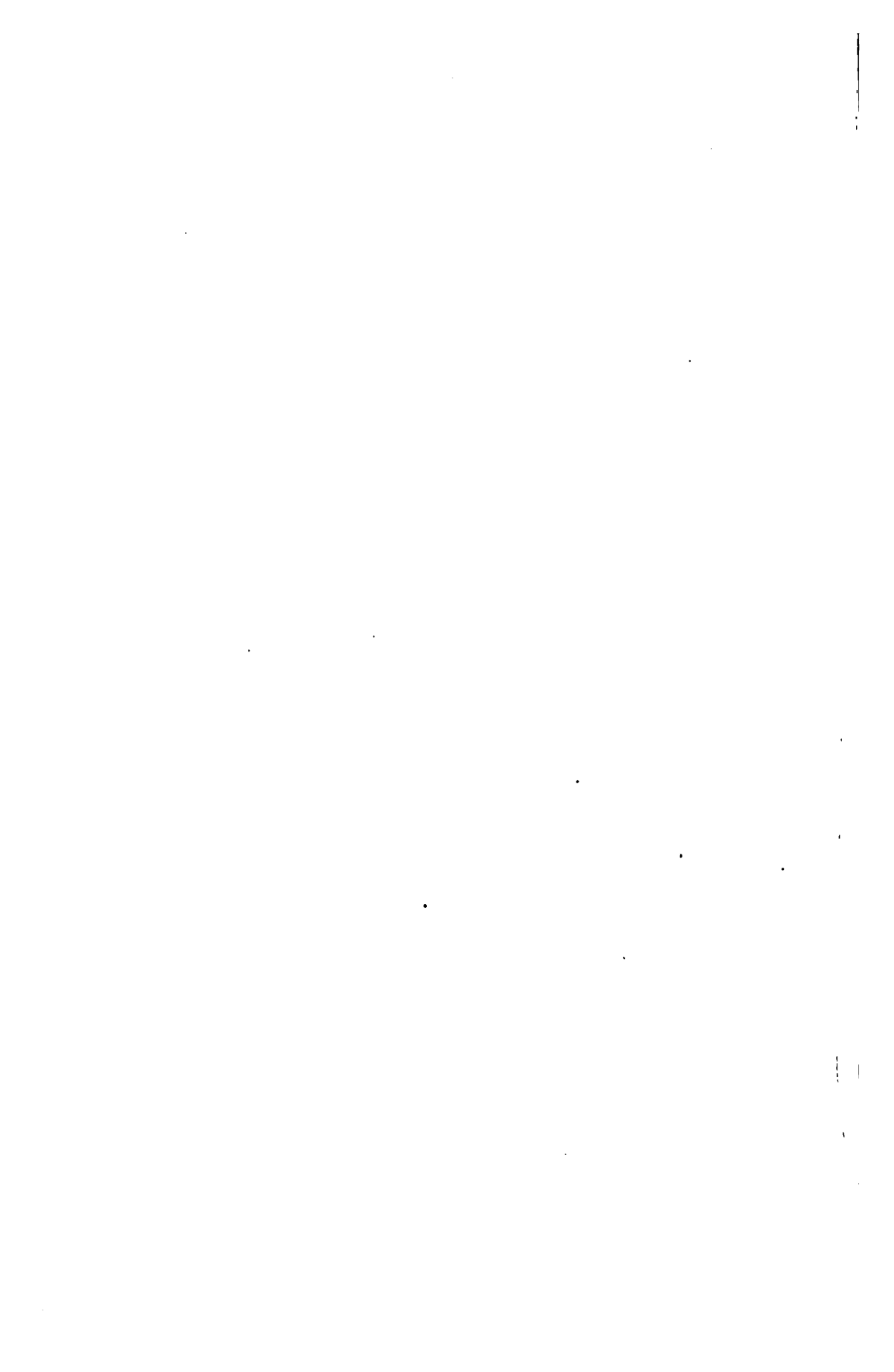

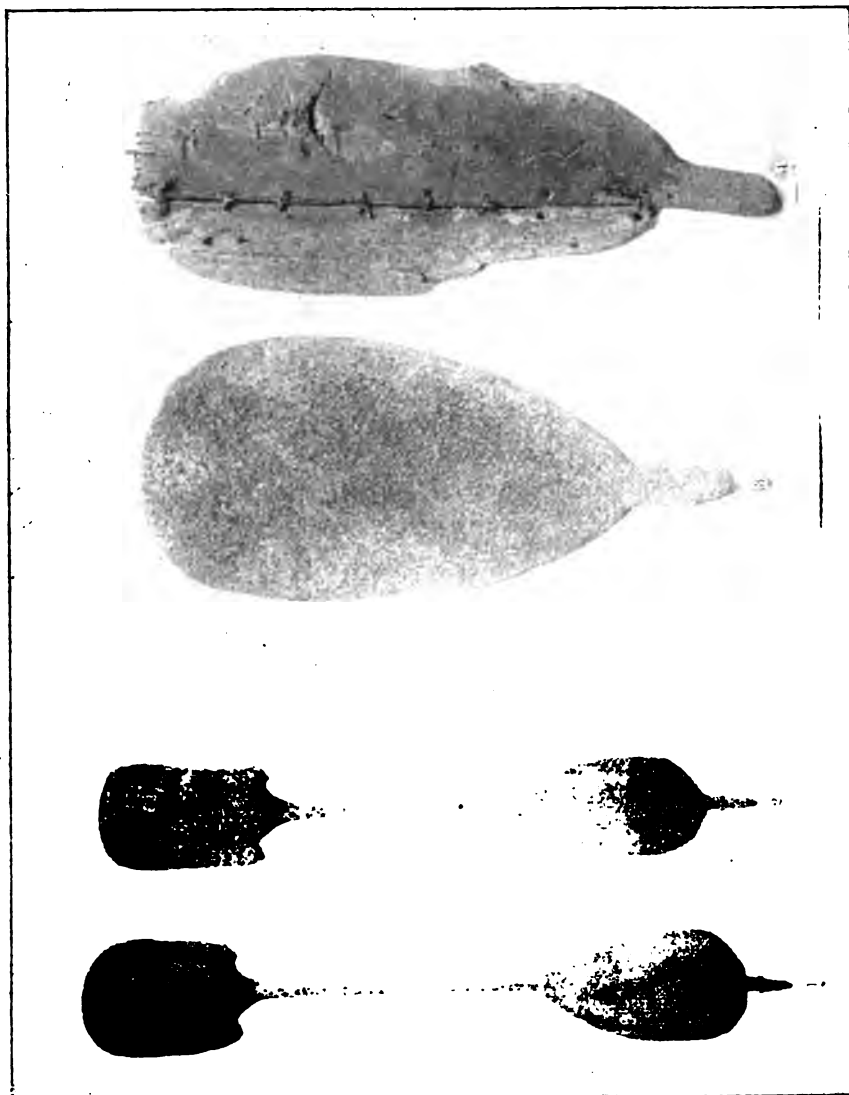

DANCING WANDS AND FETISH BOARDS.

FIGS. 1, 2. DANCING WANDS. (Cat. No. 12740, U. S. N. M., Easter Island. Collected by Paymaster W. J. Thomson, U. S. N.)
FIGS. 3, 4. FETISH BOARDS. (Cat. Nos. 12741-12742, U. S. N. M., Easter Island. Collected by Paymaster W. J. Thomson, U. S. N.)

Vertical line of text on the left margin.

Horizontal line of text at the bottom left corner.

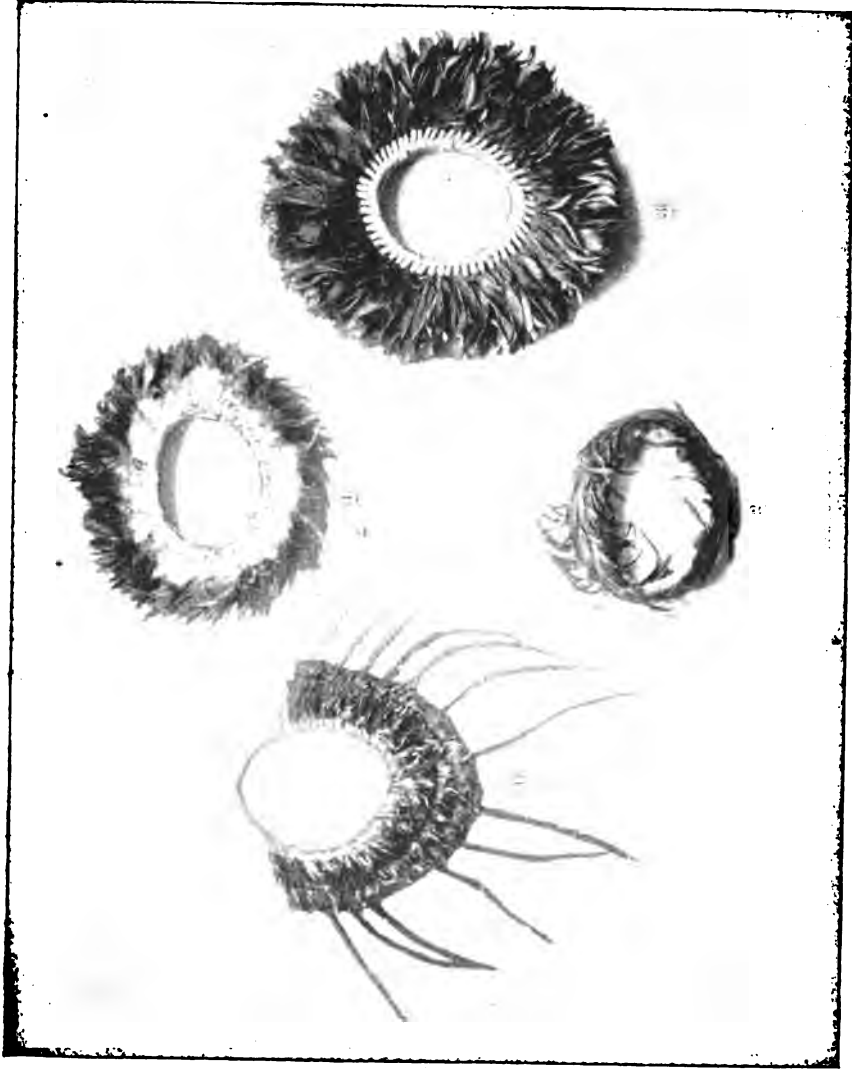

FEATHER HATS.

(Cat. Nos. 12750-12753, U. S. N. M. Easter Island. Collected by Paymaster W. J. Thomson, U. S. N.)

persons of note, and were given a place of honor at feasts and ceremonies.

Stone image.—Called Moai Maea. Male figure; held in the same position as those made of wood. (Plate LI, fig. 1.)

Wooden clubs.—Called Ua. Made of toro-miro wood, 6 feet long, point slightly widened and the handle ornamented with a bi-fron head with eyes of bone and obsidian. These clubs were only used batons of office by the chiefs, and the handle was supposed to represent the effigy of the owner. (Plate LII, figs. 1 and 2.)

Wooden club.—Called Poa. Made of heavy wood, about 30 inches long, gradually widened from the handle to a broad blade, round at the end. These were used for fighting and were handled with great dexterity.

Wooden club.—Called Ao. Made of light wood, used as wands dancing. The flattened ends are sometimes ornamented with heads supposed to represent females noted for skill and grace in this accomplishment. (Plate LIII, figs. 1 and 2.)

Wooden club.—Called Ariiki. Made of toro-miro wood, the end being turned at right angles from the short handle. The club is ornamented all over with heads. This was the baton of the king and used only by him. Obtained with much difficulty and expense.

Calabash.—Called Hue Vai. Opened at the small end only, used as a water vessel, and for domestic purposes.

Calabash.—Called Epu Moa. Known as the fowl gourd, and a superstition ascribes a beneficial influence over the chickens fed and water from it.

Calabash.—Called Tata. Used chiefly in boats for bailing.

Calabash.—Very old specimen obtained from an ancient tomb covered with hieroglyphics similar to those found on the incised tablets. These calabashes grow in profusion on the island, but are worthy of note on account of the prominent place they occupy in the tradition and because the seed was introduced by the original settlers.

Fish-net.—Called Kupenga Maito. This form of net has been in use from an early period, and is made from the fiber of wild hemp. Nets of different sizes used in fishing, as well as those for fighting and other purposes, were of similar material and mesh. (Plate XIII.)

Feather hat.—Called Vana-vana. Head-dress made of black and green variegated feathers, used only in delivering a challenge to combat for revenge. (Plate LIV, fig. 1.)

Feather hat.—Called Hau Kura-kura. Small head-dress of brown and red feathers worn by soldiers in time of war. (Plate LIV, fig. 2.)

Feather hat.—Called Han Pan-ten-ki. Head-dress of long, black, green, and variegated feathers worn by dancing-people. (Plate LI, fig. 3.)

Featherhat.—Called Han Tara. Small head-dress of trimmed feathers

ers ornamented by long tail feathers behind; used by chiefs on occasions of ceremony. (Plate LIV, fig. 4.)

Feather hat.—Called Han Vaero. Head-dress used in dancing, and formerly at marriage feasts. (Plate LV, fig. 1.)

Feather hat.—Called Han Hie-hie. Large and heavy head-dress made of black feathers worn by chiefs as insignia of office. These hats are made of chicken feathers secured by the quill ends to a foundation of knitted hemp, intended to fit the head closely. They are frequently referred to in the traditions. (Plate LV, fig. 2.)

Wallet.—Called Kate. Made from bullrushes taken from the crater of Rana-Kau. (Plate LI, fig. 2.)

Mat.—Called Moenga. Made of bullrushes and used for sleeping mats.

Obsidian spear-points.—Plate LVI.—Large collection showing the nine classes into which they are divided by the natives. Fig. 1, narrow leaf-shaped spear-head, called Mataa Nutakuku. Fig. 2, wide round-pointed spear-head, called Mataa Rei-pure-pure-rova. Fig. 3, narrow and long-pointed spear-head, called Mataa Neho-mango. Fig. 4, narrow spade-shaped spear-head, called Mataa Hikutiveva. Fig. 5, broad straight-edged spear-head, called Mataa-hae. Fig. 6, smooth round-edged spear-head, called Mataa Aro-kiri. Fig. 7, broad fan-shaped spear-head, called Mataa Nutu-kuku. Fig. 8, concave and convex sided spear-head, called Mataa Roa. Fig. 9, long sharp, irregular pointed spear-head, called Mataa Hai-haerve. These spear-heads were fastened to poles about 8 feet long, by lashings of hemp, and formed the chief weapon used by the natives in their frequent strifes. They were thrown to a distance, as well as a thrusting weapon, much after the manner in which the Zulus use their assagais. The volcanic glass of which the points were made, crops out at many places on the island, but was chiefly obtained at the obsidian mountain of Orito. Spear-heads of different shapes and sizes were dependent upon individual taste and skill. The best samples in the collection were purchased from Mr. Salmon; others were found in the tombs and burial-places; and some were picked up on the old battle-grounds.

Fetish-board.—Called Timoika. Broad, flat paddle made of whalebone, 30 inches long and 14 inches wide. This wand is used in working a charm against an enemy. The injured individual while performing a sort of convulsive dance, makes mystic movements with the paddle, meanwhile muttering incantations in a monotonous tone. The result is believed to be the speedy death of the person against whom the fetish is invoked. (Plate LIII, fig. 3.)

Potato fetish.—Called Rapa. Small, light paddle double bladed, about 24 inches long, painted light red in color. It was used with appropriate ceremonies at times when the potato crop was in danger from insects or drought, and was believed to ward off and guard against evil spirits. (Plate LIII, fig. 4.)

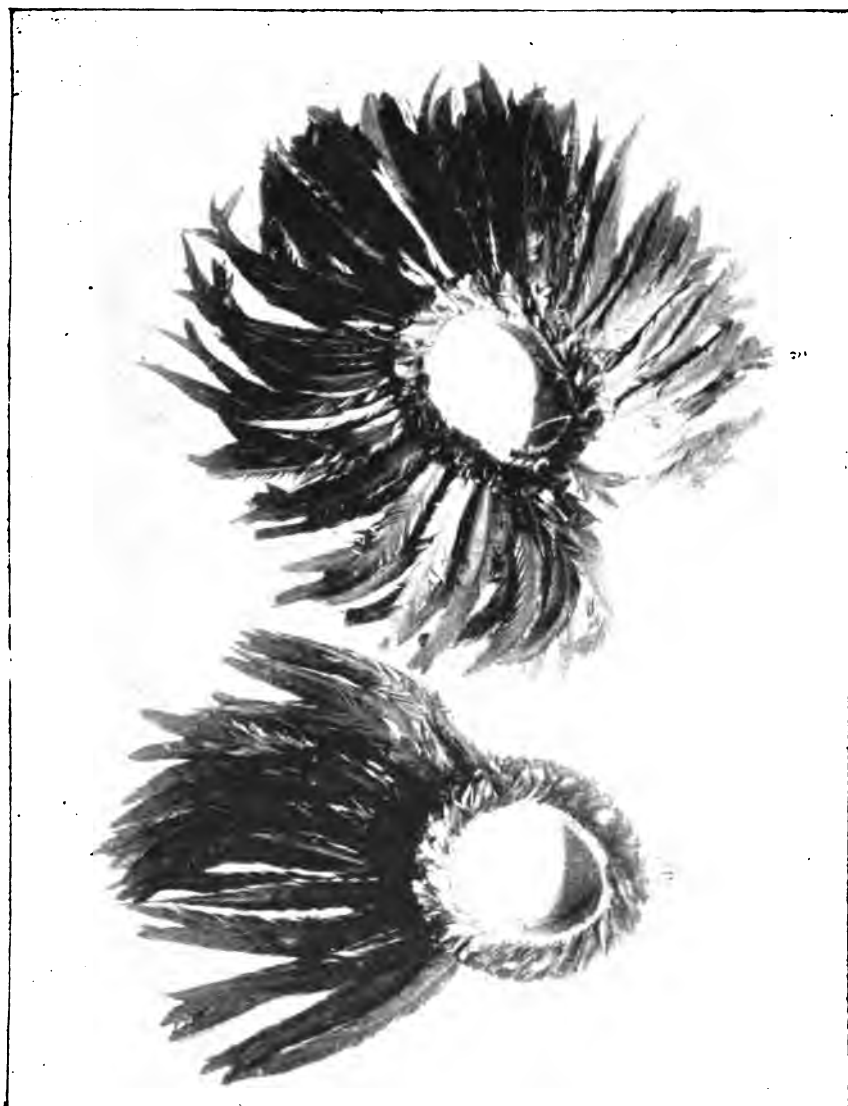

FEATHER HATS.
(Cat. Nos. 128754-128755, U. S. N. M. Easter Island. Collected by Pymaster W. J. Thomson, U. S. N.)



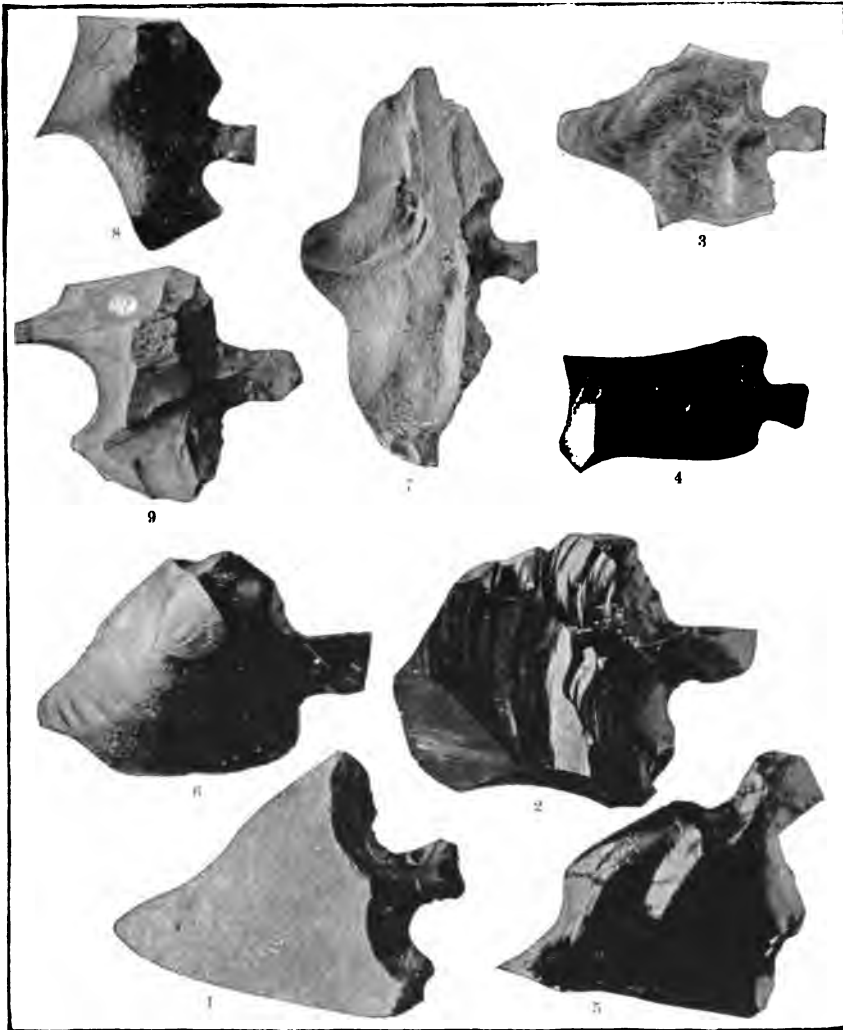

OBSIDIAN SPEAR-HEADS.

(Cat. Nos. 129722-129730, U. S. N. M. Easter Island. Collected by Paymaster W. J. Thomson, U. S. N.)



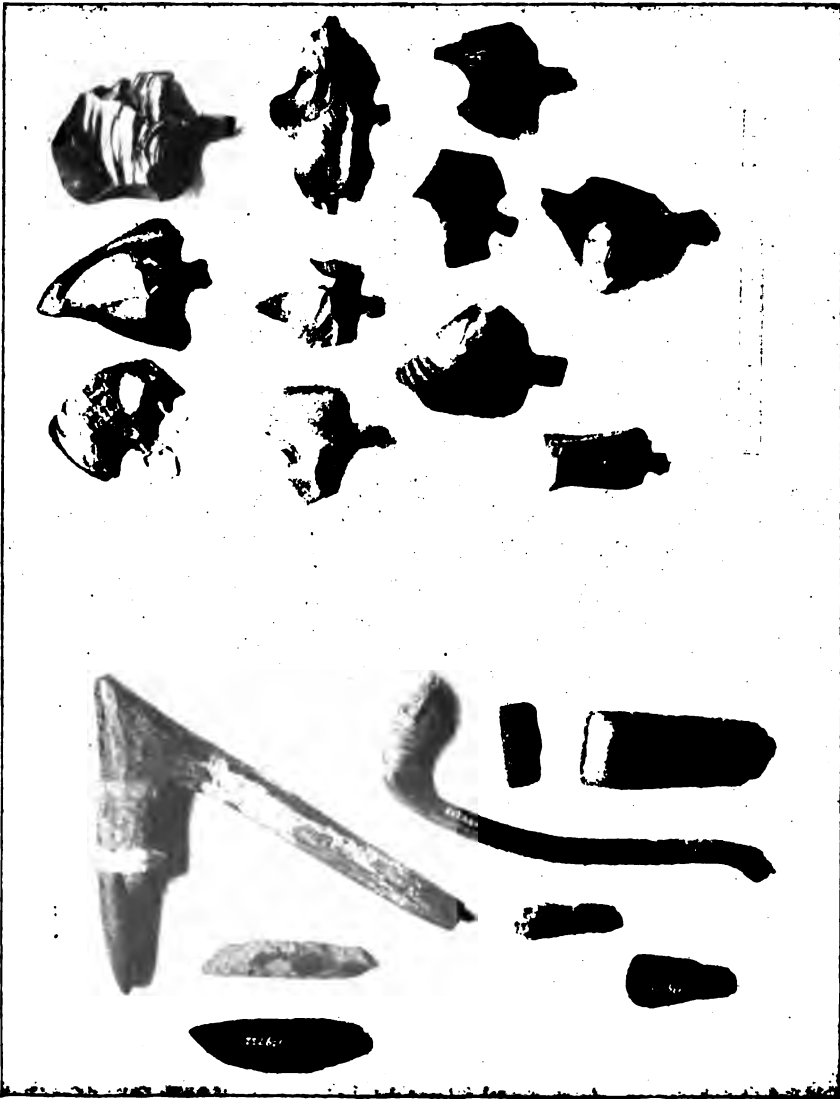

STONE ADZES AND OBSIDIAN SPEAR-HEADS.

STONE ADZES. (Cat. Nos. 126724-126734, U. S. N. M., Easter Island. Collected by Paymaster W. J. Thomson, U. S. N.)
OBSIDIAN SPEAR HEADS. (Cat. Nos. 126722-126730, U. S. N. M., Easter Island. Collected by Paymaster W. J. Thomson, U. S. N.)

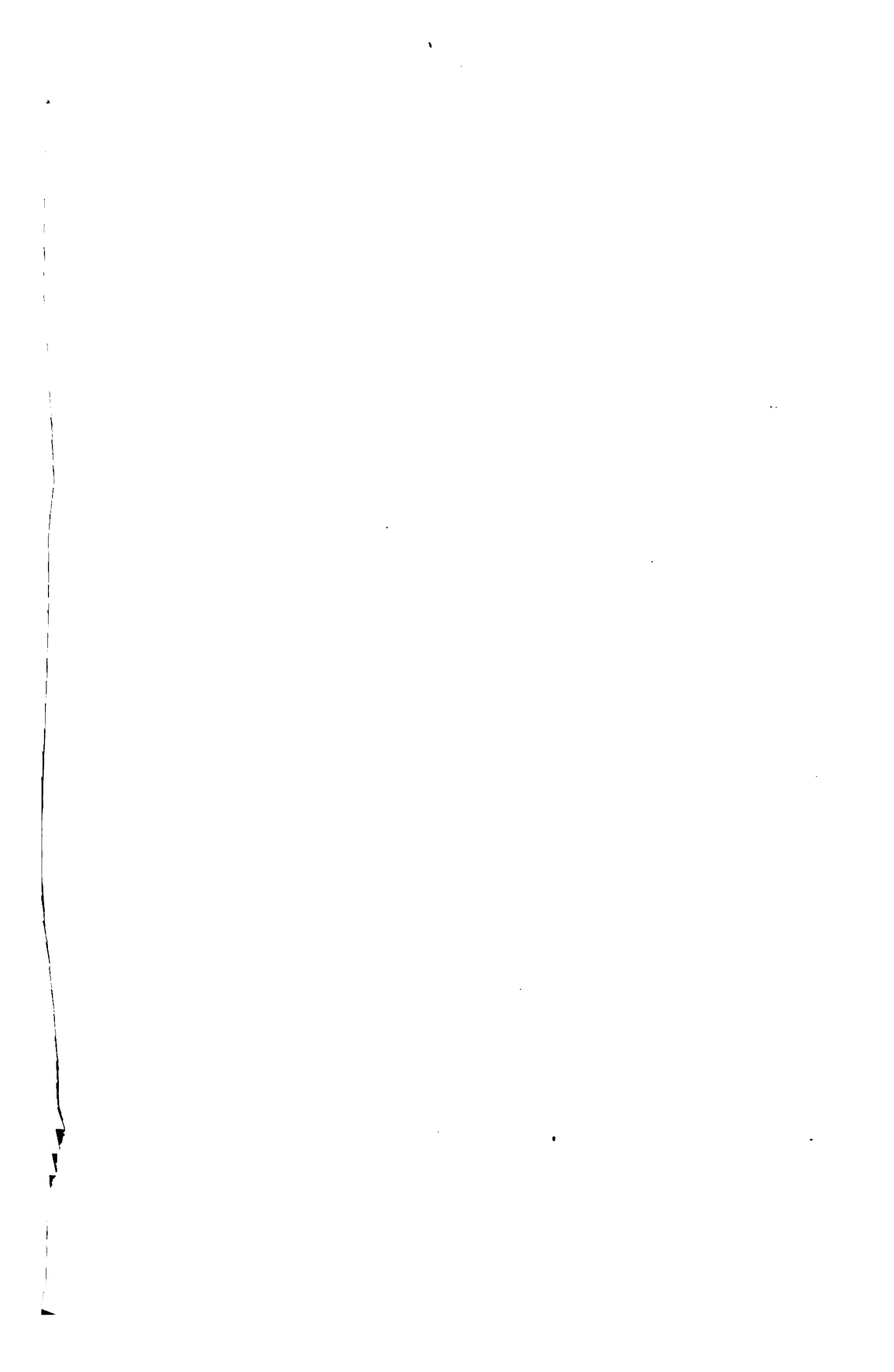

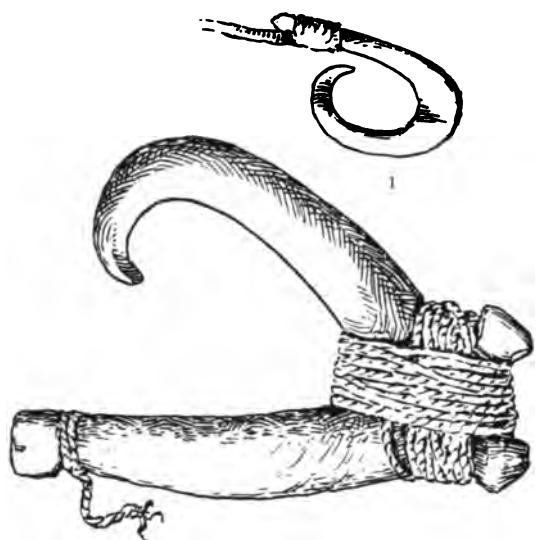

2



3

FISHHOOKS.

- Fig. 1. FISHHOOK OF HUMAN BONE. (Cat. No. 129736, U. S. N. M. Easter Island. Collected by Paymaster W. J. Thomson, U. S. N.)
Fig. 2. FISHHOOK OF HUMAN BONE. (Cat. No. 129737, U. S. N. M. Easter Island. Collected by Paymaster W. J. Thomson, U. S. N.)
Fig. 3. FISHHOOK OF STONE.

Stone adzes.—Called Toki. The collection comprises twenty-five different sizes, called by distinctive names which signify the use for which they are designed. Tools of this class were always used in a wooden handle. (Plate LVII.)

Stone knife.—Called Hoe. Ground down to a knife-blade with a point and cutting edge, used principally for fashioning the eyes and faces of the images. (Plate LI, fig. 3.)

Ax handles.—Miro Toki. Hard-wood, with natural joint, used for holding stone implements. (Plate LVII.)

Fish god.—Called Mea Ika. This rough, ill-shaped stone was one of the objects really worshipped by the natives. Some of them bear evidences of tool marks, but it does not appear that any effort was made to carve them into shape or decorate them. These gods were never common, and were possessed by communities or clans, and not by individuals. The legends claim that they were all brought to the island by Hotu Matua and the first settlers. (Plate LI, fig. 4.)

Bonito god.—Called Mea Kahi. A stone with apparently no distinguishing characteristics, and nothing to merit the profound religious homage paid to it. It is not clear why the bonito should have the distinction of a separate god from the other fish, unless it be for the reason that it appears in great numbers in these waters, and has always been highly esteemed as an article of food. Fish always constituted an important diet with the natives, and the abundance in which they were found was ascribed to the faithful and constant adoration of these stone gods. (Plate LI, fig. 5.)

Fowl god.—Called Mea Moa. A beach pebble with slight traces of tool-marks, but it might readily be passed among other stones without attracting attention. To the fowl god is ascribed the custody of chickens, and its beneficial influence was secured by being placed under a setting hen for a short time before the eggs were hatched. (Plate LI, fig. 6.)

Stone Fish Hook.—Called Mugai Kihī. These primitive hooks, now very rare on the island, were made of the hardest rock to be obtained, and were ground into shape by long and constant rubbing. (Plate LVIII, fig. 3.)

Bone fish hooks.—Called Mugai Iri. In accordance with an ancient superstition, these hooks were manufactured from the thigh-bones of deceased fishermen. The curve was fashioned with a small barb which prevented the escape of the fish. The form is so perfectly adapted to the purpose that the natives still use their old bone hooks in preference to those of European make. A fish-hook of similar design was used by the Indians of Santa Cruz Island. (Plate LVIII, figs. 1 and 2.)

Incised tablets.—Called Hokau Rongo-Rongo. Two specimens in excellent state of preservation, showing the hieroglyphics used in the written language. (Plates XXXVIII–XLI.)

Double paddle.—Called Mata Kao-kao. Made of heavy wood, bal-

anced by wide blades ornamented with outlined faces. Used in the ancient canoes in a similar manner to that practiced by the Indians of America. (Plate LII, fig. 3.)

Ancient scull oars.—Called Mata Kao. Angular float of peculiar shape and unique design attached to a long handle. Used for steering and sculling very large canoes. Very old and highly prized by the islanders as the only specimen of the scull-oar used by their ancestors. (Plate LIX.)

Human skulls.—Called Puoko Iri. An examination of these skulls shows very little difference between the crania of the present people and those found in the most ancient tombs. Three specimens obtained from the King's platform have hieroglyphics engraved upon them, which signify the clan to which they belonged. (Plate L.)

Native cloth.—Called Hami Nua. Made of the inner bark of the hibiscus and paper-mulberry trees. The manufacture of the "tappa" has now ceased altogether. (Plate LI, fig. 7.)

Tattooing implements.—Called Ta Kona. Tools used for puncturing the skin. Made of bird bones.

Needles.—Called Iri. Both bone and wooden needles used for sewing tappa cloth, and other varieties for knitting meshes of nets. (Plate LX, fig. 1.)

Fetish stones.—Called Atua Mangaro. A collection obtained by digging beneath the door-posts of the ancient dwellings. The majority are simply beach pebbles; others have been formed by rubbing; and one is a triangular-shaped stone with a face outlined upon it. These were placed beneath the houses, with much ceremony, and were supposed to ward off evil influences. (Plate LX, fig. 2.)

Neck ornaments.—Called Hoko Ngao. Carved wood in fanciful designs worn during the dance.

Pigments.—Called Penetuli. Natural paints used by being ground down in the heated juice of the sugar cane.

Frescoed slabs.—Taken from the inner walls and ceilings of the stone houses at Orongo. (Plate XXIII.)

Fetish stones.—Buried under the corner-stones of the houses.

POLYNESIAN ARCHÆOLOGY.

The most ancient monuments of Polynesia are the lithic and megalithic remains, coincident in style and character with the Druidical circles of Europe, and the exact counterpart of those of Stonehenge and Carnac in Brittany. These earlier efforts of the human art are invariably the remains of temples, places of worship, or of edifices dedicated in some way to the religion and superstitions of extinct generations, whose graves cover every island and reef. The most numerous, and perhaps the most ancient structures, are quadrangular in shape, and are composed of loose lava stones, forming a wall of great firmness and strength. These temples frequently exceed 100 feet in length, with a

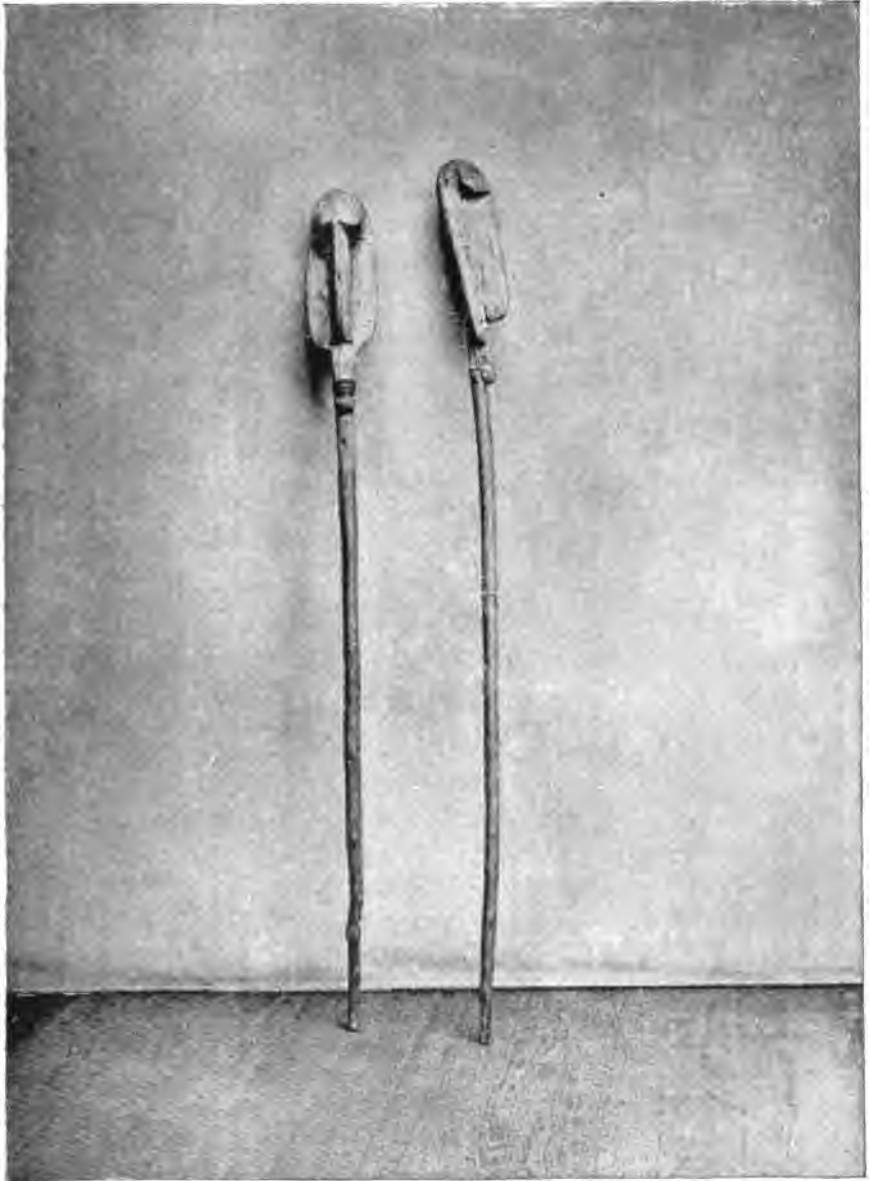

ANCIENT SCULL-OARS.

(Cat. No. 129746, U. S. N. M. Easter Island. Collected by Paymaster W. J. Thomson, U. S. N.)

[The body of the page contains extremely faint and illegible text, likely bleed-through from the reverse side of the document.]

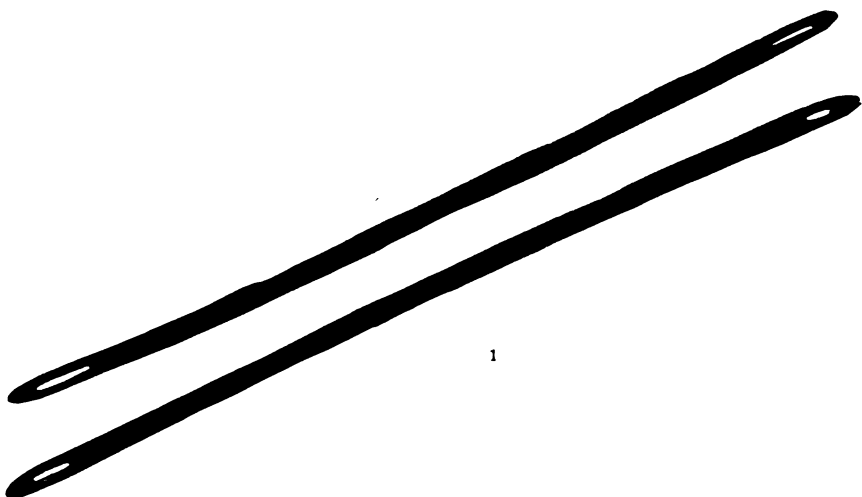

1



2

NETTING-NEEDLES AND FETISH-STONES.

Fig. 1. NETTING-NEEDLES. (Cat. No. 129738, U. S. N. M. Easter Island. Collected by Paymaster W. J. Thomson, U. S. N.)

Fig. 2. FETISH-STONES. (Cat. Nos. 129765-129772, U. S. N. M. Easter Island. Collected by Paymaster W. J. Thomson, U. S. N.)



proportionate width, and were designed to be roofless. They contain remains of altars composed of the same materials as the wall of the main inclosure, generally located at one end, and in shape resembling parallelograms. In many cases, these edifices are in as perfect a state of preservation as when countless numbers of human victims were immolated upon their altars, though time has obliterated all traces of everything perishable.

In the search for prehistoric remains, the diversified character of the many islands that dot the South Sea should be borne in mind. Coral groups and atolls, these wonderful formations produced by the ceaseless work of zoöphytic animals, being of comparatively recent creation, were perhaps merely tide-water reefs, when the islands of purely volcanic character were peopled by lawless and turbulent tribes, constantly engaged in warfare and in making depredations upon each other. Even where there is sufficient evidence of antiquity to warrant the search, the absence of monuments upon the low-lying islands of coral formation, may be accounted for by the lack of suitable material for their construction, or to the destroying hurricanes that occasionally sweep across this part of the Pacific, which are accompanied by a furious sea that breaks completely over the narrow atolls, carrying death and devastation to all things animate and inanimate.

The height of the atolls, in many cases, does not exceed 5 or 6 feet above the normal level of the sea surrounding them, and instances are unfortunately abundant, of islands that have been transformed in a few hours, from a scene of tropical luxuriance and with a contented people surrounded by nature's most bountiful gifts, to one of utter barrenness and desolation. The largest and most important islands of Polynesia are of volcanic character, and bear evidences of having been inhabited from a remote period. Here may be duplicated the Teocallis of Palenque, Copan, and Uxmal. In some islands these ancient monuments were searched out with great difficulty, having been so completely overgrown with dense tropical vegetation that their existence was not suspected by the indifferent people of to-day.

While the islanders never advanced to a high civilization, and their best efforts consist in cromlechs, dolmens, and elevated platforms or truncated pyramids, their handiwork is still preserved, and points with abundant interest to the history of a rude and early age.

The primitive Polynesians, like their contemporaries, the Incas of Peru, may be judged in regard to their condition and history, by the monuments they have left, for with the exception of Easter Island, there is no trace of their having possessed a written language. Tribes flourished, were conquered and passed out of existence, without leaving a trace behind them except perhaps, a shadowy tradition. The natives in this genial climate have always dwelt in rude structures of thatch and cane, which after a few years of abandonment would decay and leave no sign behind, unless it be a few broken implements lying about. Among

them, traditions have always been preserved with care, and it is wonderful to find how the history of a people can be followed in this way for hundreds of years. The Samoans claim a complete chronicle dating through twenty-two generations of the reigning family of Malietoa, and extending over a period of eight hundred years, while the Tongans can chronicle a fairly accurate history of their priesthood through twelve centuries.*

The priests have usually been the custodians of the national traditions, and there is sufficient evidence to show that every precaution was taken to have them handed down from one generation to another, pure and unchanged, for oral record was their only means of committing to posterity the deeds of their ancestors.

To be intrusted with the traditions, constituted of itself an office of high dignity, and the holder was afforded the protection of a taboo of the most rigorous character.

Family records were perpetuated with the national history, but as might be expected, there was a tendency to embellish them when extended back beyond a reasonable limit, with mythological personages and improbable occurrences. Still the extraordinary power of these keepers to preserve unimpaired for centuries, events and facts or even the genealogy of important families, would astonish those who are familiar only with written history, and whose memories depend upon artificial aids. Except in a few cases, the traditions of the natives do not extend back far enough to throw much light upon the ancient monuments found upon the islands. This is due in a measure to the fact, that in only isolated localities have the people lived unmolested for any great length of time. The tribes were continually at war with one another. From love of conquest, and jealousy, no tribe was safe from the depredations of its neighbor, although living upon terms of supposed friendship. The love of war induced frequent expeditions planned for the destruction of the tribes of adjacent islands, while occasionally a combination was made for more extensive operations against the unsuspecting natives of a different group. The visitors usually put to death the fighting men of the conquered tribes and absorbed the others. The traditions of both parties were preserved separately for a time, but they naturally tended to merge together, and in this state, a combination of the glories of both tribes were handed down never to be unraveled to their succeeding generations. The monuments of antiquity scattered throughout Polynesia, with the exception of Easter Island, increase in importance as we advance to the westward, commencing with the circles of uncut stones, and advancing by regular steps until we arrive at the more elaborate sculptures. This fact indicates the decline that

* These genealogies, although widely known and generally admitted to be true, have received the special investigation of some of the missionaries. The Rev. Shirley Baker, now premier of Tonga, assures us that there is no reason to doubt them, and that on the other hand there are many reasons for accepting them as absolute truth.

took place in the social and mental culture of the people as they ramified eastward through the various islands of the Pacific. Detachments arriving at the different groups separated into distinct communities as accident or fancy directed; here they became segregated, and rapidly degenerated in knowledge and in the arts.

Starting with the Sandwich Islands, we find that the Hawaiian prehistoric remains are confined to the most primitive forms of structures, such as the remains of the pagan temple at Waikiki, and the enormous heiau at Punepa near Iole, both of which are notable types of walled inclosures, and also the catacombs of Waimea, which do not greatly differ from some of the places of sepulture in other islands.

Farther to the South and West, the Marquesas and Society groups show nothing beyond the primitive works of people who have passed away ages ago, leaving no other signs of their having existed.

The island of Rapa-titi, in mid Pacific and just outside the tropics, contains evidences of a numerous population at some remote period. The island is remarkably mountainous, though quite small, with pinnacles rising to the height of 2,000 feet, and precipitous cliffs jutting into the sea. Massive forts command all the principal valleys; they are constructed of stone; built in terraces; and furnished with towers for observation and rallying points.*

In the Friendly Islands are found some interesting relics of antiquity. Near the ancient metropolis of Moa, on the island of Tongatabu, and about 12 miles from Nukualofa, the present capital of the group, are the graves of the Tui-Tongas.

These embrace nineteen truncated pyramids, measuring about 100 feet square on the base lines, and rising in three terraces to a height of 25 feet. The stones used in their construction are of coral concrete, and many of the huge blocks are 18 feet long by 5½ feet high and 3 feet thick, and weigh fully 20 tons each.

The labor of building these tombs was enormous, and when it is considered that the great blocks were cut from the coral reef about 3 miles distant, and transported to the spot by savages who were ignorant of the laws of mechanics, and who were without appliances, we can not fail to be lost in wonder at the magnitude of the work accomplished. These pyramids are of various ages, extending over a period of twelve hundred and fifty years. They are overgrown by a dense forest of fao and banyan trees, of immense size and great age, the roots of which have dislodged and thrown down some of the largest stones. The Tui-Tongas were high-priests and their genealogy has been carefully preserved.

* In 1867, the French purchased the sovereignty of this little island for a gallon of rum and some old clothes, thus cutting out a prospective American Steam-ship Company that had fixed upon it for a coal depot. Coal is found here in small quantities, and this fact has been adduced in support of the theory of a submerged continent in the Pacific, a fallacy evident to the geologist. Although there are several bays, a landing may be made at any point owing to the remarkable smoothness of the sea. The people bear a close resemblance to the New Zealanders.

The priesthood was hereditary, descending from father to son. Under the laws of Tonga the high-priests could marry only the daughters of the king. Their sons became priests, and the daughters occupied a position analogous to that of the Vestal Virgins and were not permitted to marry. This long line is now extinct, the last of the Tui-Tongas having been laid with his fathers in 1863.

About 6 miles beyond these tombs, on the eastern shore, stands an ancient cromlech, or more properly speaking a dolmen. This interesting monument is composed of three blocks of coral concrete. The two uprights are 14 feet high, 8 feet wide and nearly 4 feet thick, and weigh over 15 tons each, while the cross-piece is somewhat smaller and weighs about 10 tons. The native tradition is that these larger masses of stone were cut from the coral reef about 2 miles distant, and that the vertex was brought by one of their large canoes from Wallis Island. While it is possible for this legend to be founded upon fact, there is room for strong doubt, since the same formation exists upon both islands; but the difficulty of handling a stone of that size and weight, and of carrying it a distance of 600 miles by sea, would hardly be warranted when it could be quarried on their own shores. Viewed, however, as a trophy, and the cromlech as a sort of triumphal arch to commemorate a victory, (for the Tongans were perhaps the most successful of the ocean rovers of the Pacific) the legend of the stone seems entitled to greater credence than the neglected pile would at first warrant. The traditions do not go back far enough to tell us by whom this cromlech was erected, but simply assert its erection by one of the early kings on the advent of his dynasty, a fact which the disintegration of the stone, due to age, would seem to corroborate. The Samoans formerly erected stone pillars to the memory of their chiefs, but the most interesting relic of former ages, in this group, is the ruins of a heathen temple located in the mountains near the center of the island of Opolu. Secreted in an almost inaccessible gully, this temple was built in the form of an ellipse, measuring 57 feet one way by 39 feet the other. The roof was evidently thatched with pandanus leaves, as is the custom to the present day, but three large columns of basaltic rock formed the center supports, while the eaves rested upon the pillars of the same stone placed at intervals of 3 feet apart around the ellipse. Many of these stones are still standing, but the site has been almost obscured by a dense tropical growth.

Within a few feet of the old temple is an ancient tomb covered with a large block of stone and marked by an upright basaltic column. Samoan legends do not give much information about this ruin, but the Tongan traditions hold that the temple was built by them, after they had conquered the Samoans, and that the tomb is that of one of the Tui-Tongas who accompanied the successful expedition, and who died and was buried alongside of the temple. This conquest took place at least eight hundred years ago, for it was about this time that Malietoa I. was

made king, for his bravery and success in freeing his country from the Tongan yoke.

Plans were made to open this tomb, but for the lack of time could not be carried out, and the observations on this interesting relic were confined to one hasty visit.

Continuing still farther to the westward, to the island of Tinian, one of the Ladrões, are found two ranges of stone columns, over a dozen in number, and somewhat similar in size and shape to those of the cromlech at Tongatabu; but the curious feature of this ruin is that each column is surmounted by a large semi-globe, flat surface upward, weighing 4 tons. Freycinet supposes them to be supports of wooden ceilings to houses, that long ago have fallen into ruin, but other authorities assert that they are sepulchral urns. The natives call them "the houses of the ancients."

Upon the adjacent islands are numerous remains of a similar character, but in most cases the columns are smaller.

In the island of Ponape, Caroline group, are found remains of a higher grade of stone work and which are a puzzle to ethnologists.* Upon the bank of a creek that empties into Metalanien harbor is an inclosure with massive walls built of basaltic prisms 300 feet long and 35 feet high. There is a gateway opening upon the creek composed of enormous basaltic columns laid flat, inside of which is a court inclosed by walls 30 feet high. There are terraces against the wall inside, also built of basaltic prisms 8 feet high and 12 feet wide. The inclosure is nearly square and is divided into three parts by low walls running north and south.

In the center of each court is a closed chamber 14 feet square, ornamented with basaltic columns and roofed with the same stone. On the central ridge of the opposite side of the island, 10 miles distant, are a large number of very fine basaltic columns, and this must have been the quarry for the structure just described, for the configuration of the land is such that roads would have been impracticable, and the only deduction is that the material must have been taken down to the coast and thence by water to the location on the creek.

This is reported to have been the home of the buccaneers, but it is impossible that they could have put up works of such magnitude. There are other ruins on the island, and also some mounds of considerable size, 12 feet high and a quarter of a mile long. On Kusai, and other islands of the group are found ruins, but those of Ponape are by far the most remarkable.

Though not properly in the province of the work, a short description by Mr. Wallace of some of the architectural wonders of Java is inserted. He estimates the date of their construction at five hundred years ago when the island was under the sway of the Hindoos.

* From Wallace's "Australia."

The road to Wonosalem led through a magnificent forest, in the depths of which we passed a fine ruin of what appeared to have been a royal tomb or mausoleum. It is formed entirely of stone, and elaborately carved. Near the base is a course of boldly projecting blocks, sculptured in high relief, with a series of scenes which are probably incidents in the life of the defunct. These are all beautifully executed, some of the figures of animals in particular being easily recognizable and very accurate. The general design, as far as the ruined state of the upper part will permit of its being seen, is very good, the effect being given by an immense number and variety of projecting or retreating courses of squared stones in place of mouldings. The size of the structure is about 30 feet square by 20 feet high, and as the traveler comes suddenly upon it on a small elevation by the road side, overshadowed by gigantic trees, overrun with plants and creepers, and closely backed by the gloomy forest, he is struck by the solemnity and picturesque beauty of the scene, and is led to ponder on the strange law of progress, which looks so like retrogression, and which in so many distant parts of the world has exterminated or driven out a highly artistic and constructive race, to make room for one which, as far as we can judge is very far its inferior. The number and beauty of the architectural remains in Java have never been popularly illustrated or described, and it will therefore take most people by surprise to learn that they far surpass those of Central America, perchance those of India. To give some idea of these ruins, perhaps to excite wealthy amateurs to explore them thoroughly, and to obtain by photography an accurate record of these beautiful sculptures before it is too late, I will enumerate the most important as briefly described in Sir Stanforns Raffle's History of Java.

Near the center of Java, between the native capitals of Djoko-Kerta and Sura-Kerta, is the village of Brambanam, not far from which are abundance of ruins, the most important being the temples of Loro-Jongran and Chandi-Sewa. At Loro-Jongran there were separate buildings, six large, and fourteen small temples. They are now a mass of ruins, but the largest temple was supposed to have been 90 feet high. They were all constructed of solid stone, everywhere decorated with carvings and bas-reliefs, and adorned with numbers of statues, many of which remain entire. At Chandi-Sewa, or the "thousand temples," are many fine colossal figures. Captain Baker, who surveyed these ruins, said that he had never in his life seen such stupendous and finished specimens of human labor, and the science and taste of ages long since forgotten, crowded together in so small a compass as in this spot. They cover a span of nearly 600 feet square, and consist of an outer row of eighty-four temples; a second row of seventy-six; a third row of sixty-four; a fourth of forty-four; and a fifth forming an inner parallelogram of twenty-eight; in all two hun-

dred and ninety-six small temples disposed in five regular parallelograms. In the center is a large cruciform temple surrounded by forty flights of steps, richly ornamented with sculpture and containing many apartments.

The tropical vegetation has ruined most of the smaller temples, but some remain tolerably perfect, from which the effects of the whole may be imagined. About half a mile off is another temple, called Chandi Kali Bening, 72 feet square and 60 feet high, in fine preservation, and covered with sculptures of Hindu mythology surpassing any that exists in India. Other ruins of palaces, halls and temples, with abundance of sculptured deities, are found in the same neighborhood.

About 80 miles eastward, in the province of Kedu, is the great temple of Borobods. It is built upon a small hill, and consists of a central dome and seven ranges of terraced wall, covering the slope of the hill, forming open galleries, each below the other, and communicating by steps and gateways. The central dome is 50 feet in diameter; around it is a triple circle of seventy-two towers; and the whole building is 620 feet square and about 100 feet high. In the terraced walls are niches containing cross-legged figures larger than life, to the number of about four hundred; both sides of the terraced walls are covered with bas-reliefs crowded with figures carved in hard stone, which must therefore occupy an extent of nearly 3 miles in length.

The amount of human labor and skill expended upon the great pyramids of Egypt, sink into insignificance when compared with that required to complete this sculptured hill temple in the interior of Java.

About 40 miles southwest of Samarang, on a mountain called Juong Prau, an extensive plateau is covered with ruins. To reach the temples, four flights of stone steps were made up to the mountain from opposite directions, each flight containing more than a thousand steps. Traces of nearly four hundred temples have been found here, and many (perhaps all) were decorated with rich and delicate sculptures. The whole country between this and Brambanam, a distance of 60 miles, abounds with ruins, so that fine sculptured figures may be seen lying in ditches, or built into the walls of inclosures.

In the eastern part of Java, at Kediri, and in Melang, there are equally abundant traces of antiquity, but the buildings themselves have been mostly destroyed; sculptured figures, however, abound, and the ruins of forts, palaces, baths, aqueducts, and temples can be everywhere traced.

The ruins of the ancient city of Majapahit cover miles of ground with paved roads, walls, tombs, and gateways, while sculptures of Hindu gods and goddesses of hard trachytic rock are found in the forests or *in situ* in temples. Some of the buildings are of brick of curious construction; the bricks are burned and built together without cement, and yet adhere incomprehensibly.

LANGUAGE—VOCABULARY.

The natives reckoned their time, and in fact do so still by moons or months, commencing the year with August, which was, according to the traditions, the time when Hotu-Matua and his followers landed upon the island.

The following corresponds nearly to the English months set opposite:

Anekena	August.	Tuaharo	February.
Hora-iti (little summer)	September.	Tetnupu	March.
Hora-nui (big summer).....	October.	Tarahao	April.
Tangarouri.....	part of November.	Vaitu-nui (big winter)	May.
Kouti	November and December.	Vaitu-poto (short winter)	June.
Ruti	December and January.	Maro or Temaro.....	July.
Koro.....	January.		

The natives have recently divided the months into weeks, giving to the days the names of First day (Raa-po-tahi), Second day (Raa-po-rua), Third day (Raa-po-toru), etc. The week is commenced on Monday in order to bring the seventh day on Sunday.

The month is divided into two equal portions, the first beginning with the new moon, and the second with the full moon. The calendar at the time of our visit to the island ran about as follows, the new moon being full on November 26:

Kokore tahi (first Kokore) ..	November 27	Kokore toru (third Kokore) ..	December 13
Kokore rua (second Kokore) ..	November 28	Kokore há (fourth Kokore) ..	December 14
Kokore toru (third Kokore) ..	November 29	Kokore rima (fifth Kokore) ..	December 15
Kokore há (fourth Kokore) ..	November 30	Tapume	December 16
Kokore rima (fifth Kokore) ..	December 1	Matua	December 17
Kokore ono (sixth Kokore) ..	December 2	Orongo, last quarter	December 18
Maharu, first quarter	December 3	Orongo taane	December 19
Ohua	December 4	Mauri nui.....	December 20
Otua	December 5	Marui Kero	December 21
Ohotu	December 6	Omutu.....	December 22
Maure	December 7	Tueo	December 23
Ina-ira	December 8	Oata.....	December 24
Ra Kan	December 9	Oari, new moon	December 25
Omotohi, full moon	December 10	Kokore tahi (first Kokore) ..	December 26
Kokore tahi (first Kokore) ..	December 11	Etc., etc., etc.	
Kokore rua (second Kokore) ..	December 12		

The natives of Easter Island speak a dialect of the Malayo-Polynesian language, which is so widely spread in the South Sea and Malay Archipelago. Any one who will take the trouble to compare the accompanying vocabulary with the same words used by the natives of New Zealand, Tahiti, Rorotonga, Samoa, and any of the islands of Polynesia, will see that many of the words are identically the same, and others show a slight variation.

Not only do the words of this language resemble those spoken throughout the South Sea, but all the dialects possess, in common, the

peculiarity of having a dual number of the personal pronouns in addition to the singular and plural. For example, he or she is, "Ko-ia," in the Maori it is, "ia;" they two, on this island is "rana-â," in the Maori it is "raua;" they, in this dialect is "pouro," in the Maori, it is "ratou." Words are frequently reduplicated to denote the plural of collectives in nouns, the comparative, or superlative degree in adjectives, and repeated action in verbs. "Iti" signifies little, "iti-iti," expresses very little, and the word for small child is "poki iti-iti." Food, or to eat, is "Kai," to eat much or heartily is expressed by "kai-kai." The names of several of the colors are usually duplicated, as red, "mea-mea;" black, "uri-uri;" white "tea-tea;" vermilion "ura-ura."

An interesting feature of the language is the native name for pig, "Oru," which differs from the corresponding term in all of the other Polynesian dialects. It is probably derived from the grunting sound made by the animal. In nearly all of the kindred dialects the name for pig is "puaka," a word which is also applied by some of them to all quadrupeds except the rat. The Easter Islanders have given this name to cattle, calling a cow "puaka tamahine" (female puaka), and a bull "puaka tamaroa" (male puaka). This tends to show that although pigs had probably been introduced on the islands from which the ancestors of the present inhabitants came, they took none with them in their migration, and only preserved the word puaka in a vague sense, as signifying a large animal with four legs. When cattle were introduced, they consequently applied the term to them, and coined the new one afterwards.

Fingers are called "manga-manga" and toes, "manga-manga vae," or literally the fingers of the foot. "Kiri" means covering, and to express the wood shoe they say "Kiri vae," or covering, for the foot. "Ivi" is the name applied to both needle and bone, which probably indicates that the original needles were made of bone.

In the pronunciation of words of two syllables, the accent is on the first; in words of three syllables it is generally on the second, and in polysyllabic words it is on the penultimate. Modern articles recently introduced on the island are called by their English names, or something that has a similar sound.

It is worthy of note that the word "Atua" is used to signify both god and devil.

VOCABULARY.

Absent	Ngaro.	A or and	E.
Adieu	Kamoi.	Age	Mata hi.
Air	Hangu.	Abdomen	Manava.
Aid	Hanu.	Ankle	Kari-kari vae.
All (whole)	Auanake.	Arms	Kaufa.
Ancestor	Tupuna.	Arm	Rima.
Artisan	Maori.	Artery	U'a nobo toto.
Antumu	Vaha-tonga.	Ash-wood	Mari-kuru.
Ax	Toki.	Ape-fish	Nohue.

Arrow-root	Pia.	Cure	Hakaora.
Bad	Rake-rake.	Cut	Hauva.
Bath	Hopu.	Cut-grass	Kaverimai.
Battle (war)	Tana.	Cape	Heihu.
Bay	Paconga.	Coat	Lukan.
Before	Vaha.	Come here	Ohogimai.
Below	Iraro.	Clay	Oone vai.
Bird	Manu.	Cry	Tangi.
Bird (tropic)	Makohe.	Cattle	Puaka.
Bitter	Kava.	Crab	Pikea.
Black	Uri-uri.	Calf of leg	Reru.
Boat	Vaka Poe-poe.	Chest	Uma.
Boy	Poki-tanaroa.	Chin	Kanae.
Branch	Manga miro.	Clitoris	Matakao.
Bring me	Kotomai.	Copulate	Tuki-tuki.
Brother (younger)	Hangn potu.	Convulvulus	Tanoa.
Brother (elder)	Atariki.	Calabash	Hue.
Brown	Hiku vera.	Cockroaches	Ngarara.
Bury	Muraki.	Cemetery	Papekoo.
Bull	Puaka tanaroa.	Cheek	Kukunne.
Bush	Miro taka-taka.	Dance	Hoko-hoko.
Button	Herreo.	Darkness	Pouri.
Boar	Oru tamaroa.	Day	Raa.
Back	Tua iri.	Death	Mate.
Beard	Vere.	Defeat	Kio.
Bladder	Tana mimi.	Dew	Hau.
Blood	Toto.	Diaper	Hami Kaufa.
Bone	Iri.	Dirty	Go-o-onea.
Breath	Hangu.	Docile	Mangaro.
Buttock	Evè taki-evè.	Dog	Paihenga.
Bulrush	Naatu.	Drink (water)	Kaunu taa-vai.
Boobies (birds)	Kuia.	Dry	Paka-paka.
Basket	Kete.	Dry, v.	Haka paka-paka.
Calm	Marie.	Dung	Tutai.
Canvas	Hecki keho.	Dwell	Noho.
Cannibal	Kai tangata.	Devil	Atua.
Cat	Gooli.	Dish-cloth	Te maro.
Catch	Kato.	Drinking-cup	Rapa-rapa.
Caught	Roa A.	Dead	Heniatu.
Care	Ana.	Ear-ring	Taringa.
Chief	Honui.	Earth	Oone.
Child	Poki iti-iti.	Eat (food)	Kai.
Clean	Maita Kia.	Eat (heartily)	Kai-kai.
Climb	Kahiti.	Evening	Ata-ta.
Cloak	Nua.	Eel	Koiro.
Clothing	Hami.	Ear	Taringa.
Cloud	Rangi tea-tea.	Elbow	Turi rima.
Club (short)	Para.	Eye (or face)	Mata.
Club (dancing)	Ao.	Eye-brow	Hihi.
Club (long)	Ua.	Eye-lash	Veke-veke.
Cocoonut	Niu.	Eye-lid	Tutu Mata.
Comb	Tapani.	Far	Konui.
Cooking place	Heumu.	Feign	Haka kemo.
Correct	Riva mao á.	Female	Tamahini.
Cow	Puaka tamahini.	Fire	Ahi.

Fish	Ika.	Heaven	Rangi.
Fishing	Ika kato omai.	Heavy	Panghi.
Fishing-line	Eaho.	Here	Inri-iā.
Fish-hook	Herou.	High	Runga.
Fish-snood	Ekave.	Hot	Vera.
Flea	Koura.	House (hut)	Hare.
Flower	Pua.	Hunger	Marnaki.
Fly	Kakaure.	Hurry	Horo-horan.
Food	Kai.	Hush	Gamu.
Fowl	Moa.	Hat	Hau.
Fork	Manga-manga.	He, she, it	Koia.
Fool	Heva.	Horse	Hoi.
Fray	Tana.	Hen	Eufa.
Fury	Pohi.	Hair	Ranoho
Full	Titi ā.	Hand	Rima.
Fancy	Tangi-hangi.	Head	Puko.
Few	Tae nengo-nengo.	Heart	Mokoikoi.
Face	Mata.	Hip	Tipi.
Fat	Nāko.	Hibiscus	Moana.
Fore-arm	Paonga.	Hill	Otu.
Forehead	Korae.	Heel	Rike.
Finger	Manga-manga.	Infant	Poki porekoiho.
Finger (index)	Rima tuhi henna.	Iron-rust	Toto ohio.
Finger (middle)	Roaroa tahanga.	I or me	Kovan.
Finger-ring	Rima tuhi ā hana.	Instep	Peka-peka vae.
Finger (little)	Ko manarao.	Intestines	Nene-nene.
Foot	Vae.	Ice-plant	Herepo.
For, or to	Ki.	Image	Moai.
Father	Metua.	Jest	Haka reka.
Girl	Poki tamahini.	Joy	Koa.
Give me	Karai-mai.	Kill	Tingai.
Glance	Mata ui.	Knife	Hoe.
Go	Kaho.	Kidney	Makoikoi.
Go away	Rari kau.	Knee	Turi.
God	Atua.	Kelp	Harepepe.
Gold	Tui-tui.	King	Ariiki.
Gold coin	Ohio.	Land	Kaina.
Good	Riva-riva-maitai.	Lantern	Hera parapa.
Grass	Mouku.	Large	Nui.
Grave	Avanga.	Laugh	Ekata.
Great	Nui.	Leaf	Ranpa.
Grief	Topa tangi.	Life	Po-o-te tangata.
Gull	Kia-kia.	Light	Maehā.
Gun	Hango.	Light (weight)	Marma.
Gave	Eaai.	Lightning	Uira.
Get out	Kahoa.	Little	Iti.
Gourd vine	Hue.	Lonely	Hoko tabi.
Grass (fine)	Turumea.	Long (far)	Konni roa.
Grass (bunch)	Moku.	Lose, v.	Marere.
Goddess	Kirato.	Limpet (Chiton <i>magnificus</i>)	Hemama.
Good-by	Kamoi.	Leg	Heru.
Greeting	Kakoia.	Lips	Ngutu.
Hail	Rangi.	Liver	Até.
Half	Vaenga.	Lung	Inanga.
Handkerchief	Rupa.		

Lichen	Kihi-kihi.	Play	Kori.
Leek	Hekekeohe.	Prawn	Ura.
Luck	Hera-ki-to-mea.	Pitch	Piarhioa.
Lobster	Ura.	Population	Heatua.
Man	Tangata.	Puffed	Pupuhi.
Make	Haka.	Pure	Putu.
Male	Tamaroa.	Physilia utriculus	Papa Ki.
Mat	Moenga.	Palm (of hand)	Paraha Rima.
Meet	Pire.	Pancreas	Kiko o te ivi tikā.
Moon	Mahina.	Penis	Ure.
More	Kina.	Perineum	Vaha takitua.
Morning	Popohanga.	Prepuce	Kiri ure.
Mountain	Mounga.	Pubes	Puku.
Move	Hakaneke.	Pulse	Ua naiei.
Mud	Oone heke-heka.	Rage	Pohi.
Memory	Manuao.	Rat	Kiora.
Modern	Hou anei.	Red	Mea-mea.
Mamma	U.	Rest	Hakaora.
Moustache	Verē ngutu.	River	Vai tahē.
Mouth	Haha.	Road	Ara.
Muscle	Kiko na-na.	Rock	Maka motu.
Milk-thistle	Poporo-hiva.	Roll, v.	Katuru.
Marshmallow	Mova.	Root	Aka.
Name	Ingoa.	Rope	Huti.
Narrow	Vaka-vaka.	Rain	Ua.
Native	Hoā kona.	Rib	Kava-kava.
Needle	Iri.	Salt	Kava.
New	Hou.	Sand	Oone.
Next	Tetahi.	Sea-urchin	Hetuke.
Night	Po.	See, v.	Kui.
No	Aita.	Servant	Pukuranga.
Now	Anei rā.	Ship	Miro.
Nail (finger)	Mai kuku.	Shirt	Gahu.
Navel	Pito.	Shoe	Kiri vai.
Neck	Ngao.	Shoot, v.	Pakakina.
Nipple	Matañ.	Shooting	Hango pakakina.
Nose	Ihu.	Short	Poto-poto.
Nostril	Poko-poko ihu.	Shoulder	Kapu hivi.
Obsidian	Mahaa.	Silver	Monie.
Oar (paddle)	Matakao.	Sky	Rangi uri-uri.
Obey	Haka-rongo.	Sleep	Han-uru.
Omitted	Patu.	Slip	Kahinga.
Of	Ka.	Smoke	Au umu.
Paint	Penetuli.	Smoking	Kangan.
Paper	Para-para.	Snail	Pipi.
Path (trail)	Ara.	Soon	Anei ra nei.
Place	Pahu.	Sorrow	Tangi toka-tangi.
Pick	Kaverimai.	Speak	Paran vangana.
Pig	Oru.	Spear	Mataa.
Pine	Koromaki.	Spirit (soul)	Kuhango.
Pipe	Puhi-puhi.	Spring (season)	Vaha hora.
Plaiting	Tanra.	Steal (thief)	Toki-toki.
Plant	Mea tupu.	Stand up	Komaru.
Plantation	Kona oka kai.	Star	Hetu.

Stone	Kihi-kihi.	Together	Amogio.
Stone (tool)	Tauki.	Tendon	Na na.
Stone ax	Toke.	Testes	Miripau.
String	Huti.	Thigh	Papa Kona.
Sugar-cane	Toa.	Thumb	Rima metua nea-neā.
Summer	Hora.	Tongue	Arero.
Sun	Raa.	Toe	Manga-mauga vae.
Suspenders	Pena.	Tooth	Niko.
Swallow, v.	Kahoco.	Toe (great)	Manga-manga tumu.
Satchel (valise)	Kete.	To, or for	Ki.
Shell	Pule.	Tea-plant	Ti.
Sit	Noho.	Thread	Taura.
Sit down	Kano.	To fight	Kavava.
Slowly	Koro iti.	To throw away	Parue.
Small	Iti.	To awake	Karu.
Soaked	Ngare-perepe.	To smoke	E ono.
Stocking	Tokin.	To cough	Etehu.
Stop (halt)	Maroa.	Umbrella	Hemahia.
Stopped	Hakanoho hia.	Under	Iraro.
Stuffed	Mea popo.	Up	Runga.
Sheep	Mamoi.	Urethra	Na mimi.
Sow	Oru tamahine.	Uterus	Henua.
Small univalve	Ngngongi.	Valley	Ava mounga.
Sea-bass	Kodoti.	Vengeance	Kopeka.
Scalp	Kiri puoko.	Vermilion	Ura-ura.
Scrotum	Kiri maripu.	Vessel (water)	Ipu.
Shin	Paka.	Victor	Matatoa.
Shoulder	Kapu hivi.	Vine (fern)	Riku.
Sole (of foot)	Pararaha vae.	Virgin	Nire.
Spine	Tua papa.	Vagina	Takapan.
Spleen	Para.	Vein	Ua.
Stomach	Kopu mau.	Vulva	Kannutu.
Sea-weed	Miritoun.	War	Tana.
Strength	Riri.	Warrior	Tangata Matan.
Shark	Ninki.	Water (fresh)	Vai.
Skin	Kite.	Water (salt)	Vai-kava.
Talk	Paran.	Wave	E.
Fame	Mangaro.	White	Tea-tea.
Taro	Taro.	Who	Korai.
Tattooing	Tā Konā.	Whole (all)	Ananakē.
Tenderly	Ko viti.	Wide	Hakarava.
Thief	Toke-toke.	Widow	Hove.
Thin	Paki roki.	Widower	Hovē.
Thirst	Mate vai.	Wife	Na via.
Thunder	Hatu tiri.	Wild	Manu.
Tobacco	Ava-ava.	Wind	Tokeran.
To-morrow	Apo.	Winter	Tonga.
Free	Miro tupu.	Woman	Via.
Trunk of tree	Tutuma.	Wood	Miro.
Turtle	Honu.	Worm	Koreha.
They	Pouro.	Write	Motu rongo-rongo.
The	Te.	Wet	Rari.
Those	Rana ā.	When	Ahea.
Thou	Koe.	We	Matou.

Waist	Kakari manara.	Yes	Aë.
Wrist	Kakau rima.	Youth	Kope tungu-tunga.
White-bait (fish)	Poopo.	You	Koe.
Year	Tau.	Yam	Kape.
Yellow	Pava.		

NUMERALS.

In counting the natives use the fingers of both hands but never the toes.

1 = Ka-tahi.	50 = Ka rima te aanghuru.
2 = Ka-rua.	60 = Ka ono te aanghuru.
3 = Ka-toru.	70 = Ka hitu te aanghuru.
4 = Ka-ha.	80 = Ka raru te aanghuru.
5 = Ka-rima.	90 = Ka ira te aanghuru.
6 = Ka-ono.	100 = Ka rau.
7 = Ka-hitu.	101 = Ka tahi te rau ma tahi.
8 = Ka-varu.	102 = Ka tahi te rau ma rua.
9 = Ka-iva.	200 = Ka rua te rau.
0 = Aanghuru.	201 = Ka rua te rau ma taki.
10 = Ka tahi te aanghuru.	300 = Ka toru te rau.
11 = Ka tahi te aanghuru Ka tahi.	301 = Ka toru te rau ma tahi.
12 = Ka tahi te aanghuru Ka rua.	400 = Ka ha te rau.
13 = Ka tahi te aanghuru Ka toru, etc.	401 = Ka ha te rau ma tahi.
20 = Ka rua te aanghuru.	500 = Ka rima te rau, etc.
21 = Ka rua te aanghuru Ka tahi.	1,000 = Piere.
22 = Ka rua te aanghuru Ka rua.	2,000 = Ka rua te piere.
23 = Ka rua te aanghuru Ka toru, etc.	3,000 = Ka toru te piere.
30 = Ka toru te aanghuru.	4,000 = Ka ha te piere.
31 = Ka toru te aanghuru Ka tahi.	10,000 = Ka mano.
32 = Ka toru te aanghuru Ka rua.	100,000 = Ka peka.
33 = Ka toru te aanghuru Ka toru, etc.	1,000,000 = Ha ra.
40 = Ka ha te aanghuru.	Over one million, mingoi-ngoi.

From 1 to 10 the syllables are pronounced as one word, in a multiple of ten the words are distinctly separated. A record of numbers was kept by stringing pieces of bulrush together.

ABORIGINAL SKIN-DRESSING—A STUDY BASED ON MATERIAL IN THE
U. S. NATIONAL MUSEUM.

By OTIS T. MASON,
Curator of the Department of Ethnology.

INTRODUCTION.

Consider for a moment all the industries included within the word "leather." It involves everything done to the hides of animals from the moment they are taken off by the butcher until they are manufactured and ready to be sold to the consumer. It is important to enter somewhat into detail at this point before describing the skin-working apparatus of the American aborigines, so as to bring into a congenial relationship the earliest and the latest manifestation of a great series of industries.

The hides of cattle, sheep, goats, horses, dogs, and indeed of all domestic animals, the peltries of all wild animals that are of any use whatever to man, are gathered up in a kind of civilized or wild harvest, as the case may be, by butchers, trappers, hunters, etc., and sent to the tannery or to the manipulators answering to this trade.

Here commences a diversity of treatment, ending in the preparation of the hide with the hair remaining, by the furrier; in the production of a soft leather by a process called tawing; or in the manufacture of true leather by the use of tannin in some form. We have done now with the secondary industries.

The products of the leather factories are taken up and prepared for consumption by harness-makers, shoe-makers, glove-makers, satchel-makers, embossers, book-binders, carriage-makers, armorers, machinists, musical-instrument-makers, taxidermists, and the like, and passed on through the great Briareus of commerce to those who will destroy them in use.

After fully realizing this immense body of industries, we are in a position to appreciate one or two facts respecting savagery, to wit, how largely the products of the skins of animals entered into the activity of primitive men; how necessary it is, in order to reconstruct that civilization, to know what modern savages do with these same substances, and finally to collect the tools and observe the processes of aboriginal

peoples working at this series of trades in order to know the life-history of a great human occupation.

The first artisans of this craft were, for the most part, women, who, indeed, were the inventors and fostering patrons of all these simple arts which lay at the foundation of most of our modern peaceful industries.

Let us follow the savage woman through her daily cares in order that we may comprehend the significance of her part in the play. The slain deer lying before her cave or brush shelter, or wigwam, shall be the point of departure in the inquiry. She strikes off a sharp flint flake for a knife. By that act she becomes the first cutler, the real founder of Sheffield. With this knife she carefully removes the skin, little dreaming that she is thereby making herself the patron saint of all subsequent butchers. She rolls up the hide, then dresses it with brains, smokes it, curries it, breaks it with implements of stone and bone, with much toil and sweat, until she establishes her reputation as the first carrier and tanner. With fingers weary and worn, with needle of bone and thread of sinew, and scissors of flint, she cuts and makes the clothing for her lord and her family; no sign is over the door, but within dwells the first tailor and dress-maker. From leather especially prepared she manufactures moccasins for her husband, which to his speed adds wings. Compared with the tardy progress of her barefooted man in the chase, they are indeed the winged sandals of Hermes, and she is the aboriginal St. Crispin. Out of little scraps of fur and feathers, supplemented with bits of colored shell or stone or seeds, she dresses dolls for her children, makes head-dresses and toggery for the coming dance, adorns the walls of her squalid dwelling, creating at a single pass half a dozen modern industries—at once, toy-maker, milliner, modiste, hatter, upholsterer, and wall-decker.

In order to comprehend the steps in the processes of the aboriginal tanner it may be serviceable to take a hurried glance through a modern tannery. The methods of procedure are somewhat as follows:

(1) Salted or dried hides are soaked to make them pliable, washed, and the extraneous flesh taken off with a flesher, an instrument like a drawing knife, sharp on one edge and dull and smooth on the other. Market hides are soaked in fresh water to remove blood and dirt.

(2) The cleaned hides are then placed for a few days in a vat of lime water, which opens the pores, loosens the hair and combines with the oily matter in the hide to form a soap. Putrefaction softening is also resorted to for removal of the hair.

(3) The hides are then rubbed down with the smooth side of the flesher, the hair removed, and the skin made as pure and clean as it can be. They are at the same time rendered porous for the reception of the tannin.

(4) They are then hung in a series of tan-pits, in which the water is more and more charged with tannic acid until the hide is converted into leather.

(5) After rinsing, the hides are subjected to scouring in a machine by which one man can go over a hundred a day. But the interesting part remains that Turkey-stone is still the only substance that will do the work. The whole operation at this point is no more than a savage process, except that machinery is used to move the stone.

(6) The subsequent processes of drying, oiling, sweating, and pressing are varied with the uses of the leather. The genius of the inventor has been invoked to substitute machinery for these simple hand processes. After all the problems are the same, to remove the hair without impairing the hide, to introduce some antiseptic substance within the texture, to break up the fibrous tissue, and to render it pliable as possible. The subsequent processes of dyeing and preparing for special uses involve all the accretions of civilization, and produce the complexity of the more highly organized processes.

ANIMALS WHOSE SKINS ARE UTILIZED BY AMERICAN ABORIGINES.

It will help us in getting an adequate conception of the amount of work on peltries by our aborigines to consider for a moment the great number and variety of animals whose skins were necessary to their happiness. The mention of savage skin-working usually recalls the seal, elk, reindeer, musk-ox, buffalo, bear, deer, beaver, and fox, but a moment spent in examining the species of mammals which the fastidious taste of an Esquimo woman demands before her wardrobe is completed will enlarge one's knowledge.

In order to properly estimate the industry under consideration, a list of the animals whose skins are known to have been used by our aborigines is appended.

MAMMALS.

Felidæ.

- Lynx rufus* (Güldenstädt). Bay lynx or wild cat. North America.
Lynx baileyi Merriam. Plateau wild cat. Colorado, Utah, and Arizona.
Lynx canadensis (Geoff. and Desm.). Canada lynx. Northern North America.
Felis yaguarundi Desm. Yaguarundi cat. North America, south of the United States.
Felis concolor Linn. Puma or cougar. America generally.
Felis pardalis Linn. Ocelot or tiger cat. Southwestern North America.

Canidæ.

- Canis lupus* Linn., var. *griseo-albus*. Gray wolf. North America generally.
Vulpes macrotis Merriam. Big-eared fox. Southern California.
Vulpes fulvus (Desm.), var. *decussatus*. Cross fox. Northern North America.
Vulpes fulvus (Desm.), var. *fulvus*. Red fox. Northern North America.
Vulpes fulvus (Desm.), var. *argentatus*. Silver fox; black fox. Northern North America.
Vulpes macrurus Baird. Prairie fox. Western States.
Vulpes velox (Say). Kit fox or swift fox. Western States.
Vulpes lagopus (Linn.). Arctic fox. Alaska.

Urocyon virginianus (Schreber). Gray fox. United States generally.

Urocyon virginianus (Schreber), var. *littoralis*. Coast gray fox. Islands of the California coast.

Mustelidæ.

Mustela pennanti Erxl. Fisher. Northern North America.

Mustela americana Turton. Pine martin or American sable. Northern United States.

Mustela caurina Merriam. Washington Terr.

Putorius erminea (Linn.). White weasel; ermine. Northern United States.

Putorius longicauda Bonaparte. Long-tailed weasel. Western United States.

Putorius vison Rich. Mink. North America generally.

Putorius nigripes Aud. and Bach. Black-footed ferret. Western States (in holes of prairie dogs).

Gulo luscus Sabine. Wolverine or glutton. Northern North America.

Taxidea americana Waterh. American badger. Western United States and Pacific slope.

Mephitis mephitica (Shaw). Common skunk. Eastern United States.

Mephitis estor Merriam. Arizona.

Spilogale putorius (Linn.). Little striped skunk. Florida.

Spilogale interrupta (Rafin.). Little striped skunk. Kansas.

Spilogale ringens Merriam. Little striped skunk. Alabama.

Spilogale indianola Merriam. Little striped skunk. Texas.

Spilogale lucasana Merriam. Little striped skunk. Lower California.

Spilogale leucoparia Merriam. Little striped skunk. Texas.

Spilogale gracilis Merriam. Little striped skunk. Arizona.

Spilogale saxatilis Merriam. Little striped skunk. Utah.

Spilogale phenax Merriam. Little striped skunk. California and Oregon.

Conepatus mapurito (Gmelin). White-backed skunk. Southwestern United States.

Lutra canadensis Sab. American otter. North America generally.

Enhydra marina Fleming. Sea otter. Pacific coast of the United States.

Ursidæ.

Ursus horribilis Ord. Grizzly bear. Western United States and Pacific slope.

Ursus richardsoni Reid. Barren ground bear. Arctic America.

Ursus americanus Pallas. Black bear. United States generally.

Thalarectos maritimus (Linn.). White or polar bear. Northern America, Europe, and Asia.

Procyonidæ.

Procyon lotor (Linn.). Raccoon. United States generally.

Otaridæ.

Callorhinus ursinus (Linn.). Fur seal. North Pacific Ocean and Bering Sea.

Eumetopias stelleri (Lesson). Steller's sea lion. Pacific coast.

Phocidæ.

Phoca vitulina Linn. The common seal; harbor seal. North Atlantic and Pacific oceans.

Phoca groenlandica (Fabr.). Harp seal. Arctic seas.

Phoca fasciata Zimm. Banded or ribbon seal. Pacific coast, Arctic seas.

Erignathus barbatus (O. Fabricius). Square-flipper seal. Arctic seas.

Halichoerus gryphus (O. Fabricius). Gray seal. North Atlantic ocean.

Cystophora cristata (Erxl.). Hooded seal. North Atlantic ocean.

Macrorhinus angustirostris Gill. Sea elephant; elephant seal. Pacific coast.

Odobænidæ.

- Odobænus rosmarus* (Linn.). Atlantic walrus. North Atlantic.
Odobænus obesus (Illig.). Pacific walrus. North Pacific.

Bovidæ.

- Bison americanus* (Gmelin). Bison, or American buffalo. The great prairie region (nearly extinct).
Ovibos moschatus Blainville. Barren grounds of Arctic America.
Mazama montana (Ord). Rocky Mountain goat. Northern Rocky Mountains of the United States and British America.
Ovis canadensis Shaw. Bighorn; Rocky mountain sheep. Rocky Mountain region.

Antilocapridæ.

- Antilocapra americana* Ord. Pronghorn antelope or cabree. Plains west of the Missouri from lower Rio Grande to the Saskatchewan.

Cervidæ.

- Alces machlis* (Linn.). Moose. Northwestern United States to Alaska.
Rangifer tarandus (Linn.), subspecies *caribou*. Woodland caribou. Arctic and subarctic America.
Rangifer tarandus (Linn.), subsp. *groenlandicus*. Barren-ground caribou. Arctic America.
Cervus canadensis Erxl. American elk; wapiti. Northern North America.
Cariacus virginianus (Boddaert). Virginia deer. United States east of the Missouri.
Cariacus macrotis (Say). Mule deer. Central North America.
Cariacus columbianus (Rich.). Columbia black-tailed deer. Pacific slope.

Dicotylidæ.

- Dicotyles tajaou* (Linn.). Peccary. Red River, Arkansas, and southward.

Delphinidæ.

- Delphinapterus catodon* (Linn.). White fish or white whale. Arctic and subarctic seas (ascending large rivers).
Monodon monoceros Linn. Narwhal. Arctic seas.
Phocæna communis Lesson. Harbor porpoise; herring hog. North Atlantic and Pacific oceans.
Phocæna dallii True. Dall's porpoise. Coast of Alaska.
Globicephalus scanmoni Cope. Blackfish. Pacific coast.
Grampus griseus (Cuv.). Grampus; cow-fish. North Atlantic.
Orca gladiator (Lacépède). Killer whale. Pelagic.

Physeteridæ.

- Physeter macrocephalus* Linn. Sperm whale. Tropical and temperate seas.

Talpidæ.

- Scalops aquaticus* (Linn.). Common mole. United States generally.

Scuridæ.

- Sciurus niger* Linn.* Fox squirrel. Eastern United States, westward to the plains.
Sciurus carolinensis Gmelin.* Gray squirrel. United States.
Sciurus fessor Peale. California gray squirrel. Pacific slope.
Sciurus aberti Woodhouse. Tuft-eared squirrel. Southern Colorado, New Mexico, and Arizona.
Sciurus hudsonius Pallas.* Red squirrel; Chickaree. North America generally.
Tamias striatus (Linn.). Chipmunk. Eastern United States.
Tamias quadrivittatus (Say)*. Missouri striped squirrel. Pacific slope, eastward to Michigan.
Tamias lateralis (Say)*. Say's striped squirrel. Rocky Mountain region, from Mexico northward.
Spermophilus grammurus (Say)*. California ground squirrel. Pacific coast to Western Texas and New Mexico.
Spermophilus harrisi Aud. and Bach. Harris's ground squirrel. The Great Basin.
Spermophilus leucurus Merriam. Lower California.
Spermophilus franklini (Sabine). Gray gopher. Northern Illinois, northward to the Saskatchewan.
Spermophilus mohavensis Merriam. Mohave Desert.
Spermophilus mollis Kennicott. Short-tailed spermophile. Utah and Nevada, northward.
Spermophilus neglectus Merriam. Arizona.
Spermophilus tereticaudus Aud. and Bach. Round-tailed ground squirrel. Arizona.
Spermophilus tridecemlineatus (Mitchell)*. Striped gopher; prairie squirrel. The prairies of the United States.
Spermophilus mexicanus (Erxleben). Mexican ground squirrel. Southwestern Texas and southern New Mexico, southeastward into Mexico.
Spermophilus parryi Rich.* Parry's marmot. Northern parts of the continent, from the northern States to Hudson Bay and Bering Strait.
Spermophilus pilosoma Bennett.* Sonora ground squirrel. Eastern base of the Rocky Mountains north to western Wyoming.
Spermophilus cryptospilotus Merriam. Desert spermophile. Arizona.
Spermophilus canescens Merriam. Arizona.
Spermophilus richardsoni (Sabine). Yellow gopher. Plains of the Saskatchewan southward to the upper Missouri.
Spermophilus townsendi Bach. Townsend's ground squirrel. Plains of the Columbia.
Cynomys ludovicianus (Ord). Prairie dog. Great plains east of the Rocky Mountains.
Cynomys gunnisoni Baird. Short-tailed prairie dog. Sonoran region.
Cynomys leucurus Merriam. Wyoming.
Arctomys monax Linn. Woodchuck. Eastern North America.
Arctomys caligatus Eschscholtz. Hoary marmot. Rocky and Cascade Mountains from Washington northward.
Arctomys flaviventer Aud. and Bach. Yellow-bellied marmot. Rocky Mountains and westward to the Pacific coast.
Arctomys dacota Merriam. Dakota woodchuck. Black Hills, Dakota.

Haplodontidæ.

- Haplodon leporina* Rich. Sewellel; Showtl. Pacific slope (especially about Puget Sound).
Haplodon major Merriam. Sierra Nevada Showtl. Sierra Nevada Mountains.

* The species of rodents marked with an asterisk run into numerous geographical races. Descriptions of most of these will be found in the works of Drs. Coues and J. A. Allen, especially in *Monographs U. S. Geological Survey*, Vol. XI; also among the writings of Dr. C. H. Merriam, in *North American Fauna*, published by the U. S. Department of Agriculture.

Castoridae.

Castor canadensis Kuhl. American beaver. North America generally.

Geomyidae.

Geomys bursarius Rich. Pouched or pocket gopher. Missouri to Minnesota and Nebraska.

Geomys tuza (Ord). Florida salamander. Southeastern States.

Geomys castanops Baird. Texas pouched gopher. Texas and New Mexico.

Thomomys talpoides (Rich.). California gopher. Northern and western North America.

Thomomys clusius Coues. Small-footed pouched gopher. Rocky Mountains.

Muridae.

Cunicuculus torquatus (Pallas). White Lemming. Arctic America.

Myodes obensis Brants. Lemming. Arctic America.

Fiber zibethicus Cuv. Musk-rat. United States, except the southwestern portion and southern Florida.

Hystriidae.

Erethizon dorsatus (Linn.) var. *dorsatus*. White-haired porcupine. Northern United States.

Erethizon dorsatus (Linn.) var. *epixanthus*. Yellow-haired porcupine. Pacific slope and upper Missouri regions.

Leporidae.

*Lepus timidus** Fab., var. *arcticus*. Polar hare. Arctic and subarctic America.

Lepus americanus, Erxl. American hare; varying hare. Central United States to Alaska.

Lepus campestris, Bach. Prairie hare. Central plains of North America.

Lepus callotis Wagler. Jackass hare; jack rabbit. Southwestern United States.

Lepus texianus Waterh. Jack rabbit. Arizona.

Lepus californicus Gray. California hare. California.

Lepus sylvaticus Bach.* Gray rabbit; cotton-tail. United States generally.

Lepus arizonæ J. A. Allen. Arizona jack cotton-tail.

Lepus bachmani Waterhouse. Bachman's hare. Texas.

Lepus trowbridgii Baird. Trowbridge's hare. California.

Lepus palustris Bach. Marsh hare. Southeastern United States.

Lepus aquaticus Bach. Water hare. Southern States.

Lagomyidae.

Lagomys princeps Rich. Little chief hare or Pika. Rocky Mountain region from Colorado and Utah northward to Alaska.

Lagomys schisticeps Merriam. Sierra Nevada Pika. Sierra Nevada Mountains.

Dasypodidae.

Tatusia novemcinctus (Linn.). Armadillo. Southwestern United States and Southward.

Didelphidae.

Didelphys marsupialis Linn. Opossum. United States generally.

* The species of rodents marked with an asterisk run into numerous geographical races. Descriptions of most of these will be found in the works of Drs. Coues and J. A. Allen, especially in *Monographs U. S. Geological Survey*, Vol. XI; also among the writings of Dr. C. H. Merriam, in *North American Fauna*, published by the U. S. Department of Agriculture.

REPTILES.

Crocodilidæ.

Crocodylus americanus Seba. Florida crocodile. Southern Florida.

Alligator mississippiensis Daudin. Alligator. Southeastern North America.

Testudinidæ.

Testudo carolina Linn. Florida gopher tortoise. Southeastern North America.

Emydæ.

Malacoclemmys palustris (Gmelin). Diamond-back terrapin. Coast from New York to Texas.

Pseudemys rugosa (Shaw). Red-bellied terrapin. New Jersey to Virginia.

Pseudemys concinna (Leconte). Florida terrapin. Southeastern United States.

SKIN-DRESSING AMONG THE ESKIMO.

For the purpose of approaching this industry in its earliest and least complex state a few quotations from early travelers and explorers are introduced. Crantz, in the history of Greenland (p. 167), speaks as follows:

"For their 'kapitek,' or hairy seal-skin clothes, they scrape the seal-skin thin, lay it twenty-four hours in the 'korbik,' or urine tub, to extract the fat or oil, and then distend it for drying with pegs on a green place. Afterwards, when they work the skin, it is sprinkled with urine, rubbed with pumice-stone, and suppled by rubbing between the hands.

"(2) The sole leather is soaked two or three days in a urine tub; then they pull off the loosened hair with a knife or with their teeth, lay it three days in fresh water, and so stretch it for drying.

"(3) In the same manner they prepare the 'eresak' leather that they use for the legs of boots and the overleather of shoes, only that it is scraped very thin to make it pliable. Of this leather they also make the sea-coats which the men draw over their other clothes to keep out the wet when they go to sea. It is true it grows as soft and wet as a dish-cloth by the salt water and rain, but it keeps the wet from the undergarments.

"(4) In the same manner they dress the 'erogak,' of which they make their smooth black pelts to wear on shore, only in working it they rub it between their hands; therefore it is not so stiff as the foregoing, but loses the property of holding out water and is not fit for boots and sea-coats.

"(5) The boat-skins are selected out of the stoutest seal hides, from which the fat is not quite taken off. They roll them up and sit on them and let them lie in the sun covered with grass several weeks till the hair will come off. Then they lay them in the salt water for some days to soften them again. They draw the borders of the skins tight with

their teeth, sew them together, and smear the seams and stitches with old seal blubber instead of pitch, that the water may not penetrate. But they must take care not to impair the grain, for if they do the corroding sea-water will easily eat through the leather.

“(6) The remnants of this and the other sorts they shave thin, lay them upon the snow or hang them in the air to bleach them white, and if they intend to dye it red chew the leather with some bark of the roots of pine, which they gather up out of the sea, working it in with their teeth.

(7) They soften the skin of the fowls about the head and then draw it off whole over the body. The processes of tanning, Hall says, are first to scrape the skin by an instrument called *Sek-koon* (by the Frobisher Bay Innuits, *Teg-se-koon*). (Plates LXX, LXXI.)

This instrument is about 6 inches long, including the handle, and is made of a peculiar kind of whet or oil stone, or else of musk-ox or reindeer bone or of sheet-iron. The second step is to dry the skins thoroughly; the third, to scrape again with the *sek-koon*, taking off every bit of the flesh; the fourth, to wet the flesh side and wrap it up for thirty minutes, and then again scrape with the *sek-koon*, which last operation is followed by chewing the skin all over, and again scraping and cross scraping with the instrument. These laborious processes Hall describes as resulting “in the breaking of the skin, making the stiff hide soft, finished like the chamois skin.” The whole work is often completed within an hour. (Narrative of the Second Expedition made by C. F. Hall, pp. 91, 92.)

“In Cumberland Sound,” says Kumlien, “when a seal skin is about to be prepared for drying the blubber is first removed somewhat roughly, the skin then laid on a board, and with the woman’s knife the membrane underneath the blubber is separated from the skin. The knife must be very sharp to do this successfully. The operators always push the knife from them. It takes considerable experience to do the job well. When all the blubber is removed, which will take three or four hours of faithful work, the skin is taken outside, and by means of the feet is rolled and rubbed around in the snow for some time, and by this process they succeed in removing every trace of grease from the hair. When thoroughly washed the skin is put upon the stretchers, if it be winter, to dry; these stretchers are merely four poles, which are lashed together at the corners, like a quilt-frame, the proper distance apart to suit the size of the skin. The skin is secured in place by seal-skin thongs passed through little slits along its edges and made fast to the poles.

When the skin is properly stretched upon the frame it is put above the lamps inside the snow-but to dry. As the sun gets higher and begins to have some effect the skins are stretched, flesh side up, on the southern slopes of snow banks, and are secured by means of wooden or bone pegs about a foot in length.

As the season advances and the snow melts they begin to stretch the skins upon the ground by means of the before-mentioned pegs. The skins are not allowed to rest upon the ground, but are raised a few inches to allow the air to circulate underneath. Skins dry very fast when exposed in this manner.

The first days of spring are always a busy time with the Eskimo women. One thing is, they get more freshly-killed skins to prepare, and then they generally have a surplus stock of the winter's catch, which they could not take care of by the slow process of drying over the lamps in the luts during winter. The skins of the young in the white coats are dried in some considerable quantities, as it takes about fifteen to make a single suit of clothes, and many of them have double suits made from this material. They have no idea of any tan, and prepare the skins by merely rubbing them with their skin-scrapers.

We insert a sketch of a very old skin-scraper, such as are now found only in the old graves (Plate LXX, Fig. 3). It is made of stone, with a wooden handle, which is fastened to the stone by means of a strip of whalebone. Another and a later pattern is made from the scapula of the reindeer. A better idea of its manufacture can be got from the sketch than by a description. Such scrapers are still in use, but serve as a sort of auxiliary to one made from a tin can, resembling a little scoop in shape and having a wooden handle. This is the style of scraper made at the present day, and is by far the most effective instrument of the three. The manner of using these scrapers is to take the skin firmly in the left hand, to put the knee or foot upon the extreme part of it, holding it securely, while the scraper is worked with the right hand, pushing downward with some force. If the skins are very dry when they begin they are somewhat softened by rubbing with the hands, or even chewing the most stubborn parts. They continue using these tools upon a hide till it gains the desired pliability. All the work of stretching, drying, cleaning, washing, and softening the skins falls on the women.

"The skins of *Phoca barbata* are stretched on a frame like those of the netstick, but not until the hair has been removed. The cutting of the hair is one of the nastiest and most disgusting sights one can imagine. It generally falls to the lot of some old woman to do this. The skins are allowed to lie and become somewhat putrid, a portion of the blubber remaining on. The only tool used is the woman's knife before mentioned. When about to clean one of these skins the squaw takes off her boots, stockings, and pantaloons, and tucking her feet under her body, lays this dirty, bloody, greasy, stinking skin on her bare thigh, the flesh side down. She then pushes the knife against the hair, cutting or rather shaving it off. As her hand becomes too oily to hold on to the skin, she puts her fingers into her mouth and thus cleans them. When properly cleaned, it is dried in the manner already spoken of, except that the back and belly of the animal are dried separately, as the

skin is different on those portions of the body, and would cure unevenly. When finished it is almost as stiff and dry as a board. This skin is used mainly for the soles of boots; the pattern is cut from the hide and then chewed till it becomes sufficiently soft to sew. This last operation is also mainly performed by the old squaws. When they are too old to sew they become oojook chewers as the last resort, and when their teeth fail them they are better off in the grave." (Ludwig Kumtieu. Bull. National Museum, No. 15.)

Amongst the Central Eskimo, says Dr. Franz Boas, the latest authority, the skin of the seal (*Phoca, fastida*) is dressed in different ways according to the purpose for which it is intended. In skinning the animal a longitudinal cut is made across the belly with a common butcher's knife or one of ancient pattern (An. Rep. Bur. Ethnol VI., Fig. 460). The skin, with the blubber, is cut from the flesh with the same knife. The flippers are cut off at the points, and thus the whole skin is drawn off in a single piece. The woman's knife, ulo is used to clean and prepare the skins (*id.* Fig. 461), in which operation the women spread the skin over a piece of whalebone (*Asimautang*), a small board, or flat stone, and sit down before it, resting on their knees, the feet bent under the thighs. They hold the skin by the nearest edge, and pushing the ulo forward, remove the blubber and deposit it in a small tub, which stands near the board. As they proceed to the opposite end of the skin the finished part is rolled up and held in the left hand.

If the skin is to be used with the hair on it, the tough membrane (*mami*) which covers the inner side is removed in the same way as the blubber, and after it has been carefully patched and the holes have been cut all round the edge, it is stretched over a gravelly place or on snow by means of long pegs (*paukton*), which hold it a few inches above the ground, thus allowing the air to circulate underneath it. The skin itself is washed and rubbed with gravel, snow, or ice, and every hole made by the bullet or by the spear or in preparing it is sewed up. It very seldom happens that the women in preparing it damage the skin or even the thin mammae. It is particularly difficult to split the skin near a hole. First, they finish the work all around it and then carefully sever the membrane at its edge. The skin is dried in the same way as the membrane. In the early part of spring, though it may still be very cold, a few choice young seal skins are dried on snow walls which face the south. In order thoroughly to dry a seal skin, one fine warm spring day is needed. If the Eskimos are greatly in need of skins they dry them in winter over the lamps. A frame is made of four poles, lashed together, according to the size of the skin. A thong passes through the slits along its edge and around the frame, keeping the skin well stretched. Thus it is placed over the lamps or near the roof of the hut. However, it is disagreeable work to dry the skins inside the huts, and as they are much inferior to those which are dried on the ground, the Eskimos avoid it if they can. When so prepared the seal skins are only fit for

covering tents, making bags, etc.; they are too hard to be used for clothing, for which purpose the skin of yearlings is almost exclusively employed.

The young seals having shed for the first time have a very handsome coat, the hair being of a fine texture and much longer than in older animals. From the middle of May until late in summer their skins are most suitable for the manufacture of summer clothing, but it is necessary to protect the carcass of the killed animals from the burning rays of the sun as soon as possible, or the skin will be quickly spoiled.

After being dried they are cleaned with a sharp scraper (*teserqun*) (Boas, Figs. 465, 466). The skin is then soaked in salt water and washed again. As soon as it is dry it is softened with a straight scraper (*seligoung*) (Boas, An. Rep. Bur. Ethnol., VI, Fig. 468).

Skins of *Phoca fetida*, *Cystophora cristata*, and *Phoca groenlandica* are prepared in the same way.

Those that are intended for kayak covers, boots, mittens, quivers, etc., are prepared in a different way. They are either put into hot water or laid in a brook for a few days until the hair begins to loosen. Then both sides are cleaned and worked with the ulo, in order to clean and shave them. When the hair has been removed they are dried and made pliable in the same way as has been described. If it is intended to make the skin as soft as possible, it is allowed to become putrid before it is cleaned. Then the hair and blubber are removed, and afterwards it is left to hang in the sun a few days until it acquires a light color.

The large ground seal *Erignathus barbatus* is skinned in a different manner. Its skin is very thick, even thicker than sole-leather, and is extremely durable, and suitable for all sorts of lines, particularly traces, lashing and harpoon lines, and for soles, drinking cups, and boat covers. The skin of the back and of the breast dries unequally, and therefore a piece covering the throat and breast is taken out and dried separately. If it is to be used for lines, it is cut by making girdles about 6 inches in width around the body. The hair and blubber are removed from these cylindrical rings, from which lines are made by cutting spirally, a string 70 or 80 feet long being thus obtained.

This line is stretched as taut as possible between two rocks, and while drying it undergoes an enormous tension. Before it is taken from the rocks the edges are rounded and cleaned with a knife.

Walrus hide is always cut up before being prepared. As soon as the walrus is killed it is cut into as many parts as there are partners in the hunt, every part being rolled up in a piece of skin and carried home in it. Sometimes the skin is used for making boats, but generally it is cut into lines. Both kinds of hide, that of the walrus and that of the ground seal, are as stiff as a board when dried and require much work before being fit for use. They are chewed by the natives until they become thin and pliable. The whole skin must be chewed in this way before it can be used for soles and boat covers. Afterwards it is scraped

with the tesirqun and softened with the straight scraper. The new thongs after being dried between the rocks must be also chewed until they become sufficiently pliable, after which they are straightened by a stretcher that is held with the feet (Boas, Fig. 469.) Frequently they are only pulled over the sole of the boot for this purpose, the man taking hold of the line at two points and pulling the intermediate part by turns to the right and to the left over the sole of the foot.

Another kind of line is cut from the hide of the white whale, which is skinned in the same way as the ground seal; but, as it must be slit on the spinal column, the single pieces of line are much shorter, and they can not be used to the same extent as seal lines. Some lines are cut from the skins of *Pagomys fatidus*, but these are weak and greatly inferior to lines of ground-seal hide.

Deer skins are dried in summer and dressed after the ice has formed. Like all other kind of skins, they are not tanned, but curried. They are hung up on the rafters of the hut, and the workers in Ogo and Akudnirn, the women—in Hudson Bay the men—take off their jackets and begin preparing them with the sharp scraper. After being cleaned in this way they are thoroughly dried, either by hanging them near the roof of the hut, or according to Gilder, by wrapping them around the upper part of the body next to the skin, after which they are again scraped with the tesirqun. This done the flesh side is wetted, the skin is wrapped up for half a day or a day, and afterwards undergoes a new scraping. Then it is chewed, rubbed, and scraped all over, thus acquiring its pliability, softness, and light color. In the spring the skin of bears and of seals are sometimes dried on large frames which are exposed to the sun, the skins being tied to the frames with thongs. Smaller quadrupeds, as foxes and ermines, are skinned by stripping the entire animal through its mouth without making a single cut in the skin. Birds are opened at the breast, and the body is taken out through this small hole; the head, wings, and legs being cut off at the neck and the joints. Ducks are frequently skinned by cutting the skin around the head and the outer joints of the wings and legs, and stripping it off. The skins are cleaned by sucking out the fat and chewing them.

Skins of salmon are used for water-proof bags, intestines of seals, particularly those of ground seals, are carefully dried, and after being sewed together are used for sails, windows, and kyak jackets.

The Malemut Eskimo tan and soften the seal skin used for boot-soles in urine (Whimper, Tr. Ethnol. Soc. 1868). For making kyaks and umiaks seal skins are used. The skin is prepared in the first instance, while the hair is yet on it, by spreading fermented fish-spawn over it, and allowing it to remain until the hair rots off. It is then stretched on a frame and saturated with urine until it becomes translucent. The fat is removed with bone and stone knives, metal being considered likely to cut it. (Whimper, Alaska, 162.)

The hide scraper of the Chukchis is of stone or iron, and fastened to a wooden handle, and looks like a spokeshave. It is, indeed, the lineal descendant of the bone scraper. With this tool the moistened hide is cleaned very particularly, and is then rubbed, stretched, and kneaded so carefully, that several days go to the preparation of a single reindeer skin. That this is hard work is also shown by the woman who is employed at it in the tent dripping with perspiration. While thus employed she sits on a part of the skin and stretches out the other part with the united help of the hands and bare feet. When the skin has been sufficiently worked she fills a vessel with her own urine, mixes this with comminuted willow bark which has been dried over the lamp, and rubs the blood-warm liquid into the reindeer skin. In order to give this a red color on one side the bark of a species of *Pinus* (?) is mixed with the tanning liquid. The skins are made very soft by this process, and on the inner side almost resemble chamois leather. Sometimes, too, the reindeer skin is tanned to real chamois of very excellent quality.*

The Tuski understand the art of tanning and are able to produce very fair specimens, but practice it principally with seal skin, which is dressed in all colors. The white is very delicate and much prized. Deer skins are dressed with ammonia, red ochre and other materials. They are rendered very soft and pliable (W. H. Hooper, p. 183). This description answers perfectly to the work done on the reindeer hide, both with and without the hair, by the Indians and Eskimo of Ungava, Canada.

A large collection of those brought by Lucien Turner will be found in the National Museum. The softness of the texture is marvelous. Not one particle of rigid fiber seems to have been left in the skin. In order to effect this perfect flexibility the statement of Nordenskjöld is not overrated. Indeed, those who have seen some of the best of the wigwams made of buffalo hide depilated will recall the softness and pliability effected in this refractory material by the application of human muscle, which after all is the chief ingredient in aboriginal tanning.

CHAPTER III.

SKIN DRESSING AMONG THE INDIANS.

The skin-working apparatus of the Naskopi Indians is described by Lucien Turner.

This instrument is one of the few really labor-saving tools of the poorly equipped Naskopi; and is particularly effective in removing the hair from the hides of various mammals or the fat from the flesh side of the skins. The skin is removed from the beast and laid aside until a convenient time arrives for preparing it for its intended uses. The

* Nordenskjöld, *Voyage of the Vega*, New York, 1882, Macmillan, 486, Fig. 1.

time depends on the season of the year; for if it be in the height of the deer-killing the poor squaw has her hands full of labor, since she must not only remove the skins from the carcasses, but prepare the flesh for drying, smoking, or other manner of preserving it for the future. To these labors are to be added the other domestic duties which fully occupy the shortening days of the year, and often cause her to express a wish that the deer were less plentiful for the time being. When a number of reindeer skins have been collected they are wetted and thrown into a pile, where they are allowed to decompose or ferment until the hair is loosened in its follicle. The process may be inspected from time to time, and when advanced to a proper state a skin is taken from the heap to undergo the act of depilation, which is effected in the following manner. (Plate LXVII, Fig. 1.)

The radius or large bone of the fore-leg of the reindeer is cleaned of its flesh and one side of the shaft or central portion of the bone is removed, leaving two sharp edges. One edge is dull or rounded for reasons which will appear clear in the manner of using the scraper. The other or outer side (for the instrument is to be held in a certain way) is rendered sharp, so as to form an edge, but not so keen as to cut the pelt. The skin is now placed upon a short beam of wood about 3 or 4 inches in diameter and long enough to reach obliquely from the abdomen of the standing person to the ground at a convenient distance, say 4 feet in length. Over this beam the skin is laid with the hinder part of the skin towards the person, so as to allow the edge of the scraper to work against the layer of hair. The scraper is now seized with one end in each hand and applied to the portion of the skin lying in contact with the beam. A skilful push dislodges the hair, and the skin appears clean and free from hair wherever the edge of the bone has scraped its surface. The process continues until each part of the skin is brought under the edge of the scraper and the work is complete. This instrument is also employed to remove the excess of water from a skin that has been wetted to bring it into the degree of pliability desired. It is employed in the same manner to remove the scurf from the skins of the white whales (*Delphinapterus calodon*), captured in goodly numbers each year near Fort Chimo. (I must here add that the Whale River (Fort George) Indians perform this labor, as the Naskopis consider the whale too oily a creature for them to work. It only proves that the employment of this instrument is not confined to the Naskopi Indians.)

It should be understood that this form of aboriginal beaming-knife is employed for removing the hair from reindeer skins that are to be converted into parchment (raw hide) or into buckskin. It is to be remarked that the scraper is used only after the flesh side of the skin has received attention. The flesh side requires another form of instrument to effect the removal of the skin-muscles, ligaments, and adherent fat. An instrument is especially made for removing that part. The heel bone of the reindeer is cut very obliquely at the lower end, so that the flat edge

may form a blade, which is ground sharp and then finely serrated. A strap-like loop is tied around the bone, and when the tool, which is adze and chisel combined, is grasped, the hand is prevented from slipping along the bone by the loop passing under the wrist and supporting the hand. The adherent muscle is quickly separated from the skin and forms a sort of vellum, which may be dried and serve as wrappers for bundles of furs or dry meat. The fleshy side of the skin is rubbed with a mixture of decomposed brains and liver and laid away for several hours. The process of rubbing is next resorted to, resembling the act of rubbing linen in the laundry between the hands. When the desired pliability is gained, the superabundant fat and moisture are removed by calcareous earths, bone dust, or flour, to act as absorbents. The skins are now ready for any purpose. (Plate LXVIII, Figs. 1, 2, 3.)

Lieut. G. T. Emmons, U. S. Navy, says that the Chilkat women procure the hair of the Rocky Mountain goat for their sacred blankets by rolling up the hide until it sweats and the pores are opened. A woman then sits on the ground, lays the skin on her lap, and with her hands scrapes off the hair in great flakes, without the use of a beaming-knife of any kind. This, of course, is the simplest form of depilation. The next is that practiced by the Indians of northern California, who employ a rib of the elk, without any modification whatever.

The manner of preparing buckskin by the Nisqually and Columbia River Indians is as follows: Immediately after the animal is killed the skin, having all the hair scraped off, is stretched tight on a frame. It is there left until it becomes as dry as parchment, then it is rubbed over with the brains of the animal, which impart oil to it. It is then steeped in warm water and dried in the smoke, two women stretching it all the time it is drying. It is then again wet and wound tightly around a tree, from which it is again taken, smoked, and drawn by the women as before. When nearly dry it is rubbed with the hands, as in washing, until it is soft and pliable, and then it is ready for use.

Mr. Forest stated to me that he had put on a suit twenty-four hours after the animal had been running in the forest. (Wilkes.)

The Crows, like the Blackfeet, are beautifully costumed, and perhaps with somewhat more of taste and elegance, inasmuch as the skins of which their dresses are made are more delicately and whitely dressed. The art of dressing skins belongs to the Indians in all countries; and the Crows surpass the civilized world in the beauty of their skin-dressing. The art of tanning is unknown to them, when civilized habits and arts have not been taught them; yet the art of dressing skins, as we have it in the civilized world, has been (like hundreds of other ornamental and useful customs which we are practicing) borrowed from the savage without our ever stopping to inquire whence they come or by whom invented.

The usual mode of dressing the buffalo and other skins is by immersing them for a few days under a lye from ashes and water until

the hair can be removed, when they are stretched upon a frame or upon the ground with stakes or pins driven through the edges into the earth, where they remain for several days, with the brains of the buffalo or elk spread upon and over them, and at last finished by "graining," as it is termed by the squaws, who use a sharpened bone, the shoulder-blade, or other large bone of the animal, sharpened at the edge somewhat like an adze, with the edge of which they scrape the fleshy side of the skin, bearing on it with the weight of their bodies, thereby drying and softening the skin and fitting it for use. (Plate XCI.)

The greater part of these skins, however, go through still another operation afterwards, which gives them a greater value and renders them much more serviceable—that is, the process of smoking. For this a small hole is dug in the ground, and a fire is built in it with rotten wood, which will produce a great quantity of smoke without much blaze, and several small poles of the proper length stuck in the ground around it, drawn and fastened together at the top, around which a skin is wrapped in form of a tent, generally sewed together at the edges to secure the smoke within it. In this the skins to be smoked are placed, and in this condition the tent will stand a day or two inclosing the heated smoke, and by some chemical process or other which I do not understand the skins acquire a quality which enables them, after being wet many times, to dry soft and pliant as they were before, which secret I have never yet seen practiced in my own country, and for the lack of which all of our dressed skins, when once wet, are, I think, chiefly ruined.

An Indian's dress of deer skins, which is wet a hundred times upon his back, dries soft; and his lodge also, which stands in the rains and even through the severity of winter, is taken down as soft and as clean as when it was first put up.

A Crow is known wherever he is met by his beautiful white dress and his tall and elegant figure, the greater part of the men being 6 feet high. The Blackfeet, on the other hand, are more of the herculean make, about middling stature, with broad shoulders and great expansion of chest, and the skins of which their dresses are made are chiefly dressed black or of a dark-brown color, from which circumstance, in all probability they—having black leggins or moccasins—have got the name of Blackfeet. (Catlin's *Eight Years*, pp. 46-47, vol. 1.)

Among the Sioux the hides were stretched and dried as soon as possible after they were taken from the animals. When a hide was stretched on the ground pins were driven through holes along the borders of the hide. These holes had been cut with a knife. While the hide was still green the women scraped it on the under side by pushing a webajabe over its surface, thus removing the superfluous flesh, etc. The webajabe was formed from the lower bone of an elk's leg, which had been made thin by scraping or striking. The lower end was sharpened by striking, having several teeth-like projections, as in the accompanying figure. A withe was tied to the upper end, and this was secured to the arm of

the woman just above the wrist. When the hide was dry the woman stretched it again upon the ground, and proceeded to make it thinner and lighter by using another implement called the weubaja, which she moved towards her after the manner of an adze. This instrument was formed from an elk horn, to the lower end of which was fastened a piece of iron (in recent times) called the wen-hi. (Plates XC and XCI.)

When the hide was needed for a summer tent, leggins, or summer clothing of any sort, the weubaja was applied to the hairy side. When the hide was sufficiently smooth grease was rubbed on it, and it was laid out-of-doors to dry in the sun. This act of greasing the hide was called wawexigxi, because they sometimes used the brains of the elk or buffalo for that purpose.

Dougherty stated that in his day they used to spread over the hide the brains or liver of the animal, which had been carefully retained for that purpose, and the warm broth of the meat was also poured over it. Some persons made two-thirds of the brain of an animal suffice for dressing its skin. But Frank La Fleche says that the liver was not used for tanning purposes, though the broth was so used when it was brackish.

When the hide had been dried in the sun it was soaked by sinking it beneath the surface of any adjacent stream. This act lasted about two days. Then the hide was dried again and subjected to the final operation, which was intended to make it sufficiently soft and pliant. A twisted sinew about as thick as one's finger, called the "wexikinde," was fastened at each end to a post or a tree about 5 feet from the ground. The hide was put through this and pulled back and forth. This act was called waxikinde. On the commencement of this process, called ta"pě, the hides were almost invariably divided longitudinally into two parts each, for the convenience of the operator. When finished they were again sewed together with awls and sinews. When the hides were small they were not so divided before they were tanned.

The skins of elk, deer, and antelopes were dressed in a similar manner. (J. O. Dorsey, *An. Rept. Bur. Ethnol.* 1881-'82, p. 310.)

Dressing skins by the Sioux Indians is thus described by a noted traveler: "They had killed a large elk, the skin of which the women were employed in dressing. They had stretched it out by means of leather straps on the ground near the tent, and the women were scraping off the particles of flesh and fat with a well-contrived instrument made of bone, sharpened at one end, and furnished with little teeth like a saw, and at the other end a strap, which is fastened around the waist. The skin is scraped with the sharp edge of this instrument until it is perfectly clean. Several Indians have iron teeth fixed to this bone." (Maximilian's Travels.)

Again: "We looked at the women as they worked; for the shoes they made they had softened the leather in a tub of water and stretched it in the breadth and length with their teeth. In another

tent the women were dressing skins, either with a pumice-stone or with the toothed instrument described before. They then pulled the skin over a line in all directions to make it pliable." (Maximilian, p. 158.)

Among the Kiowa Indians those skins taken are mostly dressed for lodges. They are first staked on a smooth spot of ground and water put upon them, when they are ready for fleshing. This consists in removing the flesh with an instrument made of a straight bar of iron, about a foot in length, flattened at one end and filed to the edge. This being grasped in the hand, and a succession of quick blows given, the work slowly proceeds. The skin is then dried, after which the hair is removed in a dry state, and the skin reduced to the proper thickness by dressing down on the hair side. This is done with an instrument made by firmly tying a flat piece of steel, filed to a beveled edge at one end and with the corners rounded, to a large prong of a deer's horn. This is so trimmed, in connection with the body of the horn, as to form an elbow, and is used a little as a carpenter uses his adze. This work is usually done in the cool of the morning. The brains of the animal, having been properly taken care of for the purpose, are now soaked and squeezed by the hand until reduced to a paste and applied to both sides of the skin, which is afterwards worked and rubbed until flexible.

The preparation of robes is from winter skins, and differs from the foregoing only in being dressed down on the flesh side, so as to leave the wool and hair upon the robe, and is more thoroughly worked and scoured by means of a sharp gritted stone. (Thomas C. Battey. *A Quarter of a Century among the Indians*, 1875, pp. 187-188.)

The Pitt River Indians and the Modocs tan their leather by nearly the same process. When an Indian wants buckskin for clothes, immediately after skinning a deer he cuts its head open, procures the brains, spreads the skin on a smooth log with the bark off. The flesh side of the skin being up, he rubs the brains over it and allows it to dry. This makes the hide not only grain easier, but half tans it. The skin is then thrown into the stream, where it is allowed to remain three or four days. This raises the grain. It is then thrown across a slick smooth piece of log about 10 or 12 inches in diameter. One end of this stick is usually about 3 feet off of the ground and the other end resting on the ground. The neck of the skin is now pulled 6 or 8 inches over the elevated end of the graining log, and the stomach of the grainer pressed tightly against it. A flat stick is usually placed between the stomach and the skin. This enables the workman to hold the skin from slipping. He has what is known as a graining-knife. This knife is now made of iron, but was not long since made of hard yew wood. It is from one-fourth to three-eighths of an inch thick, by 2 to 3 inches wide. It is curved edgewise to fit the round surface of the graining-log. The edge is perfectly square. There is a handle at each end, and the knife is taken by each handle and pushed vigorously down the skin. This is rather slow work; still, an Indian will

grain twelve or fifteen skins in a day. After a skin is grained it is thrown into a basket of water. This water has a lot of roots cut up in it that causes the water to lather like soap. In fact it is called soap-root, and is used not only for tanning, but for washing clothes, etc. The hide is allowed to remain in this soapy water from three to four days. It is then taken out and rubbed and pulled dry. This completes the tanning of a skin. If, though, it be a very large one, the same process is gone through with, except the graining, the second time, which invariably leaves the skin soft and nice. This rule is slightly varied by some of the tribes. For example, the brains will be taken from the deer's head and cooked about half. This keeps it from spoiling. The skin is soaked longer to raise the grain, sometimes a little ashes being sprinkled on the skin, which makes the grain slip. After graining the skin is thrown into brain-water and soaked, instead of using the soap-root water. It is then worked as before described until soft. We now have buckskin. To prevent this from becoming stiff and hard when wet if it is thoroughly smoked. This smoking process is also practiced by the settlers here, but I think the idea originated with the Indians. A ditch is cut in the ground about 2 feet deep and 20 or 25 feet long. At one end of this ditch a rough fire-place is made, being usually walled up with rock. Over the other end of the ditch is a large hollow log, something like a bee-gum, only larger and taller. In this the buckskins are hung, and the top of the gum pretty well closed. Sticks are laid cross-wise close together from one end of the ditch to the other and covered completely over with dirt. This makes a blind ditch from fire-place to the gum. A fire is now built in this fire-place, and the smoke naturally follows the ditch, there being an escape for the smoke in the top of the gum. The idea of having the ditch long is a good one; the smoke becomes cool in its passage through the ground, and there is no danger of burning the buckskin. A buckskin is smoked two or three days. After this it can be washed like a piece of cloth, and when dry is equally as soft.

The tribes belonging to the Shoshonian stock inhabiting the Great Interior Basin were formerly most expert manufacturers of buckskin leather. Clothing, tents, and much of their paraphernalia were made of three kinds—the white, the yellow, and the brown. The processes of preparing were identical in the main with those described. However, the hair was removed in many cases by rolling up the hide in ashes wet with warm water for a few days. The hair was then removed by means of a wooden knife, a rib, or in later times with an old case-knife or bit of hoop-iron. The yellow and the brown skins received their tint by drying them over a smoldering fire of dry willow for the former and green willow for the latter color. The skins were vigorously pulled and stretched in every direction while the drying and smoking were going on. (Compare Plates XCI, XCII, XCIII.)

Tanning among the Pawnees is thus effected: The hide is extended

upon the ground and with an instrument resembling an adz, used in the manner of our carpenters, the adherent portions of dried flesh are removed and the skin rendered much thinner and lighter than before. The surface is then plastered over with the brains or liver of the animal, which have been carefully retained for the purpose, and the warm broth of meat is also poured over it. The whole is then dried after which it is again subjected to the action of the brains or broth, then stretched in a frame and while still wet scraped with pumice-stone, sharp stones, or hoes until perfectly dry. Should it not be sufficiently soft it is subjected to friction by pulling it backward and forward over a twisted sinew.

This generally terminated the process. On the commencement of it the hides are almost invariably divided each longitudinally into two parts for the convenience of manipulations and when finished they are again united by sewing with sinew. This seam is almost always present in the bison robe, but one of the largest we have seen is used for covering on one of our beds, and has been dressed entire, being destitute of a seam. When the process of tanning and dressing is completed and the inner surface of the skin dry, figures are traced upon it with vermilion and other showy colors. These are designed as ornaments, but are sometimes the record of important facts. (Long's Ex., Vol. I, pp. 221, 440.)

The Senecas used to tan green hides. If a hide was dry it was soaked in the water of a running stream, after which it was stretched on a smooth log the size of a man's leg. With a knife-blade, placed in a curved stick, all the hair and outside skin was scraped off. After that the flesh was scraped off and the skin thoroughly dried. It was then soaked in a suds made of deer's brains and warm water, one or two Indians rubbing with stones, much like those called axes plowed up in the fields, and often pulling the skin. A hole 18 inches in diameter was then made in the ground and the skin suspended above it on upright sticks and smoked, until the desired color is produced, by burning rotten wood beneath. The skin was then ready for use.

Skin-dressing among the Eastern Indians is thus described :

These skins they convert into very good leather making the same plume and soft. Some of these skinnes they dress with haire on and some with the haire off. The hairy side in winter they weare next their bodies and in warme weather they weare the haire outwards. They make likewise some coates of the Feathers of Turkeys which they weave together with twine of their owne makinge very prettily ; these garments they weare like mantels knit over their their shoulders and put under their armes. They have likewise another sort of mantels made of Mose skinnes, which beast is a great large Deere so bigge as a horse. These skinnes they commonly dresse bare and make them wonderous white and stripe them with size round about the borders, in form like lace set on by a taylor and some they stripe with size in works of severall fashions very curious, according to severall fantasies of the workmen where- in they strive to excell one another. And mantels made of Beares skinnes is an usuall wearinge among the natives that live where the beares doe haunt. They make skinnes of Mose skinnes, which is the principal lether used to that purpose and for

want of such lether which is the strongest, they make shoes of deeres skinnes very handsomely and commodious, and of such deeres skiinnes as they deesse bare they make stockings that comes within their shoes, like a stirrup stockinge and is fastened above at their belt which is about their middell. A good well growne deere skin is of great account with them and it must have the tale on, or else they account it defaced. The tale being three times as long as the tales of our English Deere, yea foure times so longe. This when they travell is raped round about their body and with a girdle of their making bound round about their middles to which girdle is fastened a bagg in which his instruments be with which hee can strike fire upon any occasion.

Of their several arts and employments; as first in dressing all manner of skinnes, which they do by seraping and rubbing, afterwards painting them with antique embroyderings in unchangeable colors, sometimes they take off the haire especially if it bee not killed in season. (Wood's N. England Prospect. Prince Pub. Soc. I. Page 101.)

DETAILS OF SKIN-DRESSING AMONG THE NAVAJOS.

When the author at first contemplated this paper he found that the accounts of the most careful observers were not quite up to his requirements. He therefore wrote to his friend Dr. R. W. Shufeldt, U. S. Army, begging him to define the process as minutely as possible. The result was most satisfactory and was published in the Proceedings of the Museum for 1888. As much of Dr. Shufeldt's paper as is necessary to complete this narrative is here reproduced, together with the illustrations. The reader should note especially the similarity of the hair scraper to those from Point Barrow, Labrador, the Interior Basin, and the graves of Madisonville, Ohio. (Plates LXI to LXVII.)

Dr. Shufeldt employed a Navajo to do the work for him. In a day or two this Indian returned with a fine doe, an adult specimen of *Cariacus macrotis*. He had skinned the legs of the animal from the hoofs up as far as the ankles, which he disarticulated partially, so the limbs could be tied more compactly together, and thus be less liable to either frighten his horse or catch in the low timber as he returned home with his game.

"The deer which had been captured for me had already been eviscerated and the skin divided from its chin to its tail, the entire length of the under side of the animal. In a moment with a sharp hunting-knife he divided the skin on the inside of the thighs, from the ankles to the abdominal division, making similar incisions on the inside of the forelimbs. The legs were quickly skinned, the small tail split up on its under side and the vertebræ removed, while with his knife the hide was started on both sides from the abdominal and throat incision and quickly removed in the direction of the animal's back. Thus it was that the skin was removed from the entire body and up to the ears first; then as he arrived at the latter, their cartilages were cut through close to the skull, leaving the great ears of this species of deer attached to the hide. When he arrived at the eyes, these were skinned round, much in the same way as a skilful taxidermist manages the eyes in any vertebrate specimen he may be preparing. Upon arriving at the muzzle

he simply divided the skin all around, posterior to the external nostrils, and the operation of removing the hide was completed. (Pl. LXI.) He next proceeded to dig a hole in the ground about as big as a bushel. The bottom of this excavation was tramped hard with his feet and the hide placed therein, hair side up, and immediately covered with cold water. On top of the hide he placed a camp-kettle bottom side up, and braced it down with the spade. This was to prevent the skin from drying and to keep the dogs from eating it during the night.

“In the morning he left the camp with an axe to soon return with the trunk of a small pine tree. At its thickest end it was about 6 inches through, and about 4 inches at the smaller extremity. From one side of the larger half he removed the bark, completely exposing the smooth surface of the wood beneath it. He next cut a deep notch in the big end of this stick, so as to assist in bracing it against the limb of a small cedar tree near by, with the smooth surface facing him and the small end of the stick resting firmly upon the ground some two feet from the base of the cedar tree. Around about was plentifully bestrewn some clean short hay, to prevent the hide from being soiled upon the ground beneath. He now returned to the hole where the skin had remained over night, and it was taken out to be washed in clean water, when he proceeded with a sharp knife to remove all superfluous tissue from its raw side, skinned the ears carefully by removing completely the cartilaginous parts, then cleared away the muscles which had remained attached about their bases, trimmed off the remains of the panniculus muscle, and indeed left nothing but a thoroughly clean hide which received its final dip in clear water.

“It was now ready to have the hair shaved from it. The tanner obtained his scrapers from the bones of the fore limb of the deer he had killed, and the ulna and radius of this limb are wonderfully well fitted to perform the work of this natural spoke-shave. These bones, as we well know, are, in a deer, as in many other hoofed animals, quite firmly united together, having a form well known to the comparative osteologist. The shaft of the ulna, which is closely approximated to the shaft of the radius, has its posterior edge thin and sharp, which is still further improved by the tanner scraping it with his knife. The olecranon process, with the deep sigmoid notch, forms an excellent handle at one end, while the enlarged distal end of the radius, with the carpal bones, which are usually left attached, forms a good one at the other. Moreover, the curvature of the shafts of this consolidated bone is favorable for the use of our Indian tanner, who, in using this primitive instrument, slings it at either end in his hands, and works with it in shaving off the hair much in the same manner as one of our carpenters uses a spoke-shave, only here the sharp edge of the ulna bone takes the place of the knife-edge in doing its special work. (Plate LXII.)

“Before proceeding further I should mention that, after removing the hide, on the first day he placed the skinned head of the deer, without

the lower jaw, in the low ashes of a camp-fire, where the brains were able to become semi-baked during the first night, as these parts too are utilized in the tanning process.

"Next to shaving off the hair, the hide is thrown over a small log he had arranged against the tree in the morning, being held in place by catching the skin of the head between the notch and the limb, the skin of the hinder parts being always nearer the ground, and as the work proceeds it is deftly shifted about by the tanner.

"Now all the hair, except on the lower parts of the legs and the tail, is rapidly scraped off with these bone scrapers, including the black epidermis. Some tanners use a deer's rib, or that of the beef, and others a dull hunting-knife, but the bones of the deer's fore-arm is the usual instrument, and it is quite remarkable to observe how skilfully it is managed, and how rarely a hole is cut in the skin. The shaving is carried to the very edges of the hide all around, and even the backs of the ears are carefully scraped, the entire operation lasting from two to four hours, depending upon the size of the deer.

"In appearance the hide now has the same form as when removed from the animal, the hair side is clean and white, the body side devoid of all superfluous tissue, the back of the ears still showing the black epidermal layer of the skin, as it is only from these parts where it is not scraped off with the hair; the hair also is left on the skin of the lower halves of the four limbs.

"A thorough washing is now given it in several changes of clear, cold water, though sometimes in the last wash the water may be made slightly tepid, and in this it is allowed to stand while the tanner prepares the brains of the animal soon to be used in another stage of his work. Picking up the deer's skull from the ashes where he had left it the night before, he took an ax and split it along the bifrontal suture, cleaving the skull partly in two, then chipping off the parietal bones he was enabled to lift out the brains nearly entire. They were at once transferred to a basin of tepid water, where by gentle manipulation the little slivers of the bone (which had gotten into it while splitting the cranium), the blood, etc., were effectually removed. Next they were placed in a small quantity of tepid water in another basin and put upon a low fire, where they were allowed to simmer for over an hour. At the end of this time the water, then being not so hot but that one could comfortably hold his hand in it, had come to be of a muddy color, and our tanner, using the fingers of one hand as a sieve, lifted out from the water the little particles of brain in a small pile upon the palm of his opposite hand; then, by rubbing this together between the palms of his hands, it was soon reduced to a pasty mass. This process was continued until all the brains were thus reduced and dissolved, and then the water in which they were had about three times its quantity of tepid water added to it, nearly filling the small basin.

"Returning to the skin, it was now removed from the water where it had been left, carefully rinsed, and wrung out with the hands much as

we see washing women wring clothes, and carried over to the tree where the scraping process had been done. Here the tanner selected a small limb about 5 or 6 feet from the ground and passed the head and neck of the hide under and over it, and then carefully folded this latter part lengthwise along the middle of the body surface of the hide, and twisted the whole over and over again until he came to the fore legs. It will be seen that the limb was firmly folded within a loop of the hide, and by pulling heavily upon it I saw that there was no such thing as its slipping. In a similar manner the skin of the fore legs was folded lengthwise inside the hide; then the borders of the abdominal incision were likewise folded in, and in turn the skin of the hind legs, but this latter had, of course, to be thrown in, in the direction of the tree, so as to include them. The borders of the hinder parts were thrown over in such a way as to form a loop like the one around the limb of the tree. During all of this operation the hide was being twisted from left to right, and at its completion looked like a wet hide rope, fast, as we have described, to the tree at one end and looped over a stick about two feet long at its middle at the other. This latter was used as a twister by the tanner, for now he proceeded to wring the hide thoroughly by twisting it over in one direction, causing the water to be rapidly squeezed out of it. (Pl. LXIII.) By continuance of this twisting the skin was finally brought up close to the limb of the tree in a hard coil, where by hooking the turning stick under the limb it was held in that position and allowed to drip for nearly an hour. At the end of the above-mentioned time the Indian unhooked the stick, untwisted the hide, and took it down. It had apparently shrunk two-thirds of its size, and looked like a damp, semi-tanned dog-skin. The tanner immediately set to work to pull it into shape as he walked in the direction of his camp-fire.

“Spreading out a small buffalo robe, he sat down on it (Plate LXIV) and proceeded to pull the hide vigorously with his hands in every direction. Catching hold of the extreme edges, he tugged away at it until it was nearly its original size. I noticed, however, that he only employed his hands in this part of the operation, and never once resorted to his feet for assistance in the stretching.

“After he was satisfied that the entire surface of the hide was opened and exposed again, he carefully spread it out perfectly flat, with the hair side up, upon the buffalo robe on which he had been sitting; then, taking his basinful of dissolved deer brains, he commenced applying it with his hand to the surface from which the hair had been removed. It is never put on the opposite side of the skin. In doing this he frequently rubbed the solution well in, using his open hand for the purpose, and as he came to the head, ears, and legs he worked the stuff in with his fingers, and occasionally kneaded it with his knuckles, going over the entire skin on the side referred to until his basin of brains was expended and the whole had been worked in as described. (Plate LXV,

“Upon asking him why he put it only on the hair side, he gave me to understand that the pores were on that side, and consequently the brains could get into the skin more effectually, and upon inquiring why he put them on at all, he said, ‘To make it soft.’ Buckskin that is tanned without using brains is harsh and stiff afterwards, and still worse in these particulars if it happens to get wet at any time.

“The Navajoes often use beef brains for this purpose, especially when their game is taken far from camp and they do not care to pack the deer skulls home on their ponies. In early days they employed deer brains as a rule, but in some cases the brains of the buffalo, when that animal existed in their country.

“Finally, as the last step of the process, he commenced, by folding in the edges of the skin all round continuously, to make it up into an ellipsoidal ball, quite firm, though not tightly rolled. He then wrapped it up in the buffalo robe and allowed it to remain out in the sun for about fifteen minutes for the purpose, he said, ‘of letting the brains go well into him.’

“Once more in its wet and limp condition it is thoroughly opened, and this time spread out over the top of a sage bush near by with the outer surface exposed to the sun and sufficiently from the ground to prevent the dogs from getting at it, or its being soiled through accident. It was now about 3 o'clock in the afternoon, and very warm, and the skin at once commenced to show the effects of it as the first stages of drying set in. Nevertheless, I was informed that the hide would now be allowed to remain there and dry until dark, when it would be placed up on top of the “hogan” for the night, or in the event it rained, to be taken in and hung up on the inside. Next morning I was on the ground at 9 o'clock, and was thoroughly surprised at the appearance of the hide when it was brought out and shown me. Although I was familiar with the making of buckskin, not only as practiced by the Navajoes, but by the Sioux and other North American Indians, I never happened to have seen it in this particular stage, that is, right after the drying on the second day.

“I found that it had again shrunken so as to be not more than one-third of its original size, or just after it had been removed from the animal. It was hard and appeared almost brittle, as though it might be broken in two; moreover it was semi-transparent, and easily transmitted the light through it, or even prominent objects might be outlined through it in favorable lights. In color it was of a deep, muddy amber, or a semi-translucent Roman ocher, and one would never have suspected in the world that it was either a deer hide, or that in a few short hours it be converted into the softest and most durable fabric in the country—a tanned buckskin.

By the exercise of considerable ingenuity and careful bending he now forced the skin into a large camp-kettle containing water from which the chill had been taken off by the addition of a little warm water, and

in this it was allowed to soak well for the next three hours, standing all this time out in the morning sun.

Some of the Indians insist that this soaking should be done in cold water (spring water), and a new Mexican guide who has been among the Navajoes for many years, being an excellent tanner himself, claims that it is almost the universal practice to soak it in cold water on the morning of the third day instead of in tepid water. However, there was but little difference, for on the present occasion the water was almost cold from the start, and quite so after the skin had been in twenty minutes. This washing, the Indians tell me, was to remove all traces of the brains which were rubbed into the skin on the day before. He next gives it three or four thorough rinsings in clear cold water, and takes it over to the tree to wring it. This is done precisely in the manner already described above and shown in the plates.

“Likewise it is curled once more, made into a coil, twisted and re-twisted upon itself, and allowed to drip in this condition for nearly half an hour. It is then once more undone and drawn out into shape, as on a previous occasion after wringing.

“He is very careful now in exposing the entire surface; pulling the edges, stretching the skin of the ears, flattening out the skin that covered the legs, and paying similar attention to the little tail.

“In the mean time he had brought a large square piece of canvas and spread it out upon the ground near where he was at work. It is upon this that the last stages of the operation will be performed. Bringing next a sharp knife, it takes him but a moment to whittle out from a soft piece of pine an instrument that resembled a large wooden awl. This, with the knife, he threw upon the canvas sheet, where they may be distinctly seen in Plate LXVI. To return to our hide, how different it looks after this second wringing; but he persists in pulling away at the edges all around, over and over again, until the whole is manipulated into a shape to suit him. Even this primary handling now has its effect, and in some places the skin begins to grow like buckskin. At last he sits down on the middle of the canvas sheet, having first thrown aside his hat and removed his moccasins. He wears nothing but his thin Navajo shirt and trousers, while beside him is his wooden awl and sharp knife. (Plate LXVI.)

“He threw the now limp skin lengthwise over his naked feet and pulled it with both hands in the direction of his body. Rapidly repeating this operation, he turned it and tugged at it the other way. But it was most often thrown over his feet and vigorously pulled towards him. Then he stretched it out with his hands, pulled it this way and then pulled it that, worked at the edges to get them limp and pliant, manipulated the ears and the skin of the legs. But during all this an interesting change was coming over it, the heat of an August sun was rapidly drying it, it was fast coming to a velvet-like softness throughout, and attaining its original size, it was changing to a uni-

form pale clay color. The hair side was smooth, while the inside was roughish. Indeed, in a few moments more it was buckskin.

"Picking up next his wooden awl, he commenced far forward on the extreme edge of the skin on the right side of the neck, and by successively stretching it over the handle of the awl, cut upon this edge some dozen or thirteen holes with his knife. Then beginning in front, he put the awl in every hole, and by holding on to the edge of the opposite side with his left hand he was enabled to powerfully stretch the skin of the neck transversely. This operation is shown in Plate LXVI. His mark must go on next, so turning the skin of head over, he cut on either side just below the ear on the body or inner surface of the skin a leaf-like figure, with the apex pointing forward and outward.

"This was the last touch of all, and the now finished fabric, if we may call it a fabric, so pliant, so soft, and withal so useful, was spread out on the canvas for an hour in the sun to receive its final drying, after which it passed into the possession of the National Museum. One of these finished skins retains much the same form as the hide had when first removed, though it may be rather longer from the stretching. The backs of the ears are always black; the edges all around are uneven and harder than the rest of the skin; the hair remains upon the distal moieties of the skin of the legs; bullet-holes of exit and entrance will be usually seen, and there may be an accidental rent or two of small size.

"The Navajoes value these hides at a price varying from \$1.50 to \$2, depending upon the size and the need they have of the money. Squaws, I am told, never engage in manufacturing them, while the Indian boys learn the art at a very early age."

SKIN-DRESSING AMONG ABORIGINES OF OTHER PARTS OF THE WORLD.

In Patagonia the skin of the guanaco is dried with the hair on in such a manner that when wet it retains its pliability and softness. This process of preserving skins seems to be peculiar to the Indian tribes, and is not unlike that by which buffalo robes, bear skins, and other articles of luxury and even necessity among us are prepared by the North American Indians. Guanaco skins are cut into pieces of all sizes and sewed into a thousand fanciful patterns, every workman originating a style to suit himself. (Bourne, "Captive in Patagonia," p. 53.)

The following is the method among the Fors in Darfur, Central Africa: As soon as the animal has been skinned the skins are scraped and put into water in which okun (the bark of a tree) has been mixed. After several days they are taken out, scraped again with iron knives, and afterwards pegged out under the shade of a tree or under a shed made for the purpose. They are then rubbed and beaten with flat stones. At times they are also rubbed with butter. (Proc. Roy. Soc. of Edinburgh, 1884-'85, p. 262.)

The Wagaudas are good tanners and manage to get their skins as

soft as the best kid leather. In some cases the hair is removed, but generally it is left on. They first dry the skins in the sun, then stretch them on a frame, and the inner surface is carefully scraped with a sharp knife. They are then rubbed for a long time with flat heavy stones until quite smooth. This produces a fine grain. Butter or oil is then applied in considerable quantities and the skin once more placed in the sun. This latter process is repeated several times. Both men and women are employed in tanning. Some skins are dyed after the hair has been removed, others have patterns printed on them, and the thick buffalo hide, from which sandals are made, is ornamented by either a knife or a red-hot nail. Leather rope is sometimes used in house-building; if so, it is without tanning. Straps, traps, and nets are first tanned. (Proceedings Royal Soc., Edinburgh, 1881-'86, p. 730.)

Friendly Islanders remove the hair and entrails of the hog with knives of split bamboo, also used in carving cooked pig. Nutka Sound, iron, knife, chisel, mallet, polisher. (Cook.)

In making an opossum rug the Yarra tribe employ some skill and knowledge. In the first place, it is necessary to select good, sound, well-clothed skins. These, as they are obtained, are stretched on a piece of bark and fastened down by wooden or bone pegs, and kept there until they are dry. They are then well scraped with mussel-shell or a chip of basalt, dressed into proper shape, and sewn together. (H. B. Smyth, *Aborigines of Victoria*, I, 1878, p. 271.)

THE SCRAPER.

Whenever the savage has come in contact with the whites he has been quick to substitute iron for stone in his arrow-heads, knives, etc. Not so with his scraper. Indeed the white man keeps up the use of stone, glass, etc., in his modern tannery. In some respects these implements are the most interesting example of the history of the civilization of man. They may not actually be the earliest implement made or used, but they have been the longest in use. We might despair of explaining their extreme antiquity.

They commence to appear with the earliest age of man and have continued in use to the present day, and are essentially the same instrument now as at the beginning. Their use was all but universal among the prehistoric peoples of North America, but they were equally universal in the paleolithic era. They were the principal implement of the early cave dwellers in western Europe and so continued through all the other prehistoric ages. They extend through all time among all peoples and have figured in all civilizations. Neither in form nor substance did it change perceptibly during the prehistoric ages. It is the one enduring implement that was also used by prehistoric man. It is therefore of the utmost importance for the archæologist who wishes to rehabilitate a certain ancient culture to consider carefully all the elements of that culture which crystallize around this little implement. He may have in

his cabinet a few pieces of stone which he labels "scrapers." At once in looking at them there springs upon the imagination of the philosophic student visions of clothing, houses, beds, furnitures, boats, lines for all conceivable purposes, the paraphernalia of state, ceremony and religion, the garniture of the dead.

We may now pay attention to particular examples. Laying aside for the moment flaying, sharpening, cutting, and sewing tools, the reader is invited to look especially at the collection of scrapers in the U. S. National Museum. (Plates LXVII-XCIII.)

Under this general table have been grouped together all of those aboriginal implements which belong to the tanner's craft. They are found in all the countries where man has used the depilated skins of animals for any purpose whatever. In the American Continent this region is bounded on the north, only by the line of uninhabited territory. It extends southward through Greenland, Alaska, Canada, and the United States. The warm climate of middle America requires the substitution of vegetable clothing, so that the scraper is no longer a necessity. The essential elements of a scraper are its grip or handle and its working portion or blade. In the first scrapers the blade and grip were one. Indeed the Little Lake, Concow, and Redwood Indians used formerly the dried rib of a large mammal, and now think there is nothing better than the rib of a steer without any change of form. (Plates LXXXIV, fig. 3.) This implement is caused to vary in structure by the following conditions: (1) The natural supply of material. (2) The skins to be manipulated. (3) The tribal technique. (4) The culture grade of the people.

Even among the Eskimo one can see how in the change of location slate, chert, and jade replace one another. This is a universal law of industries.

Again, to prepare a seal-skin for the Bidarka demands a different treatment and tool from those required in producing the soft product of the antelope hide by the Navajo.

Not so well as in language, nevertheless, in a marvelous degree, the history of a people is written in their implements and industries. Tribes have their own ways of doing things. A museum curator has reason to be thankful for this every day, owing to the careless manner in which many of his acquisitions are labeled.

Again, the nicety of the tool is a sure guarantee of the status of a people. The cylindrical scrapers are variously made. A segment from the hollow base of a walrus tusk, a strip of antler bent into the form of a hoop and properly lashed, or a strip of the same material strained to the form of a horseshoe, has a cable of raw-hide stretched between the calks of the shoe. In all of these, one edge of the cylinder is sharpened to a chisel edge to increase its efficiency. The cup-shaped scraper made of walrus ivory is often labeled in collections as a vessel, but a slight inspection will show that it is a veritable tool. The shape is that of a low oblong pan, not over 3 inches long, 2 inches wide, and 1 inch high.

This is grasped in the hand, bottom up, and drawn across the hide until a quantity of fat is secured, which is deftly conveyed to the stone lamp or some convenient receptacle. (Plates LXXX-LXXXI.)

In connection with the making of moccasin is the art of tanning deer-skins. It is done with the brain of the deer, the tanning properties of which, according to tradition, were discovered by accident. The brain is mingled with moss, to make it adhere sufficiently to be formed into a cake, which is afterwards hung by the fire to dry. It is thus preserved for years. When the deer-skin is fresh, the hair, and also the grain of the skin are taken off, over a cylindrical beam, with a wooden blade or stone scraper. A solution is then made by boiling a cake of the brain in water, and the moss, which is of no use, being removed, the skin is soaked in it for a few hours. It is then wrung out and stretched, until it becomes dry and pliable. Should it be a thick one, it would be necessary to repeat the process until it becomes thoroughly penetrated by the solution. The skin is still porous and easily torn. To correct both, a smoke is made, and the skin placed over it in such a manner as to inclose it entirely. Each side is smoked in this way until the pores are closed, and the skin has become thoroughly toughened, with its color changed from white to a kind of brown. They also use the brain of other animals, and sometimes the backbone of the eel, which, pounded up and boiled, possesses nearly the same properties for tanning. Bear-skins were never tanned. They were scraped and softened, after which they were dried, and used without removing the hair, either as an article of apparel or as a mattress to sleep upon. (Lewis H. Morgan, *League of the Iroquois*, 1851, pp. 361, 362.)

After flaying the seal, the Eskimo often finds the inner surface of the skin coated with fat, and the first operation is to remove this by means of a special tool, which we may call the fat-scraper. By means of this the fat is scraped clean from the hide and placed in the soap-stone lamp, for which purpose some of the forms are specially adapted. These implements occur in the Eskimo area all the way from Ungava to Kodiak and are of three forms, the spoon-shaped, the cylindrical, and the cup-shaped scraper. The simplest form is a segment of reindeer scapula (*Rangifer tarandus*), so cut as to have the inferior border at the back of the knife and the thin part between this border and the spine for the blade. This implement is also used for scaling and opening salmon and is a most efficient tool. Almost as simple as the foregoing, is a fat-scraper made of the split antler of the reindeer. The spongy part is scraped out and the borders brought to the proper edge. Some specimens of this type are ingeniously worked out, so as to have one of the small prongs for a handle, while the spoon or scraping portion is from the split portion of the antler. Bits of walrus-tusks are also carved into the shape of a long-bladed spoon. From the long spoon-shaped scraper, branches off, in the region between Behrings Strait and Norton Sound, a very dainty ladle-shaped implement with projections on the

hinder margin to fit the fingers. This is a very effective tool, both in its grip and the handiness with which its contents may be conveyed to the lamp. (Plate LXIX.)

There is not so great a variety of apparatus in the hand of the aboriginal leather worker as will be found at present in possession of the civilized craftsmen, yet there are several classes of tools worthy of attention.

The pre-Columbian butcher's or flaying knife has not been sufficiently studied. This will form the subject of a subsequent chapter.

The leather cutting knife is also worthy of careful study. Among the Eskimo collections it goes by the name of woman's knife or ulu. Among our modern industries this peculiar Eskimo form has a curious history. When women ceased to be leather workers and went into the kitchen they carried the ulu with them, but transferred it to another function, that of meat chopping. On the other hand, when men became leather workers, they borrowed this same implement from the women, and it may be seen any day in the saddler's shop. All of these woman's knives have crescent-shaped or plano-convex blades set in handles of wood, musk-ox horn, antler, walrus ivory, and other substances peculiar to each region. The blades are of slate, jade, or metal and are kept sharp by rubbing with the incisor tooth of a beaver. Now there is no tool more common in our collections than this same knife. It is safe to say that no Eskimo girl or woman is without one or more.

As we come further south the chipped thin blade takes the place of the smooth blade of the Eskimo, but only in very restricted areas has any observer reported the Indians as using stone blades for cutting leather.

Seeing the great numbers of this particular tool among modern savages, it is incumbent upon the archæologist to look out among his specimens, the scissors, the shoemaker's knife, and the saddler's knife of pre-historic peoples. He will probably find them among the boxes he has been labeling spear-heads.

The north Alaskan Eskimo type of scrapers consists of a grip more or less fitted to the hand and a chipped blade, with a varying length of shaft between them. In the handle the different type-forms grow out of the provisions made for accommodating the thumb, the first two fingers, the last two fingers, and the palm of the workman.

In the front end of this handle the blade is inserted in a rude socket; the rear of the handle slopes down like a Derby hat to form the palm rest. On the left side is the thumb groove, on the upper side are the first finger grooves, on the right side and bottom is a great sweeping excavation which may be called the finger pocket. On grasping one of these implements one is struck with the ingenuity with which every part of the hand is brought into its maximum activity and every necessity of the operation provided for. (Plates LXXII to LXXIX.)

The palm is provided with a nicely rounded surface for pushing, the

first fingers with the best facility for bearing down, the thumb for guiding, and the last two fingers for pulling the tool back, and at the same time they are protected from injury by the hide beneath.

The student of technology is at every moment astonished to see how the Eskimo, wherever he sets out to invent, leaves nothing to be desired as regards facility. Remember, also, that as we go southward and get away from the walrus, the scraper handle is made of wood, and losing the graceful proportions of its northern relative, grows more and more like the tool of the southern Indians.

Typical Eskimo scraper handles seem to be divided into two classes, even in the same locality, for which no reason is assigned.

One class is characterized by an under-cut extending quite symmetrically across the under side, and the material has some uniformity of thickness, as in a ladle. In most of these the grip descends to its base in the rear almost vertically, and in none of them is there any considerable tail-piece. The finger grooves, except in a few aberrant forms, are extremely shallow, and the outline above much curved.

The other class is characterized by an under-cut which primarily does not extend across the under side. The impression on a soft surface is quite similar to that of a human foot without toes. In some specimens the thumb side of the bottom is notched out somewhat, but this has no functional connection with the real under-cut.

Now, in all the specimens of this type the tail-piece is more or less pronounced. The finger grooves run the whole gamut of profundity, from a shallow groove to deep pockets in which half of each finger is buried. In outline this class is more parallel-sided.

No literature is at hand upon the subject, but from the manner in which these implements are poised it would seem that they go in pairs, as the jack-plane and smoothing-plane, the spoon-shaped tool serving for the rough or first process, the flat-bottomed class for finer work in finishing. But this is only guessing.

Every one who has handled a series of these implements has been astonished at the diminutive hands of the workwomen who have wielded them. To dress the hide is woman's work, but the men, also have small hands. Again, while I have found three left-handed throwing-sticks in a hundred; in more than a hundred scrapers I have never seen one left-handed.

Scraper blades among the northwestern Eskimo are made from a plano-convex spall of black chert, jasper, etc., kept flat on the under face and chipped into shape on the upper face. The cutting edge is rounded and chisel-shaped, and is usually the broadest part of the blade. The general outline varies from circular, or even a flattened ellipse through infinite varieties, to an oblong parallelogram rounded at either end. Indeed, one and the same blade may be all of these forms at various periods of its existence by a process now to be explained.

One of the commonest tools in ethnotechnic cabinets is the stone

chipper of bone used in forming the edges of arrow-heads, spear-heads, scrapers, etc. The writer has only recently learned the indispensable character of this tool. In the first place every chipped implement after being separated from the parent block is made out and out with one of them. But this is only the beginning. The writer has lately learned that the hunter and the leather-worker are never without one, and they bring it into requisition with a frequency which reminds one of the old plantation slave sharpening his scythe every few minutes, to get a rest.

Lieutenant Stoney, speaking of his experience at Kotzebue Sound, says that the leather-worker is incessantly touching up his scraper edge with the chipper, and that in time he wears it out to a mere stub. This constant sharpening also accounts for the fact that few specimens show signs of great wear. It is important to repeat this, that the constant use of the edging tool rapidly wears down the scraper blade and keeps the edge sharp. This accounts for the great difference in the length of the blades in our cabinets and for the fact that they show so little sign of use.

A very old skin-scraper, such as are now found only in the old graves, is made of stone, with a wooden handle, which is fastened to the stone by means of a strip of whalebone. Another and a later pattern is made from the scapula of the reindeer. A better idea of its manufacture can be got from the sketch than by a description. Such scrapers are still in use, but serve as a sort of auxiliary to a scraper made from a tin can, resembling a little scoop in shape and having a wooden handle. This is the style of scraper made at the present day and is by far the most effective instrument of the three. (Boas, VI An. Rep. Bur. Ethnol., Figs. 465, 466, 468.)

The manner of using these scrapers is to take the skin firmly in the left hand and putting the knee or foot upon the lower part of it, hold it securely while the scraper is worked with the right hand, pushing downward with some force. If the skins are very dry they are somewhat softened by rubbing with the hands, or even chewing the most stubborn parts. They continue using these tools upon a hide till it gains the desired pliability.

After removing the fat with a muscle shell, the skins are tendered to the men, and especially to the guests, as a piece of civility to chew or gnaw betwixt meals. This is esteemed a delicacy. Then the skins are macerated or steeped in the urine tub. After that they are dried in the air a little and finally milled to perfection by their teeth. They make their thin light under-garments of the backs of the sea-fowl skins; their warm winter garments of the bellies, and their fine holiday dress of the necks, and these they commonly turn feathers outward.

List of specimens in the U. S. National Museum on which this paper is based, showing the catalogue number, the material and shape of the implement, the place or tribe from which it was procured, the length, and the collector.

FAT-SCRAPERS.

Number.	Material.	Shape.	Place.	Length.	Collector.
				<i>Inches.</i>	
36501	Antler	Spoon	Kushinuk	6½	Nelson.
37967	do	do	Chaltnmut	7	Do.
44771	do	Bow	Sledge Island	2½	Do.
44987	Ivory	Ring	do	2½	Do.
44988	Antler	Bow	do	3	Do.
44989	Ivory	Ring	do	2½	Do.
44990	do	do	do	2½	Do.
55911	Antler	Hoop	Bristol Bay	3½	McKay.
56603a	Ivory	Dish	Point Barrow	4½	Ray.
56603b	do	do	do	3½	Do.
63351	do	do	St. Lawrence Island	3½	Nelson.
63352	do	do	do	3	Do.
53353	do	do	do	2½	Do.
63354	do	do	do	3½	Do.
63355	do	do	do	3	Do.
63356	do	do	do	4½	Do.
63642	Antler	Bow	Cape Wankarem	2½	Do.
63686	Ivory	Ring	Diomedes Island	2½	Do.
63687	do	do	do	1½	Do.
63800	Antler	Spoon	Point Hope	3	Do.
63833	Ivory	Dish	do	4	Do.
63900	Antler	Spoon	Diomedes Island	3	Do.
89251	Ivory	Dish	Point Barrow	3½	Ray.
89253	do	do	do	8½	Do.
89255	do	do	do	3½	Do.
89258	do	do	do	3½	Do.
127508	Antler	Spoon	Togiak River	7½	Applegate.
127632	do	Hoop	do	2½	Johnson.
127791	do	do	Kushinuk	3½	Do.
127892	do	do	Nakneek	4	Fisher.
127896	do	Spoon	Kotzebue Sound	3½	Stoney.

HIDE-SCRAPERS.

[Used for cutting flesh and hair from a dried skin. The handle, blade and lashing indicate environment, skill, and amount of contact with the white race.]

Number.	Material.	Place.	Length.	Collector.
			<i>Inches.</i>	
10398	Wood, bone, sinew	Igloodik	6½	Hall.
24350	Wood, slate, spruce root	Norton Sound	6½	Nelson.
24350	do	St. Michael's Island	9½	Turner.
24361	Wood, slate	Norton Sound	4½	Do.
24689	Wood, slate, rawhide	do	11½	Do.
33084	do	do	7½	Nelson.
33086	do	do	12½	Do.
33090	do	Kegiktoiwik	9½	Do.
33093	Ivory, flint	Norton Sound	3½	Do.
33094	Wood	Kegiktoiwik	6½	Do.
34083	Wood, stone, twine	Cumberland Gulf.	4½	Kamlein.
34084	do	do	4	Do.

HIDE-SCRAPERS—Continued.

Number.	Material.	Place.	Length.	Collector.
			<i>Inches.</i>	
34085	Wood, stone inserted.....	Cumberland Gulf.....	3 $\frac{1}{2}$	Kumlein.
37613	Ivory, no blade.....	Nubviak.....	4 $\frac{1}{2}$	Nelson.
37614	...do.....	Kotzebue Sound.....	2 $\frac{1}{2}$	Do.
38252	Wood, flint, spruce root.....	Lake Yukton.....	6 $\frac{1}{2}$	Do.
38253	Wood, slate, spruce root.....	...do.....	6 $\frac{1}{2}$	Do.
38288	Ivory, no blade.....	...do.....	3 $\frac{1}{2}$	Do.
38485	Wood, slate, spruce root.....	...do.....	10	Do.
38602	Wood, slate, sinew twine.....	Cape Vancouver.....	18 $\frac{1}{2}$	Do.
38603	Wood, slate, rawhide.....	...do.....	17 $\frac{1}{2}$	Do.
38868	Wood, slate, spruce root.....	Kuskokvim.....	19	Do.
38828	Wood, celt, rawhide.....	Big Lake.....	12 $\frac{1}{2}$	Do.
38839	Crutch of wood, slate, spruce root.....	...do.....	17	Do.
39062	Wood, flint, rawhide.....	Norton Sound.....	6	Do.
43228	Ivory, flint.....	Oonalakleet.....	5 $\frac{1}{2}$	Do.
43405	Wood, slate.....	Cape Prince Wales.....	7	Do.
43408	Wood, slate, rawhide.....	...do.....	4 $\frac{1}{2}$	Do.
43886	Crutch of wood, slate, rawhide.....	Mission Alaska.....	16 $\frac{1}{2}$	Do.
43927	Wood, slate, spruce root.....	Nubviak.....	11 $\frac{1}{2}$	Do.
44086	Wood, slate.....	Koyuk River.....	6 $\frac{1}{2}$	Do.
44140	Wood, no blade.....	Norton Bay.....	5 $\frac{1}{2}$	Do.
44180	Ivory, no blade.....	Cape Darby.....	5 $\frac{1}{2}$	Do.
44357	Wood, no blade.....	Norton Bay.....	4 $\frac{1}{2}$	Do.
44085	Wood, flint inserted.....	Koyuk River.....	4 $\frac{1}{2}$	Do.
44084	Ivory, no blade.....	...do.....	4	Do.
44982	Wood, slate, rawhide.....	Sledge Island.....	7 $\frac{1}{2}$	Do.
44983	...do.....	...do.....	7 $\frac{1}{2}$	Do.
44984	...do.....	...do.....	7	Do.
48623	Ivory, no blade.....	Kotzebue Sound.....	2 $\frac{1}{2}$	Do.
48624	...do.....	...do.....	3 $\frac{1}{2}$	Do.
48625	Ivory, flint inserted.....	...do.....	4 $\frac{1}{2}$	Do.
48626	Ivory, no blade.....	...do.....	3 $\frac{1}{2}$	Do.
48627	...do.....	...do.....	5 $\frac{1}{2}$	Do.
48882	Wood, slate, spruce root.....	Lake Yukon.....	7 $\frac{1}{2}$	Do.
48941	...do.....	Sabotnisky.....	11 $\frac{1}{2}$	Do.
55910a	...do.....	Bristol Bay.....	15 $\frac{1}{2}$	McKay.
55910b	...do.....	...do.....	13 $\frac{1}{2}$	Do.
55910c	...do.....	...do.....	12 $\frac{1}{2}$	Do.
55910d	...do.....	...do.....	15 $\frac{1}{2}$	Do.
55910e	Wood, slate, rattan root.....	...do.....	16	Do.
55910f	Wood, slate, spruce root.....	...do.....	15 $\frac{1}{2}$	Do.
55910g	...do.....	...do.....	16 $\frac{1}{2}$	Do.
55910h	Crutch of wood, slate, rawhide.....	...do.....	13 $\frac{1}{2}$	Do.
55910i	...do.....	...do.....	14	Do.
55910k	...do.....	...do.....	14 $\frac{1}{2}$	Do.
55910l	...do.....	...do.....	16 $\frac{1}{2}$	Do.
56548	Ivory, no blade.....	Point Barrow.....	3 $\frac{1}{2}$	Ray.
56549	...do.....	...do.....	4 $\frac{1}{2}$	Do.
63559	...do.....	Point Hope.....	3 $\frac{1}{2}$	Nelson.
63655	...do.....	...do.....	4	Do.
63851	Ivory, flint inserted.....	...do.....	3 $\frac{1}{2}$	Do.
63852	...do.....	...do.....	3 $\frac{1}{2}$	Do.
63853	...do.....	...do.....	4 $\frac{1}{2}$	Do.
63854	Ivory, no blade.....	...do.....	3 $\frac{1}{2}$	Do.
63856	...do.....	...do.....	3 $\frac{1}{2}$	Do.

GRAINING TOOL, WITH FINE TEETH AT THE END.

Number.	Material.	Tribe.	Length. <i>Inches.</i>	Collector.
14196	Iron	Sioux	15	Palmer.
19894	Bone	Utes	7½	Powell.
31316	...do	Pueblos	11½	Yarrow,
89924	...do	Ungavas	12½	Turner.
89925	Bone and irondo	14½	Do.
89927	Wood and irondo	13	Do.
90246	Bonedo	13	Do.

BEAMING TOOLS OF BONE, FOR REMOVING HAIR.

Number.	Material.	Place or people.	Length. <i>Inches.</i>	Collector.
11891	Bone	Pai Utes	10½	Powell.
19881	...dodo	14½	Do.
38244	...do	Madisonville		Metz.
38490	...do	Kuskovim	9½	Nelson.
55912	Wood and iron	Bristol Bay	14½	McKay.
89928	Bone	Ungavas	13½	Turner.
89930	...dodo	14	Do.
90248	...dodo	12½	Do.
90248	...dodo	11½	Do.

ADZE-SHAPED SCRAPERS WITH IRON BLADES.

Number.	Handle.	Tribe.	Length. <i>Inches.</i>	Collector.
.....	Antler	Sioux	14½	Blackmore.
1462	...do	Comanches	11	Berlandier.
6336	...do	Gros Ventres	11	Matthews.
6337	...dodo	13½	Gray and Matthews.
6896	Wood	Comanches	12	Palmer.
6897	...dodo	11	Do.
9064	Antler	Sioux	12	Gardner.
9652	...do	Utes	11½	Lyon.
11100	...do	Crows	13½	Stevenson.
11226	...do	Pai Utes	11½	Powell.
19892	...do	Utes	9	Do.
19853	...dodo	11½	Do.
31317	Wood	Pueblos	11	Wheeler.
130622	Antler	Crows	14½	Allen.

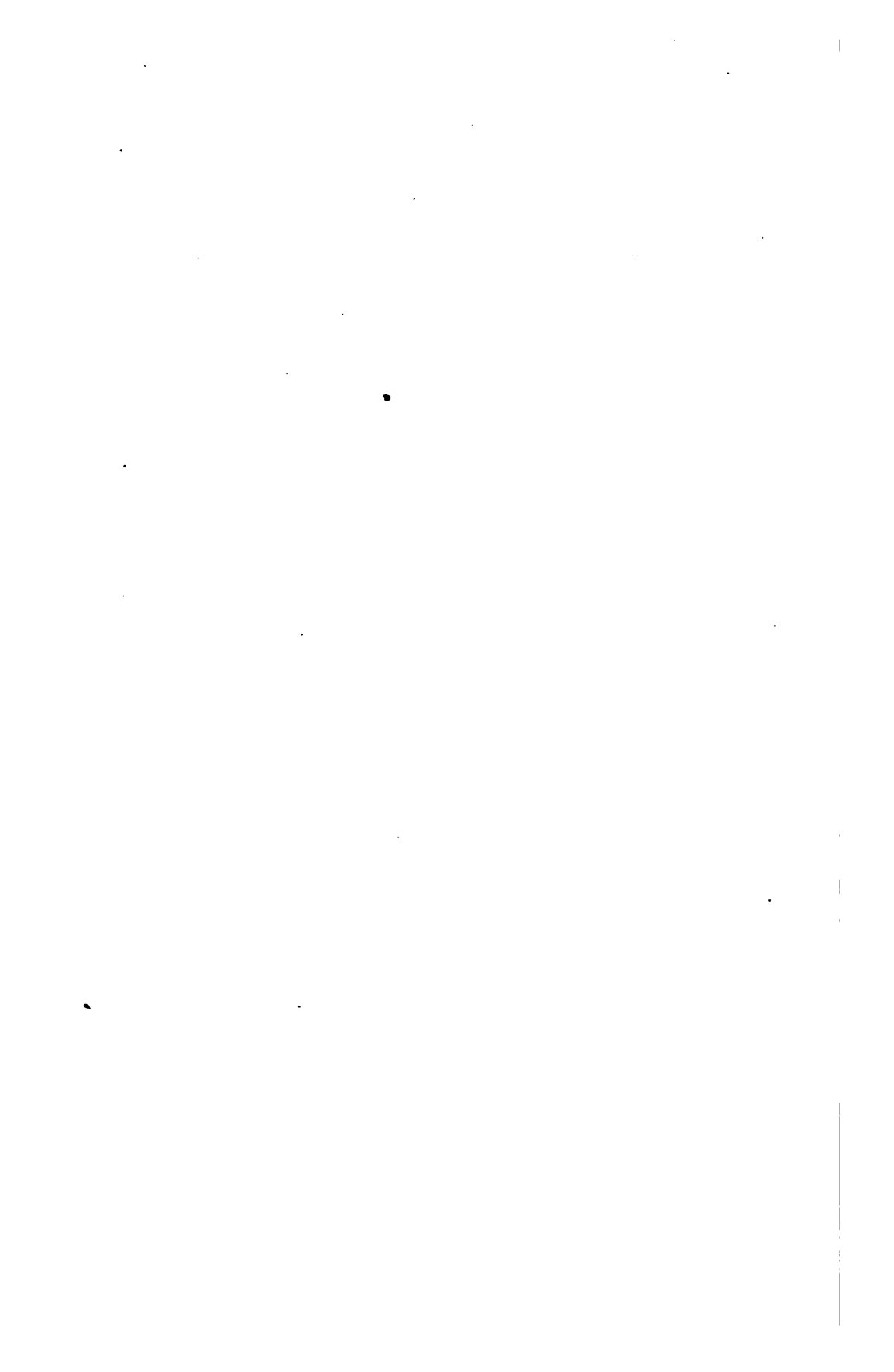

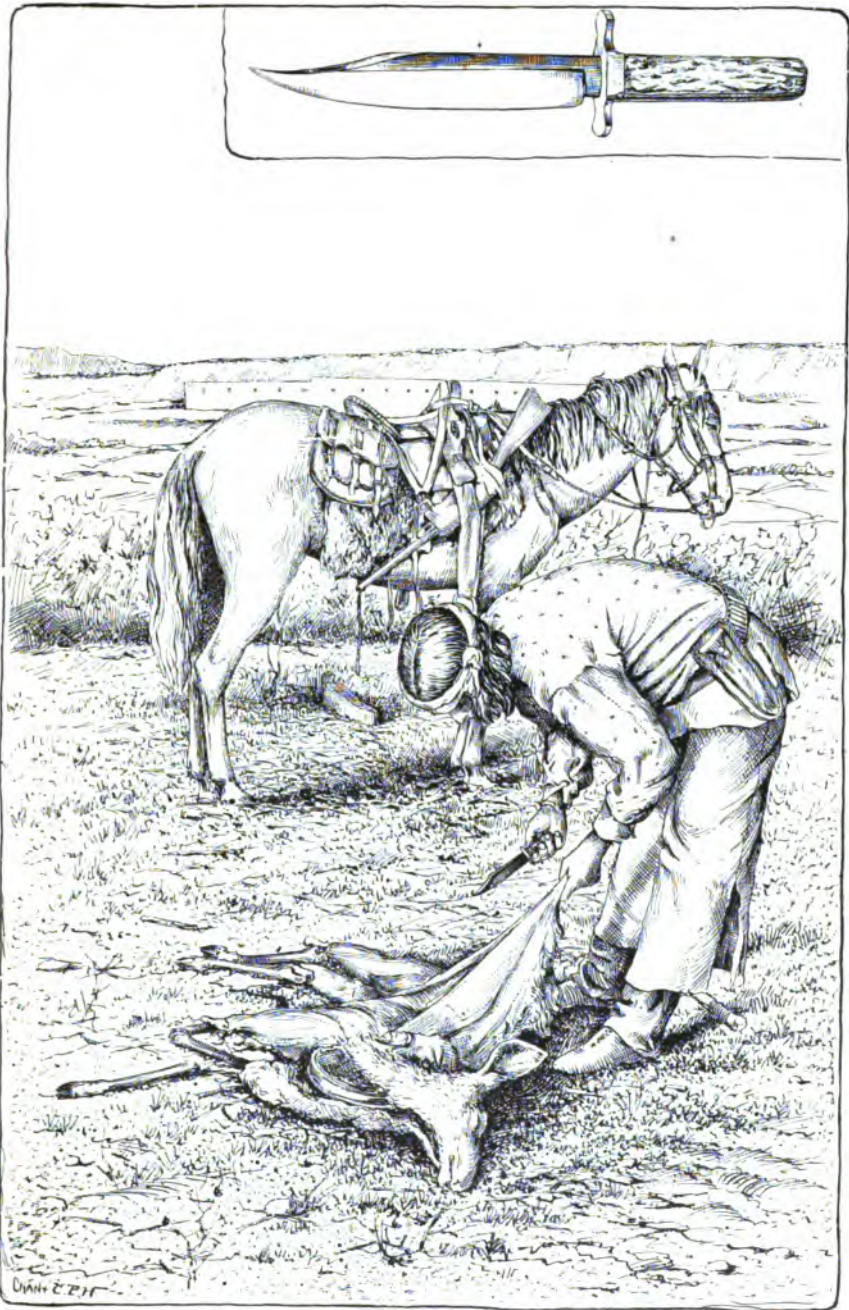

NAVAJO INDIAN SKINNING DEER. (After Shufeldt.)

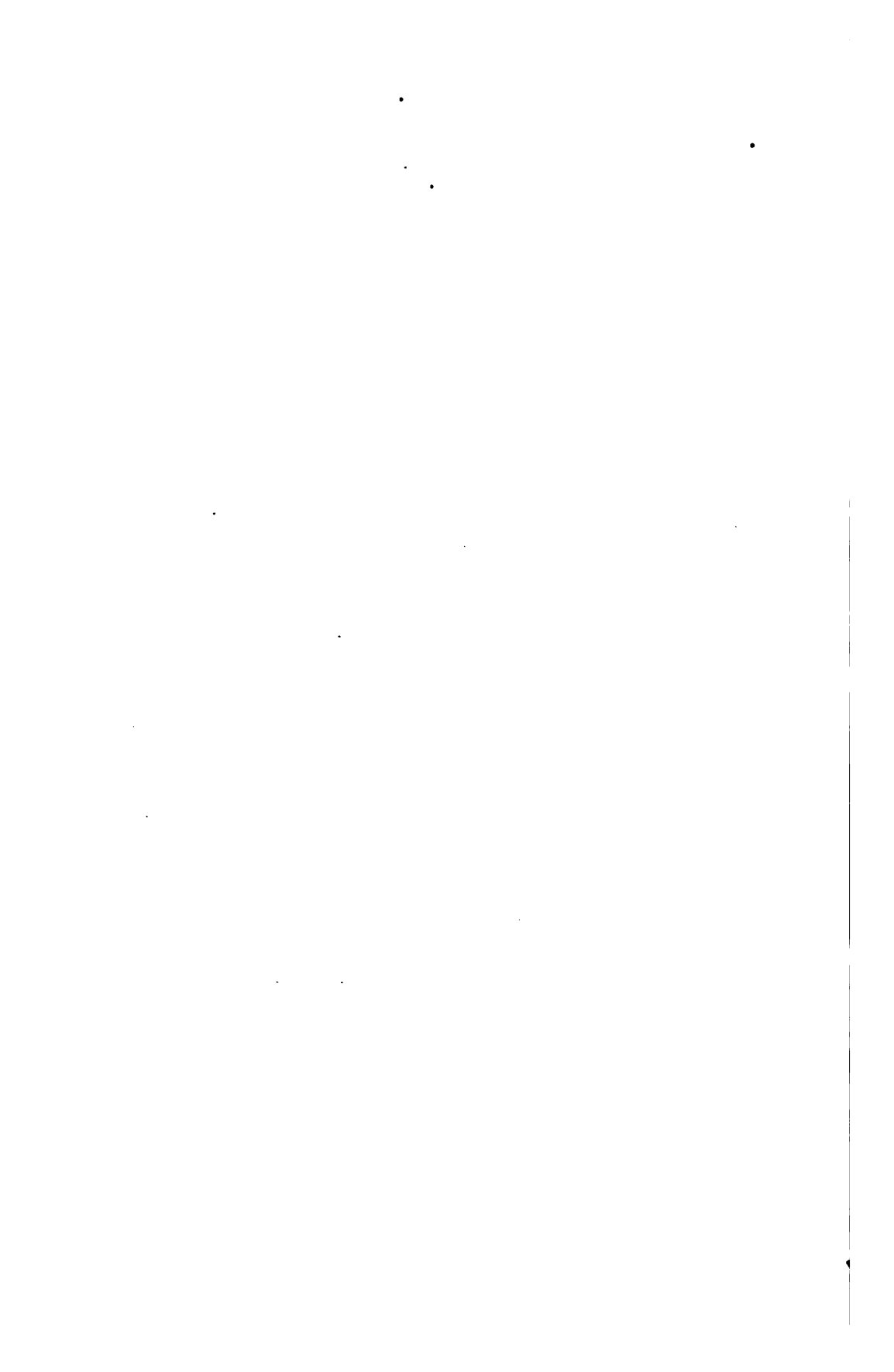



NAVAJO INDIAN REMOVING HAIR FROM DEER-SKIN. (After Shufeldt.)

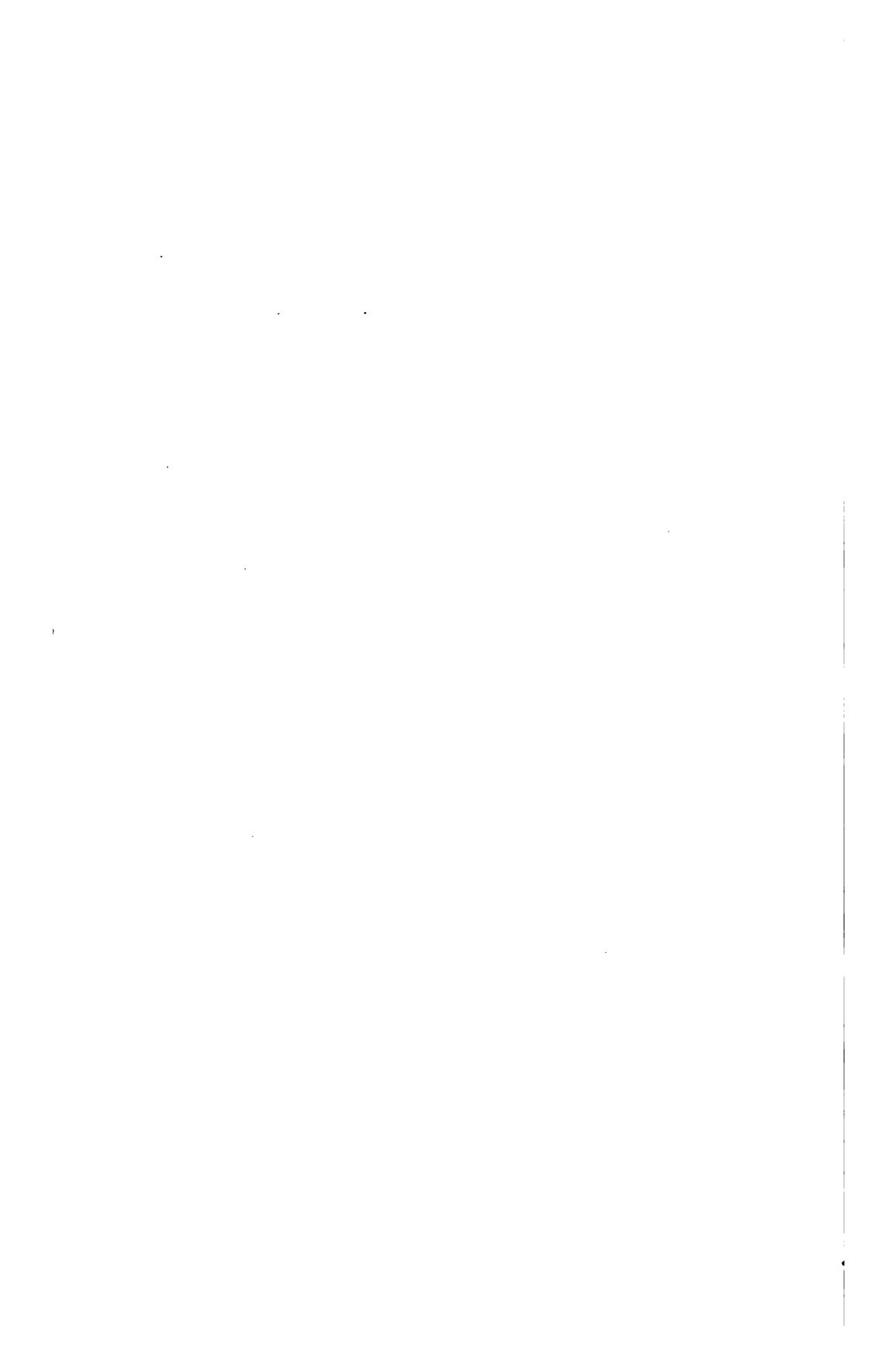



NAVAJO INDIAN WRINGING WATER FROM A DEER-SKIN. (After Shufeldt.)

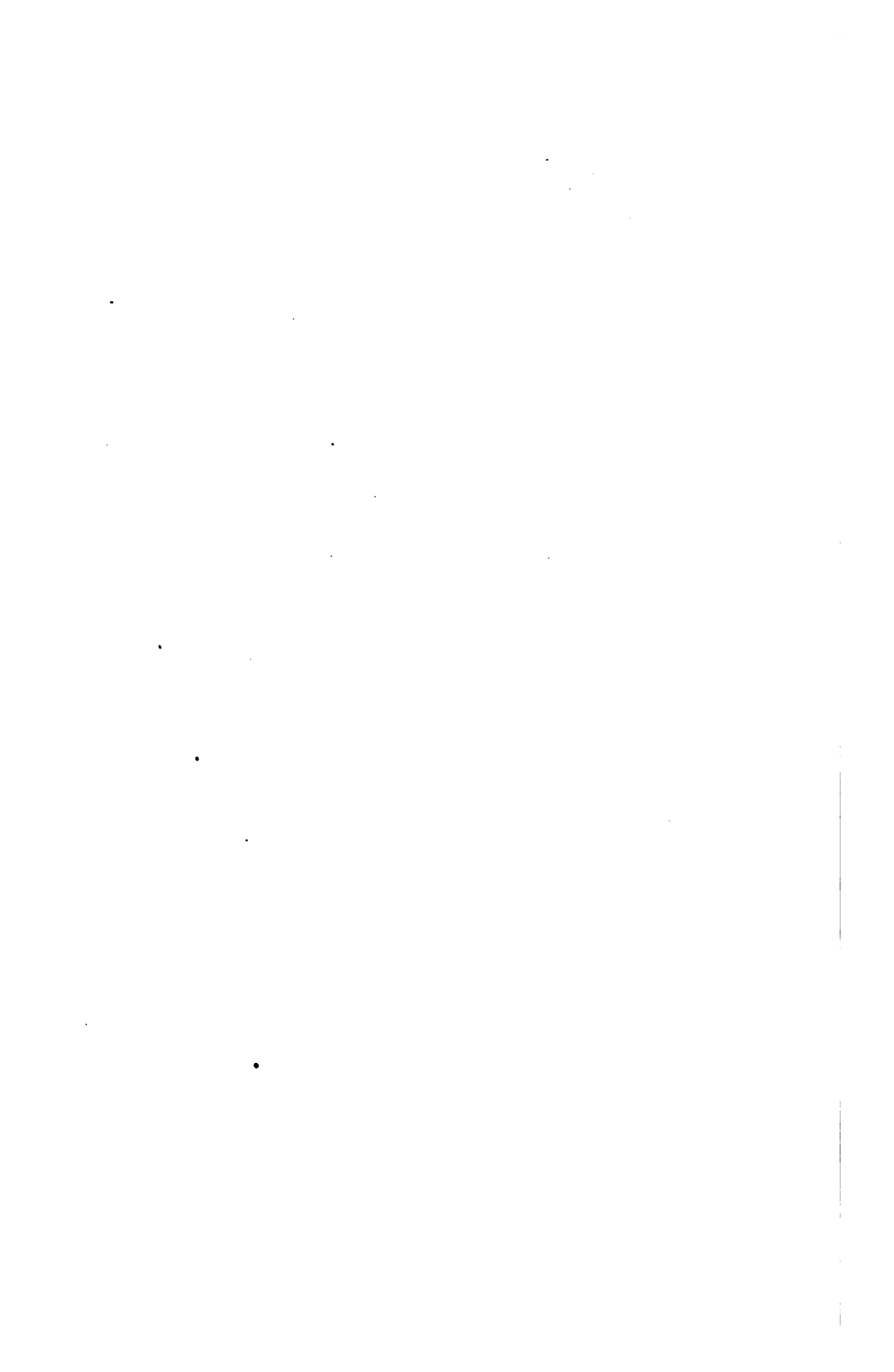



NAVAJO INDIAN PULLING DEER-SKIN INTO SHAPE AFTER WRINGING. (After Shufeldt.)

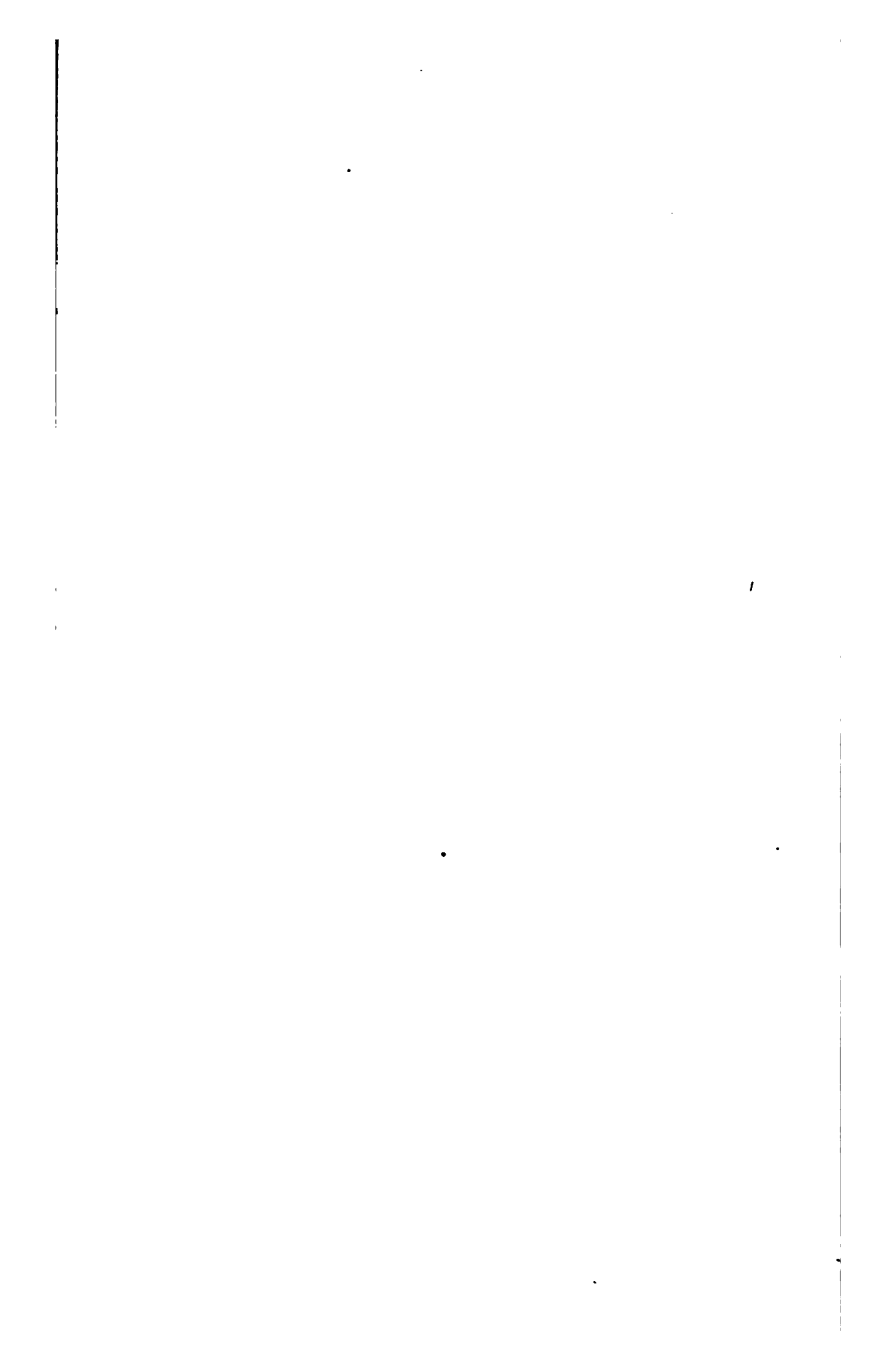

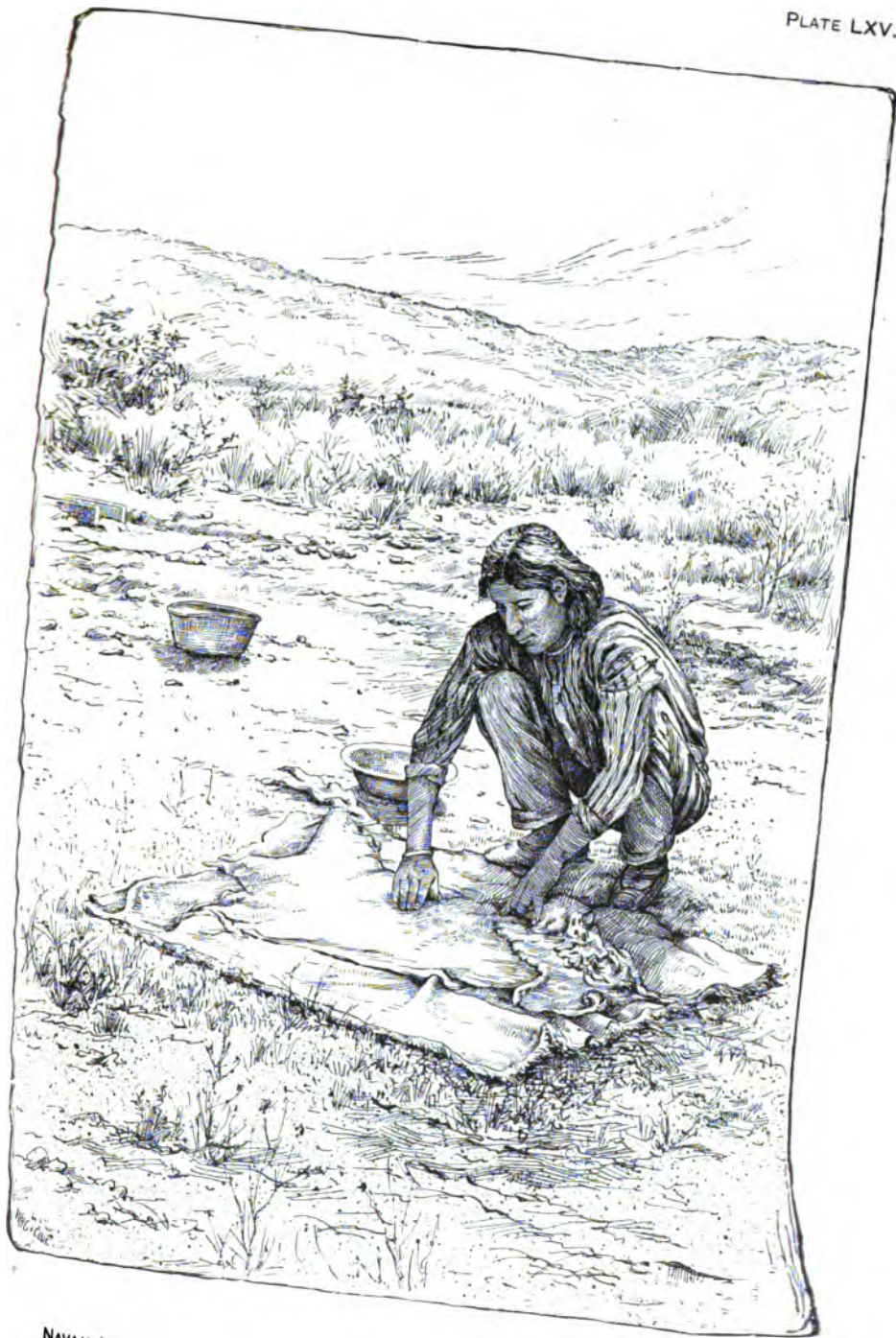

NAVAJO INDIAN APPLYING BRAINS TO DEER-SKIN TO MAKE IT SOFT. (After Shufeldt.)





NAVAJO INDIAN FINISHING DEER-SKIN BY STRETCHING IT. (After Shufeldt.)

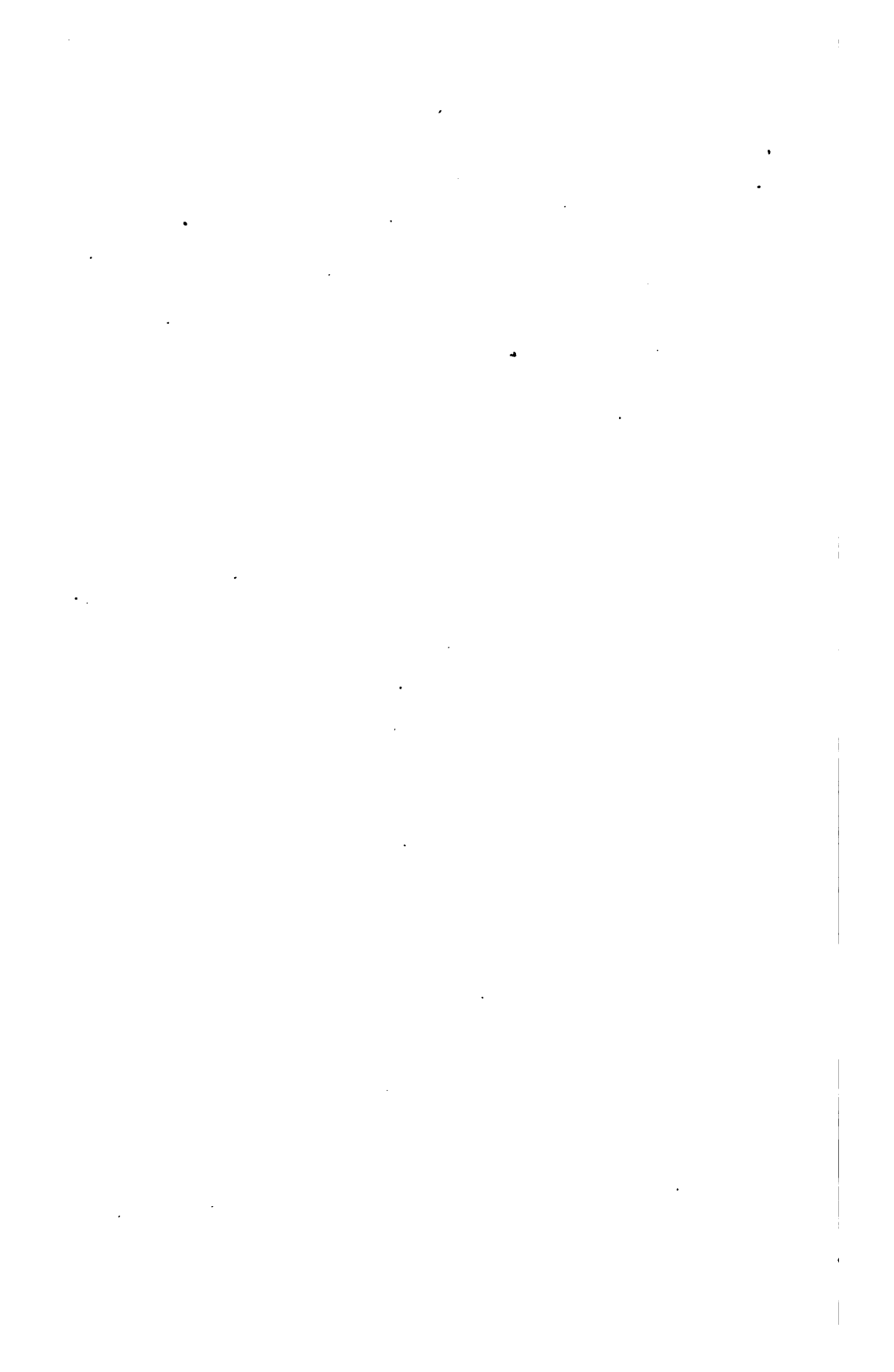

EXPLANATION OF PLATE LXVII.

Fig. 1. BEAMING TOOL. Made of the tibia of a musk-ox. The bone has been hacked in so as to have the broad inner part of the posterior wing for a rest and the middle of the front portion for an edge. The natural form of the bone lends itself splendidly to this method of treatment. Compare this with Fig. 3, Pl. LXVII, and Fig. 1, Pl. LXXXIV.

Cat. No. 90248, U. S. N. M. Indians of Ungava, Canada. Collected by Lucien M. Turner.

Fig. 2. BEAMING TOOL. Made from the leg bone of the reindeer. Only half of the specimen is given, but enough remains to show the absolute similarity between this and the great number of broken implements of the same sort found in the Madisonville cemetery, Ohio. See next figure. The perforation on the lower side is common in many Eskimo tools.

Cat. No. 89488, U. S. N. M. Eskimo of Point Barrow. Collected by Capt. P. H. Ray. U. S. Army.

Fig. 3. BEAMING TOOL. Made from the leg bone of a deer. The bone has been cut away so as to afford two edges for removing the hair in skin working. This specimen comes from the celebrated cemetery at Madisonville, Ohio, and is here reproduced to show the great similarity of form in various parts of the country.

Cat. No. 43076, U. S. N. M. Graves of Madisonville, Ohio. Collected by Dr. C. L. Metz.



BEAMING TOOLS.

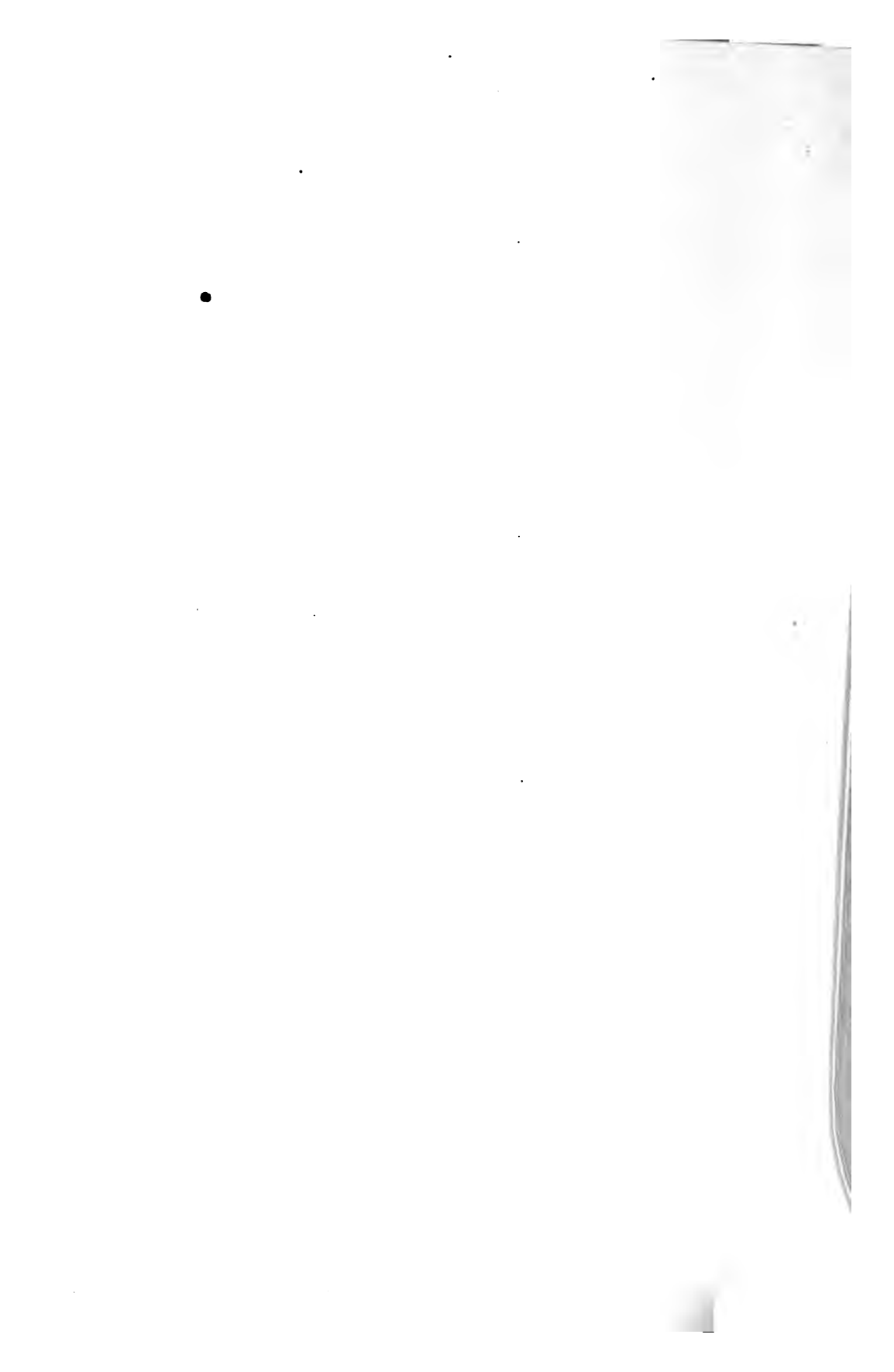

EXPLANATION OF PLATE LXVIII.

Fig. 1. GRAINER. Of the humerus of the musk-ox. The upper joint furnishes the handle and the hard portion of the bone cut diagonally forms the edge. Fine serrations on the edge furnish the graining surface.

Cat. No. 90246, U. S. N. M. Eskimo and Indians of Ungava, Canada. Collected by Lucien M. Turner.

Fig. 2. GRAINING TOOL. Handle of pine. Blade of iron, finely toothed and lashed to the shaft with a buckskin strip. A thong fastened to the top of the handle passes around the wrist and catches the force of the blow. This is an excellent device for giving emphasis to the work of the tool.

Cat. No. 89927, U. S. N. M. Eskimo and Indians of Ungava, Canada. Collected by Lucien M. Turner.

Fig. 3. GRAINER. Made from the "bit" of a plane and finely serrated. In use this is placed on the primitive bone grainer and lashed with buckskin.

Cat. No. 90260, U. S. N. M. Eskimo and Indians of Ungava, Canada. Collected by Lucien M. Turner.

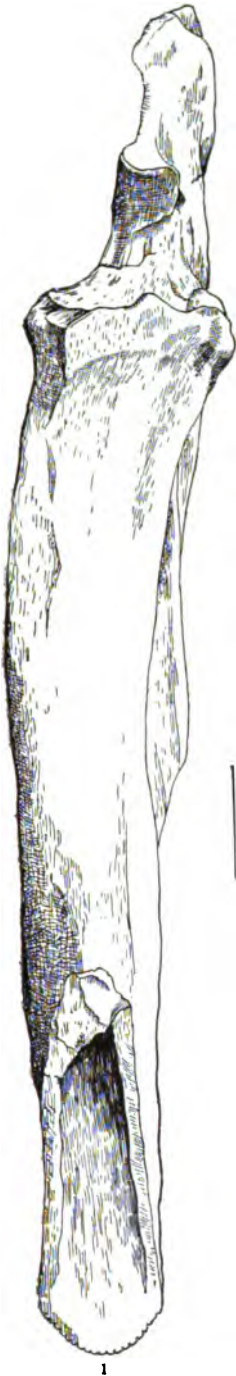

1



3

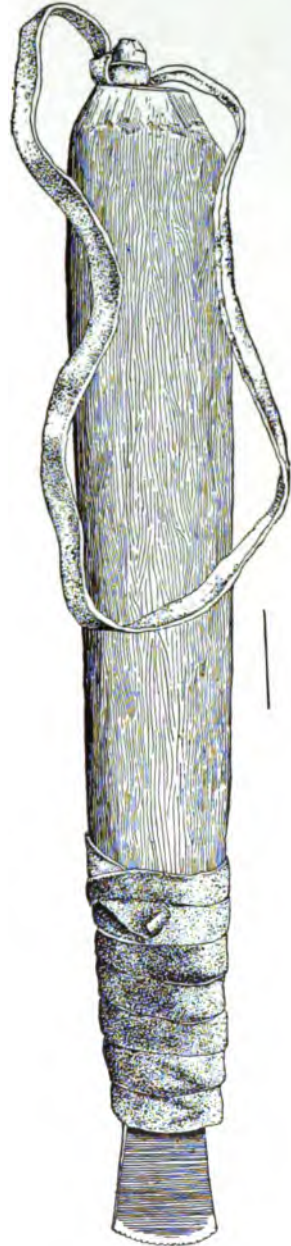

2

GRAINING TOOLS.

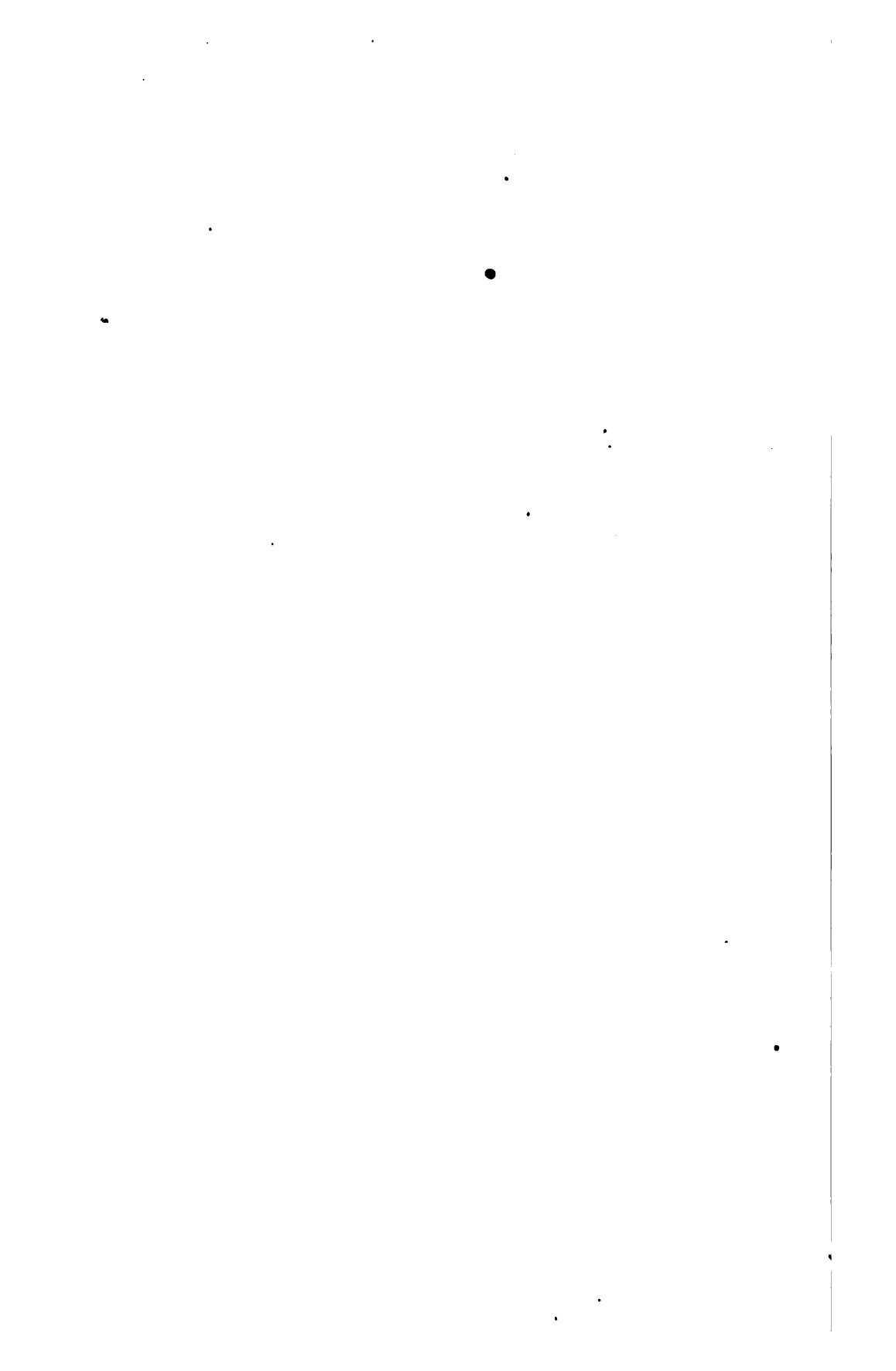



EXPLANATION OF PLATE LXIX.

Fig. 1. FAT-SCRAPER. Of antler. Much larger than the examples from the west. The antler is first split. About one-third of the piece retains the core to form a grip, and from the remainder the core is scraped away and the edge of the hard portions sharpened.

Cat. No. 90250, U. S. N. M. Indians and Eskimo of Ungava, Canada. Collected by Lucien M. Turner.

Fig. 2. SCRAPER. Probably for removing fat. Reproduced here from Captain Holm's celebrated work on East Greenland.

Fig. 3. FAT-SCRAPER. Of antler. A strip of the horn split off and the lower part scraped to an edge.

Cat. No. 90397, U. S. N. M. Eskimo of Igloodik. Collected by Capt. C. F. Hall.

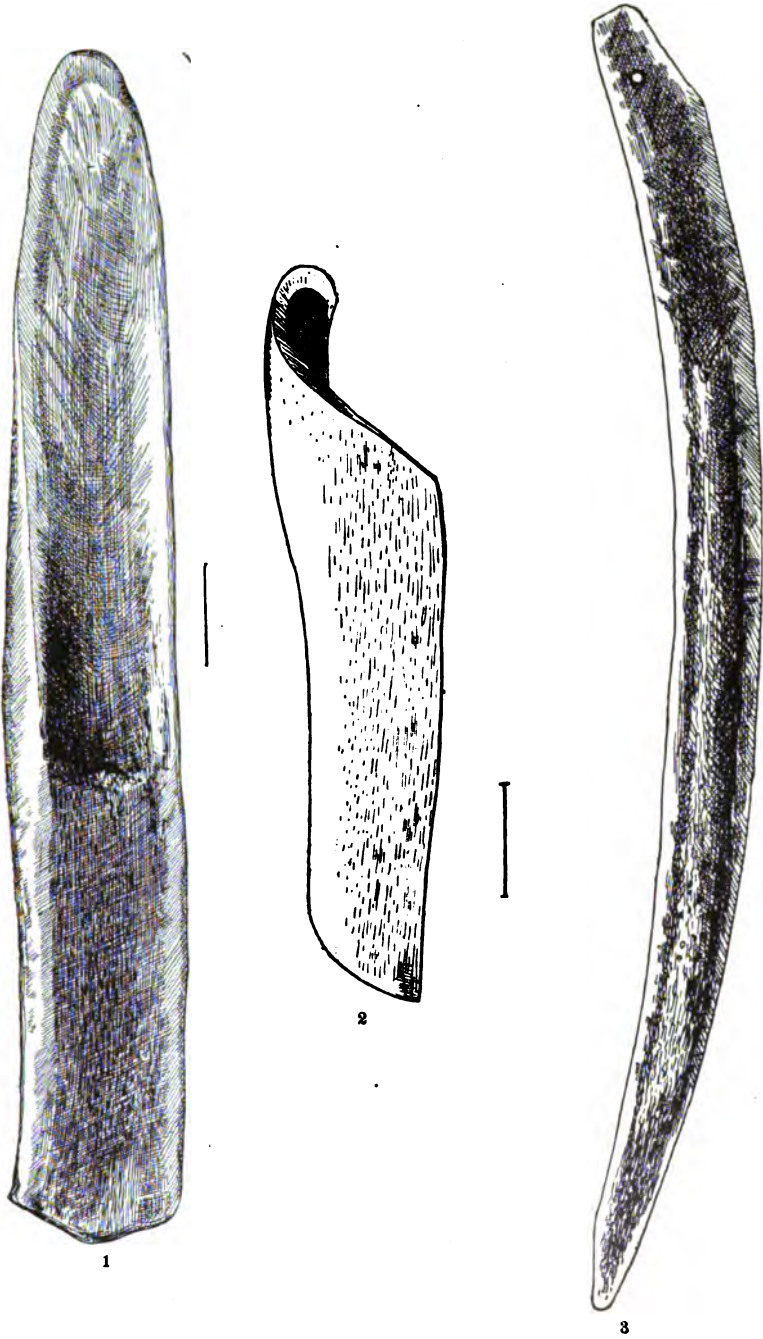

FAT-SCRAPERS.

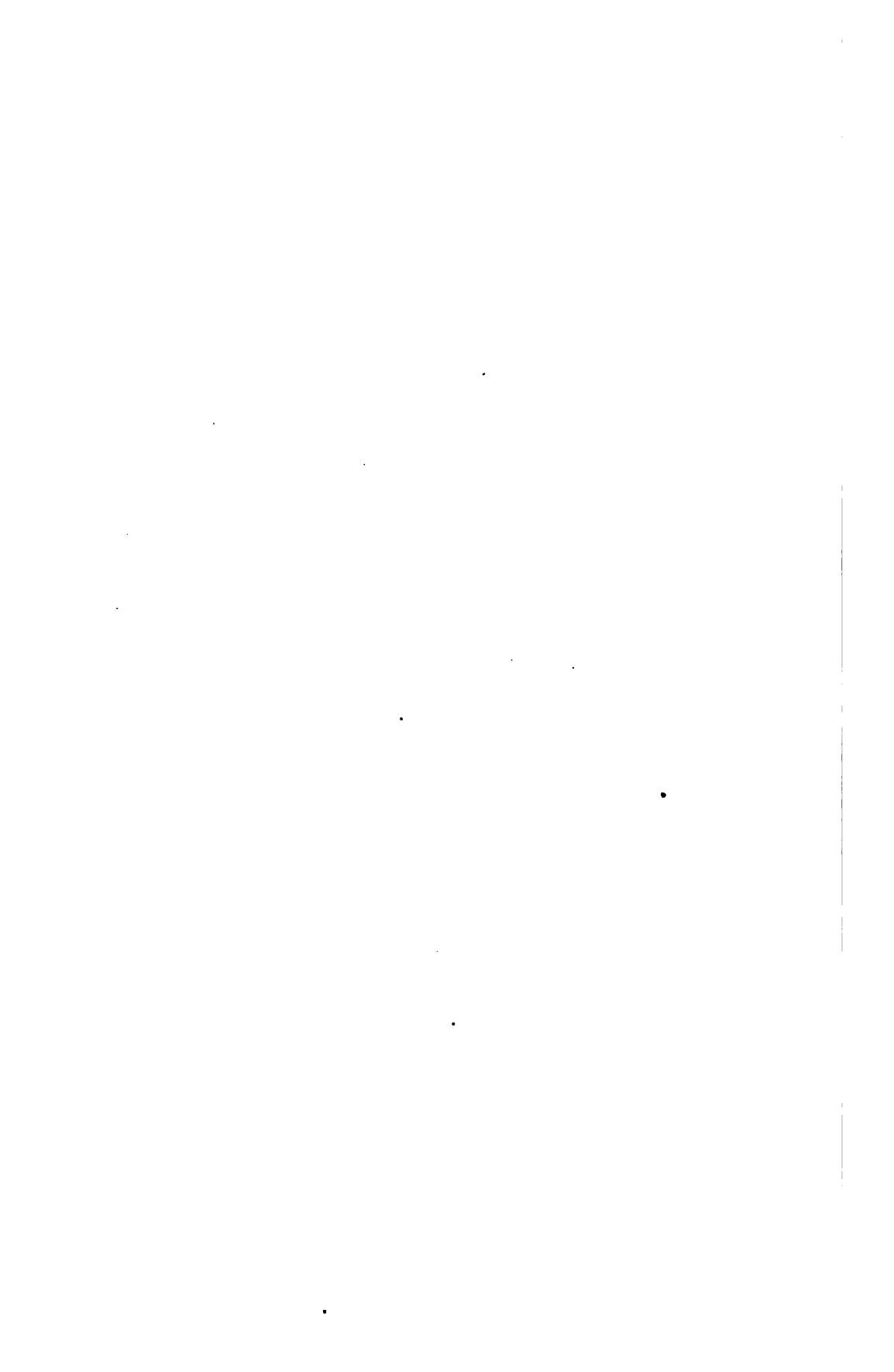

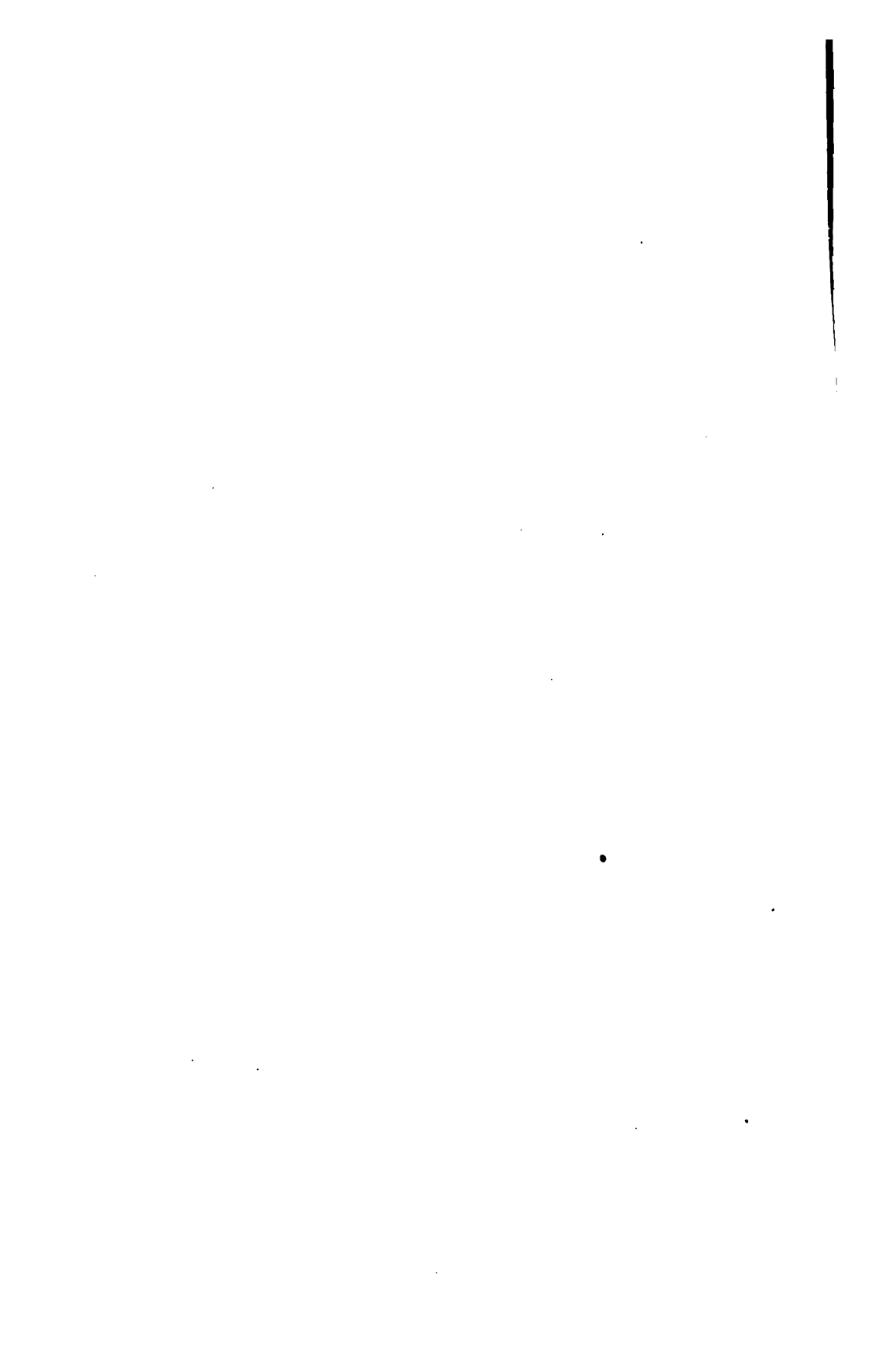

EXPLANATION OF PLATE LXX.

Fig. 1. SCRAPER. Blade of bone, with edge resembling that of a gouge, fastened to a pine handle by a seizing of sinew. The edge is very smooth and worn, and the specimen must have been used more as a beaming tool. The drawing marked (2) is a precisely similar form dug from the ash-pit graves of Madisonville. The attention of archæologists is here called to the fact that all the specimens from that celebrated cemetery are allied to modern northern implements.

Cat. No. 10897, U. S. N. M. Eskimo of Iglulik. Collected by Capt. C. F. Hall.

Fig. 3. SCRAPER. Handle of soft wood, faintly and rudely cut in and grooved like the beautiful ivory specimens from Alaska. Thumb groove, fore and middle finger grooves atop; ring finger groove and undercut large notch for finger, small. The blade is a dull celt of sandstone let half its length into a socket in the end of the handle. Length, 4 inches.

Cat. No. 84064, U. S. N. M. Eskimo of Cumberland Gulf. Collected by L. Kumlien. There are three examples of this type in the National Museum.

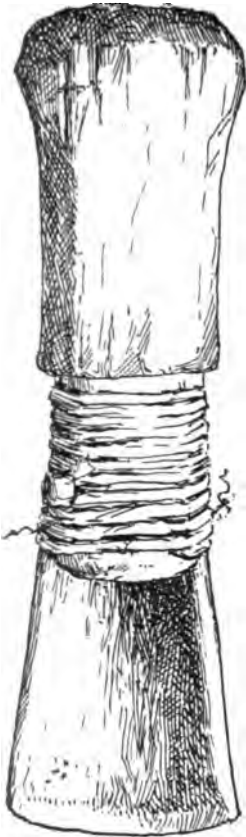

1

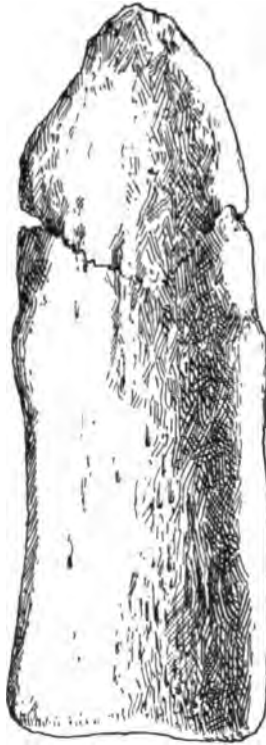

2



3

SCRAPERS.

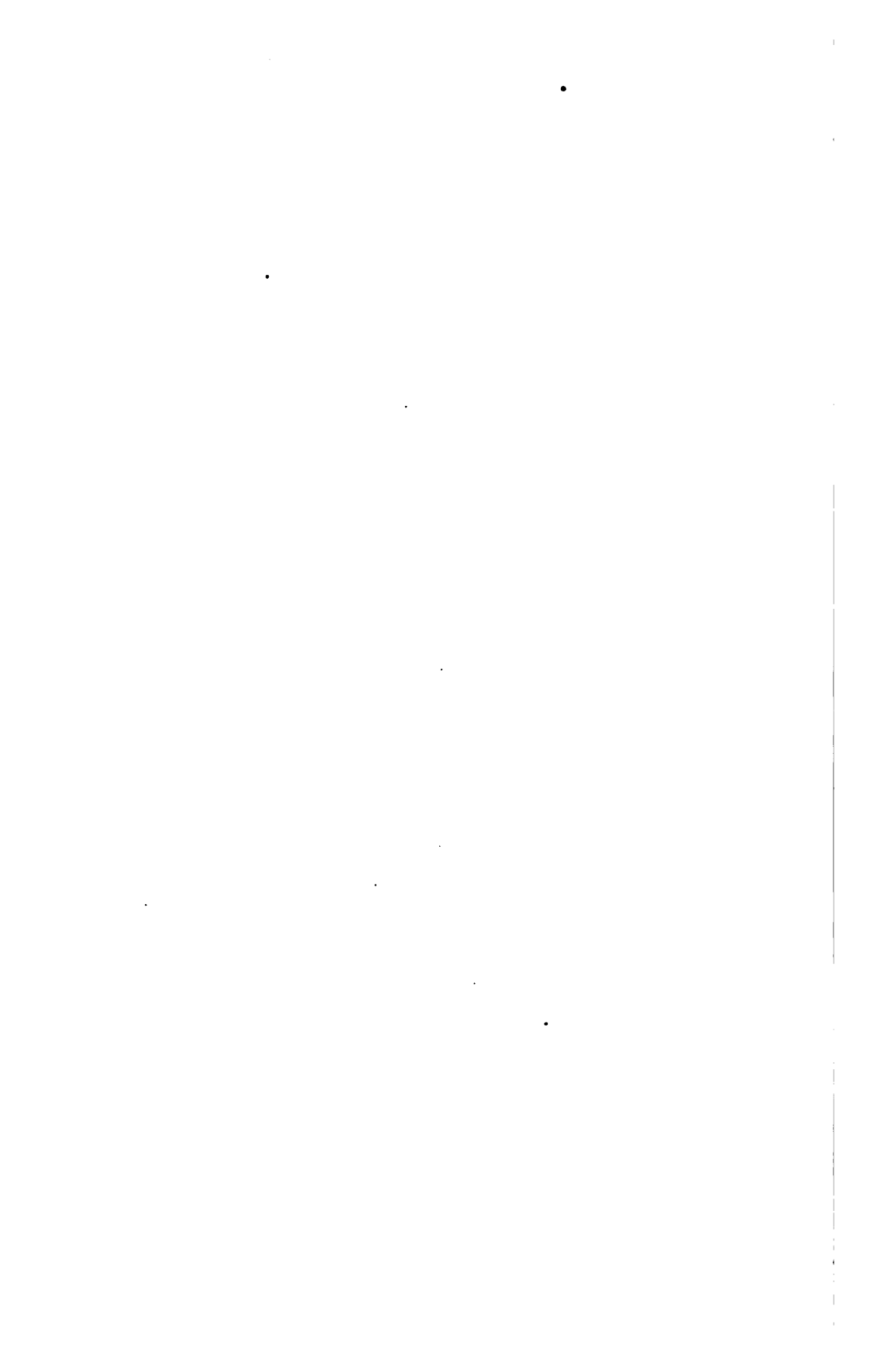

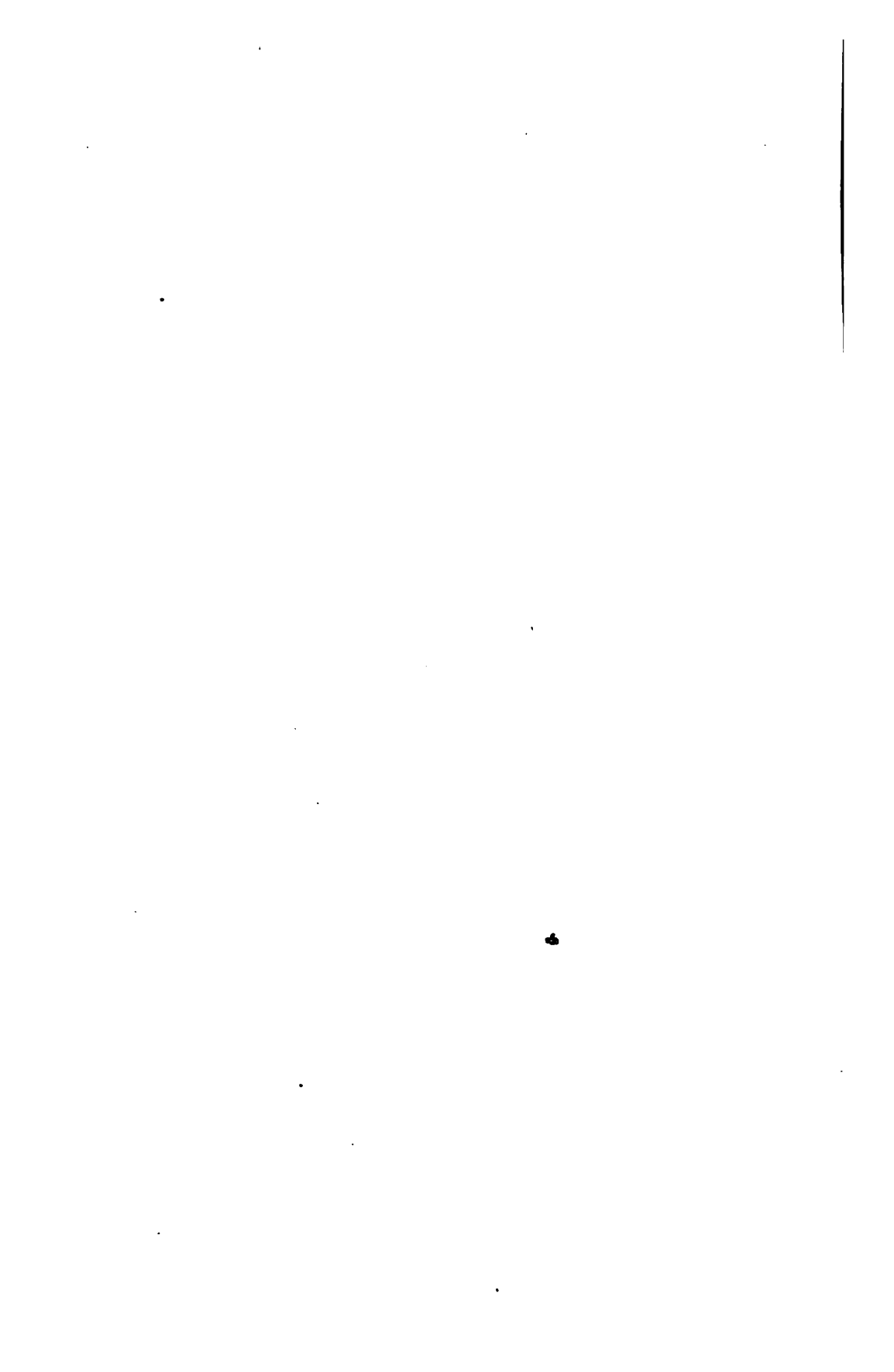

EXPLANATION OF PLATE LXXI.

Fig. 1. SCRAPER. Handle of antler. Blade of iron driven into the end of the handle.
The antler shows longitudinally the marks of the sand-saw.

Cat. No. 2020, U. S. N. M. Eskimo of Anderson River, Canada. Collected by B. R. Ross.

Fig. 2. SCRAPER BLADE. Of dark chert.

Cat. No. 36290, U. S. N. M. Eskimo of Cape Vancouver. Collected by E. W. Nelson

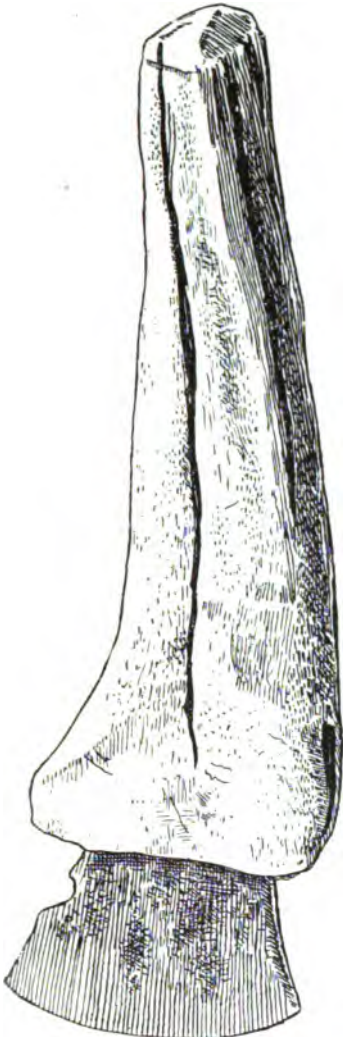

1

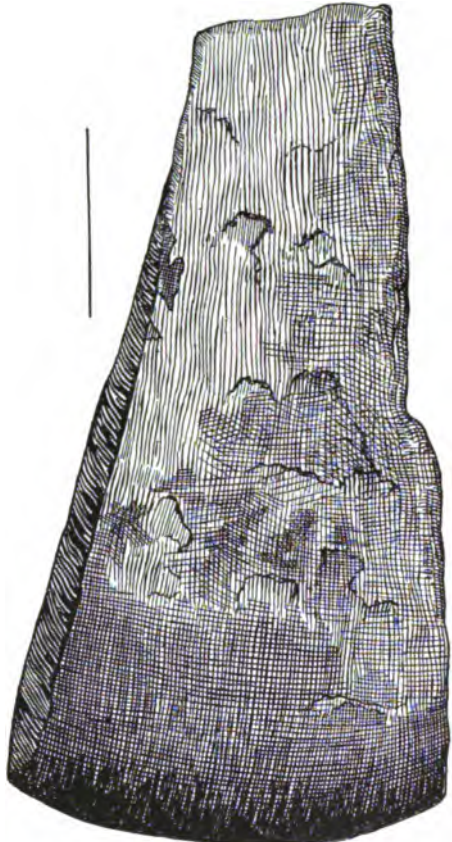

2

SCRAPERS.



EXPLANATION OF PLATE LXXII.

Fig. 1 (*a*, *b*, and *c*). SCRAPER. Long, large-sized handle of spruce. Thumb groove for a large digit, deep and wide. Groove for forefinger, pocket for middle finger, undercut nearly across the bottom. Tailpiece rectangular, thin, and nearly flat. Unlike most other implements of this class the specimen has for a blade a thin scale of sandy shale.

Cat. No. 83309, U. S. N. M. Eskimo of Point Barrow, Alaska. Collected by Capt. P. H. Ray, U. S. Army.



a



b



c

SCRAPER.

EXPLANATION OF PLATE LXXIII.

Fig. 1 (*a* and *b*). **SCRAPER.** Of walrus ivory. Thumb groove slight. Fingers separated by a ridge three and three-quarters inches in length. Undercut quite across and extending into a spoon-shape cavity of the palm rest, which is pierced for a suspending cord. This is a broad, heavy, and effective implement.

Cat. No. 89321, U. S. N. M. Eskimo of Point Barrow, Alaska. Collected by Capt. P. H. Ray, U. S. Army.

Fig. 2. **SCRAPER.** Of walrus ivory. There are no grooves for digits. The undercut extends quite across and the implement rests on its front and rear edge. The palm rest declines at an angle of 90 degrees and terminates abruptly without horizontal appendix. The blade, of reddish-brown jasper, is held in its socket by a washer of rawhide.

Cat. No. 89313, U. S. N. M. Eskimo of Point Barrow, Alaska. Collected by Capt. P. H. Ray, U. S. Army.

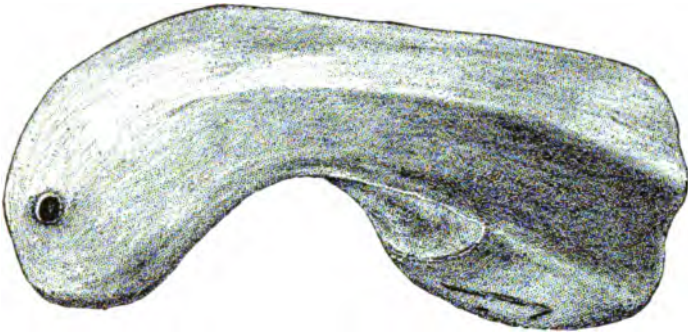

1a

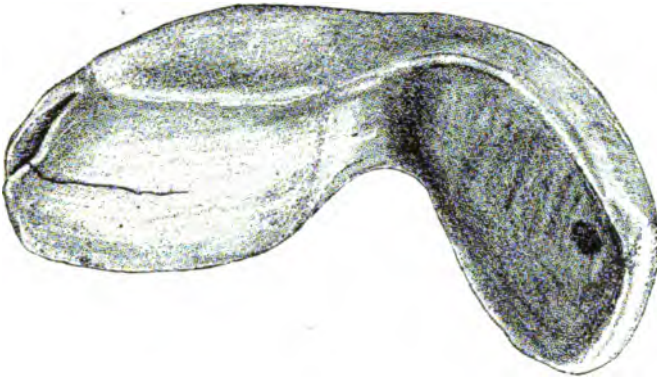

1b

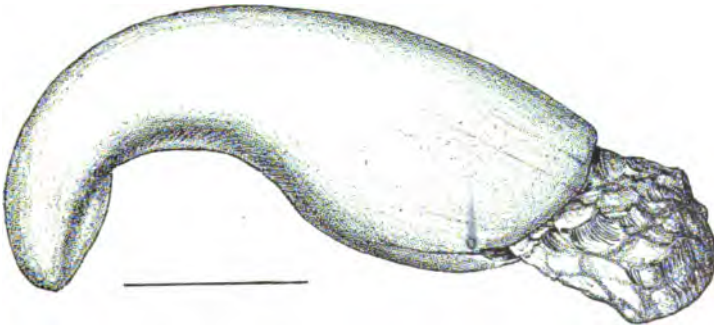

2

SCRAPERS.

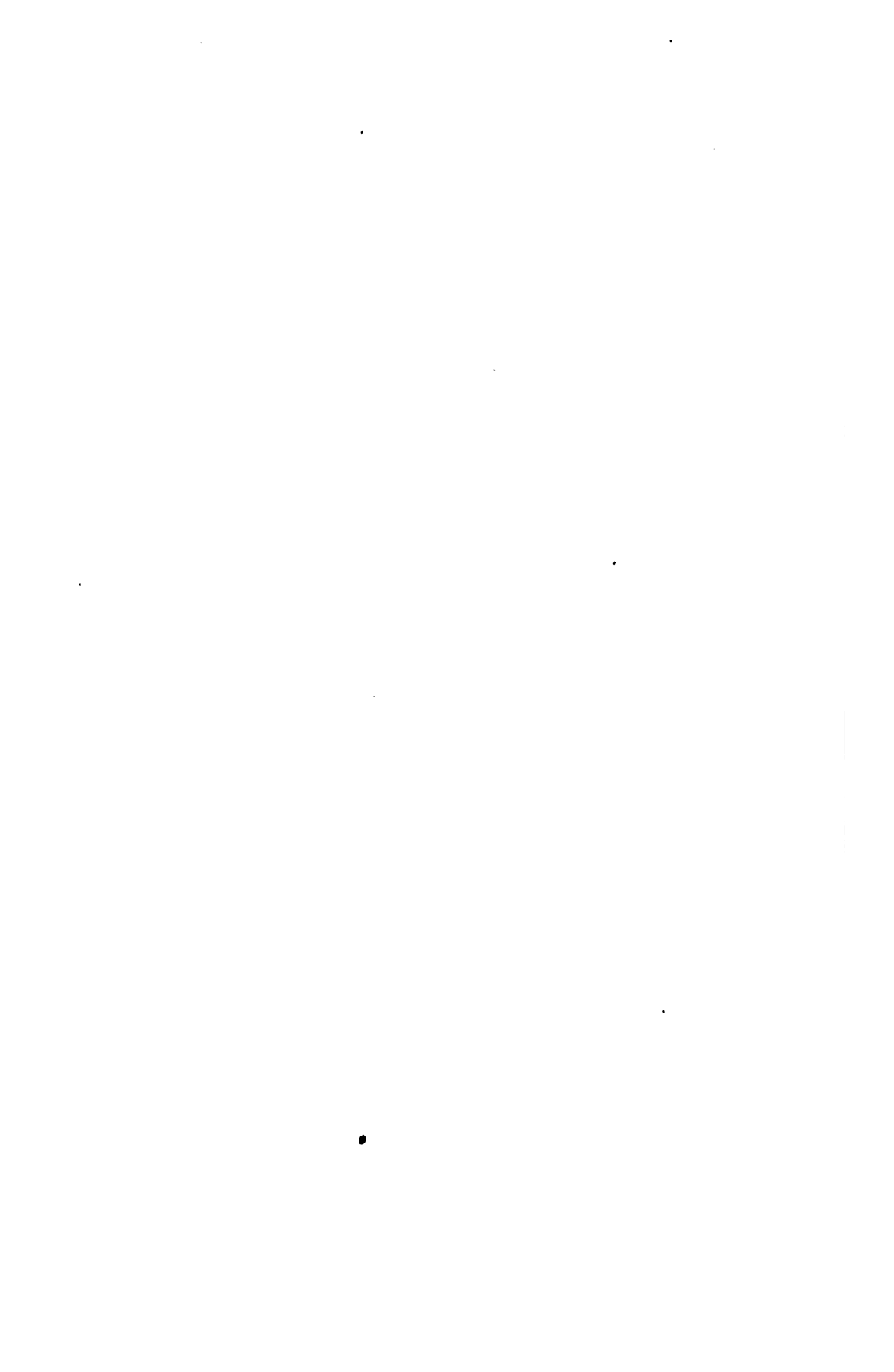



EXPLANATION OF PLATE LXXIV.

Fig. 1. SCRAPER. Of walrus ivory. A delicate, mottled specimen, shaped in front like the incisor of a horse. Thumb groove very slightly and delicately hollowed. There is an undercut on this side, but it serves no earthly purpose. In this and many other specimens this cut seems to be a fashion without an aim. The finger grooves are continuous to the margin next the stone blade and are models of graceful carving. The undercuts on both sides are nearly alike, causing the implement to rest on the front and rear. This is one of the most beautiful pieces in the Museum.

Cat. No. 99317, U. S. N. M. Eskimo of Point Barrow, Alaska. Collected by Capt. P. H. Ray, U. S. Army.

Fig. 2. SCRAPER. Of walrus ivory, resting upon the front and tailpiece. The thumb groove a shallow pit. Front finger grooves slight hollows. Undercut extending entirely across, but much smaller on the thumb side. Blade of black chert, held in place by a packing of cord much broader than the handle.

Cat. No. 99315, U. S. N. M. Eskimo of Point Barrow, Alaska. Collected by Capt. P. H. Ray, U. S. Army.

Fig. 3. SCRAPER. Of walrus ivory. Heavy and high arched. The specimen is new and is ornamented with incised lines coarsely fringed. This specimen has never been used and is the only one in the National Museum with the slightest ornamentation. It rests upon the front margin of the blade socket and the edge of the declined tailpiece and is singularly lifted up. Thumb groove deep, bordered above by a long ear-shaped piece in high relief. The finger grooves are long, narrow, and deep. The undercut is peculiar, that portion in which the fingers fit being separated from the more shallow portion on the left by a sharp offset. The ear-shaped projection will be noticed faintly on several other specimens.

Cat. No. 99314, U. S. N. M. Eskimo of Point Barrow, Alaska. Collected by Capt. P. H. Ray, U. S. Army.

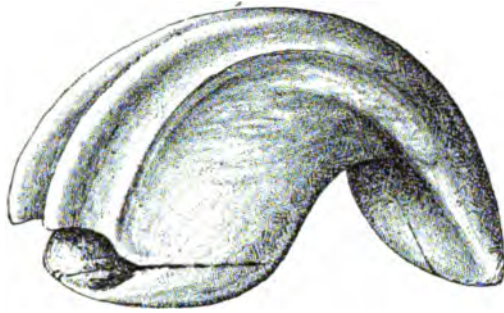

1



2

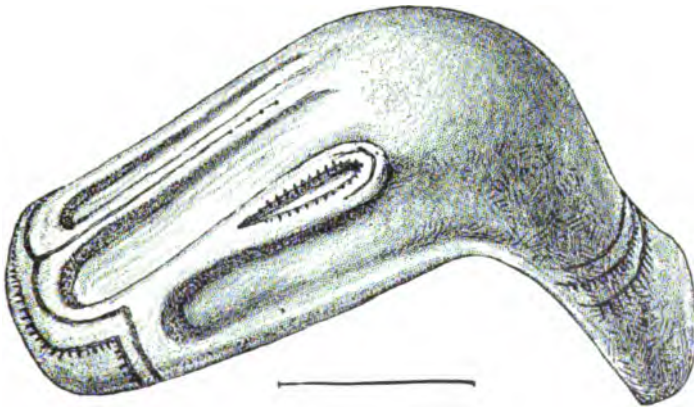

3

SCRAPERS.

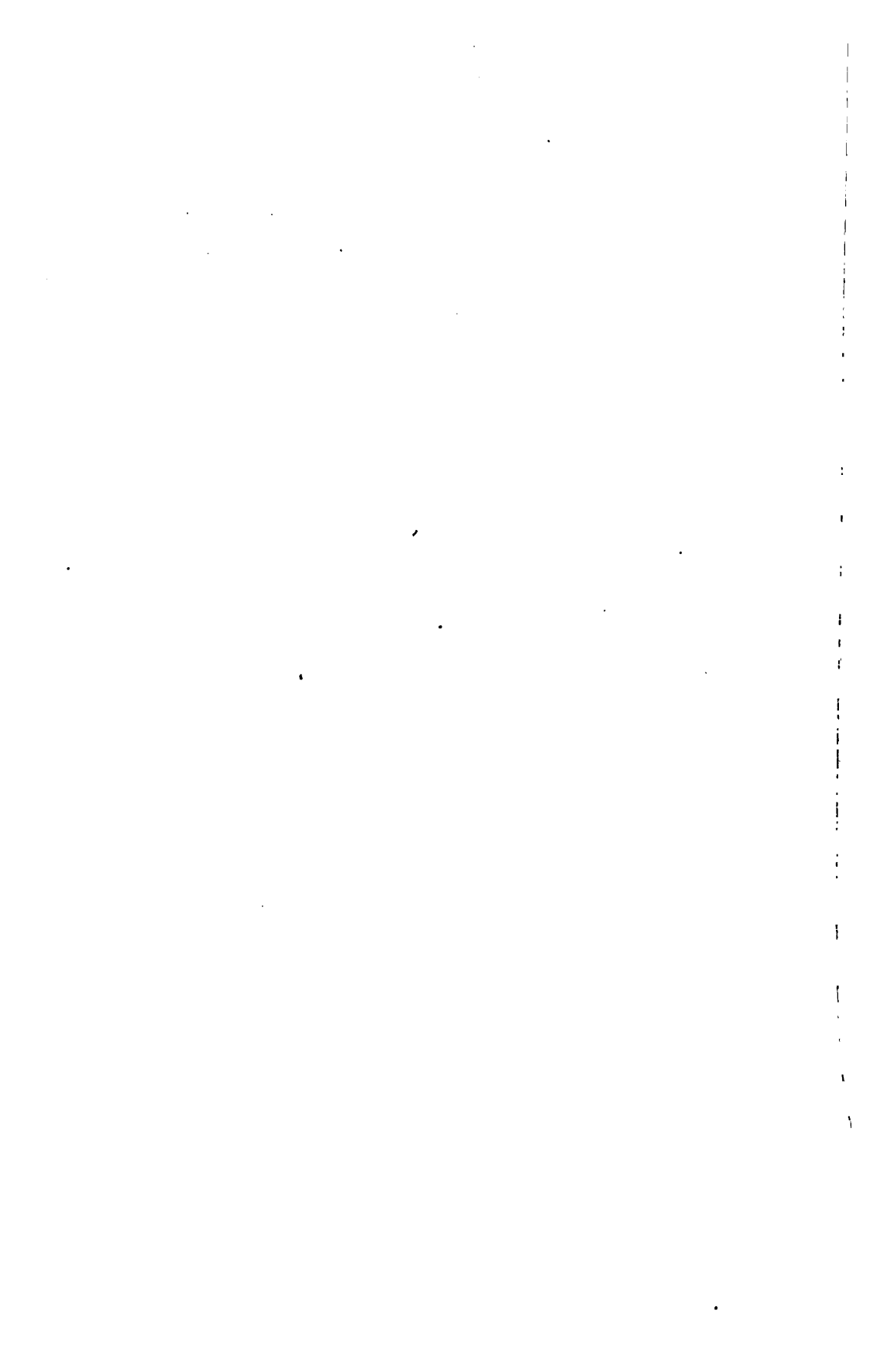

EXPLANATION OF PLATE LXXV.

Fig. 1. SCRAPER. Of walrus ivory. The specimen lies flat, touching a horizontal surface all around its underside. The last two specimens, on the contrary, touch only at the front and rear. Thumb groove a deep furrow, almost concealing the digit. Finger grooves two slight cup cuttings for the tips. Undercut not extending all the way across, so that the lower margin under the thumb touches the ground all the way from front to rear.

Cat. No. 89316, U. S. N. M. Eskimo of Point Barrow, Alaska. Collected by Capt. P. H. Ray, U. S. Army.

Fig. 2. SCRAPER. Handle of wood. Flat bottomed. The material is so much cut away that the thumb pocket, the upper and the side finger pockets all communicate, and the thumb groove at the end opens into the blade socket.

Cat. No. 89310, U. S. N. M. Eskimo of Point Barrow, Alaska. Collected by Capt. P. H. Ray, U. S. Army.

Fig. 3. SCRAPER. A clumsy specimen of spruce wood resting upon a flat base, scarcely affected by the undercut. The thumb groove wide and for the first joint a deep pocket. Upper finger groove only for the forefinger. For the middle finger there is a separate undercut pocket and for the last two fingers the undercut is deeply pocketed. The front is precipitate, 2 inches high; the rear prolonged into a flat tailpiece, broader than the rest of the implement. There are a few specimens of this class made of wood, unique in form, but there are no others with precipitate front.

Cat. No. 89311, U. S. N. M. Eskimo of Point Barrow, Alaska. Collected by Capt. P. H. Ray, U. S. Army.

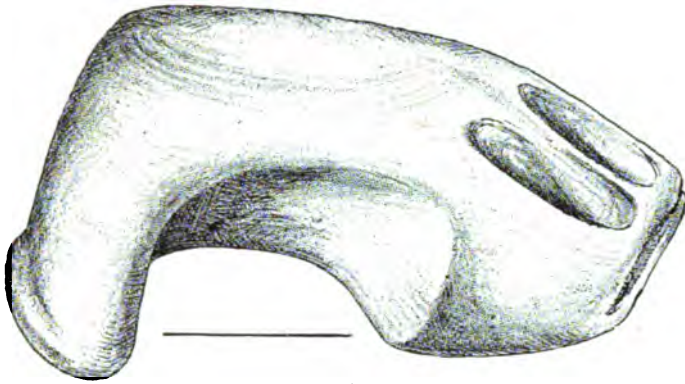

1

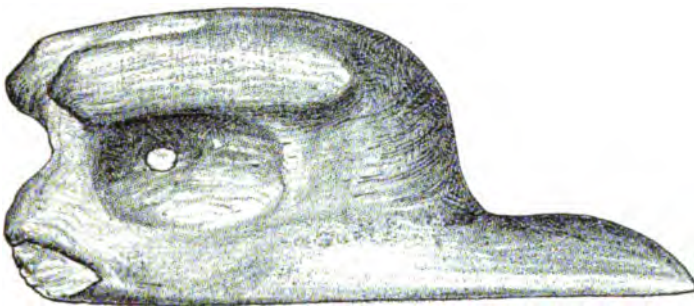

2



3

SCRAPERS.

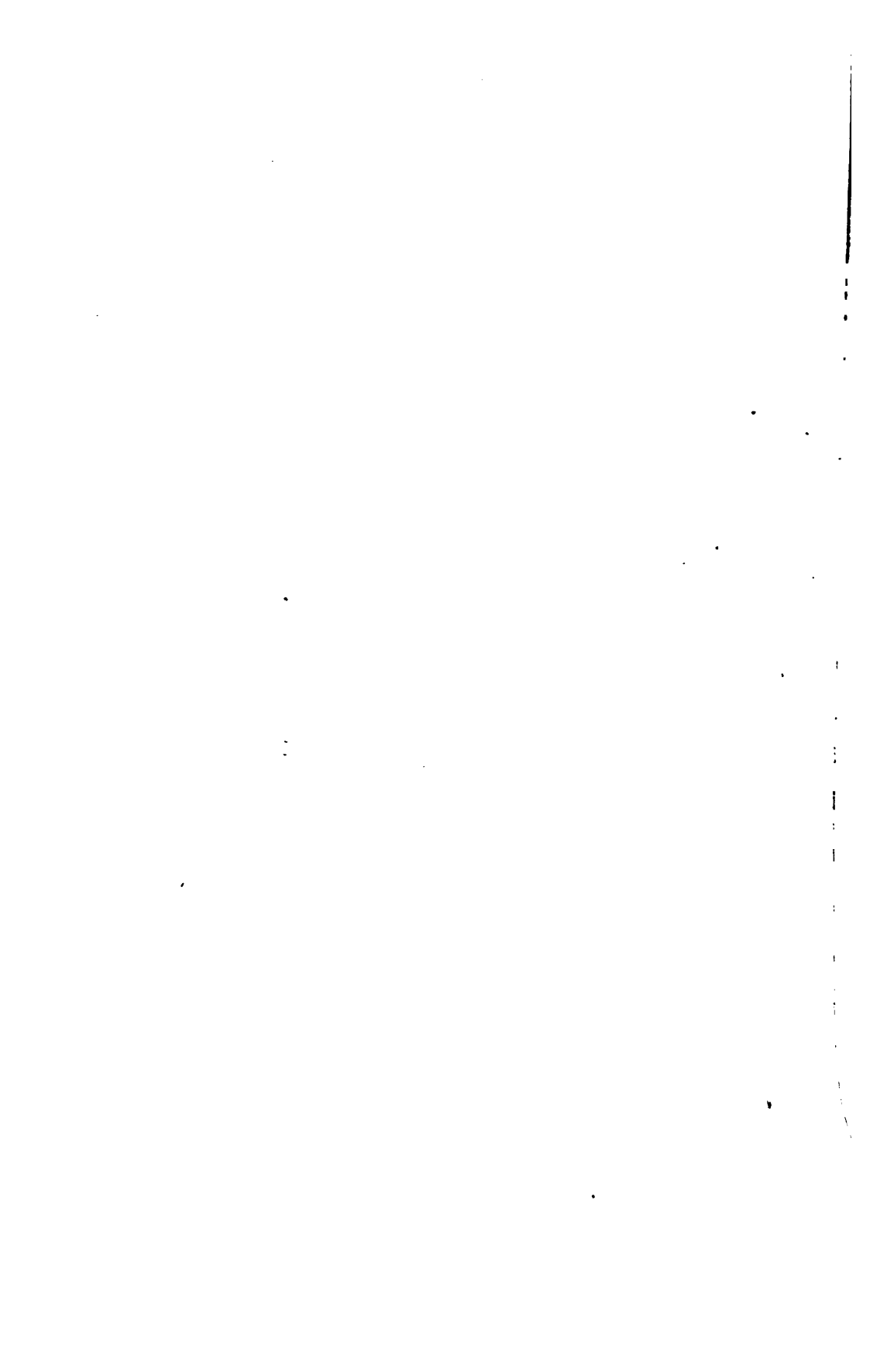

EXPLANATION OF PLATE LXXVI.

Fig. 1 (*a* and *b*). SCRAPER. Handle or grip of wood, with deep pocket grooves for the digits. The thumb is almost hidden in its cavity. On top there are three grooves for the fore, the middle, and the ring finger, respectively, and a very deep pocket into which the ends of all three are concealed. The little finger fits into a deep pocket on the right side and there is not the slightest shadow of undercut, the lower surface resembling exactly that of a carpenter's plane. The blade, of drab flint, is neatly inserted into the front and packed with canvas. A blue bead inserted on top in front of the finger pocket is the only ornament.

Cat. No. 63848, U. S. N. M. Eskimo of Point Hope, Alaska. Collected by E. W. Nelson.

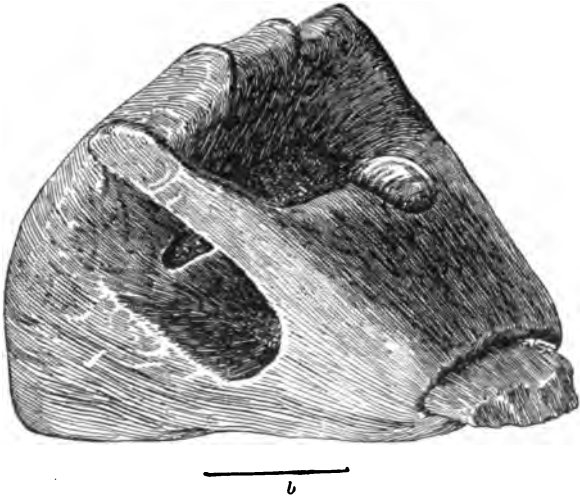
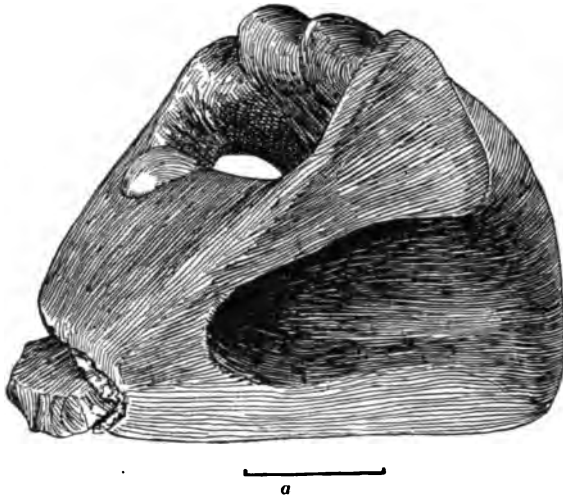

SCRAPER.

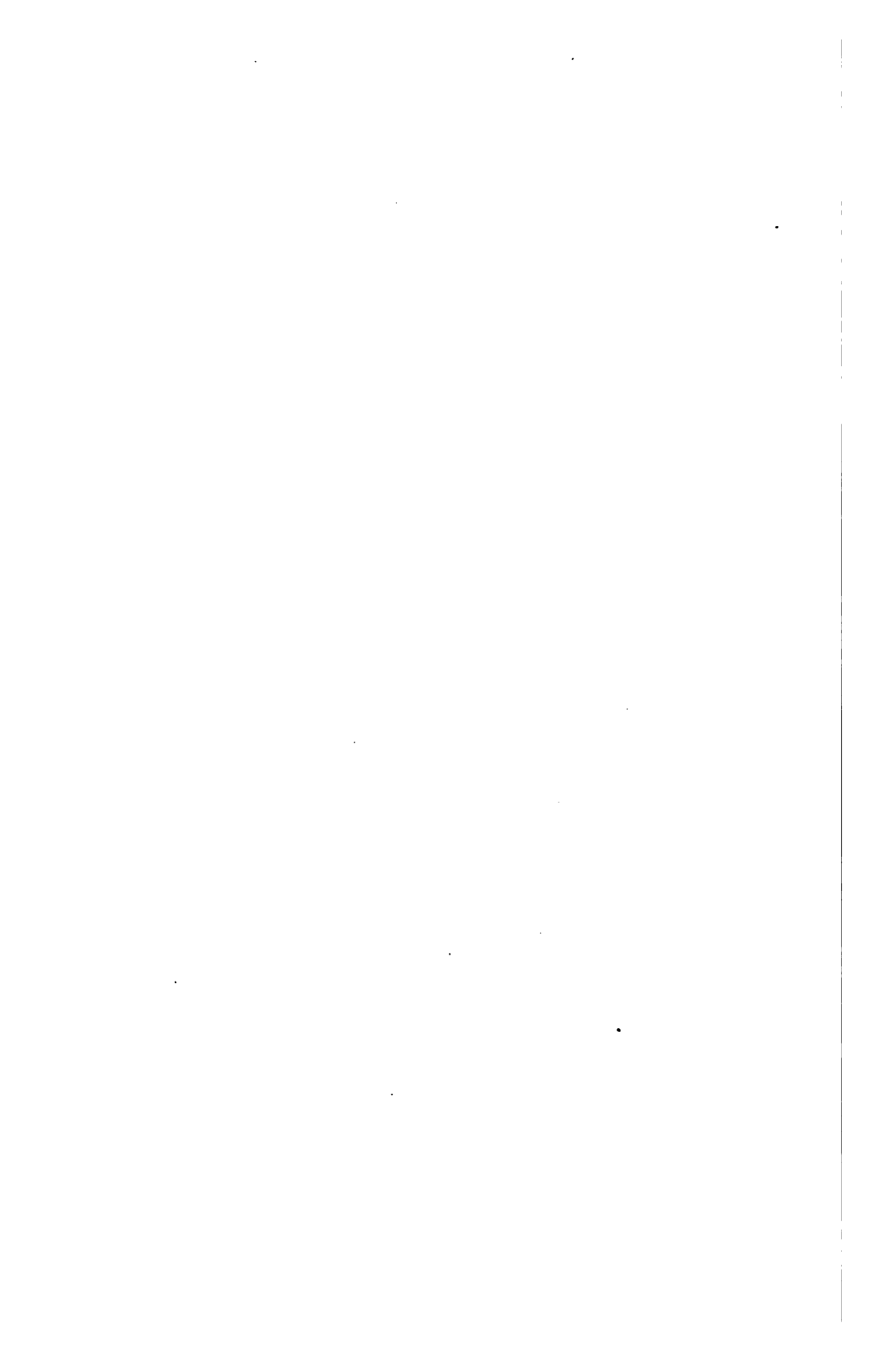



EXPLANATION OF PLATE LXXVII.

Fig. 1. SCRAPER. Handle of spruce. Thumb groove fitted to both phalanges of the thumb. Finger grooves slight. Undercut only two-thirds across the bottom, giving the implement a rest along the entire left side. The top is arched high up and there is a slight bell-shaped tailpiece. Blade of black chert, secured with a leather washer into a grooved socket—that is, half the depth of the mortise is cut out on the sides. This would fit a blade of any width.

Cat. No. 68947, U. S. N. M. Eskimo of Point Hope, Alaska. Collected by Capt. P. H. Ray, U. S. Army.

Fig. 2. SCRAPER. Handle of hard wood. Thumb groove deep and long, over which an ear-shaped projection is carved, as in Plate LXXIV, Fig. 3, from Point Barrow. Finger groove rounded out to give the appearance of a skull and terminating 1 inch behind the stone blade. Undercut not wide and hook-shaped in base outline. The tailpiece is gouged out like the rim of a bell. This form is quite an oddity and leads to the conclusion that each implement was made to fit the hand of the workman. This being the case they reveal as great a diversity in the size of Eskimo hands as exists among the white race.

Cat. No. 68849, U. S. N. M. Eskimo of Point Hope, Alaska. Collected by Capt. P. H. Ray, U. S. Army.

Fig. 3. SCRAPER. Of walrus ivory. A very graceful old handle, much discolored, resting on the front or haft and the broad flattened tailpiece. Thumb groove shallow, but exactly fitting and bounded above by the ear-shaped ridge so prominent in Plate LXXIV, Fig. 3, from Point Barrow. Finger grooves extending to the stone blade. Undercut consists of two distinct parts, that for the last two fingers and a smaller one under the thumb, a common characteristic, but serving only to remove useless material. The tailpiece is long, broad, and gracefully curved into the grip.

Cat. No. 63855, U. S. N. M. Eskimo of Point Hope, Alaska. Collected by Capt. P. H. Ray, U. S. Army.

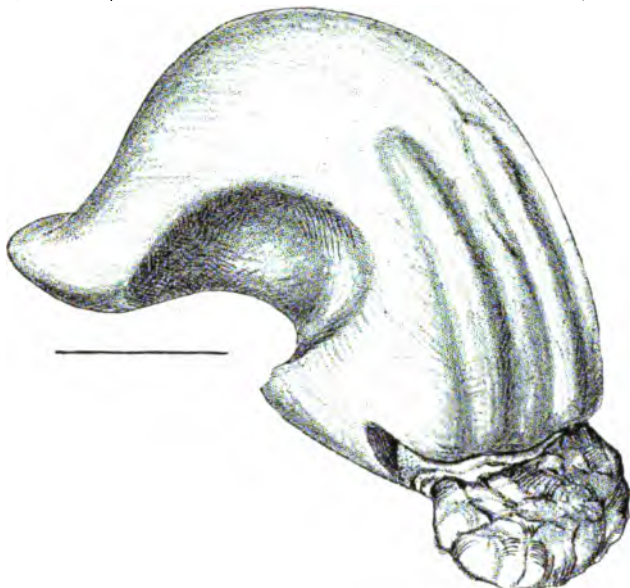

1



2

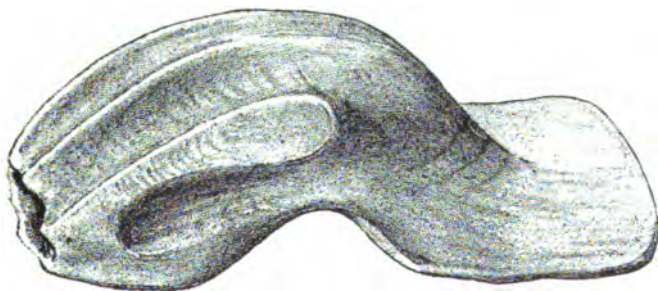

3

SCRAPERS.

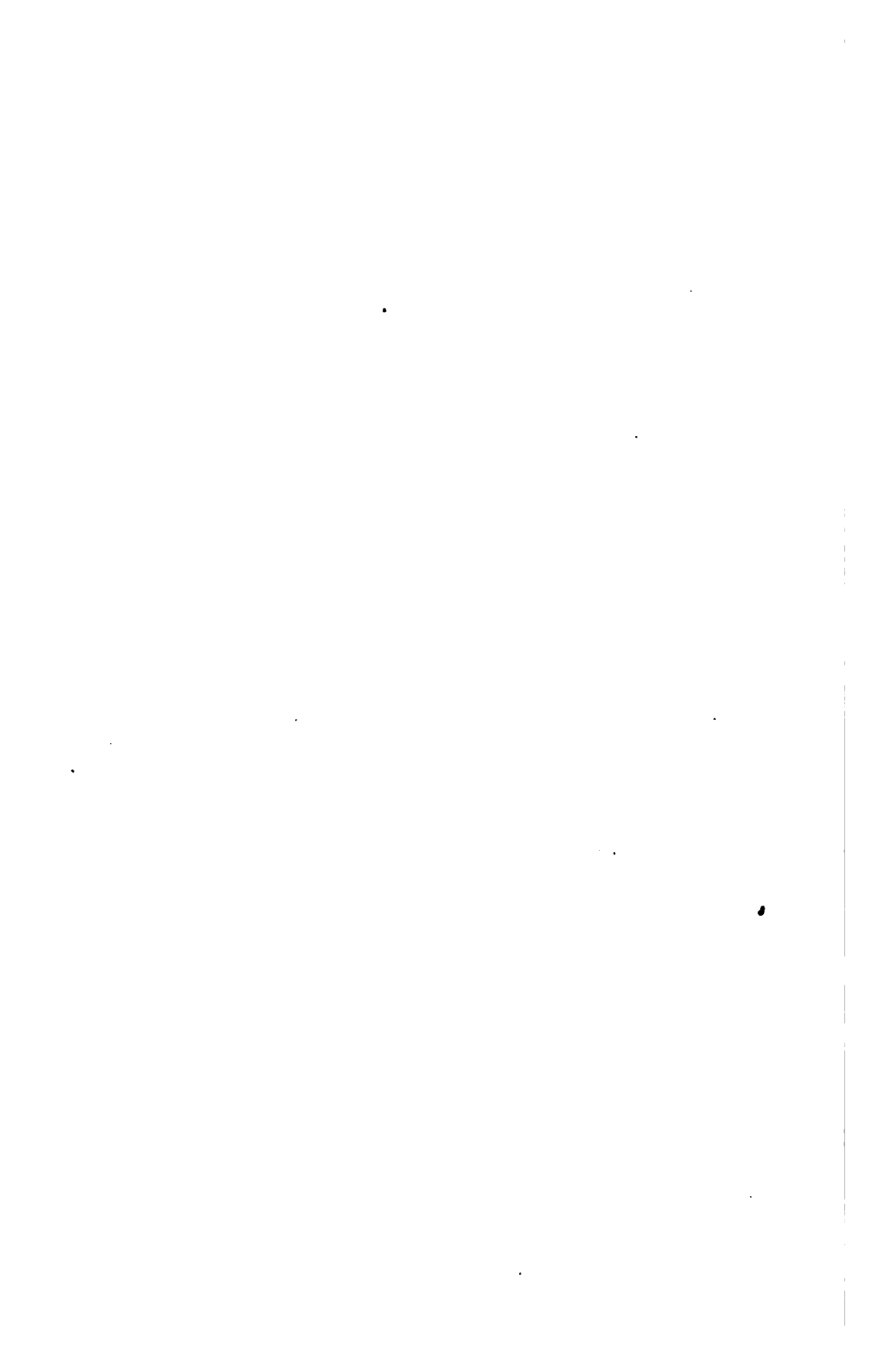



EXPLANATION OF PLATE LXXVIII.

Fig. 1 (*a* and *b*). SCRAPER. Handle of spruce wood, with marked characteristics, resting on the front and long tailpiece and slightly arched up in the middle. Thumb groove profound, finger grooves moderately deep. Undercut two-thirds the distance across the bottom. Between this and the blade is a cul-de-sac for the third or ring finger. The grip is high arched and the flat tailpiece projects abruptly from its base. The socket is broad and intrudes slightly on the sides. Split by a stone blade, the old device of a groove and lashing has been resorted to.

Cat. No. 127886, U. S. N. M. Eskimo of Hotham Inlet, Alaska. Collected by Capt. P. H. Ray, U. S. Army.

Fig. 2. SCRAPER. Of walrus ivory. A slender spoon-shaped handle. Thumb is scantily provided for and the finger grooves are mere shadows. The undercut is scalloped delicately on its side to receive the string and the middle finger. The socket is very broad and deep but entire on its margin. There is a delicious continuity of curvature over the entire surface of this specimen, so that not a single sharp turn occurs anywhere except in the socket.

Cat. No. 48624, U. S. N. M. Eskimo of Kotzebue Sound, Alaska. Collected by Capt. P. H. Ray, U. S. Army.



1a



1b



2

SCRAPERS.

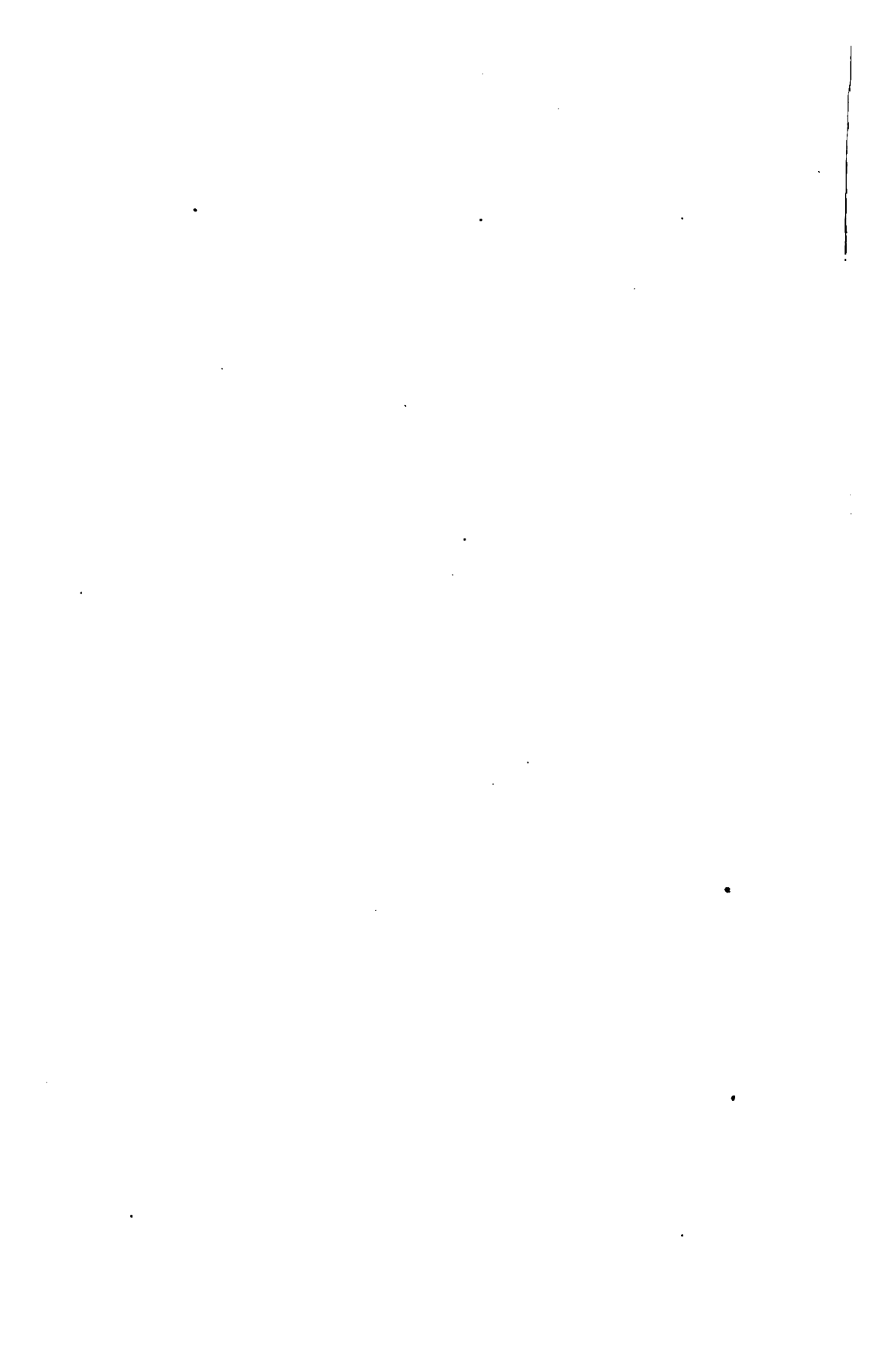

EXPLANATION OF PLATE LXXIX.

Fig. 1. SCRAPER. Of spruce wood. High arched on top and resting on its two ends. The thumb groove is deep and pocketed. Finger grooves deeply pocketed and divided by a thin partition. Undercut two-thirds across the bottom, which is slightly arched up. Grip high arched and subtended by a narrow bell-shaped tailpiece, the margin of which is prolonged. Socket a very deep mortise extending to the thumb and finger pockets.

Cat. No. 64177, U. S. N. M. Eskimo of Hotham Inlet, Alaska. Collected by Capt. P. H. Ray, U. S. Army.

Fig. 2. SCRAPER. Of walrus ivory. An abnormal specimen, made from the proximal end of a walrus tusk. Evidently the maker racked his ingenuity to get the most out of his material. Provision for the thumb and first two fingers is made by the core cavity in front. The undercut trenches largely on the same cavity, which extends onward through the grip. The socket is mortised an inch deep.

Cat. No. 64181, U. S. N. M. Eskimo of Hotham Inlet, Alaska. Collected by Capt. P. H. Ray, U. S. Army.

Fig. 3. SCRAPER. Handle of pine wood; blade of drab-colored chert; lashing of unshredded sinew, with washers of rawhide. This is a rude specimen, representing only the outline and commencement of the type characters in the one-handed scraper. There is no thumb groove on the side; no finger groove on the top. On the under face of the right-hand side are two very shallow grooves for the ring and little finger. The protection of the hand is secured by the angle of the handle. The blade has chip-pings only on the upper side. It is laid in a roughly gouged hollow, so as to bring its under surface flush with that of the handle. A Pawnee Indian informed the writer that the careless lashing on so many hafted tools is owing to the fact that the blade is continually taken out to be sharpened, which tallies with Lieutenant Stoney's testimony.

Cat. No. 43405, U. S. N. M. Eskimo of Cape Prince of Wales. Collected by Capt. P. H. Ray, U. S. Army.

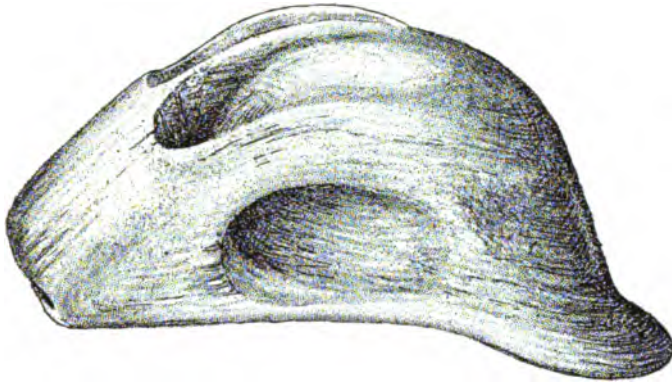

1

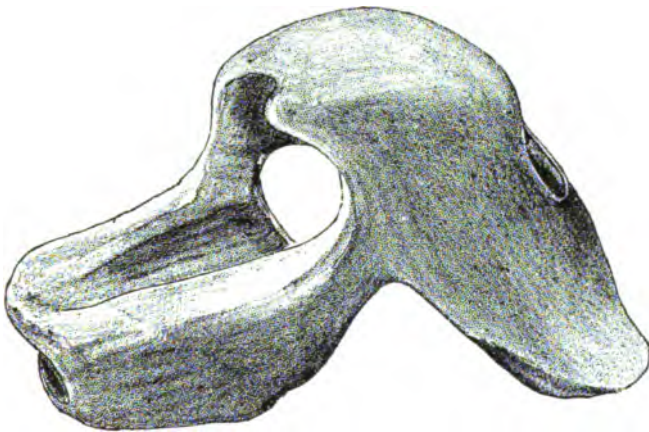

2

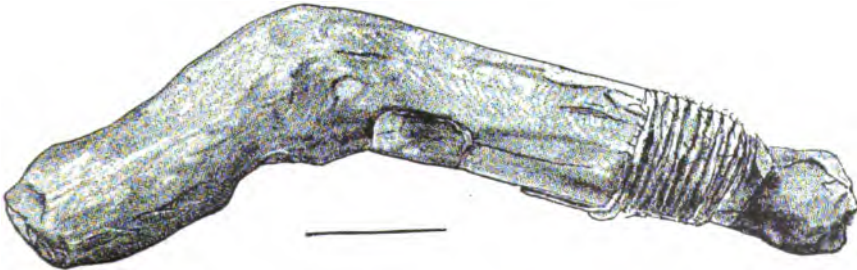

3

SCRAPERS.

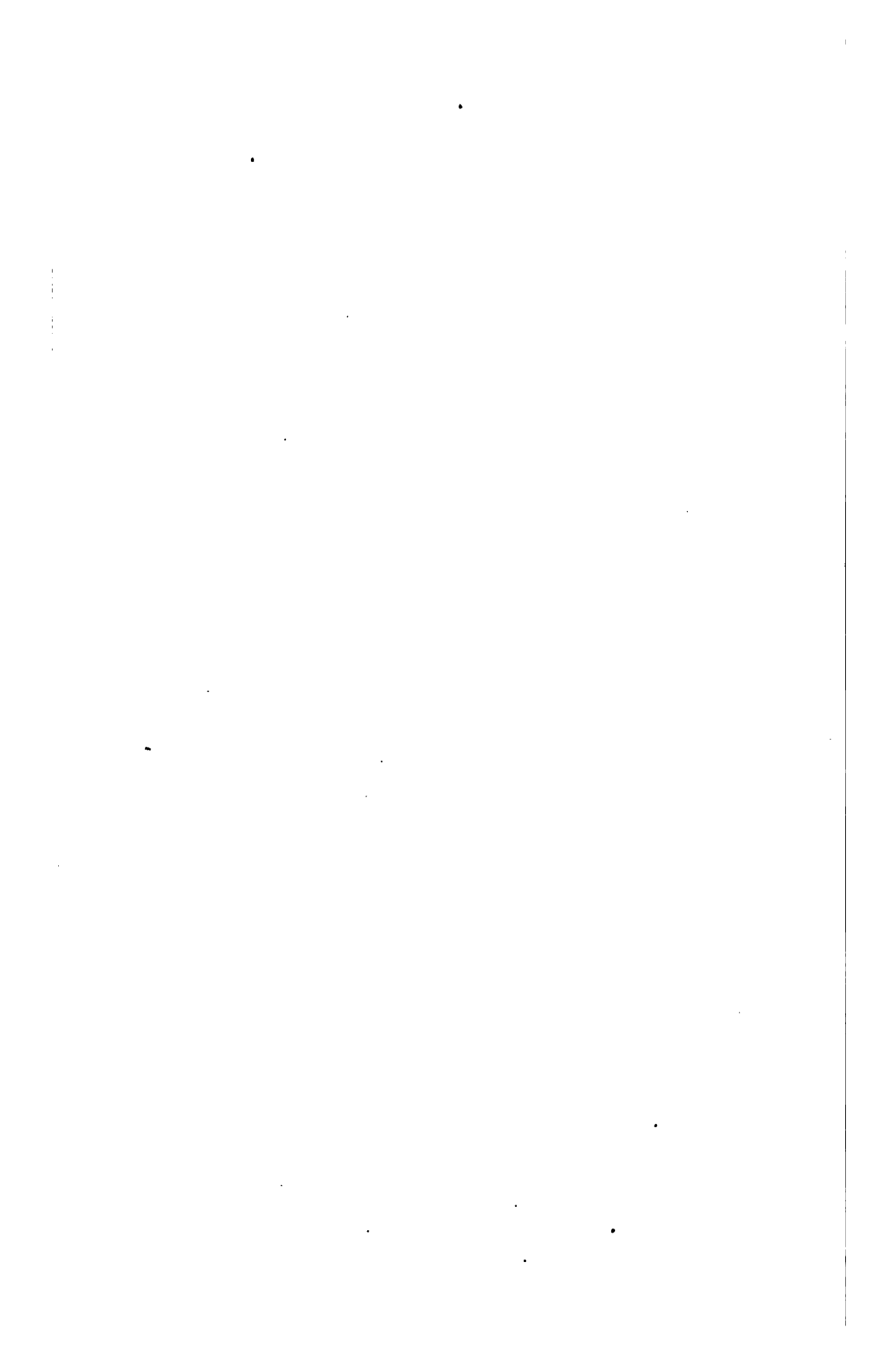

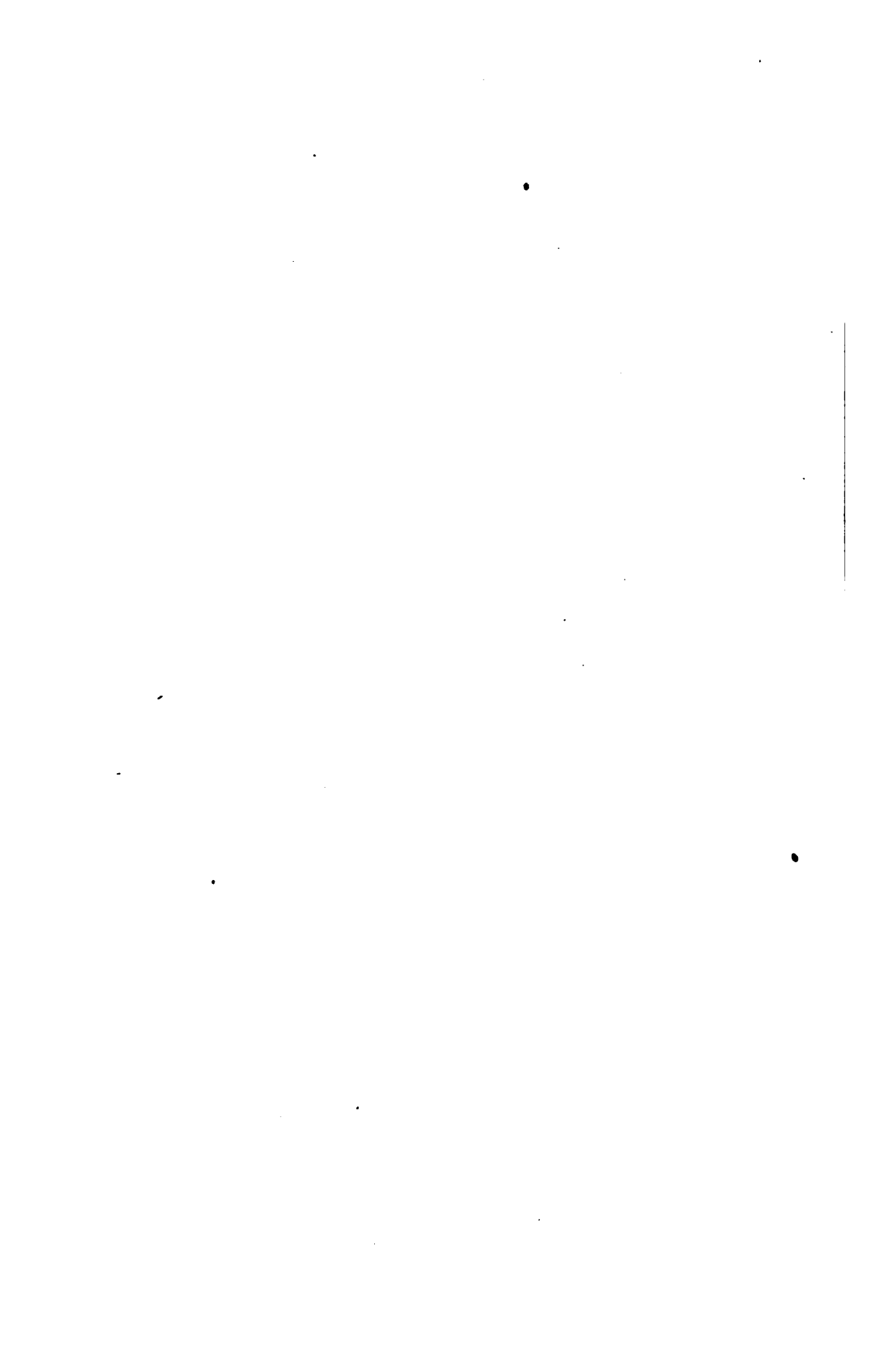

EXPLANATION OF PLATE LXXX.

Fig. 1. FAT-SCRAPER. Dish-shaped. Made from a section of walrus tusk. This form of scraper might easily be mistaken for a dish, but an examination of the edge shows that on one side at least it has been scraped down sharp. There are types of these scrapers—the dish-shaped, the hoop-shaped, the horseshoe-shaped, the knife or spoon shaped, the scoop-shaped, and the ring-shaped, and each shape has a definite locality.

Cat. No. 63355, U. S. N. M. Eskimo of St. Lawrence Island. Collected by E. W. Nelson.

Fig. 2. FAT-SCRAPER. Of walrus ivory. Shaped like an old-fashioned milk skimmer or a grocer's scoop. The form is quite graceful and the graceful ridges on the upper margin afford a firm grip to the hand. This form is in the Straits and Kotzebue.

Cat. No. 63900, U. S. N. M. Eskimo of Diomed Islands. Collected by E. W. Nelson.

Fig. 3. FAT-SCRAPER. Fine old specimen of discolored walrus ivory. Blade, ladle, or skimmer shaped. Two prongs carved to imitate bears' heads form the most convenient grip.

Cat. No. 127896, U. S. N. M. Eskimo of Kotzebue Sound. Collected by Lieut. G. M. Stoney, U. S. Navy.

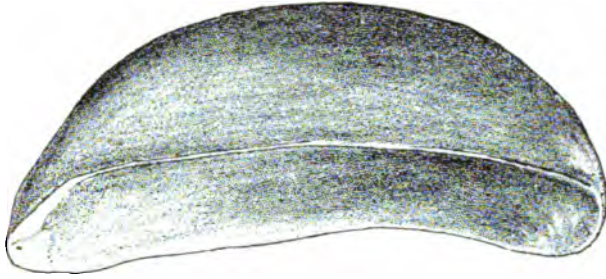

1

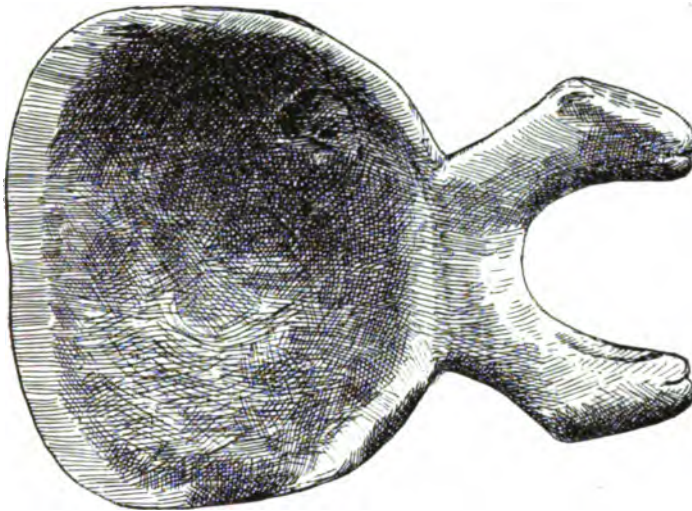

2

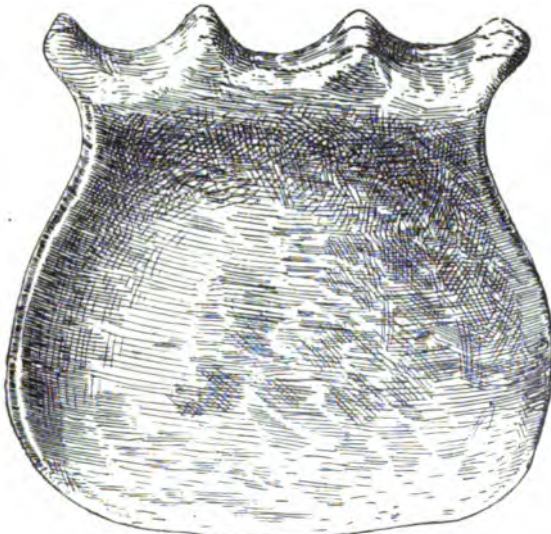

3

FAT-SCRAPERS.

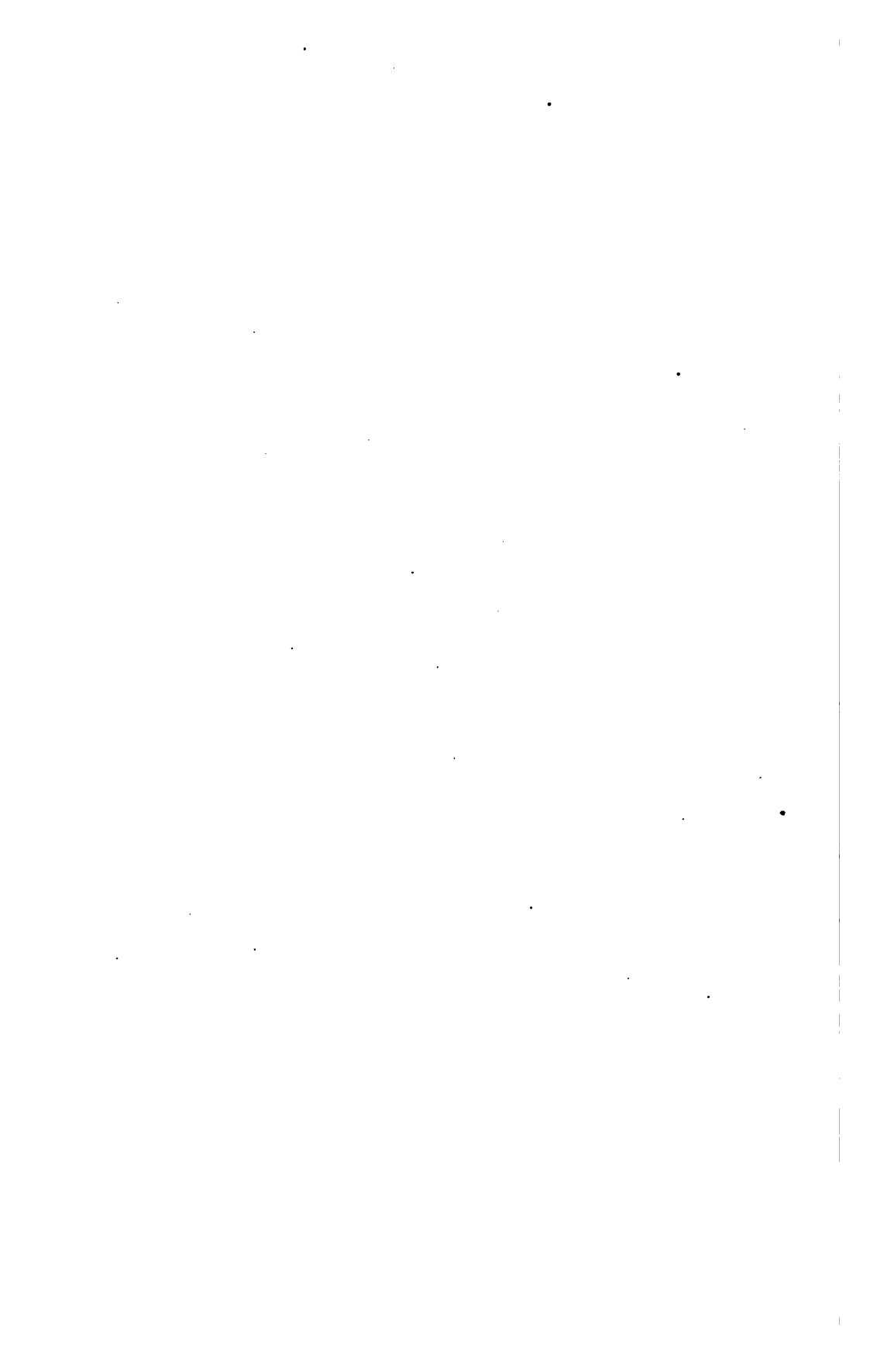



EXPLANATION OF PLATE LXXXI.

Fig. 1. **FAT-SCRAPER.** A strip of ivory 6 inches long, 1 inch wide, and shaped like a knife blade, one-eighth of an inch thick at the back, where it is also bent and held in position by a rawhide string passed once or twice across through holes in the ends of the ivory and then carefully wrapped around the cross strings. Its use is said to be for scraping fat from seal skins to be put in the soapstone lamps.

Cat. No. 63642, U. S. N. M. Eskimo of Cape Wankarem. Collected by Capt. P. H. Ray, U. S. Army.

Fig. 2. **FAT-SCRAPER.** Made of a section of the lower end of a walrus tusk sawed off like a napkin ring. The inner side being soft and the outer side hard, it is the easiest thing in the world to scrape away the soft part, so as to have an edge like the tooth of a rodent. Used to remove fat from skins before dressing them. This form of scraper is not found in the Museum collection except from Sledge Island and the Diomedes.

Cat. No. 44990, U. S. N. M. Eskimo of Sledge Island. Collected by E. W. Nelson.

Fig. 3. **FAT-SCRAPER.** Made of a narrow, thin strip of antler bent in form of a horseshoe and held in place by a strip of rawhide passed backward and forward through two holes in each end and then wrapped in a neat coil across. The loop on the outside of the ends is neatly countersunk. One margin of the antler strip is scraped to an edge from within, so as to preserve the outer hard portion for work.

* Cat. No. 44771, U. S. N. M. Eskimo of Sledge Island. Collected by E. W. Nelson.



1



2

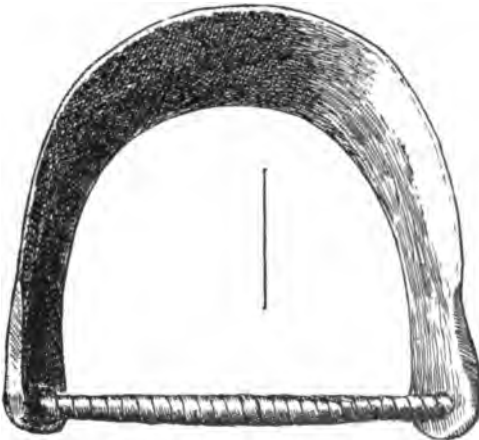

3

FAT-SCRAPERS.

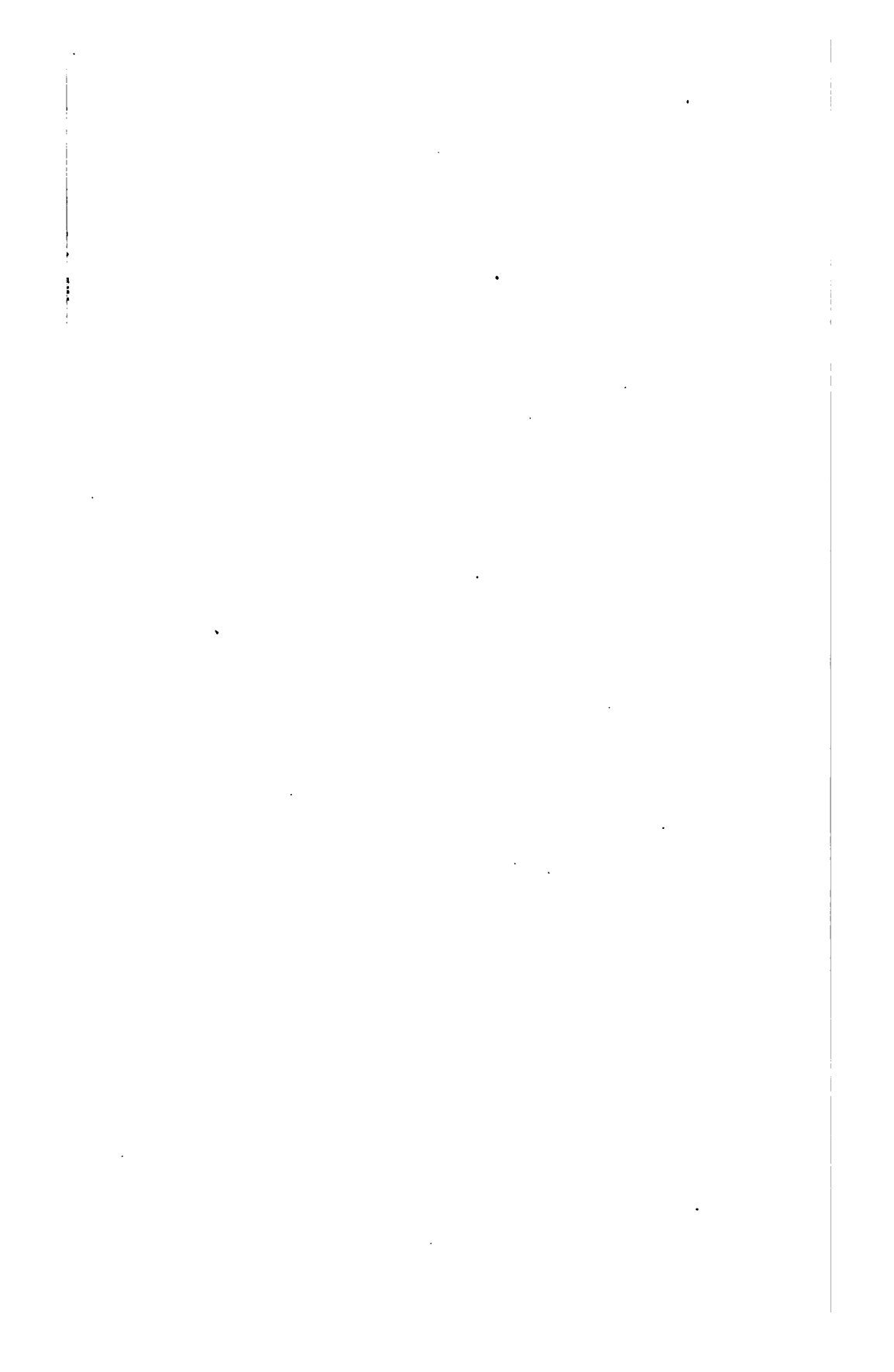

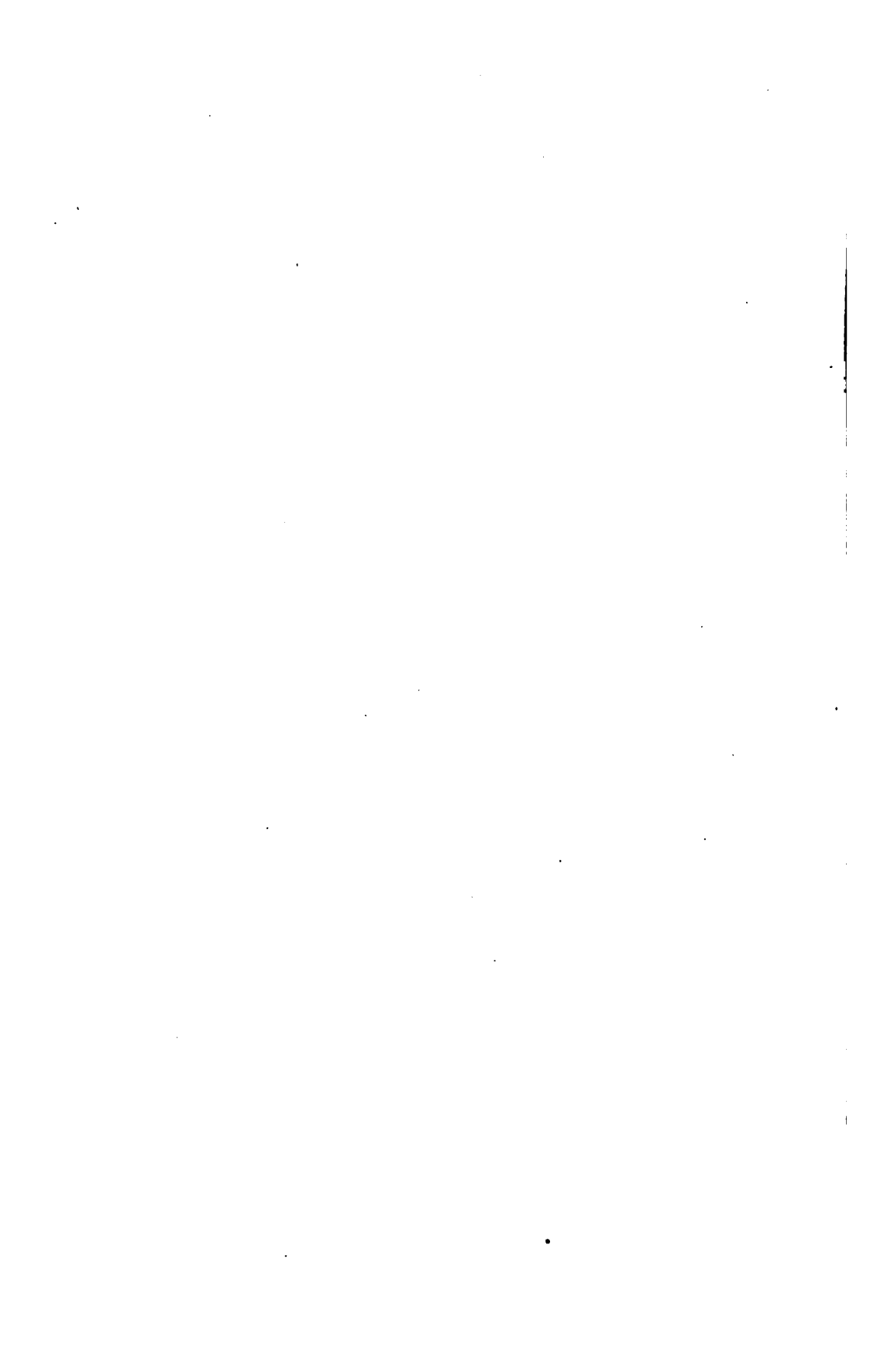

EXPLANATION OF PLATE LXXXII.

Fig. 1. SCRAPER. Handle of wood, blade a flat celt of schist let into the lower part of the handle neatly and lashed in place with spruce root. A very large but neatly made specimen. It is an excellent example of transition between the short and the long handle. Place for the thumb is excavated; lift margin for the forefinger on the upper surface, and for the other three fingers underneath. The palm of the hand rests against the depressed end.

Cat. No. 43927, U. S. N. M. Eskimo of Norton Bay, Alaska. Collected by E. W. Nelson.

Fig. 2. SCRAPER. With wooden handle of medium length. The grip in its curve with the handle suggests a pistol butt. The shaft is a long triangle and on the underside excavated to receive the celt-like blade of hard volcanic rock. This blade has a chisel edge and is held in place by means of a thong of raw seal-hide fastened by tucking the end under. The attention of archaeologists is especially called to the mounting and function of this polished blade with chisel edge, as they have many similar pieces in their cabinets. Length, 11½ inches.

Cat. No. 24669, U. S. N. M. Eskimo of Norton Sound, Alaska. Collected by Lucia M. Turner.



1

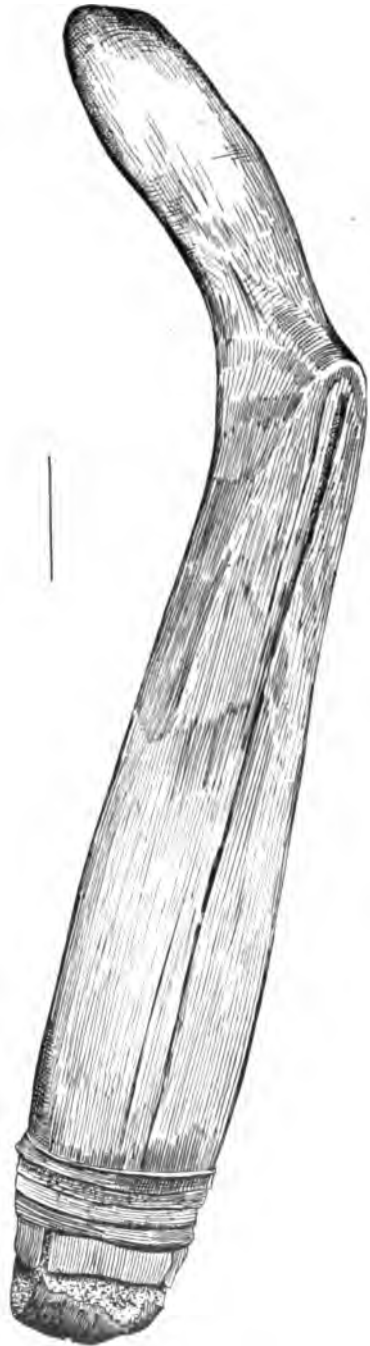

2

SCRAPERS.

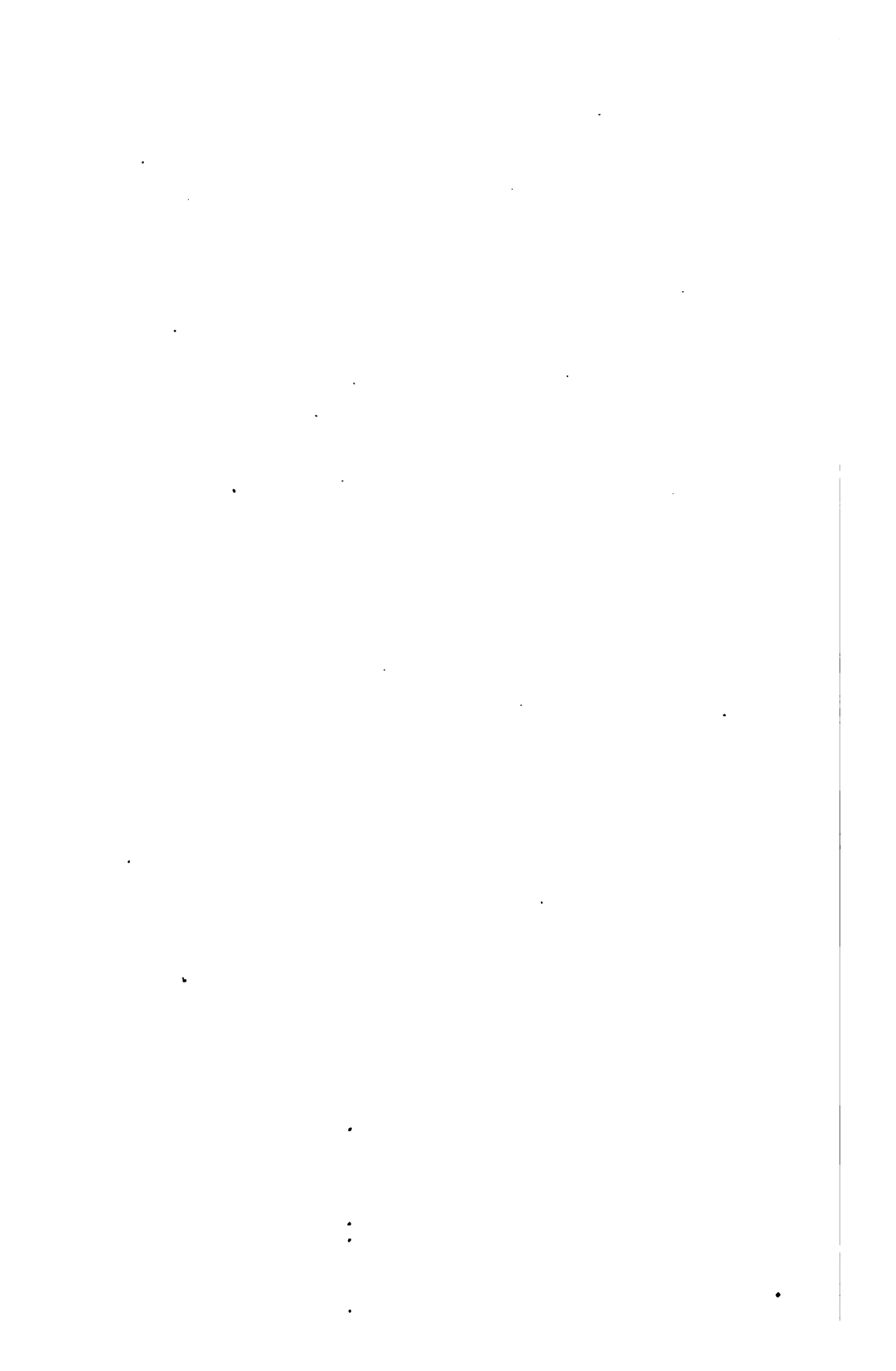



EXPLANATION OF PLATE LXXXIII.

- Fig. 1. **SCRAPER.** Handle of wood, grip cylindrical, shaft triangular, expanding downward to fit neatly the blade of slate, which lies in a cut on the under side and is held in place by a neat lashing of fine rawhide string.
Cat. No. 129216, U. S. N. M. Eskimo of St. Michaels, Alaska. Collected by Lucia M. Turner.
- Fig. 2. **SCRAPER HANDLE.** Of walrus ivory; very old. The noticeable marks are the economy of material, the smallness of the owner's hand, the slight grooves for thumb and first two fingers, and chiefly the spoon-shaped cavity beneath for the ring and the little finger. Length, $3\frac{1}{4}$ inches.
Cat. No. 38093, U. S. N. M. Eskimo of Norton Sound, Alaska. Collected by E. W. Nelson.
- Fig. 3. **SCRAPER.** Handle of spruce wood. This is an interesting connecting link between the shaftless type and the long shafted type of the South. The shaft from the point of the thumb is about $1\frac{1}{4}$ inches; no finger grooves. Under cut two-thirds across. Grip a straight incline without tail piece.
Cat. No. 44086, U. S. N. M. Eskimo of Koyuk River. Collected by Capt. P. H. Ray, U. S. Army.

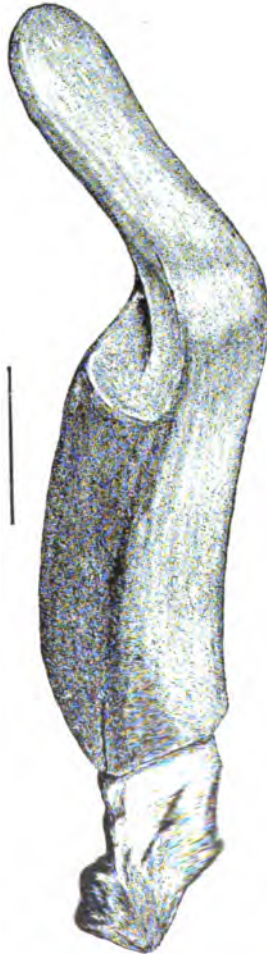
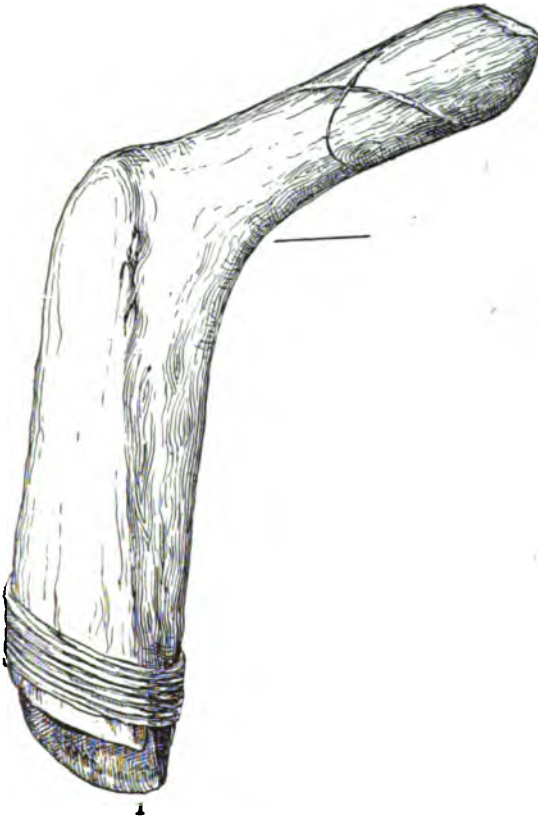
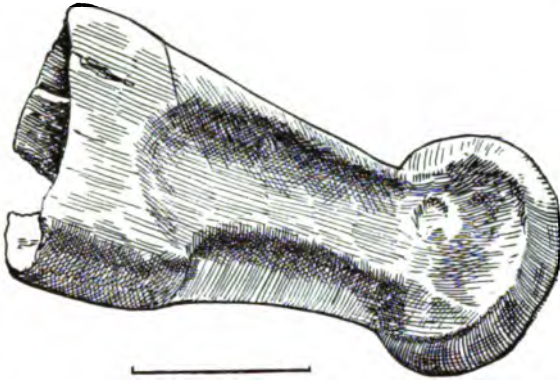

SCRAPERS.

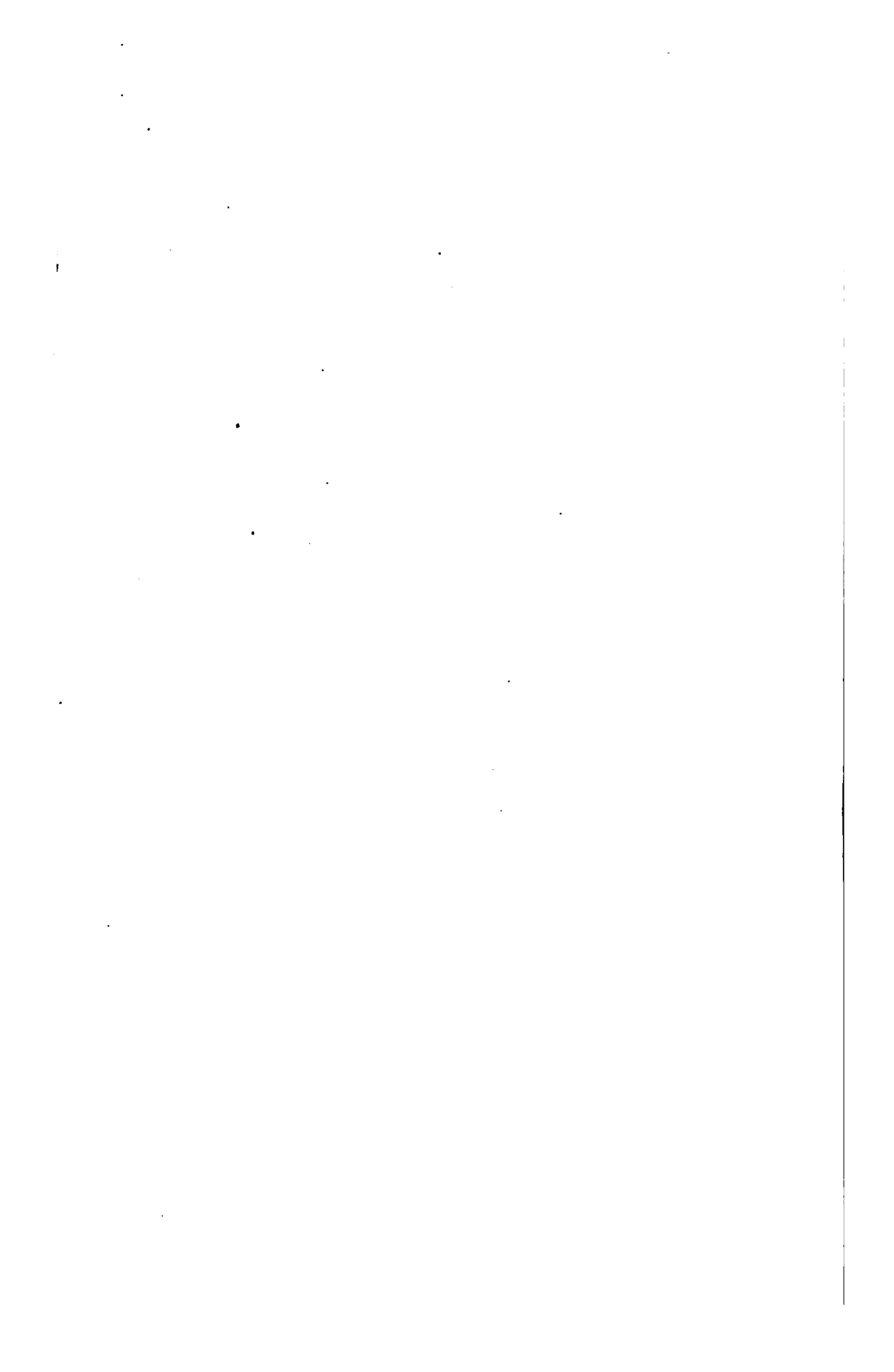



EXPLANATION OF PLATE LXXXIV.

Fig. 1. **FAT-SCRAPER.** Made of the radius of the deer. The rounded front portion is cut away so as to furnish a rest on the ridge of the incurved portion and two edges, one on either side. The hard lower edge of the implement is also ground to a chisel edge like that of a graining tool. Every portion of the implement affording a hard, bony surface has been ground to an edge.

Cat. No. 38490, U. S. N. M. Eskimo of Mission, Alaska. Collected by E. W. Nelson

Fig. 2. **FAT-SCRAPER.** Of walrus ivory. Ingeniously carved so as to furnish a grip and a long opening for the thumb. One edge only is sharpened. The implement fits only the right hand and shows that the Eskimo scraped away from himself and not towards himself.

Cat. No. 127508, U. S. N. M. Eskimo of Togiak River, Alaska. Collected by I. Applegate.

Fig. 3. **SCRAPER.** Made of the rib of a deer, with little or no modification of form. The Indians of California are said to use a rib in the same manner.

Cat. No. 38244, U. S. N. M. Eskimo of Mission, Alaska. Collected by E. W. Nelson

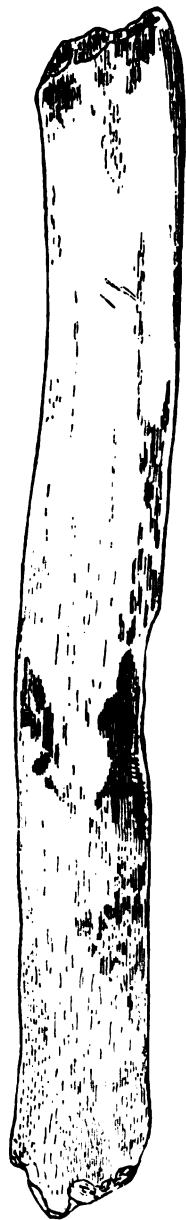
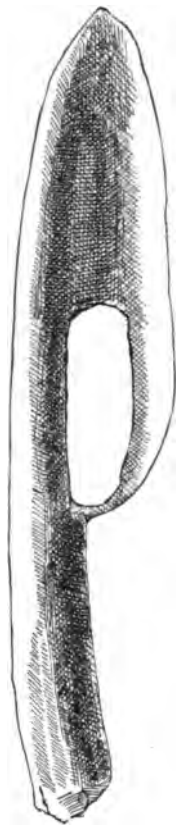

SCRAPERS.

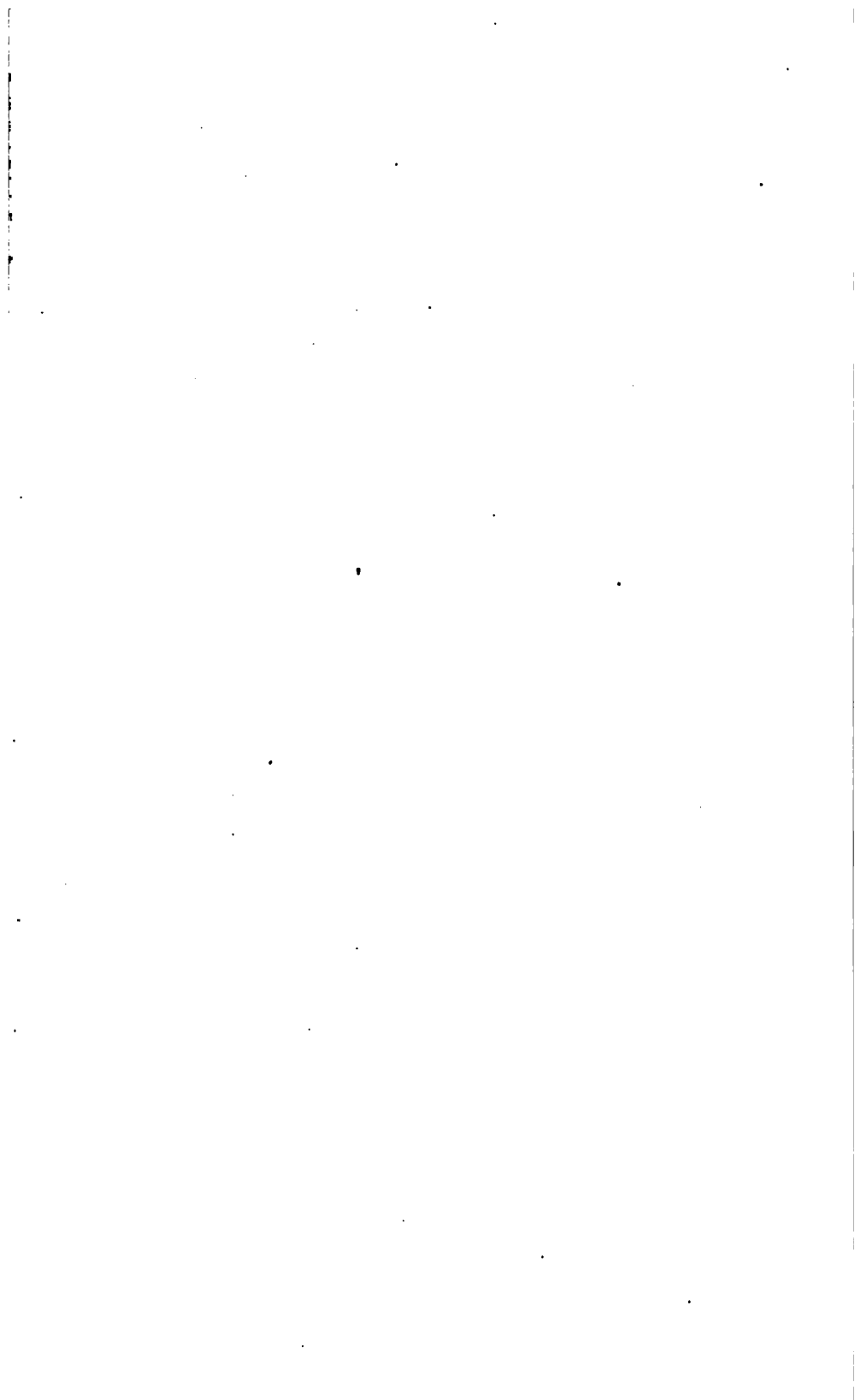



EXPLANATION OF PLATE LXXXV.

Fig. 1. SCRAPER. Handle of pine, quite old, slightly fitted to the hand. Blade of slate lashed to the handle roughly by a leather thong passing through a perforation.

Cat. No. 127502, U. S. N. M. Eskimo of Togiak River. Collected by I. Applegate.

Fig. 2. SCRAPER. Handle a curved piece of pine wood, pistol-shaped. Blade: ground celt of black chert, edge wedge-shaped, lashed to the handle with a splint of pine root. The blade is made to fit to the handle by a padding of grass. If the unknown may be explained by the known, this specimen finds a function for many flat, wedge-shaped celts.

Cat. No. 38252, U. S. N. M. Eskimo of Lower Yukon. Collected by E. W. Nelson.

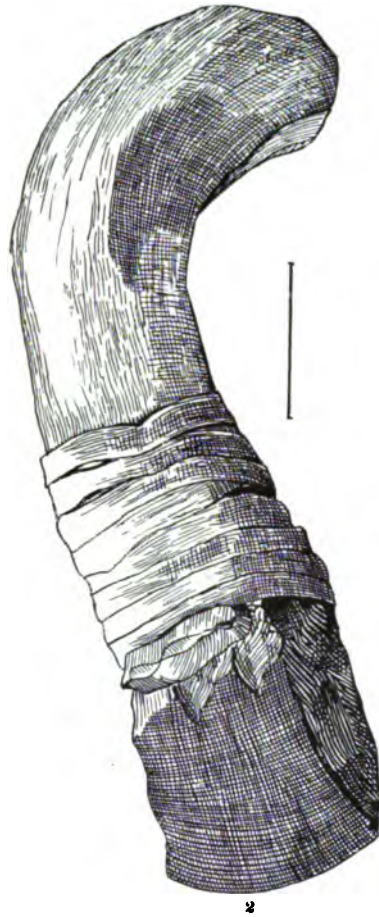
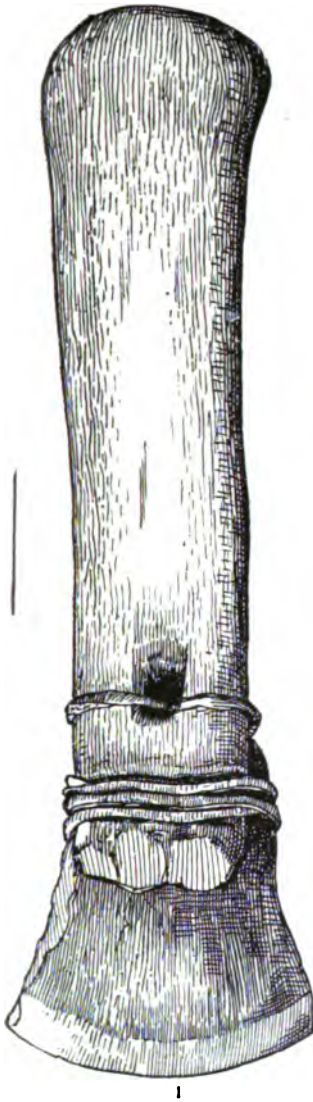

SCRAPERS.

1

1

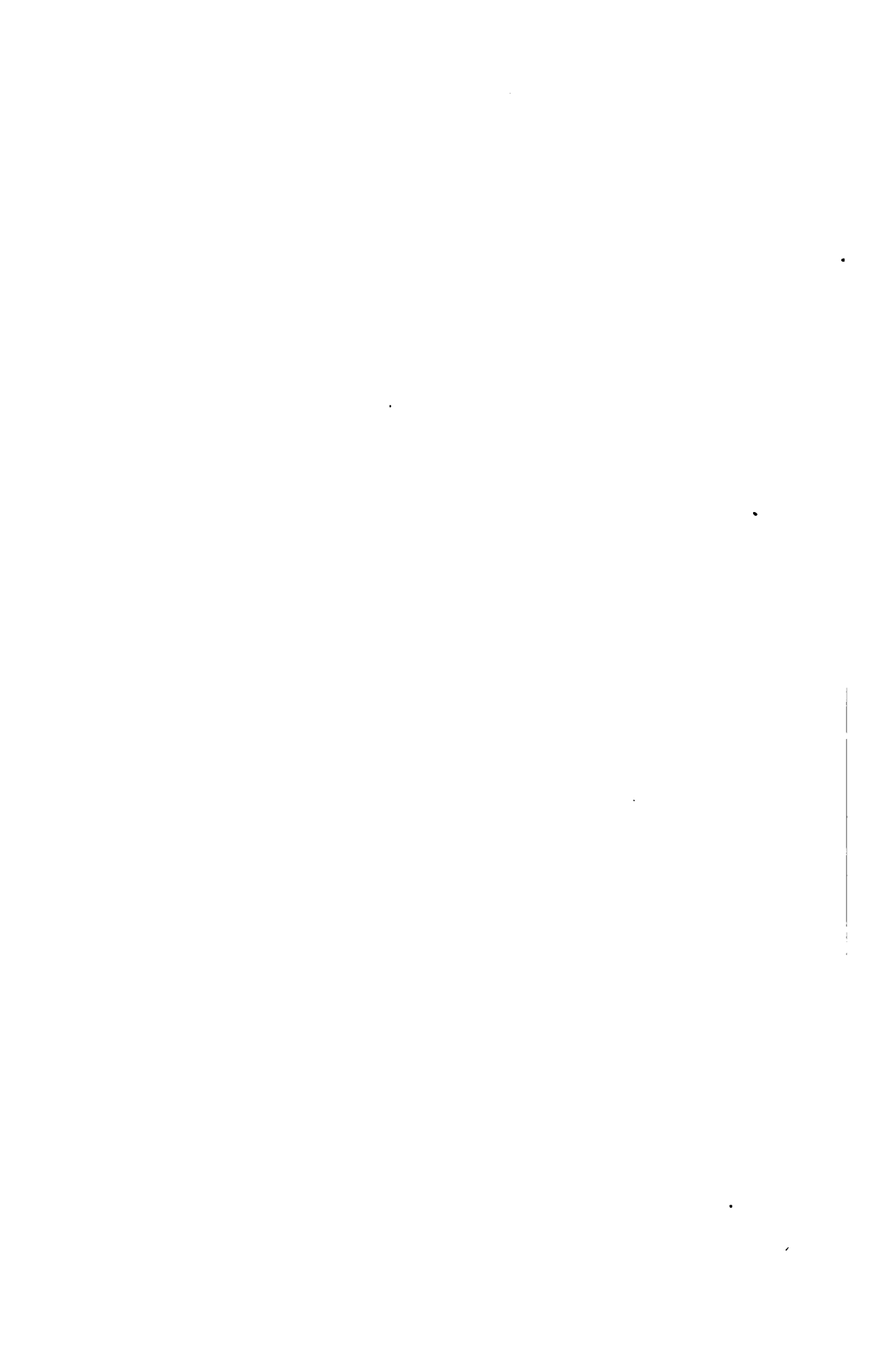

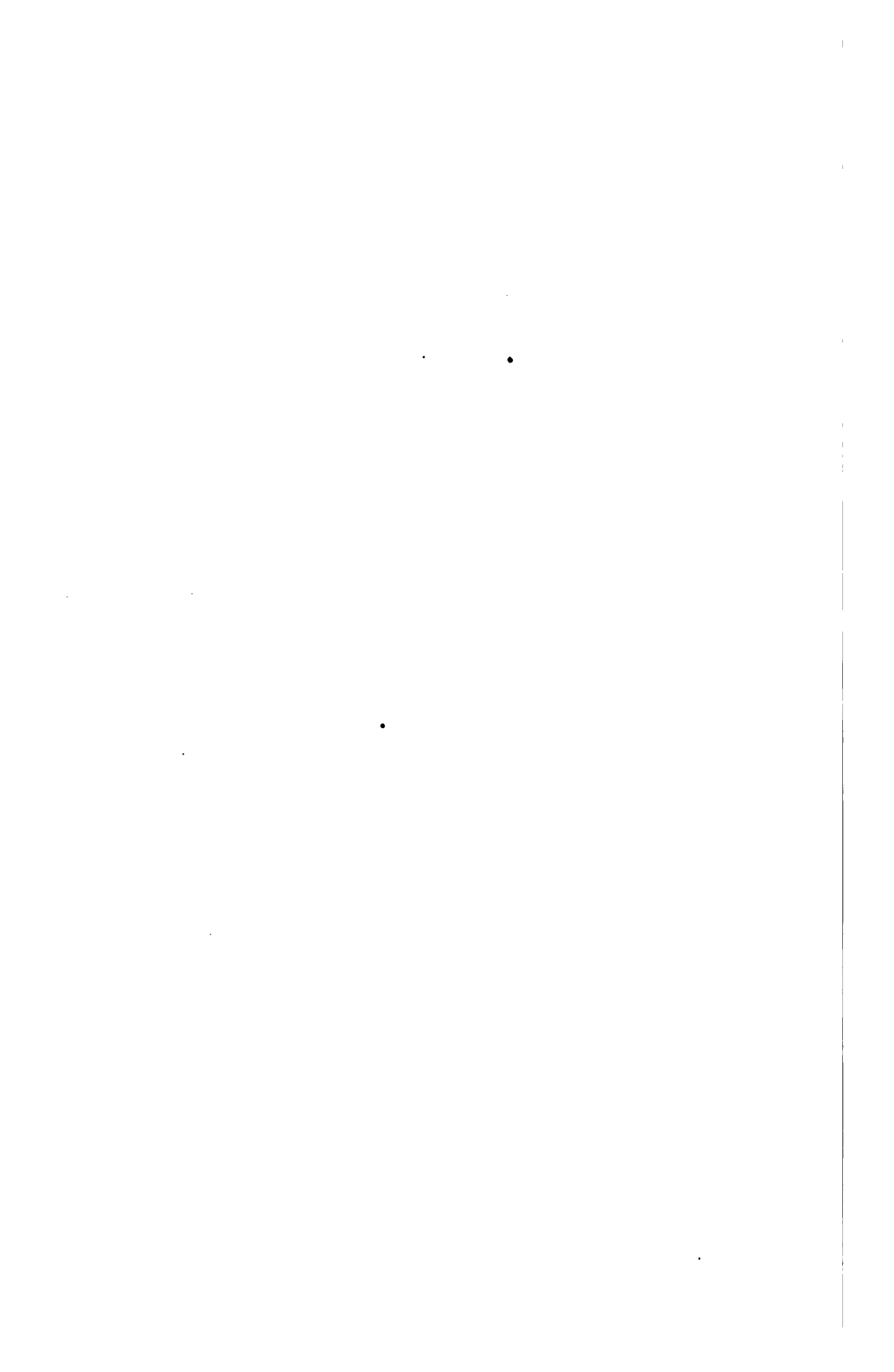

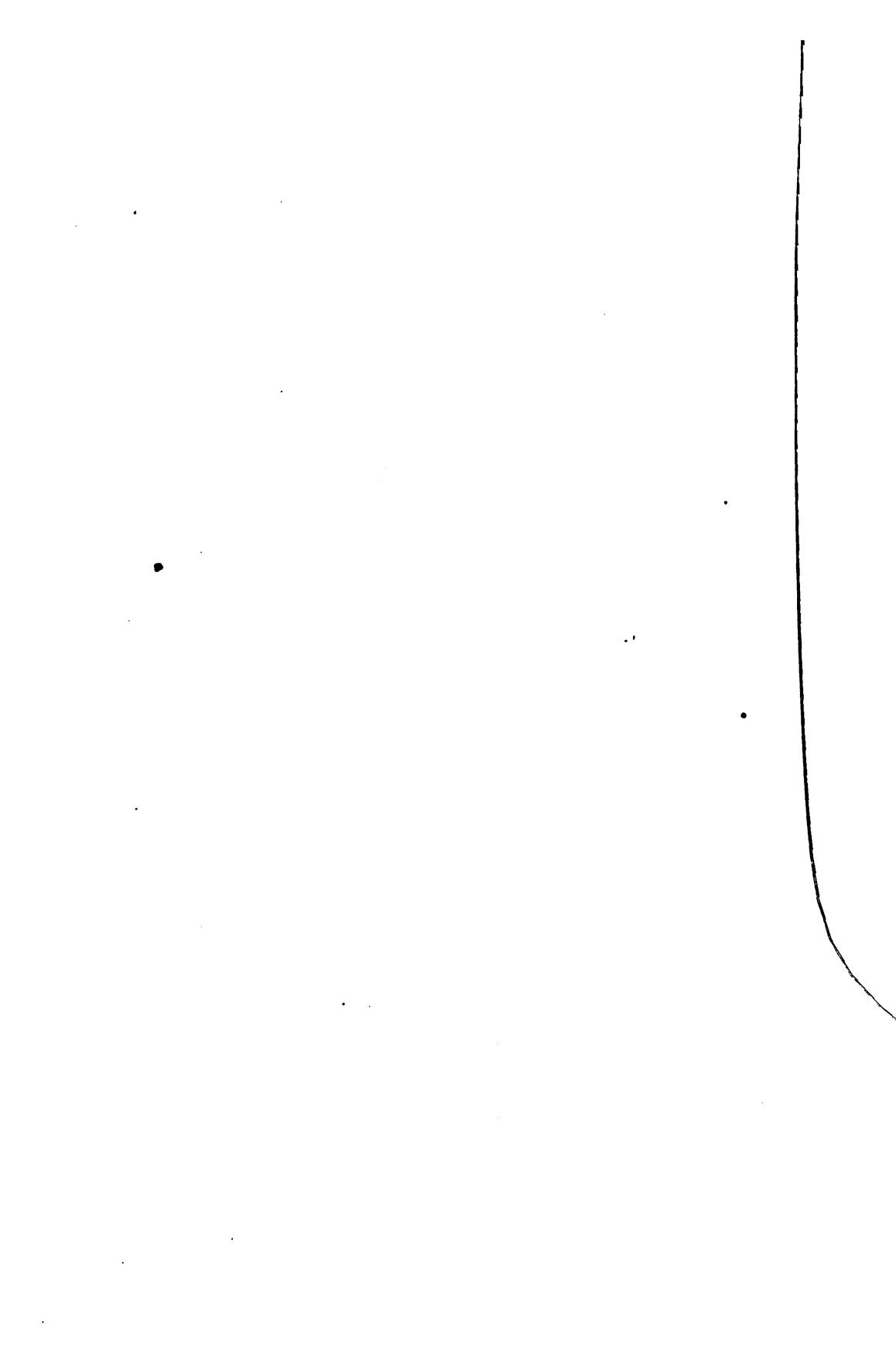

EXPLANATION OF PLATE LXXXVII.

Fig. 1. SCRAPER. Handle of wood 15 inches long. Grip a crutch handle mortised to the end of the shaft perpendicularly to the edge of the blade. Blade a long, narrow celt of schistose rock fitted to a shoulder of the shaft and held in place by a neat seizing of spruce root. The crutch handle is confined to Big Lake and the region around Bristol Bay.

Cat. No. 38838, U. S. N. M. Eskimo of Big Lake, Alaska. Collected by E. W. Nelson.

Fig. 2. SCRAPER. Handle a natural curve of spruce wood. Blade a very wide celt of schistose rock, fitted to a notch in the handle, and held in place with a lashing of fine rawhide string. The unique feature of the specimen is the disproportion between the blade and the handle.

Cat. No. 38828, U. S. N. M. Eskimo of Big Lake, Alaska. Collected by E. W. Nelson.

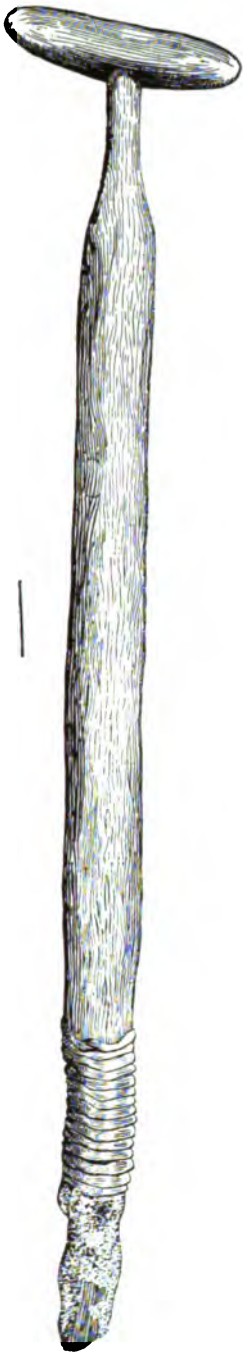

1



2

SCRAPERS.

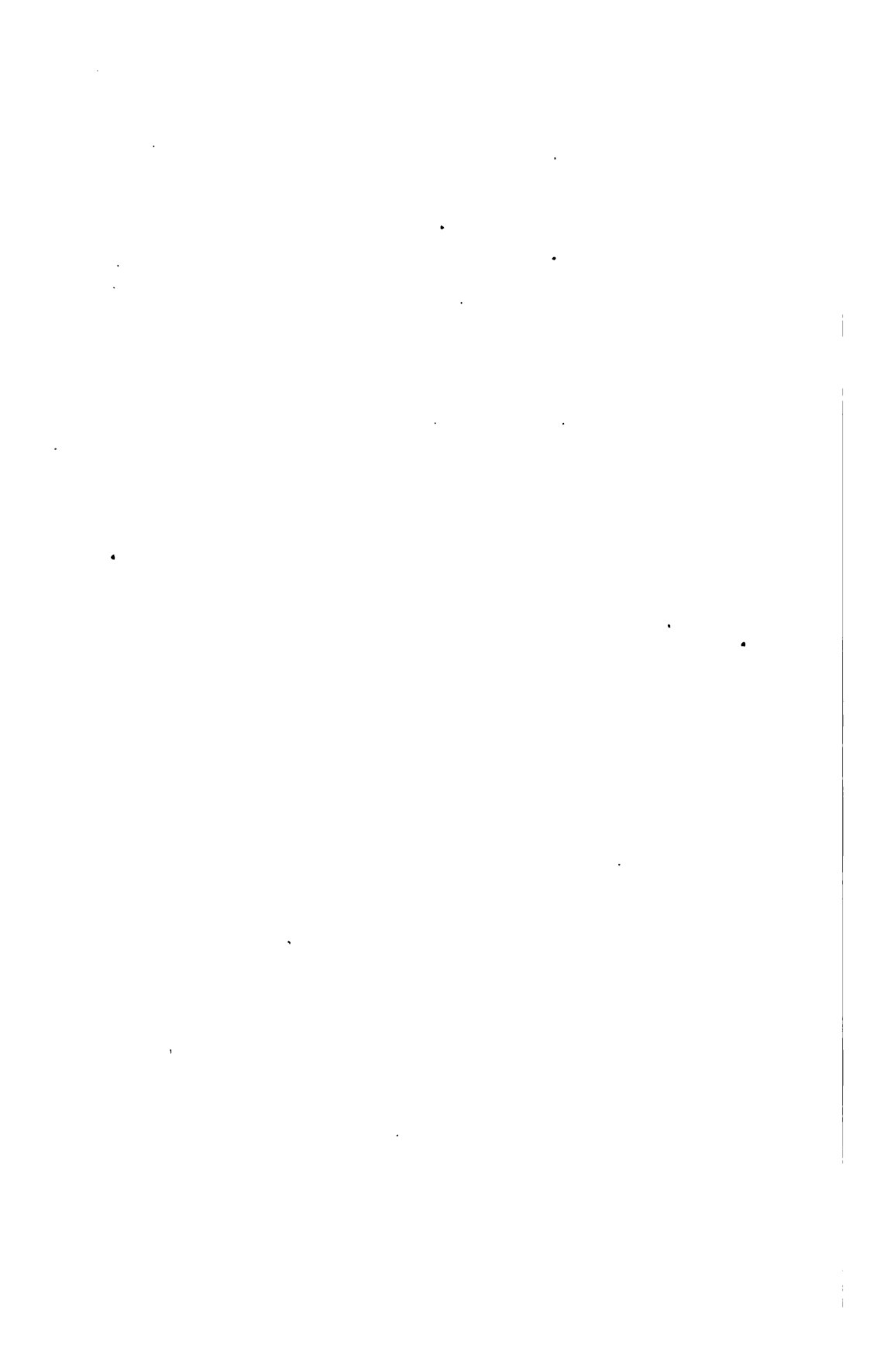



EXPLANATION OF PLATE LXXXVIII.

Fig. 1. SCRAPER. Handle a forked stick of spruce with the bark still on. Blade a celt of hard slate fitted to a notch on the handle and held in place by a lashing of rattan. This seizing shows the happy faculty of the Eskimo in grasping every available thing that comes to his hands.

Cat. No. 55910(e), U. S. N. M. Eskimo of Bristol Bay. Collected by C. L. McKay

Fig. 2. SCRAPER. Handle a natural curved stick of spruce. Blade a very long, smooth celt of schistose rock, set into a notch on the handle, 4 inches long and held in place by a seizing of spruce root. Rather a clumsy piece.

Cat. No. 55910(e), U. S. N. M. Eskimo of Bristol Bay. Collected by C. L. McKay.

Fig. 3. BEAMING TOOL. Made of a strip of hoop iron inclosed between two half cylinders of wood and held in place by seizing of pine root at the end. The iron is ground to an edge along one margin and the wood has been chamfered away to give the edge a chance to work. This is an excellent specimen, showing the hair in the interstices.

Cat. No. 55912, U. S. N. M. Eskimo of Bristol Bay. Collected by C. L. McKay.

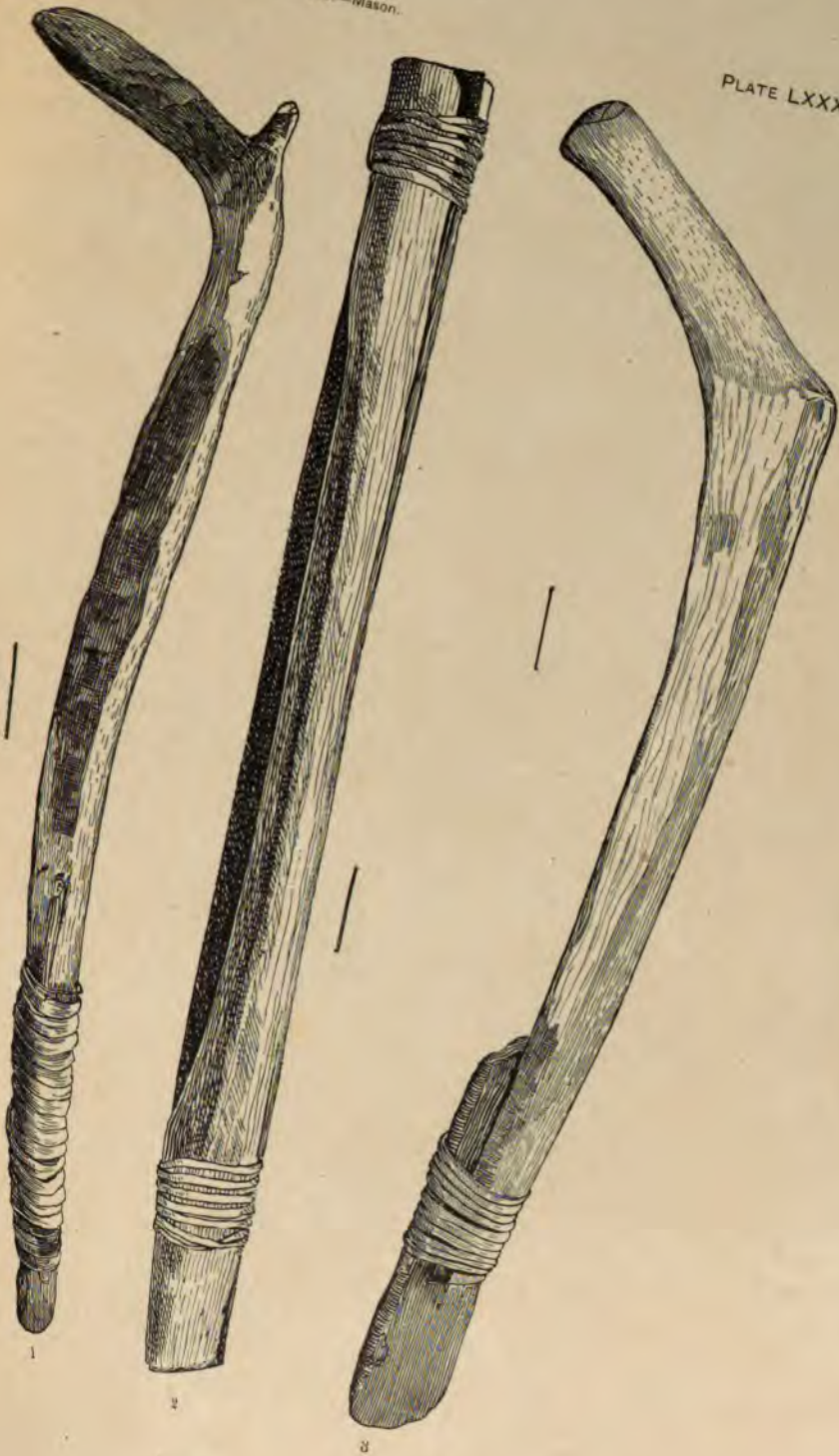

SCRAPERS.

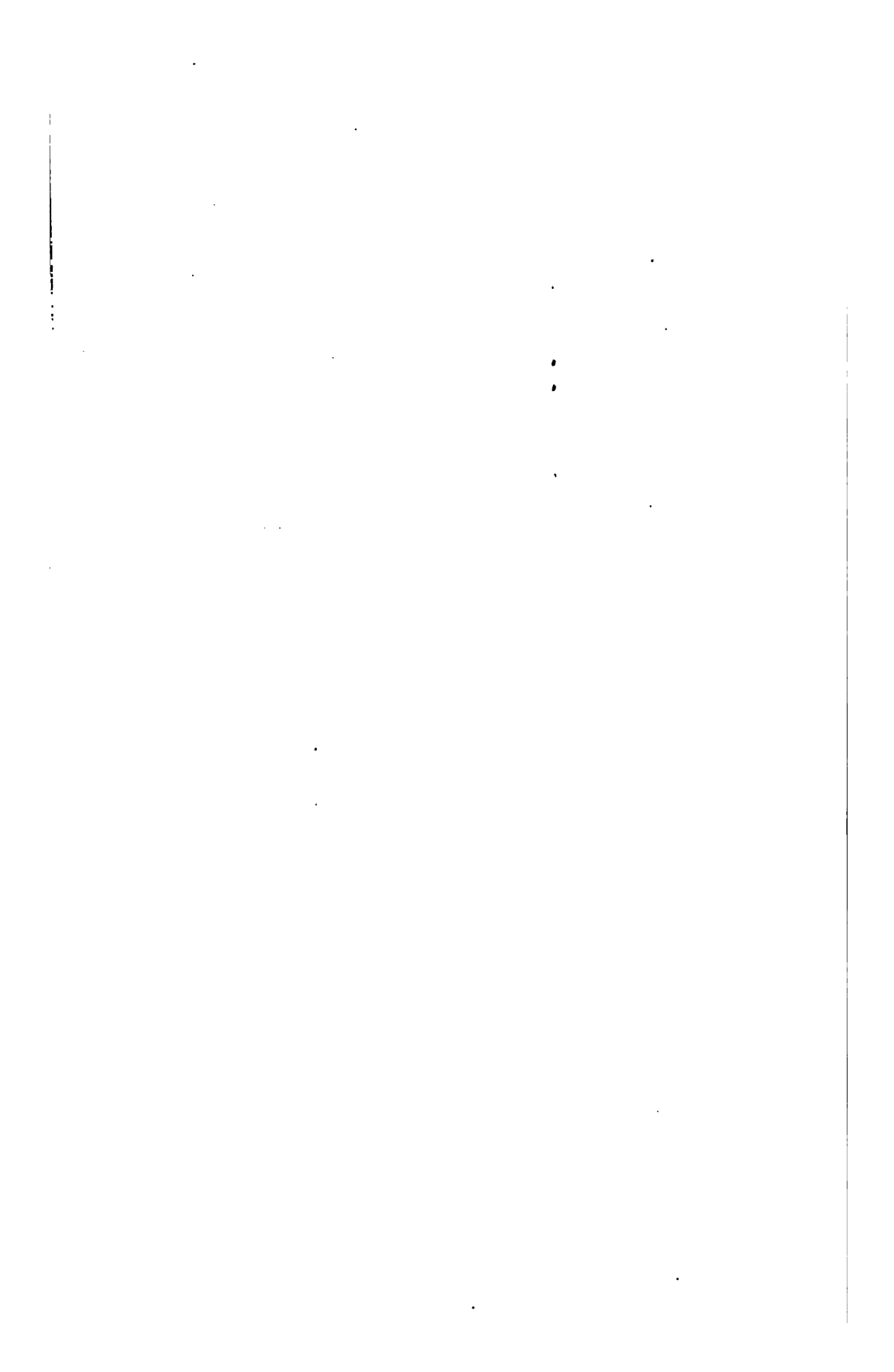



EXPLANATION OF PLATE LXXXIX.

Fig. 1. FAT-SCRAPER. Made of a thin band of antler bent in form of a hoop. ends overlapping but not interlocked. Held in form by a rawhide string wrapped three times around the exterior. A unique specimen.

Cat. No. 127792, U. S. N. M. Eskimo of Nakneek, Alaska. Collected by W. J. Fisher.

Fig. 2. FAT-SCRAPER. Ingeniously made of a broad, thin strip of the outer crust of antler, wide in the middle and narrow at the ends. This strip is bent in shape of a truncated cone, and one end cut, arrow-shaped, is thrust through a triangular cut in the other end and tangled. Of course all this was done when the horn was softened. This type is confined to Bristol Bay.

Cat. No. 55911, U. S. N. M. Eskimo of Bristol Bay. Collected by C. L. McKay.

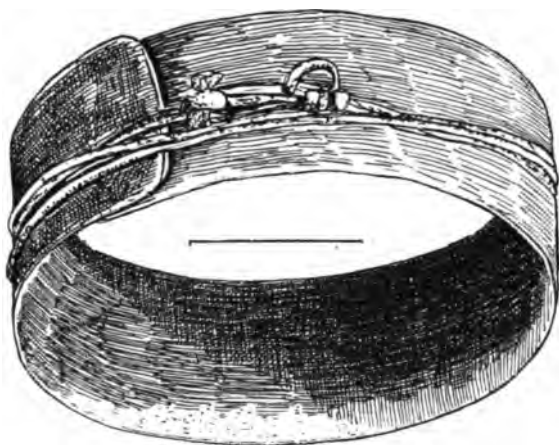

1

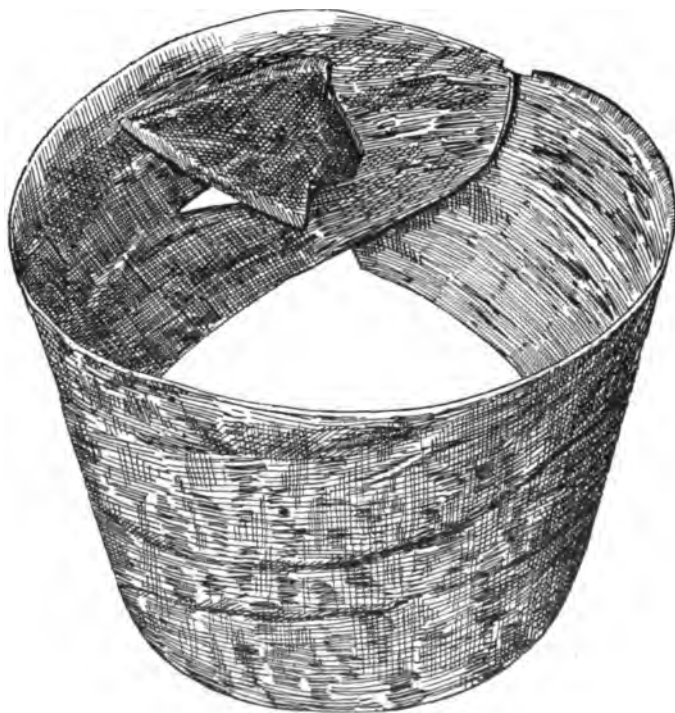

2

FAT-SCRAPERS

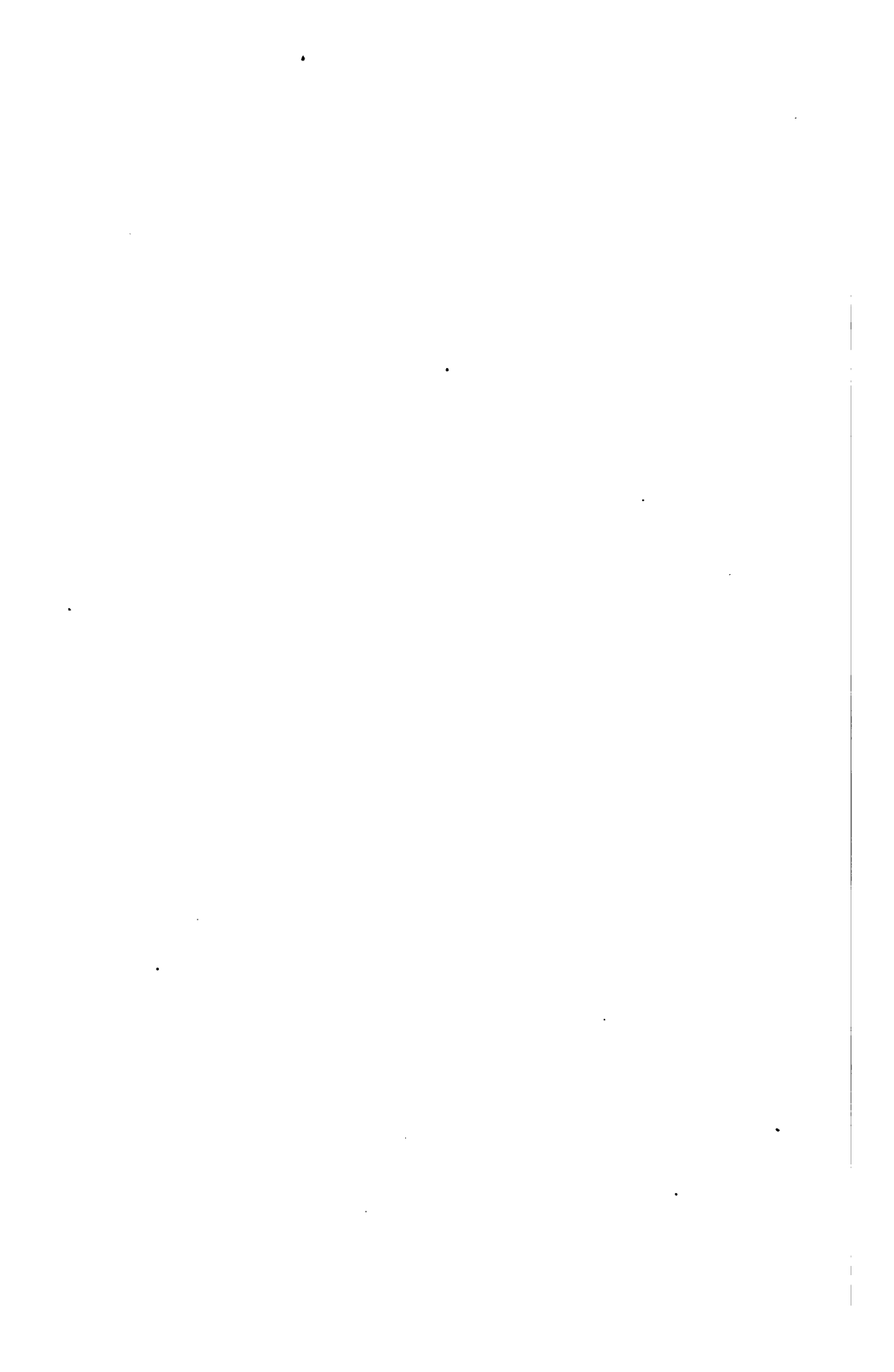



EXPLANATION OF PLATE XC.

Fig. 1. BEAMING TOOL. Made from the tibia of a horse. There has been little or no modification of the bone. The fibula furnishes a most excellent natural edge for the tool.

Cat. No. 19891, U. S. N. M. Piute Indians, southern Utah. Collected by Maj. J. W. Powell.

Fig. 2. GRAINING TOOL. Made of the tibia of the deer. At the middle part, where the bone is hardest, it is cut in two diagonally so as to expose a square edge on the posterior part. Teeth are cut in this edge to soften the skin after treatment.

Cat. No. 19894, U. S. N. M. Utes of northern Utah. Collected by Maj. J. W. Powell.

Fig. 3. GRAINING TOOL. Made of the tibia of a horse. The column cut diagonally across the middle or hardest portion so as to furnish a square edge on the posterior side. Very fine teeth have been made along this edge for graining or softening the skin.

Cat. No. 31316, U. S. N. M. Indians of the pueblo of Isleta, New Mexico. Collected by Dr. H. C. Yarrow and Lieut. George Wheeler, U. S. Army.

Fig. 4. GRAINING TOOL. Made of iron. An old-fashioned wagon skein, used on wooden axles before iron axles were invented. The upper or inner portion shows the holes for the rivets. Its edge is serrated for graining the hide. The buckskin thong is wrapped around the forearm and serves as a brace to hold the tool rigid. The shaft is covered with buckskin to protect the hand.

Cat. No. 14196, U. S. N. M. Sioux Indians, Dakota. Collected by Edward Palmer.



1

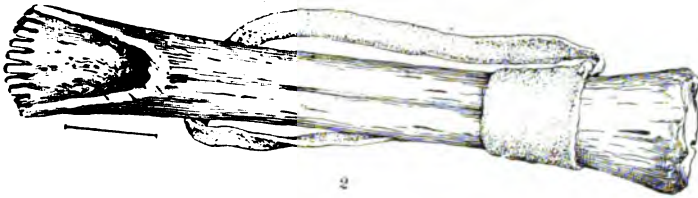

2

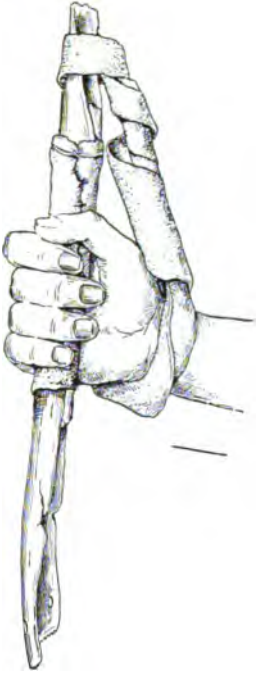

4

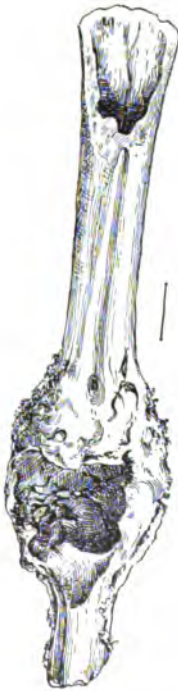

3

BEAMING AND GRAINING TOOLS.

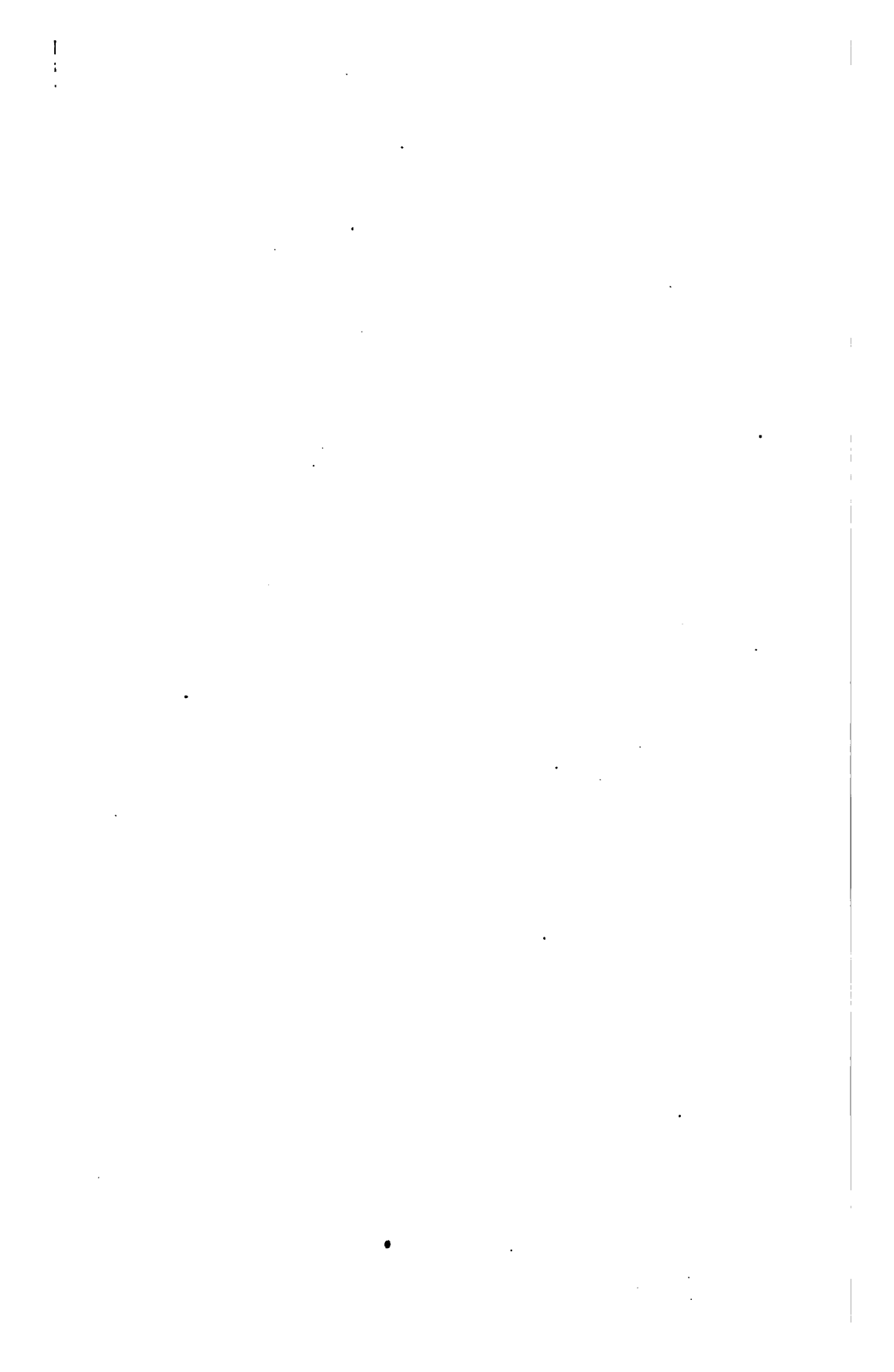



EXPLANATION OF PLATE XCI.

Fig. 1. SCRAPER. Of the antler of the elk, with a provision for the blade left in one of the prongs. In modern times steel takes the place of stone blades.

Cat. No. 6337, U. S. N. M. Gros Ventres Indians, Dakota. Collected by Drs. Gray and Matthews, U. S. Army.

Fig. 2. SCRAPER. Handle of antler. Blade of steel fastened in place with buckskin thong.

Cat. No. 11100, U. S. N. M. Crow Indians, Montana. Collected by Col. James Stevenson.

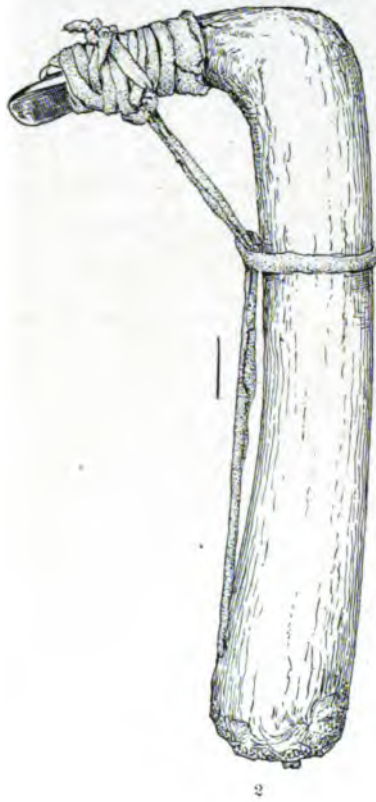
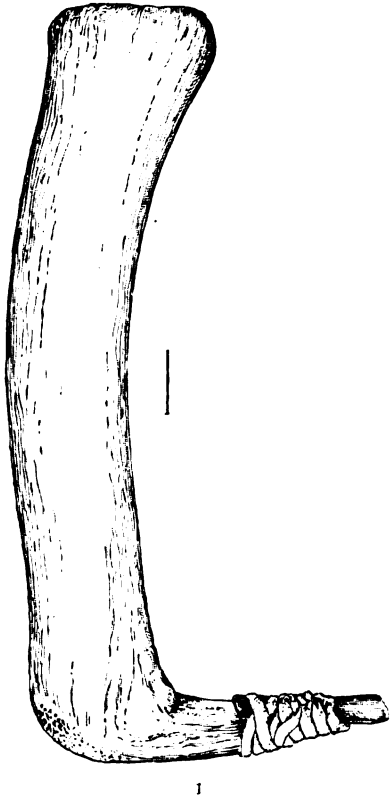

ADZE-SHAPED SCRAPERS.





EXPLANATION OF PLATE XCII.

Fig. 1. SCRAPER. Adze type. Handle of the antler of the elk, the grip being the principal column, and the blade attached to a short section of a branching prong. The blade of the modern tool is of iron, seized loosely with a thong of buckskin so as to be removed easily for sharpening.

Cat. No. 11226, U. S. N. M. Piutes of Utah. Collected by Maj. J. W. Powell.

Fig. 2. SCRAPER. Adze-shaped. Handle of wood cut from a natural knee-shaped stem. The blade of iron is lashed to the flat inner face of the handle, which is not shouldered to catch the blow. Length, $11\frac{1}{4}$ inches.

Cat. No. 31817, U. S. N. M. Pueblo Indians of New Mexico. Collected by Lieut. G. Wheeler, U. S. Army.

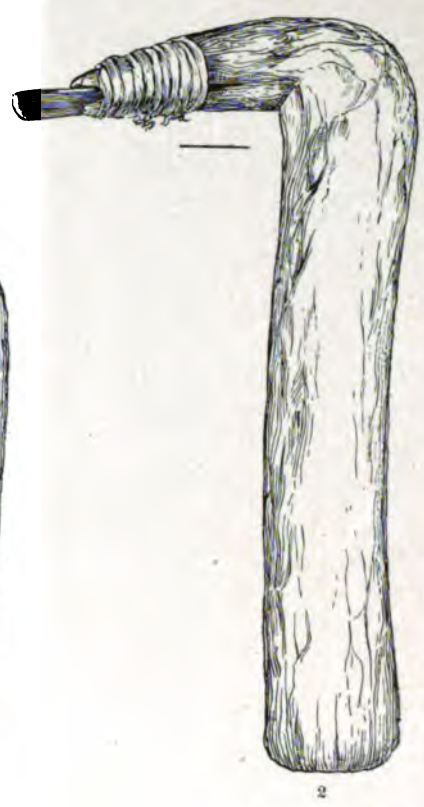
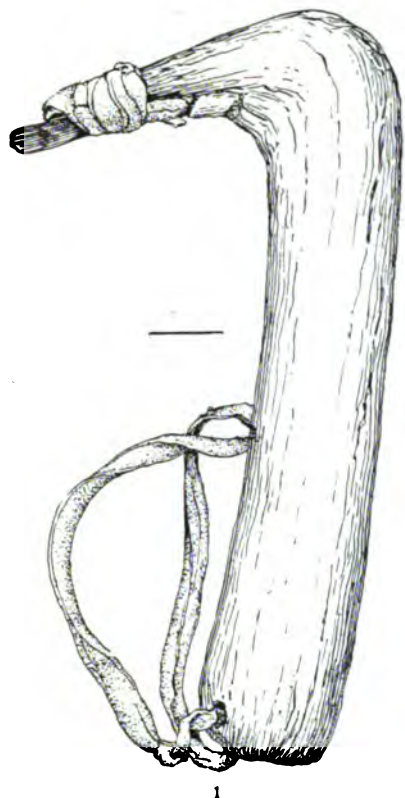

ADZE-SHAPED SCRAPERS.

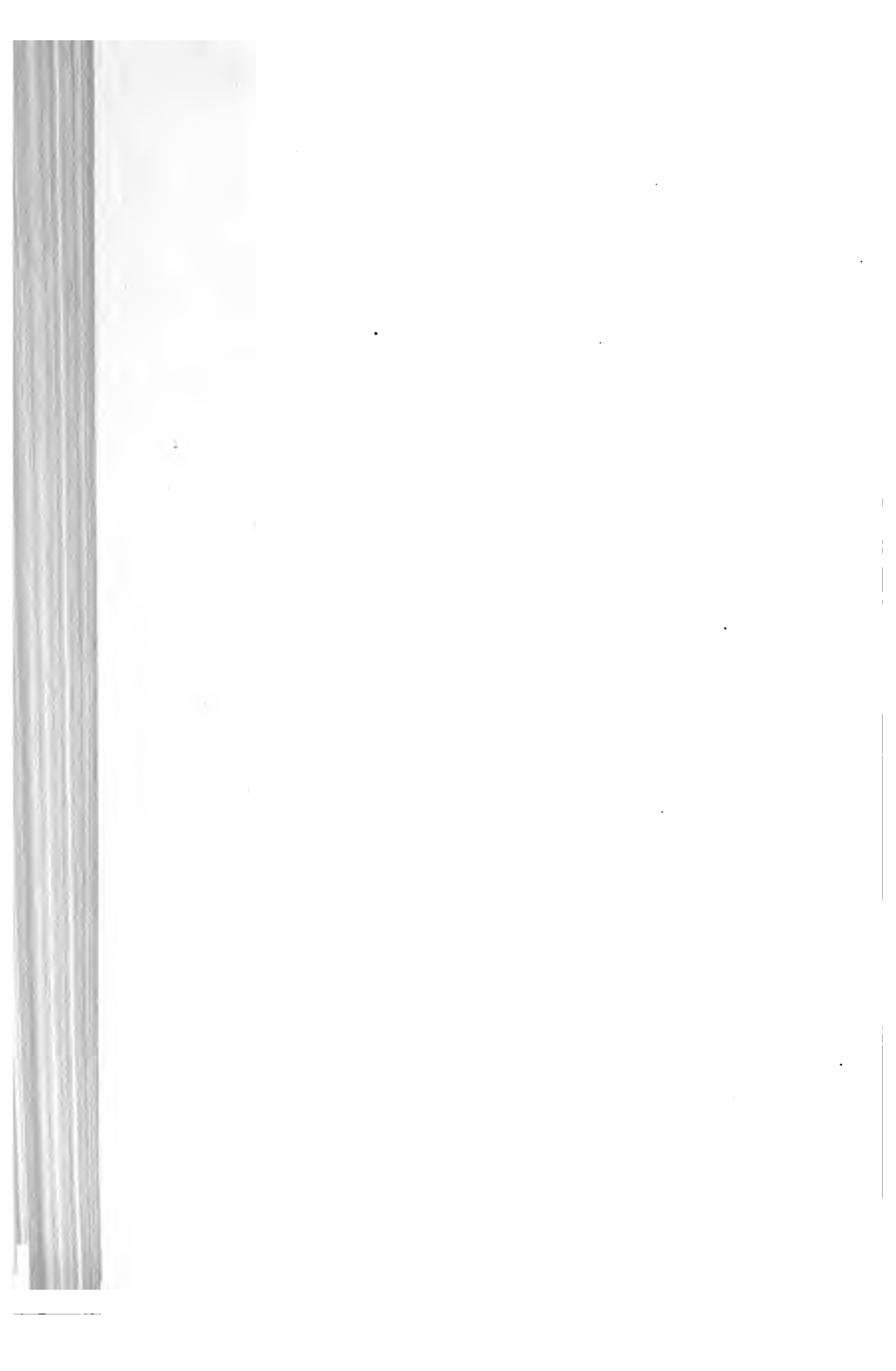



EXPLANATION OF PLATE XCIII.

Fig. 1. SCRAPER. Handle of wood; adze-shaped. Blade of iron, like a plane bit. It is fitted to the handle by a wrapping of buckskin and securely fastened by a rough seizing of buckskin thong and rag. As the blade must be removed constantly for sharpening, the lashing is very rudely done. Length, 12 inches.

Cat. No. 6806, U. S. N. M. Comanche Indians of northern Texas. Collected by E. Palmer.

Fig. 2 (a, b, and c). SCRAPER. Handle of wood. Blades of obsidian. The obsidian blades are inserted into holes, one on each side of the curious handle, and fastened by a black mastic made with the gum of the colqual. Handle, 9 inches.

Arusi Galla tribes in southern Shoa. Collected by Henry H. Giglioli and described in *Internat. Archiv. für Ethnographie*, Vol. II, page 218.

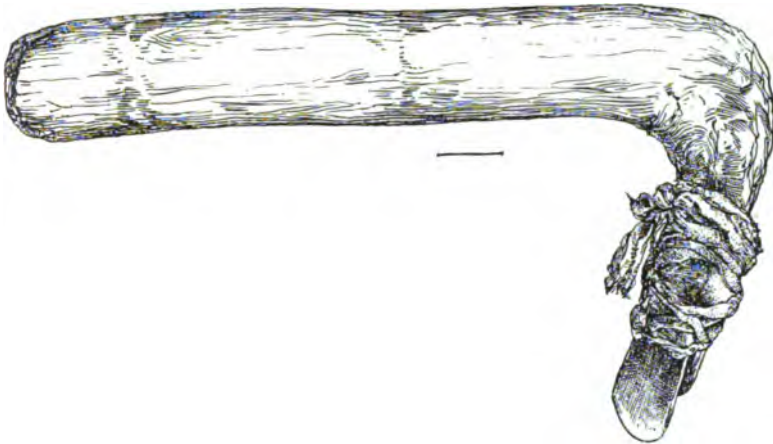

1

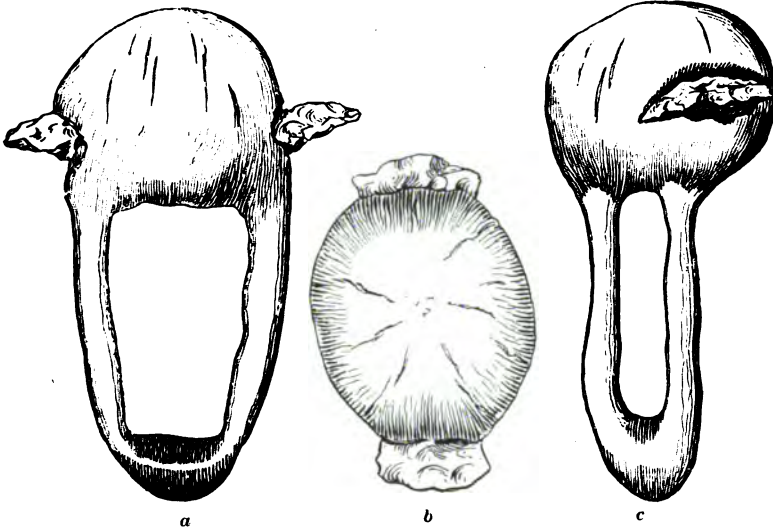

a

b

c

2

ADZE-SHAPED SCRAPERS.









PLATE XCIV.
FIGURE 1. *Leopardus pardus*.
Drawing by J. A. Rehn.

THE PUMA, OR AMERICAN LION: FELIS CONCOLOR OF LINNÆUS.

By FREDERICK W. TRUE,
Curator of the Department of Mammals.

The Puma is the only large, unspotted, native American cat.* The general color of the fur is tawny, but on the under surfaces of the body it is whitish. The color of the central line of the back is darker than that of the sides and the end of the tail is dusky brown. The ears are black externally, with a central whitish area. The upper lip is white from the nostrils to the middle of the mouth, and at the latter point is a prominent black spot. The nostrils are flesh-colored. Baird compares the color of the Puma to that of the Virginia deer, and states that it varies with the seasons as it does in the deer; that is, the summer coat is reddish and the winter coat grayish.†

There is much variation in color among individuals of this species, but it has not been proven that this is correlated with the varying

* Nine species of cats are found in North America north of the Isthmus of Panama. These are—

The Puma, *Felis concolor* Linné.

The Jaguar, *Felis onca* Linné.

The Ocelot, *Felis pardalis* Linné.

The Tiger Cat, *Felis tigrina* Erxleben.

The Eyra, *Felis eyra* Desmarest.

The Yaguarundi, *Felis yaguarundi* Desmarest.

The Bay Lynx, *Lynx rufus* (Güldenstädt).

The Plateau Lynx, *Lynx baileyi* Merriam.

The Canada Lynx, *Lynx canadensis* (Desmarest).

The Puma, on account of its wonderfully extensive range, reaching from Patagonia to Canada, may perhaps be considered as the most characteristic of American animals, though it is less powerful than the Jaguar. The Jaguar and Ocelot enter the territory of the United States only on the extreme southwestern border. The Eyra, Yaguarundi, and Tiger Cat have never been found north of the Rio Grande. The Lynxes are common in the United States. The spotted form of the Bay Lynx, found in Texas, and the banded form, found in Oregon and Washington, have been described as separate species, under the names *Lynx maculatus* and *Lynx fasciatus*. They are now generally regarded as geographical races of the Bay Lynx. The Canada Lynx is a distinct species.

† Baird, Mammals of North America, 1859, p. 83.

climatic conditions of its range.* The occurrence of albino Pumas in the Alleghany Mountains and in New Mexico has been reported, but not authoritatively.†

Burmeister remarks on this point: "Very rarely individuals of this species of a brown, nearly black color have been found, while differences in color between yellowish-brown and yellowish gray are not rare. I am aware that individuals nearly white and others nearly black have been observed, but I have never seen such myself."‡

New-born Pumas are very different in appearance from the adults. Instead of being of uniform color, the back and legs are covered with large blackish-brown spots, and the tail is ringed with the same color. According to Dr. W. A. Conklin these markings disappear in about six months after birth.||

The male Puma represented in Plate XCIV is of the following dimensions: Head and body, measured along the curves, 53 inches; tail, 26

* There is an early allusion to this matter in Müller's translation of Linnæus's System of Nature, published in 1796. After mentioning the discrepancy between Pennant's and Schreber's measurements of the Puma, this author remarks: "It is not however, to be wondered at that different measurements are given, when it is considered that the two animals from which they were taken were born in such very different regions. The climate likewise contributes to changes in their disposition and hence those living in North America are much less ferocious and much weaker than those which are born in hotter regions. It has influence also upon the color. In the Iroquois country the species is gray, in other regions reddish." (Müller, Linnæus's Natursyst. Fortsetzung nach 13ten Ausgabe, 1. Theil, Säugethiere, 1796, p. 207.)

† See *Forest and Stream* newspaper, xvii, p. 110; also, *American Field*, xx, 1883, p. 2.

‡ Burmeister: Description Physique de la République Argentine, iii, 1879, p. 132.

§ This difference between the young and adults in coloration led the veracious Garcilasso de la Vega into error. In his Royal Commentaries he writes: "A Spaniard whom I knew killed a great lioness in the country of the Antis, near Cuzco. She had climbed into a high tree, and was killed by four thrusts of a lance. They found two whelps in her belly, which were sons of a tiger, for their skins were marked with their sire's spots." (Royal Commentaries, 1609, book 8. < Hakluyt Society, xi, 1869, p. 385.) According to Castelnau, young North American Pumas have white spots. Burmeister states that he never saw such individuals in Brazil.

|| Dr. W. A. Conklin, in Merriam's Vertebrates of the Adirondack Region. < Transactions of the Linnean Soc., New York, i, 1882, p. 35, foot-note.

They persist, however, though always more or less indistinct, until the animal has reached its full size, or perhaps in some cases, throughout life. The term spotted notwithstanding, can not be applied to the species in the same sense as to the Jaguar, Leopard, and Ocelot. It may be mentioned in this connection that lions, which about the eye are unspotted, sometimes appear in photographs as spotted animals. I subjoin some notes on the color of a number of flat skins of Pumas, which I recently examined through the kindness of Mr. F. S. Webster, of Washington.

(a) Length without tail, 4 feet 9 inches. Color very pale tawny. Spots appear on all parts of the body.

(b) Length without tail, 4 feet 4 inches. Shows spots of darker tawny than the general color of the body.

(c) Length without tail, 4 feet 7 inches. Color very pale. Shows very faint spots.

(d) Total length, 6 feet 11 inches. Color gray. Numerous irregular small spots of white and single white hairs. No dark spots.

(e) Total length, 6 feet 10 inches. Color pale tawny. Numerous white hairs. Faint spots on the legs only.

inches; height at the shoulder, 22½ inches. Audubon and Bachman give the following dimensions of a male killed by J. W. Audubon at Castroville, Tex., January 28, 1846. From point of nose to root of tail, (whether measured along curves, not stated), 5 feet 1 inch; tail, 3 feet 1 inch; height of ear posteriorly, 3 inches.*

The male Puma measured by Azara was somewhat smaller, the head and body being 51½ inches and the tail 29 inches.† The system of measurement is not given.

The average dimensions obtained from these three individuals are: For the head and body, 55¼ inches, and for the tail, 30¼ inches; total, 85 inches.

Dr. Edgar A. Mearns has generously permitted me to copy his measurements of the nineteen individuals killed by him in Arizona between 1884 and 1888. Measurements of total length are given in seven instances. These are as follows :

	Total length.	Length of head and body.	Length of tail with hairs.
	Inches.	Inches.	Inches.
Female, Mogollon Mountains, Arizona.....	72.5	44.5	29.5
Male, 10 miles southwest of Fort Verde, Arizona.....	80.0	51.2	31.1
Male, east slope of Mogollon Mountains, Arizona.....	78.0	31.0
Female, east slope of Mogollon Mountains, Arizona.....	60.0	25.5
Male, east slope of Mogollon Mountains, Arizona.....	84.0	36.0
Do.....	72.0	23.0
Do.....	72.0	30.0

I have found no authentic record of any individuals measured before skinning of which the dimensions were greater than those of Audubon's

- (f) Total length, 5 feet 9¼ inches. Color grayish. A few very faint spots.
- (g) Total length, 5 feet 8 inches. Color gray. Shows large spots throughout, and also two bars on the shoulders, and a line of very distinct spots along the spine.
- (h) Total length, 5 feet 8 inches; color gray; numerous spots, especially on the legs.
- (i) Total length, 5 feet 5 inches (tip of tail wanting). Similar to "g," but the spots less distinct.
- (j) Total length, 5 feet 6 inches. Similar to "g."
- (k) Total length, 5 feet 4 inches (tip of tail wanting). Color gray. Shows large dusky spots throughout.
- (l) Total length, 5 feet 3 inches. Color pale tawny. Spots distinct but pale.
- (m) Length without head, 4 feet 1 inch. Color a beautiful vinaceous tawny, overlaid everywhere with large dusky spots. A broad, dark spinal band, and very distinct shoulder bars. A black line along the entire tail, above. The terminal third of the tail entirely blackish.

*Audubon and Bachman, Viviparous Quadrupeds of North America, II, 1851, p. 306.

Buffon gives the following measurements received in a letter from Collinson (whether measured along curves not stated): Head and body, 5 feet 4 inches; tail, 2 feet 6 inches. This is probably English measure. < (Œuvres Comp. de Buffon, edited by Richard, xv, 1826, p. 74, under heading of *Le Cougar de Pennsylvanie*.

† Azara, Apuntamientos para la Historia Natural de los Quadrúpedos del Paraguay, II, 1802, p. 124. "Longitud, 74 pulgadas; cola, 26¼."

specimen mentioned above. The total length in that case was 8 feet 2 inches. There are, however, records of measurements of flat skins of greater size.* I have myself measured a skin from Colorado in the National Museum, (No. 19906), of which the total length in a straight line is 8 feet 4 inches. Mr. Livingston Stone states that the skin of a Puma killed on the McCloud River, California, "measured 8½ feet when stretched."† The average total length of nine flat skins of adults in the possession of Mr. F. S. Webster, of Washington, is 7 feet 4 inches.

The area over which the Puma ranges extends from New England and British Columbia to the Straits of Magellan. On the Atlantic coast of North America the species has apparently not been found in the States of New Hampshire, Rhode Island, New Jersey, or Delaware. On our northern boundary I find no mention of its having been found in Michigan or Indiana. In Ohio it was extirpated prior to 1838, and probably more recently in Illinois and Indiana. I find no record of its occurrence in Nevada, but as it has been found in the surrounding States it seems improbable that it should be entirely absent here.

With these exceptions there are recorded instances, more or less numerous, of the occurrence of the Puma in every State and Territory of

* Since this was written, Prof. C. L. Bristol, of Vermillion, South Dakota, has sent me a letter addressed to him by Mr. James G. Needham, taxidermist of Galesburgh, Illinois, in which the writer states that he knows of several mounted specimens in which the head and body taken together exceed 60 inches in length, and that he has recently mounted one from near Lake Valley, New Mexico, a fine dark skin, which measured 70 inches from the nose to the root of the tail. The tail was 39 inches long and the total length 109 inches.

† *Forest and Stream*, XIX, 1882, p. 208.

Anonymous and pseudonymous writers in the various natural history and sporting journals give still larger dimensions. Thus we read of a Puma killed at Lauder, Wyoming Territory, which measured "10 feet from tip to tip" (*American Field*, XXIV, 1885, p. 486) and even of one from Colorado that was 11 feet 3 inches long (*S. C. C. Forest and Stream*, XIX, 1882, p. 127).

While it is well known that giants, which greatly exceed ordinary individuals in size, exist among many kinds of animals, it is necessary that statements regarding them in order to receive credence should be accompanied by unquestionable proofs. The best vouchers are the skins and skulls of the specimens preserved in museums. The cases cited above are not properly vouched for. It may be said, furthermore, that among the twenty skulls of Pumas in the National Museum there is none which by the most liberal calculation could be supposed to belong to an individual exceeding 8½ feet in total length. The greatest length of the largest skull, (No. 1158, from Prairie Mer Rouge, Louisiana), is 8½ inches, and its basilar length, that is, from the back of the incisor teeth to the front edge of the *foramen magnum*, 6½ inches.

In recording measurements of fresh specimens, it should always be stated whether the line is allowed to follow the curves of the back or whether the measurements are made in straight lines. It should also be remembered, as regards measurements of total length, that an individual with a well-developed body, but a short tail, may appear to be a smaller and feebler animal than one with a long tail, when the contrary may in reality be the truth.

the Union, dating from the beginning of the century. Like many other large American animals, however, the Puma has retired before the advance of civilization, and in many of the more thickly populated States it is improbable that even stragglers could be found at the present day.*

* The localities in the several States and Territories in which individuals have been captured or seen, so far as they are recorded in the literature at command, are given in the following list :

Upper Canada.—A specimen from this region was seen by Audubon. (Audubon and Bachman, Quadrupeds of North America, II, 1851, p. 312.) A second specimen was killed near the city of Ottawa. (William Couper, in *Forest and Stream*, VIII, 1877, pp. 299, 300. Communicated by Dr. Elliott Cones.) King reports having seen one which was killed by Dr. Maitland near St. Catherine's. (King, Sportsman and Naturalist in Canada, 1866, p. 16.) There is an improbable narration of a Puma having attempted to attack some men in a boat near St. Francis on the St. Lawrence River, in Small's Animals of North America, 1864, p. 49. The size, weight, and other particulars are, however, given.

Manitoba.—The Puma is not included by Mr. E. E. Thompson in his recent list of the mammals of Manitoba. (Trans. Manitoba Sci. & Hist. Soc., No. 23, May, 1886.)

British Columbia.—Abundant in Vancouver's Island, and ranges to 56° north latitude in British Columbia, according to J. C. Hughes. (*Forest and Stream*, XXI, p. 103.)

Alabama.—Hallock states that the Puma is occasional in De Kalb County. (Sportsman's Gazetteer, 1877, p. 3.)

Arizona.—Generally distributed, but found most frequently in the wooded and mountainous portions of the Territory. (Coues, *American Naturalist*, I, 1867, pp. 281-292.) Drs. Coues and Yarrow killed two specimens in the Triplet Mountains. (Wheeler's Survey, v, Zoology, 1875, pp. 40, 41). Dr. Edgar A. Mearns, U. S. Army, has kindly given me measurements of nineteen Pumas killed by him in Arizona between December, 1884, and February, 1888. Four were killed near Fort Verde; six, in the Mogollon Mountains; four, at the head of Beaver Creek, Yavapai County; and five, on the Verde River.

Arkansas.—Nuttall reported the occurrence of the Puma on the Arkansas River, north of Little Rock, in 1819. (Travels into Arkansas Territory, 1821, p. 118.) Mr. Hallock states that the dense cane-brakes, swamps, and forests of Cross County are infested by Pumas. They are occasionally found also in the dense cane-brakes along the Red River, in Jackson County, and great numbers in Prairie County, in the cane-brakes between the White and Cache Rivers; also in Phillips County, in the vicinity of Helena, in the woods; in Pulaski County, near Little Rock; and in St. Francis County. (Sportsman's Gazetteer, 1877, pp. 8, 9.) One is reported to have been killed near Bayou Bartholomew, in Jefferson County, in 1883. (*Forest and Stream*, XX, 1883, p. 125.) There is also an account of a hunt on Crooked Bayou in the southeastern part of the State in 1887 in *Forest and Stream*, XXVIII, 1887, p. 323.

California.—Abundant throughout the State, as appears from the statements of various authors. Mr. H. W. Henshaw, however, stated in 1875 that the species had apparently disappeared from the lower and more thickly settled portions. (Wheeler's Survey, Report of 1876, pp. 305-312.) Mr. Hallock mentions the Puma as occurring in 1877 in Butte, Humboldt, Klamath, Trinity, Mendocino, Los Angeles, Marin, Nevada, Santa Clara, Shasta, Siskiyou, Sonoma, and Tehama Counties. (Sportsman's Gazetteer, 1877, pp. 11-18.) Specimens were obtained in Shasta County in 1884 by Mr. C. H. Townsend. See also *Forest and Stream*, XIX, 1882, p. 208; XX, 1883, p. 203; XXIII, 1885, p. 497, (McCloud River); XXV, 1885, p. 46 (Concho Valley); XXVIII, 1887, p. 493; XXX, 1888, pp. 239, 350, 411. *American Field*, XXI, 1884, p. 451; XXV, 1886, p. 343 (San Buenaventura); XXVII, 1887, p. 105 (Georgetown).

Colorado.—Common in Park County in 1874, according to Dr. J. A. Allen. (Bull. Essex Inst., vi, 1874, pp. 43-66). Elsewhere in the mountains, according to Drs. Coes and Yarrow. (Report Wheeler's Survey, v, 1875, pp. 35-129.) Mr. Hallock states that they occur in the North Park, in Summit County. (Sportsman's Gazetteer, 1877, p. 22.) Three specimens were received from Cañon City in 1877 by the National Museum. See also *Forest and Stream*, xxx, 1888, p. 243 (Rifle Creek).

Connecticut.—Linsley, in 1842, saw a specimen reported to have been killed in the northern part of the State. (*Amer. Journ. Sci.*, XLIII, 1842, pp. 345-354.)

Dakota.—Mr. G. B. Grinnell saw a single individual in the Black Hills in 1874, but believed them to be quite numerous in that region. (Ludlow, Rep't of a Reconnaissance of the Black Hills, 1874, pp. 77-85.) Mr. Vernon Bailey also learned in 1887 that they were considered quite common in the Black Hills, and saw a young one which had been captured there. (Rep't Ornithologist, Dept. Agric., 1888, p. 431.) Hoffman reported in 1877 that specimens were occasionally captured in the oak groves on Oak Creek in the vicinity of Grand River. (Proc. Boston Soc. Nat. Hist., xix, 1877, pp. 94-102.)

Florida.—Dr. J. A. Allen stated in 1870 that the Puma was not unfrequent in the more unsettled parts of the State. (Bull. Mus. Comp. Zoology, II, 1870, p. 186.) Maynard in 1843 reported that it was common in the interior and more southern parts of the State, but was not found on the Keys. (Quart. Journ. Boston Zool. Soc., II, 1853, Nos. 1-4.) The late Mr. Judson, however, writing under the pseudonym of "Ned Buntline," reported that a Puma was captured on Key Largo. (*Forest and Stream*, XIII, 1880, p. 994.) See also a note on one killed in Manatee County in 1887, in *American Field*, xxviii, 1887, p. 7.

Georgia.—Found along the water-courses in this State thirty years ago, according to Audubon. (Audubon and Bachman, Quadrupeds of North America, II, 1851, p. 312.) According to Mr. Hallock the scream of the Puma is not uncommonly heard in Barlow County and in the hill country generally; also in Thomas County, in the vicinity of McDonald. (Sportsman's Gazetteer, 1877, pp. 37-40.)

Idaho.—Mr. Hallock reported in 1877 that Pumas could be found in the mountains and forests of Idaho County. (Sportsman's Gazetteer, 1877, p. 42.) A person writing under the pseudonym of "Nica" reports that he killed a Puma in Northern Idaho in 1888. (*Forest and Stream*, xxx, 1888, p. 308.)

Illinois.—Kennicott in 1855 stated that a single individual had been known to occur in Cook County. (Trans. Illinois State Agric. Soc., I, 1855, pp. 577-580.) The species has probably disappeared from the State. Professor Leidy calls attention to a fossil skull found 30 feet below the surface, in the bed of the Kaskaskia River, in Proc. Acad. Nat. Sci. Phila., 1888, p. 9.

Indiana.—I have not met with any mention of the occurrence of the Puma in this State. Haymond omits it from his list of mammals observed in Franklin County in 1869, published in the Report of the Geological Survey of Indiana for that year.

Indian Territory.—Woodhouse in 1853 remarks of this species: "It was observed in the Indian Territory in the neighborhood of a swamp." He does not give the location of the swamp. (Sitgreaves, Exped. down the Zuni and Colo. Rivers, 1853, p. 47.)

Iowa.—Dr. C. A. White writes in 1869 as follows: "The panther has been known within our limits but very rarely." (Proc. Boston Soc. Nat. Hist., XIII, 1869, p. 181, foot-note.)

Kansas.—According to Mr. F. W. Cragin, four Pumas were captured and three others seen in the counties of Harper, Barbour and Comanche in the winter of 1834-'85. (Bull. Washburn Laboratory of Nat. Hist., I, 1885, p. 42.)

Kentucky.—I am obliged to Prof. John R. Procter, director of the geological survey of Kentucky, for a letter regarding the occurrence of the Puma in Kentucky, written at his request by Mr. R. T. Durrett, of Louisville. On the authority of manuscripts in his possession, Mr. Durrett states that John Sanders killed a Puma in a chestnut-oak tree at the Knobs, 6 or 7 miles south of Louisville, in 1784. A young Puma was

killed on Mr. Durrett's father's farm, in Allen County, by a negro, in 1815. The Puma was last seen in Kentucky in 1863, when a full-grown individual, having a total length of 7 feet, and weighing 111 pounds, was killed by Mr. John Custis and others, within 6 miles of Lexington.

There is also mention of two or three killed near Reeder in *American Field*, XXIII, 1885, p. 174.

Louisiana.—A skull from Prairie Mer Rouge, obtained by James Fairie, in 1853, is in the National Museum. Baird includes the Puma in his list of the mammals of the Red River of Louisiana. (Marcy's Exploration of the Red River of Louisiana, 1853, Appendix F.) See also *American Field*, XXVIII, 1887, 390 (Red River). Mr. Hallock states in 1877 that Pumas were to be found in Grant Parish, about Flagon, Clear, Big, and Trout Creeks. (Sportsman's Gazetteer, 1877, p. 62.)

Maine.—Included without comment in Holmes's list of the mammals of the State, in the sixth annual report of the Maine board of agriculture, 1861, p. 123. I am credibly informed that no Pumas have been killed in the State in recent years.

Maryland.—The species formerly occurred here, according to Audubon and Bachman. (See Quadrupeds of North America, II, 1:51, p. 312.) It is included by Scott among the indigenous animals of the State, under the name of Panther. (Joseph Scott, A Geog. Descript. of the States of Maryland and Delaware, 1807, p. 28.)

Massachusetts.—Emmons states that the Puma was not to be found here in 1840, though it existed in the State at an earlier day. (Emmons, Report on the Quadrupeds of Massachusetts, 1840, p. 36.) Dr. J. A. Allen, in 1869, writes: "The Panther has probably been for some time extinct in Massachusetts, though undoubtedly once occurring here." (Bull. Mus. Comp. Zool., I, 1863-1869, p. 153.) There was a rumor that one was seen near East Douglass as late as 1883. See *Forest and Stream*, XX, 1883, p. 48.

Michigan.—No record was found of its occurrence in this State. It is not mentioned in a list of the vertebrates of the State, published by M. Miles, M. D., about 1861. (Presumably in the report of the geological survey of the State for that year. I have seen only an undated excerpt.)

Minnesota.—Not included in Head's list of mammals found in the vicinity of Fort Ripley in 1854. (Smithsonian Report, 1854, p. 291.) Mr. Frank J. Locke makes the following statement: "I recently had a bloodless encounter with a huge panther the only one seen in this locality for years." (*Forest and Stream*, XX, 1883, p. 226.)

Mississippi.—Audubon states, in 1851, that the Puma was to be found in the swamps of this State, and relates several adventures with it in the region of the Yazoo River. (Quadrupeds of North America, II, 1851, p. 308.) Wailes, in 1854, writes: "The Panther is now rarely met with except in dense and extensive swamps and canebrakes." (Report on the Geology of Mississippi, 1854, p. 315.) Mr. Hallock states in 1877 that there was an excellent region for Pumas in Tunica County, at Hudson, near the Mississippi River; also in Washington County. (Sportsman's Gazetteer, 1877, p. 92.) See also an improbable story in *Forest and Stream*, XX, 1883, p. 125. In this connection, the remarks of Du Pratz, a writer of the last century, are of interest. Du Pratz appears to have established himself near Natchez. Writing in 1758, he says of the Puma or *Tigre*: "One sees them but little; and if this animal was as common as a certain author (? Buffon) would have us believe, the ancient inhabitants of the country would have seen a certain number, but I have never heard mention of but one. I have seen two at different times about my habitation." (M. Le Page Du Pratz, *Histoire de la Louisiane*, II, 1758, pp. 91-92.)

Missouri.—I found no records of the occurrence of the Puma in this State since the beginning of the century, when Dr. J. Watkins, in a letter to Dr. Barton, included it among the mammals found in the country west of St. Louis. (Trans. Amer. Philos. Soc., VI, 1809, pp. 69-72.)

Montana.—The Puma occurs in congenial localities throughout the Territory. It was seen by Mr. G. B. Grinnell at the mouth of Alum Creek in 1875. (Reconnaissance

from Carroll, Montana, to Yellowstone Nat. Park in 1875, by Wm. Ludlow, 1875, pp. 63-72.) A Puma from Fort Keogh is living in the Smithsonian park at this date. See also *Forest and Stream*, xxvi, 1886, p. 508; xxx, 1888, pp. 411, 350. Mr. Vernon Bailey found the Puma at Tilyou's Ranch, Dawson County, in 1887. (Rep't Ornithologist, Dep't Agriculture, 1888, p. 431.)

Nebraska.—Aughey remarks regarding the Puma in this State: "I have only seen it a few times on the Niobrara and the Loup." (S. Aughey, *Geology of Nebraska*, 1880, p. 119.)

Nevada.—I have found no distinct record of its occurrence in this State.

New Hampshire.—No evidence found of its occurrence in this State.

New Jersey.—Omitted by Beesley from his list of the wild animals of Cape May County (*Geology of the County of Cape May*, 1857, p. 137) and by Abbott from his list of the mammals of the State published in the Report of the Geological Survey of New Jersey, 1868, pp. 751-761.

New Mexico.—Bartlett found the Puma along the water courses of this Territory thirty-five years ago. (Narrative of Explorations in Texas, New Mexico, etc., II, 1853, p. 555b.) Woodhouse states that the Puma was observed in the mountains of New Mexico. He also in another place states that its cry was heard on the San Francisco Mountains. (He calls it *Felis pardalis*.) (Woodhouse in Sitgreaves's Exped. down the Zuni and Colorado Rivers, 1853, pp. 37 and 47.) Drs. Cones and Yarrow reported in 1875 that the Puma was tolerably common in the mountains of Colorado, New Mexico, and Arizona. (Rep't Wheeler's survey, v, 1875, pp. 35-29.) Mr. J. Preston True states that his guide killed a Puma at Albuquerque in 1888. (*Forest and Stream*, xxx, 1888, pp. 350, 411. See also *Forest and Stream*, xii, 1879, p. 294, and *American Field*, xx, 1883, p. 201.)

New York.—The Puma is still found in the Adirondack Mountains. Dr. C. H. Merriam gives a list of forty-six killed in that region between 1871 and 1881, and estimates that nearly a hundred were killed between 1860 and 1882. (Trans. Linnæan Society of New York, I, 1882, p. 39.) DeKay stated, in 1842, that the species was occasionally seen in the Catskill Mountains. (Nat. Hist. of New York, Zoology, 1842, pp. 47, 48.) He also remembered the appearance of one in Westchester County, within 25 miles of New York City, when a boy, and was informed that one had been killed in Warren County. See also *Forest and Stream*, xxiii, 1884, pp. 4 and 264; xxv, 1885, p. 286; vi, 1876, 138 (Lewis County); x, 1878, p. 138 (Fulton Lakes).

North Carolina and South Carolina.—Audubon, in 1851, stated that it was occasionally killed along the water-courses of these States. (Audubon and Bachman, *Quadrupeds of North America*, II, 1851, p. 312.) I find no reference to its occurrence here at a later date. Dr. Merriam in 1883 reported that the Panther was unknown in the Great Smoky Mountain region of Tennessee and North Carolina. (*Amer. Jour. Science*, xxxvi, 1888, p. 459.)

Ohio.—Kirtland stated, in 1838, that the Puma was formerly found in Ohio, but had disappeared. He mentions specimens in Dorfeuille's Museum in Cincinnati. (Rep't Geol. Survey of Ohio, 1838, p. 176.) Later writers do not include the species.

Oregon.—Suckley and Gibbs, in 1859, reported the Puma common in Oregon and Washington, and abundant in the mountains of the Klamath River. (Nat. History of Wash. Territory, U. S. Pacific R. R. Survey, 1859.) Mr. Hallock mentions that Pumas were numerous in Josephine County, in 1877. (Sportsman's Gazetteer, 1877, p. 138.) See also *Forest and Stream*, xxvii, 1887, p. 104 (near Puget Sound).

Pennsylvania.—Audubon stated that the Puma was abundant at the headwaters of the Juniata River in 1851. (Audubon and Bachman, *Quadrupeds of North America*, II, 1851, p. 311.) McMurtrie states that a woman was killed by a Puma in Pennsylvania in January, 1830. (Cuvier's Animal Kingdom, I, 1831, p. 115.) (See also *Forest and Stream*, III, 1874, p. 67. Berks County). Mr. Hallock states that Pumas were to be found in Cambria County, near Ebensburg, in 1877; also in Elk County, near Ridgway. (Sportsman's Gazetteer, 1877, p. 140.) Mrs. B. H. Warren writes me that

a Puma was killed in the northeastern part of the State about fifteen years ago, and adds: "It is asserted by apparently reliable persons (hunters) that a few of these are yet to be found in Cameron and Potter Counties."

Rhode Island.—No record of its occurrence in this State has been found.

South Carolina.—See North Carolina.

Tennessee.—Heywood, in his *Early History of Tennessee*, mentions the Puma as among the wild animals of the State. Mr. Hallock states in 1877 that the cane-breaks of Shelby county afforded fine grounds for hunting Pumas. (*Sportsman's Gazetteer*, 1877, p. 153.) There is a report that a Puma was killed on Wheatley's plantation, 8 miles south of Memphis, in the *Chicago Field*, XIII, 1880, p. 11. (See North Carolina).

Texas.—Common all over the State in 1880, according to Professor Cope. (*Bull. U. S. Nat. Mus.*, No. 17, 1880, p. 9.) There are specimens in the National Museum from Eagle Pass and the Brazos River, collected respectively in 1853 and 1857.

Utah.—The Puma, according to Dr. J. A. Allen, is not common, but quite generally distributed in the Great Salt Lake valley. (*Bull. Essex Inst.*, VI, 1874, pp. 43-66.) Drs. Cones and Yarrow state that they occur in eastern and middle Utah but are not numerous. (*Rept. Wheeler's Survey*, v, Zoology, 1875, p. 40.)

Vermont.—Thompson mentions a Puma killed in Manchester in 1850, and states that the species had become very rare at that time. He knew of one killed in Roxbury in 1821. (Z. Thompson, *Nat. Hist. of Vermont*, 1853, p. 38; Appendix, p. 12.) At an earlier time one was killed in Bennington. It had taken a calf out of a pen where the fence was 4 feet high. (*Williams's History of Vermont*, 1794, pp. 86, 87.) Dr. J. A. Allen saw a specimen which was killed on Pine Hill, Weathersfield, in 1867. (*Bull. Mus. Comp. Zool.*, I, 1863-1869, p. 153) A Puma was reported killed in West Wardsboro' in 1-75, and another near Brattleboro' in 1885. (See *Forest and Stream*, v, 1875, p. 300, and xxv, 1885, p. 306.)

Virginia.—A specimen was received from Capon Springs in 1850 by the National Museum. Mr. Hallock makes the very interesting statement that the Puma is found in the Dismal Swamp. I find no other reference to its occurrence in the low coast lands of the South Atlantic States, except in Florida. (*Sportsman's Gazetteer*, 1877, p. 167.)

Washington.—Dr. Cooper pronounced it very common in 1859. He mentions one captured while swimming in the Columbia River. (*Nat. Hist. Washington Territory*, 1859, p. 74.) A specimen collected by Dr. George Gibbs in 1855 was received from Fort Steilacoom by the National Museum. Dr. Suckley, in 1859, reported the species especially abundant in Cowlitz, Chehalis, and Nisqually Counties. (*L. c.*, p. 108.) There are references to its occurrence in Cedar Mountain, Black River, and White River, at recent dates. (See *Forest and Stream*, XXX, 1888, p. 308; *American Field*, XXI, 1884, p. 302.)

West Virginia.—I am in possession of a letter from Mr. W. H. Hill, of Gurley Bridge, to Mr. Randolph I. Geare, dated August 14, 1890, in which it is stated that six or more Pumas have been killed in Webster County during the last eight or ten years, and that it has been ascertained from reliable sources that Pumas now infest the wilds of the Alleghany range in the Counties of Randolph and Webster, and are also to be found in Logan County, near the Cumberland range. Individuals have also been taken in the Counties of Randolph and Greenbrier.

Wisconsin.—Laphan, on the authority of Dr. Hoy, refers to it as occurring in northern Wisconsin, in his catalogue of the animals of the State, published in 1852. (*Fauna and Flora of Wisconsin*, prepared for the State Agricultural Society, p. 339.)

Wyoming.—Dr. J. A. Allen, in 1874, writes of the Puma as follows: "More or less common in the timber of the Medicine Bow Range, as it is also throughout the timbered portions of the Rocky Mountains." (*Bull. Essex Inst.*, VI, 1874, pp. 43-66.) According to Mr. Hallock it was to be found, in 1877, in Laramie and Sweetwater Counties. (*Sportsman's Gazetteer*, 1877, p. 181.)

The Puma occurs throughout Central America* and in all parts of South America to the Straits of Magellan.†

The first mention of the Puma appears to be the remark in the letter of Columbus regarding his fourth voyage in 1502. In the narrative of his exploration of the coast of Honduras and Nicaragua he writes: "I saw some very large fowls (the feathers of which resemble wool), lions [*leones*], stags, fallow-deer, and birds.‡

There are also references to the occurrence of the Puma in North America of very early date in the narratives of Laudonnière, Hariot, Coronado, Hawkins || and others.

The Puma, regarded as a species, possesses in a remarkable degree the power of adapting himself to varied surroundings. He endures severe cold during the winter in the Adirondack Mountains§ and other parts of our northern frontier, and tracks his prey in the snow. He is equally at home in the hot swamps and canebrakes along the river-courses of our southern States.¶ In South America he inhabits the treeless, grass-covered pampas as well as the forests.** In the Rocky Mountains, as I am informed by Mr. William T. Hornaday, he ascends to the high altitudes in which the mountain sheep are found. Mr. Livingston Stone saw tracks of the Puma on the summit of Mount Persephone in California, at an elevation of 3,000 feet.†† Similarly, Darwin states that he saw the footprints of the Puma on the cordillera of central Chili, at an elevation of at least 10,000 feet.‡‡ According to Tschudi,

* For list of localities see Alston fr. Godman & Salvin's, *Biologia Centrali-Americana, Mammalia*, 1879-1882.

† Burmeister, *Description Physique de la République Argentine*, III, 1879, pp. 130-132.

‡ Hakluyt Soc., II, 1847, p. 193.

This letter was written in Jamaica, 1503, and according to R. H. Major appears to have been first published in Venice in 1505, although Pinelo and Ferdinando Columbus asserted that it was published elsewhere in Spanish as well.

|| *Mexico*.—"Here are many sorts of beasts, as Beares, Tigers, Lions, Porkepicka," etc. Coronado, *Relation of Mexico*, 1540. (Hakluyt's *Collection of Voyages*, III, 1810, p. 369.)

Florida.—"It is thought that there are lions and tygres as well as unicornes; lions especially; if it be true that is sayd, of the enmity betweene them and the unicornes; for there is no beast but hath his enemy, as the cony the polecat, a sheepe the wolfe, the elephant the rinoceros; and so of other beasts the like: insomuch that whereas the one is, the other can not be missing." (John Hawkins, *First Voyage to the West Indies*, 1562, I. c., p. 616.)

Landonnière mentions "a certaine kinde of beast that differeth from the Lyon of Africa." (Four Voyages by Certain French Captains into Florida (1561-1565), I. c., p. 369.)

Virginia.—"The inhabitants sometime kill the Lion, and eat him." Thos. Hariot. "A briefe and true report of the new found land of Virginia" (1587). (L. c., p. 333.)

§ See Dr. C. H. Merriam, *Trans. Linnean Soc.*, New York, I, 1882, p. 32.

¶ Audubon and Bachman, *Quadrupeds of North America*, II, 1851, p. 312.

** Azara, *Quadrúpedos del Paraguiay*, I, 1802, p. 120.

†† *Amer. Naturalist*, XVII, 1883, p. 1188.

‡‡ *Voyage of the Beagle*, p. 269.

the Puma is found in Peru in the highest forests and even to the snow-line (though seldom here).* A writer in the *Encyclopædia Britannica* † states that "in Central America it is still common in the dense forests which clothe mountain ranges as high as 8,000 or 9,000 feet above the sea-level."

In these different regions the Puma always selects for his abode such spots as afford some shelter, but we find him in the thickets and copses, rather than in the great forests.‡ "Those panthers that we have observed," writes one of the naturalists of the Mexican Boundary Survey, "were always found in the most solitary places, generally where there were thick bushes, and in the vicinity of rocky spots, affording caverns for secure concealment, and in which to bring forth their young."||

The Puma seeks his prey chiefly at dawn and twilight and under cover of night, but he also sometimes hunts by day. The different species of American deer are his principal quarry, but he preys also upon smaller mammals. He will even feed upon the different species of American porcupines, despite their quills, which lacerate his mouth and face.§ Audubon and Bachman state that raccoons and skunks, as well as birds, form a part of his food, and that he will eat carrion when hard pressed by hunger.¶ To this list Brehm adds the South American Coati,** Agouti †† and Paca,‡‡ and the Rhea, or American ostrich.|||| Drs. Coes and Yarrow state that in New Mexico and Arizona the Puma kills hundreds of wild turkeys and has indeed broken up many of the former breeding-places.§§ Pennant asserts that the wolf serves the Puma for prey. This is improbable. Nevertheless, he reports that there was in the Museum of the Royal Society of London the skin of a Puma which was shot shortly after it had killed a wolf.¶¶

Of the larger domestic animals, such as the horse and cow, the Puma

* *Fauna Peruana*, 1844-'46, p. 132.

† Ninth ed., xx, 1886, p. 105.

‡ Burmeister, *Description Physique de la République Argentine*, III, 1879, p. 130.

|| Kennerly, *U. S. and Mex. Bound. Survey*, Pt. II, *Mammals*, 1859, p. 6.

§ De Kay, *Zoology of New York*, Pt. I, *Mammalia*, 1842, p. 49; Merriam, *Trans. Linnean Soc.*, New York, I, 1882, p. 30.

¶ Audubon and Bachman, *Quadrupeds of North America*, II, 1851, p. 307.

** *Nasua narica*.

†† *Dasyprocta aguti*.

‡‡ *Coelogenys paca*.

|||| Brehm, *Thierleben, Säugethiere*, I, 1876, p. 382.

§§ Report, *Wheeler's Survey*, v, *Zoology*, 1875, p. 40.

¶¶ Pennant, *History of Quadrupeds*, 3d ed., I, 1793, p. 290. Jardine also mentions this skin. See *Naturalists' Library*, xvi, p. 127. Pennant states also, in the place cited, that the Puma leaps upon the moose, as well as on other wild animals, which is improbable.

attacks only the young, but he will carry away a full-grown sheep from the fold,* and not unfrequently preys upon the llama in South America.†

In the less settled portions of America the Puma has proved at times a great hindrance to stock raising.‡ Kennerly states that in Sonora, Mexico, it kills many colts and calves, and is poisoned with strychnine by the herdsmen.§ Mr. C. H. Townsend remarks in 1887: "It is practically impossible to raise colts in the Shasta County hills, California, on account of these pests. They destroy many hogs and young cattle also, but do not present so serious an impediment to the keeping of these animals as in the case of horses."|| I have recently received similar reports from other sources.

The Puma does not ordinarily attack men, but on the contrary when surprised attempts to flee from them. Nevertheless it seems probable that some individuals, when strongly pressed by hunger, or moved by other unusual circumstances, may be emboldened to make such attacks. Hensel affirms that such is the case.¶ Darwin states that he had heard of two men and a woman who were killed by Pumas in Chili.** McMurtrie mentions that a woman was killed by a Puma in Pennsylvania, January, 1830.†† That the Puma sometimes kills the hunter who has

* See Azara, *Quadrúpedos del Paraguay*, I, 1802, p. 208; Williams, *History of Vermont*, 1794, pp. 86-87.

† It appears that the Puma received permission to kill llamas from the god Coniraya. The tale of Coniraya's pursuit of the beautiful Cavillaca is thus narrated by Avila: "The god went on and met a lion, which in reply to his question told him that he was very near the goddess Cavillaca, and that if he made a little more haste he would overtake her. This good news pleased the sage, and he blessed the lion saying: 'You shall be respected and feared by all, and I assign to you the office of punisher and executioner of evil doers; you may eat the llamas of sinners, and after your death you shall still be honored; for when they kill you and take your skin they shall do so without cutting off the head, which they shall preserve, with the teeth, and eyes shall be put in the sockets so as to appear to be still alive. Your feet shall remain hanging from the skin with the tail, and, above all, those who kill you shall wear your head over their own, and your skin shall cover them. This shall they do at their principal festivals, so that you shall receive honor from them. I further decree that he who would adorn himself with your skin must kill a llama on the occasion, and then dance and sing with you on his back.'" <Narrative of Errors, False Rites, etc., of the Indians of Huarochiri, collected by Francisco de Avila. Hakluyt Soc., XLVIII, 1873. (Edited by C. R. Markham.)

‡ Burmeister, *Descr. Physique de la Répub. Argentine*, III, 1879, p. 131.

§ U. S. Mex. Bound. Survey, Pt. II, Mammals, 1859, p. 5.

|| Proc. U. S. National Museum, 1887, p. 189. See also *Forest and Stream*, XXXV, 1890, p. 312.

¶ *Fide* Brehm, *Säugethiere*, I, 1876, p. 382.

** Voyage of the Beagle, p. 269.

†† Commenting on Cuvier's statement, he remarks; "That this animal, our common panther, does not always confine itself to sheep, etc., is well known, and has lately been proved, January, 1830, by an unprovoked attack upon an unfortunate woman in Pennsylvania. The ferocious brute seized upon her as she was passing along the road, and killed her in an instant." (McMurtrie, *Cuvier's Animal Kingdom*, I, 1831, p. 115.)

wounded him is doubtless true, as any wounded animal is likely to turn upon its persecutor, but this is quite different from an unprovoked assault.*

It is the habit of the Puma to spring upon his prey from an eminence, such as a ledge of rock or a slight rise of ground. If he fails to strike his victim, he seldom pursues it for any considerable distance. In northern regions, however, he sometimes pursues the deer when they are almost helpless in the deep snow.† It was reported to Darwin that the Puma killed its prey by jumping upon the shoulder and turning the head back with its paw until the vertebræ of the neck are broken or dislocated. Azara ascribes the same habit to the Jaguar.‡

The female brings forth her young in some secluded spot. In the Adirondacks, according to Dr. Merriam, "the lair is usually in a shallow cavern on the face of some inaccessible cliff or ledge of rocks."|| "In the southern States," says Audubon, "where there are no caves or rocks, the lair of the Cougar is generally in a very dense thicket or in a cane-brake. It is a rude sort of bed of sticks, weeds, leaves, and grasses or mosses, and where the canes arch over it, as they are evergreen, their long pointed leaves turn the rain at all seasons of the year."§

From two to five young are born at a time. Bartlett states that in captivity the number is usually two, but sometimes one. Their young are reared without difficulty.¶ They are brought forth at the close of winter or early in spring in the Northern parts of the United States,|| and at the beginning of summer in South America, that is at the end of December.** The period of gestation is from thirteen to fourteen

* Catesby, in a generally judicious account of the Puma, remarks: "The smallest cur, in company with his master, will make him take to a tree, which they will climb to the top of with the greatest agility. The hunter takes this opportunity to shoot him, though with no small danger to himself, if not killed outright, for descending furiously from the tree he attacks the first in his way, either man or dog, which seldom escape alive." (Natural History of Carolina, II, 1743, p. xxv.)

† Merriam, l. c., p. 32.

‡ Darwin, Voyage of the Beagle, p. 269; Azara, Quadrúpedos de la Paragúay, I, 1802, p. 93. These statements are in a measure corroborated by reliable writers on Asiatic mammals, who affirm that the tiger frequently kills its prey in the same manner. Sterndale remarks, however, that as the attack is usually made in the evening or at night, and very suddenly, it is not easy to determine the exact manner in which the prey is killed. He mentions having seen five cattle, killed by tigers, which had the neck dislocated. (Sterndale, Mammals of India, 1884, p. 174.) Darwin saw skeletons of guanacos with the neck dislocated, which were believed to have been killed by Pumas.

|| Merriam, l. c., p. 35.

§ Audubon and Bachman, l. c., p. 311.

¶ Proc. Zool. Soc., London, 1861, p. 141.

** Burmeister, l. c., p. 118.

weeks.* The young first open their eyes when nine or ten days old. Their total length when born is from 10 to 12 inches.† Dr. Merriam is of the opinion that in the Adirondacks the Puma does not breed oftener than once in two years.‡

The age which the Puma attains in the state of nature is unknown. It may be remarked, however, that one lived in the Zoological Garden at Frankfort, Germany, sixteen years, one month, and nine days. It died from injuries received by accident, October 13, 1878.‖ Dr. W. A. Conklin states that the various species of cats live in captivity fifteen or sixteen years, but show signs of decay at twelve years.§

Authoritative writers upon the habits of the Puma in North America agree that the adults do not commonly or frequently make use of trees except when traversing precipitous cliffs or when pursued by dogs. Under the latter circumstances they do not climb into a tree, but jump upon the nearest branch, even though it be at a considerable distance from the ground.¶ Rengger, in his *Travels in Paraguay*, however, states that both the Puma and the Ocelot climb well, and that in the forest they make their flight not only on the ground, but also by springing from tree to tree.** He tells us in another place that he once saw a Puma chase a troop of monkeys through the forest by jumping from bough to bough among the trees.†† However incredible this may at first appear, it becomes less so when we consider the wonderful denseness of the South American forests, described by Humboldt and other writers.‡‡

The Puma, like the cat, has the habit of scratching the bark of trees with its claws, for the purpose of sharpening or smoothing them. Having mentioned this habit as possessed by the Jaguar, Darwin writes: "Some such habit must also be common to the puma, for on

* Dr. W. A. Conklin (in Merriam's *Mammals of the Adirondacks*, l. c., p. 35) gives ninety-one days for a female kept in captivity in the Central Park menagerie, New York. Head-Keeper Devereux Fuller reported ninety-six or ninety-seven days in the case of the Puma in the Zoological Gardens, London, in 1852. (*Proc. Committee of Science, Zool. Soc. of London*, Pt. II, 1832, p. 62.)

† Pumas living in captivity in the London Zoological Gardens bred in five instances between the years 1848 and 1867. See Selater, *Proc. Zool. Soc. London*, 1868, p. 624.

‡ Merriam, l. c., p. 35.

‖ *Zool. Garten.*, xx, 1879, p. 70.

§ *Chicago Field*, xiv, p. 67.

¶ Mr. Livingston Stone states that old hunters in California affirm that the Puma is able to jump upon boughs that are more than 20 feet above the ground. (*Amer. Naturalist*, xvii, 1863, p. 1188.)

** Rengger, *Reise nach Paraguay*, 1835, p. 203.

†† Rengger, *Säugethiere von Paraguay*. *Fide* Brehm.

‡‡ It may be observed that a writer in the *Forest and Stream* newspaper affirms that he saw a Puma climb a tree that had no limbs below thirty feet from the ground, and knew of another that climbed a straight tree with no limbs below thirty-five feet. He states, however, that both individuals were of small size. (*Forest and Stream*, xxx, 1888, p. 308. See also, pp. 289 and 512.) Dr. Merriam informs us that the kittens sometimes climb trees in play. (Merriam, l. c., p. 33.)

the bare, hard soil of Patagonia I have frequently seen scores *so* deep that no other animal could have made them."*

Many reliable authorities are agreed that the Puma does *not* ordinarily emit loud cries or screams,† but Kennerly, one of the naturalists of the Mexican boundary survey, states that on one or two occasions the cry of the Puma was heard at a distance, and Schott writes as follows: "After dark his mournful note is heard resounding through the solitudes of the deserts. The note, listened to once attentively, is apt to make a deep, lasting impression. The different native names, as pronounced in Spanish, sound very appropriately to the note, and it is likely that the cry of the animal forms the base of its names. The note itself is often several times repeated, with intervals of from two to four minutes. As night advances the cry is heard but rarely."‡ He also writes: "A Puma was killed on the Rio Bravo, between Fort Duncan and Laredo. During his struggle with the hunters and dogs he raised a terrible cry, twice or thrice, to express his rage, and perhaps also to give his family the notice of danger."|| Dr. J. A. Allen reports that he once heard the Puma's cry near his camp in Montgomery, Colorado.§ Eliot likewise states that he heard the cry of the puma at night, while camping on the St. John's River, Florida. He did not, however see the animal.¶ Darwin states that the Puma does not often utter cries. He writes: "It is a very silent animal, uttering no cry, even when wounded, and only rarely during the breeding season.**"

In captivity the Puma purrs when pleased, after the manner of the cat, and the female has been heard to utter a mewling sound.††

The flesh of the Puma is eaten by certain of the South American

* Voyage of the Beagle, p. 136. Darwin is of the opinion that this practice is indulged in for the purpose of tearing away the ragged points of the claws, and not for sharpening them.

† See Merriam, c. 1., p. 37. Audubon & Bachman, l. c., p. 311.

‡ U. S. Mex. Bound. Survey, Pt. II, Mammals, 1859, p. 6.

§ L. c.

¶ Bull. Essex Inst., VI, 1874, p. 53.

|| D. G. Eliot, Monograph of the Felidæ, 1863, p. 72. See also Suckley, Nat. Hist. of Washington Territory, 1859, p. 108.

** Voyage of the Beagle, p. 270.

†† A tame Puma was kept by Edmund Kean, the actor, as a pet. Its skeleton is now in the Museum of the Royal College of Surgeons in London. Jardine gives some particulars about this individual. "The celebrated Kean possessed one which followed him loose, and was often introduced to company in his drawing room. We have frequently been in company with the animal which served for the accompanying illustration. It was extremely gentle and playful, and showed no symptoms of ferocity to the strangers who came to see it. Its motions were all free and graceful, and it exhibited the greatest agility in leaping and swinging about the joists of a large unoccupied room in the old college of Edinburgh."

"While in London," observed Mr. Wilson, "it made its escape into the street during the night, but allowed itself to be taken up by a watchman, without offering even a show of resistance."—Naturalists' Library, xvi, p. 113.

Indians, and was likewise eaten by the natives of North America, according to Catesby.* Darwin, who tasted it himself, states that it is white in color and has the flavor of veal.† Numerous other explorers and travellers make the same comment. Azara says on this point: "I have known my peons to eat it in preference to beef, even when that meat was to be had in abundance."‡

The Puma is known under a multiplicity of English names. Among these are Panther, Painter, Congar, Catamount, Wild Cat, American Lion, California Lion, Silver Lion,§ Mountain Lion, and Tiger.

The word *Puma* is the native Peruvian name,|| according to Garcilasso de la Vega,¶ La Condamine,** Tschudi,†† and other authors.‡‡

Cougar is an English form of the word *Couguar*, which Buffon derived by abbreviation from *Cuguacu-ara*.§§ This latter word, lengthened to *Cuguacuarana*, is, according to Markgrave, the native Brazilian name.|| Azara, however, states that the ancient name, used by the Guarani

* Natural History of Carolina, II, 1743, p. xxv.

† Voyage of the Beagle, 1832, p. 116.

‡ Cuadrúpedos del Paraguay, I, 1802, p. 128.

§ According to Brehm, Thierleben, Säugethiere, I, 1876, p. 381. Kirtland, in treating of the Mammals of Ohio, recognizes two species of Puma which he calls "Mountain Tiger," and "Mountain Cat," respectively. (Geol. Survey of Ohio, 1838, p. 176.)

|| Belonging to the Quichua language.

¶ (Garcilasso de la Vega, Royal Commentaries, 1609, pt. 2, book 7. <Hakluyt Soc. Vol. XLV, p. 238.

** De la Condamine, Abridged Narrative of Travels through the Interior of South America. Read before the Acad. Sci. Paris, 1745. <Pinkerton's Coll., XIV, 1813, p. 246

†† Tschudi, Fauna Peruana, 1844-1846, p. 126. It is here spelled *Poma*.

‡‡ The word occurs in several places in Garcilasso de la Vega's work, and its meaning is explained. This is the earliest reference to it that I find, though there may possibly be earlier ones.

"Puma-tampu means a deposit of lions, composed of the words *puma*, a lion, and *tampu*, a depot." (Commentaries, Hakluyt Soc., XLI, 1869, p. 232.)

"The part of the city [of Cuzco] where the house of the Fathers of the Company of Jesus now stands was called *Amaru-cancha*, or the district of Amaru, which means a very large kind of serpent. The part where they kept the lions, tigers, and bears was called *Puma-curcu*, and *Puma-chipana*, giving the name of the lion, which they call *puma*" (l. c., II, book 5. Hakluyt Soc., XLV, p. 30).

"Next [in the palace of Yuca Mauco Ccapac in Cuzco], still following our eastern route, comes the ward called *Puma-curcu*, which means 'the beam of the lions.' *Puma* is a lion and *curcu* a beam; because they fastened the lions, which were presented to the Yuca, to large beams in that ward until they were tame and fit to be removed to the place where they were permanently kept." (l. c., II, book 7. Hakluyt Soc. XLV, p. 238.)

§§ "Le *couguar*, nom que nous avons donné à cet animal et que nous avons tiré par contraction de son nom brésilien *cuguacu-ara*, que l'on prononce *cougua-couare*. On l'appelle *tigre rouge* à la Guiane." Œuvres Complètes de Buffon, edited by Richard vol. xv, 1-26, p. 67, foot-note.

||| Markgrave, Hist. Rerum Naturalium Brasiliæ, 1648, lib. VI, p. 235.

Indians of Paraguay was "*Guazúará*. Others called it "*Yagüá-pitá*," meaning red Yagüá, or *Yagüati* meaning white Yagüá.*

The word "Painter" is a corruption of Panther. It is *unfortunate* that this latter name has gained general acceptance in the United States, since the true Panther is a spotted, Old World cat, very different in appearance from the Puma.

The name Mountain Lion is not altogether inappropriate, as the Puma somewhat resembles the female Lion in color and general form.† From the earliest days the Puma has been called the Lion (*Leon*) by Spanish Americans, and the name is still used.

The names Catamount, or Catamountain, and Wild Cat have no special applicability to the Puma. They have been used by English writers to designate the European Wild Cat (*Felis catus*) and Lynxes, and by Americans have been applied to the Lynxes of this country.

Besides those names which are in common use, there are some which have been invented from time to time by various authors, and are known to zoologists as "book-names." Buffon's name *Couguar* really belongs to this class, as do also the names Brazilian Cat (die brasilian-

*Azara, *Quadrúpedos del Paraguay*, I, 1802, p. 120. In another place, (l. c., p. 91) Azara states that the word *Yagüá* originally signified a dog. (A writer in the *Encyclopædia Britannica* says "a big dog.") At the instigation of my friend Prof. O. T. Mason, Dr. A. Gatschet has kindly given me some very interesting information regarding the word *Yagüá*. "It appears," he writes, "that *aguará* was used in the Guarani language for all quadrupeds, or at least the wild ones, the dog being *yagüá* or *aguarati*; the wolf, *agnara guacú* (the large quadruped); the fox, *aguará*; the bear, *aguará ráná*. In the cognate Tupi, *jagua* means tail, and as the initial *j* becomes deciduous, I infer that *aguará* means nothing else than 'having a tail.' Thus in Tonkawé (Texas) a large number of birds and the smaller quadrupeds are also called after their tail (*ta*) and its length or other properties."

†Some early writers, believing that the Puma was in truth the same as the Lion, were puzzled by the fact that all the skins appeared to be those of females, as they were without manes. Thus Adriaen van der Donck writes: "Although the New-Netherlands lay in a fine climate, and although the country in winter seems rather cold, nevertheless lions are found there, but not by the Christians, who have traversed the land wide and broad and have not seen one. It is only known to us by the skins of the females, which are sometimes brought in by the Indians for sale; who on inquiry say, that the lions are found far to the southwest, distant fifteen or twenty days' journey, in very high mountains, and that the males are too active and fierce to be taken." (Van der Donck, *A Description of the New-Netherlands*, 2d ed., 1656. Coll. N. Y. Hist. Soc., I, 1841, p. 167. See also De la Condamine in Pinkerton's *Collection of Travels*, etc., xiv, 1813, p. 246.)

Garcilasso de la Vega remarks of the land of the Yncas: "Lions are met with, though they are not so large nor so fierce as those of Africa. The Indians call them Puma." (Royal Commentaries, II, book 8. Hakluyt Soc., vol. XLV, 18, p. 238.)

See also Clavigero, *Hist. of Mexico*, Cullen's trans. I, 1807, p. 37.

ische Katze of Müller),* the Brown Tiger of Pennant, and the Red Tiger (*Tigre Rouge* of Barrère).†

As already stated, the Puma is called the lion (*Leon*) by Spanish-Americans, while the Jaguar is styled the tiger (*Tigre*). Early Spanish writers, however, did not always distinguish between the two, and sometimes mentioned the Puma under the name of Tiger, or used the name in some modified form, as red tiger, etc.‡ Molina states that it is called *Pagi* in Chili,§ and according to Clavigero, it was known to the Mexicans as *Mitzli*.||

The Puma is the *Felis concolor* of Linnæus.¶ This name has been adopted by subsequent authors, almost without exception. Schreber, however, has two figures of the species in his work on mammals, one of which is styled *Felis discolor***

Molina, in 1782, gave it the name of *Felis puma*,†† and Lesson, that of *Felis unicolor*.‡‡

* Müller, Linn., *Natursyst.*

† *Nouvelle Relation de la France Équinoxiale*, p. 166.

See also Pennant, *Synopsis of Quadrupeds*, German ed. by Bechstein, 1799, p. 299 (der rothe Tiger); Hall, *Vierfüßs.*, p. 533 (der grosse americanische Tiger); Aless, *Quadr.*, I, pl. 17 (*Tigre rossa*).

A note in the *Encyclopedia Metropolitana* (XIX, 1845, 62) states of the Puma: "It is sometimes called the Poltroon Tiger." Desmarest (*Mammalogie*, 1820, p. 218) also cites this name (*Tigre Poltron*), but I do not know its origin.

‡ See the last foot-note; also, Du Pratz, *Hist. de la Louisiane*, II, 1758, p. 91 (*Tigre*).

The Germans and the Scandinavians have adopted Buffon's name *Couguar*, spelled *Kugar*.

§ *Saggio Storia Nat. del Chili*, 1782, pp. 295, 296.

|| *History of Mexico*, Cullen's trans., 1807, I, p. 37; II, p. 319.

I have made no especial attempt to trace out the native North American names of the Puma, but may mention that Kennerly gives the following native names: *Chimbica* (Cochimis of L. California); *Futin* (Apache). Dr. Gatschet, however, does not find the latter word in the Apache language, but in Pinal Apache the name is *ntó-i-tcho* or *ntú-i-tchu*. *Toho* or *tehu* means great. Prince Maximilian zu Wied gives the following (the spelling is German): *Mischipischú* (Ojibway), *Ingronga* (Osage), *Ingronga-sindä* (Omaha), *Schuntü-Haschka* (Mandan) ["The long tail"], *Ihtupák-achati* (Minnitari). (*Reise in Nord Amerika*, p. 99.)

¶ Linn., *Mantissa Plantarum*, 1771, p. 522. (*Fide* Flower. There is no copy of this book in Washington.)

** Schreber's *Säugethiere*, Plate CIV, B.

†† Molina, *Saggio Storia Nat. del Chili*, 1782, p. 295.

‡‡ Lesson, *Manuel de Mammalogie*, 1827, p. 190. (*Fide* Eliot.)

ANIMALS RECENTLY EXTINCT OR THREATENED WITH
EXTERMINATION, AS REPRESENTED IN THE COLLECTIONS
OF THE U. S. NATIONAL MUSEUM.

By FREDERIC A. LUCAS,
Assistant Curator of the Department of Comparative Anatomy.

It is not, perhaps, generally realized how extensive and how rapid are the changes that are taking place in almost the entire fauna of the world through the agency of man. Of course changes have perpetually taken place in the past through the operation of natural causes, and race after race of animals has disappeared from the globe, but there is this wide difference between the methods of nature and man; that the extermination of species by nature is ordinarily slow, and the place of one is taken by another, while the destruction wrought by man is rapid, and the gaps he creates remain unfilled.

Some of the more obvious causes of extermination are to be found in the systematic killing of animals for their various products, the destruction caused by domesticated animals introduced into new countries, and the bringing of wild land under cultivation. These are the more simple and apparent destructive forces at work, and those that most directly affect the larger animals, smaller creatures being influenced by smaller causes. Thus the erection of telegraph wires, especially in sparsely wooded regions, has proved very destructive to birds, and a more deadly though more restricted source of danger is found in lofty electric lights, against which the birds dash themselves during their nocturnal migrations. The extinction of the Rytina and Great Auk, the almost complete extirpation of the Bison, and the reduced numbers of the Walrus are good examples of destruction wrought directly by the hand of man, while in addition to such cases are the still more numerous instances of the very perceptible decrease of animals once abundant. Species used for food or otherwise of economic value suffer most, fashion affects some, some are necessarily destroyed for the protection of man and his domesticated animals, and others are killed merely for sport. It has taken comparatively few years to so reduce the untold millions of the

Passenger Pigeon that the bird is now unknown in localities where it once abounded. Year by year the Halibut is growing scarcer and scarcer, and year by year the Lobster canneries find an increasing difficulty in obtaining necessary supplies, while there is already a dearth of Oysters in the once seemingly inexhaustible waters of Chesapeake Bay. The Atlantic Salmon is practically kept from extermination in the waters of the United States by the efforts of the U. S. Fish Commission, and the same is true of the Shad in many localities, while much attention is being paid to the artificial cultivation of Cod in order to preserve the inshore fisheries.*

One reason for this growing depletion is to be found in the common and fatal fallacy that because some animals exist in large numbers, the supply is unlimited and the species needs no protection, a belief that is usually acted upon until the species is verging on extinction. Unfortunately, too, those most directly interested in the preservation of game—using the term in the widest sense—are usually the most bitter opponents of any protective measures, especially if the change will produce even a temporary inconvenience. The proposed reduction in number and change in location of nets in a certain Canadian Salmon stream met with vigorous protests from the fishermen; yet, a few years after the passage and enforcement of laws making the alterations, the catch of fish had increased tenfold. Cases exactly similar to this may be met with everywhere, and any attempt to enforce a close season, allow fish free access to their spawning beds, or to protect them when there, is almost certain to meet with strenuous opposition from local pot hunters and fishermen. The Michigan pigeon-catchers insist that it does no harm to take Pigeons in the nesting season, provided traps or guns are not used *too* near the breeding places; the Potomac fishermen complain bitterly because they are not allowed the privilege of preventing all Shad and Herring from ascending to the spawning ground; and the lobster catchers and dealers object to laws prohibiting the capture and sale of Lobsters under a certain size. All this is short sighted in the last degree, and yet as previously stated, those who should be found on the side of the law are only too often arrayed against it. Fashion is principally concerned in the destruction of fur-bearing mammals and birds for millinery purposes, although alligators, crocodiles, and of late various reptiles have come into vogue for the manufacture of fancy leather, and the demand for "novelties" seems on the increase. In 1885 Pecaries were so abundant in the counties of Medina, Uvalde, and Zavalla, Texas, that their well-worn trails were everywhere to be seen, while

*During the winter of 1889-'90 about 130,000,000 eggs of Cod, Haddock, and Pollack were brought to the hatcheries of Gloucester and Wood's Holl. Previous labors of the Fish Commission are already bringing about visible results and young cod are now plentiful where they were previously scarce or even unknown.

A somewhat amusing incident was the sending of young Cod from Plymouth, Massachusetts, to Gloucester for identification, the Plymouth fisherman having forgotten what they looked like.

their favorite haunts could be readily picked out by the peculiar musky odor characteristic of these little animals. Shortly after this date, hog-skin goods being in favor, a price of fifty cents each was offered for Peccary hides, with the result that by 1890 the Peccaries had become practically exterminated.

A yearly record of the sales of some London firms would indicate quite clearly the whims of fashion, some of the present tendencies being shown by the fact that 30,000 monkey skins and 250,000 Australian "opossums" were disposed of at a single sale. Birds are auctioned off in still more extraordinary numbers and among the items of one sale were 6,000 Birds of Paradise, 5,000 Impeyan Pheasants, 360,000 assorted skins from India, and 400,000 Hummingbirds, the number of birds disposed of at this one auction exceeding that contained in all the collections, public and private, of the United States, while one dealer in 1887 sold no less than 2,000,000 bird-skins. The fashionable seal-skin sacque demands a yearly slaughter of about 185,000 fur seals, but these figures seem small when compared with those representing the catch of the plebeian hair-seals, 875,000 of these being annually killed for oil and leather.

At the principal localities where the northern Fur Seal occurs the killing is regulated by law and there is little danger of the animal being exterminated, but the southern species has been so recklessly hunted at its breeding-places on the coast of South America and in the Antarctic seas that a southern sealing voyage is now very much in the nature of a lottery, and few or no animals are now to be taken at localities that formerly yielded thousands of skins.

To supply the world with ivory for a year necessitates the death of 100,000 elephants, and if these were placed in single file they would make a procession over 180 miles long. If, however, Stanley is correct, the death of the elephant is but a portion of the price paid for ivory, of which every pound weight has cost the life of a "man, woman or child," while "every twenty tusks have been obtained at the price of a district, with all its peoples, villages and plantations."

The extermination of the buffalo over large areas of country was partly a matter of necessity in order that the land might be rendered available for stock-raising; the wolf and coyote are poisoned for the preservation of sheep, and for a like cause the Tasmanian thylacine has been hunted to the verge of extinction. Following this necessary destruction comes the unnecessary or unpremeditated but unavoidable loss caused by the domesticated animals which have replaced the original possessors of the soil. Such for example is the more or less complete extirpation of rattlesnakes that follows the introduction of hogs, and although this is a consummation most devoutly to be wished for, it is none the less a case in point.

The sentimental importation of birds by colonists is another piece of mischief, and is proving very detrimental to the interesting avi-fauna of New Zealand and the Sandwich Islands, where, as in our own country, the English sparrow is largely instrumental in crowding out native

species. The direct harm done is best seen where the smaller species, such as goats, dogs, cats, and hogs have been introduced into small islands destitute of carnivorous mammals, and where most of the birds are tame and many species ground dwellers. One of the most interesting birds now being rapidly destroyed by imported animals is the New Zealand kiwi, which is preyed upon by dogs, and especially by cats, whose small size enables them to pursue the kiwi through the dense bush of its favorite haunts, while the nocturnal habits of both bring them out in search of food at the same time. Very rarely an animal seems to learn wisdom by experience and escape destruction by change of habit, but such instances are rare, although among them is the case of the Samoan tooth-billed pigeon (*Didunculus strigirostris*) which formerly bred on or near the ground, and was so greatly reduced in numbers by cats as to be threatened with extermination. Eventually the bird took to nesting and roosting in trees and has since been gradually on the increase.

Among the larger and more striking animals whose threatened extinction is largely due to the rifle of the sportsman, is the true zebra, now confined to a small area in South Africa; and the giraffe is rapidly disappearing from the same cause. The decrease of our own large game is well known; our only parrot, the Carolina parakeet, will probably be extirpated in Florida by visitors, and the eastern pinnated grouse is restricted to the island of Nantucket, although long ago laws were framed for the protection of the "Heathen," as the compositor caused the bill to read. The clearing and cultivation of land operates directly and indirectly in a variety of ways, and is by no means an unmitigated evil to the wild animals affected by it, being fatal to some and directly beneficial to others. The larger, more dangerous, or more gregarious quadrupeds are naturally the first to disappear, but smaller animals on the contrary, and especially birds, profit by the destruction of their natural enemies and the food furnished by cultivated fields and become more numerous.

Thus in western Kansas the jack-rabbits are on the increase owing to the fact that the bounty on coyotes is two dollars while the price of a rabbit's scalp is only five cents, a difference of value that has resulted in the rapid decrease of the rabbits' natural check, the coyote. Western Kansas, too, affords another, and most excellent illustration of the direct influence of population upon the decrease or increase of the larger animals. Up to 1834 the region just mentioned was very sparsely settled, antelope were comparatively abundant and mule deer were frequently to be seen. During 1835 and 1836, under the mistaken impression that western Kansas was suitable for farming purposes, there came a tide of immigration from the east, and before the rising wave of increasing population the mule deer disappeared entirely and the antelope became extremely scarce. The country, so far as farming was concerned, having been tried and found wanting, an ebb tide of emi-

gration took place, and as the farms were abandoned by man, their former occupants again took possession, and by 1888 and 1890 antelope became not uncommon, while the mule deer appeared in localities where none had been seen for years. The felling of forests, burning over of land, and draining of swamps are the grosser factors of agriculture, and produce some of the more evident changes, but other far-reaching though indirect results follow the alterations thus made in physical character and food supply. A good example of local extermination is to be seen in the Virgin Islands, where the land mollusks were completely destroyed by the practice of burning over the land, and only dead shells remain to show their former abundance in that locality. Drainage and extended cultivation have driven many birds from Great Britain in spite of efforts to retain them, including the wild goose, crane, and bustard, while clearing away forests about the headwaters of streams has an important bearing on the decrease of trout, whose favorite spawning-grounds are thereby dried up. Other fish are destroyed, driven out, or prevented from entering streams by the pollution of water caused by sewerage and factories, by the erection of impassable dams, and, in some cases, by the sediment caused by hydraulic mining on a large scale. In fact, almost every accompaniment of civilization has some effect on wild animals. Telegraph wires kill thousands of birds on the prairies and electric lights are equally destructive in cities, and so in various ways the ranks of the wild animals are becoming rapidly thinned out. Although regret at the impending or actual extermination of a species is often purely a matter of sentiment, there is no lack of instances where the strictest utilitarian is quite as much interested as the naturalist in the preservation of a species from destruction. The pity of it is that in so many cases a small amount of protection would not only preserve for the naturalist the animals he wishes to study, but furnish the "practical" man with an additional source of wealth.

The following papers are based on some of the specimens contained in the collections of the U. S. National Museum, and their object is to note a few of the more important or interesting animals that have recently become extinct, or whose extermination seems imminent, and to show the cause of their destruction. This, in nearly every instance, is reckless slaughter by man, and although species have occasionally become extinct in recent times from natural causes, such cases are the exception and not the rule. Of necessity these accounts have been gathered from various sources, the most important of which are given, but it may be said that although so largely compilations, they contain in a condensed form information that is widely scattered, and often not readily accessible.* In many cases the works referred to contain very full bibliographies of the animals under consideration.

* I am indebted to Dr. Leonhard Stejneger for the article on the Mamo, and to Drs. Buchner and Radde for information concerning European bison.—F. A. L.

THE WEST INDIAN SEAL.

(*Monachus tropicalis*.)

Toward the end of August, 1494, the flotilla of Columbus, who was cruising among the West India Islands in the vain endeavor of finding a passage to the mythical province of Cipango, became scattered, and in the hope of catching sight of the missing caravels, the admiral came to anchor off the coast of Hayti, and sailors were sent to climb the rocky islet of Alta Vela and scan the horizon for sails. On their return the sailors came upon a band of "sea wolves" asleep on the sands, and true to the instincts of the white race immediately proceeded to kill them, which they did to the number of eight. The "sea wolves" thus rudely made acquainted with the advent of civilization were specimens of the West Indian seal (*Monachus tropicalis*), this species and its congener of the old world (*Monachus albiventer*) being the only members of the family of earless seals that dwell in warm latitudes.

The general color of the West Indian seal is umber brown, tinged with gray from the light color of the tips of the hairs. The color becomes lighter on the sides and the under surface is, in adult individuals, more or less yellowish white. The newly born young are glossy black, and the coloration varies slightly with age. As in color, so also in its osteology, the West Indian seal presents a few features suggestive of the otaries, or eared seals, while curiously enough there is an additional suggestion of that family in the animal's movements when on land. As is well known, the earless seals depend almost entirely on their fore limbs and abdominal muscles for terrestrial locomotion, the hind flippers either trailing behind or being held stiffly extended and clear of the ground. On the other hand the otaries use all four feet in walking, the body being arched so as to completely clear the ground, while the hind feet are directed outward and slightly forward. Progress is effected by drawing the hind feet up to the fore feet and thrusting these forward by straightening the body so that the seal moves slowly ahead, not unlike a gigantic inch-worm. Now while the West Indian seal does not stand on all fours, the hind feet are brought forward by curving the body upward, when straightening itself the creature pitches ahead on its breast, advancing about a foot by the operation. The teeth of this seal are very powerful and seem quite as well adapted for crushing shells as for capturing fish, though unfortunately the stomachs of all that have been examined were empty and failed to throw any light on the favorite food of the animal. Like other seals the West Indian seal can go for a long time without food, and one in the possession of a Mr. Hill died only after a prolonged fast of four months, and even then the animal was very fat. We learn from Mr. Elliott that at the fur-seal rookeries of Alaska the males go three and occasionally four months without eating, although in their case they become much emaciated. The West Indian seal is a striking ex-

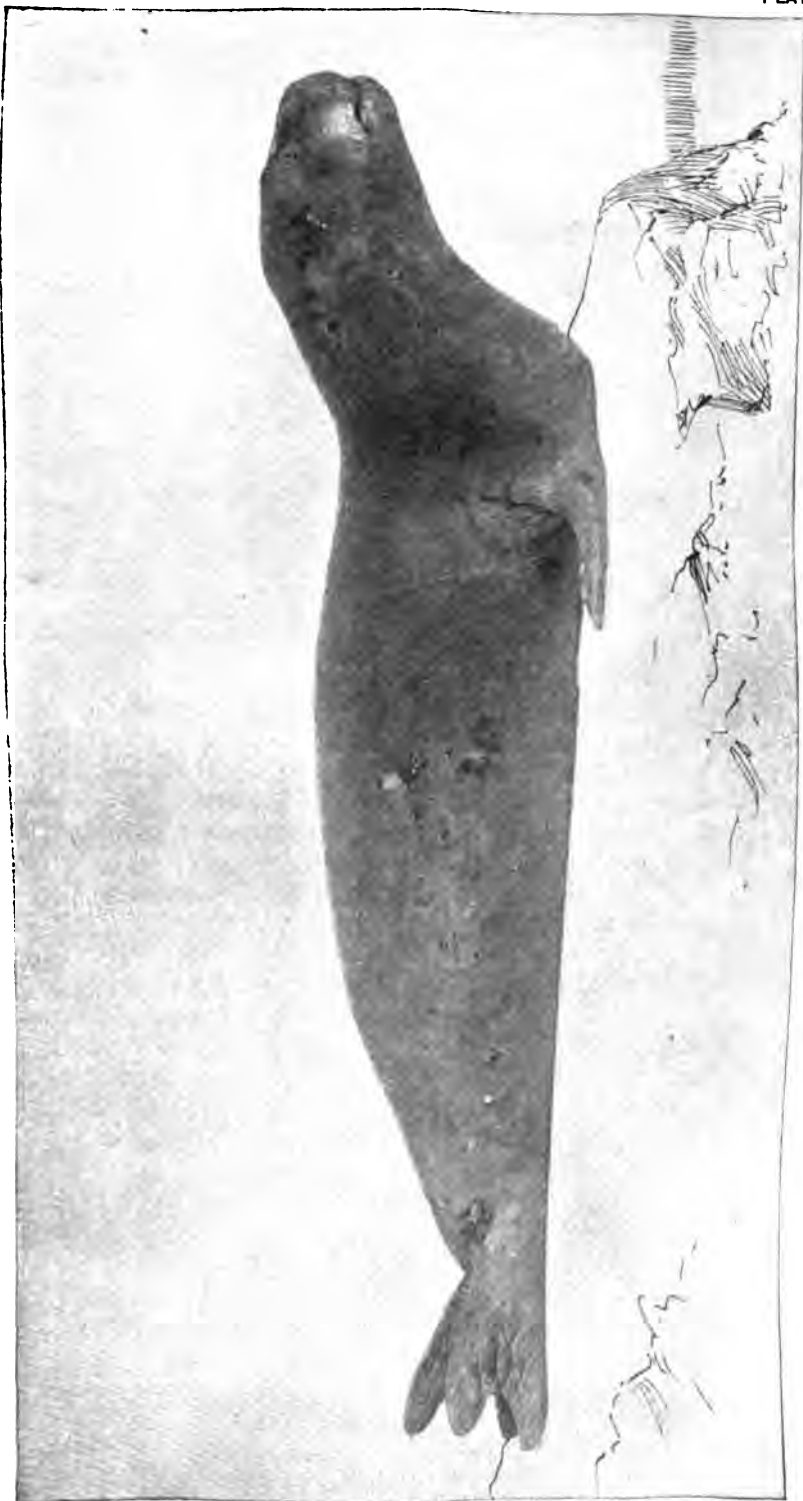

THE WEST INDIAN SEAL.

Monachus tropicalis.

(Cat. No. 18950, U. S. N. M. Cuba, 1883.)



ample of how little knowledge we may have of an animal whose existence has been known for centuries, and whose habitat is neither inaccessible nor far from the habitations of civilized man. Thus, though the discovery of this seal is almost coeval with the discovery of America, up to 1880 but a single specimen had fallen into the hands of naturalists, although for many years the animal must have been common in various portions of the Caribbean Sea and Gulf of Mexico, its range being from the Bahamas to the Gulf of Campeche. This very abundance was, however, the cause of its destruction, for the opportunity of prosecuting the seal fishery in a region where it could be carried on with comparatively little danger and throughout the entire year was too good to be neglected.

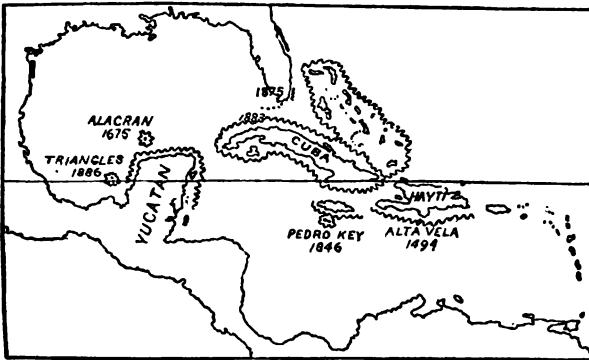

MAP 1.—Distribution of the West Indian Seal. (The irregular lines show the former range of the animal. The figures refer to the year in which seals are known to have been taken at the localities indicated.)

In 1675 Dampier notices a seal-fishery in operation at the Alacrane Islands, north of Yucatan, saying that: "Here are many seals; they come up to sun themselves only on two or three of the Islands * * * the Spaniards do often come hither to make Oyl of their Fat; upon which account it has been visited by English-men from *Jamaica*, particularly by Capt. Long: who, having the command of a small bark, came hither purposely to make Seal-Oyl, and anchored on the North side of one of the sandy Islands, the most convenient Place, for his design." Later on Captain Long discovered that although his anchorage might be conveniently located, it nevertheless possessed certain undesirable drawbacks, for one of the fierce "northers" that sweep across the Gulf of Mexico, came up and blew his bark ashore. He was, however, fortunate enough to get the vessel off, and having repaired her "went merrily away for Trist" with a full cargo of "Oyl." Sir Hans Sloane, founder of the British Museum, who visited the Bahamas in 1687-'88, wrote that these "Islands are filled with seals; sometimes fishers will catch one hundred in a night. They try, or melt them, and bring off their oil for lamps to the islands." By 1813 the seal seems to have

been pretty thoroughly exterminated and to have become mainly confined to the Pedro Kays, some low rocky islets lying about 60 miles south of Jamaica, and it was from this locality that, in the spring of 1846, the specimen was secured which was presented by Gosse to the British Museum, and, as above stated, long remained unique. The West Indian seal has been reported from time to time as occurring at Salt Key Bank, in the Bahamas, on the coast of Yucatan, and two were even taken on the coast of Florida about 1875, but not until 1883 did a second specimen find its way into a museum. This, an immature female, was taken near Havana, and through the courtesy of Professor Poey secured for the U. S. National Museum, and after a lapse of three hundred and seventy years its position among seals exactly defined (Plate XCV). In 1886 Mr. Henry L. Ward visited the Triangles, three little islets 108 miles northwesterly from Yucatan, and there found, as he had hoped, a colony of seals, from which he secured some forty specimens before a rising norther forced the party to run back to Campeche. Just how plentiful the seals are now Mr. Ward does not tell us, but at some time they must have been abundant, since the writer's father, who was at the Triangles in 1856, found quantities of skeletons and spoiled hides, indicating the recent existence of a flourishing seal fishery. Whether the West Indian seal is doomed to destruction or not is a little uncertain, for so far as food, climate, and suitable breeding places are concerned, everything is favorable to its existence, and in time it may, like the southern right whale, to some extent fill up its now decimated ranks. On the other hand, when a species has been reduced below a certain point it seems, like a stone rolling down-hill, to pursue its downward course with continually accelerated speed until the bottom is reached and the species exists no more.

AUTHORITIES.

- A Naturalist's Sojourn in Jamaica. P. H. Gosse, London, 1851. 307-314.
 On the West Indian Seal (*Monachus tropicalis*). F. W. Trne and F. A. Lucas, Smithsonian Report, 1884, Part II, 231-235. Three plates.
 Notes on the Life History of *Monachus tropicalis*. Henry L. Ward, American Naturalist, March, 1857. 257-264.
 The West Indian Seal (*Monachus tropicalis*). J. A. Allen, Bulletin American Museum Natural History, New York, Vol. II, No. 1, 1888. 1-34. Plates of stuffed specimens and skeletons.

THE CALIFORNIA SEA-ELEPHANT.

(*Macrorhinus angustirostris*.)

The California sea-elephant so nearly resembles that of the antarctic seas that one general description can easily serve for both. The sea-elephant is aptly so called, both on account of its size and because the male is furnished with a proboscis, which though short is suggestive of its namesake of the land. It is the largest of the seals, greatly exceeding the walrus, for an old male sea-elephant reaches a length of 15 to



THE CALIFORNIA SEA ELEPHANT.

Macrorhinus angustirostris.

(Cat. No. 13811, U. S. N. M. San Cristobal Bay, Lower California.)

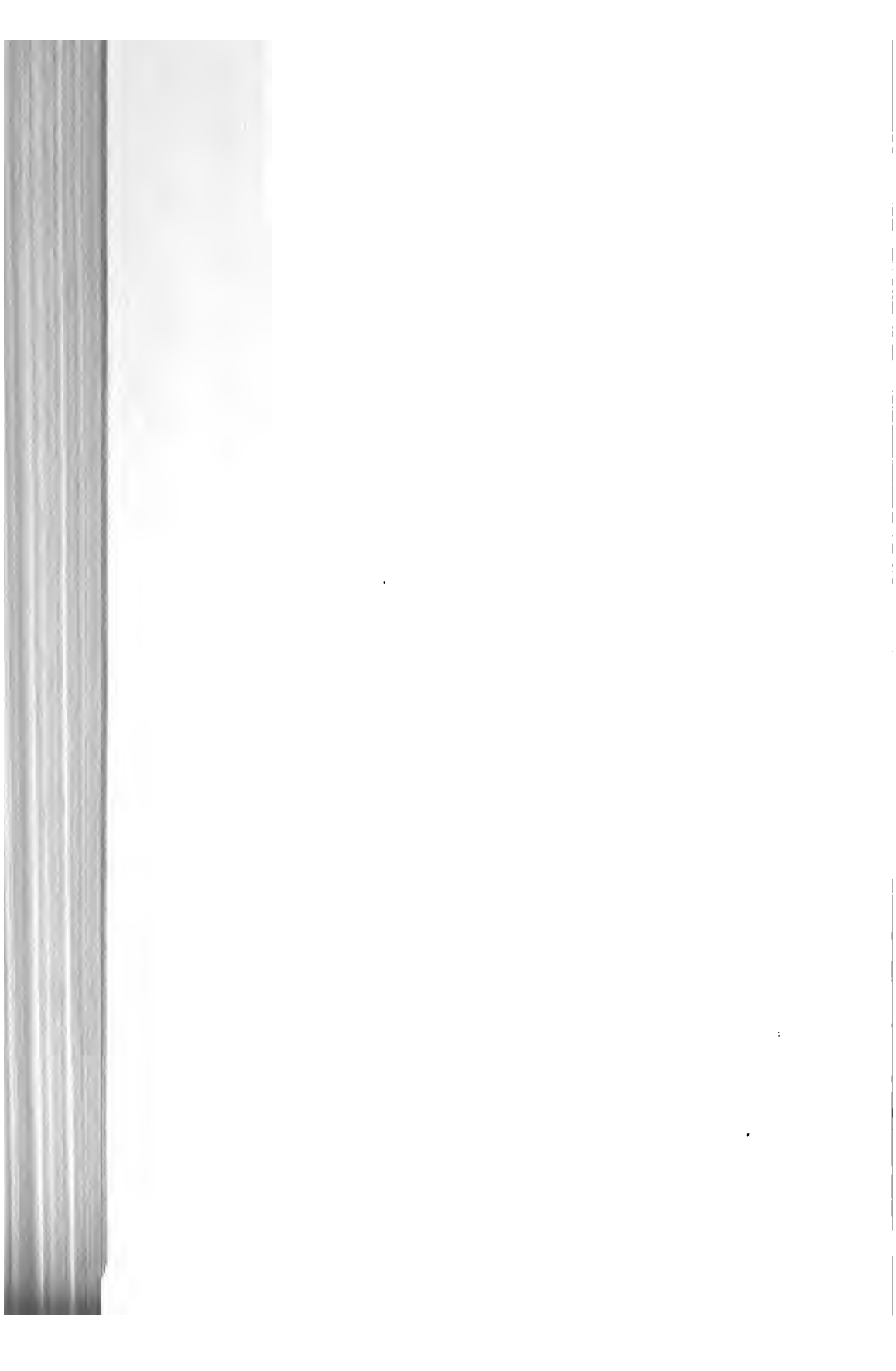

16 feet, or counting from tip of proboscis to the end of the outstretched hind flippers, a length of 20 to 22 feet. When in good condition the animal is very fat, old males attaining a circumference of 15 to 18 feet, and one of the last-mentioned size has yielded as much as 210 gallons of oil. The female sea-elephant is much smaller than the male, not exceeding 9 or 10 feet in length; the female, moreover, is destitute of a proboscis, as are also all young, this being the mark of a full grown male. The color is gray, with a blackish or olive cast, darkest on the back.*

Considering the former abundance of these animals on the California coast, very little has been recorded of their habits or habitat, but the sea-elephant appears to have ranged along the coast of California and Lower California from about latitude 25° to 35°, although in early days it may have considerably exceeded these limits. As just noted above, the other species of sea-elephant is a southern animal of wide distribution, and the nearest it approaches to the isolated northern species is on the western coast of South America. It may be that the gap now existing between these points was once filled up, and that since the disappearance of the animals at intermediate localities the northern species has become differentiated from the southern. Or, again, the California species may have originated from a few stragglers who wandered north and being undisturbed increased and multiplied. Prior to 1852 sea-elephants were extremely abundant in the vicinity of Cerros Island, where the sealers erected rough stone huts in order to prosecute their labors to the best advantage. The animals were accustomed to crawl out on certain favorite beaches, and in spite of their bulky forms and slow mode of progress ascended the ravines for a distance of half a mile or so, congregating in herds of several hundred. In such situations they fell an easy prey to the hunters whose methods are well described by Captain Scammon:

The sailors get between the herd and the water; then raising all possible noise by shouting and at the same time flourishing clubs, guns, and lances, the party advance slowly toward the rookery, when the animals will retreat, appearing in a state of great alarm. Occasionally an overgrown male will give battle or attempt to escape, but a musket-ball through the brain dispatches it, or some one checks its progress by thrusting a lance into the roof of its mouth, which causes it to settle on its haunches, when two men with heavy oaken clubs give the creature repeated blows about the head until it is stunned or killed. After securing those that are disposed to show resistance, the party rush on the main body. The onslaught creates such a panic among these peculiar creatures that, losing all control of their actions, they climb, roll, and tumble over each other, when prevented from further retreat by the projecting cliffs. We recollect in one instance, where sixty-five were captured, that several were found showing no signs of having been either clubbed or lanced, but were smothered by numbers of their kind heaped upon them.

*It is a difficult matter to accurately describe the color of seals, as under varying conditions they appear quite differently. When alive the hair is close to the body and is either wet or greasy, appearing from this cause much darker than it really is. Mounted specimens are frequently stained by grease so that the pelage has a yellowish cast. For these reasons authors disagree considerably in their descriptions of the color of these animals.

By 1860, sea-elephants had become so scarce that their pursuit was no longer profitable, and from that time up to 1880 so few stragglers were seen about Guadaloupe and San Benita Islands that the animal was currently regarded as extinct. In 1880 the schooner *San Diego* killed thirty sea-elephants at the Elephant Beach, San Cristobal Bay, on the main-land of Lower California, 50 miles south of Cerros Island. In 1882 forty were killed, and six young ones brought alive to San Francisco, one of which found its way to the National Museum by way of the Philadelphia Zoo. (Plate XCVI.) In 1883 one hundred and ten sea-elephants over a year old were taken, at least fourteen being bulls of large size. In 1884 ninety-three animals were taken by the sloop *Liberty*, a few females and young being left undisturbed, which were unfortunately all killed later in the season by the crew of the *City of San Diego*. In October of the same year Mr. Townsend, with the schooner *Laura*, visited the locality in the interests of the U. S. National Museum; but although three young were seen they were spared in the hope that their presence might induce larger animals to haul out later on. Continuing the search southward the *Laura* visited all localities in Lower California formerly inhabited by the sea-elephant, and finding none, returned to San Cristobal in December and took fifteen whose skins and skeletons made their way to the National Museum at Washington. It is quite possible that this is the end of the California sea-elephant although a few may still exist to be slaughtered later on. It is greatly to be deplored that this animal should have been exterminated, when it could so easily have been preserved by each year sparing the young and a few adults. But it is a curious fact that those most interested in the preservation of any animal are not only indifferent on that point, but are the most strenuous opponents of any measure to effect such a result, and even were it not too late to endeavor to protect the sea-elephants it is not to be supposed that they could be saved from ultimate destruction.

AUTHORITIES.

- Marine Mammals of the Northwestern Coast of North America. Charles M. Scammon, San Francisco, 1870.
 History of North American Pinnipeds. J. A. Allen, Washington, 1880.
 An Account of the Recent Capture of the Californian Sea Elephant, and Statistics Relating to the Present Abundance of the Species. Charles H. Townsend, Proceedings U. S. National Museum, 1885, pp. 30-93.

THE ATLANTIC AND PACIFIC WALRUSES.

The walrus is too well known to require even a passing description, but it may be said that although very similar in appearance the walrus of the Atlantic and that of the Pacific are distinct species, respectively known as *Odobænus rosmarus* and *Odobænus obesus*. The scarred and wrinkled appearance, so characteristic of these animals, is well exhibited by the head of the Pacific walrus shown on Plate XCVII. Al-



HEAD OF PACIFIC WALRUS.

Odobænus obesus.

(Cat. No. 18718, U. S. N. M. Walrus Island, Pribylov group, Alaska.)



though not as yet verging on extinction, the ranks of both species have been sadly decimated, and the animals have been completely extirpated in localities where they once abounded. In Europe the walrus has occasionally been met with on the coast of Scotland, and was formerly plentiful on many of the islands adjacent to the northern coast of the continent, and even along the continent itself, reaching eastward to the Lena River, in Asia. In America the Atlantic walrus formerly ranged from Nova Scotia northward to about 80 degrees, being abundant in the Gulf of St. Lawrence and occurring on Sable Island and the eastern coast of Newfoundland. The walrus was known in Europe as early as 870 to 890, and appears to have been an object of the chase on the coast of Finmark in 980, while by 1600 it was the object of a regular fishery by the English and others. In the early part of 1600 Cherie, or Bear Island, lying about 280 miles to the northward of North Cape, Norway, was the scene of operation, and many a ship load—ships were small in those days it should be remembered—of oil and ivory was obtained at this locality. The walruses were accustomed to haul out on shore, and by getting between them and the water immense numbers were killed in a short time, the bodies of those first slain being used as a barrier to obstruct the retreat of the survivors. On one occasion six or seven hundred were killed in six hours, and on another nine hundred to a thousand in less than seven hours. Naturally this abundance did not long continue, and in eight years the animals had become scarce and shy, while soon after they were completely extirpated in this locality. Farther and farther to the north, to Spitzbergen and the shores of Greenland, the hunters pursued the rapidly-diminishing herds of walruses, until the pursuit in itself became no longer profitable, and, as at present, the walrus fishery was carried on merely as an adjunct to the whale fishery. So early as 1534 Cartier mentions meeting with walruses in the vicinity of the Magdalen Islands, and it probably was not long before a regular "fishery" for these animals was established on the Island of Ramea, very probably one of the Magdalen group. In 1581 the French ship *Bonaventure*, at l'Ile Blance "slewe and killed to the number of fifteene hundred Morses or Sea Oxen, accounting small and great," and in 1593 the ship *Marigold*, in company with another vessel, sailed from Falmouth for the express purpose of hunting the walrus. The *Marigold* seems to have been well equipped, for among the crew of thirty were three coopers and two butchers, but owing to delay on the part of her consort the season was lost. An English company located on Sable Island, and at about the same time a French company was established at Miscou, Bay-Chaleur. The English company soon came to grief, but its French rival did a flourishing business as long as the walruses lasted, killing so many that years after the company and its headquarters of New Rochelle had passed away, the bones of the slaughtered animals remained in such quantities as to form artificial beaches. In those days walrus ivory seems to have been in fashion, for a note in Hakluyt tells us that

"The teeth of the sayd fishes, whereof I have seen a dry fat full at once, are a foote and sometimes more in length; and have been sold in England to the combe and knife makers at 8 groats and 3 shillings the pound weight whereas the best Ivory is solde for halfe the money." The Pacific walrus never had so extensive range as its relative of the Atlantic, reaching in scattered numbers to about 55 degrees north, on the American coast and 60 degrees on the Asiatic coast, and extending thence northwards to the limit of ice. Point Barrow on the east and Cape Schelatskoi (157° 30' east longitude) on the west seem to be the natural boundaries of the Pacific walrus, the species being unusually abundant at Bristol Bay, Alaska. The existence of the Pacific walrus was made known not far from 1640 or 1645, but it did not become a regular object of pursuit until about 1860, its immunity being due to the fact that whaling was far more profitable than the pursuit of the walrus. As the whale decreased in numbers the whalers directed their attention more and more to the walrus, and between 1870 and 1880 there was brought to market 1,996,000 gallons of oil and 398,868 pounds of walrus ivory, these amounts representing the destruction of not far from 100,000 animals. Although far inferior to elephant ivory the demand for walrus tusks is nevertheless great, and while the price per pound was, in 1879, but 40 or 45 cents, it was worth in 1880 \$1 to \$1.25 per pound, and in 1883 \$4 to \$4.50. Being rather a stupid animal, and with due caution readily approached when on the ice, under favorable conditions the walrus is slaughtered in much the same manner as the bison was killed by skin hunters. In making a shot, as it is technically termed, a man provided with one or two rifles and an abundance of ammunition approaches the herd from leeward, and picking off the more wakeful or more suspicious animals first, proceeds to kill the walrus until so many have been secured as can be handled or until the herd becomes alarmed and takes to the water. The Pacific walrus is in greater danger of extermination than its congener of the Atlantic, owing to the fact that the range of the species is restricted, while its haunts are regularly resorted to by the North Pacific whaling fleet, whose crews, as previously stated, devote considerable time to the chase of the walrus, and have reduced the numbers of this huge animal about one-half during the last ten years.

AUTHORITIES.

- Marine Mammals of the Northwestern Coast of North America. Charles M. Scammon. San Francisco, 1874.
- History of North American Pinnipeds. J. A. Allen. Washington, 1880.
- The Fisheries and Fishery Industries of the United States. Section V. Washington. 1887.



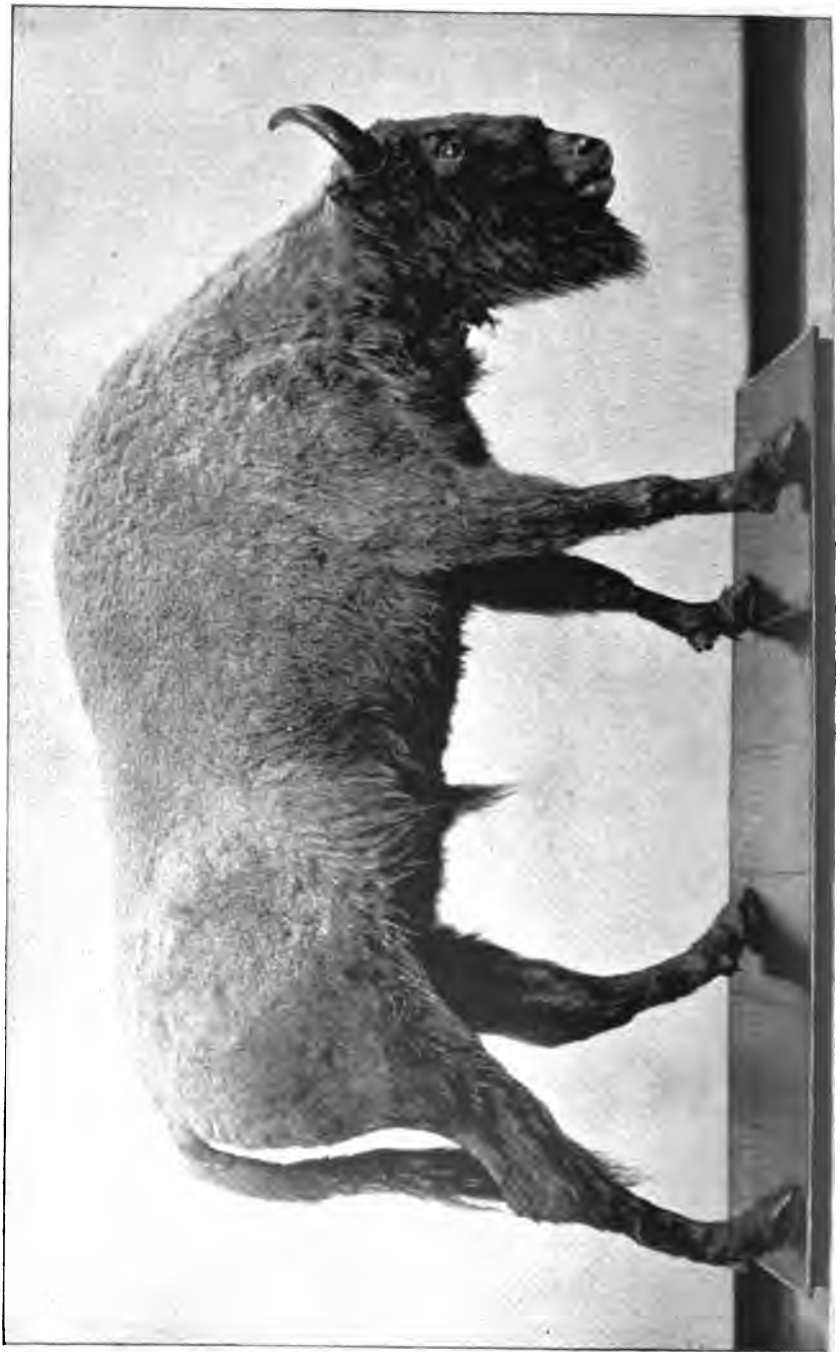

THE PHOTOGRAPH BY M. W. BROWN

THE EUROPEAN BISON.

(Bison bonassus.)

The European bison, or zubr* (*Bison bonassus*), bears a very close resemblance to its American relative, but is a little taller, not so heavily built at the fore quarters, and lacks the shaggy hair about the head and neck that gives the American bison so fierce an appearance. Although never existing in such enormous numbers as the American bison, the zubr in early days seems to have very generally inhabited the forests of Central Europe. Cæsar found the animal in Germany and Belgium, and some were brought to Rome, where they were slaughtered in gladiatorial exhibitions of the Coliseum.

The American and European bison were quite different in their habits, although this was largely due to the physical characteristics of the regions respectively inhabited by the two species, the American species preferring the open plains, where it associated in immense herds, feeding upon grass, while the European species was a forest dweller, found in small bands and living very largely on the bark and twigs of young trees. The difference in habits between the two animals is well shown by the fact that the European bison was not found on the steppes of southern Russia, although this region in many respects resembles the plains of the western and southwestern United States. At present the European bison is restricted to part of Lithuania and the more inaccessible portion of the Caucasus, this latter region being the only locality where the animal is found in a state of entire freedom. The Lithuanian herd, which has enjoyed imperial protection for many years, dwells in the Bjelowesche forest of the province of Grodno; is watched over by a large number of keepers, and is fed during the winter, while in the Caucasus the zubr is protected by the rugged nature of the region it inhabits and also by an order of the Grand Duke Michael, issued in 1860, forbidding the slaughter of the animal. The specific identity of the Lithuanian and Caucasian bison is still in dispute, but that there is at least a subspecific distinction between them seems probable, from the fact that the Caucasian animal is less thickly haired than the Lithuanian, although living at a greater altitude and exposed to a greater degree of cold.

Up to 1500 the European bison seems to have been common in Poland, where it was looked upon as royal game, and hunted in right royal manner by the King and nobility, as many as two thousand or three thousand beaters being employed to drive the game. In 1534 the animal was still so numerous in the vicinity of Girgau, Transylvania, that

* This species is commonly but improperly called the aurochs, but, as Professor Alfred Newton says, "the aurochs (= ox of yore), Latinized by Cæsar in the form of *urus*, is, or was, the *Bos primigenius*, or *Bos urus*, of scientific nomenclature.

"It is wholly by mistake that in its extinction as a wild animal its ancient name was transferred to the bison, or zubr."

peasants passing through the woods were occasionally trampled to death by startled bison, and hunts were undertaken by the nobles in order to reduce the numbers of the animals. In spite of this local abundance, it is probable that about this time the bison was in a great measure restricted to Lithuania, and although so late as 1555 one was killed in Prussia, it is almost certain that this was merely a straggler from the main herd. In 1752 a grand hunt was organized by the Polish King Augustus III, and in one day sixty bison were killed, besides a considerable quantity of other large game, the Queen, who participated, killing twenty bison, and finding time in the intervals of sport to do some light reading. This achievement was deemed worthy of commemoration by a monument, although the manner in which the battue was conducted renders the performance less remarkable than might appear at first sight. Two huge, strongly built, converging fences were erected, and just by the exit, at the apex of the gigantic V thus formed, was a platform on which the royal party sat at ease and shot the game as it emerged from the trap into which it had been driven by a small army of beaters. For some time after the above event little seems to have been recorded concerning the zubr, so that Desmarest, writing in 1822, says that if any remain in Lithuania they must be very few in number.* There were, however, over five hundred bison in Lithuania at that time, for in 1820 there was that number, this being a considerable increase since 1815, when there was estimated to be only three hundred. About this time active measures must have been taken for the protection of the Lithuanian herds, for in 1830 "owing to the better enforcement of the laws" it comprised seven hundred individuals. In 1831 a local revolt occurred, the game laws were set at naught, and the number of bison reduced to six hundred and thirty-seven. Order having been restored the bison began to recuperate, and according to the official enumeration at the end of each decade, there were in 1840, seven hundred and eighty, in 1850, one thousand three hundred and ninety, and in 1860, seventeen hundred. Political troubles, however, were the bane of the bison, and just as the prosperity of the Lithuanian herd seemed assured, the Polish uprising of 1863 took place; many bands of insurgents sought refuge in the forests; the bison were left to take care of themselves; and were so rapidly killed off, that the next official count showed only eight hundred and forty-seven. For a short time after peace was restored, the herd increased to a slight extent, but later on it began to decrease, the enumeration of 1880 showing but six hundred, a number that has since been lessened, the herd being still upon the wane. The cause of this decrease is not quite apparent, and although it has been ascribed to inbreeding, it would seem as if some other reason must be sought for, since the wild cattle at Chillingham, England, are still extant, although

*Dictionnaire Universelle d'Histoire Naturelle.

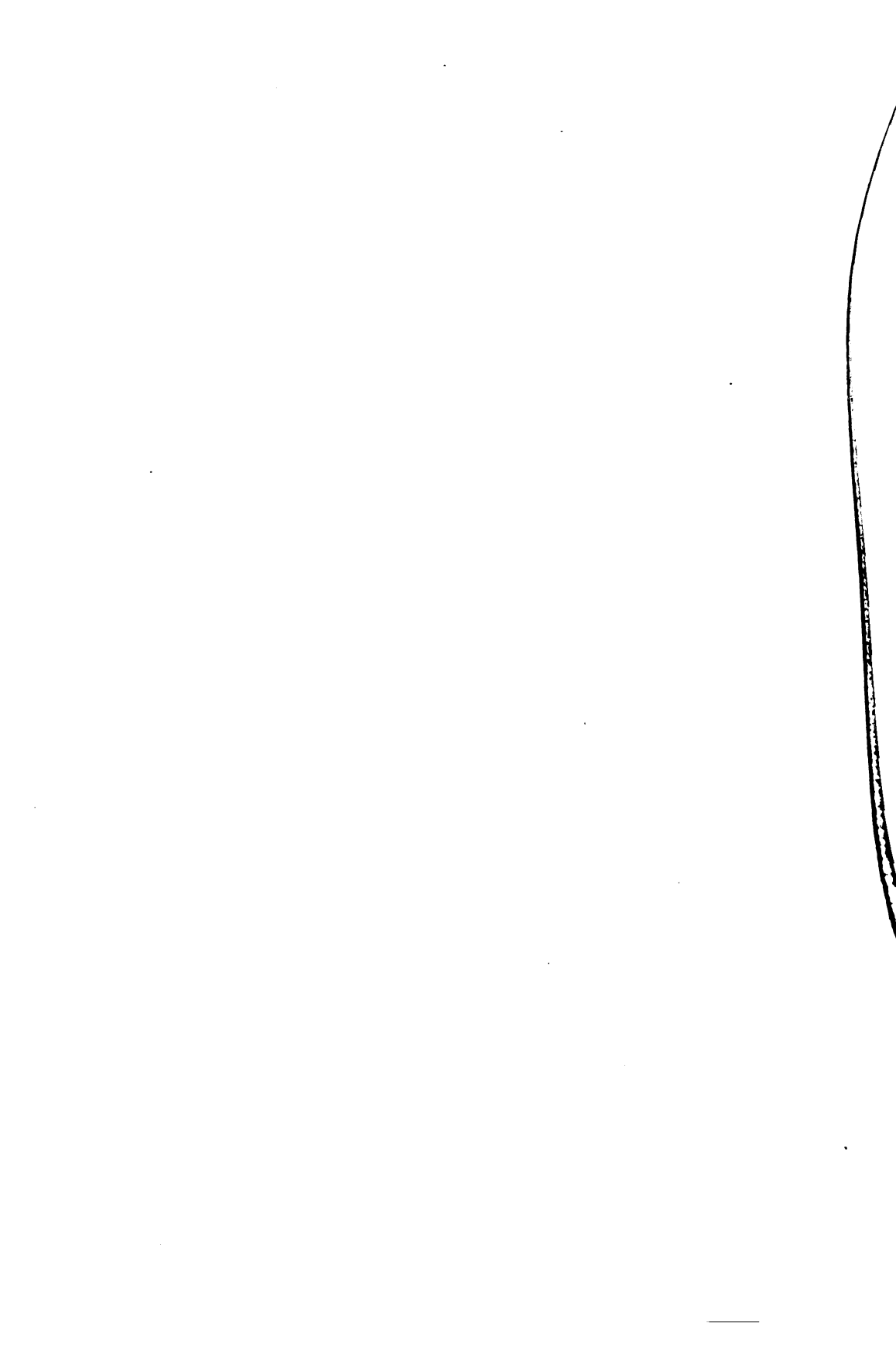



STELLER'S SEA COW.

Fylina stipes.

(Cat. No. 21063, U. S. N. M. Bertug Island. Collected by Dr. L. Stejneger.)

from the smallness of the herd they have of necessity been very largely inbred.* That inbreeding has something to do with the decrease of the bison is indicated by the observed fact that many of the females bring forth calves after having been infertile for several successive years, but although it has been suggested that this might be helped by the introduction of animals from the Caucasus, the remedy would be difficult of application as well as expensive. As the herd is, or at least was, divided into ten or twelve bands, each confined to a different part of the forest, perhaps some improvement might be effected by judiciously crossing the members of these various groups. The present rate of decrease is slow, and the Lithuanian herd will exist for many years, even if the loss is not prevented. As for the Caucasian bison, protected as it is by nature as well as by man, it may endure for centuries to come, and improbable as it once may have seemed, be in existence long years after the American bison has ceased to live even in tradition.

THE RYTINA OR ARCTIC SEA-COW.

(*Rytina gigas.*)

The extinct Arctic sea-cow or rytina, an animal nearly related to the existing Manatee and Dugong, played somewhat the same part in the exploration of the northwest coast of America that the buffalo did in the settlement of the western plains. In the autumn of 1741 Bering, returning from a voyage of discovery to the coast of Alaska, was shipwrecked on the island now bearing his name, this being the larger of two islands lying about 100 miles from the coast of Kamchatka, and known as the Commander Islands. The survivors of the expedition, who were forced to remain on Bering Island for the ensuing ten months, are frequently, though erroneously, said to have subsisted to a great extent on the flesh of the huge sirenian discovered by them, and described subsequently under the name of *Manatus gigas*. As a matter of fact, the first rytina taken by Bering's party was not killed until the 12th of July following the wreck, seal, otters, and later on, fur seals, furnishing a supply of meat.

For our knowledge of the external appearance of the rytina, its habits, and the localities it was wont to frequent, we are indebted to G. W. Steller, the surgeon of Bering's command, and an enthusiastic naturalist, who carried on his researches in spite of the privations attending a wreck, the inclemency of the weather, and the ravages of disease. As the Caribbean seal, described on a preceding page, presents the anomaly of a member of an arctic family living in the tropics, the ry-

* The Chillingham cattle are, in fact, subject to disease due to inbreeding, but this is scarcely to be wondered at, for the herd was once reduced to a single individual, a cow with calf, which proved to be a bull, and from this pair the present herd was built up.

tina offers, or rather offered, the spectacle of a creature whose relations are confined to the tropics residing in a subarctic region. In point of size the rytina far exceeded its relatives, attaining a length of from 24 to 30 feet and an aldermanic circumference of 19 or 20, weighing according to Steller's estimates 8,000 pounds. The head was very small in proportion to the body, the jaws toothless, being provided in lieu of teeth with a thick, horny pad, very similar to that covering the anterior portion of the lower jaw of the dugong. Owing to the peculiar structure of the epidermis, an exaggeration of the condition found in the manatee and elephant, the skin was so thick, rough, and wrinkled that, being dark colored, its appearance was compared by Steller to the bark of a tree. Although in places the epidermis was an inch in thickness, and so extremely hard as to necessitate the use of an axe in order to cut it, the dermis was only one-sixth of an inch thick. The rytina was gregarious, and found in herds about the mouths of streams, where it lived on seaweeds, especially on the large abundant laminarias. It was stupid, sluggish and comparatively help-



MAP 2.—Bering Island, from a map by Dr. L. Stejneger, showing the principal streams. A. Arf Island near which Pallas's cormorant is last known to have been taken. B. Spot where Bering's party wintered.

less, being unable to protect itself by diving, and occasionally washed ashore by the breakers. Inability to dive forced the rytina to seek its food in shallow water, and since the storms and ice of winter often rendered it a difficult matter to approach the shore at that season, spring usually found the animal much reduced in flesh.

Soon after the return of the survivors of Bering's party to Kamchatka, expeditions were fitted out for the purpose of wintering on the Commander Islands and hunting fur-bearing animals, the great northern sea-cow offering an abundant supply of fresh meat, a great desideratum in those days, when scurvy was one of the greatest and most common dangers encountered by navigators. The first expeditions were followed by others, the rytina being relied upon to furnish the bulk of the provisions, and vessels sailing for the northwest coast of America were also accustomed to stop at Bering Island for the purpose of laying in a supply of salted sea-cow. At that date there were no cattle in Kamchatka to furnish either fresh or salted provisions, so that the rytina was a veritable god-send to the fur-hunters who improved their opportunities to the utmost. As Dr. Stejneger has shown, it is a matter of record that between 1743 and 1763 nineteen parties of from thirty to fifty each wintered on Bering Island, while others are known to have wintered on Copper Island, and still others simply touched there for supplies. During their stay these parties lived on fresh rytina, while a large part of their occupation consisted in killing and salting down the animal for future use. Small wonder is it that a helpless creature of restricted range and slow reproduction should have succumbed rapidly to the systematic attacks of man. This slaughter of the sea-cows must have resulted in their extermination, even had it been carried on with the utmost care, but the end was hastened by the method of capture employed by the small parties of hunters who were scattered along the northern and eastern shores, and were compelled to attack and kill the huge beast single-handed. Ordinarily the rytina was taken by the harpoon from an eight-oared boat, the animal after a short struggle being towed ashore and dispatched, but the fox hunters used to cautiously approach the creature while lying in shallow water and endeavor to mortally wound it with a lance thrust. It naturally happened that comparatively few would be killed outright, the majority escaping to deep water, there to die of their wounds, and later on to drift ashore, where the body would be found by the hunters. Some, of course, would never reach the shore, while others would be recovered after such a lapse of time as to be unfit for food, the more that the rytina spoiled so rapidly that if not properly cared for within twenty-four hours after death the flesh was worthless. By 1754, only nine years after the discovery of the island, the sea-cow had become extirpated on Copper Island, and by 1763 was probably nearly exterminated on Bering Island, as from that time on records of visits to the place are rare. According to the careful estimates of Dr. Stejneger there were not more than fifteen hundred to two thousand rytinas about the island at the time of its discovery, there being hardly more than fifteen suitable feeding places, so that the work of extermination was not difficult. The last individual of the race was killed in 1767 or 1768, and although Professor Nordenskjöld imagined he had discovered evidence that a

specimen had been seen so late as 1854, the animal at that time seen by the natives appears in the light of all testimony on the subject, to have been a narwhal. Up to 1883 two skeletons, one in the Imperial Museum of St. Petersburg, and one in the collection of the Imperial Academy of Helsingfors, and two ribs in the British Museum, were all the remains of the rytina preserved in scientific institutions. At that date Dr. Stejneger visited Bering Island, influenced largely by the hope of securing specimens of this extinct sea-cow for the U. S. National Museum. This hope was fully realized, for in the course of a stay of two years, a considerable series of more or less complete skulls was obtained, besides many vertebræ, ribs, and other bones. These were buried at various depths in the sand, and were discovered by probing with an iron rod, rytina bones being readily distinguished by their greater density from those of cetaceans, that are found in the same locality.

Many bones were found at so considerable a distance from the water's edge as to suggest that the land had risen since the extinction of the rytina, a probability that was changed to a certainty by the discovery of a nearly complete skeleton far inland.

This interesting find is thus recorded by Dr. Stejneger in the Proceedings of the Geographical Society of Bremen :

Toward noon it was reported to me that the skeleton of a sea-cow had been found. Conceive my agitation, and the haste with which the spades were seized. We had to walk some distance, and when I reached the spot, I found the report confirmed. From the bank of the brook which ran from the south several ribs protruded. The brook had slowly eaten its way into the hillock of sand, and thus by degrees exposed and washed away the bones. When we began to dig, we saw at once that it was the tail end which was missing. The distance from the sea was about 500 feet, and the skeleton lay about 10 to 12 feet above high-water mark. It was imbedded in a hillock of sand, which belonged to one of the inner rows of dunes. The hillock was about 12 feet high, and the skeleton, which was lying upon its back with the head toward the west, was situated at about an equal distance from the base and the grass, covered upper surface of the hill. The sand was wet and fine, of the same kind which is still thrown up daily by the sea at the not far distant beach and showed alternating brown and blue layers. Near the bones the sand sometimes was blackish, iridescent, which was due to the fact that the bones were in a very advanced state of decomposition. This became evident to me after the first few strokes of the spade. Indeed, the skeleton as such was worthless. The separate bones had not cohesion enough to allow of their being lifted without injury, their own weight being too heavy. Even the ribs, which otherwise are of ivory-like consistency and density, had rotted throughout, and some of the bones were so soft that they felt like "green butter soap" to the touch. In order, however, to ascertain all the circumstances precisely, I continued the excavation until all the fragments had been brought to light. Altogether there were found fourteen dorsal vertebræ with the ribs belonging to them, the cervical vertebræ, the skull, the breast bone, two shoulder bones, two upper arm bones, but only one forearm. All the bones were in their natural position, with the exception of the breastbone, which lay outside of the skeleton, near the right fore-limb, while the left fore-limb, consisting only of shoulder blade and humerus, lay inside the thorax. Although none of the bones were of any use to us, nevertheless I did not look upon our labor as lost, since they enabled me to determine, in the first place, the conditions under which many of these skeletons had been destroyed, and secondly that the island had risen, since these remnants had been buried under the sand of the former shore.

Although the skeleton just referred to was unfortunately of no use as a specimen, sufficient bones were obtained to render possible the "making up" of a fairly complete skeleton. (Plate XCIX.) Unfortunately there is one point which even the extensive series of bones collected by Dr. Stejneger fails to determine, and that is the question as to whether or not the rytina had any bones in the hand. Steller, who was an exceedingly pains-taking and accurate observer, expressly states that there were none, and none have as yet been found; while, on the other hand, the bones of the fore-arm possess well defined articular surfaces showing that bones were at least present in the wrist.

With the exception of a rib from Attu no remains of rytina have as yet been found at any localities save Bering and Copper Islands, but it is probable that these were the last retreat of the survivors of a once numerous race, and that they were discovered in time for man to complete the extermination of a species that, from unknown causes, had long been on the wane.

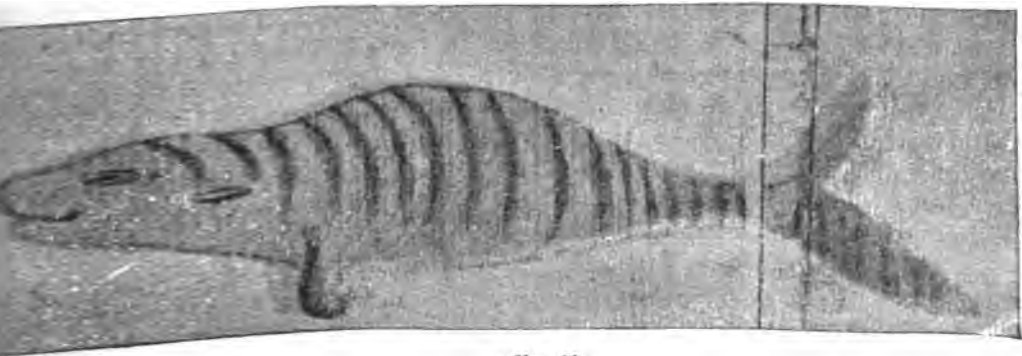

FIG. 21.

STELLER'S SEA COW.

Facsimile of figure on chart compiled by Lieutenant Waxell, navigator of Bering's party.

AUTHORITIES.

Symbolæ Sirenologicae. Joanne Frederico Brandt, Petropoli, Typis Academiae Scientiarum. 1846. E scriptis Academiae Scientiarum Imperialis Petropolitanae.
 Investigations relating to the date of the extermination of Steller's Sea Cow. Leonhard Stejneger. Proceedings U. S. National Museum, 1884, Vol. VII, 181-189.
 How the Great Northern Sea Cow (*Rytina*) became exterminated. Leonhard Stejneger. American Naturalist, Vol. XXI, No. 12, Dec. 1887, 1047-1054.

THE MAMO.

(*Drepanis pacifica* Gmel.)

It has long been expected that *Drepanis pacifica*, one of the most beautiful and peculiar birds restricted in its range to the Sandwich Islands, will have to be counted among the species which have become extinct in recent times. And now that Mr. Scott Wilson has returned from a thorough ornithological survey of the archipelago without hav-

ing obtained anything but a stuffed specimen from a local collection formed many years ago, it is almost certain that the "Pacific Sickle-bill" has disappeared from among the living, and that the few specimens in the museums, perhaps less than half a dozen, are all that is left of a species that once was common in the "Eden of the Pacific." Mr. Scott Wilson is also the first one to suggest the probable cause of its extinction, for he saw some of the celebrated feather wreaths, or "leis," of the natives composed of yellow feathers taken from this bird, and from the fact that the Hawaiian name of the bird, "*Mamo*," is the same as that of the costly war-cloaks, he concludes that the robes in olden times were chiefly wrought of the beautiful golden-yellow feathers from its back, which are much deeper in color, as they are larger and longer, than the axillary tufts of the O-o. In order to understand how probable this explanation of the final extermination of the bird is, we shall have to briefly describe these ornamental capes and cloaks. In former times the kings, chiefs, and noble Hawaiians, whenever they appeared in public on special occasions, in peace or war, donned the royal flowing capes or cloaks made of gay birds' feathers fastened to a groundwork of coarse netting, which seem to have had the same significance and to have been as eagerly coveted and highly revered as the ermine and purple in feudal Europe. Smaller ornaments, "leis," or feather-wreaths were used as neck-laces by the ladies. Perhaps the most magnificent of these robes was that of Kamehameha I, the great conqueror who united all the islands under his scepter. Mr. Scott Wilson gives the following description of it:

The fabrication of the great yellow war-cloak of Kamehameha I had been going on through the reign of eight preceding monarchs. The groundwork is of coarse netting, to which are attached, with skill now impossible to be applied, the delicate feathers, those on the border being reverted. Its length is 4 feet, and it has a spread of 11½ feet at the bottom, the whole having the appearance of a mantle of gold.*

As only a few feathers on each bird were used, it may be imagined how many thousand birds it required to furnish the feathers of a single robe, and it is a greater wonder that there were enough birds than that the species of the brighter color became extinct. Small bunches of these feathers were received by the kings as a poll-tax from the lower classes of the people, but these were not enough, so the chiefs used to have "a regular staff of bird-catchers who were expert in this vocation. They made use of the sticky juice of the bread-fruit, called in Hawaiian 'pihali,' and the tenacious gum of the fragrant 'olapa,' a common tree in some parts of the forests, smearing the stuff about the branches of a flower-covered 'ohai.'" It is asserted that the O-o (*Moho*

* The cloak deposited in the U. S. National Museum by Mr. R. O. Aulick is of precisely the same size as this, but is a trifle over one-half composed of red feathers. It was formerly the property of the powerful chief Kekuaskalami, who, on the abolition of idolatry in 1819, rebelled, with the intention of restoring the ancient religion. The rebellion was unsuccessful and Kekuaskalami killed. The cloak was presented to Commodore J. H. Aulick by King Kamehameha III in 1841.





THE CALIFORNIA VULTURE.

Pseudogryphus californianus.

(Cat. No. 103375, U. S. N. M. Jolon, Southern California.)

nobilis), a black honey-sucker, with a tuft of elongated yellow feathers under the wing, was caught alive, the feathers pulled out, and the bird then let loose, but as the body feathers of the Mamo (*Drepanis pacifica*) were the only ones to be used it had probably to be killed, and this may be the very reason why the former is still a comparatively common bird on the island, while the latter has become extinct. The Mamo was a honey-sucker remarkable for its long and curved bill, which earned for it the name "Sickle-bill," *Drepanis*. As already mentioned, it is very rare in museums—we can at present only recall four specimens—and a good description is yet a desideratum. In default of a better we reproduce the original, which was made by Latham a little over a hundred years ago from specimens brought home by Captain Cook's expedition, during which the Hawaiian Islands were discovered.

Length, 8 inches; bill, 1½ inches, stout at the base, and very much hooked; color of it brown, with a pale base; the upper parts of the body are black, except the lower part of the back, the rump, and upper tail coverts, which are of a fine deep yellow, the under parts of the body dusky; the shoulders, inner ridge of the wing, and part of the inner wing coverts are of the same yellow; the bastard wing yellowish-white at the end; the under wing coverts snow white; the sides of the vent, the vent itself, and the thighs are yellow; the tail and quills black; the legs black-brown.

This is not the only Hawaiian bird which has become extinct within historical times. A similar fate has probably also befallen *Chaetoptila angustipluma* (Peale), of which probably not more than one specimen exists besides the type which is in the U. S. National Museum, and the small tailless Rail (*Pennula ecaudata*) which is nearly as rare. But still worse, many more of the feathered tribes found only in those wonderful islands seem to be near extinction, partly because of the destruction of the forest, partly on account of the introduction of hardier and more aggressive species, such as the detested English sparrow. So gloomy is the prospect that Mr. Scott Wilson exclaims: "It would not be rash to say that ere another century has elapsed but few native species will remain."

THE CALIFORNIA VULTURE.

(*Pseudogryphus californianus*.)

The California Vulture disputes with the Condor the claim of being the largest of the New World vultures, for, while the Condor is a little the more strongly built the California Vulture has a little the greatest spread of wing, large specimens having an alar extent of a little more than 10 feet. It is more plainly clad than the Condor, the general color being brownish-black, slightly glossy above, while the conspicuous ruff of soft white feathers that encircles the neck of the great vulture of the Andes is lacking in its northern relative. The tips of the greater wing coverts are whitish, forming a line across the closed wing, and a broad band of white extends along the under side of the wing,

forming a conspicuous mark when the bird sails overhead. Plate C. This vulture formerly ranged from the Colorado to the Columbia Rivers, between the Sierra Nevadas and the sea, and is said to have been in the habit of ascending the Columbia for a distance of 500 miles in order to feast upon the abundant dead salmon cast up on the banks. While this section of country is the regular habitat of the California Vulture, individuals have been reported from Arizona, or even so far outside these limits as southwestern Utah, though these last may be regarded as stragglers. A few hundred miles more or less would, of course, be nothing to a bird of such powers of flight that it seems to float in the air with as much ease as a fish floats in water, for it would seem as if nature having assigned the vultures to do scavenger's duty had made some amends by giving them a strong and graceful flight. Like the other members of the family, the California Vulture feeds chiefly on carrion; in spite of its size and strength rarely attacking living animals, unless they have been so severely wounded as to be unable to walk, and while several have been known to combine forces and attack and kill young calves, this is very exceptional.

The strength of these birds is shown by the fact that four of them were able to drag the carcass of a young bear, weighing 100 pounds, for a distance of 200 yards, but owing to the structure of their feet and the weakness of the beak and claws their powers of offence are by no means commensurate with their size. The bird seems never to have been very abundant, and although Dr. Newbury speaks of it as common in the Sacramento Valley in 1856, he does not mention it as occurring in flocks. On the Columbia not more than two or three would be seen at a time, and although Dr. Canfield has seen as many as a hundred and fifty gathered around a dead antelope, it is probable that in this case they had assembled from over a great area—brought together by the actions of the bird who first discovered the dead animal. Soaring as they do at great heights these birds command a view over a territory many miles in extent, their keen eyes not only searching the ground below, but keeping a sharp lookout on the behavior of any of their fellows that chance to be within sight. No sooner does one bird spy a prospective dinner than another, still farther away, is apprised of the fact by his actions, and in a like manner, number two informs a third, so that the good news is rapidly spread, and throughout a vast area the vultures come hurrying to one point. It is thus that Canon Tristram accounts for the vast congregation of vultures at Sevastopol during the Crimean war, supposing that in this manner "may have collected the whole race from the Caucasus and Asia Minor."

The threatened extermination of the California Vulture is indirectly, rather than directly, due to the agency of man, for its suspicious nature has ever rendered this bird difficult to capture, while the breeding places are in out of the way and often inaccessible localities, and although the Mexican miners of Lower California are said to kill the bird

on every possible opportunity in order that they may use the quills as receptacles for gold dust, the destruction thus caused would naturally be but small. The free use of strychnine in ridding the cattle ranches of wolves and coyotes has caused the disappearance of this bird, which has been poisoned by feeding on the carcasses prepared for the four-footed scavengers. The California Vulture is now extremely rare, and in spite of many efforts to obtain specimens of this interesting bird few have been taken of late years, those few coming from southern California, which now seems to be the chief habitat of this Vulture.

THE DODO AND THE SOLITAIRE.

(*Didus ineptus* and *Pezophaps solitaria*.)

What the brahma is among domestic fowls the dodo was to a far greater extent among the order of pigeons, a grotesque, aberrant, and gigantic member of the group. The first mention of the dodo* is in an account of the voyage of the Dutch Admiral Jacob Cornelius Van Neck to Mauritius in 1598. The dodo is there called Walckvogel, or disgusting fowl, partly on account of the toughness of portions of its flesh and partly because even the best portions of the dodo were poor in comparison with the tender meat of the abundant doves. This curious bird was found only in Mauritius. Another closely related species, the

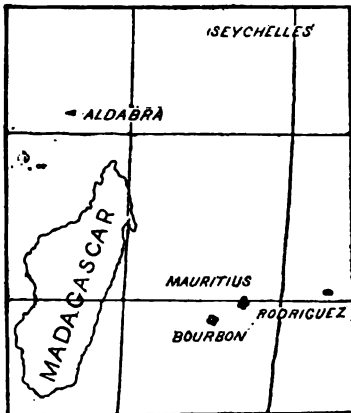

MAP 3. - Distribution of didine birds.

Solitaire of Leguat (*Pezophaps solitaria*) was found in Rodriguez, and probably a third member of the family at Bourbon, this last species being known only from the description of travelers, for not even a bone of it has ever come under the ken of naturalists. This peculiar distribution of didine birds is analagous to that of the Galapagos tortoises, although not quite so extraordinary, since the islands of Mauritius, Reunion, and Rodriguez are much farther apart than are those of the Galapagos Archipelago, and the chance of animals being accidentally transported from one to another consequently much less. Mauri-

* From the Portuguese Doído, a simpleton.

tius, Rodriguez, and Reunion had also their respective species of large tortoises, but these too went the way of the dodo and its kindred, and only bones remain to tell the story of their former abundance. De Bry, the chronicler of Van Neck's voyage, says the Walckvögel were "bigger than our swans, with large heads, half of which is covered with skin like a hood. These birds want wings, in place of which are three or four blackish feathers. The tail consists of a few slender curved feathers of a gray color."

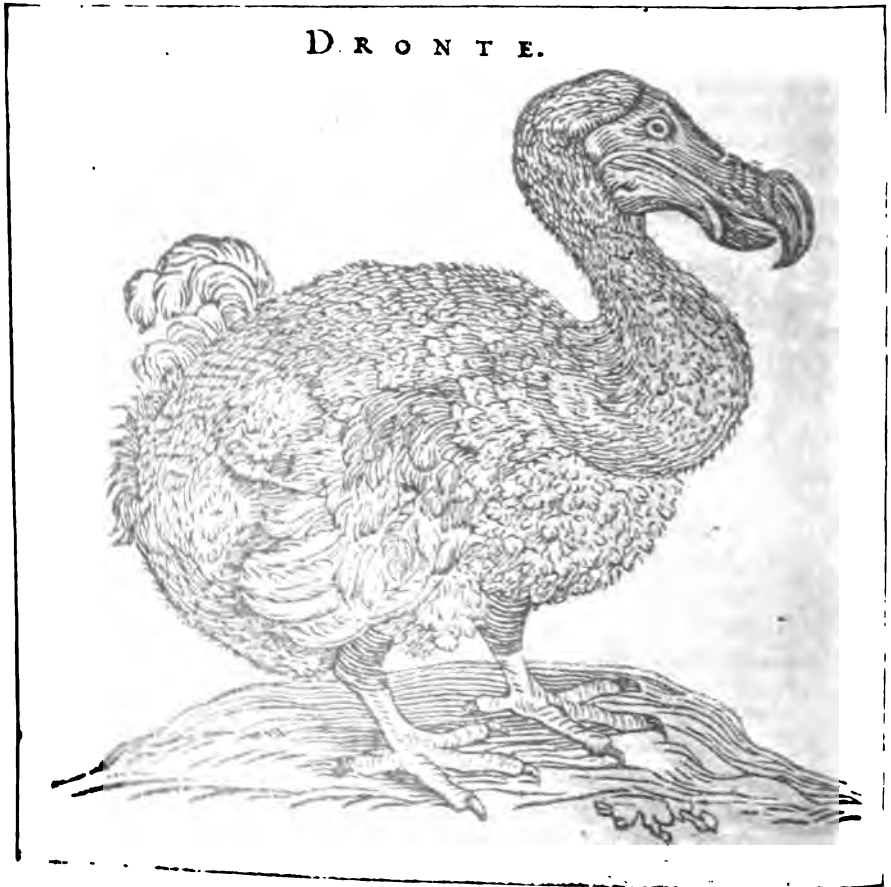

FIG. 22.

Facsimile of Piso's figure of the Dodo.*

* This figure was probably made from one of Savary's paintings, and is found on page 70 of an appendix to a work by Gulienus Piso.

The title is as follows: *Gulieni Pisonis Medici Amstelædamensis de Indiæ Utriusque Re Naturali et Medica, Libri Quatuordecim: Quorum contenta pagina sequens recitatur Amstelædami Apud Ludovicum et Daniëlen Elzevierios. AD CIO IOCLVIII. Jacobi Bontii Medici Civitatis Bataviæ Novæ in Java Ordinarii Historiæ Naturalis et Medici Indiæ Orientalis. Libri Sex. Liber quintus, Caput xvii, p. 70 De Dronthe, alias Dodæ avis.*

For a better idea of the appearance of the dodo we are indebted to the pictures of Roelandt Savary and his nephew Johu, Dutch artists of the first half of the 17th century, from whose paintings* we gather that the dodo was a heavy-bodied, short-legged bird, with a disproportionately large head, and huge, formidable-looking hooked bill. The body was sparingly clad in loose feathers, the wing feathers alone being stiff, the tail resembling a small feather duster. The general color, as noted by De Bry, was gray, or blackish, but the breast seems to have been brown, and the wings and tail yellowish, or dirty white. The bird, so Cause tells us, laid a single egg "the size of a half-penny roll, in a nest made of herbs heaped together," the somewhat indefinite size ascribed to the egg being qualified later on by comparison with that of the great white pelican (*Pelecanus onocrotalus*), which it was said to resemble in size. Not being acquainted with mankind the birds of Mauritius, like those of other uninhabited islands, were at first extremely tame, but the dodo seems to have been not only unsuspecting but stupid into the bargain, a fact that rendered its extermination all the easier. It appears to have been customary upon the discovery of any new and edible animal, to give thanks to Providence and straightway proceed to slaughter the creature, but in the case of the dodo the thanks were omitted, although the exterminating process was at once begun.

Although the discoverers of the bird seem to have thought poorly of its gastronomic qualities, and indeed it would hardly compare favorably with doves, tortoises, turtles, and the abundant fishes of Mauritius, the next vessel to reach this isle of plenty made sad havoc with the unfortunate dodos. This was the ship of one William Van West Zannen, who stopped there in 1601, and seems to have made things very lively for all living creatures. He writes that "The dodos, with their round sterns (for they were well fattened), were also obliged to turn tail; everything that could move was in a bustle; the fish which had lived in peace for many a year were pursued into the deepest water pool." One day Zannen's crew took twenty-four dodos, on another twenty, "so large and heavy that they could not eat any two of them for dinner." The abundance of game is shown by the fact that five men not only captured twenty dodos in a day, but also some thirty other birds,† and with a good supply salted down, Van Zannen sailed away. Other Dutch ships followed in Van Zannen's wake, feasted on tortoise and dodo, and, salting down a store, departed, leaving the ranks of the dodos sadly depleted. The last notice of the living Dodo occurs in a

* These were made from birds brought alive to Holland.

† This day's work seems to have inspired the chronicler's muse, for he records it in a four-line poem, translated by Dr. Strickland:

"For food the seamen hunt the flesh of feathered fowl.
They tap the palms, the round-sterned dodos they destroy:
The parrot's life they spare, that he may scream and howl,
And thus his fellows to imprisonment decoy."

"A coppey of Mr. Benj. Harry's Journall when he was chief mate of the Shippe Berkley Castle," which shows that he was in Mauritius in 1681 and saw "dodos, whose flesh is very hard." In 1693, a little less than a century after its discovery, the bird seems to have become extinct. For Leguat, the careful describer of the solitaire, makes no mention of the dodo, and moreover remarks that ducks, coots, and turtles of all kinds were then become rare. While man began the work of extirpation it is quite likely that his allies, cats, dogs, and pigs, completed the task, for wherever these animals have been introduced and run wild they have wrought sad havoc among the feathered race by destroying their eggs and young.* The cat and dog are said to be largely responsible for the rapid decrease of the New Zealand kiwi, and when the curious nocturnal bird passes out of existence it will, in great part, be due to the attacks of those two animals. Shortly after the dodo became extinct the Dutch, who had so far been the occupants of Mauritius, left the island and in 1715 the French took possession, only to give place to the English in 1810, one result of these various changes being that all knowledge of the quaint and curious bird was so utterly lost as not even to live in tradition, while the few specimens preserved in museums were so little known that some naturalists became skeptical as to the previous existence of such a bird as the dodo.

The publications of Duncan, Broderip, and Strickland, however, speedily dissipated the slight haze of doubt, and in 1866 Mr. George Clark of Mauritius, succeeded in obtaining a considerable series of bones, a portion of which served Mr. Owen for his memoir on the osteology of the dodo. These bones were procured from the mud at the bottom of a small marsh, known as the Mare aux Songes,† lying about a quarter of a mile from the sea. (Plate CI.) At the beginning of the present century this marsh, as well as the land immediately about it, was still covered with large trees whose fruits had doubtless formerly served the Dodo for food, and in this spot the bird seems to have lived and died in peace, for none of the bones are cut or gnawed, and here it leaves its remains for the benefit of future naturalists. Curiously enough this is the only place in Mauritius where bones of the Dodo have been brought to light, although various other localities have been tried in the hope of coming upon relics of this interesting bird.

The Solitaire (*Pezophaps solitaria*), while presenting a general likeness to the Dodo, was somewhat more lightly built, and had decidedly longer legs and neck and a smaller beak. For a knowledge of the external appearance and habits of the Solitaire we are entirely dependent on the account of Francois Leguat, who in 1691 founded a colony at Rodrigues, which endured only for the brief space of two years, owing to the

* Dr. Strickland considers runaway slaves to have been the principal agents in the work of destruction, for, hiding in caves and forests, they would have found in the flightless birds just the prey they would have liked.

† *I. e. Marais aux Songes*, songe being the local name of *Calidium esculentum*.



TIBIAS.

1. TIBIA OF SOLITAIRE (*Pezophaps solitarius*). (Cat. No. 18246, U. S. N. M.)
2. TIBIA OF DODO (*Didus ineptus*). (Cat. No. 18243, U. S. N. M.)
3. DOMESTIC TURKEY (*Meleagris gallopavo*).



fact that Leguat seems to have not thought of providing wives for his colonists. While Leguat's description has been quoted and requoted, there is no other source from which information may be drawn, and it must once more be used.

He writes:

Of all the birds in the island the most remarkable is that which goes by the name of the Solitary, because it is very seldom seen in Company, tho' there are abundance of them.

The feathers of the Males are of a brown grey Colour; the Feet and Beak are like a Turkey's, but a little more crooked. They have scarce any Tail, but their Hind-part covered with Feathers is roundish, like the Crupper of a Horse; they are taller than turkeys. Their neck is straight and a little longer in proportion than a Turkey's when it lifts up his Head. Its Eye is black and lively, and its Head without comb or cop. They never fly, their Wings are too little to support the weight of their Bodies; they serve only to beat themselves, and flutter when they call one another.

They will whirl about for twenty or thirty times together on the same side, during the space of four or five minutes. The motion of their Wings makes then a noise very like that of a Rattle; and one may hear it two hundred paces off. The Bone of their Wing grows greater toward the Extremity, and forms a little round mass under the Feathers, as big as a Musket Ball. That and its beak are the chief Defense of this Bird. 'Tis very hard to catch it in the Woods, but easy in open Places, because we run faster than they, and sometimes we approach them without much Trouble. From March to September they are extremely fat, and taste admirably well, especially while they are young. Some of the Males weigh forty-five Pounds.

Though these Birds will sometimes very familiarly come up near enough to one, when we do not run after them, yet they will never grow Tame. As soon as they are caught they shed Tears without Crying and refuse all manner of Sustenance till they die.

When these Birds build their Nests, they choose a clean Place, gather together some Palm-Leaves for that purpose and heap them up a foot and a half high from the Ground, on which they sit. They never lay but one Egg, which is much bigger than that of a Goose. The Male and Female both cover it in their turns, and the young which is not able to provide for itself in several Months, is not hatch'd till at seven Weeks' end. All the while they are sitting upon it they will not suffer any other Bird of their Species to come within two hundred Yards round of the Place; But what is very singular, is, the Males will never drive away the Females, only when he perceives one he makes a noise with his Wings to call the Female, and she drives the unwelcome Stranger away, not leaving it till 'tis without her Bounds. The Female does the same as to the Males, and he drives them away. We have observ'd this several Times, and I affirm it to be true.

The Combats between them on this occasion last sometimes pretty long, because the Stranger only turns about, and do's not fly directly from the Nest. However the other do not forsake it till they have quite driven it out of their Limits. After these Birds have raised their young One, and left it to itself, they are always together, which the other Birds are not, and tho' they happen to mingle with other Birds of the same Species, these two Companions never disunite. We have often remarked that some Days after the young one leaves the Nest, a Company of thirty or forty brings another young one to it, and the new fledg'd Bird, with its Father and Mother joining with the Band, march to some bye Place. We frequently followed them, and found that afterwards the old ones went each their way alone, or in Couples, and left the two young ones together, which we call'd a Marriage.

This Particularity has something in it which looks a little Fabulous, nevertheless, what I say is sincere Truth, and what I have more than once observ'd with care and Pleasure.

Through the efforts of Professor Alfred Newton and his brother Edward a large collection of bones of the Solitaire was obtained from Rodriguez in 1866, these remains forming the basis for a very complete account of the osteology of the bird. These bones were procured from caves, but owing to the impossibility of securing intelligent supervision, little can be said concerning their probable age, except that they seem to long antedate the settlement of the island. It is interesting to note that the wing bones corroborate Leguat's description of the Solitaire, for they show the presence of a rounded callosity at the angle of the wing, just about the size of an old fashioned musket ball.

AUTHORITIES.

The Dodo and its Kindred. H. G. Strickland and A. G. Melville. London, 1846.
 Article Dodo, Alfred Newton. Encyclopædia Britannica, volume VII, ninth edition.

On the Osteology of the Solitaire or Didine Bird of Rodriguez. Alfred and Edward Newton: Philosophical Transactions of the Royal Society of London, 1869, p. 327-362.

THE LABRADOR DUCK.

(*Camptolaimus labradorius*.)

The Labrador Duck was one of the many sea ducks which, during their southern migration, furnished considerable sport to gunners along the coast. In size and appearance it was not unlike the familiar Old Wife, or Quandy (*Harelda glacialis*), to which, indeed, it is nearly related. The body and primaries of the male are black, the rest of the wing, head and neck white, with a black collar and longitudinal stripe on the crown. (Plate CII.) The female is plumbeous gray, slightly darker on the under side. This duck ranged southward in winter to the coast of New Jersey and Chesapeake Bay, its summer habitat and breeding ground being, according to Audubon, southern Labrador. It is hardly no means impossible, however, that the empty nests ascribed to the Labrador Duck may have been those of the Eider (*Somateria Dresseri*), if they were found on the breeding grounds of that species, and are said to have resembled them in shape and size. While the Labrador Duck seems to never have been very common, it was not sufficiently rare to attract the notice of collectors, and hence a very small number of specimens, about thirty-six, are in existence. Considerable interest is attached to two of these specimens in the U. S. National Museum, as they were collected by no less a person than Daniel Webster, and figured by Audubon. Webster was an enthusiastic sportsman, and his home Marshfield, close by Brant Rock, was one of the best localities for shooting on the coast of Massachusetts. The ducks in question, however, came from Vineyard Island. The bird, so Audubon tells us, was frequently for sale in the markets of New York and Baltimore, and according to the same authority, a "bird stuffer" of Camden, New



THE LABRADOR DUCK. (Male.)

Camptolaimus labradorius.

(Cat. No. 61800, U. S. N. M. Collected by Daniel Webster and figured by Audubon.)



Jersey, used to take them like fishes on a long line baited with mussels. When interest in ornithology became more general, and collectors and collections multiplied, it soon became evident that the Labrador Duck was extremely rare, and it is now believed to have become entirely extinct, no example having been taken since December, 1878. It is a little difficult to understand why the Labrador Duck should have disappeared, for the bird was possessed of good powers of flight, bred in comparatively unfrequented localities at the north, and, as just stated, was not especially sought after. Some epidemic may have swept off the greater part of the race, but this is purely supposititious, as nothing of the kind is known to have occurred. That epidemics do occur among birds is shown by Dr. Stejneger's account of the Pelagic Cormorant (*Phalacrocorax pelagicus*) of the Commander Islands, thousands upon thousands of which died during the winter of 1876-'77, so that masses of dead birds covered the beach all around the islands. As this bird formed an important article of food during the time of year when the fur seal is not slain, fears were entertained by the residents of the island that the bird might become extinct, like Pallas Cormorant. But although the birds were scarce during the summer of 1877, their numbers have since increased, although they have never attained their former abundance. A possible cause for the original depletion may have been the taking of eggs by the Indians, for the Eider, which breeds along the southern coast of Labrador, suffers severely from their depredations. A small dog is trained to hunt through the bushes near the water's edge, the favorite nesting place of the Eider, while his master silently paddles along close to the shore to note just where a bird is driven from the nest, and in this manner many eggs are taken. Now if the Labrador Ducks bred over a comparatively small extent of country, near the summer camp of a band of Indians, their original decrease would be readily accounted for. Dr. Stejneger has so clearly shown (*Stand. Nat. Hist.*, Vol. IV. Birds, p. 151) how the extinction of this or other species might have come about that the account is here quoted in full:

It seems to be a fact that when a migratory species has reached a certain low number of individuals, the rapidity with which it goes towards extinction is considerably increased.

Two circumstances may tend toward this result. We know that when birds on their migrations get astray, having lost their route and comrades, they are nearly always doomed to destruction, that fate not only overtaking single individuals, but also large flocks to the last member.

If the safety of the wanderers, therefore, greatly depends upon their keeping their correct route, the safety decreases disproportionately the scarcer the species become, since, if the route is poorly frequented, the younger and inexperienced travelers have less chance of following the right track, and more chance of getting lost, and consequently destroyed. The fewer the individuals, the more disconnected become the breeding localities, the more difficult for the birds to find each other and form flocks in the fall. Finally the number will be reduced to a few colonies, and the species, consequently in danger of extinction, and a casualty, which, under ordinary circumstances, would only affect a fraction of the members, now may easily prove fatal to the remainder of the species.

We need only suppose that during one unfortunate year nearly all the broods were destroyed by inundations, fires, or frost, to perceive what difficulty the few birds left in the autumn would have in wending their way without getting astray.

We know that the proportion of birds returning in spring is comparatively small and the flocks are considerably thinned down.

Under the circumstances presumed, there will hardly be birds left to form flocks. But birds used to migrate in flocks do not like or can not travel alone; hence they are forced to follow flocks of allied species, which may take them to localities far from their home. In that way a few scattered pairs may survive, and breed here and there, a number of years after the rest are destroyed, and such are probably the few Labrador Ducks which have been captured occasionally during the last twenty years or more.

There is a possibility that a few such pairs may be in existence, but, however hardy, their fate is sealed, and perhaps not a single one will get into the hands of a naturalist.

AUTHORITIES.

The Birds of America. John James Audubon, 1840-1844.
Standard Natural History, Vol. IV. Birds. Chenomorphæ, p. 151. L. Stejneger,
Boston, 1885.

THE GREAT AUK.

(*Alca impennis.*)

The Great Auk, or Garefowl (*Alca impennis*), was the largest member of the Auk family, distinguished not only by its size, but by its flightlessness, enjoying the proud distinction of being the sole bird of the northern hemisphere incapable of flight. The name by which the Great Auk was originally and commonly known in America was Peruvian, and the southern birds, now known by that title, did not receive this appellation until many years after. Garefowl is of Scandinavian origin, and comes to us by way of western Scotland.

In color the Great Auk much resembled its lesser relative, the Razorbill, the head, neck, and back being black, and the under parts white. A peculiar mark of the bird was a large white spot in front of the eye, one old writer with a greater love of the marvelous than of truthfulness stating that this spot was found on the right side only. The wings, although far too small to sustain the bird in the air, formed an admirable pair of oars, the Great Auk being a most expert swimmer and diver, and performing even longer migrations than many of its relatives that were endowed with the power of flight. (Plate CIII.) Many, possibly all, of the Auk family use their wings quite as much as their feet for propulsion under water, and they may literally be said to fly beneath the sea as well as over it. It has been noted that the inability of the Great Auk to fly was due to lack of development of the bones of the forearm and hand, the humerus being proportionately as long as in other Auks. This modification of structure was directly correlated with the aquatic habits of the Garefowl, for the resistance of water being vastly greater than that of air, a wing especially adapted for subaquatic flight would



THE GREAT AUK.

Alca impennis.

(Cat. No. 57338, U. S. N. M. Eldey Island, off the coast of Iceland.)



demand less surface and more power than a wing formed for aerial locomotion. In the case of the Great Auk this demand was met by shortening the outer portion of the wing, while other birds that use their wings in diving obtain as far as possible the same result by only partially opening their wings.

The Great Auk was confined to the North Atlantic, ranging on the European side from Iceland to the Bay of Biscay, and on the American from Greenland to Virginia, these localities marking the extreme limits of the bird's migrations.

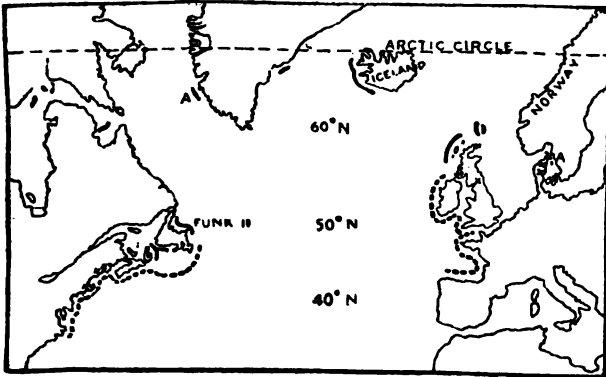

MAP 4.—Distribution of the Great Auk. The heavy, black line shows the summer habitat, and the interrupted line the winter range of the species. A, localities where specimens have been taken, but where the occurrence of the bird was probably accidental. X, places where remains of the Great Auk have been found in shell heaps.

Greenland was the habitat of the Garefowl to a very limited extent, and the same may be said of the coast of Norway, while the southern limits given above were reached only during the winter migrations of the bird. The positively known breeding-places were few in number, those where the bird bred abundantly, being the Garefowl Skerries off the coast of Iceland and Funk Island on the Newfoundland coast. These islands, or more properly islets, were very similar in their general character, being isolated rocks, lying at some distance from shore and difficult of access. Of course the reason for this similarity is apparent. The Great Auk and its eggs formed desirable articles of food, and since the bird was helpless on land, it was easily captured, whence it came to pass at an early date that the bird was exterminated at all localities easy of access. Another and more important factor in the extermination of the Auk, especially in America, is to be found in the gregarious habits of the bird and its predilection for certain breeding-places. This habit of the Garefowl is shown by other birds which are restricted to their breeding habitat without any apparent reason, although there may be some unknown cause in the nature of food-supply that might account for it. A good example of this is found in the Gannet, which, although a bird of powerful flight, breeds at only three localities on the eastern coast of America, and in Europe crosses the North Sea to nest in Scot-

land, when localities seemingly quite as favorable exist along the shores of Norway. There were apparently plenty of suitable breeding-grounds for the Great Auk in Maine and Labrador, but had the bird bred in small colonies at localities scattered along this wide expanse of territory, would have been in existence to-day.

The most important European breeding place of the Great Auk was an islet 25 miles off Reykjanes, Iceland, where, for many years, it had a somewhat precarious existence, several times seeming to have been so reduced in numbers that expeditions in search of birds and eggs were not worth the risk. Still the bird would have existed in that locality many years longer than it did, but for volcanic disturbances in March, 1830, during which the Geirfuglasker sank beneath the sea, compelling the existing Great Auk to seek new-breeding places. Most of them appear to have moved to an islet by the name of Eldfuglasker, and this being near the coast and more accessible, the few remaining Great Auks were in the course of fourteen years all killed, the last pair being taken about the 3d of June, 1844, this being the last authentic record of the Great Auk in Europe. It was from this locality that most of the skins now extant were obtained, only one mounted specimen being recorded from American localities, although nearly all the skeletons have come from Newfoundland. The history of the Great Auk in America may be said to date from 1534, when, on May 21, the boat's crews from Cartier's vessels landed on Funk Island, and, as they are told, "In lesse than halfe an hour we filled two boats full of them, as if they had bene stones. So that besides them which we did use for fresh, every ship did powder and salt five or sixe barreles of them." The Great Auk having thus been apprized of the advent of civilization, the regular manner, continued to be utilized by all subsequent visitors. The French fishermen depended very largely on the Great Auks to supply them with provisions; passing ships touched at Funk Island for supplies; the early colonists barreled them up for winter use, and the great abundance of the birds was set forth among other inducements to encourage emigration to Newfoundland. The immense numbers of Great Auks may be inferred from the fact that they withstood these drains for more than two centuries, although laying but a single egg, and consequently increasing but slowly under the most favorable circumstances. Finally some one conceived the idea of killing the Great Auk for their feathers, and this sealed its fate. When and where the scheme originated, and how long the slaughter lasted, we know not, for the matter is rather one of general report than of recorded fact, although in this instance circumstantial evidence bears witness to the truth of Cartwright's statement that it was customary for several crews of men to pass the summer on Funk Island solely to slay the Great Auks for their feathers. That the birds were slain by millions; that their bodies were left to molder where they were killed; that stone pens were erected and that for some purpose frequent and long continued fires were built

on Funk Island, is indisputable. This locality has been but thrice visited by naturalists, the last time in the summer of 1887, by a party from the U. S. National Museum, who, by the aid of the U. S. Fish Commission, were enabled to obtain much information in regard to this interesting spot, and to make very extensive collections of remains of the Great Auk. Just when the Great Auk ceased to exist in America is unknown, for there were few naturalists on this side of the water when the Garefowl was being done to the death; but the extinction took place not far from 1840, almost coincidently with the extermination of the bird in Europe. Few birds have received more attention than has the Great Auk since it became extinct, and it has been the subject of numerous papers, both popular and scientific, while its remains bring extravagant prices whenever chance brings them into the market. The last skeleton sold brought \$600, the last skin \$650, while an egg brought \$1,250, and then was resold for the round sum of \$1,500.

AUTHORITIES.

- The Garefowl and its Historians. Alfred Newton. *Natural History Review*, 1865; pp. 467-488.
 Relics of the Great Auk. John Milne. *London Field*, March 27; April 3 and 10, 1875.
 The Great Auk or Garefowl. Symington Grieve. *Edinburgh*, 1885.
 The Expedition to Funk Island, with Observations upon the History and Anatomy of the Auk. Frederic A. Lucas. *Report U. S. Nat'l Mus.*; 1887-'88; pp. 493-529.

PALLAS' CORMORANT.

(*Phalacrocorax perspicillatus*.)

Pallas' Cormorant was the largest of its family, and with rich plumage and crests, presented a striking appearance. Above and below it was of a deep, lustrous green with blue gloss on the neck, and rich purplish

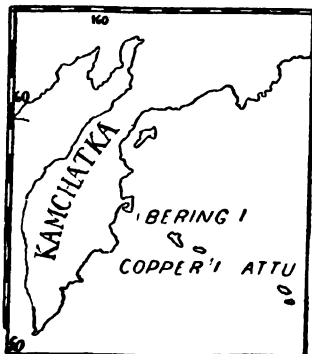

MAP 5.—The distribution of Pallas' Cormorant.

on the scapulars. Long, slender, straw-colored feathers were interspersed through the plumage of the neck, and the shafts of the tail feathers were white.

The specific name of *perspicillatus*, spectacled, was bestowed upon the bird of Pallas on account of the broad ring of bare, white skin surrounding the eyes. So far as is known, the bird was found only on Bering Island, where it was discovered by Steller in 1741, at the time of Bering's unfortunate shipwreck, when the bird was largely used for food by the survivors.

The known history of Pallas' Cormorant is extremely brief, and has been so well recorded by Dr. Stejneger in the Proceedings of the U. S. National Museum for 1888, that one can not possibly do better than to quote his account. Omitting the technical portion, it is as follows:

It seems as if the very causes which terminated the existence of the Great Auk worked the same result in Pallas' Cormorant, and it is even probable that if the latter at some early period, also inhabited the other Aleutian Islands, as is most likely, volcanic eruptions may have played a rôle in this drama as well as in that of the Great Auk. True, the latter was entirely deprived of its power of flight, but it is evident both from the measurements of the skins as well as of those of the bones, given below, that the wings of the cormorant were disproportionately small. Steller speaks of its great bulk of body and its weight, which varied between 12 and 14 pounds, so that one single bird was sufficient for three starving men of the shipwrecked crew.

With this bulk it combined an unusual "stoliditas," but it is pretty clear that this stupidity, which made them such an easy prey, was due more to their slowness of locomotion on land and in the air than to any special temperament or dullness of intellect. The natives of Bering Island inform me that the meat of this species was particularly palatable compared with that of its congeners, and that, consequently, during the long winter, when other fresh meat than that of the cormorants was obtainable, it was used as food in preference to any other. In brief, all the circumstances combined to make short work at exterminating this bird at its last refuge, for there is no evidence that it has ever been found during historical times in any other locality than Bering Island. The result was that Pallas' cormorant, which was found by Steller and his shipwrecked comrades on that desolate island in 1741, and which at that time—that is, before man ever visited its rocky shores—occurred there in great numbers, "*frequentissimi*," as Steller says, became extinct in about one hundred years from its discovery. The history of this bird forms an interesting parallel to that of the great northern sea-cow (*Rytina gigas*).

Up to 1837 or 1839 Steller seems to have been the only naturalist who had seen this bird, for, although naming it in his Zoographia, all Pallas knew of the species was derived from Steller's observations, whose description he merely quotes. It is, then, safe to conclude that it was not among the many water birds collected by Billings' expedition, which brought such rich spoils home from the Kuriles and the Aleutian Islands, but which did not touch at Bering Island. In the above mentioned year Captain Belcher, with the *Sulphur*, visited Sitka, and was there presented by Kupriannoff, the Russian governor, with one of the specimens of this bird in his possession. This specimen is evidently the one now in the British Museum, while the others went to the St. Petersburg Academy, from which one was again secured by the Leyden Museum. Although obtained from the governor in Sitka, there is nothing to indicate whence came the specimens; but inasmuch as Bering Island at that time belonged to the administrative district of Sitka, at which port all the furs were received from that island before being shipped to Europe; all vessels from Bering Island consequently first stopping at Sitka, there is every probability that the specimens in question were collected on that island.

During my circumnavigation of Bering Island I landed on September 1, 1882, at Pestshanij Mys near the northwestern extremity of the island. Ascending the steep

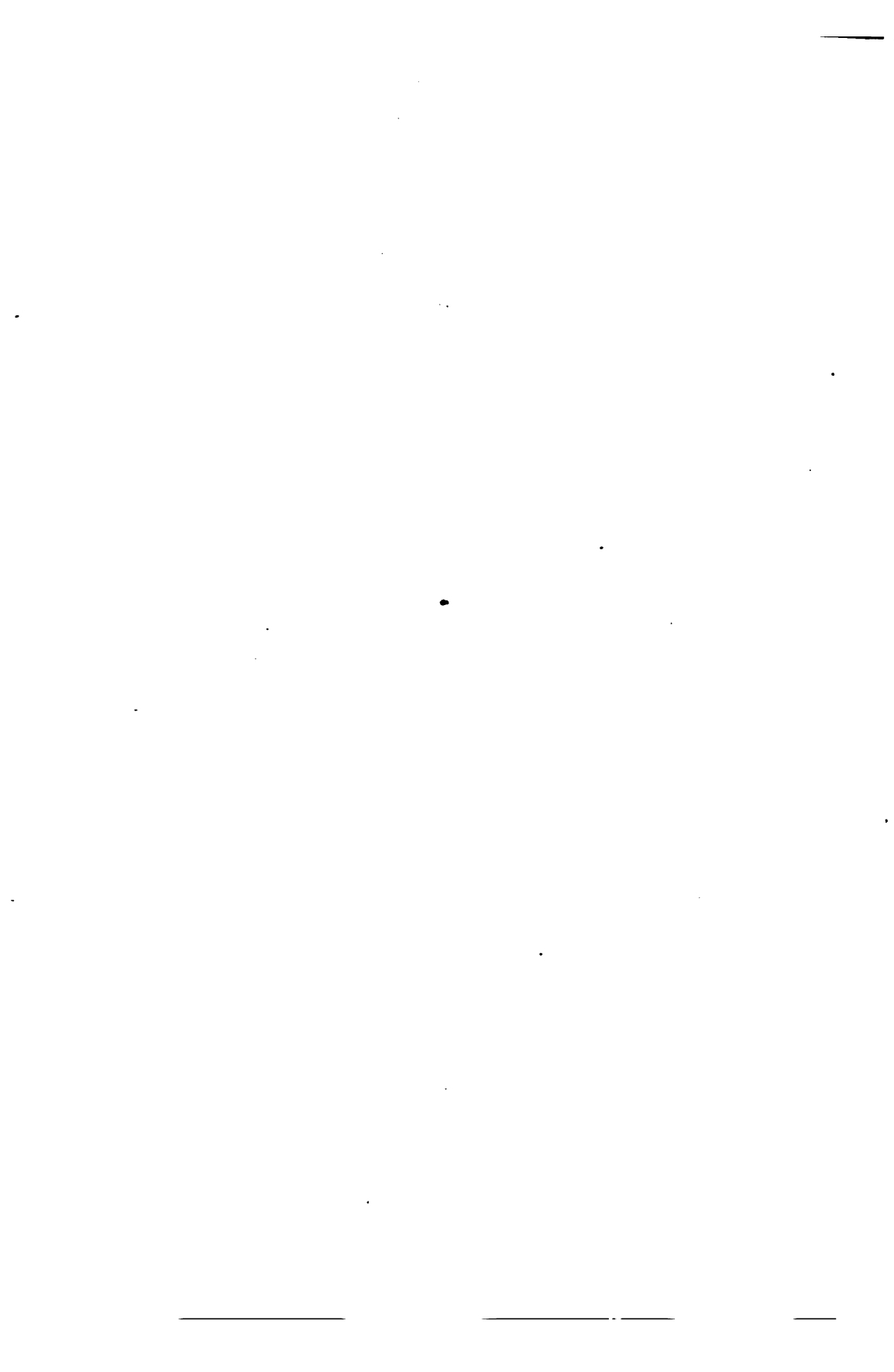

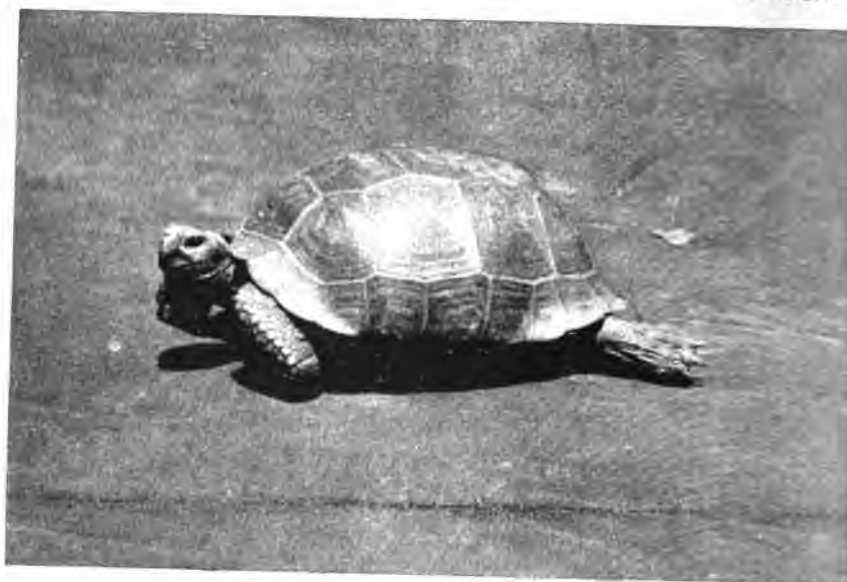

GALAPAGOS TORTOISE

Testudo nigrata

(Duncan Island? From living specimen in the National Zoological Park. Collected by the U. S. Fish Commission steamer *Albatross* in 1888.)

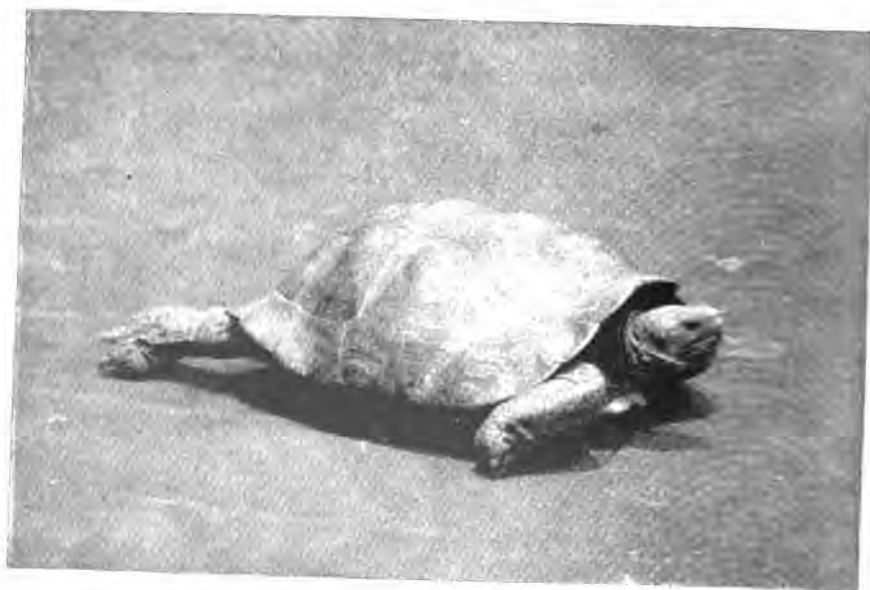

GALAPAGOS TORTOISE.

Testudo lephorhynchus

(Albemarle Island) From living specimen in the National Zoological Park. Collected by the U. S. Fish Commission steamer *Albatross* in 1888.)

coast escarpment which is here about 35 feet high, I found near the edge of the terrace a rather extensive deposit of bones of various mammals and birds arranged in thin layers of sand and sod alternating. The average thickness of the deposit was about 2 feet, and the present area covered in the neighborhood of 600 square feet, though it was evident that it was formerly of much greater extent, the ocean having encroached upon the land and carried away great portions of the terrace. The bones were in fairly good condition, some of the smaller and delicate ones even excellently well preserved, and none of them showed signs of violence. There were bones of the Arctic Fox, the Sea Otter, the Sea Lion, and other species of seals, as well as various kinds of water birds. Among the latter a particularly large pelvis of a *Phalacrocorax* at once attracted my attention, and as I had had Pallas' Cormorant on my mind since I started from Washington, I was not slow in concluding that I had to do with the bones of this bird. Had I had time to dig out the whole deposit I should probably have obtained more bones, but with the above suspicion I did as much digging and collected as many bird bones as the circumstances would allow.

The bones thus obtained, twenty-three in number, are the only portions of the skeleton known to science, all that now exists of Pallas' Cormorant being four mounted specimens and a handful of bones. There is a slight possibility that Pallas' Cormorant may yet be found about some of the small, uninhabited islands towards the western end of the Aleutian chain, but this is merely a possibility and nothing more.

AUTHORITIES.

Standard Natural History, Vol. iv. Birds. Steganopodes, p. 191. L. Stejneger.
Contribution to the History of Pallas' Cormorant. Leonhard Stejneger and Frederic A. Lucas. Proceedings U. S. National Museum, Vol. xii, pp. 83-94.

THE GALAPAGOS AND MASCARENE TORTOISES.

The Galapagos Archipelago, which comprises fifteen small islands, lying directly on the equator, was so christened by the Spaniards of the sixteenth century on account of the abundance of great, black tortoises (*galapago*) found there. (Plate CIV.) These turtles, of which there are several closely related species inhabiting various islands of the group, are typical land-tortoises of the genus *Testudo*, characterized by a high, arched carapace, and club feet. The nearest relatives of the Galapagos tortoises are found in the island of Aldabra, to the north and west of Madagascar, and in the Seychelles (see map 3), whither they were introduced from Aldabra. There were—the past tense is painful—closely allied species inhabiting the Mascarene Islands, but these were long since “eaten off the face of the earth by gluttonous man” and the place thereof knoweth them no more. The same fate is impending over the Galapagos tortoises, and sooner or later they will live only in the name of their former abiding place.

The Galapagos tortoises and their allies present a doubly interesting instance of the peculiar geographical distribution of animals. Not only are they as a group confined to small islands remote from one another and from the continent, but, with one exception, each species of tortoise is restricted to a single island.

In the case of the Mascarene tortoises this is not so singular, as Mauritius, Bourbon, and Rodriguez are some distance apart; but the Galapagos tortoises inhabit islands most of which are in sight of one another, and some separated by only 8 or 10 miles of sea.

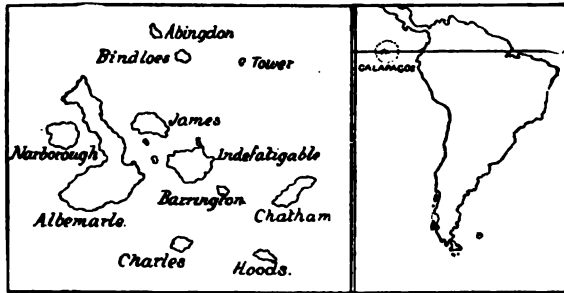

MAP 6.—The distribution of Galapagos Tortoises.

The exception noted above to the rule that a given island possesses but a single species of tortoise, is Albemarle Island, which has two, but in this instance the island is divided by lava streams whose broken irregular surfaces present impassible barriers to such creatures as tortoises. It is unfortunate, in view of the interest attached to the subject, that the exact locality of many of the tortoises brought from the Galapagos Islands should be unknown, the more that unless the problem of their distribution is soon settled it never can be. Dr. Gunther enumerates six species, the first two of which are certainly known to have come from the islands assigned to them, two are in a measure conjectural, and two are unknown. Three, probably four, species are in the collection of the U. S. National Museum, but in this case a little uncertainty hangs over the exact locality they came from, owing to the fact that several were obtained at Chatham Island, whither they were brought from other islands of the archipelago. One very large individual, however, was obtained at Abingdon Island, where the tortoises are probably extinct, the weathered skeleton having fortunately been preserved in a tolerably complete condition. The Galapagos tortoises are vegetable feeders, living largely on succulent cactus, which serves the double purpose of food and drink. They are very fond of water, and although seeming to thrive on the smaller islands which are without springs, make long pilgrimages to reach the wells on the upper portions of the large islands. Although the tortoises travel day and night while on these journeys, owing to their proverbially slow rate of speed (three or four miles an hour) it requires two or three days to make the trip. Regular roads, similar to those that would be made by a low-bodied cart, branch out from the springs in every direction, leading from them to the coast, and it was by following up these well-traveled paths that the Spaniards first discovered the watering places. These tortoises are currently reported to be totally deaf, and Porter

records that they took no notice even of the report of a gun, while Darwin states that they seemed quite unaware of any approach from the rear, but would draw in their extremities with a loud hiss as soon as they saw him. Dampier, who visited the Galapagos group in 1680, was perhaps the first to publish an account of the tortoises that supplied him with fresh provisions, as they did many a mariner after him, these creatures being indeed ideal live stock for sailors' purposes, requiring little care and no food, yet existing on this diet for three or four months. Dampier does not tell us from what islands he obtained his tortoises, but in his time they must have been abundant throughout the entire Archipelago. Occasional mention is made of the Galapagos tortoises by vessels which stopped there for provisions and water, and many more touched there without putting their visits on record. In 1813 Porter, of the celebrated *Essex*, who visited the islands for the purpose of way-laying British whaling vessels, obtained tortoises abundantly on Hoods, Marlborough, James, Charles, and Indefatigable Islands, but although only shells and bones were seen on Chatham Island, the tortoises must still have been numerous there, since they still exist in that locality. Porter was the first to note the fact that differences existed between the tortoises from the various islands. In 1835, during the now famous voyage of the *Beagle*, Darwin found the tortoises still numerous on Chatham, Charles, and James Islands, although he notes that the numbers had been much reduced, owing to quantities taken by the whalers and by parties from the mainland, who visited the islands for the purpose of salting tortoise meat and making oil from the fat. H. M. S. *Herald* in 1846 reported the tortoises extinct on Charles Island, and in 1875 Captain Cookson says that only a few individuals were left on Chatham Island, and that they were much lessened in numbers on Hood, James, and Indefatigable Islands, although plentiful in Albemarle and Abingdon. Small wonder that the ranks of these slow-growing, slower-paced reptiles should be getting thinned out, when we read that vessels have taken away as many as seven hundred at one time, and that the crew of a frigate captured two hundred in a single day. Of course these figures are exceptional, yet prior to 1870 as many as forty or fifty whalers annually visited the islands, stopping there some time and carrying away a hundred or so of tortoises when they departed, the number thus taken from Charles Island alone being estimated at 6,000, the total number from all the islands reaching several millions.

In 1829 the Government of Ecuador established a penal colony on Charles Island, whose members relied principally upon the tortoises to keep them in fresh meat and the orchilla* gatherers, who visit the

* The Spanish name for the orchilla weed (*Rocella tinctoria*), a widely distributed species of lichen, from which a purple dye is obtained.

The lichen formed a portion of the food of the tortoises, and it is rather interesting that, having first aided in their increase, it should later on prove an important factor in their destruction.

islands annually, count upon these animals to furnish them with a large proportion of their supplies.

The manufacture of tortoise oil must be credited with having caused the destruction of large numbers of tortoises, and as late as 1875 Captain Cookson found a party of seven engaged in its preparation on the island of Bemarle. In twelve months they had made 3,000 gallons, a quantity that probably represented an equal number of tortoises, though 5 or 6 gallons have been obtained from unusually large and old animals, the average yield is about 1 gallon. Dogs, too, introduced by the colonists, have played their customary rôle in the extirpating process, chiefly by destroying the young tortoises, which they watch for and devour as soon as hatched, but also by killing animals of considerable size. With so many enemies, no means of defense, and no power of escape by flight, it is surprising that any tortoises should to-day exist, and the fact that they are not yet exterminated shows how wonderfully abundant they must have been when the islands were discovered.

In 1888 the U. S. Fish Commission steamer *Albatross* succeeded in obtaining a limited number of tortoises, but they were comparatively small, mostly mere infants of 10 or 20 pounds weight, although one specimen weighing about 40 pounds was secured. This is a sad falling off from former days, for in Darwin's time individuals weighing 100 pounds were not uncommon, while the governor of the penal colony told Darwin that he had seen tortoises so large that it required six or eight men to lift one from the ground, a statement not at all incredible since a tortoise from Aldabra turned the scales at 870 pounds. The decline in weight is due to the fact that the tortoises are killed when they are still young and before they have had time to attain any considerable size. Turtles live to a great age (the specimen from Aldabra was known to be over eighty) and like other reptiles continue to grow throughout life, so that great size is an indication of corresponding age. A tortoise obtained by Captain Cookson, estimated by an old tortoise hunter to be four years old, weighed only 9 ounces, so that the rate of growth would seem to be more rapid in old rather than in young individuals.

Probably no more large tortoises will come from the Galapagos group, and though the race may linger for some time longer, it will ultimately become extinct. The story of the Mascarene tortoises is soon told. Van Neck, the discoverer of the Dodo, found them abundant in Mauritius at the time of his visit in 1598, and he tells us that some were of such immense size that six men could be seated in one shell. In 1642 Bontekoe, on a trip to Bourbon, took twenty-four tortoises beneath a single tree, a statement which shows how numerous they then were. Rodriguez must, however, have been the headquarters of these animals, for Leguat says: "There are such plenty of land turtles in this isle that sometimes you see two or three thousand of them in a drove, so that you may go above a hundred paces on their backs."

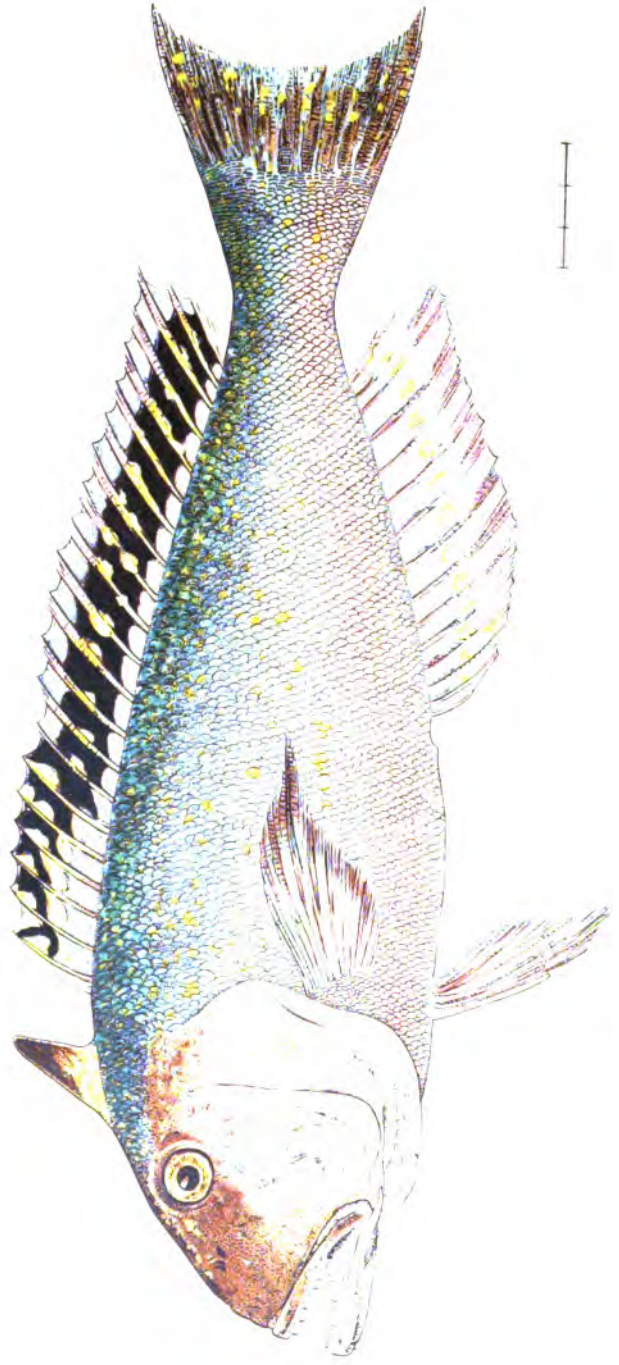

THE TILE-FISH.

Lopholatilus chamaeleonticeps, Goode & Bean. (p. 380.)

Drawing by H. L. Todd, from No. 92609 U. S. National Museum, collected on the south coast of Mexico by the U. S. Fish Commission.

In 1761 vessels were employed in transplanting tortoises from Rodriguez to the Dutch colony at Mauritius, where they were used in the hospital and in exchange for various commodities with the Dutch East Indiamen who frequently touched there. In the early part of the present century the race seems to have become extinct, and save the few bones rescued from the marshes of Mauritius and the caves of Rodriguez, nothing is left to show that these large and formerly abundant tortoises ever existed.

• AUTHORITIES.

- Natural History and Geology of the Voyage of the Beagle. Charles Darwin, London, 1876 (second edition).
 Description of the Living and Extinct Races of Gigantic Land Tortoises. Albert Gunther. Philosophical Transactions of the Royal Society of London, 1875, pp. 251-284.
 Remarks on the Tortoises of the Galapagos. Commander W. E. Cookson. Proc. Zool. Soc. London, 1876, pp. 520-526.
 Article: Tortoise. Encyclopædia Britannica. 9th ed. Vol. xxiii. pp. 455-459.
 The Gigantic Land Tortoises of the Galapagos Islands. G. Baur. Am. Nat., Dec., 1889; pp. 1039-1057.

THE TILE FISH.

(*Lopholatilus chamaeleonticeps*.)

The tile fish is the largest member of a small family of fishes (the *Latilidae*), most of which are inhabitants of tropical or subtropical waters, although the tile fish itself ranged northwards to the latitude of Philadelphia. The tile fish was rather brilliantly colored, being pale-violet above and whitish below, with numerous markings of pale yellow. (Plate CV.) In size it varied from five to forty pounds, and it was an inhabitant of moderately deep water, being found at a depth of from ninety to one hundred and twenty-five fathoms. Up to 1879 the tile fish was unknown, and its discovery may be said to have been accidental. In May, 1879, Captain Kirby, of the schooner *Wm. V. Hutchings*, while trawling* for cod to the southward of Nantucket, took 5,000 pounds of a fish not only new to him but new to science. The greater part of the fish taken on the first haul of the trawls were thrown away, but as the samples that had been kept proved, on being cooked, to be most excellent eating, those subsequently taken were salted down, and when taken to Gloucester a portion was smoked. In July, 1879, more tile fish were taken—this time on hand lines—by Captain Dempsey, of the schooner *Clara F. Friend*, while trying for cod, but as there were no indications of the latter being present, Captain Dempsey, who naturally preferred to deal with fish with which he was acquainted, proceeded to other grounds. In 1880 and 1881, while engaged in exploring the

*Among American fishermen a trawl is a line from half a mile to three miles long, having hooks at intervals of a few feet. In England a trawl is a net dragged along the bottom, the mouth being kept extended by a long beam.

sea-bottom of the southern coast of New England, the United States Fish Commission steamer *Fish Hawk* took tile fish on several occasions at depths of from 70 to 134 fathoms. The indications of the apparent abundance of a new and edible fish of large size made Professor Baird desirous of obtaining fuller knowledge of its habits and habitat, in the hope that it might readily be taken in large numbers and prove an important addition to the list of food fishes. Unfortunately the fish commission had not yet built the schooner *Grampus*, so, having no vessel especially adapted for fishery research and prepared to encounter any weather, it was necessary to charter a fishing-smack for the work. Unfortunately, too, bad or threatening weather seemed to have been chartered with the smack, and only a brief and unsatisfactory trip could be made on the tile fish-ground, so that research was of necessity postponed until 1882. In the months of March and April, 1882, vessels arriving at Philadelphia, New York, and Boston reported having passed large numbers of dead or dying fish scattered over an area of many miles, and from descriptions and the occasional specimens brought in, it was evident that the great majority of these were tile fish. Naturally these fish were not evenly distributed over all the area in which they were seen, some observers reporting them as scattering, and others as at times so numerous that there would be as many as fifty on the

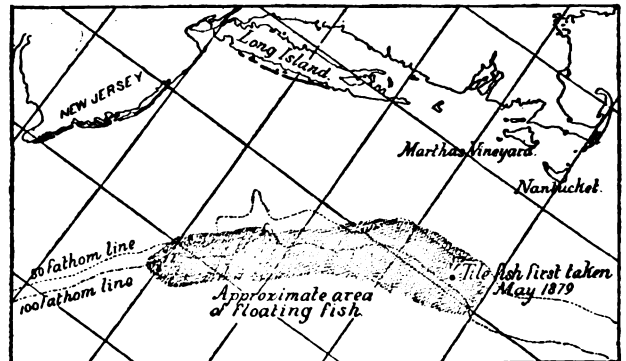

MAP 7.—Showing destruction of tile fish. From a map prepared by Capt. J. W. Collins.

space of a rod square. As one account after another came in it became apparent that a vast destruction of fish had taken place, for vessels reported having sailed for 40, 50, and 60 miles through floating fish; and in one case the schooner *Navarino* plowed for no less than 150 miles through waters dotted as far as the eye could reach with dying fishes. From careful computations made by Capt. J. W. Collins, it seems that an area of from 5,000 to 7,500 square statute miles were so thickly covered with dead or dying fish that their numbers must have exceeded the enormous number of one billion. As there were no signs of any disease, and no parasites found on the fish brought in for examination their death could not have been brought about by either of these causes.

and many conjectures were made as to the reason of this wholesale destruction of deep-water fishes, such as would ordinarily be unaffected by conditions prevailing at the surface, submarine volcanoes, heat, cold, and poisonous gases being variously brought forward to account for the loss of life.

Professor Verrill has noted the occurrence of a strip of water, having a temperature of 48° to 50° Far., lying on the border of the Gulf-Stream slope, sandwiched in between the Arctic current on the one hand and the cold depths of the sea on the other. During 1880 and 1881 Professor Verrill dredged along the Gulf-Stream slope, obtaining in this warm belt, as he terms it, many species of invertebrates characteristic of more southern localities. In 1882 the same species were scarce or totally absent from places where they had previously been abundant, and this taken in connection with the occurrence of heavy northerly gales and the presence of much inshore ice at the north, leaves little doubt that some unusual lowering of temperature in the warm belt brought immediate death to many of its inhabitants. This is the more probable, as it is a well-known fact that sudden increase of cold will bring many fish to the surface in a benumbed or dying condition, and there are no indications of any shock or earthquake having occurred at the time the dead fish were first noticed. Whether the entire race of tile fish has become extinct, or whether they will later on be discovered on grounds to the southward of the localities where they were formerly found, it is impossible to say. Certain it is that none have been taken since the spring of 1882, although in the autumn of that year Captain Collins made careful trials in their former habitat with a view of ascertaining if any remained there. It is no less singular that so large and plentiful a fish should have remained so long unknown than that it should disappear almost as soon as it was discovered. Should the tile fish appear no more, it will be one of the few animals exterminated in modern times, for whose extinction man is in no ways accountable.

AUTHORITY.

History of the tile fish. J. W. Collins. Report of the Commissioner of Fish and Fisheries for 1882, pp. 237-292, Washington, 1884.



THE DEVELOPMENT OF THE AMERICAN RAIL AND TRACK, AS ILLUSTRATED BY THE COLLECTION IN THE U. S. NATIONAL MUSEUM.

BY J. EFFRETH WATKINS,

Curator of the Department of Transportation and Engineering.

In the brief report upon the section of steam transportation for the year 1887, a statement was made to the effect that considerable information had been secured which it was hoped to use "in preparing a series of models to illustrate the beginnings and development of the English and American systems of track.

"While illustrated histories of the steamboat and locomotive are numerous, I am not aware that any systematic attempt has been made to preserve the history of the development of the systems of permanent way which, after many years of experiment, are now being reduced to a series of standards depending on the traffic." (Report of U. S. National Museum, 1887, p. 79.)

These expectations were realized to a sufficient extent to warrant the preparation of the series of original rail sections, models, and drawings to illustrate the origin and development of American permanent way for the Exposition at Cincinnati in 1888.

The interest manifested in that collection led me to present a paper entitled "The Development of the American Rail and Track" at the annual convention of the American Society of Civil Engineers, at Sea Bright, New Jersey, June 21, 1889. This will appear in the transactions of that society during the coming year.*

At the conclusion of that paper I took occasion to state that in its preparation "I preferred to confine myself to a description of such rails as are represented by original sections, models, or drawings in the section of transportation and engineering in the U. S. National Museum."

"I am fully conscious that I have been compelled to overlook many things which are of great historical interest, owing to the fact that our collection is small—only a nucleus in reality."

* See Transactions of the American Society of Civil Engineers, April, 1890, p. 209-

Although some additions to the collection have since been made, a large portion of the facts here stated, together with many of the illustrations, also appear in the original paper.

GOOD TRACK AS IMPORTANT AS THE LOCOMOTIVE.

As the improved wagon roads in the past made it practicable to transfer the burden from the pack mule to the wheel vehicle, and the traveler from the saddle horse to the light, comfortable, and rapidly moving carriage, so the development of the iron railway of the nineteenth century has made it possible for us to enjoy the safety, speed, and comfort of the express train of to-day, drawn by the fleet and powerful locomotive.

In considering the improvement in methods of transportation, I am led to think that there is a tendency to overestimate the benefits arising from the invention and improvement of the locomotive, and to overlook what has been done by those who devoted time and thought to the development of the various systems of permanent way.

The improvement made in track construction in England during the first quarter of the century made the introduction of the locomotive there possible.

Trevithick's locomotive of 1804, crude as it was, would have been much more successful, and might have brought him much greater fame as one of the first inventors of the locomotive, had the track upon which it ran been constructed according to modern methods.

Long before the locomotive was a practical machine the advantages of the cast-iron tramroad were fully appreciated.

By careful calculation a distinguished London engineer, in 1802, found that while it cost 3s. 4d. per ton per mile to transport bulky freight over turnpikes, the cost on iron horse tramroads was only one-tenth, 4d.

George Stephenson, while president of the "British Carrying Companies," stated "that by the introduction of the horse tramroad the monthly expense of that company for coal carriage alone had been reduced from £1200 to £300.

An edition of "Wood's Treatise of Railroads," published in 1830, which was one of the earliest and most reliable standard works on railroad subjects, calls attention to the economical operation of the coal railroad, 9 miles long, near Mauch Chunk, Pennsylvania, then operated by horse power, and states that by this method "it has repaid its whole cost since 1827."

On a large proportion of the American railways projected before 1830, it was intended that horse power should be used.

In Austria the advantages of a horse tramway were also understood.

In 1828 thirty-nine miles of the horse railway from Budweis to Lintz—constructed across the mountains which separate the Moldau and the Danube—was opened to traffic. This road was extended 41 miles

farther in 1832, and for many years paid a dividend of 5 per cent. upon a capitalization of \$10,000 a mile, being subsequently increased to a length of 130 miles in 1839.

The modern horse railways in our cities and their suburbs earn handsome dividends by carrying passengers at a lower fare per mile than the steam railway companies find profitable.

THE IRON COAL ROAD.

The circumstances connected with the origin of the iron railroad, and particularly the relations which existed between coal, iron and the railway in the beginning, are of the greatest interest. Man's physical necessities exert a powerful influence upon the inventive faculties, and the trite proverb arising therefrom is nowhere better exemplified than in the history of the conception, birth, and growth of the railroad.

The demand for a new fuel to replace the faggot and the log was the necessity that became more and more urgent as the forest disappeared to satisfy the demands of a dense population. This condition of affairs directed thought toward devising improved methods for transporting pit coal from the collieries of Great Britain to the adjacent navigable streams or near seaports.

Although coal had been mined in England as early as the middle of the ninth century, it was not until 1259 that Henry III granted the privilege of digging coal to certain persons in Newcastle. By the beginning of the fourteenth century it had become an important article of export, and was called "sea cole," owing to the fact that it was shipped by vessels to various ports.

EARLY USE OF IRON.

Several methods of iron making were understood and practiced by the ancients.

The Bible bears evidence in many texts to the high esteem in which the iron worker was held. Tubal Cain is described in Genesis IV as "an instructor of every artifice in brass and iron." In alluding to the Israelites in Deuteronomy IV is the statement: "For the Lord hath taken you and brought you forth out of the iron furnace, even out of Egypt."

Processes of making iron were known to the Babylonians and Assyrians. The stones in the celebrated bridge said to have been built by Nitocris were held together by bands of iron kept in place by molten lead. "Among the ruins of Sargon's palace objects of iron and bronze, such as hooks and rings, chains, pickaxes, hammers, ploughshares, weapons, fragments of chariots, and tools of all sorts were picked up."

The Phœnicians, Persians, and even the Chinese were acquainted with processes of forging iron centuries before the Christian era; and in India, in the temple of Kuttub at Delhi, there stands a pillar of solid

forged iron over 16 inches in diameter and nearly 60 feet high, supposed to have been erected in the third century.

But these methods must be included among the lost arts—arts lost in the great abyss of the middle ages, which swallowed up so many of the results of the skill and ingenuity of the ancient world.

But among the Greeks and the ancient nations of the Orient, as we learn from Homer, the early historians, and the latest inscriptions and archæological discoveries, iron was once regarded as a precious metal. Homer's elaborate description of the shield of Achilles, forged by Vulcan, undoubtedly shows that the art of working iron was fully understood in that semifabulous epoch.*

Iron first came into use in the arts and manufactures when Spain flourished under the Visigoths, who are said to have derived it from their ancestors, the Scythians, of whose history so little is definitely known. Spanish iron brought high prices for many years.

THE IRON INDUSTRY IN ENGLAND.

Early in the fifteenth century many blast furnaces were in existence in France, and soon afterward they were introduced in Sussex, Kent, and Surrey, in England, and this gave impetus to the iron industry of England. As the processes of extracting iron from various ores became more fully understood, the demand increased, and in order to keep up the supply great inroads were made each year upon the forests for fuel.

During the reign of Queen Elizabeth (1558-1603) the iron industry increased so rapidly that the consumption of wood became a most serious matter, as iron was then smelted exclusively by charcoal.

The destruction of the forests was so rapid that Parliament passed acts in 1558, 1581, and 1584 restricting the cutting of wood for charcoal, and thus the iron industry languished for over a century.

In the mean time thought had been directed to the processes of smelting iron with pit coal. Sturdevant's method, although patented in 1611, was not practicable; and Dudley, who eight years after solved the problem with some success, was so much abused by the charcoal smelters, that fearing bodily injury he too abandoned the business. Nothing further seems to have been done toward using coal for smelting iron ore in England during the seventeenth century.

THE IRON INDUSTRY IN AMERICA.

As early as 1621 a considerable quantity of iron was produced in Virginia, and that colony led the industry until 1628, when Massachusetts forged ahead.

As wood fuel was plenty in America the industry grew so rapidly that Parliament passed an act in 1660 prohibiting the exportation of

* Manual of Oriental Antiquities, Ernest Babelen, p. 125.

iron from the colonies except in English ships; and in 1679 a duty of 10s. was imposed by the British Government upon each ton of pig iron exported.

In 1750, about 3,500 tons of pig iron having been imported into England from America, a law was passed by Parliament removing this duty, but prohibiting all persons in the colonies, under penalty of £200, from erecting a forge or working a tilt hammer or a rolling mill. This was one of the "grievances" that instigated the Declaration of Independence.

The historian Bancroft, commenting on this fact, says:

*America abounded in iron ore; its unwrought iron was excluded from the English market, and its people were rapidly gaining skill at the furnace and forge. In February, 1750, the subject engaged the attention of the House of Commons. After a few days' deliberation a bill was brought in which permitted American iron in its rudest forms to be imported duty free; but now that the nailers in the colonies could afford spikes and large nails cheaper than the English, it forbade the smiths of America to erect any mills for slitting or rolling iron, or any plating forge to work with a tilt.**

In 1761 less than 17,000 tons of iron had been made in all Great Britain and over 4,500 tons had been imported from America.

COAL-MINE TRAMROADS.

The earliest railways were laid in the coal mines and from the mines to the adjacent water courses. These ways consisted of squared timber rails laid in the ground, held to gauge by cross timbers, to which they were fastened by wooden pins.

Roger North in 1672, in his biography of his brother Francis, the Lord Chancellor, describes a wooden railway which he had seen at Newcastle during the reign of Charles II, as follows: "The manner of the carriage is by laying rails of timber from the colliery down to the river exactly straight and parallel, and bulky carts are made with rowlets fitting these rails, whereby the carriage is so easy that one horse will draw 4 or 5 chaldrons of coals." The Newcastle chaldron weighed 5,936 pounds, so that one horse hauled 8 or 9 tons.

EARLY AMERICAN COAL MINES.

Coal was mined in America as early as 1770 on the James River in Virginia, and was used at the Westham foundry to manufacture shot and shell during the Revolutionary War.

* The exact wording of the act as finally passed was as follows: "And that pig and bar iron in his Majesty's colonies in America may be further manufactured in this kingdom, be it further enacted by the authority aforesaid, that from and after the 24th day of June, 1750, no mill or other engine for slitting or rolling of iron, or any plating forge to work with a tilt hammer, or any furnace for making steel, shall be erected, or after such erection continued in His Majesty's colonies in America; and if any person or persons shall erect or cause to be erected, or after such erection continue, or cause to be continued, in any of the said colonies, any such mill, engine, forge or furnace, every person or persons so offending shall, for every such mill, engine, forge or furnace, forfeit the sum of 200 pounds lawful money of Great Britain."

Ashbel Welch, in the Presidential address at the annual convention of the American Society of Civil Engineers at Washington in 1883 states that, "About the year 1817 Josiah White and Erskine Hazard commenced the improvement of the Lehigh River, and made other preparations to inaugurate the anthracite coal trade. In 1820 they sent to market 365 tons, which was the beginning of the regular anthracite coal trade of America."

Before 1825 coal mining commenced to be an industry in the Schuylkill and Lehigh regions. In this country, as in England, the earliest railroads were built in and from the coal mines at Mauch Chunk, Honesdale, and Pottsville in Pennsylvania and Chesterfield in Virginia to the nearest navigable streams.

The first locomotive that ever turned a driving wheel on a railroad on the Western Continent was imported from England in 1829,* for use on the Delaware and Hudson Canal Company's coal road at Honesdale, Pennsylvania.

As the supply of coal was increased by improved methods of mining and cheaper means of transportation, it gradually superseded charcoal in the manufacture of iron. The cost of pig iron was reduced from £11 10s. in 1660 to £3 in 1760, and the price did not vary much from this until the American Revolution cut off the supply of iron that England had been receiving from the colonies. This was several years before the introduction of good steam pumping engines, which between 1775 and 1790—through the improvements and inventions made by Watt in the engines of Savery and Newcomen—reached such a degree of perfection that good steam pumps were put in every prominent colliery and the amount of coal mined reached enormous proportions as the cost of mining it was lessened.

IRON FURNACES IN ENGLAND.

The following statement shows the growth of the iron industry in England during eighty-five years prior to the introduction of the locomotive, in 1825:

Year.	Iron.	Number of furnaces.	Production.
			Tons.
1740	Charcoal iron	59	17,350
1788	{ Charcoal iron	24	13,100
	{ Pit coal (coke)	53	48,800
1796	{ ... do	121	124,870
	{ Charcoal	None.	
1802	Pit coal (coke)	168	170,000
1806	... do	227	250,000
1825	... do	305	600,000

* The locomotive "Stourbridge Lion," a full-sized model of which is in the Section of Transportation and Engineering in the U. S. National Museum.

Thus, even before the successful introduction of the locomotive, coal, iron, and the railroad had become three equally important factors in the creation of the great systems of transportation, which have made our prosperity and the higher civilization of to-day possible.

CAST IRON FIRST USED FOR RAILS IN ENGLAND.

The price of iron was materially reduced as coal became cheap and abundant, and at length it became possible to use it in the construction of rails. The earliest iron used in track construction was cast in plates 3 or 4 feet long, 2 or 3 inches wide, and one-half or three-fourths of an inch thick. These plates were spiked on top of the wooden stringer rail where the wear was the greatest.

As timber was dear in England at the close of the last century, many attempts were made to devise a cast-iron rail that should suit the traffic of the English tramroads.

We have in the collections several models of the cast-iron rails that were used from 1789 to 1816. A fair impression can be obtained of the crude ideas that the early English tramway contractors had in regard to rails from an examination of the drawings.

Fig. 23, cast-iron edge rail, 1789. Patented in England by William Jessop, mine engineer, and laid on a road in Loughborough. The rail was fish-bellied, and at first was not supported by a chair, the wood or

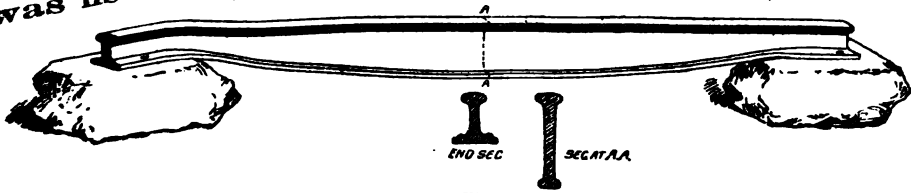

Fig. 23.
JESSOP'S PATENT EDGE RAIL. (1789.)
(From model in the U. S. National Museum.)

stone block being hewn to fit the end of the rail. Near the ends the rail had a flat projecting base, in which there were holes for the bolts which fastened them to the wooden block or sleeper.

Fig. 24, cast edge rails, 1797, with joints supported by chairs. These were the first chairs adopted, and were cast the reverse of the ends of



Fig. 24.
EDGE RAILS, LAWSON COLLIERY, NEW CASTLE-ON-TYNE. (1797.)
(From model in the U. S. National Museum.)

the rail, having two bolts through the stem of the rail at each joint. They were laid on the Lawson Main Colliery Road, New-Castle-on-Tyne, England, by Mr. Barnes, and were at first supported by timber but finally by stone blocks.

Fig. 25, cast edge rails, 1802; 4 feet 6 inches long. Invented by Wyatt, and used on the railway at the slate quarry at Lord Penrhyn estate, near Bangor, North Wales. The general shape of the cross-



Fig. 25.
WYATT'S HEXAGONAL RAIL, BANGOR, NORTH WALES. (1802.)
(From model in the U. S. National Museum.)

tion of this rail was a hexagon. At each end of the rail a dovetail block, 2 inches long, was cast at the bottom. This was slipped into a chair, which had previously been attached by a bolt to the wooden stone support.

Fig. 26, cast tram rail, 1803, "with flange higher in the middle and a nib under the tread to add strength." Used on the Surrey Railway.

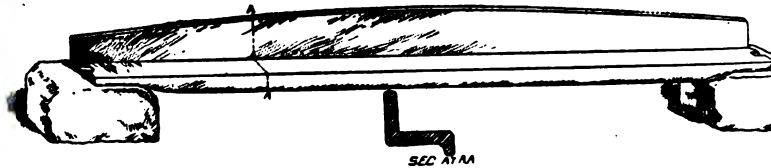

Fig. 26.
TRAM RAIL, SURREY RAILWAY. (1803.)
(From model in the U. S. National Museum.)

England. These rails had a rectangular notch, half square, in the joints being completed by one square-headed iron spike, which counter-sunk.

Fig. 27, cast rail with concave top, 1803. To be used also by wagons and to be imbedded in common roads. This rail, patented

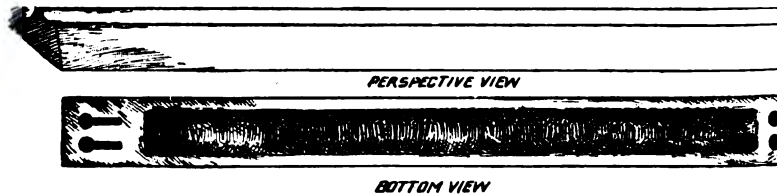

Fig. 27.
WOODHOUSE'S PATENT CONCAVE RAIL FOR WAGONS.
(From model in the U. S. National Museum.)

Josiah Woodhouse, was fastened to transverse cross ties by bolts slipped into slits through the base.

Among the most interesting relics in the collection are two of cast tram rails, 3 feet long, from the track from Penydarren Works, Glamorgan, near Aberdare Junction, Wales. These rails were a portion of the original track upon which Trevithick's first locomotive, the help man, ran in 1804, and was a gift of J. W. Widdowson, Esq., London and Northwestern Railway of England, to the U. S. National

Museum. A drawing of these rails with the stone supports, one of which is also in the collection, is shown in Fig. 28.

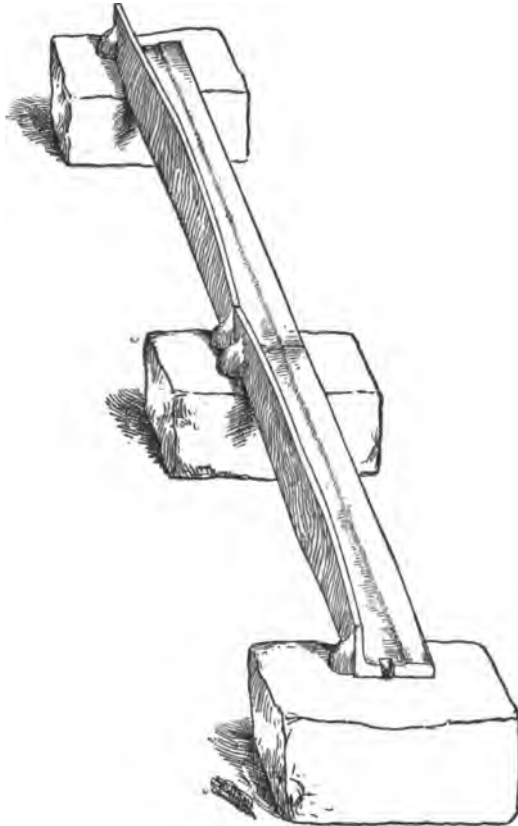

Fig. 28.

TRAM RAIL, PENYDABEN WORKS TO GLAMORGAN CANAL, WALES. (1804.)
(Original in the U. S. National Museum.)

Fig. 29 is drawn from a model of a cast tram rail, designed to be laid without bolts or spikes. Charles Le Cann, of Llanelly, Wales, in 1808,

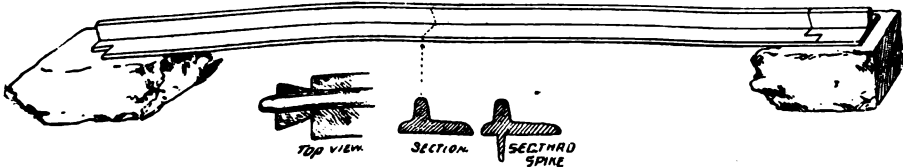

Fig. 29.

TRAM RAIL, DESIGNED BY CHARLES LE CANN, LLANELLY, WALES. (1801.)
(From model in the U. S. National Museum.)

received a premium of 20 guineas from the Society of Arts for the invention of this rail, which was ingenious in construction. Projecting pins,

pyramidal in shape, were cast on the bottom of the tram rail at the points where the stone supports came under the rail, the joints being dovetailed into each other; the need of any other form of joint fixture was thus dispensed with. These rails were about 5 inches wide, and weighed 42 pounds per yard.

Fig. 30 is from a model of a cast rail patented by Losh and George Stephenson, of Killingsworth, England, in 1816. A half-lap joint was used, through which a horizontal pin was passed transversely across

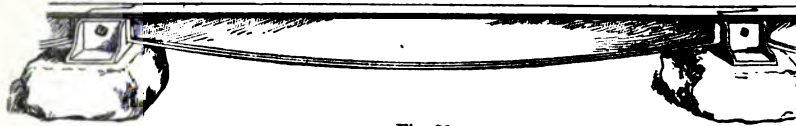

Fig. 30.
EDGE RAIL, PATENTED BY LOSH AND STEPHENSON, LAID ON STOCKTON AND DARLINGTON RAILROAD,
1825. (1816.)
(From model in the U. S. National Museum.)

joined the rails together, at the same time fastening them to the cast iron chair. A large portion of the Stockton and Darlington Railroad was laid with this rail in 1825.

ROLLED IRON RAILS INTRODUCED.

Early in this century inventive genius increased the power of the stationary engine and the efficiency of the steam blast and of the machinery for working and handling iron.

The puddling furnace, first used in 1784, was radically improved by Henry Cort about the beginning of the century. He also invented and introduced the rolling mill about the same time, so that it became possible

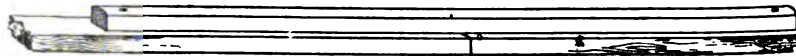

Fig. 31.
LORD CARLISLE'S WROUGHT-IRON RAIL. (1811.)
(From model in the U. S. National Museum.)

to roll iron rails cheaply. These were at first rolled in lengths of about 12 feet. Drawings from the models of the early English rolled rails are shown.

Fig. 31 is a bar rail laid in Lord Carlisle's quarries, 1811.

Fig. 32, wrought iron rail, patented 1820, by John Birkenshaw, of the Bedlington Iron Works, England. A clause in the patent specification

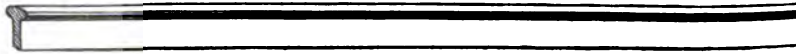

Fig. 32.
WROUGHT-IRON RAIL, PATENTED BY JOHN BIRKENSHAW. (1820.)
(From model in the U. S. National Museum.)

reads: "The upper surface to be slightly convex to reduce friction. The upper part to rest on supporting blocks, chairs, and

sleepers. The wedge form is used because the strength of a rail is always proportioned to the square of its breadth and depth. Hence this (wedge) form of rail possesses all the strength of a cube equal to its square. The joints are made with a pin." Birkenshaw showed great ingenuity in designing the rolls by which these rails were fairly rolled in lengths of 18 feet. Cast bars were soon after dispensed with. The model is made from drawings and specifications, English patent No. 4503, to John Birkenshaw, sealed October 23, 1820.

Fig. 33, wrought-iron edge rail with fish-bellied web. These rails were used by Stephenson in 1829 in laying the Liverpool and Man-

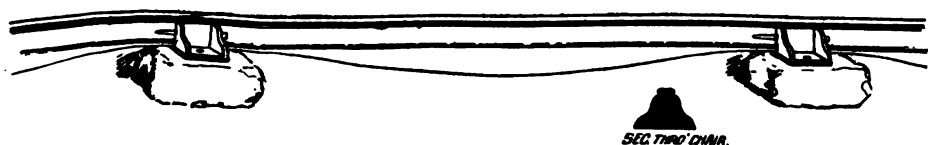

Fig. 33.

FISH-BELLY RAIL, DESIGNED BY GEORGE STEPHENSON AND LAID ON THE MANCHESTER AND LIVERPOOL RAILWAY. (1829.)
(From model in the U. S. National Museum.)

chester Railway. Chairs used at joints; rails 15 feet long; supports 3 feet apart; weighed 35 pounds per yard.

Fig. 34 shows a cross section of the original rail laid on the old Portage Railroad over the Allegheny Mountains in Pennsylvania. These



Fig. 34.

ENGLISH ROLLED RAIL, CLARK'S PATTERN, LAID ON THE OLD POSTAGE RAILWAY OF PENNSYLVANIA, 1833.
(From original in the U. S. National Museum.)

rails were imported from England in 1832 and laid in 1833. A section of this rail is in the collection. A portion of the New Jersey Railroad (from Jersey City to New Brunswick) was also laid with T rails of the fish-belly pattern, similar to Fig. 33.

In Fig. 35 the dotted line indicates the depth of the rail between the ties. The plate is from an original rail in the collection which was laid

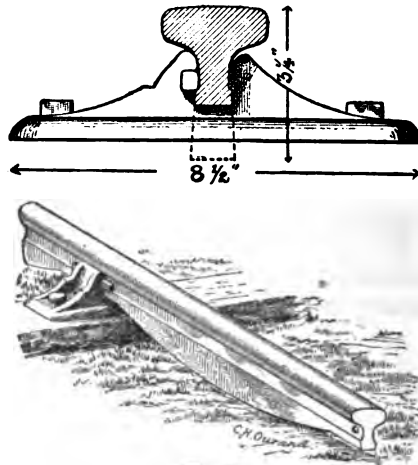

Fig. 35.

ENGLISH FISH-BELLY RAIL, LAID ON THE NEW JERSEY RAILROAD NEAR NEWARK, 1832.
(From original in the U. S. National Museum.)

near Newark, New Jersey, in 1831. It was the original design to lay the whole Portage Railroad with stone blocks and T rails.

THE ORIGIN OF THE AMERICAN RAIL AND TRACK.

In 1825-'27 a few isolated coal tramroads existed in the mining regions in Pennsylvania and Virginia and in the stone quarries in Massachusetts. These roads were laid with wooden rails, capped with thin merchant bar iron. About this time the Pennsylvania Society for the Promotion of Internal Improvement sent an engineer abroad to examine the English railways. The fully illustrated report made by William Strickland, published during the year 1826, shows that rapid advances in track construction had been made in Great Britain during the preceding decade, notwithstanding the fact that comparatively few locomotives were at work and only one railway for general traffic had been opened.

This report, without doubt, contained the most trustworthy information obtainable at that time by American railway projectors.

But America presented a very different problem from England to the pioneer railway builders. England was an old country, rich in commerce and foremost in manufactures, of comparatively small area and very densely settled, having a population of nearly two hundred to the square mile of territory, while the population of the whole United States was less than four to the square mile. In the seven States, Connecticut, Massachusetts, New York, New Jersey, Pennsylvania, Delaware, and Maryland, where most of the early railways were projected, the average population was a little over thirty-five to the square mile.

ENGLISH AND AMERICAN ENGINEERS.

The British railway projectors had the advantage of being able to call into their service a trained force of civil engineers. Many of these engineers were connected with well-organized scientific societies, or were generally experienced in the construction of public works, and were familiar with what had been done for years on the coal tramroads; men on whose judgment the wealthy capitalist was willing to supply the money for the proposed improvement. England also had numerous machine-shops fairly well equipped with tools and stationary engines, and many coal mines and iron foundries in operation, which made it possible to obtain without difficulty the material for laying the tracks with heavy rails firmly attached by strong chairs to the sleepers that were imbedded in stone ballast.

With the exception of making the rail heavier, and using steel instead of iron, and substituting an iron for the wooden cross-tie, and strengthening the splice chair, there has been no great change in the English system of track laying in the last fifty years.

Many of the civil engineers who were first called into the service of the American railroads were connected with the Army Engineer Corps, having obtained their training at West Point, the only institution in the United States where engineering was taught during the first quarter of the century. In many cases these officers were detailed for a term of years to the "Board of Engineers for Internal Improvements"* to make surveys for various projected roads and canals. The preliminary surveys for the Camden and Amboy, the Pennsylvania, and the Baltimore and Ohio Railroads were made with the assistance of officers of this Corps.

In some cases, however, these surveys were made by canal or road engineers who had obtained experience in canal and turnpike construction. On the railroads then built the curves and gradients were frequently sharp and steep, as few cuts or fills were made, and these cheap roads were quickly extended, through a rapidly growing country, with a view to connect the navigable water courses, and to unite with the steam-boat companies in forming "through lines." By the aid of these roads the Western and Southern States rapidly increased in population and commercial prosperity. In 1832 the South Carolina Railroad from Charleston to Hamburg, 135 miles long, which was then the longest railroad in the world, was a continuous trestle work, with rails of squared timber, capped with strap iron, framed to the top of posts, where grading would have been necessary.

*The Board of Engineers for Internal Improvements received their instructions directly from the President of the United States, 1824-'32.

AMERICA WITHOUT ROLLING MILLS AT THE BEGINNING OF THE RAILROAD ERA.

When the corner-stone of the Baltimore and Ohio Railroad was laid in 1828, there was not a rolling mill in all the United State where rails of the character laid on the Stockton and Darlington Railroad could be rolled ; in fact, the only rails rolled in America for several years after was the strap rail of merchantable bar iron $2\frac{1}{2}$ inches wide and five-eighths of an inch thick, the holes for the spikes often being drilled by hand.

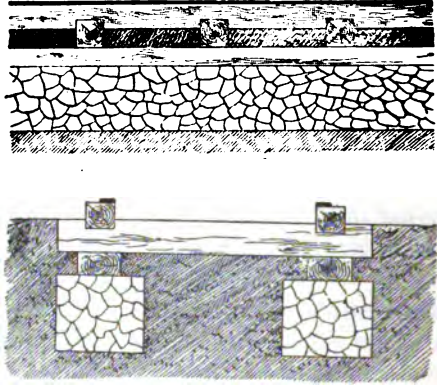

Fig. 36.

WOODEN STRINGER AND STRAP RAIL, ALBANY AND SCHENECTADY RAILROAD, 1837.
(From a drawing in the U. S. National Museum.)

On the Albany and Schenectady road strap rail was laid on longitudinal sleepers of wood, supported on trenches filled with broken stone. (See Fig. 36.)

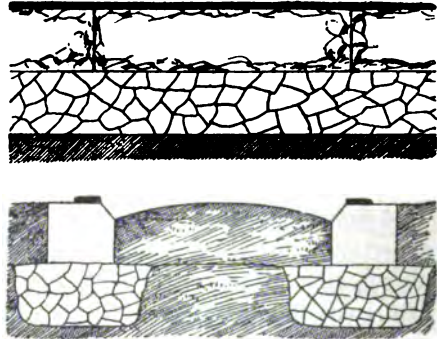

Fig. 37.

STONE STRINGER AND STRAP RAIL, BALTIMORE AND OHIO RAILROAD, 1833.
(From original rail and stone block in the U. S. National Museum.)

On the Baltimore and Ohio Railroad, and the Columbia road in Pennsylvania, the strap rail was attached to the edges of stone blocks, which were laid on trenches filled with broken stones ; the corners of the stone stringers were chamfered. (See Fig. 37.)

A thick rectangular rail laid on the Baltimore and Port Deposit Railroad in 1838 is illustrated in Fig. 38, from a drawing in the collection.

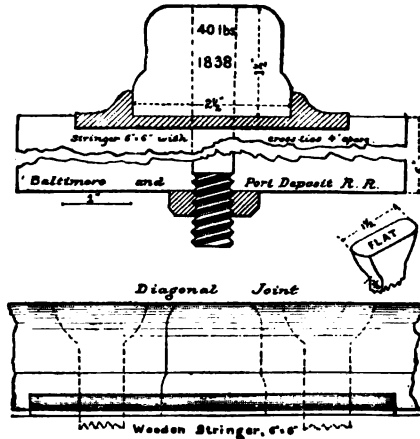

Fig. 38.

THICK RECTANGULAR RAIL, LAID ON THE BALTIMORE AND PORT DEPOSIT RAILROAD, 1838.
(From drawing in the U. S. National Museum.)

Roads, such as the Camden and Amboy in New Jersey, Boston and Providence, Philadelphia and Germantown, and the Pennsylvania (then under State control), which did not adopt this construction, were compelled to obtain their edge rails and rail fastenings from England.

The following memorial presented to the Twentieth Congress (H. R. Doc. No. 206) by the Baltimore and Ohio Railroad Company, and referred to the Committee on Roads and Canals March 17, 1828, is of the greatest interest in this connection.

To the Senate and House of Representatives of the United States in Congress assembled :

The memorial of the president and directors of the Baltimore and Ohio Railroad Company respectfully sheweth: That your memorialists have it in contemplation, and are at this time taking measures, to construct a railroad, with at least two sets of tracks, from the city of Baltimore to the Ohio River, which will, it is estimated, unavoidably require not less than fifteen thousand tons of malleable iron.

Your memorialists, taking into consideration the actual quantity of this indispensable article now annually manufactured in our own country, and further considering the numerous lines of railroads already projected in different parts of the United States, are confirmed in the opinion that it will be difficult, if not impossible, to procure amongst ourselves a sufficient quantity for these numerous undertakings, and, consequently, that an enormous enhancement of the present price must be the inevitable consequence unless supplies to a considerable extent be drawn from abroad ; which enhancement of an article so necessary both in the manufacturing and agricultural operations of the country would manifestly be injurious to both these important interests.

Your memorialists are persuaded that so enlightened a body as the Representatives of the people of the United States are fully aware of the vast importance of the undertaking in which this company have embarked. It is indeed an enterprise in

which every section of our country has a deep and vital interest. Its direct effect upon the prosperity of the nation, if successfully accomplished, and its beneficial influence in perpetuating the happy union of these States, is perceived and appreciated by all; at the same time it should not be overlooked that this great work is such deep national concernment, and pregnant with such important consequences, has been undertaken, and so far conducted, by individual enterprise, and is almost exclusively dependent upon private resources for its accomplishment.

Under these considerations your memorialists take leave respectfully to ask of the National Legislature for the passage of an act authorizing the Baltimore and Ohio Railroad Company to import from abroad, if it should be found needful, such quantities of iron and iron machinery as may be requisite for the construction of the proposed road, free of duty.

In presenting these views of an object essentially national to the representatives of their country, your memorialists rely on the wisdom and patriotism of Congress to afford such relief as may be deemed proper, either by an exemption from duty or by a drawback upon the material actually used in the construction of the road; at the same time they confidently believe that in granting the indulgence now asked for, the best interests of the nation will be substantially promoted, whilst no injury will ever accrue either to the manufacturing, agricultural, or other important interests of the country.

Signed on behalf of the Baltimore and Ohio Railroad Company.

P. E. THOMAS,
President

The half century from 1825 to 1875 may be called the experimental era of the American railroad, since the experience obtained during this time has finally led to the adoption throughout the whole country of an almost uniform standard of track construction, depending upon the local traffic. To trace the changes in form and the development of the modern American rail during this period is of the greatest interest.

THE FIRST RAIL ROLLED WITH A BASE.

From an examination of the minutes of the board of directors of the Camden and Amboy Railroad, September, 1830, I find that in the instructions given to Robert L. Stevens, president and chief engineer of that company, who had been ordered to visit England to inspect the "iron rail," which the management of that company preferred to wooden rail plated with strap iron.

Mr. Stevens sailed a few days later, and it was during this voyage that he designed the first rail ever rolled with a base, whittling several model sections out of wood, which he obtained from the ship's carpenter.

He was familiar with the Birkenshaw rail, with which the best English roads were then being laid, but he saw that, as it required an expensive chair to hold it in place, it was not adapted to our country where metal workers were scarce and iron was dear. He added a base to the T-rail, dispensing with the chair. He also designed the "hook headed" spike, which is substantially the railroad spike of today, and the "iron tongue," which has been developed into the

bar, and the rivets, which have been replaced by the bolt and nut, to complete the joint.

A fac-simile of the letter which he addressed to the English iron masters a short time after his arrival in London was published in the Report on the Section of Transportation, 1887 (page 79). It contains a cross-section, side elevation, and ground plan of the rail for which he requested bids. The letter reads:

LIVERPOOL, November 26, 1830.

GENTLEMEN: At what rate will you contract to deliver at Liverpool, say from 500 to 600 tons of railway, of the best quality iron rolled to the above pattern in 12 or 16 feet lengths, to lap as shown in the drawing, with one hole at each end, and the projections on the lower flange at every 2 feet, cash on delivery?

How soon could you make the first delivery, and at what rate per month until the whole is complete? Should the terms suit and the work give satisfaction a more extended order is likely to follow, as this is but about one-sixth part of the quantity required. Please to address your answer (as soon as convenient) to the care of Francis B. Ogden, consul of the United States at Liverpool.

I am, your obedient servant,

ROBERT L. STEVENS,
*President and Engineer of the Camden and South Amboy
Railroad and Transportation Company.*

The base of the rail which he first proposed was to be wider where it was to be attached to supports than in the intervening spaces. This was afterwards modified, so that the base was made one width, 3 inches, throughout. Mr. Stevens received no favorable answer to his proposals, but being acquainted with Mr. Guest (afterwards Sir John Guest), then a member of Parliament and proprietor of large iron works in Dowlais, Wales, he prevailed upon him to have the rails rolled at his works. Mr. Guest became interested in the scheme and accompanied Mr. Stevens to Wales, where the latter gave his personal supervision to the construction of the rolls. After the rolls were completed the Messrs Guest hesitated to have them used, through fear of damage to the mill machinery, upon hearing which Mr. Stevens deposited a handsome sum guaranteeing the expense of repairing the mill in case it was damaged. The receipt for this deposit was preserved for many years among the archives of the Camden and Amboy company. As a matter of fact, the rolling apparatus did break down several times. "At first," as Mr. Stevens in a letter to his father, which I have seen, described it, "the rails came from the rolls twisted and as crooked as snakes," and he was greatly discouraged. At last the mill men acquired the art of straightening the rail while it cooled. The first shipment, consisting of 550 bars, 18 feet long, 36 pounds to the yard, arrived in Philadelphia on the ship *Charlemagne* May 16, 1831. The weight of the next shipment, several months afterwards, was increased to 42 pounds per yard,

the rail being $3\frac{1}{2}$ inches high. Over 30 miles of this rail was immediately laid down. For sections of rail as designed and rolled see Fig. 39.

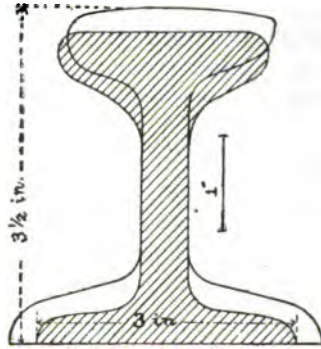

Fig. 39.

STEVENS RAIL ROLLED WITH CONVEX TOP AND BASE, DESIGNED BY ROBERT L. STEVENS, 1830, GENERALLY USED ON AMERICAN RAILROADS SINCE 1836. Shaded section shows rail as originally designed, 1830. Section not shaded shows rail as rolled, 1831.

(From original in the U. S. National Museum.)

This rail was fastened to stone blocks with hook-headed spikes; the joints were iron tongues fastened to the stem of the rail by rivets put on hot. This was the standard rail of the Camden and Amboy Railroad, 1831-'40.

From a letter written by Francis B. Stevens to James M. Swank, a special agent of statistics, dated Hoboken, New Jersey, March, 1889, the following extracts are taken :

I have always believed that Robert L. Stevens was the inventor of what is called the T-rail, and also of the method of fastening it by spikes, and I have never known any one else claim his right to the invention questioned.

Mr. Stevens's invention consisted in adding the broad flange on the bottom, with a base sufficient to carry the load, and shaped so that it could be secured to the wood below it by spikes with hooked heads, thus dispensing with the cast-iron chair, and making the rail and its fastening such as it now is in common use.

In the year 1836, and frequently afterwards, he spoke to me about his invention of this rail. The Camden and Amboy road laid with this rail was opened October 1832, two years after the opening of the Manchester and Liverpool Railroad. Of this I was a witness. This rail, long known as the old Camden and Amboy rail, differed but little, either in shape or proportions, from the T-rail now in common use, and weighed only 36 pounds to the yard. For the next six or eight years after the opening of the Camden and Amboy Railroad it was little used here or abroad, nearly all the roads built in the United States using the flat iron bar, about $2\frac{1}{4}$ by $\frac{1}{2}$ inch, nailed to wooden rails, the English continuing to use the chair and wedges.

My uncle always regretted that he had not patented his invention. He mentioned to me upward of forty years ago that when advised by his friend, Mr. F. B. Ogden, the American consul at Liverpool, who was familiar with the circumstances of the invention, to patent it, he found that it was too late, and that his invention had become public property.

A few years after,* on much of the Stevens rail laid on the *Camden and Amboy Railroad*, the rivets at the joints were discarded and the bolt with the screw thread and nut, similar to that now used, was adopted as the standard. (See Fig. 40.)

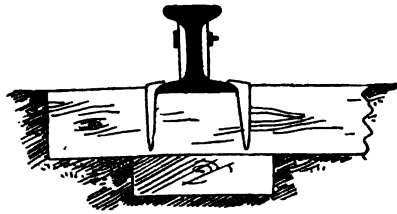
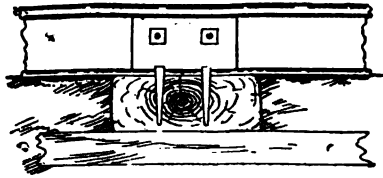

Fig. 40.

STANDARD TRACK OF THE CAMDEN AND AMBOY RAILROAD, 1837.

(From a drawing in the U. S. National Museum made from an engraving in "Engineering in North America" by G. Stevenson, London, 1837.)

Fig. 41 shows how this rail was used on a superstructure on the piling through meadows and marshy ground.

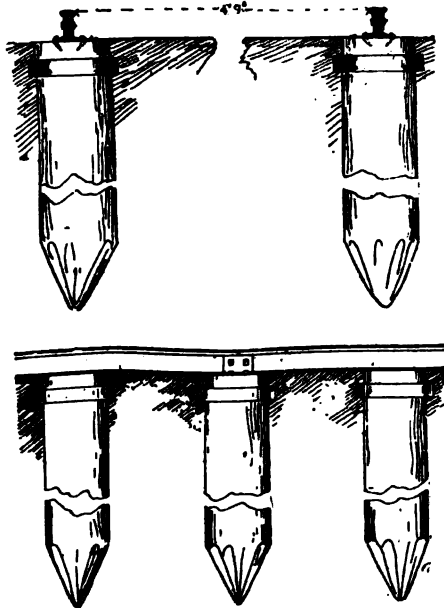

Fig. 41.

TRACK OF THE CAMDEN AND AMBOY RAILROAD. RAILS LAID ON PILING THROUGH MARSHES, 1837.

(From a drawing in the U. S. National Museum.)

* See Stevenson's *Engineering in America*, 1837.

The Stevens rail did not come into general use for several years, the next road to adopt it being the Boston and Providence, about 1840.

On the Boston and Lowell Railroad, Massachusetts, the fish-bellied rail was laid in chairs on stone blocks. As late as 1847 the Hudson River road used the Stevens rail, supported by chairs, but these were soon afterwards discarded.

THE FIRST AMERICAN TRACK.

Mr. Francis B. Stevens also informs me that in 1835 he was employed by the Camden and Amboy company to make a profile of the road bed from South Amboy to Bordentown. At that time there were many places (the longest being a piece 2 miles long, from the wharf at Amboy to Deep Cut) where the Stevens rail was spiked to the cross-tie according to the present practice. This method was at first resorted to as a temporary expedient, on account of the delay in getting stone blocks from Sing Sing. In the meantime it was found that the wood ties were more satisfactory, and in a year or two all the stone blocks were replaced by wood ties. Without doubt the Camden and Amboy was the first railroad in the world to be laid according to the present American practice.

On other roads the wooden tie was afterwards laid on account of the high price of stone blocks and stone stringers, the use of which was originally contemplated.

Speaking of the engineering practice in this era, the late Ashbel Welch said in his presidential address to the American Society of Civil Engineers:

American engineers have often shown that *poverty* is the mother of invention. For example, they used wooden cross-ties as a temporary substitute, being too poor to buy stone blocks, and so made good roads because they were not rich enough to make bad ones.

CAST-IRON RAILS MADE IN AMERICA.

In Johnson's "Notes on the Use of Anthracite," he described tests of cast-iron rails made during 1841 at Lyman's foundry, near Pottsville, Pennsylvania. These rails were designed for colliery railways. They were only 6 feet long. For 3 or 4 inches at each end the rail had a section similar to the Stevens rail; for the remaining 5½ feet the rail was somewhat similar to the English bull-headed rail.

Previous to the year 1842, when Congress passed the celebrated high tariff law, all imported iron rails were admitted to the country almost free of duty. The tariff on manufactured iron, agreed upon by that Congress, increased the cost of English rails so much that the railways were forced to seriously advocate the erection of American rolling mills for the special purpose of making rails.

RAILS FIRST ROLLED IN AMERICA.

The first rail mill erected in this country was located at **Mount Savage**, Allegheny County, Maryland. The first rail was rolled in the summer of 1844. In honor of that event the Franklin Institute of Philadelphia awarded a medal to the proprietors in October, 1844.

The rail was of the Ω form, similar to the Evans (British) patent, and the first few hundred tons manufactured were laid on the Baltimore and Ohio Railroad, between Mount Savage and Cumberland.

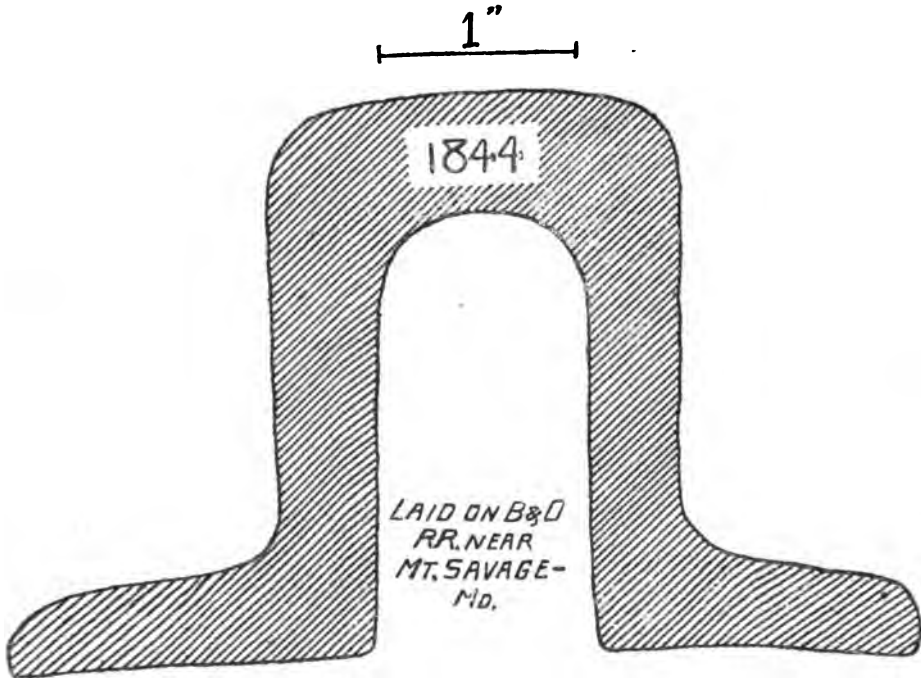

-FIRST RAIL ROLLED IN AMERICA-

Fig. 42.

FIRST RAIL ROLLED IN AMERICA, BALTIMORE AND OHIO RAILROAD, 1844.
(From a section of the original rail in the U. S. National Museum.)

A section of this rail, which weighs 42 pounds to the yard, was presented to the National Museum by the late Colonel James Randolph, for many years consulting engineer of the Baltimore and Ohio Railroad Company. Fig. 42 is drawn from the original, and is actual size.

THE STEVENS RAIL IN AMERICA.

Fig. 43 shows the Stevens rail as used on the Philadelphia and Reading Railroad in 1837

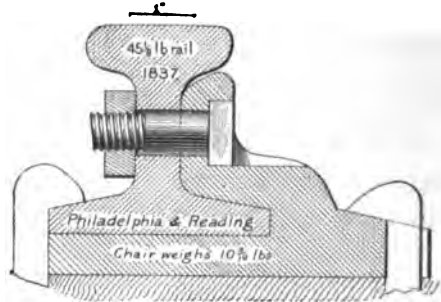

Fig. 43.

THE STEVENS RAIL SUPPORTED BY CAST-IRON CHAIR. PHILADELPHIA AND READING RAILROAD, 1837.

(From a drawing in the U. S. National Museum.)

The rail was supported by chairs. This method was believed at the time to be a considerable advance upon previous practice, but was soon abandoned on account of the increase in expense which it entailed.

The Stevens rail was laid on the Vicksburg and Jackson Railroad in 1840 (see Fig. 44). In the Southern States the longitudinal planks,

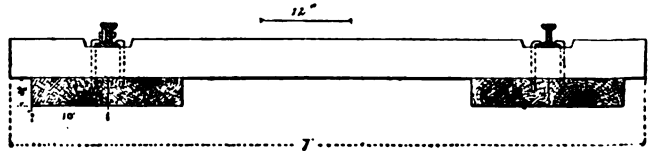

Fig. 44.

THE STEVENS RAIL AS LAID ON THE VICKSBURG AND JACKSON RAILROAD, IN MISSISSIPPI, 1840.

(From a drawing in the U. S. National Museum.)

which were placed under the ends of the cross-ties on many of the railroads, were called "mud-sills," and this name became historic during the civil war, 1861-'65.

The Stevens rail had come into general use in America before 1845, although several railway companies which had imported T-rails from England continued their use on their tracks until the rails were worn

out. For this reason the T-rail without base was in use on the *Boston and Worcester* in 1850 (see Fig. 45), and on the *Hempstead Branch of the Long Island Railroad* as late as 1855 (see Fig. 46).

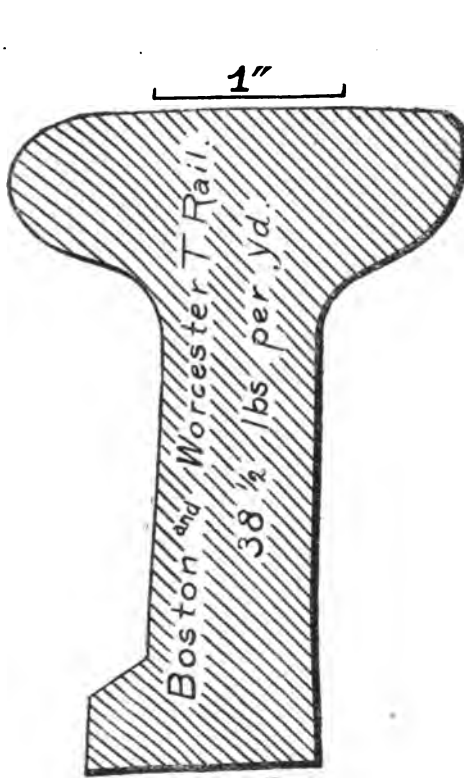

Fig. 45.

T-RAIL, BOSTON AND WORCESTER RAILROAD.
(From a drawing in the U. S. National Museum.)

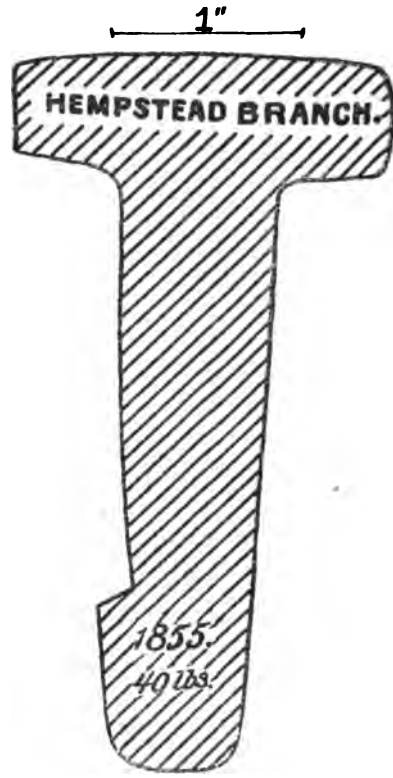

Fig. 46.

T-RAIL, HEMPSTEAD BRANCH, LONG ISLAND RAILROAD, 1855.
(From model in the U. S. National Museum.)

Every American road, however, without exception, replaced the T-rail and strap rail, by rail of the Stevens pattern, as rapidly as their financial condition permitted, continuing to import all rails from England until 1845.

THE STEVENS RAIL FIRST ROLLED IN AMERICA, 1845.

In the History of Iron of all Ages Swank states (p. 344) :

The Montour Rolling Mill, at Dauville, Pennsylvania, was built in 1845 expressly to roll rails, and here were rolled in October of that year the first T-rails* made in the United States, and that the first T-rail rolls in this country were made for the Montour Iron Company by Haywood & Snyder, proprietors of the Colliery Iron Works at Pottsville, the work being done at their branch establishment at Dauville, Pennsylvania, 1846.

Among other early rail mills were the following, with the date when

*As the form of the English T-rail was dispensed with in America, rails of the Stevens pattern (called H-rail in 1832) have been known as T-rails for many years.

they began to roll rails: Boston Iron Works, May 6, 1846; Trenton Iron Works, Cooper & Hewitt, proprietors, June, 1846; New England Iron Company, Providence, Rhode Island, September 1, 1846; Phoenix Iron Company, Phoenixville, Pennsylvania, November, 1846.

The rapidity with which American capital was diverted in this direction, has for the last forty years been one of the great arguments used by the advocates of a high tariff for the protection of American industries.

During the year 1848 a very interesting experiment was tried by the Camden and Amboy Railroad. Arrangements were made with Cooper & Hewitt, at the Trenton Iron Works, to roll a 92-pound rail, 7 inches high, with a base $4\frac{1}{2}$ inches wide; 15 miles of the Camden and Amboy road were laid with this rail the following year. The engineer of that company believed that he had at last solved the problem of track construction, inasmuch as this rail gave an admirable opportunity for a strong joint. By experience it was found that this rail was too rigid, and produced so much concussion by the train that the ends soon hammered out, and where the ballasting was imperfect great damage was caused to the rolling stock; consequently the rail was soon after taken up. Much of this old rail found its way to the cities, where it was bought by architects and contractors for building purposes.*

The fact that this rail was rolled successfully resulted in the introduction of the "I" beam for architectural purposes, Cooper & Hewitt having done a large business at the New Jersey Iron Works, at Trenton, in this line ever since that time. Fig. 47 is drawn from a section

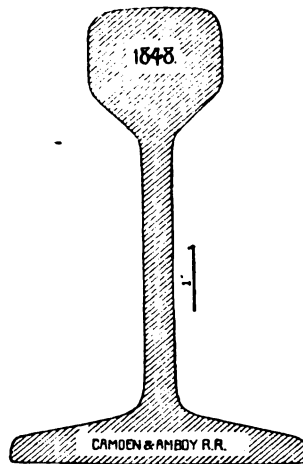

Fig. 47.

92-POUND RAIL, 7 INCHES HIGH, CAMDEN AND AMBOY RAILROAD, 1848.
(From original section in the U. S. National Museum.)

of this rail in the collection. It was laid between Bordentown and Burlington in 1849.

*Among other places, many of these rails were used for beams in the United States Mint at Philadelphia.

PEAR-SHAPED RAILS.

The early American T-rails were made of inferior iron, and this was one of the causes that led to the adoption of the section with a pear-shaped head, with which many roads were laid during the next fifteen or twenty years.

Sections of four of the pear-shaped rails described in the report of the railroad commission of the State of New York for 1845 are in the collection.

Cross-sections of these rails are shown.

Fig. 48 is a pear-shaped rail. New York and Erie Railroad. Fifty-six pounds to the yard. In use in 1855.

Fig. 49 is a pear-shaped rail. New York Central Railroad. Fifty-six pounds to the yard. In use in 1855.

Fig. 50 is a pear-shaped rail. Buffalo, Corning and New York Railroad. Sixty-two pounds to the yard. In use in 1855.

Fig. 51 is a pear-shaped rail. Saratoga and Schenectady Railroad. Sixty-five pounds to the yard. In use in 1855.

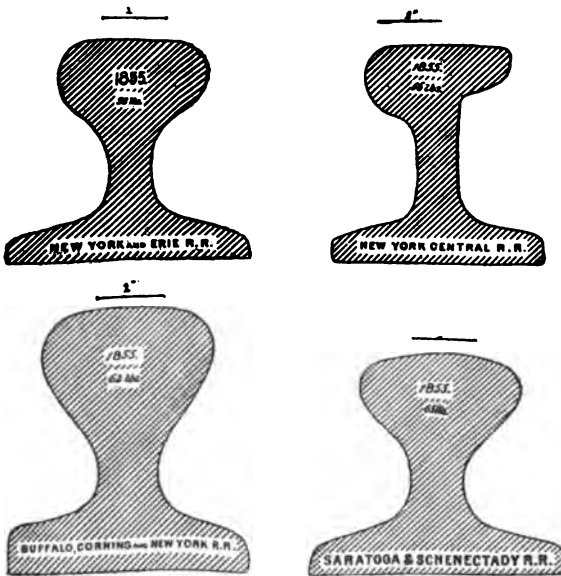

Figs. 48, 49, 50, 51.

PEAR-HEADED RAILS, 1855.

(From models, full size, in the U. S. National Museum.)

The obtuse angle between the lower side of the head and the stem of the rail made it difficult to apply a splice bar of any kind to advantage, and this fact led to the introduction of the ring joint (see Fig. 120) (one iron ring passing through two slots, one in each stem of adjacent rails and passing around under the base of the rail and held in position by a wedge driven between the ring and the rail stem). Chairs and other joint fixtures attached entirely to the base of the rail were also experi-

mented with, but generally without satisfaction, judging from the fact that none have survived.

The difficulty in making good joints with the pear-headed rail was overcome, by some of the engineers, by planing away a portion of the head of the rail for a foot or 18 inches from each end. In Fig. 52

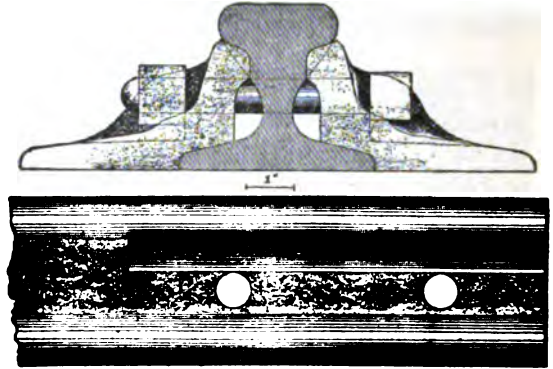

Fig. 52.
ERIE RAIL WITH ENDS STAMPED FOR ADAMS' CAST-IRON BRACKET SPLICE, 1857.
(From a drawing in the U. S. National Museum.)

shown a section of the pear-headed rail, fitted for splice bar, used on the Erie Railroad. On this rail a cast-iron angle splice, containing bolts and measuring 9 inches in length, was used as early as 1857.

On the Pennsylvania Railroad and on the Belvidere-Delaware Railroad, as will be seen in Fig. 53, the rails in some cases were planed

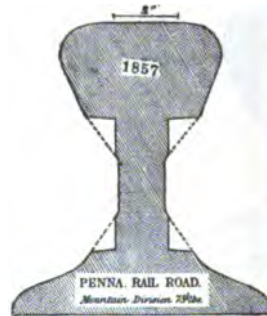

Fig. 53.
73-POUND RAIL, PENNSYLVANIA RAILROAD, MOUNTAIN DIVISION. UNDER HEAD
PLANED FOR SPLICE, 1857.
(From a drawing in the U. S. National Museum.)

special reference to the use of a splice bar almost square at the head and base, as early as 1857.

In 1853 an interesting experiment was tried on the Boston and Lowell Railroad. After running for some time on the head (pear-shaped

of the rail it was inverted. Fig. 54 shows the effect of running *on the base* for three years. The dotted line indicates the original section.

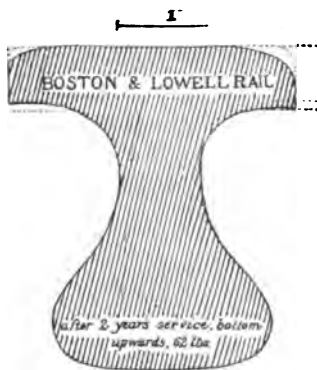

Fig. 54.
62-POUND PEAR-HEADED RAIL, BOSTON AND LOWELL RAILROAD. SHOWING WEAR AFTER TWO YEARS SERVICE, BOTTOM UPWARD.
(From a drawing in the U. S. National Museum.)

COMPOUND RAILS.

The difficulty in obtaining satisfactory joint fixtures on the American pear-shaped section led to the introduction of the compound rail.

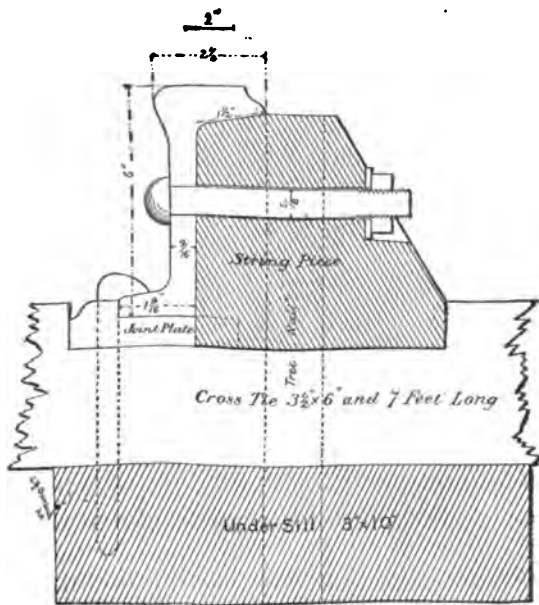

Fig. 55.
COMPOUND RAIL, WOOD AND IRON. DESIGNED BY B. H. LATROBE, 1841, FOR BALTIMORE AND OHIO RAILROAD.
(From a drawing in the U. S. National Museum.)

Fig. 55 is from a drawing of a compound rail of wood and iron designed by Benjamin H. Latrobe, in 1841, for the Baltimore and Ohio

Railroad. The Z-iron was 5 inches high and weighed 45 pounds to the yard. The track consisted of longitudinal under sills, which supported the cross-ties, $3\frac{1}{2}$ by 6 inches and 7 feet long. The wooden portion of rail was made to fit closely against the stem and under the head of the Z-iron, to which it was joined by five-eighths inch bolts with screw nuts. The iron and wood stringer was laid to "break joints," so that splice bars except a base plate was needed at the joints.

A section of an ingeniously devised all-iron compound rail laid on the Baltimore and Ohio Railroad in 1848 is shown in Fig. 56. A section of the original rail is in the collection.

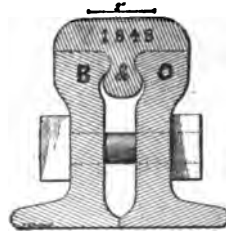

Fig. 56.

COMPOUND RAIL, BALTIMORE AND OHIO RAILROAD, 1848.

(From original section in the U. S. National Museum.)

Several of the railway companies in New York State laid a large mileage of compound rails of various patterns.

Fig. 57 is a drawing of a compound rail weighing 75 pounds to the yard, on the New York Central Railroad in 1855.

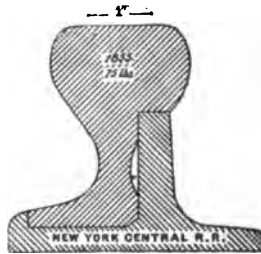

Fig. 57.

COMPOUND RAIL, NEW YORK CENTRAL RAILROAD, 1855.

(From original section in the U. S. National Museum.)

Four sections of compound rails in use in New York in 1855 are shown in Figs. 58, 59, 60, and 61.

Fig. 58. Compound rail. New York Central Railroad. Sixty pounds to the yard.

Fig. 59. Compound rail. New York Central Railroad. Seventy-five pounds to the yard.

Fig. 60. Compound rail. Troy Union Railroad. Sixty-five pounds to the yard.

Fig. 61. Wide compound rail. Troy Union Railroad. Sixty-five pounds to the yard.

Full-size models of these rails are in the collection.

When the track composed of this type of compound rails was new, it is described by those who rode upon it as being the finest track of the period. No satisfactory nut-lock was in use at that time, and as the screw-threads or rivets wore and traffic became heavier, the different parts of the rails could only be kept together by constant attention, in screwing up the nuts or putting in new rivets. As the rails laid were of iron, the wear of the inner surface was considerable, so that in a little while the track was badly damaged and the old solid rail was substituted.

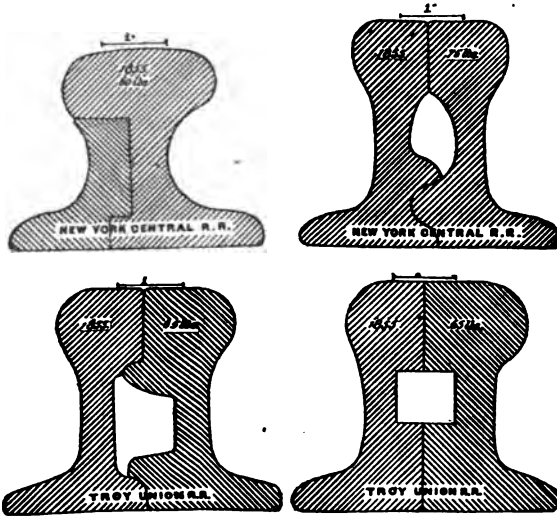

Figs. 58, 59, 60, 61.

COMPOUND RAILS, NEW YORK CENTRAL AND TROY UNION RAILROADS, 1855.
(From models in the U. S. National Museum.)

It is still an unsolved question whether or not, with some improvement in the section, and made of steel and held together with the improved bolt and nut-lock, the compound rail may be the rail of the future.

POOR RAILS LAID DURING WAR TIMES.

During the next ten years little seems to have been done by American railroad contractors to improve the shape of the rail or joint fixtures; in fact, during the civil war, iron was so dear that very little rail was rolled. Few new railroads were built and repairs to tracks were only made under the gravest necessity. Almost all the forms of rails which were made during these few years were designed by the proprietors of rail mills, who naturally adopted such shapes as were easy for them to make, and the railroads, when further delay was dangerous, went into the market and purchased such as were offered at the lowest price, without regard to the shape of the rail, the quality of the iron, or whether it was designed for light or heavy traffic.

THE ASHBEL WELCH RAIL.

After the close of the war in 1865, it became necessary to relay a large percentage of the mileage of almost every railroad. Upon many of the roads some rails were in use with which the roads were originally laid. The late Ashbel Welch, in "A Memoir on Rails," read before the American Society of Civil Engineers, June 10, 1874, states that "during the year 1865 the task presented itself to me of devising or selecting suitable forms of rails for the system of railroads occupying the central part of the State of New Jersey between Philadelphia and New York, of which I was the executive officer as well as engineer.

The 62-pound Ashbel Welch rail, which was rolled by the Bethlehem Iron Company during the following year, was $4\frac{1}{2}$ inches high, the base being 4 inches and the stem one-half an inch thick; the angle of inclination of bearing surfaces both on the top of the base and bottom of the head being 14 degrees.

Figs. 62 and 63 are from original sections of the Welch 50-pound and 62-pound rail in the collection. Substantially this form of rail was

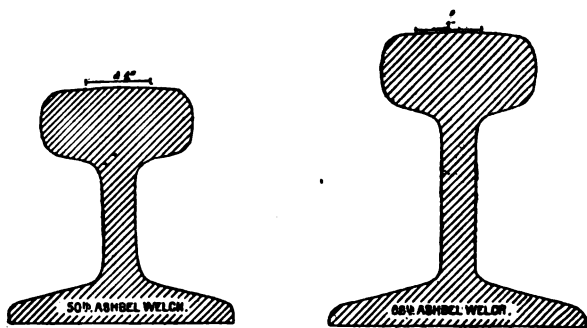

Figs. 62, 63.

ASHBEL WELCH RAILS, FIG. 62, 50 LBS. PER YARD; FIG. 63, 62 LBS. PER YARD, 1866.

(From original sections in the U. S. National Museum.)

adopted by the railroads in the Eastern and Middle States previous to the year 1873, although when the rails were first laid the cross-section was strongly objected to.

Mr. Welch's labors in this direction led to his being considered one of the foremost rail designers in America, and in 1873 he was appointed chairman of a committee by the American Society of Civil Engineers to report on the "form, weight, manufacture, and life of rails," the other members being M. N. Forney, O. Chanute, and I. M. St. John. The report of that committee, presented at the annual convention, June, 1874, was the most exhaustive treatise on the subject of rails published up to that time.

In Mr. Welch's memoir attached to that report, in alluding to his pattern of 1865, he states: "I made one decided mistake in this pattern by not having the outer bottom corners of the head sharp enough, or rather I yielded too much to the feeling against such an unsightly

thing as an angle head." The rail proposed by Mr. Chanute in the same report is not dissimilar to the section of standard 66-pound rail now in use on the Chicago, Burlington and Quincy and several other railroads. Fig. 64 is from a drawing in the collection.

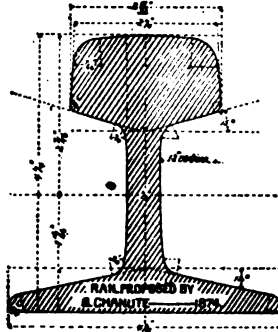

Fig. 64.
RAIL PROPOSED BY O. CHANUTE, 1874.
(From a drawing in the U. S. National Museum.)

English engineers had, in the mean time, given considerable attention to the Ω rail (or "box rail," as it is sometimes called) both in England and in Canada.

Imported Ω rails were laid as early as September, 1835, on the Wilmington and Susquehanna Railroad. In 1845 a modification of the Ω rail was laid on the Drogheda Railway in Ireland—the rail being compressed inwardly at the bottom until the inside corners were made to touch. In America a small quantity of a similar rail was manufactured at the Mount Savage rolling mill, called "hollow rail." This was done by heating the rail after it had been rolled to size and passing it through a set of rods designed for the purpose.*

A cross-section of this form of rail in use on the Great Western Railway of England is shown in Fig. 65, while in Fig. 66 a cross-section

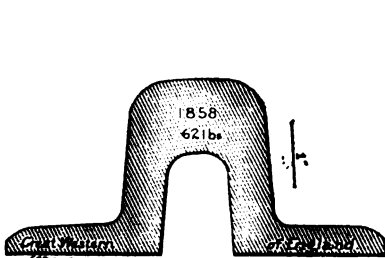

Fig. 65.
"BOX RAIL," GREAT WESTERN RAILWAY OF ENGLAND, 1858.
(From a drawing in the U. S. National Museum.)

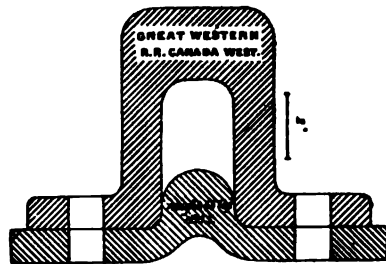

Fig. 66.
GREAT WESTERN RAILWAY OF CANADA, 1855.
(From a drawing in the U. S. National Museum.)

of the Ω rail with a metal shoe running the full length of the rail to which it was bolted (thus adding to its strength), as used on the Great

*If any of the rail was laid, I fail to find the fact recorded.

Western Railway of Canada, is shown. Both of these figures are from drawings in the collection.

The Ω rail was in use in several of our Southern States during the war of 1861-'65.

It was found that the Ω rail was almost certain to fail when laid on cross-ties, and for this reason roads, notably the Nashville and Chattanooga, that used it always favored the superstructure with the rail bearing on a longitudinal stringer instead of a cross-tie.

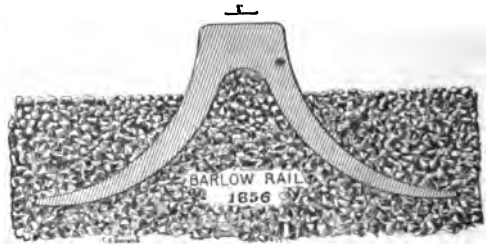

Fig. 67.
BARLOW'S "SADDLE-BACK" RAIL, 1856. LAID WITHOUT SUPPORTS.
(From a drawing in the U. S. National Museum.)

Fig. 67 is from a drawing of Barlow's "saddle-back rail" in the collection. This rail has an extreme width of 13 inches and were designed to dispense with the use of wooden ties or stringers in track construction.

The rail was laid in broken stone with tie bars 10 feet apart. Many hundred miles of this type of rail were laid in England prior to 1850. A mile or two also were laid on the Reading Railroad in the United States. "Between 5 and 6 miles of this rail, closely riveted together, were used in England in 1856 and were in use for several years without experiencing any difficulty from expansion."*

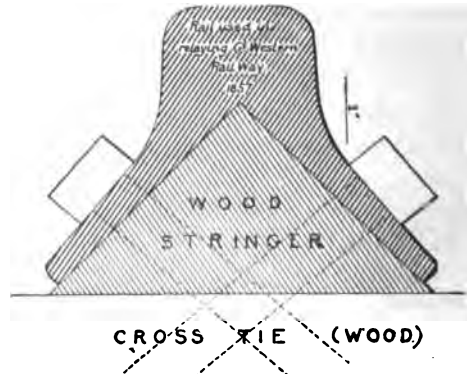

Fig. 68.
TRIANGULAR WOODEN STRINGER CAPPED WITH IRON, GREAT WESTERN RAILWAY OF ENGLAND, 1857.
(From a drawing in the U. S. National Museum.)

A triangular wood stringer capped with iron was used on the Great Western Railway when that road was relaid in 1857. The rail was held in place by bolts as shown in Fig. 68, made from a drawing in

*Colburn & Holly, p. 92.

collection. As no splice bars save a thin plate to protect the wood at the end of the rail were used, this rail was expected to become popular, but its use was abandoned a few years afterwards.

Previous to 1850 English rails were usually rolled in lengths of 15, 16, and 18 feet; by 1855 the latter length became the universal standard.

As improved methods were adopted in iron manufacture, the length was increased in order to reduce the number of joints.* By 1857 rails were made at progressive mills 21 to 24 and 27 feet long and by 1860-'65 the 30-foot limit was reached.

Although longer lengths have been manufactured at a few mills, the 30-foot rail has been considered the standard for over a quarter of a century.

STEEL RAILS.

The first steel rails in Europe are said to have been rolled at the Ebbw Vale Works, in Wales, about 1855. The steel was produced by the Uchaturis process. Zerah Colburn states that "the quality of the steel is said to be equal to that used for razors."

The difficulty in obtaining good iron on this side of the water led the more prosperous American companies to continue to import steel and iron rails from abroad for some years.

Fig. 69 is a cross-section of the steel rails rolled at Dowlais, Wales, for the New Orleans, Memphis and Chattanooga Railroad in 1869, from a drawing in the collection.

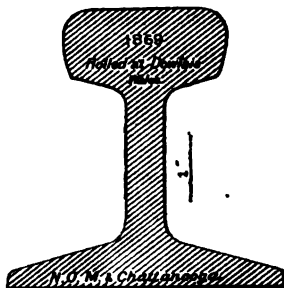

Fig. 69.

RAIL FOR NEW ORLEANS, MEMPHIS, AND CHATTANOOGA RAILROAD,
ROLLED AT DOWLAIS, WALES, 1869.
(From a drawing in the U. S. National Museum.)

STEEL RAILS ROLLED IN AMERICA.

The introduction of Bessemer steel in America and the conflicts in the United States Patent Office, which finally resulted in a compromise and consolidation of the various interests involved, form a very interesting chapter in the history of American manufacture.

In Swank's "History of Iron in all Ages" I find that "the first steel rails ever made in this country were rolled at the North Chicago Rolling Mills in May, 1865." These were experimental rails, only a few

* In 1840 it was not uncommon to find eight hundred joints in a mile of single track. Now, 1890, the number is reduced to about three hundred and fifty.

being rolled in the presence of a committee of the American Iron and Steel Association.

The first steel rails ever rolled in the United States upon order in the way of regular business were rolled by the Cambria Iron Company, Johnstown, Pennsylvania, in August, 1867. In no one year during the next five years were more than 40,000 tons of Bessemer steel rails manufactured in the United States.

About 1870-73 attempts were made by several rail manufacturers to roll rails that should have a steel head and iron web and flange—"standard top rail," it was called. A considerable quantity of this rail was rolled by the Trenton Iron Company for the New Jersey division of the Pennsylvania Railroad Company. While this experiment was reasonably successful the lessened cost of making steel, soon afterwards made it practicable to make the whole rail of steel.

The production of steel rails, which aggregated 90,000 tons in 1870, increased from year to year, so that in 1882, ten years later, the output reached nearly 1,500,000 tons, the price falling from \$140 to \$35—one-quarter the cost of ten years before.

During the last ten or twelve years no radical change has been made in the shape of the section of rails laid by first-class railroads. It is true that the constantly increasing weight of the locomotive and of the loading of the freight cars has made it necessary to use heavier rails, but the increased metal being put in the head, where the traffic is heavy, or in the base (the base of some standard sections being made as wide as 5 or 5½ inches), where the cross-ties upon which the rail is laid are of soft wood. The general shape of the rail has, however, been but slightly changed.

Sections of the standard rails laid by the Pennsylvania Railroad Company are shown in Figs. 70, 71, 72, 73, 74, 75, and by the Chicago, Burlington and Quincy Railroad Company* in Figs. 76, 77, 78, 79.

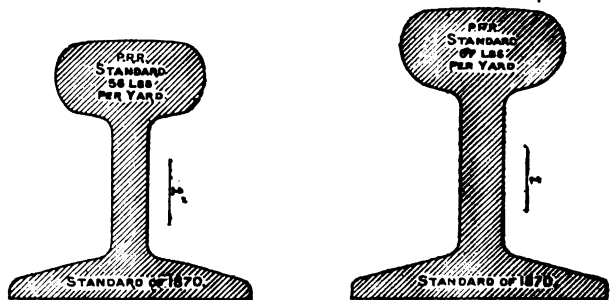

FIG. 70.

FIG. 71.

PENNSYLVANIA RAILROAD STANDARD RAILS, 1870.

(From drawings in U. S. National Museum.)

* For abstract of letter from Mr. F. A. Delanoë, second vice-president Chicago, Burlington and Quincy Railroad, giving interesting historical data regarding rails used on the Chicago, Burlington and Quincy Railroad, see below.

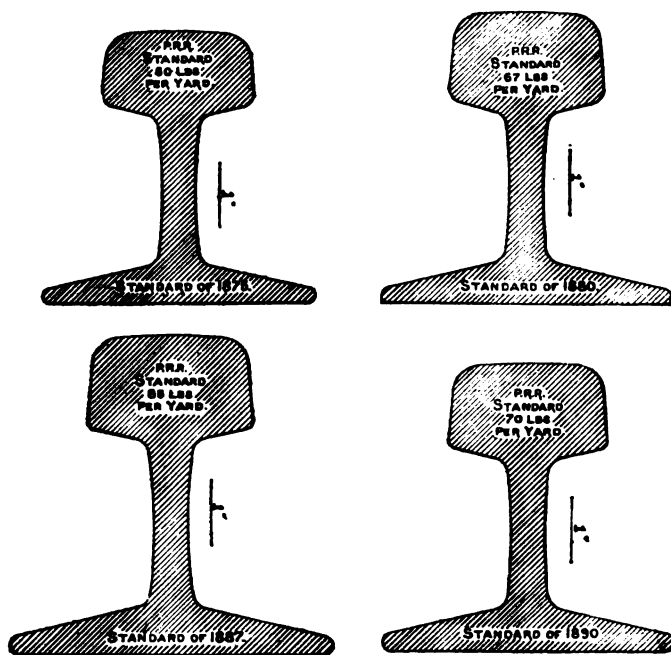

Figs. 72-75.

PENNSYLVANIA RAILROAD STANDARD RAILS, 1875, 1880, 1887, 1890.
(From drawings in the U. S. National Museum.)

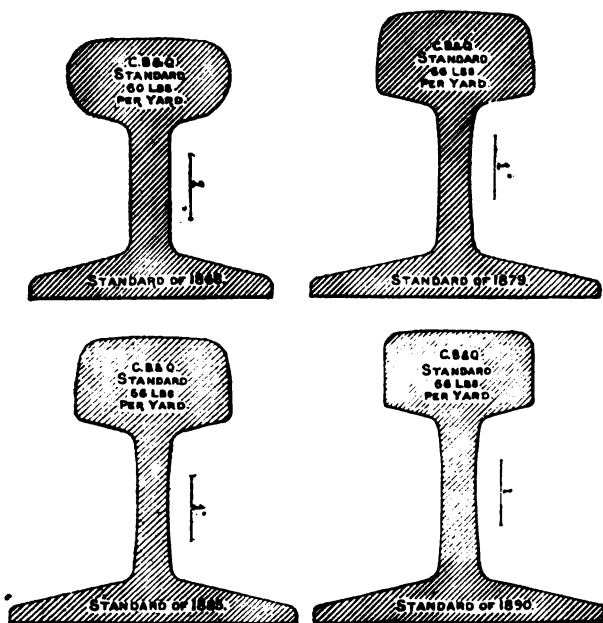

Figs. 76-79.

STANDARD CHICAGO, BURLINGTON AND QUINCY RAILROAD COMPANY'S STANDARD RAILS,
1868, 1878, 1885, 1890.

(From chart furnished by Chicago, Burlington and Quincy Railroad.)

Figs. 80, 81, 82, 83, 84, 85, and 86 show sections of the rails manufactured during various years at the works of the Bethlehem Iron

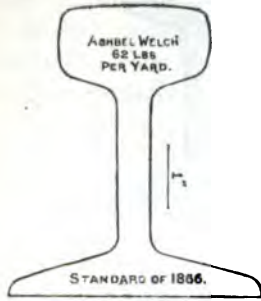

Fig. 80.

RAIL ROLLED BY THE BETHLEHEM IRON COMPANY, ASBEL WELCH PATTERN, 62 POUNDS, 1866.

(From chart furnished by the Bethlehem Iron Company.)

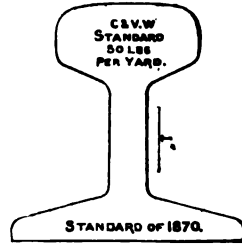

Fig. 81.

RAIL ROLLED BY THE BETHLEHEM IRON COMPANY, C.V. AND W. RAILROAD PATTERN, 50 POUNDS, 1870.

(From chart furnished by the Bethlehem Iron Company.)



Fig. 82.

RAIL ROLLED BY THE BETHLEHEM IRON COMPANY, HIGH VALLEY RAIL PATTERN, 40 POUNDS.

(From chart furnished by the Bethlehem Iron Company.)



Fig. 83.

RAIL ROLLED BY THE BETHLEHEM IRON COMPANY, ST. LOUIS AND SANTA FE RAILROAD PATTERN, 52 POUNDS, 1879.

(From chart furnished by the Bethlehem Iron Company.)

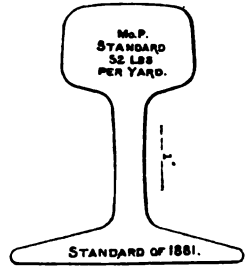

Fig. 84.

RAIL ROLLED BY THE BETHLEHEM IRON COMPANY, MISSOURI PACIFIC RAILROAD PATTERN, 52 POUNDS, 1881.

(From chart furnished by the Bethlehem Iron Company.)

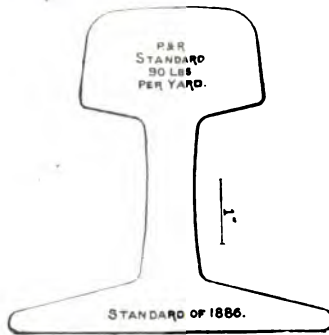

Fig. 85.

RAIL ROLLED BY THE BETHLEHEM IRON COMPANY, PHILADELPHIA AND READING PATTERN, 90 POUNDS, 1886.

(From chart furnished by the Bethlehem Iron Company.)

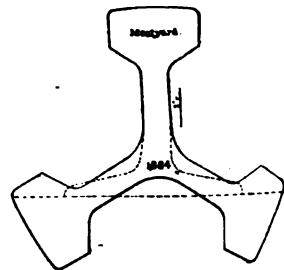

Fig. 86.

RAIL ROLLED BY THE BETHLEHEM IRON COMPANY, "MEAT-YARD PATTERN," 1886.

(From chart furnished by the Bethlehem Iron Company.)

pany. The plates are made from drawings courteously furnished the officials of this company.

Sections of rail rolled by the Phoenix Iron Works during the years 1855, 1856, and 1857 are illustrated under the paragraph devoted to splices. (See Figs. 115, 116, 117.)

THE STEVENS RAIL IN EUROPE.

About 1837 a rail with a base similar to the Stevens rail was designed by Charles Blacker Vignoles, an English railway engineer, and the names "Vignoles's rail" and "contractor's rail" have been applied to the various modifications of the Stevens rail, both in England and on the continent, since that time.

A section of the Stevens rail, 4½ inches high, with a base 6 inches wide, in use on the Great Western Railway of England in 1858, is shown in Fig. 87, which is made from a drawing in the collection. This

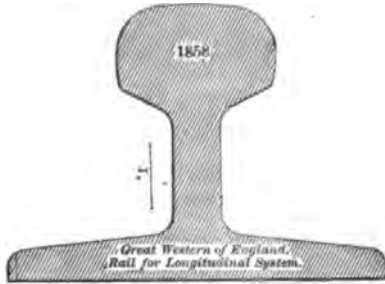

Fig. 87.

STEVENS RAIL LAID ON GREAT WESTERN RAILWAY, OF ENGLAND (LONGITUDINAL SYSTEM), 1858.
(From a drawing in the U. S. National Museum.)

rail was made with a wide base in order that it should have sufficient bearing on the stringer, to which it was attached by screw bolts. The Great Western was a broad-gauge railroad, the gauge being 7 feet.

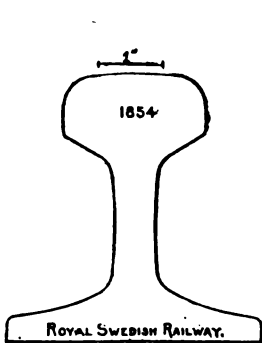

Fig. 88.

STEVENS RAIL ADOPTED BY THE ROYAL RAILWAY OF SWEDEN, 1854.
(From drawing in the U. S. National Museum.)

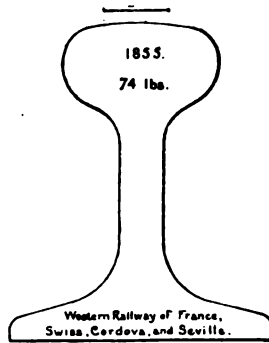

Fig. 89.

STEVENS RAIL IN USE ON THE WESTERN RAILWAY OF FRANCE, 1855.
(From drawing in the U. S. National Museum.)

The types of Stevens rail adopted by the Royal Swedish Railway in 1854 and by the Western Railway of France in 1855 are shown in Figs. 88 and 89, made from drawings in the collection.

A cross-section of the "rail Vignole," about $5\frac{1}{2}$ inches high, with base $5\frac{1}{4}$ inches wide, in use on the Chemin de fer Du Nord, France, 1888, is shown in Fig. 90, which is made from a drawing in the collection.

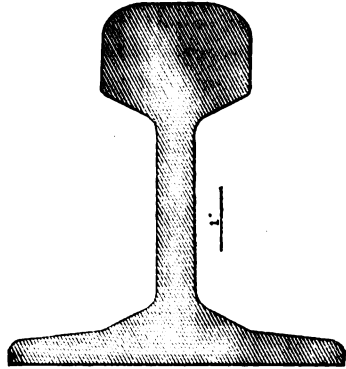

Fig. 90.
STEVENS RAIL, CHEMIN DE FER DU NORD, FRANCE, 1888. (CALLED THE VIGNOLE RAIL IN EUROPE).
From a drawing in the U. S. National Museum.

A cross-section of the standard rail adopted by the Belgian authorities for the government railroads, 1889, is shown in Fig. 91. The modification of the Stevens rail was designed by Mr. C. P. Sandberg.

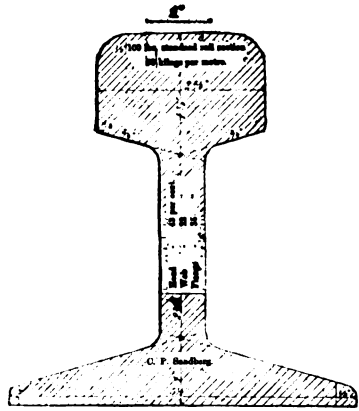

Fig. 91.
STANDARD RAIL OF BELGIAN GOVERNMENT RAILWAYS, 1889. SANDBERG SECTION.
From a drawing in the U. S. National Museum.

special reference to joint fixtures, cost and speed, and the loading of trains which are to run over it. The rail is $5\frac{3}{4}$ inches high, with $5\frac{1}{2}$ inches wide, and weighs about 100 pounds per yard.

THE "BULL-HEADED" RAIL.

The bull-headed rail was originally designed with a view to use the top and, after the top had become worn, the bottom as a rail.

surface, and in some cases as shown in the rail laid on the Strasbourg Railway in 1858, the top and bottom were rolled exactly alike. (See Fig. 92, made from the drawing in the collection.) But as it was found

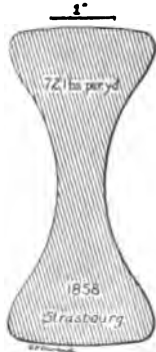

Fig. 92.

BULL-HEADED RAIL—STRASBOURG RAILWAY, 1858.

(From a drawing in the U. S. National Museum.)

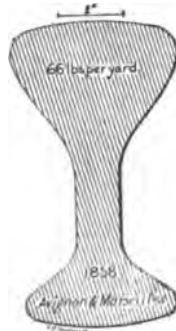

Fig. 93.

BULL-HEADED RAIL—AVIGNON AND MARSEILLES RAILWAY, 1858.

(From a drawing in the U. S. National Museum.)

that the wear of the rail in the chairs made the lower surface rough, this practice was abandoned, and a larger portion of the metal has since generally been put into the head to give increased wearing surface. A section of the rail designed with this end in view, and in use on the Avignon and Marseilles Railway in 1858, from a drawing in the collection, is shown in Fig. 93.

English railway managers continue to lay the "bull-headed" rail in chairs in a very similar manner to what was done fifty or sixty years ago.



Fig. 94.

BULL-HEADED RAIL—BATH BRANCH GREAT WESTERN OF ENGLAND, 1858.

(From a drawing in the U. S. National Museum.)

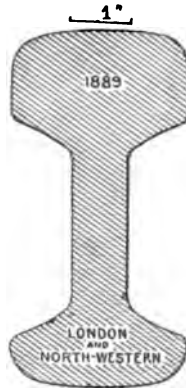

Fig. 95.

BULL-HEADED RAIL—LONDON AND NORTH-WESTERN RAILWAY, 1889.

(From original in the U. S. National Museum.)

Cross-sections of the rail laid on the Great Western Railway in 1858 is shown in Fig. 94 (from a drawing in the collection), and a cross-section of the rail of the London and Northwestern Railway in 1889 is shown in Fig. 95 (from an original rail in the collection).

STRINGERS AND TIES OF WOOD.

The high price of iron led the engineers of many early roads, built upon a small capitalization to design a superstructure composed mainly of wood, as little iron as possible being used. The wooden rail, capped with strap-iron, previously alluded to, was attached to longitudinal stringers, and these were kept "in line" by cross timbers 4, 5, and sometimes 6 feet apart.

On roads laid with English T-rails in chairs, or with the Stevens rail spiked to the support, the necessity for a longitudinal support for the rail did not exist, and the stringer being dispensed with, it became necessary to put the cross-ties closer together.

Ties have been used from time to time of various widths, lengths, and thicknesses, split, sawed, and hewn, as illustrated in Figs. 96, 97, and 98.



Fig. 96.
CROSS-TIE—SPLIT QUARTER LOG.

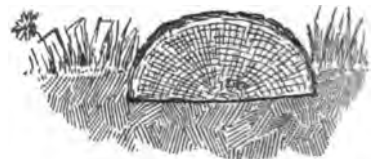

Fig. 97.
CROSS-TIE—SPLIT HALF LOG.

The specifications for cross-ties now require that they be hewn on both sides, as shown in Fig. 98, and that they be cut to exact lengths, 96 or 102 inches.

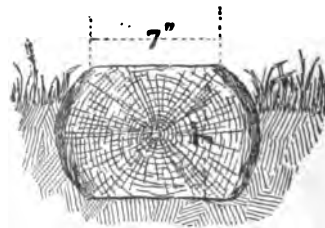

Fig. 98.
CROSS-TIE—WHOLE LOG HEWN BOTH SIDES.

METAL TIES.

The extensive use of metal ties in foreign countries has led a few American managers to put down a limited number of experimental iron ties on their roads. About two thousand iron ties of the standard adopted by the London and Northwestern Railway of England, were

placed in the tracks of the Pennsylvania Railroad Company about a year ago. Fig. 99 illustrates a steel cross-tie* with rail fastenings, in

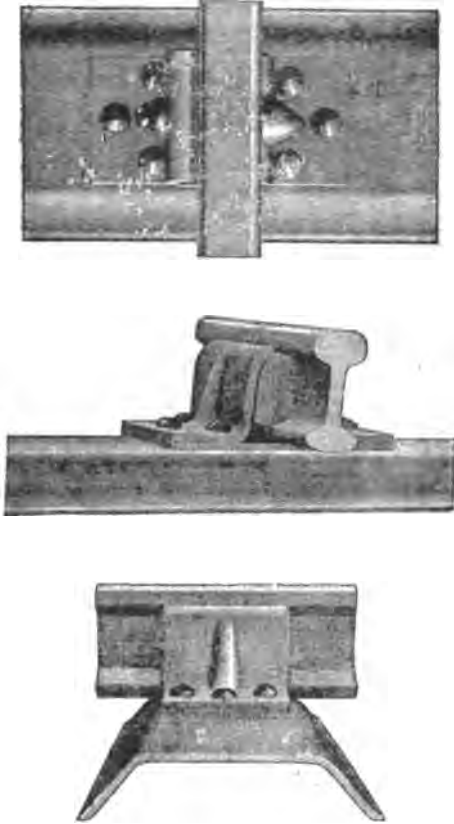

Fig. 99.

STEEL TIE AND PERMANENT WAY, LONDON AND NORTHWESTERN RAILWAY, 1885.

(From original in the U. S. National Museum.)

the collection. It is the opinion of the chief engineer of the Pennsylvania Railroad that the iron tie will not be extensively used in America as long as white-oak standard cross-ties can be purchased for \$1 or less.^f

An exhaustive report upon the iron cross-ties used by European railways, compiled by Russel E. E. Tratman, of the Engineering News, will be found in the report of B. E. Fernow, chief of the Division of Forestry, in Bulletin No. 3 of the U. S. Agricultural Department.

* Presented to the U. S. National Museum by Mr. F. W. Webb, general locomotive superintendent London and Northwestern Railway, Crewe, England. Compare Plate III (opposite page 124). Report of the U. S. National Museum for 1886.

† Seventy cents is the price paid for a white oak cross-tie 7 by 7 inches, 8½ feet long, by the Pennsylvania Railroad in 1890.

METAL TRACK IN ENGLAND AND HER COLONIES.

Fig. 100 illustrates the steel cross-tie, riveted chair and wedge in use on the London and Northwestern Railway in 1889. Steel wedges as well as wedges of wood are used to keep the "bull-headed" rail in place.

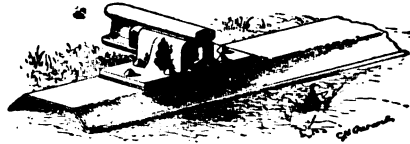

Fig. 100.

METAL TRACK, LONDON AND NORTHWESTERN RAILWAY OF ENGLAND, 1889.
(From a drawing in the U. S. National Museum.)

The iron cross-tie on the Midland Railway is somewhat similar to that used on the London and Northwestern (see Fig. 101). The chair, however,



Fig. 101.

METAL TRACK, MIDLAND RAILWAY OF ENGLAND, 1889.
(From a drawing in the U. S. National Museum.)

is attached to the cross-tie by bolts and nuts, instead of by rivets as in the former system. The ends of the ties on the outer sides of the double tracks are generally depressed as shown. Between the tracks the ends are left open, so that the ballast may be properly tamped.

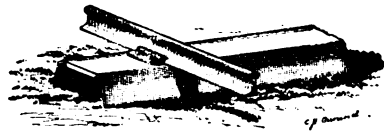

Fig. 102.

METAL TRACK, NORMANTON LINE, QUEENSLAND, 1889.
(From a drawing in the U. S. National Museum.)

Iron cross-ties are also used on the Normanton line, Queensland, see Fig. 102, the rail being held in position by an adjustable clip, on the inside of the base, with nut and screw arranged so that slight corrections in the gauge can be made when necessary.



Fig. 103.

METAL "POT" TIE SYSTEM, MIDLAND RAILWAY OF INDIA, 1889.
(From a drawing in the U. S. National Museum.)

On the Indian Midland Railway the cast "pot" tie has been used with favorable results. See Fig. 103. The gauge is maintained by iron rods

extending across the track and held in position by wedges driven into a slot in the end of each tie bar.

HOLLAND, GERMANY AND BELGIUM.

The "Post" tie, see Fig. 104, has been used extensively on the continent of Europe. The section varies in depth and width at the center,

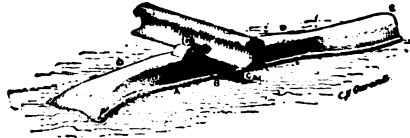

Fig. 104.
METAL TRACK, HOLLAND "POST" TIE, 1889.
(From a drawing in the U. S. National Museum.)

quarter, and ends; being the deepest in the center, an admirable opportunity is given for ballasting. The rail is held to the tie by an adjustable clip fastened by bolt and nut.



Fig. 105.
METAL TRACK, GREAT CENTRAL RAILWAY OF BELGIUM, 1889.
(From a drawing in the U. S. National Museum.)

The iron ties used on the Great Central Railway of Belgium (see Fig. 105), are also made narrow in the middle, and the rail on this tie is fastened with a screw bolt, the head of which has a direct hold on the base of the rail.

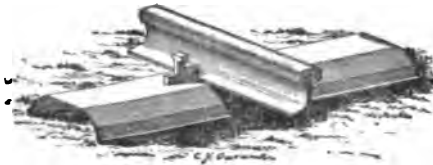

Fig. 106.
BERGH AND MARCHÉ METAL TRACK SYSTEM, ELBERFELD RAILWAY, GERMANY, 1889.
(From a drawing in the U. S. National Museum.)

The Bergh and Marche system is used on the Elberfeld Railway, of Germany. The fingered fastening slides over the base of the rail, holding it to the tie. See Fig. 106.

On the Right-Bank-of-the-Rhine Railway, the Haarman longitudinal system is now in use (See Fig. 107). Iron cross-ties are first imbedded

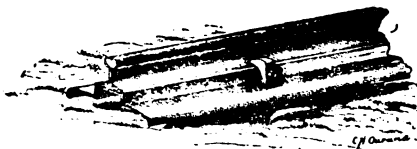

Fig. 107.

HAARMAN LONGITUDINAL METAL TRACK, RIGHT-BANK-OF-THE-RHINE RAILWAY, 1889.
(From a drawing in the U. S. National Museum.)

in the ground, and to these the longitudinal iron sleepers are fastened. The base of the rail is held in place by a very complicated system of fastening.

FRANCE, EGYPT, SPAIN, ETC.

The Vantherin tie, which is used on several French railways, is similar in shape to that used on the Midland Railway, of England, the chair being attached to the tie by bolt and nut. See Fig. 108.



Fig. 108.

METAL TRACK, VAUTHERIN SYSTEM, FRANCE, 1889.
(From a drawing in the U. S. National Museum.)

On the Egyptian Agricultural railroads the Stevens rail is laid in a series of short pieces of stamped iron which are held in place by

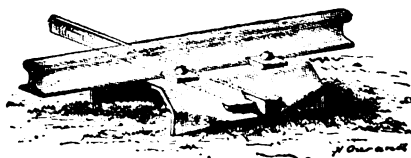

Fig. 109.

METAL TRACK, EGYPTIAN AGRICULTURAL RAILWAY, 1889.
(From a drawing in the U. S. National Museum.)

rods. This system is in use through portions of Egypt where the nature and character of the soil make it possible to use this system, which is similar to the "pot" tie system in India. See Fig. 109.

On the Bilbao and Las Arenas Railway, of Spain, a system (see Fig. 110) is in use similar to the "Post" system as far as the fastenings are



Fig. 110.
METAL TRACK, BILBAO AND LAS ARENAS, SPAIN, 1889.
(From a drawing in the U. S. National Museum.)

concerned. The cross section of the tie does not vary, however, either in depth or width.

The bull-head rail is laid on "pot" ties on portions of the Central Railway of the Argentine Republic. This system requires the use of



Fig. 111.
METAL TRACK, CENTRAL RAILWAY, ARGENTINE REPUBLIC, 1889.
(From a drawing in the U. S. National Museum.)

the chair with wedge fastening, (see Fig. 111). The rails are held to gauge by iron tie-rods.

JOINT FIXTURES.

Failure of the rail at the joint has from the beginning of railway construction directed thought towards the invention of the ideal fixture "as strong at the joint as at any part of the rail," an ideal which, after sixty years of experiment, has not yet been attained.

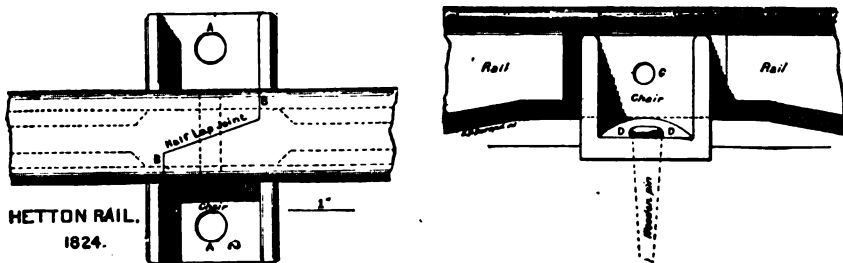
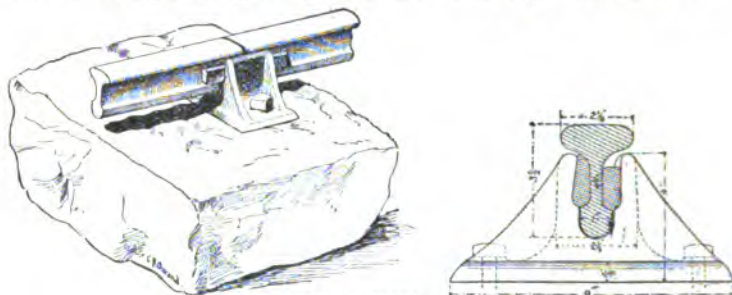

Fig. 12.
HALF-LAP JOINT, HETTON RAIL, 1824.
(From a drawing in the U. S. National Museum.)

The miter or "half lap joint" was used on the Hetton Colliery road in England in 1824. Fig. 112 is from a drawing in the collection.

The wooden pin shown secured the chair to a short wooden pile driven into the ground. The rails were 4 feet long. The joint fixtures in tracks laid with various types of T-rails* were chairs slightly longer than those in the quarters and middle of the rail, and the ends of the rail were held in place by wedges, as shown in Figs. 113 and 113a.



Figs. 113, 113a.

JOINT CHAIR AND WEDGE, OLD PORTAGE RAILROAD, 1832.

(From original in the U. S. National Museum.)

The drawing is made from one of the original stone blocks from the old Portage Railroad in Pennsylvania, 1832, with rail and chair complete, which is in the collection. The rails, chairs, and joint fixtures for that road were manufactured in England in 1830.

THE BEGINNINGS OF THE SPLICE BAR.

The splice-bar or fish-plate was of necessity an American invention since the Camden and Amboy Railroad, which was the first iron rail laid without chairs, found it necessary to use it. In Robert L. Stevens' original specifications, each rail was to have a projection on the stem at one end, which was intended to be riveted to the stem of the adjoining rail. Owing to impracticability of manufacture this plan was not

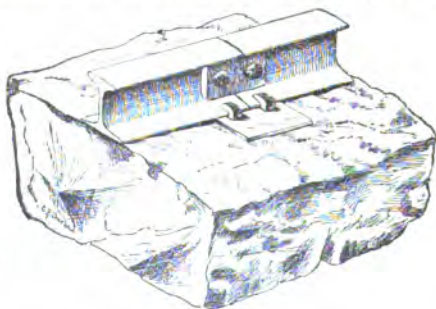

Fig. 114.

STONE BLOCK, RAIL, AND JOINT TONGUE LAID ON CAMDEN AND AMBOY RAILROAD IN 1830.

(From original specimen in the U. S. National Museum.)

carried out, and joint tongues (an illustration of which is to be found in the Report U. S. National Museum for 1886, Figs. 1 and 2, Plate opposite page 122) were used. These iron tongues were attached to the stems of the rail with hot rivets. Fig. 114 is from a drawing made for

* T-rails were first rolled in lengths of 8, 12, and 16 feet.

an original stone block, rails, and joint fixtures, which were laid on the Camden and Amboy Railroad in 1830 and taken out of the track when the road was relaid with cross-ties a few years later.*

As will be seen by reference to Fig. 40 † the Camden and Amboy Railroad Company used the fish plate with screw-bolt and nut previous to 1837. This practice does not appear to have been pursued in England until ten years later. It is stated that “the fish joint (with bolts through the stem of the rail) was designed by W. Bridges Adams, 1847, and has been applied throughout the London and Northwestern Railway.” ‡

Rolled fish-plates 18 inches in length came into general use about 1850-'55. In 1858 those on the North London Railway of England were 27 inches long. Figs. 115, 116, and 117 are from drawings of the rails

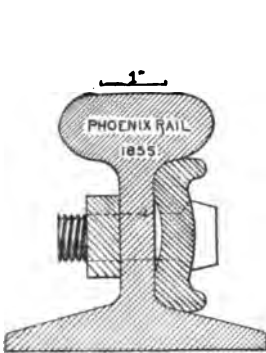

Fig. 115.

SINGLE SPLICE BAR FOR RAIL,
ROLLED BY THE PHOENIX IRON
COMPANY, 1855.
(From chart furnished by the Phoenix
Iron Company.)

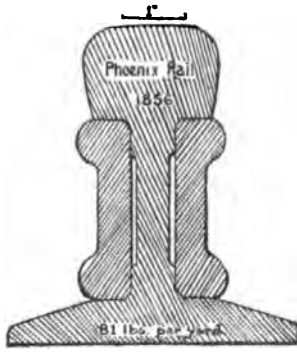

Fig. 116.

DOUBLE SPLICE BAR FOR RAIL,
ROLLED BY THE PHOENIX IRON
COMPANY, 1856.
(From chart furnished by the Phoenix
Iron Company.)



Fig. 117.

DOUBLE SPLICE BAR FOR RAIL,
ROLLED BY THE PHOENIX IRON
COMPANY, 1857.
(From chart furnished by the Phoenix
Iron Company.)

and splice-bars manufactured by the Phoenix Iron Company, of Phoenixville, Pa., previous to 1857. The figures are made from a chart § which the company had prepared in that year to show the many shapes of iron they were prepared to roll.

*On some roads the ends of the rails were simply spiked to the stone block or wooden stringer, and no attempt was made to fasten the rails to each other.

† From Stevenson's Engineering in North America, 1837.

‡ The Permanent Way of European Railways, Colburn & Holley, N. Y., 1858.

§ This chart, the only one in existence, was forwarded by the Phoenix Iron Company to Washington for inspection. For this courtesy the curator is indebted.

Fig. 118 shows the standard splice bar adopted by the Pennsylvania Railroad in 1870.



Fig. 118.

PLAIN SPlice BAR, PENNSYLVANIA RAILROAD, 1870.
(From a drawing in the U. S. National Museum.)

WOODEN BLOCK JOINTS.

The cost of the iron joint fixtures led to experiments with wooden blocks as early as 1840. Many roads that had used nothing but wood and iron tie plates at the joints, added materially to the strength of these joints by drilling the stem of the rail, and bolting a block of wood of the proper shape to the outer side of the rail. About 1860 some of the Eastern roads adopted a standard joint fixture composed of a wooden block 48 inches long for the outside of the rail and an iron splice bar to fit closely against the stem on the inside. Fig.

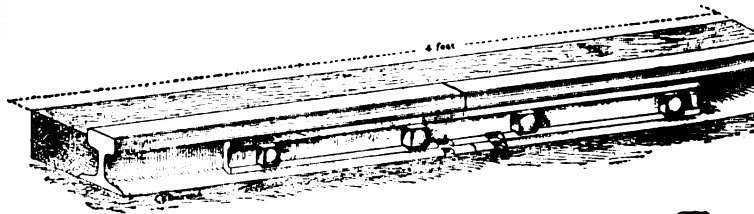

Fig. 119.

WOODEN JOINT BLOCK, NEW JERSEY RAILROAD, ABOUT 1860.
(From original in the U. S. National Museum.)

drawn from a set of the original joint fixtures that had been used on the tracks of the present New York Division of the Pennsylvania Railroad for many years.* Many of these blocks were used with steel rails and made excellent track, when kept in proper repair.

SLOT RAIL AND RING JOINT.

About 1850, on some parts of the Camden and Amboy and West Jersey Railroads, the ring joint was used. A slot about 2 inches long was cut in the stem of each rail at both ends; into these slots a ring

* Presented to the National Museum by Mr. James R. Smith, supervisor New York Division Pennsylvania Railroad, Newark, N. J.

slipped which encircled the base, to which it was secured by a wedge driven on each side of the stem between the ring and the base of the rail.

Fig. 120 is drawn from a ring joint and wedges which were in the track of the West Jersey Railroad for many years.*

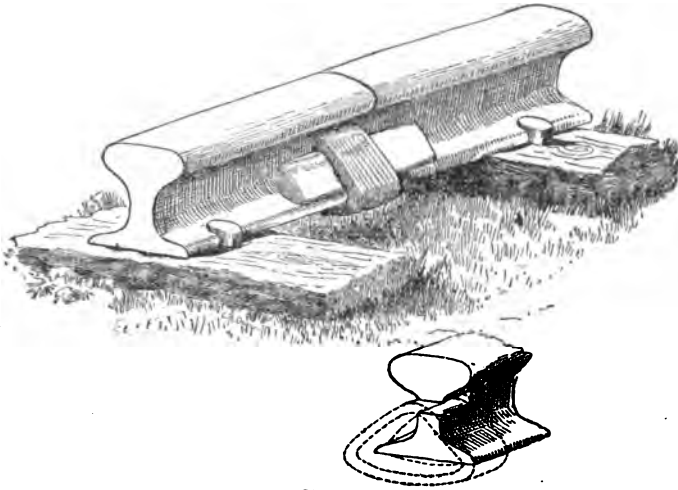

Fig. 120.
RING, JOINT, AND WEDGE USED ON THE WEST JERSEY RAILROAD.
(From original in the U. S. National Museum.)

About 1850, G. Samuels patented the method of scarfing the rail-heads and bending the ends of the rail so that the stems could be riveted together in the same way that boiler plates are put together, but this invention was not put into practice.

THE ANGLE SPLICE BAR.

As early as 1857 the angle splice bar (or cast-iron bracket joint, as it was then called) was tried on the Erie Railroad. The form of this splice-bar has been already illustrated in Fig. 52. It was abandoned after a short trial.

The wrought-iron angle splice-bar, somewhat similar in section to the Adams cast bracket joint, seems to have come into use about 1868.

*Presented to the Museum by Mr. W. McAllister, master mechanic of the Pennsylvania Railroad, at Camden, N. J.

Figs. 121, 122, 123, and 124* show the variations in form of the angle bar on the Pennsylvania Railroad, 1875, 1880, and 1890.



Fig. 121.
ANGLE SPLICE BAR, PENNSYLVANIA RAILROAD, 1875.
(From a drawing in the U. S. National Museum.)

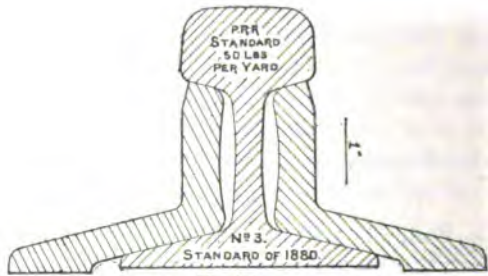

Fig. 122.
ANGLE SPLICE BAR, PENNSYLVANIA RAILROAD—50-LB. RAIL, 1880.
(From a drawing in the U. S. National Museum.)

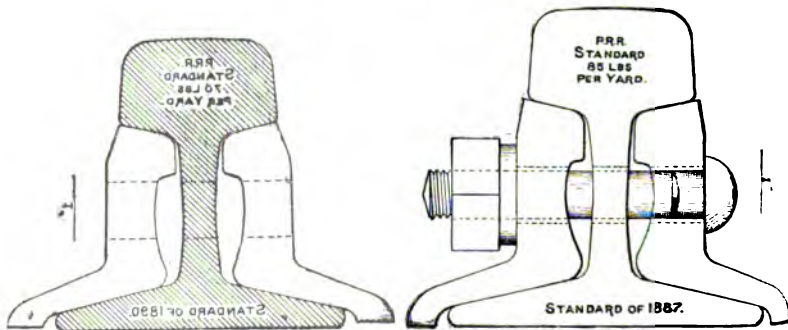

Fig. 123.
ANGLE SPLICE BAR, PENNSYLVANIA RAILROAD, STANDARD FOR 70-LB. RAIL, 1890.
(From a drawing in the U. S. National Museum.)

Fig. 124.
ANGLE SPLICE BAR, PENNSYLVANIA RAILROAD, STANDARD FOR 85-LB. RAIL, 1890.
(From a drawing in the U. S. National Museum.)

* These plates are from drawings in the collection deposited by Mr. Joseph T. Richards, assistant chief engineer of the Pennsylvania Railroad.

Figs. 125, 126, 127, and 128* show the various standards of angle splice-bars adopted by the Chicago, Burlington and Quincy Railroad, 1868, 1879, 1885, and 1890.

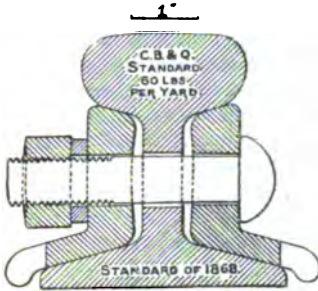

Fig. 125.
ANGLE SPLICE BAR, CHICAGO, BURLINGTON AND QUINCY RAILROAD, 80-LB. RAIL, 1868.
(From a drawing in the U. S. National Museum.)

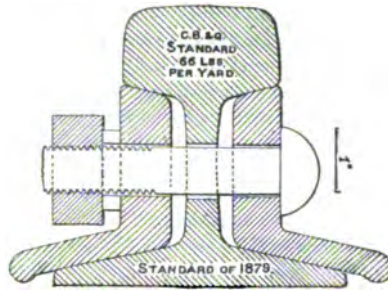

Fig. 126.
ANGLE SPLICE BAR, CHICAGO, BURLINGTON AND QUINCY RAILROAD, 66-LB. RAIL, 1879.
(From a drawing in the U. S. National Museum.)

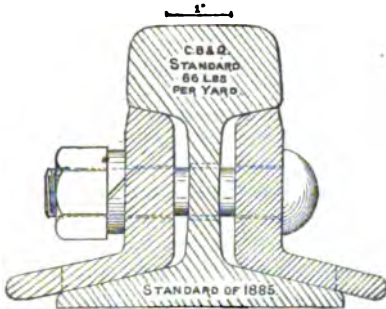

Fig. 127.
ANGLE SPLICE BAR, CHICAGO, BURLINGTON AND QUINCY RAILROAD, 66-LB. RAIL, 1885.
(From a drawing in the U. S. National Museum.)

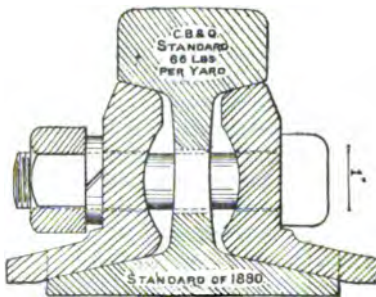

Fig. 128.
ANGLE SPLICE BAR, CHICAGO, BURLINGTON AND QUINCY RAILROAD, 66-LB. RAIL, 1890.
(From a drawing in the U. S. National Museum.)

Mr. F. A. Delano, second vice-president of the Chicago, Burlington and Quincy Railroad, in charge of the bureau of rail and joint inspection of that company, has compiled the following data concerning the rails and joint fixtures on that road during various years, and has communicated the same to the curator by letter, from which the following abstracts have been taken :

CHICAGO, BURLINGTON AND QUINCY RAILROAD COMPANY,
SECOND VICE PRESIDENT'S OFFICE,
BUREAU OF RAIL AND JOINT RAIL INSPECTION, TESTS, AND RECORDS,
Chicago, June 19, 1890.

DEAR SIR: Regarding your request for standard rails in use on the Chicago, Burlington and Quincy in 1870, 1880, and 1890, I take the liberty of going further back than the dates you mention, in order to illustrate more fully the development of track, and show, if possible, what the tendency has been.

When the Chicago, Burlington and Quincy Railroad was first organized in 1854,

* These plates are from drawings in the collection deposited by Mr. F. A. Delano, second vice-president of the Chicago, Burlington and Quincy Railroad.

with 58 miles of railroad, the track was laid with compound or continuous iron riveted together. I have not a drawing of this rail, but you are doubtless familiar with the design. The rail was rudely similar to the present T rail divided in half vertically through the web, and these two halves riveted together broken jointed, so that the end of one half rail did not come at the end of another half rail. This made an excellent track for the time being, as the reports show, and indeed it was a very expensive track, for the rail weighed some 72 pounds per yard and cost some \$70 to \$80 per ton. This compound rail, however, soon began to show its defects, which I cannot hardly explain here, and some two years later, when the Chicago, Burlington and Quincy by consolidation with the Central Military Tract Railroad became an important road with 138 miles of track, the T rail was adopted as standard and used with cast-iron chairs at the joints. Wrought-iron chairs I find were also used to a limited extent at this time.

In 1862 the construction of the road from Aurora to Chicago, a distance of 35 miles, was begun, and for this purpose 3,500 tons of "the best quality iron rail were purchased of the Cambria Iron Company, of Pennsylvania, at a price of \$65 per ton delivered at Chicago."

The chief engineer, in his report for that year, says that the compound rail was being removed from track as rapidly as possible, and being replaced with newly rolled iron T rails of the ordinary pattern. These T rails had a maximum length of 21 feet.

In 1864 the general use of fish-plates, a flat piece of iron fitting close to the web of the rail between the head and the base, was adopted. The chief engineer in his report for that year says "the fish-joint splices make a smoother track, less liable to get out of repair, and cost less than the ordinary rubber chair." This allusion to the "rubber chair" rather puzzles me. I do not understand whether a piece of rubber was introduced into the bottom of the ordinary cast-iron chair to obviate the track from noise and stop the rattling, or not; but I presume that this was the case. At this time quite a large proportion of the rail laid in each year was rerolled iron, and I find that the cost of rerolling amounted to over \$35 per ton at Chicago, a good deal more than that in 1865 and 1866, on account of the high prices for iron and material following the war period.

In the summer of 1867, 3 miles of experimental steel rails were laid in different places in Illinois where they would receive very severe service. I can not learn the exact section or weight per yard of this rail; but, from what I can learn, I imagine that the rail weighed between 56 and 60 pounds per yard, and was very similar in design to the old 60-pound rail, shown in print No. 1, which I send you. This rail was laid with fish-plates similar to the then recent practice with iron rails, and in the case of iron rails, it was laid with "supported" or "on-tie" joints, the ends of the rails being notched to admit of spiking at that point and prevent the rails from creeping. The first experience with this rail was not altogether favorable. In 3 miles of track laid, seven rails broke in the first year; in each case, however, the chief engineer tells us, where the holes in the splice bars had been punched instead of drilled. In the next two years, however, there were no breakages and in 1870 it was decided to adopt steel as standard for main track renewals or new construction. During the year 72 miles of steel rails were laid, which with the 6 miles already laid made 78 miles of steel rail out of 302 miles then in operation. The road consisted of a line from Chicago to East Burlington and from Galesburg to Quincy. The steel rail then used was substantially the rail shown in blue print No. 1, which I send you, with a plain fish-plate and not the angle-bar, which was adopted in 1871.

In 1875 or 1876 an angle-bar was adopted for this rail, and this was slightly modified in 1879. This provided for a "supported" or "on-tie" joint. The only difficulty with it was that the slot near the center of the angle bar was frequent cause of breakage at that point. In 1879, therefore, the 66-pound rail for a suspended track was designed and made the standard.

In 1880 the length of the road in operation was 2,653 miles in Illinois, Iowa, and Nebraska. Of this mileage, 1,100 miles were steel rails. When the 60-pound rail was discarded as a standard in 1879, two sections of steel rail were adopted of a substantially similar design and weighing 56 and 66 pounds per yard, respectively, for lines of light and heavy traffic. The joint used on the 66-pound rail is already mentioned, and the joint on the 56-pound rail provides for a "supported" or "on-tie" joint, the idea being that with a stronger or heavier rail a suspended joint could be used, where it would not be a good thing for a weaker rail. Both these rails continued to be used almost up to the present date. During this period considerable dissatisfaction was found with the angle bar for the 56-pound rail, which, on account of its slot in the center, frequently broke. To obviate this difficulty, without seriously adding to the cost of the rail, I lengthened the angle bar at one end for this rail and the old 60-pound rail $5\frac{1}{2}$ inches, thus allowing the slot at the joint to be omitted, and yet preserving the on-tie or supported joint. This was adopted as standard early in 1889. During this period also considerable dissatisfaction of 1889 the angle bar was lengthened 6 inches, so as to allow a three-tie supported joint, the same cross-section of angle bar, however, being used.

Quite recently, in the year of 1890, the old 66-pound section of rail has been superseded by a new standard, namely, the Northern Pacific 66 pound rail, with the angle bar. The notable difference between this rail and the other 66-pound rail lies in the fact that the distribution of metal in the different parts of the rail is more equal. The rail itself is stiffer and higher, and the angle bar very much stiffer. These differences have been made chiefly by putting considerable less metal in the head of the rail, because we have found in practice that a very small portion of the head wears away, and that the rail is usually removed from track for other causes.

You will note particularly what an advance has been made in perfecting the joint. After trying the suspended joint, we returned again to the supported joint, at the same time making the angle bar much stiffer, bringing the bolt-holes closer to the end, and using seven-eighths instead of three-fourths bolts.

In the mean time the Chicago, Burlington and Quincy Railroad is experimenting with a view of adopting for lines of the heaviest traffic a heavier rail. In 1888 two sections of 85-pound rail were designed, and $7\frac{1}{4}$ miles of each section were rolled and laid in track side by side in 1889. In 1890 a similar amount of each section has again been rolled and laid in track. It is impossible at present to determine which rail is likely to give the best satisfaction, but we hope before spring to get some light on the subject. Besides the test in track which is being made of these two sections of 85-pound rail, quite elaborate tests of each section were made about a year ago at the United States Government Watertown Arsenal, the results of which I dare say you have seen.

In the mean time, while we are debating what shall be the design and weight of our rail for the lines of the heaviest traffic, it is a settled fact that we shall not again buy for standard-gauge railroad any rail lighter than 66 pounds per yard. The Chicago, Burlington and Quincy, owning and controlling as it does upwards of 7,000 miles of railroad, always has large quantities of rail not sufficiently good for main track use, but which either with or without the sawing off of the ends is perfectly good for branch-line service, so that our lines with very light traffic will usually be laid either with the light rail which was originally put there or with second-hand rail removed from main line.

Hoping that I have given you the information you desired, I have the honor to remain, yours, truly,

FRED. A. DELANO.

Mr. J. E. WATKINS,
Curator, U. S. National Museum, Washington, D. C.

RAILS ROLLED BY THE BETHLEHEM IRON COMPANY.

Fig. 129 is from a drawing presented to the collection by the Bethlehem Iron Company through the courtesy of Mr. E. M. McIlvain to the standard joint fixture of the Lehigh Valley Railroad, 1890.

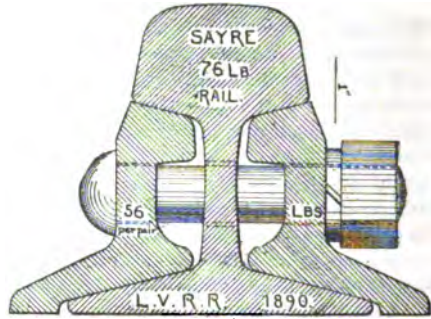

Fig. 129.

DOUBLE ANGLE SAYRE-FRITZ SPLICE BAR, LEHIGH VALLEY RAILROAD, 1890.
(From a drawing in the U. S. National Museum.)

The rail is of the Sayre pattern, and the splices are of the Sayre-Fritz standard.

LETTER FROM THE BETHLEHEM IRON COMPANY.

SOUTH BETHLEHEM, PA., June 30, 1890.

SIR: The first rails rolled by us were iron rails, and owing to our early records having become mislaid, we are at a loss as to what to send you to be of any use. I enclose, however, under separate cover, a number of blue prints, that we trust you may be able to use to advantage.

You will note that a great many of the sections on the blue prints are marked as unknown. Records relating to these sections have been lost or mislaid. Were we able to do so, the year the rail was rolled the section and name of the road on which the rail has been noted on the blue prints.

We also send you a blue print of a compound rail, which, however, we never attempted to make, the scheme not having originated with us. You will also find inclosed several sections designed by Mr. Robt. H. Sayre, with Sayre-Fritz splice plates.

Respectfully,

THE BETHLEHEM IRON COMPANY,
E. M. McILVAIN,
Assistant to Vice-President.

J. E. WATKINS,
U. S. National Museum, Washington, D. C.

Several types of joint fixtures designed to support the base of the rail have been designed from time to time. Fig. 130 shows a joint of this type which was in use on a western railroad in 1869. Fig. 131 illustrates the Fisher and Norris joint as improved by Mr. Clark Fisher in 1888, in which the base of the rail is made to take much of the strain at the joint.

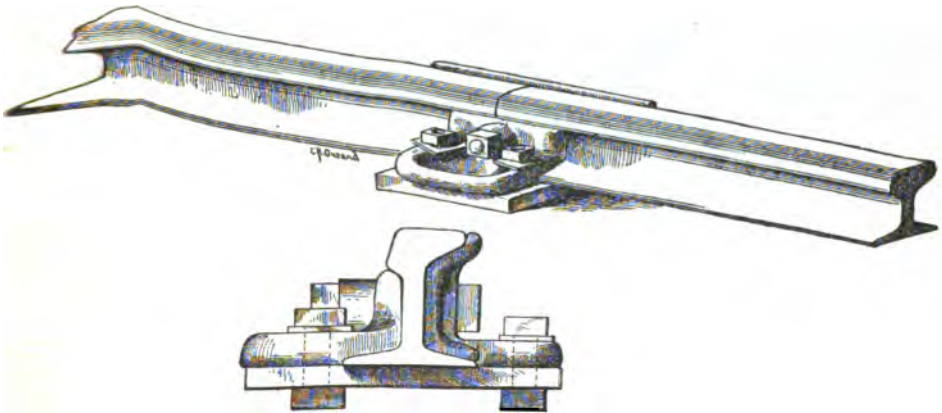

Fig. 130.
JOINT FIXTURE USED ON WESTERN RAILROADS, 1869.
(From original in the U. S. National Museum.)

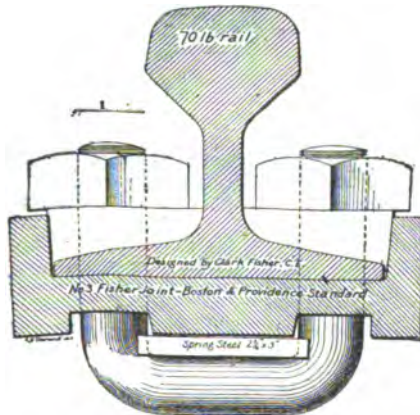

Fig. 131.
FISHER & NORRIS JOINT FIXTURE AS IMPROVED BY CLARK FISHER, 1888.
(From a drawing in the U. S. National Museum.)

PRIMITIVE FROGS.

Mr. Isaac Dripps, who in 1831 erected the locomotive John Bull at Bordentown, New Jersey (all of the parts of the engine having been made by Stephenson & Co., New Castle-on-Tyne, England), has furnished the information for Fig. 132, which illustrates the manner in which a large Ω shaped staple was made to take the place of a frog at the point where the "turn in" track branched off from the main line at the engine-house at Bordentown.

When it was necessary to take the engine out of the house t was straddled across the rail the two arms dropping into holes into the sleeper.

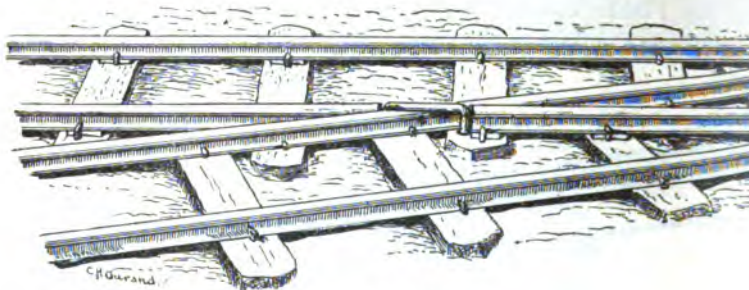

Fig. 132.

⌒ STAPLE IRON USED AS A MAKESHIFT FOR A FROG, CAMDEN AND AMBOY RAILROAD,
(From a drawing in the U. S. National Museum.)

The iron of which the ⌒ was made was thick enough to rail flange of the locomotive wheel above the top of the rail. After engine was safely put on the main track the ⌒ was taken out both rails were right for the main line.

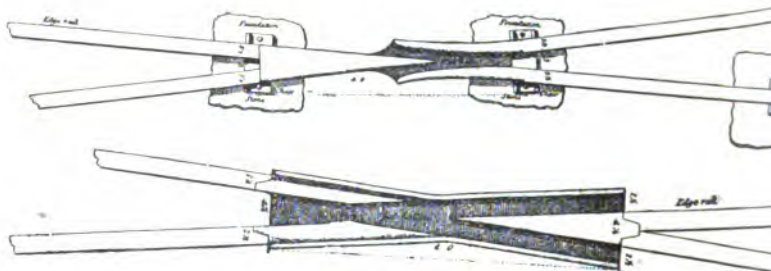

Fig. 133.

FROGS, COLLIERY RAILROADS OF ENGLAND, 1825,
(From drawings in the U. S. National Museum.)

Frogs of various shapes were used on the colliery roads of England previous to the introduction of the locomotive. Fig. 133 is from a drawing in the collection, which was made from the report made by Wil

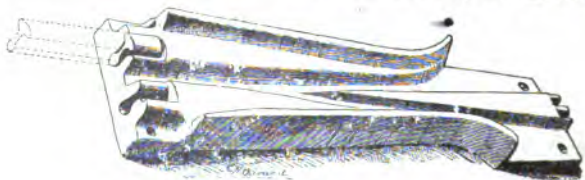

Fig. 134.

FROG, OLD PORTAGE RAILROAD, ABOUT 1835.
(From original in the U. S. National Museum.)

Strickland in 1826 to the Pennsylvania Society for Internal Improvement, in which two types of frogs, which he examined while in England in 1825, are illustrated and described. Fig. 134 is drawn from an

frog (deposited in the collection) which was laid on the old Portage Railroad about 1835. It will be noticed that the casting at the end of the frog is designed to fit the Clarence T-rail previously described.

As the speed of trains increased, the cast-iron frog was found to be unsafe, and various forms of rail frogs were constructed. Fig. 135 is

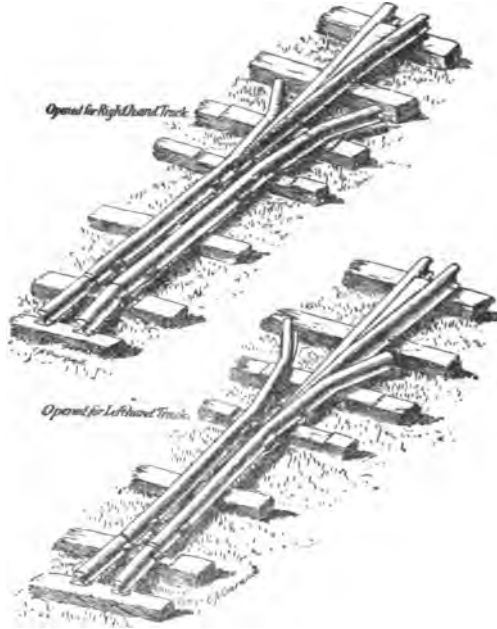

Fig. 135.
RAIL FROG, INVENTED BY JOSEPH WOOD, NEW JERSEY, 1859.
(From model in the U. S. National Museum.)

made from a model of an old rail (shifting) frog in the collection. This type of frog was invented by Mr. Joseph Wood, of Red Bank, New Jersey, in 1859, and formed the basis of the invention of many types of spring-rail frogs now in use.

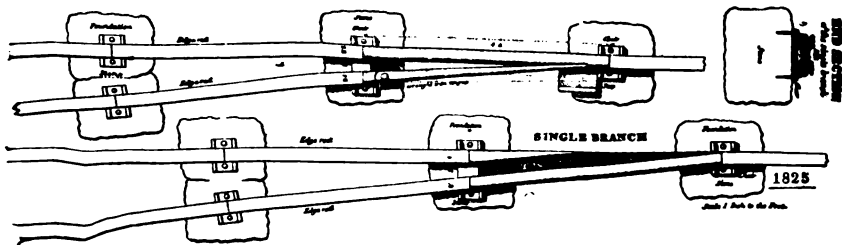

Fig. 136.
SWITCHES IN COLLIERY RAILROADS, ENGLAND, 1825.
(From drawings in the U. S. National Museum.)

SWITCHES.

Two types of switches in use in England in 1825 are shown in Fig. 136. The drawings in the collection from which these are made are

taken from Strickland's report, previously alluded to. Among the early forms of switches used in America was the lever switch, with the heavy iron counter-weight (see Fig. 137) to keep it in position. Sometimes

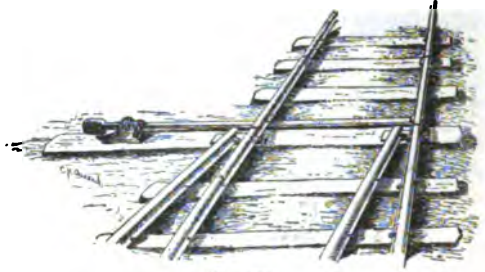

Fig. 137.

SWITCH WITH "BALL" COUNTER-WEIGHT.

(From a drawing in the U. S. National Museum.)

the "ball" was omitted, and the lever was secured by a padlock fastened to a staple driven into a cross-tie.

It is to be hoped that an opportunity may be given to extend the collection of frogs and switches in the near future, so that the history of the development of these two very important track-appliances may be preserved.



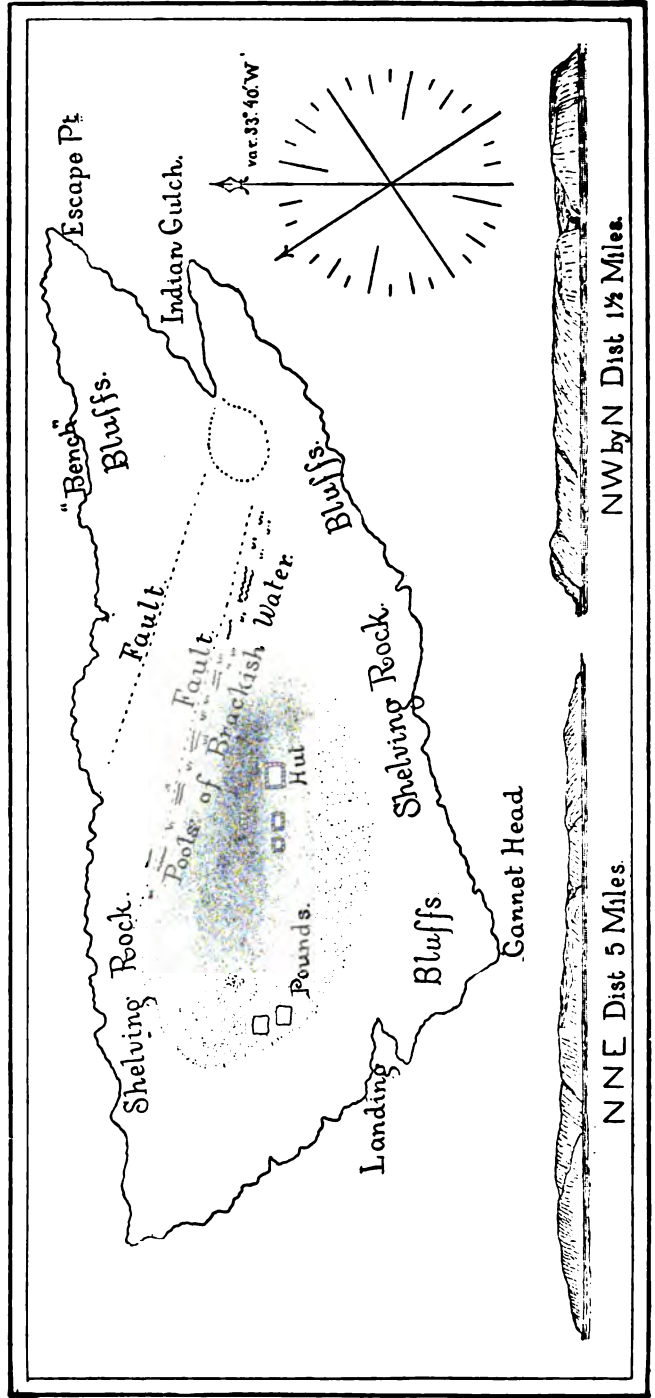

SKETCH MAP OF FUNK ISLAND.
 (The shaded portion indicates the location of remains of the Great Auk, intensity of shade denoting corresponding abundance of bones.)

EXPLORATIONS IN NEWFOUNDLAND AND LABRADOR IN 1887,
MADE IN CONNECTION WITH THE CRUISE OF THE
U. S. FISH COMMISSION SCHOONER GRAMPUS.*

By FREDERIC A. LUCAS,
Assistant Curator of the Department of Comparative Anatomy.

In the spring of 1887 the writer was detailed by Professor Baird to accompany the U. S. Fish Commission schooner *Grampus* on a cruise to northeastern Newfoundland and the Gulf of St. Lawrence, primarily to obtain, if possible, bones of the Great Auk; secondarily to collect such other specimens as might be obtainable. Two years earlier Professor Baird had approved a proposed plan of visiting Funk Island, off Cape Freels, Newfoundland, a former breeding place of the Great Auk, in the hope of finding remains of that extinct bird, but the many difficulties in the way precluded carrying this plan into effect until the building of the *Grampus* and her projected trip made it feasible. From a scientific standpoint it was extremely desirable to secure bones of the Great Auk, since up to 1887 there were but nine skeletons of that species preserved in museums, only one being in the United States, while the U. S. National Museum possessed but a single bone. Even viewed commercially, a collection of Auk bones would be of considerable value, since the small number of existing specimens had caused them to bring a high price whenever brought into the market.†

It was eminently fitting that a search for remains of the Great Auk should be undertaken in connection with fishery researches, since this bird once formed an important factor in the prosecution of the early

* This report is supplementary to the paper by Mr. Lucas, entitled "The Expedition to Funk Island, with Observations upon the History and Anatomy of the Great Auk," in the Report of the National Museum for 1888. It was at first intended for publication in the Report of the U. S. Fish Commission. Certain statements concerning the Great Auk in Mr. Lucas's previous paper are repeated in this report, but it is believed that they are essential in this connection for the proper understanding of the narrative. For fuller details concerning the Great Auk and its extinction, the reader is referred to the Report of the National Museum for 1888, and for detailed notes on the birds collected see report of William Palmer, in Proceedings U. S. National Museum, vol. XIII, pp. 249-265.

† In this connection it may be of interest to state that one of the skeletons collected by the *Grampus* expedition and exchanged for natural history specimens with a London dealer, was sold by him to the Museum of Science and Arts, Edinburgh, for £120, or about \$600.

Newfoundland fisheries. The very earliest reference to the Great Auk in America occurs in the account of Cartier's first voyage, in 1534, wherein the chronicler records a visit to Funk Island for the purpose of procuring birds for fresh provisions, and, under the name of Great Apponatz, tells of the capture of a boat-load of this flightless fowl. From that time onward, so long as the species existed, fishermen and colonists availed themselves of the prodigious store of Great Auks which, after the manner of mankind, they assumed that Providence had provided for their special benefit. The extent to which the Great Auk was used is shown by Anthonie Parkhurst's statement, written in 1578, that "the Frenchmen who fish neere the grand baie doe bring small store of flesh with them, but victuall themselves with these birds" (the Great Auks). Granting that this exaggerates the facts in the case, it seems evident that the birds were very largely employed for provisions, and since, in 1578, there were about one hundred and fifty French vessels, aggregating about 7,000 tons, employed in the cod fishery, the destruction of Great Auks must have been immense.

Captain Richard Whitbourne, who was sent in 1615 to establish order in Newfoundland, on his return wrote a book, which was freely distributed in order to encourage emigration to that country, and in this we find the abundance of Great Auks held forth among other inducements. Says the narrator: "These Penguins* are as bigge as geese and flye not, for they have but a little short wing, and they multiply so infinitely upon a certain flat iland that men drive them from thence upon a board into their boats by hundreds at a time, as if God had made the innocency of so poore a creature to become such an admirable instrument for the sustentation of man."

In more recent times we are told that the merchants of Bonavista and other localities used to sell salted Auks by the hundred weight for provisions, and Audubon says that the young were used for bait. †

Undoubtedly the drain made upon the numbers of the Great Auk for the purposes just mentioned would have ultimately caused its extermination, but the direct cause for its rapid extinction was the killing of the birds for the sake of the feathers. This destruction was rendered all the more rapid and profitable from the fact that the breeding grounds of the Great Auk, like those of the Gannet, were extremely restricted, so that during the breeding season the entire race was to be found assembled at two or three localities. Whatever may have been the case in prehistoric times, there are no allusions to the Great Auk in the accounts of early navigators that even hint at its occurrence in

*The name Penguin was originally applied to the Great Auk, and not to the southern bird now bearing the appellation, and was the name by which the Great Auk was commonly known in America.

†These two statements are taken from works on the Great Auk, and the authority for the first is not given. Still, there seems no room to doubt the truth of either. On the other hand, no reference occurs anywhere to the use of the eggs of the Auk, although they must have been taken by the boat load.

half a dozen places, while it yet remains to be shown that in the last century of its existence the bird bred at any other locality than Funk Island. The feather-hunters probably went to Funk Island in the spring and resided there until the sea-birds had finished breeding, systematically killing all the Great Auks they could; and this was kept up until, like the Rytina, the Great Auk had been slaughtered out of existence. The extermination took place about 1840, and at that date American ornithology was in its infancy, so that not a single specimen of the Great Auk was preserved out of all the millions that were slain, and there are in existence only two stuffed specimens of the Great Auk from America. Fortunately, the conditions under which the Auks were killed were such as to preserve their skeletons, and the greater part of the bones now preserved in museums are from Funk Island, a source from which others may doubtless be procured.

At the time the *Grampus* expedition was planned, little could be ascertained in regard to the exact conditions under which bones of the Great Auk had been found at Funk Island, neither could anything be learned respecting the character of the island, beyond the fact that it was a mere isolated rock. The voyage, as planned, was from Gloucester to the Gulf of St. Lawrence, and thence to the east coast of Newfoundland, stopping *en route* at St. John's and Funk Island. From Funk Island the *Grampus* was to proceed northwards along the coast of Newfoundland, and through the Strait of Belle Isle to Mingan, stopping at those localities where it might seem desirable to gather information, collect specimens, or which stress of weather made it necessary to visit. From Mingan we were to return to Canso and thence home. It was expected that there would be no opportunity for collecting until we reached the vicinity of the Bird Rocks, but on account of bad weather the *Grampus* lay by for a day at the Magdalen Islands, and a small collection was made of its somewhat scanty avifauna, for although birds are quite abundant there, the number of species is small.*

Only a single mammal was seen, viz., a small Harbor Seal (*Phoca vitulina*), scarcely suggesting the fact that these islands were once the seat of a flourishing Walrus fishery, and that thousands of these huge beasts were formerly taken annually, as well as large numbers of Harp Seals.

The first reference to walruses in this locality occurs in the account of Cartier's first voyage, in 1534, where, in speaking of Brion's Island, he says that "About the said island are very great beastes, as great as oxen, which have two great teeth in their mouths like unto elephant's teeth, and live also in the sea."

The writer has been unable to positively identify the Brion's Island of Cartier, part of his description applying very well to Bryon Island of to-day and part applying equally well to Grindstone Island, the

* Dr. Louis B. Bishop, whom we met at the Magdalenes, has published in the "Auk" for July, 1889, a list of sixty-six species observed by him, and notes that he did not find several species noticed by Mr. Cory in 1878.

northernmost of the Magdalenes. In spite of the distances, course descriptions so carefully recorded in the log-books of the early navigators, it is quite impossible to recognize the small places at which they stopped, and very difficult to definitely locate any. It is also a little puzzling, at first, to see why Cartier and his immediate followers should have gone around Newfoundland to enter the Gulf of St. Lawrence, but bearing in mind that at that time Newfoundland was supposed to be a portion of the American continent, it is easy to see the reason for the course pursued. Vessels made Cape Bonavista for a landfall, thence ran north to Carpunt (some place on the Labrador coast), and entered the entrance of the Strait of Belle Isle.

Proceeding down the strait, Chateau Bay and Blanc Sablon were often visited, two places that still bear the appellations originally bestowed upon them, and from there the course was to the south until the Islands of Birds, Brion's Island, and Ramea were successively reached. Ramea is another stumbling-block, and from the name which it is described may have been either the Magdalenes or Brion's Island, Charles Leigh's account seeming to point to Brion's Island, the southernmost of the Magdalenes, this supposition being more probable from the fact that the Isle of Ramea was a famous resort for walrus.

It is now many years since a walrus has been taken in the Gulf, and all, much longer since one was killed on the Magdalenes, and since the disappearance of the walrus, the sources of prosperity so much depended upon by the early voyagers have one by one dwindled away.*

The goodly fir-trees have become scrubby spruce, the great cod fishery has become few and far between, the herring industry is comparatively unimportant, and a few short years have sufficed to seriously diminish the lobster fishery. All this means want and distress for the population of these islands, which, never too well off at best, has several times been saved from starvation by government aid, and once during the last twenty-five years forced to eat their very dogs.

While lying at Grindstone Island we first made the acquaintance of the Gannets, whose headquarters are the Bird Rocks, and had the opportunity to watch them fishing. The birds are usually associated in small, straggling flocks, and with outstretched necks and eyes on the lookout for fish, they fly at a height of from 75 to 100 feet above the water, or occasionally somewhat more. The height at which they

* The following glowing description by Charles Leigh occurs in Hakluyt, 1600, p. 201 :

"Concerning the nature and fruitfulness of Brion's Island, Isle Blanch and Ramea, they do by nature yield exceeding plenty of wood, great store of wheat like barley, strawberries, gooseberries, mulberries, white roses, and store of peason. Also, about the sayd islands the sea yieldeth great abundance of divers sorts. And the sayd islands also seeme to proffer, through the labour, plenty of all kinde of our graine, of roots, of hempe, and other necessary commodities."

net flies above the water is proportioned to the depth at which the fish are swimming beneath, and Captain Collins tells me that when fish are swimming near the surface the Gannet flies very low and darts obliquely instead of vertically upon his prey. Should any finny game be seen within range, down goes the Gannet headlong, the nearly closed wings being used to guide the living arrow in its downward flight. Just above the surface the wings are firmly closed, and a small splash of spray shows where the winged fisher cleaves the water to transfix his prey. Disappearing for a few seconds the bird reappears, rests for a moment on the water, long enough to swallow his catch, and then rises in pursuit of other game. The appetite of the Gannet is limited only by the capacity of its stomach, and a successful fisher may frequently be seen resting on the water, too heavily laden to rise without disgorging a part of its cargo, which it sometimes must do to escape from the pathway of an approaching vessel.

The Guillemot (*Cephus columba*) breeds in the caves of Entry Island, and a few old birds were seen off Grindstone Island.

On the 9th of July the *Grampus* ran over to the Bird Rocks, and extensive collections were made of the various birds from whose abundance these little rocky islets took their name. They are described in the account of Cartier's first voyage, and from the occasional references that occur in Hakluyt seem to have been visited now and then for supplies of birds and eggs, a practice still followed by the fishermen of to-day. Many birds and eggs are taken annually, and although eggging is prohibited by law after a certain date, game laws are easier enacted than enforced, and many eggs are gathered out of season and many breeding birds killed. The principal species of birds inhabiting the Bird Rocks are the Gannet (*Sula bassana*); Razorbill (*Alca torda*); Common Murre (*Uria troile*); Brunnich's Murre (*Uria lomvia*); and Puffin (*Fratercula arctica*). Besides these a few Kittiwake Gulls (*Rissa tridactyla*) are found there, and Leach's Petrel (*Oceanodroma leucorhoa*) breeds in rat-like burrows on the summit of the Great Rock. The Gannet has bred here from time immemorial, and the abundance of these great white birds, "which bite even as dogs," led Cartier to christen these rocks the "Isles des Margaulx," or Islands of Gannets.

Cartier's account is as follows:

" * * * We came to these islands, two of which are as steepe and upright as any wall, so that it was not possible to climbe them, and betweene them there is a little rocke. These islands were as full of birds as any field or medow is of grasse, which there do make their nestes, and in the greatest of them there was a great and infinite number of those that wee call Margaulx, which are white and bigger than any geese, which were senered in one part. In the other were onely Godetz, but toward the shoare there were of those Godetz, and Great Apponatz, like to those of that island that we above have mentioned. We went downe to the lowest part of the least island, where we killed above a thousand of those Godetz and Apponatz. We put into our boates so many of them as we pleased, for in lesse than one houre we might have filled thirtie such boats of them.

In 1597 Charles Leigh wrote that "the three Islands of Birds are sandy red, but with the multitude of birds upon them they looke white," and even as late as the time of Audubon, the Gannets were so numerous that the tops of the rocks seemed covered with snow. At that time they were largely used for bait by the fishermen of Bryon Island, some forty boats being supplied from this source, and some idea of their abundance may be gathered from the fact that Audubon's captain told him that on one occasion his boat's crew, in less than one hour, killed six hundred and forty birds with no better weapons than sticks. Up to 1860, however, the Gannets were sufficiently numerous not only to cover the summits of the rocks, but many of the ledges along the sides, and Dr. Bryant estimates that 50,000 pairs were then breeding on the top of the Great Rock alone, although these figures require to be discounted a little. In 1870 a writ of ejectment was served on the bird tenantry occupying the summit of the Great Rock, by the erection of a lighthouse, and by 1872 the Gannets breeding there were reduced to 5,000. In 1881 Mr. Brewster found the birds on the Great Rock confined to the ledges along the sides, although the Little Rock was still densely populated, and the total number of Gannets was estimated at 50,000. In 1887 not a Gannet was raised on the Little Rock, although a few were breeding on the little pillar of rock adjacent to it, and M. Turbid placed the number of Gannets at 10,000, considering this an increase over previous years. The Murres, Razorbills, and Puffins have probably suffered somewhat less than their more conspicuous comrades, although even among them the decrease must have been very great. Still, their smaller size and consequent ability to breed in crevices of the rock and on ledges too narrow to accommodate a bulky Gannet has been of great service to them, while the Razorbill also seems to be learning by experience the desirability of putting an egg out of sight whenever practicable. The Puffins find safety in their burrowing habits, and breed quite extensively in the decomposed sandstone at the northeastern portion of the Great Rock, as well as under the overhanging, inaccessible ledges of the northern side of the Little Rock. The little rocky pillar mentioned above is well occupied by birds of various species, while owing to the difficulty of scaling this islet, the little colony is fairly secure. From its size, the precipitous nature of the sides, and the fact that only one landing lies contiguous to the breeding birds, the Great Bird Rock must ever remain the stronghold of this interesting colony of sea-fowl. The Little Rock, although formerly said to be difficult, or even impossible to scale, is now easily climbed, owing to the falling of portions of rock, and as there are two places where landing is comparatively easy, the spot is much resorted to by fishermen, and the birds in consequence lead a very precarious existence.

There is no regular division of the feathered inhabitants of the Bird Rocks into large colonies according to species, the separation being

rather by size, Gannets occupying the highest and broadest ledges, and Murres and Razorbills taking what is left. There is, of course, something of a tendency for little groups of the same species to nest together, but Brunnichs and the Common Murre may be seen occupying the same ledge. While the erection of the light-house on the Great Rock did not directly affect the Murres and Razorbills as it did the Gannets, it nevertheless led to the decrease of the smaller birds in a very curious manner. In foggy weather a cannon is fired every half hour to warn passing vessels of the hidden danger, and this gun, being placed near the northern cliff, is in proximity to the favorite breeding-places of the Murres and Razorbills. The effect produced upon the birds is well described by Mr. Brewster, who says:

At each discharge the frightened Murres fly from the rock in clouds, nearly every sitting bird taking its egg into the air between its thighs, and dropping it after flying a few yards. This was repeatedly observed during our visit, and more than once a perfect shower of eggs fell into the water around our boat. So seriously had the Murres suffered from this cause that many of the ledges on the side of the rock where the gun was fired, had been swept almost clear of eggs.

This was in 1881, but now M. Turbid says that the birds have become somewhat accustomed to the sound, so that the destruction from this cause is comparatively small, and we noticed that very few birds would fly at the report of a shot-gun, although fired close by them.

At the time of our visit young birds of the various species breeding at the Bird Rocks were common, with the exception of Gannets and Leach's Petrels. The Gannets are the last of the young birds to make their appearance, the three that we obtained from the pillar near the Little Rock being the first of the season. The difficulty of securing Leach's Petrels renders any exact statement regarding them impossible, and it can only be said that all of the five eggs obtained contained embryos.

The following table, kindly furnished by M. Turbid, shows the date of arrival of the various species, the time of their becoming common, and the date at which the first young were noticed.

	First seen.	Common.	Young seen.
Kittiwake	Mar. 11	Apr. 9	June 21
Murre	Mar. 12	Apr. 10	June 24
Gannet	Apr. 5	Apr. 27	July 7
Razorbill	Apr. 18	Apr. 25	July 5
Puffin	May 7	May 8	July 1
Leach's Petrel	May 10	May 13	(?)

From this table it appears that the Puffins and Petrels arrive in a body, while the other birds straggle along over a period of three or four weeks.

It was the intention, wind and weather permitting, to have touched at Penguin Islands, off Cape la Hune, as the name indicated the possi-

ble former presence of the Great Auk. Weather, however, is a very uncertain quantity in or about the Gulf of St. Lawrence, and owing to fresh breezes and heavy sea this part of the programme was unavoidably omitted. These Penguin Islands seem to agree in location with the island of Penguin mentioned by M. Hore, who says that "they came to part of the West Indies about Cape Briton, shaping their course thence northeastwards until they came to the island of Penguin, which is very full of rocks and stones." At the same time "about Cape Briton" is extremely vague, and the location of the island is a mere matter of conjecture, the case not being helped by a marginal note to the effect that the island is in latitude 30 degrees.

Only two Shearwaters (*Puffinus major*) were collected between the Magdalens and St. John's, Newfoundland, although large flocks of these birds were seen near Cape Race in company with the Sooty Shearwater (*Puffinus obscurus*). From the intimate association of the two birds it seemed quite possible that they were merely two phases of plumage of the same species, but although every effort was made to obtain a series, both by chasing with dories and sailing upon them with the schooner, the birds were so extremely wild that only two were obtained, both *Puffinus major*.

A three days' stop was made in St. John's, during which time we endeavored to obtain as much information as possible concerning Funk Island. Unfortunately the few who had visited the place were bent on other errands than collecting Auk bones, and almost the sole fact gathered was that the best landing was on the northerly side.

On July 21 the *Grampus* left for Funk Island, steering northward past Cape Bonavista, as Jacques Cartier had done three centuries ago a half before. Funk Island lies $31\frac{1}{2}$ miles north by east from Cape Freels, and 25 miles east-southeast from Offer Wadham Island, the locality being seldom resorted to except by sealers in early spring and occasional fishing boats during the summer. At a distance of 600 and 1,200 yards to the north of the island, respectively, are two low rocks while within a radius of two miles are numerous shoal-patches, so that Funk Island and its vicinity have small attractions for the navigator. To add to the dangers of approach, there is no lighthouse, a thing much needed. The morning of the 22d found us with a light breeze and smooth sea about eight miles distant from Funk Island, but so moderate was the weather that it was a little after noon before we were abreast of the eastern end, where, at the distance of about a mile, it was proposed to anchor. Everything had long been in readiness for a start shoreward, and a short time before coming to anchor, a dory containing Mr. Palmer and myself provided with a simple camping outfit and provisions for several days was sent to effect a landing. Owing to the fickleness of the weather and frequent occurrence of fogs in this vicinity, our plans had been so laid that should occasion require, we might remain on the island and prosecute the work of searching for remains of the Great Auk while

the *Grampus* sought a more pleasant berth than the immediate vicinity of Funk Island. The locality is bad, not only from the presence of numerous rocks and shoals and from the fact that owing to the irregularities of the bottom, the sea in rough weather breaks badly when the depth of water is considerable, but also on account of icebergs, which are unpleasant neighbors in a fog. The uncertainty in the way of collecting at Funk Island is well shown by the fact that while the islet has been a regular resort of fishermen from the time of its discovery, the only two collectors who visited the spot, Stuvitz, in 1841, and Milne, in 1873, were obliged to leave hastily on account of threatening weather, while another party also, desiring to visit the island in 1887, was unable to effect a landing. The light breeze blowing at the time of our visit was from the southward, the most favorable direction, since it brought the best landing place to leeward. This landing is on the northerly side, a few hundred yards to the westward of the eastern point, and consists of a step of stone about four feet wide, sloping gently upward from the water's edge. Above and below, this step runs out to nothing, although at the upper end it terminates in a fissure large enough to accommodate one's foot, the rough rock affording good hold for the foot or hand. The rock is here almost perpendicular, so that one may stand on the "bench," as this landing is termed, and toss a lead into 20 fathoms of water, this depth and steepness of rock offering no resistance to the swell which, when this side is to leeward, rises and falls along the rock without breaking. Although, as stated, the wind was light at the time of our visit, the boat rose and fell along the rock 4 or 5 feet at every heave of the sea, while on the south side of the island, where at a distance it had seemed quite possible to beach a boat safely, the swell proved to be rolling in so heavily that a landing would have been quite out of the question, and the same was the case on the northwestern end. On the southwestern side of Funk Island, near Gannet Point, is another landing place, but this is resorted to only when a northerly wind makes landing at the "bench" impracticable.

Professor Milne, who visited Funk Island July 20, 1873, found a great abundance of birds, especially Terns and Murres, but although the Arctic Terns were abundant in 1887, eggs and young lying scattered over the ground, the Murres were extremely scarce, and the same may be said of the Razorbill, these birds having been practically exterminated by the eggers, who several years ago used to obtain many loads of eggs here. The eggs of the Arctic Tern being small and those of the Puffin extremely difficult to secure, eggng as an occupation is no longer profitable, but the number of birds is now so small that the visits of the Fogo fisherman will probably prevent any increase of the edible species.

Cartier mentions the Gannet as being found here, and the most likely breeding spot for this bird bears the name of Gannet Head, but no trace of this species was to be seen, nor is it mentioned by Milne.

The Arctic Terns were a veritable nuisance, hovering in a cloud over our heads, screaming harshly, and swooping down almost on our heads, demonstrations largely due to the presence of their nests. It was curious to witness the behavior of the young Terns, who, at our approach, would either squat close to the ground or else creep up to some tuft of grass or cranny of the rock, into which they would thrust their heads and apparently seem to consider themselves as out of sight.

Puffins are very numerous; their burrows honeycomb the northern slope, where the soil is deepest, and their quaint proprietors, perched upon blocks of stone, gravely inspected all our movements. Not until toward sunset, however, was the real abundance of Puffins manifest, but at that time they came flocking home from distant fishing-grounds, gathering along the precipitous eastern part of the island in great numbers.

The height of Funk Island is given as 46 feet, but it certainly seems much higher, whether viewed from the sea or from the highest part of the islet. It is about half a mile long, possibly a little more, and about a quarter of a mile wide, the greatest length being from east-southeast to west-northwest. The eastern and southwestern portions are precipitous, but on the north and northwest the rock slopes into the sea, and here the Great Auks must have landed, choosing their side according to the wind, but having a rough time of it at best. The rock itself is a coarse-grained feldspathic granite, traversed by two faults, which divide the island into three portions of unequal extent. The northeastern is bare rock, the central portion has a little vegetation here and there, while a great part of the southwestern swell, which comprises the larger part of the island, is covered with vegetation and plentifully strewn with blocks of granite weathered off from the bed-rock. The process of weathering can be seen very well on parts of the middle division of the island and at the eastern end, where the rock in places forms curious thin ledges that in time will break into slabs. Along the line of the southernmost fault is a considerable depression, into which considerable water drains, forming pools of brackish water and little patches of marsh. The western portion alone was inhabited by the Great Auk, this only being accessible to the flightless fowl, which was prevented by the character of the rock from either landing on the eastern end or reaching it after having landed elsewhere.

The former breeding-grounds of *Alca impennis* are pretty well mapped out by vegetation which has sprung up since the extermination of the Great Auk, and the density of which bears a direct relation to the abundance of buried remains. (Plate CVI.)

The soil has been formed partly during the occupancy of the Auk and partly since its extinction, the older portion consisting very largely of fragments of egg-shells mixed with granite pebbles. This stratum is from two inches to nearly a foot in thickness, and is overlaid by a stratum of decomposed Auks and decayed vegetation, above which is a thin turf of matted roots.

Bones are found at all depths, but are most abundant, although poorest in preservation, near the surface. The final cause for the extermination of the Great Auk, as previously stated, is said to have been the trade in feathers, and the birds are said to have been scalded, plucked, and thrown aside, their bodies being so fat that they could be used as fuel. Whether this last statement is or is not correct may be uncertain, but the others are borne out by the condition of the remains. These are most numerous along the crest of the island, where the upturned sod reveals vast numbers of bones, interspersed here and there with patches of charcoal, showing where the kettles swung in which the birds were scalded. The parboiling was done along this ridge for the reason that it was away from the sea, and thus would not alarm the birds when landing, while at the same time the drainage pools near at hand would supply water for the kettles. From this point to the westward the bones decrease in numbers, few being found on the southerly slope of the island, although even here a deep stroke of the hoe never failed to bring to light a bone or two.

Remains of the stone inclosures, "compounds" they were called, into which the Auks were driven like so many sheep, and where they were kept until wanted, are still to be seen, the most complete lying near the western point. These inclosures were readily made by standing on edge some of the numerous granite slabs, which seem to have been placed by nature just where they were most needed by the bird-hunters. Almost in the center of the island are the ruins of three small huts, two nearly leveled to the ground, the third, with its walls several feet high, forming a conspicuous land-mark on the crest of the island. Tradition is silent concerning the two older structures, but the third and best preserved is variously stated to have been built for the accommodation of a sealing crew, placed here to winter some years ago, and to have been erected by a party of guano-seekers in 1863. It is now difficult to say which is the correct statement, but as for the others, it seems quite probable that they were put up years ago by the exterminators of the Auk.

That the feather-hunters must have plied their trade with great vigor is shown by the millions of bones scattered over an area of many acres, and there is no doubt in the writer's mind but that parties passed the entire season here in order to prosecute their work to the best advantage. The sea would supply them with fresh fish, the island with eggs and birds, occasional visits from the mainland would furnish such other provisions as might be needed, such as water and wood, so that the work of destruction sped merrily on to its end.

Professor Milne doubted if all the bones he saw were those of the Great Auk, but his doubts were without foundation, for it requires careful searching to obtain remains of any other bird. Besides a large number of carefully-selected bones, a barrel full of indiscriminately chosen remains was brought away, and yet in all this mass of material there

was less than a handful belonging to any other species than the Great Auk. In one spot, indeed, we did come upon a small number of bones of the Murre mixed with a few of the Great Auk, the inference being, from the thinness of the deposits and fresh look of the bones, that they represented a comparatively recent date, when the Auks were becoming scarce and other birds were being killed to supply the deficiency.

An occasional fragment of egg-lining was met with, and one nearly perfect, but we came upon no trace of any complete body of an Auk, two or three of which were secured by the guano-seekers in 1863. The large extent of ground covered by the remains prevented as careful an examination as would have been possible in a more restricted area although the first desire of our party was to obtain as good a series of bones as was practicable. The most useful digging-implements with which we were provided were clam-hoes, and by peeling off the soil here and there with one of these, an idea was obtained as to the general disposition of remains in various parts of the island.

On the northerly slope the Puffins had pretty well explored the ground, and around their numerous burrows lay little collections of bones, among them an occasional bone in a most excellent state of preservation, although the larger part were badly weathered. These scattered bones were a most welcome sight to us as we passed from the bare rock to the turf-clad portion of the island, for the many unmistakable humeri of the Great Auk were an assurance that our search was not likely to prove a failure.

On the evening of the 22d we returned to the *Grampus*, as the weather promised to be fair on the morrow, and early on the morning of the 23d again landed and proceeded with the work of collecting, snatching a little time from our labor to make a hurried circuit of the island. Had the enterprise been a commercial one, we might have remained much longer, but as the main zoölogical object of the voyage had been secured in the shape of a fine collection of Auk bones, and as much remained to be done in connection with fishery researches, we left land on the afternoon of July 23 for Seldom-Come-By, Fogo Island.

About 16 miles to the westward of Cape Freels the chart shows two small dots bearing the legend "Penguin Islands," and although the main object of the voyage, so far as remains of the Great Auk were concerned, had been successfully accomplished, it was none the less desirable to add if possible to the existing store of information in regard to that extinct bird. These islands are not far from Seldom-Come-By, and as the wind was fair, the *Grampus* accordingly ran over to them on the morning of July 24. The appearance of the islets was not encouraging, as they were low, flat, thickly covered with grass, and by no means suggestive of suitable breeding places for the Great Auk, which seems to have preferred, or rather been restricted to, bare, isolated rocks at some distance from any habitable spot. The turf proved to be extremely thick and tough, indicating long-continued growth of vegetation.

station, and although holes were dug in many places quite to bed-rock, no bones were thus discovered, nor were any seen at any point of the island. The Great Auk, it is true, may once have bred here, but from the character of the islands this is extremely doubtful, while the proximity of the mainland would have made them at all times easy of access and rendered the extermination of the bird an easy matter. To-day the principal inhabitants of Penguin Islands are Field Mice (*Arvicola riparia*), whose burrows are to be seen on every hand, while paths running from one hole to another cover the ground in places with a perfect network. A little exploration of the more populous districts showed that beneath the surface was a veritable labyrinth of intercommunicating burrows, some old and some new. In some instances Petrels (*Oceanodroma leucorhoa*) were found to have taken possession of deserted habitations of the Field Mice, much as the Burrowing Owl occupies the dwellings of the Prairie Dog, and from the great abundance of burrows it is probable that a considerable number of these little birds breed here. The eggs found were perfectly fresh, and as those collected at the Bird Rocks on July 9, contained well-advanced embryos, it would seem probable that this Petrel raises two broods a year. Although the Petrels were breeding here, none were seen about the islands, nor were any seen around the Bird Rocks, where they were breeding on the summit, so that if the males assist in the work of incubation, they must keep well away from the land until after dark. A few nests of the Arctic Tern were scattered over one end of the island, the eggs being in an advanced stage of incubation; one or two Puffins were seen, and a Sandpiper or two, but on the whole the results obtained were of a negative character.

On July 29 we arrived at Canada Bay, where there is a small fishing-hamlet, and where we were led to hope that seals might be found, a hope that was, however, doomed to disappointment, for very few seals were seen at Canada Bay, and these were the ever present Harbor Seal. Cetaceans were quite abundant, the Dolphin (*Delphinus delphis*), Porpoise (*Tursiops tursio*), and Puffing Pig (*Phocaena communis*) being frequently seen, *Tursiops* running up the Bras d'Or branch of the bay for a mile or so; but, in spite of their abundance, all these species were extremely shy, and it was found impossible to approach within striking or shooting distance of any of them. Small Finback Whales were also seen occasionally, one of which was accustomed to visit the harbor toward sunset, making his appearance with great regularity. Both land and sea birds were almost entirely lacking, although Mr. Palmer succeeded in obtaining a pair of the rare Welch's Ptarmigan (*Lagopus velchi*) during an excursion to the Cloud Hills, which lie on the western side of the bay. On this trip comparatively recent signs of Caribou were also noticed. Two small trout-streams empty into the western side of Canada Bay, the course of each being interrupted by vertical falls, above which no trout were to be obtained. Trout caught in the

lower part of the larger brook showed very clearly the effect of water, being slightly silvery, although, owing to the very small size of the brook, no "sea-trout" were taken. In the Greenland lakes are said to feed largely on larvæ of the mosquito, and from the abundance of this insect, as well as the black fly, at Canada Bay, it was likely to be the case there also. An occasional salmon was seen in the inner harbor, but fish of all kinds were scarce, and cod was totally absent, so great being the dearth of food that dried caplin was a common article of diet.

After lying fog-bound for four days the *Grampus* left Canada Bay August 3, and on the morning of the 4th was off Cape Bauld, a locality where, according to reports gathered at Toulinguet, the Penguin (or Auk) was still occasionally seen. While no reliance was placed on rumors, as a matter of duty inquiries were made of the crews of several fishing-boats, the result being, as was anticipated, that nothing was known of the bird in that vicinity.

Rounding the northern point of Newfoundland, we entered the Gulf of Belle Isle, and on August 4, owing to stress of weather, the *Grampus* put in to Black Bay, on the Labrador coast. Little or no collecting was done here, owing to the fact that there was nothing to be collected, animals of all kinds being very scarce, although the usual Harbor Seal was present and a few Ravens were seen, but these were too wild to be taken. The Black River, which empties into Black Bay, is a small stream of some importance, the fishing privilege being rented to William Ellworthy. Sea-trout are said to be abundant in the lower part of the mouth of Black River, but owing to the overcast sky and low temperature at the time of our visit, they remained in deep water. Only one or two young salmon were taken here. Very small sea-trout abound in a tributary of Black River, and in one pool a number of large trout were taken, the most noteworthy fact in regard to them being that, while all were living under similar conditions, two were brilliantly colored, while the remainder were extremely dull, but the trout taken later on at Mingan.

August 11 found the *Grampus* at Mingan, where it was hoped it might be able to secure specimens of the great Gray Seal (*Halobalena gryphus*), or, as it is locally known, the Horse-head. This, the largest of the North Atlantic seals, is by no means common in museums, and appears not to be very abundant at any locality, playing but a small part in the seal fisheries. According to Dr. C. Hart Merriam, to whom we are indebted for information as to the whereabouts of the Gray Seal, the Mingan group is the only locality in the Gulf of St. Lawrence where this animal is found, with the possible exception of Anticosti. The Gray Seal occurs on the south side of Harbor Island, on Mingan Island, and at the Perroquets, these last being the most frequented. Like other members of the seal family, it is fond of crawling out upon rocks, especially on sunny days, when it will lie basking in the

shine for hours at a time. The seals do not come on shore at any convenient spot, but at a limited number of chosen localities, and these vary according to the force and direction of the wind. Except in very light breezes the lee-side of the island is selected, not entirely on account of the difficulty of effecting a landing on the windward side, but also because the seal relies very largely upon its acute senses of smell and hearing to warn it of approaching danger from the land. The chosen landing-places are where a shelf of rock, raised but little above the level of the sea, descends vertically for several feet beneath, thus enabling the seal to plunge head first into the water and disappear at once from sight. Before landing, the animal will swim back and forth several times with head raised and eye, ear, and nose on the alert to detect any sign of danger, the wary nature of the creature being well shown by the fact that almost immediately after emerging from the water, the animal turns completely around so as to lie with the head seaward and in readiness for an instant dive. The fairer the day and the lighter the breeze, the more readily the seals come ashore, while during rough weather they not only do not land so often but are more watchful when they do come out. The time for hauling out varies with the state of the tide, and as nearly all the places where the right conditions, as noted above, obtain, are covered at high water, it is between the middle of the ebb and middle of the flood that the seals come ashore.

The hearing of this seal is extremely acute, as we had a most excellent opportunity of ascertaining during the first of our attempts to secure a specimen. A party had been landed on Mingan Island, and while Mr. Palmer was engaged in searching for birds and botanical specimens, Captain Collins and myself were looking for seals. The wind at the time was blowing rather freshly from seaward, and a number of Gray Seals were discovered hauled out on the lee-side at a spot so situated that there was unfortunately no cover nearer than 150 yards, and even this was accessible only by crossing a patch of shingle some 50 yards wide and in full sight of the seals. Lying flat upon our stomachs we began slowly and painfully wriggling across this open space, the seals apparently taking no notice of our actions. About half the distance had been traversed when the distant report of the small collecting-gun, sounding no louder than a faint crack of a whip, caused the entire group of seals to plunge into the water as promptly as if they had been waiting for some preconcerted signal. Upon coming to the surface at a safe distance from shore the seals swam back and forth looking for the cause of the disturbance and diving whenever the pop of the collecting-gun reached their ears. No enemy being visible and everything becoming quiet, they once more returned to shore, clambering out with more ease than one might suppose such creatures would exhibit. No use is made of the hind flippers when on land, progression being effected by the front limbs and the abdominal

muscles, the hinder portion of the body being bent slightly upward, the hind-legs sticking out stiffly in the rear.

These seals are occasionally taken by the Indians for the oil and skin, the animals being either shot while lying on the rocks, or while swimming in water sufficiently shallow for the body to be recovered by means of a long gaff. As a rule one Indian is provided with a seal-skin suit, cap included, and his part of the game is to crawl about the rocks imitating the motions and cry of a seal, while Indian number two is concealed near at hand with a birch-bark canoe in readiness. No shot is fired unless there is almost a certainty of either killing or mortally wounding a seal where it can be secured, a wounded animal being gaffed and towed ashore.

The Harp Seal (*Phoca groenlandica*) also occurs at Mingan, and animals were seen that probably belonged to this species, although, as none could be taken, it is impossible to speak positively in regard to the matter. The Harbor Seal (*Phoca vitulina*) is common about all the islands and in the channel between Harbor Island and the mainland. A small Pike Whale (*Balænoptera rostrata*) was accustomed to cruise through the channel with tolerable regularity, but no other cetaceans were seen in the vicinity, although fish were said to be abundant, and Caplin were seen in small schools. An effort was made to kill this whale with a bomb lance while it was busily engaged in pursuing a school of lant, but although the animal at first seemed to pay no attention to the boat, yet upon being fired at, although missed, the whale immediately left, showing his senses of sight and hearing to be very acute. The course of the whale could be quite readily traced, the point at which he was about to make his appearance being indicated by a circle of wildly leaping little fish, the nose of their pursuer emerging a second or two later. Several times the animal rose almost vertically, about a third of his length appearing above the water, and on these occasions the conspicuous white bars across the flippers served to identify the species.

The birds were moving southwards, and although young Eider Ducks (*Somateria Dresseri*) in the down were taken, the Black Duck (*Anas obscura*) and white-winged Coot (*Melanetta velvetina*) were seen flying southwards in considerable numbers. The Eider is said to breed hereabouts in the bushes near the shore, but the only young specimens seen were taken, as just stated, at Mingan Island, and had probably been raised there. Large flocks of Bonaparte's Sandpiper (*Actodromas fuscicollis*) were gathered around the tide-pools on the northern end of Mingan Islands and a few Curlew were observed, these being extremely shy. Gulls (*Larus argentatus smithsonianus*) were abundant, and are said to breed on Mingan, although the only young birds taken were obtained from nests under the evergreens of Harbor Island. The Gannet formerly bred in small numbers at the Perroquets, but the continual taking of their eggs by the Indians residing near by, has nearly extirpated

them, and but few were seen, none being breeding birds. *Puffius (Fratercula arctica)*, with well-advanced young, and Murres (*Uria troile*), were found at the Perroquets, and Guillemots (*Cepphus grylle*), in spotted plumage, near Mingan. The Canada Grouse (*Dendragapus canadensis*) was occasionally seen at Mingan. These birds were extremely tame, and when flushed from the ground frequently alighted in low spruces, where they would allow themselves to be approached as near as twenty or fifteen feet.

The Mingan River is a noted salmon stream, while its tributary, the Manitou, abounds in trout, salmon being prevented by a fall from ascending this stream for more than 3 miles. The so-called Sea Trout is usually plentiful at the mouth of the Mingan from half flood to half ebb, and many large ones, averaging about two pounds each, are taken in gill-nets by the few Indians residing here. Owing to rough weather and heavy rains few fish were taken during our stay, those at the mouth of the river being the silvery sea-trout, and those up the stream the dull-colored variety.

The unfavorable weather prevented our obtaining any of the desired seals, and on August 20th the *Grampus* proceeded to Percé, reaching that place next morning. Percé is a place of considerable interest to the naturalist from the fact that Percé Rock is the abode of a large rookery of Cormorants (*Phalacrocorax dilophus*), while the precipitous seaward side of Bonaventure Island is occupied by Gannets, this being the third of their breeding-places on the Atlantic coast, and, next to the Bird Rocks, the most extensive. Dr. Bryant in 1860 estimated the number of Gannets breeding at Bonaventure to be 250,000, but this must be considered as entirely too high. Whatever the number may once have been, at the date of our visit it would not apparently exceed 3,000, although this is merely a guess, time being insufficient to make a careful estimate by counting various sections of the colony. Although the cliffs on the seaward side of Bonaventure Island are 250 feet in height and nearly vertical, it is said that a considerable number of eggs are obtained from the uppermost ledges, some of which may be reached directly from the summit and others by the aid of ropes. The conservatism of the Gannet is well shown by the fact that although Percé Island is only a mile away, and its summit perfectly inaccessible, not a Gannet breeds there. Favored by a light inshore wind, we were able to approach sufficiently near the base of the cliff to secure four young Gannets, by shooting them where the character of the ledge was such that a bird when killed would fall into the sea.

On the 9th of July we had obtained at the Bird Rocks, Gannets from one to four days old, very small and almost naked. Here, forty-three days later, the young were very far from being able to fly, and although they had attained a weight of five pounds were still covered with long, soft down, the wings being so feebly developed that it would evidently be some time before they could leave the nest. The instinct

to keep still must be strong in the little Gannets, for often but a few inches lie between them and destruction, some of the rocky shelves being so narrow as to cause one to wonder how eggs and young escape being swept off by wind and rain.

Percé or Arch Rock, is a vertical mass of rock, 288 feet high, and apparently inaccessible, although some years ago an enterprising fisherman succeeded in reaching the summit,* then as now occupied by birds. The greater part of these are Cormorants (*Phalacrocorax dilophus*), but a few Gulls (*Larus argentatus*) mingle with them, and two Blue Herons (*Ardea herodias*) were also seen. The Cormorants are said to feed largely on the refuse of the fish dressed for drying by the Percé fishermen, but numbers may be seen in the morning starting out for more distant fishing grounds. It was to intercept some of these birds, and to collect any others that were to be obtained, that early in the morning we started for Arch Island, where long before daybreak the gulls had begun their clamor. The gull is ever complaining about something, and at almost any hour of the night the querulous cry of some wakeful bird may be heard. At the Mingan Islands the gulls and terns had been a decided nuisance, following us everywhere in a clamorous crowd, by cry and action pointing out our whereabouts to the ever suspicious seals. Now we found them circling around the island, along whose lofty summit the cormorants were arrayed in straggling groups of three or four, craning their long necks over the edge of the cliff. Some were already returning from fishing trips, while others were starting out for their morning work, winging their way with out-stretched necks and heavy wing-beats, their black forms sharply outlined against the morning sky. Fishing-boats were putting off from shore, their black hulls, and red, tanned sails adding to the picturesqueness of the scene, while the bold, red summit of Percé Mountain shone brilliantly over all. In the rôle of collector, however, the birds had prior claims to our attention, and before breakfast several cormorants and guillemots (*Cepphus grylle*) were secured, these last being the first adults of the species taken since leaving the Magdalens. The little guillemots are wonderfully expert swimmers and divers, and in rough water their small size frequently enables them to elude pursuit, even when they do not take wing. On this occasion, however, the water was smooth, the birds could be readily discerned whenever they rose to the surface, and pursuers and pursued were more on an equality than is usually the case.

Although a few petrels and phalaropes (*Phalaropus fulicarius*) were taken on the homeward voyage, the work of collecting practically ended with our morning excursion at Percé. Naturally the most valuable portion of the collection consisted of the remains of the Great Auk, which, as indicated by the humeri, represented over seven hundred individuals. The humerus, however, is by far the most abundant bone, some

* See "St. Nicholas" for — 1889, p. —

portions of the skeleton, like the breast-bone and pelvis, very rarely being found in a good state of preservation. Still it may be said that the collection made by the *Grampus* party equals, or exceeds, the combined sum of all other Great Auk remains preserved in museums, for besides the large number of individual bones, about ten complete, or nearly complete, skeletons have been made up, one of which has been presented to the Museum of Comparative Zoölogy at Cambridge, Massachusetts, and one to the American Museum of Natural History in New York City.

Next in importance to the bones of the Great Auk were the pair of Welch's ptarmigans, secured by Mr. Palmer, these being the second pair ever taken, and the only birds in summer plumage. The rest of the material needs no special mention, although the numerous eggs, embryos, nestlings, skins, and skeletons form a very valuable addition to the collection of the U. S. National Museum, and their importance is enhanced by the fact that all the specimens were carefully prepared.

It is very evident, upon comparing our own observations with the accounts of previous observers, that the sea-birds have greatly decreased in numbers, even during the last decade. The gannets have suffered the most; the murre and razorbills next; while the puffins, on the contrary, may even have increased in numbers, owing to the fact that their burrowing habit makes the task of obtaining their eggs too difficult to be profitable. While regret at the diminishing number of the sea birds is partly a matter of sentiment, and the naturalist in particular can but deplore their loss, there is, however, a practical side to the question, although the relations between fish, birds, and men are so complicated that little can be stated positively in regard to the loss or gain due to the birds. Naturally the sea-fowl do not have the same economic importance as in the early days of the Newfoundland fisheries, although they are still used for bait and food, many being killed by the fishermen for this latter purpose, and large quantities of eggs are gathered annually. In this manner the birds are of direct value to fishermen, while indirectly they are of much service in pointing out the presence of fish.

On the English coast the actions of gannets often show the position of schools of herring, while on our own shores they frequently indicate the appearance of schools of mackerel. Gulls and terns, shearwaters and auks feed largely upon capelin and lant; and as these small fishes are preyed upon by schools of cod, their presence is frequently an indication that larger fish are not far off; and if the feathered fishermen are compelled to seek their prey at a distance, the chances are that their human competitors will be obliged to do so also. In this connection it may be worth while to note that when at Funk Island the puffins were apparently doing their fishing at some distance from the island, and that two fishing-boats from Fogo tried for cod in the vicinity without success. The question of the quantity of fish eaten by sea-birds is one, which must also be taken into consideration; and while at first sight it

might seem that the destruction of fish-eating birds could be only favorable to the fish, it may be said that until much more is known regarding the food of the birds, the exact relations existing between birds and fish can not be determined. The gannet is charged with devouring large quantities of fish, and while the charge is undoubtedly true, it would seem better for the present to protect the bird than to run any risk of exterminating a species which on both sides of the water has decreased from 20 to 50 per cent. during the last twenty years. So nicely are the economies of nature often adjusted, that interference with them often leads to wholly unexpected results; and it may well be that in destroying fishes that feed upon the spawn of larger species, the sea-birds far more than offset the harm they may do by devouring the young of food-fishes.

Although the many favors received during the voyage have been duly credited in the report of Captain Collins, I would yet like to add my own acknowledgments for the many favors received during the voyage, especially to the Rev. M. Harvey, and to Commander Wakeham.

In conclusion, I desire to thank Captain Collins, not only for his indorsement of the plan at the outset, and for his personal aid and interest in every detail of the varied work of collecting, but for the many courtesies received at his hands during the two months' cruise of the *Grampus*.

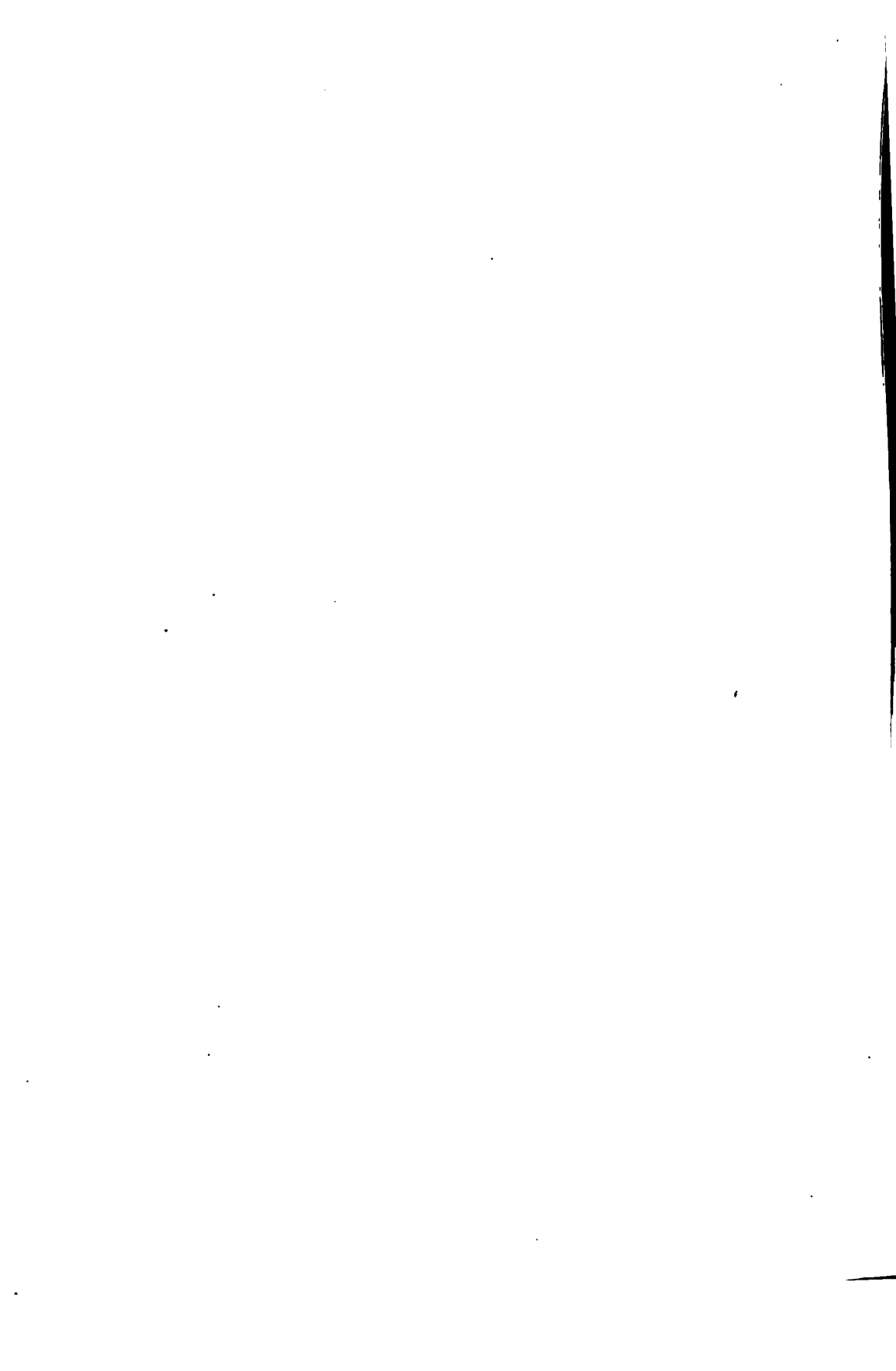

EXPLANATION OF PLATE CVII.

BRONZE BUDDHA,
(TOKUGAWA PERIOD).

Dimensions, including base and wooden *goko*—halo, 70 inches. Figure—base to crown, $38\frac{3}{4}$ inches; width of base, $32\frac{1}{2}$ inches; length of head, $13\frac{1}{2}$ inches; width of face, $10\frac{1}{4}$ inches. Cast in Ise, Japan, A. D. 1648.

JAPAN, 1888.

129.965.

Collected by EDWARD GREY.

The drawing imperfectly conveys the majesty and repose of the original, the modeling of which, with the exception of the hands, resembles that of the Kamakura figure. Its back is covered with the following engraved inscription.

戶 江 列 島

天保九年七月二十日
日十月十一日
日十月十一日

東海大學
相模社
乃主注
天保九年七月二十日

天保九年七月二十日
天保九年七月二十日
天保九年七月二十日

天保九年七月二十日
天保九年七月二十日
天保九年七月二十日

天保九年七月二十日
天保九年七月二十日
天保九年七月二十日

These contain many doctrinal and metaphysical words and phrases, of Sanscrit or Pāli origin, which may be briefly translated, as follows: the form of the record, names, etc., being transposed in order to render it intelligible to Western readers:

“This bronze image of ‘The Buddha of Five Wisdoms,’ was made by Saburo-biyoye Katsutane, son of the great caster, Yoshitane Tsuji of the Fujiwara clan, whose title was Tajima no Kami, Anson, who lived at the Port of Yasuno in the Province of Seishiu (Ise).

“He respectfully cast it for Shichirouyemon Tadanori Takamine, who lives in the town of Matsuzaka in the district of Jidaka, Seishiu (Ise), whose religious name and the religious name of his wife are given, and ‘who desire the blessings of future life for (the souls of) their Fathers, Mothers, and of six unnamed relatives, and for themselves.’

“It was respectfully offered by them to the temple of Joshozan Soan in Yamada, Seishiu (Ise), on the 15th day 9th month of the 1st (rat) year of the Period of Keian—October 30th, 1648, when it was reverently consecrated by *Shonin* (Rev'd) Kwansei-kudatsu, of the Society of Benren (Distinguished pure Lotus), twenty-first Priest of the temple of Sanyenzan Zojo, in the district of Shiba, Yedo, Province of Bushiu (Mus.)”



BRONZE BUDDHA.
(TOKUGAWA PERIOD)



ON A BRONZE BUDDHA IN THE U. S. NATIONAL MUSEUM.*

BY CHARLES DE KAY.

The fine arts of Japan have been known in the West for many centuries and like the cognate arts of China have received the sincerest form of flattery, imitation. Yet a true knowledge is still to come. Between a barbarian contempt for eastern art and the claim of a recent Japanese art-commission returning from a voyage around the world, that the only living art to-day is that of Nippon, there must be a middle term. We are only beginning to assume toward the oriental mind that attitude of sympathy which is necessary to the understanding of its products. Moreover, we are only on the threshold of the historical and legendary view of the development of the fine arts of the extreme Orient, which forms the second and almost equally important basis for appreciation. So it comes that, notwithstanding the wealth of examples of many branches of the fine arts belonging to the Middle Flowery Kingdom and to Nippon, such matters as porcelain and bronze are still regions largely unexplored. In porcelains the beautiful book of Stanislas Julien is invaluable; with regard to bronzes from Japan the old writer Kaempfer and the comparatively modern F. von Siebold did excellently for their time and generation, yet have left the field open for separate and exhaustive treatises.

One branch of art throws light on another. Thus the French work by M. Gonse and the still more useful volumes lately published in London by Dr. Anderson, dealing as they do very largely with the paintings or water colors of the Japanese, will be of inestimable service to the man who has the leisure and talents to devote a book to bronzes from Japan. The present sketch, which revolves round the bronze Buddha lately bought for the National Museum, does not presume to speak of more than a few pieces belonging to the two chief religions of Japan, namely, to Buddhism, the popular faith introduced from the main-land about twelve hundred years ago by Koreans and Chinese, who brought with them a transformed species of the great religion born in but ejected from India; and to Shintoism, the former state religion of Japan. The latter appears to have been formed from Chinese

* Reprinted by permission of the author from "The Chautauquan," October, 1888.

Confucianism, to have absorbed the original spirit and hero-worship of the Japanese, and to have borrowed something from Buddhism itself.

Bronze work resembles other Sinico-Japanese art in its apparent lack of distinctiveness, its seeming unity of impression on those who have not studied it well. As the individuals of an Asiatic or African people seem to be all alike until familiarity with them develops as great differences, man from man, as we find in Europe, so a close examination of Japanese bronzes brings one to the point where the work of the different epochs betrays different characteristics, and individual workmen in metal emerge from the common herd of designers and casters into artists of renown. In the east great respect is paid to tradition in art. Families of artisans have inherited certain ways of work. Religion has been powerful enough to counteract the impulse to be original by deviating from the models of the past. Difficult as the question must be until some one resident in Japan, having access to the temples and museums under government control, and yet acquainted with the contents of public and private collections in Europe, shall found a system of the history of Japanese bronzes, it is possible to distinguish three grand epochs.

The first is represented by the meager yields of grave-mounds. An early wave of conquest appears to have come from the south, favored by the prevailing winds and currents, and brought the men of bronze weapons and implements, before whom the native race, perhaps the hairy people called Ainus, perhaps a mixture of this people with settlers from Korea who had iron weapons, gradually receded toward the north. The second is the great religious epoch, started with a wave of Buddhism from Korea about the time that Europe was settling down after the conquests of the heathen, when missionaries were sallying out from Rome on the one side, and Ireland on the other, and things were shaping themselves for Charlemagne to found his empire. To this epoch belong the gigantic Buddhas at Nara and Kamakura. The third period is associated with the political supremacy of the Tokogawa clan, and runs from about 1600 nearly to our day, say 1868. The Japanese are now in the fourth period, where they are profoundly influenced by the western world in their arts as well as in their polity, and, as many native and foreign observers think, very unfortunately influenced.

From considering Japanese bronzes to have a marked family likeness, one soon learns to note the greatest distinctions among them. In general, one may say that intricate design and bold combinations of high and low relief, technical knowledge in founding, and fantastic subjects, belong to the third or flourishing epoch lately ended. Not that very beautiful, simple, big work is lacking to the present century, but it does not represent the rule.

But however we may distinguish, however we may, according to temperament or training, prefer on the one hand the big sober work of

earlier centuries, or, on the other, the enormously clever design, the bewildering luxuriance of form and suggestion, shown during the period of two centuries and a half lately elapsed, we can not withhold wonder and admiration from the Japanese for their work in bronze in all epochs. It has the stamp of individuality as most European work has not. Bronzes with us are too apt to look like things turned out of a hopper, like buttons from a mill. The profusion of ornament which alarms and irritates fastidious people who have formed their taste on masterpieces surviving from the great Greek and Italian epochs, becomes interesting so soon as the meaning of the various decorative motifs dawns on them. Thus the crane is associated with a certain sage, hero, or saint who is a sort of patron god of knowledge and longevity. The tortoise is a symbol wishing one long life; the peach blossom means that the giver desires the recipient to be beloved and to become the parent of lovely children.

There is a mighty cosmogony, there is a vast and bewildering hagiology, there is a labyrinth of legend, in which Buddhist ascetics, local Buddhas, old heroes of the people, animals endowed with magical powers, and even inanimate things which take on life, are fit subjects for the potter and the founder in bronze. The result is that one is tempted to say that no country has ever shown bronzes which contain so much human interest by way of subject, so much point with respect to usefulness in temple and house, so much elegance of finish, beauty of shape, and originality of design as the Japanese.

By far the greater part of the bronzes in Japan have to do with the service of a temple. There are many other uses for the metal, of course, such as coinage, weapons, ornaments for the person, utensils for the house, decorative pieces, boxes, trays, flower-holders, and what not. But the houses of nobles in Japan are far from luxurious, and as a rule the costliest things are appointments of or gifts to a temple. Shintoism in its purer form had no idols and few altar-ornaments in its temples, but Buddhism in the form which it has taken far from its seat in India, encouraged these luxuries. Japanese writers who belong to the comparatively free-thinking sects which may be allied to Confucianism have always reproached the native Buddhists with using the fine arts to captivate the multitude, deceiving the eye with pictures and statuettes and the understanding with monkish tricks. They have taken much the same attitude toward Buddhism that the Reformation took toward Roman Catholicism.

On the other hand the same thing was cynically defended on the ground that Buddhist monks were useful in keeping the common people ignorant and steeped in superstition. Or, the argument was, that it suited a certain phase of mind. "People may go so far as to destroy those who hold to names and pictures," wrote a Japanese apologist in 1690 in his preface to the *Buts-zo-dsu-i*, translated by Dr. J. Hoffman into German; "yea, to give to the flames the wooden statues of Buddha. But will the silly layman for that understand any better the glorious

purpose of upward endeavor? The Most Illuminated whom mankind worships, and who in his great mercy did good to all creatures and brought them to salvation, verily he willed that also the silly common man should strive gradually, step by step, to Perfection." The book is a description of native and foreign saints; the writer, apparently by no means a vigorous or ardent believer in Buddhism, makes a shrewd appeal to that class of minds in all parts of the world which sees in religious forms a wholesome regimen for the ignorant.

But since 1874 Buddhism has lost the support of the Shoguns and feudal upper class, owing to the practical abolishment of their power. They were patrons of Buddhism from policy, if not from conviction, and the bronze gifts to temples have fallen off. Moreover, they were patrons of bronze work not religious in purpose, and now they, or such as can be said to represent them, dress like Europeans, aspire to European habits, and use foreign furniture. Last, but not least of all, the full establishment of commerce with the West, before the country was prepared for it, appears to have had for its first effects a singularly rapid and universal lowering of the artistic quality of all objects of art, because cheap and quickly fabricated articles in enormous quantities had to be supplied to America and Europe. From these causes of discouragement the production of good bronzes, that is to say, bronzes of a high artistic, not merely a fine technical quality, has undoubtedly fallen away.

Some connoisseurs prefer the most important castings in bronze made by the early Buddhists of Japan, owing to their grandeur, simplicity, and noble massiveness. Such are the colossal Yakushi in the temple at Nara and the famous Daibuts, or seated figure of Buddha, cast by Kimimaro in A. D. 749. In pottery and *faïence* the same taste is likely to prefer the comparatively small and undecorated pieces which the native collectors treasure in silken bags and fondle with the amiable folly of him who is ridden by his hobby. Professor Morse describes these amateurs as aghast at the overdecorated vases which modern Japanese potters fabricate for us, and which the dealers sell us for pieces of the great epochs.

Besides the colossi mentioned there are other images in bronze of a larger size, but they have rarely left the country. A seated Buddha of this sort, which was exported to the United States before the Japanese became attentive to the need of preserving the monuments of Japan, had a romantic career of neglect and discovery in New York; it is now in the National Museum at Washington, thanks to the knowledge of Mr. Edward Greay, the author of various translations from the Japanese (Plate CVII).

It has a bronze halo, and differs from the beautiful and impressive seated Buddha at Kamakura in size and in the position of the fore-fingers. These do not touch each other along the two upper joints, but lie one within the other. A slight trait of this kind is of the greatest importance to a Buddhist. It marks the difference between figures

Of the greatest of all Buddhas at various moments of his ecstasy or absorption into Nirvana, or it distinguishes *the* Buddha from foreign or local saints who have presumably reached the Buddhahood by meritorious pondering. He has the famous knob on his forehead, about which many legends revolve; also the short round curls over his head, supposed to be the snails which guarded him from sunstroke, and he carries the mark on the top of his head. He has the large ears with their lobes pierced and distended, but no earrings. The figure represents Buddha, after having taught his doctrine, merging himself into Nirvana. To an adept, the position of his thumbs and forefingers expresses a world of hidden meanings.

The figure is luckily provided with a copious inscription which is couched in phrases anything but easy of translation, owing to the curious phraseology of monkish scribes. A Japanese does not use idioms like ours in ordinary matters, but when it comes to writing he is further influenced by the enigmatical style of a literature profoundly influenced by that of China. To this we must add the peculiarity of expressions that were meant originally to translate Sanscrit or Hindoo modes of religious speech which have been further filtered through an obsolete form of Chinese by persons devoid of an exact knowledge of tongues. The sense of the lettering, according to Mr. Greey, is that this, "The Buddha of the Five Wisdoms," was cast by Saburo Biyoyé Katsutaré in the province of Isé, and was dedicated to a temple in Yamada, province of Isé, in the year 1648. Then follow the religious names (for the Japanese laymen took religious names as freely as Catholics who enter monasteries do to-day) of the person who paid for the statue. Then come the religious names of friends and those of the dead whose souls the giver wished to benefit thereby. Then the priest who dedicated the pieces is mentioned and he slyly slips in the names of his own ancestors. Finally appears the name of the scribe whom the priest employed to carve the words. The motto of "The Buddha of the Five Wisdoms" is as follows: *All the world can share the Blessings of Buddhism.* It may be noted that in Japan the number five has especial sanctity. Thus there are five elements, five yearly festivals, five chief colors, five great laws, five tones in music. The temple where this Buddha was dedicated was that of Joshagan Soan in Yamada. One would like to know if it has survived the wreck of time, the fall of puppet emperors and guardian nobles, of the old worship and the iconoclasm preached by Christians. Shall we suppose that the priest of the temple at Yamada was like that Yekeo Hoshi who is said to have recited, seated mournful in his neglected fane, these verses, paraphrased by Dickens:

My mountain dwelling's roof of thatch
Is with Yahemigura moss o'ergrown;
Of passers-by no glimpse I catch,
I dwell uncheered and alone;
'Tis autumn time
And mankind dread the rig'rous clime.

Without doubt there was a celebration of *kai-cho*, or opening of eyes, when this figure was dedicated in some such temple as that of keo Hoshi, deserted by the fickle populace for more attractive faiths. The ceremonies were as elaborate and solemn as that in Catholic countries on the dedication of a chapel. Pieces of colored paper were pasted over his eyes, and at a given moment torn off, so that the image might gaze on his worshippers. Not far off stood such a great incense-burner as the hall of a shrine always shows. Mounting on steps, attended by priests constantly replenished it with incense, the offerings of the devout, bought at extortionate prices on the temple grounds. On either side of the alcove where the Buddha sat enthroned, and well out of sight, rose, we may be sure, two temple lanterns exquisitely cast in bronze. The roof or lid, of the lantern has in high relief the dragon of the clouds holding the magic jewel in his claws. About the pagoda-shaped lantern itself, four fishes spring outward like gargoyles; they are modeled in the round and are very lively looking animals out of their element. Below the lantern is a bamboo grove with ascetics in relief. Then comes a frieze of animals representing the hours and houses of the zodiac. The dragon appears on the stem, answering to that above to the "waters above and the waters below," while the beginning of the cosmogony shows in the foot of the lantern with tortoises and conventional waves to represent the ocean.

The whole piece symbolizes the world—water, earth, air, fire, ether—while the Buddhist saints occupy a significant position high above the reach of time (the hours and zodiac), close to the palace of heaven (the pagoda), and the realms of ether (the upper dragon).

Let us examine the incense-burners. They are large, but not of the size that the great popular temples show. Elephant heads form the two arms, and the survival in Japan of Hindoo ideas in religion is further seen in the frieze, which consist of Rakans or magical saints somewhat like the Rishis of India. The bowl into which the incense is thrown is poised upon the heads of three naked wrestlers, who support it under the burden, but are so gross of form, so mighty of muscle, that they bear the round jar with little suggestion of discomfort. No dragon *motif* is used here, for in China and Japan that fabulous being appears to have largely lost his connection with fire and the sun, in order to undertake the care of rain, cloud, and moisture everywhere.

With some plausibility the dragon is thought to be one remnant of the original native religion taken up by Buddhism in China and Japan. Compared with the monster as depicted in stone and colors by artists of our Middle Ages, it is a graceful creature. Dragons a foot or two long, made of an incredible number of pieces held together, are among the marvels of Japanese workers in iron and bronze; great prices are paid when the foundry-man or iron-smith is a famous artist. They sometimes have a character of their own which justifies one in placing them among serious works of art. When taken in the hand their fl

ibility and coldness make them seem alive, while their singular motions and threatening look express capitally the fierceness and wayward nature attributed to a symbol of the least stable of elements. To us and to skeptical natives it is a curious, ingenious plaything, but to the Japanese of the old religions or to the Buddhist, it means a good deal more : it is a talisman to exorcise the dangers that lurk in sky and sea.

Here, then, are such specimens of Japanese bronze-work as Americans can examine in their own country, either in museums, in the shops of dealers, or in the private galleries of the country. Perhaps too much has been made of the degeneracy of Japanese workmen in these days. It is true that they seem no longer to have a fixed and definite aim for their energies, but that could hardly be when in political matters all is floating, all is changing. Yet they still show wonderful skill, patience, and fertility of resource; they seem able to imitate almost anything from the past, if not to originate great designs. In metal work especially are they wonderfully strong; it is not too much to say that they lead the world for variety of design, beauty of finish, boldness of relief, and readiness to follow new leads. Despite the croaking of critics native and critics foreign, who shall say that when the genius of these workers in metals shall have adapted itself to the new state of things, it will not take another flight into the realms of high art?

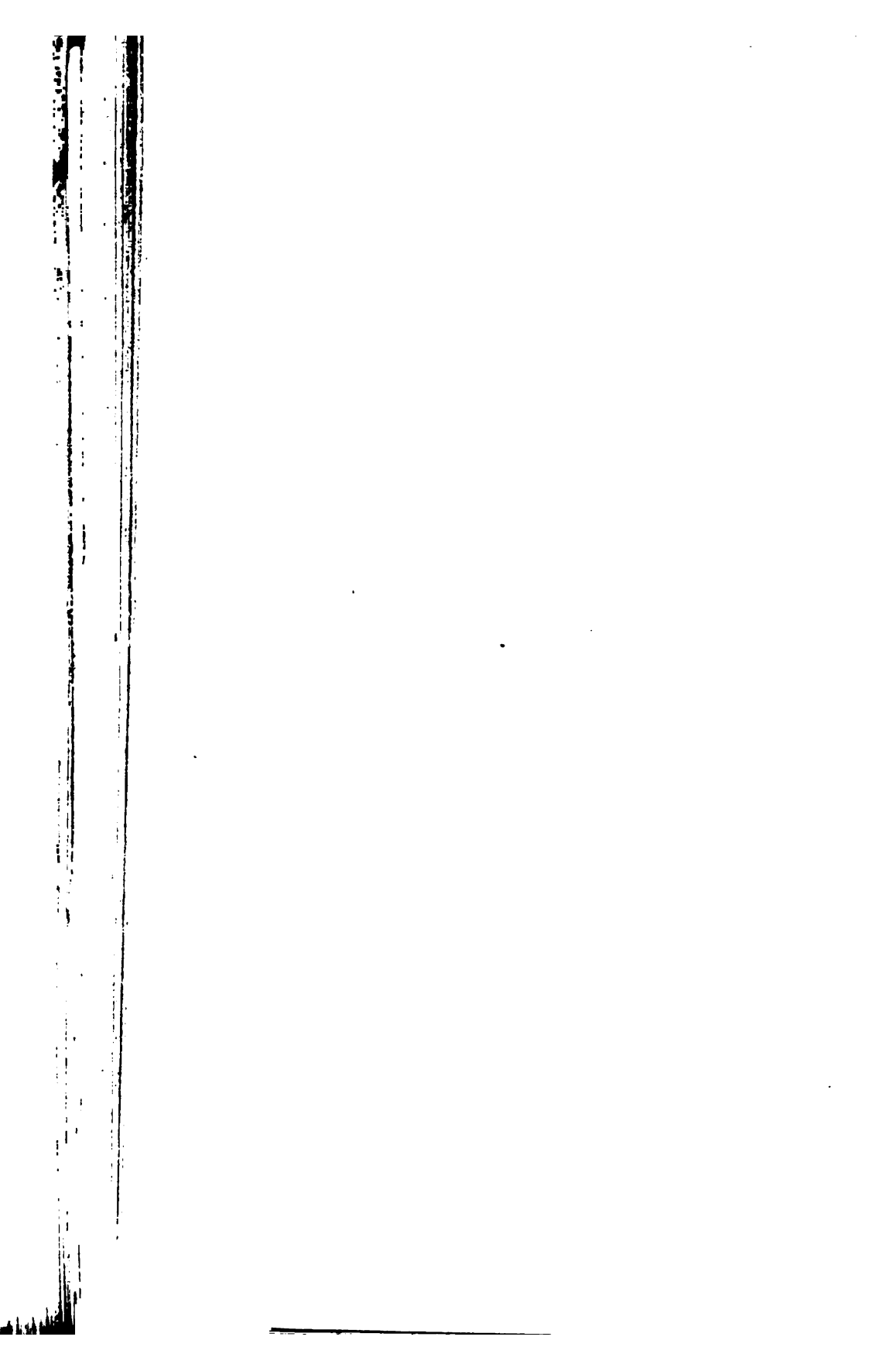

SECTION IV.

BIBLIOGRAPHY OF THE U. S. NATIONAL MUSEUM

FOR THE

FISCAL YEAR ENDING JUNE 30, 1889.



BIBLIOGRAPHY OF THE U. S. NATIONAL MUSEUM

FOR THE

FISCAL YEAR ENDING JUNE 30, 1889.

I.—PUBLICATIONS OF THE MUSEUM.

PROCEEDINGS FOR 1887.

Department of the Interior: | United States National Museum.
 | — | Proceedings | of the | United States National Museum.
 | Vol. X. | 1887. | — | Published under the direction of the
 Smithsonian Institution. | — | Washington: | Government
 Printing Office. | 1888.

8vo., pp. VIII, 771; 39 plates, 8 text figures.

The following is a list of the signatures of the Proceedings of the U. S. National Museum, published between July 1, 1888 and June 30, 1889, and forming parts of Volumes X and XI:

Date of publication.	Signa- ture No.	Pages.	Date of publication.	Signa- ture No.	Pages.
VOLUME X.			VOLUME XI—Continued.		
1888.			1888.		
Aug. 6.....	32	497-512	Nov. 8.....	3	33- 48
Aug. 6.....	33	513-528	Nov. 8.....	4	49- 64
Aug. 6.....	34	529-544	Nov. 8.....	5	65- 80
Aug. 6.....	35	545-560	Nov. 8.....	6	81- 90
Aug. 6.....	36	561-576	Nov. 8.....	7	91-112
Aug. 6.....	37	577-592	Nov. 8.....	8	113-128
Sept. 19.....	38	593-608	1889.		
Sept. 19.....	39	609-624	Jan. 5.....	9	129-144
Sept. 19.....	40	625-640	Jan. 5.....	10	145-160
Sept. 19.....	41	641-656	Jan. 5.....	11	161-176
Sept. 19.....	42	657-672	Mar. 12.....	12	177-192
Sept. 19.....	43	673-688	Mar. 12.....	13	193-208
Oct. 12.....	44	689-704	Mar. 12.....	14	209-224
Oct. 12.....	45	705-720	Mar. 12.....	15	225-240
Oct. 12.....	46	721-736	Mar. 26.....	16	241-256
Oct. 12.....	47	737-752	Mar. 26.....	17	257-272
Oct. 12.....	48	753-768	Mar. 26.....	18	273-288
Oct. 12.....	49	769-771	Mar. 26.....	19	289-304
VOLUME XI.			Mar. 26.....	19	289-304
Nov. 8.....	1	1-16	Total.....	37	580
Nov. 8.....	2	17-32			

BULLETINS (Current Numbers).

Department of the Interior: | U. S. National Museum. | —Serial Number 44.— | Bulletin | of the | United States National Museum | No. 33. | — | Published under the direction of the Smithsonian Institution. | — | Washington: | Government Printing Office. | 1889.

8 vo., pp. 198.

Smithsonian Institution. | United States National Museum. | [Serial Number 45] | Bulletin | of the | United States National Museum. | No. 34. | The Batrachia of North America. | By | E. D. Cope. | — | Washington: | Government Printing Office. | 1889.

8 vo., pp. 515; 86 plates, 119 text figures.

Smithsonian Institution. | United States National Museum. | — | Bulletin | of the | United States National Museum. | No. 35. | Bibliographical Catalogue of the Described Transformations | of North American Lepidoptera. | By | Henry Edwards. | — | Washington: | Government Printing Office. | 1889.

8 vo., pp. 147.

Smithsonian Institution. | United States National Museum. | — | Bulletin | of the | United States National Museum. | No. 36. | Contributions to the Natural History of the Cetaceans, | A Review of the Family Delphinidæ. | By | Frederick W. True | — | Washington: | Government Printing Office. | 1889.

8 vo., pp. 191; 47 plates, 1 text figure.

Smithsonian Institution. | United States National Museum. | — | Bulletin | of the | United States National Museum. | No. 37. | A Preliminary Catalogue of the Shell-bearing Marine | Mollusks and Brachiopods of the Southeastern | Coast of the United States, with illustrations of many of the Species. | By | William Healy Dall A. M., | Honorary Curator, Department of Mollusks, U. S. National Museum. | — | Washington: | Government Printing Office. | 1889.

8 vo., pp. 221; 74 plates.

CIRCULARS.

Circulars No. 37, No. 38, No. 39, No. 40, No. 41 were published during this year. They bear the following titles:

No. 37. Catalogue of the Contributions of the Section of Graphic Art to the Ohio Valley Centennial Exposition, Cincinnati, 1888. By S. R. Koehler.

8 vo., pp. 31.

No. 38. The Contribution of the Section of Oriental Antiquities to the Ohio Valley Centennial Exhibition. By Cyrus Adler.

8 vo., pp. 7.

- No. 39. **Description of Exhibit made by the Department of Prehistoric Anthropology in the National Museum at the Ohio Valley and Central States Exposition in Cincinnati, Ohio, 1888.** By Thomas Wilson.
8 vo., pp. 33; 50 text figures.
- No. 40. **Guide to the collection illustrating the Families of Mammals, exhibited in the Ohio Valley Centennial Exhibition in 1888 by the U. S. National Museum.** By Frederick W. True.
8 vo., pp. 26.
- No. 41. **Contributions of the Department of Transportation and Engineering to the Ohio Valley Centennial Exposition, 1888.** By J. Elfreth Watkins.
8 vo., pp. 18.

II.—PAPERS BY OFFICERS OF THE NATIONAL MUSEUM AND OTHER INVESTIGATORS WHOSE WRITINGS ARE BASED DIRECTLY OR INDIRECTLY ON MUSEUM MATERIAL.

ALPHABETICAL LIST OF NAMES.

- Adler, Cyrus, Johns Hopkins University, Baltimore, Maryland.
 Allen, J. A., American Museum of Natural History, New York.
 American Ornithologists' Union.
 Atwater, W. O., Director of office of Experiment Stations, U. S. Department of Agriculture.
 Bartlett, Edward, Maidstone, Kent, England.
 Baur, G., Yale College, New Haven, Connecticut.
 Bean, Tarleton H., U. S. Fish Commission; Honorary Curator, Department of Fishes, U. S. National Museum.
 Beckham, Charles Wickliffe, Bardstown, Kentucky.
 Bendire, Charles E., U. S. Army, Honorary Curator, Department of Birds' Eggs, U. S. National Museum.
 Berlepsch, Hans von, Münden, Germany.
 Bishop, Louis D., New Haven, Connecticut.
 Boaz, Franz, New York, New York.
 Bollman, Charles H., Indiana University, Bloomington, Indiana.
 Brewster, William, Cambridge, Massachusetts.
 Butler, Amos W., Brookville, Indiana.
 Catlett, C., Staunton, Virginia.
 Chapman, Frank M., American Museum of Natural History, New York, New York.
 Clark, A. Howard, U. S. National Museum.
 Clarke, F. W., U. S. Geological Survey; Honorary Curator, Department of Minerals, U. S. National Museum.
 Cope, E. D., Philadelphia, Pennsylvania.
 Cory, Charles B., Boston, Massachusetts.
 Dall, William Healey, U. S. Geological Survey; Honorary Curator, Department of Mollusks, U. S. National Museum.
 Davison, J. L., Lockport, New York.
 Dewey, Fred. P., Curator, Department of Metallurgy and Economic Geology, U. S. National Museum.
 Dugès, A., Guanajuato, Mexico.
 Eggers, H., Milwaukee, Wisconsin.
 Eigenmann, Carl H., Indiana University, Bloomington, Indiana.
 Elliott, D. G., American Museum of Natural History, New York, New York.
 Evermann, Barton W., Indiana University, Bloomington, Indiana.

- Fernow, B. E., Chief of the Division of Forestry, U. S. Department of Agriculture.
Honorary Curator, Department of Forestry, U. S. National Museum.
- Fewkes, J. Walter, Museum of Comparative Zoology, Cambridge, Massachusetts.
- Galloway, B. T., Department of Agriculture.
- Gill, Theodore, Washington, District of Columbia.
- Godman, F. D., London, England.
- Goode, G. Brown, Assistant Secretary, Smithsonian Institution, in charge U. S. National Museum.
- Goss, David K., Indiana State University, Bloomington, Indiana.
- Goss, Col. N. S., Topeka, Kansas.
- Hartlaub, G., Bremen, Germany.
- Hasbrouck, E. M., Toccoa, Georgia.
- Haupt, Paul, Johns Hopkins University; Honorary Curator, Section of Oriental Antiquities, U. S. National Museum.
- Hitchcock, Romyne, Acting Curator, Sections of Textiles and Foods, U. S. National Museum.
- Holmes, William H., Bureau of Ethnology; Honorary Curator, Department of American Aboriginal Pottery, U. S. National Museum.
- Hough, Walter, Department of Ethnology, U. S. National Museum.
- Howard, L. O., Assistant Entomologist, Department of Agriculture.
- Hudson, W. H., Buenos Ayres, Argentine Republic.
- "Ibis," Editors of the.
- Jenkins, Oliver P., De Pauw University, Greencastle, Indiana.
- Johnston, Jr., C., Baltimore, Maryland.
- Jordan, David Starr, President, Indiana University, Bloomington, Indiana.
- Kay, Charles De, 103 East Fifteenth Street, New York, New York.
- Knowlton, Frank H., Assistant Curator, Department of Fossil Plants, U. S. National Museum.
- Koehler, S. R., Curator, Section of Graphic Arts, U. S. National Museum.
- Langley, Samuel P., Secretary, Smithsonian Institution.
- Lawrence, George N., New York, New York.
- Leidy, Joseph, Philadelphia, Pennsylvania.
- Lesquereux, Léo, Columbus, Ohio.
- Linton, Edwin, Washington and Jefferson College, Washington, Pennsylvania.
- Lucas, Frederic A., Assistant Curator, Department of Comparative Anatomy, U. S. National Museum.
- Mason, Otis T., Curator, Department of Ethnology, U. S. National Museum.
- Merriam, C. Hart, Ornithologist, Department of Agriculture.
- Merrill, George Perkins, Curator, Department of Geology, U. S. National Museum.
- Merrill, J. C., Assistant Surgeon, U. S. Army, Fort Reno, Indian Territory.
- Murdoch, John, Librarian, Smithsonian Institution.
- Niblack, Albert P., Ensign, U. S. Navy.
- Pilsbry, Henry A., Academy of Natural Sciences, Philadelphia, Pennsylvania.
- Price, W. W., Riverside, California.
- Rathbun, Richard, U. S. Fish Commission; Honorary Curator, Department of Marine Invertebrates, U. S. National Museum.
- Richmond, Charles W., U. S. Geological Survey, Washington, District of Columbia.
- Ridgway, Robert, Curator, Department of Birds, U. S. National Museum.
- Riley, Charles Valentine, Entomologist, Department of Agriculture; Honorary Curator, Department of Insects, U. S. National Museum.
- Robinson, Wirt, Lieutenant, U. S. Army, Fort Adams, Rhode Island.
- Salvin, Osbert, 10 Chandos Street, Cavendish Square, London, England.
- Selater, Philip Lutley, Secretary of the Zoological Society of London, London, England.
- Sennett, George B., New York, New York.

- Shufeldt, R. W., Captain, Medical Corps, U. S. Army, Fort Wingate, New Mexico.
 Simpson, Charles Torrey, Ogallala, Nebraska.
 Smith, John B., Assistant Curator, Department of Insects, U. S. National Museum.
 Stearns, R. E. C., Adjunct Curator, Department of Mollusks, U. S. National Museum.
 Stejneger, Leonhard, Curator, Department of Reptiles, U. S. National Museum.
 Stephen, Alexander M., Keam's Cañon, Arizona.
 Sterki, V., New Philadelphia, Ohio.
 True, Frederick W., Curator, Department of Mammals, U. S. National Museum.
 Vasey, George, Botanist, Department of Agriculture; Honorary Curator, Department of Botany, U. S. National Museum.
 Walcott, Charles D., U. S. Geological Survey; Honorary Curator, Department of Invertebrate Fossils (Paleozoic), U. S. National Museum.
 Ward, Lester F., U. S. Geological Survey; Honorary Curator, Departments of Fossil and Recent Plants, U. S. National Museum.
 Warren, B. H., State Ornithologist, Harrisburg, Pennsylvania.
 Watkins, J. Elfreth, Curator, Section of Transportation, U. S. National Museum.
 White, Charles A., U. S. Geological Survey; Honorary Curator, Department of Invertebrate Fossils (Mesozoic), U. S. National Museum.
 Whitfield, J. W., American Museum of Natural History, New York City.
 Wilson, Thomas, Curator, Department of Prehistoric Anthropology, U. S. National Museum.

LIST OF PAPERS.

- CYRUS ADLER.** The Views of the Babylonians concerning Life after Death.
Andover Review, x, pp. 92-101.
 The Assyro-Babylonians believed in a future life. Reward and punishment were as a rule awarded in the flesh. A region of the blessed was reserved for a select few.
- CYRUS ADLER.** Assyrian weak verbs.
Proc. Am. Orient. Soc., October, 1888, pp. xcviii-c.
 Showing that these classes of weak verbs, usually confounded, can be sharply differentiated.
- CYRUS ADLER.** The U. S. National Museum exhibit of Oriental Antiquities at the recent Cincinnati Exposition.
Proc. Am. Orient. Soc., October, 1888, pp. i-iii.
 Brief description of the exhibit.
- CYRUS ADLER.** Note on the proposed edition of the life and writings of Edward Hincks.
Proc. Am. Orient. Soc., October, 1888, pp. ci-civ.
 Record of progress of the work and additions to the bibliography.
- CYRUS ADLER.** Report on the progress of Oriental Science in America during 1888.
Proc. Am. Orient. Soc., May, 1889, p. cxliv.
 Announcement of intention to prepare report and request for cooperation.
- J. A. ALLEN.** Descriptions of new subspecies of the Seaside Finch (*Ammodramus maritimus*).
The Auk, v, July, 1888, pp. 284-287.
 (1) *Ammodramus peninsulae*, Scott's Seaside Sparrow, p. 284; habitat, "Southwestern Florida (Tarpon Springs and Cedar Keys) and Louisiana (Grand Isle)." (2) *Ammodramus maritimus sennetti*, Texan Seaside Sparrow, p. 286; habitat, "Gulf Coast of Texas (Corpus Christi)."
- J. A. ALLEN.** Description of a new species of the Genus *Tityra*, from Ecuador.
The Auk, v, July, 1888, pp. 287-288.
Tityra nigricaps, p. 287; habitat, "Head-waters of the Napo, Ecuador."
- J. A. ALLEN.** On *Cychloris* (lege *Cyclorhis*) *viridis* (Veill) and its near Allies, with remarks on other species of the Genus *Cyclorhis*.
Bull. Am. Mus. Nat. Hist., II, No. 3, June 17, 1889, pp. 123-135.
 An important systematic review of the genus, elucidating many mooted points of synonymy, relationship, and distribution, accompanied by an excellent "key to the species," and illustrated by seven woodcut figures of heads.
Cychloris favipectus trinitatis, new subspecies from Trinidad.

J. A. ALLEN. Descriptions of new species of South American Birds, with remarks on various other little-known species.

Bull. Am. Mus. Nat. Hist., II, No. 2, June 28, 1889, pp. 137-151.

The new species described are as follows: (1) *Thryothorus macrourus*, p. 137, Bogota; (2) *Thryothorus longipes*, p. 138, Ambato, Ecuador; (3) *Platyrhynchus bifasciatus*, p. 141, Chapada, Matto Grosso, Brazil; (4) *Platyrhynchus insularis*, p. 143, Tobago; (5) *Euscarthmus ochropterus*, p. 143, Chapada, Matto Grosso, Brazil; (6) *Sublegatus virescens*, p. 149, Chapada, Matto Grosso, Brazil; (7) *Thamnophilus doliatus mexicanus*, p. 151, Mexico (name substitute for *Thamnophilus affinis*, preoccupied).

Other species treated are as follows: *Porphyrospiza carulescens* (Wied), p. 140; *Mecocerculus uropygialis*, Lawr., p. 141; *Euscarthmus pelzelni* Sol., p. 143; *Habrura superciliiaris* (Wied), p. 145; *Habrura minima* (Gould), p. 146; *Phyllomyias incanescens* (Wied), p. 147; *Ornithiopsis cinerascens* (Wied), p. 148; *Peristera mondetoura*, Bon., p. 151. In addition to these important critical notes are others with special titles, as follows: (1) Note on *Thryothorus "mystacalis"* of the Rusby Collection, p. 139 (considered to be either "a very large, very strongly colored example of *T. genibarbis* or else an undescribed form"); (2) Note on the type of the Genus *Habrura* Cab. and Heine, p. 147 (type decided to be *Pachyrhamphus minimus* Gould); (3) Note on *Formicivora griseigula* Lawr., p. 151 (which "proves . . . to be an immature *Thryothorus coraya*").

AMERICAN ORNITHOLOGISTS' UNION. Supplement | to the | Code of Nomenclature and Check-List | of | North American Birds | adopted by the American Ornithologists' Union | Prepared by | a Committee of the Union | — | New York | American Ornithologists' Union, 1889, 8vo., pp. 23.

As explained in the preface, it consists "of the tenable species and subspecies, genera and subgenera, added since the publication of the Check-List, together with any necessary eliminations and valid changes in nomenclature made since the Check-List was issued. The supplement here presented records the ruling of the Committee on about one hundred distinct questions, involving additions to the Check-List or changes in its nomenclature. The matter is classified under three heads: I, Additions; II, Eliminations; III, Changes in Nomenclature.

The additions number twenty-three species, and forty-three subspecies, one genus, and three subgenera. The eliminations are two species and one subspecies. The changes in nomenclature are three affecting genera, two affecting subgenera, fifteen affecting species, and two affecting subspecies.

The committee to whom the work was assigned by the Union consists of Messrs. Allen, Brewster, Coues, Merriam, and Ridgway. Mr. Ridgway acted as the committee's secretary, to whom also fell the greater part of the work of preparing the manuscript for printing. (J. A. Allen, in *The Auk*, April, 1889, pp. 168, 169.)

AMERICAN ORNITHOLOGISTS' UNION. Check-List | of | North American Birds | according to the Canons of Nomenclature | of the | American Ornithologists' Union | — | Abridged Edition | Revised | — | Published by the American Ornithologists' Union | 1889, 8vo., pp. 71.

The Abridged Check-List "contains only the scientific names, English names, concordances and current numbers." The list of fossil birds contained in the original Check-List, however, has been omitted, and a list of introduced or naturalized Species has been added. This addition of the Check-List is thus not only abridged, but revised to date. It is printed on only one side of the paper, thus adapting it for use in labeling, or for the reception of notes or additions. The preparation of the manuscript for this edition was made by Dr. Merriam, at the request of the committee. He also supervised the printing and compiled the list of "Naturalized Species," which task had been especially assigned to him by the committee.

Collation of the abridged edition with the original Check-List and Supplement shows an almost faultless correspondence, the only discrepancies of any importance being in the numeration, where 420 c in the abridged edition should be 420 b, and 519 c should be 519 b.

The "Hypothetical List," however, has been renumbered, there having been here one elimination and two additions. (J. A. Allen, in *The Auk*, April, 1889, p. 169.)

W. O. ATWATER. First Annual Report of the Storrs School Agricultural Experiment Station, Storrs, Connecticut, 1888, p. 104.

W. O. ATWATER. Report of the Director of the Office of Experiment Stations. *Report of the U. S. Commissioner of Agriculture*, 1888, pp. 537-558.

W. O. ATWATER. Organization of the Agricultural Experiment Stations in the United States.

Bull. Experiment Station, No. 1, U. S. Department of Agriculture, February, 1889, p. 82.

- W. O. ATWATER. The What and Why of Agricultural Experiment Stations. *Farmers' Bulletin*, No. 1, U. S. Department of Agriculture, June, 1889, p. 16.
- W. O. ATWATER. Coöperative Field Experiments with Fertilizers. *Circular No. 7, U. S. Department of Agriculture*, March, 1889, p. 39.
- W. O. ATWATER. Explanations and Directions for Soil Tests with Fertilizers. *Circular No. 8, U. S. Department of Agriculture*, March, 1889, p. 11.
- W. O. ATWATER. Digest of the Annual Reports of the Agricultural Experiment Stations in the United States for 1888, part I. *Bull. Experiment Station*, No. 2, U. S. Department of Agriculture, June, 1889, p. 258.
- EDWARD BARTLETT. A Monograph | of the | Weaver-Birds, | Ploceidæ, | Arboreal and Terrestrial | Finches, | Fringillidæ, | By | Edward Bartlett, | Curator of the Maidstone Museum (Kent, England.) | — | Contents (Names of species treated in each separate part). Maidstone: Published by the author. 1888. Printed by J. Burgess-Brown, Week Street.
- Royal 8vo, illustrated by hand-colored lithographic plates.
- Part I contains text and colored plates of the following species: (1) *Chrysomitris atrata*, the Black Siskin; (2) *Textor dinemelli*, the Great Whiteheaded Weaver; (3) *Textor boehmii*, Bohm's Weaver; (4) *Pyrhula nipalensis*, the Nepanese Bullfinch; (5) *Paroaria cucullata*, the Crested Dominican Cardinal; (6) *Munia oryzivora*, the Java Sparrow (two plates).
- Part II contains the following: (1) *Cardinalis virginianus*, the Virginian Nightingale; (2) *Chrysomitris uropygialis*, the Yellow-rumped Siskin; (3) *Passer domesticus*, the House Sparrow; (4) *Textor panicivorus*, the Great Red-billed Weaver (two plates); (5) *Textor albivestris*, the Great Black Weaver.
- G. BAUR. Osteologische Notizen über Reptilien (Fortsetzung III). *Zoologischer Anzeiger*, XI, No. 285, August 6, 1888, pp. 417-424.
- Treats of *Proganochelys quenstedtii* Baur. Attempt at a classification of the typical *Pleurodira*; osteological peculiarities of the living *Pleurodira*; and *Cotpocheilus* Garman.
- G. BAUR. Osteologische Notizen über Reptilien (Fortsetzung IV). *Zoologischer Anzeiger*, XI, No. 291, October 22, 1888, pp. 592-597.
- Besides additional notes on the osteological peculiarities of the living *Pleurodira*, and a short one on the occipital condyle of *Pelomedusa subrufa* La Cep., the present "Fortsetzung" is devoted to a discussion of the "Systematic position of *Dermatemys* Gray," with the result that the genus is placed in a special family, *Dermatemydidæ*, and a similar article on *Manouria*, which is made a subfamily, *Manouriinae*, under the *Testudinida*.
- G. BAUR. Osteologische Notizen über Reptilien (Fortsetzung V). *Zoologischer Anzeiger*, XI, No. 296, December 31, 1888, pp. 736-740.
- The various subheadings of this article indicate the nature of the notes as follows: *Trionychoidea*; the quadrato-jugale of *Terrapene carolina* L. Peculiarities in the skulls of *Staurotypidæ*, *Cinosternidæ*, and *Dermatemydidæ*; *Pleurodira*; the saddle-shaped articulations of the cervical vertebrae of *Podocnemis*.
- G. BAUR. Osteologische Notizen über Reptilien (Fortsetzung VI). *Zoologischer Anzeiger*, XII, No. 298, January 21, 1889, pp. 40-47.
- The present series contains notes, relating to *Testudinata*, on the epipterygoid of the *Pinnata*; on the number of pleuralia (costalia) in the *Chelonians*; on the peripheralia (marginalia) of the *Pinnata*; on the connection of carapace with plastron in the *Pinnata*; on the absence of foramen palatinum in the *Chelonidæ* and the *Dermochelyidæ*; on the nuchale of the *Pinnata*; and on the cervical vertebrae of the *Pinnata*.
- G. BAUR. Notes on the American *Trionychoidea*. *American Naturalist*, XXII, 1888, pp. 1121, 1122.
- Recognizes two genera, *Platypeltis*, with one species, *P. agassizii* Baur (*P. ferox* Agass., nec Schn.), and *Aspidonectes*, with six species.
- G. BAUR. The Systematic Position of *Meiolania*, Owen. *Annals and Magazine of Natural History*, (6) III, January, 1889, pp. 54-62.
- The result of the author's researches is summed up as follows: "I am inclined to consider *Meiolania* as a highly specialized branch of the true land-tortoises."
- G. BAUR. On *Aulacochelys*, Lydekker, and the systematic position of *Anosteira* Leidy, and *Pseudotrionyx*, Dollo. *Annals and Magazine of Natural History*, (6) III, March, 1889, pp. 273-276.
- The author considers the genus *Aulacochelys* as not entitled to recognition, being based upon trivial characters. He also gives his reasons for referring *Anosteira* either to the *Staurotypidæ* or the *Cinosternidæ*, but concludes by provisionally following Boulenger in placing this genus with *Pseudotrionyx* in a separate family.

G. BAUR. Die Systematische Stellung von *Dermochelys* Blainv.

Biologisches Centralblatt, ix, No. 5, May 1, 1889, pp. 149-153, and concluded in No. 6, May 15, 1889, pp. 180-191.

Author maintains his former standpoint that *Dermochelys* should not be removed from the "Pinnata," and that the group "Athece" is not well founded.

TARLETON H. BEAN. The Red-spotted Trout of New England.

Shooting and Fishing, v, January 10, 1889, pp. 6, 7.

TARLETON H. BEAN. Rubbish in the Thames.

Forest and Stream, xxxi, January 17, 1889, p. 520.

TARLETON H. BEAN. Lake and Brook Trout Hybrid.

Forest and Stream, xxxi, January 17, 1889, p. 520.

TARLETON H. BEAN. Landlocked and Atlantic Salmon.

Forest and Stream, xxxi, January 17, 1889, p. 520.

TARLETON H. BEAN. Some Recent Papers by Charles Girard.

Forest and Stream, xxxi, January 17, 1889, p. 515.

TARLETON H. BEAN. Notes on Salmon, Trout, and Eels.

Forest and Stream, xxxii, January 24, 1889, p. 9.

TARLETON H. BEAN. Lake Trout.

Forest and Stream, xxxii, January 24, 1889, p. 9.

TARLETON H. BEAN. Black Bass in Ponds.

Forest and Stream, xxxii, January 24, 1889, p. 9.

TARLETON H. BEAN. Introduction of a supposed Carp Sucker into New South Wales.

Forest and Stream, xxxii, January 24, 1889, p. 10.

TARLETON H. BEAN. Notes on Fish Fungus.

Forest and Stream, xxxii, January 24, 1889, p. 10.

TARLETON H. BEAN. Saibling in Sterling Lake.

Forest and Stream, xxxii, January 24, 1889, p. 10.

TARLETON H. BEAN. Oyster killed by Starfish.

Forest and Stream, xxxii, January 31, 1889, p. 29.

TARLETON H. BEAN. Fish and Fishing in Alaska.

Forest and Stream, xxxii, January 31, 1889, p. 27; also February 7, 1889, pp. 48, 49.

TARLETON H. BEAN. Saibling in Sterling Lake.

Forest and Stream, xxxii, February 7, 1889, p. 50.

TARLETON H. BEAN. Sawdust in Streams.

Forest and Stream, xxxii, February 21, 1889, p. 91.

TARLETON H. BEAN. The Hagfish.

Forest and Stream, xxxii, February 14, 1889, p. 66.

TARLETON H. BEAN. Explorations in Gulf of Mexico.

Forest and Stream, xxxii, March 28, 1889, p. 195.

TARLETON H. BEAN. Rainbow Trout in France.

Forest and Stream, xxxii, April 4, 1889, p. 218.

TARLETON H. BEAN. Salmon and Trout of North America.

Forest and Stream, xxxii, April 4, 1889, pp. 219-222.

TARLETON H. BEAN. Ozark Mountain Trout.

Forest and Stream, xxxii, May 9, 1889, p. 320.

TARLETON H. BEAN. Crossing of Salmon and Trout.

Forest and Stream, xxxii, May 9, 1889, p. 321.

TARLETON H. BEAN. Saibling and Brown Trout Hybrid.

Forest and Stream, xxxii, June 6, 1889, p. 401.

TARLETON H. BEAN. The Pike-Perch.

Forest and Stream, xxxii, June 27, 1889, p. 470.

CHARLES WICKLIFFE BECKHAM. Observations on the Birds of Southwestern Texas.
Proc. U. S. Nat. Mus., x, September 19, 1886, pp. 633-696.

In this posthumous paper of over sixty pages the late Mr. Beckham has recorded his observations on the birds observed by him during December, 1886, and January, February, and March, 1887, in Bexar, Brio, and Nueces Counties, Texas. The list includes 283 species, of which 226 were found in Bexar County. All are copiously annotated. In the first eleven pages he reviews the work of his predecessors in the same field, comparing their results with his own, and also describing the topographic and floral features of the region under consideration. He says: "At first it was my purpose to record only the results of my own observations, but upon reflection it seemed better to embody the notes of the other obser-

ers who had collected in the same localities, and thus present a pretty fair picture of the avifauna along what I believe to be an important line of faunal inoculation if such a term be permissible." He thus quotes frequently from the observations of Dr. H. B. Butcher, Messrs. H. E. Dresser, N. C. Brown, G. B. Sennett, Dr. J. C. Merrill, and J. L. Hancock, whose papers are cited in the "Bibliography," with which the paper closes. He has thus not only added much original matter, but condensed in convenient form the scattered records of previous observers. Under *Colinus virginianus texanus* (p. 655) he gives at length his reasons for believing that *C. graysoni* will be found to intergrade with this form as well as with *C. ridgwayi*. At page 686 he notes his interesting experience with the rare Golden-cheeked Warbler (*Dendroica chrysoparia*), and has many pleasant biographical notes on many of the lesser known species. This, it is sad to recall, was nearly Mr. Beckham's last work in ornithology, his death occurring even before the publication of the present paper (See *Auk*, v, p. 445).—J. A. A., in *The Auk*, April, 1889, pp. 173, 174.

CHARLES E. BENDIRE. Notes on the habits, nests, and eggs of the genus *Sphyrapicus* (Baird).

The Auk, v, No. 3, July, 1888, pp. 225-240.

An elaborate and interesting paper.

CHARLES E. BENDIRE. Notes on the nest and eggs of *Peucaea aestivalis bachmani* (Aud) Bachman's Sparrow.

The Auk, v, No. 4, October, 1888, pp. 351-356.

CHARLES E. BENDIRE. Notes on the habits, nests, and eggs of the genus *Glaucidium* (Boie).

The Auk, v, No. 4, October, 1888, pp. 366-372.

CHARLES E. BENDIRE. Notes on the habits, nests, and eggs of *Dendragapus obscurus fuliginosus*, the Sooty Grouse.

The Auk, vi, No. 1, January, 1889, pp. 32-39.

CHARLES E. BENDIRE. Notes on the general habits, nests, and eggs of the genus *Passerella*.

The Auk, vi, No. 2, April, 1889, pp. 107-116.

CHARLES E. BENDIRE. Description of the supposed nest and eggs of *Zonotrichia querula*, Harris Sparrow.

The Auk, vi, No. 2, April, 1889, pp. 150-152.

CHARLES E. BENDIRE. Notes on the Lost River Sucker, *Chasmistes luxatus* (Cope).

Forest and Stream, xxii, No. 22, June 20, 1889, pp. 444, 445, two figures.

HANS VON BERLEPSCH. Descriptions of new species and subspecies of Birds from the Neotropical Region.

The Auk, v, October, 1888, Supplement, pp. 449-460.

The new species and subspecies are as follows: (1) *Campylorhynchus zonatus castaricensis*, p. 449, Costa Rica; (2) *Certhia mexicana albescens* (*C. familiaris montana* Ridgw.), p. 450, Ciudad Durango, NW. Mexico; (3) *Basilenterus godmani*, p. 450, Veragua and Costa Rica; (4) *Eucometis spodocephala pallida*, p. 451, Yucatan; (5) *Eucometis spodocephala stictothorax*, p. 451, Veragua; (6) *Eucometis cristata affinis*, pp. 451-453, Venezuela (Porto Cabello); (7) *Icterus gularis yucatanensis*, p. 454, Yucatan; (8) *Myiobius ridgwayi*, p. 457, Southern Brazil (Province of Rio de Janeiro); (9) *Synallaxis coryi*, p. 458, Venezuela (Merida).

LOUIS D. BISHOP. Notes on the Birds of the Magdalen Islands.

The Auk, vi, April, 1889, pp. 144-150.

An annotated list of 66 species.

FRANZ BOAS. The Houses of the Kwakiutl Indians, British Columbia.

Proc. U. S. Nat. Mus., xi, 1888, pp. 197-213, plates xxxviii-xl, 21 figures.

CHARLES H. BOLLMAN. Description of a New Species of Insect, *Fontaria pulohella*, from Strawberry Plains, Jefferson County, Tennessee.

Proc. U. S. Nat. Mus., xi, 1888, p. 316.

CHARLES H. BOLLMAN. Notes on a collection of Myriapoda from Mossy Creek, Tennessee, with a description of a new species.

Proc. U. S. Nat. Mus., xi, 1888, pp. 339-342.

CHARLES H. BOLLMAN. Notes on some Myriapods belonging to the U. S. National Museum.

Proc. U. S. Nat. Mus., xi, 1888, pp. 343-350.

CHARLES H. BOLLMAN. Catalogue of the Myriapods of Indiana.

Proc. U. S. Nat. Mus., xi, 1888, pp. 403-410.

WILLIAM BREWSTER. Descriptions of supposed New Birds from Western North America and Mexico.

The Auk, vi, April, 1889, pp. 85-98.

New species and subspecies described are the following: (1) *Ptilinopus cyanopygia pallidus*, 85, Alamos, Sonora; (2) *Empidonax pulverius*, p. 86, "Sierra Madre Mountains of Chihuahua (Pinos Altos), Mexico"; (3) *Empidonax griseus*, p. 87, "Lower California, Arizona (Southern Sonora"; (4) *Melospiza lincolni striata*, p. 89, British Columbia; (5) *Euphonia godmani*, p. 90, "Coast region of Western Mexico" (type in National Museum collection); (6) *Progne subis hesperia*, p. 92, California and Lower California; (7) *Comptothlypis pumila*, p. 93, Hacienda de San Rafael, Chihuahua; (8) *Dendroica nigrifrons*, p. 94, Sierra Madre of Chihuahua; (9) *Thryophilus sinaloa cinereus*, p. 96, Alamos, Sonora; (10) *Ptilinopus nigriceps restricta*, p. 97, Southern Sonora.

(See also under J. C. MERRILL.)

AMOS W. BUTLER. On a new subspecies of *Ammodramus sandwichensis* from Mexico. *The Auk*, v, July, 1888, pp. 264-266.

Ammodramus sandwichensis brunnescens, new subspecies, p. 265. "Habitat, in winter the mountains of Mexico."

C. CATLETT.

(See under F. W. CLARKE.)

FRANK M. CHAPMAN. A List of Birds observed at Gainesville, Florida.

The Auk, v, July, 1888, pp. 267-277.

An annotated list of 149 species, in the preparation of which National Museum specimens were examined.

A. HOWARD CLARK. Review of the Fur-seal Fisheries of the World.

"Report of the Secretary of State in relation to the Seal Fisheries in Bering Sea." Senate Executive No. 106, Fiftieth Congress, second session, February 12, 1889, pp. 90-94.

F. W. CLARKE. The Constants of Nature, part I. A Table of specific gravities of solids and liquids. New edition, revised and enlarged.

Smithsonian Miscellaneous Collections, No. 659, 1888.

F. W. CLARKE. Expert testimony.

Popular Science Monthly, September 1888.

F. W. CLARKE. Preface to Traphagen's "Index to the literature of columbian ornithology." *Smithsonian Miscellaneous Collections*, 1888.

F. W. CLARKE. The waters of the Yellowstone Park.

The Epoch, December 21, 1888.

A review of U. S. Geological Survey Bulletin 47.

F. W. CLARKE. Administrative report as chief chemist of the U. S. Geological Survey.

Seventh Annual Report U. S. Geological Survey.

F. W. CLARKE and C. CATLETT. A platiniferous nickel ore from Canada.

Am. Jour. Sci., May, 1889.

F. W. CLARKE and G. P. MERRILL. On nephrite and jadeite.

Proc. U. S. Nat. Mus., xi, 1888, p. 115.

E. D. COPE. On a new species of *Charina* from California.

Proc. U. S. Nat. Mus., xi, 1888, p. 88.

E. D. COPE. On a new species of *Bufo* from Texas.

Proc. U. S. Nat. Mus., xi, 1888, pp. 317-318.

E. D. COPE. On the Snakes of Florida.

Proc. U. S. Nat. Mus., xi, 1888, pp. 381-394, pl. xxxv, figs. 3, 4.

E. D. COPE. Catalogue of Batrachia and Reptilia, brought by William Taylor from San Diego, Texas.

Proc. U. S. Nat. Mus., xi, 1888, pp. 395-398, pl. xxxvi, fig. 2.

E. D. COPE. On the *Eutæniæ* of southeastern Indiana.

Proc. U. S. Nat. Mus., xi, 1888, pp. 399-401, pl. xxxvi, fig. 1.

CHARLES B. CORY. Description of a new *Myiarchus* from the West Indies.

The Auk, v, July, 1888, p. 266.

Myiarchus herlepsi; habitat, Island of St. Kitts, West Indies.

WILLIAM HEALEY DALL. Description of a new species of *Hyalina*.

Proc. U. S. Nat. Mus., xi, 1888, p. 214, figs. 1-3.

Hyalina sterkii, the smallest species of *Zonites* yet known to the United States, is described and named for Dr. V. Sterki, of New Philadelphia, Ohio, who collected it at that place and presented the types to the Museum.

- WILLIAM HEALEY DALL.** Documents relating to the Alaskan Boundary Question. In *Senate Executive Document No. 146, Fiftyeth Congress, second session.* Washington, Government Printing Office, 1889.
- These comprise: (1) Letter to Mr. Moore, Third Assistant Secretary of State (*op. cit.*, pp. 2-4); (2) Letter to Mr. Bayard, Secretary of State (*op. cit.*, pp. 10-12); (3) Letter to Mr. Bayard, Secretary of State (*op. cit.*, pp. 12-13); (4) Memorandum on the Alaskan Boundary (*op. cit.*, 13-23); (5) Supplementary memorandum on the views of General Cameron, as submitted in the letter of Dr. George M. Dawson to Sir Charles Tupper in regard to the Alaskan Boundary (*op. cit.*, pp. 23-28).
- These documents discuss the wording and true intent of the treaty in which the boundary of the Territory of Alaska is defined, and criticise a construction of it put forward on behalf of certain claims of the Dominion of Canada.
- WILLIAM HEALEY DALL.** Ocean Currents. The Ocean. In *Popular Cyclopedia*, (The). *Methodist Book Concern, New York*, 1889.
- The above articles, written for the publication cited, were of a general character, and have not been seen by the author in print.
- WILLIAM HEALEY DALL.** Notes on the soft parts of *Trochus infundibulum* Watson, with an account of a remarkable sexual modification of the epipodium, hitherto undescribed in Mollusca.
- The Nautilus*, Philadelphia, III, No. 1, May, 1889, pp. 2-4.
- This article describes the soft parts of this abyssal species, and shows that the right anterior epipodial lappet is rolled up and peculiarly modified to serve as a seminal conduit.
- WILLIAM HEALEY DALL.** (Note on) *Paludina scalaris* Jay.
- The Nautilus*, Philadelphia, III, No. 1, May, 1889, p. 8.
- This points out that the whole group of *Ameria* is distinct from the *Physida*, and a glance at the tentacles of the living animal should be sufficient to determine whether it should be referred to the *Limnæida* or the *Planorbida*.
- WILLIAM HEALEY DALL.** Notes on *Lophocardium*, Fischer.
- The Nautilus*, III, No. 2, June, 1889, pp. 13, 14.
- This article determines for the first time the soft parts of this subgenus, points out that the hinge is destitute of lateral teeth, and describes a new species from Lower California, *L. annetta*, dredged by the U. S. Fish Commission in 1888.
- WILLIAM HEALEY DALL.** Bulletin of the Museum of Comparative Zoölogy at Harvard College, Vol. XVIII. Reports on the results of dredging under the supervision of Alexander Agassiz, in the Gulf of Mexico (1877-'75), and in the Caribbean Sea (1879-'80) by the U. S. Coast Survey Steamer *Blake*, Lieut. Commander C. D. Sigsbee, U. S. Navy, and Commander J. R. Bartlett, U. S. Navy, commanding. XXIX. Report on Mollusca, by W. H. Dall, Part II. Gastropoda and Scaphopoda. Cambridge, the Museum, June, 1889. 492 pp., 8vo. Plates x-xi.
- In this paper about 470 species and varieties collected by the *Blake* are enumerated, discussed, and described, or compared with others obtained by the U. S. Fish Commission from the same region. Three hundred and eighty-five species and varieties and 30 genera, subgenera, or sections are treated as new. A large amount of new information in regard to the anatomical characters of the Mollusca referred to is contained in the report, together with the revision of the synonymy of many of the species of the coasts of the United States.
- Perhaps the most interesting data are those relating to the anatomy of *Pleurotomaria*; of the bivalves belonging to the families *Poromyidae*, *Dimyidae*, *Verticordiidae*, and *Ouspidariidae*, together with the description of recent genera like *Conomitra*, *Dolophanes*, *Mesostoma*, *Diastoma*, *Mesorhytis*, and *Potichotoma*, hitherto known only as Tertiary fossils. The elucidation of the characters of the animal in *Aurinia*, *Scutellina*, *Capulus*, *Turricula*, etc., and the determination of the presence of a verge in many *Rhiphidoglossa* is also an addition to knowledge of much interest.
- J. L. DAVISON.** Breeding of the Cerulean Warbler (*Dendroica cerulea*) in Niagara County, New York.
- The Auk*, v, October, 1888, pp. 430, 431.
- FREDERIC P. DEWEY.** Pig Iron | of | Unusual Strength, | by | Fred. P. Dewey, | United States National Museum, Washington, D. C. | A paper read before the American Institute of Mining Engineers, | Buffalo Meeting, October, 1888. | — | Author's Edition. | 1889.
- 8vo., pp. 1-17.
- Gives the result of the research into the operation of the Mairkirk furnaces.

- FREDERIC P. DEWEY.** Note on the Nickel Ore of Russell Springs, Logan County, Kansas.
Engineering and Mining Journal, XLVI, September 15, 1888, p. 213.
 A preliminary note on the subject.
- FREDERIC P. DEWEY.** The Nickel Ore of Russell Springs, Logan County, Kansas.
Transactions, American Institute of Mining Engineers, XVII, p. 636.
 Gives the result of the examination of this nickel ore.
- FREDERIC P. DEWEY.** Hamps's Method of Determining Cu_2O in Metallic Copper.
Proc. U. S. Nat. Mus., XI, 1888, pp. 77-82.
- A. DUGÈS.** Description of *Storeria dekayi*, var. *anomala*.
Proc. U. S. Nat. Mus., XI, 1888, pp. 9-10; 4 figures.
- H. EGGERS.** A Study of the Boomerang.
Proc. U. S. Nat. Mus., XI, 1888, pp. 363-367; 3 figures.
- CARL H. EIGENMANN.**
 (See under DAVID STARR JORDAN.)
- D. G. ELLIOTT, F. R. S. E.** The *Jacariæ*.
The Auk, V, July, 1888, pp. 288-306.
 A systematic review, including bibliography, synonymy, diagnoses of the family, generic species, a "Key to the Genera and Species," geographical distribution, etc. A paper, embracing, besides useful matter under the above heading, important revisions of synonymy.
- BARTON W. EVERMANN and OLIVER P. JENKINS.** Notes on Indiana Fishes.
Proc. U. S. Nat. Mus., XI, 1888, pp. 43-57.
- BARTON W. EVERMANN and OLIVER P. JENKINS.** Description of 18 new species of Fishes from the Gulf of California.
Proc. U. S. Nat. Mus., XI, 1888, pp. 137-158.
- B. E. FERNOW.** Need of a Forest Administration of the United States.
Trans. Amer. Assoc. Adv. Science, 1888.
 Read before the American Association for the Advancement of Science, Cleveland, 1888.
- B. E. FERNOW.** Methods employed in discussing Forest Influences on Rainfall.
Annual Report of the Dept. of Agriculture, 1889.
 Read before the Philosophical Society of Washington, February, 1889.
- B. E. FERNOW.** The Mining Industry in its Relation to Forestry.
Trans. Amer. Inst. Mining Engineers, 1888.
 Read before the American Institute of Mining Engineers, October, 1888.
- J. WALTER FEWKES.** Report on the *Medusa* collected by the U. S. Fish Commission steamer *Albatross* in the region of the Gulf Stream in 1885 and 1886.
Annual Report Commissioner of Fish and Fisheries for 1886 (1889), pp. 513-536, plate 1.
 The following new genus and species are described: *Pleurophysa*, Fewkes; *Pleurophysa insignis*, Fewkes.
- B. T. GALLOWAY.**
 (See under GEORGE VASEY.)
- THEODORE GILL.** Eutheria and Prototheria.
American Naturalist, XXII, March, 1888, pp. 258, 259.
- THEODORE GILL.** The Primary Groups of Mail-cheeked Fishes.
American Naturalist, XXII, April, 1888, pp. 356-358.
- THEODORE GILL.** Some Extinct *Scleroderms*.
American Naturalist, XXII, May, 1888, pp. 446-448.
- THEODORE GILL.** Culture and Science.
American Naturalist, XXII, June, 1888, pp. 481-490.
- THEODORE GILL.** The Characteristics of the *Elacatids*.
Proc. U. S. Nat. Mus., X, 1887, pp. 612-614, pl. 39.
- THEODORE GILL.** Note on the *Gramma loreto* of Poey.
Proc. U. S. Nat. Mus., X, 1887, pp. 615, 616.
- THEODORE GILL.** The Extinct *Scleroderms*.
American Naturalist, XXII, September, 1888, pp. 828-830.
- THEODORE GILL.** *Glyptocephalus* not identical with *Bucklandium*.
American Naturalist, XXII, October, 1888, p. 925.
- THEODORE GILL.** On the proper name of the genus *Labrax* of Cuvier.
Proc. U. S. Nat. Mus., XI, p. 252.

- THEODORE GILL.** Note on the genus *Dipterodon*.
Proc. U. S. Nat. Mus., xi, 1888, pp. 67, 68.
- THEODORE GILL.** Note on the genus *Gobiomorus*.
Proc. U. S. Nat. Mus., xi, 1888, pp. 69, 70.
- THEODORE GILL.** On the proper generic name of the Tunny and Albicore.
Proc. U. S. Nat. Mus., xi, 1888, pp. 319, 320.
- THEODORE GILL.** On the *Psychrolutidae* of Gunther.
Proc. U. S. Nat. Mus., xi, 1888, pp. 321-327.
- F. DU CARL GODMAN.**
(See under OSBERT SALVIN.)
- G. BROWN GOODE.** Museum History and Museums of | History, | A paper read before the American Historical Association in | Washington, D. C., December 26-28, 1888, | By G. Brown Goode, LL. D., | Assistant Secretary of the Smithsonian Institution in Charge | of the National Museum. | — | [Reprinted from the papers of the Association], | — | New York. | The Knickerbocker Press. | 1889.
8vo., pp. 253 [497]-275 [519].
- G. BROWN GOODE.** The depths of the Ocean.
Atlantic Monthly, LXIII, January, 1889, pp. 124-128.
A review of Alexander Agassiz's "American Thalassography," with a historical sketch of the deep sea work of the Agassizs, father and son, in connection with the U. S. Coast Survey.
- G. BROWN GOODE.** An interesting dialogue, in 1676, between Bacon "the Rebel," and John Goode of "Whitby."
Magazine of American History, XVIII, November, 1887, pp. 418-422.
A letter written to Sir William Berkeley, by John Goode, a Virginia planter, giving in dialogue form "the full substance of a discourse" between himself and Nathaniel Bacon, which seems to indicate that Bacon was from the beginning of his career in Virginia a seditious personage, and that his rebellion was not the result of Berkeley's failure to support the colonists in their efforts to repel the incursions of the Indians, as Bacon's admirers have sometimes argued, but was premeditated. Dialogue quoted in full from Colonial Entry Book (Public Record's Office, London), vol. LXXI, pp. 232-240.
- G. BROWN GOODE.** Memories of Professor Baird.
The Okautauguan, ix, October, 1888, pp. 21-24.
- G. BROWN GOODE.** (A brief biographical sketch of Professor Baird).
Report of the Secretary of the Smithsonian Institution, 1888, pp. 79-89.
- G. BROWN GOODE.** Virginia Cousins. A study of the Ancestry and posterity of John Goode of Whitby, a Virginia Colonist of the Seventeenth Century, with notes upon related families, a key to southern genealogy, (etc.). With a preface by R. A. Brock.
Richmond, Virginia, J. W. Randolph & English, 1887.
Small 4to.-pp. xxxvi, 526. Illustrations.
Reviewed.—*Magazine of American History*, XXI, pp. 174-5. *New England Hist. Genealogical Registers*; *Southern Churchman*, September 6, 1888; *Central Presbyterian*, Richmond, September 12, 1888; *Gloucestershire* (England), *Notes and Queries*, January, 1889, (By R. A. Brock).
- DAVID K. GOSS.**
(See under DAVID STARR JORDAN.)
- N. S. GOSS.** New and rare birds found breeding on the San Martir Isle (Gulf of California).
The Auk, v, July 1888, pp. 240-244.
New species described are *Sula gossi* Ridgw. (Blue-footed Booby), p. 241, and *Sula brewsteri* Goss (Brewster's Booby), p. 242. The additional species mentioned is *Phaethon aethereus* Linn. (Red-billed Tropic Bird), p. 244.
- G. HARTLAUB.** (Letter to editors of *The Ibis*, referring to a "Review of the Genus *Psittacula* Brisson," by Robert Ridgway, published in *Proc. U. S. N. M.*, 1887, pp. 529-548.)
The Ibis, 5th ser., vi, No. 24, October, 1888, pp. 493-494.
- E. M. HASBROUCK.** Restoration of the Audubonian form of *Geothlypis trichas* to the American avifauna.
The Auk, vi, April, 1889, pp. 167, 168.
Geothlypis trichas roscoe (Aud.); habitat, "in summer Mississippi Valley, north of Wisconsin, Minnesota, etc.; in winter Gulf States, including Florida."

PAUL HAUPT. Dimensions of the Babylonian Ark.

Am. Jour. of Philology, ix, pp. 419-424. Abstract Proc. Am. Orient. Soc., October, 1888, pp. lxxxix-xc.

Determination of the dimensions of the ark in the cuneiform account of the flood; 120 half-cubits for both the depth and width, and 600 half-cubits for the length.

PAUL HAUPT. Some passages in the Cuneiform Account of the Deluge.

Johns Hopkins University Circulars, viii, No. 69, February, 1889, pp. 17, 18.

New translation of column 1 of the Babylonian account of the flood on the basis of recently found fragments.

PAUL HAUPT. Semitic Studies in this country.

Hebraica, v, p. 89.

Progress of Semitic study in this country during the last decade. Suggests more coöperation and centralization, and the publication of a series of Semitic dictionaries in the English language, especially a Hebrew-English dictionary and a National Society Biblical Archaeology.

PAUL HAUPT. Contributions to the History of Assyriology with special reference to the Works of Sir Henry Rawlinson.

Johns Hopkins University Circulars, viii, No. 72, April, 1889, pp. 57-62.

On the importance of the study of the history of Assyriology. Biographical sketch of Sir Henry Rawlinson, by C. Johnston, jr. Tentative Bibliography of his works by W. M. Arnold.

ROMYN HITCHCOCK. Victor Schumann and His Work.

Anthony's Photographic Bulletin, xx, 1889, pp. 616-620.

ROMYN HITCHCOCK. The Action of Light on Silver Chloride.

Proc. Amer. Assoc. Adv. Sci., 1889.

Reprinted in *Amer. Chem. Jour.*, xi, 1889, pp. 474-480.

ROMYN HITCHCOCK. Notes on Eclipse Photography.

Anthony's Photographic Bulletin, xx, 1889, pp. 680-684.

ROMYN HITCHCOCK. Eikonogen and Pyrogallol, with remarks on the comparison of developers.

Anthony's Photographic Bulletin, xx, 1889, pp. 710-715.

Read before the Chemical Society of Washington, November 14, 1889.

WILLIAM H. HOLMES. The Use of Gold and other Metals by the Ancient Inhabitants of Chiriqui.

Bulletin, Bureau of Ethnology, 27 pages.

WILLIAM H. HOLMES. Textile Fabrics of Ancient Peru.

Bulletin, Bureau of Ethnology, 17 pages.

WILLIAM H. HOLMES. Ancient Art of the Province of Chiriqui.

Sixth Annual Report of the Bureau of Ethnology (1888), pp. 13-167, 285 text figures.

WILLIAM H. HOLMES. A Study of the Textile Art in its relation to the Development of Form and Ornament.

Sixth Annual Report of the Bureau of Ethnology (1888), pp. 180-252, 358 text figures.

WALTER HOUGH. The George Catlin Indian Gallery.

The American, Philadelphia, xvii, January 5, 1889, p. 185.

A review of Mr. Thomas Donaldson's monograph in the Smithsonian Report for 1888, part II.

WALTER HOUGH. Samoa in the National Museum.

The American (Philadelphia), xvii, March 9, 1889, p. 329.

WALTER HOUGH. An interesting Collection from Thibet.

The American (Philadelphia), xvii, p. 73.

A notice of the W. W. Rockhill collection from Thibet in the National Museum.

WALTER HOUGH. The Corrugation in African Sword Blades and other Weapons.

Proc. U. S. Nat. Mus., xi, 1888, p. 172.

WALTER HOUGH. An Eskimo Strike-a-Light from Cape Bathurst.

Proc. U. S. Nat. Mus., xi, 1888, pp. 181-184: 6 figures.

L. O. HOWARD.

(See under CHARLES V. RILEY.)

W. H. HUDSON.

(See under P. L. SCLATER.)

EDITORS OF "THE IBIS". A Pteroptochian from Costa Rica.

The Ibis, 6th ser., 1, No. 2, April, 1889, p. 262.

Mention of "the discovery in the volcano of Poas, Costa Rica, of a remarkable new bird, which will apparently constitute a new genus of Pteroptochidae." (*Zeledonia coronata*, a new genus and species, soon to be described in the "Proceedings" of the U. S. National Museum.)

- OLIVER P. JENKINS.
(See under BARTON W. EVERMANN.)
- C. JOHNSTON, JR. The Chaldean Astronomy.
Proc. Am. Orient. Soc., May, 1889, pp. cxi-cxli.
The beginnings of Chaldean astronomy. Theories of the calendar method of reckoning time. Observation and calculation of eclipses.
- DAVID STARR JORDAN. On the occurrence of the Great Lake Trout (*Salvelinus namayoush*) in the waters of British Columbia.
Proc. U. S. Nat. Mus., xi, 1888, p. 58.
- DAVID STARR JORDAN. List of fishes collected by Alphonse Forrer about Mazatlan, with descriptions of two new species—*Heros beani* and *Paxilia butleri*.
Proc. U. S. Nat. Mus., xi, 1888, pp. 329-334.
- DAVID STARR JORDAN. Descriptions of fourteen species of fresh-water fishes collected by the U. S. Fish Commission in the summer of 1888.
Proc. U. S. Nat. Mus., xi, 1888, pp. 351-362, 3 plates.
- DAVID STARR JORDAN. List of fishes now in the U. S. National Museum, collected in Nicaragua by Dr. Louis F. H. Birt.
Proc. U. S. Nat. Mus., xi, 1888, pp. 411, 412.
- DAVID STARR JORDAN and DAVID K. GOSS. A review of the Flounders and Soles (*Pleuronectidæ*) of America and Europe.
Annual Report of the Commissioner of Fish and Fisheries for 1886 (1889), pp. 225-342.
- DAVID STARR JORDAN and CARL H. EIGENMANN. A Review of the *Sciænidæ* of America and Europe.
Annual Report of the Commissioner of Fish and Fisheries for 1886 (1889), pp. 343-451.
- CHARLES DE KAY. On a Bronze Buddha at Washington.
The Chautauquan, ix, No. 1, October, 1888, pp. 31-33.
- F. H. KNOWLTON. Is Protection a Benefit? A plea for the Negative. By Edward Taylor (Review).
Public Opinion, v, No. 119, July 21, 1888, p. 342.
- F. H. KNOWLTON. The Aryau Race. Its Origin and Achievements. By Charles Morris (Review).
Public Opinion, v, No. 121, August 4, 1888, p. 382.
- F. H. KNOWLTON. Malformation of Cabbage Leaf.
Garden and Forest, i, No. 25, August 15, 1888, p. 296, fig. 48.
- F. H. KNOWLTON. The Origin of Floral Structures through Insect and other agencies. By George Henslow (Review).
Public Opinion, October 27, 1888.
- F. H. KNOWLTON. Animal Memoirs. By Samuel Lockwood (Review).
Public Opinion, vi, October 27, 1888.
- F. H. KNOWLTON. Marine Painting. By Walter W. May (Notice).
Public Opinion, vi, No. 4, November 3, 1888, p. 83.
- F. H. KNOWLTON. On the Senses, Instincts, and Intelligence of Animals. By Sir John Lubbock. (Review).
Public Opinion, vi, No. 6, November 17, 1888, p. 125.
- F. H. KNOWLTON. The Kingdoms of Nature. By Ransom Dexter. (Review).
Public Opinion, vi, No. 5, November 10, 1888, p. 103.
- F. H. KNOWLTON. Francis Bacon: His Life and Philosophy. By John Nichol. (Review).
Public Opinion, vi, No. 6, November 17, 1888, p. 126.
- F. H. KNOWLTON. Potomac Fossils.
The Washington Post, November, 1888; *The Washington Star*, November, 1888; *The Omaha Bee*, November, 1888.
- F. H. KNOWLTON. New Species of Fossil Wood (*Araucarioxylon arizonicum*) from Arizona and New Mexico.
Proc. U. S. Nat. Mus., xi, 1888, pp. 1-4, pl. 1.
- F. H. KNOWLTON. Description of two New Species of Fossil Coniferous Wood from Iowa and Montana.
Proc. U. S. Nat. Mus., xi, 1888, pp. 5-8, pls. ii-iii.
Describes *Cupressinoxylon Glasgowii* and *C. elongatum*.
- H. Mis. 224, pt. 2—48

- F. H. KNOWLTON. Description of two Species of Palmoxyylon—one new—from Louisiana.
Proc. U. S. Nat. Mus., xi, 1888, pp. 89-91, pl. xxx.
- F. H. KNOWLTON. Astronomy with an Opera Glass. By Garrett P. Serviss. (Review.)
Public Opinion, vi, December 8, 1888, p. 186.
- F. H. KNOWLTON. Sea Vistas in Many Climes. By Susie Barstow Skelding. (Review.)
Public Opinion, vi, December 8, 1888, p. 186.
- F. H. KNOWLTON. The Boy Travelers in Australasia. By Thomas W. Knox. (Review.)
Public Opinion, vi, December 8, 1888, p. 186.
- F. H. KNOWLTON. American Weather. By Genl. A. W. Greely. (Review.)
Public Opinion, vi, December 22, 1888.
- F. H. KNOWLTON. Insects injurious to Fruits. By W. Saunders. (Review.)
Public Opinion, vi, December 22, 1888.
- F. H. KNOWLTON. Lorin Mooruck, and other Indian Stories. By George Truman Kercheval. (Review.)
Public Opinion, vi, No. 14, June 12, 1889.
- F. H. KNOWLTON. Microscopic Physiography of the Rock-making Minerals. (Review.)
Public Opinion, vi, No. 14, January 12, 1889, p. 293.
- F. H. KNOWLTON. The Earth in past Ages. By Sophia S. Herrick. (Notice.)
Public Opinion, vi, No. 14, January 12, 1889, p. 294.
- F. H. KNOWLTON. Mineral Resources of United States for 1887. By Dr. David Day. (Notice.)
Public Opinion, vi, No. 14, January 12, 1889, p. 294.
- F. H. KNOWLTON. The Florida of To-day. By J. W. Davidson. (Review.)
Public Opinion, vi, No. 15, January 19, 1889, p. 314.
- F. H. KNOWLTON. A Text-book of General Astronomy. By Charles A. Young. (Review.)
Public Opinion, vi, No. 16, January 26, 1889, p. 336.
- F. H. KNOWLTON. The Fossil Wood and Lignites of the Potomac Formation.
The American Geologist, iii, February, 1889, pp. 99-106.
Abstract published in *Cleveland Leader*, August 17, 1888, and in *Proc. Am. Assoc. Adv. Sci.*, xxxvii, pp. 206-208.
A paper read before the S. S. S. Science, Cleveland, August 16, 1888.
- F. H. KNOWLTON. Description of a Problematic Organism from the Devonian the Falls of the Ohio.
American Jour. of Science, xxxvii, March, 1889, pp. 202-209, three text figures.
Describes a curious Chara-like organism under the name of *Calciophara Lemont*.
- F. H. KNOWLTON. Botany for Colleges and Academies. By A. Chambers-Ketchum. (Review.)
Public Opinion, vi, February 2, 1889, p. 358.
- F. H. KNOWLTON. The Folk-Lore of Plants. By T. F. Thiselton-Dyer. (Review.)
Public Opinion, vi, March 16, 1889, p. 512.
- F. H. KNOWLTON. Mental Evolution in Man. By George J. Romanes. (Review.)
Public Opinion, vi, March 30, 1889, p. 561.
- F. H. KNOWLTON. Nature and Man. By Wm. B. Carpenter. (Review.)
Public Opinion, vii, April 13, 1889, p. 20.
- F. H. KNOWLTON. Prompt Aid to the Injured. By Dr. Alvah H. Doty. (Review.)
Public Opinion, vii, April 13, 1889, p. 19.
- F. H. KNOWLTON. The History of Ancient Civilization. By Rev. S. Verschoor. (Review.)
Public Opinion, vii, May 11, 1889, p. 112.
- F. H. KNOWLTON. College Botany. By E. S. Bastin. (Review.)
Public Opinion, vii, May 25, 1889, p. 156.
- S. R. KOEHLER. Radiren und Gradiren.
Chronik für vervielfältigende Kunst, Vienna, i, No. 6, October, 1888.

- S. R. KOEHLER—Continued.**
 Noch einmal "Radiren und Gradiren;" same Journal, I, No. 7, November, 1888.
 A collection of quotations from German literature, from the sixteenth century downwards, to fix the term used in German in past centuries to designate the art of etching.
- S. R. KOEHLER.** Eine neue Geschichte des Holzschnittes.
Chronik für vervielfältigende Kunst, Vienna, I, No. 6, October, 1888.
- S. R. KOEHLER.** Die Meister der Holzschneidekunst.
Kunstchronik, Leipzig, xxiv, No. 1, October, 1888.
 Preliminary announcements of W. J. Linton's forthcoming work, "The Masters of Wood Engraving."
- S. R. KOEHLER.** Exhibition of Albert Durer's engravings, etchings, and dry-prints, and of most of the woodcuts executed from his designs. Selected from the collection of Mr. Henry F. Sewall, of New York, and from the Gray Collection belonging to Harvard College: together with eight original drawings from the collection von Franck. November 15, 1888, to January 15, 1889. Boston: Printed for the Museum by Alfred Mudge & Son, 24 Franklin Street, 1888.
 12mo., pp. xxii, 81.
 Contains a catalogue, arranged chronologically, of all of Durer's authenticated works on metal and of most of the woodcuts from his designs, together with some of the doubtful works. Also notes, with inferences to the leading writers on Durer, and an introduction.
- S. P. LANGLEY.** The New Astronomy | by | Samuel Pierpont Langley, PH. D., LL. D. | Director of the Allegheny Observatory, member of the National Academy | Fellow Royal Astronomical Society, etc., etc. | illustrated | — | Boston | Tichnor & Company | 211 Tremont street | 1888.
 8vo., pp. xii, 260; 93 figures.
- GEORGE N. LAWRENCE.** Description of a new species of bird of the genus *Catharus* from Ecuador.
Proc. U. S. Nat. Mus., x, August 6, 1888, p. 503.
Catharus verlepsi, Lawr.; habitat western Ecuador (Cayandeled).
- GEORGE N. LAWRENCE.** An account of the Breeding Habits of *Puffinus auduboni* in the island of Grenada, West Indies, with a note on *Zenaida rubripes*.
The Auk, vi, January, 1889, pp. 19-21.
- GEORGE N. LAWRENCE.** Remarks upon abnormal coloring of plumage observed in several species of birds.
The Auk, vi, June, 1889, pp. 46-50.
- GEORGE N. LAWRENCE.** A new name for the species of *Sporophila* from Texas, generally known as *S. moreletii*.
The Auk, vi, January, 1889, pp. 53, 54.
 Renamed *Sporophila moreletii sharpei* (p. 53).
- JOSEPH LEIDY.** Notice of some Fossil Human Bones.
Transactions of the Wagner Free Institute of Science, II, 1889, pp. 9-12; 2 plates.
 Description of fossil human bones exhibited in the Museum of the Academy of Natural Sciences, Philadelphia.
- LEO LESQUEREUX.** Recent Determinations of Fossil Plants from Kentucky, Louisiana, Oregon, California, Alaska, Greenland, etc., with descriptions of New Species.
Proc. U. S. Nat. Mus., xi, 1888, pp. 11-38, pls. iv-xvi.
- LEO LESQUEREUX.** List of Fossil Plants collected by Mr. I. C. Russell at Black Creek, near Gadsden, Alabama, with descriptions of several New Species.
Proc. U. S. Nat. Mus., xi, 1888, pp. 83-87, pl. xxix.
- EDWIN LINTON.** Notes on Cestoid Entozoa of Marine Fishes.
Amer. Jour. Sci., xxxvii, March, 1889, pp. 239, 240.
- FREDERIC A. LUCAS.** Great Auk Notes.
The Auk, July, 1888, pp. 278-283.
 Notes on some supposed breeding-grounds of the Great Auk.
- FREDERIC A. LUCAS.** Abnormalities in the Ribs of Birds.
The Auk, July, 1888, pp. 329, 330.
 Noting instances in which birds were found to have more or less ribs than the normal number for the species.

FREDERIC A. LUCAS. The Home of the Great Auk.

Pop. Sci. Monthly, August, 1888, pp. 456-464. Two figures in text.

A description of the visit of the Grampus Expedition to Funk Island.

FREDERIC A. LUCAS. The Main Divisions of the Swifts.

The Auk, January, 1889, pp. 8-13. Figures of skulls in text.

A brief account of the osteological characters of the Swifts, by which they are divided into two families, *Dendrochelidonidæ* and *Micropodidæ*, the latter family being subdivided into *Micropodinæ* and *Chaturinæ*. The family *Dendrochelidonidæ* is established for the Swifts of southern Asia and the Malay Archipelago.

FREDERIC A. LUCAS. Costal Variations in Birds.

The Auk, April, 1889, p. 195.

Noting the fact that the Great Auk frequently had an extra (ninth) pair of ribs.

FREDERIC A. LUCAS. Notes on the Osteology of the Thrushes, Miminæ, and

Proc. U. S. Nat. Mus., xi, 1888, pp. 173-180, pl. xxxvii, and text figures.

Gives briefly the osteological characters of the three groups above noted, and concludes that the *Miminæ* are not closely related to the Wrens.

OTIS T. MASON. The Savages' Side-Arms.

American Anthropologist, ii, No. 1, January, 1889, pp. 77, 78.

Finds a use for the "leaf-shaped implements."

OTIS T. MASON. How to Straighten a Spear Shaft.

American Anthropologist, ii, No. 2, April, 1889, p. 158.

Describes the method employed by the Lenca, in Honduras.

OTIS T. MASON. The Ray Collection from Hupa Reservation.

Report of the Smithsonian Institution for 1888, Part I, pp. 205-239, 118 figures.

An ethnographic sketch of a small tribe of Indians of northern California, belonging to the Athapascan stock.

OTIS T. MASON. Woman's Share in Primitive Culture.

The American Antiquarian, xi, No. 1, 1889, pp. 3-13.

Maintains that Spencer's division of culture into two epochs, militancy and industry, is rather a sexual question and holds that woman originated most of our industrial occupations.

OTIS T. MASON. The Beginnings of the Carrying Industry.

American Anthropologist, ii, No. 1, January, 1889, pp. 21-46, 8 text figures.

Describes the first steps in the history of transportation and shows how important the man himself has been in this industry.

OTIS T. MASON. The Stone Age at Mount Vernon.

Proc. U. S. Nat. Mus., xi, 1888, p. 402.

C. HART MERRIAM. *Euthedia canora* from Sombrero Key, Florida. A bird new to the United States.

The Auk, v, July, 1888, p. 322.

C. HART MERRIAM. Description of the Breeding Plumage of Chadbourne's Sparrow (*Spizella arenacea*) with evidence of its specific distinctness.

The Auk, v, October, 1888, pp. 402, 403.

Based on specimens from Dakota and Nebraska.

GEORGE P. MERRILL and J. E. WHITFIELD. The Fayette County Meteorite.

Am. Jour. Science, August, 1888, pp. 113-119, 3 text figures.

This paper gives results of microscopic and chemical examinations of a meteorite from the locality mentioned, material for the same being donated by Mr. E. E. Howell, of Rockwell, New York.

GEORGE P. MERRILL. On the San Emigdio Meteorite.

Proc. U. S. Nat. Mus., xi, 1888, pp. 161-167, 1 plate, showing microstructures.

This paper gives in detail descriptions of a stony meteorite found in the San Emigdio Mountains, California, and of which a brief description was given in the *Am. Jour. Sci.* of the same year.

GEORGE P. MERRILL. On the Serpentine of Montville, New Jersey.

Proc. U. S. Nat. Mus., xi, 1888, pp. 105-111, 2 plates (showing macro- and micro-structures).

The paper describes in some detail the origin of the serpentine by a process of metasomatism from a white non-aluminous monoclinic pyroxene.

GEORGE P. MERRILL. On the Ophiolite of Thurman, Warren County, New Jersey. With notes on the Eozoon Canadense.

Am. Jour. Sci., March, 1889, pp. 189-191.

Gives results of microscopic examinations showing that the serpentine of this rock, resulting from the case of that from Montville, New Jersey, from the alteration of a non-aluminous pyroxene, and calls attention to the similarity of the structures produced by this alteration to the eozoonal structures of Dawson.

- GEORGE P. MERRILL** and **F. W. CLARKE**. On Nephrite and Jadeite.
Proc. U. S. Nat. Mus., xi, 1888, pp. 115-130, 1 plate (showing microstructures).
 Containing results of examinations of Nephrites, Jadeites, and allied substances from Alaska, Central America, New Zealand, and other sources, and compares the results with those obtained by other authorities.
- GEORGE P. MERRILL**. On a Peridotite from Little Deer Isle, in Penobscot Bay, on the coast of Maine.
Proc. U. S. Nat. Mus., xi, 1888, pp. 191-195, 1 plate, 2 text figures (showing microstructures).
 Shows that an eruptive rock from this locality described by Jackson as a "Greenstone trap mixed with serpentine," is a peridotite of the variety pierlite.
- GEORGE P. MERRILL**. The Literature of Geysersite.
Am. Geologist, December, 1888, p. 437.
 Calls attention to previous papers by the author on the beds of volcanic dust in Harlan and Furnas Counties, Nebraska, which had apparently been ignored by Dr. Hicks.
- GEORGE P. MERRILL**. Among the Pennsylvania Slate Quarries.
Sci. Am. Supplement, January, 1889, 3 columns.
- GEORGE P. MERRILL**. Salt from Sea Water.
Sci. Am. Supplement, April.
- GEORGE P. MERRILL**. On the Selection of Building Stone.
Stone (Indianapolis, Indiana), December, 1888, pp. 196, 197.
- GEORGE P. MERRILL**. The Serpentine and Verdantique Marbles.
Stone (Indianapolis, Indiana), January, 1889, pp. 220-222.
- GEORGE P. MERRILL**. The Onyx Marbles.
Stone (Indianapolis, Indiana), February, 1889, p. 224.
- GEORGE P. MERRILL**. Our Red and Pink Granites.
Stone (Indianapolis, Indiana), February, 1889, pp. 246, 247; 1 figure.
- GEORGE P. MERRILL**. The Concord Granites.
Stone (Indianapolis, Indiana), February, 1889, p. 269.
- GEORGE P. MERRILL**. Poor Weathering Qualities of Marble.
Stone (Indianapolis, Indiana), February, 1889, p. 276.
- GEORGE P. MERRILL**. Oolitic Limestones.
Stone (Indianapolis, Indiana), April, 1889, pp. 296, 297; 1 figure, showing microstructure.
- GEORGE P. MERRILL**. The Porphyries.
Stone (Indianapolis, Indiana), May, 1889, p. 7; 1 figure, showing porphyritic structure.
- GEORGE P. MERRILL**. The Coloring Matter of Rocks.
Stone (Indianapolis, Indiana), June, 1889, p. 20.
- GEORGE P. MERRILL**. Glaciers and Stone Quarrying.
Stone (Indianapolis, Indiana), June, 1889, p. 24.
 (See also under F. W. CLARKE.)
- J. C. MERRILL** and **WILLIAM BREWSTER**. Notes on the Birds of Fort Klamath, Oregon, with remarks on certain species by William Brewster.
The Auk, v, July and October, 1888, pp. 251-263, 357-366.
 The critical notes, by Mr. Brewster, are based in part on specimens borrowed from the National Museum.
- JOHN MURDOCH**. A Remarkable Eskimo Harpoon from East Greenland.
Proc. U. S. Nat. Mus., xi, 1888 (1889), pp. 169-171; 3 figures.
- ALBERT P. NIBLACK**. Ethnology of the Coast Indian tribes of Alaska.
Proc. U. S. Nat. Mus., xi, 1888 (1889), p. 328.
- HENRY A. PILSBRY**. New and little known American Mollusks.
Proc. Acad. Nat. Sci., Philadelphia, 1889, pp. 81-88, plate lii.
Pacillozonites reinianus Pfeiffer var. *Goodei* Pilsbry is described from specimens collected by Mr. G. Brown Goode at Bermuda and lent for examination by the U. S. National Museum.
- W. W. PRICE**. Nesting of the Red-faced Warbler (*Cardellina rubrifrons*) in the Huachuca Mountains, southern Arizona.
The Auk, v, October, 1888, pp. 385, 386.
- W. W. PRICE**. Xantú's Becard (*Platyparis albiventris*) in the Huachuca Mountains, southern Arizona.
The Auk, v, October, 1888, p. 425.

RICHARD RATHBUN. Descriptions of new species of Parasitic Copepods, belonging to the genera *Trebius*, *Perissopus*, and *Lernanthropus*.

Proc. U. S. Nat. Mus., x, 1887, pp. 559-571, pls. xxix-xxxv.

The following new species are described: *Trebius tenuifurcatus* Rathbun, from sting Vineyard Sound, U. S. Fish Commission. *Perissopus communis* Rathbun, from four species of fish, ranging from Massachusetts to Florida. Var. *Stimpsoni* Rathbun, from Egg Harbor, New Jersey; Dr. William Stimpson; host unknown. *Lernanthropus noortii* Rathbun, on gills of menhaden (*Brevoortia tyrannus* Latrobe). Vineyard Sound, U. S. Fish Commission; abundant. *Lernanthropus Pomatomis* Rathbun, from gills of bluefish (*Pomatomus saltator*). Vineyard Sound, U. S. Fish Commission.

CHARLES W. RICHMOND. Another Saw-whet Owl (*Nyctala acadica*) in the District of Columbia.

The Auk, vi, April, 1889, p. 189.

A specimen shot at Capitol View Park, March 12, 1889. Three other specimens, taken at different times in the District, are noted.

ROBERT RIDGWAY. Remarks on *Catharus berlepschi* Lawr.

Proc. U. S. Nat. Mus., x, August 6, 1888, p. 504.

The species indorsed, its synonymy given, and habitat extended to Peru.

ROBERT RIDGWAY. Description of a new *Tityra* from western Mexico.

The Auk, v, July, 1888, p. 263.

Tityra personata griseiceps, new subspecies.

ROBERT RIDGWAY. Descriptions of some new species and subspecies of birds of Middle America.

Proc. U. S. Nat. Mus., x, August 6, 1888, pp. 505-510.

New birds described, are the following: (1) *Catharus fumosus*, p. 505, Costa Rica and Guatemala; (2) *Mimus gracilis leucophæus*, p. 506, Cozumel; (3) *Harporhynchus longirostris netti*, p. 506, southern Texas; (4) *Campylorhynchus castaneus*, p. 507, Guatemala and Honduras; (5) *Thryophilus rufalbus castanonotus*, p. 508, Nicaragua to Columbia; (6) *Myiarchus cinerascens davisii*, p. 508, Costa Rica; (7) *Dendroornis laurerci*, p. 509, Isthmus Panama; (8) *Dendroornis lawrencei costaricensis*, p. 510, Costa Rica.

ROBERT RIDGWAY. Note on the generic name *Uropsila* Scl. & Salv.

Proc. U. S. Nat. Mus., x, August 6, 1888, p. 511.

Uropsila being preoccupied, a new name, *Hemiura*, is proposed as a substitute.

ROBERT RIDGWAY. Description of new species and genera of birds from the Lower Amazon.

Proc. U. S. Nat. Mus., x, August 6, 1888, pp. 516-528.

These birds were collected by Mr. C. B. Riker, near Santarem, during June and July.

They number three genera and fifteen species, besides one from Guiana, described in foot note, as follows: *Thryothorus herberti* Riker, m. s., *T. ayacensis* (from Guiana); *Thryophilus tenuirostris*, *Cyphorhinus griseolateralis*, *Colaptes* (gen. nov., *Colaptes* preoccupied) *inornatus*, *Ornithion napæum*, *Tyrannulus reguloides*, *Attila viridiflora*, *Thamnophilus inornatus*, *Heterocnemis* (?) *hypoleuca* *Dichrozona* (gen. nov.) *zoniata*, *Phlogopsis boiverni* Riker, m. s., *Rhagmatorhina* (gen. nov.) *gymnops*, *Dendroornis fuscus*, *Dendrocolaptes obsoletus* and *Zenaidra jessie* Riker, m. s. These, with three species, elsewhere described by Mr. Ridgway, formed indeed a rich harvest from a few days' work.

ROBERT RIDGWAY. A review of the genus *Psittacula* Briss.

Proc. U. S. Nat. Mus., x, August 6, 1888, pp. 529-548.

This is an important monographic revision of the genus, giving full descriptions and synonymy of the species, eleven in number, of which three species (*Psittacula inornata* Tres Marias Islands; *P. exquisita*, Cartagena, Colombia; *P. delicosa*, Santarem) and two subspecies (*P. passerina virida*) are characterized as new.

ROBERT RIDGWAY. Catalogue of a collection of birds made by Mr. Charles Townsend on islands in the Caribbean Sea and in Honduras.

Proc. U. S. Nat. Mus., x, August 6, September 10, 1888, pp. 572-597.

Thirteen species are recorded from Grand Cayman (including *Columbigalina passerina* Towns, m. s., subsp. nov.); thirty from Swan Island (including *Contopus ricinus* *Butorides saturatus*, sp. nov.); three from Ruatan Island; fifty-six from Truxillo, Honduras (*Thamnophilus intermedius*, *Centurus santacruzii pauper*, and *Egyptila vinacea* are characterized as new), and ninety-three from Segovia River, Honduras, of which the following are regarded as new: *Pitylus polio-gaster scapularis*, *Sturnella magna incerta*, *Thalurania townsendi*, *Colinus nigrogularis segoviensis*, *Porzana exilis vagans*, *Tyrisona excellens*.

Also, *Columba purpureo-incta*, described as a new species from Demarara, British Guiana.

- ROBERT RIDGWAY.** Description of a new *Psaltriparus* from southern Arizona.
Proc. U. S. Nat. Mus., x, September 19, 1888, p. 697.
Psaltriparus santarita; habitat, Santa Rita Mountains, southern Arizona.
- ROBERT RIDGWAY.** Supplementary remarks on the genus *Pittacula* Brisson.
The Auk, v, October, 1888, supplement, pp. 460-462.
Having reference to "A Review of the Genus *Pittacula* Brisson," by the same author, in
Proc. U. S. Nat. Mus., vol. x, 1887, pp. 529-548.
- ROBERT RIDGWAY.** Description of a new Western subspecies of *Accipiter velox* (Wils.), and subspecific diagnosis of *A. cooperi mexicanus* (Swains.).
Proc. U. S. Nat. Mus., xi, November 8, 1888, p. 92.
Accipiter velox rufilatus, subsp. nov.; habitat, western North America, east to Rocky Mountains, north to Kodiak, south into Mexico. The habitat of *Accipiter cooperi mexicanus* is given, "Western United States and south into Mexico."
- ROBERT RIDGWAY.** Note on *Astrelata sandwichensis* Ridgw.
Proc. U. S. Nat. Mus., xi, November 8, 1888, p. 104.
Compared at writer's request with type of *Astrelata phaeopygia* Sal., by Mr. Osbert Salvin, and found identical.
- ROBERT RIDGWAY.** Description of a new pigeon from Guayaquil, Ecuador.
Proc. U. S. Nat. Mus., xi, November 8, 1888, p. 112.
Columba guayaquilensis, sp. nov.
- ROBERT RIDGWAY.** Description of the adult male of *Acanthidops bairdi*.
Proc. U. S. Nat. Mus., xi, March 12, 1889, p. 196.
An adult male from El Alto, Volcan de Poas, Costa Rica (No. 114907), U. S. Nat. Mus., collected July 27, 1888, by Sr. Anastasio Alfaro, the first ever obtained.
- R. (OBERT) R. (IDGWAY).** Charles Wickliffe Beckham.
The Auk, v, October, 1888, pp. 445, 446.
Obituary notice, and list of his ornithological publications.
- CHARLES V. RILEY.** Personal Reminiscences of Dr. Asa Gray. Address before the Asa Gray Memorial Meeting, held under the auspices of the botanical section of the Biological Society of Washington.
Bot. Gazette, xiii, July, 1888, pp. 178-186.
- CHARLES V. RILEY.** Salutatory.
Insect Life, i, pp. 3, 4.
Need of a periodical bulletin for the speedy publication of important notes on entomology.
- CHARLES V. RILEY.** The Willow-shoot Saw-fly (*Phyllacus integer* Norton).
Insect Life, i, July, 1888, pp. 8-11, fig. 2.
Natural history, ravages, and means against *Phyllacus (Oephus) integer*; description of egg, larva, cocoon, and imago, with figures of egg, larva, imago, and injured twigs.
- CHARLES V. RILEY.** The Morelos Orange Fruit-worm (*Trypeta ludens* Loew).
Insect Life, i, August, 1888, pp. 45-47, fig. 9.
Injuries to the fruit of the orange in Mexico by the larva of *Trypeta ludens*; habits of the same; characters and figures of its larva, puparium, and imago; structural details of the larva and puparium are also figured; liability of its introduction into the United States.
- CHARLES V. RILEY.** On the Causes of Variation in Organic Forms. Address as Vice-President, section of biology, A. A. A. S., 1888.
Proc. Amer. Assoc. Adv. Sci., xxxvii.
Separate: Salem, September, 1888, p. 51.
Reprint: *Pop. Sci. Mo.*, 1889, xxxiv, February, pp. 484-496; April, pp. 809-820.
- CHARLES V. RILEY.** Further Notes on the Hop Plant-louse (*Phorodon humuli*).
Insect Life, i, 1888, pp. 70-74.
Paper before the Society for the Promotion of Agricultural Science; summary of recently ascertained facts concerning the life history of *Phorodon humuli*; time of acquiring wings; prior appearance of ♂♂; fewness of eggs which survive the winter.
- CHARLES V. RILEY.** A Destructive Cricket in Louisiana.
Insect Life, i, September, 1888, pp. 87, 88.
Portion of letter from Michael Dempsey concerning injury by a *Gryllus* sp. to cotton, sweet and Irish potatoes, peas, and tobacco. In reply, the use of poisoned bait is recommended.
- CHARLES V. RILEY.** The Parsnip Web-worm (*Depressaria heracliana* DeG.).
Insect Life, i, October, 1888, pp. 91-98, fig. 13.
Synonymy, early accounts, importation, habits and natural history, descriptions and figures of larva, pupa, and imago of *Depressaria heracliana*; distribution, food-plants, enemies of, and means against, the same.

CHARLES V. RILEY. A Lady-bird Parasite.

Insect Life, 1, October, 1888, pp. 101-104, figs. 14, 15.

Habits of parasitized *Megilla maculata*, with figure of the same and of the cocoon and imago of *Centistes americana* n. sp.

CHARLES V. RILEY. Remarks on the Hessian Fly.

Insect Life, 1, October, 1888, pp. 107, 108.

Abstract of paper read before the Society for the Promotion of Agricultural Science; relative to errors in the published minutes of the early meetings of the American Philosophical Society, and argues for the introduction of the species from Europe.

CHARLES V. RILEY. The Orchid *Isosoma* and a Remedy for its Injury.

Insect Life, 1, October, 1888, p. 121.

Notice of proposed means against *Isosoma orchidearum*.

CHARLES V. RILEY. Some Recent Entomological Matters of International Concern. Paper read before the Philosophical Society of Washington, March 31, 1888.

Insect Life, 1, November, 1888, pp. 126-137, figs. 24-34.

Original habitat of *Icerya purchasi*; distinct from *I. sacchari*; list of enemies and parasites discovered in California; benefits derived from the introduction of parasites; summary of the life history of *Oecidomyia destructor*; its presence and destructiveness in America and England; its introduction into England from Europe; prospective injuries in England; summary of the life history of *Phorodon humuli*; figures various stages of *Icerya purchasi* and *Phorodon*.

CHARLES V. RILEY. The Habits of *Thalessa* and *Tremex*.

Insect Life, 1, December, 1888, pp. 168-179, figs. 36-39, pl. 1.

Review of recorded observations on the larval habits of *Thalessa*; habits of the larva and pupa of *T. lunator* and *Tremex columba*; description and figure of the method of oviposition in *T. lunator* and of *Rhyssa persuasoria*; structure and figure of ovipositor, and description and figure of the egg, of *T. lunator*; armor of the males; account of supposed oviposition of *Thalessa* in exposed lepidopterous larvae; description of *Heteropelma datana* sp.; habits and transformations of *Tremex columba*; figures larva with details, pupa, imago of *T. columba*, and larva, pupa, ♂ and ♀ of *Thalessa lunator*; structural details of larva and imago are also given.

CHARLES V. RILEY. Insecticide Appliances. Modifications of the Riley or Cyclone Nozzle.

Insect Life, 1, February, 1889, pp. 243-249, figs. 54-57.

The typical Riley nozzle; modifications of the eddy-chamber system of nozzles in the United States; the Universal Spray-tip; foreign modifications of the Riley nozzle—the Noel nozzle; figures of the Riley nozzle; the Universal Spray-tip and the Noel nozzle.

CHARLES V. RILEY. Notes on Pronuba and Yucca Fertilization.

Proc. Ent. Soc. of Washington, 1, No. 3, March 30, 1889.

Criticism at length of G. D. Hulst's article in *Entomologica Americana*, vol. II, pp. 236-238, as printed in *Insect Life*, vol. 1, p. 387, June, 1889.

CHARLES V. RILEY. Two brilliant and interesting Micro-lepidoptera new to our Fauna.

Proc. Ent. Soc. of Washington, 1, No. 3, March 30, 1889.

Describes *Setiostoma fernaldella* n. sp., from California, *Walsinghamia* n. gen., and *Walsinghamia diea* n. sp., from Florida.

CHARLES V. RILEY. Insecticide Appliances.

Insect Life, 1, March, 1889, pp. 263-268, figs. 58-63.

Foreign modifications of the Riley nozzle (continued); the Vermorel nozzle, the Albert modification, the Japy modification, the Marseilles modification, and the New Zealand Triplet modification; figures of all the nozzles.

CHARLES V. RILEY. Additional Note on the Megilla Parasite.

Insect Life, 1, May, 1889, pp. 338, 339.

Letter from Rev. T. A. Marshall, of England, in which this parasite (*Centistes americana*) is stated to belong in the genus *Perilitus*; description of same as *P. americana* n. sp.; Glove Lady-bird parasite.

CHARLES V. RILEY. Notes on Pronuba and Yucca Pollination.

Insect Life, 1, June, 1889, pp. 367-372.

Criticism at length of Mr. Hulst's remarks in *Entomologica Americana*, vol. II, pp. 236-238.

CHARLES V. RILEY and L. O. HOWARD (editors). The Corn-feeding Syrphus-fly.

Insect Life, 1, July, 1888, pp. 5-8, fig. 1.

Summary of larval habits of *Syrphidæ*; food-habits; injuries and means against *Mesograpta polita*; description of all stages and figures of larva; puparium and adult of the same.

- CHARLES V. RILEY and L. O. HOWARD (editors).** Extracts from Correspondence. (Answers by editors.)
Insect Life, 1, pp. 13-17.
 The Garden Web-worm (*Eurycreon rantalis*) reappears. An enemy to the Date Palm in Florida. A Virginia *Stimulium* called "Cholera Gnat." Comparative Merits of the Arsenical Solutions. Probably a New Enemy to Pear from Oregon. An extraordinary twilight flight of *Lachnosterna*.
- CHARLES V. RILEY and L. O. HOWARD (editors).** The Privet Web-worm (*Margarodes quadristigmatis* Gn.).
Insect Life, 1, July, 1888, pp. 22-26, fig. 4.
 Value of *Ligustrum vulgare* as a hedge plant; natural history; description of all stages and means against *Margarodes quadristigmatis*; figures larva, cocoon, and imago, and structural details of larva and pupa of the same.
- CHARLES V. RILEY and L. O. HOWARD (editors).** The Chinch Bug in California.
Insect Life, 1, July, 1888, pp. 26, 27.
 Record of the occurrences of *Blissus leucopterus* on the Pacific coast.
- CHARLES V. RILEY and L. O. HOWARD (editors).** German Phylloxera Laws.
Insect Life, 1, July, 1888, p. 27.
 Rules for importing plants to Germany, with comments.
- CHARLES V. RILEY and L. O. HOWARD (editors).** Kerosene Emulsion against the Cabbage-worms.
Insect Life, 1, July, 1888, pp. 27, 28.
 Letter of F. E. Anderson on the effect of kerosene emulsion as a means against cabbage-worms, with comments.
- CHARLES V. RILEY and L. O. HOWARD (editors).** Swarming of Hackberry Butterflies.
Insect Life, 1, July, 1888, pp. 28, 29.
 Note on the swarming of *Apatura celtis* in May, 1887.
- CHARLES V. RILEY and L. O. HOWARD (editors).** Southward Spread of the Asparagus-beetle.
Insect Life, 1, July, 1888, p. 29.
 Extent of the distribution southward of *Orioceria asparagi*.
- CHARLES V. RILEY and L. O. HOWARD (editors).** Caterpillars Stopping a Train; a Newspaper Exaggeration.
Insect Life, 1, July, 1888, p. 30.
 Correspondence showing an exaggeration of the number of caterpillars on a railroad track in South Carolina.
- CHARLES V. RILEY and L. O. HOWARD (editors).** Injury by the Rocky Mountain Locust.
Insect Life, 1, July, 1888, pp. 30, 31.
 Note concerning the injury done by *Caloptenus spretus* in Minnesota.
- CHARLES V. RILEY and L. O. HOWARD (editors).** The Periodical Cicada in 1888.
Insect Life, 1, July, 1888, p. 31.
 List of localities in which *Oicada (Tibicen) septendecim* and its race *tredecim* are supposed to have occurred in 1888.
- CHARLES V. RILEY and L. O. HOWARD (editors).** The Sweet-potato Saw-fly (*Schizocerus ebenus* Norton).
Insect Life, 1, August, 1888, pp. 43-45, figs. 7, 8.
 Record of injuries, mention of parasites, characters and figures of eggs, larva, and imago of *Schizocerus ebenus*; figure of *Eubadizon schizoceri* n. sp.; structural details of larva also figured.
- CHARLES V. RILEY and L. O. HOWARD (editors).** Extracts from Correspondence. (Answers by editors.)
Insect Life, 1, August, 1888, pp. 50-58.
 A new Tomato Enemy in Georgia. Precursors of Brood V of the Periodical Cicada, 1871-1888. Mites infesting an old Grain Elevator. The Streaked Cotton-wood Leaf-beetle in the East. Hibernation of Mosquitoes. Leaf Hoppers and the "Die-back" of the Orange. The Barnacle Scale injuring Persimmon. *Euryomia melancholica* vs. Cotton Boll. Hibernation of the Two-spotted Lady-bird. Work of the Bronzy Cut-worm in Missouri. The Bamboo *Sinoxylon*. An Enemy to Young Carp.

- CHARLES V. RILEY and L. O. HOWARD (editors). The Twelve-spotted *Diabrotica* injuring Fruit Trees.
Insect Life, 1, August, 1888, pp. 58, 59.
 Occurrence of *Diabrotica 12-punctata* injuring plums, apricots, etc.
- CHARLES V. RILEY and L. O. HOWARD (editors). Economic Entomology in India.
Insect Life, 1, August, 1888, p. 60.
 Notice of paper on economic entomology by E. C. Cotes; amount of injury and double-broodness of *Calandra oryzae* in India.
- CHARLES V. RILEY and L. O. HOWARD (editors). New European natural Enemies of the Asparagus Beetle.
Insect Life, 1, August, 1888, pp. 61, 62.
 Discovery of *Calocoris chenopodii* and *Myobia pumila* as enemies of *Oriocoris asparagi* in Europe; absence of enemies of the same beetle in America.
- CHARLES V. RILEY and L. O. HOWARD (editors). Concerning the Uji Parasite of the Silk-worm.
Insect Life, 1, August, 1888, p. 62.
 Notice of Bigot's determination that *Ujimyia* is synonymous with *Leskia*; need of additional observations on the habits of *Leskia*.
- CHARLES V. RILEY and L. O. HOWARD (editors). Outlook for Locust or Grasshopper Injury.
Insect Life, 1, September, 1888, p. 63.
 Prediction as to locust injury: favorable outlook for the coming year; injuries by sedentary or non-migratory species.
- CHARLES V. RILEY and L. O. HOWARD (editors). Injury done by Roaches to the Files in the Treasury at Washington.
Insect Life, 1, September, 1888, pp. 67-70.
 Account of injury to books by *Periplaneta americana* and *Ectobia germanica*; recommendation of California buhach as a means against the same.
- CHARLES V. RILEY and L. O. HOWARD (editors). Extracts from Correspondence (Answers by editors.)
Insect Life, 1, September, 1888, pp. 85-87.
 The Strawberry Weevil in Pennsylvania. *Graptodera punctipennis* injuring Nursery Stock.
Lachnosterna hirticula injuring Poplars and Oaks. Insects confounded with the Hessian Fly prior to the Revolution. Injury from non-migratory Locusts in Michigan.
- CHARLES V. RILEY and L. O. HOWARD (editors). A new Enemy to Honey Bees.
Insect Life, 1, September, 1888, p. 88.
 Records *Euthyrhynchus floridanus* as feeding on *Apis mellifica*.
- CHARLES V. RILEY and L. O. HOWARD (editors). An unpublished Habit of *Allorhina nitida*.
Insect Life, 1, September, 1888, pp. 88, 89.
 Records *Allorhina nitida* eating *Raetilia aurantiaca*.
- CHARLES V. RILEY and L. O. HOWARD (editors). Recent Swarmings of Insects.
Insect Life, 1, September, 1888, pp. 90, 91.
 Comments on records of large swarms of *Tortrix (Cacæcia) fractivittana* and of *Mamestra dactylus subspinosa*.
- CHARLES V. RILEY and L. O. HOWARD (editors). An Inexpert Defense.
Insect Life, 1, September, 1888, p. 91.
 Extracts from Manchester (England) Courier concerning charge of homicide for falsifying wine with arsenic, with comments.
- CHARLES V. RILEY and L. O. HOWARD (editors). Insect Damage to the Corks of Wine Bottles.
Insect Life, 1, September, 1888, pp. 91, 92.
 Summary of paper by Preudhomme de Borre regarding insects which feed on corks.
- CHARLES V. RILEY and L. O. HOWARD (editors). Locusts in Algeria.
Insect Life, 1, September, 1888, p. 92.
 Ravages, and means taken by the Government to suppress the locusts in Algeria.
- CHARLES V. RILEY and L. O. HOWARD (editors). Enemies of *Icearya* in New Zealand.
Insect Life, 1, September, 1888, p. 92.
 Value of birds as destroyers of *Icearya purchasi*.

- CHARLES V. RILEY and L. O. HOWARD (editors). Special Notes.
Insect Life, 1, October, 1888, pp. 93, 94.
 Chinch Bug affected by epidemic diseases in Minnesota and Illinois. Enhanced value of wax owing to its use in the phonograph, graphophone, etc. Notice of proposed monograph of the *Pyraïdæ*, by C. H. Fernald. Criticism of paper by G. D. Hulst, giving descriptions of *Epipaschia* and *Phycitida*.
- CHARLES V. RILEY and L. O. HOWARD (editors). The Puralane Caterpillar (Larva of *Copidryas gloveri* Grote and Robinson).
Insect Life, 1, October, 1888, pp. 104-106, figs. 16-20.
 Life, history, and figures in all stages of *Copidryas gloveri*.
- CHARLES V. RILEY and L. O. HOWARD (editors). Extracts from Correspondence. (Answers by editors.)
Insect Life, 1, October, 1888, pp. 109-112.
 A *Stomoxys* injuring stock in Oregon; the Colorado Potato-beetle in Nova Scotia; the Green-striped Maple-worm; Wheat Saw-flies; Was it an accident or a wily Milkman? Cranberry Gall-mites.
- CHARLES V. RILEY and L. O. HOWARD (editors). Synonymy of the Mealy Bug of the Orange.
Insect Life, 1, October, 1888, p. 118.
Dactylopius destructor and *D. phyllococcus* identical with *D. citri*.
- CHARLES V. RILEY and L. O. HOWARD (editors). Entomology in Chili.
Insect Life, 1, October, 1888, pp. 118, 119.
 Notice of recent works on the entomology of Chili; enumeration of the Coleoptera common to the United States and Chili.
- CHARLES V. RILEY and L. O. HOWARD (editors). The Pear *Diplosis* in England.
Insect Life, 1, October, 1888, pp. 120, 121.
 Identity of the pear-midge of England with *Diplosis pyricora* Riley.
- CHARLES V. RILEY and L. O. HOWARD (editors). False Report of Phylloxera in Australia.
Insect Life, 1, October, 1888, pp. 121, 122.
 Fungus mistaken for Phylloxera.
- CHARLES V. RILEY and L. O. HOWARD (editors). The Insidious Flower-bug.
Insect Life, 1, October, 1888, p. 122.
 Notice of injury to Chrysanthemums by *Triphleps insidiosus*.
- CHARLES V. RILEY and L. O. HOWARD (editors). Special Notes.
Insect Life, 1, November, 1888, pp. 122-126.
 Critical review of A. J. Cook's report on insecticides and implements for their application; critical review of C. P. Gillette's report on "A few important Chinch-bug remedies" and the other "Arsenic experiments;" scarcity of Shade-tree pests in Washington the past summer.
- CHARLES V. RILEY and L. O. HOWARD (editors). Extracts from Correspondence. (Answers by editors.)
Insect Life, 1, November, 1888, pp. 142-144.
 Danger to human beings by use of Paris green. The Clover-seed Midge in Ohio. The acid secretion of *Notodonta concinna*. Out-of-door hibernation of *Lecanium hemisphaericum* in Pennsylvania.
- CHARLES V. RILEY and L. O. HOWARD (editors). Insects introduced into Chili.
Insect Life, 1, November, 1888, pp. 153-155.
 Critical review of paper by R. A. Philippi on the changes in the fauna of Chili caused by man.
- CHARLES V. RILEY and L. O. HOWARD (editors). Remarkable abundance of the Cecropia Silk-worm.
Insect Life, 1, November, 1888, p. 155.
 Ravages of *Attacus cecropia* in Nebraska.
- CHARLES V. RILEY and L. O. HOWARD (editors). The Clover-root Borer.
Insect Life, 1, November, 1888, p. 156.
 Notes increasing range of *Hylesinus trifolii*.
- CHARLES V. RILEY and L. O. HOWARD (editors). A Point in Favor of the English Sparrow.
Insect Life, 1, November, 1888, p. 156.
 Notes the destruction of *Schizoneura lanigera* by the English Sparrow.
- CHARLES V. RILEY and L. O. HOWARD (editors). The Rear-horse domesticated.
Insect Life, 1, November, 1888, p. 156.
Mantis (Phasmomantis) carolina an enemy to Blattidæ.

- CHARLES V. RILEY and L. O. HOWARD (editors). Professor Forbes's Investigation on the Food of Fresh-water Fishes.
Insect Life, 1, November, 1888, pp. 158-161.
 Critical review of papers by S. A. Forbes on the food of fresh-water fishes, with extracts.
- CHARLES V. RILEY and L. O. HOWARD (editors). The Hosts of a few larger *neumonids*.
Insect Life, 1, November, 1888, p. 161.
 Records of hosts of several *Ichneumonidae*.
- CHARLES V. RILEY and L. O. HOWARD (editors). Special Notes.
Insect Life, 1, December, 1888, pp. 163-168.
 Notes on strictures made concerning *Insect Life* which is devoted to the promotion of entomology in all its branches. Recent California work against the Fluted Scale. Replies to inquiries concerning the right to patent gas-treatment against *Coccidæ*. Introduction of living parasites. Success of the mission to Australia. Credit to whom credit is due. Statement of facts regarding the discovery and introduction into California of *Lestophoniceryæ*. Notice of a new entomological journal, *Entomologiska Meddelelser, udgivne af det danske entomologiske Forening ved Fr. Meinert, Copenhagen*. Result of the Rural New Year potato contest: Ravages of *Orepidodera cucumeris*. Some insect enemies of tobacco mentioned in report of K. Lindeman.
- CHARLES V. RILEY and L. O. HOWARD (editors). A Sandwich Island Sugar Borer (*Sphenophorus obscurus* Bois.).
Insect Life, 1, December, 1888, pp. 185-189, figs. 44, 45.
 Ravages, means against; descriptions and figures of larva, pupa, and imago of *Sphenophorus obscurus*; figure showing work of the same.
- CHARLES V. RILEY and L. O. HOWARD (editors). Extracts from Correspondence (Answers by editors.)
Insect Life, 1, December, 1888, pp. 190-192.
 The "Red Bug" injuring oranges again. Further injury in the Treasury by roaches supposed to have been passed by a patient. A Tineid on carpets in Texas. Leaf-stripping Ants in Arizona. Stinging Caterpillar of *Lagoa opercularis*.
- CHARLES V. RILEY and L. O. HOWARD (editors). Grain insects in Australia.
Insect Life, 1, December, pp. 193, 194.
 Danger from the importation of grain insects into Australia; means for preventing the same.
- CHARLES V. RILEY and L. O. HOWARD (editors). Further concerning the Locust War in Algeria.
Insect Life, 1, December, 1888, pp. 194, 195.
 Conclusions of d'Herculais concerning locusts and their invasion of Algeria.
- CHARLES V. RILEY and L. O. HOWARD (editors). An important contribution to Lepidopterology.
Insect Life, 1, December, 1888, p. 195.
 Review of Walsingham's revision of the genera *Acrolophus* and *Anaphora*; arranged according to the American species.
- CHARLES V. RILEY and L. O. HOWARD (editors). The Poisonous Nature of the Meconium of Lepidoptera.
Insect Life, 1, December, 1888, p. 196.
 Commencement on Goosens's note concerning the poisonous nature of the Meconium of Lepidoptera.
- CHARLES V. RILEY and L. O. HOWARD (editors). The food-habits of North American *Calandridæ*.
Insect Life, 1, December, 1888, pp. 198, 199.
 Mention of the food-habits of the genera of North American *Calandridæ*.
- CHARLES V. RILEY and L. O. HOWARD (editors). A remarkable insect enemy of live stock.
Insect Life, 1, December, 1888, p. 199.
 Comments on account of the poison of *Thelyphonus giganteus* and *Mantis* (= *Phasmodon carolina*).
- CHARLES V. RILEY and L. O. HOWARD (editors). Further on the Importation of the *Lestophonus*.
Insect Life, 1, December, 1888, pp. 199, 200.
 Announcement of the successful introduction from Australia of *Lestophonus iceryæ* and insect enemies of *iceryæ purchasi*.

CHARLES V. RILEY and L. O. HOWARD (editors). Special Notes.

Insect Life, 1, January, 1889, 201-204.

F. M. Webster to assist in the collection of parasites of *Icerya purchasi* in Australia, and to report on the agricultural aspects of the Melbourne Exposition. Resignation of W. B. Alwood from, and appointment of C. L. Marlatt on, the Divisional force. Increase of workers in economic entomology under the Hatch Experiment Station act; advantage of their forming a national organization. Kerosene emulsion; an error corrected. On Dr. Holland's collection of butterflies. Recent entomological publications: Comstock's "Introduction to Entomology," Smith's monograph of the "Sphingidae of America north of Mexico," Lintner's Fourth Report, Saunders's Butterflies, and Packard's Entomology for Beginners.

CHARLES V. RILEY and L. O. HOWARD (editors). A Contribution to the Literature of fatal Spider Bites.

Insect Life, 1, January, 1889, pp. 204-211, fig. 46.

Poisonous nature of the bites of *Latrodectus mactans*; similar character of the bites of its European congener *L. malmigniatum*, with a general review of the literature of the subject; the "Katipo" of New Zealand a poisonous spider; figures of male and female of *L. mactans* and of the abdomen of different stages and varieties of the same.

CHARLES V. RILEY and L. O. HOWARD (editors). On the emasculating Botfly (*Cuterebra emasculator* Fitch).

Insect Life, 1, January, 1889, pp. 214-216, fig. 48.

Review of Dr. Fitch's account of this insect. Letter from C. Hart Merriam on the occurrence of *Cuterebra* in the gray squirrel, red squirrel, and chipmunk; figures of larva with enlarged views of parts.

CHARLES V. RILEY and L. O. HOWARD (editors). Extracts from Correspondence. (Replies by editors.)

Insect Life, 1, January, 1889, pp. 217-223.

Larva of *Hyperchiria* on Saw Palmetto in Florida. *Acanthacera similis* injuring Pineapple in Florida. *Hylesinus trifolii* in Ohio. A Proposed Remedy for the Chinch Bug. Two Species of *Anomala* injurious to the Vine in the South. Beetle borings in an Opium Pipe from China. A Grape vine Flea-beetle in the Southwest. A *Phylloxera* on the Pecan. *Anthrenus* destroying Whalebone.

CHARLES V. RILEY and L. O. HOWARD (editors). Geographical Range of the Chinch Bug.

Insect Life, 1, January, 1889, p. 226.

Recorded outside of the United States in Cuba, Mexico, Guatemala, and Panama.

CHARLES V. RILEY and L. O. HOWARD (editors). Damage to Fruit by the Adult of *Allorhina*.

Insect Life, 1, January, 1889, pp. 226, 227.

On the authority of the Pacific Rural Press on *Allorhina* attacks peaches, grapes, and even cornstalks; fig-eating habit of *A. nitida*.

CHARLES V. RILEY and L. O. HOWARD (editors). The Imbricated Snout-beetle.

Insect Life, 1, January, 1889, p. 227.

The potato a food-plant of this beetle; list of recorded food-plants.

CHARLES V. RILEY and L. O. HOWARD (editors). *Chloridea rhexia* injuring Tobacco.

Insect Life, 1, January, 1889, pp. 228, 229.

Tobacco a new food-plant; means against.

CHARLES V. RILEY and L. O. HOWARD (editors). Special Notes.

Insect Life, 1, February, 1889, pp. 231-234.

Cercus viridiflorus a probable food-plant of *Cactophagus validus*. Reprint of "Classification of Coleoptera of North America," by LeConte and Horn. Revision of Chambers's Index, by Lord Walsingham. The second shipment of *Icerya* parasites. A secondary *Icerya* parasite. Entomological work at Cornell.

CHARLES V. RILEY and L. O. HOWARD (editors). The Red Bug or Cotton Stainer

(*Dysdercus suturellus* H. Schf.).

Insect Life, 1, February, 1889, pp. 234-241, figs. 50-52.

Geographical distribution, food-plants, habits and natural history; remedies against; value as a dye; figures of all stages.

CHARLES V. RILEY and L. O. HOWARD (editors). Extracts from Correspondence. (Replies by editors.)

Insect Life, 1, February, 1889, pp. 252-254.

Late autumnal occurrence of Mites in great numbers. *Balaninus nasices* in granulated sugar. Sap-beetles in injured figs.

- CHARLES V. RILEY and L. O. HOWARD (editors). Notes on the Cochineal Insect. *Insect Life*, 1, February, 1889, pp. 258, 259.
On some insect enemies of the Cochineal insect (*Ooccus cacti*) in Texas—a predaceous caterpillar (*Dakruma coccidivora*) and a new parasitic fly (*Leucopsis bellula*, n. sp.) which is described by S. W. Williston; Cochineal insect in Florida.
- CHARLES V. RILEY and L. O. HOWARD (editors). Special Notes. *Insect Life*, 1, March, 1889, pp. 261, 262.
Poisonous bites.—Notices of letters bearing on bites of Spiders. Cranberry Fungus Galls. The Secondary *Icerya* parasite. National Organization of Entomologists. Unsigned articles in *Insect Life* credited to Riley and Howard. Fred Tepper collection of Lepidoptera goes to the Michigan Agricultural College.
- CHARLES V. RILEY and L. O. HOWARD (editors). Extracts from Correspondence (Answers by editors.) *Insect Life*, 1, March, 1889, pp. 280-286.
The Red-legged Flea-beetle injuring peach orchards. The Spider bite question again. The Hay Worm in Kentucky. A Rose-bud Cecidomyia. Beetles infesting yeast cakes. Mites in flaxseed. Bees versus Fruit.
- CHARLES V. RILEY and L. O. HOWARD (editors). Winter appearance of the *Certhia* Moth. *Insect Life*, 1, March, 1889, p. 292.
Severe winter more favorable than mild winter to hibernation of insects.
- CHARLES V. RILEY and L. O. HOWARD (editors). Immunity of Southern Dakota from the Chinch Bug. *Insect Life*, 1, March, 1889, p. 294.
Letter to W. W. Corbett giving reasons for the above.
- CHARLES V. RILEY and L. O. HOWARD (editors). Burning the Stubble for Hessian Flies. *Insect Life*, 1, March, 1889, pp. 294, 295.
Reference to the discussion between Mr. Enock and Miss Ormerod of the advisability of burning stubble, with letter on the subject to Mr. Enock.
- CHARLES V. RILEY and L. O. HOWARD (editors). Special Notes. *Insect Life*, 1, April, 1889, pp. 297-300.
Mr. Koebele's mission concluded: general results given. The periodical Cicada in 1889; range of Brood VIII of the seventeen-year race. Mr. W. G. Klee's work on Economic Entomology in California. Kind words from a veteran entomologist. The Lepidoptera of Australia: Alex. W. Scott's MSS. relating to life histories to be published. Resignation of B. Smith as Assistant in the Department of Insects at the National Museum and appointment of M. L. Linell as aid in the Department. The Entomologist to go to Paris as one of the Assistant Commissioners to the Paris Exposition: Mr. Howard left in charge.
- CHARLES V. RILEY and L. O. HOWARD (editors). Extracts from Correspondence (Answer by editors.) *Insect Life*, 1, April, 1889, pp. 313-320.
Buffalo Gnats on the Red River. The new Flour Moth in England. Abundance of an Insect in Dakota. The Bean Weevil in California. Grass Cut-worms. The Texas Hessian Fly. A Boll-worm letter.
- CHARLES V. RILEY and L. O. HOWARD (editors). Late important publication relative to the Hessian Fly. *Insect Life*, 1, April, 1889, pp. 322, 323.
Notices of papers on the Hessian Fly by Miss Ormerod and Messrs. Lindeman, Forbes and Enock.
- CHARLES V. RILEY and L. O. HOWARD (editors). Fungicides as Insecticides. *Insect Life*, 1, April, 1889, p. 323.
Lime and copper sulphate solutions efficacious against the Rose Bug, Locusts, and garden snails.
- CHARLES V. RILEY and L. O. HOWARD (editors). New Food-plant for the Scurfy Bark-louse. *Insect Life*, 1, April, 1889, p. 324.
Chionaspis furfurus Fitch attacks the "Cherry currant;" list of previously known food plants.
- CHARLES V. RILEY and L. O. HOWARD (editors). Obituary. *Insect Life*, 1, April, 1889, p. 324.
Notice of the death of Samuel Lowell Elliott.

- CHARLES V. RILEY and L. O. HOWARD (editors). Precursors of Brood VIII of the Periodical Cicada.
Insect Life, I, April, 1889, p. 324.
Appearance of Cicada in greenhouse, February 23.
- CHARLES V. RILEY and L. O. HOWARD (editors). A Spider-egg Parasite.
Insect Life, I, April, 1889, p. 324.
Pimpla inquisitor bred from the cocoon of *Argiope riparia*.
- CHARLES V. RILEY and L. O. HOWARD (editors). Spraying Fruit Trees.
Insect Life, I, April, 1889, pp. 324, 325.
An unsuccessful example of spraying for the Codling Moth.
- CHARLES V. RILEY and L. O. HOWARD (editors). A Bryobia in New Zealand.
Insect Life, I, April, 1889, p. 325.
A Mite (*Bryobia*) damaging the leaves of the apple in New Zealand.
- CHARLES V. RILEY and L. O. HOWARD (editors). The Box-Elder Bug.
Insect Life, I, April, 1889, p. 325.
Notes on food-plants and abundance of *Leptocaris trivittatus*; reference to article by Prof. E. A. Popenoe.
- CHARLES V. RILEY and L. O. HOWARD (editors). The Florida Wax-scale in California.
Insect Life, I, April, 1889, pp. 325, 326.
The Wax-scale of Florida (*Ceroplastes floridensis*) received from W. E. Collins, of California; food-plants; remedies.
- CHARLES V. RILEY and L. O. HOWARD (editors). Special Notes.
Insect Life, I, May, 1889, pp. 327, 328.
Australian enemies of *Icerya* in California. Notice of the second edition of Saunders's "Insects Injurious to Fruits." Catalogue of Oriental insects. A new Government publication. The Journal of the Board of Viticulture, Victoria, Australia.
- CHARLES V. RILEY and L. O. HOWARD (editors). Extracts from Correspondence. (Answers by editors.)
Insect Life, I, May, 1889, pp. 340-346.
Trumpet-creeper injured by *Lygæus rectivatus*. *Thrips tritici* injuring orange blossoms. White Ants in Australia. White Grub injury to strawberries. Larva of *Cicada septendecim*. A *Phytoptus* on plum. A Lac Insect on the creosote bush. A *Rhizococcus* on grass in Dakota. Saw-fly on *Polygonum dumetorum*. *Oecinis* sp. on chrysanthemum. Ants destroying young maples in Nebraska.
- CHARLES V. RILEY and L. O. HOWARD (editors). The Spider-bite question.
Insect Life, I, May, 1889, pp. 347-349.
Additional cases of bites by poisonous Spiders; letter relating thereto.
- CHARLES V. RILEY and L. O. HOWARD (editors). *Uropoda americana* on *Euphoria inda*.
Insect Life, I, May, 1889, p. 349.
The Mite (*Uropoda americana*) recorded as infesting *Euphoria inda*.
- CHARLES V. RILEY and L. O. HOWARD (editors). The Blackbird and the Boll Worm.
Insect Life, I, May, 1889, p. 351.
Blackbirds extracting the Boll Worms from green corn (!).
- CHARLES V. RILEY and L. O. HOWARD (editors). Swarms of Gnats in Iowa.
Insect Life, I, May, 1889, p. 351.
The Gnat (*Ohtronomus nigricans*) swarming at Keokuk, Iowa.
- CHARLES V. RILEY and L. O. HOWARD (editors). New Remedy for Striped Bugs.
Insect Life, I, May, 1889, p. 351.
Calomel mixed with flour or ashes, recommended by Vick's Magazine.
- CHARLES V. RILEY and L. O. HOWARD (editors). The European Ribbon-footed Corn-fly.
Insect Life, I, May, 1889, pp. 353, 354.
Othlorops tantopus damaging barley and rye in Sweden not a new pest.
- CHARLES V. RILEY and L. O. HOWARD (editors). *Hermetia mucens* infesting Bee-hives.
Insect Life, I, May, 1889, pp. 353, 354.
Letter from Dr. W. B. Rohmer, describing the oviposition of the fly (*Hermetia mucens*) and habits of the larvæ.

- CHARLES V. RILEY and L. O. HOWARD (editors). The Chinch Bug this year.
Insect Life, 1, May, 1889, p. 354.
Alarm caused by the Chinch Bug in Arkansas.
- CHARLES V. RILEY and L. O. HOWARD (editors). Codling Moth destructive in Tasmania.
Insect Life, 1, May, 1889, p. 354.
Energetic Government work against the Codling Moth.
- CHARLES V. RILEY and L. O. HOWARD (editors). Gas lime for the Onion Moth.
Insect Life, 1, May, 1889, p. 354.
Method of application as given by a correspondent of the Gardener's Chronicle.
- CHARLES V. RILEY and L. O. HOWARD (editors). Paris green for the Garden Web-worm.
Insect Life, 1, May, 1889, p. 354.
Professor Cassidy's experiments with Paris green against the Garden Web-worm (*Eurantaia*).
- CHARLES V. RILEY and L. O. HOWARD (editors). The Phylloxera in Asia Minor.
Insect Life, 1, May, 1889, pp. 354, 355.
Deliberate importation of the *Phylloxera* into Asia Minor.
- CHARLES V. RILEY and L. O. HOWARD (editors). Bark Lice on the Cocoa-nut.
Insect Life, 1, May, 1889, p. 355.
The cocoa-nut palm in Jamaica infested by *Fiorinia pellucida* and *Mytilaspis buxi*.
- CHARLES V. RILEY and L. O. HOWARD (editors). Important publications of the year in Economic Entomology.
Insect Life, 1, May, 1889, pp. 355, 356.
Professor Targioni-Tozzetti's second report on agricultural entomology, Florence.
Miss E. A. Ormerod's report on injurious insects for 1888, London, 1889; Mr. Fletcher's report as entomologist and botanist to the Dominion of Canada, Ottawa.
- CHARLES V. RILEY and L. O. HOWARD (editors). The Pyrethrum Industry.
Insect Life, 1, May, 1889, p. 356.
Number of tons imported; California's product.
- CHARLES V. RILEY and L. O. HOWARD (editors). A new use for the Fluted Orange.
Insect Life, 1, May, 1889, p. 356.
Introduction of *Icerya purchasi* into Florida proposed by a writer in the "Florida Dispatch" as a remedy for overproduction of oranges.
- CHARLES V. RILEY and L. O. HOWARD (editors). Codling Moth Notes.
Insect Life, 1, May, 1889, p. 356.
Notice of D. B. Wier's article on Orchard work in the "Orchard and Farm," and of A. Popenoe's experiments in spraying apple trees with arsenicals.
- CHARLES V. RILEY and L. O. HOWARD (editors). (Obituary notice.)
Insect Life, 1, May, 1889, p. 357.
Notice of the death of Count Eugene Keyserling; value and extent of his work on Arachnida and spiders.
- CHARLES V. RILEY and L. O. HOWARD (editors). (Special Notes.)
Insect Life, 1, June, 1889, pp. 359, 360.
Australian Entomology: Articles on, in "Garden and Field" (Adelaide). The proposed Entomologists' Union. The Cave Fauna of North America, memoir on, by Dr. Packard. Beetles (*Tenebrioides mauritanica*) which lived in an insecticide. Bulletin on Root Disease in Florida. Chinch Bug kept in check by rains.
- CHARLES V. RILEY and L. O. HOWARD (editors). (Extracts from Correspondence.)
Insect Life, 1, June, 1889, pp. 375-380.
First injurious appearance of the Army Worm in Florida. The Camellia Scale. The Italian Lady-bird. *Valgus canaliculatus* a Quince enemy. *Lasioderma serricornis* injurious to nettles. *Dryocampa imperialis* on Elm and Linden. Larvæ of *Tenebrio molitor* in a worm's stomach. Another note on the retarded development of *Caloptenus spretus* eggs and pupæ in the hattan, Kansas.
- CHARLES V. RILEY and L. O. HOWARD (editors). Linen injured by *Agrotis* L.
Insect Life, 1, June, 1889, pp. 380, 381.
Nature of the injury caused by the larvæ of *Agrotis exclamatoris* to linen in the north; preventives.

- CHARLES V. RILEY** and **L. O. HOWARD** (editors). Impression of an Insect on Paper.
Insect Life, 1, June, 1889, p. 381.
 Impression of a *Lithobius* on rice-paper of Indian manufacture.
- CHARLES V. RILEY** and **L. O. HOWARD** (editors). The destructive Leaf-hopper injuring Timothy.
Insect Life, 1, June, 1889, p. 381.
 Reference to Mr. J. G. Barlow's letters relating to the work of *Cicadula exilis* in Timothy meadows; previous writings on this insect; Timothy a new food-plant.
- CHARLES V. RILEY** and **L. O. HOWARD** (editors). *Pieris rapæ* and *protodice* in Colorado.
Insect Life, 1, June, 1889, p. 382.
 Remarkable omission of *P. rapæ* from list of Cabbage Butterflies in Colorado in report of Professor Cassidy; previous records of it in Colorado.
- CHARLES V. RILEY** and **L. O. HOWARD** (editors). *Phylloxera* at the Cape of Good Hope.
Insect Life, 1, June, 1889, p. 383.
 Localities where found; bisulphide of carbon used.
- CHARLES V. RILEY** and **L. O. HOWARD** (editors). A new Butterfly publication.
Insect Life, 1, June, 1889, p. 383.
 Brief notice of Mr. A. Sidney Olliff's "Australian Butterflies."
- CHARLES V. RILEY** and **L. O. HOWARD** (editors). The Bot-fly of the Ox.
Insect Life, 1, June, 1889, pp. 383, 384.
 Notice of the investigation undertaken by the Farmers' Review, of Chicago, of the Bot-fly of the Ox, or Ox Warble-fly.
- CHARLES V. RILEY** and **L. O. HOWARD** (editors). The *Phylloxera* in Colorado.
Insect Life, 1, June, 1889, p. 385.
 Danger of its introduction; prompt action against by a Colorado vine grower.
- CHARLES V. RILEY** and **L. O. HOWARD** (editors). The *Rhizococcus* on grass.
Insect Life, 1, June, 1889, p. 385.
 Egg sacs of a *Rhizococcus* on grass from Nova Scotia, received from Mr. Fletcher; previously found on grass in Dakota; a dipterous parasite.
- CHARLES V. RILEY** and **L. O. HOWARD** (editors). A new Grape Pest in the South-west.
Insect Life, 1, June, 1889, pp. 385, 386.
 A Flea-beetle (*Gastroidea formosa*) reported by W. J. Howerton, of Florence, Arizona, as feeding on grape leaves; Canagre, food-plant of larva; measures against.
- CHARLES V. RILEY** and **L. O. HOWARD** (editors). An *Aleurodes* on Tobacco.
Insect Life, 1, June, 1889, p. 386.
 Reported by Prof. P. Gennadius, of Athens, Greece, to feed on tobacco; habits of; nature and extent of damage.
- CHARLES V. RILEY** and **L. O. HOWARD** (editors). A Corn-root Worm in South Carolina.
Insect Life, 1, June, 1889, p. 386.
Diabrotica 12-punctata reported by Dr. J. W. Thomas to seriously injure corn in South Carolina; nature of the attack; means against.
- CHARLES V. RILEY** and **L. O. HOWARD** (editors). A Deer Bot-fly.
Insect Life, 1, June, 1889, pp. 386, 387.
 Larva of a Deer Bot-fly (*Cephenomyia*?) received from Mrs. A. E. Bush, of San José, California; manner of attack.
- CHARLES V. RILEY** and **L. O. HOWARD** (editors). The shield method for Leaf-hoppers.
Insect Life, 1, June, 1889, p. 387.
 Description of Mr. Eugene Weston's method of destroying the Grapevine Leaf-hopper.
- WIRT ROBINSON**. Notes on some Albino Birds presented to the U. S. National Museum, with some remarks on Albinism.
Proc. U. S. Nat. Mus., xi, 1888, pp. 413-416.
- OSBERT SALVIN** and **F. DU CANE GODMAN**. *Biologia Centrali (Americana Zoologia)*, Aves, vol. II (part 1, December, 1888; 2, February, 1889; and 3, March, 1889), pp. 1-104; pls. 36-40.
 Includes the families *Oxyrhamphidae* and *Tyrannidae*, part of this great work.

PHILIP LUTLEY SCLATER. Catalogue of the Passeriformes, or Perching Birds in the Collection of the British Museum. — Oligomydæ, or the Families Tyrannidæ, Pipridæ, Cotingidæ, Phytotomidæ, Philepittidæ, Pittidæ, Xenicidæ, and Eurylæmidæ. By Philip Lutley Sclater. London: Printed by order of the Trustees. 1888.

8vo., pp. xx, 494; list of plates, and 26 colored plates.

The number of species treated in this work is 665, as follows: *Tyrannidæ*, 412 species, 78 genera; *Ozyporphidæ*, 3 species, 1 genus; *Pipridæ*, 70 species, 19 genera; *Cotingidæ*, 113 species, 29 genera; *Phytotomidæ*, 4 species, 1 genus; *Philepittidæ*, 2 species, 1 genus; *Pittidæ*, 4 species, 4 genera; *Xenicidæ*, 3 species, 2 genera; *Eurylæmidæ*, 11 species, 8 genera; 668 species, 133 genera.

The following are described as new: *Ochthornis* (new genus, type *Elainæ littoralis* p. 31; *Cenotricicus* (new genus, type *Muscicapa rusticeps* Lafr.), p. 86; *Empidochaneas* p. 218 (Venezuela and British Guiana).

PHILIP LUTLEY SCLATER and W. H. HUDSON. Argentine Ornithology. A Descriptive Catalogue of the Birds of the Argentine Republic. By P. L. Sclater, M. A., Ph. D., F. R. S., etc., with notes on their habits, by W. H. Hudson, M. Z. S., late of Buenos Ayres. Wood-cut of Burmeister's *Cariama*. — Volume II. — London: R. H. Porter, 18 Princess street, Cavendish Square. 1889.

8vo., pp. xxiv, 251, 10 hand-colored lithographic plates, representing the following species: Plate xi, *Chaetocercus burmeisteri*; plate xiii, *Coccyzus cinerus*; plate xiv, *Conurina*; plate xv, *Bolborhynchus aymara*; plate xvi, *Buteo urainsoni*; plate xvii, *Ammodramus involucris*; plate xviii, *Cygnus nigricollis*; plate xix, *Rallus maculatus*; plate xx, *Myadestes darwini*.

This second and last volume includes the orders *Macrochires*, *Pici*, *Coccyges*, *Pittaci*, *Scolopacidae*, *Accipitres*, *Steganopodes*, *Herodiones*, *Anseræ*, *Columbæ*, *Gallinæ*, *Geranomorphæ*, *Limicolinæ*, *Gaviæ*, *Pygopodes*, *Impennes*, *Orypturi*, and *Struthiones*. The introduction (pp. xvii-xx) gives a general review of the subject of geographical distribution of birds within the tropical region, defines the several subregions (six in number), and goes somewhat in detail in discussing the relationship of the Argentine bird-fauna, which, it is stated, "comes within the limits of the Patagonian subregion." The appendices are: "I. List of the Principal Authorities upon the Ornithology of the Argentine Republic referred to in the present work" (page 221), and "II. List of some of the principal localities where collections have been made, mentioned in this work" (p. 231).

GEORGE B. SENNETT. A New form of Clapper Rail.

The Auk, v, July, 1888, pp. 305, 306.

Rallus longirostris scottii, Scott's Rail, p. 305; habitat, west coast of Florida.

GEORGE B. SENNETT. An addition to the List of North American Birds.

The Auk, v, July, 1888, p. 319.

Rallus longirostris caribæus Ridgw.; Galveston and Corpus Christi, Texas.

GEORGE B. SENNETT. The Clapper Rails of the United States and West Indies compared with *Rallus longirostris* of South America.

The Auk, vi, April, 1889, pp. 161-166.

Revises the group, and recognizes the following species and subspecies: (1) *Rallus crepitans* Gmel., Atlantic and Gulf coasts of United States; (2) *Rallus longirostris caribæus* Ridgw., West Indies and coast of Texas; (3) *Rallus crepitans saturatus* Hensh., Rio Grande near Lake Pontchartrain, Louisiana; (4) *Rallus obsoletus* Ridgw., Pacific coast of United States; (5) *Rallus scottii*, Sennett, west coast of Florida, and (6) *Rallus coryi* Mayn., Bahama Islands.

R. W. SHUFELDT. The Osteology of *Habia melanocephala*, with Comparative Notes upon the Skeletons of certain other Conirostral Birds and of Tangers.

The Auk, v, No. 4, October, 1888, pp. 438-444, 2 text figures.

R. W. SHUFELDT. On the Mesozoic Mammalia.

The West American Scientist, v, No. 3, November, 1888, pp. 20-22.

Review of Professor Osborn's Monograph published by the Academy of Natural Sciences, Philadelphia (vol. ix, No. 2, July, 1888).

R. W. SHUFELDT. Notes on Brewster's and the Blue-footed Gannet.

The Auk, vi, January, 1889, p. 67.

R. W. SHUFELDT. The Navajo Tanner.

Proc. U. S. Nat. Mus., xi, 1888, pp. 59-66; plates xxiii-xxviii.

R. W. SHUFELDT. Observations upon the Osteology of the North American Aurochs (*Bos primigenius*). *Proc. U. S. Nat. Mus.*, xi, 1889, pp. 215-251; 30 figures.

- R. W. SHUFELDT.** Observations upon the Osteology of the Order *Tubinares* and *Steganopodes*.
Proc. U. S. Nat. Mus., xi, 1888, pp. 283-315; 43 figures.
- R. W. SHUFELDT.** On the Position of *Chamaea* in the System. | By | R. W. Shufeldt. | Reprinted from the Journal of Morphology, vol. III, No. 3. | ——— | Boston: Ginn and Company. | 1889.
 8vo, pp. 475-502, 8 text figures.
 A comparative study of the structure of *Chamaea*.
- CHARLES TORREY SIMPSON.** Contributions to the Mollusca of Florida.
Proc. Davenport Acad. of Sci., v, February-March, 1889, pp. 45-72, 63*-72*, 8vo.
 This is a list of shells collected in Florida by the author, many of which were identified at the National Museum for him, and of which a large number of the species were donated to the collection. It contains descriptions of *Pleurotoma simpsoni* (p. 54), *Tralia minuscula* (p. 69), and *Pandora (Kennerlia) bushiana* (p. 71), by W. H. Dall, and *Natica (Lunatic) semiculcata* (p. 72*), by Mr. Simpson.
- JOHN B. SMITH.** New Species of *Oncocnemis*.
Insect Life, i, July, 1888, pp. 18-20.
 Describes as new *O. fasciatus*, California; *O. tenuifascia*, Colorado; *O. tricolor*, Colorado; *O. terminalis*, Colorado; *O. simplex*, Utah.
- JOHN B. SMITH.** List of the *Sphingidae* of Temperate North America.
Entomologica Americana, iv, August, 1888, pp. 89-94.
 A preliminary revised list of species based upon a monographic study of the family.
- JOHN B. SMITH.** Annual address of the President of the Entomological Club of the A. A. A. S.
Entomologica Americana, iv, September and October, 1888, pp. 101-112, 125-134.
 Gives a review of the principal collections of the United States, and of the methods of preserving and arrangements adopted in the various public museums, giving a more detailed review of the collections in the U. S. National Museum.
- JOHN B. SMITH.** *Cerathosia tricolor* Smith.
Entomologica Americana, iv, September, 1888, pp. 122, 123.
 An enumeration of the characters of the genus and a discussion of its relationships.
- JOHN B. SMITH.** Monograph of the *Sphingidae* of America north of Mexico.
Trans. Am. Ent. Soc., xv, October, 1888, pp. 49-242; plates iv-xiii.
 Review of the literature of the family and a careful description of all the genera and species.
- JOHN B. SMITH.** Notes on *Lachnosterna fusca* Auct.
Insect Life, i, December, 1888, pp. 180-185.
 Separates the species known as *fusca* into *Lowe*, describing as new *L. arcuata*, *L. dubia*, and *L. grandis*. Figures of the genitalia of both sexes of each species are given.
- JOHN B. SMITH.** *Arctiidae* vs. *Noctuidae*.
Canadian Entomologist, xx, December, 1888, pp. 236-238.
 Discusses the relationship of *Cerathosia tricolor*, and sets out the characters separating the *Arctiidae* and *Noctuidae*.
- JOHN B. SMITH.** Note on the position of the *Cerathosia*.
Entomologica Americana, v, January, 1889, p. 8.
 Quotes two letters from Mr. H. B. Moeschler, confirming the author's view of the family reference of this genus.
- JOHN B. SMITH.** An Introduction to Entomology (Review).
Entomologica Americana, iv, January, 1889, pp. 19, 20.
 A review of J. H. Comstock's book on Entomology.
- JOHN B. SMITH.** Notes on *Cydosia* and *Cerathosia*.
Proc. U. S. Nat. Mus., xi, 1888, pp. 185-190, 2 figs.
- ROBERT E. C. STEARNS.** On certain Parasites, Commensals, and Domiciliars in the pearl oysters, *Meleagrinae*.
Report of Smithsonian Institution, 1886 (1889), part I, June, 1889, pp. 339-344; plates i-iii.
 Describes and figures certain fish and other parasites of the pearl oysters.
- LEONHARD STEJNEGER.** Palmén's contributions to the knowledge of the Bird Fauna of the Siberian Coasts of the Arctic Sea.
The Auk, v, July, 1888, pp. 306-311.
 A review of Palmén's "Bidrag till Kännedomen om Sibiriska Ishafskustens Fogelfauna."
- LEONHARD STEJNEGER.** Review of Japanese Birds. VII. The Creepers.
Proc. U. S. Nat. Mus., x, September 19, 1888, pp. 606-611.

- LEONHARD STEJNEGER. Henry James Stovin Pryer (Obituary Notice.)
The Auk, v, October, 1888, pp. 332, 333.
 Reprinted on a single sheet.
- LEONHARD STEJNEGER. (Obituary Notice of Prof. Modest Bogdanow.)
The Auk, v, October, 1888, pp. 333, 334.
 Reprinted on a single sheet.
- LEONHARD STEJNEGER. Notes on European Marsb-Tits with Description of a New
 Subspecies from Norway.
Proc. U. S. Nat. Mus., xi, November, 1888, pp. 71-76.
Parus colletti, sp. nov., p. 74.
- LEONHARD STEJNEGER. Further Contributions to the Hawaiian Avifauna.
Proc. U. S. Nat. Mus., xi, November 8, 1888, pp. 93-103.
 Species treated are *Puffinus knudseni*, sp. nov., p. 93; *Anous melanogenys* Gray, p. 94; *Fulica alai* Peale, p. 95; *Arenaria interpres* (Linn.), p. 96; *Himantopus knudseni* Stejn., p. 96; *Meniscus femoralis* Peale, p. 97; *Dasyla acuta* (Linn.), p. 97; *Spatula clypeata* (Linn.), p. 98; *Anas wyvilliana* Sol., p. 98; *Nycticorax naevius* (Bodd.), p. 102; *Fregata aquila* (Linn.), p. 102.
- LEONHARD STEJNEGER. Notes on the European Crested Titmice.
Proc. U. S. Nat. Mus., xi, November 8, 1888, pp. 113, 114.
 Two forms recognized: *Parus cristatus* Linn. and *Parus cristatus mitratus* Brehm.
- LEONHARD STEJNEGER. *Cucullaris propatagialis* in Oscinine Birds.
Science, xiii, 1889, p. 16.
- LEONHARD STEJNEGER. The proper name for the genus *Melanipitta* (*sic*) of Schlegel.
The Auk, vi, January, 1889, p. 79.
 Showing that the name *Melospitta* had been proposed by himself in "Standard Natural History of Birds," 1885, p. 466, thus antedating Dr. P. L. Sclater's substitute *Coracopitta* (Cat. Brit. Mus. xiv, p. 499).
- LEONHARD STEJNEGER. (Obituary Notice of Nicholas Michailovitch Prjevalsky.)
The Auk, vi, January, 1889, pp. 80, 81.
- LEONHARD STEJNEGER. Diagnosis of the Kamschatkan Three-toed Woodpecker (*Picoides albidior*).
Proc. U. S. Nat. Mus., xi, January 5, 1889, p. 168.
- LEONHARD STEJNEGER. (Letter to the editor of *The Ibis* in regard to Mr. W. Ogilvie-Grant's paper on the species of the genus *Platalea* in *The Ibis* for January, 1889, pp. 32-58.)
The Ibis, sixth ser., i, No. 2, April, 1889, pp. 258, 259.
- LEONHARD STEJNEGER. Review of Japanese Birds. VIII. The Nutcracker (*Nyctycaetes macrorhynchus*).
Proc. U. S. Nat. Mus., xi, 1889, pp. 425-432.
- ALEXANDER M. STEPHEN. The Navajo Shoemaker.
Proc. U. S. Nat. Mus., xi, 1888, pp. 131-136; 7 figures.
- V. STERKI. A Study of the American Species of Vertigo contained in the U. S. National Museum, with the description of a new subgenus of *Pupidea*.
Proc. U. S. Nat. Mus., xi, 1888, pp. 369-380; 1 plate, 6 figures.
- FREDERICK W. TRUE. Description of *Geomys personatus* and *Dipodomys compactus*, two new species of Rodents from Padre Island, Texas.
Proc. U. S. Nat. Mus., xi, 1888, pp. 159, 160.
- FREDERICK W. TRUE. Guide to a Collection illustrating the Families of Mammals exhibited in the Ohio Valley Centennial Exposition in 1888, by the U. S. National Museum.
Proc. U. S. Nat. Mus., xi, Appendix No. 48, 1888, pp. 1-26.
- FREDERICK W. TRUE. Description of a new species of Deer (*Cariacus claratus*), from Central America.
Proc. U. S. Nat. Mus., xi, 1888, pp. 417-424.
- GEORGE VASEY. List of Plants from Lower California sent to the Smithsonian Institution by Lieut. Charles F. Pond, U. S. Navy.
Proc. U. S. Nat. Mus., xi, 1888, p. 368.

- GEORGE VASEY.** The Genus *Panicum* in the United States.
Bull. No. 8, Botanical Div. Dept. of Agriculture, 1889, pp. 20-30.
 This is a synopsis of the genus, consisting of a division into sections, and descriptions of our 64 species (excluding those included in *Optismenus*). Ten of the species described have not been published before.
- GEORGE VASEY.** Notes on some rare Grasses.
Bull. Torrey Botanical Club, November, 1883.
- GEORGE VASEY.** On two species of Gramineæ.
Bull. Torrey Botanical Club, November, 1883.
- GEORGE VASEY and B. T. GALLOWAY.** U. S. Department of Agriculture. | Botanical Division. | Bulletin No. 8. | — | A Record | of | Some of the Work of the Division, | including | Extracts from Correspondence | and | other Communications. | Prepared by | Dr. Geo. Vasey | and | B. T. Galloway, | under the direction of the Commissioner of Agriculture. | — | Washington: | Government Printing Office. | 1889.
 8vo. pp. 1-67.
- CHARLES D. WALCOTT.** Cambrian Fossils from Mount Stephens, Northwest Territory of Canada.
Am. Jour. Sci., 3d ser., xxxvi, September, 1888, pp. 161-166.
 Also published in pamphlet form.
- CHARLES D. WALCOTT.** The Stratigraphical succession of the Cambrian Faunas in North America.
Nature, xxxviii, No. 988, October 4, 1888, p. 561.
- CHARLES D. WALCOTT.** Stratigraphic position of the Olenellus Fauna in North America and Europe.
Am. Jour. Sci., 3d ser., xxxvii and xxxviii, pp. 374-392; 29-42.
- CHARLES D. WALCOTT.** Description of New Genera and species from the Middle Cambrian.
Proc. U. S. Nat. Mus., xi, 1888, pp. 441-446, 1 text figure.
- LESTER F. WARD.** What shall the Public Schools teach?
The Forum, New York, v, July, 1888, pp. 574-583.
 A defense of industrial education from the standpoint that it stimulates the constructive faculty and leads to the subjection of nature by man through invention, which is the process through which alone civilization takes place.
- LESTER F. WARD.** True and False Civil-Service Reform.
The Historical American, i, Cleveland, Ohio, July, 1888, pp. 25-30; Belford's Magazine, Chicago, Illinois, iii, July, 1889, pp. 202-210.
 Opposes the prevailing practice of attacking the personal character of office-holders as calculated to lower the moral tone of the service by deterring good men from accepting office; defends this class against such attacks and the service against indiscriminate charges of corruption; argues for a system that shall remove all inducements to office-seeking and secure the special training of those who are to transact the business of the state in the methods of government operations and the business of a nation.
- LESTER F. WARD.** Dabney's Sensualistic Philosophy.
The Historical American, i, Cleveland, Ohio, July, 1888, p. 78.
 A rather severe adverse criticism of the matter, the manner, and spirit of the work reviewed, namely, "The Sensualistic Philosophy of the Nineteenth Century, considered by Robert L. Dabney, D. D., LL. D., etc. New and enlarged edition. New York: Anson D. F. Randolph & Co."
- LESTER F. WARD.** Evidence of the Fossil Plants as to the Age of the Potomac Formation.
American Journal of Science, third series, xxxvi, August, 1888, pp. 119-131.
 This paper was read by invitation before the National Academy of Sciences, at the U. S. National Museum, April 20, 1888. It deals chiefly with the results of Prof. William M. Fontaine's researches in this field, summarizing the data contained in his unpublished Monograph of the Flora of the Potomac Formation, and specially emphasizing the fact that the flora contains a large proportion of Jurassic types, and that its dicotyledonous forms are very archaic in character, constituting, in all probability, their earliest recorded appearance. It is maintained that, owing to this peculiar character, they do not necessarily prove that the Potomac Formation is Cretaceous.

LESTER F. WARD. Asa Gray and Darwinism.

The Historical American, 1, Cleveland, Ohio, August, 1888, pp. 85-92, with portrait as front piece to magazine.

This paper was read at the Gray memorial meeting of the botanical section of the Biological Society of Washington, April 5, 1888. It gives an historical account of Dr. Gray's early and sustained relations with Charles Darwin, his instrumentality in furthering the spread of his views, the nature of his acceptance of those views, and the manner in which, as a botanist, Dr. Gray has been able to utilize Darwinian principles as a working basis in his department of science.

LESTER F. WARD. Our Better Halves.

The Forum, New York, VI, November, 1888, pp. 266-275.

It is maintained in this article that the female sex is primary and the male secondary in organic economy; that woman represents the principle of heredity, and that acquired qualities in woman are more regularly transmitted than in men. The alleged superiority of the males of animals is shown to be apparent only, and confined to some higher types, acquired chiefly through the operation of sexual selection. The conclusion is drawn that "the elevation of woman is the only sure road to the evolution of man."

LESTER F. WARD. Nya Anmärkningar om Williamsonia af A. G. Nathorst. (Notiz.)

Am. Journ. Sci., third series, XXXVI, November, 1888, p. 301.

Brief notice of a paper with the above title in the *Öfversigt af Kongl. Vetenskaps Akademiens Förhandlingar* for Juni, 1888, No. 6, announcing the discovery of *Williamsonia angustifolia* Nath., attached to *Anomozamites minor* (Brongn.) Nath.

LESTER F. WARD. The Paleontologic History of the genus *Platanus*.

Proc. U. S. Nat. Mus., XI, Washington, 1888, pp. 39-42, plates xvii-xxi.

An attempt to trace the history of the genus back through the several formations in the United States to the Dakota group, and to show that many of the forms that have been referred to *Sassafras*, *Aralia*, *Liquidambar*, and *Aspidiophyllum*, are probably ancient types leading up to it.

LESTER F. WARD. American Weather. (Review.)

The Epoch, IV, January 25, 1889, p. 463.

Notice of General A. W. Greely's book, so entitled.

LESTER F. WARD. The "King Devil."

Botanical Gazette, XIV, January, 1889, pp. 10-17.

An account of the discovery of a hawk weed (*Hieracium præaltum*) in 1879 near Carthage, Evans Mills, Jefferson County, New York, then a recent immigrant from Europe, and an investigation and of its subsequent spread, and injurious effects; made in 1888 in the same locality. The plant had then become a scourge to the farmers and had acquired the name of King Devil.

LESTER F. WARD. Remarks on an undescribed vegetable organism from the Union group of Montana.

Proc. Am. Assoc. Adv. Sci., Cleveland meeting, 1888, XXXVII, Salem, 1889, pp. 199-201.

Abstract of a paper read before the Geological Section of the American Association describing a very singular organism collected by the author on the Lower Yellowstone River at Glendive, Montana, believed by him to be a comprehensive type of vascular cryptogam related to *Ophioglossum*, *Isocetes*, and *Selaginella*. Illustrated by lantern views.

LESTER F. WARD. The Paleontologic History of the genus *Platanus*.

Proc. Am. Assoc. Adv. Sci., Cleveland meeting, 1888, XXXVII, Salem, 1889, pp. 201, 202.

Abstract of a paper of same title read before the Geological Section of the American Association, illustrated by lantern views and published in full with 5 plates in *Proc. U. S. Nat. Mus.*, XI, 1888, p. 39 (*q. v. supra*).

LESTER F. WARD. Some Social and Economic Paradoxes.

The American Anthropologist, II, April, 1889, pp. 119-132.

The same paper revised and published in full which appeared in an abridged form in *Scientific Monthly*, vol. XI, April 13, 1888, pp. 172, 174-176. See brief abstract of contents under entry of same date.

LESTER F. WARD. (Administrative Report to the Director of the U. S. Geological Survey for the year ending June 30, 1886.)

Seventh Annual Report of the U. S. Geological Survey, 1885-'86, June, 1889, pp. 123-126.

LESTER F. WARD. (Carboniferous Glaciation.)

Public Opinion, vii, June 15, 1889, p. 221.

A notice of an article by Mr. C. D. White entitled: Carboniferous Glaciation in the Southern and Eastern Hemispheres, with some notes on the *Glossopteris* flora.

Attention is specially called to the importance of the view expressed in Mr. White's article that the *Glossopteris* flora, though Mesozoic in aspect, is probably Permian in age and is the true ancestor of the widespread Rhaetic and Jurassic floras of the northern hemisphere, and was developed in response to the gradual lowering of the temperature at the period, replacing the true Carboniferous types which could not survive the change, and subsequently migrating northward on the return of the tropical climate to reappear at many points as a distinctive Mesozoic flora.

B. H. WARREN. Report | on the | Birds of Pennsylvania. | With Special Reference to the Food-habits, based | on over Three Thousand Stomach | Examinations. | By B. H. Warren, M. D., | Ornithologist of the State Board of Agriculture; Associate Member of the American | Ornithologists' Union; Secretary of the Chester County (Pa) | Academy of Arts and Sciences, etc. | Illustrated with fifty plates. | — | Harrisburg : | Edwin K. Meyers, State Printer. | 1888.

8vo, pp. xii, 260.

The purpose of this book appears to be to enlighten the public, especially the farming communities in Pennsylvania, in regard to the birds that are to be found in the State, to awaken a desire for their protection upon economic grounds, and to stir up an interest in natural history among the people.

"The Report was printed by direction of the legislature of Pennsylvania for gratuitous distribution in the State, and the demand so far exceeded the supply that the edition of 6,000 copies was quickly exhausted, and, we are very glad to learn, the publication of a second edition of 10,000 copies, revised and enlarged, has been ordered. When this book has found its way into schools and farmhouses throughout Pennsylvania the profit to the birds, to the farmers, and to Ornithology that ought to result is incalculable. If other States would follow such a good example, it would be an important step toward lifting the cloud of ignorance that hangs over the rural mind upon matters of natural history."

(J. A. Allen in *The Auk*, vi, 1889, pp. 170, 171.)

J. ELFRETH WATKINS. The Evolution of the Railway Passenger Car.

Supplement to Harper's Weekly, August 25, 1888.

Describing the construction of various types of passenger railway cars, with 26 illustrations, showing the successive steps that have led up to the most improved modern parlor and sleeping cars.

J. ELFRETH WATKINS. Origin of the English and American Railway Systems. Causes of their Differences.

Read before the Philosophical Society of Washington, February, 1889. Describing the conditions of trade, manufacture, and commerce, which led to the invention of the stationary engine, the railway, and finally to the steam locomotive.

J. ELFRETH WATKINS. Development of the American Rail and Track.

Read before the Annual Convention of the American Society of Civil Engineers, at Seabright, New Jersey, June 21, 1889. Describing the various types of wooden, cast-iron, and rolled iron rails, together with a brief review of the history of the manufacture of iron and steel, and the beginning and development of the American rail. Extended and reprinted in this volume.*

CHARLES A. WHITE. On the Puget Group of Washington Territory.

Am. Jour. Sci., xxxvi, 3d ser., pp. 143-180.

Applies the name Puget Group to a formation occupying a large part of Puget Sound basin and the adjacent slope of the Cascade Mountains, which was probably deposited about the close of the Cretaceous period, and which, although an estuary deposit, is apparently synchronous, at least in part, with the Laramie and Chico Groups. Mentions the occurrence of the genus *Batissa*. The first recognition of this genus, either fossil or living, in North America.

CHARLES A. WHITE. Remarks on the genus *Aucella*, with especial reference to its occurrence in California.

Monographs of the U. S. Geological Survey, vol. 13. Geology of the quicksilver deposits of the Pacific slope, pp. 226-232; plates iii and iv.

Gives 2 plates and 21 figures of recognized species of the genus *Aucella*. Discusses stratigraphical relations and specific identity of different forms. Refers strata in which the genus occurs in North America to the opening epoch of the Cretaceous.

* See section III.

CHARLES A. WHITE. On *Hindeastræa*, a new generic form of Cretaceous *Astræida*. *Geol. Mag.*, London, December, III, v, No. 8, pp. 362, 363; five text figures. Describes and figures a little Coral from Kaufman County, Texas, found in strata of the Ripley Group, under the new generic and specific name of *Hindeastræa discoidea*.

CHARLES A. WHITE. On the Permian Formation of Texas. *Am. Naturalist*, xxiii, pp. 109-128; 1 plate.

Discusses the interdelimitation of the Paleozoic and Mesozoic, also the commingling of Paleozoic and Mesozoic types. Gives descriptive section of the Permian of Texas and lists invertebrate fossils found in those strata. Describes and figures three new species: *Platystrophia cumminsi*, *Medlicottia copei*, *Popanoceras walcottii*.

CHARLES A. WHITE. On Invertebrate Fossils from the Pacific Coast.

Bull. U. S. Geol. Survey, No. 51, parts 1-5, pp. 1-102; plates 1-14.

Part 1. New Fossil Mollusca from the Chico-Tejon series of California, pp. 11-27. Describes new genus *Vasculum* and describes and figures the following new species: *Ostrea (Atrypa) dilleri*, *Zirphæa plana*, *Actæon inornatus*, *Vasculum obliquum*, *Lysis oppanensis*, *Trochus (Anadema) gemiferus*, *Stomatia obstricta*, *Gyrodes dowelli*, *Rimella macilenta*, *Machilis obruta*, *Faunus maroidulus*, *Ceratia neritina*, *Trophon condoni*, *Cominella lecontei*, *Fulgur hilgardi*, *Fulguraria gabbi*, *Cancellaria dilleri*, *Ammonites turneri*.

Part 2. The occurrence of equivalents of the Chico-Tejon series in Oregon and Washington Territory, pp. 28-32. Gives numerous localities. Attention is called to similarities and differences existing in Gabbs and Conrads' descriptions of species.

Part 3. Cretaceous Fossils from Vancouver Island region, pp. 33-48. The fossils described are from three small islands at the southern end of the Gulf of Georgia, adjacent to Vancouver Island. They are known as Sucia, Waldron, and Sheep Jack. The following new species are described: *Perna excavata*, *Vanikoropsis suciaensis*, *Ammonites naclurei*.

Part 4. The Molluscan Fauna of Puget Group, pp. 49-63. The unique character of this brackish water fauna, together with other facts, shows that the body of water in which this deposit was formed was an estuary. It is a rich coal-bearing formation, but in its origin it was separated from any other coal-bearing strata of the Pacific Coast region. The following new species are described and figured: *Cardium (Adacna) ?* —?, *Cyrena brevidens*, *Corbicula willisi*, *C. pugetensis*, *Batissa newberryi*, *B. dubia*, *Psammobia obscura*, *Sanguinolaria caudata*, *Teredo pugetensis*, *Neritina* —? *Cerithium* —?

Part 5. Mesozoic Mollusca from the southern coast of the Alaskan Peninsula, pp. 65-70. The fossils described in this article are from the shores of Kialagvic, or Wrangell Bay, on the southern side of the Alaskan Peninsula. They are certainly Mesozoic and seem to indicate that they come from a formation somewhat earlier than the Cretaceous. The following new species are described and figured: *Oculleza increbescens*, *Glycimeris? dalli*, *Belemnites* —? *Belemnites* —? *Ammonites (Lillia) howelli*, *A. (Lillia) kialagvikensis*, *A. (Amaltheus) whiteavesti*.

J. E. WHITEFIELD.

(See under **GEORGE P. MERRILL**.)

THOMAS WILSON. Display of Prehistoric Anthropology by the Smithsonian Institution.

The Commercial Gazette, Cincinnati, August 19, 1888.

Relates to exhibit of prehistoric objects at Cincinnati Exposition.

SECTION V.

**LIST-OF ACCESSIONS TO THE U. S. NATIONAL MUSEUM DURING THE
YEAR ENDING JUNE 30, 1889.**



LIST OF ACCESSIONS.

- ABBOTT, CHARLES C.** (Trenton, New Jersey). Alcoholic specimens of *Tylosurus marinus* (?). 20991.
- ABBOTT, W. H.** (Washington, District of Columbia). Campaign badges. 21621.
- ABERT, CHARLES** (Homewood, Norbeck, Maryland). King Snake (*Ophibolus getulus*) from Maryland. 21962.
- ACADEMY OF NATURAL SCIENCES** (Philadelphia, Pennsylvania), (through H. A. Pilsbry). One specimen of *Helix granum* Strebhel, from Panama, and two specimens of *Helix cæca* Guppy, from Trinidad. 22155.
- ADAMS, C. F.** (Champaign, Illinois). Sixteen specimens of the land-shells of Borneo, collected by the donor (21509); a group of Rhinoceros Horn-bills from Borneo (purchased). (22098.)
- ADAMS, W. H.** (Elmore, Illinois). Specimens of fossil shells from Peoria County, Illinois. 21521.
- ADAMS, W. W.** (See under Bureau of Ethnology.)
- ADLER, DR. CYRUS** (Smithsonian Institution). A knife from Alaska. 22145.
- AGRICULTURE, DEPARTMENT OF:**
The Bureau of Animal Industry (through Dr. D. E. Salmon, chief of the bureau). A collection of parasites prepared by Dr. Cooper Curtice. 21071.
The Division of Ornithology and Mammalogy (through Dr. C. Hart Merriam, ornithologist). A collection of mammal skins and skulls from Titusville, Florida (22002); from Canaveral, Florida (22003); from Cloverdale, California (22004); from Ukiab, California (22055); a collection of mammals from near Lake Worth, Florida (22078).
The Division of Entomology (through Prof. C. V. Riley, entomologist). A collection of insects, principally Coleoptera, from Michigan. 21391.
(See under Barrows, Walter B., Bruner, T. K., and Fisher, Dr. A. K.)
- ALASKA COMMERCIAL COMPANY** (San Francisco, California). A bidarka. 21119.
- ALLEN, COL. J. I.** (Stillwater, Montana). Two photographs of Crow Indians (20979); two pairs of Indian moccasins (21455, 21549); an Indian dress, arrow, pipe, wallet, and broken sword from Custer's battlefield, 1876 (21588); various Indian relics (21748).
- ALLEN, IRA R.** (Fair Haven, Vermont). Minerals from Amelia Court House, Virginia. 21362.
- ALLEN, T. C.** (Los Angeles, California). A photograph of old San Diego Mission founded about 1746, and photograph of old mission bills. 21587.
- AMEND, B. G.** (New York City, New York), (through W. S. Yeates). Three specimens of rutile from Magnet Cove, Arkansas. 22033.
- AMERICAN MUSEUM OF NATURAL HISTORY** (New York City, New York). A flint implement (lent for comparison and study) (21293); three Chicken Turtles (*Chrysemys reticulata*) from Louisiana (21987).
- AMERICAN SOCIETY OF CIVIL ENGINEERS** (New York City, New York). A badge of this society. 21607.
- AMMEN, Admiral DANIEL** (Ammendale, Maryland). A two-horse carriage used by General U. S. Grant in Washington prior to his election to the Presidency of the United States, and by him presented to the donor in the summer of 1870. 22087.

- AMOROSA, ALPHONSE (Washington, District of Columbia). A Fish Hawk. 2110.
- ANCIENT AND HONORABLE ARTILLERY COMPANY (Boston, Massachusetts). A bronze medal of the two hundred and fiftieth anniversary of the Company. 21534.
- ANDERSON, ROBERT (Jeffersonville, Indiana). A portion of a human skull found at an Indian burial-place near Jeffersonville, Indiana. 22007.
- ANDREWS, E. H. (Treasury Department). Three vanilla beans from Costa Rica, Java, and West Indies. 21991.
- ANDRUS, Rev. A. N. (Painesville, Ohio). A Koordish costume, worn by the troops in Bohtan, a district of eastern Turkey; also gun-trappings used by the Koords. (Purchased.) 21666.
- ANGELL, G. W. (New York City, New York). Dry Coleoptera collected at Caracas, Venezuela. 21743.
- ANIMAL INDUSTRY, BUREAU OF (See under Agriculture, Department of.)
- ARMY MEDICAL MUSEUM (War Department). Pottery and stone implements and old graves in the mountains near Lima, Peru. 21995.
- ASHFORD, E. W. (U. S. National Museum). Four Chinese coins. 21740.
- ASKEW, H. G. (Tyler, Texas). A collection of Texas shells (22124); seven species of shells from Texas (21967).
- AUCKLAND MUSEUM (Auckland, New Zealand), (through Prof. T. F. Cheeseman). Four birds' skins, 15 birds' skeletons, 170 shells, and 140 specimens of New Zealand rocks, minerals, and ores. (Exchange.) 21169.
- AUSTRALIAN MUSEUM (Sydney, Australia), (through S. Sinclair, secretary). Collections of birds and mammals. 21651.
- AVERY, ARTHUR (Washington, District of Columbia). A living squirrel. 2110.
- AVERY, Dr. WILLIAM C. (Greensborough, Alabama). A nest and set of four eggs of Bachman's Sparrow (20851); two specimens of Bachman's Sparrow (*Peucaea aestivalis bachmani*) (21460); nest and six eggs of Loggerhead Shrike (*Lanius ludovicianus*) (21944); a Florida Grackle from Alabama (21985); nest and five eggs of Brownheaded Nut-hatch, and nest and four eggs of Grasshopper Sparrow (3 specimens) and skin of Florida Grackle (*Quiscalus quiscula aglaus*) (22033).
- AVERY, S. P. (New York City, New York). Dry points and soft-ground etchings: Miss Mary Cassatt (21009); lithograph landscape by Tudot (21265); a lithograph "Er, Sie, Es," by C. M. Seippel (21447); four sale and exhibition catalogues (21925).
- AYERS, BENJAMIN D., Jr. (Chester, Pennsylvania). A campaign badge. 21740.
- BAILEY, W. W. (Providence, Rhode Island). Specimens of dried plants. 21740.
- BAIRD, Miss LUCY (Washington, District of Columbia). Eighty gold, silver, and copper coins, tokens, and medals of North and South America, France, England, and Sweden. 20949.
- BAIRD, Mrs. S. F. (Washington, District of Columbia). A silver medal presented to Prof. S. F. Baird by the Acclimatization Society, New South Wales. 20948.
- BAKER, A. B. (Wa Keeney, Kansas). A Black-footed Ferret (*Putorius nigripes*) (21851).
- BAKER, COLGATE (Kobe, Japan). Twenty samples of Japanese tea. 21675.
- BAKER, DANIEL (Buckeystown, Maryland). Specimens of building-stones from Maryland. 21671.
- BAKER, JOHN (Gloucester, Massachusetts). A Snipe Eel caught on Grand Island, Massachusetts. 22079.
- BALDWIN, CORNELIUS (Nelson, Ohio). A stone implement. 21896.
- BALDWIN, GLEASON & Co. (New York City, New York). Twenty specimens of paper made from celluloid. 22064.
- BALDWIN LOCOMOTIVE WORKS (Philadelphia, Pennsylvania). Blue-print photographs of modern locomotives (21068); model of the locomotive "Old Side" (21597).
- BALLAUF, D. (Washington, District of Columbia). Model of locomotive for the Centennial Exposition at Cincinnati. (Purchased.) 21090.

- BANCROFT, HESTER (Washington, District of Columbia). A specimen of pink satin spar from Colorado. 21473.
- BANGS, C. (Wolverton, Minnesota). Copper implements found in Wilkin County, Minnesota. 21641.
- BANGS & Co. (See under National Museum, U. S.)
- BANNARD, WILLIAM N. (Camden, New Jersey). A railroad-pass issued in 1864. 21669.
- BARON, O. T. (Elk, California). Doubleday's Humming-bird (*Iache doubledayi*) from Guerrero, Mexico. 21397.
- BARROWS, WALTER B. (Department of Agriculture). Insects, reptiles, and land-shells from the Argentine Republic, South America. 21385.
- BARTLETT, WILLIAM (Caribou, Maine). A pair of Swedish shoes (wooden) from New Sweden, Maine. 21523.
- BASINSKI, JULIUS, AND BROTHERS (Miles City, Montana). A plant. 21123.
- BAUR, Dr. G. (New Haven, Connecticut). A living Snapping Turtle. 21032.
- BAXTER, R. F. (Glens Falls, New York). A large block of "Ophite" marble from Thurman, Warren County, New York. 20348.
- BAYARD, Hon. THOMAS F. (See under State Department.)
- BAYLEY, W. S. (Waterville, Maine). Rocks from Minnesota. 21848.
- BEACHLER, CHARLES (Crawfordshire, Indiana). Fossil mammal teeth from Indiana. 21130.
- BEAN, B. A. (U. S. National Museum). A Herring from Savannah, Georgia. 21560.
- BRAD, DAN (New York City, New York). Insects and nest agglomerations of *Odynerus birenimaculatus*. 21878.
- BEARDSLEE, L. A. (Little Falls, New York.) A picture of a crustacean caught at Sitka. 22393.
- BEAUMONT, J. J. (Worcester, Massachusetts). Souvenir badge of the Massachusetts delegates to the Twenty-second National Encampment, Grand Army of the Republic. (Deposited.) 21139.
- BECK, W. H., and LEMON, GEORGE E. (Washington, District of Columbia). Fourteen specimens of desclozite from the Mayflower mine, Montana. 21532.
- BECKER, GEORGE F. (U. S. Geological Survey). A collection of rocks from the Washoe District, Nevada. 21616. This collection, embracing over 2,000 specimens, was made by Mr. Becker for his own use and study, and upon it was based the article in Bulletin 17, U. S. Geological Survey, by Arnold Hague and Joseph P. Iddings, entitled, "The Development of Crystallization in the Igneous Rocks of Washoe, Nevada." (See under Interior Department, U. S. Geological Survey.)
- BECKWITH, PAUL (U. S. National Museum). Military decorations and coins (21083); an illustration of various military and naval uniforms (21111); a photograph of the cathedral of the City of Mexico, showing the calendar-stone (22120); two campaign badges (21127); badges and devices (21163); a copy of the "Tri-weekly Mercury," Charleston, South Carolina (21214); a military campaign medal of the Crimea (21259); a pocket candle-dish used in camping (21313); a badge of the Grand Army of the Republic (21321); three political badges (21322); bronze medal of Abraham Lincoln, in exchange (21413); two pieces of the provisional money of Peru (22173). Also a pack of playing cards and two badges of the Grand Army of the Republic (21245). Deposited.
- BEECHER, Prof. C. E. (New Haven, Connecticut), (through Mr. W. S. Yeates). A massive garnet from Minerva, New York. 22031.
- BELDING, L. (Stockton, California). Three birds' skins from California. 21436.
- BELL, CAREY (Utica, Ohio). A stone ax found in Washington township, Licking County, Ohio. 20914.
- BELL, JAMES (Gainesville, Florida). Living Snakes from Florida (21112, 21303, 21339, 21811).
- BELL, WILLIAM (Philadelphia, Pennsylvania). Two photographic cameras. 20919.

- BEMENT, C. S. (Philadelphia, Pennsylvania). A large specimen of azurite crystals from the Copper Queen mine, Bisbee, Arizona. (Purchased.) 21933.
- BENDIRE, Capt. C. E. (U. S. National Museum). An Indian bow from Fort Custer, Montana. 21682.
- BENTON, WILLIAM (Middleburgh, Virginia). A specimen of hematite. 21885.
- BERLIN, ROYAL MUSEUM OF. (See under Royal Museum of Berlin.)
- BERNADOU, Ensign J. B. (Navy Department). Three Corean books. 21599.
(See under Navy Department.)
- BETTY, Dr. E. G. (Cincinnati, Ohio). A fossil fish from Colorado (20931); three silver coins (20951).
- BIDWELL, Mrs. C. A. (Clip, Arizona). Specimens of dunortierite from near Clip Yuma County, Arizona. (Exchange.) (21453, 21625.)
- BIGGINS, T. J. (Washington, District of Columbia). A living Fish Hawk. 21126.
- BILLINGS, Dr. J. S. (U. S. Army Medical Museum). Three pieces of pottery from Ancon, Peru (21387); two pairs of gaffs for cock-fighting (21388).
- BIRT, Dr. LOUIS F. H. (Greytown, Nicaragua), (through J. F. Le Baron). Alcohol specimens of mammals, reptiles, fishes, birds, crayfish, crabs, etc., collected near Greytown, Nicaragua. 21483.
- BISHOP, LOUIS D. (New Haven, Connecticut). A Gray-cheeked Thrush (*Turdus aliciae*) from Magdalen Island, Gulf of St. Lawrence. 21431.
- BISSIG, FRANK (Payson, Arizona). A specimen of ore. 21089.
- BLACK, ALEXANDER W. (Philadelphia, Pennsylvania). A campaign badge. 21759.
- BLACK, Dr. E. C. (Wheatland, Indiana). Twenty small leaf-shaped implements from a deposit in Harrison Township, Knox County, Indiana. 21076.
- BLACKFORD, E. G. (New York City, New York). Fishes from Sterling Lake, New Jersey (21540); fishes from shores of Oyster Bay, New York (21611); specimens of the Ovate Pompano from the west coast of Florida (21721); and two Snappers (*Lutjanus*) (21784).
- BLAIR, A. A. (Philadelphia, Pennsylvania). Two specimens of crystallized hematite from the Isle of Elba (22117); a specimen of crystallized hematite from Virginia mine, Rio Albano, Isle of Elba. (Exchange.) (21624.)
- BOARDMAN, G. A. (Calais, Maine). A Tennessee Warbler, from Lake Charm, Florida. 21960.
- BOAS, Dr. FRANZ (New York City, New York). A pair of copper bracelets from grave at Salmon River, Vancouver Island, British Columbia. 21890.
- BOBAN, Dr. E. (Paris, France). Nine vases. (Purchased.) 21830.
(See under Bureau of Ethnology.)
- BOBBETT, WALTER (Brooklyn, New York). Twenty-three impressions showing the method of printing tints and colors from relief-blocks. 21548.
- BOEHMER, GEORGE H. (Smithsonian Institution). Arrow-heads and charred wood (20941); stone implements found in Delaware (20943); a bronze medal commemorative of the centenary celebration of the Royal Batavian Society, Academy of Sciences (21121); postage and revenue blanks, postal cards and stamp wrappers used in Austro-Hungary (21692); also views and plans of cathedrals at Milan, Italy (22128).
- BOGRA, F. F. (Washington, District of Columbia). The skeleton of a dog. 21605.
- BOLDEN, J. (Washington, District of Columbia). A living American Widgeon (*Mareca americana*). 21302.
- BOLLMAN, C. H. (Bloomington, Indiana). A collection of Myriapods. 21787.
- BONFELS AND COMPANY (Beirut, Syria). Twenty-four photographs of Egyptian temples. (Purchased.) 21382.
- BONNETT, PETER (chief of revenue and marine division, Treasury Department). Photographs of the natives and scenery of Northern Alaska. 20992.
- BORNEMAN, J. G. (Eidenach, Germany). Lower Cambrian fossils. (Exchange.) 21869.

- BOSS, E. S.** (Petoskey, Michigan). A fossil coral paper-weight. 21717.
- BOSTON BRIDGE WORKS** (Boston, Massachusetts). Photographs of four railroad bridges. 21279.
- BOSTON PHOTOGRAVURE COMPANY** (Boston, Massachusetts). Eighteen photographs made by the donors. 20883.
- BOSTON SOCIETY OF NATURAL HISTORY** (Boston, Massachusetts). Rocks from Massachusetts, New York, Michigan, Iowa, and Ceylon. (Exchange.) 21545.
- BOURKE, Captain JOHN G.** (War Department). A stick for fire-making, from Apache Indians. 22093.
- BOUSSOD, VALADON & Co.** (New York City, New York). Fifteen specimens of process work (photogravure photo-aquatint, chromo typogravure, typogravure) made by the donors. 20999.
- BOWERS, E. S.** (Webster, North Carolina). An amethyst (21151); two sapphire corundums from Laurel Creek, Georgia; a brown star sapphire, and a corundum crystal doublet from Macon County, North Carolina (22030); amethysts from Macon County, North Carolina (22070).
- BOWERS, STEPHEN** (Ventura, California). A small collection of stone relics from California. 20987.
- BOWIE, N. M.** (Nottingham, Maryland). A Fox Squirrel (*Sciurus niger ludovicianus*). 21544.
- BOWMAN, D. A.** (Bakersville, North Carolina). Minerals. 20913.
- BOYD, W. H.** (Reading, Pennsylvania). A buttonhole badge of the Union Veteran Legion (21323); a silver badge of the Union Veteran Legion (21663).
- BRACKETT, FRED.** (Washington, District of Columbia). Badges worn by committees, and set of printed forms used by executive committees at the inauguration ceremonies March 4, 1889. 21909.
- BRADFORD, HARRY B.** (Washington, District of Columbia). Specimen of *Lepus campestris*. 21514.
- BRADLEY, JOHN** (Norfolk, Virginia). A campaign badge. 21757.
- BRAUN, BARON** (Vienna, Austria). Three meteorites. (Exchange.) 21258.
- BREMEN, H. W.** (Silver City, New Mexico). A root, a supposed antidote for snake-bites. 20962.
- BREZINA, Dr. ARISTIDES.** (See under Vienna, Imperial Royal Natural History Museum of). 21257.
- BRIGGS, S. M.** (Washington, District of Columbia). Ore and products from Piedmont Reduction Works, Thomasville, North Carolina. 21250.
- BRILL, JOHN A.** (Philadelphia, Pennsylvania). Two postage-stamps of the last century. These stamps were preserved by the heirs of Hon. Welbore Ellis, commissioner of internal revenue for Great Britain, A. D. 1769, and were given to E. J. Walker, of Newcastle-on-Tyne, who, in turn, presented them to Mr. John A. Brill. 2044.
- BRIMLEY, H. H. AND C. S.** (Raleigh, North Carolina). Thirteen mammal skins. (Purchased.) 21691.
- BRITISH MUSEUM** (Natural History Department, London, England). Three casts of *Meiolania* from Lord Howe Island, England. (Exchange.) 21522.
- BRITTON, Col. A. T.** (Washington, District of Columbia). A programme and souvenir of the Harrison and Morton Inauguration Ball, March 4, 1889. 21807.
- BROCKETT, PAUL** (U. S. National Museum). An insect (20954); a medal of Cincinnati Exposition (21199).
- BROOKS, THOMAS H.** (Montevideo, Uruguay). Skin and bones of a Sea Lion from the coast of Maldonado, Uruguay. 21608.
- BROWN, CAMPBELL** (Spring Hill, Tennessee). Flint implements from Spring Hill, Tennessee. 21424.
- BROWN, D. R. C., and BUTLER, ELMER T.** (Aspen, Colorado). A miniature model of Aspen mountain, Colorado, through D. W. Brunton, mining engineer, Leadville, Colorado. 21103.

- BROWN, HERBERT** (Tucson, Arizona.) A nest and three eggs of *Harporhynchus bendirei* (21907); nests and five eggs of Blue-gray Gnatcatcher (*Poliopitila plumbea*) and fourteen eggs of Bendire's Thrasher (*Harporhynchus bendirei*) from Tucson, Arizona (22060).
- BROWN, MAURICE M.** (Machodoc, Virginia). Four living herons. 22051.
- BROWN, Miss H. LOUISA** (Boston, Massachusetts). An original lithograph by Andre Calame (21578); several drawings and etchings (21605).
- BROWN, Miss MINNIE C.** (Rochester, New York). A specimen of Niagara limestone. 21720.
- BRUCE, DAVID** (Brookport, New York). Insects from various localities (21399) collection of Lepidoptera principally from Colorado (purchased). (21679.)
- BRUNER, T. K.** (Department of Agriculture). A specimen of rutile in quartz Alexander County, North Carolina. 22027.
- BRUNTON, D. W.** (See under Brown, D. R. C.)
- BUHRING, FRED** (New York City, New York). A Buhring rubber-machine specimens of work. 21938.
- BUTLER, ELMER T.** (See under Brown, D. R. C.)
- BURCH, MILLARD** (Ballston, Virginia). Six living Night Herons. 22096.
- BUREAU OF ANIMAL INDUSTRY.** (See under Agriculture, Department of.)
- BUREAU OF ETHNOLOGY** (Maj. J. W. Powell, Director). Collections of pottery, implements, woven fabrics, shells, beans, etc., forming accession 21171, made up of the following individuals: W. W. Adams, shell-beads from Union Springs, New York; E. Boban, pottery from Mexico; Arthur P. Davis, pottery from Pueblo, Alto, New Mexico; Gerard Fowke, pottery from Yellow Lake, Wisconsin; W. Gill, stone objects from Chain Bridge, Virginia; William A. Hakes, pottery fragments and stone objects from Susquehanna Valley, New York; H. P. Henshaw, pottery fragments from Two Rivers, Wisconsin; H. W. Henshaw, one fine stone collected by L. L. Frost, Susanville, California; W. H. Holmes, pottery and stone objects from New Mexico; G. H. Huribut, woven fabrics from Ancon, Peru; Col. C. C. Jones, pottery fragments from Stallings Island, Georgia; James D. Middleton, pottery fragments from Irvine, Pennsylvania; V. Mindeloff, pottery fragments from Oraibi, New Mexico; Maj. J. W. Powell, pottery and stone objects from near Abiquia, Mexico; James Stevenson, pottery from Moki, Arizona; 851 specimens of pottery, stone, and other objects from various localities in New Mexico; 68 specimens of stone implements from Moki, Arizona; one stone from Jemez Springs, New Mexico; 32 specimens of pottery, stone, and vegetable fiber objects from Flagstaff, Arizona; Dr. Taylor, pottery fragments from Mobile, Alabama; Gen. G. P. Thruston, pottery fragments from Nashville, Tennessee; James P. Tilton, pottery fragments from Newburyport, Massachusetts; Charles L. R. Wheeler, one cast of stone knife from Westerlo, County, New York; Dr. H. C. Yarrow, one earthen bowl from Deep Creek, California; through James Mooney, a collection of ethnological specimens from the East Cherokee Reservation, North Carolina (21450); fragments of pottery from New Mexico, collected by Maj. J. W. Powell (21815); pottery from Jemez, New Mexico, collected by W. H. Holmes (21816); pottery from Irwin County, Pennsylvania, collected by James D. Middleton (21817); fragments of pottery from Yellow Lake, Burnett County, Wisconsin, collected by Gerard Fowke (21818); pottery and modern Cherokee work from the East Cherokee Reservation, North Carolina, collected by James Mooney (21819); fragments of pottery, Pueblo Alto, New Mexico, collected by Arthur P. Davis (21820); pottery from Oraibi Moqui, Arizona, collected by Victor Mindeloff (21821).
- BURGER, PETER** (U. S. National Museum). A pair of old scales (20972); an iron flint-lock pistol (21535).
- BURKE, JAMES** (Washington, District of Columbia). Two living White-crowned Sparrows. 21446.

- BURNS, FRANK** (Greenville, Virginia). Fossil shells from Natural Bridge (21364). Also an old plantation hoe found near Middlebrook, Augusta County, and supposed to be over 150 years old, made in Maryland and carried to the valley of Virginia at the close of the Revolution. (21372.)
- BURT, GRINNELL** (Warwick, New York), (through W. S. Yeates). Minerals from Des Moines, Iowa, and Ellenville, New York. 22014.
- BUSH, JOHN C.** (Paterson, New Jersey). A badge of the Phelps Guards of Paterson, New Jersey. 21775.
- BUSSEY, Gen. CYRUS** (Assistant Secretary of the Interior). A leaf from an account book 100 years old. 22142.
- BUTLER, ELMER T.** (See under Brown, D. R. C.)
- BUTTIKOFER, J.** (Leiden, Holland). Skin and skeleton of *Colobus ursinus*; also skin and skull of *Colobus ferrugineus*. (Purchased). 22005.
- BUTTON, WILLIAM P.** (Troy, New York). A badge of "Veteran Boys in Blue" Republican Club. 21776.
- CALL, Hon. WILKINSON** (Washington, District of Columbia). A living Yellow Macaw from South America. 21694.
- CALLAWAY, J. E.** (Ravanna, Missouri). A hair-ball from Mercer County, Missouri. These balls are formed in the fourth compartment of the stomachs of cattle from hairs licked from the surface of the body. 20920.
- CAMERON, General JOHN** (Washington, District of Columbia). Two ribbon badges "Grand Army of the Republic," Memorial Day, Washington, District of Columbia, 1883 (20950); Grand Army of the Republic invitations, programmes, and medals (21226); a Grand Army badge (21414).
- CAMMERMEYER, ALBERT** (Christiania, Norway). Model of a Viking ship. (Purchased). 20887.
- CANNON, B. F.** (Russel Springs, Kansas). Nickel ore from Kansas. 21221.
- CANTERBURY MUSEUM** (Christchurch, New Zealand). An exceedingly valuable collection of woods from New Zealand. (Exchange). 21207.
- CARACCILO, H.** (Trinidad, West Indies). Reptiles from the West Indies. 21659.
- CARLOS, CTR.** (Cape Gracias, Nicaragua), (through Messrs Eggers and Heinlein). Reptiles and insects from Nicaragua. 21593.
- CARPENTER, Captain G. S.** (Fort Klamath, Oregon). Three Water Lizards. 20971.
- CARPENTER, Mrs. J. M.** (Washington, District of Columbia). A living parakeet. 20903.
- CARR, SILAS** (Providence, Rhode Island). A collection of minerals (exchange) (22075); eight stone hammers from Johnston, Rhode Island. (22114.)
- CARTER, GEORGE W.** (Washington, District of Columbia). A slab of marble from the Virginia Marble Company, Loudoun County, Virginia. 21466.
- CASELL & Co.** (New York City, New York). Twelve wood-cuts from designs by G. Doré. 21928.
- CASSELBERRY, Mrs. Dr.** (Morgantown, West Virginia), (through Mr. Walter Hough). A coffee-biggin. 21132.
- CENTRAL PARK MENAGERIE** (New York City, New York), (through W. A. Conklin, Director). A stork in the flesh (21222); three eggs of Black Swan (*Cygnus atratus*). (21405.)
- CENTURY COMPANY, THE** (New York City, New York). Five proofs of wood-engravings (deposited). 21006.
- CHANDLER, W. H.** (U. S. National Museum). A basket from Niagara Falls. 21749.
- CHANDLER, Prof. C. F.** (New York City, New York). One hundred and thirty-seven engravings, illustrating the various mechanical engraving processes. 20366.
- CHANG YEN HOON** (Chinese minister, Washington, District of Columbia). A bronze temple urn of the Shang dynasty, 1762 B. C., with carved stand exchange (21844); an ancient jade audience-ring held in the hands of those who were favored with an audience before the Chinese Emperor (21964).

- CHASE, Mrs. M. J. (Philadelphia, Pennsylvania). A brown pearl from a mussel obtained from New Jersey. 21922.
- CHATARD, Dr. F. E. (Baltimore, Maryland). Native silver from Chanarcillo, (Purchased). 21153. (See under Interior Department, U. S. Geological Survey.)
- CHAZARO, M. M. (Tlacotalpan, Vera Cruz, Mexico). Seeds of Fruit of the Vine which grow in the mountains of Soyaltepec, District of Tuxtepec, State of Oaxaca. 21735.
- CHEESEMAN, Prof. T. F. (See under Auckland Museum).
- CHENEY, Mrs. EDNAH D. (Jamaica Plain, Massachusetts). A book, "Memoir of Cheney, Engraver." 21556.
- CHERRIE, GEORGE K. (American Museum of Natural History, Central Park, New York). Birds' skins from New York. 21614.
- CHERRY, T. J. (Newark, Ohio). Four perforated tablets, one slate knife, and a ceremonial object and a stone tube. (Purchased). 21361.
- CHESTER, A. (Washington, District of Columbia). Section of Sequoia bark from California tree 96 feet in circumference. 20976.
- CHIDSEY, CHARLES E. (Scranton, Mississippi). Sixty-eight specimens of porphyry from Alabama. 22170.
- CHILDS, L. J. (North Fairfield, Ohio). A living Raccoon (*Procyon lotor*). 21212.
- CHISOLM, ALFRED (Savannah, Georgia). An Albino Red-wing Blackbird (*Agelaius phoeniceus*). 21754.
- CHISOLM, F. F. (Denver, Colorado). A specimen of borite. 21392.
- CHITTENDEN, F. H. (Brooklyn, New York). Specimens of *Balaninus quercus*.
- CHRISTIANIA UNIVERSITY (Christiania, Norway). Dried plants from Norway. 21687.
- CINCINNATI SOCIETY OF NATURAL HISTORY (Cincinnati, Ohio), (through Horace Smith). A collection of bone, stone, and shell implements from graves at Xenia, Ohio. 21206.
- CLARK, WALDO, Jr. (Mullan, Idaho). A specimen of plattnerite from near Mullan, Idaho. 22095.
- CLARKE, J. M. (Albany, New York). A box of fossil wood. 20985.
- CLARKE, Prof. F. W. (U. S. National Museum). Nine mineral specimens. (Purchased). 21155.
- CLARKE, S. C. (Marietta, Georgia). Eight shells (*Helix albolabris*) from Marietta, Georgia. 21465.
- CLAY, Col. CECIL (Washington, District of Columbia). Skin of moose (*Alces alces*) (21610); skull and antlers of moose killed by donor in Canada; also several accessories (bushes, moss, etc.) (21747).
- CLEMENTS, Miss GABRIELLE D. (Philadelphia, Pennsylvania). Four etchings. (Deposited). 21022.
- CLEVELAND, Hon. GROVER (Washington, District of Columbia). Two enamel table covers, one silver watch-chain, one gold breast-pin, one ivory carving bird, one small basket, presented by the Queen of Madagascar. 21722.
- COAST AND GEODETIC SURVEY. (See under Treasury Department.)
- COCKERELL, HENRY (Washington, District of Columbia). A Green Heron from the Potomac Branch. 21113.
- COCKERELL, T. D. A. (West Cliff, Colorado). Shells from Colorado. 21990. (See under Colorado Biological Association.)
- CODY, Hon. W. F. (North Platte, Nebraska). Two living Elks (*Cervus canadensis*) from Wyoming. 21307.
- COFFIN, Hon. C. E. (Muirkirk, Maryland). Specimens of white pig-iron. 20982.
- COLEMAN, SAMUEL (Newport, Rhode Island). Eight etchings. (Deposited). 21115.
- COLBURN, A. E. (Washington, District of Columbia). A Red-headed Woodpecker. 21115.

- COLLET**, Prof. ROBERT (See under Zoölogical Museum, Christiania, Norway.)
- COLLIN**, Madame VEUVE A. (Washington, District of Columbia). A bust of the late President Garfield, made by A. Collin, sculptor (deceased). 21172.
- COLLINS**, Miss EVA A. (U. S. Fish Commission). A specimen of cardinal from Cozumel. (Exchange.) 21746.
- COLLINS**, FRANK S. (Malden, Massachusetts). A collection of one hundred species of marine algæ. Most of the specimens are new to the Museum collection. 21441.
- COLLINS**, W. H. (Detroit, Michigan). Thirty-eight specimens of birds' skins. (Purchased.) 20632.
- COLMAN**, W. D. (Washington, District of Columbia). A living Prairie Dog. 21580.
- COLORADO BIOLOGICAL ASSOCIATION** (West Cliff, Colorado). Specimens of fungi from Colorado, (21576); land and fresh-water shells from Colorado (21877); also, through T. D. A. Cokerell, shells from Colorado. (21990.)
- CONKLIN**, W. A. (See under Central Park Menagerie, New York City, New York.)
- CONRAD**, A. H. (Shenandoah, Iowa). A collection of Devonian fossils from Iowa. 22046.
- COOKE**, HENRY D., Jr., (Georgetown, District of Columbia). A living Capuchin Monkey from Central America. 21117.
- COOPER**, WILLIAM (Ticonderoga, New York), (through W. S. Yeates). Minerals from Ticonderoga, New York, and also from Pennington County, South Dakota. 22015.
- COPE**, Prof. E. D. (Philadelphia, Pennsylvania). A bird-skin (Audubon's type of *Helminthophaga bachmani*) (exchange) (21508); cast of fossil (*Phenacodus primavus*, found in the Wind River Valley of Wyoming Territory) (purchased) (21881).
- COPELIN**, A. J. W. (Chicago, Illinois) Photographs of locomotives. (Purchased.) 20898.
- COPENHAGEN**, ZOOLOGICAL MUSEUM OF (through Dr. Chr. Lütken). Sixty-seven species of Fishes. 21065.
- CORBY**, E. C. (Curaçao, Venezuela). A collection of beetles from Maracaibo, Venezuela. 22169.
- CORY**, CHARLES B. (Boston, Massachusetts.) Birds' skins from Grand Cayman, and Cayman Brac, West Indies. 21400.
- COVES**, Dr. ELLIOTT B. (Washington, District of Columbia.) Three living Screech Owls (21430); ten eggs of Fish Crow (*Cornus ossifragus*) (exchange) (22063).
- COX**, Mrs. THOMAS C. (Washington, District of Columbia), General George Washington's shaving-table. This table was presented to General Washington by the first French minister accredited to the United States. By Washington's will it was bequeathed to Dr. David Stuart of Fairfax County, Virginia, and was left by Dr. Stuart to his heirs. 21367.
- CROSBY**, Prof. W. O. (Boston, Massachusetts). Infusorial earth from Pope's Creek, Maryland. 22148.
(See under von Müller, Baron Ferdinand.)
- CROSS & HILLEBRAND**. (See under Interior Department, U. S. Geological Survey).
- CROSSCUP and WEST** (Philadelphia, Pennsylvania). Six proofs of Ives' process work by the donor. 21027.
- CUNNINGHAM**, H. F. (Orlando, Florida). A spider. 21173.
- CURTICE**, Dr. COOPER (U. S. Department of Agriculture). Animal parasites prepared by Dr. Curtice. (Deposited.) 20071.
(See under Agriculture, Department of.)
- CURTIS**, C. J. (Croom Station, Maryland). An egg of *Zenaidura macroura*. 21906.
- CURTIS**, GEORGE H. (Cincinnati, Ohio). Mounted slides showing the Diatomaceæ of the Cincinnati group. 21897.
- CURTIS**, W. E. (Washington, District of Columbia). Five pieces of pottery from Ancou, Peru (purchased) (21825); a plaster-cast of a stone carving representing the Llama (22107).
- DALL**, W. H. (Smithsonian Institution). A living bat. 22042.

- DALLAS, JOHN (Fairfield, Connecticut). Four insects from Cincinnati. 21871.
- DAMANTE, ZELLA (Washington, District of Columbia). A Boa Constrictor. 217
- DANA, WILLIAM J. (Boston, Massachusetts). Ten proofs of wood-engravings by donor. 20867.
- DARTON, NELSON H. (See under Interior Department, U. S. Geological Survey).
- DAVIDSON, Mrs. Clara B. (St. Louis, Missouri). A sabre presented to General J. Davidson, U. S. Army, for bravery and gallant conduct during the capture of Little Rock, Arkansas, in 1863. 22123.
- DAVIS, ARTHUR P. (See under Bureau of Ethnology.)
- DAVIS, B. F. (Pawtucket, Rhode Island). Souvenir badges of Grand Army of the Republic. 21162.
- DAVISON, J. L. (Lockport, New York). Three specimens of Cerulean Warbler (21047); a Rose-breasted Grosbeak (*Zamelodia ludoviciana*) in the flesh (2140); nest and three eggs of Cerulean Warbler (*Dendroica cerulea*), one egg of Cowbird (*Molothrus ater*) (21366).
- DAWSON, Sir J. WILLIAM (Montreal, Canada). Thirty-seven specimens of Cambrian and lower Silurian fossils, Quebec group, graptolites. (Exchange.) 21838.
- DAY, BENJAMIN (New York City, New York). Apparatus for drawing with rapid shading medium; also specimens of work. 21937.
- DAY, Dr. DAVID T. (U. S. Geological Survey). Coke made from natural gas (20934); minerals from New Almaden, California, and a specimen of mineral from Easton, Pennsylvania (21733).
- DAY, E. L. (Buckhannon, West Virginia). Stone implements and fragments of pottery from West Virginia. 21945.
- DEAN, Miss MARY OWEN (Washington, District of Columbia). Arrow-heads from Romney, Hampshire County, West Virginia. 21517.
- DECHENT, WILLIAM F. (Brooklyn, New York). A badge of the Sängerbund of Brooklyn, New York. 20844.
- DERBY, Prof. ORVILLE A. (See under Museo Nacional, Rio de Janeiro, Brazil).
- DESPARD, H. (New York City, New York). Six etchings by Mrs. Eliza Great (Deposited.) 20015.
- DIEHL, Mrs. ANNA RANDALL (New York City, New York). Twelve oriental etchings. 20964.
- DILLAGE, Miss BLANCHE (Philadelphia, Pennsylvania). Four etchings. (Deposited.) 21017.
- DILLER, Prof. J. S. (U. S. Geological Survey). A White-footed Field Mouse (*Peromyscus leucopus*) from Mt. Shasta, California. 21097. (See under Interior Department, U. S. Geological Survey).
- DILLON, M. A. (Washington, District of Columbia). Three pamphlets relating to the organization of the Union Veteran Union. 20967.
- DISBRO, A. J. (Fredericksburg, Virginia). A Virginia Treasury note; one dollar. 20982.
- DODGE, J. HEATH (Bethesda, Maryland). A living Owl (*Bubo virginianus*). 22107.
- DODGE, WILLIAM C. (Washington, District of Columbia). One Harper's Ferry lock rifle; one military Remington rifle, and one Sharp's carbine; for exhibition at the Cincinnati Exposition. 20841.
- DOLE, C. A. (Glendive, Montana). A living wolf. 20995.
- DONALDSON, THOMAS (Philadelphia, Pennsylvania). A guest's ticket to the Chicago National Convention, June 19, 1888. 21049.
- DOST, THEODORE O. (Philadelphia, Pennsylvania). Badge of the First Ward of Philadelphia, Pennsylvania. 21774.
- DOUGLASS, A. E. (New York City, New York). Flint implements from Boone, Saline, Chariton, and Howard Counties, Missouri. (Exchange.) 21573.
- DOUGLASS, Mrs. ANNA E. (Cambridgeport, Massachusetts). Plaster busts of the Governors of all States, in office January 1, 1860, except of Oregon and California. 21590.

- DOWLING, THOMAS** (Washington, District of Columbia). Eleven mineral specimens from Mexico and Michigan. (Purchased.) 21793.
- DRAKE COMPANY, THE** (Sioux Falls, South Dakota). Four slabs and specimen of agatized wood from Chalcedony Park, Arizona. (21370, 21490.)
- DREHER, W. D.** (Knoxville, Tennessee). An Indian axe from Tennessee. 22057.
- DRENEUF, M. HARDY DU** (Rio de Janeiro). Bird-skin. (Purchased.) 20908.
- DREW, FRANK L. AND CHARLES E.** (Lisbon, Iowa). A living American Swan (*Cygnus columbianus*). 21889.
- DULIN, EDWARD M.** (Langley, Virginia). A living mink. 21064.
- DURAND, J.** (South Orange, New Jersey). A mediaval lamp. 21696.
- DURNEY, J. T.** (Baltimore, Maryland). Four lamps. (Purchased.) 21960.
- DURY, CHARLES** (Cincinnati, Ohio). A series of Coleoptera and Lepidoptera. 21256.
- DUTTON, Capt. C. E.** (U. S. Geological Survey). A specimen of crystallized azurite from the Copper Queen Mine, Bisbee, Arizona. 21623.
- DWIGHT, W. B.** (Poughkeepsie, New York). Six specimens of Middle Cambrian fossils. 21903.
- DWYER, P. O.** (Franklin, New Jersey), (through W. S. Yeates). Twenty-two specimens of minerals from Franklin, New Jersey. 22018.
- EAKIN, Dr. J.** (Columbus, Ohio). Badge of the Sixty-eighth General Assembly of Ohio. 21767.
- EAKINS, L. G.** (See under Interior Department, U. S. Geological Survey.)
- EARLE, FRANK** (Tombstone, Arizona). A specimen of desclozite with calcite from "Lucky Cuss" Mine, Tombstone, Arizona. 21833.
- EASTMAN, DRY PLATE & FILM Co.** (Rochester, New York). A valuable collection of photographic apparatus and prints. 21099.
- ECHAUREN, FRANCISCO** (Paris, France). A bronze medal to commemorate the war of Chili with Peru and Bolivia. 21917.
- EDMONDS, GEORGE B.** (Washington, District Columbia). An earth-worm from the District of Columbia. 22157.
- EDWARDS, VINAL N.** (Wood's Holl, Massachusetts). A Mink (*Putorius vison*) from Wood's Holl, Massachusetts. 21237.
- EDWARDS, WILLIAM J.** (Phoenix, Arizona). Specimens of nickel ore from Arizona. 21533.
- EGGERS, H.** (Milwaukee, Wisconsin). Two patent boomerangs. 20974.
- EGGERS & HEINLEIN.** (See under Carlos, Cte.)
- EIGEMANN, C. H.** (San Diego, California). Two new species of fishes. 21752.
- EINSTEIN, SAMUEL** (Washington, District of Columbia). A dog. (22035.)
- ELDER & Co.** (Glasgow, Scotland). Photographs of steamships *Etruria* and *Umbria*. 21004.
- ELIAS, JOSEPH & SON** (Baltimore, Maryland). A foot-stove. (Purchased.) 21953.
- ELLINGSON, KNUTE** (Virginia City, Montana). Samples of ore from Montana. 20960.
- ELLIS, J. FRANK** (U. S. Fish Commission). Four living alligators from Tampa, Florida. 21493.
- EMERSON, WILLIAM OTTO** (Haywards, California). Three nests and twenty-nine birds' eggs. 21908.
- EMMONS, Prof. S. F.** (See under Interior Department, U. S. Geological Survey.)
- ENGLISH, GEORGE L. & Co.** (Philadelphia, Pennsylvania). A mineral specimen from Franklin, New Jersey (21342); nineteen mineral specimens from various localities (exchange) (21343); two minerals from Silverton, Colorado (21428); two orthoclase crystals from Japan (21853); five crystals of beryllanite from near Stoneham, Maine (purchased), (21831); a specimen of terminated crystals of hubnerite from Silverton, Colorado (22069); minerals from various localities (purchased), (22099, 22159).

- ENGLISH, I. D. (Spruce Pine, North Carolina), (through W. S. Yeates). Five specimens of minerals from North Carolina. 22042.
- ETTINGSHAUSEN, Prof. Dr. CONSTANTIN VON (University Gratz, Styria, Austria, Hungary). Four species of fossil plants. 21434.
- EVANS, JOHN A. (Coalport, Pennsylvania). A spear-head from Fairfax County, Virginia. 21921.
- EVERMANN, Prof B. W. (Bloomington, Indiana). A collection of thirty species fishes from Indiana, taken in the Tippecanoe and Wabash Rivers, and in Deep Creek, Indiana. 20853.
(See under Jenkins, Prof. O. P.)
- FAIRCHILD, Col. ASHBEL (Morgantown, West Virginia). Flint-lock horse-pistol and lantern. (Deposited.) 21136.
- FALCONER, J. M. (Brooklyn, New York). An engraving "The Building of Brooklyn Bridge" (21062); one etching and one dry point by the donor. (20837.)
- FARQUHAR, Dr. G. S. (Glenford, Ohio.) Stone implements from Perry County, Ohio. 21377.
- FARRINGTON, O. C. (New Haven, Connecticut). Serpentine rock from Maltby Rock, Connecticut. 21185.
- FAUCHER, G. L. (West Winsted, Connecticut). Stone implements from Connecticut. 21437.
- FENTON, HENSCHEL (New York City, New York). An old English double flanged (Purchased). 21866.
- FIELD and GREENWOOD (Brownsville, Texas). A skin of Varied Bunting (*Passerculus versicolor*) from Texas (22161); a bird-skin (Couch's Kingbird) and sternum of Albino Green-winged Teal from Texas (21401); a Derby Flycatcher from Texas (21595); a specimen of Merrill's Parauque (*Nyctidromus albicollis merrilli*) from Brownsville, Texas (21870); and a Texas Seed-eater. (22082.)
- FIELD, G. W. (Brockton, Massachusetts). Three birds. 20939.
- FIRST JAPANESE TRADING COMPANY (New York City, New York). A Japanese musical instrument, and two Japanese masks (purchased) (21170); porcelain-walrus drum, and palanquin from Japan (purchased) (21178).
- FISH, CHARLES F. (Fall River, Massachusetts). Forty-nine photographs of Indian objects. 22137.
- FISH COMMISSION, U. S. (Washington, District of Columbia). Twelve living phant tortoises, seven living amblystomas, and three living Painted Terrapins (21369); (through Colonel M. McDonald) two living opossums, and six living turtles (21480); a collection of archaeological, and geological specimens, including mammals, reptiles, batrachians, insects, arachnids, myriopods, birds' eggs, skeletons of birds, mammals, fossils, plants, seeds, lichens, mosses, fungi and ferns, woods, made by the steamer *Albatross* during the voyage from Norfolk, Virginia to San Francisco, California, in 1887 and 1888; a collection of birds, fishery implements and models, obtained by the steamer *Albatross* (21699); a large collection of birds, mammals, plants, reptiles, stone implements, birds' skeletons, geological objects, and fossil woods made by the steamer *Albatross* in Alabama (21734); three specimens of Marbled Cat-fish collected by Mr. Rogan, Russellville, Tennessee (21835); skin and skeleton of Spotted Porpoise collected by the Fish Commission schooner *Grampus* (21874); a collection of fishes made by Prof. C. Gilbert and Dr. J. A. Henshall in the tributaries of the Ohio River (22094); and three specimens of Sting Ray (*Trygon centrura*) from Chesapeake Bay (22140). (See under Latimer, C. E., and Lee, Prof. L. A., and Thomas Lee.)
- FISHER, Dr. A. K. (Department of Agriculture). A large collection of birds' skeletons (deposited) (21497); Fish Crows (*Corvus ossifragus*) from Washington, District of Columbia (21790).
- FISTON, F. ALBERT (New York City, New York). A campaign badge. 21761.

- FITZGERALD, DAVID** (Washington, District of Columbia). Two Indian arrows. 2110.
- FLEMING, R. B. L.** (The Plains, Virginia). Two living foxes. 22132.
- FLINT, EARL** (Rivas, Nicaragua). Specimens of lizards. 20966.
- FLINT, Dr. J. M.** (See under Phelps, Rear Admiral T. S.)
- FOOTE, A. E.** (Philadelphia, Pennsylvania). Collection of minerals from various localities. 21592.
- FORBES LITHOGRAPH MANUFACTURING COMPANY** (Boston, Massachusetts). Seventy-four albertypes made by the donors. 20884.
- FORBES, R. B.** (Boston, Massachusetts). A photograph of the auxiliary steam-packet *Massachusetts*, built in 1845. 20905.
- FOWKE, GERARD.** (See under Bureau of Ethnology.)
- FORRER, R.** (Strasburg, Germany). One old relief cut, "Prelum Ascensianum." (Purchased). 22066.
- FRANCIS, Miss M.** (Newport, Rhode Island). A typewriter invented by the late Dr. Samuel Ward Francis in 1857. 21102.
- FRANKLIN, Dr.** (Chillicothe, Ohio). A stone pipe, and a fragment of a boat-shaped object from Chillicothe. 21360.
- FRAZER, GEORGE B.** (West Medford, Massachusetts). A collection of 724 specimens of stone implements from Massachusetts. 21781.
- FRELLINGHUYSEN LANCERS' ASSOCIATION** (Newark, New Jersey). Two inauguration ribbon-badges. 21854.
- FRESHWATER, JOHN** (Loudenville, Ohio). Two stone scrapers. 21505.
- FRITSCH, E.** (New York City, New York). Two specimens of Algerian marble. 20862.
- FRITSCH BROTHERS** (New York City). Two ounces of "oil of Eucalyptus quintessential." 21566.
- FROST, L. L.** (Susanville, California). Indian implements (20977); archæological specimens from California (21588).
- FRYER, GEORGE G.** (Philadelphia, Pennsylvania). Four ethnological objects. 21108.
- FUNK, C. E.** (Denver, Colorado). A campaign badge. 21750.
- GALBRAITH and LESLIE, Drs.** (Chillicothe, Ohio). A fragment of a drilled ceremonial object from Chillicothe. 21358.
- GALE, DENIS** (Gold Hill, Colorado). Birds in alcohol, from Colorado (21344); a fine collection of birds' nests and eggs from Colorado (21396); five birds' skins from Colorado (21554).
- GALLAHER, J. S.** (Washington, District of Columbia). Two portraits. 21485.
- GALT, J. A.** (Columbia, Virginia). Stone relics. 21929.
- GALT, W. M.** (Washington, District of Columbia.) A duplex watch made in London, England. 21575.
- GANNETT, HENRY** (Washington, District of Columbia). A Sharp's rifle, for exhibition at Cincinnati Exposition. 20840.
- GARDNER, F. C.** (Washington, District of Columbia). Two metal medals of General U. S. Grant. (Deposited.) 21412.
- GARMAN, S.** (See under Museum of Comparative Zoölogy, Cambridge, Massachusetts.)
- GASKILL, Capt. J. L.** (Atlantic City, New Jersey, keeper of the U. S. Life-saving Station at Absecon, New Jersey). A specimen of Sowerby's Whale (*Mesoplodon bidens*) 21862.
(See under Treasury Department, U. S. Life-Saving Service.)
- GASKILL, WILLIAM H.** (Morehead City, North Carolina, keeper of the Life-Saving Station at Cape Lookout, South Carolina). A fresh specimen of Sun-fish (*Mola rotunda*), caught at the station. 21912.
(See under Treasury Department, U. S. Life-Saving Service.)

- GASSETT, C. W. (Worcester, Massachusetts). Original badge of the Grand Army of the Republic in gold and enamel, the first design used. (Deposited.) 2113.
- GATEWOOD, Dr. W. EMMET (Stockport, Ohio). A living Tiger Salamander (*Ambystoma tigrinum*) from Wolf Creek, Morgan County, Ohio. 21683.
- GNBBIE & Co. (Philadelphia, Pennsylvania). Ten impressions from photographic plates. 21899.
- GEOLOGICAL COMMISSION OF PORTUGAL (LISBON, PORTUGAL). Twelve plaster casts of bilobites found in Portugal. 21855.
- GERRARD, EDWARD (London, England). A collection of skins of monkeys. (Purchased.) 22071.
- GERSTENBERG and REUTER (Washington, District of Columbia). A living pine. 21282.
- GETCHELL, Mrs. E. L. (Worcester, Massachusetts). Six etchings. (Deposited.) 21021.
- GIBSON, F. W. (Falling Springs, Pennsylvania). A cast of a supposed fossil human face, found in the Hamilton sand-rock, Pennsylvania. This cast may prove an interesting contribution to science, since, if the fossil is that of a human, it would seem to indicate the existence of man in the Tertiary period. 21021.
- GIBSON, Ensign JOHN. (See under Gurley, W. C.)
- GIGLIOLI, Prof. HENRY H. (See under Zoological Museum, Florence, Italy.)
- GILBERT, Prof. C. H. (See under Fish Commission, U. S.)
- GILL, Dr. L. W. (See under Bureau of Ethnology.)
- GILMAN, Z. D. & Co. (Washington, District of Columbia). A stereoscopic cast of a fossil. 20890.
- GLASCOTT, Mrs. JOSEPHINE (Washington, District of Columbia). Two living doves. 21745.
- GLEAVES, ALBERT (Annapolis, Maryland). Photographs of projectile in flight from a Hotchkiss magazine rifle. 20896.
(See under Navy Department).
- GOODCHILD, J. G. (London, England). Specimens of fossils from England. 21021.
- GOODE, Dr. G. BROWN (Washington, District of Columbia). Six campaign medals (21106); four lithographs of army hospitals in existence from 1862 to 1865 (21125); four campaign badges (21149); a set of admission tickets to the Valley Centennial Exposition at Cincinnati, Ohio, 1888 (21551); specimen of wood-engraving and process-work (21994); two silhouettes and eight engravings (22090.)
- GOODRICH, C. F. (Newport, Rhode Island). Photographs of torpedo experiments. 20990.
- GORDON, JOHN J. (Boonton, New Jersey). Diopside with secondary serpentine inclusions. Montville. (Purchased.) 21187.
- GORDON, S. J. (New York City, New York). A photograph of the late Captain Rogers' steamship *Savannah*, 1819. 21800.
- GORDON, WILLIAM A. (Washington, District of Columbia). A living Ground Squirrel. 21080.
- GOSSE, Dr. H. T. (See under Musée d'Ethnologie, Geneva, Switzerland.)
- GRAHAM, JOHN (warden District jail). A collection of knives, razors, tweezers, and a sandbag made by prisoners in the District jail. 21270.
- GRANGER, Lieut. SAMUEL (Paterson, New Jersey). Badge of the Phelps Guards. 21768.
- GRANIER, EMIL (Atlantic, Wyoming). A polished agate. (Exchange.) 21507.
- GRANT-BEY, Dr. JAMES (Cairo, Egypt). Seven water-color sketches of ancient Egyptian monuments; two fragments of leather cover a fac-simile of the catafalque of Isis Kheh, a queen of the Twenty-first Dynasty 1,000 B.C., Egypt, (21417); and a fragment of mummy-cloth with characters of the "Ritual of the Dead" (21730).

- GREEN, LOREN W.** (Charlestown, New Hampshire). Several specimens of birds, nests, and eggs (20897); six dried skins of chipmunk (21036); a woodchuck (21044); six mammal skins, two insects, and one turtle (21073); a wood rabbit, muskrat, and squirrel from New Hampshire. (21543).
- GREEN RIVER ZIRCON MINING COMPANY** (Hendersonville, North Carolina), (through W. S. Yeates.) Fifty-one zircon crystals from Green River, Henderson County, North Carolina. 22032.
- GREEN, W. J.** (Washington, District of Columbia). Seven marbles cut from amethyst, carnelian, bloodstone, and agate. 21341.
- GREENWOOD, E. C.** (Brownsville, Texas) A White Pelican from Corpus Christi. 21852.
- GREEY, EDWARD** (New York City, New York). One large bronze sitting figure of a Japanese Buddha; Japanese fire engine; and Japanese bow and arrow (purchased) (20862); Japanese bronzes, lamp made in Tokyo, 1850-75 (copy of larger lamps made from A. D. 1603); koro resting on three figures of Oni (imps) made in Osaka, date 1800-50; koro of curious archaic form, made in Yeddo, 1700-50; koro of globular form with three legs, made in Yeddo, 1800-50; vase of amphore shape on four slender feet, date 1875; copy of an old bronze; trumpet-shaped vase made in Osaka, about 1750-1800; koro of Tokyo bronze, 1860-70; bronze koro representing boy seated on a drum; figure of Samurai at prayer, resting on a bronze base, showing the old Kamishimo, or official overdress, made in Yeddo, 1700-1800; koro, figure of Shoki and two demons of sickness, made in Osaka, 1800-50; hibachi, with pierced lid and upper rim; body decorated with archaic designs of birds in relief; koro with lid, made in Kyoto, 1800-20; koro with lid, made by Tsuji Ki-ho, about 1850; old form (purchased) (21176).
- GREGORY, J. R.** (London, England). Three specimens of meteorites. (Exchange.) 22040.
- GRETTON BROTHERS** (Pittsburgh, Pennsylvania). Photographs of Jones and Laughlin's Steel Works, Pittsburgh, Pennsylvania. (Exchange.) (21487, 21714.)
- GRINNELL, GEORGE BIRD** (New York City, New York). A living Mountain Sheep (purchased) (21383); skin of a Mountain Goat (purchased) (22162).
- GRINNELL, W. F.** (See under State, Department of.)
- GUESDE, L.** (Guadeloupe, West Indies). A collection of birds' skins from Guadeloupe. (Exchange.) 21210.
- GUNNING, MARY** (Greeley, Colorado). Plants collected in Colorado. 21707.
- GURLEY, W. C.** (Marietta, Ohio), (through Ensign John Gibson, U. S. N.) A photograph of a flash of lightning. 21476.
- GUTEKUNST, F.** (Philadelphia, Pennsylvania). Five proofs of photographs by the lender (21025); a collection of plates and prints illustrating the process of collographic printing. (21482.)
- HACKMAN, D. R.** (Washington, District of Columbia). A living Sparrow Hawk. 21606.
- HAGAN, J. T.** (Washington, District of Columbia). A living alligator from Florida. 21496.
- HAHN, GEORGE R.** (New York City, New York). Proof of a woodcut by Dr. Alexander Anderson. (Deposited.) 21010.
- HAIG, GEORGE W.** (Philadelphia, Pennsylvania). Specimens of stone implements from Cohocksink Creek, Philadelphia, Pennsylvania. 21100.
- HAIGHT & DUDLEY** (Poughkeepsie, New York). Four pamphlets containing specimens of color-printing. 21895.
- HAKES, WILLIAM A.** (Binghamton, New York). Fragments of pottery from Broome County, New York. (Exchange.) 21826.
(See under Bureau of Ethnology.)
- HALE, Miss ELLEN D.** (Boston, Massachusetts). Two etchings. (Deposited.) 21006

- HALL, Mrs. JOHN W. (Washington, District of Columbia). A living alligator Jacksonville, Florida. 21241.
- HALLOCK, CHARLES (Plainfield, Massachusetts). Rock specimens from Massachusetts. 21273.
- HAMILTON, H. P. (Three Rivers, Wisconsin). Fragments of pottery from Wisconsin (Exchange.) 21823.
(See under Bureau of Ethnology.)
- HAMILTON, M. (Savannah, Georgia). A plant from Georgia (20573); a plant (*Pias amplexicaulis*) supposed to be an antidote for snake-bite, sent for experimental purposes. (21266.)
- HANKS, Prof. HENRY G. (San Francisco, California). Four specimens of handkerchiefs. 21525.
- HARDEN, E. B. (Philadelphia, Pennsylvania). Silver prints taken from two mines, showing the interior of an anthracite coal mine. 20879.
- HARDING, Miss ELLEN M. (Washington, District of Columbia). A living domestic fowl. 20918.
- HARE, SIDNEY J. (Kansas City, Missouri). Six flint knives from a mound in Kansas City. 20993.
- HARKNESS, HENRY (U. S. National Museum). A campaign badge. 21147.
- HARMAN, R. V. (London, England). Photographs of the races conquered by the Egyptians. (Purchased.) 20984.
- HARMON, H. C. (Mount Pleasant, District of Columbia). A living Horned Owl (*virginianus*), from Loudoun County, Virginia. 21537.
- HARPER BROTHERS (New York City, New York). Original drawings of illustrations of an article by J. E. Watkins, "The evolution of the passenger car" (21091), illustrations of the railway passenger car. (21150.)
- HARRIS, I. H. (Wagnerville, Ohio). Stone implements from Fort Ancient, Ohio; a flint knife from Logan County, Ohio. 21609.
- HARRIS, WILLIAM C. (New York City, New York.) A fish from Lake Milton, Michigan. 21312.
- HARTON, E. S. (Attleborough, Massachusetts). Campaign badges. 21161.
- HARTSHORNE, CHARLES H. (Waynesville, North Carolina). A building-stone from McDowell County, North Carolina. 21942.
- HARVARD COLLEGE OBSERVATORY (Cambridge, Massachusetts). Nine silver lanterns and ten lanterns. 20938.
- HASBROUCK, E. M. (Brownwood, Texas). A living Civet cat from Texas. 21150.
- HAWLEY, E. H. (U. S. National Museum). A photograph of the gunship *New York* built at Sackett's Harbor, New York, in 1813, in twenty days, from stunted timber. 21277.
- HAWLEY, F. S. (Broadalbin, New York). Glass lamp, a tinder-box, and a candle-box (21276); a foot-stove used in 1830-40 (21741).
- HAWORTH, ERASMUS (Oskaloosa, Iowa). Rocks from Maine. (Exchange.)
- HAY, ROBERT (Junction City, Kansas). Five specimens of halite from Kiowa County, Kansas. 22103.
- HAYDEN, W. P. (Raymond, Maine). Three specimens of minerals from Raymond, Maine. (Purchased.) 21156.
- HAYWARD, HOWARD (Raleigh, North Carolina). A collection of stone implements found near Raleigh, North Carolina. 21512.
- HEIGHWAY, A. E. (Cincinnati, Ohio). Two specimens of staurolite crystals from Fannin County, Georgia. 21432.
- HEILBRONNER, RAOUL (Paris, France). Mediæval scientific instruments. (Purchased.) 21295.
- HELIOTYPE PRINTING COMPANY (Boston, Massachusetts). A collection of photolithographs, heliotypes, and heliochromes (21479, 20882).

- HEMPHILL, HENRY** (San Diego, California). Mollusks, crustaceans, and sponges from California. 21289.
- HENDRICKS, ERIC** (Washington, District of Columbia). A living opossum. 22116.
- HENRY, Miss M. A.** (Washington, District of Columbia). Two fog-horns used by the late Prof. Joseph Henry in experiments for the Light-House Board. 22059.
- HENSHALL, Prof. J. A.** (See under Fish Commission, U. S.)
- HENSHAW, H. W.** (U. S. Geological Survey). Birds' skins from various localities, 196 specimens (21040); three mounted birds and one bird-skin (20857); eleven birds from Oregon and California (21552); fifteen birds from California and the District of Columbia (21579); specimens of reptiles, insects, and mammals from the District of Columbia (presented) (21785); a charm-stone from San Luis Obispo County, California (21792), and five Killifishes from the Washington and Alexandria Canal near Arlington, Virginia (exchange) (21993).
(See under Interior Department, U. S. Geological Survey.)
(See under Bureau of Ethnology.)
- HENSON, HARRY V.** (Yokohama, Japan). A bird from Japan. 21037.
- HESSEL, DR. RUDOLPH** (Washington, District of Columbia). A worm 32 inches long removed from the abdomen of a dog (20868); a Meadow Mouse (21104).
- HEWETT, G. C.** (Washington, District of Columbia). A specimen of "uintahite" from Uintah County, Utah. 21751.
- HIESTAND, J. G.** (Denver, Colorado). A mineral from Colorado. 21060.
- HILLEBRAND, DR. W. F.** (U. S. Geological Survey). Twenty-eight specimens of minerals from the Tintic District, Utah, and 363 specimens of turquoise from Las Cerillas, New Mexico. (Purchased.) 21502.
(See under Interior Department, U. S. Geological Survey.)
- HIRAYAMA, FARO** (Osaka, Japan). Two specimens of square bamboo-stalks from Huga, Kitanaka Kori, Japan. 21645.
- HITCHCOCK, Prof. C. H.** (Hanover, New Hampshire). Specimens of garnetiferous amphibolite (21570); rocks and minerals from New Hampshire, and Connecticut (exchange) (21217).
- HITCHCOCK, R.** (U. S. National Museum). Specimens of rocks from Kawachi, Japan (21613); invertebrates and shells from Japan (21631); specimens of native medicinal preparations from Japan (purchased) (21633); various Japanese costumes, prayer-books, straw-ropes, fans, etc., from Japan (21640); a specimen of grass-bamboo stalk in flower from Osaka, Japan (21646); puff-balls, shells, insects, reptiles, and mammals from Japan (21649); four specimens of stibnite from Saijo mine, Iyo Province, Japan (21667); a portion of betel-nut from Colombo, Ceylon (21689); specimens of pottery and clay coffins from burial-mounds in Japan (21963); and six photo-collotypes (22140).
- HOBBS, CHARLES** (Washington, District of Columbia). A living Rattlesnake from Deer Park, Maryland. 21288.
- HODGE, Col. E. B.** (Plymouth, New Hampshire). Three specimens of trout from Sunapee Lake (21429); three specimens of fishes in alcohol (21635).
- HOLM, THEODORE** (U. S. National Museum). Several ethnological objects collected from ancient graves at Upernavik, Alaska (21418); a Tortoise (*Cistudo carolinus*) from the District of Columbia (22153).
- HOLMES, W. H.** (See under Bureau of Ethnology.)
- HOPE, HENRY W.** (Paint Post-office, Ohio). A small collection of stone implements. 21603.
- HORAN, HENRY** (U. S. National Museum). A knife from Morocco (21146); a workman's card of entry to the New Orleans Exposition 1884-'85 (21213); carpenter's tools (21381); eight tickets of admission to the Cincinnati Exposition 1888 (21467); medal of Sioux City Corn Palace; and a badge of eleventh Assembly District Campaign Club of New York City (21770).

- HORNADAY, WILLIAM T. (Washington, District of Columbia). Two buffalo-horn
(purchased) (20838); a Japanese box used for carrying passengers (21326); White-
headed Eagle (21974).
- HOUGH, E. C. (Washington, District of Columbia). A living Screech Owl (*Megascops asio*). 21564.
- HOUGH, Mrs. L. I. (Morgantown, West Virginia). A basket, formerly used in making
ing bread. 21137.
- HOUGH, WALTER (U. S. National Museum). Waffle-iron and a wooden lock (21137);
a rude implement of black chert found near Morgantown, West Virginia (21137);
a lamp from Morgantown, West Virginia (21459); and several ethnological
objects of curious design (21731).
(See under Mrs. Dr. Casselberry and Miss Emma Protzman.)
- HOWARD, ERNEST (U. S. Geological Survey). A specimen of steatite from
Run, Fairfax County, Virginia. 21901.
- HOWELL, E. E. (Rochester, New York). Specimens of siliceous oolite (21788);
specimens of *Eurypterus* from the water-line near Buffalo, New York (21845).
- HOWELL, J. W. (Bisbee, Arizona). Minerals from Copper Queen Mine, Bisbee,
Arizona. (Purchased.) 21501.
- HOY, Dr. P. R. (Racine, Wisconsin). Two fishes from Biloxi, Mississippi (21788);
two pieces of pine tree, showing injuries made by sap-sucker (21719); a
fresh-water sponge (22167).
- HUFFMAN, JOHN (Washington, District of Columbia). A living White-headed
from Prince William County, Virginia. 21491.
- HUIDEKOPER, Master REGINALD (Washington, District of Columbia). A living
ing Squirrel. 22086.
- HULST, GEORGE D. (Brooklyn, New York). Larvæ of insects. 21109.
- HUMPHREY, GEORGE M. (Pawnee City, Nebraska). A copper medal and
20865.
- HUNT, C. E. (Washington, District of Columbia). A Fire-bellied Squirrel from
tral America. (Purchased.) 21123.
- HUNTER, ALEXANDER (Washington, District of Columbia). A Confederate
jacket. 21203.
- HUNTER, WILLIAM (Accotink, Virginia). A notched axe from Accotink, Fairfax
County, Virginia (21920); 264 stone implements from Mount Vernon, Virginia
(21943).
- HURLBURT, E. (Utica, New York). Drillings from a deep well at Utica. 21737.
- HURLBUT, G. H. (See under Bureau of Ethnology.)
- HUYCK, THOMAS B. (Washington, District of Columbia). Two living alligators
from Florida. 21601.
- ILLINOIS STATE LABORATORY OF NATURAL HISTORY (Champaign, Illinois).
mounted specimens of Lepidoptera. 21803.
- INTERIOR DEPARTMENT (Geological Survey, U. S.). Several pieces of Indian pottery
and a number of stone implements, found in Prentiss County, Mississippi (21137);
fossil fish remains collected by H. W. Turner in California (21055); a specimen
of native platinum from Washington Territory (21152); rocks from California
collected by Prof. J. S. Diller (21182); a large collection of rocks (comprising
about 2,000 specimens) of the Comstock lode and Washoe district, Nevada,
gathered by S. F. Emmons and G. F. Becker. This collection is fully described
in Mr. Becker's report upon the geology of this region (Monograph III, U. S.
Geological Survey) and also in Messrs. Hagne and Iddings' paper on the "Composi-
tion of Crystallization in Igneous Rocks" (Bulletin U. S. Geological Survey,
No. 17) (21198); a collection of minerals made by Dr. W. F. Hillebrand at
various localities (21422); a mineral from Yellowstone National Park, Wyoming,
collected by Walter H. Weed (21452); 1,371 minerals collected by S. L. Peck
in St. Lawrence, Lewis, and Jefferson Counties, New York, embracing the

INTERIOR DEPARTMENT (Geological Survey, U. S.)—Continued.

- pink tremolite, blue calcite, graphite, tourmaline, talc, pyrite, etc. (21475); minerals from Bisbee, Arizona, collected by Dr. W. F. Hillebrand (21527); mineral specimens (99) collected by Dr. W. F. Hillebrand in Arizona, Dakota, and New Mexico (21528); mineral specimens (87) from Las Cruces, New Mexico, collected by Dr. W. F. Hillebrand (21529); minerals from Utah and New Mexico (21530); minerals from Colorado (21531); specimens of Oriskany (drift) fossils from Potomac River, below Washington, District of Columbia (21629); rocks and soils from various localities (21789); a large collection of geological specimens from Arizona, Utah, and California, collected by Prof. J. S. Diller (21753); (through Dr. W. F. Hillebrand) a specimen of gaiterite containing zunyite from Silverton, California (21836); specimens of the trachyte body near Rosita, in the Silver Cliff region of Colorado, collected by S. F. Emmons (21786); specimens (37) of wood opal from the Madison River, Montana, collected by Dr. A. C. Peale (21837); specimens (804) of lower Cambrian fossils from Conception Bay, Newfoundland, collected by C. D. Walcott (21861); specimens (3) of lower Cambrian fossils from New York, Nevada, and Vermont, collected by C. D. Walcott (21876); minerals from Colorado, collected by L. G. Eakins (21879); specimens (3,240) of middle Cambrian fossils from Conception Bay, Newfoundland (21914); minerals from Montana, collected by Dr. A. C. Peale (21932); specimens (39) of trimmed rocks from the trias of the New Jersey region, collected by Nelson H. Dartou (21966); mineral specimens (139) collected in Colorado by Messrs. Cross and Hillebrand (21988); miocene fossils from New Jersey marls (21989); specimens (24) of crystallized trona from Owens Lake, California, collected by Dr. T. M. Chatard (22068), and a specimen of infusorial earth from Patuxent River near Dunkirk, Maryland (22102).**
- IVES, FRED E. (Philadelphia, Pennsylvania). A collection of models, specimens of work illustrating the original "Ives Process" (21484); a book, "A New Principle in Heliochromy" (21713); twenty-five specimens illustrating the "Ives Process" (21940).**
- JACKSON AND SHARP COMPANY (Wilmington, Delaware). Photographs of railway-cars (21158); blue-print drawings of railway-cars (21159).**
- JACKSON, B. F. (Athelston, Arkansas). A clay pipe. (Purchased.) 21953.**
- JACKSON, WILLIAM H. (Pigeon Cove, Massachusetts). Skull of Little Piked Whale. 21046.**
- JAPANESE FAN COMPANY (New York City, New York). Model of jinrikisha. (Purchased.) 21345.**
- JELLISON, WILLIAM G. (Hamilton, Ohio). A badge of the Lone Star Lodge, No. 39. 21772.**
- JENKINS, Prof. O. P. and Prof. B. W. EVERMANN (Greencastle, Indiana). Eighteen new species of fishes from the Gulf of California. 20952.**
- JENNINGS, ALLAN H. (Baltimore, Maryland). A Yellow-crowned Night Heron from the Bahama Islands (21435); a skin of Kirtland's Warbler (*Dendroica kirtlandi*) from New Providence, Bahama Islands (21444).**
- JEWETT, Dr. J. W. (New York City, New York). A miscellaneous collection of drugs. 21492.**
- JOHN STEPHENSON COMPANY (New York City, New York). An album containing photographs of street-cars. 20968.**
- JOHNSON, J. ORVILLE (Washington, District of Columbia). Frame containing twelve daguerreotypes. (Deposited.) 20998.**
- JOHNSON STEEL STREET RAIL COMPANY (Johnstown, Pennsylvania). Three sections of tracks showing joint-fixtures, and fourteen short sections of rails for street-railway. 21337.**
- JONES, B. J. (Columbus, Ohio). Two living quails from Mexico. 21956.**

- JONES, Col. C. C. (Augusta, Georgia). Fragments of pottery from Stallings I near Augusta. 21*27.
(See under Bureau of Ethnology.)
- JONES, T. G. (St. Clair, Pennsylvania). Fossil ferns, leaves, etc., from Pennsylvania. (Exchange.) 21503.
- JORDAN, Prof. DAVID S. (Bloomington, Indiana). Nine new species of fishes Virginia and North Carolina (21285); two fishes (*Cryptolomus berryllinus*, *Sparisoma flavescens*) from Key West, Florida (21628).
- JOY, P. L. (U. S. National Museum). An interesting and valuable collection of Japanese birds containing 651 specimens, representing 172 species. This collection result of several years' collecting in an entirely unexplored country, ornithologically considered. The collection contains many very rare species, which are represented in only a few museums (purchased), (21035);* 547 specimens of Korean birds (purchased) (21039); two specimens of birds from China (21069); two five arrows from China, and a Buddhist rosary from Japan (21264); shells from Japan (21290); a phallic emblem from phallic temple near Yokohama (21515); a pipe used by the aborigines of Formosa, Japan (21841); and a collection of Chinese prehistoric objects (21859).
- JUENGLING, F. (New York City, New York). Twenty-seven wood-engravings from a donor. 22135.
- KEMP, Prof. J. F. (Ithaca, New York). Specimens of rocks. (Exchange.) (21035).
- KEPPEL, FREDERICK, & Co. (New York City, New York). Twenty-two colored etchings, and woodcuts. (Purchased.) 21709.
- KERN, CHARLES E. (Washington, District of Columbia). Twenty birds' skins from Nicaragua. 21983.
- KESLER, C. W. (Statesville, North Carolina). Specimens of actinolite from North Carolina (21215); 95 specimens of minerals from Alexander and Iredell Counties, North Carolina (exchange) (22021).
- KETTERLINUS PRINTING HOUSE (New York City, New York). Nine specimens of printing and engraving on stone (21996); a lithographic stone and several specimens of work (22122).
- KEUFFEL & ESSER, (New York City, New York). An air-pump, made by G. F. Esser, of Augsburg, Germany, in 1879. 21626.
- KEYS, C. R. (Burlington, Iowa). Land and fresh-water shells from Iowa. (Exchanged.) 20961.
- KICKHOFF, C., Jr. (New York City, New York). Samples of alloys from Germany. 21050.
- KIMMEL & VOIGT (New York City, New York). A collection of materials and tools used in printing intaglio plates. 21443.
- KING, Maj. W. R. (U. S. Army, Willets Point, New York). Six photographs of the Hell Gate Explosion. 20958.
(See under War Department.)
- KINNES, ROBERT (Dundee, Scotland). A female Narwhal skull with two horns, captured by Capt. James Fairweather in Prince Regent's Inlet, off Lancaster Sound, Baffin's Bay. 21952.
- KLACKNER, C. (New York City, New York). Four etchings. (Deposited.) 21035.
- KNIFE, S. W. (Oceanic, New Jersey). Specimens of stone implements. 21562.
- KNOEDLER, M., & Co. (New York City, New York). Four photogravures. (Purchased.) 21712.
- KNOWLTON, F. H. (U. S. National Museum). A counterfeit silver dollar. 21541.
- KNUDSEN, VALDEMAR (Waiawa, Sandwich Islands). Two petrels. 21655.
- KNUT, S. PRENTISS (Washington, District of Columbia). Twenty-six small Chinese clay figures and scarabei. 21919.

* See report on the Department of Birds, section II.

- KOEHLER, S. R.** (Roxbury, Massachusetts). A collection of 445 woodcuts, etchings, process-prints, etc. (deposited) (21030); 15 wood engravings and 6 etchings (21894); 47 specimens of photo-mechanical engravings (21947).
- KOENIG, GODFREY** (Sassin, Washington). Five eggs of Short-eared Owl (*Asio accipitrinus*) from Washington (22061); 11 birds' eggs (22127).
- KOHN, G.** (New Orleans, Louisiana). A Cumberland Terrapiu from Rayne, Louisiana (21798); 12 Chicken Turtles (*Chrysemys reticulata*) from Louisiana (21799); 12 Terrapins (*Pseudemys troostii*) from Louisiana (purchased) (21863); 6 specimens of Le Sueur's Terrapins (22091).
- KURTZ, W.** (New York City, New York). A frame of azaline pictures (20930); 15 proofs of half-tone process, worked by the donor (21024); 5 collographic prints by Tessu de Mothay (21472); three pictures (21547).
- LACROIX, A.** (Paris, France). Specimens of minerals from various localities. (Exchange.) 22118.
- LAFLAMME, ABBÉ J. C. K.** (Quebec, Canada). Graptolites from the Quebec group of Quebec Province, Canada. 21887.
- LAIRD, CHARLES H.** (Washington, District of Columbia). A Whitney-Kennedy rifle and a Marline rifle, for exhibition at the Cincinnati Exposition. 20843.
- LAKES, ARTHUR** (Golden City, Colorado). Fossil shells from Colorado. 22143.
- LAMBORN, DR. ROBERT H.** (New York City, New York). Two opals from Queretero, Mexico. 22072.
- LANGILLE, OLLIE** (Knowles, Maryland). A living mink. 21000.
- LANGLEY, Prof. S. P.** (Secretary, Smithsonian Institution). Twelve Fire-Flies (*Pyrophorus*) from Cuba and Guadeloupe. 22109.
- LATIMER, C. E.** (U. S. Fish Commission). A Fall-fish (*Semotilus bullaris*) from Patuxent River, Sandy Spring, Maryland. 21802.
(See under Fish Commission, U. S.)
- Laurie, THOMAS** (London, England). Laurie's anatomical model of the heart. 21892.
- LAWRENCE, WALTER U.** (New York City, New York). An original blank card of invitation to a dinner given by President and Mrs. Washington. 22008.
- LE BARON, J. F.** (See under Birt, Dr. Louis, F. H.)
- LEE, J. C.** (Washington, District of Columbia). A specimen of iridescent anthracite coal. 20924.
- LEE, L. A., THOMAS LEE, and CHARLES H. TOWNSEND** (U. S. Fish Commission). One hundred and eighty-seven specimens of birds' skins from Bahia, Brazil. (Purchased.) 21678.
- LEE, THOMAS** (U. S. Fish Commission). A horse-bola and a guanco-bola from Punta Arena, South America. 21468.
- LEE, WILLIAM** (Colon, South America). A grasshopper and a moth from South America. 21469.
- LEON, DR. NICOLAS** (Morelia, Mexico). A specimen of *Laelia autumnalis*. 21567.
- LESH, HARRY** (Wichita, Kansas). A ribbon badge of the Wichita wheelmen. 21179.
- LEWIS, E. M.** (Fort Wood, Bedloe's Island, New York). Birds killed by flying against the statue "Goddess of Liberty," in New York Harbor. 21247.
- LEWIS, GEORGE A.** (Wickford, Rhode Island). Seven fishes from Wickford, Rhode Island (21053); a specimen of *Cyclopterus lumpus* (21910).
- LEWIS, THOMAS** (Moriah, New York), (through W. S. Yeates). A sunstone from Mineville, New York; also a supposed meteorite from New Hampshire. 22010.
- LEWIS, W. H.** (Jefferson County, West Virginia). A duck's egg of peculiar color. 20873.
- LIBRARY COMMITTEE, JOINT** (U. S. Capitol). A marble statue, "Il Penseroso," by Mozier; placed in the National Museum by the authority of the Joint Committee on the Library. 21433.

- LICHTENTHALER, G. W. (Bloomington, Illinois). A valuable collection of ferns containing 110 species from the Hawaiian Islands. (Exchange.) 21143.
- LINDSTRÖM, DR. G. (Stockholm, Sweden). Collection of cambrian fossils from Sweden. (Purchased.) 21650.
- LINSLEY, JOEL (Benning's, District of Columbia). A specimen of charcoal. 21200.
- LITTLE, MAJ. F. E. (Laurel, Maryland). A living Mink (*Putorius vison*). 21560.
- LONDON AND NORTHWESTERN RAILWAY COMPANY (Crewe, England). Nine photographs, showing exterior and interior views of railway carriages. 21373.
- LOUGHMAN, HENRY S. (Brownsville, Ohio). Flint chips and implements, arrowheads, etc., from Flint Ridge, Ohio. 21376.
- LONGLEY, LUTHER (Raymond, Maine). A leaf-shaped implement of yellow ja. 21393.
- LONGLEY, W. E. (Chicago, Illinois). Two butterflies and two moths from Florida. 22112.
- LORING, GEN. CHARLES G. (Boston, Massachusetts). A cast of a head in terra-cotta from Sansonate, in the Republic of San Salvador. 22141.
- LOVETT, EDWARD (Croydon, England). Ethnological objects, stone implements, pottery, bones, etc., from England (21292). A Maundy set of coins, jubilee pattern (22105).*
- LOWERY, G. P. (New York City, New York). Aluminum and copper alloy. 21150.
- LUCAS, F. A. (U. S. National Museum). A skeleton of Kangaroo Rat. (Exchange.) 22076.
- LUCAS, J. A. (Silver City, New Mexico). Seven mineral specimens from the "Copper Glance" and "Potosi" Copper Mines, Grant County, New Mexico (21121 specimens of copper pseudomorph after azurite (22160).
- LUCAS, W. H. (Washington, District of Columbia). A living Eagle (*Haliaeetus cephalus*). 21727.
- LUCHS, L. (Washington, District of Columbia). A chart of the History of Iron and a meerscham pipe. 21891.
- LUKENS, H. R. (Wissahickon, Pennsylvania). A badge of the Manufacturers' Club, Manayunk, Pennsylvania. 21763.
- LYMAN, H. H. (Montreal, Canada). A specimen of *Hepialus thule*, a rare Lepidoptera. (Exchange.) 22165.
- LYONS, EVAN (Georgetown, District of Columbia). A specimen of *Chasmodon*, from an oyster shell. 21648.
- MCCARTHY, GERALD (Raleigh, North Carolina). Specimens of dried plants. (Exchange.) 21724.
- MCDVITT, DANIEL L. (Smithsonian Institution). A Bluebird (*Sialia sialis*) in flesh. 21319.
- MCDONALD, COLONEL MARSHALL (See under Fish Commission, U. S.)
- MCGEORGE, H. W. (Washington, District of Columbia). A living Opossum (*Didelphis virginianus*). 21888.
- MCGINNIS, WILLIAM H. (Youngstown, Ohio). Stone relics from Pennsylvania (21212); stone implements and flakes of flint from Youngstown, Ohio (21240).
- MCGINTY, HENRY (Brooklyn, New York). Badge of the Joseph Benjamin Bazaar. 21766.
- MCGREGOR, ALEX. (Georgetown, New Mexico). Minerals from New Mexico. 21150.
- MCGUIRE, J. D. and F. B. (Washington, District of Columbia). A collection of marine, and fresh-water shells, numbering about five thousand specimens.
- MCGUIRE, F. B. (Washington, District of Columbia). Fourteen Colonial notes, one note of 1812. 21513.

*On Maundy Thursday the ruling sovereign of England distributes the Maundy, a bounty, and with it a set of coins to a certain number of aged people. The coins are specially prepared for this purpose, and are not used as currency.

- MCLANE, WILLIAM R.** (Washington, District of Columbia). A living opossum. 22115.
- MCLAUGHLIN, Miss M. LOUISE** (Cincinnati, Ohio). Two dry points (deposited) (21007); also an impression from an experimental etched plate executed with a brush on a warm ground (21634).
- McMILLAN, ROBERT F.** (Washington, District of Columbia). Stone implements collected near Piny Branch and Rock Creek, District of Columbia (22048, 21951).
- MACGILL, T. W.** (Franklin, Kentucky). A specimen of iron ore from Kentucky. 21075.
- MACOMBER, LEPEG** (Providence, Rhode Island). Forty-five army corps badges (21320); twenty-seven army badges (deposited) (21519).
- MALONE, Mrs. F. E.** (Washington, District of Columbia). A piece of sandstone detached from an anchor supposed to have belonged to the British man-of-war *Hussar*, sunk near Hell Gate, New York, in 1778; also specimens of salt crystals from Syracuse, New York. 21227.
- MAPES, HENRY** (Monroe, New York), (through W. S. Yeates). Three apatite crystals from Greenwood Furnace, New York. 22028.
- MARRON, THOMAS** (U. S. National Museum). A Ground Dove (*Columbigallina passerina*) from Broad Creek, Maryland (21271); three eggs of Snake (*Coluber*) from Potomac River (21858).
- MARSH, Prof. O. C.** (New Haven, Connecticut). A skeleton of a cormorant (21144); a collection of Assyrian and Babylonian seals (21948).
- MARSHALL, GEORGE** (Laurel, Maryland). A young Catbird (21092); a specimen of Egret (20997); a Field Plover (21114).
- MARSHALL, HENRY** (Laurel, Maryland). An Orchard Oriole (*Icterus spurius*) (20928); an Albino Robin (*Merula migratoria*) from Laurel, Maryland (22172).
- MARTIN, S. J.** (Gloucester, Massachusetts). A main cross-tree hauled up in 50 fathoms of water on George's bank by the schooner *Triton*. 20833.
- MARX, Dr. GEORGE** (Department of Agriculture). A lizard and snakes from Patagonia. 21283.
- MASON, CARRINGTON** (Memphis, Tennessee). Specimens of worms. 20942.
- MASON, C. S.** (Toledo, Ohio). Specimens of selenite crystals. 21239.
- MASON, Prof. O. T.** (U. S. National Museum). A fragment of stone implement found at Woodlawn, Fairfax County, Virginia, near Mount Vernon, on the surface of the ground. 21208.
- MASSON, Miss R.** (Lausanne, Switzerland). Specimens of dried plants from Switzerland. 216c8.
- MATHER, FRED** (Cold Spring Harbor, New York). Four Mandarin Ducks (21201, 21305, 21677); a living mink from Cold Spring Harbor, New York (21665); a Mink (*Putorius vison*) (21804); skeleton of a Mandarin Duck (22163).
- MATHERSON, W. J., & Co.** (New York City, New York). A snake from Campeachy, Mexico. 21555.
- MATTHEW, G. F.** (St. John, New Brunswick). Collection of Middle Cambrian fossils from the St. John formation, New Brunswick. (Purchased.) 21639.
- MATTHEWS, Dr. WASHINGTON** (Army Medical Museum). Ethnological objects. (Purchased.) 20888.
- MAYNARD, W. L.** (Worcester, Massachusetts). A souvenir badge of Rhode Island delegates to the Twenty-second National Encampment, Grand Army of the Republic. 21140.
- MEAD, CHARLES** (Sayerville, New Jersey). Three arrow-heads. 21092.
- MEARNS, Dr. EDGAR A.**, U. S. Army (Fort Snelling, Minnesota). A small collection of fishes, reptiles, and batrachians from Arizona. 20877.

- MEDER, FERDINAND** (New York City, New York). One mezzotint printed in (purchased) (21711); a color print, "Gräfin von Voss," by Gabitz (purchased) (22074).
- MEEK, S. E.** (Cedar Rapids, Iowa). Fishes from the Maumee River and Lost Ohio. 21660.
- MEINOLD, WILLIAM** (Paola, Kansas). A skull of a Flathead Indian. 21371.
- MERRIAM, Dr. C. HART** (Department of Agriculture). An important and valuable collection of well-preserved skins from the Old World, containing many valuable and species new to the Museum (exchange) (20911); two sparrows from Iowa and Nebraska (20970); skin of a Coyote from Ogden, Utah, and a Western Blue Jay from Fort Bridger, Wyoming (21325); twenty-four birds' skins from various localities (21668); two specimens of Bachman's Warbler from Sombrero, Florida (21856); three porpoise-skulls and one porpoise-skin, collected at Gadsden, River St. Lawrence (exchange) (21872); two fox-skins from northern Iowa and Texas (21965); two birds' skins from Gadabout, River St. Lawrence (exchange); a Desert Horned Lark from Dakota (21998); gastropods from Carson Valley, Nevada, and shells from Phoenix, Arizona (22077); a comb, snow-shovel, two points, all made of bone, from Upernavik and Disco, Greenland, collected by Dr. F. H. Hoadley (21589).
- MERRICK, Hon. W. M.** (Washington, District of Columbia). A living Macaw (*macao*) from Central America. 21336.
- MERRILL, GEORGE P.** (U. S. National Museum).— A large and important collection of geological specimens from Smithfield, Rhode Island (20847); pebbles from Ellsworth, Maine, and copper from Cornwall, Pennsylvania (21183); rocks from Maine and Nova Scotia (21184); serpentine rock from Pennsylvania (21189); rocks and ores from North Carolina (21188); slate from Pennsylvania (21189); dolomite from North Carolina (21190); rocks and minerals from Pennsylvania (21192); slate from Bangor, Pennsylvania (21193); rocks from Massachusetts (21194); rocks from Maine (21196, 21197); rocks from Keeseville, New York (21198) and from West Concord, New Hampshire (21218); granite from Craftsbury, Vermont (21219); photograph negatives of views taken at Webster, New York (21246); eleven specimens of rocks from Moriah Township, New York (21246); collection of peridotites, mica, dolomite, and contorted schist and rocks from Montville, New York (21247, 21271); one specimen of slag crystal from Iron Mountain, New York (21246); and a large number of specimens of stibnite and associated minerals from Montville, New Jersey (20870).
- MIDDLETON, JAMES D.** (See under Bureau of Ethnology.)
- MIDDLETON, R. MORTON** (Sewanee, Tennessee). Six Rattlesnake fangs. 20881.
- MILLER, ALEXANDER McVEIGH** (Alderson, West Virginia). Two living vipers (*Crotalus*) and a living Turtle (*Chrysemys picta*) (21338).
- MILLER, CHARLES H.** (New York City, New York). Six etchings. (Department of Agriculture) 21016.
- MILLER, Hon. J. S.** (Commissioner of Internal Revenue). Two living Black Bears (20881).
- MILLER, LEROY D.** (Sioux Falls, Dakota). A badge of South Dakota National Guard. 21777.
- MILLER, MILTON** (Washington, District of Columbia). A living Turtle Dove. 21777.
- MILLER, WILLY** (New York City, New York). Twenty-two proofs of woodcuttings. 22136.
- MILLHOLLAND, JAMES A.** (Cumberland, Maryland). A drawing of the boiler-girder-bridge, constructed in 1846 for the Baltimore and Susquehanna Railroad Company. 21078.
- MILLS, WILLIAM** (Chillicothe, Ohio). A flint chisel found near Chillicothe. 21078.

- MILLS, THEODORE A.** (Washington, District of Columbia). A bust of an Apache Indian in plaster (21729); a cast of the head of President Lincoln taken by Clark Mills sixty days before the President's death (21843).
- MILLSPAUGH, Dr. D. T.** (Kendall, New York). Two ethnological objects and one broken arrow-head. 20907.
- MINDELEFF, VICTOR.** (See under Bureau of Ethnology.)
- MINICK, ANDREW** (Seabrook, Maryland). A living Loon (*Colymbus torquatus*). 21458.
- MISSOURI AND PACIFIC RAILROAD COMPANY** (Kansas City, Missouri). Drawings of track standard. 21003.
- MITCHELL, B. F.** (U. S. National Museum). A Sparrow Hawk (*Falco sparverius*) (21116); a Wood Thrush (*Turdus mustelinus*) (21536).
- MITCHELL, E. H.** (Block Island, Rhode Island). A badge of the Republican Association of Rhode Island. 21779.
- MONTANDON, A. L.** (Bucarest, Roumania). Thirty-eight specimens of coleoptera, and 39 specimens of hemiptera from eastern Europe (21846); 84 specimens of heteroptera from the Eastern Hemisphere (exchange.) (21992).
- MOONEY, ANDREW** (Cleveland, Ohio). A masonic badge. 22158.
- MOONEY, BARNEY** (Washington, District of Columbia). Two spalls of red granite from block sent to Washington Monument by the Alexandrian Library, Egypt; one spall of fossiliferous limestone from block sent to Washington by the proprietors of the "Cincinnati Commercial." 21448.
- MOONEY, JAMES** (Washington, District of Columbia). Cherokee pipes collected in 1886 (purchased) (21449); reptiles, insects, mammals, crayfish, and a bird from various localities (21801).
(See under Bureau of Ethnology.)
- MOORE, WILLIAM A.** (Washington, District of Columbia). A French Poodle Dog. 21980.
- MOOREHEAD, WARREN K.** (Xenia, Ohio). A large and valuable collection of prehistoric antiquities, principally from the Ohio River Valley, containing 4,710 specimens, including almost every object known to American archaeologists in the localities investigated. (Deposited.) 21695.
- MORCOM, G. FRENCH** (Chicago, Illinois). A goose, supposed to be a hybrid. 21839.
- MORGAN, Dr. EDWIN L.** (Washington, District of Columbia). Canas roots, eaten by the Indians of Columbia River. 20945.
- MORGAN, Hon. JOHN T.** (U. S. Senate). A living monkey from Manterides, Chili. 21661.
- MORITZ, CELESTE** (Washington, District of Columbia). Two living White Rats. 21056.
- MOSER, Lieut. J. F.** (U. S. Coast and Geodetic Survey). Birds' skins from Florida (21142); marine invertebrates, shells, insects, snakes, and fishes collected at Cape Sable, Florida (21252).
- MOSER, J. H.** (Washington, District of Columbia). Two oil paintings, "Where the Millions Have Gone," and "The Still Hunt." (Purchased.) 20839.
- MOUNT SHASTA CHROME COMPANY** (Hazel Creek, California). Chrome ore. 21163.
- MUCHLOW, GEORGE** (Philadelphia, Pennsylvania). A campaign badge. 21756.
- MÜLLER, Baron FERDINAND VON** (Melbourne, Australia), (through Prof. W. O. Crosby). Specimens of plants from Australia. (Exchange.) 21539.
- MULLET, DICK** (Washington, District of Columbia). Crystal of auriferous pyrite, partially altered to limonite. 21674.
- MURRAY, Dr. S. P.** (Washington, District of Columbia). A living White-fronted Cebus Monkey (*Cebus albifrons*). 21693.
- MUSÉE D'ETHNOLOGIE** (Geneva, Switzerland), (through Dr. H. J. Gosse, director). A collection of Lacustrian pottery and bronzes, including vases, weights, and other objects of clay; bronze bracelets, buttons, pins, rings, instruments, car-rids, collars, fish-hooks, razor, hatchet, lance-head, sickles, knives, and pieces of wire. (Exchange.) 21577.

- MUSÉE D'HISTOIRE NATURELLE (Paris, France). One hundred and ninety-five mens of modern and antique marbles from European and African localities. change). 20872.
- MUSÉE DE ST.-GERMAIN (Paris, France). Molds of bronze implements. (Exchange). 20923.
- MUSEO NACIONAL DE COSTA RICA. A specimen of *Acanthidops bairdi* (21225); small figures in gold and copper (deposited) (21705), and a specimen of *K. (Cenchrus tinnunculus)* from Europe (20994).
- MUSEUM OF COMPARATIVE ZOOLOGY (Cambridge, Massachusetts), (through S. Hensley). A collection of fishes from Europe, South America, Central America, and the Pacific Ocean. 21228.
- MUSEUM OF NATURAL HISTORY (Tiflis, Russia), (through Dr. Gustav Radd). A collection of Caucasian and Transcaspian birds' skins. 21927.
- MUSEO NACIONAL (Rio de Janeiro, Brazil). A collection of rocks and minerals from Brazil. 20900.
(See Prof. Orville A. Derby.)
- MYER, ISAAC (Philadelphia, Pennsylvania). One cast of seal of Darius, King of Persia, and two casts of Babylonian seals. 20849.
- NASH, Dr. F. S. (U. S. Navy Department). A copy of Maj. J. W. Powell's "Introduction to the Study of North American Languages." 20996.
- NATIONAL MUSEUM (U. S.) Bassoon purchased from Bangs & Co., New York. Dr. G. Brown Goode, assistant secretary Smithsonian Institution. 21107.
(See also under George P. Merrill.)
- NAVY DEPARTMENT (U. S. Naval Academy, Annapolis, Maryland). A collection of 59 mounted birds. 21618.
(See under Ensign J. B. Bernadou; Ensign Albert Gleaves; Lieut. Charles H. Pond; Dr. F. S. Nash; Rear-Admiral T. S. Phelps; Lieut. George M. Storrs.)
- NEAL, Dr. J. C. (Archer, Florida). A collection of ethnological objects. 20849.
- NELSON, O. U. (Newark, Ohio). Specimens of stone implements from Licking County, Ohio. 21350.
- NEMEGYEI, B. M. DE (Independence, West Virginia). A specimen of caterpillar from Independence. 21211.
- NEW ENGLAND BROWN STONE COMPANY (Cromwell, Connecticut). Two specimens of building-stones. 22080.
- NEWLON, Dr. W. S. (Oswego, Kansas). A collection of invertebrate fossils—corals (21286); flint implements and fossils (21451).
- NEWMAN, Rev. J. P. (Washington, District of Columbia). Alabastrine mosque in Jerusalem (deposited), (21043); two ancient Roman copper coins (21550).
- NICHOLSON, W. L. (Washington, District of Columbia). Two etchings. 22080.
- NIELSEN, WILLIAM G. (Philadelphia, Pennsylvania), (through W. S. Yeates). A specimen of Georgia beauzite from a deposit in northern Georgia. 21924.
- NOAH, JOHN M. (U. S. National Museum). A counterfeit Mexican coin (21043) taken of 1841 (21415).
- NOLTING, AUGUST H., JR. (Brooklyn, New York). An insect from Brooklyn. 21974.
- NORRIS, H. D. B. (Marshall, Virginia). A living White-headed Eagle and a Great Horned Owl. 21974.
- NYE, WILLARD, JR. (New Bedford, Massachusetts). Stone implements from Peake Bay, Virginia; Martha's Vineyard, Massachusetts, and Seacomet Island, Rhode Island (21504); 3,781 specimens of stone implements collected in Carteret County, North Carolina (21725).
- OAKFORD, Miss ELLEN (New Haven, Connecticut). Seven etchings. (Deposited). 21019.
- OAKMAN, H. P. (Boston, Massachusetts). Souvenir badge of Ohio delegate to the twenty-second national encampment of the Grand Army of the Republic. Three buckeyes. 21141.

- OBERLIN COLLEGE** (Oberlin, Ohio). Seventeen birds' skins, chiefly from Africa, and mostly new to the collection. 21810.
- OFFUTT, F. I.** (U. S. National Museum). A badge of the Oneida Republican Battery (21773); an etching: representation of the engagement between the *Constitution* and the *Guerriere* (22088).
- OLDFIELD, Mrs. CATHERINE CHASE** (Baltimore, Maryland). Four pieces of silver, formerly the property of Judge Samuel Chase, a signer of the Declaration of Independence. 22126.
- OLDHAM, A. S.** (care Hon. P. T. Glass, House of Representatives). Two sets of buckhorns found in Lauderdale County, Tennessee. 20935.
- ORCUTT, C. R.** (San Diego, California). Shells from Lower California (20983); mammals, mammal skin, and a snake from San Diego, California (22058); insects, mostly coleoptera (22108); a collection of fossil fresh-water shells from Colorado Desert (22156); specimens of *Murex Californicus* Hds. and *Tritonidea insignis* Roe, from Lower California (22166).
- ORNITHOLOGY AND MAMMALOGY, BUREAU OF.** (See under Agriculture, Department of.)
- OSBORN, ALLEN B.** (Osbornville, New Jersey). Fresh specimens of Carp caught in a seine at Reedy Point, Metedeconk River, New Jersey. 21946.
- OSBORN, A. O.** (Waterville, New York). A number of fossils found near Waterville, New York. 20956.
- OSBORNE, J. W.** (Washington, District of Columbia). A series of 69 photographs illustrating the progress of photography (20891); a specimen of printing on metal (21477).
- OTAGO UNIVERSITY MUSEUM** (Dunedin, New Zealand), (through T. Jeffrey Parker). A collection of New Zealand fishes containing 41 species. 21074.
- PALMER, JOSEPH** (National Museum). Portions of a book eaten by insects. 20901.
- PALMER, WILLIAM** (U. S. National Museum). A living specimen of Keeted Green Snake from Alexandria County, Virginia. 21280.
- PARKE, DAVIS & Co.** (Detroit, Michigan). A collection of plants. 21500.
- PARKER, CHARLES WOLCOTT** (Newark, New Jersey). A photograph of the feather war-cloak of Kamihaniha III, King of the Sandwich Islands. 21653.
- PARSONS, FRANCIS H.** (U. S. Coast and Geodetic Survey). A very valuable collection of fragments of pottery, collected by the donor and A. B. Symons from an Indian mound near Perdido Bay, Alabama. 21930.
- PARSONS, Misses GRACE and MAUD** (Natural Bridge, Virginia). Four living Angora Goats. 21384.
- PAXTON, GEORGE E.** (Washington, District of Columbia). A specimen of pyrophyllite schist from San Diego County, California. 21673.
- PAYNE, Dr. A. S.** (Markham, Virginia). Arrow and spear-heads from Virginia. 21335.
- PATENT OFFICE.** (See under Interior Department.)
- PEALE, Dr. A. C.** (U. S. Geological Survey). Wood-opal collected by donor from Gallatin County, Montana (21457); pyrite concretions from Glendive, Montana; also sandstone, limestone, and baked clay from Dakota (21638). (See under Interior Department, U. S. Geological Survey.)
- PEARCE, RICHARD** (Argo, Colorado). Nineteen specimens of various minerals from the Tintic District, Utah, and one specimen of smithsonite from Salida, Colorado. 21526.
- PECKHAM, S. F.** (Providence, Rhode Island). An interesting collection numbering 350 specimens of petroleum and related materials, made by the donor in connection with his work for the Tenth Census. 22176.
- PEEBLES, D. BRUCE** (Edinburgh, Scotland). Pith of the rush from Orkney Islands, used as a lamp-wick. 20965.
- PENFIELD, S. L.** (See under Interior Department, U. S. Geological Survey.)
- PENN, R. HAYDEN** (Buchanan, Virginia). Four Confederate notes. 21847.

- PENNSYLVANIA RAILROAD COMPANY (Philadelphia, Pennsylvania). Packet-book (photograph) used in past years on the Columbia Canal (purchased) (2083); model of a Conestoga wagon (purchased) (20864); and model of running-gear stage-coach used between Philadelphia and Pittsburgh in 1825 (purchased) (21079).
- PENNYPACKER, C. H. (West Chester, Pennsylvania). Specimens of minerals from various localities. 21031.
- PERKINS, Prof. G. H. (Burlington, Vermont). A box of stone implements from Vermont. (Exchange.) 20878.
- PERRY, N. H. (South Paris, Maine). Minerals (21145); and minerals in exchange from Peru and Standish, Maine (21474).
- PETTIGREW, J. A. (Sioux Falls, Dakota). A specimen of *Lepus campestris*. 2158.
- PFORDE, OTTO F. (Lima, Peru), (through W. S. Yeates). Eight minerals from Franklin, New Jersey. 22019.
- PHELPS, Rear-Admiral T. S. (U. S. Navy), (through Dr. J. M. Flint). A fragment of the Napoleon willow at St. Helena, procured in 1884. 21875.
- PHILLIPS, PHELPS & HOVEY (New York City, New York). Models of sleeping-berths. 22175.
- PHILLIPS, E. EVERETT (Jersey City, New Jersey). A badge of the Toffy Guard, Jersey City, New Jersey. 21778.
- PHILLIPS, F. L. (Madison, Wisconsin). A medallion of Gen. Lucius Fairbank, Commander-in-chief Grand Army of the Republic, 1887. 20875.
- PHILLIPS, HENRY, Jr. (Philadelphia, Pennsylvania). A set of the silver and bronze coinage of the Congo Free State; also one medal. (Deposited.) 21499.
- PHOTO-ENGRAVING COMPANY (New York City, New York). Twenty-four proof-plates of relief process-work. 21028.
- PHOTOGRAVURE COMPANY (New York City, New York). Twenty-two proofs of photogravures and gelatine prints. 21026.
- PILLING, JAMES C. (U. S. Geological Survey). A living Screech Owl (*Megascops asio*). 21511.
- PILSBRY, H. A. (Philadelphia, Pennsylvania). Eleven specimens of shells (21011 specimens of land and marine shells (22038); three species of land and water shells. 22106.
- PINTARD, E. L. (Philadelphia, Pennsylvania). A journal, "The Philadelphia Photographer," 1867-'77. (Deposited.) 21059.
- PITTSBURGH REDUCTION COMPANY (Pittsburgh, Pennsylvania). Specimens of iron, num, ingot, and foil. 21969.
- PLEAS, E. (Dunreith, Indiana). Stone implements from Henry County, Indiana and Van Buren County, Arkansas. 21440.
- POLING, OTHO (Quincy, Illinois). Specimens of birds' eggs. 20902.
- POND, Lieut. CHARLES F. (U. S. Navy). Rocks, minerals, and petrified wood from Lower California (21272); dried plants from San Benito and Cerros Islands, Lower California (21736); and a collection of plants from Cerros Island and San Bartolome Bay (21882).
- PORTUGAL, GEOLOGICAL COMMISSION OF. (See under Geological Commission of Portugal.)
- POTTER, Rev. J. L. (Drakesville, New Jersey). A complete suit of a Persian Median priest, from Teheran, Persia. (Purchased.) 21865.
- POWELL, Maj. J. W. (Washington, District of Columbia). Native copper from Houghton, Michigan (21407); two feet of the Harpy Eagle (*Thrasaetus harrisi*) from South America (21454); and dog's-head handle of agatized wood from Chalcedony Park, Arizona (21936).
(See under Interior Department, U. S. Geological Survey; also Bureau of Ethnology.)
- POWER, MAURICE J. (New York City, New York). A bust of George Washington in bronze. This is a copy of the life-cast made by Houdon, in 1785. 21783.

- POWER**, Rev. F. D. (Washington, District of Columbia). Six shark teeth from Virginia. 21796.
- PRANG**, L., & Co. (Boston, Massachusetts). A collection of chromolithographs illustrating the process of reduction on India-rubber machines. 21481.
- PRANG**, LOUIS (Roxbury, Massachusetts) Four specimens of steno-chromic printing. 22027.
- PRATT**, N. P. (Atlanta, Georgia). A large corundum crystal from Georgia. (Exchange.) 21934.
- PRENTISS**, Dr. D. W. (Washington, District of Columbia). Specimens of reptiles from various localities; also specimen of fish, locality unknown. 21867.
- PRENTISS**, E. F. (Providence, Rhode Island). Various campaign badges. 21160.
- PRESTON**, E. D. (U. S. Coast and Geodetic Survey). Specimens of lava from the Sandwich Islands. 21704.
- PRICE**, THOMAS (San Francisco, California). A meteoric stone from San Bernardino County, California. 22111.
- PRICE**, WILLIAM W. (Tombstone, Arizona). A set of eggs of Sulphur-bellied Fly-catcher (20855); four birds' eggs, new to the Museum collection (20982).
- PRINDLE**, A. T. (Edinburgh, Pennsylvania). A butterfly from Pennsylvania. 22164.
- PRINDLE**, GEORGE S. (Washington, District of Columbia). Two living alligators. 21744.
- PRITCHARD**, A. L. (Pleasantville, New York). One thousand pounds of dolomite (snowflake marble.) (Purchased.) 21423.
- PROTZMAN**, Miss EMMA (Morgantown, West Virginia), (through Mr. Walter Hough). A Dutch-oven and an old brass candlestick. 21133.
- PROUDFIT**, S. V. (Washington, District of Columbia). Stone implements from Flint Ridge, Licking County, Ohio. 21438.
- PROVINCIAL MUSEUM** (Victoria, British Columbia), (through John Fannin, curator). Twenty-seven specimens of birds from Victoria, British Columbia. 21690.
- PUBLIC MUSEUM OF MILWAUKEE** (Milwaukee, Wisconsin). A cast of a peculiar skull. 21909.
- PUTNAM**, Prof. F. W. (Cambridge, Massachusetts). A friction-match (20904); turtle from Analostan Island, District of Columbia (21913).
- QUEEN**, GEORGE W. (Chicago, Illinois). A campaign badge. 21758.
- QUICKSILVER MINING COMPANY** (San Francisco, California). Twenty specimens of quicksilver ores from the New Almaden Quicksilver Mines, Santa Clara County, California (20886); pure quicksilver and acid-water (21898); and samples of quicksilver ores (21955).
- QUINN**, W. M. (Apalachicola, Florida), (keeper of the Cape San Blas light house). Twelve turtles. 21002.
- RADDE**, Dr. GUSTAV. (See under Museum of Natural History, Tiflis.)
- RADTKE**, LAUCKNER & Co. (New York City, New York). One dry-point, "An Idyl," by William H. Lippincott. 20835.
- RAGSDALE**, G. H. (Gainesville, Texas). Two birds' skins (20909); shells from Rockwell County, Texas (21949); a collection of fossil shells and a skull of Pouched-rat (*Perognathus fasciatus*) (21234).
- RAND**, THEODORE D. (Philadelphia, Pennsylvania). Serpentine rock from Pennsylvania (21331); minerals, in exchange, from Pennsylvania, and Carinthia, Austro-Hungary (21935).
- RANDOLPH**, N. V. (Richmond, Virginia). A badge of the Army of Northern Virginia. 20922.
- RASCH**, Dr., and **JENSSEN**, C. (Copenhagen, Denmark). A valuable collection of north European mosses and algae. (Exchange.) 21585.
- RATHBUN**, RICHARD (Smithsonian Institution). Five species of Devonian fossils from Brazil. 21352.

- RAYMOND, W. J. (Oakland, California). Two specimens of shells (20869); ten
mens of fossil shells from California (22144).
- REED, R. L. (U. S. National Museum). A Welsh crwth, made by R. L. Reed,
description in Hawkins's History of Music, Vol. II. 21918.
- REED, Dr. THOMAS J. (Great Falls, Montana). Two living Sparrow Hawks.
- REID, H. (Woodbridge, Virginia). Four living Gray Squirrels (21973); conts
gray squirrel's nest (22056).
- REY, Dr. E. (Leipzig, Germany). A valuable collection of birds' skins, many
specimens unrepresented in the Museum (purchased). 21045.
- REYNOLDS, E. M. (Warwick, New York), (through W. S. Yeates). Seven mi
from Franklin, New Jersey. 22012.
- REYNOLDS, E. R. (Washington, District of Columbia). A collection of 500
implements from various localities in France (purchased) (21386); n
implements from the District of Columbia, Maryland, and Virginia (
- RHODE ISLAND DOMESTIC SOCIETY (Providence, Rhode Island). The origin
tificate of authenticity of the old carding and spinning-frame made in 1
Samuel Slater. 20906.
- RICE, Prof. WILLIAM NORTH (Middletown, Connecticut). Collection of masks
posited.) 21591.
- RICE, Hon. WILLIAM T. (U. S. consul, Horgen, Switzerland). A collection of
silver, and gold coins from Japan, China, and India. 21398.
- RICHARDSON, MAX B. (Oswego, New York). Specimens of Indian clothing
posited.) 21596.
- RICHMOND, C. W. (U. S. Geological Survey). Two specimens of Red Crossbill
curvirostra minor) from Washington, District of Columbia. (Exchange.) 2
- RICKSECKER, L. E. (Santa Rosa, California). Twenty-nine specimens of M
Coleoptera collected at Guerrero, Mexico. (Purchased.) 21347.
- RIDGWAY, AUDUBON (Washington, District of Columbia). A specimen of Ol
Darter (*Boleosoma olmstedii*). 21849.
- RIDGWAY, ROBERT (U. S. National Museum). Birds' skins from Maryland, Dis
Columbia, Virginia, Indiana, and Illinois (21041); 11 birds from Laurel,
land (21553); a specimen of Carolina Chickadee (21850); 27 birds' skin
Laurel, Maryland (22081, 21978).
- RIEHL BROTHERS (Philadelphia, Pennsylvania). A photograph of a 300,
testing machine (21291); specimens of aluminum bronze (21723).
- RIGBY, JAMES (Minneapolis, Minnesota). A model of a car-wheel and a por
wheel showing cross-section. 21612.
- RIGHTON, Miss MARY (Edenton, North Carolina). A Confederate fifty-dollar
22047.
- RILEY, Prof. C. V. (Department of Agriculture). Four specimens of "Awe
fungus growing from the body of a caterpillar found in New Zealand. (21
(See under Agriculture, Department of.)
- RINGER, T. (Nagasaki, Japan). A very interesting collection of Japanese bird
taining 109 specimens, representing 74 species from southern Japan. Amo
chief attractions is a fine male of the true Somering's Pheasant (*Pha
serritillans*) and a Spoon-billed Sandpiper (*Euryorhynchus pygmaeus*). 21
- RIVERS, J. J. (Berkeley, California). Fifty-five shells. 21406.
- ROBINSON, Lieut. WIRT (Fort Adams, Rhode Island). Birds' skins from Vir
21662.
- ROCKHILL, W. W. (Washington, District of Columbia). A scroll-picture, in c
of life in Chinese Turkestan (21260); religious objects from northern Chin
Thibet (deposited) (21261).
- ROCKHILL, Mrs. W. W. (Washington, District of Columbia). Five musical in
ments from Peking, China (21317); dress of a Chinese Tartar woman (depo
(21318).

- ROESSLER, A. R.** (Burnet City, Texas). A slab of lithographic stone from Burnet City, Texas. 21926.
- ROMEYN, Capt. HENRY** (Fort Ringgold, Texas). Two living Mexican Wildcats (purchased) (21931); three living Chachalacas (*Ortalis vetula maccalli*) from Fort Ringgold, Texas (purchased) (22050).
- ROSS, CHARLES J.** (Burlington, New Jersey). A collection of twenty-one drawings. 21442.
- ROWE, A. P.** (Spruce Pine, North Carolina), (through W. S. Yeates). Four minerals from Mitchell County, North Carolina. 22043.
- ROWE, E. S.** (Washington, District of Columbia). A Strawberry Finch. 21718.
- ROWLAND, THOMAS** (New York City, New York). Two birds' skins (purchased) (20910); six birds' skins from North America (purchased) (20794).
- ROWLAND, WALTER** (Allison, Massachusetts). Twenty-four engravings by Smillie and Hinshelwood, and others from Graham's Magazine. 21390.
- ROYAL BOTANICAL GARDENS** (Trinidad, West Indies). Frogs from Trinidad. 21986.
- ROYAL BOTANICAL GARDEN** (Seebpore, India). An exceedingly valuable collection of mounted plants from India. (Exchange.) 21220.
- ROYAL GARDENS** (Kew, England). One hundred and ninety specimens of vegetable economic products, etc., comprising textiles, foods, gums, materia medica, botanical and ethnological specimens. 20488.
- ROYAL MUSEUM** (Berlin, Germany; Baron Schone, director). A series of casts of Assyrian and Egyptian antiquities. 21353. The following is a list of the casts sent:

EGYPTIAN.

- Seated figure of Osiris, found at Saggarah, in a tomb of the Thirtieth Dynasty. Bulag Museum, Cairo.
- Female mask of a marble sarcophagus lid. Berlin Museum.
- Limestone bust of Amenophis I (Eighteenth Dynasty). Turin.
- Colossal gray granite bust of Thothmes III (Eighteenth Dynasty). Turin.
- Colossal bust of Amenophis II (Eighteenth Dynasty), found at Karnak. Turin.
- Small limestone head with helmet. Turin.
- Bust of Horus (granite). Bulag Museum.
- Royal head of Eighteenth Dynasty. British Museum.
- Beardless bust of Rameses II, wearing helmet. Turin.
- Egyptian study head (limestone). Turin.
- Egyptian study head (limestone). Turin.
- Egyptian study head (limestone). Turin.
- Egyptian study head (limestone). Turin.
- Colossal head of a queen of the Eighteenth Dynasty, discovered at Thebes. Bulag Museum.
- Small Egyptian head. Berlin Museum.
- Limestone male bust of the most ancient period. Bulag Museum.
- Hermes (limestone). Bulag Museum.
- Egyptian study head (limestone). Turin.
- Egyptian head of Eleventh Dynasty (basalt). Berlin Museum.
- Stele of Amenophis I (Eighteenth Dynasty). Turin.
- Small limestone stele of Rameses II. Turin.
- Upper part of the figure of a queen. Rome.
- Stele of the priestess Hor-em-hat (limestone). Turin.
- Fragment of walking sphinx (limestone). Turin.
- Female bust (limestone). Louvre, Paris.
- Rameses III (limestone). Thebes.
- Two heads of Asiatic prisoners from Medinet. Habu (limestone).
- Assyrian stele with the figure of King Sarjon (722-705 B. C.), the conqueror of Samaria. From Cyprus. Berlin Museum.

ASSYRIAN.

- Priest and eunuch (alabaster). Berlin Museum.
 Worship of sacred tree (alabaster). Berlin Museum.
 Winged eagle-headed figure (alabaster). Berlin Museum.
 Four warriors with spear and shield (alabaster). Berlin Museum.
 Two warriors with bow and arrow (alabaster). Berlin Museum.
 War chariot with four warriors.
 Warrior with a bull (alabaster). Berlin Museum.
 Military camp in front of a fortress (alabaster). Berlin Museum.
 King with two armor-bearers and a eunuch (alabaster). Berlin Museum.
 Two servants in front of a table (alabaster). Berlin Museum.
 King on a lion hunt (alabaster). Berlin Museum.
 King slaying a lion (alabaster). Berlin Museum.
 Flute-player in front of a palm (alabaster). Berlin Museum.
 Head of a winged figure with priest's hat (alabaster). Berlin Museum.
 Head of the Ethiopian king Tahorka (limestone). Turin.
- ROYAL ZOÖLOGICAL MUSEUM (Florence, Italy), (through Prof. Henry H. Gilchrist, director). A collection embracing 150 specimens of fishes, 32 reptiles, 234 birds, and 24 mammals. 21620.
- RUDD, Miss LIZZIE (Washington, District of Columbia). Two live Gray Rabbits. 20899.
- RUSSELL, I. C. (U. S. Geological Survey). Two maps of Lake Manito, California (21300); 65 photographs of various geological views (21426).
- RUSSELL, JAMES, & SON (Baltimore, Maryland). Several ethnological objects. 21959.
- RUSSELL, MARY E. (Wilmington, North Carolina). Specimens of sponges, and a pharyngeal bone of a fish. 21604.
- RUST, HALBERT (Jeffersonville, Indiana). Seven hundred and fifty-six specimens of stone and bone implements from near Clarksville, Indiana (21498); 96 specimens from Indiana (22006).
- RUST, H. N. (South Pasadena, California). Eighteen stone implements from southern California finds near ancient Californian villages. 21425.
- RYLAND, Rev. R. (Richmond, Virginia). Samples of lightwood from Virginia. 21051.
- RYNDERS, RUBEN (Troy, New York). Several campaign badges. 21732.
- SAGE, J. H. (Portland, Connecticut). A nest and four eggs of Blue-winged Teal (*Helminthophila pinus*) and one egg of Cowbird (*Molothrus ater*). 21375.
- SAMUEL, B. F. (Poplar Plains, Kentucky). A beetle from Kentucky. 22147.
- SARTAIN, JOHN (Philadelphia, Pennsylvania). Two mezzotint engravings (21113); a mezzotinted plate (22113); and a collection of tools and proofs illustrating the process of mezzotinting (21463).
- SCHAFERT, E. F. (Media, Pennsylvania). Skeleton of Rose-breasted Cockadee. 21095.
- SCHIEFFELIN, W. H., & Co. (New York City, New York). Samples of drug and mineral medicines. 21403.
- SCHMID, LOUIS (Washington, District of Columbia). A parrot. 22134.
- SCHMID, LOUIS & SON (Washington, District of Columbia). Two living alligators (20969); skeleton of parrot (21202); and an Angora Cat (21380).
- SCHOENHOF, CARL (Boston, Massachusetts). Two woodcuts and "Aners' polygraph apparatus," containing specimens of various engraving and printing processes. (Purchased.) 21710.
- SCHREIBER, W. A. H. (Webster, North Carolina), (through W. S. Yeates). Twelve mineral specimens from Webster, North Carolina. 22026.

- SCOTT, Mrs. W.** (Sujerat, Bombay Presidency, India). Silk and cocoons (21700); Tusser silk cocoons from Sadra, India (22110).
- SCOVILLE MANUFACTURING COMPANY** (New York City, New York). Five photographic cameras and one extension tripod. 21098.
- SEELY, Prof. H. M.** (Middlebury, Vermont). Specimens of calciferous fossils from New York and Vermont. 21716.
- SEIP, JOHN** (Chi licothe, Ohio). A fragment of a drilled ceremonial object, and a grooved ax-shaped object. 21359.
- SELLNER, JOHN** (Camp Spring, Maryland). A Gray Squirrel's nest. 21893.
- SENNÀ, ANGELOS** (Pavia, Italy). Seven European bats. (Exchange.) 21515.
- SHANNON, J. PRESTON** (U. S. National Museum). Two badges of the Cincinnati Exposition. (Deposited.) 21148.
- SHARPLES, S. P.** (Boston, Massachusetts). A specimen of native gold from Little Annie Mine, Del Norte, Colorado. 21600.
- SHELBY IRON COMPANY, THE** (Shelby, Alabama). Ore, charcoal, lime, cinders, pig-iron, feldspar, and kaolin from Shelby, Alabama. 21676.
- SHERMAN, Hon. JOHN** (U. S. Senate). A specimen of polydymite from the mines of the Canadian Copper Company, near Sudbury, Ontario, Canada. 21643.
- SHINDLER, A. ZENO** (U. S. National Museum). Two living alligators. 20988.
- SHIPLEY, SAMUEL** (Washington, District of Columbia). A living Owl (*Asio accipitrinus*) from Arlington, Virginia. 21394.
- SHIRLAW, WALTER** (New York City, New York). One etching by the donor, entitled "The Reprimand," after Eastman Johnson. 20836.
- SHOCK, WILLIAM H.** (Washington, District of Columbia). A fossil fish from Missouri. 21742.
- SHORTER, WILLIAM** (Washington, District of Columbia). A Ferret (*Putorius fatidus*). 21873.
- SHROCK, JACOB M.** (Newark, Ohio). Two plates of mica found near Newark. 21356.
- SHUFELDT, Dr. R. W.** (Fort Wingate, New Mexico). A living Rattlesnake from New Mexico (20917); a skin of Western Red-tailed Hawk (21096); a Hawk (*Buteo swainsoni*) from New Mexico (21231); a Long-billed Marsh Wren (*Cistothorus palustris paludicola*) from Fort Wingate (21233); Field Mice and Pocket Mice (21254); a Pigeon Hawk (*Falco columbarius*) (21398); two birds' skins from San Pedro Martir Island, Gulf of California (21410).
- SHUFELDT, Dr. R. W., and JOHN G. MORSE** (Fort Wingate, New Mexico). Eight batrachians collected in New Mexico. 20915.
- SHUGIO, HIEROMICH** (New York City, New York). A fan-shaped head of a royal arrow from Japan. 21737.
- SHUTT, Col. GEORGE W.** (Hillsborough, Virginia). A living Hog-nose Snake (21224); 95 specimens of Oriskany (Devonian) fossils from Pendleton County, West Virginia (21630); a living Wood Rat; a Wood Rat in flesh from Hillsborough, Virginia (21647); a Barred Owl (*Syrnium nebulosum*) (21971); twenty-two living snakes from Virginia (22049, 22067, 22085, 22139).
(See under Interior Department, U. S. Geological Survey.)
- SIEBERT, A. J.** (New York City, New York). Nine doilies and one pillow-sham, decorated by platinotype. 20892.
- SILER, A. L.** (Upper Kanab Ranch, Utah). A chipped stone implement from an ancient pueblo in Arizona. 21349.
- SIMPSON, J. M.** (Washington, District of Columbia). A living Screech Owl (*Megascops asio*). 21471.
- SINCLAIR, P. J.** (Mariou, North Carolina), (through W. S. Yeates). A blank tourmaline crystal from near Statesville, North Carolina. 22029.
- SINCLAIR, S.** (See under Australian Museum.)
- SISSON, C. W.** (Washington, District of Columbia). Alligator (*Alligator mississippiensis*). (Purchased.) 21813.

- SKINNER, T. E. (U. S. National Museum). Specimens of shells, fossil shells, and oysters. 21054.
- SLOCUM, Capt. JOSHUA (Washington, District of Columbia), (through Prof. Mason). A shell ax from Barbadoes, West Indies. 21594.
- SMILLIE, Miss L. E. (Washington, District of Columbia). One dozen doilies, designed by platinotype. 20925.
- SMILLIE, T. W. (U. S. National Museum). Specimens of medal-ruling applied gravely directly from fossil shells, etc. 21494.
- SMITH, D. B. (Mount Carroll, Illinois). A cranium of a dog. 21001.
- SMITH, Dr. HUGH M. (U. S. National Museum). Four birds from Virginia and a Meadow Mouse with three young, from Sea Isle City, New Jersey (21514).
- SMITH, HORACE P. (See under Cincinnati Society of Natural History.)
- SMITH, HUBBARD T. (Washington, District of Columbia). A White-throated Monkey from South America. 21997.
- SMITH, JAMES R. (Newark, New Jersey). Wooden joint-block with sections used by the New Jersey Railroad Company in 1865; also bell of the locomotive "Railway," 1838, one of the earliest bells in use on a locomotive in America. 21489.
- SMITH, Dr. SANDERSON (New York City, New York). Seven specimens of serpentine, talc, and jade. 20846.
- SMITH, W. R. (Superintendent of Botanic Garden). A living Cockatoo (*Cacatua alba*) from Australia (21538); two game fowls (21976).
- SMYTH, J. S. (Williamsport, Pennsylvania). Two army badges. 21248.
- SNOW, F. P. (Salem, Kansas). A Wasp (*Peloponns lunatus*) from Kansas. 22000.
- SNOW, Lieut. W. F. (Oneida, Madison County, New York). A badge of the Republican Battery. 21771.
- SOLOMONS, Miss ALINE (Washington, District of Columbia). Two Egyptian scarabs. 20963.
- SOLWAY PROCESS COMPANY (Geddes, New York). Samples of raw materials and products of manufacture of soda. 22084.
- SOMERS BROTHERS (Brooklyn, New York). Specimens illustrating printing and bookbinding. 21941.
- SOUTHWICK, JAMES M. (Providence, Rhode Island). Three mineral specimens (20845); a Pin-fish (*Diplodus rhomboides*) (22138).
- SPAINHOUR, Dr. J. M. (Lenoir, North Carolina). A spider from North Carolina (21063); specimen of asbestos (21267).
- SPEEL, FRED (Philadelphia, Pennsylvania). A Toad Fish (21204); fish caught in the Mediterranean on the African coast (21304).
- SPEER, R. P. (See under State Agricultural Experiment Station, Ames, Iowa.)
- SPINNER, Gen. F. E. (Pablo Beach, Florida). Five specimens of shells. 21000.
- SPITZER, ARTHUR A. (Richmond, Virginia). A badge of the "R. E. Lee" Regiment. 20944.
- STABLER, HAROLD P. (Sandy Spring, Maryland). A Broad-winged Hawk and a Screech Owl (*Scops asio*) from Maryland (21572).
- STABLER, JAMES P. (Sandy Spring, Maryland). A Red-tailed Hawk (*Buteo lineatus*) (21627).
- STANDARD MINERAL COMPANY (New York City, New York). A specimen of mineral from New York. 20989.
- STANFORD, Hon. LELAND (U. S. Senate). A living antelope from Texas. 21000.
- STARKWEATHER, GEORGE B. (Washington, District of Columbia). A living antelope from Rock Creek, District of Columbia. 21281.
- STATE AGRICULTURAL EXPERIMENT STATION (Ames, Iowa), (through R. P. Speer, director). A collection of insects. (Exchange.) 21464.
- STATE, DEPARTMENT OF (through Hon. T. F. Bayard). Photographs of Virginia Indians (21244); a valuable and interesting collection of textile fabrics from the same source. 21000.

STATE, DEPARTMENT OF—Continued.

- worsted, silk, cotton, mohair, and alpaca, made by William F. Grinnell, United States consul at Bradford, England (21420); samples of wool collected by the United States consul at Sydney, New South Wales (21340); a collection of ores, consisting of twenty-four specimens, made by Otto E. Reimer, United States consul at Santiago de Cuba (21421); a collection of water-color sketches, and photographs of Samoan scenery and life (21636); samples of wool from the Argentine Republic (21726); iron ore, coal, and coke from Brazil, and specimens of shale showing impressions of bark or plant (21782); samples of ramie from France transmitted by Consul Mason, at Marseilles, France (21911).
- STATE NORMAL SCHOOL** (Winona, Minnesota). Insects and crustacea from Winona, Minnesota (21542); specimens of plants from Minnesota (21583); and shells (*Unios*) from the Mississippi River, near Winona, Minnesota (21636).
- STAUNTON, F. W. S.** (Tombstone, Arizona). Three specimens of cuprodescloizite from "Lucky Cuss" mine, Tombstone, Arizona. 21834.
- STEARNS, R. E. C.** (U. S. National Museum). Coal from Letheridge, Province of Alberta, Canada (21617), fifteen specimens of color-printing (21999).
- STEJNEGER, Dr. L.** (U. S. National Museum). A House Snake (*Ophibolus*) from Roslyn, Virginia (21857); a Tortoise (*Cistudo carolinus*) from District of Columbia (22152).
- STEPHENSON, J. A. D.** (Statesville, North Carolina), (through W. S. Yeates). One hundred and six minerals from Alexander and Iredell Counties, North Carolina. 22020.
- STERLING, Dr. E.** (Cleveland, Ohio). A beetle from Cleveland, Ohio. 20860.
- STUART, C. A.** (U. S. National Museum). A gas-lighting attachment (21558); a badge of the Cleveland Grays (21769).
- STEVENS, Miss MARY** (Georgetown, Massachusetts). A living opossum. 21582.
- STEVENS, RICHARD F.** (Jersey City, New Jersey). A copy of the "Federal Gazette" of January 1, 1872, containing an article on "Early Steamboating." 20850.
- STEVENSON, Col. JAMES** (U. S. Geological Survey). (See under Bureau of Ethnology.)
- STEVENSON, Mrs. MATILDA C.** (Washington, District of Columbia). Collection of blankets, basketry, pottery, religious objects, etc., from Moki and Zuni pueblos. (Purchased.) 21664.
- STEVENSON, J. J.** (University of the City of New York). Samples of crude petroleum from Pennsylvania, Ohio, and West Virginia. (Exchange.) 21954.
- STEWART, CHARLES** (Perthshire, Scotland). A cruisegean (lamp); also piece of wick used on same. 21706.
- STEWART, JAMES M.** (Washington, District of Columbia). Author's manuscript and printed copy of Washington eulogy. 20980.
- STILWELL, E. M.** (Bangor, Maine), (through Robert Edes). Two specimens of Land-locked Salmon (*Salmo sebago*) from Sebago Lake, Maine. 21379.
- STILWELL, L. W.** (Deadwood, Dakota). Seven specimens of crustaceous fossils. 22052.
- STONE, Mrs. E. J.** (Washington, District of Columbia). Specimens of crabs from Cape May, New Jersey (21070); map of Washington engraved in 1818; fac-simile of original Declaration of Independence; mahogany stereoscope containing daguerreotype views of Niagara taken 1853 to 1858; shell-basket made about 1858 (21086), and cooking implements (deposited) (21419).
- STONE, HENRY D.** (Benning's, District of Columbia). A living Muskrat from the Eastern Branch of the Potomac. 21516.
- STONE, LIVINGSTON** (Clackamas Station, Oregon). A specimen of fungus found growing in a fir log (20959); two stone axes used by the Indians on McCloud River, California (21035).
- STONE, SOLON B.** (Fort Shaw, Montana). Specimens of conglomerate from the Sun River, Fort Shaw, Montana. 21652.

- STONE, Lieut. GEORGE M. (U. S. Navy). A deer-skin coat, trowsers, boots, cap, and sleeping-bag from Eskimo of Kotzebue Sound, Alaska. 21263.
- STOVER, JOSEPH (Silver Cliff, Colorado). A specimen of ore from the Cash Lode, Colorado. 20953.
- STOUGHTON, T. M. (Turner's Falls, Massachusetts). A slab of fossil footprints (Purchased.) 21982.
- STREATOR, GEORGE J. (Garrettsville, Ohio). Ten specimens of land and fresh-water shells from West Indies, Ohio, and California. 21812.
- STRINGFELLOW, F. J. (Crewkerne, Somersetshire, England). An engine, propeller, etc., for aerial purposes. 21806.
- STRODE, Dr. W. S. (Bernadotte, Illinois). Stone relics from Illinois (20929); Horned Owl (*Bubo virginianus*) (21972).
- STRONG LOCOMOTIVE COMPANY (New York City, New York). A photograph of a steam-engine. 21814.
- STRUTHERS, JOSEPH & Co. (New York City, New York). A collection of proof blocks made by the wax process. 20874.
- STURTZ, B. (Bonn, Prussia). Rocks from Europe and Brazil. (Exchange.) 21812.
- SULZBERGER, DAVID (Philadelphia, Pennsylvania). A shofar, or ancient Jewish trumpet, made of a ram's horn. 22131.
- SUTTON, Miss GEORGIE, (Westmoreland County, Virginia). A living raccoon. 21445.
- SWAN ISLAND CLUB (Norfolk, Virginia). One hybrid duck (*Anas boschas*, *aucauta*) from Swan Island, North Carolina. 21462.
- SWAN, JAMES G. (Boston, Massachusetts). Ethnological objects from Queen Charlotte Islands, and Vancouver Island, British Columbia (purchased); specimens of bats, shells, echinoderms, and shrimps from Port Townsend; a snake from the China seas. (21739.)
- SWAN, Mrs. J. THOMPSON (Washington, District of Columbia). A photograph of the locomotive "De Witt Clinton." 21905.
- SWEENEY, T. W. (U. S. National Museum). A pair of candle-snuffers. 20973.
- SWITZER, Mrs. MARY (Rockbridge, Virginia). Three eggs taken from a land tortoise at Vesuvius, Virginia. 22119.
- SYLVESTER, H. E. (Boston, Massachusetts). Eight proofs of wood engravings. (posited.) 21029.
- SYMONS, A. B. (See under Francis H. Parsons.)
- TABLER, HOWARD (Seabrook, Maryland). A living tortoise. 21081.
- TAVERA, CHEVALIER SCHMIDT VON (minister from Austro-Hungary). An ethnological map of Hungary. 21269.
- TAYLOR, HENRY REED (Alameda, California). Specimen of Black Rail (*Porzana maicensis*). 21048.
- TAYLOR, Dr. J. S. (Mobile, Alabama). Fragments of pottery from Baldwin County, Alabama. 21282.
(See under Bureau of Ethnology.)
- TAYLOR, Dr. THOMAS (Department of Agriculture). Four photo-micrographs of insects. 20912.
- TAYLOR, THOMAS (Four Mile Run, Virginia). A Black-crowned Night Heron. 21842.
- TAYLOR, W. (Burgaw, North Carolina). An insect, and cocoon of yellow wax moth. 22168.
- TAYLOR, WILLIAM (San Diego, Texas). A stone implement from Texas. 21181.
- TAYLOR, WILLIAM M. (Mount Jackson, Pennsylvania). A few Indian relics. 20912.
- THOMPSON, C. A. (Quincy, Michigan). A specimen of stone-carving from a mine near Coldwater, Michigan. 21574.
- THOMPSON, Col. FRANK (Morgantown, West Virginia). A canteen of 1863. 21181.
- THOMPSON, GREENLAND (Morgantown, West Virginia). Muffin-rings, an earthenware keg, and an old wooden lock. 21135.

- THOMPSON-HOUSTON ELECTRIC COMPANY** (Boston, Massachusetts). Two photographs of electric motors for street-railway (21346); five photographs illustrating the construction of electric motors (21478).
- THOMPSON, MATTHEWS** (Philadelphia, Pennsylvania). A badge of the United Republicans of Philadelphia. 21765.
- THOMSON, JAMES and GEORGE** (Clydebank, Dumbartonshire, Scotland). Photographs of the transatlantic steamships *Serria* and *City of New York*. 21327.
- THORN, E. P.** (Youngstown, Ohio). A string of beads from the Sandwich Islands. 21315.
- THORNE, Capt. P. M.** (Fort Keogh, Montana). An Albino Western Meadow Lark (*Sturnella neglecta*) from Port Lyon, Colorado (21427); specimens of birds' skins from Montana (21701); a Western Savanna Sparrow (*Ammodramus sandwichensis alandinus*) (21461).
- THORPE, Dr. H. H.** (Liberty Hill, Texas). A small flint implement. 21174.
- THRUSTON, Gen. G. P.** (Nashville, Tennessee). A fragment of pottery from near Nashville. 21329.
(See under Bureau of Ethnology.)
- TIFFANY & Co.** (New York City, New York). A collection of carved ivory figures (purchased) (21229); eight watches of various designs (purchased) (21230). This firm presented a metal copy of the original memorial tablet designed to commemorate the services of the Charleston relief committee during the earthquake in 1886. The cast was made by permission of the ex-mayor, William A. Courtenay, of Charleston, South Carolina (21301.)
- TILFORD, H. J.** (Louisville, Kentucky). A petrified oyster from Crosby County, Texas. 21077.
- TILTON, JAMES P.** (Newburyport, Massachusetts). Five fragments of pottery from Plum Island, Massachusetts. (Exchange.) 21824.
(See under Bureau of Ethnology.)
- TOBIAS, H.** (Cuthbert, Georgia). A petrified rat. 21348.
- TOKYO LIBRARY AND TOKYO EDUCATIONAL MUSEUM** (Tokyo, Japan), (through M. Namiye). Two specimens of Namiye's Woodpecker from Japan (21586); plants from Japan (21961).
- TOLSON, Master THOMAS H.** (Shaurock, King George County, Virginia). A White-headed Eagle, captured by the donor. 20880.
- TOOKER, W. W.** (Sag Harbor, New York). A notched stone ax, found at the foot of a bluff in Sag Harbor, New York. 21506.
- TOWNSEND, CHARLES H.** (U. S. Fish Commission). A living Mexican Spider Monkey. 20927.
(See under Lee, Prof. L. A. and Thomas.)
- TOWNSEND, F. J.** (Painted Post, New York). A snake found in a beehive. 22178.
- TREAKLE, E. M.** (Versailles, Missouri). Natural coke and burnt clay from Missouri. 21309.
- TREASURY DEPARTMENT:**
- Coast and Geodetic Survey** (U. S.). Photographs illustrating the method in use for mounting photographic prints to scale (21066); (through E. D. Preston) specimens of lava from the Sandwich Islands (21704).
- Life-Saving Service** (U. S.), (Capt. J. L. Gaskill, keeper of the life-saving station at Absecon, New Jersey). A specimen of Sowerby's Whale (*Mesoplodon bidens*) (21862); Sunfish from William H. Gaskill, keeper of the life-saving station at Cape Lookout, North Carolina (21912).
- Light-House Board** (Washington, District of Columbia). A collection of blue-prints of lamps and flames, illustrating the illuminating system of the Light-House Service. 20856.
(See under Quinn, W. M.)

TREASURY DEPARTMENT—Continued.

- Secret Service Division. Photographs of fifty counterfeiters, for exhibit at Cincinnati Exposition. (Deposited.) 20926.
(See under E. H. Andrews and Peter Bonnett.)
- TRUE, F. W. (U. S. National Museum). Snakes and insects collected by Dr. William Wittfield near Georgiana, Florida (21165); two Field Mice and two Mice (21242).
- TSCHUSI ZU SCHMIDHOFFEN, VICTOR RITTER VON (Salsburg, Austria). Twelve birds' skins. 20921.
- TUCHFARBER COMPANY, THE F. (Cincinnati, Ohio). Specimens of work of turning ring to metal and glass (21939); six metal show-cards made by the donors of the Flambeau Club, Minneapolis. 21762.
- TURNER, H. W. (U. S. Geological Survey). Specimens of fossil fish. 21055.
- TURNER, Mrs. L. A. (Boston, Massachusetts). A complete set of badges used by the National Woman's Relief Corps. 21316.
- TWACHTMAN, Mrs. M. S. (Cincinnati, Ohio). Four etchings. (Deposited.) 21055.
- UBER, C. EDGAR (Falls Church, Virginia). Four living rabbits (20940); a specimen of Ruffed Grouse (*Bonasa umbellus*) (21303).
- ULKE, HENRY (Washington, District of Columbia). A series of fine mounted shells. 21670.
- UPHAM, E. P. (National Museum). Nine paleolithic implements from Blagden Piny Branch, District of Columbia (22130); twenty-five ethnological objects. (21365).
- VAIL, STEPHEN (Washington, District of Columbia). A piece of copper wire and a portion of that laid for the first 7 miles of the first line of telegraph, in 1844, between Washington and Baltimore. 21672.
- VALENTINE, E. P. (Richmond, Virginia). A stone implement found in St. Mary's County, Maryland. 21486.
- VAN DEUSEN, A. H. (Washington, District of Columbia). Several campaign army badges. 21561.
- VAN DOREN, W. T., Jr. (Washington, District of Columbia). Upper pharyngeal bone of a Drum-fish (21324); a book, "The Indians of Cape Flattery," by G. Swan (21416).
- VAN DYKE, EDWIN C. (Los Angeles, California). A series of Coleoptera from Los Angeles, California. 21557.
- VANKHORN, HENRY (Philadelphia, Pennsylvania). A campaign badge. 21762.
- VELIE, Dr. J. W. (Chicago, Illinois). Two eggs of the Florida Crocodile. 21055.
- VERY, C. F. (New Albany, Indiana). Various ethnological objects from Gallatin County, Kentucky (21167); 220 specimens of stone implements from Gallatin, Hardin, and Edmonson Counties, Kentucky (21514).
- VIENNA, Imperial Royal Natural History Museum of, (through Dr. A. Brezina). Meteorites from Austria (21275); 117 specimens of building stones. (21524).
- WAGNER, WILLIAM (Washington, District of Columbia). One old Kentucky horse. 20842.
- WAKEFIELD, M. M. (Annandale, Virginia). Great Horned Owl (*Bubo virginianus*) the flesh. 21268.
- WALCOTT, C. D. (U. S. Geological Survey). Two specimens of galeas from Newfoundland, and one massive rhodochrosite from North Wales (21644); 800 specimens of Lower Cambrian fossils from Conception Bay, New Foundland (21876); three specimens of Lower Cambrian fossils from New York, Nevada, and Virginia (21876); 554 specimens of Middle Cambrian fossils from St. David's, South Wales (purchased) (21904); and rocks and slate from North Wales, England (21904) (See under Interior Department, U. S. Geological Survey.)

- WALCOTT, C. W. (Colonial Beach, Virginia). A living eagle. 21957.
- WALKER, CHARLES A. (Boston, Massachusetts). Seven etchings. (Deposited.) 21014.
- WALLACE, HUGH C. (Salt Lake City, Utah). A mineral specimen. 20933.
- WALLACE, JOHN (New York City, New York). Six species of birds, nearly all new to the Museum collection, including a rare parrot from New Guinea. (Purchased.) 21072.
- WARD AND HOWELL (Rochester, New York). A piece of meteoric iron from La Bella Roca Peak, Sierra de Francisco Mountains, Mexico; two photographs of the meteorite. 21797.
- WAR DEPARTMENT (U. S. Signal Office). A Secchi meteorograph (deposited) (21101); a specimen of flexible sandstone collected by the Signal Service observer at Charlotte, North Carolina (21058); two sections of "Beck's Pantograph" and two sections of "Myers' Autographic Telegraph Instrument" (21368). (See under Army Medical Museum; Bendire, Capt. C. E.; Billings, Dr. J. S.; Bourke, Capt. John G.; Carpenter, Capt. G. S.; Dutton, Capt. C. E.; Kellogg, Lieut. Col. S. C.; King, Maj. W. R.; Matthews, Dr. Washington; Mearns, Dr. Edgar A.; Thorne, Capt. P. M.)
- WARD, FRANK A. (Rochester, New York). Lemurs; two specimens of West Indian Seals (*Monachus tropicalis*), male and female. 21255.
- WARD, H. A. (Rochester, New York). Skeleton of Black Whale (purchased) (21085); model of the human form; model of the brain; model of the trachia; model of the ear (purchased) (21374); glass models of invertebrates (purchased) (21658).
- WARD, JOHN T. (Washington, District of Columbia). Two living Barn Owls (22097); a living owl caught in the District of Columbia jail (22125).
- WARD, J. V. (Cherokee, Iowa). Stone relics taken from mounds south of Cherokee, Iowa. 21977.
- WARD, LESTER F. (U. S. National Museum). A Scarlet King Snake (*Ophibolus doliatu*s) from Rock Creek valley, District of Columbia. 22065.
- WARNER, Mrs. E. S. (Palma Sola, Florida). Eighteen shells from Florida. 22039.
- WARREN, Dr. B. H. (West Chester, Pennsylvania). Birds' skins from Pennsylvania. (21395); Loggerhead Shrike (*Lanius ludovicianus*) from Erie, Pennsylvania (22151).
- WARREN, CHARLES W. (New York City, New York). Two minerals from New York City, New York. 22073.
- WASHINGTON CAMERA CLUB (Washington, District of Columbia). A series of 36 photographs. 20889.
- WASHINGTON NATIONAL MONUMENT SOCIETY (Washington, District of Columbia), (through Col. J. M. Wilson). Various marble blocks of ancient design. 21294.
- WATERS, D. R. (Washington, District of Columbia). A living Sparrow Hawk. 21563.
- WATERS, GEORGE H. (Jersey City, New Jersey). A colored lithograph of the steamer-ship *City of New York*. 21979.
- WAY, N. S. (Accotink, Virginia). Stone implements from Fairfax County, Virginia. 21563.
- WAYNE, ARTHUR T. (Charleston, South Carolina). A Ruddy-horned Lark; seventeen specimens of Red Crossbill (purchased). 21635.
- WEBB, F. W. (Crewe, England). Photographs of Trevithick's engine and boiler. 21157.
- WEBB, JOHN S. (Disputanta, Virginia). The skin of a Black Snake. 21235.
- WEBSTER, B. T. (Louisville, Mississippi). A "mole-bug" from Louisville, Mississippi. 21886.
- WEBSTER, G. W. (Lake Helen, Florida). A collection of fossil shells from Volusia County and vicinity (21680); a collection of Florida shells from near Lake Worth (22001).
- WEED, WALTER H. (See under Interior Department, U. S. Geological Survey.) H. Mis. 224, pt. 2—52

- WELCH, JOSEPH (Brooklyn, New York). One hundred and seven English wood (Purchased.) 22000.
- WELLS, H. L. (New Haven, Connecticut). A specimen of sperrylite, from Vermine, Algoma district, Ontario, Canada. 21581.
- WELLS, J. GRANT (Grenada, West Indies). Three birds' skins, two specimens of dubon's Shear-water (*Puffinus auduboni*) and a Ruddy Duck (*Erimaturus*) 21399.
- WERTHEIMBER, L., & CO. (New York City, New York). Specimens of Loofabs (*egyptica*). This plant is indigenous to Egypt and Arabia, and is mostly for the bath and toilet, but it will occupy an important place in manufacture when its varied uses are known. Its chief merit consists in its effectual assistance to the action of chemicals and chemical decomposition. In the eastern part of Japan it is used as an absorbent for perspiration, as inner soles for boots and shoes. It is also used for lining for clothing, and the German Government uses the plant as a lining for saddles. It is sometimes called "vegetable sponge," "wash-rag," and is often used as a flesh-glove. 21124.
- WESTERN NORMAL COLLEGE (Shenandoah, Iowa). Four hundred specimens of fossiliferous fossils from Iowa. (Exchange.) 22046.
- WHAITES, EDWARD P. (Alderson, West Virginia). A white-metal medal of Centennial Celebration of the Inauguration of George Washington. 21223.
- WHARTON, JOSEPH (Camden, New Jersey). Minerals from the Gap Mine, Lancaster County, Pennsylvania. 21642.
- WHEELER, CHARLES L. R. (See under Bureau of Ethnology.)
- WHIPPLE, H. C. (Philadelphia, Pennsylvania). "Hamilton Etchings," series II, published by the Art Union of Philadelphia, 1883. 21456.
- WHITE, DR. C. A. (Washington, District of Columbia). Nineteen concretions of malachite coated with malachite, and 9 specimens of melaconite from Archer County, Texas. 21408.
- WHITE, JAMES J. (Palm Beach, Florida). Marine shells from Florida and California (21791); 11 species of shells from the vicinity of Lake Worth, Florida (21900).
- WHITNEY, E. J. (Brooklyn, New York). Four proofs of wood engravings. (Deposited.) 21005.
- WHITTUM, GEORGE E. (Alexandria, Virginia). A book entitled "A Modest Inquiry into the Nature of Witchcraft," by John Hale, Beverly, Massachusetts. 21602.
- WILKINSON, E. (Mansfield, Ohio). An egg of the Cactus Wren from Chihuahua, Mexico. 21088.
- WILLCOX, JOSEPH (Philadelphia, Pennsylvania). Minerals from various localities (21363); specimens of Tertiary fossils from Martin's Station and Ocala, Florida (21619).
- WILLIAMS ALUMINUM COMPANY (New York City, New York). Samples of ferrous aluminum alloy. 21698.
- WILLIAMS, BENJAMIN (Bisbee, Arizona). Seven minerals from the Copper Mine, Bisbee, Arizona. 21632.
- WILLIAMS, DR. GEORGE H. (Baltimore, Maryland). Rocks from Norway, Scotland, and Arran (21571); also, in exchange, rocks from Norway, and pyrite from Syracuse, New York (21697).
- WILLIAMS, G. J. (Blanon-Festiniag, Wales). Specimens of fossils and fossiliferous rocks from Wales. 21656.
- WILLIAMS, LOWELL C. (Washington, District of Columbia). Two living Prairie Dogs. 21129.
- WILLIAMS, ROBERT S. (Great Falls, Montana). A bird's nest and eggs. 21175.
- WILLIAMSON, GEORGE (Grand Cane, Louisiana). Fifty rude stone implements. 21902.

- WILLIAMSON, H. W.** (New Galilee, Pennsylvania). A small collection of stone implements (20895); stone implements from Pennsylvania and Michigan (21495).
- WILMOT, SAMUEL** (Newcastle, Ontario, Canada). A Brook Trout (*Salvelinus fontinalis*). 21622.
- WILSON, GEORGE M.** (Mullan, Idaho). A specimen of plattnerite from near Mullan, Idaho. 22092.
- WILSON, THOMAS** (U. S. National Museum). Specimens of crystals from Brittany, France (21061); two stone implements found near New Brighton, Beaver County, Pennsylvania (21087); a collection of bone, stone, and shell implements, embracing hammers, flint pieces, chips, flakes, scrapers, arrow-points, pottery fragments, from Hahn's field, 1 mile east of Newton, Anderson Township, Ohio, and rude chipped implements found 12 to 20 feet below the surface in the gravel drift of the Little Miami River at Loveland, Clermont County, Ohio (21238); flints from Clark's Works, Anderson, Ross County, Ohio (21311); stone implements from Flint Ridge, Ohio (21351); a fragment of a drilled ceremonial object from Amelia County, Virginia (21355); a collection of stone implements from Anthony Ore Mound and field, Bowling Green Township, Licking County, Ohio (21378); staurolite crystals from Brittany, France (21832); a chromolithograph, "The Adoration of the Kings," by F. Kellerhoven (deposited) (21950); 19 specimens of quartzite implements from the District of Columbia (22100); 10 antique intaglios of rock crystal (deposited) (22101); paleolithic implements from Piney Branch, District of Columbia (22129); and 105 paleolithic implements from Rock Creek, District of Columbia (22154).
- WIMSATT, RICHARD D., and L. A. JOHNSON** (Washington, District of Columbia). A living Herring Gull from the Potomac River. 21615.
- WINANS, Miss H. C.** (East Orange, New Jersey). A Gray Squirrel (*Sciurus carolinensis*) with abnormal teeth. 21299.
- WINSLOW, A. C.** (Washington, District of Columbia). The original key to the Treasury of the United States when organized under General Washington's administration. 22053.
- WOHL, HENRY** (Evans City, Pennsylvania). A piece of pottery. 20955.
- WOLF, SIMON** (Washington, District of Columbia). A series of 42 Egyptian photographs. 20561.
- WOLFE, M.** (Dayton, Ohio). Two fine line plates, and specimens of work. 22121.
- WOOD, N. R.** (U. S. National Museum). A Chimney Swift (*Chatura pelagica*) (21118); skin of Love Bird (*Agoaporus pullaria*) (21251); two living pigeons (deposited) (21333).
- WOODWARDIAN MUSEUM, THE** (Cambridge, England), (through C. D. Walcott). Nineteen specimens of Cambrian fossils. 21564.
- WOODSEY, CHARLES L.** (Coney Island, New York). A badge of the John J. McKane Association of Gravesend, New York. 21764.
- WORTH, R. N.** (Plymouth, England). Serpentine rock from England. (Exchange.) 1297.
- WORTHIEN, C. K.** (Warsaw, Illinois). Three specimens of *Ochetodon* sp. (21863); 12 mammal skins and skulls (21868).
- WORTHINGTON, W. W.** (Shelter Island, New York). Arrow-heads and flakes. (Exchange.) 21205.
- WORTMAN, Dr. J. L.** (U. S. Army Medical Museum). Four living Rattlesnakes (21057); Bee-eating Buzzard (*Pernis ptilorhynchus*) (21975).
- WRIGHT, JAMES C.** (Fredonia, Ohio). A cast of a stone bear, the original being taken from a mound in Newark, Ohio, in 1861. 21794.
- WUNDERLICH, H., & Co.** (New York City, New York). One etching, one dry-point (deposited) (21012); wood-cuts, color-prints, and etchings (purchased) (21708); engraving in *manière criblée*, "The Crowning of the Virgin" (purchased) (21981).

- YALE COLLEGE MUSEUM (New Haven, Connecticut). Nine turtles (20946); (through Prof. O. C. Marsh) a cast of a Pterodactyl (*Rhamphorhynchus phyllotis*) (exchange) (22171).
- YARROW, Dr. H. C., (Washington, District of Columbia). A swordfish head from Rock Island, Maine (21093); an ancient bowl from Deep Creek Valley, (21822).
(See under Bureau of Ethnology.)
- YEATES, Hon. JESSE J. (Washington, District of Columbia). Two specimens of granular chrysolite containing bronzite from Balsam, Jackson County, Carolina. 21154.
- YEATES, W. S. (U. S. National Museum). One hundred and nine specimens of minerals from Mineville, Essex County, New York (22009); minerals from Mineville, New York (22011); 296 minerals from Ogdensburg, New York (22012); hematite crystals from the Isle of Elba, obtained at Franklin, New Jersey (22017); 1,625 minerals from Franklin, New Jersey (22022); 326 specimens of serpentine and associate minerals from near Montville, New Jersey (22023); specimens of beryl crystals from near Burnsville, Yancey County, North Carolina (22024); 968 specimens of minerals from Webster, North Carolina (22025); lepidomelane and tourmaline crystals from Crown Point, New York (22026); 140 specimens of minerals from near Spruce Pine, Mitchell County, North Carolina (22041); and an engraving of the Declaration of Independence executed by C. Toppan in 1840 (21923).
- YEATMAN, R. H. (Ashwood, Tennessee). A leaf-shaped implement from Ashwood, Tennessee. 22104.
- YOUNG, SILAS C. (Edenville, New York), (through W. S. Yeates). A collection of minerals from Edenville, New York. 22013.
- YOUNGLOVE, Dr. J. E. (Bowling Green, Kentucky). A human thigh-bone with an arrow-head imbedded in it (21310); a carving in stone representing a human head, and a fragment of a clay figure from a mound in Tennessee (21311).
- ZAHN, HENRY (Denver, Colorado.) A piece of solidified geyser, from Washburn County, Colorado (21195); artificial geyserite bound with caustic soda, from Washburn County, Colorado (21330).
- ZELEDON, JOSÉ C. (San José, Costa Rica). A collection of birds' skins from Costa Rica, for study and comparison. 20871.
(See under Museo Nacional de Costa Rica.)
- ZOOLOGICAL MUSEUM OF CHRISTIANIA, NORWAY (through Prof. Robert C. Mearns, director). Skeleton of *Orca gladiator*. (Exchange.) 20916.
- ZOOLOGICAL MUSEUM (Copenhagen, Denmark), (through Prof. Charles L. Mearns). Sixty-seven species of fishes from Scandinavia and the Arctic regions. (Exchange.) 21065.
- ZOOLOGICAL MUSEUM (Florence, Italy), (through Prof. Henry H. Giglioli). Collections of fishes, birds, mammals, and reptiles. (Exchange.) 21620.
- ZOOLOGICAL SOCIETY OF PHILADELPHIA (Philadelphia, Pennsylvania) (through Arthur E. Brown). A cockatoo (20937); a Sheath Bill (*Chionis minor*) (21078); a Deer (*Cariacus gymnotus*) from South America (21278).

INDEXES TO ACCESSION LIST.

INDEX A. BY LOCALITY.

AFRICA.

	Accession number.		Accession number.
Cleveland, Hon. Grover.....	21722	Phillips, Henry, jr.....	21490
Grant-Bey, Dr. James.....	20975, 21417, 21730	Speel, Fred.....	21804
Horan, Henry.....	21146	Wolf, Simon.....	20861
Mooney, Barney.....	21448		

AMERICA.

NORTH AMERICA.

BRITISH AMERICA.

BRITISH COLUMBIA :		CANADA—Continued.	
Boas, Dr. Franz.....	21890	Merriam, Dr. C. Hart.....	21872, 21984
Provincial Museum, Victoria.....	21690	Merrill, George P.....	21184
CANADA :		Sherman, Hon. John.....	21643
Bishop, Louis D.....	21431	Stearns, R. E. C.....	21617
Dawson, Sir J. William.....	21838	Walcott, C. D.....	21644
Geological Survey (U. S.).....	21861, 21914	Wells, H. L.....	21581
Lafamme, Abbé J. C. K.....	21887	Willcox, Joseph.....	21363
Lyman, H. H.....	22165	Wilmot, Samuel.....	21622
Matthew, G. F.....	21639		

CENTRAL AMERICA.

Birt, Dr. Louis F. H.....	21483	NICARAGUA :	
Cooke, Henry D.....	21117	Birt, Dr. Louis F. H.....	21483
Hunt, C. E.....	21128	Carlos, Clement.....	21593
Merrick, Hon. W. M.....	21336	Flint, Earl.....	20966
COSTA RICA :		SAN SALVADOR :	
Andrews, E. H.....	21991	Loring, Gen. Charles G.....	22141
Museo Nacional de Costa Rica, 20904, 21705, 21225		YUCATAN :	
		Collins, Miss Eva A.....	21746

DANISH AMERICA.

GREENLAND.

Kinnes, Robert.....	21952	Merriam, Dr. C. Hart.....	21589
---------------------	-------	---------------------------	-------

MEXICO.

Baron, O. T.....	21397	Merriam, Dr. C. Hart.....	21965
Boban, E.....	21171, 21830	Noah, John M.....	21411
Chazaro, M. M.....	21735	Powell, Maj. J. W.....	21171
Dowling, Thomas.....	21793	Ricksecker, L. E.....	21347
Jones, B. J.....	21956	Townsend, Charles H.....	20927
Lamborn, Dr. Robert H.....	22072	Ward and Howell.....	21797
Leon, Dr. Nicholas.....	21567	Wilkinson, E.....	21088
Matheson, W. J. & Co.....	21555		

UNITED STATES.

	Accession number.		
ALABAMA:		CALIFORNIA—Continued.	
Avery, Dr. William C.	20851, 21044, 21985, 22062	Raymond, W. J.	20
Coast and Geodetic Survey (through Parsons, F. H.)	21930	Rivers, J. J.	
Shelby Iron Co., Shelby, Ala.	21676	Russell, I. C.	
Taylor, Dr. J. S.	21171, 21828	Rust, H. N.	
ALASKA TERRITORY:		Stone, Livingston	
Alaska Commercial Company	21119	Streator, George J.	
Adler, Dr. Cyrus	22145	Taylor, Henry Reed	
Beardsloe, L. A.	22893	Van Dyke, Edwin C.	
Fish Commission, U. S.	21734	White, James J.	
Holm, Theodore	21418	Yarrow, Dr. H. C.	
Stoney, Lieut. George M.	21264	COLORADO:	
ARIZONA TERRITORY:		Bancroft, Hester	
Bement, C. S.	21933	Betty, Dr. E. G.	
Bidwell, Mrs. C. A.	21453, 21025	Biological Association, West Cliff, Co.	
Bissig, Frank	21089	Brown, D. R. C., and Elmer T. Butler	
Brown, Herbert	21907, 22060	Bruce, David	
Bureau of Ethnology	21821	Brunton, D. W. (See under Brown, R. C., and Butler, Elmer T.)	
Drake Co., The	21370, 21400	Chisolm, F. F.	
Dutton, Capt. C. E.	21623	Cockerell, T. D. A.	
Earle, Frank	21833	Colorado Biological Association	2
Edwards, William J.	21533	Cross & Hill-brand	
Geological Survey, U. S.	21527, 21528, 21753	Eakins, L. G.	
Howell, J. W.	21501	Emmons, S. F.	
Mearns, Dr. Edgar A.	20877	English, George L., & Co.	2
Merriam, Dr. C. Hart	22077	Funk, C. E.	21344, 2
Mindelleff, Victor	21821	Gale, Denis	21182, 2
Powell, Maj. J. W.	21936	Geological Survey, U. S.	21182, 2
Price, William W.	20855, 20982	Gunning, Mary	
Stanton, F. W. S.	21834	Hiestand, J. G.	
Siler, A. L.	21349	Lakes, Arthur	
Stevenson, James	21171	Pearce, Richard	
Stevenson, Mrs. Matilda C.	21664	Sharples, S. P.	
Williams, Benjamin	21632	Stover, Joseph	
ARKANSAS:		Thorne, Capt. P. M.	
Amend, B. G.	22033	Zahn, Henry	2
Jackson, B. F.	21953	CONNECTICUT:	
Pleas, E.	21440	Baur, Dr. G.	
CALIFORNIA:		Dallas, John	
Agriculture, Department of	22054, 22055	Farrington, O. C.	
Allen, T. C.	21587	Faucher, G. L.	
Belding, L.	21436	Hitchcock, Prof. C. H.	
Bowers, Stephen	20987	Marsh, Prof. O. C.	2
Chatard, Dr. T. M.	22068	New England Brown Stone Company	
Day, Dr. D. T.	21733	Oakford, Miss Ellen	
Diller, Prof. J. S.	21097	Rice, Prof. William North	
Eigenmann, C. H.	21752	Sage, J. H.	
Emerson, William Otto	21908	Yale College Museum	2
Frost, L. L.	20977, 21598	Young, Silas C.	
Geological Survey, U. S.	21055, 21763, 21836, 22068	DELAWARE:	
Hanks, Prof. Henry G.	21525	Jackson & Sharp Company	2
Hemphill, Henry	21289	DISTRICT OF COLUMBIA:	
Henshaw, H. W.	21171, 21552, 21579, 21792	Abbott, W. H.	
Hillebrand, Dr. W. F.	21836	Agriculture, Department of	
Mount Shasta Chrome Company	21166	Amorosa, Alphonse	
Orcutt, C. R.	20983, 22058, 22108, 22156, 22166	Army Medical Museum	
Faxton, George E.	21673	Avery, Arthur	
Pond, Lieut. C. F.	21272, 21736, 21882	Baird, Miss Lucy	
Price, Thomas	22111	Ballauf, D.	
Quicksilver Mining Co.	20886, 21898, 21955	Beckwith, Paul	21083, 21111, 21112, 21163, 21313, 21

	Accession number.
DISTRICT OF COLUMBIA—Continued.	
Biggins, T. J.	21126
Billings, Dr. J. S.	21388
Boehmer, George H.	20941, 20943
Bogra, F. F.	21605
Bolden, J.	21302
Bonnett, Peter	20992
Bourke, Capt. John G.	22093
Brackett, Fred	21809
Bradford, Harry B.	21514
Britton, Col. A. T.	21807
Brockett, Paul	20034
Burke, James	21446
Bussey, Gen. Cyrus	22142
Cameron, Gen. John	20950, 21226, 21414
Carpenter, Mrs. J. M.	20903
Chester, A.	20976
Coast and Geodetic Survey, U. S.	21060
Cockrell, Henry	21113
Colburn, A. E.	21115
Coleman, W. D.	21580
Collin, Madame Veuve A.	21172
Cones, Dr. Elliott B.	21430, 22063
Cox, Mrs. Thomas C.	21367
Curtice, Dr. Cooper	20071
Dall, W. H.	21042
Damante, Zalla	21780
Day, Dr. David T.	20934
Dillon, M. A.	20967
Dodge, W. C.	20841
Edmonds, George B.	22157
Einstein, Samuel	22035
Fish Commission, U. S.	22146
Fisher, Dr. A. K.	21790
Fitzgerald, David	21110
Gallaher, J. S.	21485
Gannett, Henry	20840
Gardner, F. C.	21412
Gerstenberg & Rontler	21282
Geological Survey, U. S.	21055
Gilman, Z. D. & Co.	20890
Glascott, Mrs. Josephine	21745
Goode, Dr. G. Brown	21100, 21125, 21149, 21094, 22000
Gordon, William A.	21080
Graham, John	21270
Green, W. J.	21341
Haackman, D. R.	21606
Harding, Miss Ellen M.	20918
Harkness, Henry	21147
Hendricks, Eric	22116
Henry, Miss M. A.	22059
Henshaw, H. W.	20857, 21010, 21579, 21785
Hessel, Dr. Rudolph	20868, 21104
Holm, Theodore	22153
Hornaday, William T.	20838
Hough, E. C.	21564
Hough, Walter	21131, 21731
Huidekoper, Reginald	22086
Johnson, J. Orville	20998
Johnson, L. A., and Richard D. Wimsatt	21615
Library Committee, Joint	21433
Kear, Charles E.	21983
Kent, S. Prentiss	21919

	Accession number.
DISTRICT OF COLUMBIA—Continued.	
Laird, Charles H.	20843
Light-House Board (Treasury Department)	20856
Linsley, Joel	21200
Lucas, F. A.	22076
Lucas, W. H.	21727
Luchs, L.	21891
Lyons, Evan	21648
McDevitt, Daniel L.	21319
McGeorge, H. W.	21888
McGuire, F. B.	21613
McGuire, J. D. and F. B.	21253
McMillan, Robert F.	21951, 22048
Merriam, Dr. C. Hart	20911, 20970
Miller, Milton	21565
Mills, Theodore A.	21729
Mitchell, E. W.	21116
Mooney, James	21449
Moore, William A.	21980
Moritz, Celeste	21056
Moser, J. H.	20839
Mullet, Dick	21674
Murray, Dr. S. P.	21693
Nash, Dr. F. S.	20996
Newman, Rev. J. P.	21043
Nicholson, W. L.	22089
Noah, John M.	21415
Offut, F. I.	22088
Osborne, J. W.	20891, 21477
Palmer, Joseph	20901
Patent Office, U. S. (Interior Department)	21324
Power, Rev. F. D.	21796
Proudfit, S. V.	21438
Putnam, Prof. F. W.	21913
Reed, R. L.	21918
Reynolds, Dr. E. R.	21546
Richmond, C. W.	21684
Ridgway, Robert	21041
Rowe, E. S.	21718
Rudd, Miss Lizzie	20889
Schmid, Louis	22134
Schmid, Louis & Sons	20969, 21202, 21380
Secret Service Division (Treasury Department)	20928
Shannon, J. Preston	21148
Shindler, A. Zeno	20988
Shock, Wm. H.	21742
Shorter, William	21673
Signal Office, U. S.	21058, 21101, 21368
Simpson, J. M.	21471
Sisson, C. W.	21813
Skinner, T. E.	21054
Smillie, T. W.	20925
Smillie, Miss L. E.	21494
Smith, W. R.	21976
Solomons, Miss Alene	20993
Starkweather, George B.	21281
Stearns, R. E. C.	21999
Stejneger, Dr. L.	22152
Stewart, C. A.	21558, 21769
Stevens, Miss Mary	21582
Stewart, James M.	20980
Stone, Mrs. E. J.	21086, 21419

	Accession number.	
DISTRICT OF COLUMBIA--Continued.		IDAHO TERRITORY--Continued.
Stone, Henry D.	21516	Geological Survey, U. S.
Swau, Mrs. J. Thompson	21905	Horan, Henry
Sweeney, T. W.	20973	Merriam, Dr. C. Hart
Taylor, Dr. Thomas	20912	Miller, Leroy D.
Turner, H. W.	21055	Peale, Dr. A. C.
Ulke, Henry	21670	Pettigrew, J. A.
Upham, E. P.	21365, 22130	Wilson, George M.
Vail, Stephen	21672	
Van Doren, W. T., jr.	21324	ILLINOIS:
Wagner, William	20842	Adams, W. H.
Ward, John T.	22097, 22125	Copelin, A. J. W.
Ward, Prof. Lester F.	22065	Illinois State Laboratory of Natural History
Washington Camera Club	20889	Longley, W. E.
Waters, D. R.	21563	Morcom, G. Frean
Weedon, W. C.	21332	Poling, Otho C.
Williams, Lowell C.	21129	Queen, George W.
Wilson, Thomas	21950,	Ridgway, Robert
	22100, 22101, 22129, 22154	Smith, D. B.
Wimsatt, Richard D. and L. A. John- son	21615	Strode, Dr. W. S.
Winslow, A. C.	22053	Vellie, Dr. J. W.
Wood, N. R.	21118, 21333	Worthen, C. K.
Wortman, Dr. J. L.	21057, 21975	
Yeates, Hon. Jesse J.	21154	INDIANA:
Yeates, William S.	21923	Anderson, Robert
		Beachler, Charles
FLORIDA:		Black, Dr. E. C.
Agriculture, Department of 22002, 22003, 22004		Bollman, C. H.
Avery, Dr. William C.	22083	Evermann, Prof. B. W.
Bell, James	21112, 21308, 21339, 21811	Jenkins, Prof. O. P.
Blackford, E. G.	21721	Jordan, Prof. David S.
Boardman, G. A.	21860	Pleas, E.
Cunningham, H. F.	21173	Ridgway, Robert
Ellis, J. Frank	21493	Rust, Halbert
Hagan, J. T.	21496	Strode, W. S.
Hall, Mrs. J. W.	21241	
Hayck, Thomas B.	21601	IOWA:
Jordan, Prof. D. S.	21628	Boston Society of Natural History
Longley, W. E.	22112	Burt, Grinnell
Merriam, Dr. C. Hart.	21856	Conrad, A. H.
Moser, Lieut. J. F.	21252	Draw, Frank L. and Charles
Neal, Dr. J. C.	20894	Keyes, C. R.
Prindle, George S.	21744	State Agricultural Experiment Sta- tion, Ames, Iowa (through R. P. Speer)
Quinn, W. M.	21002	Ward, J. V.
Spinner, Gen. F. E.	21202	
True, F. W.	21165, 21242	KANSAS:
Warner, Mrs. E. S.	22039	Baker, A. B.
Webster, G. W.	21680, 22001	Cannon, B. F.
White, James J.	21791, 21908	Hay, Robert
Willcox, Joseph	21619	Leah, Henry
		Meinold, Will.
GEORGIA:		Newlon, Dr. W. S.
Bean, B. A.	21500	Snow, F. P.
Chisolm, Alfred	21754	
Clarke, S. C.	21465	KENTUCKY:
Hamilton, M.	20573, 21266	MacGill, T. W.
Helghway, A. E.	21432	Samuel, B. F.
Horan, Henry	21381	Very, C. F.
Jones, Col. C. C.	21827	Younglove, Dr. J. E.
Nielsen, William G.	21924	
Pratt, N. P.	21834	LOUISIANA:
Tobias, H.	21348	American Museum of Natural His- tory
IDAHO TERRITORY:		Kohn, G.
Clark, Waldo J.	22095	Williamson, George
Cooper, William	22015	

	Accession number.
MAINE:	
Bartlett, William	21523
Bayley, W. S.	21848
English, George L., & Co.	21831
Haworth, Erasmus	21236
Hayden, W. P.	21156
Longley, Luther	21393
Merrill, George P.	21154, 21196, 21197
Perry, N. H.	21145, 21474
Stilwell, E. M.	21379
Yarrow, Dr. H. C.	21093
MARYLAND:	
Abert, Charles	21962
Ammen, Rear-Admiral Daniel	22087
Baker, Daniel	21671
Bowie, N. M.	21544
Coffin, Hon. C. E.	20932
Crosby, Prof. W. O.	22148
Curtis, C. J.	21906
Dodge, J. Heath	22133
Durney, J. T.	21960
Elias, Joseph & Son	21958
Geological Survey, U. S.	22102
Gleaves, Albert	20896
Hobbs, Charles	21288
Jennings, Allan H.	21444
Langille, Ollie	21000
Latimer, C. E.	21802
Lee, J. C.	20924
Little, Maj. F. E.	21569
Marron, Thomas	21271
Marshall, George	20997, 21082, 21114
Marshall, Henry	20928, 22172
Millholland, James	21078
Mills, Theodore A.	21843
Minick, Andrew	21458
Oldfield, Mrs. Catherine Chase	22126
Ridgway, Audubon	21840
Ridgway, Robert	21011, 21553, 21978, 22081
Reynolds, Dr. E. R.	21546
Russell, James, & Son	21959
Sellner, John	21893
Stabler, Harold P.	21243, 21572
Stabler, James P.	21627
Tabler, Howard	21081
MASSACHUSETTS:	
Ancient and Honorable Artillery Com- pany, Boston	21534
Baker, John	22079
Beaumont, J. J.	21139
Boston Bridge Works	21279
Boston Photogravure Company	20883
Brown, Miss H. Louisa	21578, 21805
Cheuey, Mrs. Ednah D.	21536
Collins, Frank T.	21441
Crosby, Prof. W. O. (Boston Society of Natural History)	21545
Dana, William J.	20867
Douglass, Mrs. Anna E.	21590
Edwards, Vinal N.	21237
Field, G. W.	20939
Fish, Charles F.	22137

	Accession number.
MASSACHUSETTS—Continued.	
Forbes Lithograph Manufacturing Company	20884
Forbes, R. B.	20905
Frazer, George B.	21781
Gassett, C. W.	21138
Getchell, Mrs. E. L.	21021
Hale, Miss Ellen D.	21008
Hallock, Charles	21273
Harton, E. S.	21161
Harvard College Observatory	20938
Helio-type Printing Company	20882, 21479
Jackson, W. H.	21046
Koehler, S. R.	21030, 21894, 21947
Martin, S. J.	20833
Maynard, W. L.	21140
Morrill, George P.	21194
Moser, Lieut. J. F.	21142
Museum of Comparative Zoology	21228
Nye, Willard, Jr.	21504
Oakman, H. P.	21141
Prang, Louis	21481, 22037
Putnam, Prof. F. W.	20904
Schoenhof, Carl	21710
Stoughton, T. M.	21982
Sylvester, H. E.	21029
Thompson-Houston Electric Railway Company	21346, 21478
Tilton, James P.	21171, 21824
Turner, Mrs. L. A.	21316
Walker, Charles A.	21014
MICHIGAN:	
Agriculture, Department of	21391
Boss, E. S.	21717
Boston Society of Natural History	21545
Collins, W. H.	20832
Dowling, Thomas	21793
Harris, William C.	21312
Thompson, C. A.	21574
Powell, Maj. J. W.	21407
Williamson, H. W.	21495
MINNESOTA:	
Bangs, C.	21611
Rigby, James	21612
State Normal School, Winona	21583, 21606
Turnbull, G. W.	21, 762
MISSISSIPPI:	
Chidsey, Charles E.	22170
Geological Survey, U. S.	20876
Hoy, Dr. P. R.	21702
Webster, B. T.	21886
MISSOURI:	
Callaway, J. E.	20920
Davidson, Mrs. Clara B.	22123
Douglass, A. E.	21573
Hare, Sidney J.	20993
Missouri and Pacific Railroad Com- pany	21003
Phillips, T. L.	20875
Shock, William H.	21742
Trenkle, E. M.	21309

	Accession number.	
MONTANA:		
Allen, Col. J. Isbam	20979, 21455, 21549, 21588, 21748	
Basinski, Julius, and Brothers	21123	
Beck, W. H. and Lemon, George E.	21532	
Bendire, Capt. C. E.	21682	
Dole, C. A.	20995	
Ellingson, Kuute	20966	
Geological Survey, U. S.	21837	
Grinnell, G. B.	21383, 22162	
Peale, Dr. A. C.	21457, 21638, 21932	
Reed, Dr. Thomas S.	21052	
Stone, Solon B.	21652	
Thorne, Capt. P. M.	21461, 21701	
Williams, Robert S.	21175	
NEBRASKA:		
Becker, G. F. (U. S. Geological Survey.)		
Humphrey, George M.	20665	
Rust, Halbert	21498	
NEVADA:		
Becker, George F.	21616	
Geological Survey, U. S.	21198	
Merriam, Dr. C. Hart	22077	
Walcott, C. D.	21876	
NEW HAMPSHIRE:		
Clarke, Prof. F. W.	21155	
Green, Loren W. 20897, 21036, 21044, 21073, 21543		
Hitchcock, Prof. C. H.	21217, 21570	
Hodge, Col. E. B.	21429, 21685	
Morrill, George P.	21218	
NEW JERSEY:		
Abbott, Charles C.	20991	
Bannard, William N.	21669	
Blackford, E. G.	21540	
Brown, Mrs. M. E.	21329, 21641	
Bush, John C.	21775	
Durand, J.	21696	
Dwyer, P. O.	22018	
English, George L., & Co.	21342, 21343	
Freliughuysen, Lancers' Association.	21854	
Gaskill, Capt. J. L.	21862	
Geological Survey, U. S.	21966, 21989	
Gordon, John J.	21187	
Granger, Lieut. Samuel	21768	
Keyes, C. R.	20961	
Knipe, S. W.	21562	
Phillips, E. Everett	21778	
Life-Saving Service, U. S.	21862	
Mead, Charles	21092	
Merrill, George P.	20870	
Osborn, Allen B.	21946	
Parker, Charles Walcott	21653	
Pfordte, Otto F.	22019	
Phillips, E. Everett	21778	
Potter, Rev. J. L.	21865	
Reynolds, E. M.	22012	
Ross, Charles J.	21442	
Smith, Dr. H. M.	21510	
Smith, James R.	21489	
Stevens, Richard F.	20850	
Stone, Mrs. E. J.	21070	
Winans, Miss H. C.	21299	
Yeates, W. S.	22016, 22017, 22022, 22023	
NEW MEXICO:		
Bremen, H. W.		
Davis, Arthur P. (Bureau of Ethnology.)		
Geological Survey, U. S.		
Hillebrand, Dr. W. F.		
Holmes, W. H. (Bureau of Ethnology.)		
Lucas, J. A.		
McGregor, Alex.		
Matthews, Dr. Washington		
Mindeleff, Victor		
Morse, John G.		
Shufeldt, Dr. R. W.		
	21096, 21231, 21233, 21254,	
Stevenson, James		
NEW YORK:		
Adams, W. W.		
American Museum of Natural History, New York City		
American Society of Civil Engineers		
American Society of Mechanical Engineers		
Avery, S. P.	21009, 21265,	
Baldwin & Gleason Company		
Baxter, R. F.		
Beard, Dan		
Beecher, Prof. C. E.		
Blackford, E. G.		
Bobbett, Walter		
Boston Society of Natural History		
Boussod, Valadon & Co.		
Brown, Miss Minnie C.		
Buhring, Fred		
Burt, Grinnell		
Button, William P.		
Cassell & Co.		
Century Company, The.		
Chandlee, W. H.		
Chandler, Prof. C. F.		
Cherrie, George K.		
Chittenden, F. H.		
Clarke, J. M.		
Conklin, W. A. (Central Park Menagerie)		
Cooper, William		
Davison, J. L.		
Day, Benjamin		
Dechent, William F.		
Despard, H.		
Diehl, Mrs. Anna Randall		
Dwight, W. B.		
Eastman Dry Plate and Film Company		
Falconer, J. M.		
Fenton, Herschel		
Fiston, F. Albert		
Fritsch, E.		
Fritzsche Brothers		
Geological Survey, U. S.		
Gordon, S. J.		
Greay, Edward		
Hahn, George R.		
Haight & Dudley		

	Accession number.
NEW YORK—Continued.	
Hakes, William A	21171, 21826
Harper & Brothers	21691, 21150
Hawley, F. S.	21741
Horan, Henry	21770
Howell, E. E.	21788, 21845
Hulst, George D	21109
Hurlburt, E.	21738
Jewett, Dr. J. W.	21402
John, Stephenson & Co	20968
Jnengling, P.	22135
Kemp, Prof. J. F.	21703
Keppel, Frederick & Co	21709
Ketterlinus Printing House	21122, 21996
Keuffel & Esser	21626
King, Maj. W. R.	20958
Kimmel & Voigt	21443
Klackner, C.	21013
Knoedler & Co.	21712
Kunz, George F.	21274, 21409
Kurtz, W.	20930, 21024, 21472, 21547
Lawrence, Walter U.	22008
Lewis, Thomas	22010
Lowery, G. P.	21970
McGinty, Henry	21766
Malone, Mrs. F. E.	21227
Mapes, Henry	22028
Mather, Fred	21201,
	21305, 21605, 21677, 21804, 22103
Meder, F.	21711, 22074
Merrill, George P.	21216, 21232, 21287
Miller, Charles H.	21016
Miller, Willy	22136
National Museum, U. S.	21107
Nutting, August H., jr.	21094
Ofutt, F. I.	21773
Osborn, A. O.	20956
Phillips, Phelps & Hovey	22175
Photogravure Company	21026
Photo-engraving Company	21028
Power, Maurice J.	21783
Pritchard, A. L.	21423
Radtke, Lauckner & Co	20835
Richardson, Max B.	21596
Roland, Thomas	20910
Rynders, Reuben	21732
Scheffelin & Co.	21403
Socovill Manufacturing Company	21098
Stevly, Prof. H. M.	21716
Shirlaw, Walter	20836
Siebert, A. J.	20892
Smith, Sanderson, Dr.	20816
Snow, Lieut. W. F.	21771
Somers Brothers	21941
Solway Process Company	22084
Standard Mineral Company	20989
Struthers, Joseph & Co.	20874
Stevenson, J. J.	21954
Strong Locomotive Company	21814
Tiffany & Co.	21229, 21230, 21301
Tooker, W. W.	21506
Townsend, F. J.	22178
Wallace, John	21072
Ward, Frank A.	21255

	Accession number.
NEW YORK—Continued.	
Ward, H. A.	21374, 21658
Warren, Charles W.	22073
Waters, George H.	21979
Wheeler, Charles L. R.	21171
Whitney, E. J.	21005
Willcox, Joseph	21363
Williams Aluminum Company	21698
Williams, Dr. George H.	21697
Woolsey, Charles L.	21784
Worthington, W. W.	21205
Wunderlich, H. & Co.	21012, 21703, 21981
Yeates, W. S.	22000, 22011, 22034
Young, Silas C.	22013
NORTH CAROLINA :	
Bowers, E. S.	21151, 22070
Bowman, D. A.	20913
Briggs, S. M.	21250
Brimley, H. H. and C. S.	21601
Bruner, T. K.	22027
Bureau of Ethnology	21819
English, I. D.	22042
Greely, A. W.	21058
Green River Zircon Mining Company	22032
Hatshorn, Charles H.	21942
Haywood, Howard	21512
Jordan, Prof. David S.	21285
Kesler, C. W.	22021
Life-Saving Service (Treasury Department)	21912
McCarthy, Gerald	21724
Merrill, George P.	21188, 21190, 21246
Mooney, James	21450
Nye, Willard, jr.	21725
Righton, Miss Mary	22047
Rowe, A. P.	22043
Russell, Mary E.	21604
Schreiber, W. A. H.	22026
Signal Service (War Department)	21058
Sinclair, P. J.	22029
Spainhour, Dr. J. M.	21063, 21267
Stephenson, J. A. D.	22020
Swan Island Club, Norfolk, Va.	21462
Taylor, W.	22168
Yeates, Hon. Jesse J.	21154
Yeates, W. S.	22024, 22025, 22041
OHIO :	
Baldwin, Cornelius	21896
Bell, Carey	20914
Betty, Dr. E. G.	20951
Brockett, Paul	21199
Cherry, T. J.	21361
Childs, L. J.	21296
Cincinnati Society of Natural History	21206
Curtis, George H.	21897
Dury, Charles	21256
Eakin, Dr. J.	21767
Farquhar, G. S.	21377
Franklin, Dr.	21360
Freshwater, John	21505
Gatewood, Dr. W. Emmet	21683
Galbraith and Leslie, Drs	21358

	Accession number.	
OHIO—Continued.		PENNSYLVANIA—Continued.
Goode, Dr. G. Brown	21551	Johnson Steel Street Rail
Gurley, W. C.	21476	Johnstown, Pennsylvania
Harris, I. H.	21609	Jones, T. G.
Hope, Henry W.	21603	McGinnis, William H.
Horan, Henry	21467	Merrill, George P.
Jellison, William G.	21772	2119
Loughman, Henry S.	21376	Middleton, James D.
McGinnis, William H.	21212, 21240	Millsbaugh, Dr. D. T.
McLaughlin, Miss M. Louise.	21007, 21634	Muchlow, George
Mason, C. S.	21239	Myer, Isaac
Meek, S. E.	21680	Pennsylvania Railroad Com
Mills, William	21357	
Mooney, Andrew	22158	Pennypacker, C. H.
Moorehead, Warren K.	21695	Pilsbry, H. A.
Nelson, O. U.	21350	Pintard, E. L.
Oberlin College, Oberlin, Ohio	21810	Pittsburgh Reduction Comp
Proudfit, S. V.	21438	Prindle, A. T.
Shrock, Jacob M.	21376	Rand, T. D.
Seip, John	21359	Riehle Brothers
Sterling, Dr. E.	20860	Sartain, John
Steuart, C. A.	21769	Schafirt, E. F.
Streator, George J.	21812	Speel, Fred.
Tachfarber Co., The F.	21939, 22177	Sulzberger, David
Twachtman, Mrs. M. S.	21020	Taylor, William M.
Wilson, Thomas	21238, 21311, 21351, 21378	Thompson, Matthews
Wolfe, M.	22121	Varnhorn, Henry
Wright, James C.	21794	Warren, Dr. B. H.
		Wohl, Henry
OREGON:		Wharton, Joseph
Carpenter, Capt. G. S.	20971	Whipple, H. C.
Henshaw, H. W.	21552	Williamson, H. W.
Stone, Livingston	20959	Wilson, Thomas
PENNSYLVANIA:		RHODE ISLAND:
Ayars, Benj. D., jr.	21760	Bailey, W. W.
Baldwin Locomotive Works.	21068, 21597	Carr, Silas
Bell, William	20919	Coleman, Samuel
Billings, Dr. J. S.	21387	Davis, B. F.
Black, Alexander W.	21759	Francis, Miss M.
Boyd, William H.	21663	Goodrich, C. F.
Brill, John A.	22044	Lewis, George A.
Brown, Arthur E. (Zoological Society of Philadelphia)	20937, 21209, 21278	Macomber, Peleg
Beecher, Prof. C. E.	22031	Merrill, George P.
Bureau of Ethnology	21817	Mitchell, E. H.
Chase, Mrs. M. J.	21922	Nye, Willard, jr.
Clements, Miss Gabrielle D.	21022	Peckham, Prof. S. F.
Crosscup & West.	21027	Prentiss, E. F.
Day, Dr. D. T.	21733	Rhode Island Domestic Society
Dillage, Miss Blanche.	21017	Southwick, J. M.
Donaldson, Thomas	21049	
Dost, Theodore O.	21774	SOUTH CAROLINA:
English, George L. & Co.	22099	Tiffany & Co.
Evans, John A.	21921	Wayne, Arthur T.
Foot, A. E.	21592	
Fryer, George G.	21108	TENNESSEE:
Gebbie & Co.	21899	Brown, Campbell
Gibson, F. W.	21168	Dreher, W. D.
Gretton, F. T. and T. J.	21487, 21714	Fish Commission, U. S.
Gutekunst, F.	21025, 21482	Mason, Carrington
Haig, George W.	21100	Middleton, R. Morton
Harden, E. B.	20879	Oldham, A. S.
Hitchcock, R.	22140	Thruston, General G. P.
Ives, Frederic E.	21484, 21713, 21940	Yeatman, R. H.
		Younglove, John E.

	Accession number
TEXAS:	
Askew, H. G	21967, 22124
Field and Greenwood	21401, 21595, 21870, 22082, 22161
Greenwood, E. C.	21852
Hasbrouck, E. N.	21122
Merriam, Dr. C. Hart	21965
Ragsdale, G. H.	20909, 21234, 21949
Roessler, A. R.	21926
Romeyn, Capt. Henry	21931, 22050
Stanford, Hon. Leland	22015
Taylor, William	21181
Thorpe, Dr. H. H.	21174
Tilford, H. J.	21077
White, Dr. C. A.	21408
UTAH:	
Geological Survey, U. S.	21753
Hewett, G. C.	21751
Hillebrand, Dr. W. F.	21502
Merriam, Dr. C. Hart	21325
Pearce, Richard	21526
Wallace, Hugh C.	20933
Yarrow, Dr. H. C.	21822
VERMONT:	
Geological Survey, U. S.	21876
Merrill, George P.	21219
Perkins, Prof. G. H.	20878
Seely, Prof. H. M.	21716
VIRGINIA:	
Allen, Ira R.	21362
Benton, William	21885
Bradley, John	21757
Brown, Maurice M.	22051
Burch, Millard	22096
Burns, Frank	21384, 21372
Carter, George W.	21466
Diabro, A. J.	20981
Dulin, Edw. M.	21064
Fish Commission, U. S.	21480
Kleming, R. B. L.	22138
Galt, J. A.	21920
Geological Survey, U. S.	21629
Harmon, H. C.	21171
Hawshaw, H. W.	21537
Howard, Ernest	21993
Huffman, John	21901
Hunter, Alexander	21491
Hunter, William	21203
McLane, William R.	21920, 21943
Marron, Thomas	22115
Mason, Prof. O. T.	21858
Miller, J. S.	21208
Miller, H. D. B.	20881
Norris, H. D. B.	21974
Nye, Willard, jr.	21504
Palmer, William	21280
Parsons, Misses Grace and Maud ..	21384
Payne, Dr. A. S.	21335
Pennington, R. Hayden	21847
Powell, Rev. F. D.	21796

VIRGINIA—Continued.

	Accession number.
Randolph, N. V.	20923
Reid, H.	21973, 22056
Reynolds, Dr. E. R.	21540
Ridgway, Robert	21041
Robinson, Lieut. Wirt	21662
Ryland, Rev. R.	21051
Shutt, Col. George W.	21224, 21647, 21971, 22049, 22067, 22083, 22139
Smith, Dr. Hugh M.	21084
Spitzer, Arthur A.	20944
Stejneger, Dr. L.	21857
Sutton, Miss Georgie	21445
Switzer, Mrs. Mary	22119
Taylor, Thomas	21842
Tolson, Thomas H.	20880
Uber, C. Edgar	20910, 21303
Valentine, E. P.	21486
Wakefield, M. M.	21268
Walcott, C. W.	21957
Way, N. S.	21568
Warren, Dr. B. H.	21395
Webb, John S.	21235
Whittum, George E.	21602
Wilson, Thomas	21355

WASHINGTON:

Geological Survey, U. S.	21152
Koenig, Godfrey	22061, 22127
Swan, James G.	21739

WEST VIRGINIA:

Casselberry, Mrs. Dr.	21132
Day, E. L.	21945
Dean, Miss Mary Owen	21517
Fairchild, Ashbel	21136
Hough, Mrs. L. I.	21137
Hough, Walter	21439, 21459
Krieger, W. F.	21470
Lewis, W. H.	20673
Miller, Alex. McVeigh	21038, 21338
Morgan, Dr. E. L.	20945
Nemegyei, H. M. de	21211
Protzman, Miss Emma	21183
Shutt, Col. George W.	21630
Van Doran, W. T.	21416
Whaiter, Edward P.	21223

WISCONSIN:

Bureau of Ethnology	21818
Eggers, H.	21974
Fowke, Gerard	21171
Hamilton, H. P.	21171, 21823
Hoy, Dr. P. R.	22167, 21719
Phillips, F. L.	20875
Public Museum of Milwaukee	21909

WYOMING:

Cody, Hon. W. F.	21307
Cope, Prof. E. D.	21881
Geological Survey, U. S.	21452
Granier, Emile	21507
Merriam, Dr. C. Hart	21325

WEST INDIES.

	Accession number.	
Adams, C. F	22008	BAHAMA ISLANDS:
Andrews, E. H.	21091	Jennings, Allan H
Caracciolo, H	21650	
Cory, Charles B	21400	CUBA:
Fish Commission, U. S	21309	State, Department of
Guesste, L.	21210	
Slocum, Capt. Joshua	21594	TRINIDAD:
Streator, George J	21812	Academy of Natural Sciences.....
Wells, J. Grant	21399	Royal Botanic Garden

SOUTH AMERICA.

Barrows, W. B	21385	BRAZIL—Continued.
Call, Hon. Wilkinson	21694	Sturtz, B
Chatard, Dr. F. E	21153	Townsend, C. H
Curtis, W. E	22107	
Lee, Thomas	21468	CHILE:
Lee, William	21408	Morgan, Hon. John T
Marx, Dr. George	21283	
Museum of Comparative Zoölogy, Cambridge, Mass	21228	GALAPAGOS ISLANDS:
Powell, Maj. J. W	21454	Fish Commission, U. S
Smith, Hubbard T	21907	
Zoölogical Society of Philadelphia	21278	PANAMA:
ARGENTINE REPUBLIC:		Academy of Natural Sciences.....
State, Department of	21726	
BRAZIL:		PERU:
Dreneuf, M. du Hardy	20908	Army Medical Museum
Lee, Messrs. L. A., and Thomas, and C. H. Townsend	21678	Beckwith, Paul
Museo Nacional Brazil	20900	Curtis, W. E
Ratibon, Richard	21352	Hurlbut, G. H
State, Department of	21782	URUGUAY:
		Brooks, Thomas
		VENEZUELA:
		Angell, G. W.
		Corby, Ernst C
		State, Department of

ASIA.

Newman, Rev. J. P.	21043	JAPAN—Continued.
CEYLON:		Greey, Edward
Boston Society of Natural History ..	21545	Henson, Harry V
Hitchcock, R.	21689	Hirayama, Faro
CHINA:		Hitchcock R.
Ashford, E. W	21740	21613, 21631, 21632, 21646, 21647, 21648
Chang, Yen Hoon	21844, 21961	Hornaday, William T
Jouy, P. L.	21069, 21264	Jouy, P. L. 21039, 21264, 21290, 21550, 21551
Rice, Hon. William T	21298	Kunz, George F
Rockhill, Mrs. W. W.	21317, 21318	Rice, Hon. William T
Rockhill, W. W	21260, 21261	Ringer, T
INDIA:		Shugio, Hieromith
Indian Museum, Calcutta, India	21283	Tiffany & Co
Royal Botanical Garden, Seebpore, India	21220	Tokyo Library and Tokyo Museum
Scott, Mrs. W.	21700, 22110	Wertheimer, L., & Co
JAPAN:		
Baker, Colgate	21675	KOREA:
Bernadon, J. B	21599	Jouy, P. L
English, George L., & Co	21853	
First Japanese Trading Company	21170, 21178	SYRIA:
		Bonfils & Co

EUROPE.

AUSTRIA		DENMARK:
Boehmer, George H	21121, 21692	Rasch, Dr. and Jensen C
Vienna, Imperial Royal Natural History Museum of (through Dr. Aristides Brezina)	21257, 21524	Zoölogical Museum of Copenhagen
Tschusi zu Schmidhoffen, Victor Ritter von	20921	FRANCE:
		Echaurren, Francisco
		Heilbrocker Raoul
		Lacroix, A

	Accession number.		Accession number.
FRANCE—Continued.		ITALY:	
Musée d'Histoire Naturelle	20872	Beckwith, Paul	21259
Musée de St. Germain	20923	Blair, A. A.	21624, 22117
Reynolds, E. R.	21386	Boehmer, G. H.	22128
State, Department of	21911	Phelps, Rear-Admiral T. S.	21875
Wilson, Thomas	21061, 21832	Royal Zoological Museum, Florence..	21620
GERMANY:		Senni, Angelo	21515
Borneman, J. G.	21869	Zoological Museum, Florence, Italy..	21620
Ettingshausen, Prof. Dr. Constantin von	21434	NORWAY:	
Farrer, R.	22066	Cammermeyer, Albert	20887
Heuffel and Esser	21626	Christiana University	21687
Kickhoff, C., jr.	21050	Collett, Prof. Robert	20916
Rand, T. D.	21935	Williams, Dr. George H.	21571, 21697
Rey, Dr. E.	21045	Zoölogical Museum, Christiania	20916
Royal Museum, Berlin	21353	PORTUGAL:	
Tavera, Chevalier Schmit von	21269	Geological commission of Portugal..	21855
GREAT BRITAIN:		PRUSSIA:	
British Museum	21522	Sturtz, B.	21188
Burger, Peter	21535	ROUMANIA:	
Galt, M. W.	21575	Montandon, A. L.	21848
Gerrard, Edward	22071	RUSSIA:	
Goodchild, J. G.	21657	Beckwith, Paul	21239
Gregory, J. R.	22040	Museum of Natural History, Tiflis..	21927
Harman, K. V.	20984	SCOTLAND:	
Laurie, Thomas	21892	Elder, John, & Co.	21004
London and Northwestern Railway Company	21373	Peebles, D. Bruce	20965
Lovett, Edward	21292, 21205	Stewart, Charles	21703
Royal Gardens, Kew, England	20488	Thomson, James and George	21327
State, Department of	21420	Williams, Dr. George H.	21571
Stringfellow, F. J.	21806	SWEDEN:	
Walcott, Charles D.	21904, 21916	Lindström, Dr. G.	21650
Webb, F. W.	21157	SWITZERLAND:	
Welch, Joseph	22000	Masson, Miss R.	21682
Williams, G. J.	21656	Musée d'Ethnologie, Geneva	21577
Woodwardian Museum, The	21654	Rice, Hon. William T.	21298
Worth, R. N.	21297	TURKEY:	
HOLLAND:		Andrews, Rev. A. N.	21666
Battikofer, J.	22005		

OCEANICA.

AUSTRALASIA.

AUSTRALIA:		NEW ZEALAND:	
Australian Museum, Sydney, Aus- tralia	21651	Auckland Museum	21169
Müller, Baron Ferd. von	21539	Canterbury Museum	21207
Smith, W. R.	21538	Otago University Museum	21074
Baird, Mrs. S. F.	20948	Riley, Prof. C. V.	18642
State, Department of	21340		

MALAYSIA.

BORNEO:

Adams, C. F. 21509

POLYNESIA.

Andrews, E. H.	21991	SANDWICH ISLANDS—Continued.	
SAMOA:		Lichtenhaler, G. W.	21143
State, Department of	21636	Preston, E. D.	21704
SANDWICH ISLANDS:		Thorn, E. P.	21315
Knudsen, Valdemar	21655		



INDEX B. BY DEPARTMENTS IN THE NATIONAL MUSEUM.

DEPARTMENT OF ARTS AND INDUSTRIES.

	Accession number.		Accession number.
Abbott, W. H.	21621	Chandler, Prof. C. F.	20866
Alaska Commercial Company.....	21119	Cheney, Mrs. Ednah D.	21556
American Society of Civil Engineers.....	21607	Clements, Miss Gabrielle D.	21022
American Society of Mechanical Engi- neers.....	21637	Cleveland, Hon. Grover.....	21722
Ammen, Rear-Admiral Daniel.....	22067	Coast and Geodetic Survey, U. S. (Treas- ury Department).....	21066
Ancient and Honorable Artillery Com- pany, Boston.....	21534	Collin, Mme. Veuve A.....	21172
Andrews, E. H.....	21991	Colman, Samuel.....	21018
Ashford, E. W.....	21740	Copellin, A. J. W.....	20898
Avery S. P.....	21009, 21265, 21447, 21925	Cox, Mrs. Thomas C.....	21367
Ayars, Benjamin D., jr.....	21760	Crosscup & West.....	21027
Baird, Miss Lucy.....	20949	Dana, William J.....	20867
Baird, Mrs. S. T.....	20948	Davidson, Mrs. Clara B.....	22123
Baker, Colgate.....	21675	Davis, E. F.....	21162
Baldwin & Gleason Company.....	22064	Day, Benjamin.....	21937
Baldwin Locomotive Works.....	21068, 21597	Dechent, William F.....	20844
Ballauf, D.....	21090	Dospard, H.....	21015
Bannard, William N.....	21669	Diehl, Mrs. Anna Randall.....	20964
Beaumont, J. J.....	21139	Dillaye, Miss Blanche.....	21017
Beckwith, Paul.....	21083, 21111, 21127, 21163, 21214, 21259, 21321, 21322, 21413, 22120	Dillon, M. A.....	20967
Bell, William.....	20919	Diabro, A. J.....	20982
Berlin, Royal Museum of.....	21353	Donaldson, Thomas.....	21049
Bett, Dr. E. G.....	20951	Dost, Theodore O.....	21774
Bickel, Alexander W.....	21759	Douglass, Mrs. Anna E.....	21590
Bissett, Walter.....	21548	Eakin, Dr. J.....	21767
Bissett, Peter.....	20992	Eastman Dry Plate and Film Company..	21099
Bonner, George H.....	21121, 21602, 22128	Echaurren, Francisco.....	21917
Boston Bridge Works.....	21279	Einstein, Samuel.....	22035
Boston Photogravure Company.....	20883	Elder, John & Co.....	21004
Bussod, Valadon & Co.....	20999	Falconer, J. M.....	21062, 20837
Byrd, W. H.....	21323, 21663	Fenton, Herschel.....	21866
Cackett, Fred.....	21809	First Japanese Trading Company.....	21178
Cadley, John.....	21757	Fish, Charles F.....	22137
Calk, John A.....	22044	Fish Commission, U. S.....	21699
Catton, Col. A. T.....	21807	Fiston, F. Albert.....	21761
Chckett, Paul.....	21199	Forbes Lithograph Manufacturing Com- pany.....	20884
Chocks, Thomas H.....	21608	Forbes, R. B.....	20905
Chown, Miss H. Louisa.....	21578, 21805	Forrer, R.....	22066
Chown, Mrs. M. E.....	21329, 21681	Francis, Miss M.....	21102
Chring, Fred.....	21938	Frelinghuysen Lancers' Association....	21854
Chubb, John C.....	21775	Fritzsche Brothers.....	21566
Chasey, Gen. Cyrus.....	22142	Funk, C. E.....	21750
Chilton, William P.....	21776	Gallaher, J. S.....	21485
Chiron, Gen. John.....	20950, 21226, 21414	Galt, M. W.....	21575
Chimmeyer, Albert.....	20887	Gardner, F. C.....	21412
Chisell & Co.....	21928	Gassett, C. W.....	21138
Chisbury Company, The.....	21006	Gebbie & Co.....	21899
		Getchell, Mrs. E. L.....	21021

DEPARTMENT OF ARTS AND INDUSTRIES—Continued.

	Accession number.	
Gilman, Z. D., & Co	20890	Macomber, Peleg
Gleaves, Albert	20896	Marsh, Prof. O. C.
Goode, Dr. G. Brown	21106, 21125, 21149, 21551, 21994, 22090	Martin, S. J.
Goodrich, C. F.	20990	Maynard, W. L.
Gordon, S. J.	21800	Meder, F.
Granger, Lieut. Samuel	21768	Merrill, George P.
Greay, Edward	21176	Miller, Charles H.
Grinnell, William F.	21420	Miller, Leroy D.
Gutekunst, F.	21025, 21482	Miller, Willy.
Hahn, George R.	21010	Millholland, James.
Haight & Dunley	21895	Mills, Theodore A.
Hale, Miss Ellen D.	21008	Missouri and Pacific Railroad Company
Harden, E. B.	20879	Mitchell, E. H.
Harkness, Henry	21147	Mooney, Andrew
Harman, R. V.	20984	Muchlow, George
Harper Brothers	21001, 21150	National Museum, U. S.
Harton, E. S.	21161	Newman, Rev. J. P.
Hartshorn, Charles H.	21942	Nicholson, W. L.
Harvard College Observatory	20938	Noah, John M.
Hawley, E. H.	21277	Oakford, Miss Ellen
Heilbronner, Raoul	21295	Oakman, H. P.
Helotype Printing Company	21882, 21479	Offutt, F. I.
Henry, Miss M. A.	22059	Oldfield, Mrs. Catherine Chase
Hitchcock, R.	22140, 21633, 21689	Osborne, J. W.
Horan, Henry	21213, 22467, 21770	Penn, R. Hayden
Hornaday, William T.	21326	Pennsylvania Railroad Company. 20834,
Humphrey, George M.	20665	Phelps, Rear-Admiral T. S.
Hunter, Alexander	21203	Phillips, E. Everett
Interior Department, U. S. Patent Office..	21328	Phillips, F. L.
Ives, Frederick E.	21484, 21713, 21940	Phillips, Henry, jr.
Jackson & Sharpe Company	21158, 21159	Phillips, Phelps & Hovey
Japanese Fan Company	21345	Photo-Engraving Company
Jellison, William G.	21772	Photogravure Company
Jewett, Dr. J. W.	21492	Pintard, E. L.
John Stevenson Company	21968	Prang, L., & Co.
Johnson, J. Orville	20998	Prang, Louis.
Johnson Steel Street Rail Company, Johns- town, Pa.	21337	Prentiss, E. F.
Juengling, F.	22135	Potter, Rev. J. L.
Keppel, Frederick & Co.	21709	Power, Maurice J.
Ketterlinus Printing House	21996, 22122	Queen, George W.
Keuffel & Esser	21626	Radtke, Lauckner & Co.
Kimmel & Voigt.	21443	Randolph, N. V.
King, Maj. W. R.	20958	Reed, R. L.
Klackner, C.	21013	Revenue Marine Division (Treasury De- partment)
Knoedler, M. & Co.	21712	Rhode Island Domestic Society
Knowlton, F. H.	21541	Rice, Prof. William North
Koehler, S. R.	21030, 21894, 21947	Rice, Hon. William T.
Kunz, George F.	21275	Rigby, James
Kurtz, W.	20930, 21024, 21472, 21547	Righton, Miss Mary
Lawrence, Walter U.	22008	Ross, Charles J.
Lesh, Harry	21170	Rowland, Walter
Library Committee, Joint	21433	Royal Gardens, Kew, England.
Light-House Board (Treasury Depart- ment)	20856	Royal Museum, Berlin, Germany.
London and Northwestern Railway Com- pany	21373	Rynders, Reuben
Lovett, Edward	22105	Sartain, John
Lukens, H. R.	21763	Schieffelin, W. H., & Co.
McGinty, Henry	21766	Schoenhof, Carl
McGuire, F. B.	21512	Scott, Mrs. W.
McLaughlin, Miss M. Louise	21007, 21634	Scovill Manufacturing Company
		Secret Service Division (Treasury Depart- ment)
		Shannon, J. Preston

INDEX BY DEPARTMENTS.

835

DEPARTMENT OF ARTS AND INDUSTRIES—Continued.

	Accession number.		Accession number.
Shriaw, Walter.....	20836	Thomson, James and George.....	21327
Siebert, A. J.....	20892	Tiffany & Co.....	21229, 21230, 21301
Signal Office, U. S.....	21101, 22368	Tuchfarber Company, The F.....	21939, 22177
Smillie, Miss L. E.....	20925	Turnbull, G. W.....	21762
Smillie, T. W.....	21494	Turner, Mrs. L. A.....	21310
Smith, James R.....	21480	Twachtman, Mrs. M. S.....	21020
Smyth, J. S.....	21248	Vail, Stephen.....	21672
Solway Process Company.....	22081	Van Deusen, A. H.....	21561
Somers Brothers.....	21941	Varnhorn, Henry.....	21755
Spitzer, Arthur A.....	20944	Walker, Charles A.....	21014
Stahnecker, Hon. W. H.....	21433	Washington Camera Club.....	20889
State, Department of. 21340, 21420, 21636, 21726,	21911	Washington National Monument Society.....	21294
Stearns, R. E. C.....	21999	Waters, George H.....	21979
Stenart, C. A.....	21769	Watkins, J. E.....	21091
Stevens, Richard F.....	20850	Webb, F. W.....	21157
Stewart, James M.....	20980	Welch, Joseph.....	2200
Stone, Mrs. E. J.....	21086	Wertheimer & Co.....	21124
Stringfellow, F. J.....	21806	Whaites, Edward P.....	21223
Strong Locomotive Company.....	21814	Whipple, H. C.....	21456
Struthers, Joseph, & Co.....	20874	Whitney, E. J.....	21005
Sulzberger, David.....	22131	Whittum, George E.....	21602
Swan, Mrs. J. Thompson.....	21905	Wilson, Thomas.....	21950
Sylvester H. E.....	21029	Winslow, A. C.....	22053
Taylor, Dr. Thomas.....	20912	Wolfe, M.....	22121
Thompson-Houston Electric Railway Company.....	21346, 21478	Woolsey, Charles R.....	21764
Thompson, Matthews.....	21765	Wunderlich, H. & Co.....	21012, 21708, 21981
		Yeates, W. S.....	21923

DEPARTMENT OF ETHNOLOGY.

Adler, Dr. Cyrus.....	22145	Hawley, F. S.....	21276, 21741
Allen, T. C.....	21587	Henshaw, H. W.....	21792
Allen, J. I.....	20979, 21455, 21549, 21588, 21748	Hitchcock, R.....	21640
Anderson, Rev. A. N.....	21666	Holm, Theodore.....	21418
Arnett, William.....	21523	Horan, Henry.....	21146, 21381
Armitage, Paul.....	21313, 22173	Hough, Mrs. L. S.....	21137
Armitage, Capt. C. E.....	21692	Hough, Walter.....	21131, 21459, 21731
Armitage, J. B.....	21599	Jouy, P. L.....	21264, 21559, 21841
Armitage, Dr. J. S.....	21388	Knut, S. Prentiss.....	21919
Armitage, Dr. Frans.....	21890	Lee, Thomas.....	21468
Armitage & Co.....	21882	Lovett, Edward.....	21292
Armitage, Peter.....	20992	Luchs, L.....	21891
Armitage, Capt. John G.....	22093	Mathews, Dr. Washington.....	20888
Armitage of Ethnology.....	21450	Meinold, Will.....	21371
Armitage, Peter.....	21535	Merriam, Dr. C. Hart.....	21589
Armitage, Frank.....	21372	Mills, Theodore A.....	21729
Armitage, Mrs. Dr.....	21132	Mooney, James.....	21449, 21450
Armitage, W. H.....	21749	Morgan, Dr. Edwin L.....	20945
Armitage, Yen Hoon.....	21844, 21964	Myer, Isaac.....	20849
Armitage, J.....	21696	Newman, Rev. J. P.....	21043
Armitage, J. T.....	21960	Parker, Charles Wolcott.....	21053
Armitage, H.....	20974	Protzman, Miss Emma.....	21133
Armitage, Joseph & Son.....	21958	Pntnam, Prof. F. W.....	20904
Armitage, Col. Ashbel.....	21136	Richardson, Max B.....	21596
Armitage, Japanese Trading Company.....	21170	Rockhill, Mrs. W. W.....	21317, 21318
Armitage Commission, U. S.....	21734	Rockhill, W. W.....	21260, 21261
Armitage, David.....	21110	Russel, James, and Son.....	21959
Armitage, George G.....	21108	Shugio, Hieromith.....	21737
Armitage, John.....	21270	Solomons, Miss Alene.....	20963
Armitage, Dr. James.....	21417, 21730	State, Department of.....	21244
Armitage, Edward.....	20852, 21176	Steuart, C. A.....	21558

DEPARTMENT OF ETHNOLOGY—Continued.

	Accession number.	
Stevenson, Mrs. Matilda C.....	21664	Thorn, E. P.....
Stewart, Charles.....	21700	Thompson, Col. Frank.....
Stone, Mrs. E. J.....	21419	Thompson, Greenland.....
Stoney, Lieut. George M.....	21263	Valentine, E. P.....
Swan, James G.....	20957	Van Doren, W. T.....
Tavera, Chevalier Schmit von.....	21269	Wolf, Simon.....

DEPARTMENT OF AMERICAN ABORIGINAL POTTERY.

Billings, Dr. J. S.....	21387	Hamilton, H. P.....
Boban, Dr. E.....	21830	Jones, Col. C. C.....
Bureau of Ethnology.....	21171, 21450, 21815, 21816, 21817, 21818, 21819, 21820	Muséo Nacional de Costa Rica.....
Chidsey, Charles E.....	22170	Parsons, Francis H.....
Curtis, W. E.....	21825	Taylor, Dr. J. S.....
Davis, Arthur P.....	21820	Thruston, Gen. G. P.....
Fowke, Gerard.....	21818	Tilton, James P.....
Geological Survey, U. S.....	20876	Wohl, Henry.....
Hakes, William A.....	21826	Yarrow, Dr. H. C.....

DEPARTMENT OF PREHISTORIC ANTHROPOLOGY.

American Museum of Natural History, New York City, New York.....	21293	Hough, Walter.....
Anderson, Robert.....	22007	Hunter, William.....
Army Medical Museum.....	21995	Jackson, B. F.....
Baldwin, Cornelius.....	21896	Jouy, P. L.....
Bangs, C.....	21611	Knipe, S. W.....
Bell, Carey.....	20914	Loughman, Henry S.....
Black, Dr. E. C.....	21076	Longley, Luther.....
Boehmer, George H.....	20941, 20943	Loring, Gen. Charles G.....
Bowers, Stephen.....	20987	Lovett, Edward.....
Brown, Campbell.....	21424	Mason, Prof. O. T.....
Carr, Silas.....	22114	McGinnis, William H.....
Cherry, T. J.....	21361	McMillan, Robert F.....
Chidsey, Charles E.....	22170	Mead, Charles.....
Cincinnati Society of Natural History.....	21206	Mills, William.....
Curtis, W. E.....	22107	Millapaugh, Dr. D. T.....
Day, E. L.....	21945	Moorehead, Warren K.....
Dean, Miss Mary Owen.....	21517	Musée d Ethnologie, Geneva, Switzerland.....
Diehl, Mrs. Anna Randall.....	20964	Musée de St. Germain.....
Douglass, A. E.....	21573	Nash, Dr. F. S.....
Dreher, W. D.....	22057	Neal, Dr. J. C.....
Evans, John A.....	21921	Nelson, O. U.....
Foucher, G. L.....	21437	Newlon, Dr. W. S.....
Farquhar, Dr. G. S.....	21377	Nye, Willard, jr.....
Fish Commission, U. S.....	21699, 21734	Payne, Dr. A. S.....
Franklin, Dr.....	21360	Peebles, D. Bruce.....
Frazer, George B.....	21781	Perkins, Prof. G. H.....
Freshwater, John.....	21505	Pleas, E.....
Frost, L. L.....	20977, 21598	Proudfit, S. V.....
Galbraith and Leslie, Drs.....	21358	Public Museum of Milwaukee.....
Galt, J. A.....	21929	Reynolds, E. R.....
Gibson, F. W.....	21168	Rust, H. N.....
Grant-Bey, Dr. James.....	20975	Rust, Halbert.....
Halg, George W.....	21100	Ryland, Rev. R.....
Hare, Sid, jr.....	20993	Seip, John.....
Harris, I. H.....	21609	Shrook, Jacob M.....
Haywood, Howard.....	21512	Siler, A. L.....
Hitchcock, R.....	21963	Slocum, Capt. Joshua.....
Hope, Henry W.....	21603	Stone, Livingston.....

INDEX BY DEPARTMENTS.

837

DEPARTMENT OF PREHISTORIC ANTHROPOLOGY—Continued.

	Accession number.		Accession number.
Strode, W. S.	20929	Way, N. S.	21568
Sweeney, T. W.	20973	Williamson, George	21902
Taylor, William	21181	Williamson, H. W.	20895, 21495
Taylor, William M.	20986	Wilson, Thomas	21087, 21238, 21311, 21351
Thompson, C. A.	21574		21355, 21378, 22100, 22129, 22154
Thorpe, Dr. H. H.	21174	Worthington, W. W.	21205
Tooker, W. W.	21506	Wright, James C.	21794
Upham, E. P.	21865, 22130	Yeatman, R. H.	22104
Very, C. F.	21167, 21518	Younglove, Dr. John E.	21810, 21402
Ward, J. V.	21677		

DEPARTMENT OF MAMMALS.

Agriculture, Department of	21071, 22002, 22003, 22064, 22054, 22055, 22078	Lucas, F. A.	22076
Auckland Museum, New Zealand	21169	Mather, Fred	21804, 22163
Australian Museum, Sydney	21651	Merriam, Dr. C. Hart	21325, 21872, 21965
Birt, Dr. Louis, F. H.	21483	Mooney, James	21801
Bowie, N. M.	21544	Orcutt, C. R.	22058
Brimley, H. H. and C. S.	21691	Pettigrew, J. A.	21584
Brooks, Thomas H.	21608	Pewer, Rev. F. D.	21796
Buitkofer, J.	22005	Putnam, Prof. F. W.	21913
Callaway, J. E.	20920	Ragedale, G. H.	21234
Clay, Col. Cecil	21610	Royal Botanic Gardens, Trinidad, West Indies	21986
Curtice, Dr. Cooper	21071	Royal Zoological Museum, Florence, Italy	21620
Dalmanite, Zalla	21780	Senna, Angelo	21515
Diller, Prof. J. S.	21097	Shorter, William	21873
Fish Commission, U. S.	21699, 21734, 21874	Shufeldt, Dr. R. W.	21254
Gaskill, Capt. J. L.	21862	Shutt, Col. George W.	21647
Gaskill, William H.	21912	Sison, C. W.	21813
Gerrard, Edward	22071	Smith, Dr. H. M.	21510
Green, Loren W.	21036, 21044, 21073, 21543	Swan, James G.	21739
Grimmell, G. B.	22162	Tobias, G.	21348
Henshaw, H. W.	21785	Truc, F. W.	21165, 21242
Heasel, Dr. Rudolph	21104	Ward, H. A.	21085, 21374
Hitchcock, R.	21649	Winans, Miss H. C.	21299
Kinnea, Robert	21952	Worthen, C. K.	21868
Laurie, Thomas	21892	Zoological Museum, Christiania, Norway	20916
Life-Saving Service (Treasury Department)	21862	Zoological Museum, Florence, Italy	21620
		Zoological Society of Philadelphia	21278

DEPARTMENT OF BIRDS.

Adams, C. F.	22098	Cory, Charles B.	21400
Allen, J. I.	21455	Davison, J. L.	21047
Auckland Museum, New Zealand	21160	Dreneuf, M. Hardy du (Rio de Janeiro)	20908
Avery, Dr. William C.	22083	Field & Greenwood	21401, 21595, 21870, 22082, 22101
Barnes, O. W.	21397	Fish Commission, U. S.	21699, 21734
Belding, L.	21436	Fisher, Dr. A. K.	21397, 21790
Birt, Dr. Louis F. H.	21483	Gale, Denis	21554
Bishop, Louis D.	21431	Green, Loren W.	20897
Boardman, G. A.	21860	Greenwood, E. C.	21852
Barger, Peter	20970	Guesde, L.	21210
Berrie, George K.	21614	Henshaw, H. W.	20857, 21040, 21552, 21579
Bischoff, Alfred	21754	Henson, Harry V.	21037
Bockerell, Henry	21113	Hoy, Dr. P. R.	21719
Colburn, A. E.	21115	Jennings, Allan H.	21444
Collins, Miss Eva A.	21740	Jouy, P. L.	21035, 21039, 21069
Collins, W. H.	20832	Kern, Charles E.	21983
Cope, Prof. E. D.	21508	Knudsen, Valdemar	21655

DEPARTMENT OF BIRDS—Continued.

	Accession number.	
Lee, Messrs. L. A. and Thomas	21078	Rowe, E. S.
McDevitt, Daniel L.	21319	Rowland, Thomas
Marron, Thomas	21271	Royal Zoological Museum, Florence
Marshall, George	21082, 21114	Shufeldt, Dr. R. W.
Marshall, Henry	21172	
Mather, Fred	21305, 21077	Smith, Dr. Hugh M.
Merriam, Dr. C. Hart	20911, 20970, 21068, 21856, 21984, 21998	Stabler, Harold P.
Mitchell, R. F.	21116, 21536	Strode, Dr. W. S.
Mooney, James	21801	Swan Island Club, Norfolk, Virginia
Morcom, G. Frean	21839	Taylor, Henry Keel
Moser, Lieut. J. F.	21142	Taylor, Thomas
Museo, Nacional, de Costa Rica	20994, 21225	Thorne, Capt. P. M., U. S. A.
Museum of Natural History, Tiflis, Russia	21027	Tokyo Library, and Tokyo Education Museum
Naval Academy, U. S.	21618	Townsend, C. H.
Oberlin College	21810	Tschusi, zu Schmidhoffen, Victor von
Powell, J. W.	21451	Wakefield, M. M.
Provincial Museum, The, Victoria, British Columbia	21690	Wallace, John
Ragsdale, G. H.	20900	Warren, Dr. B. H.
Rey, Dr. E.	21045	Wayne, Arthur T.
Richmond, C. W.	21684	Wells, J. Grant
Ridgway, Robert	21041, 21553, 21850, 21978, 22081	Wilkinson, E.
Ringer, T.	21067	Wood, N. R.
Robinson, Lieut. Wirt	21662	Zoological Museum, Florence, Italy
		Zoological Society of Philadelphia

SECTION OF BIRDS EGGS.

Avery, Dr. William C.	20851, 21944, 22062	Green, Loren W.
Brown, Herbert	21907, 22060	Koenig, Godfrey
Coues, Dr. Elliott	22063	Lewis, W. H.
Curtis, C. J.	21906	Marshall, Henry
Davison, J. L.	21366	Poling, Otho
Emmerson, William Otto	21908	Price, William W.
Fish Commission, U. S.	21690	Sage, J. H.
Gale, Denis	21396	Williams, Robert S.

DEPARTMENT OF REPTILES AND BATRACHIANS.

Abert, Charles	21962	Marron, Thomas
American Museum of Natural History	21987	Matheson, W. J., & Co.
Australian Museum, Sydney	21651	Mearns, Dr. Edgar A.
Barrows, Walter B.	21385	Middleton, R. Morton
Birt, Dr. Louis F. H.	21483	Mooney, James
Bremen, H. W.	20962	Morse, John G.
Caracciolo, H.	21659	Moser, Lieut. J. F.
Carlos, Cte.	21593	Orcutt, C. R.
Carpenter, Capt. G. S.	20971	Prentiss, Dr. D. W.
Fish Commission, U. S.	21699, 21734	Quinn, W. M.
Flint, Earl	20966	Ragsdale, G. H.
Green, Loren W.	21073	Royal Zoological Museum, Florence, Italy
Hamilton, M.	21266	Shufeldt, Dr. R. W.
Henshaw, H. W.	21785	Stejneger, Dr. L.
Hitchcock, R.	21649	Swan, James G.
Hobbs, Charles	21288	Switzer, Mrs. Mary
Holm, Theodore	22153	True, F. W.
Indian Museum, Calcutta, India	21283	Ward, Lester F.
Kohn, G.	21798, 21799, 21883, 22091	Webb, John S.
Light-House Board (Treasury Department)	21002	Zoological Museum, Florence, Italy

DEPARTMENT OF FISHES.

	Accession number.		Accession number.
Abbott, Charles C.....	20991	Lütken, Dr. Chr. (Zoölogical Museum of Copenhagen).....	21065
Australian Museum, Sydney.....	21651	Lyons, Evan.....	21648
Baker, John.....	22079	Mearns, Dr. Edgar A.....	20877
Bean, B. A.....	21500	Meek, S. E.....	21660
Betty, Dr. E. G.....	20931	Moser, Lieut. J. F.....	21252
Birt, Dr. Louis F. H.....	21483	Museum of Comparative Zoölogy, Cam- bridge, Mass.....	21228
Blackford, Eugene G.....	21340, 21611, 21721, 21784	Osborn, Allen B.....	21946
Edwards, Vinal N.....	21237	Otago University Museum.....	21074
Kigermann, C. H.....	21752	Prentiss, Dr. D. W.....	21867
Evermann, Prof. B. W.....	20952	Ridgway, Audubon.....	21849
Fish Commission, U. S.....	21835, 22094, 22146	Royal Zoölogical Garden, Florence, Italy.....	21620
Gilbert, Prof. C. H.....	22094, 22146	Russell, Mary E.....	21604
Harris, William C.....	21312	Shock, William H.....	21742
Hoy, Dr. P. R.....	21712	Shutt, Col. George W.....	22139
Henshaw, H. W.....	21093	Southwick, James M.....	22158
Hitchcock, R.....	21631	Speel, Fred.....	21204, 21304
Hodge, Col. E. B.....	21429, 21685	Stillwell, E. M.....	21379
Jenkins, Prof. O. P.....	20952	Van Doren, W. T., jr.....	21324
Jordan, Prof. David S.....	21285, 21628	Wilmot, Samuel.....	21622
Lewis, George A.....	21053, 21910	Yarrow, H. C.....	21063
Life Saving Service (Treasury Depart- ment).....	21912	Zoölogical Museum, Florence, Italy.....	21620

DEPARTMENT OF VERTEBRATE FOSSILS.

Beachler, Charles.....	21130	Betty, Dr. E. G.....	20931
British Museum.....	21522		

DEPARTMENT OF MOLLUSKS AND CENEZOIC INVERTEBRATE FOSSILS.

Academy of Natural Sciences.....	22155	Moser, Lieut. J. F.....	21252
Adams, C. F.....	21509	Orcutt, C. R.....	20963, 22156, 22166
Askew, H. G.....	21907, 22124	Pilsbry, H. A.....	21520, 22038, 22106
Auckland Museum, New Zealand.....	21169	Ragadale, G. H.....	21949
Barrows, Walter B.....	21385	Raymond, W. J.....	20869
Biological Association, West Cliff, Colo.....	21877	Rivers, J. J.....	21406
Burns, Frank.....	21364	State Normal School, Winona, Minn.....	21680
Clarke, S. C.....	21465	Skinner, T. E.....	21054
Cockerell, T. D. A.....	21090	Spinner, Gen. F. E.....	21262
Fish Commission, U. S.....	21699	Streator, George J.....	21812
Geological Survey, U. S.....	21980	Swan, James G.....	21739
Humphill, Henry.....	21289	Tilford, H. J.....	21077
Hitchcock, R.....	21631, 21649	Warner, Mrs. E. S.....	22039
Jony, P. L.....	21290	Webster, G. W.....	21680, 22001
Keyes, C. R.....	20961	White, James J.....	21791, 21968
McGuire, J. D. and F. B.....	21253	Willcox, Joseph.....	21619
Merriam, Dr. C. Hart.....	22077		

DEPARTMENT OF INSECTS.

Agriculture, Department of.....	21391	Fish Commission, U. S.....	21699
Angell, G. W.....	21743	Green, Loren W.....	21073
Barrows, Walter B.....	21385	Henshaw, H. W.....	21785
Beard, Daniel.....	21878	Hitchcock, R.....	21649
Bollman, C. H.....	21787	Hulst, George D.....	21109
Brockett, Paul.....	20954	Langley, Prof. S. P.....	22109
Bruce, David.....	21380, 21679	Longley, W. E.....	22112
Carlos, Cte.....	21593	Lec, William.....	21469
Chittenden, F. H.....	21705	Lyman, H. H.....	22165
Corby, Ernest C.....	22169	Mason, Carrington.....	20942
Cunningham, H. F.....	21173	Montandon, A. L.....	21846, 21992
Dallas, John.....	21871	Mooney, James.....	21801
Dury, Charles.....	21256	Moser, Lieut. J. F.....	21252

DEPARTMENT OF INSECTS—Continued

	Accession number.	
Nemegyei, B. M. de	21211	State Normal School, Winona, Minnes
Nolting, August H., Jr'	21094	Snow, F. P
Orcutt, C. R.	22108	Spainhour, Dr. J. M
Palmer, Joseph	20901	Sterling, Dr. E
Prindle, A. T.	22164	Taylor, W
Ricksecker, L. E	21347	Townsend, F. J
Riley, Prof. C. V	21894	Ulke, Henry
Samuel, B. F	22147	Van Dyke, Edwin C
State Agricultural Experiment Station, Amea, Iowa	21484	Webster, B. T

DEPARTMENT OF MARINE INVERTEBRATES.

Beardslee, L. A	22803	Hitchcock, R
Birt, Dr. Louis F. H.	21483	Hoy, Dr. P. R
Bowman, D. A	20913	Illinois State Laboratory of Natural tory
Collins, Frank S	21441	Mooney, James
Corby, E. C	22169	Moser, Lieut. J. F
Edmonds, George B	22157	Russell, Mary E
Green, Loren W	21073	State Normal School, Winona, Minnes
Hemphill, Henry	21289	Stone, Mrs. E. J
Henshaw, H. W	21785	Swan, James G
Hessel, Dr. Rudolph	20868	

DEPARTMENT OF COMPARATIVE ANATOMY.

Amoreoa, Alphonse	21105	Marsh, Prof. O. C
Auckland Museum, New Zealand	21169	Marshall, George
Australian Museum, Sydney	21651	Mather, Fred
Birt, Dr. Louis F. H	21483	Newlon, Dr. W. S
Bogra, F. F	21605	Oldham, A. S
Brooks, Thomas H	21608	Power, Rev. F. D
Central Park Menagerie, New York	21222	Ragsdale, G. H
Clay, Col. Cecil	21747	Schafirt, E. F
Davison, J. L	21404	Schmid, Louis, & Sons
Field, G. W	20939	Shutt, Col. G. W
Fish Commission, U. S	21699, 21734	Skinner, T. E
Gale, Denis	21344	Smith, D. B
Geological Commission of Portugal	21855	Stabler, James P
Geological Survey, U. S	21055	Ward, Frank A
Howell, E. E	21845	Ward, Henry A
Indian Museum, Calcutta, India	21283	Wortman, Dr. J. L
Jackson, W. H	21046	Yale College Museum
Latimer, C. E	21802	Zoölogical, Society of Philadelphia
Lewis, E. M	21247	

DEPARTMENT OF INVERTEBRATE FOSSILS.

Adams, W. H	21521	Lindström, Dr. G
Borneman, J. G	21869	Matthew, G. F
Brown, Miss Minnie C	21720	Osborn, A. O
Conrad, A. H	22046	Ragsdale, G. H
Cope, Prof. E. D	21881	Rathbun, Richard
Curtis, George H	21897	Raymond, W. J
Dawson, Sir J. William	21838	Shutt, Col. George W
Dwight, W. B	21903	Seely, Prof. H. M
Fish Commission, U. S	21699	Stillwell, L. W
Geological Survey, U. S. .21055, 21629, 21861, 21876, 21914		Turner, H. W
Goodchild, J. G	21657	Walcott, C. D
Hurlbert, E.	21738	Western Normal College
Lafamme, Abbé J. C. K	21887	Williams, G. J
Lakes, Arthur	22143	Woodwardian Museum, Cambridge Eng land

DEPARTMENT OF FOSSIL AND RECENT PLANTS.

	Accession number.		Accession number.
Bailey, W. W.....	21715	Jones, T. G.....	21503
Basinski, Julius, and Brothers.....	21123	Leon, Dr. Nicholas.....	21567
Canterbury Museum, New Zealand.....	21207	Lichtenthaler, G. W.....	21143
Chazaro, M. M.....	21736	McCarthy, Gerald.....	21724
Chester, A.....	20976	Mason, Miss R.....	21698
Christiania University, Norway.....	21687	Müller, Baron Ferdinand von.....	21539
Clarke, J. M.....	20985	Parke, Davis & Co.....	21500
Collins, Frank S.....	21441	Pond, Lieut. Charles F.....	21272, 21736, 21882
Colorado Biological Association.....	21576	Rasch, Dr. and Jensen C.....	21585
Drake Company, The.....	21490	Royal Botanical Garden, Seebpore, India.....	21290
Ettingshausen, Prof. Dr. Constantin von.....	21434	Royal Gardens, Kew, England.....	20488
Fish Commission, U. S.....	21699, 21734	State, Department of.....	21782
Gunning, Mary.....	21707	State Normal School, Winona, Minnesota.....	21583
Hamilton, M.....	20573, 21266	Shutt, Col. George W.....	21224
Hirayama, Faro.....	21645	Tokyo Library and Tokyo Museum.....	21961
Hitchcock, R.....	21646, 21649	Wertheimber, L., & Co.....	21124

DEPARTMENT OF MINERALS.

Allen, Ira R.....	21362	Hay, Robert.....	22103
Amend, B. G.....	22033	Hayden, W. P.....	21156
Auckland Museum, New Zealand.....	21169	Heighway, A. E.....	21432
Bancroft, Hester.....	21473	Hewett, G. C.....	21751
Boss, E. S.....	21717	Hillebrand, Dr. W. F.....	21502
Beck, W. H., and Lemon, George E.....	21532	Hiestand, J. G.....	21060
Beecher, Prof. C. E.....	22031	Hitchcock, Prof. C. H.....	21217
Bement, C. S.....	21933	Hitchcock, E.....	21667
Bidwell, Mrs. C. A.....	21453, 21625	Howard, Ernest.....	21901
Blair, A. A.....	21624, 22117	Howell, J. W.....	21501
Bowers, E. S.....	21151, 22030, 22070	Kesler, C. W.....	21215, 22021
Bowman, D. A.....	20913	Kunz, George F.....	21274
Braun, Baron.....	21258	Lacroix, A.....	32118
Bruner, T. K.....	22027	Lamborn, Dr. Robert H.....	22072
Burt, Grinnell.....	22014	Lee, J. C.....	20924
Carr, Silas.....	22075	Lewis, Thomas.....	22010
Chase, Mrs. M. J.....	21922	Lucas, J. A.....	21900, 22160
Chatard, Dr. F. E.....	21153	McGregor, Alex.....	21915
Chisolm, F. F.....	21392	Malone, Mrs. F. E.....	21227
Clark, Waldo J.....	22095	Mapeo, Henry.....	22028
Clarke, Prof. F. W.....	21155	Mason, C. S.....	21239
Cooper, William.....	22015	Merrill, George P.....	21191, 21898, 21287
Coy, Dr. David T.....	21733	Museo Nacional, Brazil.....	20900
Cowling, Thomas.....	21793	Nielsen, William G.....	21924
Drake Company, The.....	21370	Pearce, Richard.....	21526
Dutton, Capt. C. E.....	21623	Pennypacker, C. H.....	21031
Dwyer, P. O.....	22018	Peale, Dr. A. C.....	21457
Edwards, L. G.....	21879	Perry, N. H.....	21145, 21474
Earle, Frank.....	21833	Pfordte, Otto F.....	22019
English, George L., & Co.....	21342, 21343, 21428, 21831, 21853, 22069, 22099, 22159	Pond, Lieut. Charles F.....	21272
English, I. D.....	22042	Powell, Maj. J. W.....	21407, 21936
Evans, A. E.....	21592	Pratt, N. P.....	21934
Geological Survey, U. S.....	21152, 21422, 21452, 21475, 21527, 21528, 21529, 21530, 21531, 21836, 21837, 21879, 21932, 21968, 22068, 22102	Price, Thomas.....	22111
Gordon, John J.....	21187	Rand, T. D.....	21935
Grozier, Emile.....	21507	Reynolds, E. M.....	22012
Green River Zircon Mining Company.....	22032	Rowe, A. P.....	22043
Green, W. J.....	21341	Schreiber, W. A. H.....	22026
Grogory, J. R.....	22040	Standard Mineral Company.....	20989
Groley, W. C.....	21476	Sharples, S. P.....	21600
Groves, Prof. Henry G.....	21525	Sherman, Hon. John.....	21643
		Sinclair, P. J.....	22029
		Spainhour, Dr. J. M.....	21267
		Staunton, F. W. S.....	21834

DEPARTMENT OF MINERALS—Continued.

	Accession number.	
Stephenson, J. A. D	22020	White, Dr. C. A
Treasury Department, U. S	21704	Willcox, Joseph
Vienna, Imperial Royal Natural History Museum of	21257	Williams, Benjamin
Walcott, C. D	21644, 21916	Wilson, George M
Wallace, Hugh C	20933	Wilson, Thomas
Ward and Howell	21797	Yeates, Hon. Jesse J
Warren, Charles W	22073	Yeates, W. S
Wells, H. L	21581	22009, 22011, 22016, 22024, 22025
Weed, Walter H	21452	Young, Silas C
Wharton, Joseph	21642	Zahn, Henry

DEPARTMENT OF LITHOLOGY AND PHYSICAL GEOLOGY.

Auckland Museum, New Zealand	21169	Mullet, Dick
Baker, Daniel	21671	Musée d'Histoire Naturelle, Paris
Baxter, R. F	20843	Museo Nacional, Brazil
Bayley, W. S	21848	New England Brown Stone Company
Becker, George F	21616	Paxton, George E
Benton, William	21885	Peale, Dr. A. C
Boston Society of Natural History	21545	Pond, Lieut. Charles F
Carter, George W	21466	Preston, E. D
Crosby, Prof. W. O	22148	Pritchard, A. L
Darton, Nelson H	21960	Rand, Theodore D
Emmons, S. F. (See under U. S. Geological Survey.)		Roesler, A. B
Farrington, O. C	21185	Russell, I. C
Fish Commission, U. S	21699	Shelby Iron Company, Shelby, Ala.
Fritsch, E	20862	Signal Office, U. S
Geological Survey, U. S	21182, 21198, 21753, 21786, 21789, 21966	Smith, Dr. Sanderson
Gretton Brothers	21714	Southwick, J. M
Hallock, Charles	21273	Stoue, Solon A
Haworth, Erasmus	21236	Stoughton, T. M
Hitchcock, Prof. C. H	21217, 21570	Sturtz, B
Hitchcock, R	21613	Vienna, Imperial Royal Natural Hi Museum of
Howell, E. E	21788	Walcott, C. D
Kemp, Prof. J. F	21703	Williams Aluminum Company, New York
Kunz, George F	21400	Williams, Dr. George H
Merrill, George P	20847, 21184, 21186, 21871, 21188, 21189, 21190, 21191, 21192, 21193, 21194, 21196, 21197, 21216, 21218, 21219, 21232, 21287, 21808	Worth, R. N
Mooney, Barney	21448	Yeates, W. S
		Zahn, Henry
		Zeledon, José C

DEPARTMENT OF METALLURGY AND ECONOMIC GEOLOGY.

Auckland Museum, New Zealand	21169	Lowery, G. P
Bissig, Frank	21089	MacGill, T. M
Briggs, S. M	21250	Merrill, George P
Brown, D. R. C., and Butler, Elmer T	21103	Mount Shasta Chrome Company
Cannou, B. F	21221	Nielsen, William G
Coffin, Hon. C. E	20932	Peckham, Prof. S. F
Day, Dr. David T	20934	Pittsburgh Reduction Company
Diller, J. S	21182	Quicksilver Mining Company
Edwards, W. J	21533	Riehle Brothers
Ellingson, Knute	20960	State, Department of
Gretton Brothers	21714, 21487	Stearns, R. E. C
Hewett, G. C	21751	Stevenson, J. J
Kickhoff, C. jr	21050	Stover, Joseph
Linsley, Joel	21200	Treacle, E. M

DEPARTMENT OF LIVING ANIMALS.

	Accession number.		Accession number.
Army Medical Museum, U. S.	21057	Langille, Ollie	21000
Avery, Arthur	21033	Little, Maj. F. E.	21569
Baker, A. B.	21851	Lucas, William H.	21727
Bell, James	21112, 21308, 21330,	McGeorge, H. W.	21888
Biggins, T. J.	21126	McLane, William R.	22115
Bolden, J.	21302	Mather, Fred	21065
Baur, Dr. G.	21032	Merrick, Hon. W. M.	21336
Bradford, Harry B.	21514	Miller, Alexander McVeigh	21038, 21338
Brown, Maurice M.	22051	Miller, Hon. J. S.	20881
Buroh, Millard	22006	Miller, Milton	21565
Burke, James	21446	Minick, Andrew	21458
Call, Hon. Wilkinson,	21694	Moore, William A.	21980
Carpenter, Mrs. J. M.	20903	Morgan, Hon. John T.	21661
Central Park Menagerie, New York.	21405	Moritz, Celeste	21056
Childs, L. J.	21296	Moser, J. H.	21839
Clay, Col. Cecil	21747	Murray, Dr. S. P.	21693
Cody, Hon. W. F.	21307	Norris, H. D. B.	21974
Colman, W. D.	21580	Palmer, William	21280
Cooke, Henry D.	21117	Parsons, Misses Grace and Maud	21384
Coues, Dr. Elliott	21430	Pilling, James C.	21511
Dole, C. A.	20995	Prindle, George S.	21744
Dall, W. H.	21042	Reed, Dr. Thomas J.	21052
Dodge, J. Heath	22183	Reid, H.	21973, 22056
Dodge, W. C.	20841	Romeyn, Capt. Henry	21931, 22050
Drew, Frank L. and Charles E.	21889	Rudd, Miss Lizzie	20899
Dubin, Edward M.	21064	Schmid, Louis, & Sons	20969
Ellis, J. Frank	21493	Sellner, John	21893
Fish Commission, U. S.	21369,	Shindler, A. Zeno	20988
Fleming, R. B. L.	22132	Shiple, Samuel	21594
Gannett, Henry	20840	Shutt, Col. George W.	21647, 22049, 22067, 22085, 22139
Gardwood, Dr. W. Emmet	21683	Simpson, J. M.	21471
Gerstner, R. B. L.	21292	Smith, Hubbard T.	21907
Glascock, Mrs. Josephine	21745	Smith, W. R.	21538, 21976
Gordon, William A.	21060	Stanford, Hon. Leland	22045
Grinnell, George Bird	21383	Starkweather, George B.	21281
Hackman, D. R.	21606	Stevens, Miss Mary	21582
Haga, J. T.	21496	Stone, Henry D.	21516
Hall, Mrs. J. W.	21241	Sutton, Miss Georgie	21445
Harding, Miss Ellen M.	20918	Tabler, Howard	21081
Harmon, H. C.	21537	Tolson, Thomas H.	20880
Hasbrouck, E. M.	21122	Townsend, Charles H.	20927
Hasbrouck, Eric	22116	Uber, C. Edgar	20940, 21303
Hendricks, Eric	21974	Velie, Dr. J. W.	22149
Hornaday, William T.	20838, 21564	Wagner, William	20842
Hough, E. C.	21491	Walcott, C. W.	21957
Huffman, John	22086	Ward, John T.	22097, 22125
Huidekoper, Master Reginald	21128	Waters, D. R.	21563
Hunt, C. E.	21601	Weeden, W. C.	21332
Huyck, Thomas B.	21435	Williams, Lowell C.	21129
Jennings, Allan H.	21615	Wimsatt, Richard D., and L. A. Johnson	21615
Joninson, L. A. and Richard D. Wimsatt	21956	Wood, N. R.	21333
Jones, B. J.	21470	Wortman, Dr. J. L.	21057
Krieger, W. F.	20843	Yale College Museum	20916
Kirtland, Charles H.			



INDEX TO REPORT.

	Page.
Abbott, Dr. W. L., correspondence with	354
Aboriginal pottery, review of work in the section of	36
skin-dressing, paper by Prof. O. T. Mason on	553
Accession list, index by departments in the National Museum	833
localities	821
Accessions, list of	777
to the Museum	111
Accounts, department of	28
Acridiidae of North America, reference to a paper on the	380
Act of Congress relating to Cincinnati Exposition	155
Adams, W. W., sends shell-beads	119, 143
Adee, Hon. A. A., sends specimens from Brazil	137
Adelard, Dr. Cyrus	27, 282
assistant curator of oriental antiquities	34
papers by	743
report of	289
Administrative staff of the Museum	28
work, review of the	47
Admiralty Islands, spear-heads from	288
Adze-shaped scrapers in U. S. National Museum	569
Aeronautic collection	5
Afghanistan, pulley from	288
Africa, accessions from	112
ethnological specimens from	288
Agassiz, Prof. Alexander	374, 383
Agriculture, Department of	141
sends a collection of parasites	115
represented at the Cincinnati Exposition	176
Secretary of, courtesies extended by the	142
Ahangakihikihi	505
Ahuakapu	501
Point, cave and tomb near	486
Ahuakoi	508
Ahukinokino	503, 509
Ahukinokino	509
Ahumat	511
Ahumea	511
Ahupoepoe	508
Ahupuapuatetea	505
Ahurai	506
Ahnririkiri	513
Ahuroa	504
Ahutakao	507

- Ahutepou
 Ahutovetore
 Ahutrature
 Ahutupai
 Akane
 Akahauga
 Alabama, accessions from
 Alaska, accessions from
 Commercial Company presents a bidarka
 knife from
 Albany Museum, Grahamstown, exchange with
 Albatross, collections made by the steamer
 birds' eggs collected by the Fish Commission steamer
 elephant tortoises collected by the
 mammals obtained by the naturalists on the
 marine specimens collected by
 mesozoic fossils collected by the Fish Commission steamer
 mollusks and fossils collected by the Fish Commission steamer
 plants collected during the cruise of the
 porpoise and sea-lion skins collected by steamer
 report on insects collected by Fish Commission steamer
 reptiles and batrachians collected by the Fish Commission steamer
 work in the Pacific Ocean accomplished by the Fish Commission
 steamer
 Alexandrian Museum
 Allen, Dr. J. A. 3
 papers by
 Allen, Col. J. I.
 sends photograph
 specimens from Stillwater
 Allen, Prof. Harrison, lecture by
 America, accessions from
 American aboriginal pottery, department of
 report on the section of
 lion. The puma, or
 rail and track, origin of the
 Geological Congress, meetings of the
 Historical Association
 meeting of the
 Ornithologists' Union
 publications of the
 Society of Civil Engineers, resolutions adopted by the
 Ammen, Rear-Admiral Daniel, deposits a carriage used by General Grant...
 Anahoirangaroa Point
 tower near
 Anakena
 Anakena Bay
 Ana Koiroraroa
 Anaonero
 Anaoraka
 Anateka
 Ancient scull-oars from Easter Island
 Angell, G. W. J., insects received from
 Angelo, Dr. Senna, bats received from
 Angle splice-bar

	Page.
al products, section of	26
als, mounted, exhibited at the Cincinnati Exposition	418
recently extinct or threatened with extermination, by Frederic A. Lucas	600
whose skins were utilized by American aborigines, list of	655
l reports of the Museum, statement concerning the	54
hi	511
.....	501
ology, International Congress of	324
dition, translation of	517, 518
Lake, pottery from	341
ations for the Museum, transfer of disbursement of	6
gical labels printed	99
specimens sent in exchange	337
Republic, collections from	123
late and proofs of Durand's	303
.....	511
essions from	113
inological specimens from	286
lding	107
t of collections	22
ns in Europe, arrangement of	445
nstries, department of	26
nologued	383
rail	680
liam H., paper on the Braconidæ by	380
useum, Oxford	430
s from	124
n, model of	414
rom	288
pace	22
asts of	290
in iti poheraa, song, translation of	526
dition, translation of	520, 521
O.	26, 141
lecture by	69
papers by	744, 745
alcoholic birds received from the	388
birds' skins from	357
collection of shells from	40
collections from the	126
minerals received in exchange from the	402
uollusks received from the	372
res from the	46, 414
ocks received in exchange from the	406
s from	126
rom	126
.....	288
.....	388
cohol received	388
coholic birds received from the	370
es received in exchange from the	402
erals received from the	46, 414
received from the	388
etons obtained from the	53
ey, exchange with	

- Austria, accessions from
 Avery, Dr. W. C., presents birds' nests and eggs
 nest and eggs of a bird
 Avery, S. P., sends a lithograph
 Aweto, specimens of, received through Professor Riley
 Ax-handles from Easter Island
 Babylonian seals, casts of
 Baker, A. B., ferret received from
 Baldwin Locomotive Works send photographs of locomotive
 Ballauf, D., sends model of locomotive
 Bangs, C., sends copper implements
 Baron, O. T., humming-bird purchased from
 Barrows, Walter B., insects collected by
 sends natural history collections
 Bartlett, Edward, papers by
 Bartlett, Hon. Charles, coöperation of
 Batchelor's Delight
 Batrachia of North America, by Prof. E. D. Cope
 Baur, Dr. G.
 papers by
 studies chelouians
 turtles and terrapins transmitted by
 Baxter, R. T., ophiolite presented by
 Bayard, Hon. T. F., transmits photographs of Indians
 Beaming-tools of bone in U. S. National Museum
 Bean, Barton A.
 Bean, Dr. T. H., honorary curator of fishes 27,
 instructed in photography
 papers by
 report of
 Beath, J. W., gems obtained from
 Beardslee, Commander L. A., contribution from
 Becker, G. F.
 monograph by
 rocks collected by
 Beckham, Charles Wickliffe, papers by
 Beck, W. H., minerals received from
 Beckwith, Paul, illustrations of uniforms from
 presents a Danish silver medal
 Beechey, Capt. F. W.
 Behrens
 Belgium, ethnological specimens from
 Bell, Carey, sends a stone ax
 Bell, James, sends rattlesnakes
 Bell, John S., lends photographs of counterfeiters
 Bell, William, sends two cameras
 Belucci, Signor Joseph, exchange with
 Bement, C. S., crystallized azurite obtained from
 Bendire, Capt. Charles E. 2
 papers by
 report of
 Berlepsch, Count Hans von 3
 papers by
 Berlin, Royal Museum of, antiquities from the

	Page.
Bernizet, M.....	449
“Best Friend,” locomotive, model of.....	266
Biblical archaeology, exhibit of.....	290
at Cincinnati Exposition.....	165
Bibliography, list of papers in the.....	67
of the National Museum for 1889.....	737
Bidarka presented by the Alaska Commercial Company.....	113
Bidwell, Mrs. A. C., minerals received from.....	402
Billings, Dr. John S., sends pottery and stone implements.....	139
Biographical notice of James Stevenson.....	187
Bird series of catalogues.....	15
Birds, department of.....	27
arrangement and classification of the collection of.....	360
exchanges of.....	53
exhibit of, at Cincinnati Exposition.....	167
labels for department of.....	99
principal accessions to the collection of.....	357
report on the department of.....	357
review of work in the department of.....	38
special researches by the curator of.....	360
Birds' eggs, department of.....	27
measurement and arrangement of.....	363
report on the section of.....	363
review of work in the section of.....	38
series of catalogues.....	18
Birt, Dr. L. F. H., mammals collected by.....	354
collects mammals in Nicaragua.....	350
outfit sent to.....	148
marine invertebrates received from.....	41
specimens received from.....	381
reptiles collected by.....	365
sends birds in alcohol.....	388
sends fishes from Nicaragua.....	369
Bishop, Louis D., papers by.....	747
Bison, papers relating to the extermination of the.....	418
Black, Dr. E. C., sends stone implements.....	116
specimens sent by.....	328
Blair, A. A., sends crystallized hematite.....	126
Blake, Lady Edith.....	286
Blake, study of mollusks collected by U. S. steamer.....	374
Blossom, H. M. S.....	448
Boas, Franz, papers by.....	747
Boehmer, George H., presents a bronze medal.....	115
Bohan, E., sends pottery.....	143
Bohea, rice-sieve from.....	287
Bolles, Lieut. T. Dix.....	282, 285
allusion to work of.....	34
Bollman, C. H.....	71, 379
entomological papers by.....	880
insects received from.....	378
papers by.....	747
.....	120
Bolman, D. A., sends minerals.....	537
Bone fishhooks from Easter Island.....	537
Bonito god from Easter Island.....	537

- Borneo, sandals from
- Boston Society of Natural History
- Botanical series of catalogues
- Botany, exchanges in department of
- exhibit of section of, at Cincinnati Exposition
- labels for department of
- report on the department of
- review of work in the department of
- Boucard, A., birds' skins purchased from
- Bowers, E. S., sends minerals
- Bowers, Stephen, sends stone relics
- Bowman, D. A., minerals received from
- Boyle, C. B
- Braconidæ, paper by William H. Ashmead on the
- Brander, William
- Brau, M
- Braun, Baron, sends meteorites
- Brazil, accessions from
- national museum of, exchange with
- Brazilian birds purchased
- Bremen, H. W., sends a root
- Brewster, William, papers by
- Brezina, Dr. Aristides, exchange with
- sends a collection of meteorites
- stones received in exchange from
- British America, accessions from
- Columbia, accessions from
- Museum, exchange with
- herbarium of
- plants sent to the
- Bronze Buddha in the National Museum, paper on the, b
- Brooks, Prof. W. K
- Brooks, Thomas H., sends sea lion
- Brown, A. E., male deer transmitted by
- Brown, Campbell, sends flint implements
- Brown, D. R. C., sends model of Aspen Mountain
- Brown, S. C., registrar
- Brown, W. Harvey
- supplied with outfit
- Bruce, David, insects named for
- Bruce, Miss M. W
- Bruner, Lawrence
- paper on the Acridiidæ of North Amer
- Bryozoans catalogued
- Building and ornamental stones, installation of the
- stones, labels for department of
- Buildings and labor, operations of the department of
- Bulletin 34 of the National Museum, published
- Bulletin 36 of the National Museum
- Bulletins of the National Museum, statement concerning
- of the National Museum, composition of the
- table of
- Bull-headed rail
- Burch, Millard, presents night herons

	Page.
Bureau of Ethnology, coöperation of the.....	143
exhibit of, at the Cincinnati Exposition.....	164
Burger, W. H.....	29
draftsman.....	111
Burns, Frank.....	371
outfit sent to.....	148
Busts of State governors.....	5
Butler, Amos W., papers by.....	748
Butler, Elmer T., sends model of Aspen Mountain.....	114
Butler, F. H., minerals obtained from.....	402
Büttikoper, Dr. J., mammals purchased from.....	350
Calabashes from Easter Island.....	535
California, accessions from.....	114
charm-stone from.....	286
sea-elephant, causes of extermination of the.....	616
vulture, threatened extermination of the.....	630
Callaway, J. E., sends a hair-ball.....	118
Cammermeyer, Albert, model of Viking ship purchased from.....	126
Camp Baird, on Easter Island.....	490
Day, on Easter Island.....	488
Mohican, on Easter Island.....	487
Whitney, on Easter Island.....	489
Canada, lepidoptera from.....	113
Cannon, B. F., sends nickel ore.....	116
Canterbury Museum, New Zealand, exchange with.....	53
<i>Cariacus elevatus</i> from Central America.....	354
Carlos, C., insects received from.....	378
Carpenter, Capt. G. S., sends water lizards.....	120
Carpenter, Capt. W. L., outfit sent to.....	148
Carr, Silas, sends minerals.....	121
Carter, G. W., slab of green marble presented by.....	406
Casey, Capt. T. L.....	71, 379
presents a coffee-biggin.....	123
Cassiberry, Mrs., presents a coffee-biggin.....	657
Cast iron first used for rails in America.....	670
rails made in America.....	21
Catalogue entries, 1888-1889.....	15
Catalogues, birds.....	18
birds' eggs.....	19
botanical series.....	9
ethnological series.....	18
fishes.....	21
foods and textiles.....	21
forestry series.....	20
fossil plants.....	21
graphic arts.....	19
insects.....	15
invertebrate fossils.....	21
living animals.....	17
mammals.....	18
marine invertebrates.....	13
metallurgical series.....	13
mineralogical series.....	18
mollusks.....	8
of the Museum.....	

- Catalogues, recent plants
 reptiles and batrachians.....
 transportation and engineering series.....
 vertebrate series (recent and fossil).....
- Catlett, C., papers by.....
- Cenozoic fossils, department of.....
- Census of the collections.....
- Central America, birds' skins from.....
 Park Menagerie, specimens received from the.....
- Cetaceans, skeletons of, obtained.....
- Ceylon, ethnological specimens from.....
- Chachalacas from Fort Ringgold, Texas.....
- Chandlee, W. H.....
- Chandler, Prof. C. F., contributes engravings.....
- Chapman, Frank M., papers by.....
- Charleston relief committee.....
- Chase, Mrs. M. J.....
- Chatard, Dr. F. E., specimen of native silver obtained from.....
- Chatard, Dr. T. M.....
- Cheeseman, Prof. T. F., exchange with.....
 sends collections from New Zealand..... 126
- Cheney, John, proof of plates engraved by.....
- Cheney, Mrs. Ednah D.....
- Cherokee dance paraphernalia.....
- Cherrie, George K., birds' skins presented by.....
- Chidsey, Charles E., sends pottery.....
- Chihuahua, eggs of cactus wren from.....
- China, accessions from.....
 ethnological specimens from.....
 religious objects from.....
- Chinese minister at Washington presents a temple urn.....
- Chisolm, Alfred, sends a bird.....
- Choctaw graves, specimens from.....
- Christiania, Zoölogical Museum of..... 53
- Cincinnati Art Museum, exchange with.....
 Exposition.....
 act of Congress relating to the.....
 exhibit of mammals sent to the.....
 joint resolution relating to the.....
 report by R. Edward Earll on the.....
 review of Government exhibits at the.....
 Smithsonian exhibit at the.....
 statement of disbursement of appropriation in connection with the.....
- Museum of Natural History, exchange with.....
 Society of Natural History sends archaeological implements.....
 specimens sent by the.....
- Circulars of the Museum, list of the.....
- Civic museums.....
- Clark, A. Howard.....
 editor of Proceedings and Bulletin.....
 papers by.....
- Clark, W. G., minerals received from.....

	Page.
Clarke, Prof. F. W.....	27, 45, 51, 141
papers by.....	748
report of.....	401
Classified service of the Museum.....	4, 29
Clay, Col. Cecil.....	37, 141
Clermont, steam-boat.....	298
Cluny Museum.....	435
Coal-mine tramroads.....	655
Coast and Geodetic Survey [U. S.].....	115, 138
Cocks, A. H., correspondence with.....	354
Cody, Hon. W. F., offers to deposit his herd of buffalos.....	421
presents American elk.....	47, 123, 420
Cœlenterates catalogued.....	383
Coins of ancient periods.....	334
Colby, Ernest C., sends beetles from Venezuela.....	124
Cole, Sir Henry.....	431
Coleman, Samuel, sends etchings.....	121
Collections, arrangement of.....	22
census of the.....	7
condition of the.....	6
increase of the.....	5, 6
principal sources of the.....	4
Collectors' outfits, list of, sent out during the year.....	148
Collett, Prof. Robert.....	388
Collin, Madame Veuve A., presents bust of Garfield.....	115
Collins, Capt. J. W.....	27, 142
Collins, W. H., birds' skins purchased from.....	118, 357
Colorado, accessions from.....	114
Colorist, work of the.....	110
Conestoga wagon, model of.....	295
Comparative anatomy, department of.....	27
important accessions to the collections of.....	387
progress in preparation of the exhibition series in the department of.....	387
report on the department of.....	387
review of work in the department of.....	42
Compound rails.....	677
Connecticut, accessions from.....	114
Conrad, Prof. A. H., sends Devonian fossils.....	116
Cook, Mrs. H. D., jr., presents a capuchin monkey.....	420
Cook, Selmon.....	47, 422
Cook's Bay.....	450
Co-operation of the Departments and Bureaus of the Government.....	137
Cope, Prof. E. D.....	70, 365, 366
papers by.....	748
reptiles sent to.....	39
sends photographs of locomotives.....	116
Copenhagen, Zoölogical Museum of, exchange with.....	53
transmits fishes.....	125, 369
Copelin, A. J. W., insects collected by.....	378
Corr. Millet, D. W., excavations at.....	326
Corr. Neto-Tarquini, excavations at.....	28
Corr. pendence and reports, division of.....	88
work accomplished in division of.....	88

Cory, Charles B., papers by	
birds' skins exchanged with	
Costa Rica, birds' skins from	
National Museum of	
birds' skins presented by the	
Cox, Mrs. Thomas C., deposits Washington's shaving-table	
Cox, W. V., chief clerk	
report on Smithsonian exhibit at the Marietta Exposition by	
Crawford, Dr. John M., cooperation of	
reference to collections made by	
Crosby, Prof. W. O., rocks received in exchange from	
Cross, C. Whitman, specimens of trachyte collected by	
Crustaceans catalogued	
Cuba, ores from	
Curators, reports of the	
Curtice, Dr. Cooper, parasites collected by	
Curtin, Jeremiah, cooperation of	
Curtis, W. E., lecture by	
stone objects brought from Peru by	
Daish, Professor, instructed in photography	
Dall, Wm. Healy, honorary curator of mollusks	27, 40,
papers by	
report of	
special researches of	
Dallas, John, insects named for	
Dampier, Capt. William	
Darton, Nelson H.	
Davidson, Mrs. Clara B., presents a saber	
Davidson, J. C., presents nest and eggs of a bird	
Davis, Arthur P	
Davis, Captain	
Davison, J. L., papers by	
Dawes, Maj. E. C	
Dawson, Hon. N. H. R., transmits historical publications	
De Kay, Charles, paper on the Bronze Buddha in the National Museum, by	
papers by	
Delano, Amasa	
Delaware, accessions from	
Denmark, accessions from	
Department of Superintendence of the National Educational Association, meetings of the	
Derby, Prof. Orville A., specimens from	54,
Development of the American rail and track, by J. Elfreth Watkins	
Dewey, Fred P	
papers by	
report of	
Dezobry, M., reference to	
Diehl, Miss A. R., deposits oriental seals	
Diehl, Rev. Israel S.	
Diller, Prof. J. S.	114, 1
District of Columbia, accessions from the	
Dodo, extermination of the	
Dole, C. A	47, 1
Dolphus, examination of the species of	

Double paddle from Easter Island.....	537
Douglass, Mrs. A. E., presents plaster busts.....	117
Drake Company, minerals received from The	372
sends slabs of agatized wood.....	111
Draftsmen	29
work accomplished by the.....	111
Dreher, W. D., grooved ax received from.....	121, 329
Dreneuf, Hardy de, birds purchased from	358
Drew, Frank and Charles, present a swan.....	421
Drury, Charles, transmits insects.....	378
Dry skins prepared.....	105
Dugés, A., papers by.....	750
Duplicates, distribution of.....	50, 51
Durand, Asher Brown.....	303
Durand, John.....	36, 296
Dürer's "St. Jerome in his Chamber".....	303
Dury, Charles, insects received from.....	120
Dyar, H. G., insects determined for.....	378
Dyer, Lieut. George L., furnishes charts.....	140
Eaha to van ariiki kete tablet, English translation of.....	523
Eakins, L. G.....	140
Earll, R. Edward.....	26
report on Cincinnati Exposition by.....	154
Early American coal mines.....	655
Easter Island, birds of.....	456
boats	474
climate of.....	453
different names given to.....	452
discovery of.....	447
division of, among the sons of Hotu-Matua.....	527
ethnographic specimens obtained on	534
exploration of.....	476
fishes of	458
fishing-nets and ropes used on	459
flora of.....	454
genealogy of the kings of.....	533
geological features of.....	450
government of.....	472
language.....	513, 546
mammals of	457
method of reckoning of time	546
natives of	460
natural caves on.....	487
origin of cannibalism on.....	529
paper on, by Paymaster William J. Thomsou, U. S. N	447
personal appearance of natives of.....	462
population of.....	460
reptiles and insects on.....	459
ruins on.....	486
sacrificial stones on.....	470
sculptured rocks on	481
skulls found on	496
stone houses on	478
tablets	513
translations of.....	517

- Easter Island, tide at
 villages and habitations on.....
 vocabulary.....
- Easter Islanders, amusements of.....
 brutal treatment of, by early voyagers.....
 burial of the dead as practised by.....
 cannibalism practiced by.....
 dances of.....
 diseases among.....
 dress of.....
 employment of.....
 mats made by.....
 method of obtaining fire used by.....
 morals of the.....
 religion of.....
 salutation in use among.....
 sea-birds' eggs gathered by.....
 superstitions of.....
 tattooing of.....
 tradition in regard to the origin of.....
 weapons and war among.....
- Eastman Dry Plate and Film Company.....
- Echinoderms catalogued.....
- Editor of Proceedings and Bulletin.....
- Educational museums.....
- Education, Bureau of, publications from the.....
- Edwards, Vinal N., presents a mink.....
- Eggers, H., papers by.....
 sends two boomerangs.....
- Egypt, accessions from.....
 ethnological specimens from.....
- Eigenmanu, Carl H., papers by.....
 type fishes received from.....
- Elba, crystallized hematite from.....
- Electrical service of the Museum.....
- Elephant tortoise, skeletal of.....
 tortoises.....
- Elk, specimens of, presented by Hon. W. F. Cody.....
- Elliott, D. G., papers by.....
- Ellis, J. Frank, presents living alligators.....
- Emmons, S. F.....
 rocks collected by.....
- Employés of the Museum, list of.....
- Engineers, English and American.....
- Engineer of property.....
- England, ethnological specimens from.....
- English & Co., G. L., minerals received in exchange from.....
- Ethnic series, organization of an.....
- Ethnographic museums.....
- Ethnological material sent in exchange.....
 series of catalogues.....
- Ethnology and antiquities of Easter Island, The, by Paymaster William J. Thomson, U. S. N.....
- Ethnology, department of.....

	Page.
Ethnology, exhibit of, at Cincinnati Exposition	163
labels for department of	99
report on department of	281
review of work in department of	34
Europe, accessions from	125
European bison, causes of the extermination of the	621
Evermann, Prof. B. W. 114, 116, 369	
papers by	750
Examination and report, specimens sent for	127
Exchanges of specimens	52
Executive clerk	28
Exhibition space, assignment of	22
Explorations in behalf of National Museum	143
Newfoundland and Labrador in 1867, by Frederic A. Lucas.	709
Fairchild, Col. Ashbel, pistol and lantern received from	123
Fairchild, Gen. Lucius, medallion of	123
Fairweather, Capt. James	388
Falconer, J. M., presents an engraving	120
Fannin, John, transmits birds from Victoria, B. C.	359
Farrington, O. C., sends minerals	114
Fat-scrapers in U. S. National Museum	587
Faxon, Prof. Walter	42, 71, 382
Feather hats from Easter Island	535
Featherstonehaugh, Dr., pottery received from	341
<i>Felis concolor</i> (Puma or American Lion) paper on	591
Fernald, Prof. H. C.	379
Fernow, Dr. B. E. 27, 37, 141	
papers by	750
report of	343
Fetish-board from Easter Island	536
Fetish-stones from Easter Island	538
Fewkes, J. Walter	42, 71, 382, 383
papers by	750
Field, G. W., sends birds	117
First American railroad track	670
Japanese Trading Company, musical instruments, etc., purchased from	125
Fish Commission [U. S.], archeological specimens transmitted by the	332
birds' eggs collected by the	363
birds transmitted by the	359
coöperation of the	142
elephant tortoises collected by the	420
represented at the Cincinnati Exposition	178
skeletons of cetaceans obtained from the	388
Fisheries, section of	26
Fishes, department of	27
exchanges of	53
report on the department of	369
review of work in the department of	39
series of catalogues	18
Fish god from Easter Island	537
<i>Fish Hawk</i> , investigation of oyster-beds by the Fish Commission steamer ...	385
Fish-hooks, tradition regarding	533
Fish-net from Easter Island	535
Fitzgerald, David, presents arrow-heads	114

- Fleming, R. B. L., sends red foxes
- Flint, Dr. J. M.
- Florence, Royal Zoölogical Museum of
- Florida, accessions from
- Flower, W. H.
- Foods, section of
- Foods and textiles, labels for sections of
- series of catalogues
- Foote, A. E., minerals purchased from
- Forbes Lithographic Manufacturing Company presents albertypes
- Forbes, Prof. S. A., insects named for
- "Forest and Stream," reprint of article published in
- Forestry, section of
- as an art
- collections, cataloguing of the
- establishment of section of
- formation of the
- labels for the
- range of
- report on the section of
- work upon the
- Division in Department of Agriculture
- exhibits installed
- preliminary classification of
- section, reasons for establishing the
- Fork-tailed gull
- skeleton of
- Forney, A. H.
- Forney, A. J.
- death of
- Fort Rupert, ethnological specimens from
- Fossil plants, department of
- review of work in the department of
- series of catalogues
- Fowke, Gerard, sends pottery
- Fowl-god from Easter Island
- France, collections from
- Francis, Miss M., sends an old typewriter
- Frazer, G. B., specimens sent by
- Frescoed slabs from Easter Island
- Fritsch, E., sends specimens of marble
- Frost, L. L.
- medicine-stone collected by
- Fry, Capt. F. G., skeleton of gorilla purchased from
- Fryer, George C., sends ethnological objects
- French, G. H., insects received from
- Friendly Islands, relics of antiquity on
- Furniture and fixtures, appropriation for
- for the Museum made in the Museum workshops
- Galapagos and Mascarene tortoises, probable extermination of the
- Islands, sketches of Elephant tortoises from
- tortoises from the
- porpoises from
- skins of sea-lion from

	PAGE.
Male, Denis, sends birds, nests, and eggs.....	114, 363
Malloway, B. T., papers by	750
Maskell, Capt. J. L.....	43, 387
sends a specimen of Sowerby's whale.....	37, 118, 138
Maskell, Capt. Wm. H., sends a sunfish	120, 138
Maere, Randolph I.....	28
chief of division of correspondence.....	88
on Museum catalogues	8
Items added to the collection	401
Genealogy of the Kings of Easter Island.....	533
General preparators.....	29
Geneva, Musée d'Ethnologie In, sends Lacustrian objects	126
Geographical index of material sent for examination and report.....	135
review of accessions to the Museum	112
Geological material, distribution of.....	408, 409
exchange of	54
received for examination and report	409
Survey (U. S.), coöperation of the.....	140
fossils from the.....	393
fossil fishes received from the.....	40, 115
geological material transmitted by the.....	407
minerals transmitted by the.....	120, 401
platinum received from the.....	122
rocks transmitted by.....	118
transmits minerals from Colorado	114
pottery and stone implements	118
Georgia, accessions from.....	116
ethnological specimens from	287
Germany, collections from.....	125
ethnographic museums in.....	442
ethnological specimen from	287
Gerrard, E., mammals purchased from.....	350
Gibson, F. W., sends cast of face	121
Giglioli, Prof. Henry H., exchange with	53
skeleton of seal sent by.....	388
specimens sent in exchange to	338
transmits natural history specimens.....	126
Gilbert, Prof. C. H., fishes collected by	142
Gill, Dr. L. W., presents stone objects.....	122
sends stone implements.....	143
Gill, Theodore, papers by.....	750, 751
Gilman, Prof. D. C.....	290
lecture by.....	69
Goaji Peninsula Indians, photographs of.....	124
Godman, F. Carl du, papers by	751
Goodrich, Commander C. F., photographs obtained through	139
Goods. G. Brown, papers by	751
presents badges, lithographs, and engravings.....	115
"The Museums of the future," by.....	427
Goss, David K., papers by.....	751
Goss, W. S., papers by	751
Gosse, Dr. H. J.....	329
Geneva, Switzerland, exchange with.....	34, 62, 286
Graham, John, sends objects from the District jail	115

- Graining-tools in U. S. National Museum.....
- Grampus*, expedition of the, to Newfoundland and Labrador.....
work of the Fish Commission schooner.....
- Granier, Emile, deposits an agate.....
- Grant Bey, Dr. James.....
collections from.....
sends Egyptian objects.....
sends ethnological objects.....
- Graphic arts, aim of the collection of.....
arrangement of collection of the section of.....
exhibit of, at Cincinnati Exposition.....
exhibit of the section of, at the Cincinnati Exposition.....
labels for the section of.....
label showing arrangement of collection illustrating the
list of contributors to the collection of.....
loans for the Cincinnati Exposition to the collection of.....
objects purchased for the section of.....
report on the section of.....
review of work in section of.....
section of.....
series of catalogues.....
suggestions relating to the growth of the collection of.....
- Great Auk, expedition to Funk Island for bones of the.....
extermination of the.....
- Great Britain, accessions from.....
- Greely, Gen. A. W., specimens transmitted by.....
- Green, Loren W., presents skins of *Tamias striatus*.....
specimens received from.....
- Greene, Charles B.....
- Greenland, ethnological specimens from.....
- Green vaults, Dresden.....
- Grey, Edward, bronze and wooden figures from.....
- Gretton Bros., photographs presented by.....
- Grinnel, Hon. W. F., collection of fabrics from.....
sends wools from England.....
- Grinnell, George Bird, obtains a Rocky Mountain sheep.....
- Guadeloupe, fishes from.....
- Guesde, A., birds received in exchange from.....
- Guesde, Louis, exchanges with.....
sends birds' skins.....
specimens sent in exchange to.....
- Gurley, Dr. R. R.....
- Haahuroa.....
- Häckel.....
- Hague, Mr., paper by.....
- Haig, George W., stone pestle received from.....
- Hakes, William A., sends pottery and stone objects.....
- Hamilton, H. P., sends pottery.....
- Hamilton, M., sends a plant.....
- Hammond, Dr. William A.....
- Hananakon.....
- Hanga-hahue.....
- Hangahohoonu.....

Iangaiti	507
Iangakouri	506
Ianga-mihihiku	508
Iangaopuna	506
Iangaoteo	504
Ianga-paukura	511
Ianga Pico Bay	450
Ianga Roa	450, 500, 509
Iangatariiri	503
Ianga-tee	511
Ianga-tutuki	508
Iangatufata	508
Ianga Varevare	500
Iaughaoigio	505
Ianga-tetera	509
Ianks, H. G., minerals received from	402
Iarden, E. B., sends silver prints	121
Iarerora	510
Iargrove, J. O	407
Iarper Brothers send illustrations of railway-car	119
Iartlaub, G., papers by	751
Iarvard College Observatory presents silver prints and slides	117
Iasbrouck, E. M., sends a civet cat	121, 421
papers by	751
Iaupt, Prof. Paul	27, 282, 291
papers by	752
visits Stockholm and Christiania as representative at the Eighth International Congress of Orientalists	28
Ia vens, Capt. John G. W., sends a specimen of <i>Merluccius bilinearis</i>	369
Ia waiian Islands, ferns from	127
prehistoric remains	541
Ia wley, E. H	29
Ia worth, Erasmus, sends rocks	118
Ia y den, Everett, lecture by	69
Ia y den, W. P., sends minerals	117
Ia y es, C. W.	397
Ie l ting and lighting, appropriation for	75
Ie l ert, M., reproductions by	282
Ie l otype Printing Company, of Boston, presents heliotypes	117
Ie l aphill, Henry, contributions from	40, 41, 114, 372, 381
Ie l adley, J. W.	29, 107
Ie l shall, Dr. J. A., fishes collected by	142
Ie l shaw, H. W., birds received in exchange from	358
lecture by	69
sends reptiles	365
a medicine-stone	114, 143
Ienson, Harry V., sends a bird from Hakodate	124
type of <i>Parus palustris hensoni</i> presented by	358
Ierbarium in the Department of Agriculture	399
Iide-scrappers in U. S. National Museum	587
Iildebrand, M. M.	322
Iildebrand, Prof. W. F.	45, 140, 147
minerals collected by	401
Iincks, Edward, life and writings of	291
Iistoical collections	26

- Historical museums
 Hitchcock, Prof. C. H., contributions received from 1
 Hitchcock, Romyn
 insects from Japan contributed by
 marine objects from Japan presented by
 papers by
 presents crustaceans and sponges from Japan
 Hoekoe
 Hohenzollerns, the museum of the
 Holmes, William H
 papers by
 report of
 Holtzinger, J. M., insects received from
 Horan, Henry, superintendent of buildings
 Horu, Dr. George H
 Hornaday, W. T 2
 buffalo skins purchased from
 chief taxidermist
 report of
 Hotu-Matua
 Hough, Mrs. L. I., sends a basket
 Hough, Walter
 arrangement of the illumination collection by
 papers by
 presents ethnological objects
 study of fire-making, heating, and lighting by
 Howard, Lieut. W. L., outfit sent to
 Howard, L. O., assistant entomologist, Department of Agriculture
 acting curator of insects
 papers by
 Howard, Mr., instructed in photography
 Howell, J. W., presents minerals
 Huatero
 Huareva
 Hudson, W. H., papers by
 Human skulls from Easter Island
 Hunter, Alexander, gives a confederate army jacket
 Hunter, John
 Hunter, William
 Hurlbut, G. H., presents woolen fabrics
 "Ibis," editors of the, papers by
 Iddings, Mr., papers by
 Illinois, accessions from
 Illustrations for Museum reports prepared by Messrs. W. H. Chandler
 W. H. Burger
 Images found on Easter Island
 Imperial Academy of Sciences, St. Petersburg
 exchange with
 plants sent to the
 Incised tablets from Easter Island
 India, collections from
 ethnological specimens from
 Indiana, accessions from
 State university
 fossils received from the

	Page.
I ndian seal, two specimens of, received in exchange.....	350
I ngalls, Hon. John J.....	46
letter to.....	29-31
nickel examined for.....	415
I nsect pests, preservation of collection from.....	379
I nsects, arrangement of reserve series of.....	379
collection by the <i>Albatross</i> , report on the.....	380
department of.....	27
exchanged.....	53
exhibit of, at Cincinnati Exposition.....	167
prepared for the Paris Exposition.....	377
important additions to the collection of.....	378
named for collectors.....	378
report on the department of.....	377
researches based upon material belonging to the department of.....	380
review of work in the department of.....	41
sent to specialists for determination.....	379
series of catalogues.....	19
I nstitutions to which Museum publications should be sent, list of.....	63
I nterior, Department of the, cooperation of the.....	140
I nternal Revenue, Commissioner of, presents two black bears.....	138
I nternational Congress of Anthropology.....	324
Orientalists, scope of.....	289
I nvertebrate fossil series of catalogues.....	15
fossils.....	27
I owa, accessions from.....	116
I ron coal road.....	653
early use of.....	653
furnaces in England.....	656
industry in America.....	654
England.....	654
I taly, ethnological specimens from.....	287
specimens from.....	126
I yenari, Tokugawa.....	295
J ackson & Sharp Co. sends prints of railway-cars.....	114
J ackson, Wm. H., sends skull of whale.....	117
J apan, accessions from.....	124
ethnological specimens from.....	288
plants from.....	399
J apanese birds purchased.....	358
jinrikisha, model of.....	295
kago.....	295
J ardin des Plantes, Paris.....	52
exchange with.....	53
plants sent to the.....	399
J ava, ruins discovered on the island of.....	543
J enkins, O. P., fishes collected by.....	114, 369
offer of assistance from.....	147
papers by.....	750, 753
seines sent to.....	149
J ennings, A. H., Kirtland's warbler presented by.....	358
J ensen, C., exchange with.....	53
J erusalem, accessions from.....	125
J ewett, Dr. J. W., sends a collection of drugs.....	138
"John Bull" locomotive.....	296
J ohns Hopkins University.....	406

- Johnston, Dr. C., jr.
 papers by
- Johnston, Miss Francis B., instructed in photography
- John Stephenson Company, sends photographs of street-cars
- Joint fixtures
- resolution relating to the Cincinnati and Marietta Expositions.....
- Jones and Laughlin Works, photographs of the
- Jones, B. J., Mexican quails received from
- Jones, Col. C. C., sends pottery
- Jones, T. G., specimens sent in exchange to
- Jordan, Prof. D. S.
 fishes collected by
- papers by
- transmits cretaceous fossils
- Jouy, P. L., aid in department of mollusks
- collection from prehistoric graves presented by
- Japanese birds purchased from
- Korean birds purchased from
- presents Chinese bow and arrow
- Buddhist rosary and birds received from
- Justice, Department of, cooperation of the
- represented at the Cincinnati Exposition
- Kago from Japan
- Kai
- Ka ihi uiga, song, English translation of
- Kaitiā, descendant of last king of Easter Island
- Kansas, accessions from
- Kaokaoe
- Keller, Dr. Ferdinand
- Kellogg, Lt. Col. S. C., deposits a buffalo robe
- skins of buffalo calf received from
- Kentucky, accessions from
- Kern, Charles E., birds presented by
- Kesler, C. W., minerals received in exchange from
- Kew Botanical Gardens, exchange with
- plants sent to
- sends large and varied collections
- Keys, C. R., sends shells
- Kickhoff, C., sends alloys from Germany
- Kihikihiraumea
- Killer whale received from the Royal Zoölogical Museum at Christiania
- skeleton of
- King, Maj. W. R., sends photographs of Hell Gate explosion
- King's platform, skulls from the
- Kinnes, Robert
- Kiraau
- Kirikiroa
- Kiti te eiranga
- Klyoquot Indians
- Knowlton, F. H.
 furlough of
- papers by
- Knuudsen, Waldemar, petrels presented by
- sends petrels from Waia
- Kuute, Ellingson, sends specimens of ores

	Page.
Koehler, S. R., curator of graphic arts	26, 35
papers by	754, 755
report of	301
Koenig, Godfrey, birds' eggs received from	122
Kohn, Gustave, assistance rendered by	366
sends terrapins	117
Kone-iti	511
Kope-iti	511
Korea, birds from	124
books from	288
Kotatake Mountain	486
Koto-ara-ara	511
Kote-one	511
Koteva	504
Koturara	511
Kotzebue	449
Kunz, G. F., rocks received from	406
Labels for Babylonian seals	291
preparation of	99
Labrador duck, extermination of the	636
Lacroix, M. A., exchange with	54
Lacustrine objects sent by the Musée d' Ethnologie in Geneva	126
Langley, Prof. Samuel P., papers by	755
Language, Easter Island	513
La Pérouse Bay	450
expedition	449
Latta, William J.	295
Lawrence, George N., papers by	755
Lea collection of paleozoic fossils	392
<i>Unionida</i>	40, 371
Lea, Dr. Isaac, books bequeathed by	47
fossils bequeathed by	395
Le Baron, J. F., reptiles transmitted by	365
Lectures	69
Lee, J. Fenner, sends engravings of cattle	137
Lee, Prof. Leslie A.	71, 123, 383
Brazilian birds purchased from	358
Lee, Thomas	123
Brazilian birds purchased from	358
Leidy, Dr. Joseph, papers by	755
Lesquereux, Prof. Leo, papers by	755
Letter from Assistant Secretary to Secretary relating to Smithsonian participation in Cincinnati and Marietta Expositions	149
Letters asking for information, list of	88-96
written on special subjects, arranged geographically, list of	96
Lewis, E. M., presents birds	120
Lewis, George A., presents fishes	121
Lewis, W. H., duck presented by	122
Libraries in United States, list of, to which it is desirable to send publications of National Museum	216
Library, report on operations of	47
Lichtenthaler, G. W.	53, 127
Life-Saving Service, coöperation of the	138
Light-House Board [U. S.], coöperation of the	138

- Light-House Board [U. S.], presents blue-prints of lights and flames.....
- Linell, Martin L
 appointed aid
- Linton, Prof. Edwin 42, 7
 papers by
- Lisiansky
- List of specimens sent for examination.....
- Lists of institutions and libraries intended to receive publications of National Museum
- Lithology and physical geology, department of.....
 report on the department of
- review of work in the department of.....
- Little Swan Island, subspecies of *Capromys* from
- Living animals, catalogue of.....
 department of.....
 important accessions to the collection of.....
 insufficient quarters for the
- labels for collection of.....
 report on the department of.....
 review of work in the department of.....
- London, the Great Exhibition at, in 1851.....
- Longley, W. E., insects collected by.....
- Lord Howe Island, casts of *Meiilonia* from.....
- Louisiana, accessions from
- Lovett, Edward, exchanges with.....
 sends ethnological objects.....
- Lucas, F. A..... 27, 29, 42
 osteological preparator.....
 paper on animals recently extinct or threatened with extermination by
- explorations in Newfoundland and Labrador in 1887 by.....
 papers by
- statement of osteological work accomplished by.....
- Lucas, J. A., minerals received from.....
- Lugger, Prof. Otto, insects named for.....
- Lyman, H. H., sends specimens of lepidoptera.....
- Lyon, Prof. D. G.....
- MacGill, T. W., sends specimens of limonite and ore.....
- Machaa.....
- Madagascar, accessions from.....
 Queen of, objects transmitted by the.....
- Madreporarian corals, studies of the.....
- Mahatua
- Maiki.....
- Maine, accessions from.....
 Swedish wooden shoes from.....
- Makah Indians.....
- Mammal exhibit for Cincinnati Exposition.....
 extermination series exhibited at Cincinnati Exposition.....
 groups prepared for exhibition.....
 series of catalogues
- Mammals, additions to exhibition series of.....
 department of
- exchanges in department of.....
 exhibit of, at Cincinnati Exposition.....

	Page
Mammals, groups of, mounted for exhibition.....	349
labels for department of.....	99
mounted, list of.....	105
offered to the Museum.....	421
report on the department of.....	349
review of work in the department of.....	37
whose skins were utilized by American aborigines, list of.....	555
Mamo, causes of the extermination of the.....	627
Manigault, Dr. G. E.....	353
Manumes.....	511
Manuscript catalogues, system of.....	8
Marae-toe-hau.....	528
Mari.....	506
Marietta Exposition, report on Smithsonian exhibit at the.....	180
Marine invertebrates, accessions to the collection of.....	381
collection of, transmitted to the Cincinnati Exposition.....	382
department of.....	27
distribution of.....	51
exhibition series of.....	382
exhibit of, at Cincinnati Exposition.....	168
institutions supplied with sets of.....	383
report on the department of.....	381
review of work in the department of.....	41
series of catalogues.....	18
special distribution of.....	384
Marietta Exposition, joint resolution relating to the.....	157
report on Smithsonian participation in the.....	149
Marron, Thomas, ground dove presented by.....	358
sends a bird and snake eggs.....	117
Marsh collection of prints, reference to the.....	307
Marsh, Prof. O. C.....	27, 141, 290
sends skeleton of cormorant.....	114
Marshall, George.....	29
sends birds.....	117
Martin, M. Henry.....	322
Marty, Gustav, exchange with.....	53
Maryland, accessions from.....	117
ethnological specimens from.....	287
Mason, C. S., sends crystals.....	120
Mason, Consul, sends samples of ramie from Marseilles.....	137
Mason, Otis T., curator, department of ethnology.....	27, 34
paper on aboriginal skin-dressing by.....	553
papers by.....	756
report of.....	281
visits ethnological museums in Europe.....	28
Massachusetts, accessions from.....	117
friction-match from.....	286
Mat from Easter Island.....	536
Mataakiva.....	511
Materia Medica, section of.....	26
labels for section of.....	99
Mather, Fred., Mandarin ducks presented by.....	358
sends Mandarin ducks.....	119
Matthew, G. F., fossils purchased from.....	113

- Matthews, Dr. Washington**.....
 lecture by.....
Mayflower of the Ohio, The.....
McCormick, C. M......
McDonald, Col. Marshall, collections transmitted by.....
McGinnis, Wm. H., sends stone implements.....
 specimens sent in exchange to.....
McGregor, Alex., specimens of descloizite presented by.....
McGuire, F. B. and J. D., mollusks presented by.....
 present shells.....
McGuire, J. C., collection of mollusks presented by the heirs of.....
 shells bequeathed by.....
McMasters, T. G., specimens received from.....
McMurrich, Prof. J. P.....
Mead, Charles, sends arrow-heads.....
Mearns, Dr. Edgar A., sends natural history specimens.....
 specimens from Arizona.....
Medical Congress, meeting of the.....
 Museum of the Royal College of Surgeons.....
 museums.....
Meetings of societies in the National Museum.....
Meinhold, W., sends skull of Flathead Indian.....
Meiolana, casts of.....
Meiolonia, casts of.....
Meke-Meke.....
Merriam, Dr. C. Hart.....
 birds presented by and exchanged with.....
 collections presented by.....
 papers by.....
 sends a porcupine.....
 studies of arvicoline mice by.....
Merrill, George P.....
 collecting expeditions made by.....
 collects granite.....
 gypsum at Hopewell, Nova Scotia.....
 minerals.....
 rocks and ores.....
 field work of.....
 geological material collected by.....
 granite collected by.....
 papers by.....
 report of.....
 rocks collected by..... 117,
 sends geological specimens.....
Mesoplodon bidens from coast of New Jersey.....
Mesozoic fossils, department of.....
 report on the department of.....
 review of work in the department of.....
Metallurgical series of catalogues.....
Metallurgy and economic geology, department of.....
 review of work in the department of.....
 labels for department of.....
 report on the department of.....
Metal tracks.....
Metals, arrangement of the collection of.....

	Page.
Meunier, M., exchange with	54
Mexico, accessions from	113
ethnological specimens from	287
Michigan, accessions from	118
Middleton, James D., sends pottery	121, 143
Miller, Alex. McVeigh, sends living vipers	123
Miller, Hon. J. S., presents bears	122, 138, 420
Millholland, James A., sends drawing of bridge	117
Mills, Theodore A., transmits cast of head of President Lincoln	115
Millepaugh, Dr. T., specimens sent in exchange to	338
Mindeleff, Victor	119
sends pottery	143
Mineralogical series of catalogues	13
Minerals, department of	27
exchanges of	54
exhibit of, at Cincinnati Exposition	169
principal accessions to the collection of	401, 402
report on the department of	401
review of work in the department of	45
sets of, distributed	45
Minnesota, accessions from	118
Mississippi, accessions from	118
ethnological specimens from	287
Missouri, accessions from	118
Mitchell, B. W., presents birds	115
Moaitutahi	508
Modeler	29
Modelers, work of the	104
Modeling and painting	107
Models of rails	659
Mohican, U. S. S	450
Mollusk series of catalogues	18
Mollusks, correspondents of the curator of	374
department of	27
exchanged	53
exhibit of, at Cincinnati Exposition	168
labels for department of	99
principal accessions to the collection of	372
report on the department of	371
review of work in the department of	40
Mongolia, Buddhist book from	288
Monkeys added to the collection	420
Monsier, Jules	325
Montana, accessions from	118
ethnological specimens from	286
Montandon, A. L., exchange with	53
sends insects from eastern Europe	126, 378
Montelius, M	322
Mooney, James	119
Cherokee dance paraphernalia from	281
ethnological specimens from	143
outfit sent to	148
Moorehead, Warren K., deposits stone objects and pottery	120
prehistoric objects sent by	329

- Moran, Peter
 presents a collection illustrating the etching process
 Morcom, G. Frean, goose presented by
 Morgan, Senator J. T., monkey presented by
 Moritz, Celeste, presents white rats
 Morocco, knife from
 Morrill, James S.
 Morse, Prof. E. S., lecture by
 Mortillet, M. Gabriel de
 Moser, Lieut. J. F., birds presented by
 collections received from
 marine invertebrates received from
 specimens collected by
 mollusks transmitted by
 outfit sent to
 presents shells
 sends collections from Cape Sable
 Motuariki
 Motuopope
 Moturea
 Moukuhoi
 Moukuroa
 Müller, Baron F. von, sends Australian plants
 Müller, Friedrich
 Müller, Prof. F. Max
 Müller's "Madonna di S. Sisto"
 Murdoch, John, lecture by
 librarian, report of
 papers by
 Murray, Dr. S. P., monkey received from
 Musée d'Ethnologie, Geneva
 exchanges with
 Musée de St. Germain, sends bronze implements
 Musée des Thermes
 Museum appropriations
 catalogues
 collections, classification of
 employés, list of
 of Comparative Zoölogy sends fishes 123, 1
 Journalism in Antwerp
 Natural History, Paris, sends a collection of marbles
 specimens of marble received from the..
 Pedagogy in Paris
 Practical Fish Culture
 the City of Paris
 significance of the word
 Museums, growth of 43
 of Fine Art
 Hygiene
 the future, scope of the
 The, by Dr. G. Brown Goode
 organization of 49
 Mutu Raw Kaw
 Myer, Isaac, sends casts of Persian seals
 Name, A. Van

	Page.
Nanteuil's "Pompon de Bellièvre," proof of	303
Narauanga.....	506
Narwhal, skull of.....	388
Natal, Botanic Gardens of.....	52, 53, 399
National Academy of Sciences, meetings of the.....	70
Dental Association, meetings of the.....	70
Herbarium.....	20
Museum, administrative staff of the.....	28
classified service of the.....	4
division of the collections in the.....	439
organization and scope of the.....	3
staff of the	26
State institutions and colleges intended to receive publi- cations of the.....	193
transfer of disbursements of appropriations of the.....	6
Native cloth from Easter Island.....	538
Navajo blankets.....	281
Navajos, details of skin-dressing among the	574
Naval Academy [U. S.], mounted birds presented by the.....	139, 359
architecture, section of	27
exhibit of, at Cincinnati Exposition.....	170
Navy Department, coöperation of the.....	139
exhibit of, at the Cincinnati Exposition	174
Neal, Dr. J. C., sends ethnological objects.....	116
Neck ornaments from Easter Island.....	538
Needles from Easter Island.....	538
Nevada, rocks from	118
New Almaden, specimens illustrating the quicksilver industry received from	414
New Brunswick, fossils from	113
New Guinea, ethnological specimens from	288
Newhall, W. H.....	415
New Hampshire, accessions from	118
New Jersey, accessions from.....	118
Newlon, Dr. W. S., fossils received from	116
Newman, Rev. J. P., deposits model of a mosque	125
New Mexico, accessions from.....	119
ethnological specimens from.....	286
New South Wales, wools from.....	126
New York, accessions from	119
foot-stove from	286
lamp, tinder-box, etc., from.....	286
New Zealand, fishes from	126
sandal from.....	288
Niagara Falls, basket from.....	286
Niblack, Ensign A. P	70, 282
papers by	757
North Carolina, accessions from	120
ethnological specimens from	297
Northrup, Dr. John I., outfit sent to.....	149
Norway, specimens from	126
Nova Scotia, gypsum from	113
Oakford, Miss Ellen, lends etchings.....	114
Oberlin College, birds' skins received in exchange from	359
presents birds' skins.....	112
Obsidian spear-points from Easter Island	536

- Obsidian spear-points, tradition regarding
- Oceanica, accessions from
- Ohau
- O'Higgins*, Chilian corvette
- Ohio, accessions from
- Oho-taka-tore
- Oldham, A. S., presents buck-horns
- 'Old Ironsides,' locomotive, model of
- Olenellus Zone, Fauna of the
- Onemakihi
- Oneonepuhea
- Onepuhea
- One-tea
- Opaarionga
- Orcutt, C. R., insects named for
- transmitted by
- outfit sent to
- presents shells
- Ordnance Bureau, specimens received from the
- Oregon, accessions from
- Oriental antiquities, section of
- labels for section of
- report on section of
- reason for establishment of section of
- review of work in section of
- Origin of Easter Islanders, tradition in regard to the
- the American rail and track
- Orkney Islands, rush pith-wicks from
- Orleans*, steamboat, model of the
- Oroi
- Orongo, sculptured rocks near
- sketch of
- stone houses at
- Osborne, J. W.
- assistance rendered by
- Osgood, Prof. Howard
- Osteological preparator, work of the
- Osteologist
- Otago University Museum
- Oteu
- Owen, Dr. David D.
- Pakaea
- Paleozoic fossils, department of
- important accessions of
- report on the department of
- review of work in the department of
- Pallas's Cormorant, extermination of the
- Palmer, Edward, spiders collected by
- Palmer, Joseph
- Palmer, William
- Panama, porpoises from the region of
- Paparchalu
- Papaturei
- Papers published by officers of the Museum and other investigators
- describing collections in the Museum, list of

	Page.
Parker, Dr. T. Jeffery, sends New Zealand fishes	126
Paris, anatomical museums in	442
Museum of Natural History in, exchange with	54
Parsons, F. H., pottery received from	341
Parsons, Misses Grace and Maude, present Angora goats	47, 122, 420
Patent Office [U. S.], coöperation of the	141
Peabody Museum, Cambridge	285
exchange with	34
Peale, Dr. A. C.	45, 140
rocks collected by	407
specimens of wood opal collected by	402
Pearce, Richard, presents minerals	402
Pear-shaped rails	675
Peck, James I	383
Peckham, Prof. S. F.	46, 121
collection of petroleum made by	413, 414
Peebles, D. Bruce, sends pith of rush	126
Penfield, Prof. S. L.	45, 140
minerals collected by	120, 401
Pennsylvania, accessions from	120
shaving and splint matches from	287
Perdido Bay, pottery from	341
Perkins, Prof. G. H. sends stone objects	121
Perry, Harry, instructed in taxidermy	106, 110
Perry, N. H., sends minerals	117
Persia, ethnological objects from	124, 288
Persian astrolabe obtained for the Museum	291
seal	290
Perthes, M. Boucherde	318
Pern, woven fabrics from	123
Petrie, W. Flinders	291
Phelps, Albert I., fossils from	393
Philippi, Dr	458
Phillips, F. L.	123
Photo-Engraving Company	36, 303
Photographer, work of the	29, 109
Photography, exhibit of, at Cincinnati Exposition	171
Photogravure Company of Boston presents phototypes	117
Pickering, Prof. E. C	109
Pierce, E., correspondence with	354
Pigments from Easter Island	538
Pilsbry, Henry A., papers by	757
Pintard, E. L., deposits a file of the "Philadelphia Photographer"	120
Plants added to the herbarium	399
duplicate sets of, distributed	399
Platform, general plan of construction of	502
Platforms on Easter Island	497
Poike Plains	490
Police and public comfort	100
Poling, Otho C., sends birds' eggs	116
Polynesia, collections from	127
Polynesian archæology	538
Pond, Lieut. Charles F.	114, 399
Porpoise casts repaired, list of	105, 106

- Post-Office Department, coopération of the
 exhibit of, at the Cincinnati Exposition
- Post, Rev. F. H., coopération of
 G. E., rocks and ores sent to
- Potato fetish from Easter Island
- Potter, Rev. J. L., sends suit of Mohammedan priest
- Pottery, American aboriginal, report on the section of
- Poussie, Dr
- Powell, Maj. J. W., coopération of
 presents feet of harpy eagle
 sends pottery from New Mexico
- Powell, Prof. W. B., lecture by
- Prang & Co., Messrs. L
- Pratt, N. P., presents a corundum crystal
- Prehistoric anthropology, department of
 exchanges in the department of
 exhibit of, at Cincinnati Exposition
 importance of the science of
 report on the department of
 review of work in the department of
- Preparators, work of the
- Preservation of collections, appropriation for the
- Preston, E. I., lavas presented by
- Price, William W., presents birds' eggs
 papers by
- Prints, collection of
- Proceedings of the National Museum, statement concerning the
- Property, supplies and accounts
- Protozoans catalogued
- Protzman, Miss Emma
- Provincial Museum, Victoria, B. C., birds received in exchange from
- Puapan
- Publication fund, history of the
- Publications
 of the National Museum during 1888-'89
 in 1889 (bibliographical notices)
 State institutions and colleges intended
 to receive
- Puma, food of the
 geographical distribution of the
 habits of the
 the, or American Lion, by Frederick W. True
- Punahoa
- Punakape
- Punamuta
- Purcell, N. J.
- Putnam, Professor F. W.
- Quartermaster-General of the Army, courtesies extended by the
- Quatrefages, Dr
- Queen Charlotte Island, ethnological specimens from
- Quinn, W. M., sends a collection of turtles
- Ragozin, Mme. Zenaide A
- Ragsdale, George H., correspondence with
 collections received from
- "Rahway," locomotive, bell of

	Page
Rail-frogs	705
Rail rolled with base	666
Rails first rolled in America	671
laid during the war	679
Rana Kao	451, 452, 477
Rana Rotaka	451, 452, 492, 493, 494
Ranke, Dr. Johanas	323
Ranson, William, in exchange with	52, 339
Rapa, Nui	453
Rasch, Dr., exchange with	53
Rathbun, Miss M. J.	382
Rathbun, Richard	27, 41, 71, 142
papers by	758
report of	381
Recent plants, department of	27
series of catalogues relating to	19
Reed, Dr. Thomas J., presents birds	118
Registry and storage	28
Reimer, Hon. Otto E., ores received from	46, 123, 137, 414
Rembrandt's "Christ Preaching"	302
Renaissance, effect of the, on art collections	430
Renga-havini	511
Report on Smithsonian exhibit at Cincinnati Exposition	154
Reports of the curators	279
Reptiles and batrachians, department of	27
report on the department of	365
review of work in the department of	38
series of catalogues	19
whose skins were utilized by American aborigines, list of	560
Revenue Marine Service, coöperation of the	138
Review of work in the scientific departments	34
Rey, Dr. E., birds purchased from	125, 359
Reynolds, E. R., stone implements purchased from	125
Rhode Island, accessions from	121
Ri chardson, C. L., correspondence with	354
Ri chmond, Charles W., papers by	758
Ri cksecker, L. E., insects purchased from	378
Ri dgway, Robert	27, 38
papers by	758, 759
report of	357
sends birds' skins	115, 116, 117, 122, 359
Ri gby, James, presents model of car-wheel	118
Ri ght whale, skeleton of, purchased	387
Ri ley, Dr. Charles V.	27, 41, 141
papers by	759-769
report of	377
Ri nger, T., presents Japanese birds	124, 359
Ri ves, Hon. A. L., sends pictures of Samoan scenery and life	137
Ri binson, Lieut. Wirt, birds presented by	359
papers by	769
Ri ca, Tirso y Agusti, ores presented by	414
Ri ck collection, arrangement of the	410
Ri ckhill, W. W., explorations in Thibet by	146
reference to explorations of	98

- Rockhill, W. W., offers to obtain specimens from Thibet
 sends specimens from Thibet.
- Rocks, historical series of
 principal accessions to the collection of
 sources of accessions to the collection of.
- Rocky Mountain sheep obtained by George Bird Grinnell
- Roggeveen, Admiral 47
- Rolled iron rails, introduction of.....
- Rollin, M.....
- Romeyn, Capt. Henry, sends living animals.....
- Roumania, insects from
- Rowland, Thomas, birds purchased from.....
- Royal Botanical Gardens at Seebpore sends mounted plants
- Ethnological Museum of Berlin
- Herbarium, Kew, England.....
- Zoological Museum of Florence.....
 sends birds' skins
 fishes
 mammals and bats.....
 reptiles
- Rumsey's steamboat
- Runga-vae.....
- Ruruoa
- Russell, Prof. I. C., geological photographs, prepared under the direction
 outfit sent to.....
 reference to exploration of.....
 rocks, soils, and clays collected by.....
- Russia, specimens from.....
- Rust, Halbert, stone and bone implements from
- Ryder, Dr. John A
- Ryland, Rev. R., sends specimens
- Rytina, or Arctic sea-cow, extermination of the
- Saiga, antelope.....
- Salmon, A. A
- D. E., transmits a collection of parasites.....
- Salvin, Osbert
- papers by
- Sandwich Islands, ethnological specimens from
- Sandusky, locomotive, model of
- Santiago de Cuba, manganese ores from
- Saturday lectures, list of
- Savannah, steamship
- Saxton, engraving machine.....
- Schafirt, E. F., sends skeleton of bird.....
- Schedule of classified service in the National Museum
- Schmidhoffen, Herr von, Tschusi, Zu., exchange with.....
 Victor Ritter, Tschusi, Zu., birds received in exchange from.....
- Scientific departments, personnel of the.....
 review of work in the
- societies to which Museum publications should be sent, list of
- staff of the Museum
- Sclater, Dr. P. L.....
 papers by
- Scotland, ethnological specimens from
- pith of rush from

	Page.
Scott, Mrs. W. , presents silk cocoons	124
S. , minerals received from	402
Scovill Manufacturing Company	110
presents cameras	119
Scrapers	581
Sea-birds' eggs gathered by Easter Islanders	482
Secret Service Division, Treasury Department , coöperation of the	138
Sectional libraries	48
Seely, Prof. H. M. , sends fossils	122
Senna, Angelo , sends European bats	126
Sennett, George B. , papers by	770
Sewall collection of prints	307
Shelby Iron Company presents minerals	113
specimens representing the smelting of pig iron re- ceived from the	414
Sherman, Hon. John , minerals received from	402
Shindler, A. Zeno	284
colorist	110
Shofar, of ram's horn , presented by David Sulzberger	125
Shufeldt, Dr. R. W. , bird presented by	359
collections sent by	139
correspondence with	354
outfit sent to	148
papers by	770, 771
presents a specimen of <i>Hesperomys truei</i>	37
specimens received from	119
Shungio, Hieromich	35
Japanese kago obtained by	295
Shute, Prof. D. K.	70
Shutt, Col. G. W. , presents a snake	122
wood rat received from	421
Sia pipe-stems from	288
Sicard, Commodore M. , specimens obtained through	139
Signal Office (U. S.) Chief of , deposits a Secchi meteorograph	115
coöperation of the	139
Simson, Charles Torrey , papers by	771
Sitka , ethnological specimens from	286
Skin-dressing among aborigines in countries other than North America	580
the Indians	566
Slot-rail and ring-joint	698
Smith, Dr. Sanderson , presents minerals	119
Smille, T. W.	29, 421
photographer	109
Smith, Dr. Hugh M. , sends birds	122
Smith, Hubbard T. , monkey received from	420
Smith, John B. , monograph of the Sphingidæ of North America by	380
papers by	771
resignation of	28, 41, 377
Smith, Prof. S. I.	42, 71, 382
Grecian exhibit at Cincinnati Exposition, review of the	162
Museum	435
meetings of	69
Solotarev, Prof.	323
extermination of the	631

- Solomon Island, adze-blades from
 Solomons, Miss Aline, presents Egyptian scarabs.
 Sommerings pheasant, presented by T. Ringer
 South America, accessions from
 ethnological specimens from
 South Carolina, accessions from
 Sowerby's whale, skeleton of
 specimen of
 specimen of, received from New Jersey coast
 Space assigned to Smithsonian exhibit at the Cincinnati Exposition
 Spainhour, Dr. J. M., presents specimens of asbestos
 Speel, Fred, sends a toad-fish
 Speer, R. P., insects received from
 Sphingidæ of North America, monograph of
 Spinner, Gen. F. E., sends shells
 Splice-bars
 Sponges catalogued
 Spoon-billed sandpiper, presented by T. Ringer
 Stabler, Harold P., sends a hawk
 Standard cases constructed
 Stanford, Senator Leland, presents a prong-horned antelope
 St. Carlos
 State, Department of, cooperation of
 exhibit of, at Cincinnati Exposition
 transmits ores and coals
 Stearns, R. E. C.
 adjunct curator of mollusks
 paper on shell money by
 papers by
 Stearns, W. A., outfit sent to
 Steel rails rolled in America
 Steel Street Railway Company of Johnstown
 Steinmeyer, Dr. F. A., paleolithic implements received from
 Stejneger, Dr. Leonard
 appointed curator of reptiles and batrachians
 papers by
 continues his work on Japanese ornithology
 report of
 studies in Japanese ornithology by
 Stephen, Alexander M., papers by
 Sterki, V., papers by
 Steuart, C. A., assistant superintendent of buildings
 Stevens, Francis B
 Stevens' rail in America
 Stevens, Richard G
 Stevens' experimental locomotive, model of
 Stevenson, Col. James
 biographical notice of
 presents specimens from Arizona
 sends pottery
 Stevenson, Mrs. Matilda C., Pueblo pottery from
 Stevenson, Prof. J. J., petroleum specimens received in exchange from
 Stevens' rail first rolled in America in 1845.
 in Europe

	Page.
St. Germain , museum of, exchanges with.....	52
Stone adzes from Easter Island.....	537
fishhook from Easter Island.....	537
image from Easter Island.....	535
knife from Easter Island.....	537
Stone , Livingston, sends specimens of fungus.....	120
stone axes sent by.....	330
Stone , Mrs. E. J., sends map of Washington and other objects.....	114
stereoscope presented by.....	110
Stoney , Lieut. George M., sends ethnological objects.....	113
Storage-cases for study series of mammals.....	351
Stoughton , T. M., slab of triassic sandstone obtained from.....	407
Straus , Hon. Oscar.....	292
Strode , W. S., sends stone implements.....	116
Students	70
Sturtz , B., exchange with.....	54
rocks received in exchange from.....	406
Sulzberger , David, presents a shofar.....	125
Swan , James G.....	285
marine specimens received from.....	381
sends a specimen of <i>Vespertilio longicrus</i>	37, 350
ethnological objects.....	113
marine invertebrates.....	41
specimens sent by.....	281
Sweeny , T. W.....	29
Switches	707
Switzerland , Lacustrian, objects from.....	126
Sydney , wools transmitted by U. S. Consul at.....	137
Symonds , Lieut. F. M.....	450
Table of catalogue entries , 1888-1889.....	21
Tabler , Howard, sends a tortoise.....	117
Tablets , examination of, on Easter Island.....	513
Tahai	500
Tahiri	511
Tahureue	509
Tanks for storage of alcoholic specimens.....	351
Taroo	511
Tattooing implements from Easter Island.....	538
Tanka	504
Taunt , Lieut. E. H., instructed in photography.....	110
taxidermy.....	106
outfit sent to.....	148
reference to explorations of.....	98
Tavera , Chevalier Schmit von, presents a map of Hungary.....	125
Taxidermists	29, 104, 106
Taylor , Dr. J. S., sends pottery.....	113, 143
Taylor , William, flint implement received from.....	332
instructed in taxidermy.....	106
sends a stone implement.....	121
Teapy	453
Tegima , S., plants transmitted by.....	399
Tehahitunukiolaira	506
Tehangakiri	509
Tehutesheru	511

- Tennessee, accessions from
 Te Pito Te Heuua, or Easter Island, paper on
 Tetonga
 Texas, accessions from
 Textile industries
 Theatrical museum in Paris
 The development of the American rail and track, by J. Elfreth Watkins
 The Ethnology and Antiquities of Easter Island, by Paymaster W. J. Thomson
 The Museums of the Future, by Dr. G. Brown Goode
 The Puma or American Liou, by Frederick W. True
 Thibet, ethnological specimens from 124
 Thompson, C. A., sends a stone carving
 Thompson, Col. Frank, war-relic received from
 Thomson, Paymaster William J., U. S. N., paper by
 Thurston, Gen. G. P., sends pottery
 Ties of metal
 wood
 Tiffany & Co., ivory figures purchased from
 minerals purchased from
 watches purchased from
 Tiflis, Museum of Natural History in, sends birds' skins
 Tilefish, destruction of the
 Tilton, James P., sends pottery
 Tokaie
 Tokyo Educational Museum
 plants from the
 specimens of *Dryobates namiyei* received in ex-
 change from the
 Tolson, Thomas H., sends an eagle
 Tongariki
 Topinard, Dr.
 Townsend, Charles H.
 Brazilian birds purchased from
 mammals collected by
 monkey received from
 Townsend, Dr. Taylor, insect collection of
 Translations of Easter Island tablets
 Transportation and engineering
 exhibition series in section of
 exhibit of section of, at Cincinnati Exhi-
 sition
 important accessions to the section of
 labels for department of
 report on the section of
 review of work in section of
 series of catalogues
 storage and distribution of duplicates
 Treasury Department, coöperation of
 exhibit of, at Cincinnati Exposition
 Trevithick's locomotive, model of
 True, Frederick W.
 paper on the puma by
 papers by
 presents mammals, snakes, and insects

	Page
True, Frederick W., report on comparative anatomy by.....	387
mammals by.....	349
Tschusi zu Schmidhoffen, Victor Ritter von, birds' skins received from.....	125
Tumatama.....	506
Tumuheipara.....	504
Turkestan, scroll-picture from.....	288
Turkey, Koordish costume from.....	288
Turnbull, T. R.....	415
Turner, W. H., fossil fishes collected by.....	115
Tutuira.....	509
Tuumae-Keke.....	527
Uber, C. Edgar, presents rabbits.....	122
Ue.....	509
Ulke, Henry, insects received from.....	378
United States, ethnographic museums in the.....	442
important accessions from the.....	113
Uruguay, skin and bones of sea-lion from.....	123
Vaiavaugarenga.....	504
Vaihu.....	450, 453
Vaimango.....	506
Vaimosi.....	508
Vancouver Island, ethnological specimens from.....	286
Van Dyke, E., alcoholic insects received from.....	378
Vasey, Dr. George.....	27, 44, 141, 142
appointed honorary curator.....	28
papers by.....	772, 773
report of.....	399
Venezuela, accessions from.....	124
Vermont, accessions from.....	121
Verrill, Prof. A. E.....	42, 71, 382
Vertebrate fossils.....	27
fossil series of catalogues.....	17
Very, C. F., sends ethnological objects.....	116
Vienna, Royal Imperial Natural History Museum of.....	54, 125
Viking ship, model of, purchased.....	126
Vinapu.....	512
Virginia, accessions from.....	122
ethnological specimens from.....	287
Visitors during inauguration season.....	5
to the Smithsonian and Museum buildings.....	67, 68
Vouchers for expenditures for furniture and fixtures, list of.....	84-86
heating and lighting, list of.....	87
preservation of collections, list of.....	77-84
Wafer, Lionel.....	447
Wakefield, M. M., sends an owl.....	122
Walcott, C. D.....	27, 43, 140, 141
papers by.....	773
report of.....	391
Walker, Commodore J. G.....	52
Wallace, J., birds purchased from.....	359
Waller from Easter Island.....	536
Walrus, causes of the extermination of the Atlantic and Pacific species.....	618
Wapiti, specimens of, presented by Hon. W. F. Cody.....	420
War Department, cooperation of the.....	138

- War Department, exhibit of, at Cincinnati Exposition.....
- Ward, H. A.
- mammals purchased from
- sends in exchange skins of Indian seal
- skeleton of whale purchased from
- Ward, J. V., sends stone implements
- Ward, John T., monkey-faced owls received from
- Ward, Lester F. 27
- papers by
- Warren, Dr. B. H., birds presented by.....
- papers by
- Washington, D. C., ethnological specimens from
- Washington, Lawrence, objects which belonged to George Washington, received from
- Washington, State of, ethnological specimens from
- (State) accessions from
- Watasse, S.
- Watkins, J. Elfreth
- curator of transportation and engineering
- engineer of property
- paper on the development of the American rail and track, by
- papers by
- report of.....
- Wayne, Arthur T., cross-bills purchased from.....
- Webb, F. W.
- sends photographs of Trevithick's engine and boiler.....
- Webster, E. W., shells received from
- Webster, G. W., mollusks received from
- Webster, Prof. F. M., insects named for.....
- Weed, W. H.
- Weeden, W. C.
- keeper of living animals.....
- Welker.....
- Wells, J. Grant, water-birds presented by
- Wells, Prof. H. L., mineral, received from
- Western Reserve collection at Cleveland
- West Indian seal, causes of extermination of the
- West Indies, accessions from the
- West Virginia, accessions from
- ethnological specimens from
- Whaites, Edward P., presents a memorial medal
- Wheeler, Charles L. R., sends cast of stone knife.....
- Whitcomb & Co., Messrs. W. H.
- gift of.....
- White, Dr. C. A. 27
- papers by
- report of
- White, J. J., mollusks collected by
- shells received from
- Whitfield, J. E., papers by
- Whitten, Dr. W. A., sends specimens from an Indian grave.....
- Wilkinson, E., forwards a bird's egg.....
- Willcox collection of minerals withdrawn

	Page.
Willcox, Joseph, fossil shells presented by	40, 41
minerals received in exchange from	402
Wille's "Satin Gown," impression of	303
Williams, B., minerals presented by	402
Williams, Dr. G. H., rocks received in exchange from	406
Williams, Lowell C., presents prairie dogs	115
Williams, Talcott, expedition of	144
preliminary report of	144-146
reference to explorations of	98
Williamson, George, sends stone implements	117
Williston, Dr. S. W.	379
Willoughby, Charles	285
Wilson, G. M., minerals received from	402
Wilson, Thomas	27
papers by	776
presents archaeological objects	120, 121, 333
minerals	125
report of	317
visits museums in Europe	28
mounds in Ohio	147
Wiltheise, C. T., specimens sent by	328
Winona, State normal school, collections from	118
Winslow, A. C., presents key of U. S. Treasury	114
Wisconsin, accessions from	123
patent boomerangs from	287
Wittfield, William, presents specimens of Florida muskrat	37, 349
Wooden block-joints	698
clubs from Easter Island	535
images from Easter Island	534
Worms catalogued	383
Worth, R. N.	54, 406
Worthen, C. K., presents manuals	116
Worthington, W. W.	119, 339
Wortman, Dr. J. L., birds' skeletons lent to	52
presents zoölogical specimens	115, 139
Wright, James C., sends cast of a stone bear	333
Wyoming, accessions from	123
Yale College Museums, turtles and terrapins received from the	421
Yarrow, Dr. H. C., resignation of	28, 38
sends an ancient bowl	114
a head of swordfish	117
Yeates, Hon. Jesse J.	820
Yeates, William S.	27
assistant curator of minerals	403
fire-making set from	288
Zahn, Henry, transmits piece of geyser	114
Zahn, S. H., specimens sent in exchange to	339
Zeledon, José C., transmits birds' skins	113
Zoölogical Society of Philadelphia, specimens received from the	37, 120, 124, 350



APPENDIX E.

PRELIMINARY HANDBOOK OF THE DEPARTMENT OF GEOLOGY IN THE U. S. NATIONAL MUSEUM.

BY GEORGE P. MERRILL, *Curator.*

INTRODUCTORY.

The history of the National Museum may be said to date from the year 1846, when, by act of Congress, the custody of the "National Cabinet of Curiosities" at that time deposited in the Patent Office Building was transferred to the Smithsonian Institution. This act provided that "all objects of art and foreign and curious research, and all objects of natural history, plants, and geological and mineralogical specimens belonging or hereafter to belong to the United States," and which were then in the city of Washington, should be delivered to the Regents of the Smithsonian Institution, and together with new specimens obtained by exchange, donation, or otherwise, should be so arranged and classified as best to facilitate their examination and study. By a subsequent act* the National Museum became the authorized place of deposit for all objects of natural history, mineralogy, geology, archaeology, ethnology, etc., belonging to the United States or collected by the Coast and Interior Survey, the Geological Survey, or by any other parties for the Government of the United States when no longer needed for investigations in progress.†

The amount of geological material which was thus brought together prior to 1876 was small and extremely varied. It consisted mainly of the collections made by Prof. J. D. Dana and his associates during the Wilkes Exploring Expedition in 1838-'42; by Professors Newberry and Blake during the Pacific Railroads surveys in 1854-'55; by the surveys west of the one hundredth meridian under the direction of the Engineer Corps of the Army, and the U. S. Geological Survey under direction of Dr. F. V. Hayden. There were, besides, various small col-

* Passed in 1857.

† The organization and objects of the National Museum, Proc., U. S. National Museum, 1881.

lections, including a series of 300 specimens of typical European and minerals obtained in 1864 from Louis Saeman in Paris; a series of 148 specimens received from the Royal Mining School of Freiberg, Saxony; another small series collected by H. Engleman in Montana, and still others collected by Dr. B. Powell from the vicinity of Hot Springs, Arkansas, by D. D. Owen in Wisconsin and Minnesota and other miscellaneous materials from scattering localities.*

The Centennial Exposition at Philadelphia in 1876 afforded Prof. James H. Baird the desired opportunity for procuring a large amount of material illustrating the mineral resources of the United States, and laying the foundation for the department of geology as it now exists. After the close of the exposition this material, prepared under the immediate supervision of Prof. W. P. Blake, together with the extensive collections donated by foreign governments, was stored in boxes for several years, awaiting the completion of the new building. This was effected in the summer of 1881, and, with the appointment of Dr. C. D. W. Hawes as curator the year previous, may properly be said to mark the history of the geological department of the National Museum.

At the time Dr. Hawes entered upon his duties as curator he assumed charge of that branch of the Tenth Census relating to the quarrying industry of the United States. To this work he gave his entire attention, and the present collection of building and monumental stones is largely the outgrowth of his exertions in this direction. Dr. Hawes's connection with the Museum was, however, too short to allow the department to become fully organized, and at the time of his death † matters were still in a state of great confusion, owing to the large amount of material that had accumulated and the extent of the work undertaken, but necessarily uncompleted. The extensive collections received from Philadelphia at the close of the Centennial Exposition in 1876, above referred to, were still unpacked and unassorted, as were also those received from the various United States geological surveys that existed prior to the present organization.

* Prior to 1873 there were no paid assistants whose duty it was to look after the collections, and it is fair to assume they suffered accordingly. Up to this time it had been the custom to send all duplicate materials to Professors Newberry and Engelm. at Columbia College, New York City, where they were made up into sets for distribution to various institutions. Some 22,000 specimens are reported as having been sent out in this way. In 1873 Mr. F. P. Endlich was appointed assistant in charge of the mineralogical collections, and continued to serve until 1879. Up to the close of 1879 the total number of duplicate specimens sent out was as follows:

	Specimens.
Fossils	10,518
Minerals and rocks	21,407
Packages of infusorial earth.....	1,928
	33,853

† Dr. Hawes died at Denver, Colorado, June 22, 1882.

To the Centennial Exhibition of 1876, the Tenth Census (1880), and the various United States geological surveys and exploring expeditions the department is largely indebted for whatever material it possessed prior to 1882. The time since the death of Dr. Hawes and the organization of the three departments of mineralogy, metallurgy, and lithology and physical geology from the one department of geology as it then existed, and the very recent reconsolidation of the departments of metallurgy, and lithology and physical geology into the one department of geology has been too short for the complete elaboration of the plan here proposed.*

In the division of the various collections comprised under the head of geology in its broadest sense, as given below, regard has been had mainly to convenience in administration and arrangement of material in a manner most readily accessible for study and reference. We thus have for our main divisions as below :

Geology { Physical and Chemical Geology.
 { Palæontological Geology.

These are then subdivided as below :

Physical and Chemical Geology...	{	Department of Minerals, F. W. Clark, U. S. Geological Survey, Honorary Curator. Department of Geology, George P. Merrill, Curator.
Palæontological Geology	{	Department of Tertiary and Recent Invertebrate Fossils, W. H. Dall, U. S. Geological Survey, Honorary Curator. Department of Cretaceous Invertebrate Fossils, C. A. White, U. S. Geological Survey, Honorary Curator. Department of Paleozoic Invertebrate Fossils, C. D. Walcott, U. S. Geological Survey, Honorary Curator. Department of Vertebrate Fossils, Prof. O. C. Marsh, New Haven, Connecticut, Honorary Curator. Department of Fossil Plants, L. F. Ward, U. S. Geological Survey, Honorary Curator.

The palæontological section as given may strike one at first thought as cut up unnecessarily, as cumbersome from the very multiplicity of its divisions. Such an arrangement has at least the advantage that each curator is afforded complete control of such material as he is especially interested in, and is not hampered with the care of a great amount of other matter; whatever may be the effect of such diffuseness upon the Museum as a place of exhibition, there can be little doubt regarding its benefits to the specialist.

Of the seven divisions mentioned above this paper has to do only with the second, that designated simply as the department of geology, and of which the writer is at present acting as curator.

In administering upon such a department one is at the very outset

*This change was effected in October, 1889.

confronted with the old question as to whether the energies of our officers are to be directed toward getting together a systematic collection of specimens arranged for study alone, or a show collection arranged behind glazed doors and properly labeled for the instruction and gratification of the general public. This is a question that has been discussed since museums began, and is perhaps now no nearer settlement than ever. I find the specialist almost wholly inclined to the first view, and I willingly acknowledge that were I working for merely my own gratification should adopt that plan.

It is to be doubted, however, if there exists a more thoroughly selfish class than that of the confirmed specialist. Looking at matters from the standpoint of his specialty, interested only in its advancement, he perhaps, in only too many instances, in his own aggrandizement demands not merely that the public contribute towards his support, but that they receive in return nothing but his published results, which are presumably intelligible to not more than one person out of every thousand the world over.

Recognizing that not merely do the public have rights in this matter, but guided by a far loftier ideal, that of educating the masses by arousing an interest in natural phenomena, it was early decided to strive and so arrange the collections of the Museum as to meet the wants of both classes. We thus have an exhibition series arranged and labeled for the general public, but at the same time accessible to the student and specialist, and also a study series stored away in drawers for the exclusive use of the latter class and to which the general public have no access.

First, as to this exhibition series. The plan of treatment adopted has been essentially the same as that given by Professor Geikie in his latest edition of his Text Book of Geology.* This not merely on account of the general excellence of the work, but because of the fact that it seemed best to conform, so far as possible, to some authoritative plan that is accessible to the public.

In following out this plan the idea advanced by Assistant Secretary Goode in his annual report for 1881, that a museum should consist of a collection of labels illustrated by specimens has been ever kept in mind. Otherwise expressed, I have striven to build up the exhibition series on the plan of a profusely illustrated text-book in which the specimens themselves form the illustrations and the text is furnished by the labels.

No object has been intentionally exhibited merely on account of its beauty, rarity, or as a curiosity, a method of treatment which may be relegated to the dime museums and cabinets of the relic hunter. Each, intended to illustrate some special point, forms a part of a more or less extended series tending toward the elucidation of the general structure and history.

* Text Book of Geology, second edition, 1885, MacMillan & Co., London.

OUTLINE.

SECTION A.—SYSTEMATIC GEOLOGY.

Considering geology not merely as a science treating of the composition and structure of the earth, but as one which comprises as well its origin and history, one whose aim it is to “trace the progress of our planet from the beginning of its separate existence through its various stages of growth down to the present condition of things,” the section begins with a consideration of:

I. THE EARTH IN ITS COSMICAL ASPECT.

In this first primary division the earth is represented as a planet and compared with other members of the solar system. This is, of course, done only by means of models and illustrations of various kinds.

II. THE COMPOSITION AND STRUCTURE OF THE EARTH—GEOLOGY.

This second primary division, which comprises the science of geology as ordinarily understood, is divided into four subsections, each of which is capable of further subdivision. These subsections are:

- I. Geognosy: A consideration of the materials of the earth's substance.
- II. Dynamical and Physiographical Geology: The agencies and methods of geological change.
- III. Structural Geology: The architecture of the earth's crust.
- IV. Stratigraphic or Historical Geology.

SECTION B.—ECONOMIC GEOLOGY.

This section treats the subject from a purely economic standpoint, and in it are exhibited only such substances as are of value either in their natural condition or on account of the useful materials they may be made to yield. It is divided into two subsections, viz:

- I. The Geographic Series.
- II. The Systematic Series.

SECTION A.—SYSTEMATIC GEOLOGY.

I.—GEOGNOSEY: A CONSIDERATION OF THE MATERIALS OF THE EARTH'S SUBSTANCE.

Under this section are shown: (1) the sixteen more common elements which, in their various combinations, are estimated to form about 99 per cent. of the substance of the earth's crust; (2) the minerals which, resulting from these combinations, go to make up rock masses; and (3) the rocks themselves. All the substances required for these exhibits are of such nature as to admit of their being readily utilized. Not even the fact that an element is a gas, both colorless and tasteless, is to be considered an obstacle, since a glass jar of hydrogen, though apparently empty, is, if properly labeled, as instructive as though the substance itself were tangible. In the collection of rock-forming minerals, the specimens are selected not for beauty or fine crystallographic development, but ordinary forms, both crystalline and massive, are shown in all their principal varieties. The collection is divided into (1) primary minerals, or those which formed at the time of the consolidation of the rock, and (2) secondary minerals, or those which have formed since its consolidation, and are due mainly to decomposition, hydration or solution and re-crystallization. The individual labels further state whether the mineral is an essential or accessory constituent, and of what class of rocks it forms a part.

The following shows the form of label here used:

APATITE.

Composition: Phosphate of lime.

Crystalline System: Hexagonal.

Common as an original constituent in granular limestone, syenite, gneiss, mica, and hornblendic schists and occasionally found in serpentine. Occurs also in slender, colorless, usually microscopic crystals in many igneous rocks of all ages, such as granite, basalt, andesite, diorite, and diabase.

More rarely it occurs massive in deposits of considerable extent and is mined for commercial purposes.

In the rock collection the samples are as a rule trimmed with a hammer into sizes approximately $3\frac{1}{2}$ by $4\frac{1}{2}$ by 1 inch, this form having been found most convenient when everything is taken into consideration. This rule is not, however, inviolable, and both size and shape are allowed to vary when the character of the rock necessitates or renders this advisable. Care is taken in all cases to procure so far as possible fresh and characteristic materials and that no specimen shall show abrasive marks from the hammer or other agencies on its exposed surface.

Advantage has here been taken of an opportunity to bring together as large a series as the present facilities will allow of such rocks as have been the subject of the close methods of scrutiny adopted in modern petrography. It therefore happens that certain groups are represented in greater profusion than their geological importance seemingly warrants. The system of installation is, however, by no means inelastic, and when these other groups shall in their turn receive the attention they merit a place can readily be made for them by substitution, or better yet by an expansion of the entire series.

In the arrangement of the exhibition portion of this collection the curator is at once confronted with one of the most unsatisfactory problems in modern petrology, that relating to classification. The rapid strides which this branch of the science is now making render any system likely to be adopted of only provisional value, and what is written to-day may by the time it appears in print be so far out of date as to be more than unsatisfactory. However readily one may classify a series designed for study only, he is, with his exhibition series, at once reminded that each specimen, selected with a definite purpose in view, with an eye to geographical as well as geological distribution, must be called by a definite name, and placed in a definite position in the series.

Whatever mental reservations the curator may have can not be made to appear on the label, nor, indeed, is it desirable that they should. Every teacher must long have recognized the fact that in the beginning no student should be confronted with all the uncertainties of any problem. Such a course tends only to confuse and discourage. It is best at first to treat of matters as apparent certainties, and when the student shall have sufficiently progressed the uncertainties will gradually unfold of themselves.

So in arranging this petrographic collection the curator has, in his classification, indicated a simplicity which perhaps does not actually exist, a system which aimed to be not so complicated as to confuse the

public, nor so simple and indefinite as to excite the contempt of a specialist.

As at present arranged all the rocks forming any essential part of the earth's crust are grouped under four main heads, the distinction being based upon their origin and structure. Each of the main divisions is again divided into groups or families, the distinction being based mainly upon mineral and chemical composition, structure, and mode of occurrence. We thus have:

I. *Aqueous rocks*.—Rocks formed mainly through the agency of water as (a) chemical precipitates, or as (b) sedimentary beds. Having one or many essential constituents. In structure massive, laminated, or bedded, crystalline, colloidal, or fragmental; never glassy.

II. *Æolian rocks*.—Rocks formed from wind-drifted material. In structure irregularly bedded; fragmental.

III. *Metamorphic rocks*.—Rocks changed from their original condition through dynamic or chemical agencies, and which may have been in part of aqueous and in part of igneous origin. Having one or more essential constituents. In structure crystalline, bedded, schistose, or foliated.

IV. *Igneous rocks*.—Eruptive. Rocks which have been brought up from below in a molten condition, and which owe their present structural peculiarities to variations in composition and conditions of solidification. In structure massive, crystalline, felsitic, or glassy, or in certain altered forms, colloidal.

The following shows the type of labels used in this series:

MICA SYENITE.

GALLATIN COUNTY, Montana. 38,600.

Collected by GEORGE P. MERRILL, 1886.

**MUSCOVITE-BIOTITE GRANITE with
accessory TOPAZ and a LITHIA MICA.**

STOCKSCHNEIDER, in the Erz-Gebirge, Saxony. 36,161.

Obtained from B. STURTZ, 1884.

PYROXENITE; Websterite.

Near WEBSTER, Jackson County, North Carolina. 38,832.

Gift of H. J. BIDDLE, 1887.

Quartzite [Novaculite].

LEIGH RIVER, Victoria, Australia. 28,321.

AUSTRALIAN CENTENNIAL COMMISSIONERS, 1876.

NOTE.—The inclosing a name in brackets, as [Novaculite] in the last formulates that such has gone out of use, or is a local or popular name of little value, and is not generally accepted.

This collection is at present arranged in eight of what are known as standard sloping table cases, and comprises some 1,600 specimens divided approximately as follows:

Aqueous rocks 350 specimens; Æolian rocks 20 specimens; Metamorphic rocks 300 specimens, and Igneous rocks 930 specimens. For further details regarding classification, kinds, and localities represented reference must be made to the handbook and catalogue of this exhibit as it will appear in the Report of the U. S. National Museum for 1890.

This petrographic collection it has been found advisable to precede by four small exhibits illustrative of (1) structural features, (2) color variations and their causes, (3) specific gravities as influenced by composition and structure, and (4) the variations in chemical composition.

It is the object of the first, or structural series, to explain the meaning of sundry terms in common use among geologists, but whose exact meaning is not always understood by the public at large. Such a collection really forms an illustrated glossary, since the meaning of each term, as "porphyritic," "cellular," etc., is shown by means of a specimen in which the structure is the most pronounced characteristic. This collection is supplemented by a series of twelve enlarged photomicrographs showing the structure of rocks as revealed by the microscope and seen in polarized light.

In preparing these transparencies, a small chip from each rock was ground so thin as to be transparent (from one five hundredth to one six hundredth of an inch), and then after being mounted between thin slips of glass was photographed through a microscope and between crossed nicol prisms. From the negatives thus prepared further enlargements were made by means of a solar camera, the final print being on glass and twelve inches in diameter; that is, that portion of the stone which is in reality about one-fourth of an inch in diameter, is here made to appear one foot in diameter.

These illustrations were then painted by hand, the artist taking his colors from an examination of the section itself under the microscope. The colors of the various minerals are not, therefore, in all cases the true colors of the minerals themselves, but rather the color they assume when after being cut at different angles with their optic and crystallographic axes they are viewed by means of polarized light. Such colors are therefore somewhat misleading at first, but are rendered necessary for the purpose of identification and to bring out sharply the lines of separation between one mineral and another and thus show the structure and composition of the rock. Owing to the thinness of the section it would appear in ordinary light, *i. e.*, light not polarized, nearly colorless or with only dark flecks and faint tinges of color here and there.

In the second, or color series, an endeavor has been made to arrange the rocks in five groups, showing (1) rocks colored by carbonaceous matter; (2) rocks colored by free oxides of iron; (3) rocks colored by the prevalence of iron rich silicates; (4) rocks the color of which is due

in part at least to structural features and the transparency of the siliceous and spathic constituents, and (5) rocks the color of which is also in part due to the physical condition of the various constituents, but more particularly to a lack of carbonaceous matter, iron or other metallic oxides. In this series is appended another showing the changes in color due (1) to the bleaching of the carbonaceous matter; (2) to the leaching out of ferruginous oxides by organic acids; (3) to the oxidation of iron protoxides to carbonates or sulphides; (4) to a like change in the iron rich silicates and (5) to a change in the physical condition of the constituent minerals, mainly the feldspars.

It is not necessary to here enlarge upon the third and fourth of the small series mentioned above, further than to say that the difference between the apparent and real specific gravity is rather strikingly shown in three contiguous glass jars each partially filled with water. The first contains a piece of pumiceous obsidian, which, buoyed up by its numerous vesicles, floats readily at the surface; the second contains the same pumice, but sufficiently pulverized to admit the water into the vesicles. The fragments, therefore, sink to the bottom, as does the compact nonvesicular portion of the same obsidian in glass No. 3. This series is described in detail in the handbook above referred to.

Aside from the collections described above as forming the exhibition series, as illustrative of the mineral aggregates forming any appreciable proportions of the earth's crust, there are in the department, scattered away in the table cases, many collections, designed primarily for study only. These are so arranged as to be accessible to the student of geology upon application to the Director of the Museum and on presentation of proper credentials, if such be deemed necessary. The collections thus scattered are classed under the head of the study series. In preparing and arranging this series it may be well to state that it is made up largely of such materials as have somewhere and at some time been subjected to investigation. Each specimen, after trimming to a size approximating 3 by 4 by 1 inch, has a number painted on it in oil colors which refers to a written catalogue, in which is given whatever detailed information regarding its source and nature may be in possession of the department. They are then placed in pasteboard trays accompanied by written labels containing the same information as is given in the catalogue, and placed in the drawers of the table cases. Material which is designed for the study series is, if of a miscellaneous nature, distributed through the collections in a systematic manner corresponding to that adopted for the exhibition series. Collections which are like those from Leadville and the Eureka District, to be noted as representing systematic work upon rocks of a definite area, or which have been studied as a group for the elucidation of some particular problem are kept intact, in order to best serve the purposes of the investigation. Characteristic rocks have in some cases been selected from these collections for exhibition purposes, but the individuality of the collections

is in no case allowed to become destroyed. The more important collections in this study series are mentioned below :

Systematic study series.—This collection comprises some three thousand specimens of miscellaneous rocks from all parts of the globe, classified systematically as in the exhibition series.

The Leadville collection.—This comprises some three hundred and eighty eruptive, sedimentary, and metamorphic rocks and ores as collected and studied by Messrs. S. F. Emmons and C. Whitman Cross, of the U. S. Geological Survey, from the vicinity of Leadville, Colorado. It is a representative collection of the material described by the above-named authorities in Monograph XII of the U. S. Geological Survey, J. W. Powell, Director, and entitled "Geology and Mining Industries of Leadville." A characteristic series of the rocks and ores has been selected out and placed upon exhibition in the section devoted to economic geology. (Catalogue Nos. 68801–69540 inclusive.)

The Washoe collections.—These collections represent the work done by G. F. Becker and colleagues in the Washoe District and Comstock Lode, Nevada, the results of which were published in Monograph III of the U. S. Geological Survey, entitled "The Geology of the Comstock Lode." They have also been the subject of investigation by Messrs. Hague and Iddings of the Geological Survey, whose results are embodied in Bulletin No. 7, U. S. Geological Survey, 1885, entitled "The Development of Crystallization in the Ingeous Rocks of Washoe, Nevada." The collection is in part duplicated. There is first a series of 198 specimens typical rocks of the region in sizes some 4 by 5 by 1 inch, and second, the main study series in sizes about 1½ by 1 by 1½ inches, and comprising 2,064 specimens. (Catalogue Nos. 24001–24198 inclusive and 70691–72754 inclusive.)

The collections of the Fortieth Parallel Survey.—This comprises some three thousand specimens of eruptive and sedimentary rocks collected by members of the Fortieth Parallel Survey, under the direction of Clarence King in 1867–73. The eruptive rocks of the series were described by Prof. F. Zirkel in Vol. VI (Microscopic Petrography) of the Reports of the U. S. Geological Explorations of the Fortieth Parallel. (Catalogue Nos. 20301–23398 inclusive.)

The Hawes collections.—These comprise some 350 specimens eruptive and altered rocks representing in part the work done by Dr. Hawes in connection with the New Hampshire surveys as published in Part IV, Vol. III, of these reports. It also includes the small fragments described in his paper on the Albany granites and their contact phenomena. (Am. Jour. of Science, 1881, XXI, p. 21–32; Catalogue Nos. 29628–29290.)

The Pacific Slope quicksilver collections.—These comprise several hundred small specimens (mostly 4 × 6 c m) rocks and ores from the quicksilver regions of the locality above noted, as collected and described by

G. F. Becker and colleagues in Monograph XIII of the U. S. Geological Survey, entitled *Geology of the Quicksilver Deposits of the Pacific*.

U. S. Geological Survey collections.—F. V. Hayden in charge. Various collections made by the surveys under the direction of F. V. Hayden, mainly from Colorado, New Mexico, Utah, Montana, Wyoming, Idaho, and the Yellowstone National Park. These comprise some of the best hand specimens of eruptive and sedimentary rocks. Much valuable material is missing from these, having been lost or destroyed prior to 1880.

Collections from surveys west of the one hundredth meridian.—The collections made in 1871-79 under the direction of Lieut. G. M. Wheeler, U. S. Engineer Department. These comprise some 680 specimens, which, though but little studied by modern methods, are, with those of the Hayden surveys, kept together for purpose of reference.

Pigeon Point collections.—These comprise 400 specimens, illustrating various contact phenomena, as occurring at Pigeon Point on the western shore of Lake Superior, and as described by Prof. W. S. Bayley in the forthcoming bulletin of the U. S. Geological Survey.

Menominee Valley and Marquette River collections.—These comprise 354 specimens illustrative of the dynamic metamorphism of eruptive rocks, as described by Dr. G. H. Williams in Bulletin No. 62, U. S. Geological Survey.

Alaska collections.—These comprise some 250 specimens miscellaneous rocks collected mainly by W. H. Dall in 1866-68.

Missouri.—A series comprising 114 characteristic rocks from western Missouri, as collected and described by Prof. E. Hayden (Catalogue, Nos. 38628-38741, inclusive.)

Bear Paw Mountain, Montana.—A small series of eruptive, metamorphic, and drift rocks from the Bear Paw Mountains, collected by C. White and J. B. Marcou in 1883. (Catalogue, Nos. 28666-28743, inclusive.)

St. Gothard Tunnel.—A series of metamorphic rocks, comprising 80 specimens received from the Swiss commissioner to the Centennial Exposition at Philadelphia in 1876. (Catalogue, Nos. 37495-37575.)

Commander Islands, Coast of Kamtschatka.—A small series of characteristic rocks of these islands collected by Dr. L. Stejneger in 1882-83. (Catalogue, Nos. 37937-37972.)

Australian collections.—A series of some 355 rocks from Victoria, Australia, as received from the Australian centennial commissioner in 1876. (Catalogue, Nos. 28121-28475.)

Brazilian collections.—An interesting series of 269 specimens of eruptive and metamorphic rocks received from the governmental geologist O. A. Derby. (Catalogue, Nos. 69759-70027.)

To the extent that facilities have permitted, thin sections for microscopic study have been prepared from the rocks of both the exhibit and study collections. At the date of writing the number of slides amounts to some 4,000.

II.—DYNAMICAL AND PHYSIOGRAPHICAL GEOLOGY.

Under this section are discussed the agencies and methods of geological change. It is of course impossible to represent these agencies in actual operation, and we must confine ourselves to a display of results which the labels explain. In this section are placed those objects illustrative of (1) Plutonic or hypogene action, under which are included (*a*) volcanoes and volcanic action, (*b*) earthquakes, (*c*) secular upheaval and subsidence, and (*d*) hypogene causes of changes in the texture, structure, and composition of rocks; and (2) epigene or surface action as illustrated by the destructive and constructive or reproductive action of the atmosphere, water, and life in its various forms.

(1) *Plutonic or hypogene action* (Geikie, pp. 178–294).—Volcanoes and volcanic action are illustrated by a small (2 feet 4½ inches square) model of Vesuvius and Monte Somma, Italy, and which is accompanied by a collection illustrating the character of the ejectamenta. This includes the lavas of 1631, 1760, 1855, and 1872; ejected and altered blocks of limestone (73965, 72966, 72968, and 72969); ashes, sand, and dust, including the pumiceous materials such as overwhelmed Pompeii (73149); decomposed ash from the crater of 1872 (72988); lapilli from the cone of 1880; hematite with chlorides of iron, copper, potash soda, magnesia (72993); cupriferous sylvite (73032); sulphur and other sublimation or solution products. Under this head is also exhibited a fine example of the siliceous cones built up by the geysers of the Yellowstone National Park (35590); the calcareous cones sometimes formed by hot springs (10809), and a diminutive cone of a mud volcano from the same region (12879). The varying character of volcanic ejectamenta is shown by a remarkably fine series of basaltic lavas in large specimens from the now extinct volcanoes of Ice Spring Buttes, Utah (35371–35374), and the Hawaiian Islands (35849–35851), including a cake of lava dipped by Dr. Judd from the crater of Lua Pele (12823); and by acid compact and pumiceous glassy lavas (obsidians) from Mexico (35780) and the Mono craters, California (29630 to 29631).

There are also numerous smaller specimens from Vesuvius and other active volcanoes. The fragmental material ejected (Geikie, p. 186) is illustrated by ashes and sand ejected in 1883 from the volcano on Bogosloff Island (37034); by pumice dusts which, when blown from the vent, are often drifted long distances by the winds (37207); lapilli, such as frequently make up the volcanic cones (35538), and quite a series of bombs, including specimens from the Auvergne (39130); the Eifel (38755); Brazil (69988); the Hawaiian Islands (70563); a pumiceous bomb from Vulcano on the island of Lipari exhibiting the so-called bread-crust structure (73163); a large flattened bomb picked up one-half mile from the crater at Ice Spring Butte (35373); a typically elongate globular-shaped bomb from Mount Trumbull in Arizona (70586), and two peculiar basaltic bombs with large angular inclosures of granular olivine (70585) from the same region. The exhibit is supplied

mented by a series of photographs of the extinct volcanoes about Lake, California, as taken by Mr. I. C. Russell (70320-70328).

The non-volcanic igneous injections lend themselves less readily to exhibition purposes owing to the size of the materials. Among the more interesting objects now displayed are the basic trap dikes cutting coarse granite from Auburn and Norway, Maine (35964 and 35520) and the small kersantite dikes cutting crystalline limestone from Franklin Furnace, New Jersey (39041). The character of the material formed may be best comprehended by reference to the specimens in the rock collection proper.

The subjects of earthquakes and secular upheaval and depression will be treated only by means of models and illustrations. The scheme for these has not as yet been worked out in detail.

HYPOGENE CAUSES OF CHANGES IN THE TEXTURE, STRUCTURE, AND COMPOSITION
OF ROCKS.

(1) *The effects of heat.*—Among the more interesting and instructive objects here exhibited attention may be called to the series illustrating what is known as contact metamorphism, *i. e.*, rocks which have been changed or metamorphosed from their original condition by the heat and the incident chemical action of intruded igneous rocks. This series at present includes limestone in contact with a dike rock (39042) rendered white and coarsely crystalline thereby; clay changed to *celadinite or porcelain jasper* (3809); chalk rendered hard and almost crystalline by the same agencies (39121); an argillite indurated and changed to a bright red through the heat of burning beds of lignite (70320) and a considerable series of sedimentary rock from various European localities (principally the Vosges and Harz Mountains) which have been altered to the condition known as *fruchtschiefers, knotenschiefers, and hornstones, spilositcs, etc.* (See Geikie, pp. 564 and 565.) The dike of kersantite in contact with zinc ore from Franklin Furnace, New Jersey (39105), is peculiarly instructive, the heat having been sufficient to alter the ore at point of contact. In specimens 35932 and 35933 are shown argillites from Nahant, Massachusetts, which have developed in greenish oval spots due to incipient crystallization caused by the intrusion of a large mass of trap rock (diabase) shown in specimen 36767, from near Deckertown, New Jersey, is a shale indurated and banded by the intrusion of a large mass of nepheline syenite in the vicinity.

(2) *The effects of compression, tension, and fracture.*—A record of the movements which have taken place in the earth's crust is kept by means of the folds and faults developed. It is obviously impossible to reproduce these forces in actual operation, but something of their character and force may be learned from an examination of the few specimens now exhibited. The first to be noticed is a wax model made and presented by Mr. Bailey Willis, of the U. S. Geological Survey (73180). La

of wax of different colors and consistency were first laid horizontally on a board and weighted down by means of bird shot placed on the top. Pressure was then applied from the direction of the two ends (the right and the left) when the mass passed through the various stages shown in the photographs and finally assumed the shape in which it is now exhibited.

Although a mass of rock may seem to us firm and unyielding, it is nevertheless susceptible of undergoing just such a crumpling and folding as has this wax model through the long continued compressive and shearing force which from time to time has manifested itself in various parts of the earth's crust. A few examples of such folds and crumplings or contortions are here shown, and a larger, more varied series may be found under the head of structural geology. Attention may be called to the contorted gneisses from Brandon, Vermont (39818); Sherburne Falls, Massachusetts (38124); Stony Point, New York (38746), and Norway (70422).

Such a force does not always result, however, in the production of folds, but as is now well known may be productive of a foliated or schistose structure.

Interesting examples of such results are shown in a series of specimens from Slatington, Pennsylvania (70104-70107 and 70266-70267). To fully appreciate this exhibit it must be remembered that the slates were originally formed as fine sediments laid down on a sea bottom, and that the cleavage whereby they split up readily into thin sheets is due wholly to subsequent pressure (see Geikie, p. 288) and is in no way connected with the bedding which may cross it at any and all angles. In the specimens the bedding is indicated by the dark bands and the cleavage is plainly shown cutting across it.

In certain of the samples the material of these dark bands seems to have lent itself less readily to the compressive force, and may be observed to have puckered (specimens 70104 and 70105) or even to have broken and faulted repeatedly, as in the block No. 70266.

All rocks are not equally tough or elastic, and as may readily be imagined do not always show similar effects under the action of the same forces. Many brittle rocks are shattered into innumerable fragments under a shock or such pressure as would be productive of far less striking results on tougher materials. This shattering effect is shown in the collections by the polished slabs of limestone breccia from Algeria (69574). The fragments in this case have been reunited by the cementing action of infiltrating water carrying lime and iron oxides in solution and form thus our richest and most prized marbles.

Other interesting indications of great pressure and strain are shown in a series of indented and crushed pebbles. The large quartz pebble from Silesia (13048) is peculiarly interesting, having been broken repeatedly in two directions and one portion pushed over the other for a distance of a centimetre or more. Yet the parts have so firmly reunited

that the pebble is to-day apparently as strong as ever. Still effects of pressure and shearing are shown in the broken trap-dike veins of serpentine in the crystalline limestone of Smithfield, Island (69560-69572), and the foliated structure of certain gneisses.

The phenomena of jointing, produced by a sharp shock or an earthquake, is illustrated on a small scale by a specimen of gneiss from Elizabeth, Maine, in which the rock is divided at intervals of inches by rifts as sharp as though made by a lapidary's wheel. Peculiar forms of jointing are shown in shale from Cambridge, Massachusetts (70590), and slates from Carlton County, Minnesota (37039). Joints in igneous rocks and other specimens illustrative of the phenomena on a larger scale may be found under the structural (See p. 28.)

The movement of a mass of rock along the line of a joint gives rise to what is known technically as a fault. Specimens illustrative of this feature and suitable for exhibition purposes are as a rule difficult to obtain owing to their size. Nevertheless it occasionally happens that good examples may be had on a scale sufficiently small for exhibition. In each of the cases exhibited the amount of displacement was small and is readily determined by the bands of various color by which the fault are traversed. In these instances, as is not always the case in large rock masses, the faulted blocks have become reunited so firmly that the fault would scarcely be suspected but for the fact that the color bands are no longer continuous. (Specimens 72869 from Montana and 72870 from Nevada.)

The slipping of one mass of rock over another along a line of jointing give rise to smooth and striated, often highly polished surfaces known as slickensides. These are shown on massive magnetite from York State (37039); anthracite coal from Pennsylvania (70660); and the wall rock of silver mines in the Reese River district Nevada (37039).

(3) *The metamorphism of rocks.*—The subjects of the metamorphism of rocks by the heat of injected volcanic masses has already been touched upon (p. 14), as has also that form of change produced by pressure in the earth's crust and resulting in a schistose foliated or gneissoid structure (p. 15). There is one other form of change, however, which can perhaps be best illustrated here. This is the change known as *metasomatism*, a process of indefinite substitution and replacement. The details of this process are admirably shown in the series illustrating the origin of serpentine rocks.

Serpentine, it should be remembered, is essentially a hydrous silicate of magnesia, consisting, when pure, of nearly equal proportions of silica and magnesia with from 12 to 13 per cent. of water. The many varieties occurring in nature are, however, always more or less impure, containing frequently from 10 to 12 per cent. of iron oxides, together with varying quantities of chrome iron (chromite), iron pyrites, manganese blende, olivine, minerals of the pyroxene group, and the carbonate of lime and magnesia.

The reason for this great diversity in composition lies mainly in the fact that the serpentine rarely if ever occurs as an original deposit, but is always secondary, a product of alteration of either eruptive or sedimentary rocks rich in such magnesian minerals as olivine and the non-aluminous pyroxenes. As, however, these rocks rarely consist of pure magnesian silicates, but carry in addition lime, alumina, and various metallic oxides, these constituents separate out during the process of change, and recrystallize in veins, streaks, and blotches as calcite, dolomite, magnetite, etc., thus producing the common variations in color.

The theory long ably advocated by Dr. Hunt to the effect that the serpentine occurring intercalated with beds of schistose rocks and limestones resulted from metamorphism of silico-magnesian sediments deposited by sea waters is now very generally abandoned, and it is doubtful if the substance ever occurs as an original deposit even in the eozoönaal forms.¹

The following analyses will serve to illustrate the change in composition which takes place in the conversion of (I) olivine and (II) pyroxene into serpentine.

	I.		II.		III.
	a	b	c	d	
	<i>Per ct.</i>	<i>Per ct.</i>	<i>Per ct.</i>	<i>Per ct.</i>	<i>Per ct.</i>
Silica	41.32	42.72	54.215	42.38	43.48
Magnesia	54.69	42.52	19.82	42.14	43.43
Lime			24.71		
Alumina	0.28	0.06	0.50	0.07	
Ferric oxide			0.20	0.97	
Ferrous oxide	2.39	2.25	0.27	0.17	
Water	0.20	13.39	0.14	14.12	13.04

(a) Olivine, Snarum, Norway; (b) serpentine derived from the same; (c) pyroxene, Montville, New Jersey; (d) serpentine derived from the same, and (III) the theoretical composition of serpentine.

This change, it will be observed, is, in the case of the olivine, simply a process of hydration—an assumption of some 13 per cent. of water. In the pyroxene the process is more complex and consists of a loss in silica, of all the lime which crystallizes out as calcite, and an assumption of nearly 14 per cent. of water.

In the series exhibited the derivation of serpentine from a pyroxene, as indicated in analysis II above, is admirably shown by the suite of specimens from Montville, New Jersey. In the large mass placed outside the case the gray core of pyroxene may be observed covered with a thin crust of serpentine and traversed by large and small veins of the

¹ The reader is referred to "British Petrography," by J. J. H. Teall (Dulan and Company, Soho Square, London), p. 104, for a most excellent historical sketch of this subject. Also to Becker's report on the quicksilver deposits of the Pacific Slope. Monograph XIII, U. S. Geological Survey, p. 117.

same substance, the process having been arrested before completion. The same condition of affairs is shown in the smaller specimens numbered 39038, 39101, 39110, and 69195 in the case, several of these having been cut and polished to better show the various stages. In many instances the calcium set free has crystallized out by itself in the form of calcite of a blue gray tint. The exteriors of many of the nodules will be observed, are grooved and striated like glacial boulders owing to expansion and consequent crowding in the process of hydration. (See original paper "On the Serpentine of Montville, New Jersey," the bound pamphlets on the table.) Serpentine after pyroxene is admirably shown in the large polished block from Thurman, Warren County, New York.

Serpentine after tremolite is shown in specimens 70131, from Monticello, New York, and in specimens 70114, 70115, 70119, 70121, and 70122, from Easton, Pennsylvania. The least changed rock is shown in specimen 70122, and the different stages of the alteration are indicated in gradual change in color from light gray, nearly white, to greenish colors.

Serpentine after a peridotite is shown in specimen 70137 from Lizard, Cornwall, England, and in the deep, bright green rock from Monticello, Texas, Pennsylvania (70160). Serpentine after pyroxenite is shown in specimens 38478 and 38471 from Montgomery County, Pennsylvania, the first mentioned being the fresh enstatite rock, while the last is an impure serpentinous product to which it gives rise. Serpentine after pyroxene and replacing calcite, giving rise to the mixed serpentine, calcite, and dolomite rock, *ophiolite*, is shown in specimens 70082 to 70085 from Moriah, Essex County, New York.

From Plutonic or hypogene, we pass to (ii) Surface or epigene action in which section are displayed materials illustrative of the destructive, constructive, and reproductive effects of the atmosphere, of surface water, and of life in its various forms (Geikie p. 301 *et seq.*)

AIR.

Pure dry air, as stated by Professor Geikie, has but little effect on rock masses, and it is only through the aid of dissolved moisture and temperature variations that its efficacy as a geological agent becomes apparent. Nevertheless, there are certain phenomena which, although it may be of slight geological importance, are sufficiently interesting to find a place here.

Effects of lightning.—Under this head are exhibited an interesting and instructive series of fulgurites or lightning tubes. Specimens in tubular form like those from Illinois (35905), New Jersey (39313), South Carolina (37414), Florida (38312 and 73268), and Maldonado, South America (38852), are formed by the lightning striking in loose sand, the heat of the flash being sufficient to fuse the sand, and thus forming cooling the frail glassy tubes shown in the specimens. When lightning strikes on solid rock the more common result is a mere superficial

fusion, although occasional holes of slight depth are formed, as shown in specimens from Oregon and Armenia.* A more complete description of these may be found in the bound volume of pamphlets on the table.†

Effects of temperature variations.—As is well known, the usual effects of heat upon any material substance is that of expansion, and of cold contraction. In countries like the arid regions of the West the alternations of heat and cold are often so great as to produce very marked disintegration and exfoliation even in the toughest and most solid of rocks. The results of such disintegration are not of such a nature as to lend themselves readily to exhibition purposes. In the specimen shown (a compact andesite from Madison County, Montana), the entire mass of rock has on the surface become by these temperature variations broken into blocks of but a few pounds' weight each, and the surface of the ground on the neighboring slopes is everywhere covered with small chips thus flaked off with beautiful concave and convex surfaces, as may be observed in the specimen. The high plateaus and mountain tops in this region are invariably covered by loose débris in the form of thin sheets of but a few inches or many feet in diameter which have been thus flaked off.

The effects of wind.—The geological action of the wind is due mainly to (1) its efficacy as a transporting agent, and (2) to the abrasive effects of the transported substances. Its efficacy as a transporting agent can be shown only by an exhibition of the material transported and by photographs.

Of chief interest in this exhibit are the fine volcanic dusts, such as, after being ejected from the volcanic throat, are drifted by winds, it may be for many miles. Specimen 35800 was gathered at Trysil, on the coast of Norway, in November, 1875, having been blown by the wind from Iceland. No. 36974 is a product of the eruption of Krakatoa in 1883. This dust fell at the rate of an inch an hour on board the ship *Beaconsfield* while at a distance of 800 miles from its source. No. 38588 is from a bed not less than 6 feet in thickness, and which occupies the bed of a now extinct lake in Gallatin County, Montana. The photograph shows the thickness and position of this bed. Other samples shown are from similar beds in Nebraska (37023, 37024, and 38545) and Nevada (77206). Of the coarser materials thus drifted attention may be called to the gypseous sand from near Fillmore, Utah. This, as described by Geologist Gilbert, is first formed as minute crystals on evaporation of the water of playa lakes. Subsequently the winds sweeping across the dry lake beds gather the sand into drifts.

The siliceous and calcareous sands in arid regions or along sea and lake shores are often thus blown into huge drifts or dunes, which them-

* The gift of Mr. J. S. Diller, of the U. S. Geological Survey.

† On Fulgurites, Proc. U. S. National Museum, 1886, p. 83, and Fulgurites or Lightning Holes, Pop. Sci. Monthly, Feb., 1837, p. 527. See also Geikie, p. 303.

selves travel slowly across the country, burying everything which happens in their path. The shell sand shown in specimens 20255 and 20256 from the island of Bermuda is thus blown up from the shore, and the huge drifts of snow has buried garden, woodlands, and even houses. Photographs illustrative of the sand dunes of the Lake Michigan region are also here included.

The abrasive effects of material transported by the wind is obviously manifested in a highly interesting and instructive manner. It can be readily understood that sand sharply blown against any stationary object would have a tendency to wear it slowly away, a fact which is taken advantage of in the artificial sandblast used in glass and stone cutting. In many sandy regions, and particularly those where dry winds prevail a considerable portion of the year, this abrasive action becomes notably conspicuous.

Under this head are here exhibited a small series of rocks thus carried and polished. The most curious of these is the conglomerate (20257) from Nevada, into which the natural sandblast has drilled irregular worm-like holes. Others of interest are the beautifully polished specimens from Montana, collected by Dr. A. C. Peale and G. P. Merrill (Nos. 38575, 70602), and also the grooved basalt and peculiarly etched pebbles from Arizona (Nos. 37200, 38828, and 39094), collected and described by G. K. Gilbert while geologist of the surveys west of the one hundredth meridian. Here, too, is exhibited a large plate of glass from a light-house on Cape Cod, Massachusetts. During a heavy storm it became so abraded all over its exposed surface by windblown sand as to be no longer serviceable, and to necessitate its removal (No. 35253). This series is supplemented by photographs copied from Gilbert's report on the geology of the region west of the one hundredth meridian.

WATER.

Water as a geological agent acts both chemically and mechanically. The chemical processes involved are grouped by Professor Geikie (p. 317) under the heads of (1) oxidation, (2) deoxidation, (3) solution, (4) formation of carbonates, and (5) hydration. In nature it frequently happens that any or all of these processes are going on at the same time in a rock mass, the general result of the combined forces being spoken of as *weathering*. In the exhibits one or more typical illustrations are given of each of the processes working alone and a large series illustrative of the more complex process of weathering.

Oxidation is illustrated by argillite (73267), in which the iron ore has segregated in zones of varying color, giving the rock a beautifully banded structure.

Deoxidation is shown by sandstone (18927) colored brown by iron oxides, but from which a portion of the coloring matter has been leached out by organic acids.

Solution by a fine block of limestone fluted by the action of

water running down the face of the cliff (70583), and by blocks of gypsum eroded by similar means (35590).

Many rocks show the effects of solution unequally, owing to the unequal hardness and solubility of their various parts. Thus the limestone from Bear Paw Mountain, Montana (28724), is strongly ribbed by siliceous veins from between which the calcium carbonate has been dissolved. Similar phenomena are shown in specimen No. 37635.

The formation of carbonates is carried on in such a way as not readily to be shown in a series of this kind. The specimen exhibited is an eruptive rock in which many of the silicate minerals have undergone decomposition, giving rise to an abundance of carbonate of lime or calcite.

Hydration by itself can be best illustrated in the conversion of olivine into serpentine (see p. 16), and is also shown in the derivation of gypsum from anhydrite, but the change in appearance is, in the latter case, scarcely sufficiently marked to be appreciated. Hydration accompanied by oxidation, whereby the entire mass of substance falls to fragments, is well shown in the pyrite-bearing coals of Virginia, and hydration accompanied by the production of carbonates by the pyroxene altered into serpentine.

The general destructive effects of weathering are shown in an interesting series of fresh and decomposed granitic rocks from the District of Columbia, in which may be traced all gradations from the compact fresh rock through specimens more or less kaolinized and oxidized to soft pulverulent material, upon which plants may be grown. The principal changes that have taken place being, aside from a physical disintegration, an assumption of water, a removal of the alkalies potash and soda, and a conversion of the combined iron oxides into free hydrous sesquioxides, whereby the rock has changed from a gray to a bright amber red. Other objects of like nature here displayed are residual clays from the Southern States, as described by Mr. I. C. Russell in Bulletin No. 51 of the U. S. Geological Survey.* The exhibit is accompanied by a few specimens and photographs, showing spheroidal and other types of weathering common to various rocks.

Water percolating through the superficial portions of the earth's crust dissolves certain constituents either directly or sets up a series of chemical changes resulting in the production of soluble compounds which are gradually removed to be deposited elsewhere or perhaps carried down into the ocean. Nearly all spring waters are hard, owing to the amount of mineral matter contained by them, while rain waters are soft owing to the absence of all mineral matter. By the dissolving power of water are formed the numerous caverns so common in limestone regions. By the deposition of mineral matter held in solution are formed a variety of products, some of which are very beautiful.

* On the Subaërial Decay of Rocks and the Origin of the Red Color of Certain Formation.

Among these, which may perhaps be properly grouped under the head of constructive and reproductive effects of water, need at present be mentioned the exceptionally fine series of stalactites and stalagmites, mainly from the Luray Caves of Virginia; the beautiful siliceous calcareous sinters from the geysers and hot springs of the Yellowstone Park and the peculiar imitative calcareous tufas from Lake Lahoe, Nevada, as collected and described by Mr. I. C. Russell, of the U. S. Geological Survey. Besides these are many specimens less conspicuous on their size, but none the less instructive. Among them attention must be directed to the agates which were deposited from solution in the cavities of trap rocks. In the specimen from near South Boulder, Colorado, Montana, is shown a small agate still in the cavity which it formed. Other solution products are the rock salts from New Iberia, Louisiana (38461); Stassfurth, Germany, and the calc tufas coating the leaves and stems of plants from Soda Springs, Idaho (39136).

This series is supplemented by photographs of the tufa deposits about Mono Lake, California, and the geyser and hot spring deposits in the Yellowstone National Park.

Running streams carrying fine detritus act in a mechanical as well as a chemical manner. In this way are formed such curiously eroded objects as the granite boulder from Craftsbury, Vermont, in which the lower grained portion has shown greater resistance than the upper coarse part (70099). Objects of this nature are as a rule too large for exhibition as specimens, and recourse must be had to models and illustrations. Here, then, attention may be directed to the large model of the Cañon of the Colorado River, and also the ten panoramic views of the same placed high against the north wall of the range, as well as the transparencies in the windows on the south side.

The transporting and constructive power of running streams is more fully present indicated in the series only by a few vials showing the amount of mineral and organic matter contained in a litre of Potomac water during a season freshet. This part of the exhibit has not yet been worked out in detail. The transporting power of ocean currents is shown by a small collection of seeds cast up on the beach at Palisades, Plantation, island of Jamaica, a part of which are quite foreign to the island, and by fragments of pumice from the volcano of Krakatoa, which were found floating on the surface of the water at a distance of 1,315 miles from their source. There is need of more material here.

The mechanical action of waves as displayed in the undermining and breaking down of rocky cliffs can be shown only by models and illustrations. A small amount of space is, however, here given to a model illustrating the resultant product of such action.

The material selected comes from Cape Elizabeth, on the coast of Maine. The cliffs on the shore are composed of finely fissile schists which are traversed by numerous veins of quartz. The continual hammering of the waves from the open Atlantic causes the schist to

disintegrate and fall to the foot of the cliff, often in pieces of considerable size. The quartz veins being hardest and toughest remain intact until the last and often protrude some distance beyond the surface of the schist as shown in the large specimens No. 39036.

Once at the foot of the cliff the fragments are alternately thrown upon the beach and dragged back into the sea by each successive wave and its return undertow until gradually reduced to the pebble form. All stages in the process are shown from the angular fragment as it fell from the cliff to the resultant oval pebble. It will be observed that owing to the fissile nature of the schist its pebbles are always in the form of a greatly flattened oval, while those of the massive quartz are more nearly spherical. But of whatever character the material the normal shape of a beach formed boulder or pebble is oval, and this for the reason that the wave action is a dragging rather than a carrying one; the stone is not lifted bodily and hurled toward the shore to roll back with the receding wave, but is rather shoved and dragged along. Gravity tends to hold the fragments in one position so that the wear is greatest on the side which is down, and this in itself would cause them to assume an oval or flattened form even were they spherical and of homogeneous material at the start.

At the end of this series is put a sand composed of admixed coarse and fine fragments of shell, schist, and siliceous particles, and which was obtained at low tide further out from the shore. This may be regarded as illustrative of the material now forming as stratified deposits at this point of the coast.

Geological action of ice.—Materials illustrating the destructive effects of freezing water are for the time being not separated from those illustrative of the general process of rock weathering. Here are grouped only objects relating to the phenomena of glaciation as produced by modern glaciers and during the glacial epoch.

The exhibit begins with a series of photographs taken by Mr. I. C. Russell, of the U. S. Geological Survey, showing the existing glaciers on Mounts Dana and Lyell, in California, and the morainal embankments near Mono Lake (70279-70301). There are also shown scratched and scarred pebbles from the Dana glacier (37206) and a sample of the finely pulverized rock from the foot of the glacier at head of Parker's Creek, near Mono Lake (37234). A similarly formed sediment is also shown from a glacial stream in Greenland (38856). The work of the ice during the glacial period is shown by grooved, polished, and striated stones from several localities. Among the more striking of these attention may be called to the following: A large slab (30 by 48 inches) of grooved and fluted limestone from Kelley's Island, in Lake Erie (38534), and others from St. David's, Ontario (72833 and 72834). These are the slabs figured on pages 194, 195, and 214, Seventh Annual Report United States Geological Survey for 1885-'86. There is also a slab (26 by 30 inches) from Rochester, New York, showing striæ in two directions,

and numerous smaller specimens of smoothed or scratched rocks the New England States and Greenland.

Forming a part of this series are also photographs of the geopoles at Archbald, Pennsylvania (38294), and of a large drift bowlder on the northern end of Deer Isle, Maine (37413). There are also stereoscopic views showing fields covered with drift bowlders.

LIFE.

The collections illustrating the destructive effect of life in its various forms are at present writing sadly lacking in desirable materials. A few poorly selected stones bored by mollusks (No. 29644-29649) and a fine sandstone riddled by the holes of a hymenopterous insect (37413) constitute about all that is worthy of mention. The constructive effects are better shown by the diatomaceous earths (37429), marls (36850-36851), shell limestones (35814 and 37749), chalk (36013), guano (6826) and the peats and coals (36826).

The method of formation of a coral island is in this series shown by a small collection illustrative of the geology of Bermuda. The exhibit begins with a collection of the more common corals and shells of the island, and which by their disintegration have furnished the bulk of the materials of which the islands are composed. These include bowlders of which, having lain for two years in the water, are covered by a growth of *millepora alcicornis*, and which illustrate the rapidity of the formation. Following these are specimens of the corals and shells common to the neighboring waters, and the fine calcareous sand which results from their disintegration, is thrown by the waves upon the beaches, dried, and drifted inland by the winds. Following these are the rocks which result from the consolidation of these fragmental materials, a consolidation brought about by the dissolving action of water on the calcium carbonate of the shells and a redeposition of the dissolved materials at greater depths below the surface to form a cement binding together the grains. Following these are the soils and residual clays; surface and weathered rocks illustrative of the character of the roughness of the coast; stalactites and stalagmitic masses resulting from the deposition of dissolved lime in the numerous caverns which the island abounds; the exhibit closing with a series of rocks foreign to the islands, but which occur occasionally as small pebbles having been drifted from other sources, and presumably entangled in the roots of trees. For most of the materials in this collection the museum is indebted to Prof. William N. Rice and the late Dr. George Hawes.

III.—STRUCTURAL GEOLOGY: THE ARCHITECTURE OF THE EARTH'S CRUST.

Under this head are displayed stratified rocks showing (1) stratification and its accompaniments, as forms of bedding, surface markings, and concretions, and such other illustrations as lend themselves readily

exhibition purposes; (2) joints in both stratified and massive rocks; (3) inclination, strike, and dip of rocks (shown only by models and photographs); (4) curvature, cleavage, distortion and dislocation, and other modifications of the primary arrangement of the earth's crust; (5) igneous rocks as a part of the structure of the earth; and (6) veins and vein materials.

Many objects are here displayed of precisely the same nature as under dynamical geology, in the one case illustrating the methods by which certain structures are brought about and in the other the structures themselves. The text-book arrangement has not here in all cases been strictly adhered to, as not being quite adapted to our purpose.

(1) *Stratification and its accompaniments*.—(a) Forms of bedding: This department of the exhibit is at present sadly in need of suitable material. The few specimens at present on hand are small and poor, and need not therefore be further noted here.

(b) Surface markings: These are shown in their several forms as below:

Wave and ripple marks are shown in the two large slabs of Potsdam quartzite from Keeseville, New York (38758), and the Devonian sandstone from Pike County, Pennsylvania (27014). Several smaller slabs from various localities are shown in the cases. To appreciate these it must be remembered that the rocks were lain down in the form of fine sand in the shallow water of an ancient sea or ocean, and which by its oscillatory movement formed in the sand the ripples in the same manner as they may to-day be seen forming on almost any sandy lake or sea shore (Geikie, p. 470). Through the gradual sinking of the earth's crust the markings once formed became covered by other sand and thus preserved until thoroughly solidified, raised above sea level, and made available to the quarrier, all the slabs shown being obtained in the ordinary process of quarrying stone for building purposes. "Ripple marks are often made by the waves over the finer beach sands where they are low and partly sheltered, and also over mud flats. The flowing water pushes up the sand into a ridgelet as high as the force of the wave can make and then plunges over the little elevation and begins another, and thus the succession is produced. The height and breadth of the intervening space will depend on the force and velocity of the flowing water and the ease with which the sand or mud is moved. Ripple marks may be made by the vibration of waves at depths of 300 or 500 feet."—(Dana.)

Mud cracks and rain prints: Like the ripple marks the mud cracks denote shallow water deposits. Laid down as mud, the beds while still soft were exposed by the receding water and dried, cracking irregularly just as the fine clayey mud on the bottom of shallow pools may in any dry season be observed to do. Subsequently the water rose once more and washed fresh sand into the crevices formed. The elevated ridges shown on the large slab of Medina stone from Knowlesville, New York

(72959), and the smaller slabs from Hummelstown, Pennsylvania (are then but casts in sand of these old cracks (Geikie, p. 471) rain prints shown on the small slabs of Triassic sandstone from Jersey indicate that the stone while still plastic was exposed to the washing action of a shower, the drops leaving their imprint in the soft mud.

Footprints: It has not infrequently happened that animals walking in the shallow water left footprints in the mud to be covered and preserved in the same manner as were the cracks and ripple marks above mentioned. But few of these are shown here, since the subject belongs more properly to vertebrate paleontology. On the large slab pinned to the south wall are two consecutive tracks of the *Brontozoum giganteum* (H), a huge reptile estimated to have been at least 14 feet in length and which inhabited the Connecticut Valley during the Triassic period. The smaller slabs pinned high against the east wall show tracks of *Brontozoum validium* and *Sillimanium*, and *Anomæpus cuneatus*. A small slab from South Hadley Falls, Massachusetts, are shown the nests of tadpoles, *Batrachoides nidificans* of Hitchcock.

A large slab of Potsdam quartzite from New York showing faint trail of a marine mollusk (*Protichnites Loganus*), made as he crawled slowly over the soft bottom of the Cambrian ocean, serves further to illustrate the conditions under which these rocks were formed.

Concretions: The peculiar tendency which atoms or particles of matter often manifest in concreting or gathering in concentric layers about centers is shown by a large and diversified collection of concretions. As here arranged these are divided into two groups, as follows: (A) Primary concretions, formed contemporaneously with the rocks in which they are found, and (B) secondary concretions, or those which are due to segregating processes acting subsequent to the formation of the rocks in which they are found. Each of the groups may be further divided accordingly as the concretions were formed as chemical precipitates or are but aggregates of mineral particles bound together by an interstitial cement.

(A.) Primary concretions: (a) chemical deposits and (b) mineral aggregates.

Under (a) are here included the chalcedonic nodules found in iron stones (specimens 38434, 38435, and 37603), the pyrite concretions such as No. 39053, and the clay ironstones, such as Nos. 12890 and 36097. These last are often found to have cracked interiorly on drying consequent shrinkage, and the cracks to have become subsequently filled with carbonate of lime. On being cut and polished such concretions form beautiful and unique objects, as shown in the specimens from Kansas (12890), Indiana (25100), and New York (39129). To such concretions the name *Septarian nodule* is commonly given. Here also are displayed the fine oölitic and pistolitic concretions such as those of Bohemia (No. 36097), Hungary (36099), Cache Valley and Salt Lake, Utah

and 35379), and Lake Lahonton, Nevada (35378). Concerning the occurrence of these last Mr. Russell writes:*

"Among The Needles the rocky capes are connected by crescent-shaped beaches of clean, creamy sands, over which the summer surf breaks with soft murmurs. These sands are oölitic in structure, and are formed of concentric layers of carbonate of lime which is being deposited near where the warm springs rise in the shallow margin of the lake. In places these grains have increased by continual accretion until they are a quarter of an inch or more in diameter, and form gravel, or pisolite, as it would be termed by mineralogists. In a few localities this material has been cemented into a solid rock, and forms an oölitic limestone sufficiently compact to receive a polish. No more attractive place can be found for the bather than these secluded coves, with their beaches of pearl-like pebbles, or the rocky capes, washed by pellucid waters, that offer tempting leaps to the bold diver."

Such forms as these may or may not show a nucleus. It seems safe to assume that such a nucleus at first in all cases existed, though it may be in microscopic dimensions only. A shell nucleus is shown in the clay ironstone concretion from Kansas (73454), and fragmental nuclei of siliceous sinter in the concretionary nodules from the geysers of the Yellowstone National Park (12888).

Under (b) are shown concretions composed of mineral particles in a finely fragmental condition, and which have as in the last case segregated contemporaneously with the formation of the material in which they occur. Here are included a series of clay concretions from the headwaters of the Connecticut River (38425); from the Yellowstone Lake (12895); and from various beds of brick and potters' clay in New England. In certain of these the presence of a nucleus is plainly evident, those from Orono, Maine (36965), having formed about stems of grasses; those of Jefferson County, Tennessee (38357), about small shells.†

The secondary concretionary forms (B) are likewise susceptible of subdivision on precisely similar grounds. Under the head of chemical deposits would come such forms as flint nodules in chalk (36012) and the agates formed in cavities in trap rock (69569). Such do not in all cases show a concentric structure and might perhaps be better termed secretions than concretions, and classed with mineral veins. Under the

* Geological History of Lake Lahonton, a Quaternary Lake of Northwestern Nevada, Monograph XI, U. S. Geological Survey.

† The manner in which concretions of this nature are formed was shown in a very interesting manner a few years ago during the process of the work of filling in the so-called Potomac flats, on the river front at Washington, District of Columbia. For the double purpose of raising the flats and deepening the channel gigantic pumps were employed which raised the sediment from the river bottom in the form of a very thin mud and forced it through iron pipes to the flats, where it flowed out spreading quietly over the surface. The material of this mud was mainly fine siliceous sand and clay intermingled with occasional fresh water shells and plant débris. As this mud flowed quietly from the mouth of the pipe and spread out over the surface the clayey particles began immediately to separate from the siliceous sand in the form of concretionary balls, and in the course of a few minutes these would grow to be several inches in diameter. Such, owing to the rapidity of their formation, contained a large amount of sand and shells, though clayey matter predominated.

second head are included such forms as the sandstone concretions from Arkansas (37600) and New Jersey (38761 and 38427). These are due not to original deposition in concentric layers, but to the oxidizing and leaching action of meteoric waters acting on nodular inclusions of iron sulphide, or possibly carbonates. The oxide thus formed segregates in zones, and by its cementing action binds the sand grains together leaving the central portion, formerly occupied by the pyrite, empty or partially filled with loose sand; such forms are shown in specimens 38427 and 37004.

A zonal banding or shelly structure closely simulating concretionary structure is common in rocks more or less weathered and decomposed, but which is due not to original deposition or crystallization of matter about a center, but rather to the weathering of jointed blocks by the various chemical and physical forces acting from without in nature. This is here illustrated in specimen 38570 from Montana (see also under head of Rock-weathering).

Still another form of concretion due to segregating forces acting together with pressure are shown in the so-called cone-in-cones (specimens 39122, and 39175).

(2) *Joints*.—Jointing on a sufficiently large scale to be appreciable as a structural feature of the earth's crust can well be shown only by photographs and models. Here are exhibited a few isolated examples of jointing in both sedimentary and igneous rocks. Special attention is called to the large basaltic column from the Yellowstone National Park. The exhibit is at present meager, and is supplemented by a few photographs. Jointing in granite and illustrating its utility in quarrying is shown in a photograph of the Red Beach granite quarries near Carleton Place, Maine (73457). Columnar jointing in volcanic rocks is shown in a photograph of "Rooster Rocks," on the south shore of the Columbia River near Portland, Oregon (73458); in a view near Mount Davidson, California (38283); and two views of the Regla Cascades in Mexico (specimens 38305).

(3) *Inclination, strike, and dip* are subjects as yet scarcely touched upon. From necessity these phenomena can be illustrated satisfactorily only by means of models and photographs. Emmons's section model of Leadville and vicinity may be referred to here.

(4) *Curvature, cleavage, and distortion* are quite well illustrated by the series of distorted gneisses and schists shown in the cut and polished slabs from Auburn, Maine (39059); Brandon, Vermont (39058); New York (39124); the roofing slates from Pennsylvania (70104-70107) and the crushed pebbles already referred to under the head of "Effects of pressure." The sharply foliated schists from Dutch Island in Narragansett Bay are also worthy of mention (38608) as well as the large curved slate showing junction with shale (specimens 70102 and 70103 from Pennsylvania).

(5) *Igneous rocks* as structural features in the earth's crust mu

account of the large scale on which the work has been carried out be shown only in models and illustrations. Gilbert's stereogram of the Henry Mountains is one of the most striking objects now in this series, though attention should also be called to Diller's models of Mount Shasta, California; Becker's models of the Washoe district, Nevada; Dutton's models of Mount Taylor, New Mexico, and the High Plateaus of Utah.

(6) *Veins*.—Professor Geikie treats the subject of veins and vein formation under three heads: (1) Mineral veins, (2) Eruptive veins or dikes, and (3) Segregation veins.

For the present the known eruptive veins in the collections are grouped with the non-volcanic igneous ejections as dike rocks, and here we have to do with only the first and third of the above divisions. The term vein is used by the above authority to designate "any mass of mineral matter which has solidified between the walls of a fissure. When this mineral matter has been deposited from aqueous solution or from sublimation, it forms what is known as a *mineral vein*. When it has crystallized or segregated out of the component materials of some still unconsolidated, colloid, or pasty rock, it is called a *segregation vein*."

Simple as such a division may seem it is not always easy, or indeed possible to ascertain from a simple examination of the specimens to which of the two groups they may belong. As a rule the mineral veins, which appear to correspond to the fissure veins of other authors, are separated by sharp and well defined walls from the country rock, and may, and often do, show a well defined banded or comb structure as shown in the quartz and rhodochrosite vein from the silver mines at Butte, Montana (38566), and less distinctly in that composed of ruby silver and other silver sulphurets together with rhodochrosite from the Reese River district, Nevada (15136). The segregation type is less distinctly marked, the vein material being welded to the inclosing rock owing to the mutual protusion of the component materials. This type of vein is quite common in granitic rocks and is well shown in the large specimens from Rockport, Massachusetts (38757) and Auburn, Maine (39057 and 39058).

IV.—STRATIGRAPHICAL OR HISTORICAL GEOLOGY.

Under this, the fourth subdivision, is considered the chronological succession of the geological formations, the rocks being arranged according to the order of their deposition or ejection. From this series fossil forms will to a considerable extent be excluded as belonging more properly to the department of paleontology. Only a few of the more characteristic forms from each horizon will be shown.

As at present contemplated the main idea is to show that the same geological forces have been in operation and rocks of the same general nature been in process of formation from the earliest time down to the

most recent. This collection is now so far from complete that no more need be said regarding it here.

There are, however, two smaller and less comprehensive collections in this subdivision that should be mentioned. The first of these is a series of some 250 specimens, in sizes about 5 inches square, representing the characteristic rocks of the various geological horizons of New Hampshire, as described by State Geologist Hitchcock and George W. Hawes, in Vol. III of the final reports on the Geology of New Hampshire. This is accompanied by a proportional column prepared by Prof. C. H. Hitchcock, and showing on a scale of 1 inch = 1,000 feet the relative thickness of the stratified rock formations of the State.

The second series is a valuable stratigraphical collection of Canadian rocks as prepared by officers of the Canadian Survey for exhibition at the Centennial Exposition in 1876. This comprises 854 specimens in sizes about 3 by 4 by 1 inch.

The following is a complete list of the models or relief maps now on exhibition, many of which have already been referred to:

(1) Yellowstone National Park. Scale, 1 inch = 1 mile; horizontal and vertical the same. Modeled by E. E. Howell. Issued by Ward and Howell. Size, 4 feet $7\frac{1}{2}$ inches by 5 feet $5\frac{1}{2}$ inches.

(2) Elk Mountains of Colorado. Scale: Horizontal, 1 inch = 1 mile; vertical, 1 inch = 2,640 feet. Modeled by W. H. Holmes. Size, 3 feet 2 inches by 3 feet 8 inches. United States Geological Survey.

(3) Mount Vesuvius and Monte Somma, Italy. Compiled by Th. Dickert. Size, 2 feet $4\frac{1}{2}$ inches by 2 feet $4\frac{1}{2}$ inches. Issued by Ward and Howell.

(4) Geological model of Switzerland. Size, 11 by 24 inches.

(5) The Washoe District, Nevada. Scale, 1 inch = 1,666 feet; 1:20000; horizontal and vertical the same. Geology by G. F. Beane. U. S. Geological Survey. Modeled by E. E. Howell. Size 2 feet 6 inches by 3 feet 3 inches. Issued by Ward and Howell.

(6) Leadville, Colorado, and vicinity. Scale, 1 inch = 800 feet; 1:9600. Geology by S. F. Emmons, U. S. Geological Survey. Modeled by E. E. Howell. Size 2 feet $7\frac{1}{2}$ inches. Issued by Ward and Howell.

(7) The same in sections. U. S. Geological Survey.

(8) Gulf of Mexico. Scale, vertical, 1 inch = 1,000 fathoms; horizontal, of vertical to horizontal, 0.03. Size, 23 by 32 inches. Issued by U. S. and Geodetic Survey.

(9) The Yosemite Valley, California. Scale, about 4 inches = 1 mile. Horizontal and vertical the same. Modeled by E. E. Howell from surveys by King and Gardner. Size, 2 feet 5 inches by 4 feet 1 inch. Issued by Ward and Howell.

(10) The San Juan Mountains and mining regions. Scale, 1 inch = 1 mile, or 1:63360; vertical scale three times the horizontal. Modeled by T. W. Eglouston. Size $4\frac{1}{2}$ by $3\frac{1}{2}$ inches. U. S. Geological Survey. Capt. George M. Wheeler in charge.

(11) The Grand Cañon of the Colorado of the West and cliffs of southern Utah. Scale, vertical, 1 inch=5,000 feet; horizontal, 1 inch=2 miles, Modeled by E. E. Howell. Size, 6 feet 6 inches by 6 feet 7 inches. Issued by Ward and Howell.

(12) Eureka District, Nevada. Scale, 1 inch=1,600 feet or 1:19200; horizontal and vertical the same. Geology by Arnold Hague, U. S. Geological Survey. Modeled by E. E. Howell. Size, 5 feet 2 inches by 5 feet 6½ inches. Issued by Ward and Howell.

(13) Uintah and Wasatch Mountains. Scale, vertical, 1:126720; horizontal, 1 inch=4 miles, or 1:253440. Modeled by E. E. Howell. Size, 4 feet 3½ inches by 4 feet 5½ inches. Issued by Ward and Howell.

(14) Mount Taylor, New Mexico. Scale, 1 inch=1 mile; horizontal and vertical the same. Geology by C. E. Dutton, U. S. Geological Survey. Modeled by E. E. Howell. Size, 4 feet 3½ inches by 4 feet 3½ inches. Issued by Ward and Howell.

(15) Henry Mountains, Utah. Scale vertical and horizontal the same. Geology and modeled by G. K. Gilbert, U. S. Geological Survey. Size 3 feet 10½ inches by 5 feet 2½ inches. Issued by Ward and Howell.

(16) Stereogram of the Henry Mountains, Utah, showing the form the country would have if the eroded portions to the top of the Cretaceous were restored. Vertical and horizontal scale the same. Geology by G. K. Gilbert, U. S. Geological Survey. Size 3 feet 10½ inches by 5 feet 3½ inches. Issued by Ward and Howell.

(17) High Plateaus of Utah. Vertical and horizontal scale the same. Modeled by C. E. Dutton, U. S. Geological Survey. Size, 4 feet 9 inches by 4 feet 10 inches. Issued by Ward and Howell.

(18 and 19) Mount Shasta, California. Horizontal and vertical scale, 1 inch=2,500 feet. Geology by J. S. Diller, U. S. Geological Survey. Modeled by Victor and Cosmos Mindeleff. Size, 3 feet 4 inches in square.

SECTION B.—ECONOMIC GEOLOGY.

Under this head is comprised a large and important exhibit, or series of exhibits, selected to illustrate the economic aspects of geological science and the extent to which the resources of the mineral kingdom have been utilized by man.

The collections are arranged to show (1) the nature and variety of the mineral resources of the United States and (2) the nature and variety of the more interesting and important useful ores and minerals of the world at large. In these collections, as in those of systematic geology, the specimens with a few exceptions have been selected with the idea of showing as truthfully as possible the average qualities of the material and its mode of occurrence. Care is taken, of course, to present clean and freshly-broken surfaces whenever possible, and, while exceptionally fine and beautiful materials are by no means excluded, and indeed gladly accepted as rendering the exhibit as a whole more

attractive, still the typical average material as found at the mine quarry is deemed of first importance.

The size of the specimens in these collections from necessity varies greatly, and whenever space will allow regard is had to the individual characteristic of each sample. When the material is massive and homogeneous throughout the standard adopted is about 5 inches square the face and some 2 inches thick. It is obvious, however, that such sizes are not applicable to all grades and kinds of materials, and in the exhibits may be seen specimens varying from less than an ounce over 200 pounds in weight. Material in form of a powder is as a rule exhibited in bottles of from 4 to 10 ounces capacity.

The following list will serve to give an idea of the character and variety of materials here to be exhibited though, unfortunately, the arrangement of the exhibition space is not such as to enable us to carry it out in a manner as systematic as might be desired.

- (1) Stones used for purposes of building or ornamentation :
 1. The crystalline siliceous rocks, both massive and schistose : Granite, syenite, diabase, gabbro, diorite, liparite, trachyte, basalt, andesite, gneiss, and the crystalline schists.
 2. The calcareous rocks ; Limestones and dolomites, both marbles and common varieties ; alabaster.
 3. The serpentines and verdantique marbles.
 4. Fragmental rocks ; Sandstones, conglomerate, breccia, and clay slate.
 4. Minor stones used for decorative work. (See Gem collection.) Precious serpentine, jasper, malachite, agate, etc.
- (2) Stones used in the manufacture of cements, mortars, etc.: Limestone, both hydraulic and the common varieties, gypsum.
- (3) Natural abrading and polishing materials. (a) Materials used in the massive form : Grindstones, whetstones, grits, and pumice. (b) Materials used only in pulverulent form ; Quartz sand, garnet sand, crude topaz, pumice dust, emery and corundum, black diamond (bor). (c) Polishing powders : Infusorial earth, tripoli, rottenstone, chalk, etc.
- (4) Natural fertilizing substances. (a) Phosphatic and alkaline : Apatite, phosphatic sandstone, phosphorites, guano, greensand, bone phosphate, orthoclase and salts of potash. (b) Calcareous and carbonaceous : Limestone, marl, gypsum, muck, and vegetable mold.
- (5) Sulphur and salts used in chemical manufacture.
- (6) Fictile materials. (a) Clay for brick, tiles, stoneware, potter's and pipe clays. (b) Kaolin, porcelain clays, and feldspar. (c) Glass-making materials. Graphite for pencils and crucibles.
- (7) Detergents, pigments, adulterants, mineral lubricators, etc.
- (8) Ores of the precious and baser metals ; gold, silver, platinum, iridium, osmium, aluminum, copper, zinc, lead, mercury, iron, manganese, titanium, nickel and cobalt, bismuth, antimony, arsenicum, chromium, cerium, cadmium, tellurium, uranium, etc.
- (9) Useful substances of the carbon group. (a) The coals ; anthracite, bituminous and cannel coal, lignite, peat, jet. (b) Asphalt and allied substances ; asphaltum, paraffine, elaterite, ozokerite, amber, and other fossil resins. Liquid and gaseous hydrocarbons ; crude petroleum, lubricating oils, illuminating oil, naphtha, benzine, paraffine, natural gas, etc.

According to the plan devised the exhibits of this section form two independent series, which, as may readily be understood, are in part duplicates of one another. These two series are (1) the geographic series of ores and useful mineral substances and (2) the systematic series of similar objects. Owing, however, to the present lack of proper room and cases it has been found necessary to group the materials comprised in this section under three heads, and inasmuch as they must so remain until a new building is constructed or a balcony is placed around the walls of the southwest court it will be best to so describe them here.

These three series then are:

First. The collections of building and ornamental stones.

Second. The geographic series of ores and other useful mineral substances.

Third. The systematic series of ores and other useful mineral substances.

I.—THE COLLECTION OF BUILDING AND ORNAMENTAL STONES.

Under this head are included such stones as are of value in their natural condition for structural or ornamental purposes. Artificial or artificially colored materials are excluded. The nucleus of this collection was formed by the materials received from Philadelphia at the close of the Centennial Exposition in 1876. By far the larger portion was, however, collected during the investigations connected with the Tenth Census in 1880, though many important additions have since been made in keeping pace with recent developments. This exhibit comprises mainly materials from the United States, though foreign materials are by no means excluded, and indeed particular efforts have been made toward procuring such as are imported into the United States.

The specimens of this collection are as a rule cut in the form of 4-inch cubes, the various faces of which are finished as follows: Polished in front, drafted and pointed on the left side, drafted rock face on the right side, rock face on the back, and smooth sanded on the top and bottom. Stones not susceptible of a polish are merely smooth-sanded on the front face. The collection is at present arranged by States in fourteen floor upright and one wall case on the north side of the west south range, while larger specimens occupy two large pyramids in the southwest court and special bases wherever they can in our present crowded condition be placed to the best advantage.

This collection now comprises upwards of three thousand specimens and has been described in detail in my work entitled "The collection of building and ornamental stones in the U. S. National Museum: A handbook and catalogue."¹ The following figures relative to the number of specimens may, however, be here given:

¹ Rep. Smith. Inst., 1885-'86, Part II, pp. 277-648.

UNITED STATES.

Locality.	No. of specimens.	Material.
Alabama	13	Marbles, limestones, and sandstones.
Arizona	4	Limestones, and sandstones.
Arkansas	5	Limestones, quartzite, and syenite.
California	33	Steatite, marbles, granites, basalt, sandstone, and volcanic tuff.
Colorado	26	Limestones, granites, diorite sandstones, quartzite, and tuff.
Connecticut	66	Marbles, granites, gneisses, diabases, sandstones.
Dakota	2	Quartzite.
Delaware	2	Gneiss and marble.
District of Columbia	1	Massive steatite [soapstone.]
Florida	6	Shell and oolitic limestones, phosphatic sandstones.
Georgia	10	Marble, granite, gneiss.
Idaho	2	Sandstones.
Illinois	59	Limestones, dolomites, and sandstones.
Indiana	53	Do.
Indian Territory	1	Limestone.
Iowa	141	Gypsum, limestones, dolomites, and sandstones.
Kansas	63	Limestones, dolomites, and sandstones.
Kentucky	70	Do.
Louisiana	3	Sandstones and quartzite.
Maine	70	Serpentines, granites, gneisses, syenite, diabase, and slates.
Maryland	53	Steatite [soapstone] serpentines, granites, gneisses, sandstones, and roofing slates.
Massachusetts	117	Steatite [soapstone] serpentines, marbles, granites, quartz porphyry, diabase, melaphyr, and sandstones.
Michigan	19	Limestones, granites, gneiss, sandstone, roofing slate.
Minnesota	54	Dolomites, limestones, granites, quartz porphyry, diorite, gabbros, sandstones, quartzites, roofing slates.
Mississippi	5	Limestones and sandstones.
Missouri	93	Marbles, limestones, dolomites, granites, diabases, sandstones, and quartzites.
Montana	5	Marbles and granites.
Nebraska	6	Limestone.
Nevada	5	Andesites, sandstones.
New Hampshire	56	Steatite [soapstone], granites, gneisses, quartz porphyry.
New Jersey	50	Ophiolite, marbles, dolomite, gneisses, granite, diabase, sandstone, conglomerate, slate.
New Mexico	10	Gypsum, pumice, rhyolite tuffs, sandstone.
New York	150	Verdantique marbles, marbles, limestones, granites, dolomites, gneisses, porphyry, sandstone, quartzites, and roofing slates.
North Carolina	83	Steatite, marbles, limestones, granites, gneisses, quartzite, sandstone.
Ohio	222	Limestone, dolomite, and sandstone.
Oregon	4	Diabases, basalts, and sandstone.
Pennsylvania	231	Serpentines, limestones, dolomites, marbles, gneisses, quartzites, porphyries, diabases, diorites, sandstones, conglomerates, and roofing slates.
Rhode Island	21	Granites and gneisses.
South Carolina	13	Steatites, limestones, and granites.
Tennessee	72	Marbles, limestones, granites, gneisses, sandstones, conglomerate, and roofing slates.
Texas	31	Limestones and dolomites, marbles, granites, diorites, sandstones.
Utah	8	Limestones, granites, and sandstones.
Vermont	231	Steatite [soapstone], serpentine, marbles, granites, and roofing slates.

UNITED STATES—Continued.

Locality.	No. of specimens.	Material.
Virginia.....	39	Steatite [soapstone], marbles, limestones, granites, gneisses, diabases, sandstones, and roofing slates.
West Virginia.....	10	Marbles and sandstones.
Washington.....	2	Sandstones.
Wisconsin.....	54	Dolomites, gneisses, granite, quartz, porphyry, sandstone, quartzites.
Wyoming.....	3	Granites.

FOREIGN.

Canada.....	23	Granites, sandstones, roofing slates.
Bermuda.....	2	Coral limestones.
Mexico.....	135	Gypsum, marbles, volcanic tuffs, andesites, basalt, etc.
South America.....	12	Marbles.
England.....	30	Serpentine, marbles, roofing slates.
Scotland.....	20	Granite and sandstones.
Norway.....	1	
Sweden.....	1	
Austro-Hungarian Empire.....	133	Marbles, limestones, and granites.
France.....	88	Marbles.
German Empire.....	46	Marbles.
Switzerland.....	1	
Italy.....	87	Marbles, granites, travertines, etc.
Greece.....	1	
Spain and Portugal.....	190	Marbles, limestones, granites, volcanic rocks, etc.
Africa.....	15	Marbles, antique porphyry, granites.
Turkey.....	1	Marble.
China.....	6	Granites, volcanic rocks, and tuffs.
Corea.....	4	Serpentines and Verdantique marbles.
Japan.....	33	Marbles, agalmatolite, etc.
Russia.....	14	Quartz porphyries, jaspers, etc.
Australia.....	13	Marbles, sandstones, and granites.
Hawaiian Islands.....	1	Limestone.
Total.....	3,134	

The following shows the form of label used in this series :

BIOTITE GRANITE.—A fine, light-gray granite from the quarries of J. Hawkins.

GASTONIA, Gaston County, North Carolina. 27,621.

Collected by Prof. W. C. KERR, 1883.

MAGNESIAN LIMESTONE [MARBLE].—A fossil-bearing Devonian limestone used for interior decorations, and known commercially as "Madrepore Marble."

CHARLES CITY, Iowa.

38,465.

Gift of J. S. TRIGG, 1886.

II.—THE GEOGRAPHIC SERIES OF ORES AND USEFUL MINERAL SUBSTANCES.

In this exhibit, which is confined to the limits of the United States with a possibility of extension so as to include Canada and Mexico, materials are arranged on a geographic basis, *i. e.*, by States. The idea in mind is to give the public an opportunity to learn almost at a glance the character of the mineral product of any particular State or region. The exhibit is confined to the wall cases extending entirely around the South West Court.

Entering this court from the West South Range the series begins immediately upon the left.

The following statement is given relative to the arrangement of the collection and its present condition.

I—APPALACHIAN REGION.

(1) Maine is represented by some 28 specimens, comprising 20 iron ores, associates and products, 2 samples infusorial earth, 1 of quartz for making sandpaper, 2 fertilizers, 1 brick clay, 1 tin ore, and 1 of limestone for making quicklime.

(2) New Hampshire by 7 specimens, comprising 1 specimen each of gold, silver and lead, lead and zinc ore, and 3 samples of schist for making whetstones, and 1 of mica.

(3) Vermont by 39 specimens, comprising 12 iron ores, 14 samples of pigments (ochres), 4 refractory materials, 2 of schists for whetstones and each of copper, zinc, and manganese ores, kaolin, and sand for glass-making.

(4) Massachusetts by 28 specimens, comprising 14 iron ores, associates and products, 3 samples infusorial earth, 3 of emery rock, 2 of sand for glass-making and 1 each of fire clay, soapstone, copper-lead, lead, copper, and nickel ores.

(5) Rhode Island by 4 specimens only, of which 2 are coal, 1 limestone for quicklime, and 1 of titaniferous iron ore.

(6) Connecticut by 6 specimens, of which 3 are iron ores, 2 copper and 1 lead ore.

(7) New York by some 100 specimens, comprising 80 specimens iron ores, associates and products, 5 of slag or mineral wool, 2 graphitic talc, 2 dolomite used in generating carbonic acid for soda fountains, each of kaolin, abrading material, refractory material, limestone, gas coke, fuller's earth and silver-lead ore, and 2 samples petroleum.

(8) New Jersey by 67 specimens, of which 40 are iron ores, 8 iron zinc ores, 8 zinc ores, 8 clays, 1 zinc and manganese ore, and 1 green sand marl.

(9) Pennsylvania by 150 specimens, of which 101 are iron ores, associates and products, 12 copper, 2 copper-iron, 7 zinc, 2 nickel, 1 nickel cobalt, 3 chrome-iron ores, 1 each abrading material, massive tremolite, asbestos, mica, magnesite, 2 gas coke, 10 coals, and 5 petroleum.

(10) Delaware is at present wholly unrepresented.

(11) Maryland by 81 specimens, comprising 69 iron ores, associates and products of which 47 form a very complete illustration of the Muirkirk furnace, 2 copper, 2 gold, 1 manganese, and 1 chrome-iron ore, 2 siliceous sand used in mortars, and 1 each of steatite, mica, limestone, and shell marl.

(12) Virginia by 106 specimens, comprising 36 iron ores, associates and products, 24 ores of gold, 11 of gold and silver, 9 of zinc, 5 of lead, 3 of manganese, 6 of tin, 2 of copper, 2 specimens pyrite, used for making sulphuric acid, 2 of rock salt, 1 each of gypsum, soapstone, kaolin, infusorial earth, asbestos, and allanite.

(13) West Virginia by 28 specimens, comprising 16 iron ores, associates and products, 10 of coal and 2 of petroleum.

(14) North Carolina by 97 specimens, comprising 40 ores of gold, 3 of gold, silver, and lead, 1 of lead, 4 of copper, 3 of gold and copper, 2 of gold and silver, 1 of gold and iron, 7 of iron, 2 of chrome iron, 7 of nickel, 1 of manganese, 4 samples corundum, 3 of muscovite, 3 of garnet rock, 3 of phosphate rock, 1 asbestos, 5 refractory materials, 4 of steatite, and 1 each of graphite, barite, and pyrophyllite.

(15) South Carolina by 18 specimens, of which 6 are ores of gold, 6 of iron, 1 of manganese, 5 are phosphates, and 1 asbestos.

(16) Georgia by 50 specimens, of which 27 are ores of gold, 1 of gold, silver, and lead, 2 of gold and copper, 1 of gold and zinc, 4 of silver and lead, 2 of lead, 2 of copper, 11 of silver, 3 of iron, 3 of manganese, and 1 each of asbestos, corundum, and clay.

(17) Alabama by 42, of which 4 are iron ores, associates and products, and 1 coal.

(18) Florida by 18 specimens, all phosphates.

II.—MISSISSIPPI VALLEY REGION.

(19) Michigan is represented by 110 specimens, of which 50 are ores of iron, 54 of copper, 2 copper-silver, 2 silver, and 1 each of glass sand, and gypsum.

(20) Wisconsin by 11 specimens, comprising 7 iron ores, 2 lead, and 1 each of gold and manganese.

(21) Minnesota by 16 specimens, all ores of iron.

(22) Ohio by 20 specimens, comprising 10 ores of iron, 3 coals, 2 samples fire clays, 2 of sandstones for grindstones, 1 of gypsum for making land plaster, and 2 of petroleum.

(23) The Dakotas by 22 specimens, of which 3 are gold ores, 4 silver-lead, and 12 tin ores, 2 are coals, and 1 a quartzite used for street pavements and general building.

(24) Illinois by 15 specimens, comprising 12 samples coals and 3 of petroleum.

(25) Indiana by 14 specimens, of which 3 are coals, 3 abrasive materials, 3 iron ores, 3 clays, and 2 petroleum.

(26) Iowa by 5 specimens, comprising 4 samples Dubuque zinc and 1 specimen gypsum.

(27) Nebraska is almost wholly unrepresented. Two samples pumice dust from Orleans County are all the materials at present collections.

(28) Kentucky by 26 specimens, of which 20 are iron ores, 2 zinc, 1 barite, and 3 petroleum.

(29) Tennessee by 33 specimens, of which 29 are iron ores, 1 barite, and 1 petroleum.

(30) Missouri by 198 specimens, of which 64 are ores of lead, 49 of iron, 2 of lead and copper, 8 of copper, 6 of zinc and lead, 1 of lead, 2 of nickel and cobalt, 2 of gold, 1 of manganese; with the 2 samples each of coal, tripoli, lithographic limestone, 5 of barite, 1 of marcasite.

(31) Kansas by 21 specimens, comprising 14 specimens of ores, 2 of lead, 1 lead and zinc, and 1 specimen each of marcasite, rock limestone for making whiting, and pumice dust.

(32) Arkansas by 20 specimens, of which 2 are lead ores, 1 copper, 1 antimony, 1 manganese, 7 iron, 4 are of novaculite, slate the rough and manufactured material, and 1 each of coal, brookite, steatite.

(33) Indian Territory. At present wholly unrepresented.

(35) Oklahoma. At present wholly unrepresented.

(35) Mississippi. At present wholly unrepresented.

(36) Louisiana is represented by 7 specimens, of which 6 are iron and one rock salt.

(37) Texas by but 8 specimens, of which 6 are iron ores, 1 copper and 1 coal.

III.—ROCKY MOUNTAIN REGION.

(38) Montana is at present represented by 231 specimens, a proportion of which are ores of the precious metals. From Deer County there are exhibited 19 specimens gold, silver, and copper; from Lewis and Clarke County, 62 specimens, of which 26 are silver ores from the Ten-mile district, the remainder being gold, silver, copper ores; from Silver Bow County, 44 specimens of silver and copper ores, mostly from mines in and about Butte; from Meagher County, 4 specimens silver, copper, and lead ores; from Jefferson County, 4 specimens gold, silver-lead-copper ores, and tin ores; from Mineral County, 30 specimens gold and silver ores, and 1 of pumice dust; from Beaver Head County, 42 specimens gold and silver ores.

(39) Idaho by 110 specimens, as follows: Owyhee County, 56 specimens gold and silver ores; Alturas County, 30 specimens gold, lead, and mercury ores; Custer County, 13 specimens silver, lead, copper ores; Boise County, 5 specimens all gold ores; Lemhi County, 6 specimens gold and silver-lead ores.

(40) Wyoming. At present wholly unrepresented.

(41) Utah by 313 specimens, as follows: Beaver County, 40 spec

silver-lead and bismuth ores; Summit County, 11 specimens, all silver and silver-lead ores; Piute County, 3 specimens silver-lead-copper ores; Fremont County, 1 specimen coal; Juab County, 3 specimens silver-lead ores; Millard County, 1 specimen each sulphur and silver-copper ore; Weber County, 1 specimen iron ore; Utah County, 2 specimens iron and silver-lead-copper ores; Tooele County, 95 specimens silver-lead and silver-lead-copper ores; Salt Lake County, 134 specimens silver-lead and silver-lead-copper ores; San Pete County, 2 specimens gypsum; Washington County, 6 specimens silver ores; Iron County, 5 specimens iron ore and 2 specimens antimony ore; Wasatch County, 1 specimen silver-lead ore; Morgan County, 2 specimens iron ore; Emery County, 1 specimen of ozokerite; Uintah County, 1 specimen each Wurtzilite and Uintaite.

(42) Colorado by 428 specimens, of which number 267 specimens are eruptive and sedimentary rocks, ores, and vein materials, as collected and described by Messrs. Emmons and Cross, in Monograph XII, U. S. Geological Survey, entitled "The Geology and Mining Industry of Leadville." The remainder of the materials are divided as follows: Lake County, 14 specimens silver-lead ores; Gilpin County, 21 specimens auriferous pyrites and silver-lead ores; Boulder County, 59 specimens, including telluride ores of gold and silver, silver-lead ores, and auriferous sulphurets; Clear Creek County, 10 specimens silver-lead-zinc and-copper ores; Pitkin County, 1 specimen copper ore; Park County, 9 specimens silver-lead ore; La Plata County, 13 specimens silver-lead ores; Ouray County, 1 specimen silver ore; Fremont County, 6 specimens silver-lead and copper ores; Summit County, 4 specimens silver-lead ores; Jefferson County, 9 specimens auriferous pyrites, copper, and silver-lead ores; Gunnison County, 6 specimens silver-lead ores; Pueblo, 1 specimen zinc ore; Custer County, 6 specimens silver-lead and iron ores; Las Animas County, 1 specimen iron ore.

(43) Arizona by 60 specimens, of which 2 are lead ores, 2 silver-lead, 2 silver-lead-copper, 6 silver and copper, 36 copper, 2 copper and mercury, 6 silver, and 1 each of gold, chromite, infusorial earth, and barite.

(44) New Mexico by 28 specimens, of which 6 are gold ores, 16 silver, 4 copper, 1 lead, and 1 chrome iron. The exhibit includes also one specimen of the so called "riccolite," a serpentineous rock used for ornamental purposes.

IV.—PACIFIC SLOPE REGION.

(45) California. This State is at present represented by 207 specimens of various kinds, as below: Butte County, 18 specimens placer and vein-golds; Mariposa County, 10 specimens quartz-gold ore; Inyo County, 13 specimens quartz-gold ore; Calaveras County, 13 specimens quartz-gold ore; Yuba County, 5 specimens gravel and placer gold ores; El Dorado County, 1 specimen silver and 6 gold ores; Nevada County, 19 specimens quartz and gravel gold ores; Mono County, 1 specimen silver-copper ore; Tehama County, 1 specimen sulphur; Santa Barbara County, 1 specimen each asphalt and gypsum; Lake County, 9

mercury ores; Del Norte County, 2 copper ores; Placer County, 11 specimens auriferous sulphurets and placer-gold ores, iron ores, and limestone; Amador County, 13 specimens quartz and sulphure ores and 1 copper ore; San Diego County, 2 specimens gold and ores; Sonoma County, 13 specimens mercury ores; Tuolumne County, 11 specimens placer and quartz gold ores; Santa Clara County, 4 specimens mercury ores; Tulare County, 4 specimens gold-silver and ores; Los Angeles County, 1 specimen graphite; San Bernardino County, 5 specimens silver-lead-copper, 2 antimony and 2 mercury ores; Mono County, 1 specimen mercury ore; Kern County, 6 specimens gold, silver, and antimony ores; Sierra County, 5 specimens quartz and gold ores; Fresno County, 4 specimens mercury ores; Napa County, 6 specimens mercury and 1 chrome iron ore; Shasta County, 3 specimens gold and silver and lead ores; Colusa County, 1 specimen ore; from island in San Francisco Bay, 1 specimen manganese.

(46) Nevada by 444 specimens, as follows: Lauder County, 50 specimens, of which 44 are the beautiful ruby silver ores from the River district and 6 the copper ores of the Battle Mountain district; Storey County, 76 specimens, mainly from the various mines of the Comstock lode; Esmeralda County, 32 specimens silver, silver-lead, gold and copper ores, also native borax and 1 specimen ulexite; Humboldt County, 4 specimens copper ores; Washoe County, 12 specimens silver, lead, copper, and mercury ores; Nye County, 57 specimens silver, copper, gold, and sulphur ores; Humboldt County, 33 specimens, silver, lead, nickel, and cobalt ores and native sulphur; Eureka County, 11 specimens gold, silver-lead, lead and copper ores; White Pine County, 50 specimens silver, lead, and copper and iron ores; Churchill County, 1 specimen each silver and copper ore, borax, and native sulphur; Elko County, 30 specimens gold, silver, silver-lead, and copper ores; Lincoln County, 53 specimens silver-lead, silver, copper ores, and 1 specimen chalcantite; Ormsby County, 5 specimens silver-lead, copper, and iron ores; Douglas County, 2 specimens iron ores.

(47) Oregon by 28 specimens, of which 17 are gold ores, 3 silver and copper ores, 4 iridosmine, and 2 coal.

(48) Washington. This State is at present wholly unrepresented.

(49) Alaska by 22 specimens, comprising gold and silver and iron ores, coal, and graphite.

THE DOMINION OF CANADA.

Following the usual geographic divisions, the exhibit is arranged by provinces as below. The representation is meager, and but a prospective increase would be scarcely worth setting off from the thematic series.

The province of Ontario is represented by 43 specimens iron ores and associates, 5 gold ores, 1 copper, 3 copper-nickel, and 1 nickel specimens massive apatite; Quebec by 1 specimen iron ore, 1 of apatite, 1 peat, and 2 asbestos (fibrous serpentine); British Columbia 1 specimen coal and 1 of a fossil resin; New Brunswick by 2 spec-

Coal, 1 of albertite, and 1 each of pyrolusite, stibnite, barytes, and gypsum; Nova Scotia by 2 specimens iron ore and 1 of manganese; Queen Charlotte's Island by 2 specimens coal; Newfoundland by 1 specimen copper ore.

MEXICO.

The various States of the Republic are represented as follows: Sonora by some 50 specimens gold, silver, lead, and copper ores and coals; Chihuahua by 14 specimens silver and copper ores; Durango by 9 specimens silver, tin, and iron ores; Pachuca by 5 specimens silver ores; Mexico, 12 specimens silver and iron ores, sulphur, and clays; Zacatecas, 17 specimens silver and copper ores; Jalisco, 1 specimen each of iron ore, zinc, copper ore, and barite; San Luis Potosi, 1 specimen each of tin ore, sulphur, and gypsum; Aguas Calientes, 3 specimens; Vera Cruz, 1 specimen pumice; Pueblo, 1 specimen mercury, 1 manganese ores, and 2 specimens onyx; Oaxaca, 13 specimens silver, lead, copper, tin, and iron ores, coals, and gypsum.

As may be noticed by a perusal of the lists given above many important localities, both within the limits of the United States and beyond, are quite unrepresented. It is to be hoped that friends of the institution will be sufficiently interested to contribute the desired materials.

Concerning the large quantities of foreign materials previously described as forming a portion of the geographic series of this exhibit little need here be said. This for the reason that these collections will shortly be thoroughly overhauled, the better class of materials worked into the systematic series, and the remainder stored. A great deal of this present exhibit can have little interest to the general public and must give way to a better class of material.

The following shows the form of label in use in this series:

SILVER AND LEAD ORE.—ARGENTIFEROUS GALENA with PYRITE, BLENDE, QUARTZ, and MICA. From the mines of the Warren Silver and Lead Company.

WARREN, Grafton County, New Hampshire. 30,176.

Gift of WARREN SILVER AND LEAD COMPANY.

IRON AND ZINC ORE.—FRANKLINITE, ZINCITE, and WILLEMITE with CALCITE. Used in the manufacture of spiegeleisen, and of zinc oxide for paint.

BUCKWHEAT VEIN, Franklin, Sussex County, New Jersey.

12,264-

III.—THE SYSTEMATIC SERIES OF ORES AND USEFUL MINERAL SUBSTANCES.

This series deals with the same class of materials as are comprised in the geographic series, but differs in the method of arrangement, and goes further in that it is not limited to localities in the United States. The arrangement of the material here shown is naturally duplicated in the geographic series, but owing to its grouping it conveys quite a different lesson. As an illustration of this, attention may be called to the collection of nickel ores. In the geographic series, ores of nickel as they occur in the United States are shown in the State exhibits of Massachusetts, Pennsylvania, North Carolina, Missouri, Nevada, Oregon, and Alaska. In the systematic series these same ores are shown, but grouped together in such a way as to be readily compared with one another, and also with others from it may be worldwide sources, as for instance Canada, Sweden, Norway, Prussia, and New Caledonia.

This series further differs from the first mentioned in that with respect to the principal metals the ores are supplemented by collections illustrating its method of extraction and the various by-products involved.

This collection, comprising now some 4,000 specimens, was inaugurated under the direction of Mr. F. P. Dewey, formerly curator of the Department of Metallurgy, and has been described by him in a handbook entitled "Preliminary Descriptive Catalogue of the Systematic Collection of Economic Geology and Metallurgy." This will appear in Part II of the Smithsonian Report for 1889-'90.

While the arrangement of cases adopted by Mr. Dewey has been completely changed and much new material added, particularly from foreign sources,¹ still the general scheme at time of writing is practically the same, and may be briefly outlined as follows:

In the case of each metal the series begins with an exhibit of the principal minerals of which that metal forms a part. The specimens were selected to show so far as possible each mineral in its perfect state. The next step is a series of ores selected to show the material as actually mined, and associated minerals as actually mined. Following these is a third series showing the various stages in the processes of concentration, as actually practiced; and finally a fourth series, representing the processes of extracting the metals from the ores and converting them into useful forms. These collections include the ores, fuels, fluxes, and all other materials entering into the operation, and samples of the final as well as of the numerous waste and by-products. In this manner are exhibited metallic ores of gold, silver, copper, iron and steel, cobalt, nickel, lead, tin, mercury, and aluminum, while many of the more rare and important are exhibited in specimens only, as is the case with manganese, chromium, antimony, and bismuth. A fine series of alloys is also exhibited under this head.

¹ Mr. Dewey had limited the collection wholly to minerals from the United States.

Under the head of non-metallic minerals are shown a variety of useful mineral substances, including sulphur, the salts used in chemical manufacture, gypsum, grinding and polishing materials, asbestos and its application, mineral fertilizers, fictile materials, and the natural carbon compounds, as already noted.

It is not necessary to go into greater descriptive detail here regarding this series, as reference can be made to the handbook above mentioned. The following summaries are from a previous publication on the condition of the department¹. Changes and additions since made have necessitated numerous alterations.

A—METALLIC MINERALS.

The mineralogy of gold is illustrated by 29 specimens. Of these, 28 represent free gold, and one sylvanite. Of the free golds 10 represent placer gold.

This series begins with a well-crystallized specimen that is only slightly water-worn, and continues through various degrees of rounding to a well-worn nugget, weighing an ounce. Fifteen specimens represent quartz gold, beginning with crystals in a cavity in fresh quartz, and following through various steps of crystallization of the gold and decomposition of the matrix to a natural alloy of gold and silver in wholly decomposed material.

Two specimens of crystallized auriferous pyrite represent sulphuret gold, and a single specimen represents auriferous slate.

The gold ores are divided into placer, quartzose, sulphuret, telluride, and fusion ores. Beside the placer golds in the mineral series, 5 specimens illustrate hydraulic gravels, varying from characteristic samples to a very rich specimen containing several flakes of visible gold; 9 specimens, in addition to the quartz gold in the mineral collection, illustrate quartzose ores. These begin with very pure white quartz and follow through increasing amounts of other minerals, particularly sulphides in the quartz, to specimens containing large amounts of pyrite, chalcopyrite, galena, and blende. The quartzose ores graduate insensibly into the sulphuret ores, and the two really form one series.

The 10 sulphuret ores begin with pyrite and quartz and run through to pure sulphides; decomposed sulphides follow, and the series closes with 2 specimens of mispickel. Five specimens illustrate the telluride ores from Boulder County, Colorado.

The extraction of gold from its ores is illustrated by 3 collections. The operation of the hydraulic process is illustrated by 9 specimens from the North Bloomfield gravel mine, California; the stamping and amalgamating of sulphuret ores by 7 specimens from the Bobtail and Blackhawk, Colorado, and the extraction of gold, silver, and copper in a complex operation by 15 specimens from Balbach's Newark Smelting

¹ The Department of Metallurgy and Economic Geology in the U. S. National Museum, by F. P. Dewey. Trans. Am. Inst. Engineers, Vol. XIX, 1890.

and Refining Works, New Jersey. This collection is interesting showing the refining of copper and separation of the precious metals by the electric current.

The application of gold is illustrated by 11 specimens showing the manufacture of gold leaf.

Seven specimens illustrate iridosmine. Of these, 4 show the original sand, and the gold dust, iridosmine, and black sand separated by washing.

The mineralogy of silver is illustrated by 36 specimens, including the ordinary silver minerals. The silver ores are divided into free-milling and smelting ores; these again are subdivided into free-milling, roasting-milling, and silver smelting and silver-lead smelting. A few, such as leaching ores and argentiferous copper ores, do not fall into this classification. Thirteen specimens illustrate the strictly free-milling ores, or such as readily yield to stamping and amalgamation. They carry mostly free silver or cerargyrite. Twelve specimens illustrate free-milling ores which require the use of chemicals in the pan; of these, 8 are characteristic ores from the Comstock lode. Ores requiring roasting before milling are illustrated by 5 specimens, and a complete set of 19 specimens from the Ontario mine, Park City, Utah. Besides some general characteristic specimens, this includes a section along the fifth level and two sections across the vein on the sixth level.

The extraction of silver from roasting-milling ores is well illustrated by two collections made by the former curator. The first, comprising 30 specimens from the Ontario mill, illustrates every step in the process from the time the ore is dumped upon the grizzly until the bullion is shipped by express, and the tailings are turned to waste. The second collection represents in the same full way, with 17 specimens, the operation of the Moulton mill at Butte, Montana.

The treatment of argentiferous copper ores is illustrated by a collection of 32 specimens from the Argo Works, Colorado. This collection is particularly valuable on account of the assays and analyses accompanying the specimens.

The mineralogy of lead is illustrated with 14 specimens of sulphate, and carbonate. Silver-lead ores are illustrated by 5 specimens. This series begins with roughly crystallized galena, showing the characteristic cleavage, and follows through several varieties of galena to the beginning of decomposition, resulting in cerussite and anglesite. The association of galena with other sulphides is well illustrated, and a large collection of characteristic samples of cerussite closes the series.

The smelting and refining of base bullion is illustrated in collections from the Colorado smelter, South Pueblo, Colorado; the Cheltan Works, St. Louis, Missouri, and the Kansas City Smelting and Refining Works, Argentine, Kansas.

The collection from the Colorado smelter contains 59 specimens.

including a full suite of the ores, fuels, and fluxes used, the bullion and slag produced, and a variety of by-products, matte, speiss, flue-dust, accretions, etc. The value of the specimens in this case has been greatly enhanced by the large amount of information kindly furnished. The course of the operation has been fully described and plated. Nearly every specimen is accompanied by a careful and complete analysis. Numerous photographs show the disposition of the works.

The refining of base bullion is illustrated by a collection of 18 specimens from the Cheltenham Works. The smelting of a charge containing a large proportion of oxidized ores, using iron to reduce the sulphide, and the subsequent refining of the base bullion, are illustrated by 13 specimens from the Kansas City Works.

The southeastern Missouri lead region is well represented by two collections, one containing 30 specimens from the St. Joe Works, and the other 29 specimens from the Desloge Works. These are particularly interesting as illustrating two distinct methods of separating the galena from the limestone, through which it occurs disseminated. At the St. Joe Works the crushed material is delivered directly to the jigs without any sizing, while at the Desloge Works sizing is very carefully done.

A series of 28 specimens illustrates the smelting of galena with the recovery of the fume as a white paint at the Lone Elm Works, Joplin, Missouri.

The application of lead is illustrated by 11 specimens showing the Dutch process of making white lead.

The mineralogy of copper is illustrated by 22 specimens. All the ordinary copper minerals are shown. The ores of copper are divided into metallic, oxidized, and sulphuret ores. The metallic copper ores are very well represented by collections from three characteristic Lake Superior copper mines, "mass," "amygdaloid," and "conglomerate." The mass mines, in which copper is found in large masses, are illustrated by a collection of 31 specimens from the Central mine. The amygdaloid mines, in which the copper occurs disseminated through a soft amygdaloidal melaphyr, are illustrated by a collection of 61 specimens from the Osceola mine and 21 specimens from the Osceola mill. The conglomerate mines, in which the copper occurs disseminated through a tough felsitic conglomerate, are illustrated by 61 specimens from the Delaware mine and 17 specimens from the Delaware mill. These Lake Superior collections were made with great care for the Museum by special collectors.

The location of nearly every specimen within the mine was carefully noted, and the collections include many complete sections. The smelting of the separated copper is illustrated by a collection of 17 specimens from the C. G. Hussey Works, Pittsburgh, Pennsylvania, and 11 specimens from the Lake Superior Native Copper Works. Taken altogether, these seven collections, with 219 specimens, form a complete illustration of the Lake Superior copper industry.

Oxidized and sulphide copper ores are shown in the collections from the various smelting works. The smelting of oxidized ores to pig-copper is illustrated by 14 specimens from the Copper Queen mine; and the refining of this pig to ingot is illustrated by 19 specimens from the Ansonia Brass and Copper Company, Ansonia, Connecticut. The smelting of sulphide ores is illustrated by eight collections. The older form of the process is illustrated by 12 specimens from the Vermont Copper Company, Ely, Vermont; 23 specimens from the Schuylkill Copper Works, Phoenixville, Pennsylvania; 14 specimens from the Union Mining Company, Ducktown, Tennessee. A newer form is illustrated by 8 specimens from the Orford Works, Bergenport, New Jersey, and a modification involving a long road of the matte in a reverberatory furnace, is illustrated by 34 specimens from the St. Genevieve Works, Missouri. The smelting of sulphide ores containing silver for the production of a rich matte, is illustrated by three collections from Butte, Montana.

Reverberatory smelting is illustrated by 16 specimens from the Montana smelter and 10 specimens from the Parrott smelter. Shaft furnace smelting is illustrated by 11 specimens from the Bell smelter. The treatment of copper ores by the Hunt and Douglas wet process is illustrated by 14 specimens from the Schuylkill Works, Phoenixville, Pennsylvania.

The application of copper is illustrated by 18 specimens, showing more particularly the rolling of copper.

Seventeen specimens illustrate the mineralogy of iron. The extraction of iron from its ores is illustrated by 14 specimens from the Rogersfield mine and Belmont forge, New York. A large number of interesting photographs of the works accompany this collection. The manufacture of crucible steel from puddled bar is illustrated by a complete collection of 28 specimens from the Crescent Steel Works, Pittsburgh, Pennsylvania.

The manufacture of Bessemer steel is very fully illustrated by a collection of 74 specimens from the South Chicago Works, taken by special collectors. This collection begins with the ores, fuels, and fluxes used in the blast furnace. Starting with a given charge the metal is followed from the blast furnace through each stage of manipulation until the rail was rolled, 2:20 minutes after the metal was tapped from the blast furnace. Samples were taken wherever possible. To give a systematic illustration of a blow are added many general specimens, particularly a full series of refractory materials. The smelting of magnetite with a mixture of anthracite coal and coke is illustrated by 16 specimens from the Crown Point, New York, furnace; the smelting of a mixture of several (six to eight) different ores with anthracite coal and coke, by 16 specimens from the Warwick furnace, Pottstown, Pennsylvania; the smelting of very sulphurous and cupreous magnetite from a single mine with a mixture of anthracite and coke, by 18 specimens

from the North Cornwall furnace, Lebanon, Pennsylvania; the smelting of limonite with coke, by 16 specimens from the Longdale, Virginia, furnace; the smelting of hematite ores with a mixture of bituminous coal and coke, by 20 specimens from the St. Louis Ore and Steel Company, South St. Louis, Missouri, and the smelting of fossil ores with coke, by 17 specimens from the Roane furnace, Rockwood, Tennessee.

To the iron collection is added a selected number of specimens showing the results obtained by Kirkaldy, of London, in his classic investigation of the mechanical properties of Fagersta steel.

Manganese ores are specially illustrated by 4 specimens.

Nickel and cobalt: The mineralogy of nickel and cobalt is illustrated by 4 specimens and the ores by 18 more. These include samples of smaltite from the historic locality of Chatham, Connecticut; nickeliferous pyrrhotite from Dracut, Massachusetts, and the Gap mines in Pennsylvania, Canada, Alaska, Norway, and Sweden; silicate ores from North Carolina, Oregon, and New Caledonia; arsenides and derived arseniates from Missouri and Nevada. The application of the two metals is illustrated by 43 specimens.

The mineralogy of zinc is illustrated by 33 specimens. Among these are some very fine specimens of crystallized blende from Missouri. In addition to these, the ores are represented by 13 specimens.

Much blende associated with galena and a little pyrite occurs in a gangue of chert in southwestern Missouri and southeastern Kansas. The dressing of this material to separate the blende and galena is illustrated by 29 specimens from the South Side mill, Galena, Kansas. The extraction of zinc is fully illustrated by five collections. The Glendale Works at St. Louis, Missouri, reducing a variety of ores, are illustrated by 22 specimens. The Joplin Zinc Works at West Joplin, Missouri, smelting the separated blende from Galena, Kansas, are represented by 16 specimens. The Rich Hill, Missouri Works, smelting the Joplin ore and using a Siemens gas furnace to heat the retorts are illustrated by 17 specimens. The Passaic Zinc Works, Jersey City, New Jersey, are represented by 31 specimens. These works treat the complex zinc, iron, and manganese ores from Franklin, New Jersey, and produce spelter, oxide of zinc, and spiegeleisen.

The mineralogy of tin is represented by a single specimen, but the ore collection includes specimens from nearly every locality in the United States, not excepting the original tin discovery at Jackson, New Hampshire. All the principal foreign localities are also represented. The collection numbers some 50 specimens, and to these are added 6 specimens of metal, reduced from the ores, among them a small bar smelted from the Jackson ore in 1840. This is undoubtedly the "first tin ever smelted in America."

Antimony is represented by specimens from California, Utah, New Brunswick, Portugal, Australia, and New Zealand.

Chromium is represented by specimens of chromite from all the principal locations in the United States and many foreign sources.

Bismuth is represented by 2 specimens.

The mineralogy and ores of aluminum are illustrated by 10 specimens of cryolite, corundum, and beauxite.

The extraction of aluminum by the Frizmoth process is illustrated by 20 specimens, and its application by 22 specimens, metallic aluminum and its alloys, as prepared by the Pittsburgh Reduction Company.

The mineralogy and ores of mercury are illustrated by some 40 specimens from domestic and foreign sources; 13 specimens are added to illustrate the mine and works at New Almaden, California.

Under the head of the general use of metals is shown a large series of alloys described by Mr. Pearce in the Transactions American Institute of Mining Engineers, Vol. XIII, p. 738, and illustrated by 12 specimens; the manufacture and utilization of brass, by 28 specimens; of soft alloys, babbitts, solders, etc., by 41 specimens; and that of metal, by 17 specimens. Welsh tin plate is represented by 15 specimens.

B.—NON-METALLIC MINERALS.

These are illustrated as follows:

Sulphur by 10 specimens, and the manufacture of sulphuric acid by 5 specimens.

Abrading and polishing materials are shown by a fine large series of some 200 specimens novaculites, schists, and sandstones in the rough and finished state for sharpening edge tools.* Two columns of grindstone as prepared by J. E. Mitchell of Philadelphia may be noted here. Each column stands some 7 feet in height, one composed of 9 and the other 13 varieties of grindstones, laid flat, one on another. The stones are cut to a scale, being 12 inches in diameter, and each 2 inches thickness representing a diameter of 12 inches in the finished stone actually used. That is to say, stones which in the column are 12 inches thick are for actual use made 6 feet in diameter, the thickness remaining the same. All principal varieties both foreign and domestic now in use in the United States are represented. The exhibit further comprises 40 specimens corundum and emery both in lumps and in pulverized form, commercial sizes; 10 specimens of quartz for sandpaper; 5 specimens tripoli; 5 specimens infusorial earth; 15 specimens pumice in the rock form, pulverized, and as fine dust, the product of explosive volcanic action; and 29 specimens illustrating the manufacture of emery and sandpaper.

The occurrence of asbestos is shown by a large collection comprising some 60 specimens from world-wide localities. The application of

*Mainly the gift of the Pike Manufacturing Company of Pike Station, New Hampshire.

bestus is shown by 40 specimens.* Sixty specimens show characteristic forms of the various phosphates and other mineral substances used in the manufacture of fertilizers.

Fictile materials are illustrated by some 60 specimens, including all the usual varieties of clay and kaolin.

The native compounds in which carbon forms the chief constituent are shown in a series of some 500 specimens, which begins with pure carbon in the form of diamond and graphite, and follows through coals, bitumen, and petroleum, ending with natural gas.

In this series the most important collections are those of anthracite coal from the Kohinor colliery of the Philadelphia and Reading Coal and Iron Company, and the very extensive collection of petroleum, which includes varieties from all the principal localities of the United States, with a very complete illustration of its technology. A few foreign localities are also represented.

Maps showing the geographic distribution of the ores of iron and mercury, of coal, salt, petroleum, and bituminous matter accompany this series. It is hoped to add to these others showing the distribution of the precious metals as well. A table in each of the exhibition halls is supplied with books descriptive of the collections.

The following show the form of label used in this series:

PETROLEUM AND ITS DERIVATION PRODUCTS.

CRUDE PETROLEUM.—Dark greenish-red; specific gravity on sample collected June, 1885, $47\frac{1}{2}^{\circ}$ Baumé.

Well No. 12, Lot 3, 194, Howe, Forest County, Pennsylvania.
59,789.

Collected by S. F. PECKHAM.

From well in third Sandstone of the Petroleum Measures; sand here 15 feet in thickness. Oil in sand; depth of well 1,655 feet; drilled 1883; torpedoed. Yielded 1,950 barrels of oil on first day of flow.

THE APPLICATION OF GRAPHITE.

GRAPHITE.—For making pencils; contains from 5.143 to 17.682 per cent. of ash.

Dominion of Canada Plumbago Company, Buckingham, Province of Quebec, Canada. 51,612.

AMERICAN INSTITUTE MINING ENGINEERS, 1885.

* Mainly the gift of the H. W. Johns Company, of New York.

Owing to the already crowded condition of the exhibition hall the present intention to hold the strictly metallurgical portion of the exhibit within its present limits, while the remaining portions are expanded indefinitely. This means a general rearrangement of the crude materials, excepting those portions needed to illustrate the metallurgical process. It is now expected that this work of rearrangement will be begun as soon as the contemplated new floor in the west court shall be laid. It is therefore not impossible that this paper will be well under way by the time this paper shall appear in print.

○



1. 20. 11

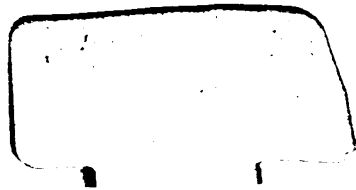

Widener Library



3 2044 092 759 240