

18  
19  
20  
21  
22  
23  
24  
25  
26  
27  
28  
29  
30  
31  
32  
33  
34  
35  
36  
37  
38  
39  
40  
41  
42  
43

一  
鑑

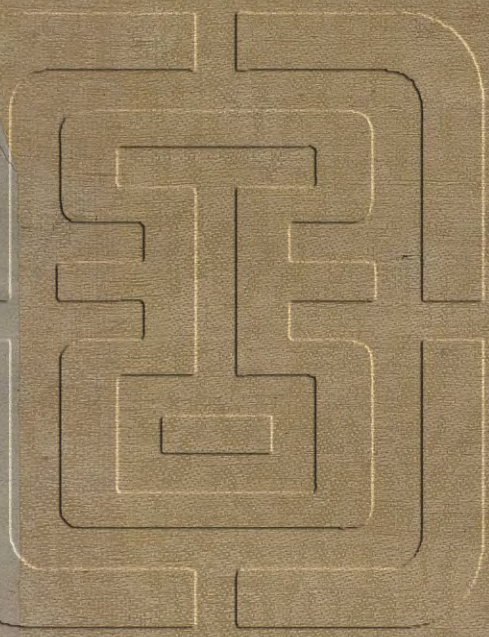

五  
320  
846  
: 20

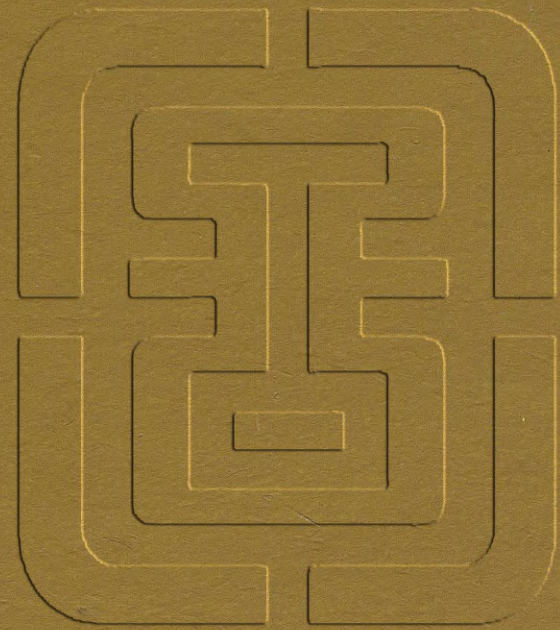
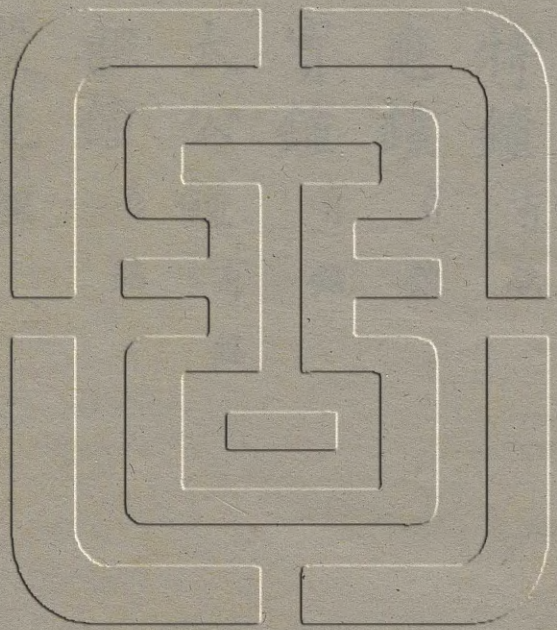

西清古鑑卷三十六目錄

鐘

周

特鐘 有銘

應鐘 有銘

寶鐘 有銘

太公鐘 有銘

經鐘 有銘

雙龍鐘

雙螭鐘

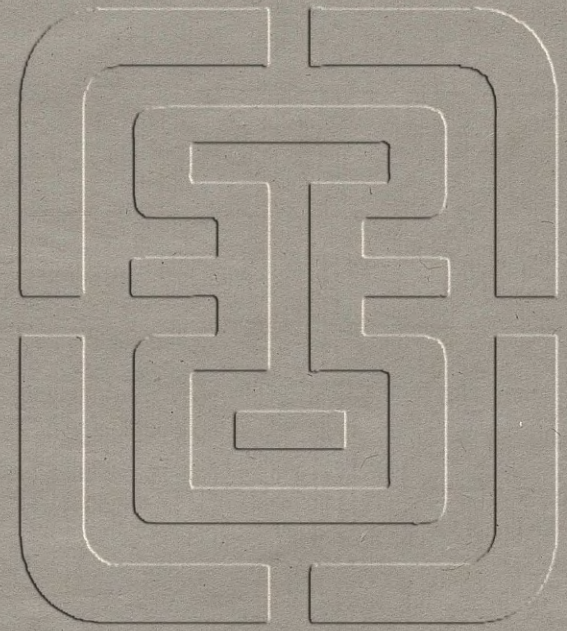
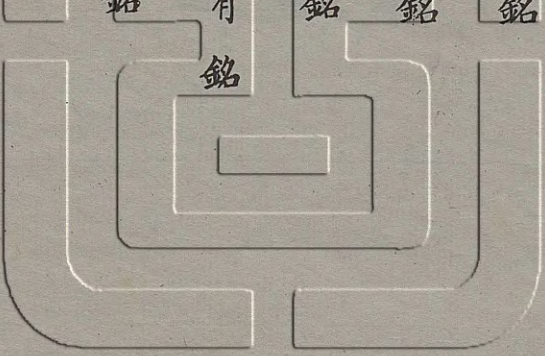

雙夔鐘

蟠夔鐘一

蟠夔鐘二

蟠夔鐘三

蟠夔鐘四

蟠夔鐘五

蟠夔鐘六

蟠夔鐘七

蟠夔鐘八

蟠夔鐘九

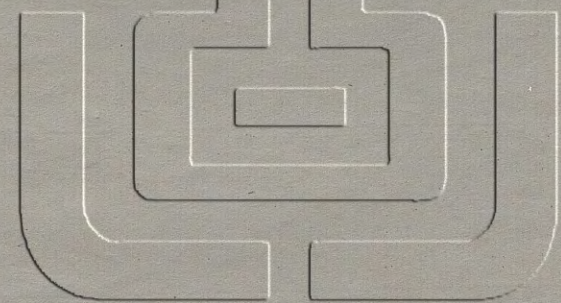

蟠螭鐘一

蟠螭鐘二

蟠螭鐘三

蟠虺鐘

盤雲鐘一

盤雲鐘二

雷紋鐘

篆帶鐘

星帶鐘

螭鈕鐘一

有銘

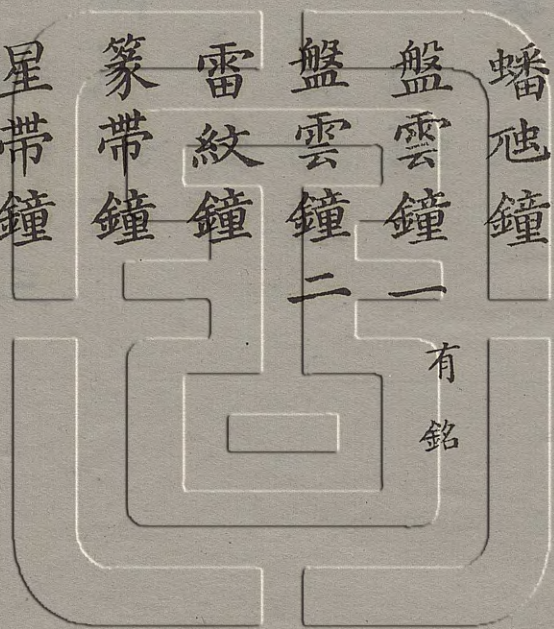

螭鈕鐘二

螭鈕鐘三

環鈕鐘

素鈕鐘

實甬鐘

編鐘

漢

角鐘一 有銘

角鐘二 有銘

雲螭鐘一

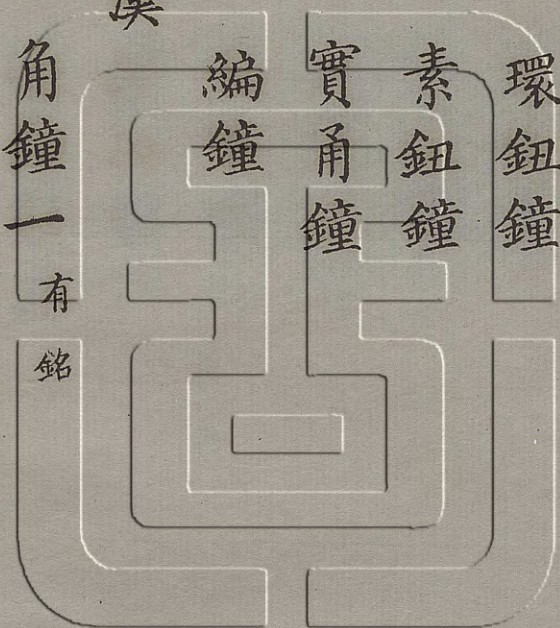

雲螭鐘二

蛟螭鐘

蟠螭鐘

編鐘一

編鐘二

蠶紋鐘

鐸

周

乳鐸

蟠夔鐸

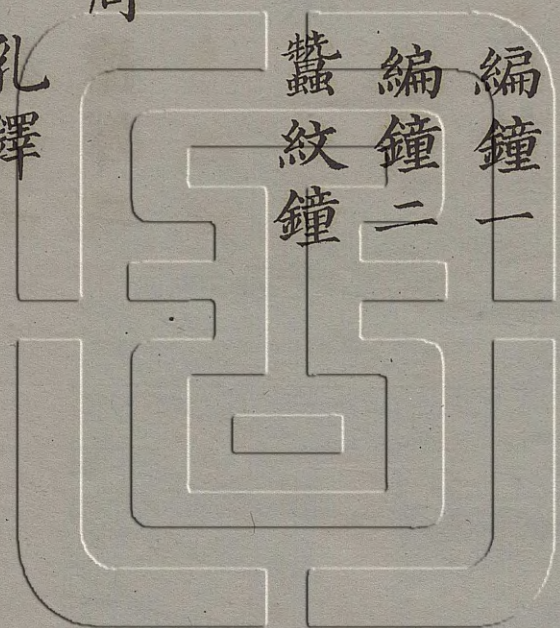

漢

檐鐸一

檐鐸二

鈴

漢

風鈴

旂鈴

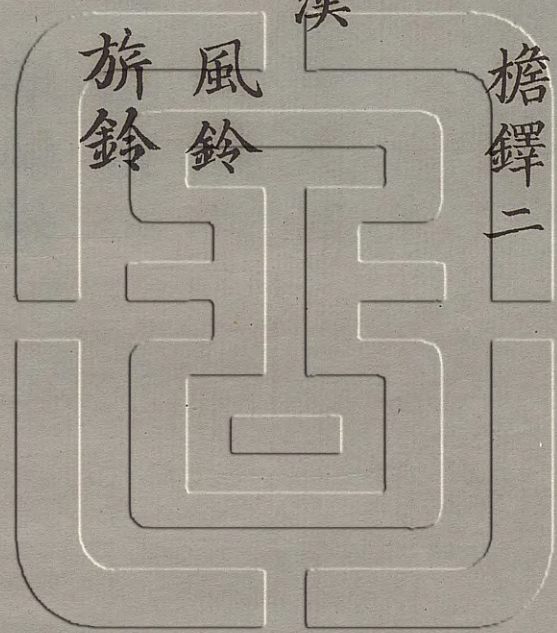

周特鐘

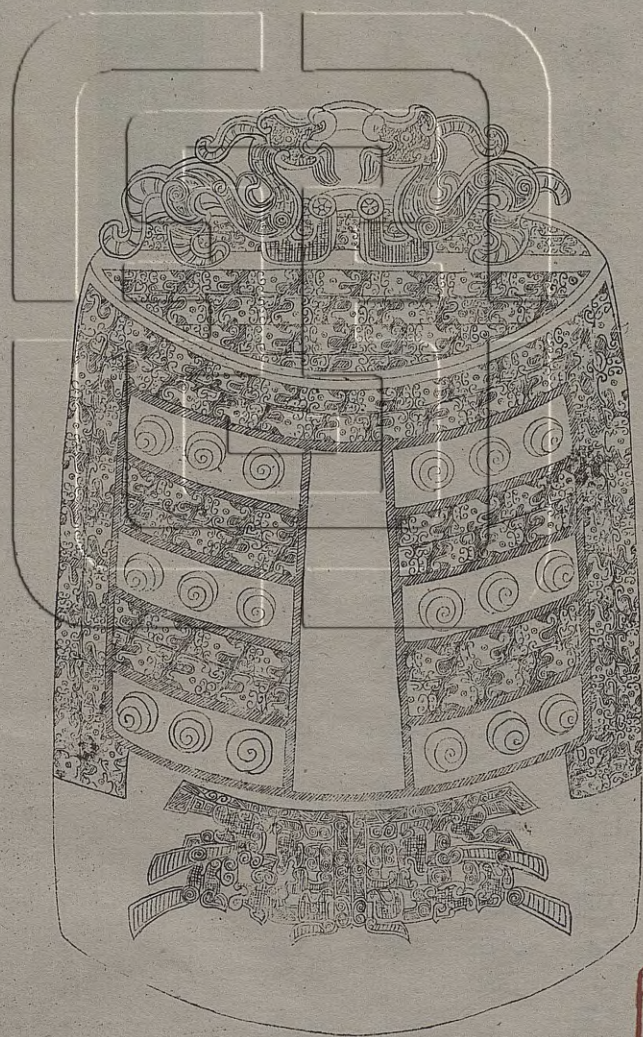

黃鐘清

黃鐘清

大和

太和

右高六寸九分鈕高一寸八分濶四寸六分兩舞相距五寸二分橫四寸三分兩銑相距五寸六分橫四寸五分枚三十六各長二分重一百九十一兩按黃鐘鐘特懸君音也律呂子聲之說發於杜氏通典五代兩宋樂懸有四清聲是子聲也又謂之半聲黃鐘正律無半變律有半

即黃鐘之清聲也宋李照不知斤為鄭衛今觀此銘黃鐘清三字是周時已有清聲蓋十二律錯綜相濟傳之自古非後人私臆所能為亦如五音之變宮變徵杜氏謂自殷以前但有五音周加文武二音謂之七聲是也太和者樂主於和則舉全樂而言之

周應鐘

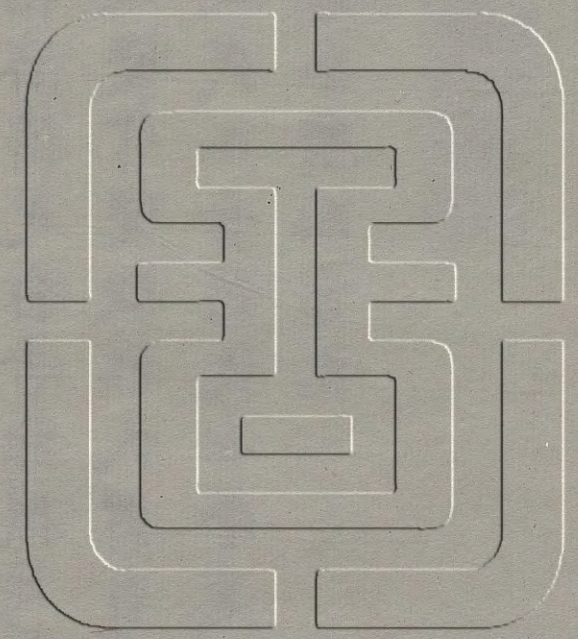
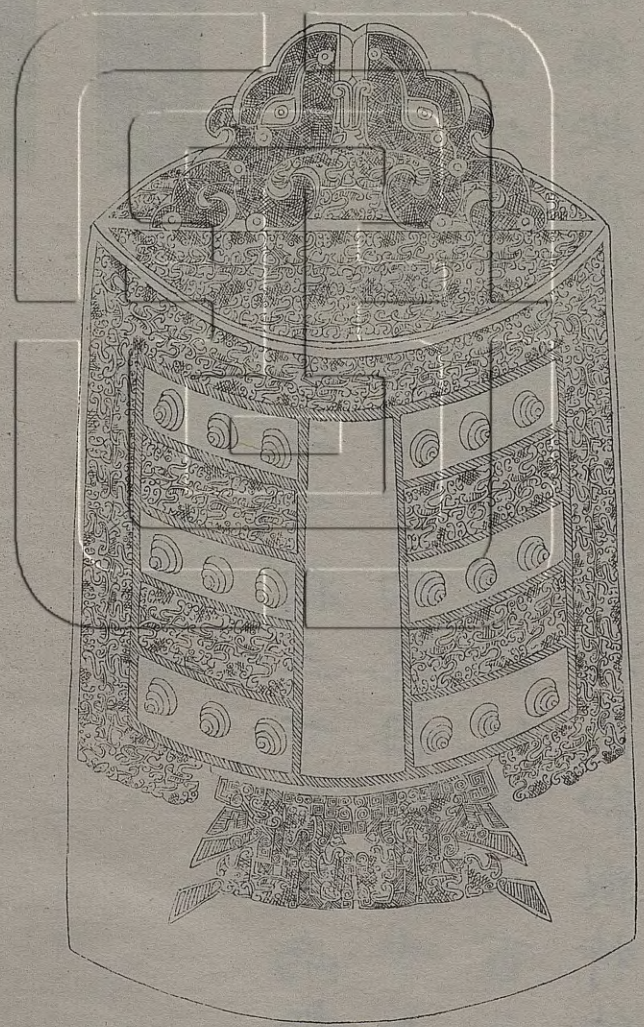



應鐘

大和

應鐘

大和

右高六寸九分鈕高二寸濶三寸九分兩舞相距五寸三分橫四寸四分兩銑相距五寸六分橫四寸四分枚三十六各長二分重二百三兩銘曰應鐘按應鐘十月律也稱大和與特鐘同

周寶鐘



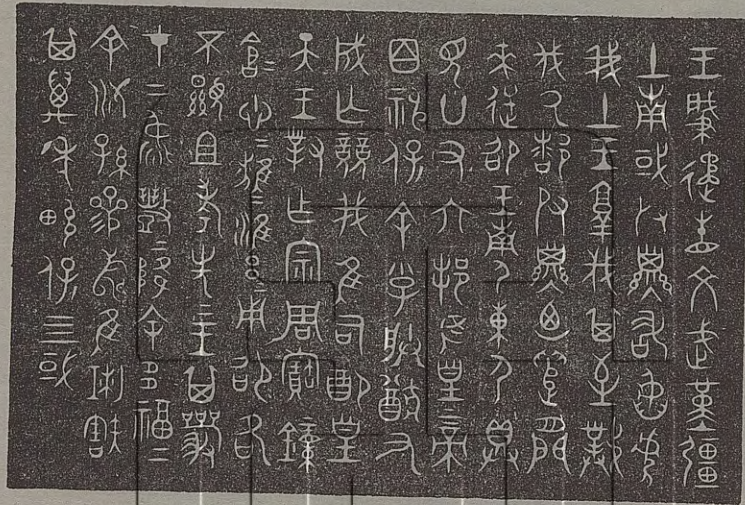

王肇遣名文武董疆  
 土南國收孽敢陷虐  
 我土王辜我其至○  
 伐乃都收孽廼遣○  
 來徙邵王南節東節具  
 見公有大邦惟皇上帝  
 罔神保余小子朕猷有  
 成作競我惟司配皇  
 天王對作宗周寶鐘  
 ○○心○ ○雖用昭格  
 丕顯祖考先王其儼  
 在上○豐降余多福  
 余洎孫參壽惟○珣  
 其萬年峻保四國

右高一尺三寸四分角長七寸一分徑二寸五分有旋兩舞相距九寸四分橫七寸五分兩銑相距一尺一寸橫八寸二分枚三十六各長一寸一分重九百六十兩銘詞幾不可句讀詩稱滔滔江漢南國之紀又禮記武始而北出再成而滅商三成而南四成而南國是疆銘曰南國應是周初時語按周禮地官掌節掌守邦節而辨其用以輔王命凡通達於天下者必有節以傳輔之銘曰南節東節而前稱肇遣名文武後云廼遣云來徙應是使命所達耳又魯頌三壽

白青石監  
 鐘

作朋鄭氏謂三卿也銘曰余洎孫三壽義同曰  
 惟皇上帝曰朕猷有成曰配皇天曰祖考先王  
 意其時功成作樂是鐘蓋大祀所縣非宴饗之  
 設矣

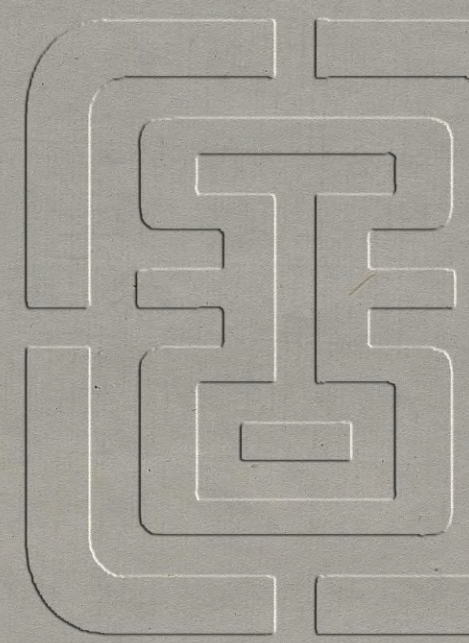

周太公鐘

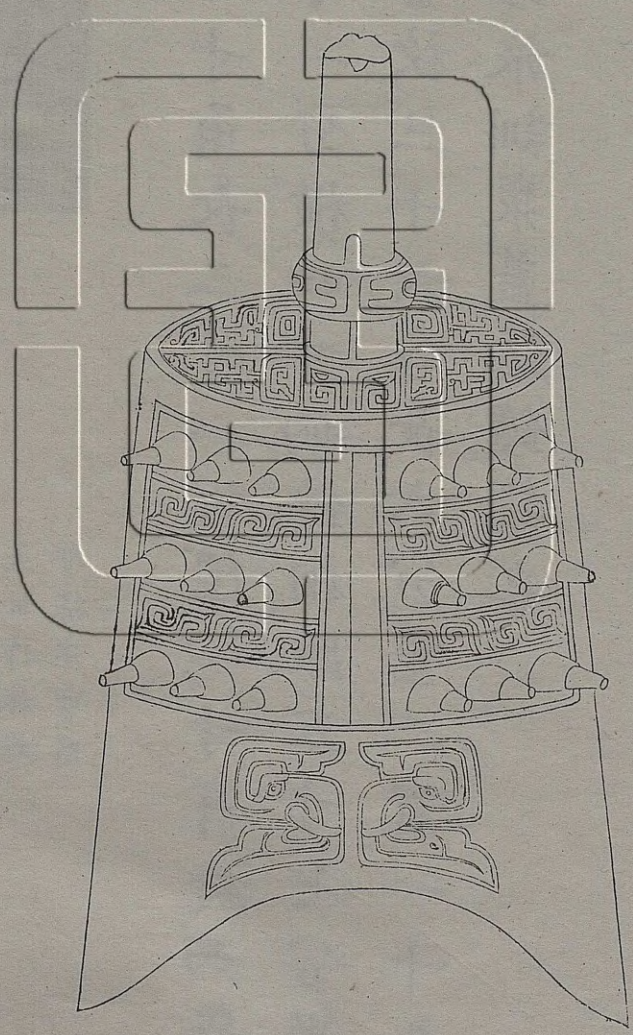

西清古錄

卷三十六

鐘

五

（八）古世所鐘  
子孫永寶用

太公作旅鐘  
子孫永寶用

右高七寸角長三寸八分徑一寸有旋兩舞相距五寸一分橫四寸兩銑相距五寸七分橫四寸二分枚三十六各長六分重二百一十九兩銘旅鐘旅訓衆蓋編鐘類也

周 誥 鐘

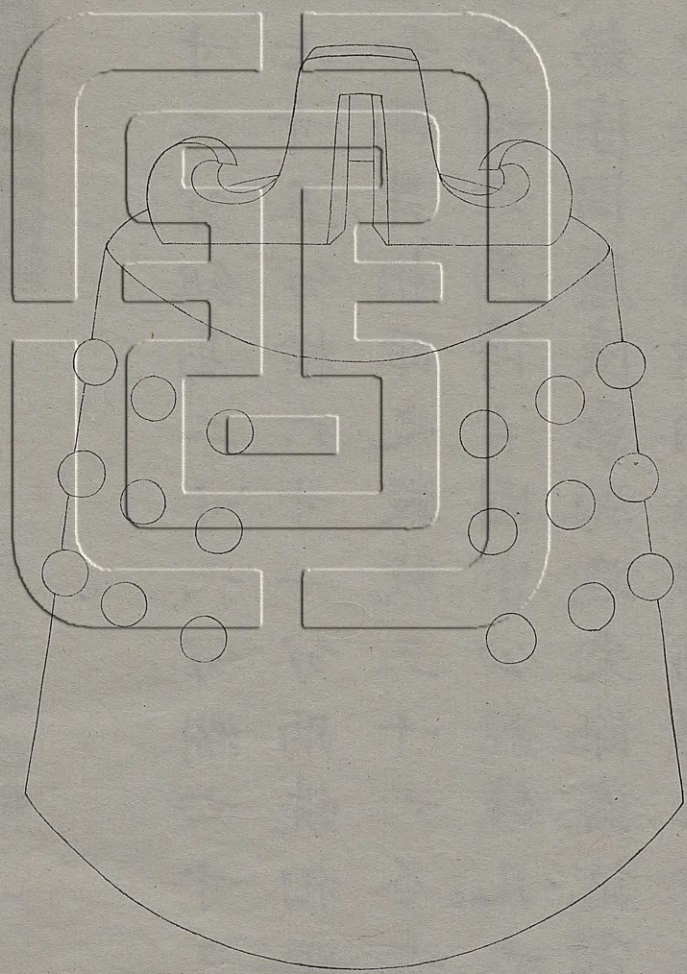

宋公成之 元工 子王 之 金 止

宋公成之 醜鐘

右高九寸二分鈕高二寸六分濶六寸三分兩  
 舞相距七寸五分橫六寸一分兩銑相距八寸  
 五分橫如兩舞相距之數枚三十六各長五分  
 重六百六十六兩博古圖宋公醜鐘凡六形制  
 各異而銘字同廬陵羅泌路史餘論記宋崇寧  
 三年甲申之歲得諸南都崇福禪窟者是也宋  
 公名成者二名固成者一不能實指為何公而  
 泌獨言平公成未知何據博古圖謂六醜為黃  
 帝樂攷樂緯叶圖徵淮南鴻烈解及班志皆言  
 之醜與莖同周禮大司樂注作五莖言能為五  
 行之道立根莖也

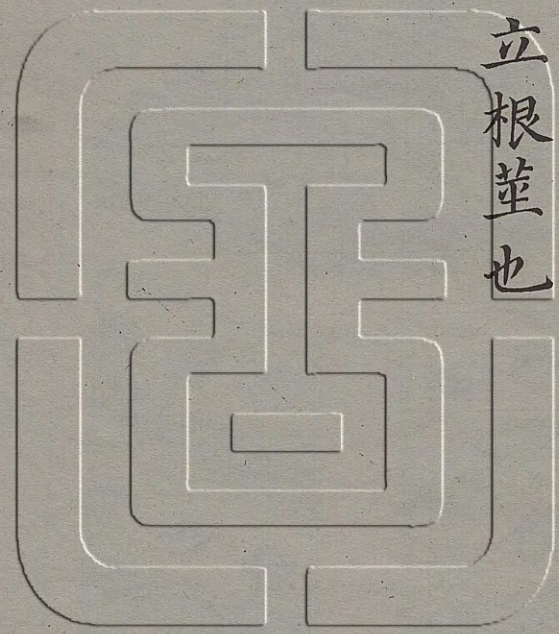

周雙龍鐘

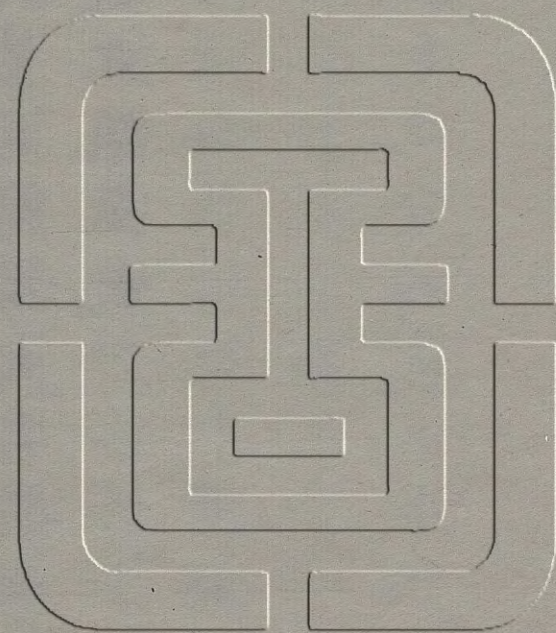
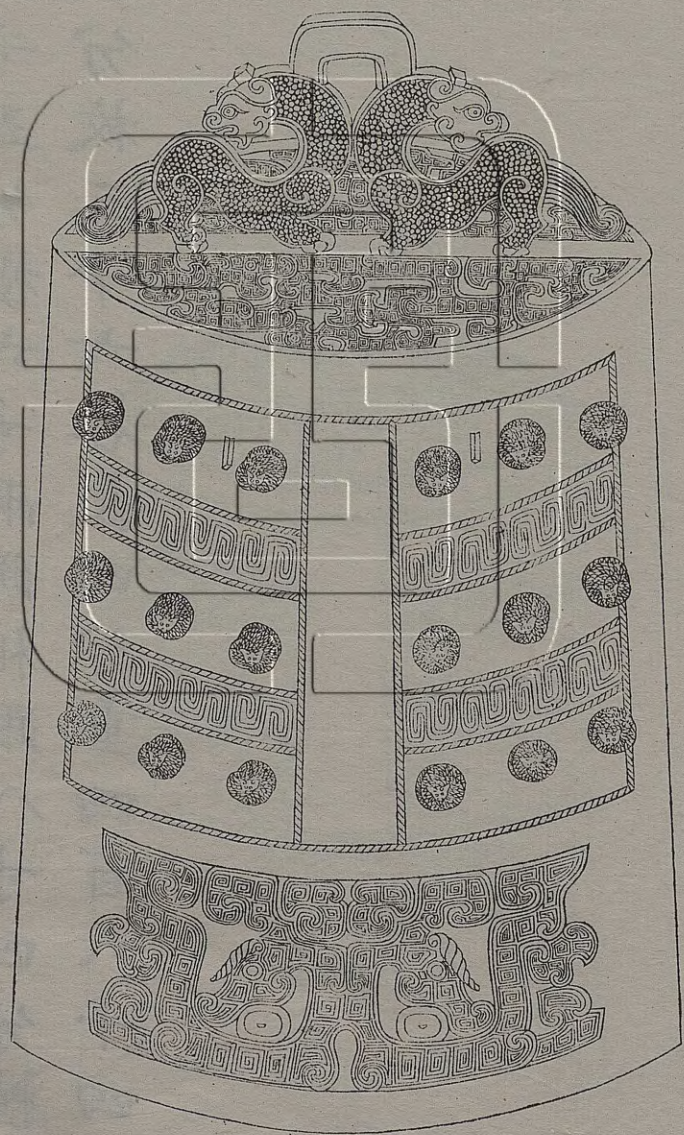

右高八寸九分鈕高三寸一分濶七寸兩舞相距七寸五分橫六寸兩銑相距八寸四分橫六寸八分枚三十六各長四分重四百六十四兩

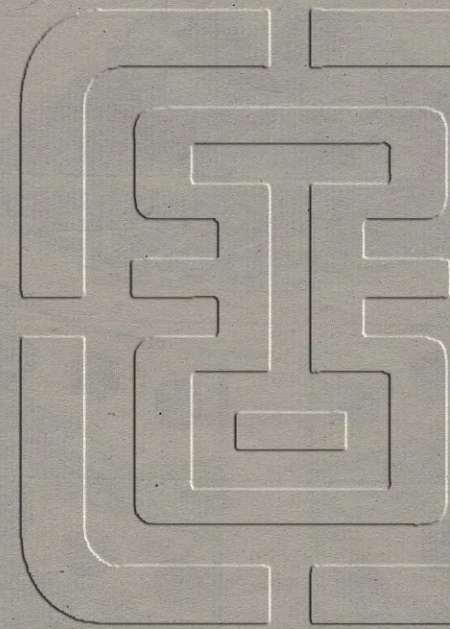

周雙螭鐘

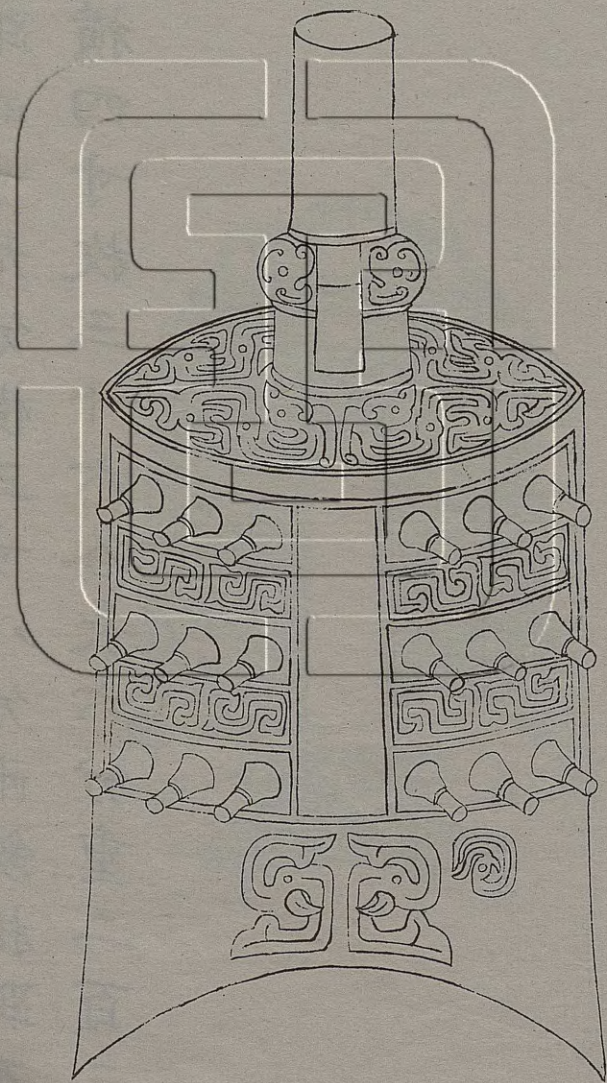

右高六寸四分角長三寸七分濶九分有旋兩  
 舞相距四寸九分橫三寸八分兩銑相距五寸  
 五分橫四寸枚三十六各長六分重二百三兩

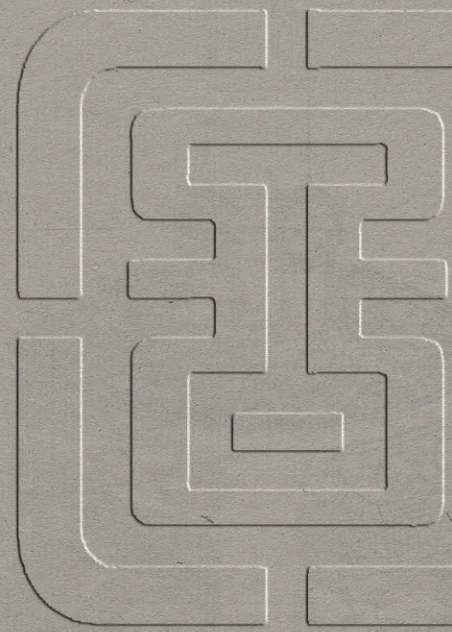

周雙夔鐘

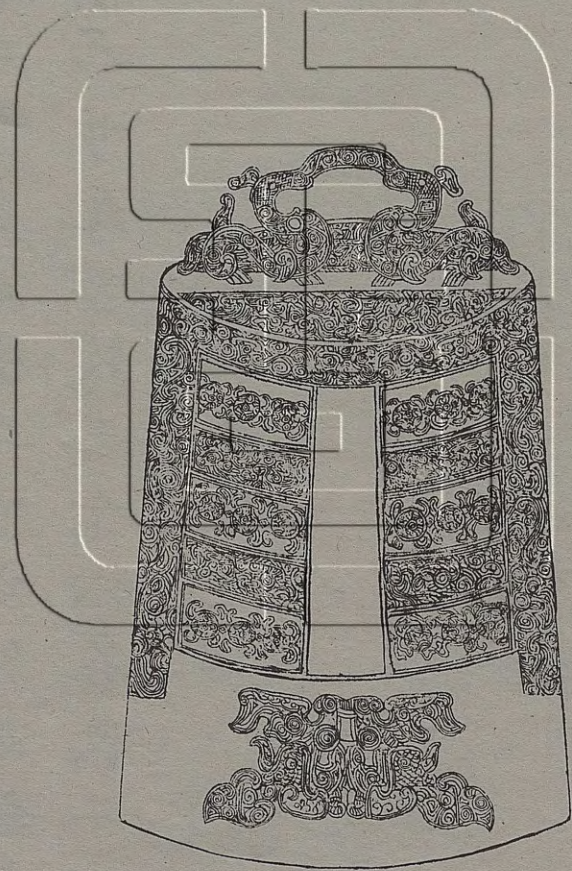



右高四寸四分鈕高一寸四分濶三寸三分兩  
舞相距三寸五分橫二寸六分兩銑相距三寸  
九分橫二寸九分枚三十六各長二分重四十  
六兩

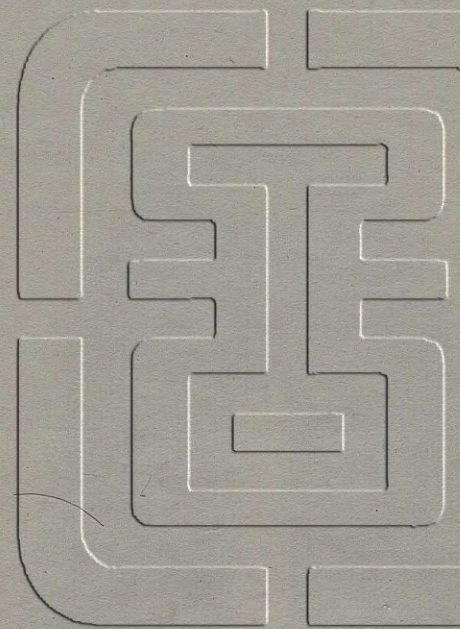

周蟠夔鐘一

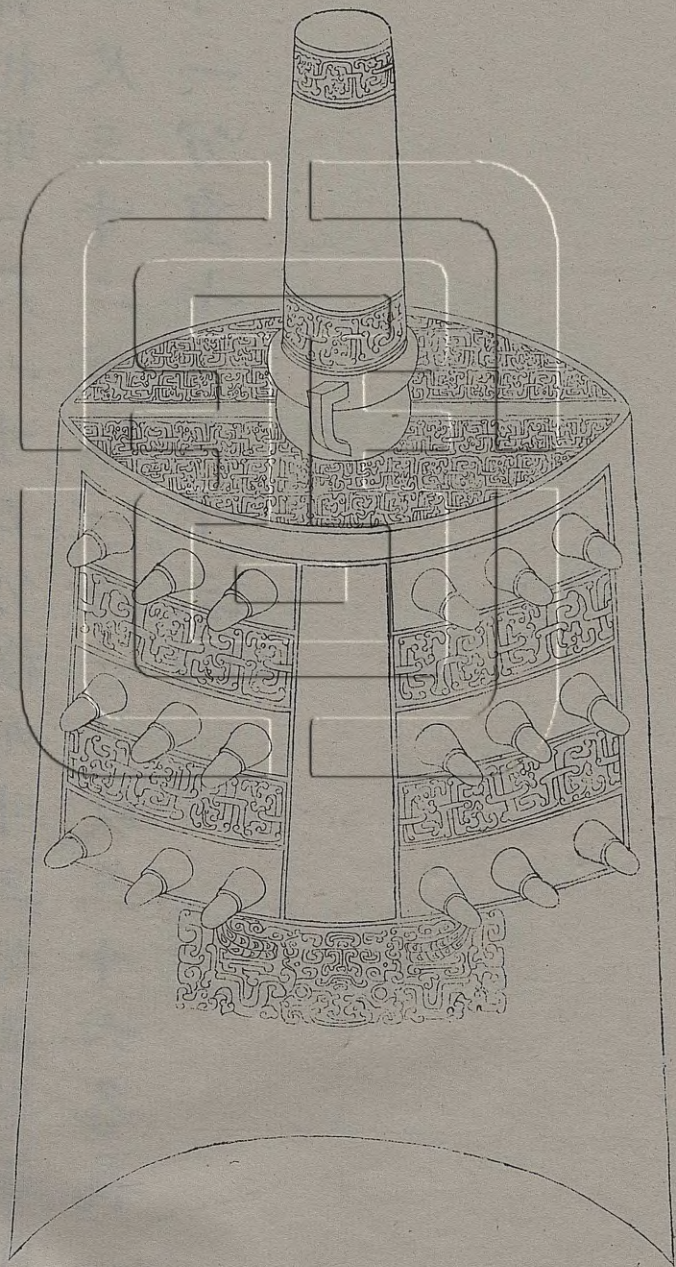

右高一尺六寸甬長九寸五分徑二寸有旋兩  
 舞相距一尺一寸五分橫九寸三分兩銑相距  
 一尺三寸二分橫一尺一寸枚三十六各長一  
 寸一分重七百六十三兩

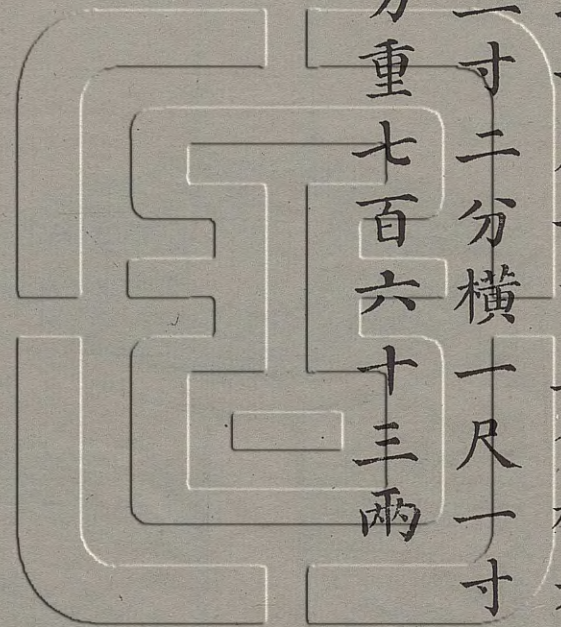

周蟠夔鐘二

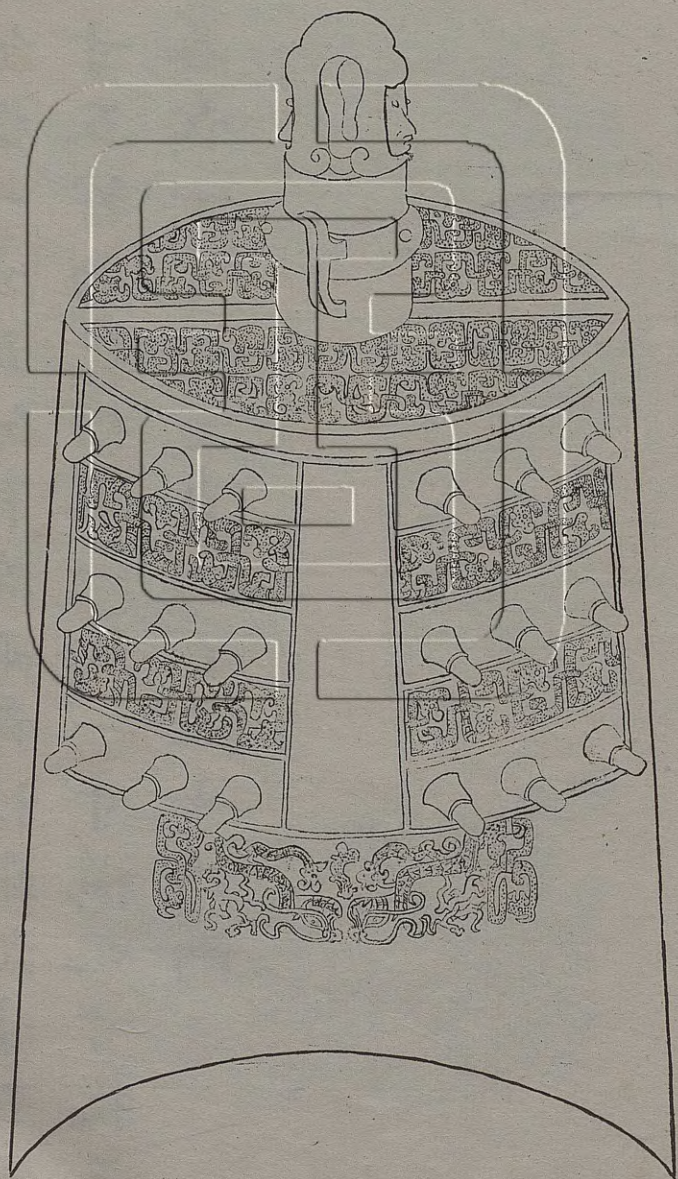

右高一尺三寸五分角微方長五寸八分縱一  
寸八分橫一寸五分有旋兩舞相距九寸五分  
橫七寸五分兩銑相距一尺一寸橫九寸枚三  
十六各長一寸一分重四百五十四兩

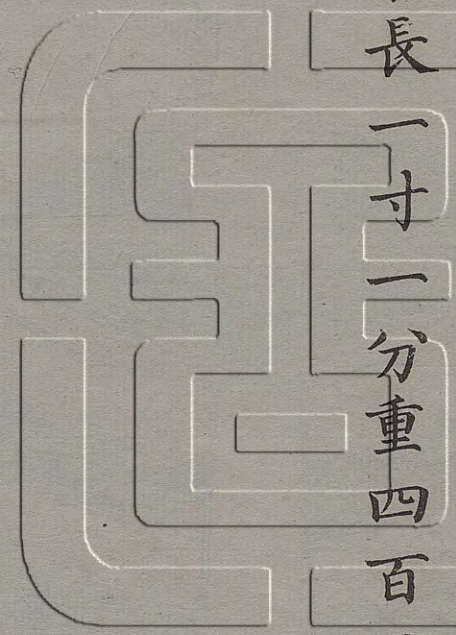

周蟠夔鐘三

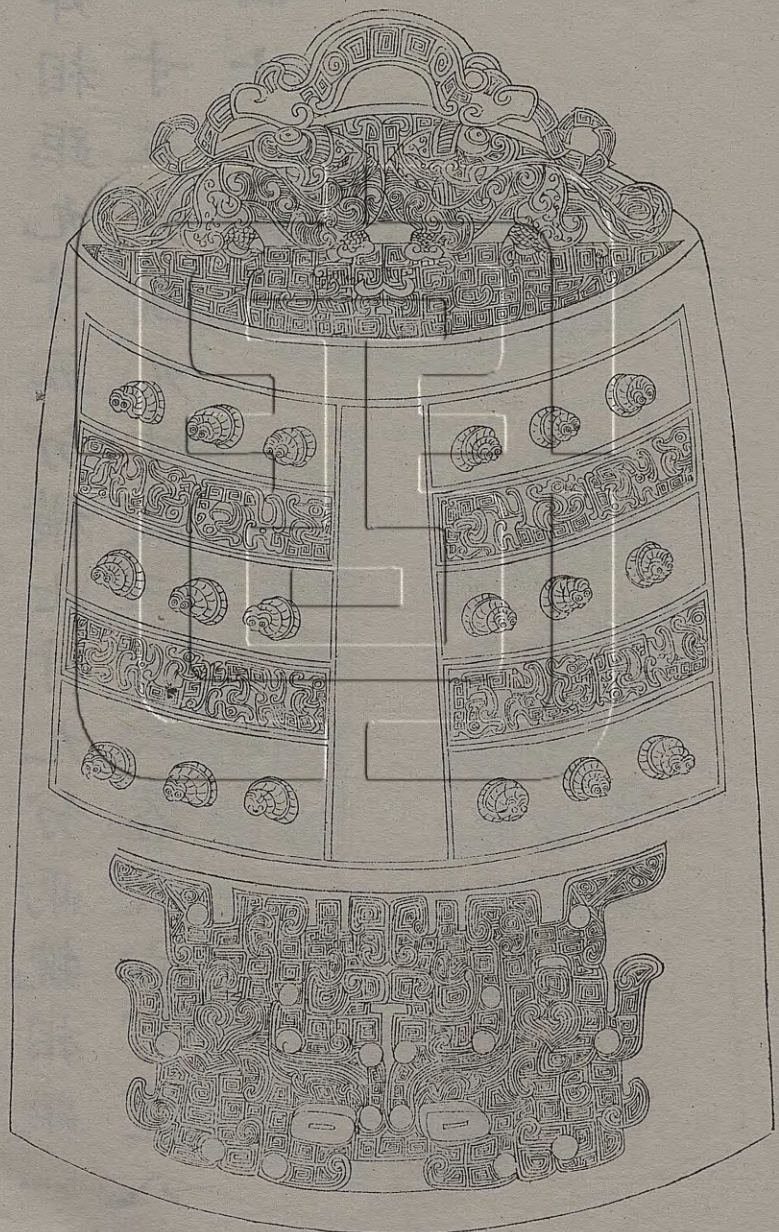

右高一尺二寸六分鈕高四寸濶九寸一分兩  
 舞相距九寸五分橫七寸九分兩銑相距一尺  
 一寸五分橫九寸枚三十六各長六分重八百  
 四十三兩

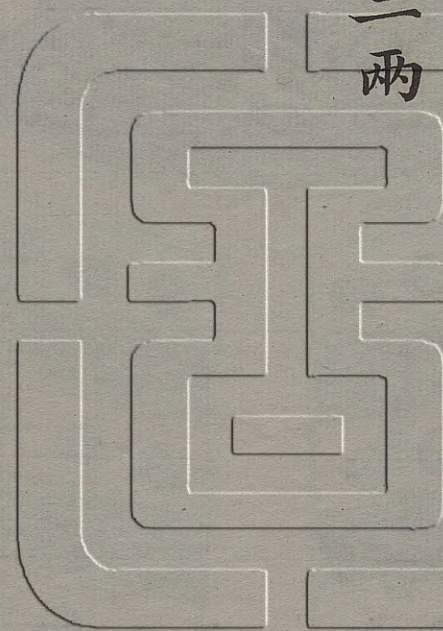

周蟠夔鐘四

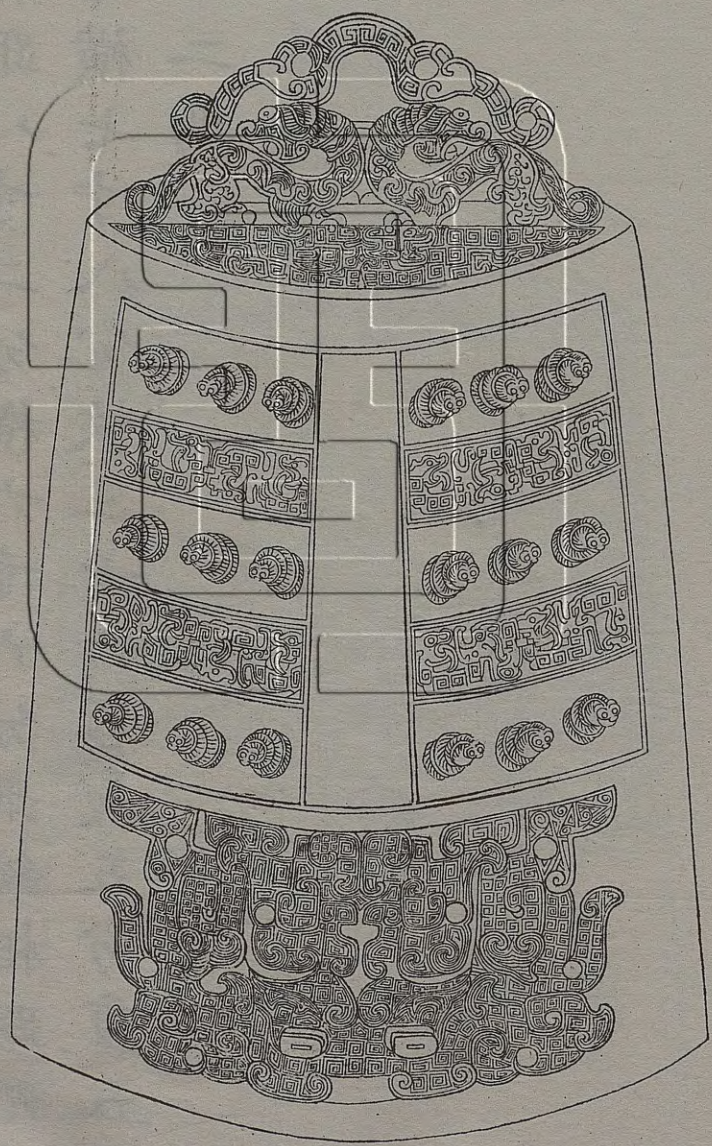

右高一尺九分鈕高三寸一分濶七寸三分兩  
 舞相距八寸二分橫六寸六分兩銑相距九寸  
 七分橫七寸八分枚三十六各長五分重五百  
 九十二兩

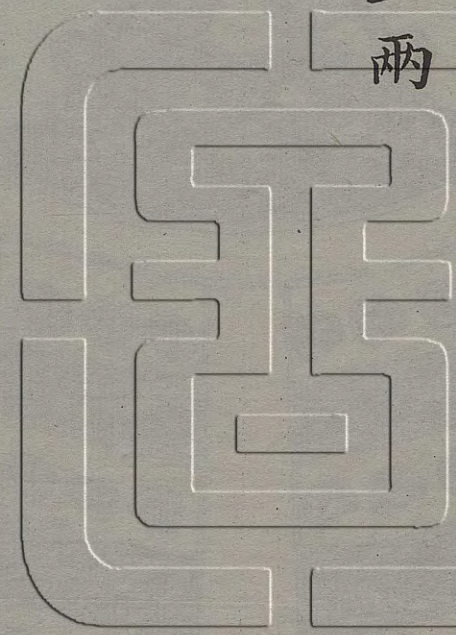

周蟠夔鐘五



右高一尺六分角長四寸八分徑一寸五分有  
 旋兩舞相距七寸六分橫五寸六分兩銑相距  
 八寸九分橫六寸四分枚三十六各長八分重  
 五百五十兩

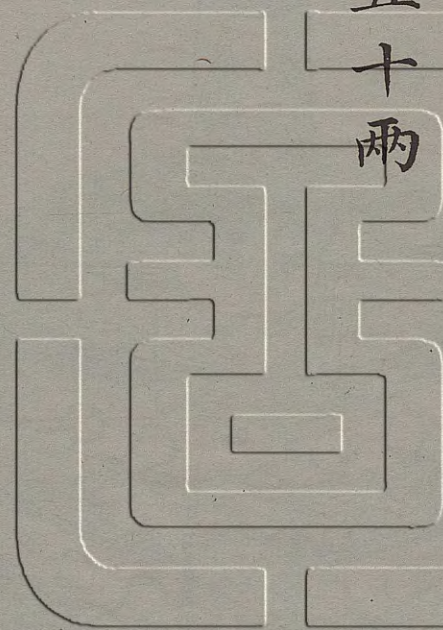

周蟠夔鐘六

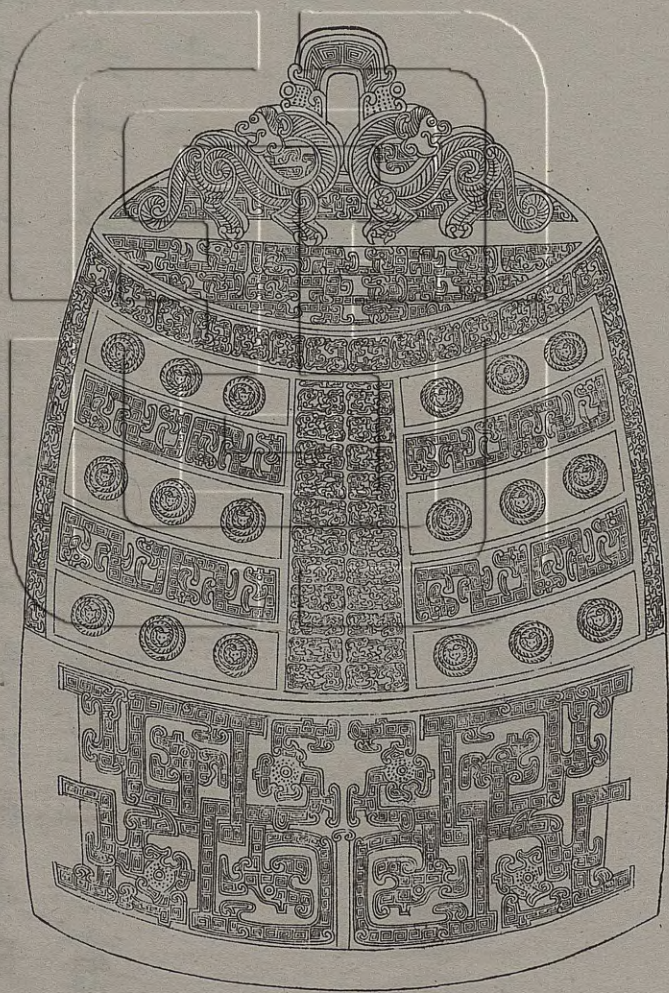

右高九寸七分鈕高二寸八分濶五寸四分兩  
 舞相距七寸二分橫五寸五分兩銑相距八寸  
 五分橫六寸五分枚三十六各長三分有半重  
 三百八十一兩

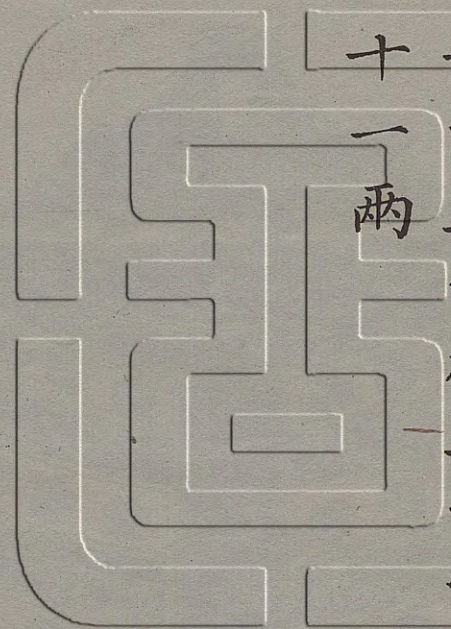

周蟠夔鐘七

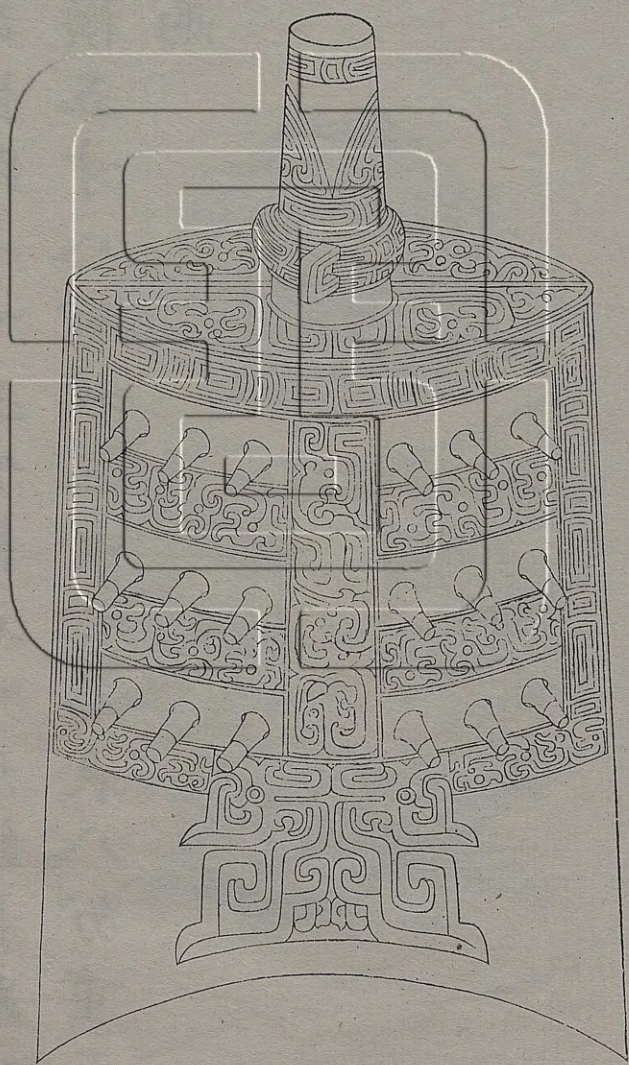

右高九寸七分角長四寸九分徑一寸五分有  
 旋兩舞相距七寸三分橫五寸兩銑相距八寸  
 四分橫五寸八分枚三十六各長八分重五百  
 五十兩



周蟠夔鐘八

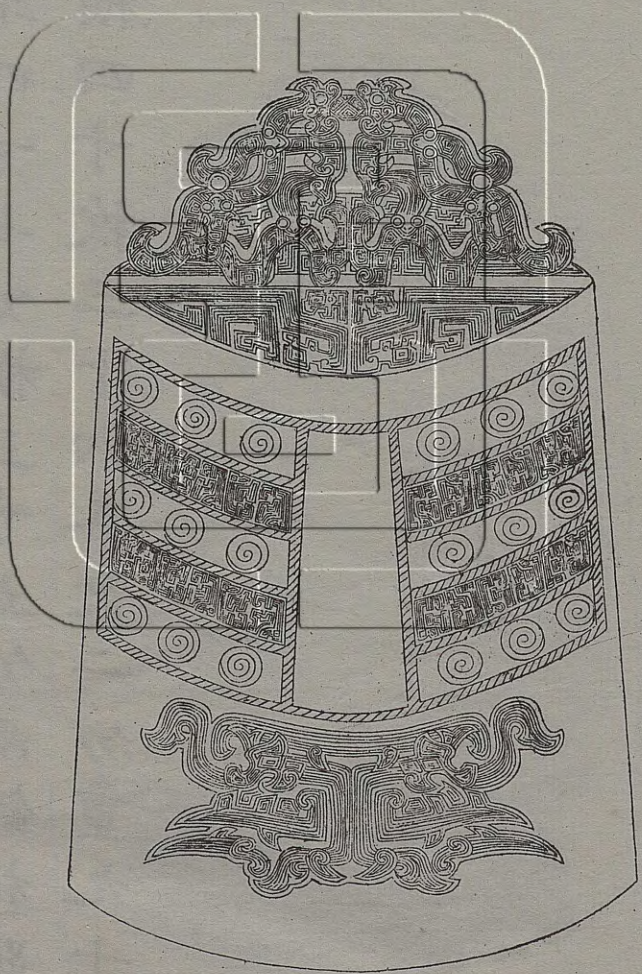



右高六寸五分鈕高二寸九分濶四寸八分兩  
舞相距四寸七分橫三寸五分兩銑相距五寸  
三分橫四寸枚三十六各長二分重九十九兩

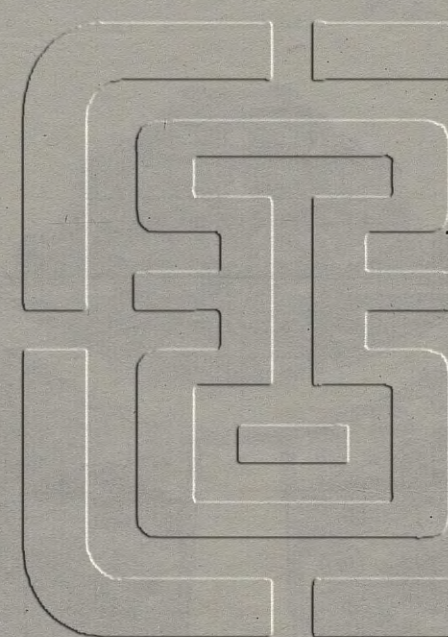

周蟠夔鐘九

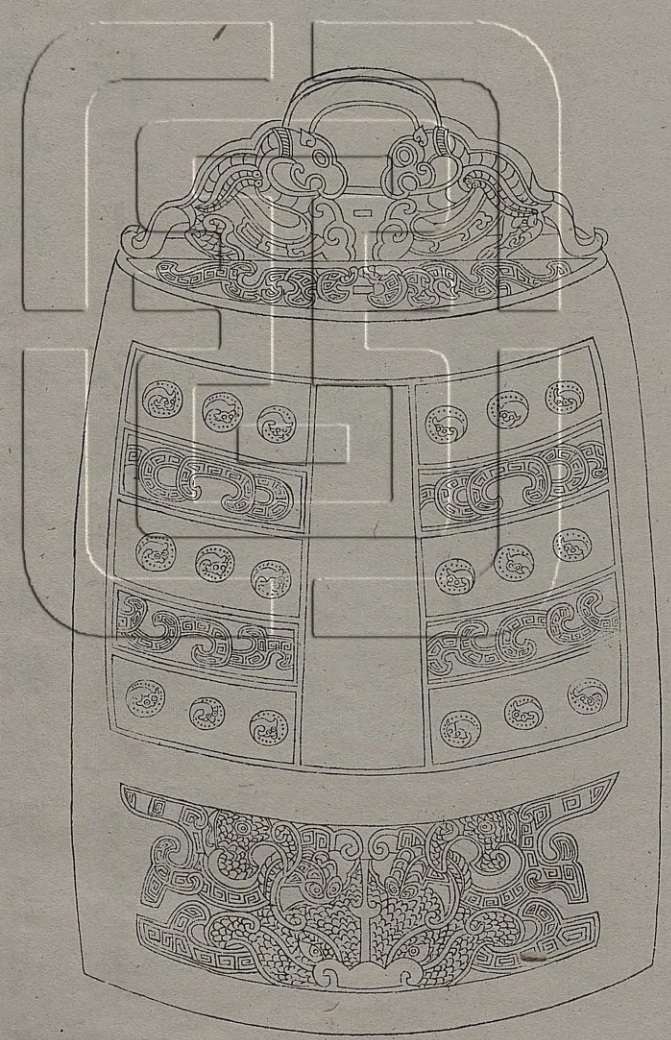

右高六寸鈕高一寸八分濶三寸八分兩舞相距四寸五分橫三寸五分兩銑相距五寸二分橫四寸枚三十六各長三分重九十六兩

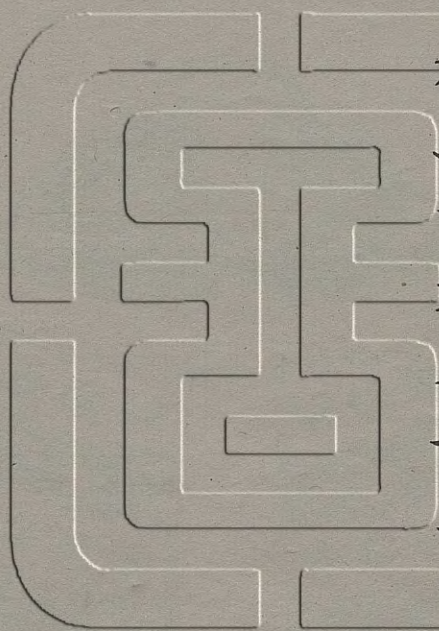

周蟠螭鐘一

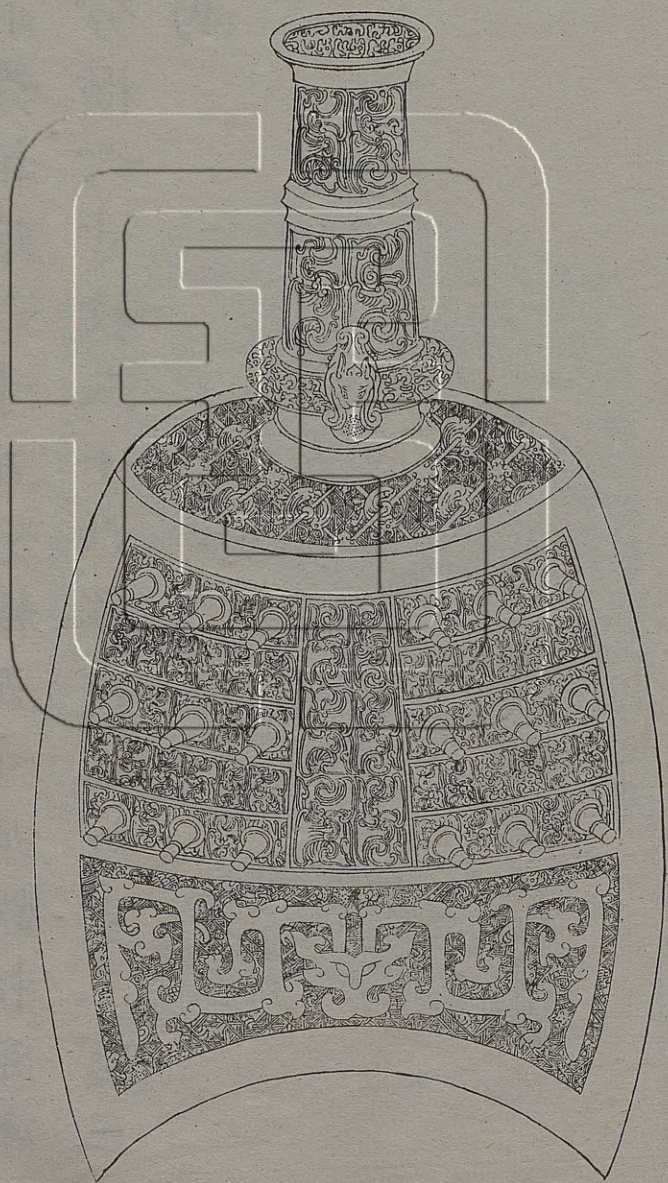

右高九寸三分角長六寸三分徑一寸八分有  
 旋兩舞相距六寸五分橫五寸兩銑相距七寸  
 六分橫六寸枚三十六各長五分重三百三十  
 九兩

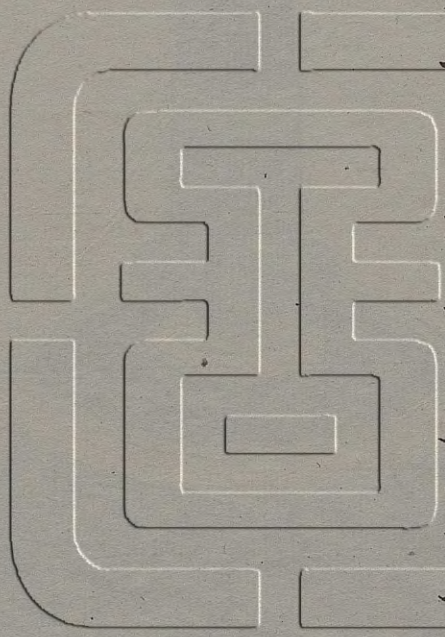

周蟠螭鐘二

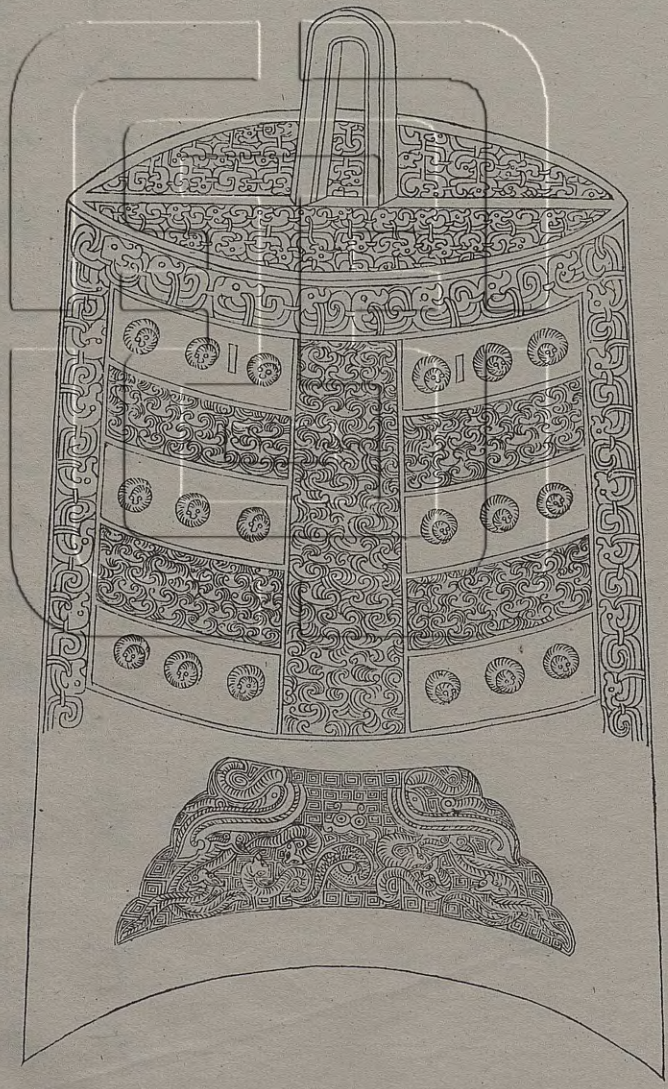

右高七寸一分鈕高二寸濶一寸二分兩舞相距四寸七分橫三寸三分兩銑相距五寸七分橫三寸八分枚三十六各長三分重一百五兩

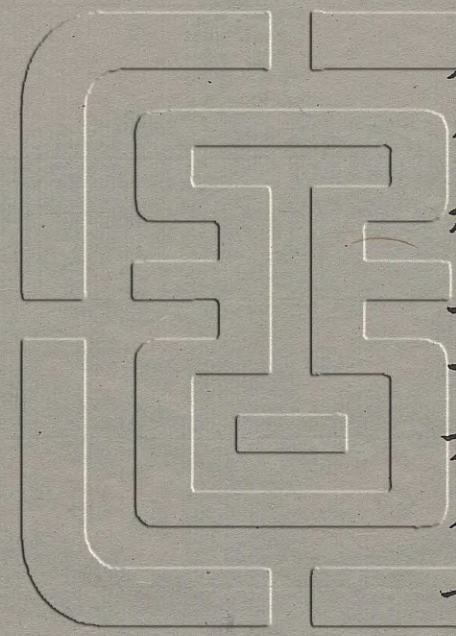

周蟠螭鐘三

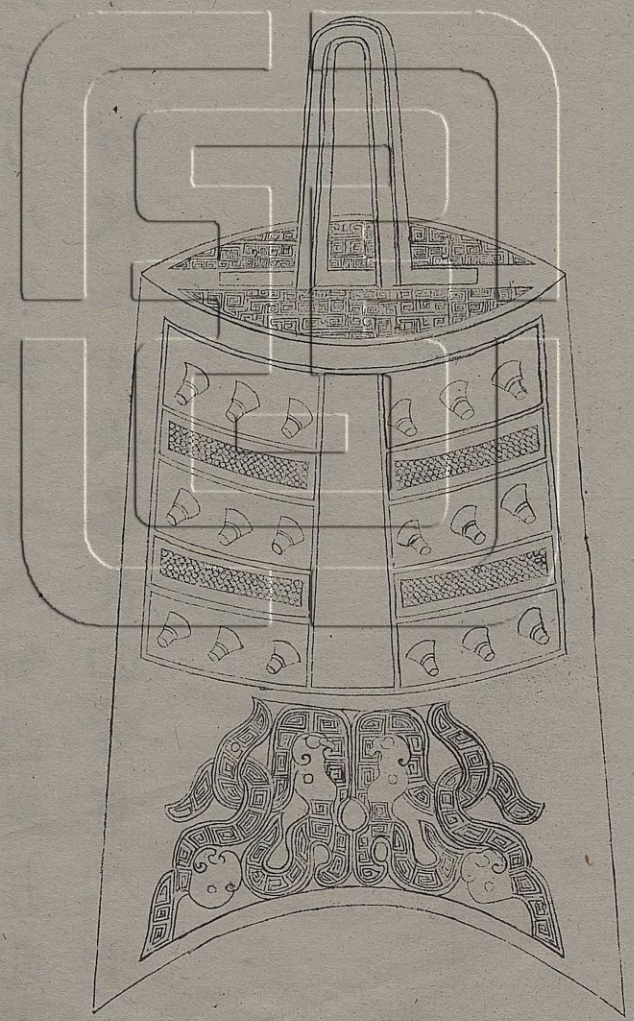

右高六寸四分鈕高二寸六分濶一寸六分兩  
 舞相距三寸八分橫二寸八分兩銑相距五寸  
 橫三寸一分枚三十六各長四分重八十三兩

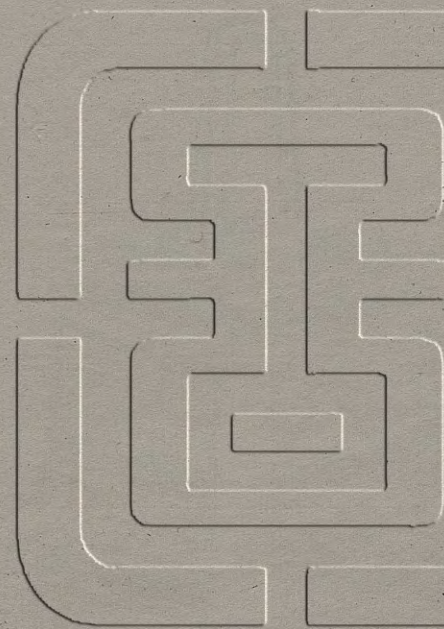

周蟠虺鐘

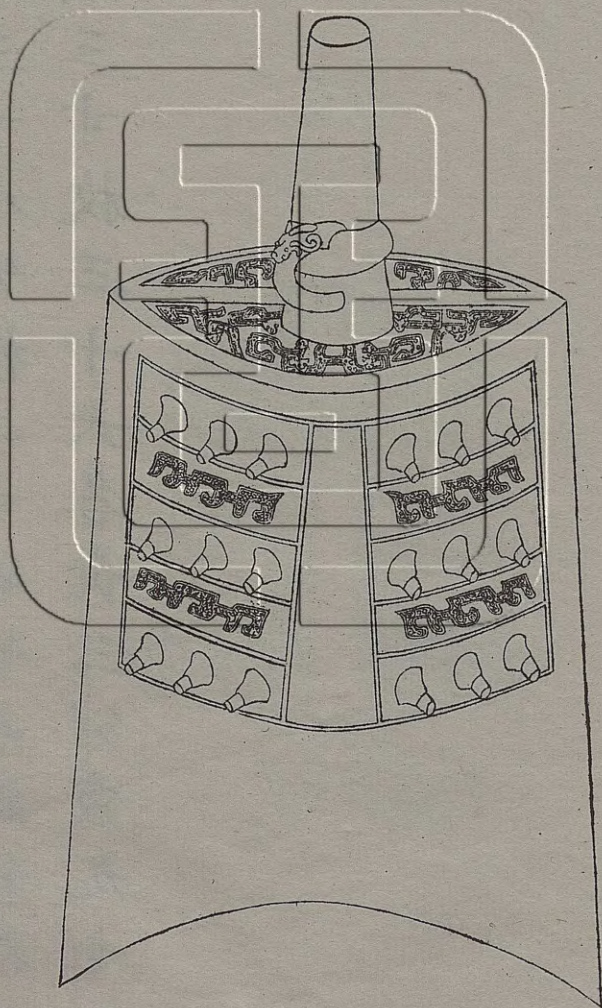

右高五寸四分角長三寸一分徑六分有旋兩  
 舞相距三寸八分橫二寸四分兩銑相距四寸  
 一分橫三寸枚三十六各長三分重九十三兩

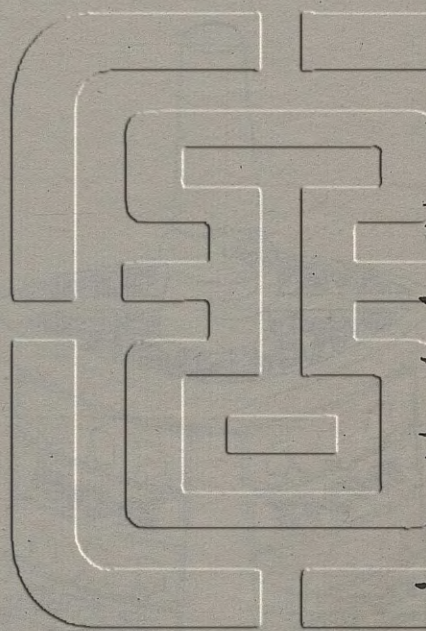

周盤雲鐘一

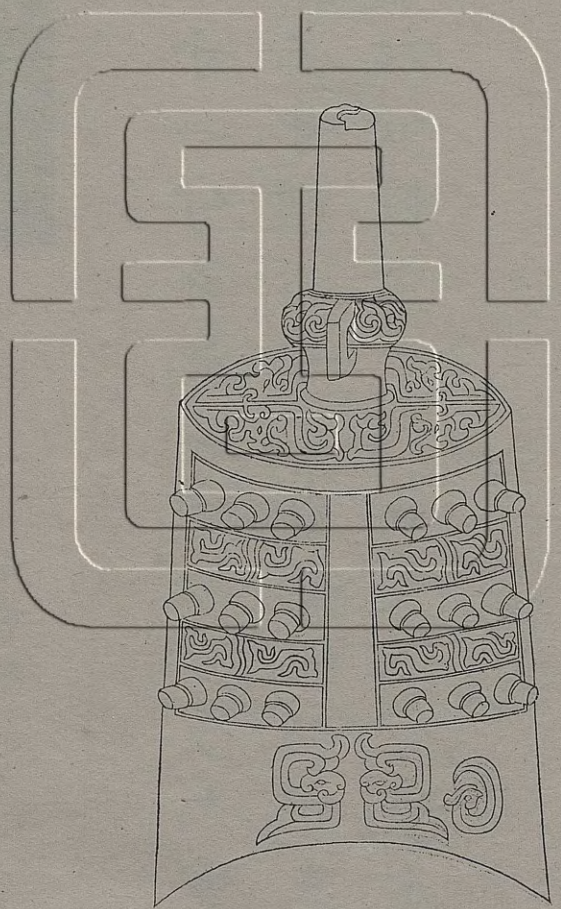

孔 寶 用

永寶用

右高四寸一分角長二寸七分徑六分有旋兩  
舞相距三寸橫二寸二分兩銑相距三寸三分  
橫二寸六分枚三十六各長五分重七十九兩

周盤雲鐘二

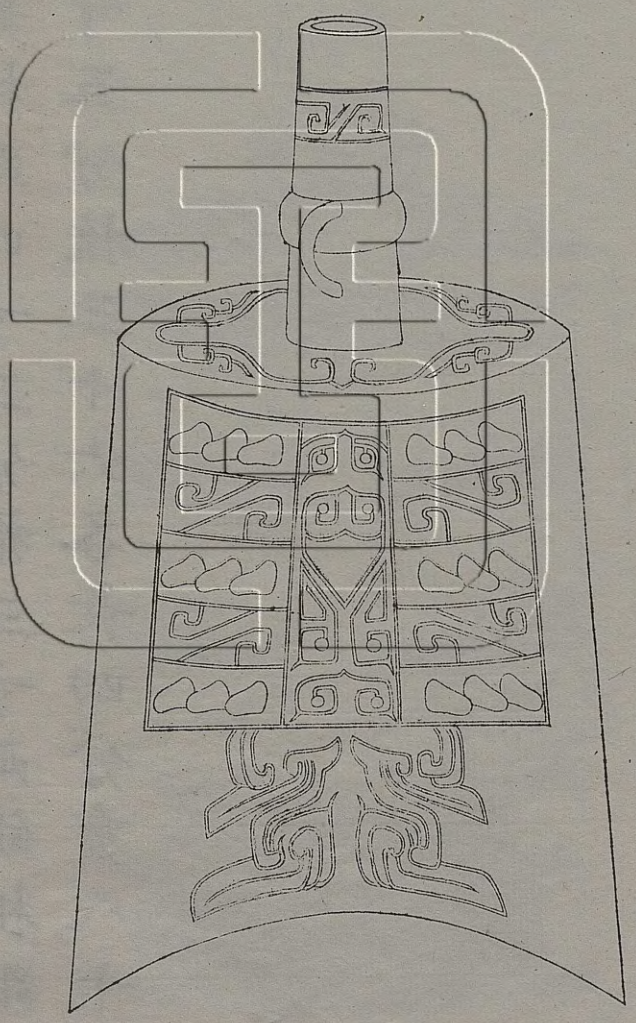

右高六寸六分甬長三寸二分徑一寸一分有  
旋兩舞相距四寸三分橫三寸兩銑相距五寸  
橫三寸五分枚三十六各長四分重八十九兩

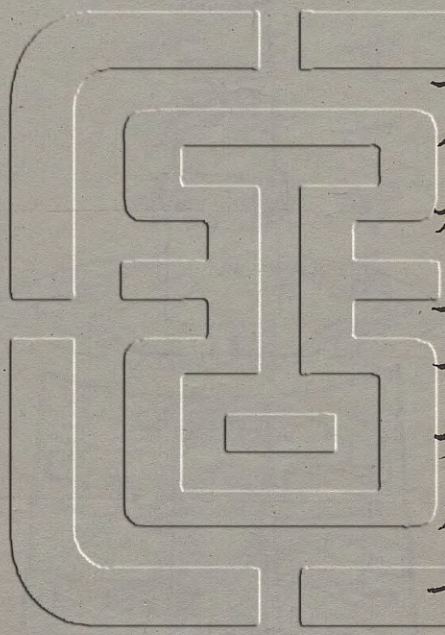

周雷紋鐘

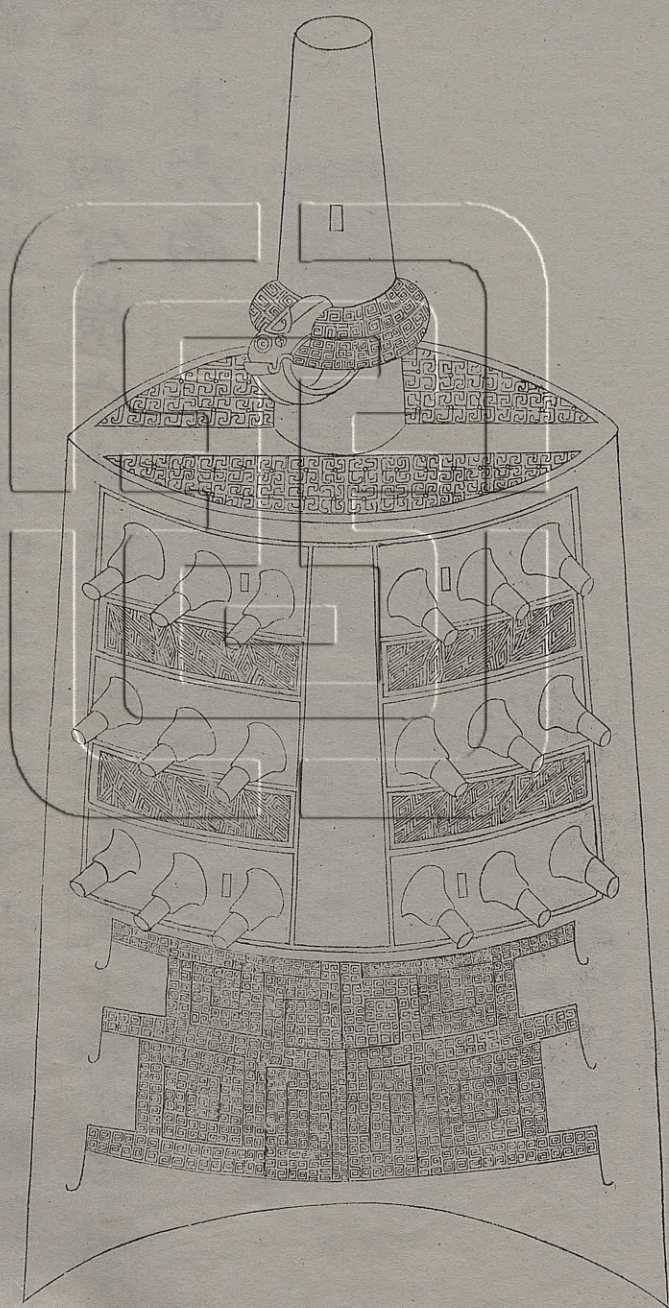



右高一尺五分角長五寸七分徑一寸三分有  
 旋兩舞相距七寸四分橫五寸六分兩銑相距  
 八寸四分橫六寸枚三十六各長七分重三百  
 四十六兩

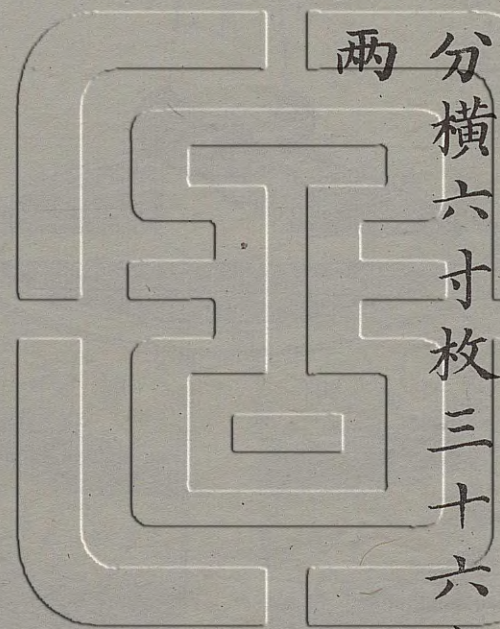

周篆帶鐘



白青下蓋 卷三十六 鐘

右高八寸二分甬長五寸徑一寸五分有旋兩  
 舞相距五寸八分橫四寸五分兩銑相距六寸  
 八分橫五寸三分枚三十六各長二分重二百  
 一十兩

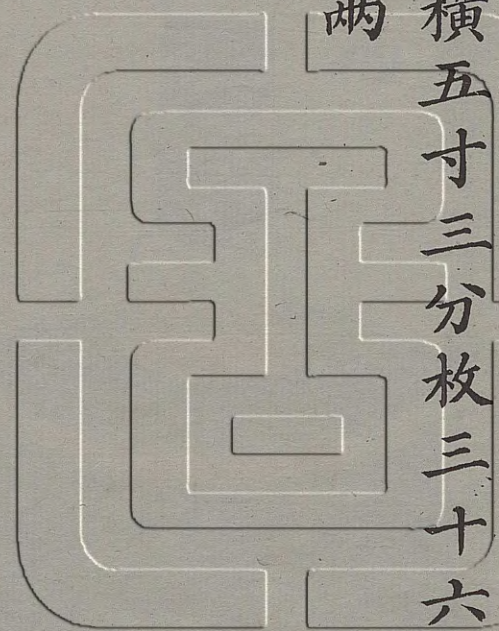

周星帶鐘

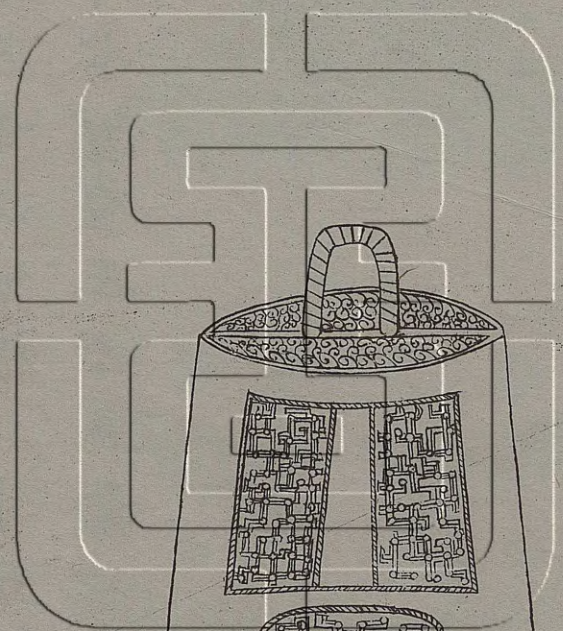
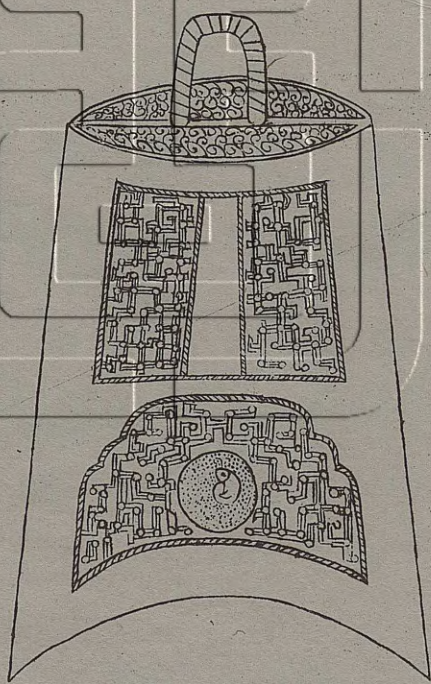

右高五寸七分鈕高一寸一分濶一寸二分兩  
舞相距三寸四分橫二寸五分兩銑相距四寸  
橫二寸七分重三十五兩

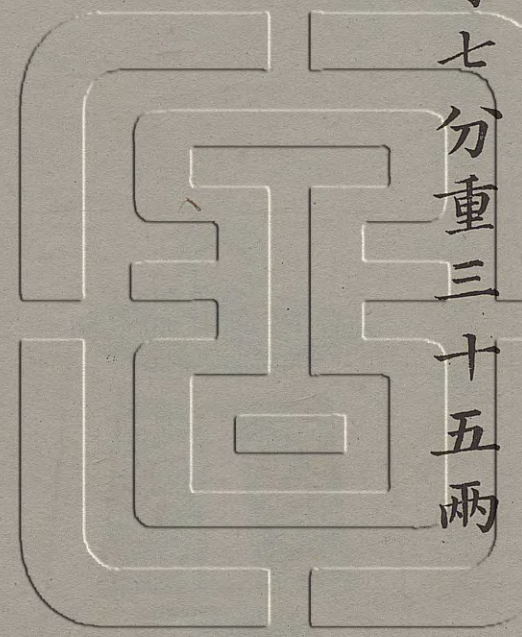

周螭鈕鐘一

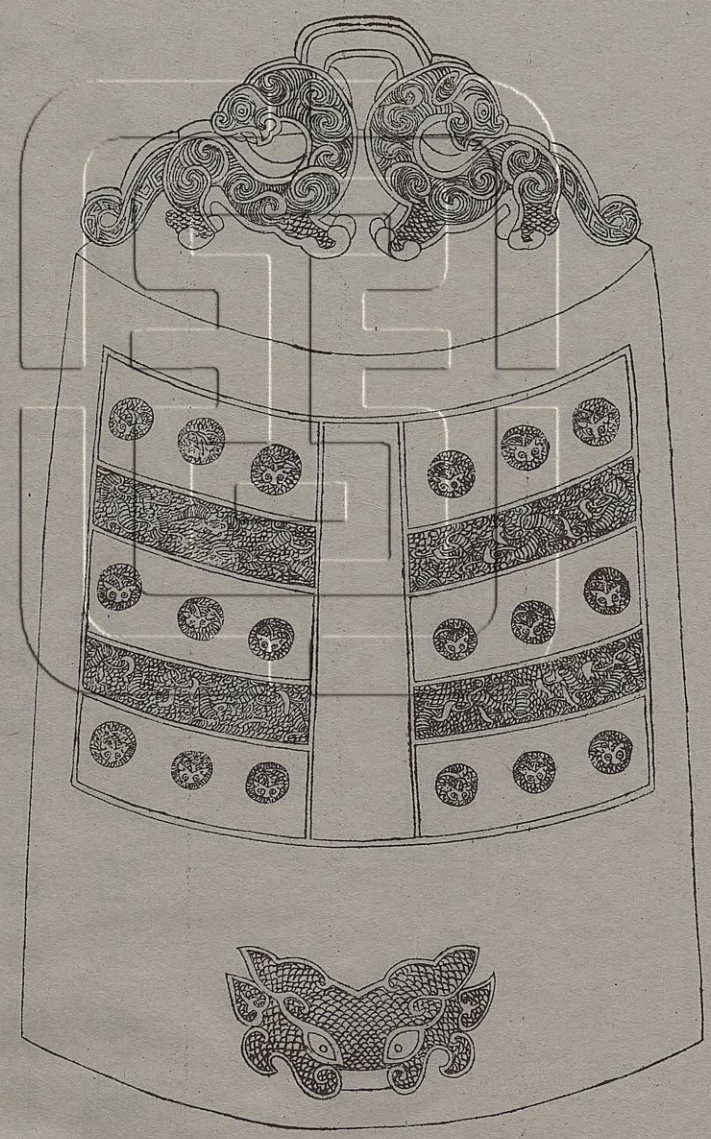

右高一尺六分鈕高二寸九分濶七寸兩舞相距八寸一分橫六寸七分兩銑相距一尺橫七寸七分枚三十六各長六分重四百二十四兩

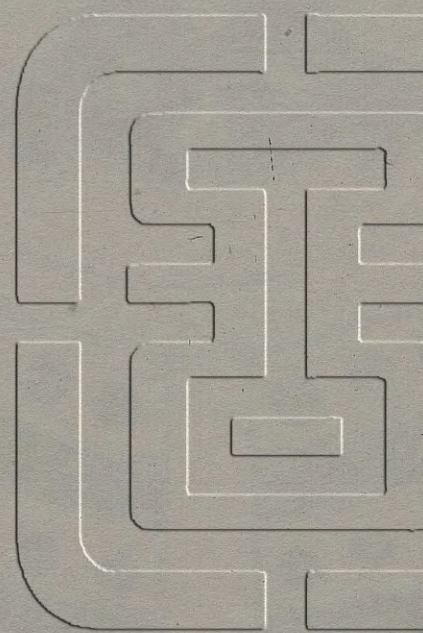

周螭鈕鐘二

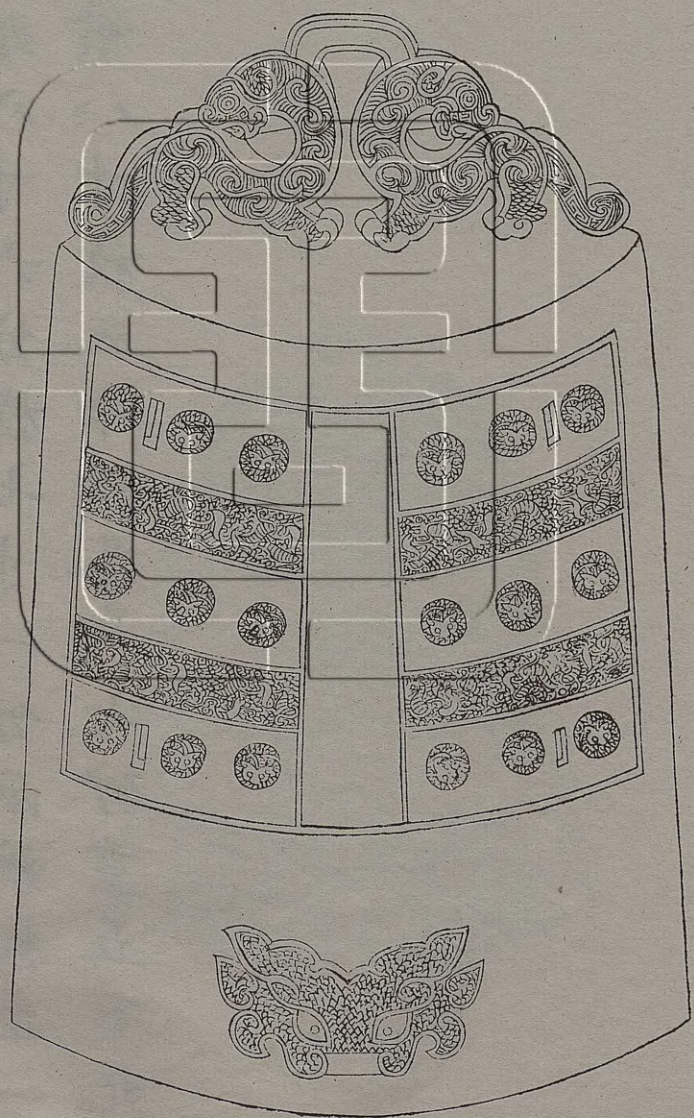

右高一尺一寸二分鈕高三寸四分濶八寸兩  
 舞相距八寸六分橫七寸一分兩銑相距一尺  
 四分橫八寸枚三十六各長七分重五百九十  
 二兩

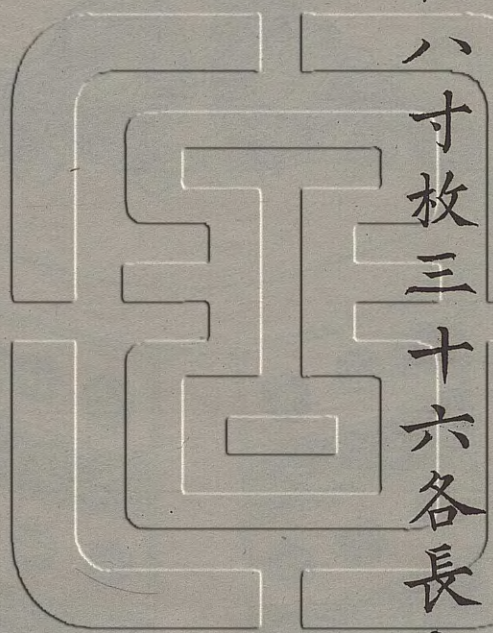

周螭鈕鐘三



右高五寸五分鈕高一寸五分濶三寸一分兩  
舞相距四寸二分橫三寸四分兩銑相距四寸  
七分橫三寸九分枚三十六各長二分重八十  
七兩



周環鈕鐘

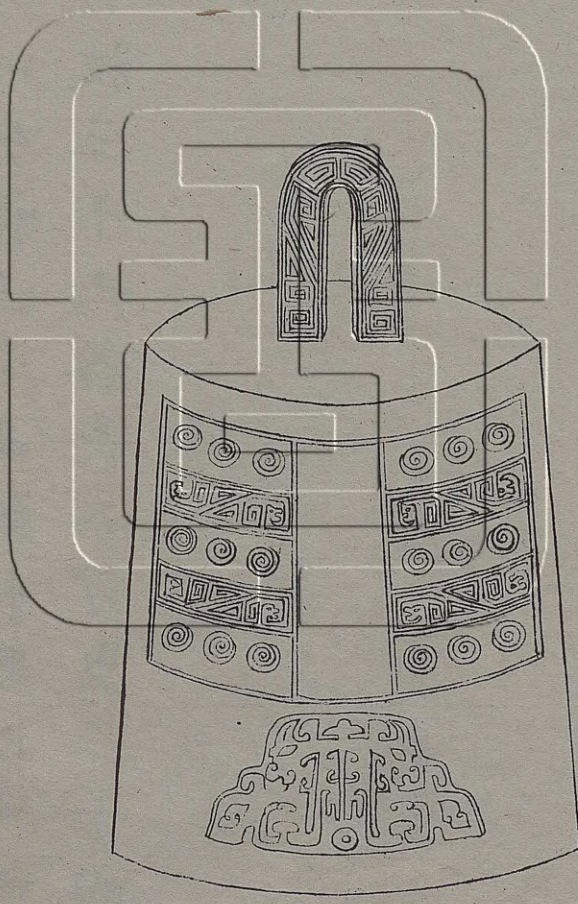

右高五寸鈕高二寸一分濶一寸五分兩舞相距四寸一分橫三寸兩銑相距四寸四分橫三寸五分枚三十六各長二分重三十四兩

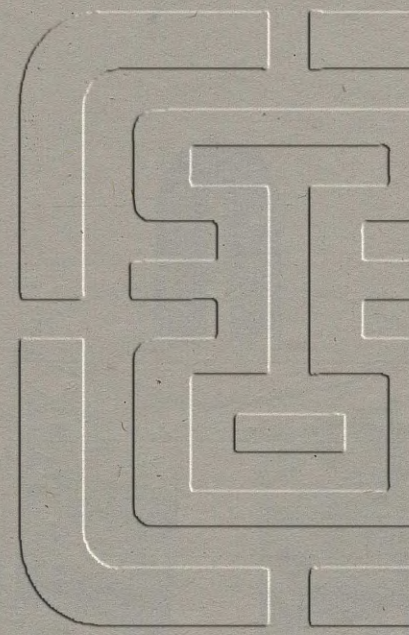

周素鈕鐘

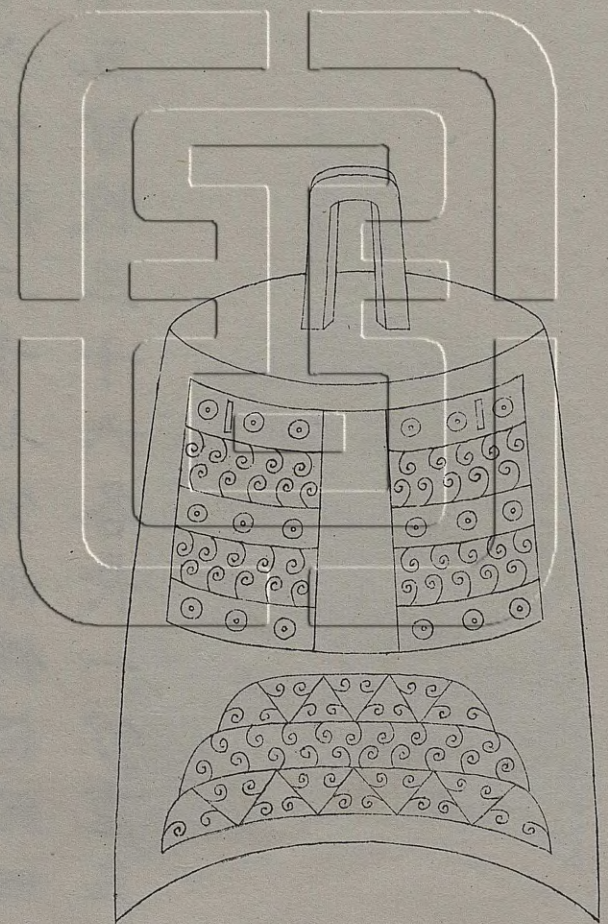

西清古鐘 卷三十六 三十一

右高六寸六分鈕高一寸四分濶一寸兩舞相距三寸六分橫二寸七分兩銑相距四寸六分橫三寸五分枚三十六各長一分重五十五兩

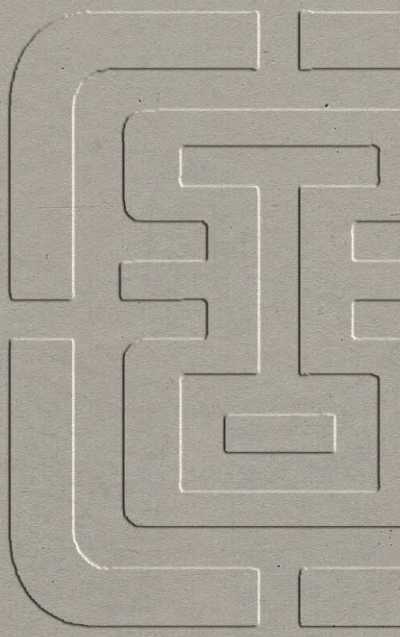

周寶角鐘

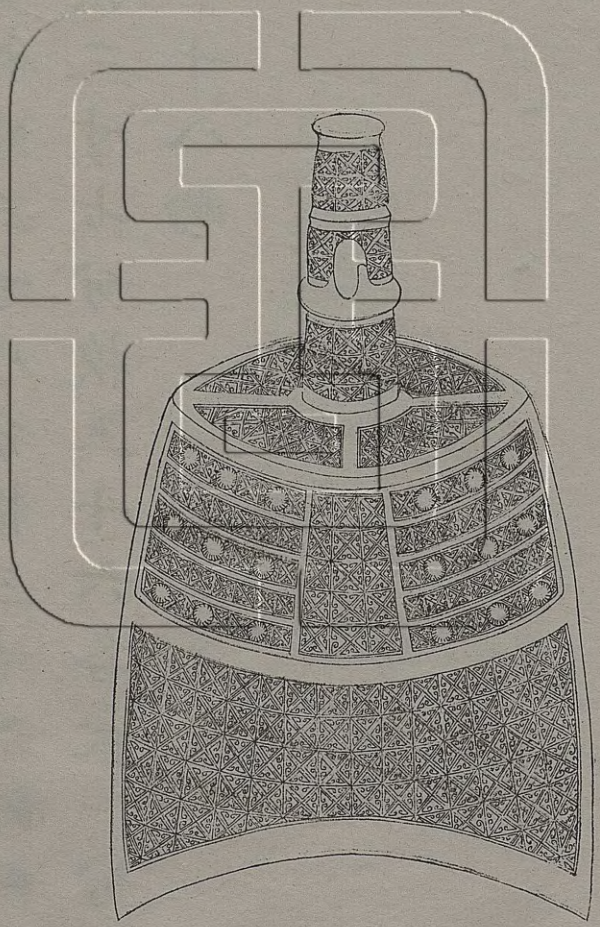

西清古鐘

卷三十六

鐘

三十一



西清古鐘  
卷三十一  
三

右高五寸三分角長三寸七分徑一寸一分有  
旋兩舞相距三寸八分橫三寸兩銑相距四寸  
六分橫三寸七分枚三十六各長一分有半重  
一百一十八兩

周編鐘

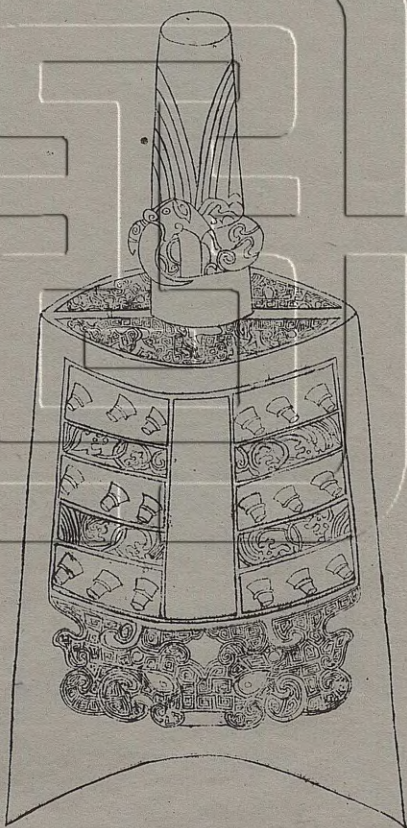

西清古鐘  
卷三十一  
鐘

右高四寸一分角長二寸七分徑六分有旋兩  
 舞相距二寸七分橫二寸兩銑相距三寸一分  
 橫二寸二分枚三十六各長二分重四十八兩

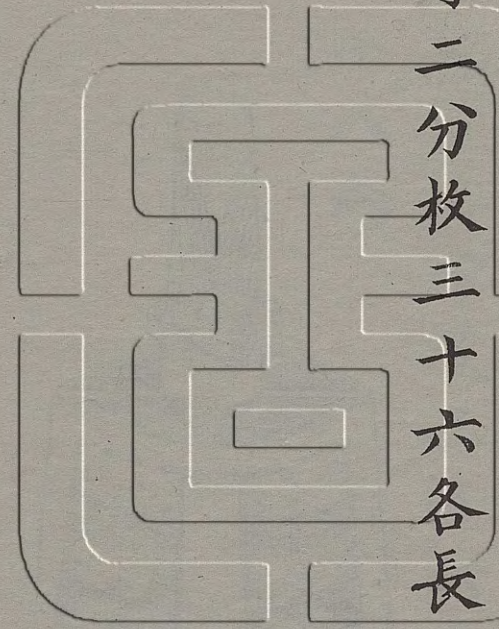

漢角鐘一



孝武西園安世鐘之角



孝武西園安世鐘已中角

右高五寸角長三寸五分徑七分有旋兩舞相距三寸五分橫二寸五分兩銑相距三寸六分橫二寸九分枚三十六各長一分重五十八兩

按漢書房中祠樂高祖唐山夫人所作孝惠二年使樂府令夏侯寬備其簫管更名曰安世樂此銘曰安世是已前稱孝武西園則茂陵也已者編列次第之號中角者意是鐘之律於五音蓋中角前云搖鐘意於搏擊者異然不可攷

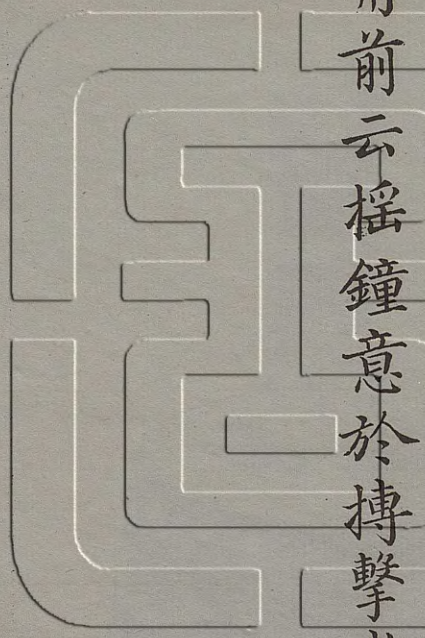

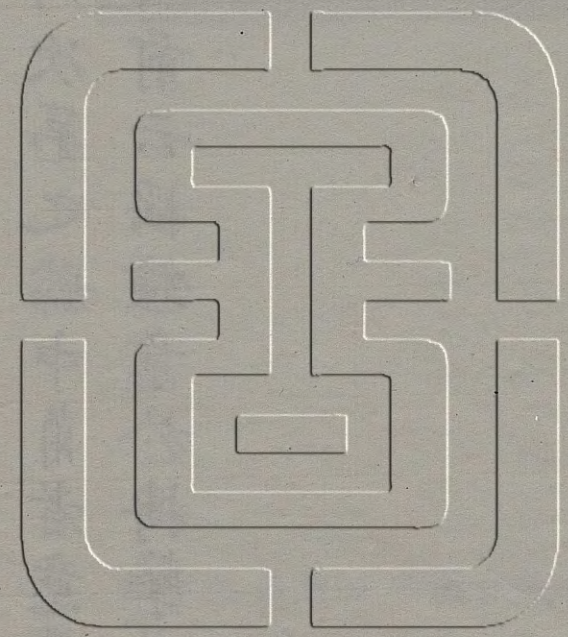

漢角鐘二



四時嘉至坐禪鐘中角

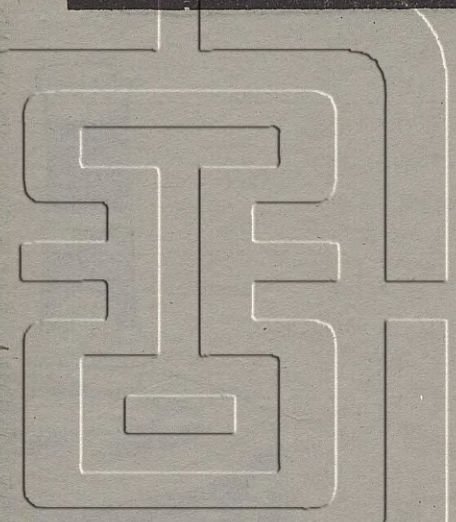

四時嘉至坐禪鐘中角

銅鐘綏和二年文工所造中丞常雷夫欽撰豐至左丞暉合譚直  
銅鐘綏和二年考工宗造守佐常雷夫欽撰豐至左丞暉合譚直

右高五寸二分角長三寸九分徑一寸三分有  
旋兩舞相距三寸六分橫二寸九分兩銑相距  
四寸三分橫三寸八分枚三十六各長二分重  
一百九兩按漢書禮樂志高祖時叔孫通制宗  
廟樂迎神於廟門奏嘉至又文帝始作四時舞  
銘曰四時嘉至此樂舞時所擊也餘文與安世  
搖鐘同後列綏和二年蓋成帝時作者百官表  
少府官屬有考工守令丞掾皆其屬惟嗇夫無  
明文張釋之傳上林有虎圈嗇夫上林亦少府  
屬宗等云云蓋其名耳

西清古鐘  
卷三十一  
鐘

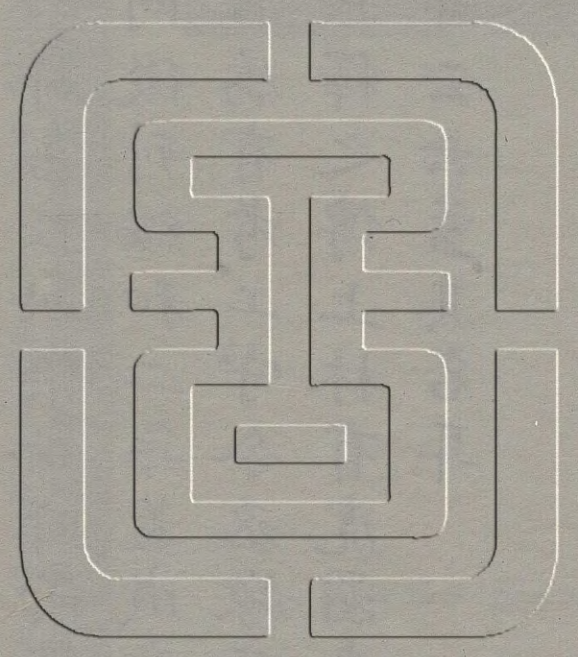

漢雲螭鐘一

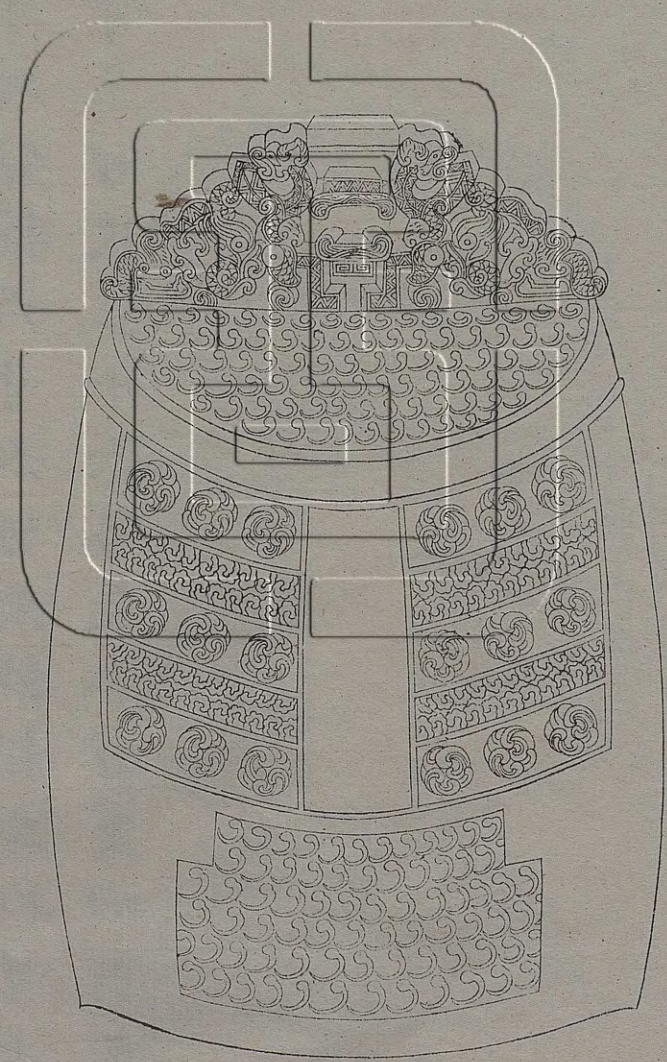

西清古鐘  
卷三十一  
鐘

右高八寸八分鈕高三寸二分濶八分兩舞相距七寸七分橫六寸六分兩銑相距八寸七分橫七寸三分枚三十六各長二分重四百九十六兩

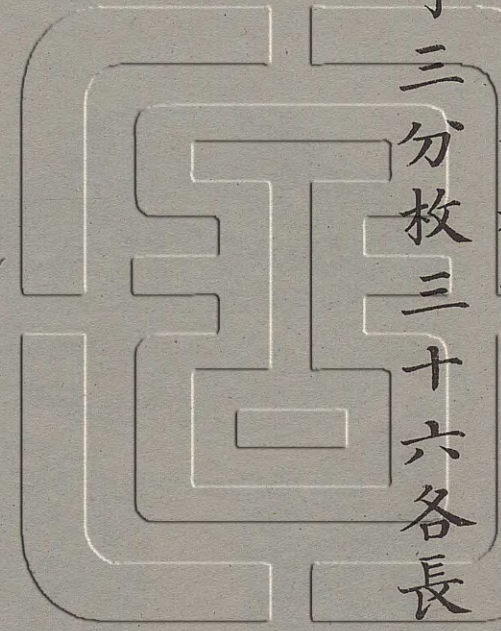

漢雲螭鐘二

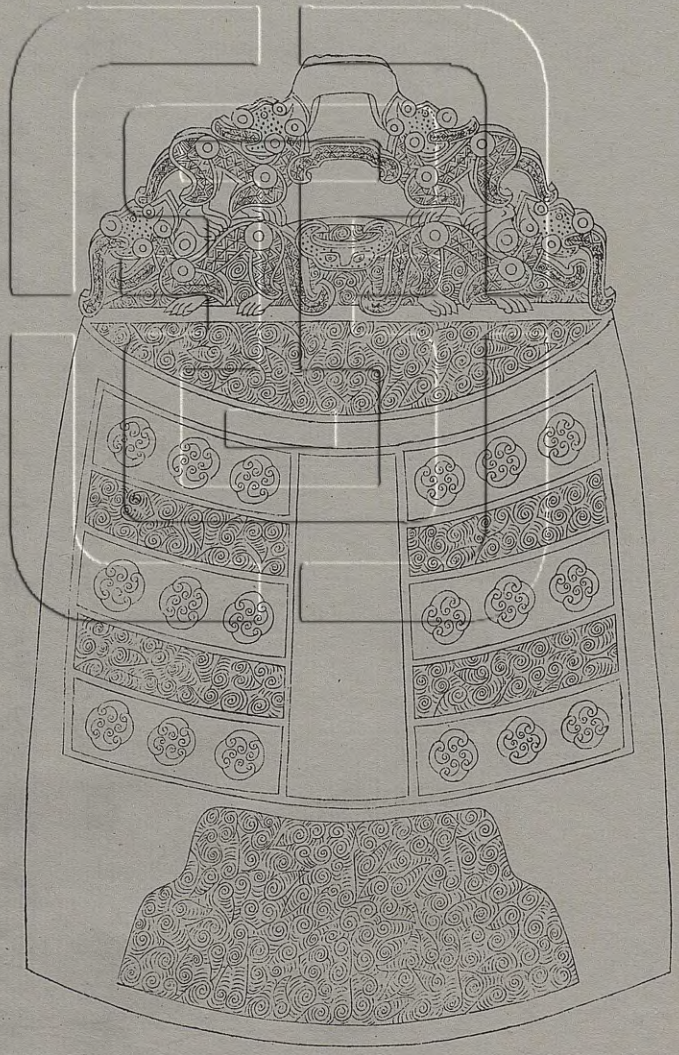

右高八寸七分鈕高三寸二分濶七分兩舞相距七寸八分橫六寸三分兩銑相距九寸橫七寸五分枚三十六各長二分重四百二十七兩

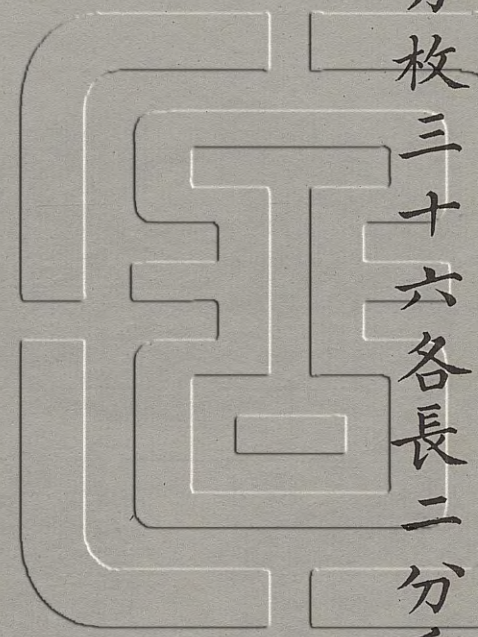

漢蛟螭鐘

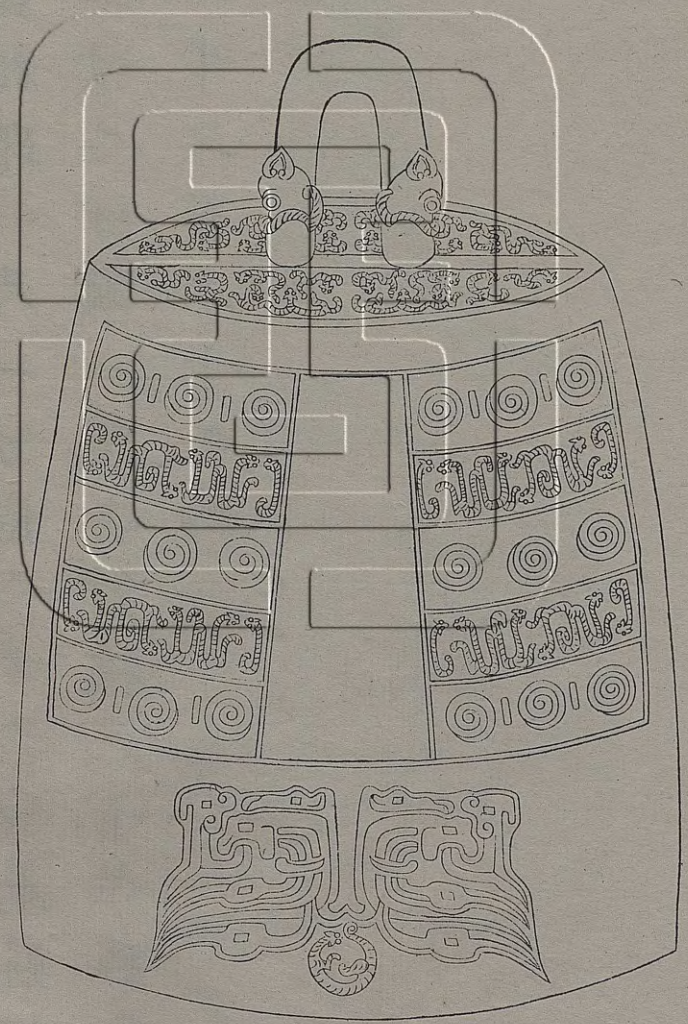



右高一尺二寸七分鈕高四寸六分濶三寸三分兩舞相距一尺一分橫八寸六分兩銑相距一尺二寸二分橫一尺二二分枚三十六各長六分重一千二百二十九兩

漢蟠螭鐘



右高八寸二分角長五寸八分徑二寸有旋兩  
 舞相距五寸七分橫四寸九分兩銑相距六寸  
 五分橫五寸三分枚三十六各長三分重二百  
 五十一兩



漢編鐘一

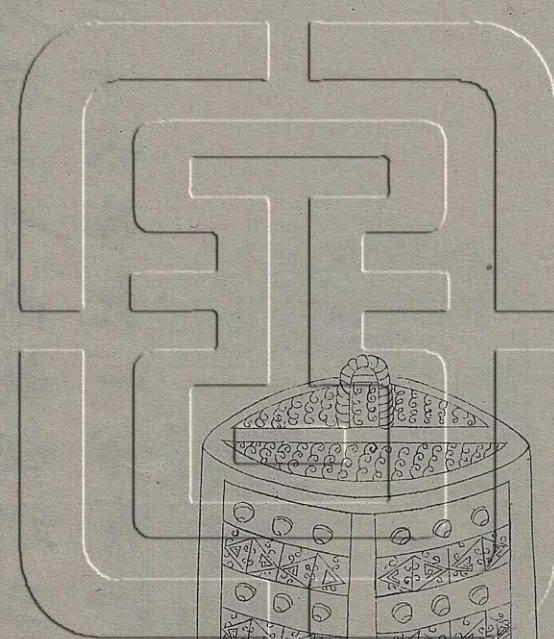
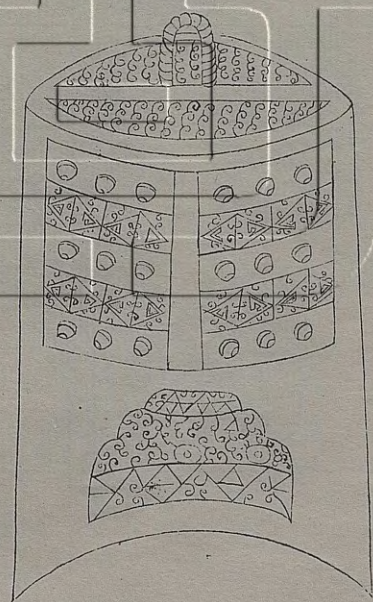

右高四寸七分鈕高九分濶一寸兩舞相距二寸六分橫二寸兩銑相距三寸二分橫二寸五分枚三十六各長一分有餘重三十兩

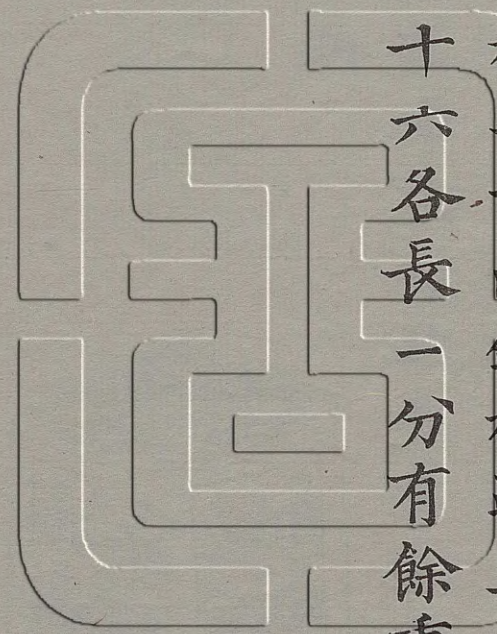

漢編鐘二

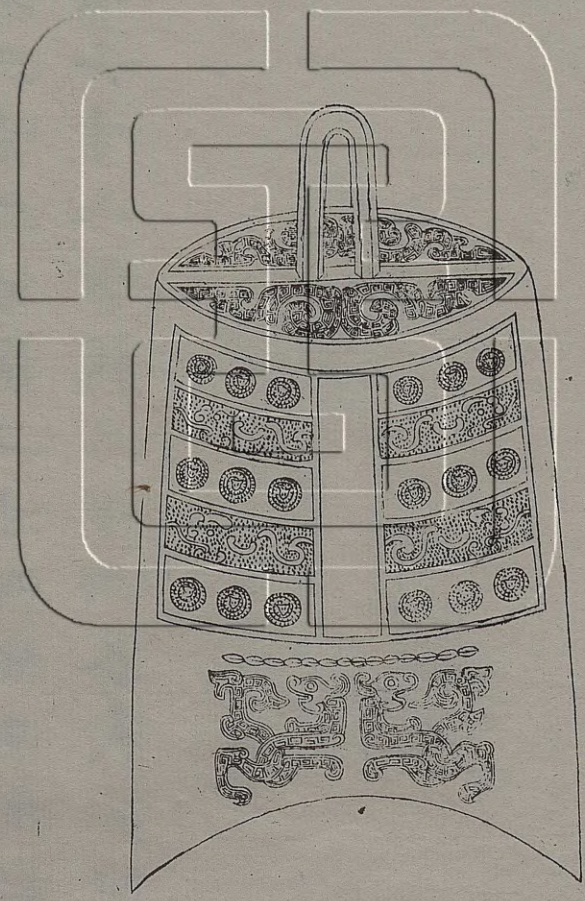

右高四寸六分鈕高一寸八分濶一寸二分兩  
 舞相距三寸二分橫二寸四分兩銑相距三寸  
 八分橫二寸八分枚三十六各長二分重五十  
 四兩

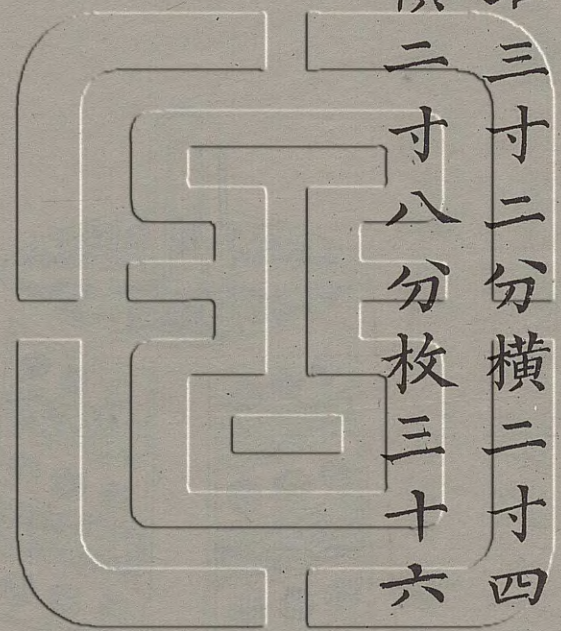

漢蟻紋鐘

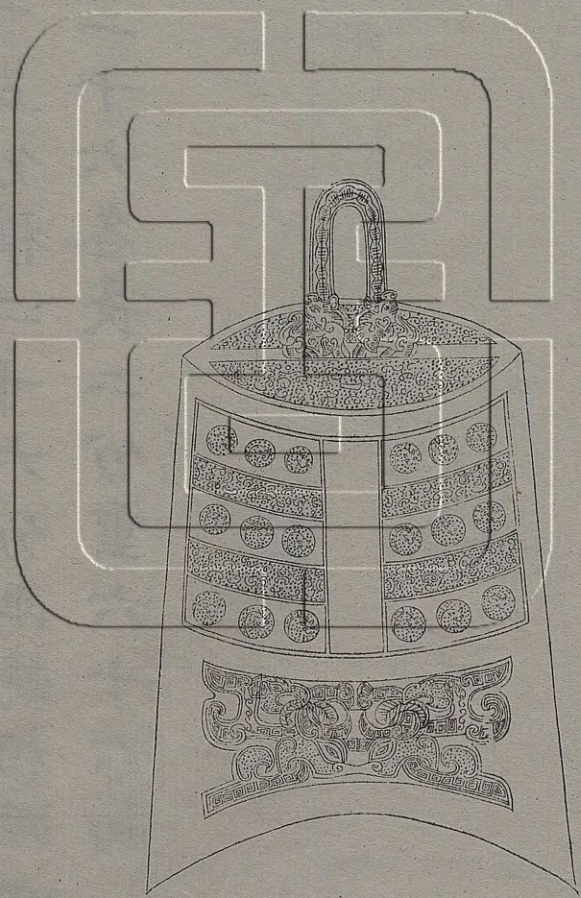

右高四寸八分鈕高一寸九分濶一寸兩舞相距三寸五分橫二寸六分兩銑相距四寸橫三寸枚三十六各長二分重六十六兩

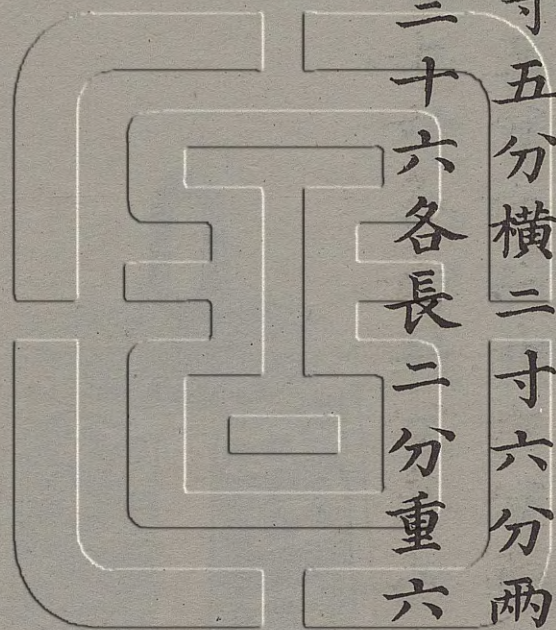

周乳鐸

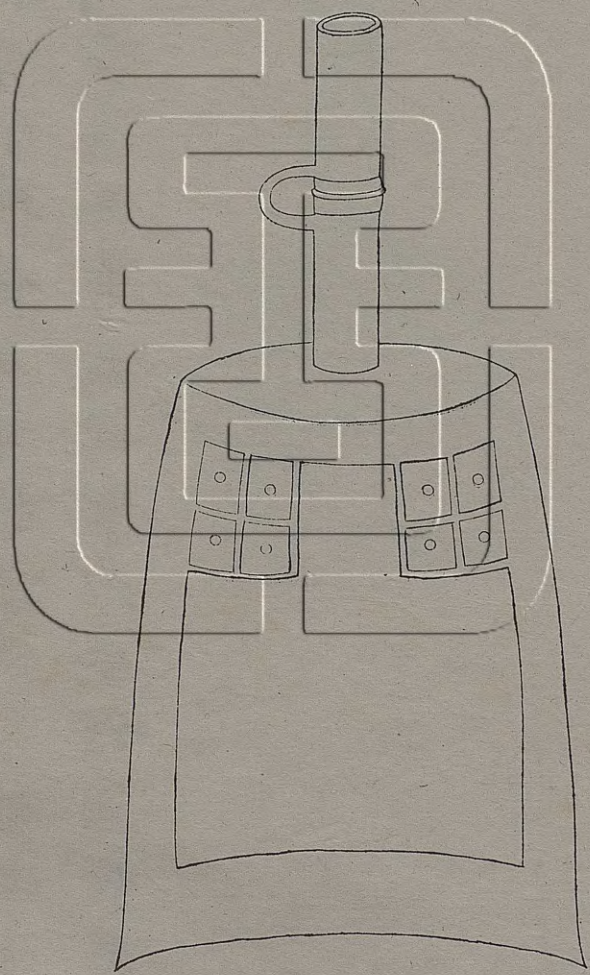

右高五寸九分柄長三寸九分上徑長三寸八分橫三寸下徑長五寸橫三寸八分重九十九兩柄為空角而有旋周官以金鐸通鼓故與鐘類也

周蟠夔鐸

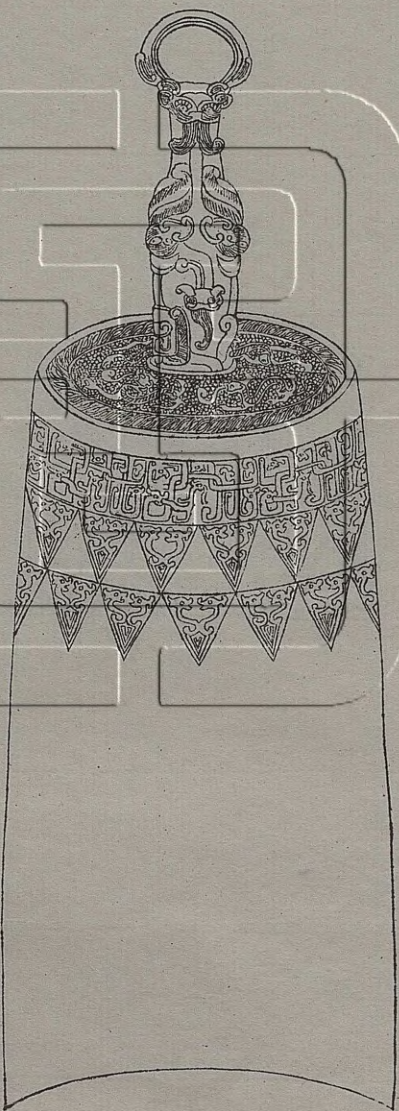

右高七寸一分柄長三寸一分上徑長三寸四分  
 分橫三寸三分下徑長四寸一分橫三寸九分  
 重一百五十一兩

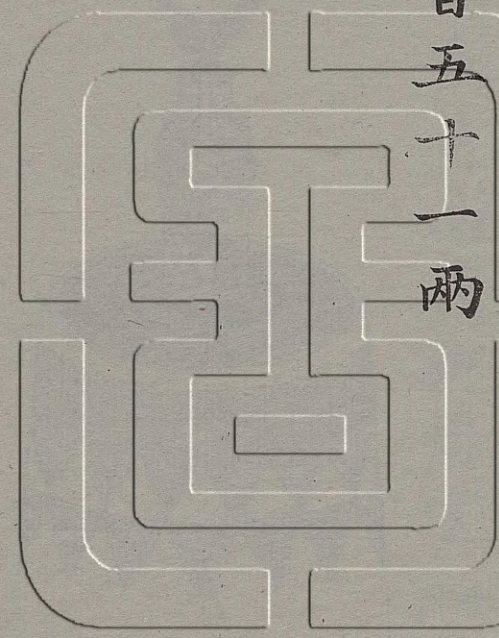

漢檐鐸一

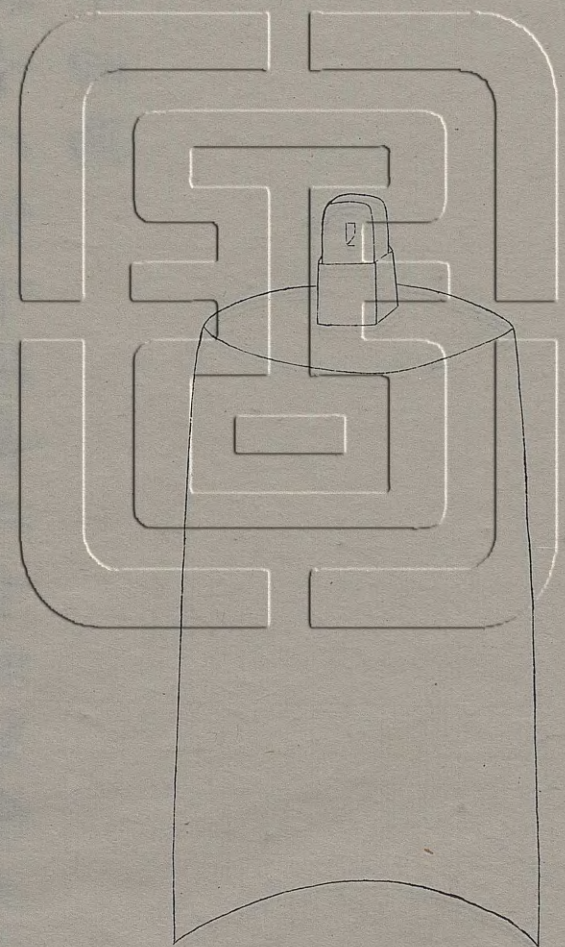

右高五寸八分柄長一寸四分上徑長一寸八分橫二寸八分下徑長二寸四分橫三寸三分重三十四兩

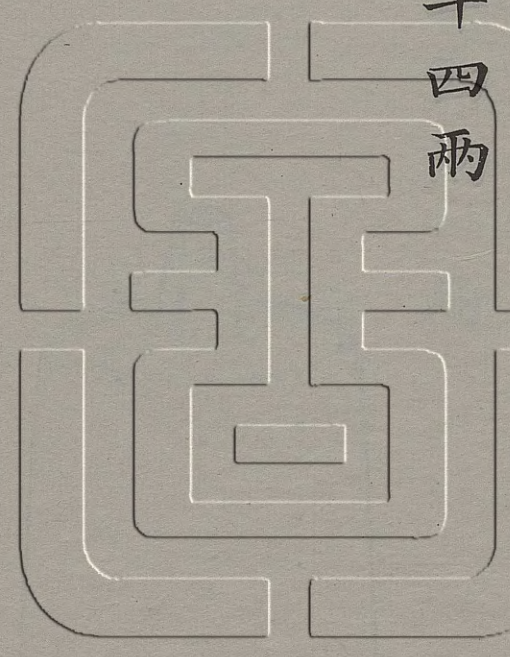

漢檐鐸二

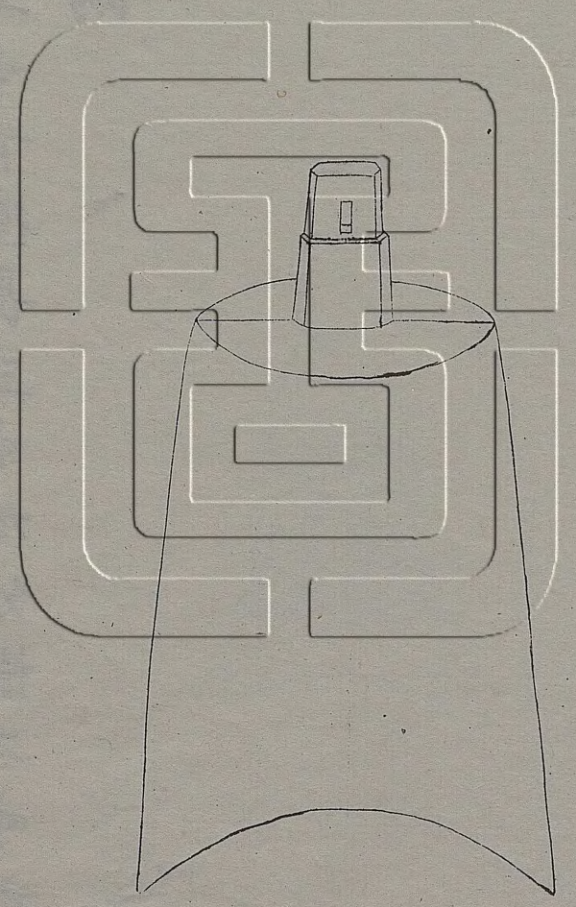



右高五寸四分柄長一寸六分上徑長三寸一分  
 分橫二寸下徑長三寸九分橫二寸六分重四  
 十二兩

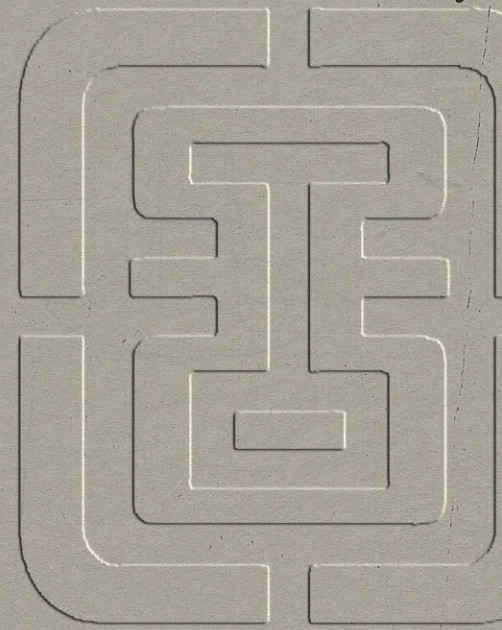

漢風鈴

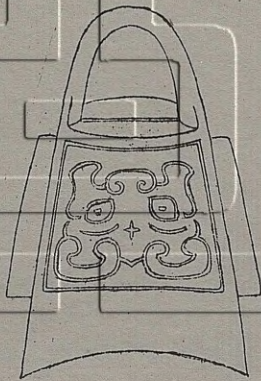
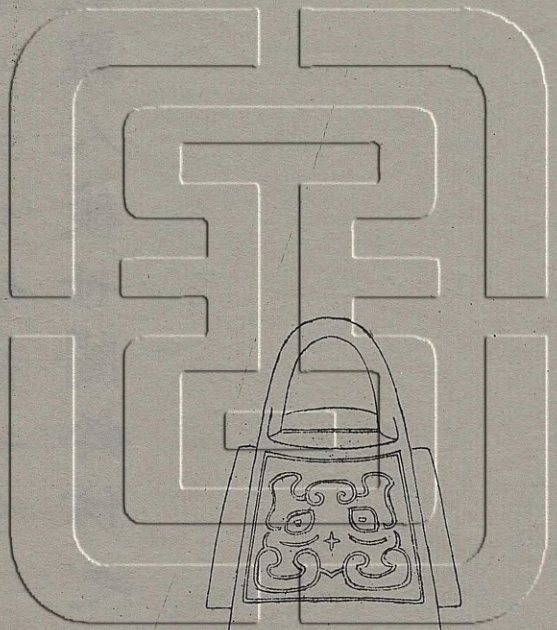

右高二寸一分鈕高七分上徑長一寸橫八分  
 下徑長一寸六分橫一寸一分重四兩周禮鳴  
 鈴以應雞人後世閣鈴仿之亦檐鐸類也

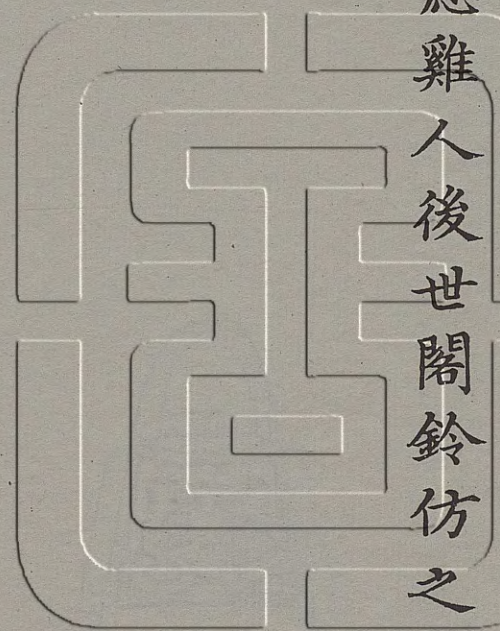

漢旂鈴

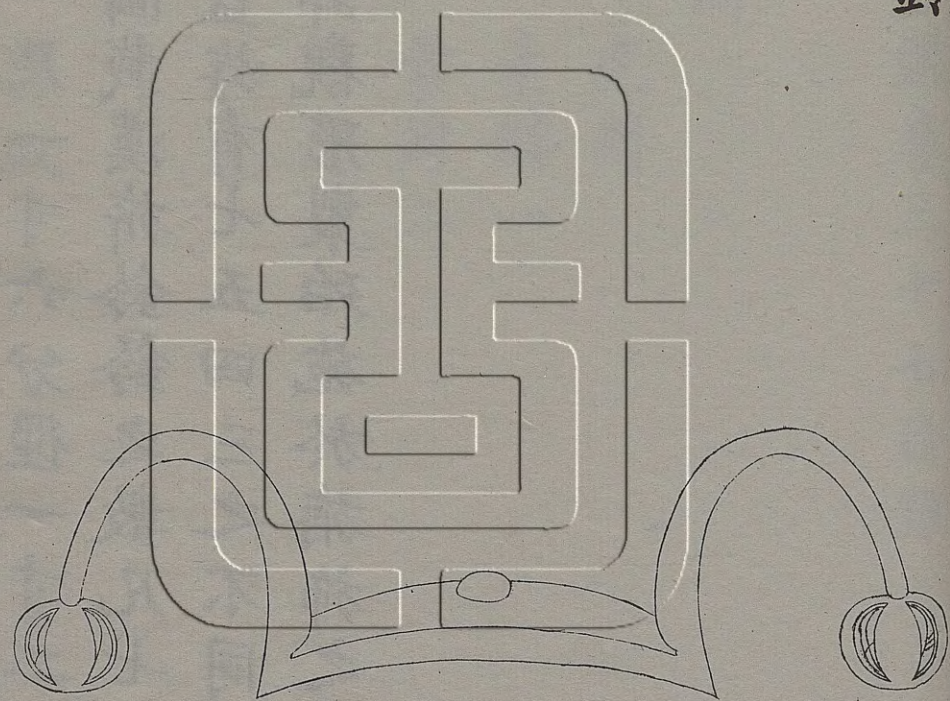

右長一尺一寸六分徑一寸二分重一十四兩  
 博古圖載漢旂鈴鈴之數凡七內府所藏有三  
 鈴者蓋旂有七五四三之不同而鈴如之茲惟  
 二鈴詳觀形製殆施於旂旆之首者歟



西清古鑑卷三十七目錄

罍

周

虎罍

素罍一

素罍二

罍虎鈕

戚

周

舞戚一

鏡

周

舞戚二

舞戚三

舞戚四

片雲戚

龍首戚



舞鏡一

舞鏡二

舞鏡三

舞鏡四

舞鏡五

舞鏡六

舞鏡七

舞鏡八

舞鏡九

舞鏡十

鼓

漢

銅鼓一

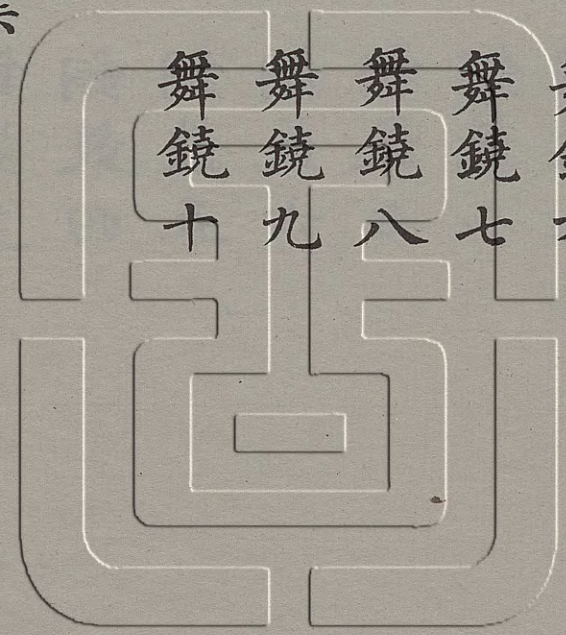

銅鼓二

銅鼓三

銅鼓四

銅鼓五

銅鼓六

銅鼓七

銅鼓八

銅鼓九

銅鼓十

銅鼓十一

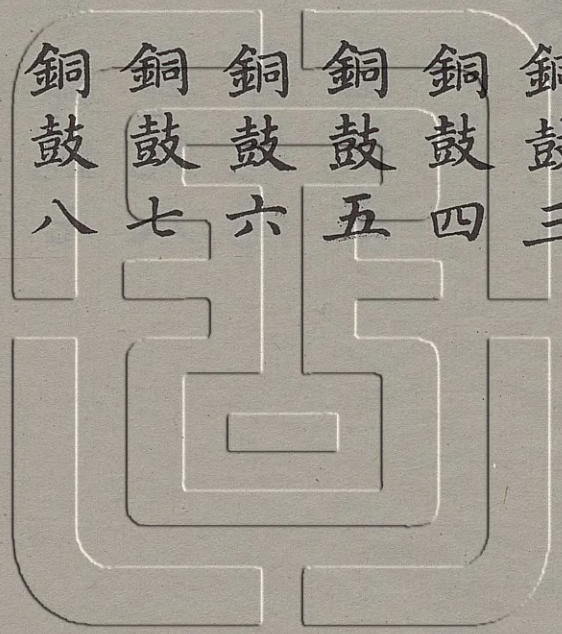

銅鼓十二

銅鼓十三

銅鼓十四

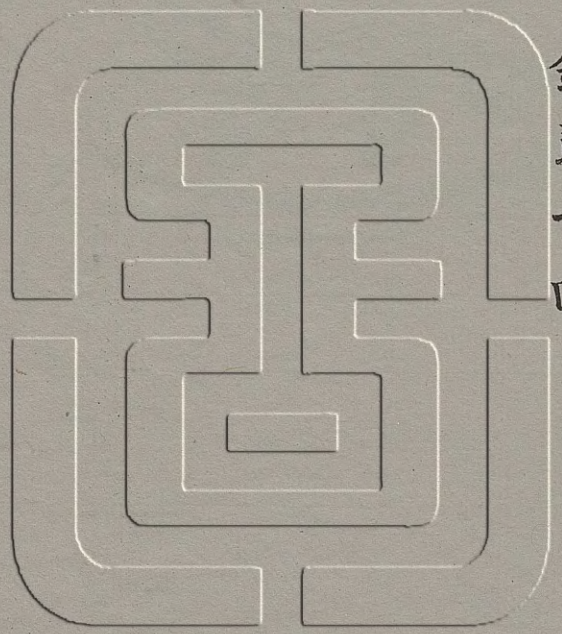

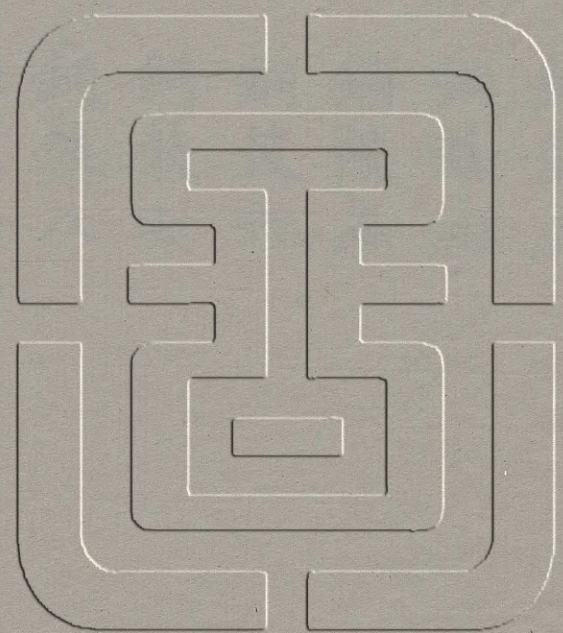

周虎鎛

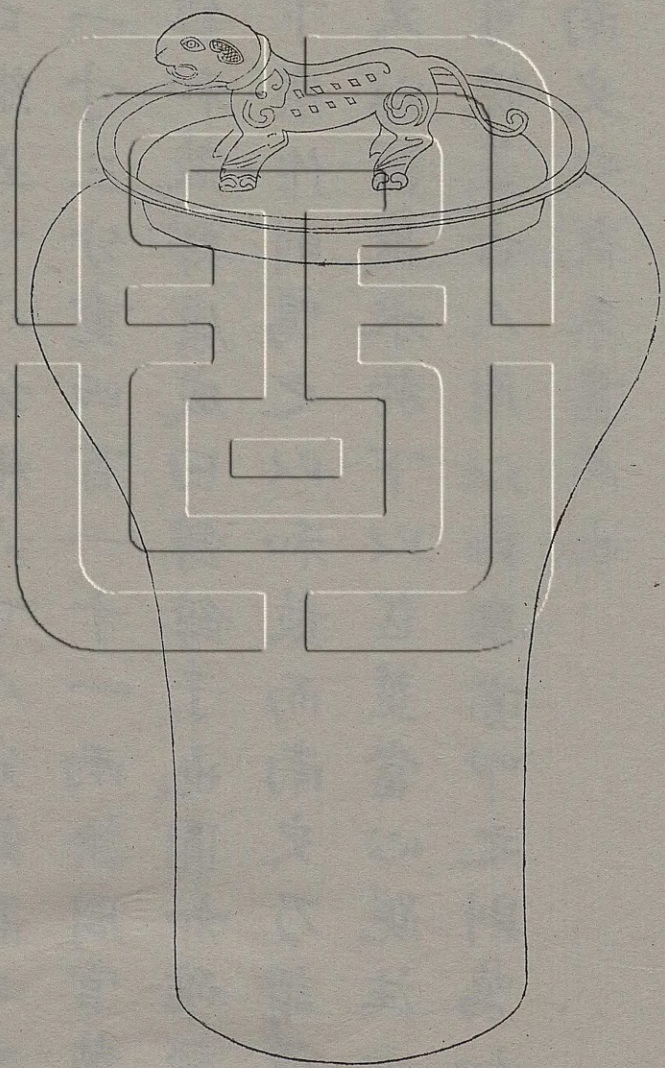

右高一尺四寸二分上縱六寸八分橫八寸二分下口縱五寸八分橫六寸八分鈕高二寸二分濶一寸三分重四百一十一兩按周官鼓人以金鐸和鼓鄭康成曰鐸鐸于也圓如碓頭大上小下樂作則鳴之以和鼓而南史乃謂灌之以水又以器盛水於下以苾莖當心跪注云云語不可曉蓋古人用以節樂亦叩之則鳴如鐘類耳南史之說未盡然也

周素鐸一

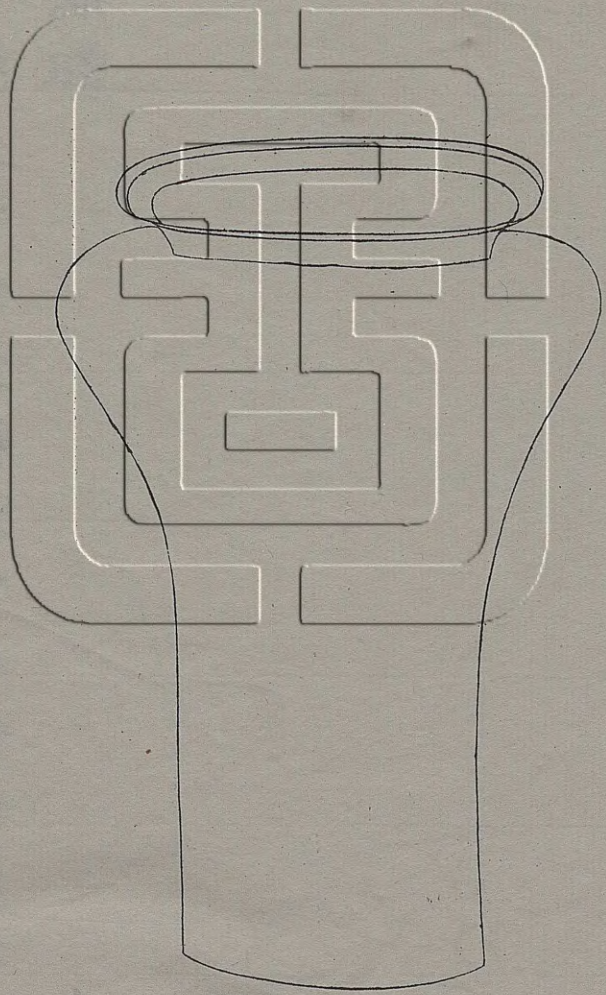

右高一尺四寸八分上縱七寸八分橫九寸二分下口縱五寸六分橫六寸八分重三百四十七兩缺鈕

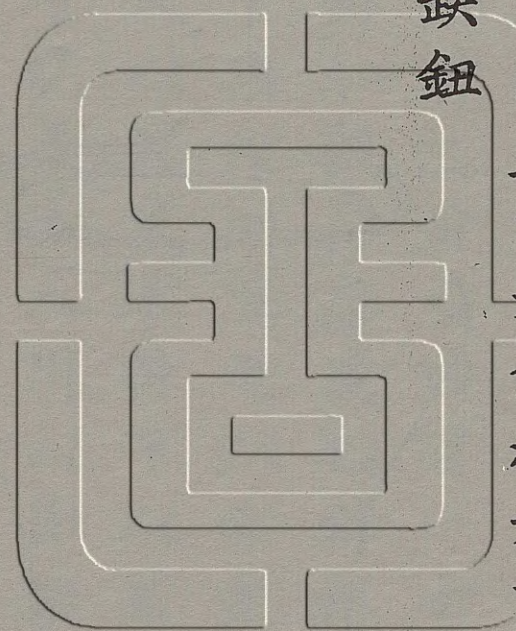

周素罇二

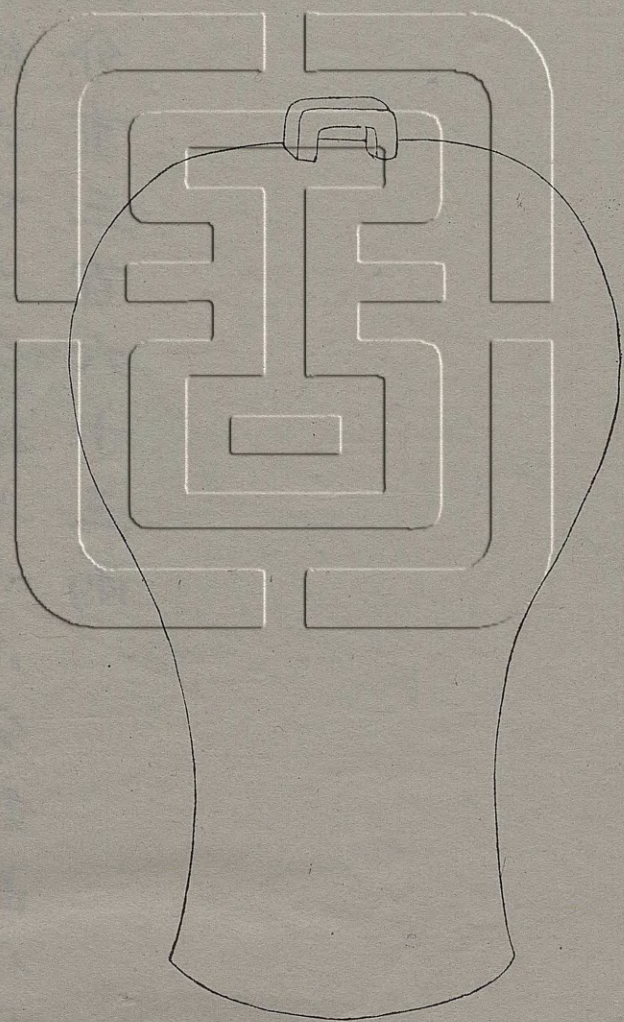



右高一尺三寸三分上縱九寸三分橫一尺四分下口縱六寸二分橫七寸八分鈕高八分濶一寸五分重三百六十三兩

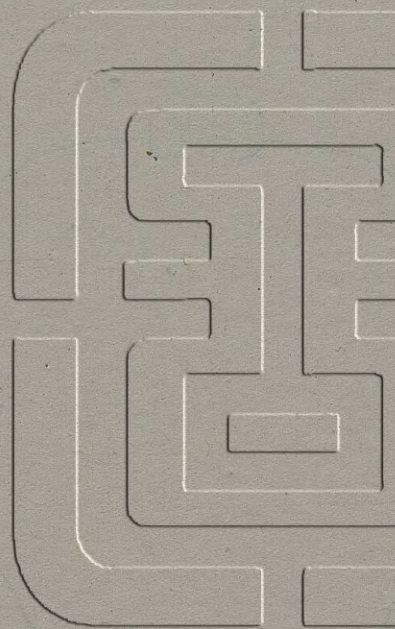

周彝虎鈕

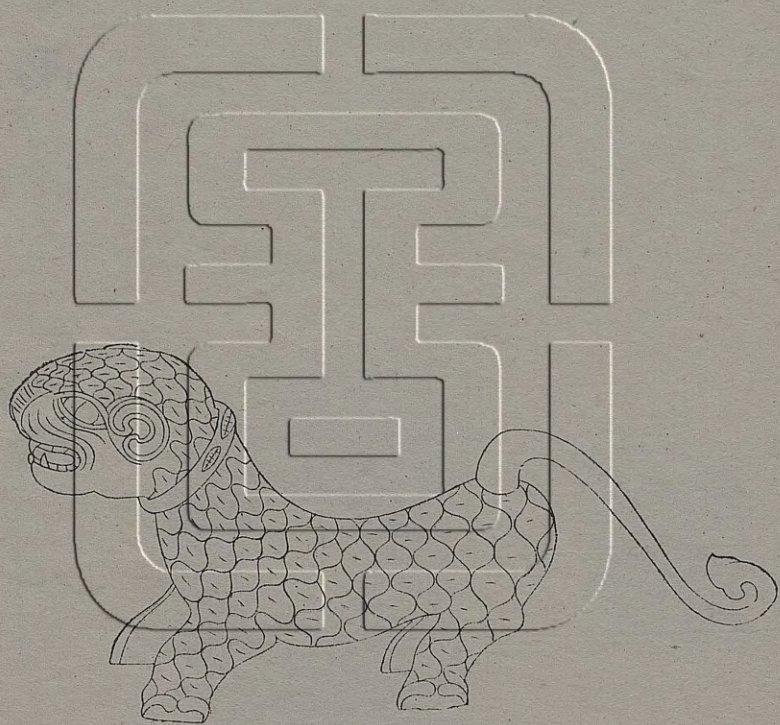

右高三寸七分通長一尺八分濶一寸五分重三十七兩

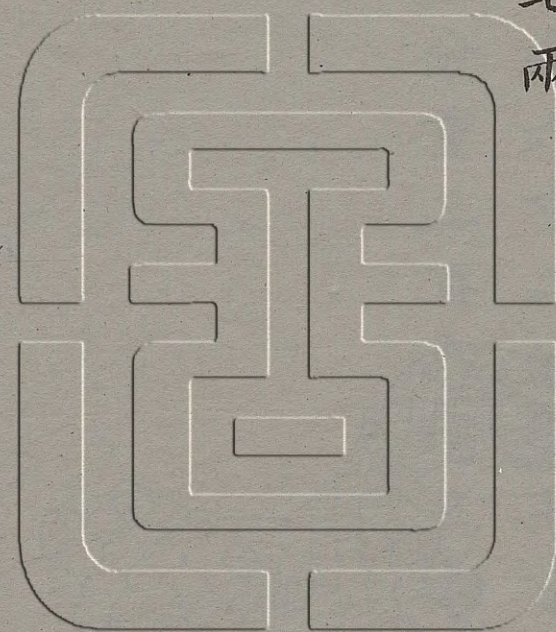

周舞戚一

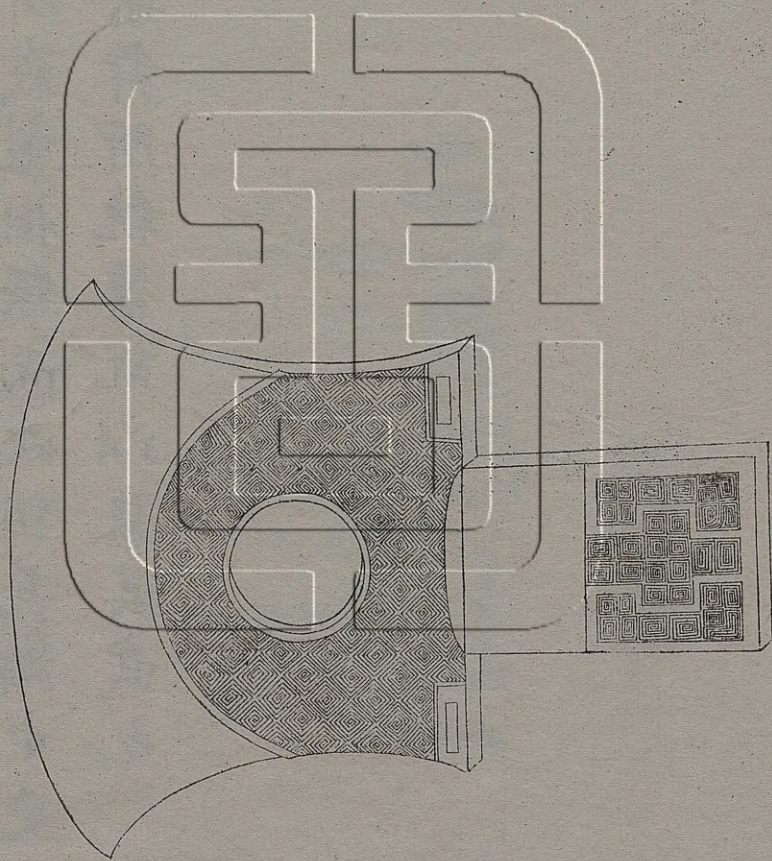

戚

右長九寸一分濶五寸四分重五十二兩與博  
 古圖所載製相類而此稍長濶中更作圓孔戚  
 斧屬樂舞所執舊說以象其武也

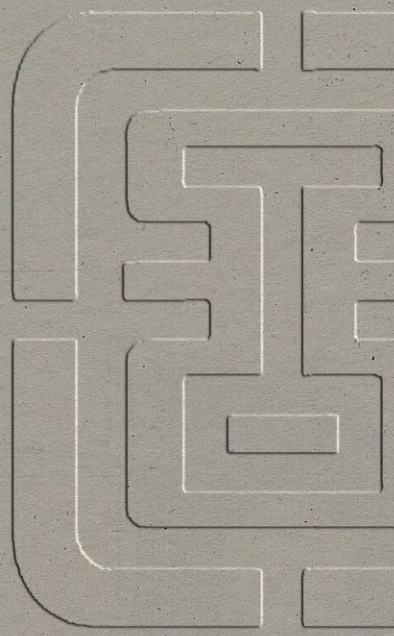

周舞戚二

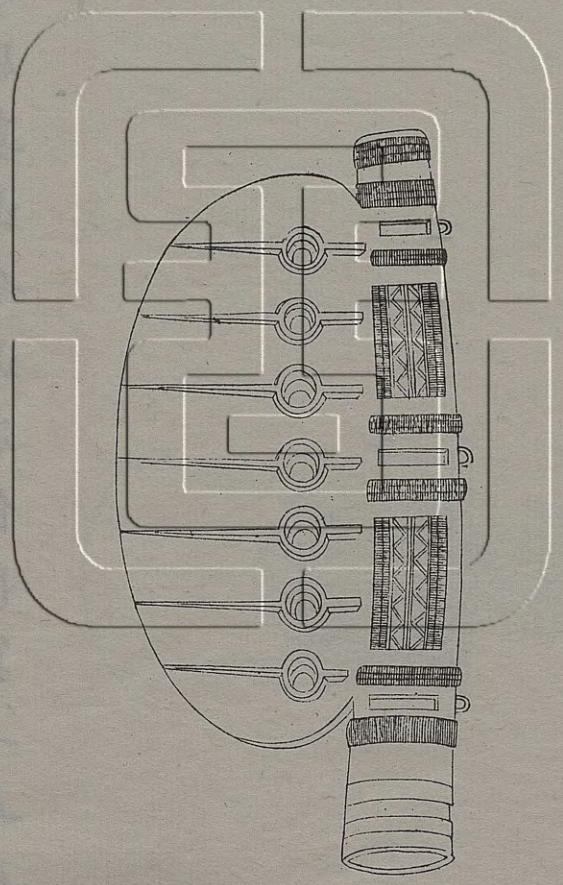

右長五寸八分濶二寸七分重一十三兩博古  
 圖片雲戚與此合此特作圓竅七安柄處亦微  
 不同耳

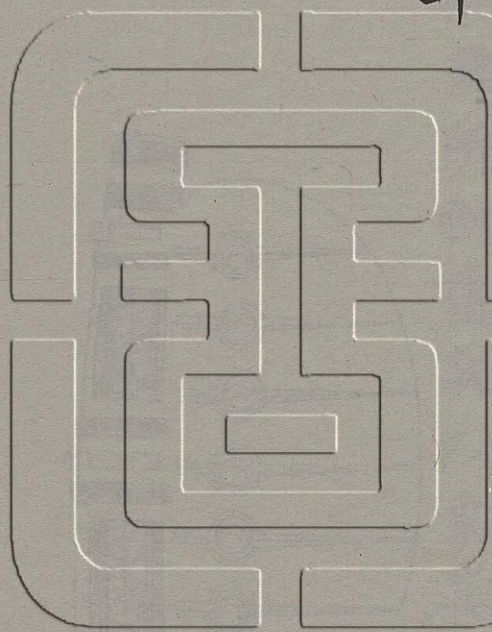

周舞戚三

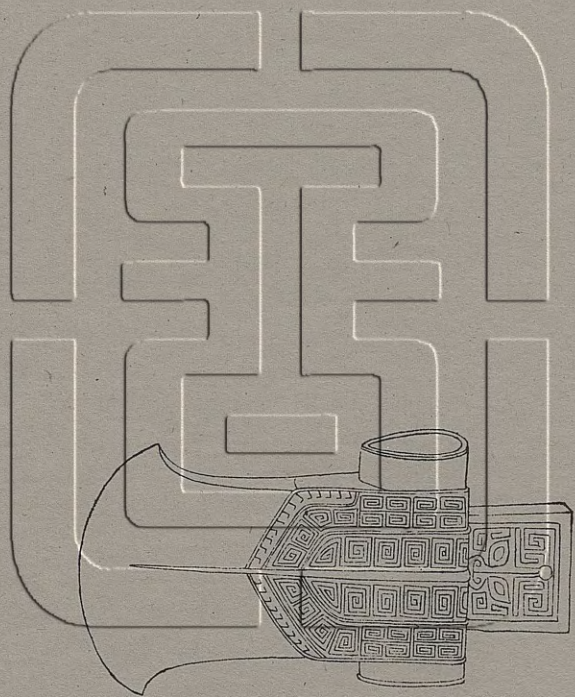

右長五寸三分濶一寸六分重一十三兩

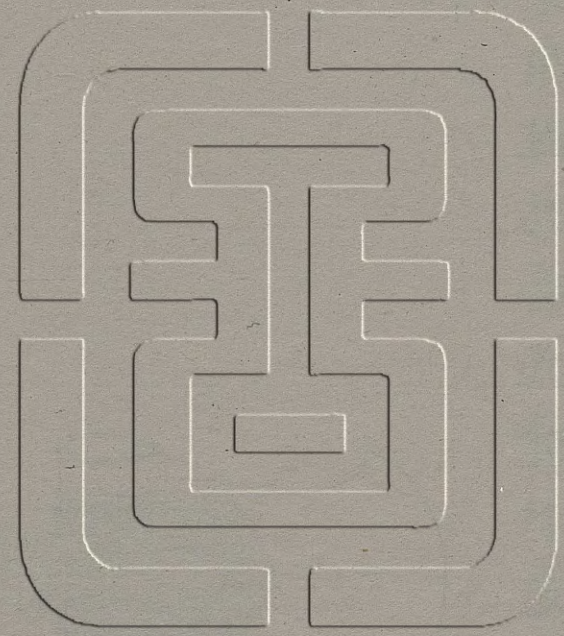

周舞戚四

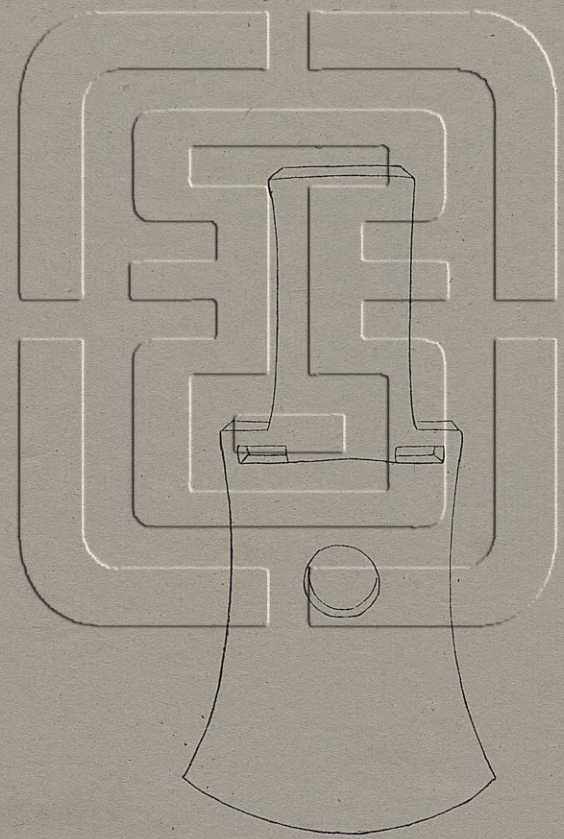

右長六寸一分濶二寸三分重一十三兩

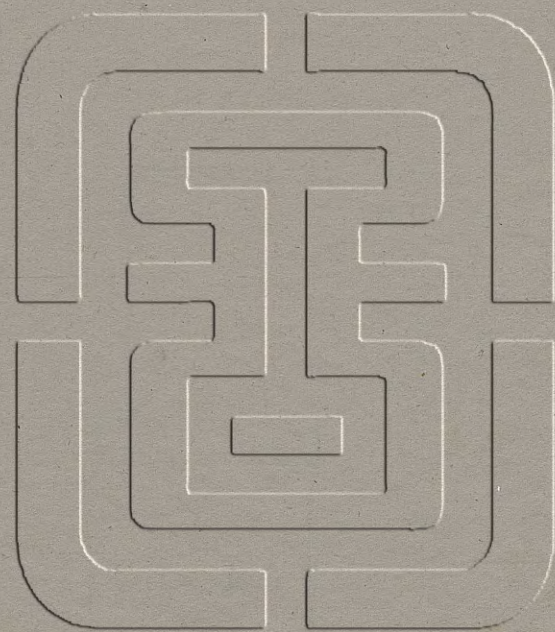

周片雲戚

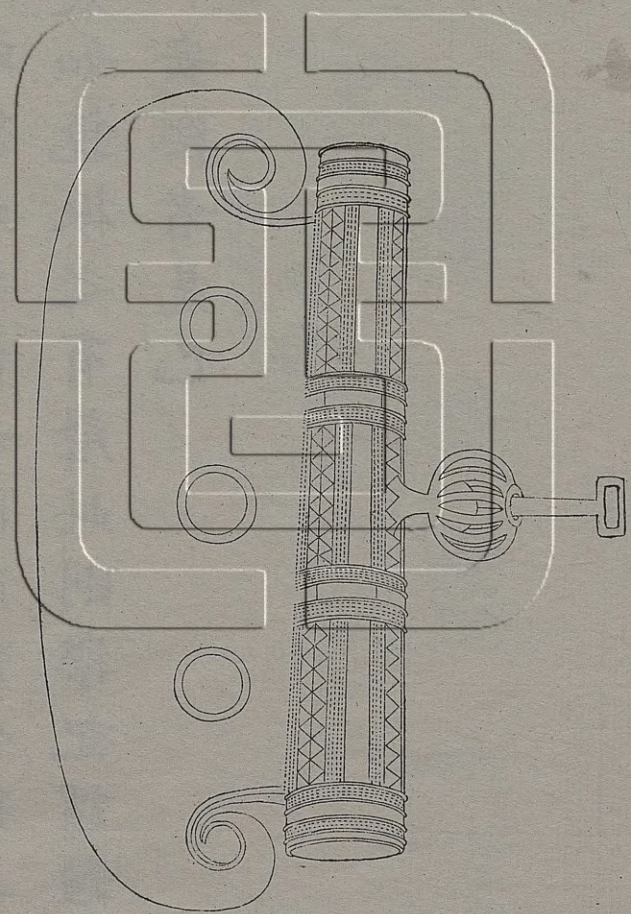

戚

右長五寸六分濶三寸四分重一十九兩若片  
 雲狀兩端微卷與博古圖所載合微異者柄旁  
 有鈴製如鏡振之有聲此則樂記謂鐘鼓干戚  
 所以和安樂者是已

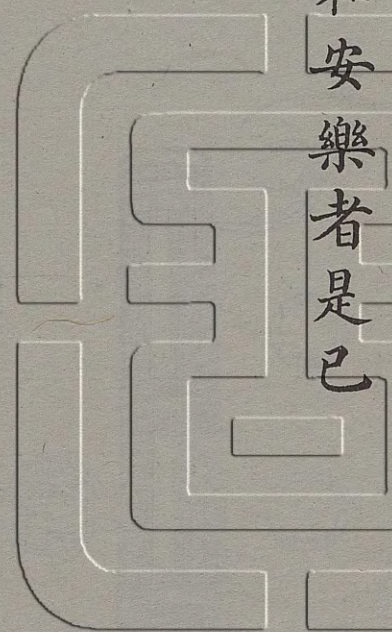

周龍首戚

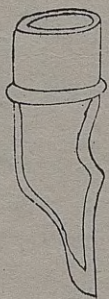
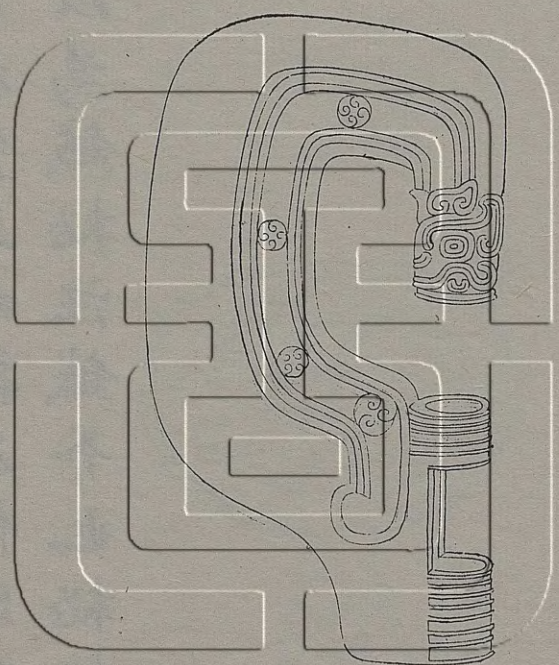

右長七寸二分濶四寸二分重一十九兩又受  
 柄處為秘重三兩按左傳昭公十二年君王命  
 剝圭以為鍼秘注鍼芥也秘柄也

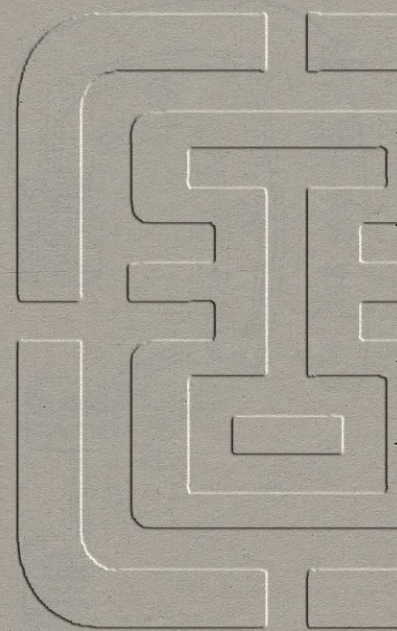

周舞鏡一

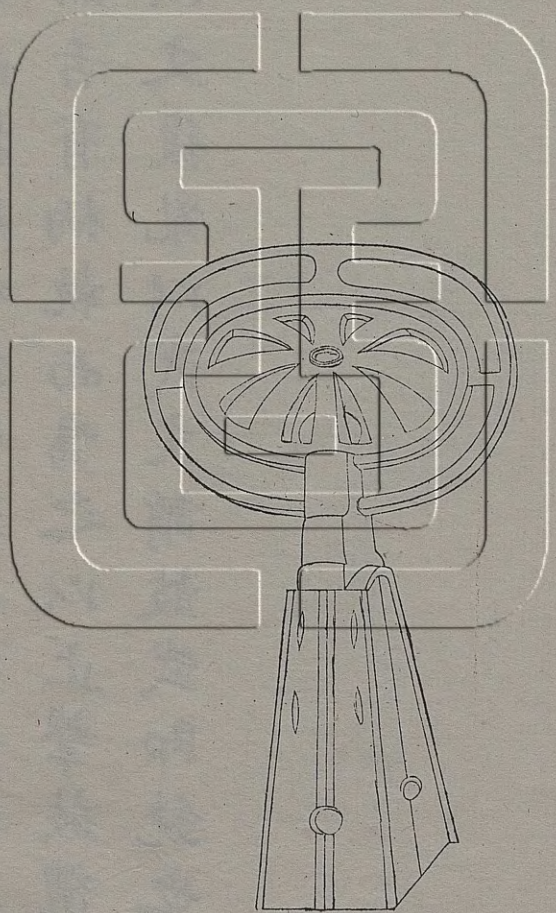



右長五寸六分徑三寸二分柄濶一寸六分重  
 一十六兩按周禮地官封人以金鏡止鼓注鏡  
 如鈴無舌有柄執而鳴之以止擊鼓禮記所謂  
 始奏以文復亂以武文謂鼓武即鏡也

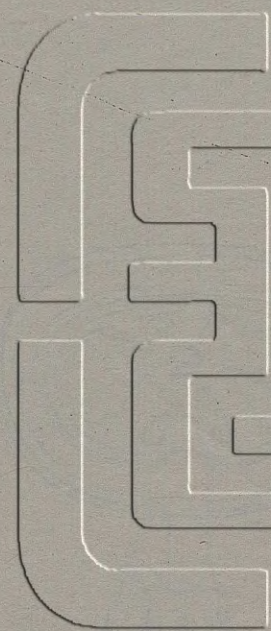

周舞鏡二

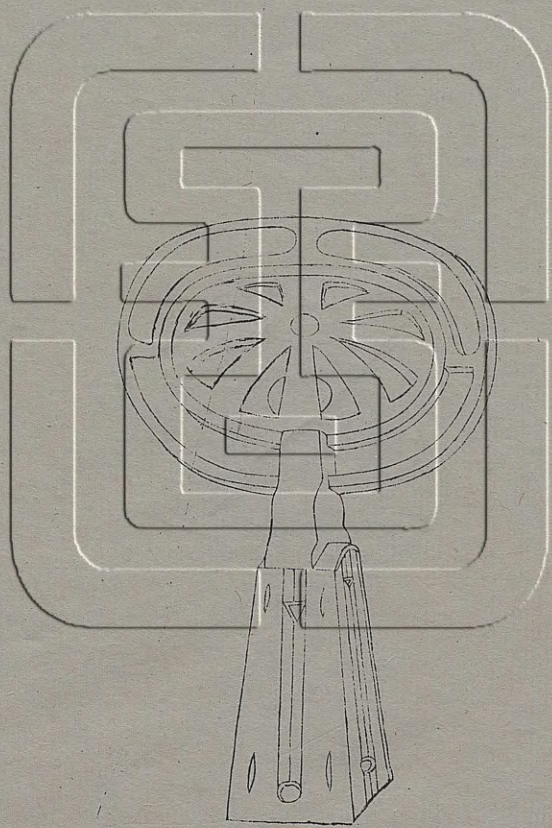

右長五寸五分徑三寸二分柄濶一寸三分重一十七兩

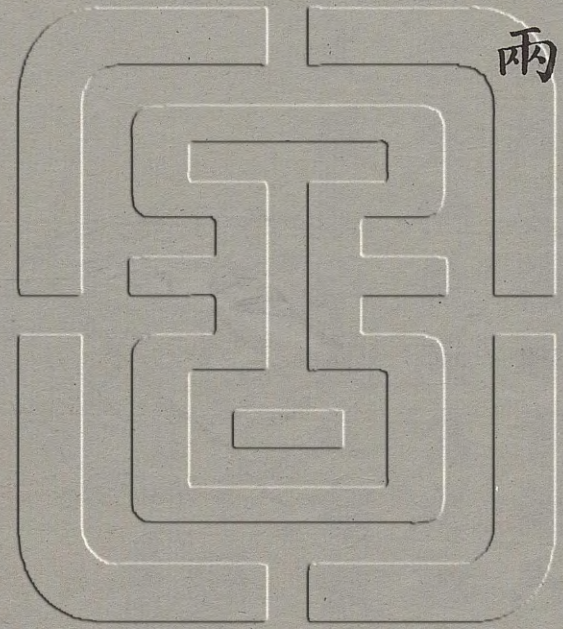

周舞鏡三

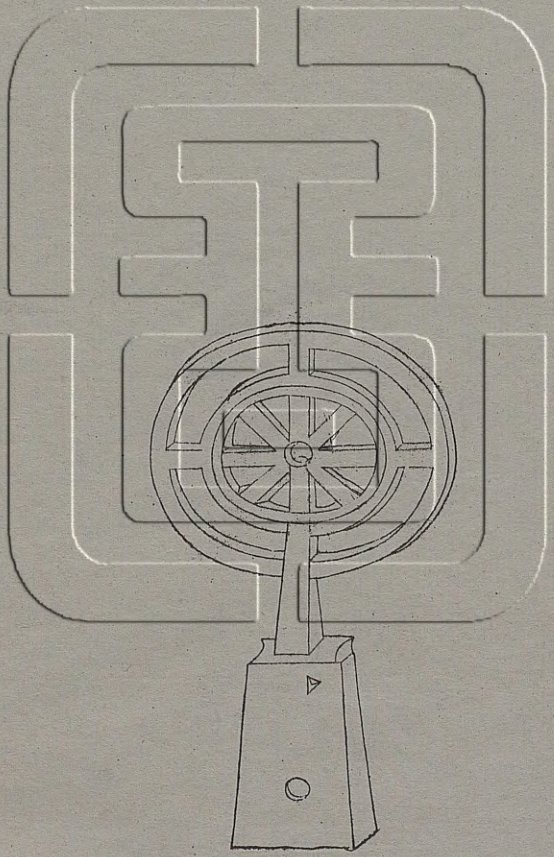

右長五寸五分徑三寸五分柄濶一寸四分重一十八兩

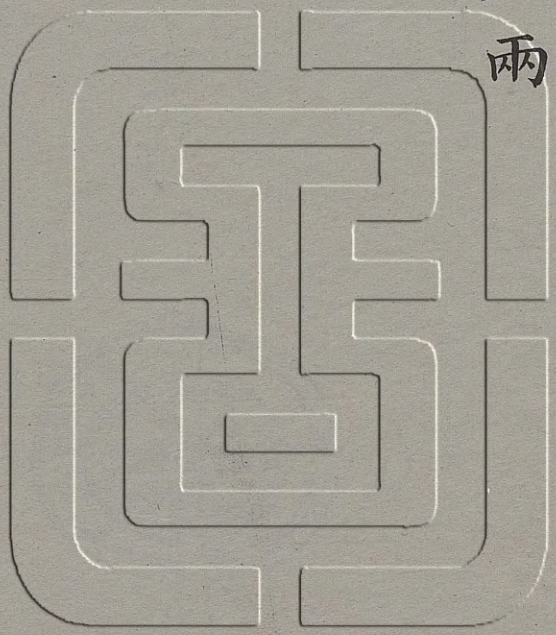

周舞鏡四

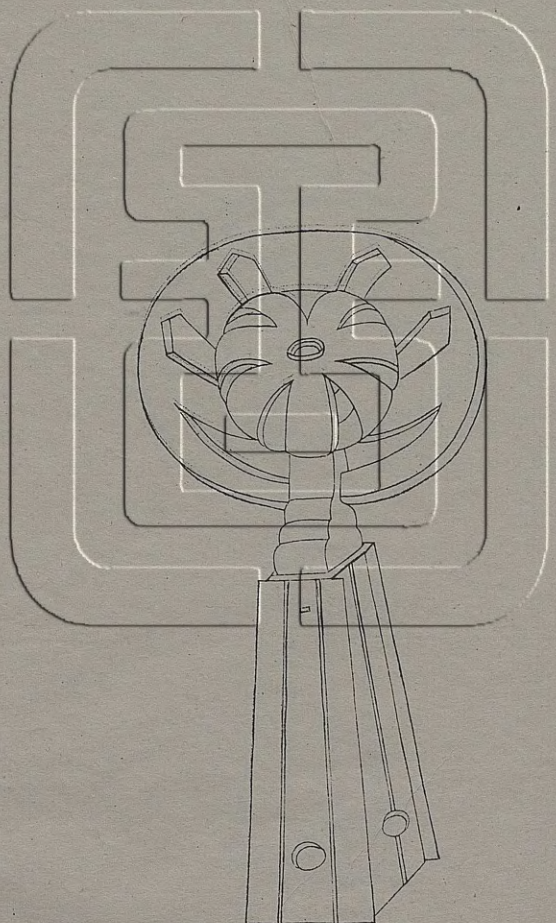

右長五寸二分徑二寸六分柄濶一寸一分重八兩

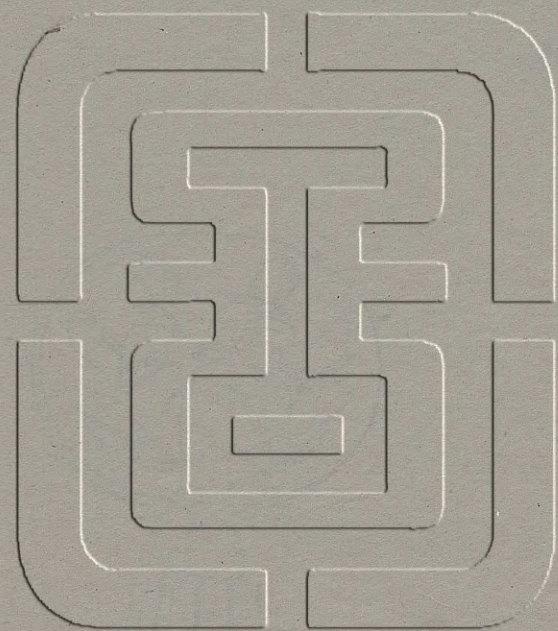

周舞鏡五

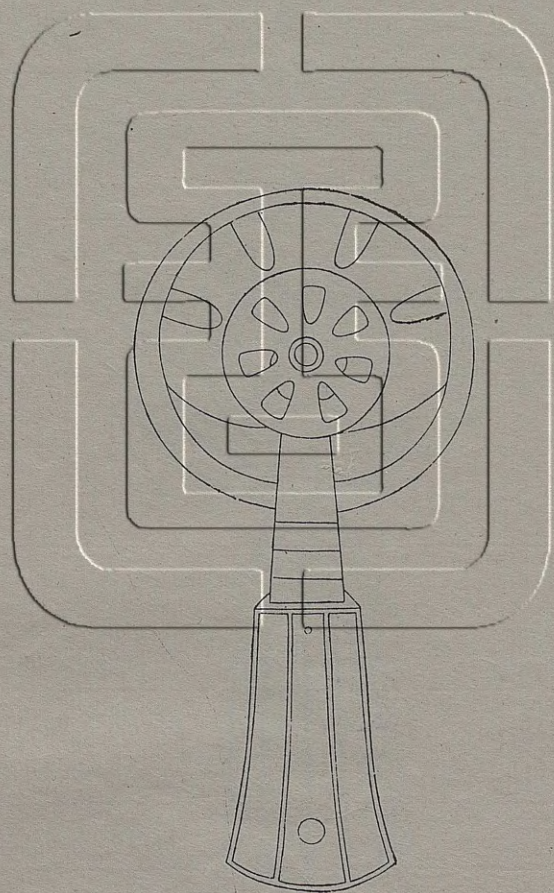

右長五寸一分徑二寸五分柄濶一寸重八兩

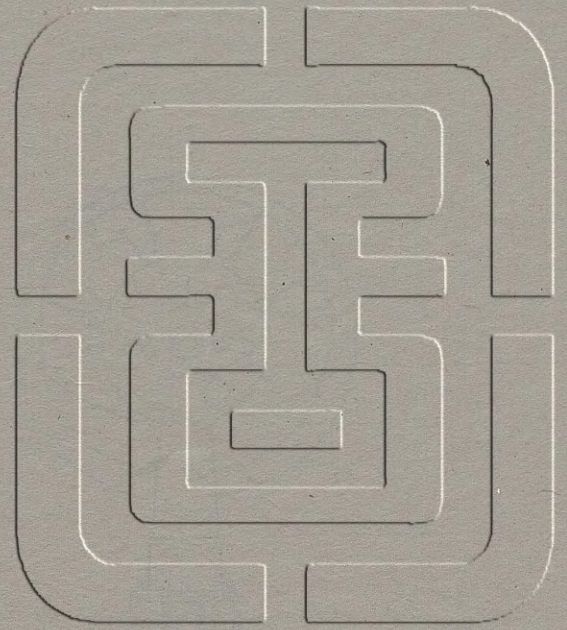

周舞鏡六

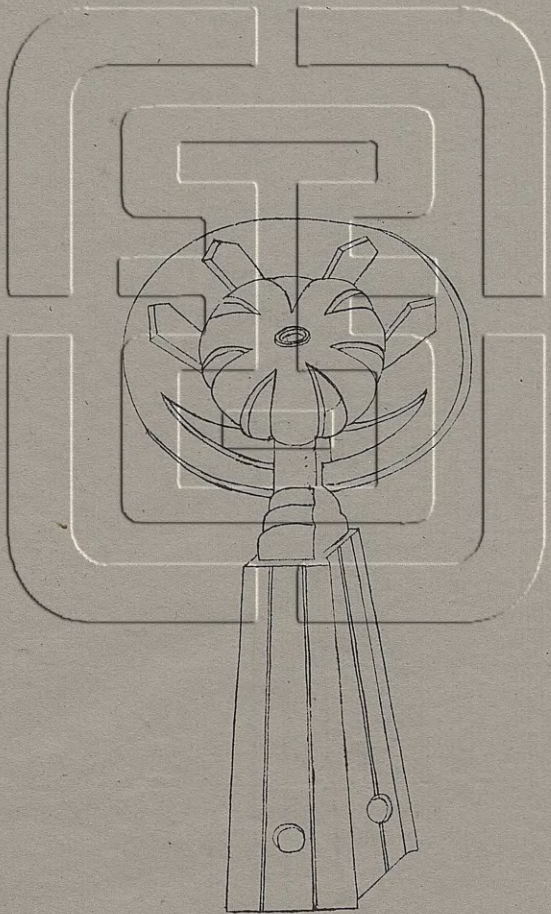

鏡

右長五寸一分徑二寸六分柄濶一寸一分重八兩

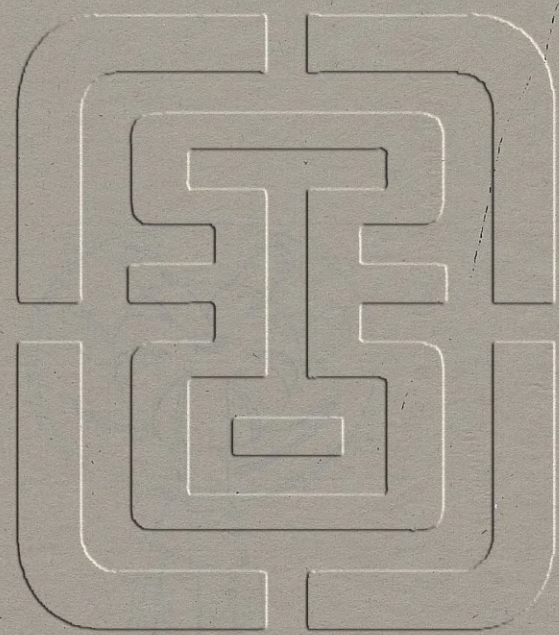

周舞鏡七

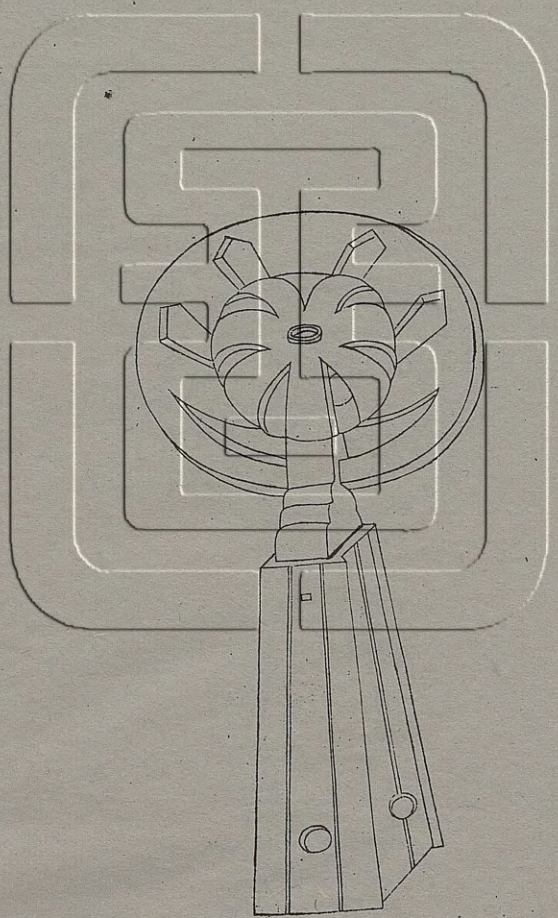

鏡

右長五寸一分徑二寸七分柄濶一寸一分重七兩

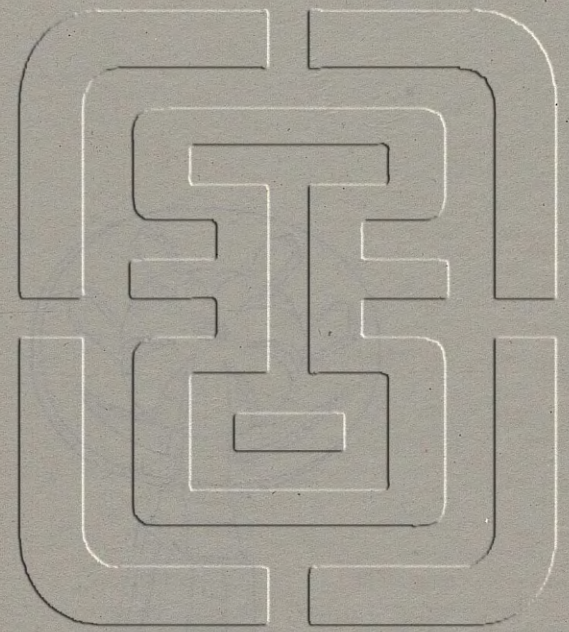

周舞鏡八

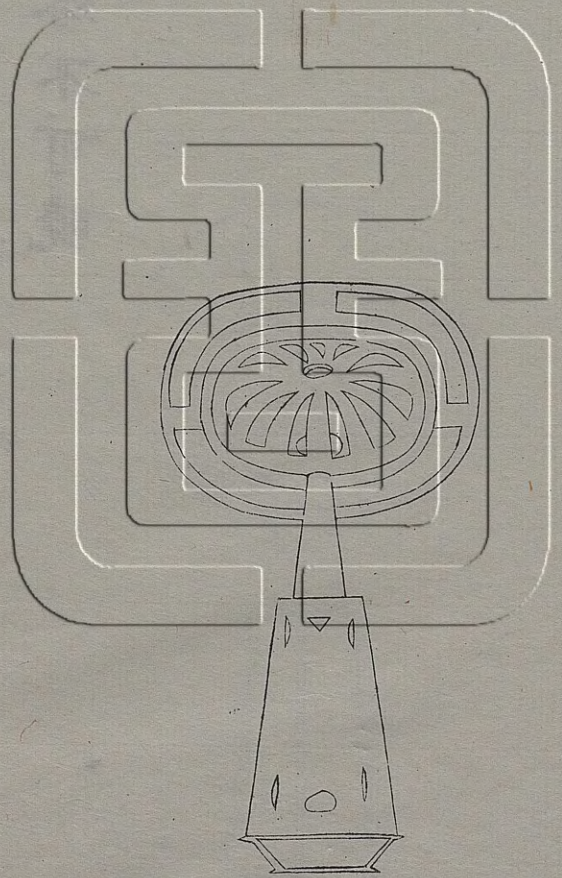

右長四寸六分徑二寸五分柄濶一寸三分重  
十兩博古圖有漢舞鏡二形製並彷彿特云有  
舌則殊不可曉



周舞鏡九

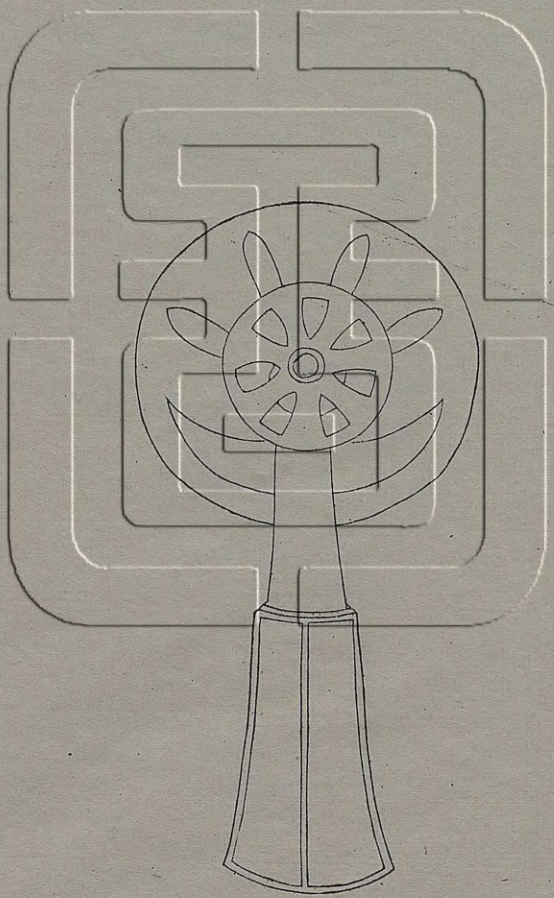



右長四寸七分徑二寸五分柄濶一寸一分重六兩

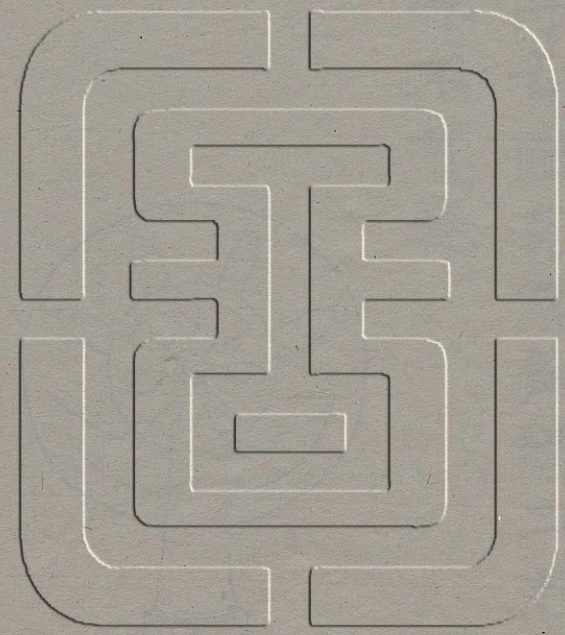

周舞鏡十

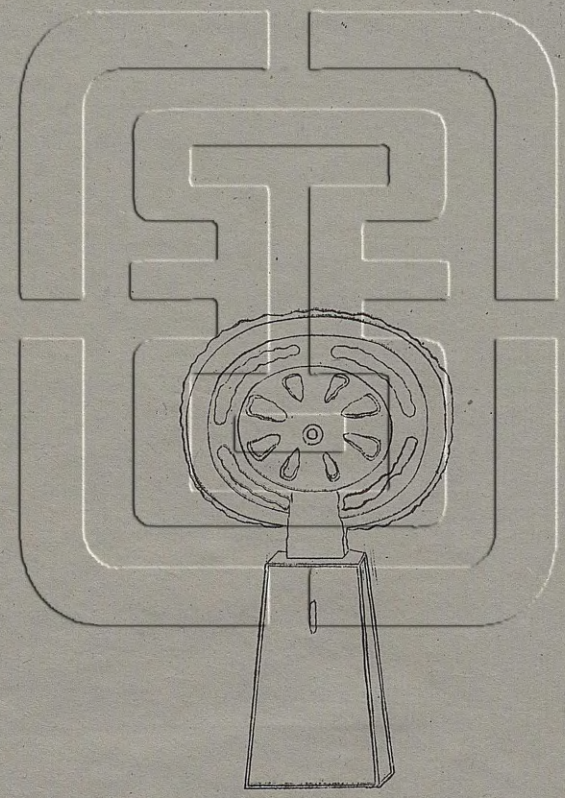

鏡

右長四寸三分徑二寸六分柄濶一寸一分重八兩

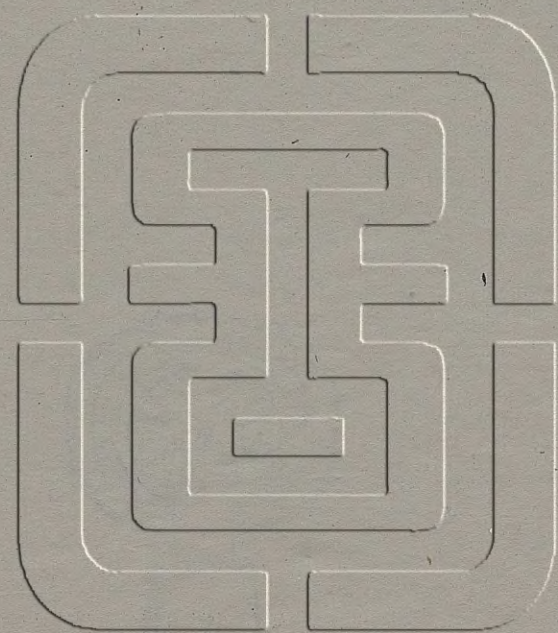

漢銅鼓一



西清古鑑  
卷三十一  
鼓

右高一尺八寸面徑二尺五寸三分腹圍八尺四分重一千二百六十兩此器今世多謂之諸葛鼓蓋武侯渡瀘後所鑄然考馬伏波平交趾亦鑄銅為鼓則先諸葛有之矣今嶺南一道廉州有銅鼓塘欽州有銅鼓村博白有銅鼓潭則因以為地名矣大抵兩川所出為諸葛遺製而流傳於百粵羣峒者則皆伏波為之今未能差別統名為漢銅鼓云又按唐嶺南節度使鄭綯出鎮時春州守林靄得之峒戶以獻綯納諸廟面濶五尺臍隱起羅布海魚蝦蟇等紋旁設兩耳語與此合而是鼓更作騎士科洗乘而馳旁挾一馬則舊說所未有也

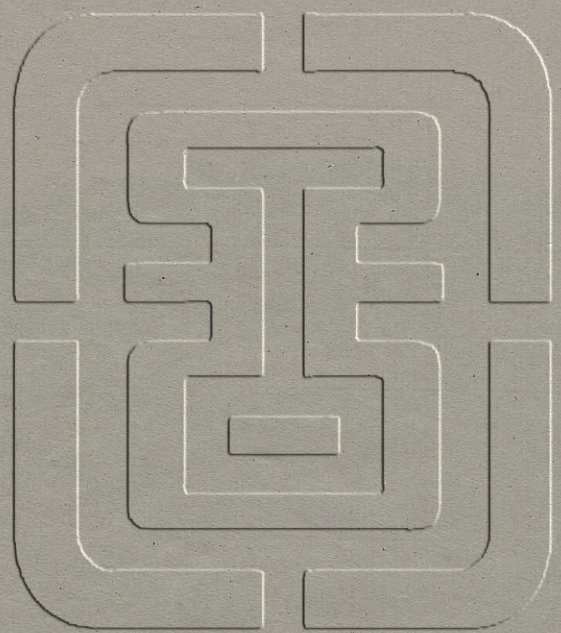

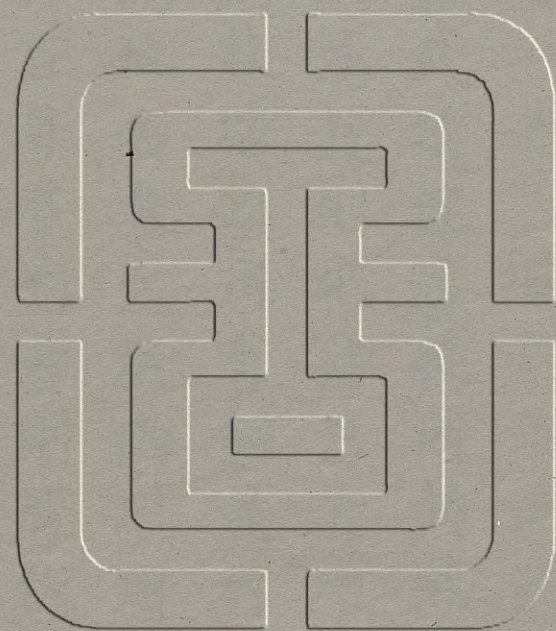

漢銅鼓二

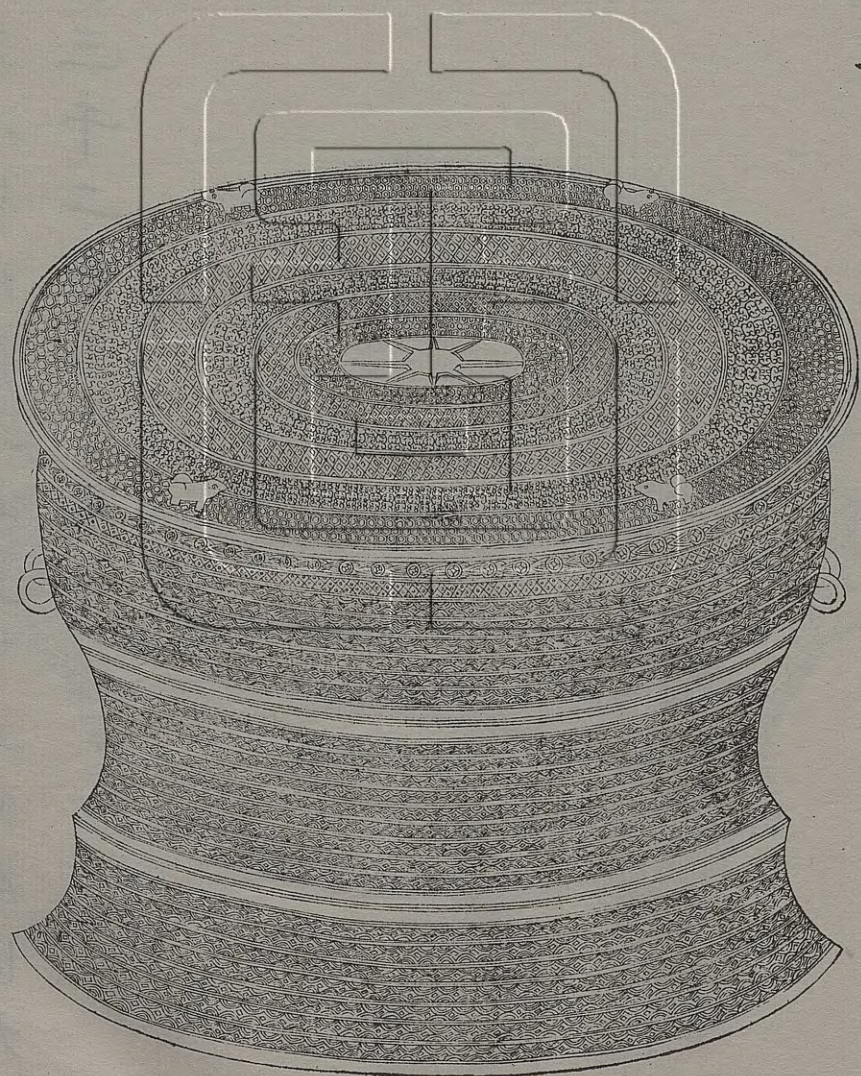

右高二尺七分面徑三尺五寸五分腹圍九尺八寸重三千二百五十兩

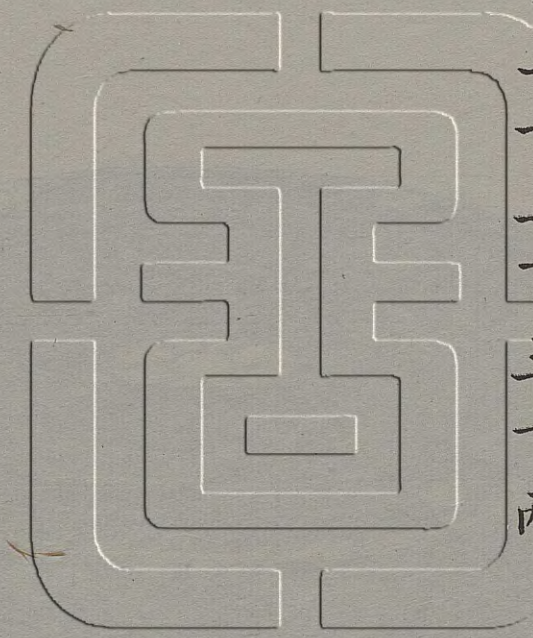

漢銅鼓三

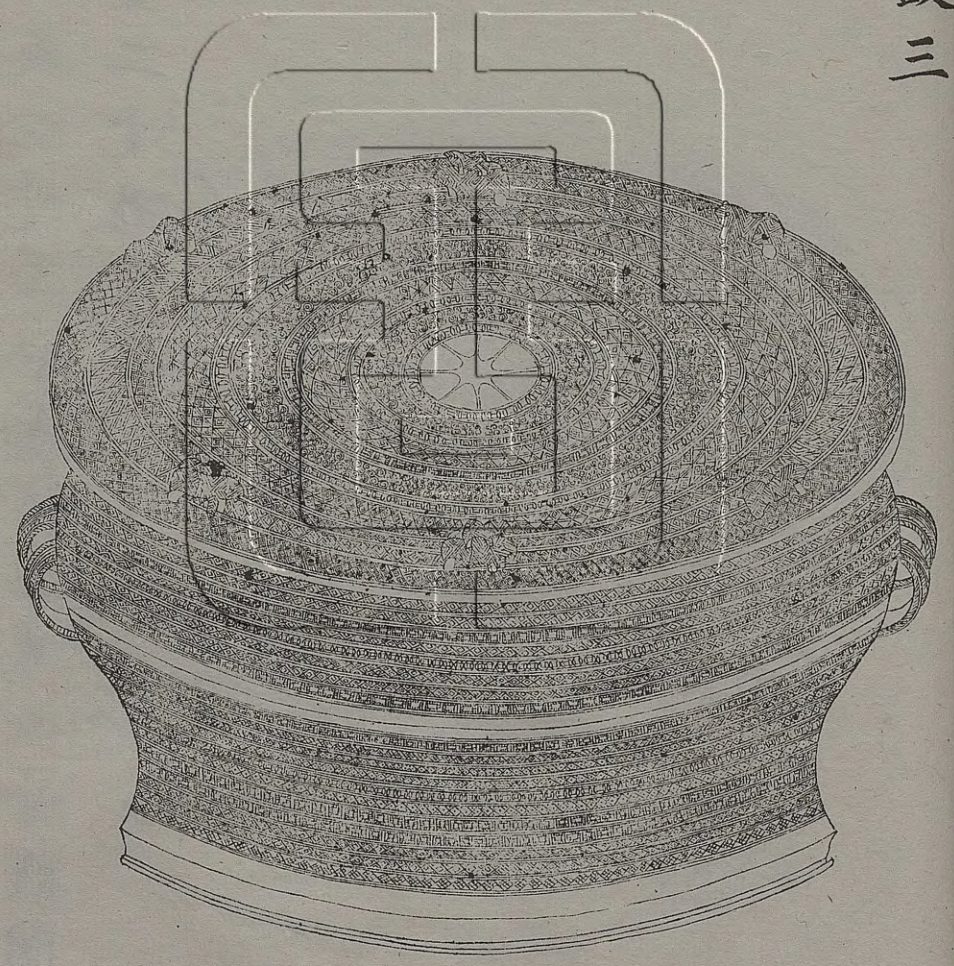

右高一尺二寸七分面徑三尺七分腹圍八尺四寸重二千五十兩



漢銅鼓四

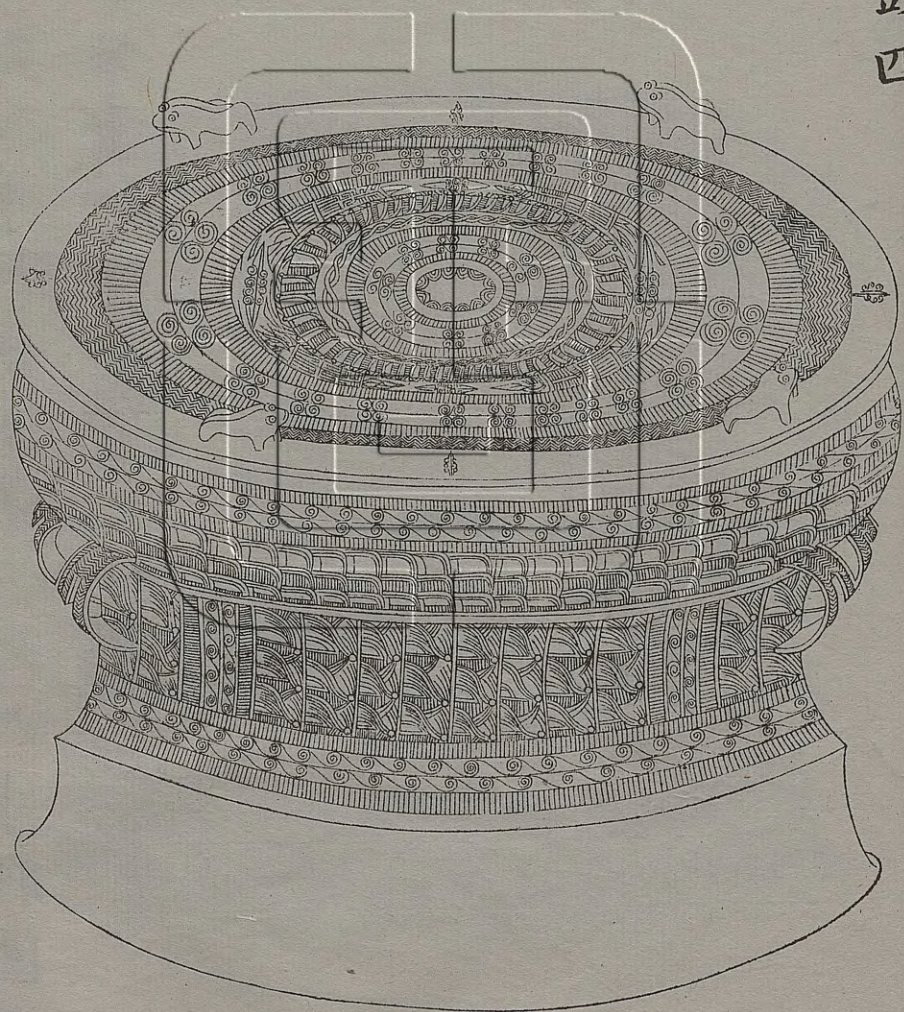

右高一尺八寸六分面徑二尺六寸腹圍六尺九寸二分重一千七百三十兩

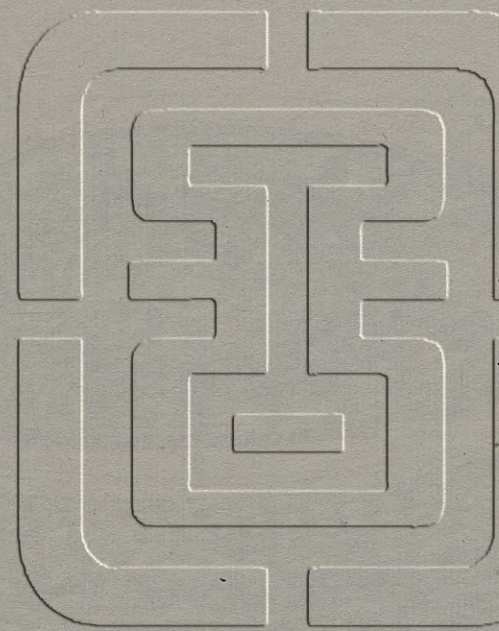

漢銅鼓五

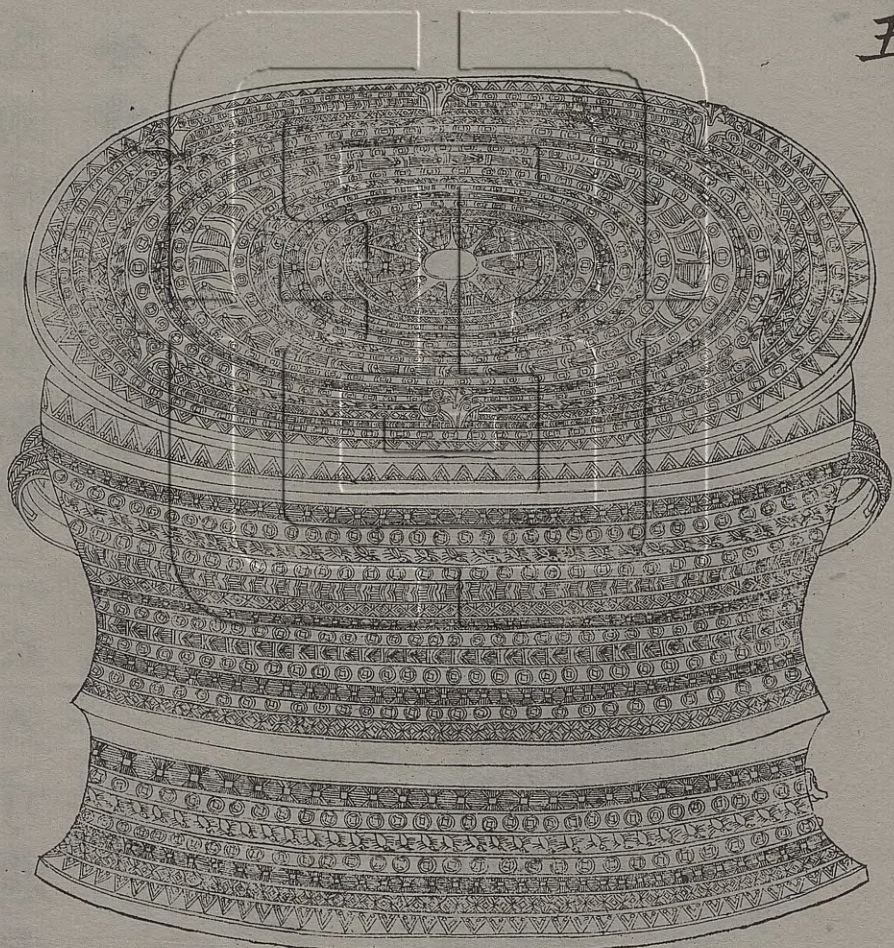

右高一尺四寸四分面徑二尺五寸腹圍七尺  
一寸二分重一千二百二十兩

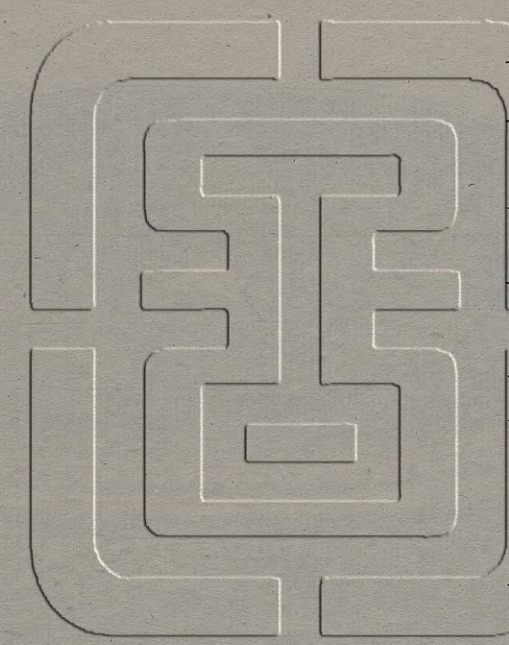

漢銅鼓六

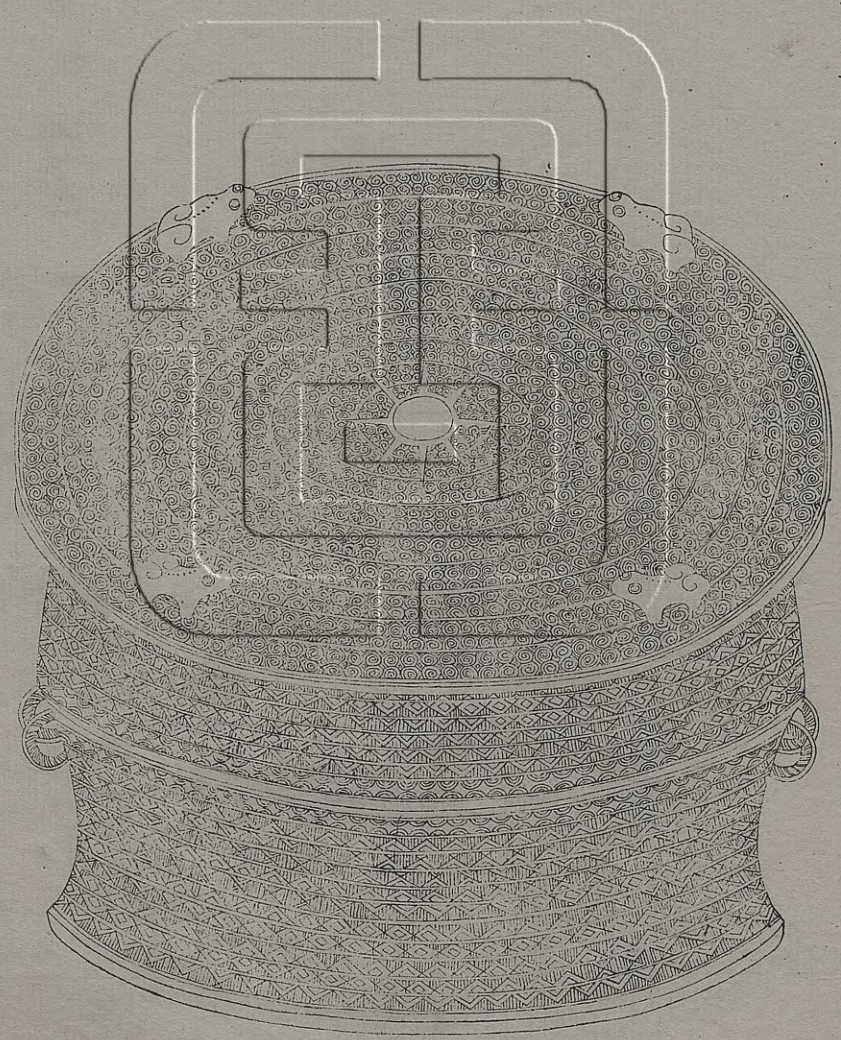



右高一尺一分面徑二尺四寸五分腹圍七尺  
八分重九百二十四兩

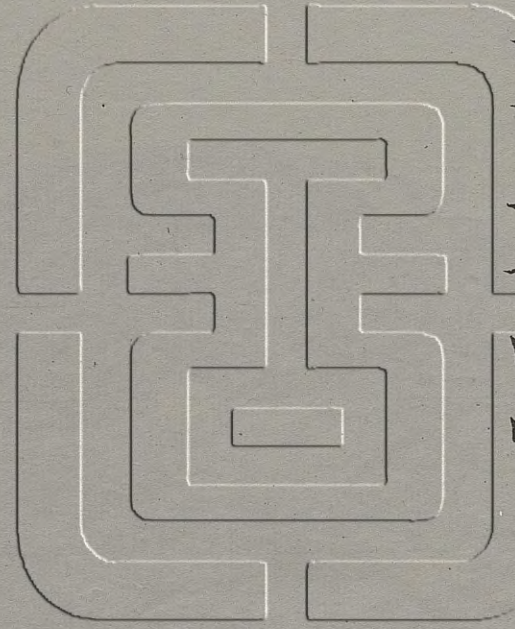

漢銅鼓七

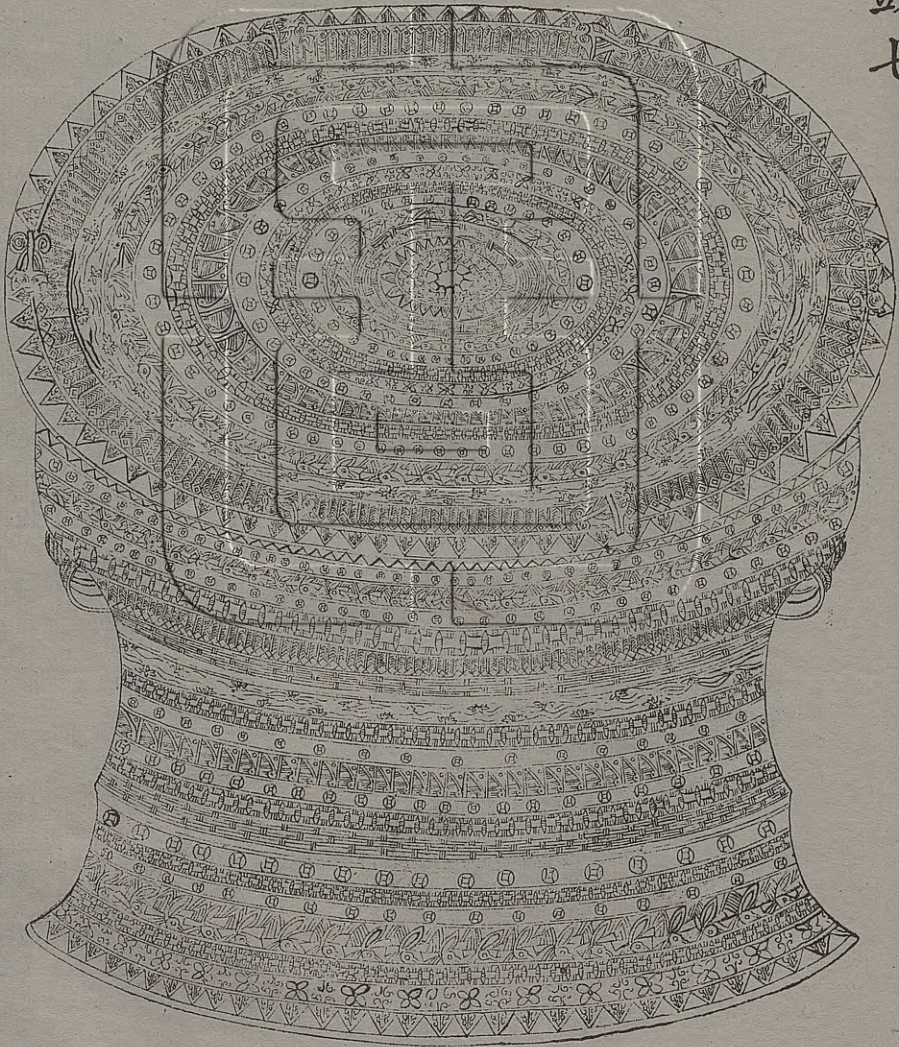

右高一尺二寸九分面徑二尺二寸腹圍六尺  
六寸二分重八百三十六兩

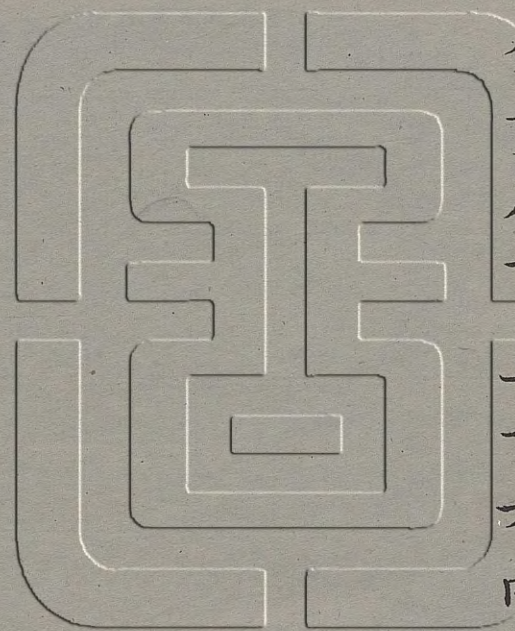

漢銅鼓八

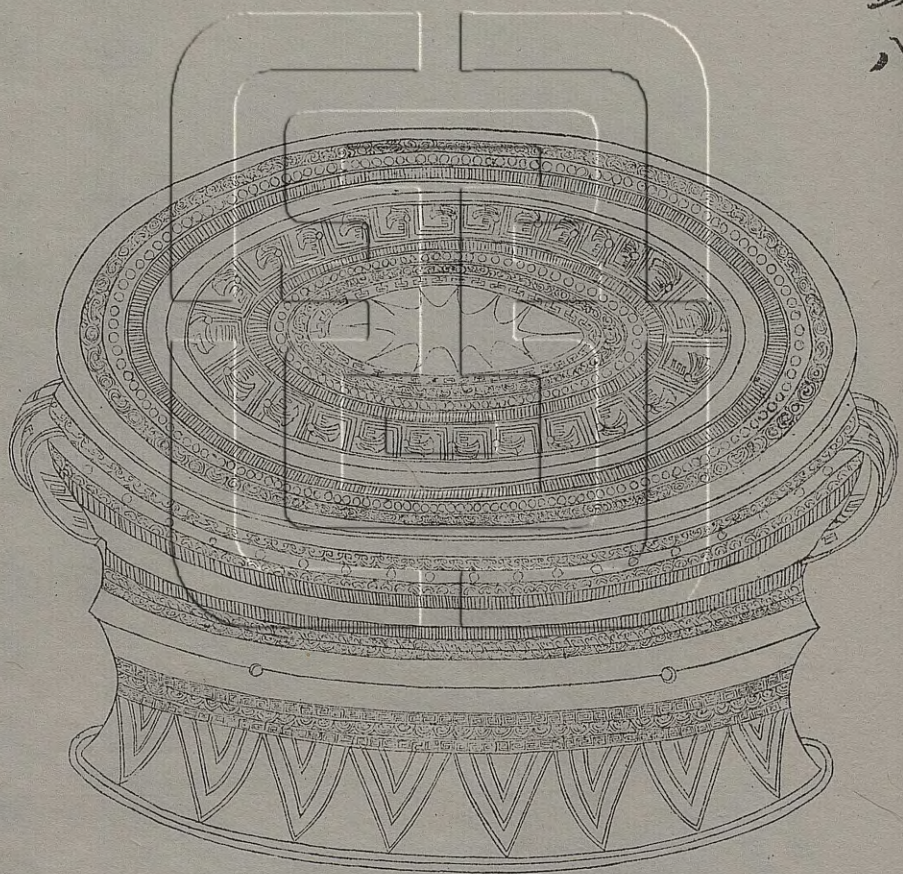

右高九寸一分面徑一尺五寸五分腹圍四尺四寸九分重四百九十四兩

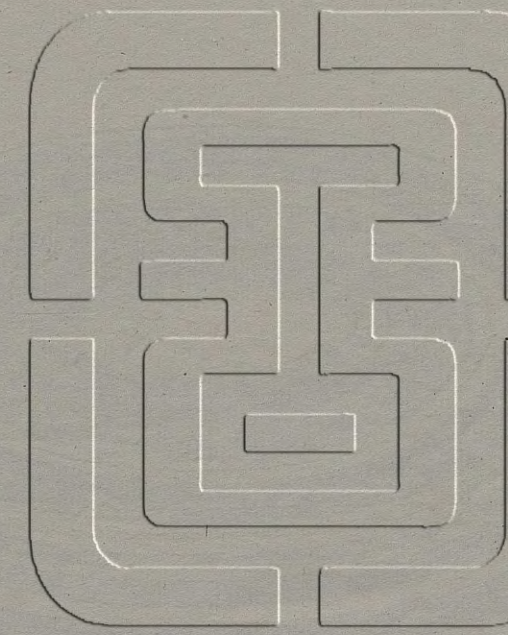

漢銅鼓九

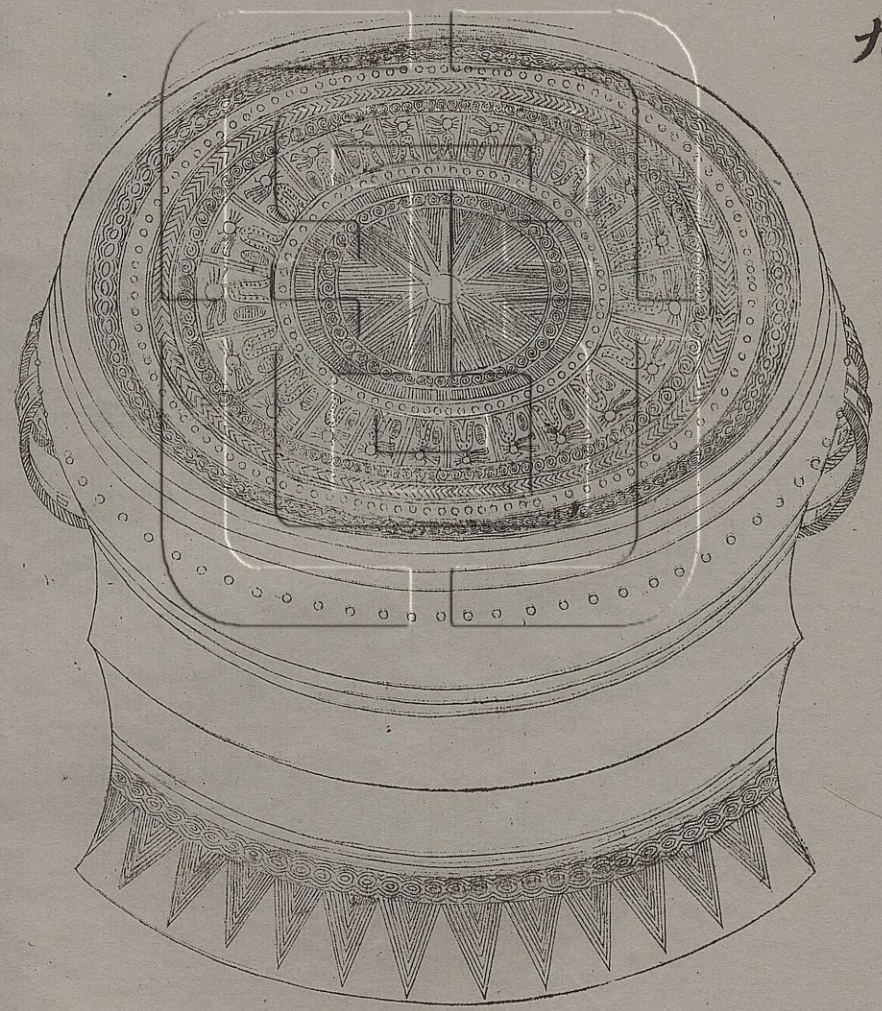

右高八寸八分面徑一尺四寸七分腹圍四尺五寸四分重四百三十五兩

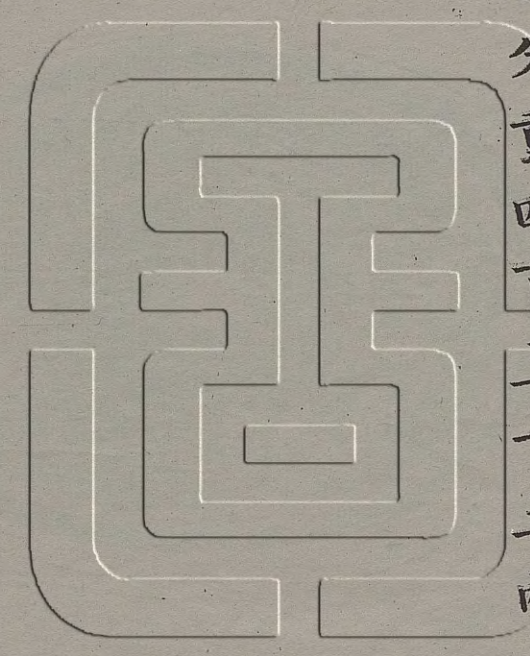

漢銅鼓十

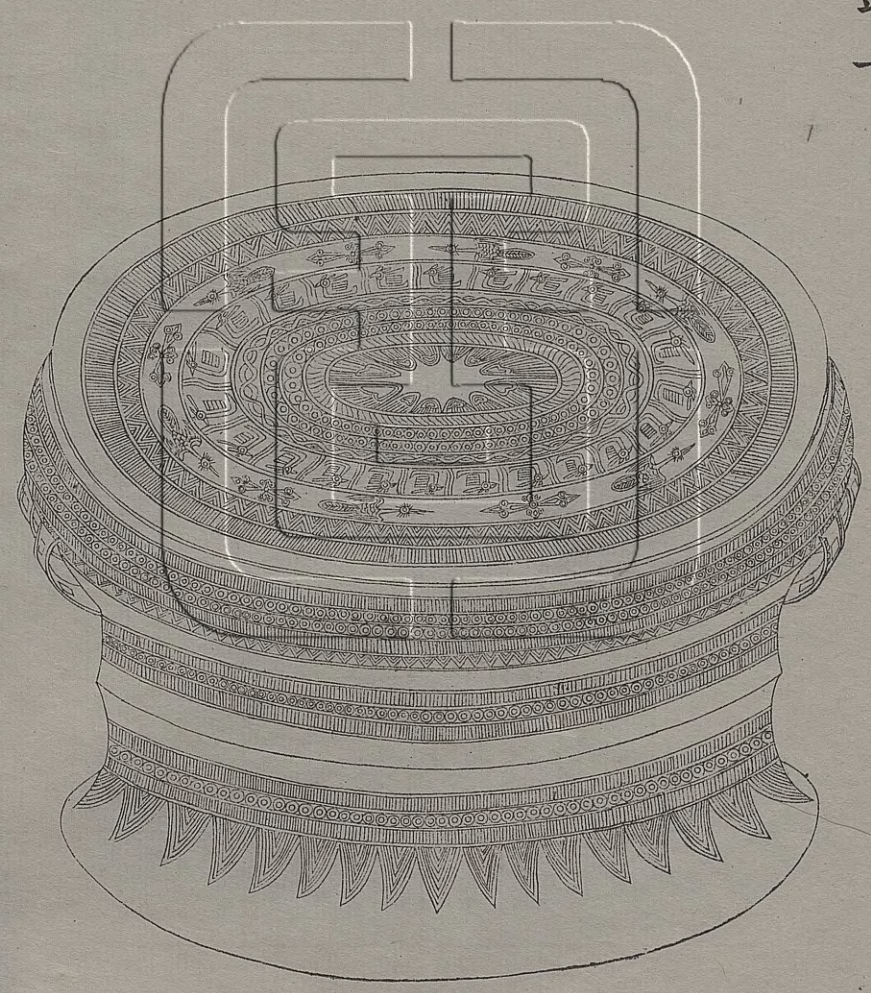

右高一尺六分面徑一尺五寸六分腹圍四尺  
三寸五分重四百三十兩

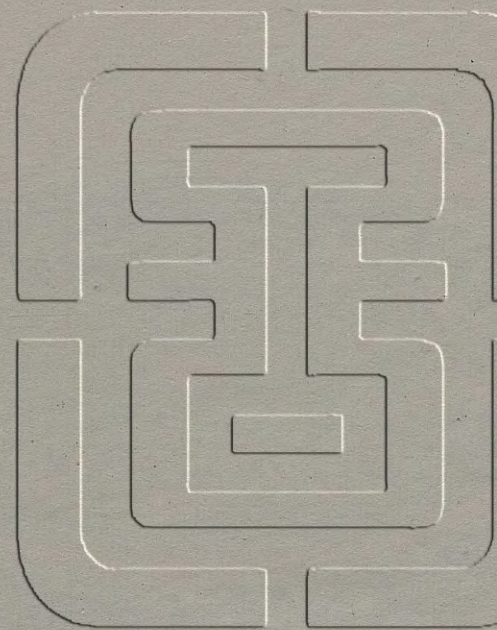

漢銅鼓十一

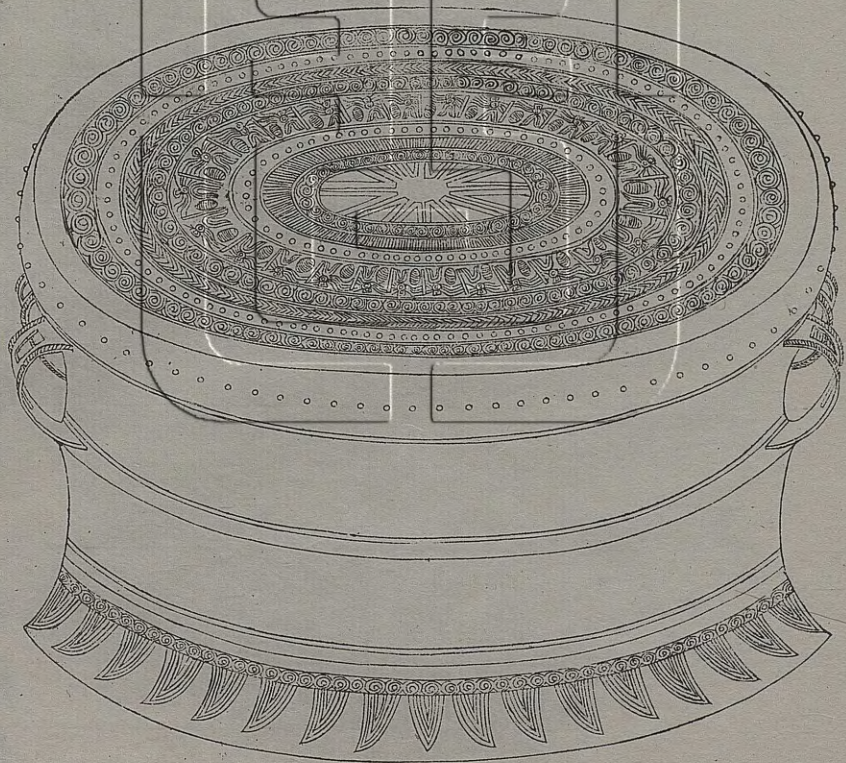

右高八寸六分面徑一尺五寸一分腹圍四尺  
六寸五分重四百一十九兩

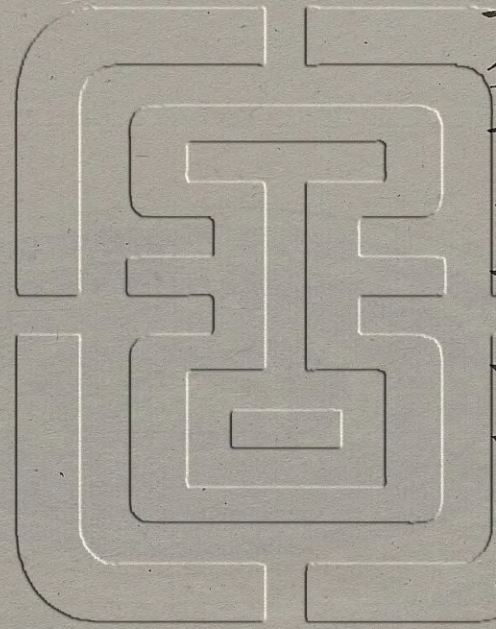

漢銅鼓十二

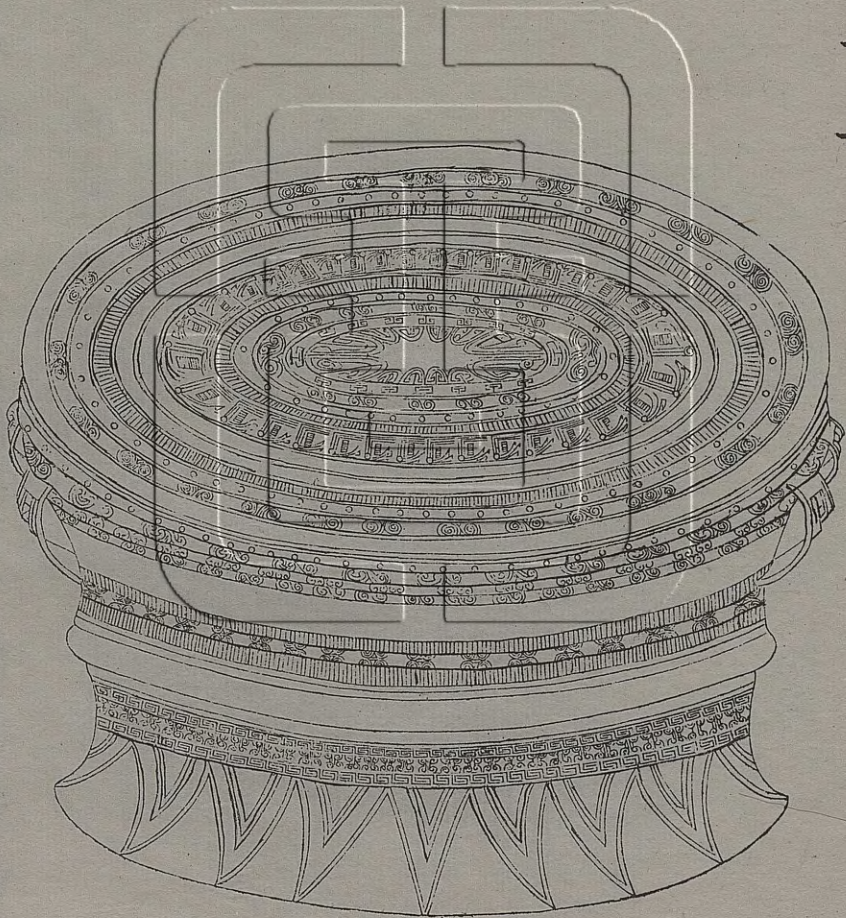

右高九寸面徑一尺五寸七分腹圍四尺七寸五分重三百九十五兩



漢銅鼓十三

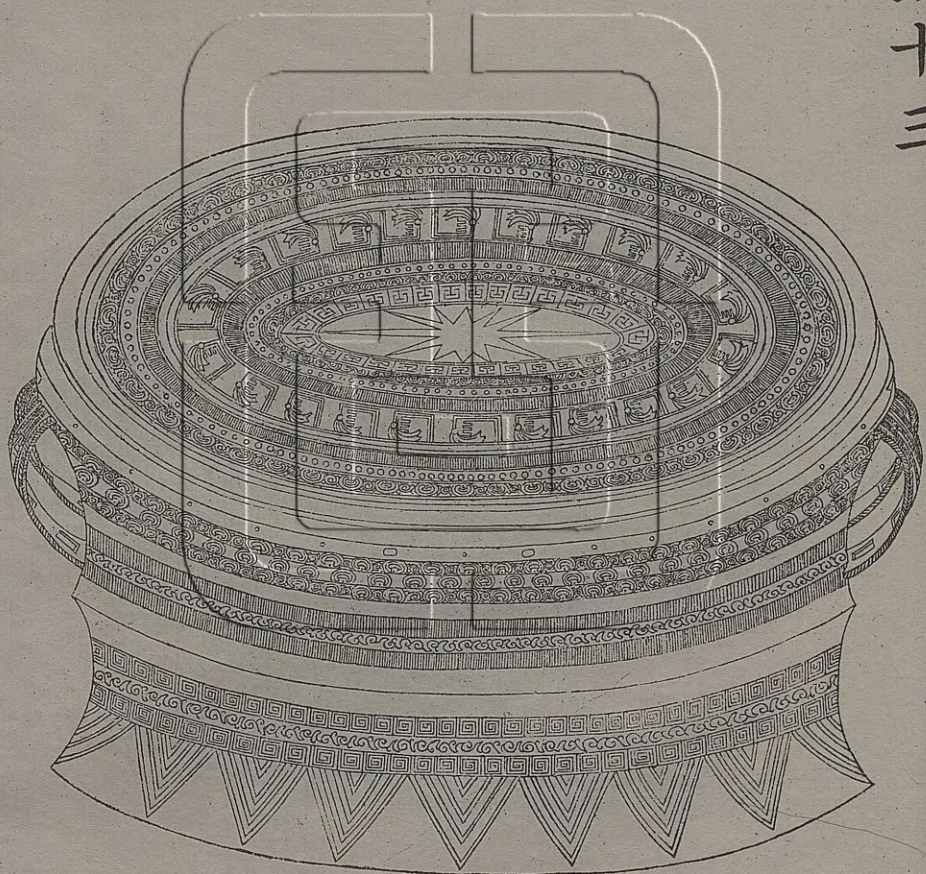

右高九寸面徑一尺五寸四分腹圍四尺六寸  
八分重三百六十六兩

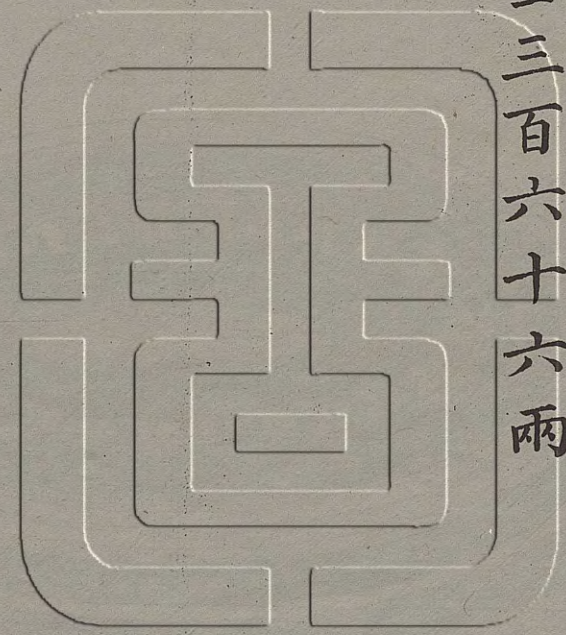

漢銅鼓十四

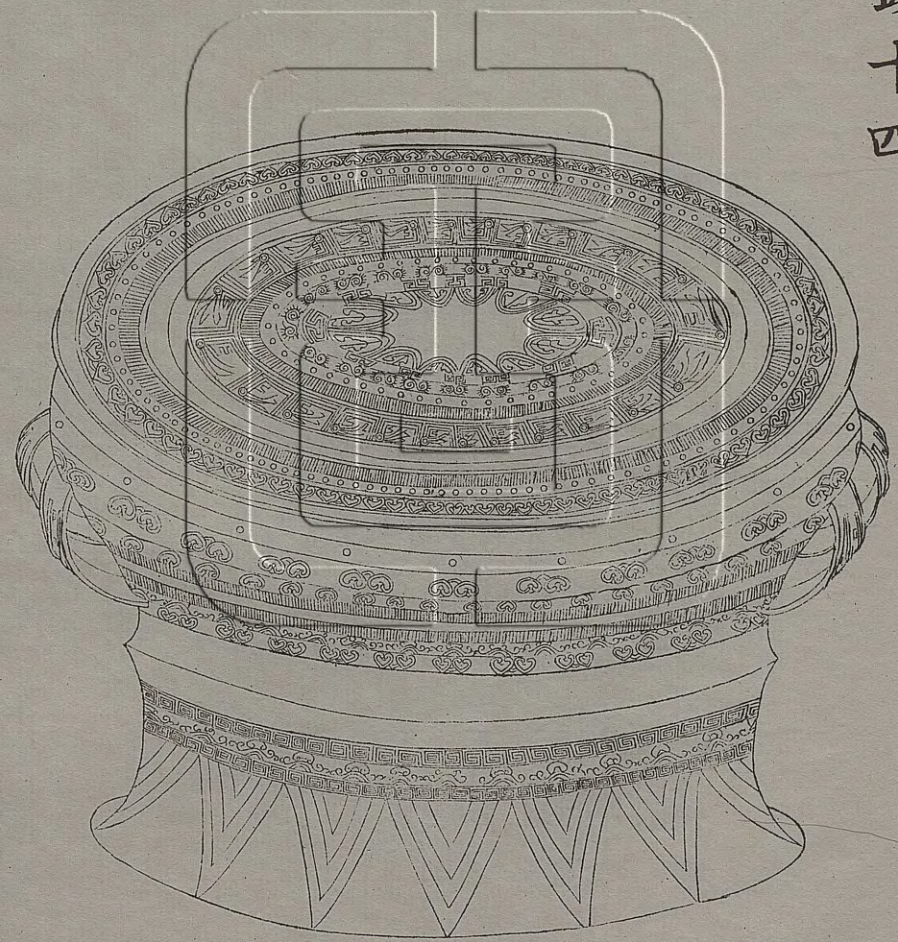



右高八寸五分面徑一尺五寸腹圍四尺二寸五分重三百一十五兩

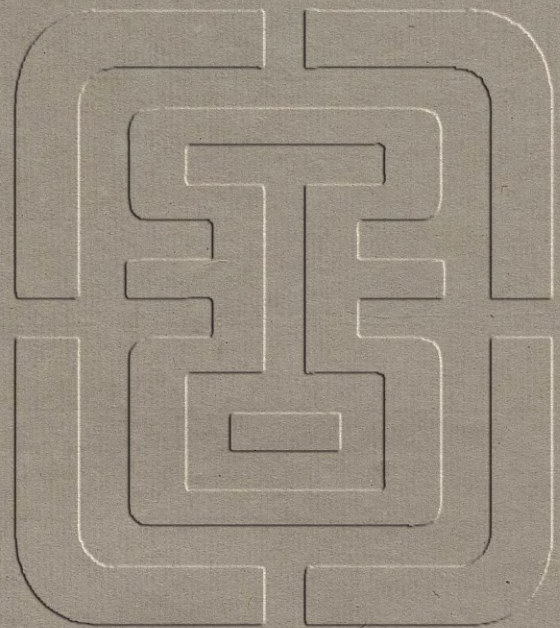

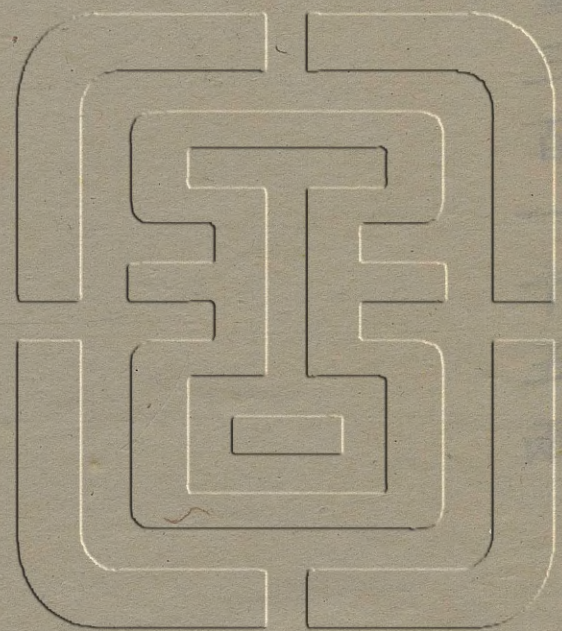
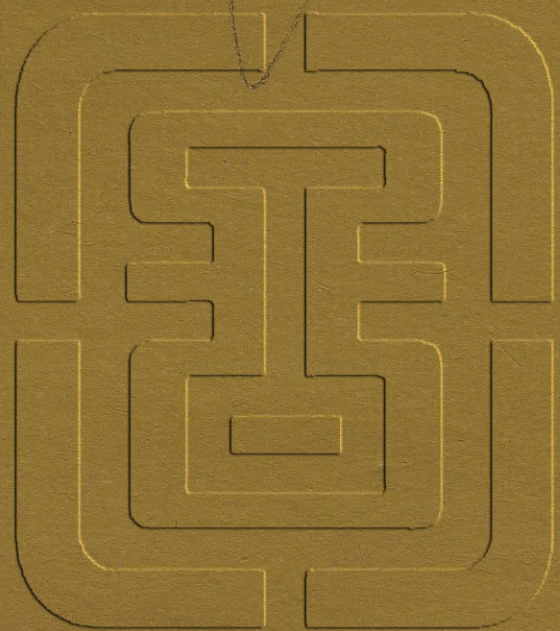

右高八寸五分  
面徑八寸  
五分重  
大五寸版圖  
四尺二寸

