

## **Historic, archived document**

Do not assume content reflects current scientific knowledge, policies, or practices.



Reserve  
SD11  
U523

136624

736624

U. S. DEPT. OF AGRICULTURE  
NATIONAL ARCHIVES LIBRARY  
NOV 1978

NOV 1978

PROCUREMENT SECTION  
Alphabetical Serial File



# LOGGING SYSTEMS GUIDE

LOGGING SYSTEMS GUIDE. U.S. Department of Agriculture, Forest Service, Alaska Region, Division of Timber Management, P.O. Box 1628, Juneau, Alaska 99802. April 1978, Series No. R10-21.

## PREFACE

This guide is mainly a combination of material from "Cable Logging Systems," published by Region 6 of the Forest Service; "Willamette Logging Systems Guide," a supplement; and Virgil Binkley's "Helicopter Logging." Some additional information has been added in the following sections: 21-Horse Logging, 30-Tractors, Skidders and Forewarders, 46.1-Yarders, 46.2-Towers, 47-Carriages, and 50-Balloon. Minor additions were also made in other sections. Because of the many references made to it, the Oregon State Safety Code was abbreviated as O.S.S.C.

The following persons were acknowledged for their help in preparing and reviewing the information presented in the publications on which this one is based: Dave Burwell, Ron Ring, Ken Weber, Faye Steward, Tom Shipler, John Sessions, John Warner, Ken Andrews, Bruce Smith, Jim Seabaugh, Dennis Caird, Andy Anderson, Paul Cunningham, and others.

It is recognized that knowledge and skill are essential in making logging safe. Practices recommended in this publication may need to be adapted to local safety requirements.



KEITH L. MCGONAGILL  
Logging Specialist  
Alaska Region

*Conclusions and viewpoints published in this text do not necessarily reflect the views or policy of the U.S. Department of Agriculture or the Forest Service. Also, reference to commercial firms, trade products, or company names is only for identification and does not imply endorsement by the U.S. Department of Agriculture or the Forest Service.*

## CONTENTS

Number  
code

<u>10</u>	<u>INTRODUCTION</u>
11	Background
12	Planning
13	Logging Systems
<u>20</u>	<u>ANIMALS</u>
21	Introduction
22	System Description
23	Requirements and Limitations
24	Operation
25	Layout Recommendations
26	Advantages
27	Disadvantages
<u>30</u>	<u>TRACTORS, RUBBER TIRED SKIDDERS AND LIGHT FLOTATION</u>
	<u>FOREWARDERS</u>
31	System Description
32	Requirements and Limitations
33	Operation
34	Layout Recommendations
35	Advantages
36	Disadvantages
<u>40</u>	<u>CABLE</u>
41	Introduction
42	<u>Landings</u>
42.1	Introduction
42.2	Types of Landings
42.3	Types of Settings
42.4	Landing Location
42.5	Landing Size
42.51	Yarding Requirements
42.51a	Lead
42.51b	Yarding Equipment
42.52	Log Sorting
42.53	Decking
42.54	Loading Requirements
42.54a	Loader Dimensions
42.55	PUM Yarding
42.6	Special Landing Consideratins for Specific Logging Systems
42.61	High Lead
42.62	Live Skyline
42.63	North Bend, South Bend, Modified North Bend (Bight Down), Block in the Bight (Bight Up).
42.64	Clamping Carriages and Skidding Drum Carriages
42.65	Thinning Landings
42.7	Landing Construction
42.8	Swing Landings
43	<u>Rigging and Wire Rope</u>
43.1	Introduction
43.2	<u>Wire Rope</u>
43.21	Component Parts

43.22	Strand Construction
43.23	Lays
43.24	Cores
43.25	Rope Measurement
43.26	Grade and Classification
43.26a	Grade
43.26b	Classification
43.26c	Wire Rope Recommendations
43.27	Stretching and Load Limits
43.28	Special Treatments and Special Ropes
43.28a	Preforming
43.28b	Flattened Strand
43.28c	Dyform
43.28d	Plastic Impregnated Wire Rope
43.29	Handling Wire Rope
43.29a	Drum Capacity
43.3	<u>Wire Rope Connections and Fittings</u>
43.31	End Splicing
43.31a	Tucked Long Splice
43.31b	Rolled Long Splice
43.31c	Jump Splice
43.32	Eyes
43.32a	Logger's Eye Splice
43.32b	Farmer's Eye Splice
43.32c	Marine Splice
43.33	Wire Rope Fittings
43.33a	Ferrules
43.33b	Hooks
43.33c	Sockets and Dees
43.33d	Swivels
43.33e	Clips
43.34	End Preparation
43.35	Efficiency of Wire Rope Connections
43.36	Connecting Wire Rope for Yarding Practice
43.4	<u>Rigging Hardware</u>
43.41	Rigger's Tools
43.42	Rigging Equipment
43.42a	Blocks
43.42b	Shackles (cleavices)
43.42c	Miscellaneous
43.5	<u>Rigging Practice</u>
43.51	Stringing Strawline
43.52	Rigging Head Trees
43.53	Rigging Tail Holds
43.54	Rigging Stumps
43.55	Rigging Tail Trees
43.56	Yarding Beyond Drum Capacity
44	<u>Anchors</u>
44.1	Introduction
44.2	Stump Anchors
44.21	Stump Anchor Mechanics
44.22	NonDesign Stump Anchor Practices
44.3	Deadmen

- 44.31 Guide for Designing Deadmen Anchors
- 44.32 Suggestions for Deadman Installation
- 44.33 Deadman Designs
- 44.4 Rock Bolts
- 44.5 Tent Pegs
- 44.6 Earth Screws
- 44.7 Equipment Anchors
- 45 Guylines
- 45.1 Introduction
- 45.2 Safety Code Requirements
- 45.3 Mechanics of Guylines
- 45.4 Guyline Length Estimation
- 46 Yarders, Towers and Undercarriages
- 46.1 Yarders
- 46.11 Horsepower
- 46.12 Transmissions
- 46.13 Interlocks
- 46.14 Frictions (Clutches)
- 46.15 Drums
- 46.15a Drum Brakes
- 46.15b Drum Capacity
- 46.16 Fairleads
- 46.17 Yarder Operations
- 46.17a High Lead Operation
- 46.17b Flyer Operation
- 46.17c Slackline Operation
- 46.17d Fallblock Systems
- 46.17e Slack Pulling Carriage Systems
- 46.17f Skidder System
- 46.2 Towers
- 46.3 Undercarriages
- 46.31 Trailer Mounted Undercarriages
- 46.32 Self-Propelled Rubber Mounted Undercarriages
- 46.33 Self-Propelled Crawler Mounted Undercarriages
- 46.34 Truck Mount
- 46.35 Sled Mount
- 47 Carriages
- 47.1 Clamping
- 47.2 Non Clamping
- 47.3 Grapple, Non-Slack Pulling, Slack Pulling
- 47.31 Grapple
- 47.32 Non-Slack Pulling
- 47.32 Slack Pulling
- 47.33a Slack Pulled by Hand
- 47.33b Slack Pulled by Yarder
- 47.33c Slack Pulled by Carriage
- 48 Types of Cable Systems
- 48.1 Jammer
- 48.11 Introduction
- 48.12 System Description
- 48.13 Requirements and Limitations
- 48.14 Operation
- 48.15 Advantages

- 48.16 Disadvantages
- 48.2 Highlead
- 48.21 System Description
- 48.22 Requirements and Limitations
- 48.22a Cutting Prescriptions
- 48.22b Direction of Yarding
- 48.22c Topography
- 48.22d Yarding Distance
- 48.22e Soil
- 48.23 Operation
- 48.24 Layout Recommendations
- 48.25 Advantages
- 48.26 Disadvantages
- 48.3 Standing Skylines
- 48.31 Introduction
- 48.31a Yarding Distance
- 48.31b Operation
- 48.31c Advantages
- 48.31d Disadvantages
- 48.32 North Bend
- 48.33 South Bend (or Modified North Bend or Bight Down)
- 48.34 Block in the Bight (or Bight Up)
- 48.35 Skidder
- 48.36 Tyler
- 48.37 Standing Skylines with Radio-Controlled Carriages
- 48.37a System Description
- 48.37b Requirements and Limitations
- 48.37c Operation
- 48.37d Layout Recommendations
- 48.37e Advantages
- 48.37f Disadvantages
- 48.4 Live Skylines
- 48.41 Flyer (or Shotgun)
- 48.41a System Description
- 48.41b Requirements and Limitations
- 48.41c Operation
- 48.41d Layout Recommendations
- 48.41e Advantages
- 48.41f Disadvantages
- 48.42 Slackline
- 48.42a System Description
- 48.42b Operation
- 48.42c Layout Recommendations
- 48.42d Advantages
- 48.42e Disadvantages
- 48.43 Live Skyline with Radio-Controlled Carriage
- 48.43a System Description
- 48.43b Operation
- 48.43c Advantages
- 48.43d Disadvantages
- 48.44 Live Skyline with Mechanical Carriage
- 48.44a Two-Drum Yarder
- 48.44b Four-Drum Yarder



48.45	Live Skyline with Radio-Controlled Grapple
48.5	<u>Running Skyline</u>
48.51	System Description
48.52	Requirements and Limitations
48.53	Operation
48.54	Grabinsky
48.55	Running Skyline with Mechanical Slack Pulling Carriage
48.56	Running Skyline with Mechanical Grapple
48.57	Running Skyline with Radio-Controlled Grapple
48.6	<u>Cable Swings</u>
48.7	<u>European Systems and Multispan Skylines</u>
48.71	Present Equipment
48.71a	American Equipment
48.71b	European Equipment
48.72	Skyline Jacks
48.73	Pulling Slack
48.74	Multispan Landings
48.75	Design Criteria
48.76	Constructed Appraisal Procedure
48.77	Sale and Development
49	<u>Summary of Logging Systems</u>
49.1	Advantages of Skyline Logging
49.2	Disadvantages of Skyline Logging
50	<u>BALLOON</u>
50.1	System Description
50.11	Haulback Configuration
50.12	Inverted Skyline Configuration
50.13	Yo-Yo Configuration
50.2	Requirements and Limitations
50.3	Operation
50.31	Rig Up Procedure
50.4	Layout Recommendations
50.5	Advantages
50.6	Disadvantages
60	<u>HELICOPTER</u>
61	Introduction
62	System Description
63	Requirements and Limitations
63.1	Yarding Cycle Variables
63.2	Landings
63.3	Service Area
63.4	Flight Path
63.5	General Safety
64	Sale Layout Recommendations
65	Advantages
66	Disadvantages
70	<u>REFERENCES</u>
90	<u>APPENDIX</u>
91	Yarder Statistics
92	Helicopter Lift Capability
93	Raft Nomenclature



# LOGGING SYSTEMS GUIDE

Compiled By

Keith L. McGonagill, Logging Specialist  
And Others

Division of Timber Management  
Alaska Region, Forest Service  
U.S. Department of Agriculture

10

## 10 - INTRODUCTION

### 11 - Background

Logging with oxen was common in the Pacific Northwest in the 1890's. After the turn of the century they were phased out by horses which were faster, easier to handle and they had no horns.

Steam and cables joined forces in the logging industry around the turn of the century with most of the original cable logging work accomplished in the Pacific Northwest. "Steam-pot" yarders pulled the logs into the landing at drum level--with attendant hangup problems, particularly with the high stumps of the day. Often corduroy skidroads were required, just as in the ox and horse logging which preceded the cables.

The solution was to get some lift on the logs, to provide some pull from above to get them over, or around, the obstacles.

The first spar, to provide this lift, was reportedly rigged by a sailing ship's rigger in the late 1800's; hence the term, "rigging". Lidgerwood patented the railroad skidder, a yarder and spar combination, in 1902. Used in railroad logging, the Lidgerwood was the forerunner of today's mobile spar.

Steampower was gradually replaced by gasoline powered internal combustion engines. These were, in turn, replaced by diesel engines. Today's logger operates highly sophisticated machines with air controls, water-cooled brakes and interlocking drums.

As the easier ground was logged off it was apparent that logging systems were needed that would yard logs long distances across adverse terrain.

Balloon logging was first attempted in Sweden using hydrogen filled World War II barrage balloons. Tests were made in Canada in 1962 and 1963 using stacked, or single hull balloons. In 1963 tests were made at Reedsport, Oregon using "Vee" balloons and a single hulled Canadian balloon. In 1965 an administrative timber sale was made in the Deception Creek drainage on the Willamette National Forest for a Vee balloon. In 1966, a natural, or onion, shaped balloon was first used on the Deception Creek sale.

The first reported testing of helicopters for logging was in Scotland in 1956. Other tests were made in Canada (1957), Russia (1959) and Norway (1963). These early attempts were not considered economically successful primarily because of the limited load carrying capacity of the machines.

Renewed efforts were made in the early 70's in both Canada and the United States. The first Forest Service timber sale specifying helicopter logging was made on the Plumas National Forest in 1971.

## 12 - Planning

Logging engineering, or logging planning, is the interface between multiple use, environmental concerns, and timber harvesting. Logging engineering covers all timber harvesting activities from "the stump to the dump". The Logging Specialists job is to insure that an area can be harvested and meet the resource objectives, using the indicated equipment and practices.

Obviously, the Logging Specialist must be able and willing to work with other specialists to insure that the minimum cost solution is identified for each timber harvest area. The minimum cost includes not only direct logging costs, but costs of activities or resources affected by timber harvest. These may have no dollar equivalent.

Logging is a specialized form of materials handling and transportation. The fact that the material in question is logs located on forested land only further defines the handling system requirements. Environmental factors more specifically define the conditions under which logs must be transported. In short, the forest must be harvested within the constraints of sound land management.

Present intensive forest management requirements, combined with operations on more difficult terrain with sensitive soils, has created demands for the highest of technological developments. This Guide presents some basic information on logging systems and some procedures for their operation. Procedures for logging system planning are discussed in FSH 2409.24 R-10, Chapter 100.

## 13 - Logging Systems

Logging systems in this Guide are divided into five categories: animal, tractor and skidder, cable, balloon and helicopter. Each system has its own rigging and operational characteristics. Each is adaptable to certain topographic characteristics and silvicultural prescriptions. The job of the Logging Specialist is to match the system and the terrain to meet objectives prescribed by the land manager.

The figure below illustrates yarding system capabilities for a range of conditions. The table below is a tabulation of the systems, along with their approximate external yarding distances. From the figure or table, a comparison of access road spacing relative to yarding distances of the various systems can be approximated.

As log transportation requirements become more complex, the Logging Specialist is faced with more complex sale transportation problems. He must become more familiar with systems and how they are employed to achieve maximum land management benefits at minimum cost. The purpose of this Guide is to aid in that goal.



## Yarding Systems Capabilities

Yarding System	Harvest Method		Design for External Yarding Distance of: <u>2/</u>					Limiting Slope % Yarding up down	Minimum Number of Lines
	CC	1/ PC	200'	600'	1000'	1500'	2000'		
TRACTOR									
uphill	x	x	←					+ 20	1
downhill	x	x		→				- 35	1
SKIDDERS									
uphill	x	x	←					15	1
downhill	x	x		→				25	1
HEELBOOM									
uphill	x	x	←					40	1
downhill	x	x		→				30	1
JAMMER w/Haulback									
uphill	x		←					55	2
downhill	x			→				35	2
MOBILE YARDER w/Carriage									
uphill	x	x		→				75	2
downhill									
HIGHLEAD									
uphill	x			→				70	2
downhill	x		←					40	2
SKYLINE - LIVE									
uphill	x	x		→				100	2
downhill	x	x		→				100	3
SKYLINE - RUNNING									
uphill	x	x		→				100	3
downhill	x	x		→				100	3
SKYLINE - STANDING									
uphill	x	x		→				100+	2
downhill	x	x		→				100+	2
BALLOON									
uphill									
downhill	x							100+	2
HELICOPTER									
uphill	x	x						100+	1 <u>3/</u>
downhill	x	x						100+	1

solid line indicates the preferred direction of yarding

1/ CC = clear cut  
PC = partial cut

2/ External yarding distance varies with the terrain, size and type of equipment

3/ Loadline

## 20 - ANIMALS

### 21 - Introduction

Yarding or skidding with horses or oxen was at one time the only means of power to move a log from the Forest to a mill site.

Animal skidding is now limited to stands which require special protection such as campgrounds, summer home sites, and some partial cuts. In areas where horse loggers are available, thinning and other special silvicultural applications may be practiced on a sustained basis.

### 22 - System Description

Animals are harnessed singly, or in teams, to a turn of logs and through brute force logs are skidded to the landing. Large draft horses, weighing 1600 to 2000 pounds, are not uncommon. Oxen were phased out of logging in the early 1900's.

Horses are normally worked in singles. Teams are common on large logs. It is desirable to have three horses, if one is injured a team is still available. Horses are alternated every couple of hours.

It is desirable to have a man for each horse.

Some horses are trained to skid logs to the landing unattended. However, unattended they tend to follow the same skid road, which can result in gouging out a rut that could create erosion problem.

### 23 - Requirements and Limitations

All aspects of planning a horse show must be in favor of the animal. Since both ends of the log are on the ground, the only advantage for the horse is favorable grade skidding, or possible skidding over snow. Even with snow packed skid trails, downhill skidding is recommended. The locations of landings and skid trails is extremely important in animal skidding. Long corners will result in increased costs.

Skid trails for teams are much wider than for singles and are limited to more gentle ground.

Skid trails must be cleared of all brush and stumps. Skid pans can be used to keep the front end of logs from digging into ground.

Logs can be cold decked for loading by a self loading truck. Decking with horses is a problem.

Horses must be located near a creek to provide drinking water.

A corral or shelter, is a necessity.



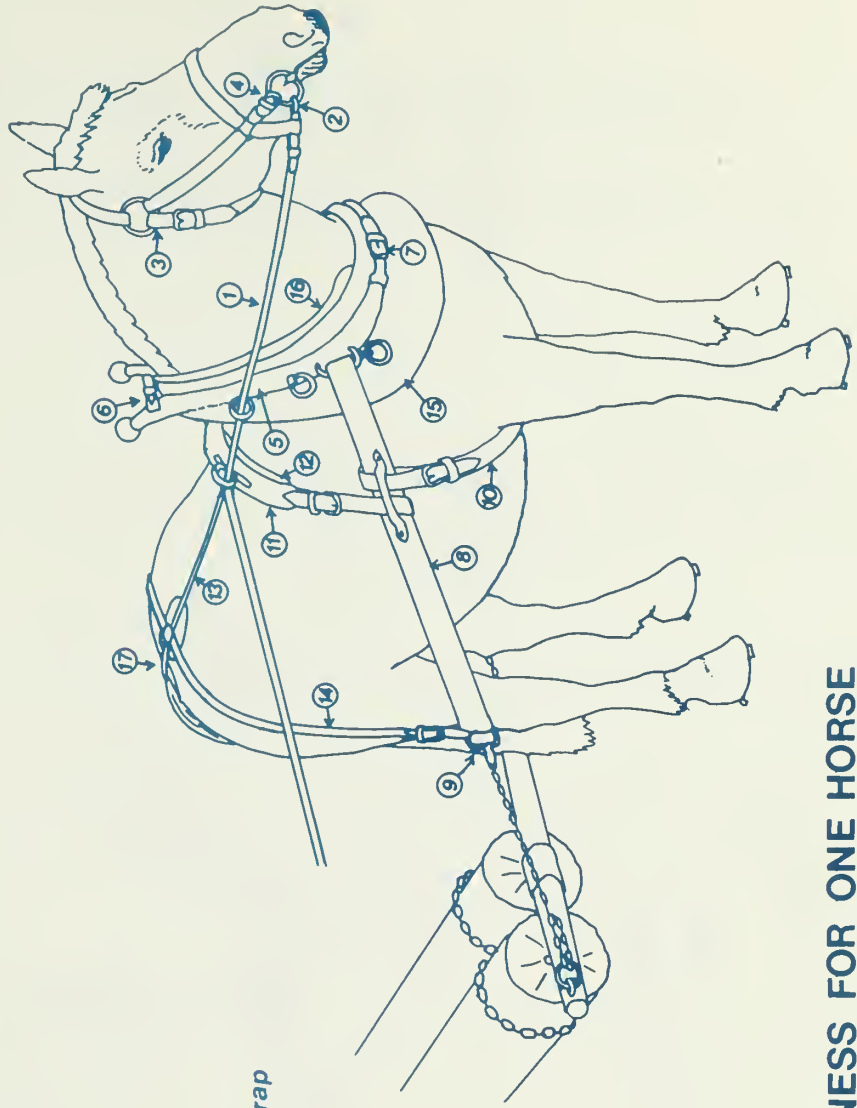

**NAME OF PARTS**

- 1 Reins
- 2 Reins Snaps
- 3 Halter Bridle
- 4 Bit Straps
- 5 Hames
- 6 Hames Top Strap
- 7 Hames Bottom Strap
- 8 Tugs
- 9 Tug Hooks
- 10 Bellyband
- 11 Saddle
- 12 Saddle Pad
- 13 Back Strap
- 14 Hip Strap
- 15 Collar
- 16 Sweat Pad
- 17 Crupper

**YARDING HARNESS FOR ONE HORSE**

# A COMPLETE SET OF TWO HORSE YARDING HARNESS

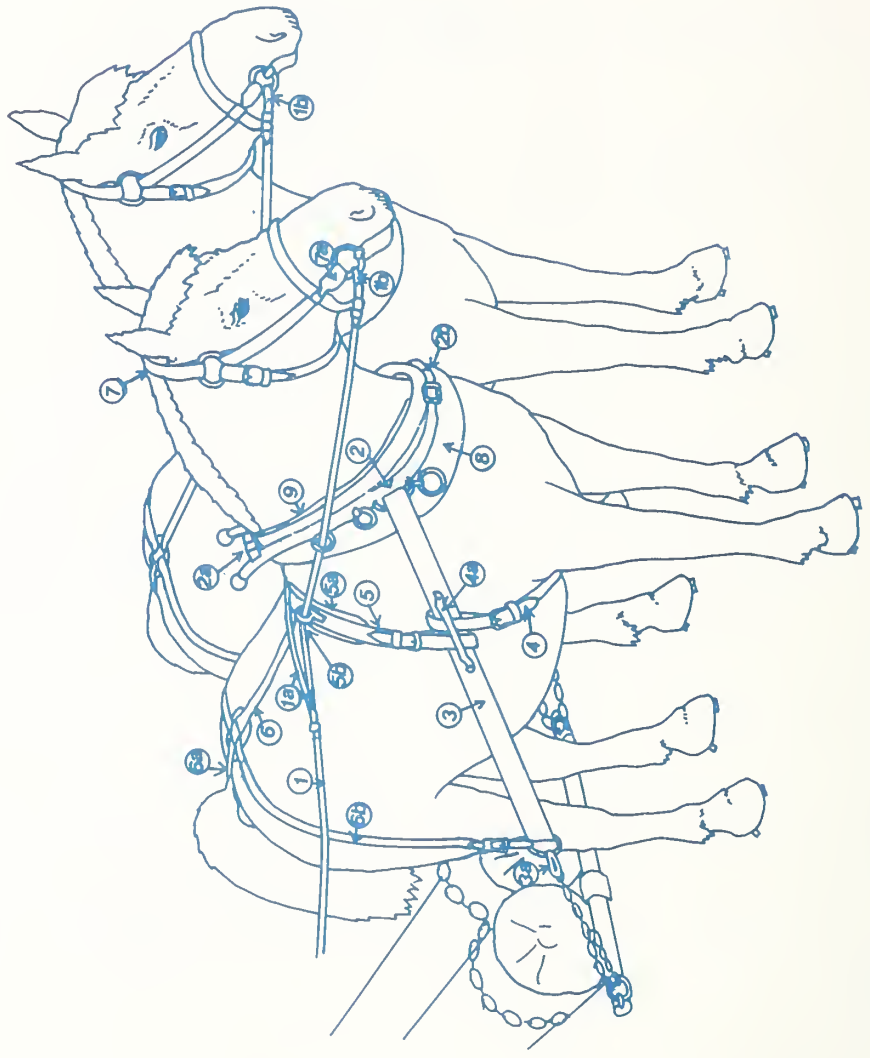

## NAME OF PARTS

- 1 Reins
- 1a Cross Reins
- 1b Rein Straps
- 2 Hames
- 2a Hames Top Straps
- 2b Hames Bottom Straps
- 3 Tugs
- 3a Tugs Hook
- 4 Bellybands
- 4a Billets
- 5 Saddle
- 5a Saddle Pad
- 5b Saddle Loop
- 6 Back Straps
- 6a Cruppers
- 6b Hip Straps
- 7 Halter Bridles
- 7a Bit Straps
- 8 Collars
- 9 Sweat Pads

## 24 - Operation

Falling and yarding may occur as one operation, as yarding production is very low. The same lay can be used for more than one tree.

It is best to begin work at the back of the setting and work forward to a landing. Operating in this manner keeps the animal in a slash free area.

Falling to the lead is essential as logs are hard for animals to turn.

Horses can't work over eight hours a day. Production is about 2.5 to 3 MBF per day for a team.

The maximum log should be about 500 board feet. The average turn should be about one-third of the animal's weight. A horse can pull its own weight on a sustained pull, but turns this size should be very infrequent.

## 25 - Layout Recommendations

1. Locate landings so skidding will be downhill. About 45 percent is the maximum slope in summer and 35 percent in winter. Horses move slower in the winter.

2. The external yarding distance shouldn't be over 500' on uniform slopes; under 300' is desirable to keep costs reasonable. Adverse skidding should not be over 100' at not more than 10 percent.

3. Avoid skidding over convex topography (concave slopes are best).

4. Avoid side hill skidding.

5. Avoid very large timber.

6. Avoid soft ground.

7. Snow, ice and rocky ground are not suitable for horses.

8. Animals can't work in a "V" bottom.

## 26 - Advantages

1. Soil damage is low.

2. Small landings can be used.

3. Utilization is good due to cutting smaller diameter, shorter logs.
4. No noise pollution.
5. Damage to leave trees in partial cuts is low.
6. Low investment and overhead costs.

### 27 - Disadvantages

1. Maintenance cost continues whether logging or not.
2. Caulked horse shoes are required to skid on frozen ground or snow.
3. Horses get tired and need rest breaks; this affect production.
4. Horses are limited to small log lengths and diameters; this affects production.
5. Horses can't work on rocky ground.
6. A longer contract period is required compared to tractors, due to slower operation.
7. There are not many horse loggers left.
8. Horses must be fed on weekends and when logging is done.
9. Repeated turns can wear out skid trails by gouging a trough. This means locating additional skid trails.
10. Slash disposal must be done by hand.

### 30 - TRACTORS, RUBBER TIRED SKIDDERS AND SOFT TRACK TORSION BAR SUSPENDED TRACTORS

#### 31 - System Description

This system is a ground lead system with one or both ends of the log dragging during skidding. One end suspension is accomplished through the use of an arch, which is integrated on the newer machines. One end suspension permits yarding larger turns, less ground disturbance and compaction.

Some machines are equipped with a grapple to eliminate the choker setting operation (must back to each log - no winch line).

This system is basically a downhill system due to the slow yarding cycle for uphill skidding. Skidding is most favorable straight downhill as there is less soil disturbance and less tendency for logs to roll down the slope during skidding, which minimizes damage to the residual stand.

Machine size is directly related to log size. Yarding tractors range from +15,000 pounds to + 180,000 pounds and from + 6 wide to + 11 wide, exclusive of blade.

Rubber tired skidders range from + 12,000 pounds to + 27,000 pounds, and from + 7' wide to + 11' wide, exclusive of blade.

Light flotation forwarders are relatively new on the scene and they aren't available in a wide range of sizes. A typical machine might weigh 25,000 pounds and have a width of 8½ feet.

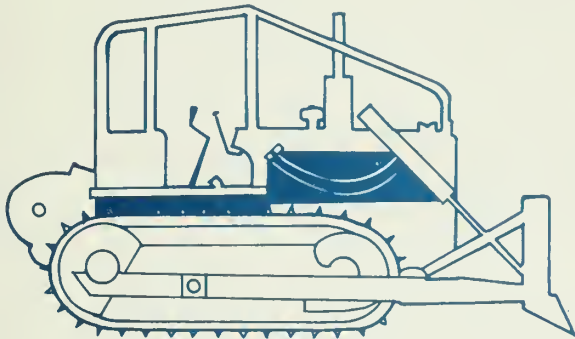

**TRACTOR**

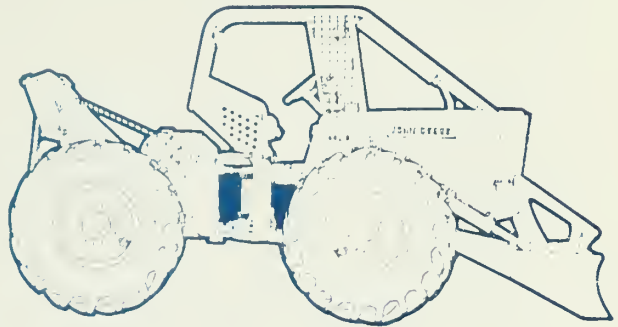

**RUBBER TIRED SKIDDER**

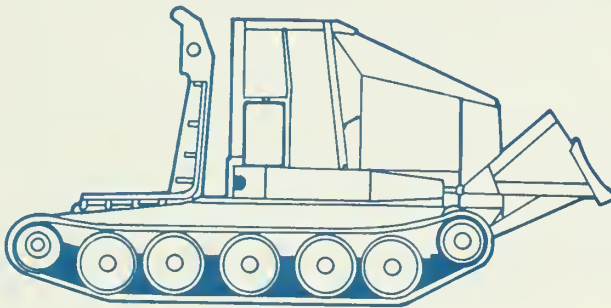

**LIGHT FLOTATION FORWARDER**

### 32 - Requirements and Limitations

In partial cuts, machine size should be limited to minimize damage to the residual stand.

Skidding operations should be limited to moderate slopes to minimize impact to soil and vegetation. The maximum desirable percent of slope will vary with the physical properties of the soil, and soil

3. Utilization is good due to cutting smaller diameter, shorter logs.
4. No noise pollution.
5. Damage to leave trees in partial cuts is low.
6. Low investment and overhead costs.

### 27 - Disadvantages

1. Maintenance cost continues whether logging or not.
2. Caulked horse shoes are required to skid on frozen ground or snow.
3. Horses get tired and need rest breaks; this affect production.
4. Horses are limited to small log lengths and diameters; this affects production.
5. Horses can't work on rocky ground.
6. A longer contract period is required compared to tractors, due to slower operation.
7. There are not many horse loggers left.
8. Horses must be fed on weekends and when logging is done.
9. Repeated turns can wear out skid trails by gouging a trough. This means locating additional skid trails.
10. Slash disposal must be done by hand.

### 30 - TRACTORS, RUBBER TIRED SKIDDERS AND SOFT TRACK TORSION BAR SUSPENDED TRACTORS

#### 31 - System Description

This system is a ground lead system with one or both ends of the log dragging during skidding. One end suspension is accomplished through the use of an arch, which is integrated on the newer machines. One end suspension permits yarding larger turns, less ground disturbance and compaction.

Some machines are equipped with a grapple to eliminate the choker setting operation (must back to each log - no winch line).

This system is basically a downhill system due to the slow yarding cycle for uphill skidding. Skidding is most favorable straight downhill as there is less soil disturbance and less tendency for logs to roll down the slope during skidding, which minimizes damage to the residual stand.

Machine size is directly related to log size. Yarding tractors range from +15,000 pounds to + 180,000 pounds and from + 6 wide to + 11 wide, exclusive of blade.

Rubber tired skidders range from + 12,000 pounds to + 27,000 pounds, and from + 7' wide to + 11' wide, exclusive of blade.

Light flotation forwarders are relatively new on the scene and they aren't available in a wide range of sizes. A typical machine might weigh 25,000 pounds and have a width of 8½ feet.

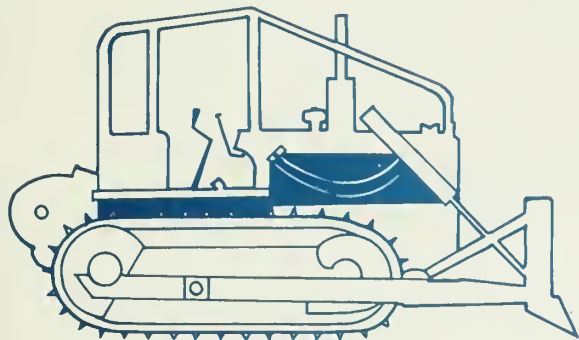

**TRACTOR**

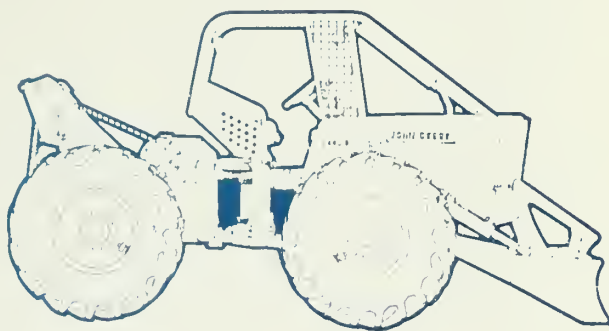

**RUBBER TIRED SKIDDER**

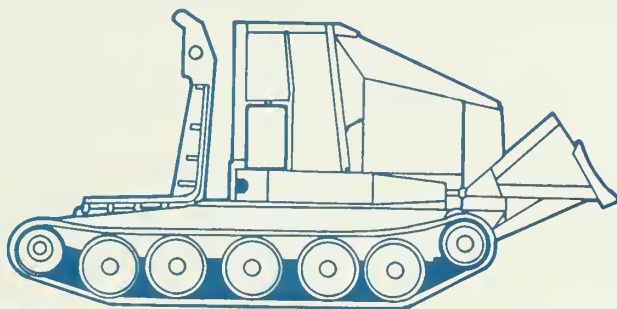

**LIGHT FLOTATION FORWARDER**

### 32 - Requirements and Limitations

In partial cuts, machine size should be limited to minimize damage to the residual stand.

Skidding operations should be limited to moderate slopes to minimize impact to soil and vegetation. The maximum desirable percent of slope will vary with the physical properties of the soil, and soil

depth. Following are maximum desirable slopes for operating this equipment.

EQUIPMENT	P.S.I.*	MAXIMUM DESIRABLE GRADES**	
		FAVORABLE	ADVERSE
Tractors	6 to 11	30%	15% to 20%
Rubber Tired Skidders	10 to 16	20%	0% to 10%
Light Flotation Forwarders	5	30% to 40%	20% to 30%

\*The P.S.I. values listed above are based on equipment weight. However, soil disturbance is more closely tied to equipment in motion. On compactable soils rubber tired skidders create a greater impact than the other two machines. Tractor and skidder yarding isn't desirable on compactable soil. On an average tractor show 20 to 25 percent of the area is in skid trails and roads, subject to compaction.

\*\*The maximum desirable grades listed above are just that. Equipment can operate on steeper slopes but damage to the site increases with the slope; the operator will drop the blade to control the equipment, logs will dig into the ground, logs will bark leave trees, skid roads can't be water barred, etc.

Maximum acceptable yarding distance is affected by many factors including: log size, volume per acre, terrain, etc. Following are some maximum yarding distances that can be considered in planning tractor sales.

#### APPROXIMATE MAXIMUM YARDING DISTANCES

<u>Skidding Method</u>	<u>Optimum Maximum Distance</u>	<u>Extreme Maximum Yarding Distance</u>
Tractor-ground skidding	300' to 600'	1000'
Tractor/arch	500' to 1000'	2000'
Rubber tired skidder	500' to 1000'	2000'
Grapple skidder	300'	500'

### 33 - Operation

In addition to the soil characteristics discussed in Section 32, skid road impact is related to volume per road, the size of the logs, the lay of the ground, the percent of defect (obstacles to work around), whether skidding straight downhill or across the slope, and the care of the operator.

Skid trail density, soil disturbance and leave stand damage can all be reduced if the tractor operator will pull the bull line out 35' to 70'.

Damage to the residual stand is reduced when timber is fell to the lead and logs are bucked to short lengths.

When ground slope is 10 to 15 percent, or more, logs tend to roll, or slide, to the lower side of the skid trail when they are yarded across the slope. The steeper the ground gets the more damage to the resi-



dual stand. Because of this, and the instability of the equipment, skid roads have to be built when yarding across slopes 20 percent and steeper.

If long skidding distances are necessary several tractors can feed a rubber tired skidder, used as a swing vehicle, which may operate on an improved skid road.

If yarding production is low, or cut volume per acre is low, and space is available, logs can be cold decked in a continuous landing for loading out later.

Front-end loaders are used frequently on tractor sides. They can also scarify, water bar and clean ditches.

### 34 - Layout Recommendations

Where topography isn't a factor, haul road spacing should be based on skidding and road construction cost. There are several methods of determining optimum road spacing. See FSH 2409.24, Chapter 100.

General landing requirements, which are applicable to this system, are discussed under Section 42. Tractor landings are usually spaced closer than cable landings, suitable sites begin available. The main objective, other than to minimize environmental impact, being to minimize skidding distance, and therefore, costs.

Tractors and skidders have to have adequate room to move efficiently off the landing after logs have been unhooked. This is easiest to do if the landing has an entrance at one side of the log deck and an exit on the other.

Reference 30-2 suggests landings being located to suit logging and loading systems as follows:

1. To permit using the optimum skid trail, or yarding pattern, which can be developed to suit the terrain.
2. To use natural breaks in the terrain, such as benches, or moderate slopes.
3. To avoid unsuitable soil conditions, creeks, or obvious wet areas.
4. To coordinate the proposed season of operation with the soil condition.
5. Away from steep sidehills where excessive cuts and fills are required.
6. No closer than two chains (130 feet) to any stream channel and locate on opposite side of road from water body.

Adverse grades should be held to a minimum because of the greatly increased turn time.

Operable grades are somewhat less when equipment is used on snow.

It is desirable for sale planners to identify on the ground the mainline skid roads and skid roads requiring excavation. Skid roads should be located to optimize economics and minimize soil damage and damage to the residual stand.

An appraisal will show whether proposed yarding distances are economic.

Rubber-tired skidders can travel up to 20 MPH, therefore, they operate more efficiently on improved skid roads.

Light flotation forewarders can operate on wet soils where repeated turns with a tractor or skidder would result in unacceptable soil disturbance. However, these machines also have their limit when the soil is too wet, or too many turns have to be yarded.

### 35 - Advantages

1. Tractor and skidder logging costs are lower than other systems on favorable terrain, within their normal yarding distances.
2. Relatively low investment cost.
3. Can be operated with a small crew.
4. Can be operated where low volume per acre is to be yarded.
5. Can move in and out of a sale easily at relatively low cost.
6. Skidders and light flotation forewarders are considerably faster than crawler tractors.
7. The tracked vehicles are more stable than wheeled vehicles.
8. Light flotation forewarders can operate on moist or compactable soils with considerably less impact than tractors or skidders.

### 36 - Disadvantages

1. Not suited to operation on wet or compactable soils.
2. Limited uphill yarding capability.
3. Mineral soil is exposed on 20 percent to 25 percent of areas logged by tractor or skidder (light flotation forewarders have considerably less impact on the soil).
4. Downhill yarding limited by soil, moisture and topographical conditions.

5. High potential for damage to leave timber in partial cuts.

6. Ground cover obstructions (stumps, culls, rock outcrops, etc.) and broken terrain increase yarding cycle time, increase use and impact on individual skid trails or roads and, in the case of rocky terrain, increase maintenance costs.

7. Site preparation and brush disposal may be required on the area not occupied by skid trails.

## 40 - CABLE SYSTEMS

### 41 - Introduction

The "Background" discussion in Section 10 briefly traces the development of cable logging systems. None of the cable systems discussed below are a panacea for use under all conditions. Some of the systems have had limited application. The Logging Specialist must have an understanding of the various logging systems so that he is able to recommend systems to fit ground conditions.

The cable yarding cycle is broken into several individual operations for analysis and time studies, as shown in the figure below. Lateral yarding takes two more steps than yarding just the logs under the in-haul line. These are the lateral movement of the skidding line in and out.

### 42 - Landings

#### 42.1 - Introduction

A landing is where logs are collected preparatory to further transportation. It must have ample space for the safe movement of equipment and storage and handling of logs, and must be located so as to provide access to all the logs in the area served by it.

Landing requirements peculiar to balloon and helicopter operations are discussed in Sections 50 and 60.

#### 42.2 - Types of Landing

- a. Continuous: Logs are decked in a continuous row along a truck road.
- b. Centralized: Landings located at spaced intervals along a truck road.

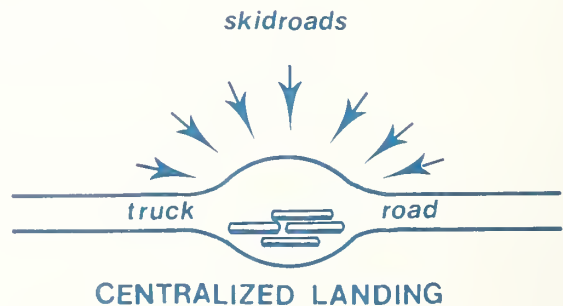
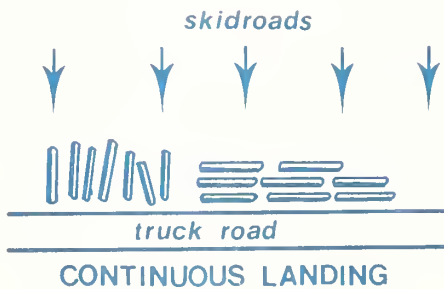

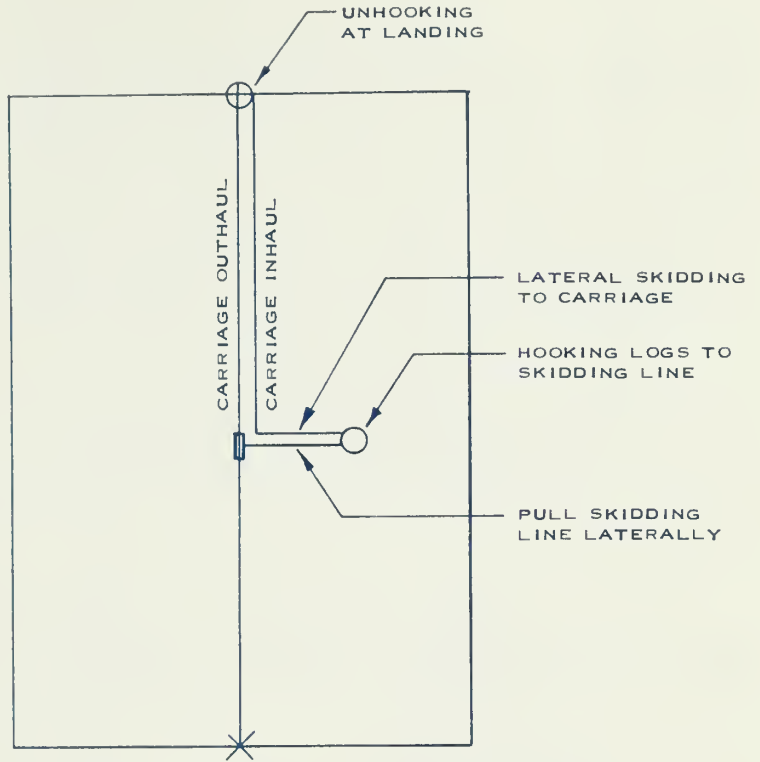

SKYLINE CRANE YARDING CYCLE

# SKYLINE ROAD PLANS

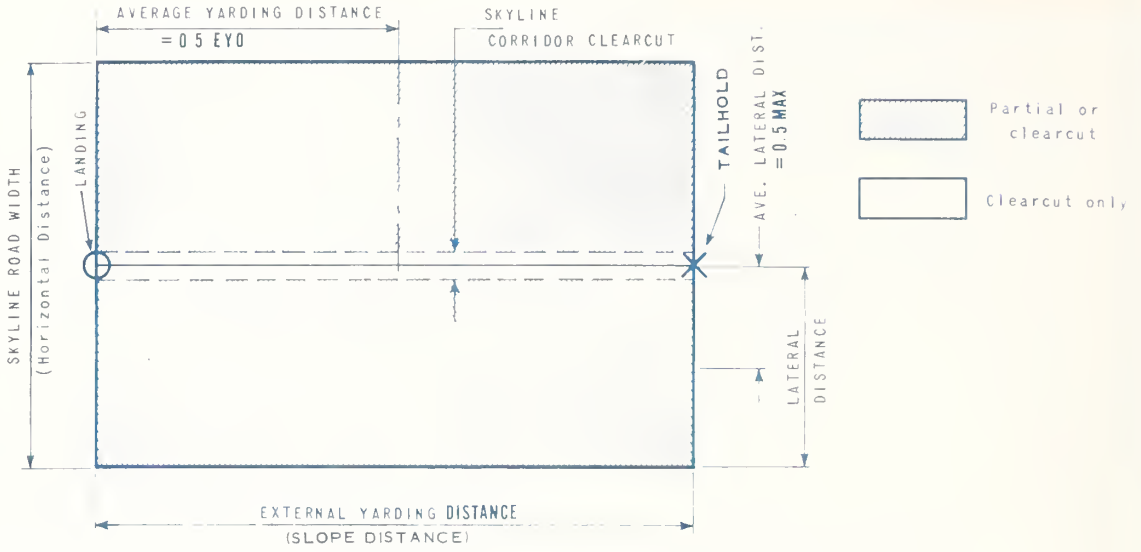

PLAN VIEW OF RECTANGULAR SETTING

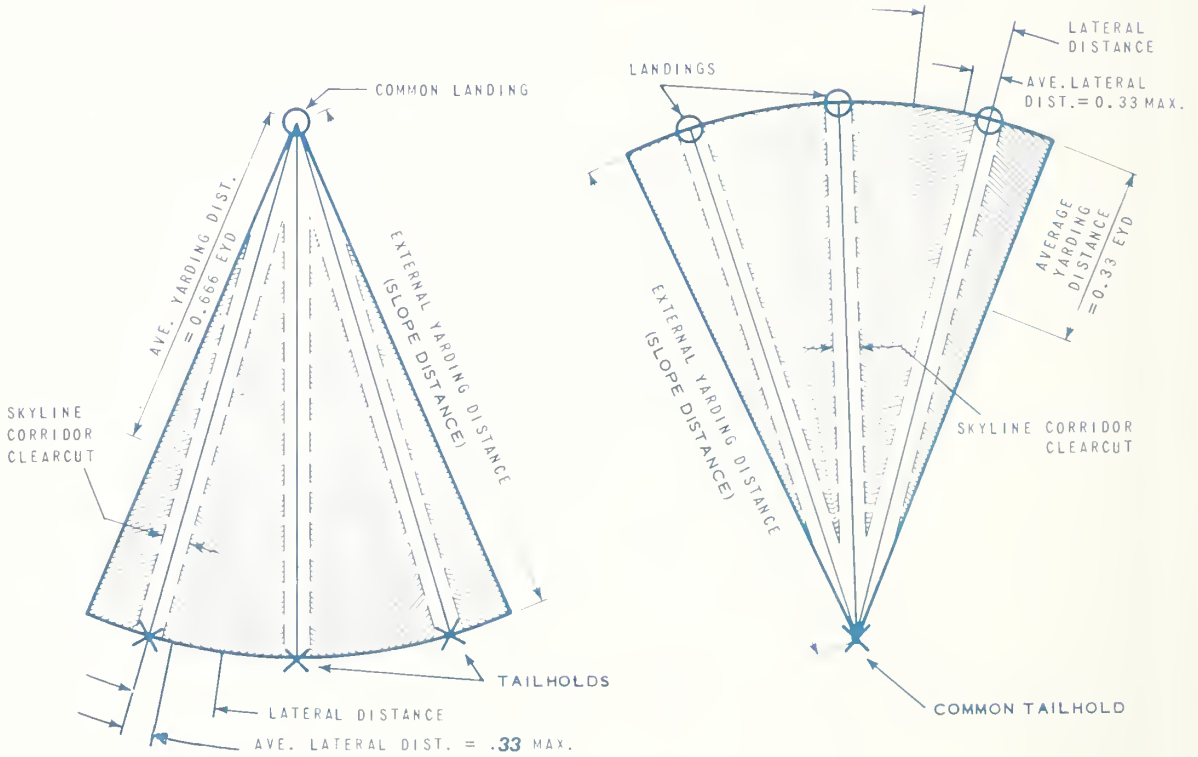

PLAN VIEW OF FAN SHAPED SETTINGS

### 42.3 - Types of Settings

a. Rectangular Setting: A setting having one landing and one tailhold.

b. Fan Shaped Setting: A setting having one common landing and more than one adjacent tailhold or one common tailhold and several adjacent landings.

### 42.4 - Landing Location

Landings must be located to complement the yarding system. Good landing sites may be available, but because of poor location they may not meet the requirements of the yarding method.

Potential landings must be identified on aerial photos when the paper plan for a proposed timber sale is prepared. These locations should then be verified on the ground during field reconnaissance (see FSH 2409.24, R-10 Chapter 100). When in the field, check to see if more desirable land locations have been overlooked.

Landings must be located to comply with State Safety and Health Standards. There must be adequate guy anchors for spars. Spars over 55 feet high will need six to eight guys. If adequate anchor stumps are not available deadmen, rockbolts, or even tractors, must be used for anchoring. Guy anchors must be located so that effectiveness is not reduced below 50 percent. See Section 44 for further information on anchors.

Skyline landings must be located to provide adequate deflection. Locations on points of ridges, or on ridgetops, may provide good skyline deflection; but they may produce steep guyline angles. Guyline angles cannot exceed  $60^{\circ}$  (See Section 45).

There must be adequate tailholds to serve the timber in the setting. Landings must be located in line with the anchor points. For example, a standing skyline with both ends anchored to stumps, must have the landing located directly under the skyline. Any change in the direction of the skyline as it passes over the head tree, or tower, must be held to a minimum.

On convex slopes the haulback drags on the ground. This results in line wear and is a fire hazard.



Directional Changes in the Skyline, at the Tower, Must be Minimal

When downhill yarding, landings must be located to provide ample area between the hill or backslop, and the spar. This area is needed to catch loose logs and debris knocked loose by downhill yarding (See figure below).

Landing locations must result in acceptable yarding distances.

There must be adequate area to acceptably serve the needs of the landing (See 42.5 and 42.6).

Tractor and balloon landings should be located below material to be moved, resulting in a valley-bottom road system.

Where possible, landings should be located so that logs don't have to be yarded across the slope, especially across the slope above a truck haul road where they can roll logs, rocks and debris down into the road.

Finally, landings should be located to avoid blind leads. In some cases damage to the residual stand, or to soils, may be avoided by using additional landings to eliminate blind leads, sidehill yarding, or inadequate deflections.

#### 42.5 - Landing Size

Some of the factors that affect landing size are:

- a. Log size
- b. The operations to be performed (yard, load, deck, sort, swing)
- c. Type and size of equipment
- d. Lead
- e. Yarding system
- f. Volume to be yarded
- g. Relationship of yarding directions and truck haul direction
- h. The need to accommodate through traffic
- i. Space available
- j. Need for vehicle parking space
- k. Location of truck turn around

In general, the larger the landing the more economical the log handling. However, this may be in direct conflict with some of the land management considerations which usually restrict landing size. There is no pat answer for landing dimensions.

The first consideration in planning landings is safety. Landings must be safe, workable and productive. Yarding production drops significantly if there isn't adequate room to deck logs and to keep the slip open.

Parking areas must be provided for crew busses, pickup trucks, fuel equipment and other equipment such as tractors or rigging trucks.

If tree-length logs are yarded, landings must be large enough so that the logs may be laid on the ground for bucking into standard lengths.



### 42.51 - Yarding Requirements

There must be room to safely land and chase the logs. It is desirable to have the full length of the logs resting on the landing. This isn't always possible because of space limitations. When space is limited, safety inspectors may accept stable logs having only 2/3 or 3/4 of their length on the landing.

A minimum of 3', or 4', between the tower undercarriage and the ends of the logs, as they are landed in the chute, is needed as a safety precaution and to keep from beating up the tower and undercarriage.

If logs are yarded downhill, a level space to stop logs short of the landing is required. The size of the space required will be affected by ground slope and log size.

If a sled yarder is used, the angle the mainline makes with the horizontal (as measured for guylines) will affect the distance the sled should be from the wood spar. The angles the mainline makes with the horizontal on both sides of the spar should be approximately the same, to minimize horizontal force on the spar. If a skyline is used with a wood spar, the same consideration should be made concerning the angles the skyline makes with the horizontal at the spar. See references on cable tensions in FSH 2409.24, R-10.

If a single drum is to be located at the landing there must be space behind the tower or spar, to accommodate it.

If a standing skyline requiring a single drum is used on a fan shaped landing, the position of the single drum will have to be changed as the skyline tailhold is changed, to keep the lateral deflection of the skyline under 10 degrees.

A change in the direction of the skyline between a single drum and the tower can be made by using a lead block. If this change puts the landing in the bight it would be a hazardous practice. The lead block requires an adequate anchor (See Section 44) as an anchor failure would wipe out the landing. Layout requiring men to work in the bight of the line is to be avoided.

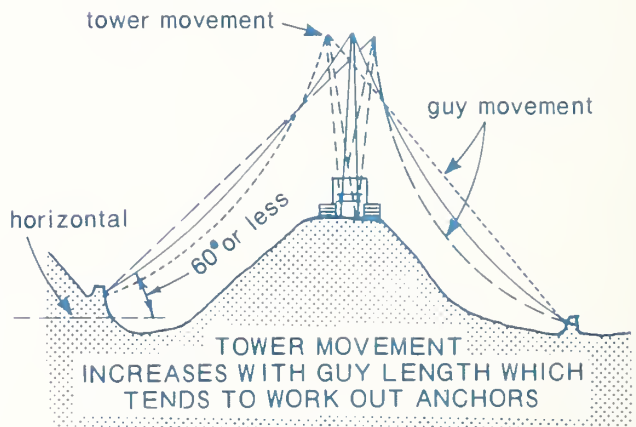
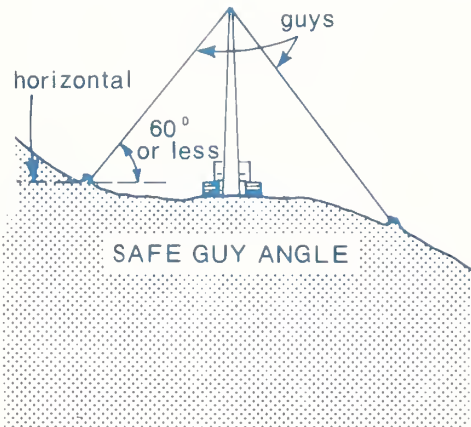
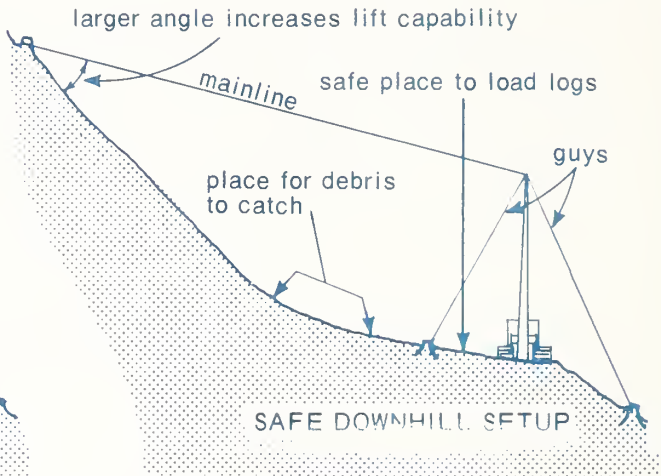
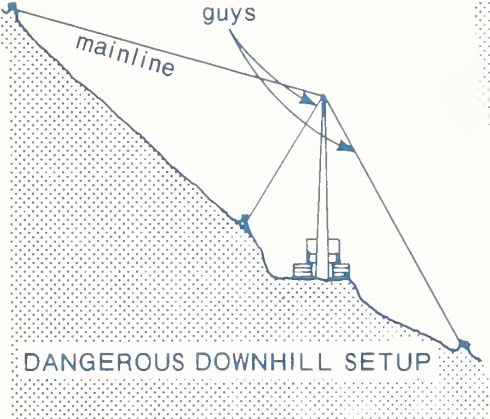
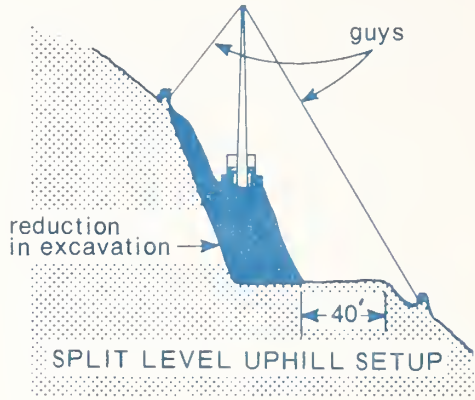
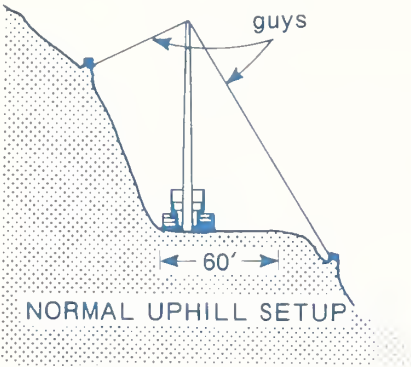

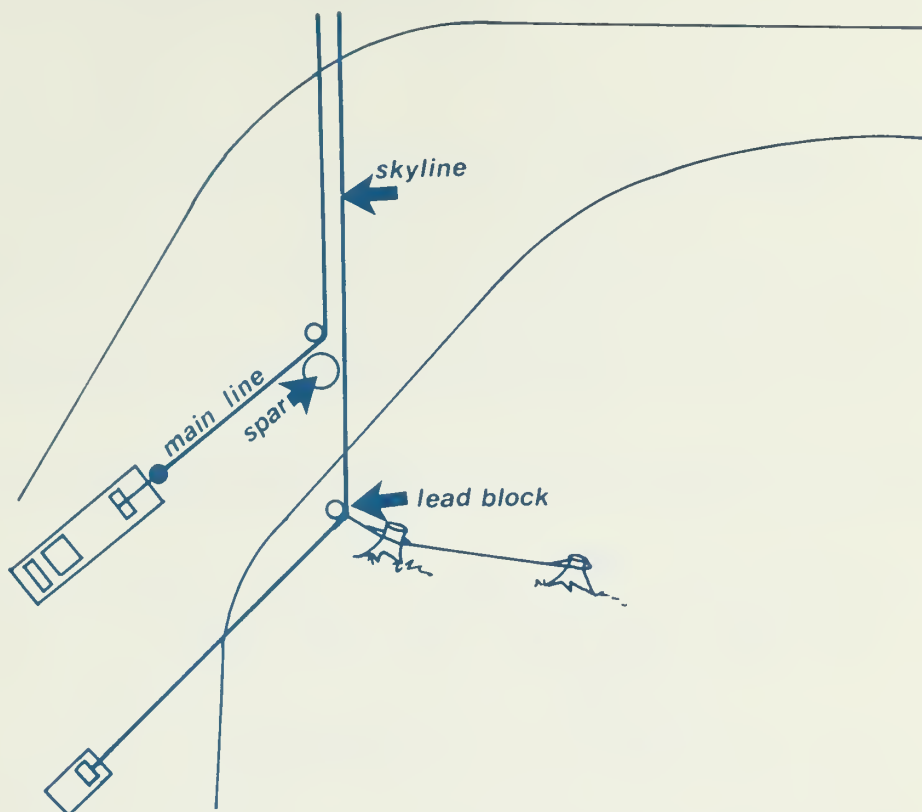

Landings in the bight of the skyline can be hazardous and should not be designed

If there are curves in the road, a fixed boom yarder can sit part way around the curve to increase the amount of landing space on the road in front of the yarder.

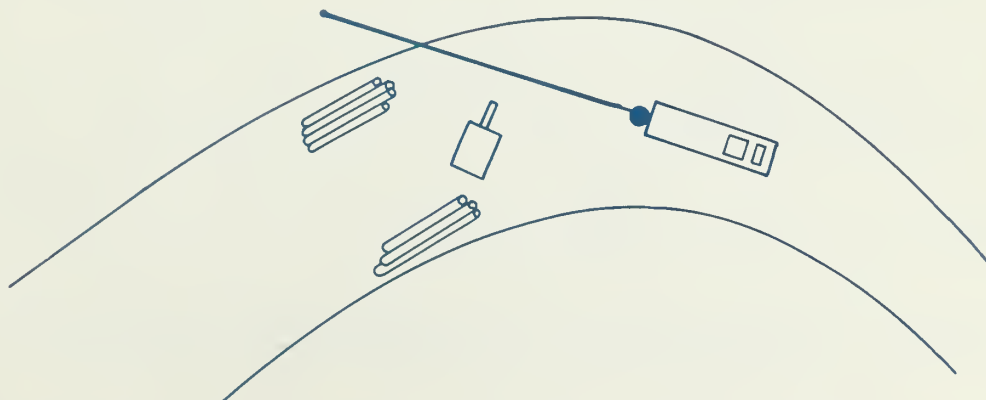

Locating the Yarder Around a Curve Increases Landing Space

### THREE TYPES OF LEADS IN HIGHLEAD LOGGING (Plan View)

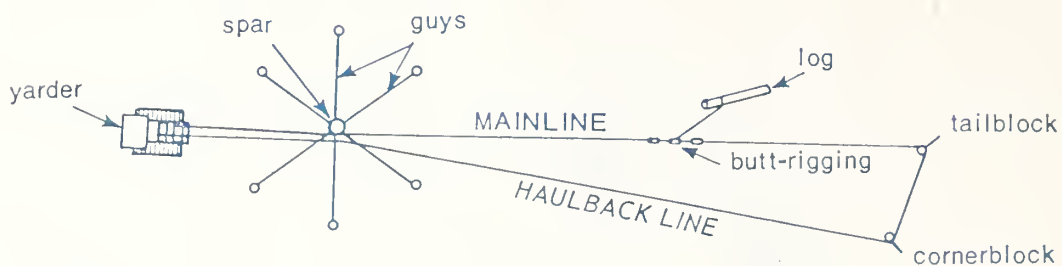

**STRAIGHT-LEAD.** — Occurs when yarding is in line with the yarder and spar. This condition subjects the guys to the least strain.

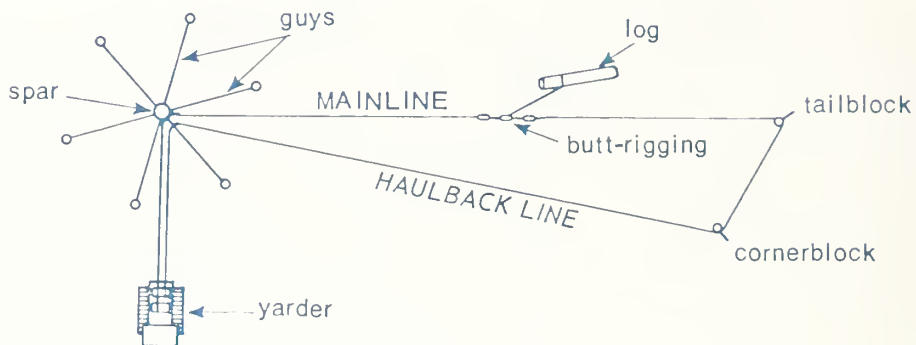

**SQUARE-LEAD.** — Occurs when yarding at right angles to the yarder and spar. The resultant force on the spar must be sustained by the opposing guys.

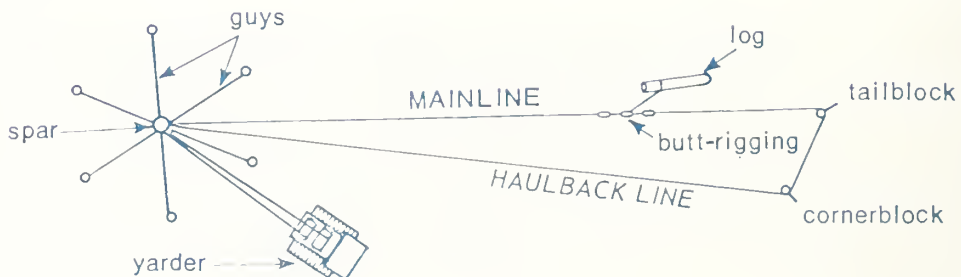

**V-LEAD.** — Occurs when the resultant angle in the mainline at the spar is less than 90 degrees. This block purchase on the opposing guys creates an unsafe working condition on rigged spar trees.

If ground slopes are under 30 to 40 percent, logs may be landed below the road, or on the fillslope of the road. On steeper ground, a leveled area is needed to land logs.

#### 42.51a - Lead

Lead refers to the angle the mainline makes with the horizontal after it passes through the tower fairlead or spar bull block.

A straight lead requires the greatest landing width. If a portable spar-yarder is operated with a square lead, the landing width can be reduced by the difference of the yarder length and width. However, the yarder may have to be turned after part of the unit is logged, to avoid yarding into a V-lead. Yarding in a V-lead with a wood spar puts a block purchase on the spar.

Using a rigged spar tree might provide an opportunity to place the yarder  $\pm 100'$  away from the landing, if landing space is crowded.

The drums on a spar-yarder are nearly directly under the fairleads, therefore, there is little difference in the lateral force on the tower whether yarding in a straight lead or in a square lead. Yarding in a V-lead is restricted, by most State Safety Codes except under certain conditions.

On slackline yarders, the skidding fairlead is located below the top of the tower and does not rotate around the axis of the tower like the haulback and mainline fairleads. It pivots on a "boss". The position of the boss prevents yarding past a square lead. On some yarders the boss may be offset from the front of the tower. This prevents yarding to a square lead on the opposite side of the tower.

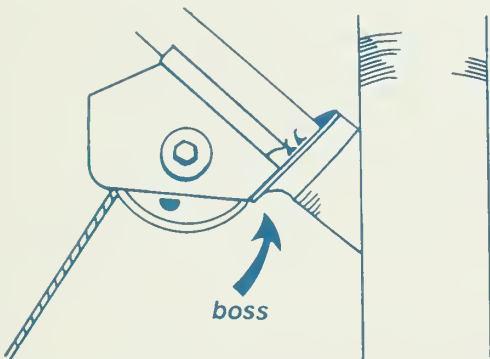

Skidding Fairlead Boss

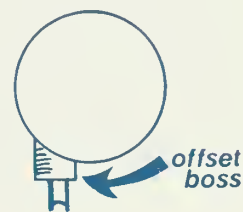

Offset Skidding Fairlead Boss

On some yarders that portion of the guylines between the guyline ring and the guyline drum, may prevent yarding to a square lead. The skidding line would saw the guylines.

When yarding long distances (2000" +) it is desirable to limit yarding to less than a quarter lead. Yarding close to a square lead puts a lot of stress on the tower. The skidding boss, which is welded to  $\frac{1}{2}$ " plate (on most towers) acts as a lever to twist the tower and to tear the boss loose from the tower.

## 42.51b

If a square lead is used, guylines should be placed to offset the skyline pull (i.e., five guylines behind the tower and three in front). At least eight guylines are desirable.

The greatest permitted lateral thrust on a wood spar tree occurs when yarding with a square lead. If there are no space limitations the yarder will probably be placed where most of the timber can be yarded with a straight lead. If space on a road side landing is limited, the yarder may be placed parallel with the road centerline.

### 42.51b - Yarding Equipment

Even though a timber sale may be appraised with a certain piece of equipment in mind, there is no assurance that the logger will use the appraised equipment. Therefore, landing size estimates should consider the range of equipment sizes that might reasonably be used on a proposed sale. Following are some approximate dimensions for yarders that can be considered when determining land space requirements.

1. Small log equipment  
Track mounted yarder  
Overall length 14' to 20'  
Overall width 12'
2. Large old growth equipment  
Yarders, Rubber or Track Mounted  
Undercarriage Length 33' to 47'  
Overall Width 11' to 14'

Exact dimensions for various machines can be obtained from equipment brochures.

Swinging boom yarders are designed to lead logs around the yarder from the skid road to the truck road. This permits using a smaller landing. If the swinging boom is used in this manner the landing only needs to be wide enough to safely land the logs, operate the loader, deck the logs and provide room for through traffic as necessary. The landing slip could be approximately 3/4 of the log length. If 40' logs are positioned diagonally across the truck road they could be safely landed on a single lane road with turnout.

If a swing boom yarder is used space must be allowed for the counter-weight to swing. This may involve excavating the backslope to gain the needed room. Most State logging safety codes require 3' or 4' of clearance between the counter-weight and the nearest obstruction.

Unless necessary to land logs, most yarding engineers do not swing yarded logs from the skid road to the truck road. Swinging the boom frequently means the engineer must slack the skyline and haulback, if used. To do so risks the possibility of backlash on the haulback drum and the resulting crossing of the line on the drum. It also lengthens the yarding circle, cutting daily yarding production.

### 42.52 - Log Sorting

If at all possible the landing should be large enough to allow logs to be sorted. The number of sorts will depend on space available, the logger's needs and environmental impact. If different species or grades of logs are hauled to different mills it would be reasonable to allow room for these sorts, if it is available and the resource impact is acceptable.

The minimum room for a sort is enough to hold a truck load of logs. If bunk logs are scarce, a number of short logs may have to be decked before enough long logs are available to build a load.

### 42.53 - Decking

The decking area may be a part of the landing area, or it may be at some distance. Logs may be decked along the road--either in the ditch or on the lower side of the road--if they can be prevented from rolling. Decking area size depends upon log size, logs yarded per day, sorts, haul distance and the number of trucks hauling. The deck should hold enough logs to load out the first string of trucks in the morning.

If there is insufficient room at the landing to deck logs, rubber-tired skidders with grapples may be used to move the logs from the landing to the decking area.

If a rubber-tired front-end loader is used to swing and deck, more operating room is required. They must pick up the log in the middle and back and turn from 90° to 180° to place logs on the deck.

Logs can be skidded directly onto preload bunks, instead of decks, to eliminate the need of a log loader. When loaded the preload bunks are raised hydraulically to permit the log truck driver to back his trailer under the load. The logs are then lowered onto the log truck.

A turning area for the trucks is needed near the decking area.

The following figure presents a graphical method for determining the number of pieces handled per setup.

## LANDING REQUIREMENTS BY: Yarding Condition, Area, Volume, Piece Size & Production

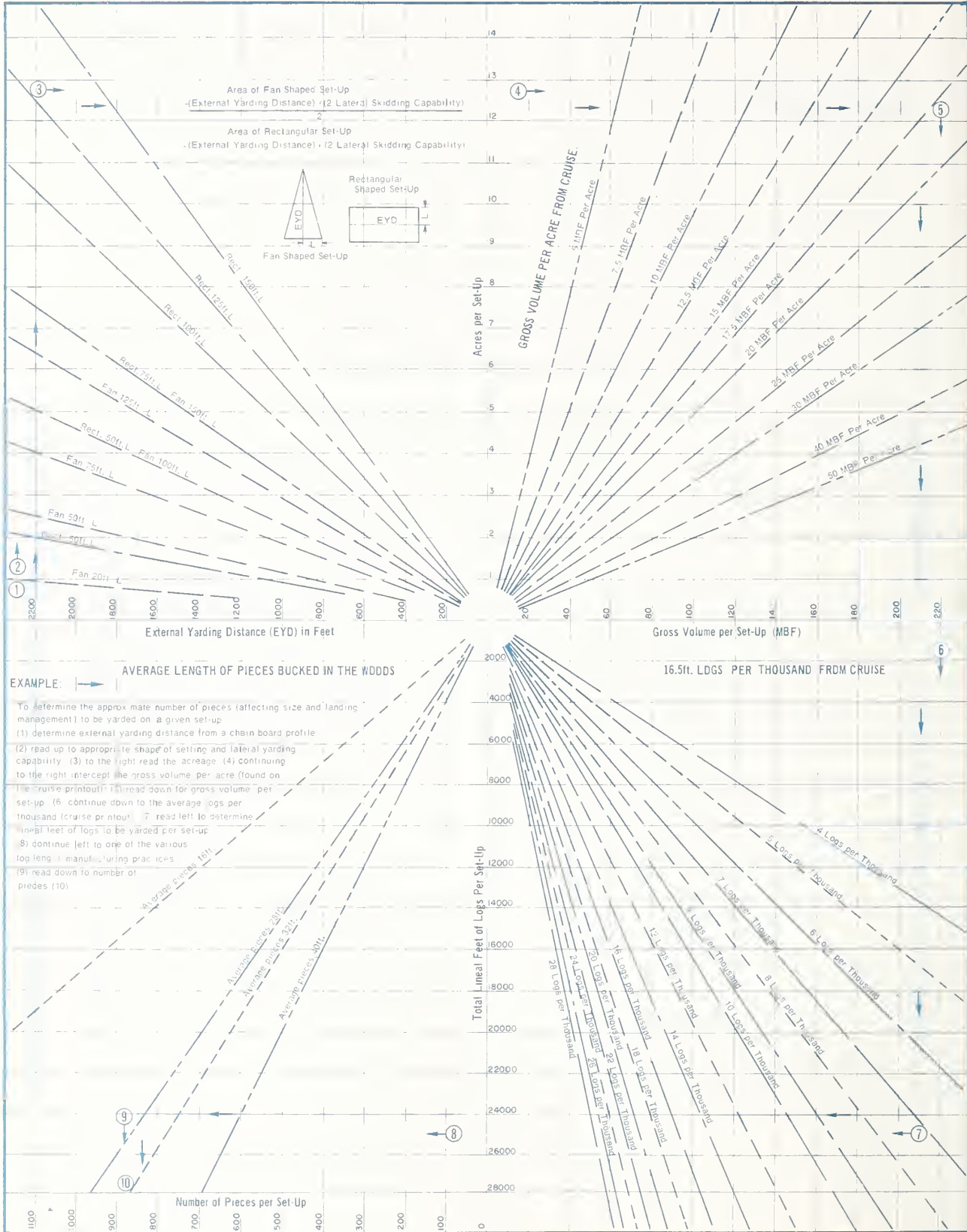



### 42.54 - Loading Requirements

Most loaders on cable shows are the swinging boom type. Front-end loaders require more room to operate than is normally available.

When a swinging boom loader is used there must be room enough for the loader to swing yarded logs around to the deck. This means a quarter circle clearance with a radius equivalent to the distance from the end of the heeled log to the center of the loader rotation. This involves a consideration of log length, boom configuration and loader design. The length of radius can be approximated by the sum of the log length and boom length.

There must be room for the counterweight to swing with a 3' or 4' clearance between it and the yarder, spar, cut bank, log deck, etc.

The loader must be on the side of the tower toward the direction of log haul.

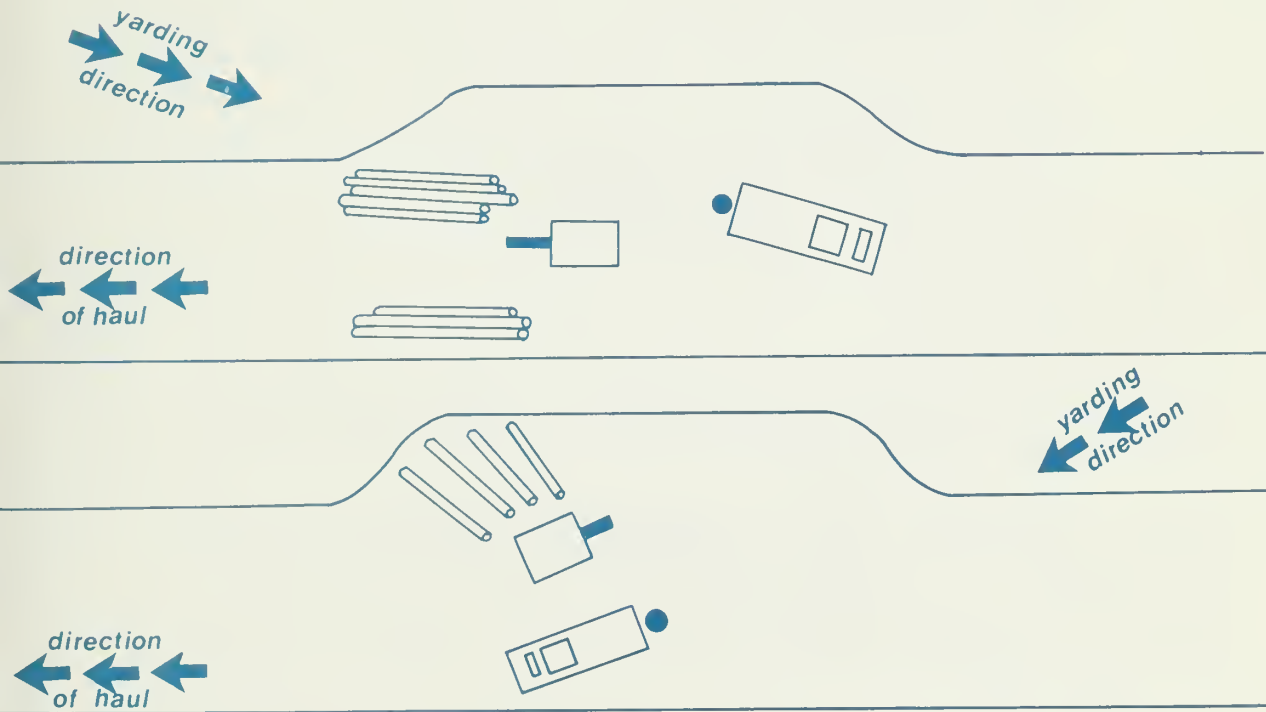

The Loader is on the Side of the Tower Toward the Direction Haul.

42.54a - Loader-Dimensions

Exact dimensions for various machines can be obtained from equipment brochures.

Following are some approximate dimensions for loaders that can be considered when determining landing space requirements:

1. Small Log Equipment

Rubber Tired Loader

Undercarriage length 18' to 25'

Overall width (outriggers extended) 17'

Counterbalance overhand when loading at right angles to undercarriage centerline 4' to 5'

2. Old Growth Equipment

Track Mounted Loader

Track Length 16'

Outside Track Width 12', to over 13' on the largest machines

Rubber Tired Loader

Undercarriage Length 24' to 26'

Overall Width Outriggers Extended 17'

Counterbalance overhand when loading at right angles to undercarriage 5' to 7'

42.55 - PUM\* Yarding

Safety in handling PUM material is a prime consideration. Logs and chunks can't be chased safely when they are landed on steep slopes, or tall, loosely piled decks.

If PUM logs are to be decked at the landing there must be sufficient decking room to safely handle the material and there must be equipment available to do the decking. It may be possible to build a bench below the landing for PUM decking, or the first culls yarded may be laid crosswise (behind stumps) to build a flatter lay for the PUM logs.

Sometimes PUM material can be burned on the landing during yarding. Sometimes PUM material has to be yarded or hauled, to a remote location for disposition. If PUM logs are to be swung, or reloaded to be decked elsewhere, there must be space on the landing for these logs and the equipment to handle them. The appraisal must reflect PUM log handling requirements.

PUM logs should be decked so that they won't move down slope during and after slash burning.

\*Piling Unmerchantable Material

## 42.6 - Special Landing Consideration for Specific Logging Systems

### 42.61 - High Lead

If there is 40' of space to land logs, and logs in the turn are 40' long, the first log will have its full length on the landing but the last log in the turn will have 9' to 15' of its length unsupported, due to the length of the butt rigging. If space is available landings should be large enough to accommodate the log hooked to the last choker in the butt rigging.

If space is limited the back logs can be yarded in closer after the first logs are unhooked. However, this will increase the yarding cycle. If shorter logs are available, hook them in the back chokers. Another option with the 40' logs is to hook the first choker to the top log and the second choker to the stump end of the butt log, with the second choker set back. This puts the center of gravity of the second log forward.

On steep ground it may not be possible to get the logs within 20' of the tower due to haulback weight. This means 20' more space needed on the landing.

On a tight landing if the last log in a turn is a big log, and it slides down the hill when it is landed, it will tighten the mainline and the front logs can't be unhooked. The turn will have to be re-landed causing a delay in the yarding cycle.

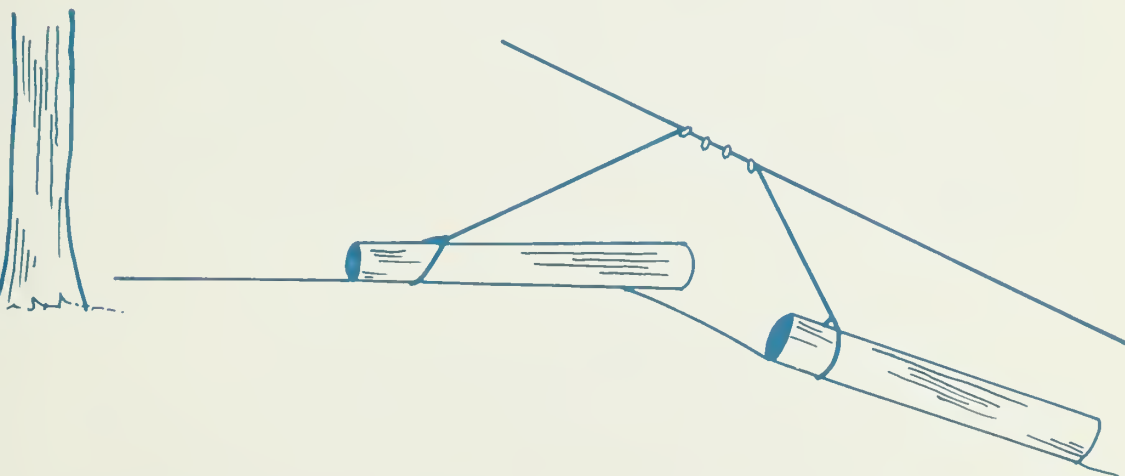

The weight of the back log keeps tension on the front log choker.

Consideration must be given to the space requirements of the loader; where it is set, and where will logs be decked.

When determining high lead landing requirements for a yarder-tower, consideration has to be given to the following:

	<u>POSSIBLE LANDING DIMENSIONS</u>	
	<u>Square Lead</u>	<u>Straight Lead</u>
(1) Length of the butt rigging (9' to 15')	9'	9'
(2) Log length (2/3 to 3/4 of the log must be on the landing)	30'	30'
(3) Yarder undercarriage length or width, depending on yarder position	12'	40'
(4) Clearance between yarder and and log (3'-4')	$\frac{3'}{54}$	$\frac{3'}{84}$
(5) Add on affect of:		
Steep ground on the haulback		
Loader space requirements		
Through traffic requirements		
Decking requirements		
Directions of lead and log truck haul		

If there isn't enough room to land logs when yarding with a square lead, the tower on some yarders can be tipped away from the yarder up to five degrees for machines where the tower is supported on the undercarriage, and up to eight degrees if the tower rests on the ground. This permits turns to be yarded past the yarder into the cut bank. Towers are designed to resist a compression force. Tipping results in lateral forces acting on the tower that weren't considered in tower design. The amount of tip should be held to a minimum.

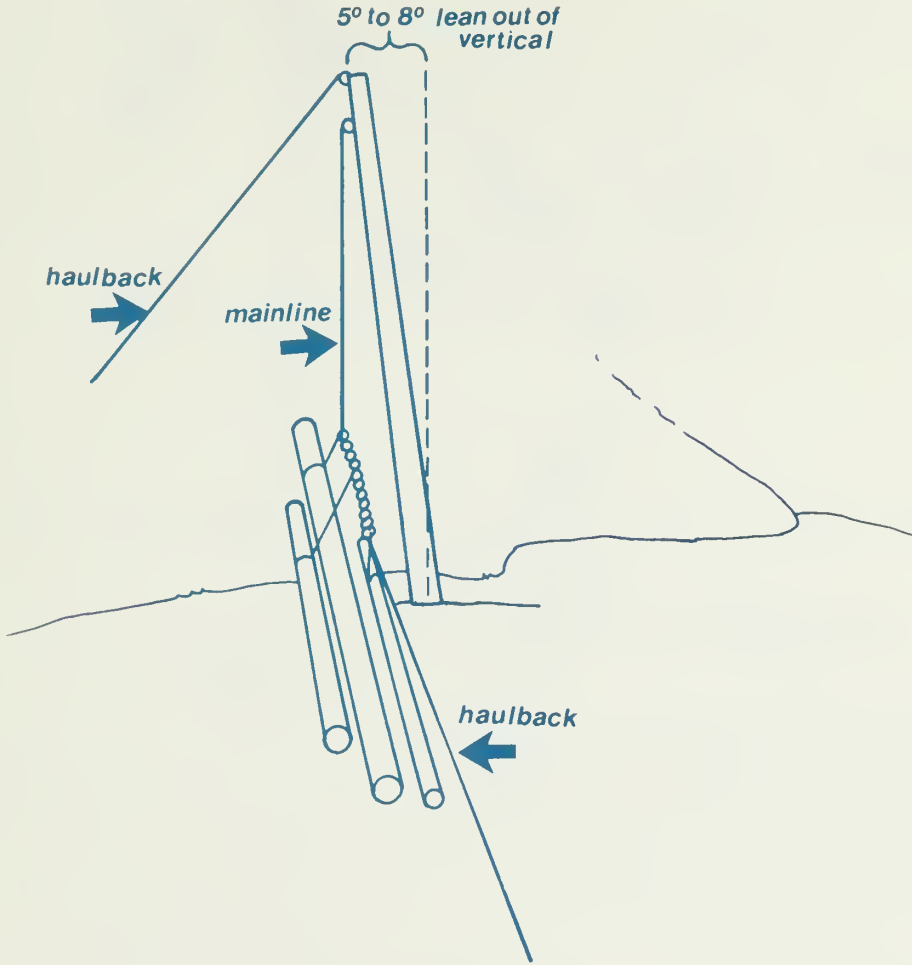

### Tower tipped to aid landing logs

If logs are being high lead yarded by a slackline yarder, and there isn't enough room to land the logs in front of the tower, the third drum on the yarder can be used to operate a dutchman on the mainline to yard the logs past the tower.

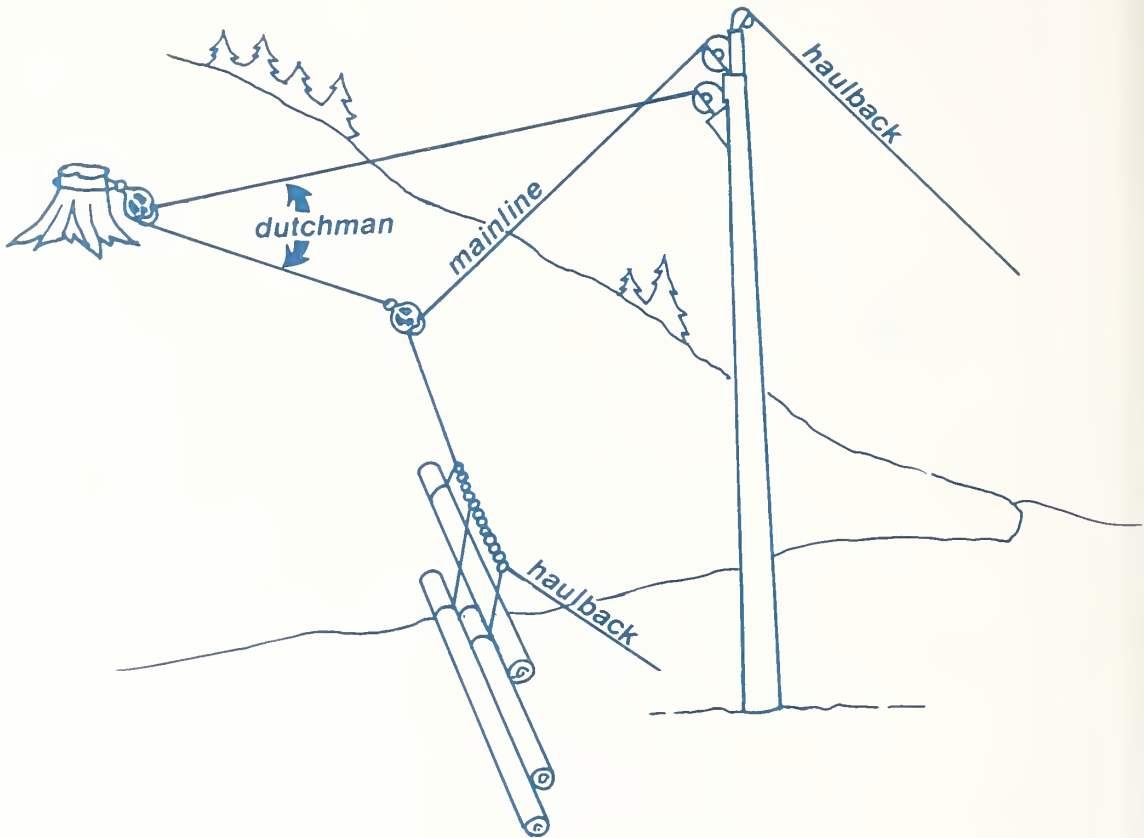

### Live Dutchman May Assist in Landing Logs in Special Situations

The dutchman is kept slack except when putting a bight in the mainline to facilitate landing logs.

This same live dutchman arrangement would work good with a flyer system operated by a slackline yarder.

### 42.62 - Live Skyline

If the logging system uses a carriage, the 9' to 15' of landing space for butt rigging can be shortened, depending on carriage characteristics.

On moderate slopes a live skyline system can use a smaller landing than a high lead system as the skyline can be slacked when logs are landed. On steep ground the skyline weight may not allow the carriage to reach the tree with the turn dragging one end on the ground. Therefore, on steep ground  $\pm$  20' more landing space may be needed.

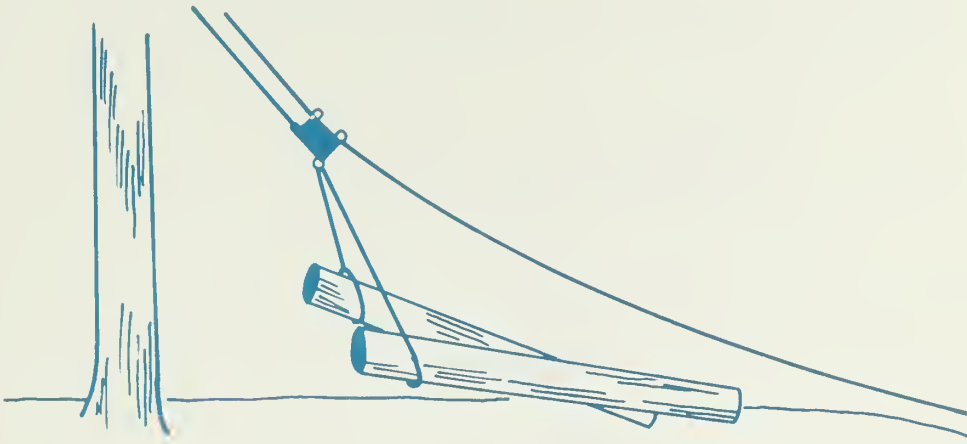

### Skyline Slacked to Land Logs

If a long flyer carriage is used the distance between the front and back chokers may be a consideration in estimating landing space requirements.

### 42.63 - North Bend, South Bend, Modified North Bend (Bight Down), Block in the Bight (Bight Up)

When logs are landed on standing skyline systems such as a north bend, south bend, or block in the bight, logs are lowered to the ground as they approach the landing. This gives more control over the turn and is safer. If the turn is kept in the air until it is over the landing and then the mainline is slacked to lower the turn, the carriage will drift down the skyline until the logs touch the ground, especially on steep ground. The logs may even miss the landing if the landing is too small.

When a south bend or north bend is used, a live dutchman can be used to pull the fall block across the landing, to permit landing logs on a tight landing. (the same as was mentioned above under high lead landings).

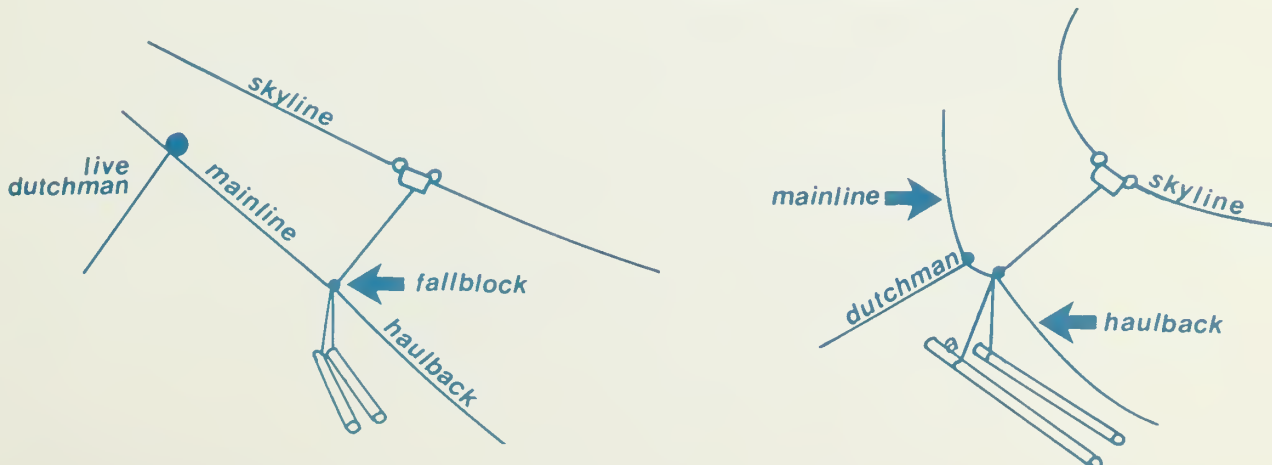

### Live Dutchman Use to Assist Landing Logs

This procedure won't work with a bight up (block in the bight) system as there is no place for the dutchman.

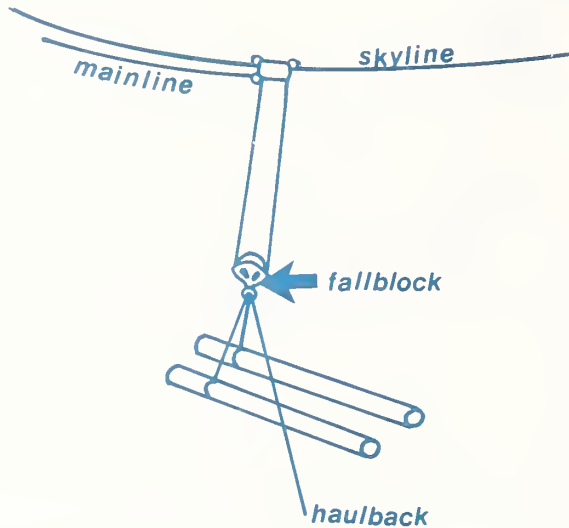

There is No Place to Use a Live Dutchman to Assit Landing Logs When Using Bight Up.

If these fall block systems are used with a live skyline, the skyline can be slacked to facilitate landing logs on a tight landing.

42.64 - Clamping Carriages and Skidding Drum Carriages

When a clamping carriage or a carriage with a self-contained skidding drum is used, logs are still lowered to the ground as the turn approaches the landing for better control and safety. Since turns are more controllable with these kinds of carriages, the landing area can be held to a minimum.

42.65 - Thinning Landings

Parallel landings are desirable in thinning sales as they result in less acreage cut for skyline corridors. It also avoids the clearcut resulting from converging skyline roads of a fan shaped landing.

Following are approximate minimum landing requirements for a fixed boom thinning yarder with width of 12' when yarding 32' logs.

Log length (3/4 of 32')	24'
Yarder width	12'
Clearance between yarder and log	3'
	<u>39'</u>

Add on loader, decking and through traffic space requirements.



If available landing space is less than  $\pm 39'$ , logs can be landed on the slope below the landing, if the slope is such that the logs will be stable and it is safe to chase them. This is probably under 30% to 40% ground slope, less if the ground is wet. Logs shouldn't be decked on ground this steep.

When turns are landed on steeper slopes, some operators hold the logs in place with a hydraulic knuckle boom loader while the chaser un-hooks the logs. This practice increases the yarding cycle time.

See comments under Section 42.51, "Yarding Requirements" about setting a yarder around a curve in the road to gain landing room and about using swinging boom yarders on narrow landings.

#### 42.7 - Landing Construction

Landings should be built reasonably level and well drained. Water should not be allowed to accumulate. Many soil failures occur on landings because of improper design, or poor construction practices. Specifications applying to roadfill construction should also apply to landing construction.

Landings should be recognized as part of the transportation system and designed as such, not as an afterthought. If their locations are known in advance of the road survey, they may be designed and built as part of the road project.

Normally, however, the landing locations are not specified as part of the road design. The logger has the option of placing landings where he desires, so long as he meets contract requirements. The backslope may be excavated to gain additional landing area. In this case, disposition of the excavated material becomes a problem. On gentle ground, where a fill slope will catch (usually under 55%), the excavated material may be used to increase landing width. After determining the landing width needed, a survey and design should be made to determine the quantity of excavation required. The quantity should be adjusted by a compaction factor. On steeper slopes where fill placement is impossible, excavated material should be hauled to a designated waste area.

Excavation can be reduced by minimizing the activity on the landing. A swing system can be used to move the logs from the landing area. It may be possible to deck logs along the road to eliminating the need for a large decking area next to the yarder.

Excavation may also be reduced by using a split-level landing (see figure below). An area above the road is leveled for the yarder. Logs are landed and loaded on the road below the yarder. Excavation required for a split-level landing depends upon ground conditions. If a natural bench occurs above the road, and access to the bench is on level ground, very little additional excavation will be required. On

side slopes between 40 percent and 60 percent, a split-level landing requires approximately half the excavation of a single-level landing for the same effective width. Excavation savings include the material excavated for the access road to the upper level. With side slopes greater than 60 percent, access to the upper level becomes a problem. The amount of material excavated for the access road may be more than the amount excavated if a single-level landing were used.

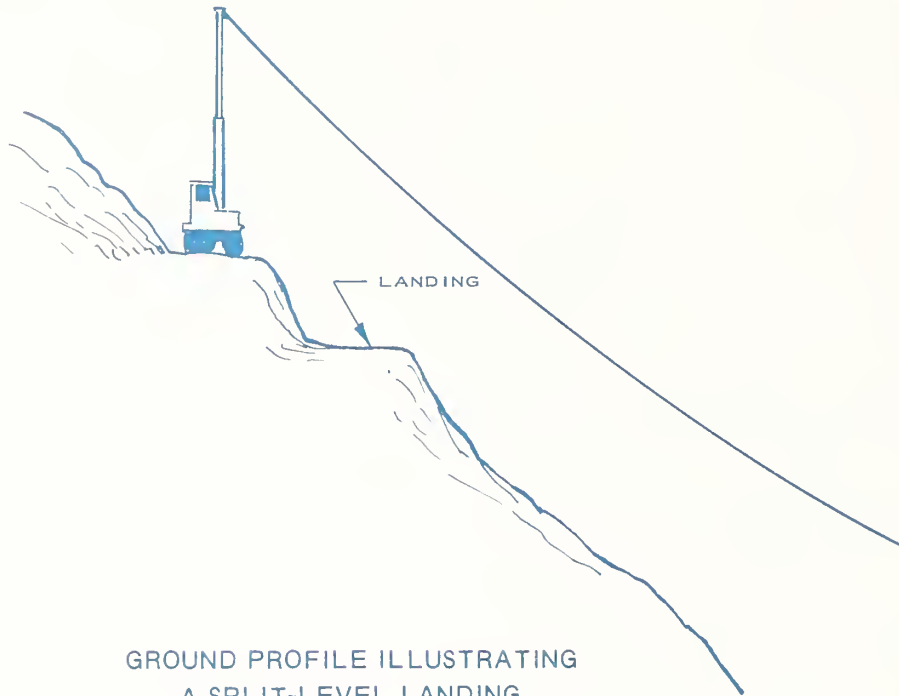

GROUND PROFILE ILLUSTRATING  
A SPLIT-LEVEL LANDING

Landings should be constructed so that they provide a level, safe operating area. Most yarding and loading equipment is designed to operate from a near-level position. Leveling is especially important with a swinging-boom loader or yarder. Usually, this type of machine is equipped with outriggers to aid leveling. Large portable spar-yarders must be manually cribbed. If a 40-foot-long yarder is placed perpendicular to the centerline of a three percent grade road, the lower side of the yarder must be raised four inches to approximately level it. However, if the yarder is placed parallel to the centerline, the lower end of the yarder must be raised 14 inches. Therefore, the amount of cribbing needed depends upon yarder positioning. The area where the logs are landed should be level, so that they may be safely unhooked by the chaser.

Steep grades on the landing approach are undesirable. There should be no grade change in the loading chute. Quite often, the trucks must back up the grade during the loading operation and loading becomes difficult. It is also difficult for trucks to maneuver and start after loading on a steep slope.

A road and landing system designed for the harvest cut may not meet the requirements for thinning, or intermediate-cut, yarding systems. A steep road grade to a clearcut landing may preclude using the road for later thinnings or intermediate cuts. It might be possible to set the thinning yarder on the steep grade by building a pad for it, but loading would have to be accomplished on flatter ground.

Following is a tabulation of criteria for landing construction:

1. Reasonably level but with enough slope to provide drainage.
2. Maximum slope can be about eight percent.
3. Slope in decking areas can be up to 20 percent if logs are decked perpendicular to the contour. High decks will require flatter areas.
4. Theoretically, an empty log truck, ready for loading on crushed rock, can start on about 4.2 percent grade. If the truck has to jockey while in this situation on a steeper grade, strawline help will be needed.

Truck scales give erroneous readings on a slope, so there will be a loss of average payload.

5. Split-level construction can often save about half the excavation required for a single-level landing.
6. Cut and fill construction can save excavation, but it is desirable to avoid landing fills on slopes over 50 percent because of the tendency for such structures to become overhangs of mixed dirt and slash during use. Such overhangs sometimes slide out years after use, causing soil and stream damage below.

#### 42.8 - Swing Landings

Swing landings often present unique problems:

1. It may not be possible to get a tractor to the proposed landing for construction. If it is possible, excess excavation cannot be end hauled away.
2. Landing size is often so small as to make hot swinging necessary.
3. Wooden spar trees may have to be raised.
4. Yarder access routes can be critical environmentally and create safety problems.

5. When the spar tree is used as a combination yarding tree and tail tree, the forces applied by two cable systems make guylines very important.

Following are some things to consider when picking a swing landing:

1. A flat area for safe log landing and decking is needed.
2. Adequate log decking room.
3. Safe guyline angle.
4. Sled yarder positions that will permit logging the unit while logs are swung hot to the truck road, if required.

Section 48.6 discusses moving a yarder across country to a swing landing.

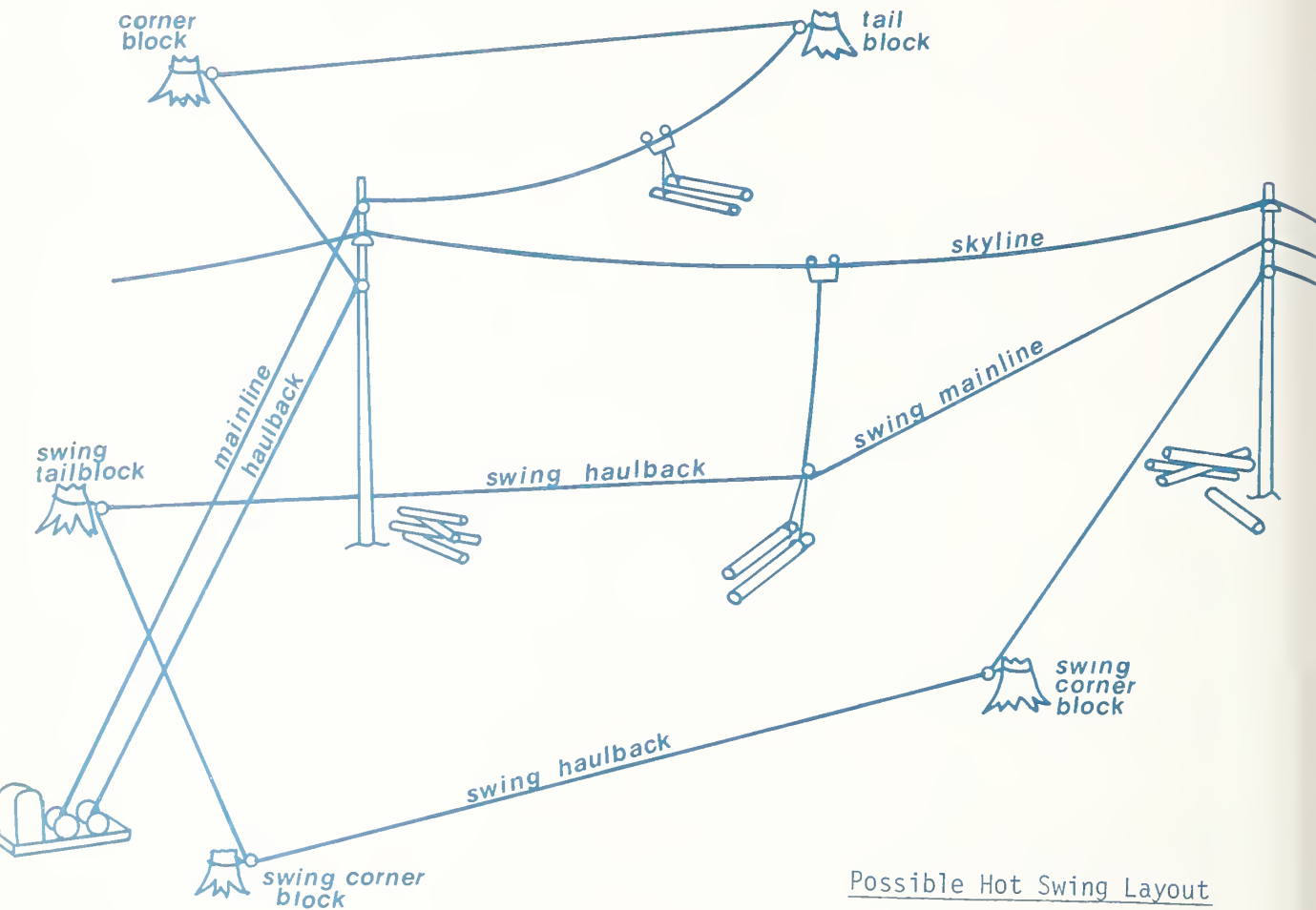

Possible Hot Swing Layout

The swing tail block will have to be changed once or twice to keep from high lead yarding logs across the swing haulback.

Most State logging safety codes prohibit yarding or swinging, more than once machine at one time on any spar tree.

The skyline could be hung either above or below the blocks on the tail spar, but it will have to be hung close to the top guys or the buckle guys. If the skyline were below the blocks, it might facilitate picking up the logs on the swing operation.

## 43 - Rigging and Wire Rope

### 43.1 - Introduction

Cable systems must be rigged up before they can operate and rigged down after yarding is completed. Some are more complicated to set up than others. The Wyssen and Baco systems require three or four days of hard and tedious labor to string the skyline and make them operational. Some of the smaller systems require only one or two hours or less.

The Logging Specialist needs a working knowledge of rigging procedures in order to adequately lay out and appraise the sale. It is difficult to learn rigging by reading a description of a rigging situation. The best way to learn rigging and the problems associated with it is to be on the ground during the rigging job. It is relatively simple to diagram the rigging procedures for a particular cable system on paper, but in doing so it is also quite easy to oversimplify. For example, the problems of handling 2,000 feet of 1½-inch diameter skyline, or of installing a 200-pound block in a tail tree.

The Sale Designer must be familiar with the safety codes applying to logging operations for the state in which he is working, and sale design should be based on rigging practices complying with that state's safety code. Conflicts often occur at the back end of a setting. For example, a sale may be designed for a 1½-inch diameter skyline with tail trees along the back edge of the unit. The safety code in Oregon, for instance, specifies that the tail tree be topped and that guylines not be anchored to live standing trees. Provisions must be made in the sale design to allow these trees to be cut.

On long span skyline sales it is especially important that the logger carefully look over the sale to assure himself that all contingencies have been considered. He must locate tail holds (stumps or trees), access to tail holds, side block holds, tail tree tie backs, landings, guyline trees, single drum settings and access routes for the single drum. These same items must have been checked earlier by the sale planners in their determination of logging feasibility for the sale.

The logger also must get Forest Service approval for his logging plan. The logging plan in the timber sale appraisal should serve as a standard in logging plan considerations.

## 43.2 - Wire Rope

Lines larger than 1-3/8" are difficult to handle and result in high rigging costs. As of 1975, only one steel tower was designed for lines larger than 1-1/2". Lines larger than 1-1/2" should be proposed only when smaller lines won't do the job and wood spars should be proposed.

### 43.21 - Component Parts

Wire rope is composed of a core, wire, center and strand.

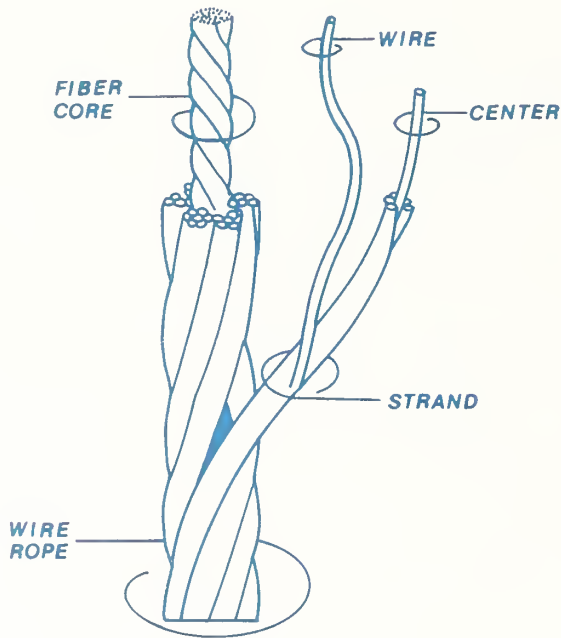

### WIRE ROPE COMPONENTS

Wire - The basic element of a wire rope is a single metallic wire. It may be either round or shaped.



Center - The center is the axial member of a strand about which the wires are laid. It may be cotton, polypropylene fiber, or one or more wires.

**WIRE CENTER****STRAND WIRE****FIBER CENTER**

Strand - A strand is a group of round or shaped wires helically laid around a center in one or more layers.

**FLATTENED****ROUND**

Core - The core of a wire rope is the axial member around which the strands are laid to form a wire rope. It may be either steel, natural fibers, or polypropylene.

**FIBER****WIRE ROPE****WIRE STRAND**

Rope - A rope is a group of strands helically laid around a core.

**FLATTENED  
STRAND****ROUND  
STRAND**

### 43.22 - Strand Construction

A strand consists of a specific number of wires of predetermined size laid in layers around a center in a given pattern or construction. Each wire in a strand performs a specific function. The center serves as the base which supports the other wires in the strand. The intermediate layer of wires serves as a supporting arch for the outer

layer of wires which, in turn, absorb the wear and tear of contact with sheaves, drums, and other surfaces. Each construction is designed to give each wire freedom of movement in relation to the adjacent wires.

For convenient reference, rope constructions are usually grouped into classifications by the number of strands and the number of wires per strand as follows:

<u>Classification</u>	<u>Wires Per Strand</u>
6 x 7	7
6 x 19	16 through 26
6 x 37	27 through 49
8 x 19	16 through 26

The number of wires per strand has a direct relationship with flexibility and resistance to abrasion. In general, the more wires per strand, the more flexible the rope and the lower its resistance to abrasion. A 6 x 19 wire rope has high resistance to abrasion, but low flexibility. This classification is commonly used for skylines, haul-back lines, and mainlines.

Following are four types of strand construction:

#### **FILLER WIRE**



Two layers of wire laid around a center wire, the inner layer having half the number of wires in the outer layer. Small filler wires, equal in number to the inner layer, are laid in the valleys of the wires of the inner layer. Example: 25 Filler Wire 1-6-6f-12.

#### **SEALE**



Two layers of wire laid around a center wire, having any number of uniform size wires in the outer layer with the same number of uniform but smaller sized wires in the inner layer. The wires in the outer layer are cradled in the valleys between the wires of the inner layer. Example: 19 Seale 1-9-9.



**WARRINGTON**

Two layers of wire laid around a center wire, having two sizes of wire alternating in the outer layer and uniform sized wires in the inner layer. The large wires of the outer layer are supported in the valleys, and the smaller wires on the crowns of the wires of the inner layer.  
 Example: 19 Warrington 1-6-(6+6).

**COMBINED PATTERNS**

Two or more of the foregoing basic strand patterns may be combined to form other single operation modifications. Example: 49 Filler Wire Seale 1-8-8f-16-16.

43.23 - Lays

The term "lay" in wire rope is used to denote three distinct features of rope construction:

a. Lay - The direction in which the strands are laid in the rope. This is described as either RIGHT lay or LEFT lay, with right lay the standard. In right lay the strands spiral to the right or clockwise; in left lay to the left, or counterclockwise.

b. Lay - The relationship of the direction of the wires in the strands to the direction of strands in the rope.

REGULAR lay wire rope is made with the wires in each strand laid in the opposite direction to that of the strands in the rope.

**RIGHT LAY - REGULAR LAY**

**LEFT LAY - REGULAR LAY**

LANG lay wire rope is made with the wires of each strand laid in the same direction as the strands in the rope.

**RIGHT LAY - LANG LAY**

In Regular lay rope the exposed portions of the wires are parallel to the center line of the rope. In Lang lay rope the wires are at an angle with the rope axis and much greater lengths of the individual wires are exposed. Regular lay rope is less liable to develop kinks in handling, is more stable, and is more resistant to crushing on drums than Lang lay rope. While Lang lay rope is more flexible and resists abrasion to a greater degree than Regular lay rope, its general use should be in accordance with specific recommendations. It should never be used with a swivel which will permit the rope to rotate and the lay to run out. Both ends of Lang lay rope must be securely fastened.

c. Lay - A unit of measure to describe the straight-line distance in which a strand makes one complete spiral around the core.

The length of lay is related to the diameter of rope and provides a basis for rope inspection. The lay length is measured as illustrated.



## 43.24 - Cores

The core is the axial member of a wire rope about which the strands are laid. The primary function of the core is to serve as the foundation of the rope, to keep it round and to keep the strands correctly spaced and supported.

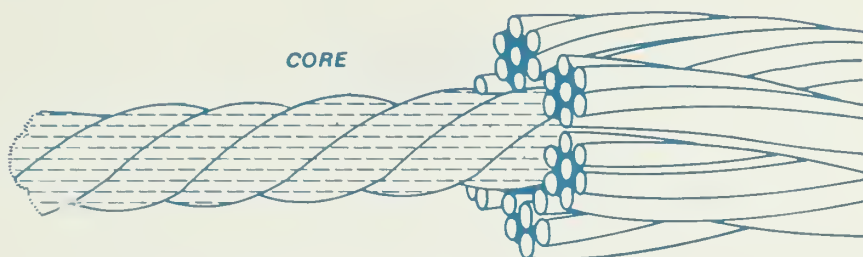

### Fiber Core

For many years fiber cores made of hemp, or sisal, were considered standard. They served their function very well. During recent years, however, rope users have come to appreciate the qualities of a man-made fiber known as polypropylene. It is an entirely new fiber made from petroleum by a complex process. It has all of the good features of sisal for core purposes plus considerably increased resistance to deterioration by corrosion, dryness, or rot.

Although a fiber core contributes nothing to the strength of a wire rope, it does aid flexibility and helps to cushion the strain of shock loads.

### Steel Core

Steel cores may be made of a single strand (WSC - wire strand core), or of a independent wire rope (IWRC). Strand cores are usually made of 7 or 19 wires. The more commonly used IWRC is a 7 x 7 wire rope.

Steel cores provide additional strength to the rope and are designed for better resistance to crushing than fiber cores.



**FIBER CORE WIRE ROPE**



**INDEPENDENT  
WIRE ROPE CORE (IWRC)**

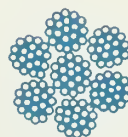

**STRAND CORE (WSC)**

43.25 - Rope Measurement

The correct diameter of a wire rope is the diameter of a circumscribed circle which will enclose all the strands. It is the largest cross-sectional measurement as illustrated below:

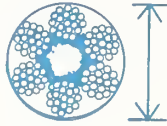
CORRECT POINT FOR MEASURING WIRE ROPE DIAMETER

The measurement should be made carefully with calipers. The illustrations below show the correct and incorrect method of measuring the diameter of wire rope.

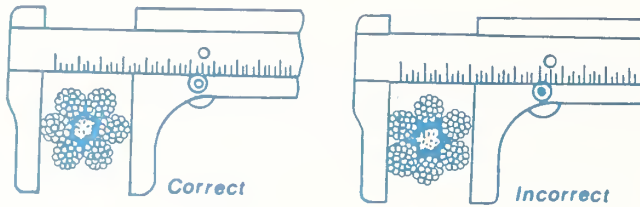
METHOD OF MEASURING WIRE ROPE

Wire rope is normally made slightly larger than its nominal size. The following table lists the tolerances of wire rope diameters.

Nominal Rope Diameter	Tolerance	
	Under	Over
0-3/4	0	1/32
13/16-1-1/8	0	3/64
1-3/61-1-1/2	0	1/16
1-9/16-2-1/4	0	3/32
2-5/16 & larger	0	1/8

43.26 - Grade and Classification43.26a - Grade

Strength and toughness are two characteristics needed in wire rope for logging. There are numerous grades of wire rope to meet various market demands. Three grades of wire could be of concern for logging operations.

1. Extra Improved Plow Steel (EIPS) is made of a special grade of steel, containing a very high carbon content, that provides about 15 percent greater tensile strength and greater toughness than IPS.

2. Improved Plow Steel (IPS) is a tough and strong grade of wire developed to perform best under the widest variety of operation conditions. It has a high carbon and manganese content which makes it hard and abrasion-resistant.

3. Plow Steel has a lower breaking strength than IPS but a somewhat increased resistance to fatigue.

#### 43.26b - Classifications

The following classes of wire rope are generally used in logging operations.

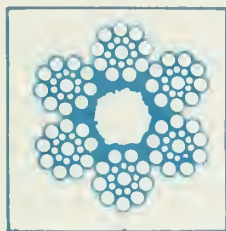

**6x19 SEALE**

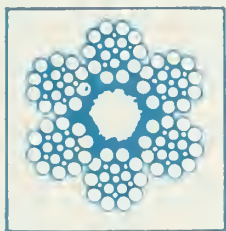

**6x21 FILLER WIRE**



**6x19 WARRINGTON**

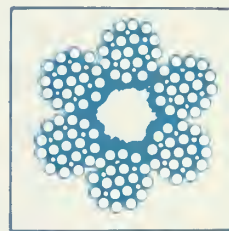

**6x25 FILLER WIRE**

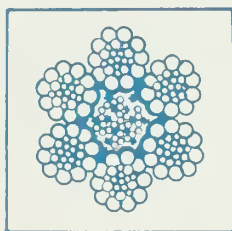

**6x26 WARRINGTON-SEALE**

Wire rope with a 6 x 19 classification is widely used in logging. This classification includes all 6-strand round strand ropes with 16 through 26 wires in each strand. All have the same weight and breaking strength, so they are grouped into one classification (6 x 19) and given one set of values.

#### 43.26c - Wire Rope Recommendations

Following are some industry recommendations for classes for wire rope for use on a steel tower. Because of differences in sheave size, fleet angles, etc., between steel towers and wood spars, the recommendations for a wood spar could be different. All lines should be PREF RRL IWRC, except chokers which are PPC.\*

Sky Line or Slack Line

6 x 19 S IPS, or EIPS; or  
6 x 26 WS IPS, or EIPS

Main Line

6 x 19 S IPS, or EIPS; or  
6 x 26 WS IPS, or EIPS

Haulback or Strawline

6 x 19 S IPS, or EIPS; or  
6 x 26 WS IPS, or EIPS

Chokers

6 x 26 WS IPS, or  
6 x 25 FW IPS, or  
6 x 31 Choker 12-IPS

*EIPS - Extra Improved Plow Steel	RLL - Right Lang Lay
RC - Fiber Core	FW- Filler Wire
RRL - Right Regular Lay	IPS - Improved Plow Steel
S - Seale	IWRC - Independent Wire Rope Core
W - Warrington	PPC - Polypropylene Fiber
PREF - Preformed	

EIPS rope has been tried by many loggers, but in general they are currently using IPS rope. An exception would be the case where the added strength of EIPS is needed for a specific job, such as for skylines when planning timber sales design for EIPS skylines. Some of the reasons for the preference for IPS over EIPS are:

1. IPS is more malleable and has a lower carbon content (0.70% to 0.75% in IPS vs. 0.80% to 0.85% in EIPS).
2. EIPS is more susceptible to burning
3. EIPS fatigues faster
4. When IPS rope is worn out it looks worn out. EIPS rope still look good when it is worn.
5. EIPS rope isn't desired for chokers and strawlines as it kinks easier than IPS.

The 6 x 26 rope is preferred to the 6 x 25 rope because it has fewer and larger outside wires which increase rope life and it seems to jagger up less.

## 43.27 - Stretching and Load Limits

### Stretch

There are two kinds of stretch to be considered within the elastic limit of a wire rope—constructional and elastic. The constructional is permanent and starts to develop as soon as stress is applied. It is caused by the adjustment of the wires and the seating of the strands upon the core. In the field most of it occurs within the first few days, or weeks, of operation depending on the amount of load. For ordinary ropes this stretch will be approximately 1/4% to 1% of the length of rope under load. The larger the load, the higher this percentage will be with the average of 1/2% to be used for normal conditions.

A large part of the constructional stretch may be removed by prestretching. The prestretching load should be equal to or greater than the estimated working load, but must be below the elastic limit.

Elastic stretch is the temporary elongation of wire rope when under load. The rope will return to its normal length when the load is removed, provided the load has been kept below the elastic limit, which is about 60% to 65% of its ultimate breaking strength for most ropes. Elastic stretch is directly proportional to the load and length of rope involved and inversely proportional to its modulus of elasticity and metallic area.

### Load Limits

Steel is elastic, to a certain extent. When load is applied the steel stretches slightly and when the strain is removed it returns to its original length. This is true only to a point called the elastic limit. If a strain is applied above this limit the steel is permanently stretched and it will not return to its original length.

A number of thorough tests have shown that there is another limit, lower than the elastic limit, that is of equal or even greater importance to the life of a wire rope. This limit is approximately 50% of the breaking strength and is known as the endurance limit. Tests have shown that if a wire is given repeated pulls, or jerks, greater than the endurance limit, the life of the wire is comparatively short, and that the wire will finally break even though it has never been strained to its breaking strength, or to its elastic limit.

To allow some leeway for shocks and overloads between the normal load and this vital endurance limit, a safe working load which is 1/3 of the breaking strength is used by the Forest Service in determining skyline payload.

This leeway between the working load and the endurance limit is necessary because any instantaneous overload or shock above the endurance limit has the same effect as a constant strain above that limit.

Repeated instantaneous overstrains such as occur in acceleration and deceleration in starting and stopping loads, or the shocks and overloads encountered in most operations, cause severe, unseen damage and shorten the service life of the wire rope.

#### 43.28 - Special Treatments and Special Ropes

##### 43.28a - Preforming

Preforming, as the name implies, means that both the individual wires and the strands are helically formed into the exact shape they will assume in the finished wire rope. The principal advantages of preforming are: greater flexibility, ease of handling, resistance to kinking, and equal distribution of load to every wire and strand.

These advantages can best be appreciated by a knowledge of the basic differences between preformed and non-preformed wire rope. With the latter, the strands are held in their helical positions by force, and are therefore, subject to strong internal stresses.

In preformed rope the wires are "at rest" having been formed before closing into the exact shape they will assume in the finished rope.

Below is a portion of a preformed wire rope showing how each strand and each wire, when taken apart, retain the exact helical shape they assume in the rope.



PREFORMED WIRE RETAINS ITS SHAPE EVEN WHEN STRANDS ARE SEPARATED



The elimination of internal stresses in preformed wire rope results in longer rope life for most operating conditions. In fact, the advantages of preformed rope are so outstanding and so universally accepted that it is now the standard. Non-preformed rope is made when its characteristics are required, but only on special order.

#### 43.28b - Flattened Strand

Flattened strand is a special wire rope made with a lang lay that performs exceptionally well on special wire rope jobs. It is expensive in comparison with other ropes. Its distinguishing physical feature is that the surfaces of its strands are relatively flat instead of round. As a result, the rope is more nearly a smooth, continuous circle than is regular round strand rope.

Since it has a lang lay, both ends of the rope have to be fastened down or the rope will unlay. The rope can't be used with swivels.

About the only application for flattened strand rope in logging is for shovel opening and closing lines.

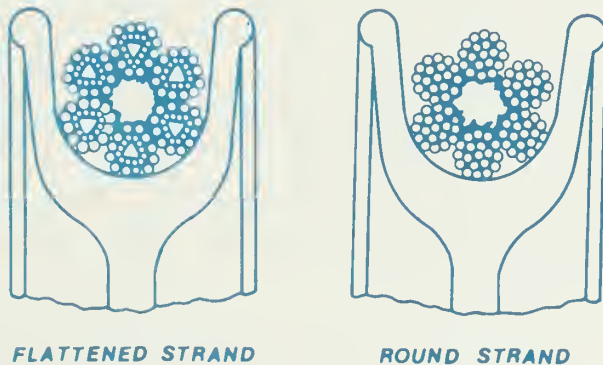

#### 43.28c - Dyform (Super Strand)

Dyform is specially manufactured to produce a stronger rope that is more resistant to abrasion and better spooling.

Dyform strands are originally made oversize. The strands are drawn through a die which flattens the outside crown wires. This reduces the rope diameter without reducing the cross section area. The strand ends up with  $\pm 15\%$  more steel and  $\pm 20\%$  more strength. The wire has a lower carbon content which aids in drawing it through the die.

In balloon yarding, normally spans are long and line speeds are fast. This results in torque build-up in the lines and the lines won't spool properly. If swivels are used to relieve the torque, the long lines and high speeds result in over-swiveling which unlays the lines. Dyform rope has  $\pm 400\%$  torque and can be used without swivels. This lower torque aids in spooling on the yarder drums.

Dyform rope is used on balloon yarders because of its added strength and its lower elongation, torque, internal abrasion and fatigue. The added strength is important because of the constant lift of the balloon.

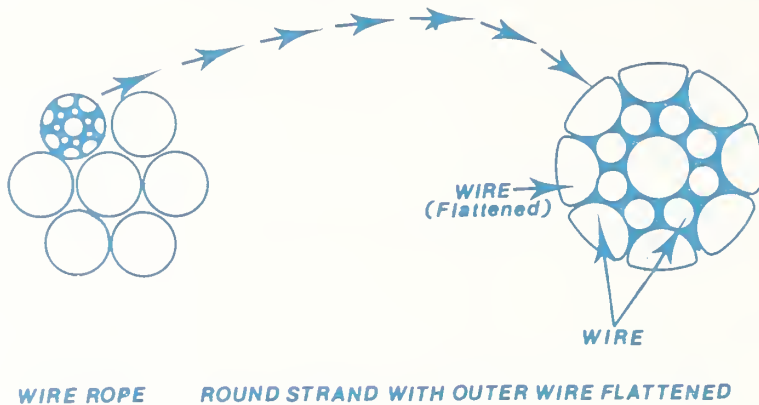

The dyform rope used on the balloon is a 6 x 26 construction with an over-size core. The over-size core creates a separation between the strands, thereby reducing chafing and increasing line life.

#### 43.28d - Plastic Impregnated Wire Rope

This is a recent development and as yet isn't used widely in logging.

Plastic can be squeezed into a wire rope after it is manufactured instead of putting in lubricant. Plastic impregnation is intended to improve line wear. This treatment increases the rope price.

The plastic makes the rope slick and hard to pull manually. Plastic doesn't have the same modulus of elasticity as wire.

#### 43.29 - Handling Wire Rope

New wire rope can be delivered to the landing by the dealer on a spool truck. Most loggers pick up their rope on a spool at the dealer's warehouse. If an operator has to handle or transport lines he may rig a used log truck as a spool truck, using wood drums which can be wound up and removed.

Mainline life is greatly increased by swapping ends a couple of times during the line's life. When this is done, the eye that connects to the butt rigging is cut off and the end is adapted to permit it to be secured to the drum. An eye has to be spliced into the end that was connected to the drum.

Skylines wear from wrapping on the drum and from bearing on the fairlead. They can also be swapped end for end, or the worn end can be cut off.

The various wire rope manufacturers have literature available on the installation, use and care of wire ropes.

43.29a - Drum Capacity

Yarder specifications give the drum capacities for the maximum-size wire rope handled. It is often possible to install a smaller diameter wire rope to gain additional length. The following table provides a "K" value to determine a drum capacity for a wire rope diameter, knowing the drum capacity for a given wire rope diameter.

Example: If a drum holds 1,450 feet of 1-3/8-inch diameter rope, how much 1-inch diameter rope will it spool?

Solution: From the following table, the K value for 1-3/8" wire rope is 0.127, and the K value for 1" wire rope is 0.239. Therefore,

$$\frac{1,450' \times K(1'')}{K(1-3/8)} = \text{Capacity of 1"}$$

or

$$\frac{1,450'}{0.127} \times 0.239 = 2,729 \text{ feet of 1" diameter rope}$$

WIRE ROPE WEIGHTS, STRENGTHS, AND K VALUES  
6 x 19, 6 x 21, or 6 x 25 IWRC\*

Diameter (Inches)	K**	Weight Lb/Ft	Extra--Improved Plow Steel	
			Safe Working Load KIPs (Safety Factor=3)	Breaking Strength KIP's
1/4	3.29	.116	2.27	6.80
5/16	2.21	.18	3.51	10.54
3/8	1.58	.26	5.0	15.1
7/16	1.19	.35	6.8	20.4
1/2	.925	.46	8.9	26.6
9/16	.741	.59	11.2	33.6
5/8	.607	.72	13.7	41.2
3/4	.428	1.04	19.6	58.8
7/8	.308	1.42	26.5	79.6
1	.239	1.85	34.5	103.4
1 1/8	.191	2.34	43.3	130.0
1 1/4	.152	2.89	53.3	159.8
1 3/8	.127	3.50	64.0	192.0
1 1/2	.107	4.16	76.0	228.0
1 5/8	.0886	4.88	88.0	264.0
1 3/4	.0770	5.67	102.0	306.0
1 7/8	.0675	6.50	116.0	348.0
2	.0597	7.39	132.0	396.0

\* Independent Wire Rope Core

\*\* This value gives only approximate capacities because it is based on a constant tension when spooling the wire, and the same number of wraps of rope in each layer.

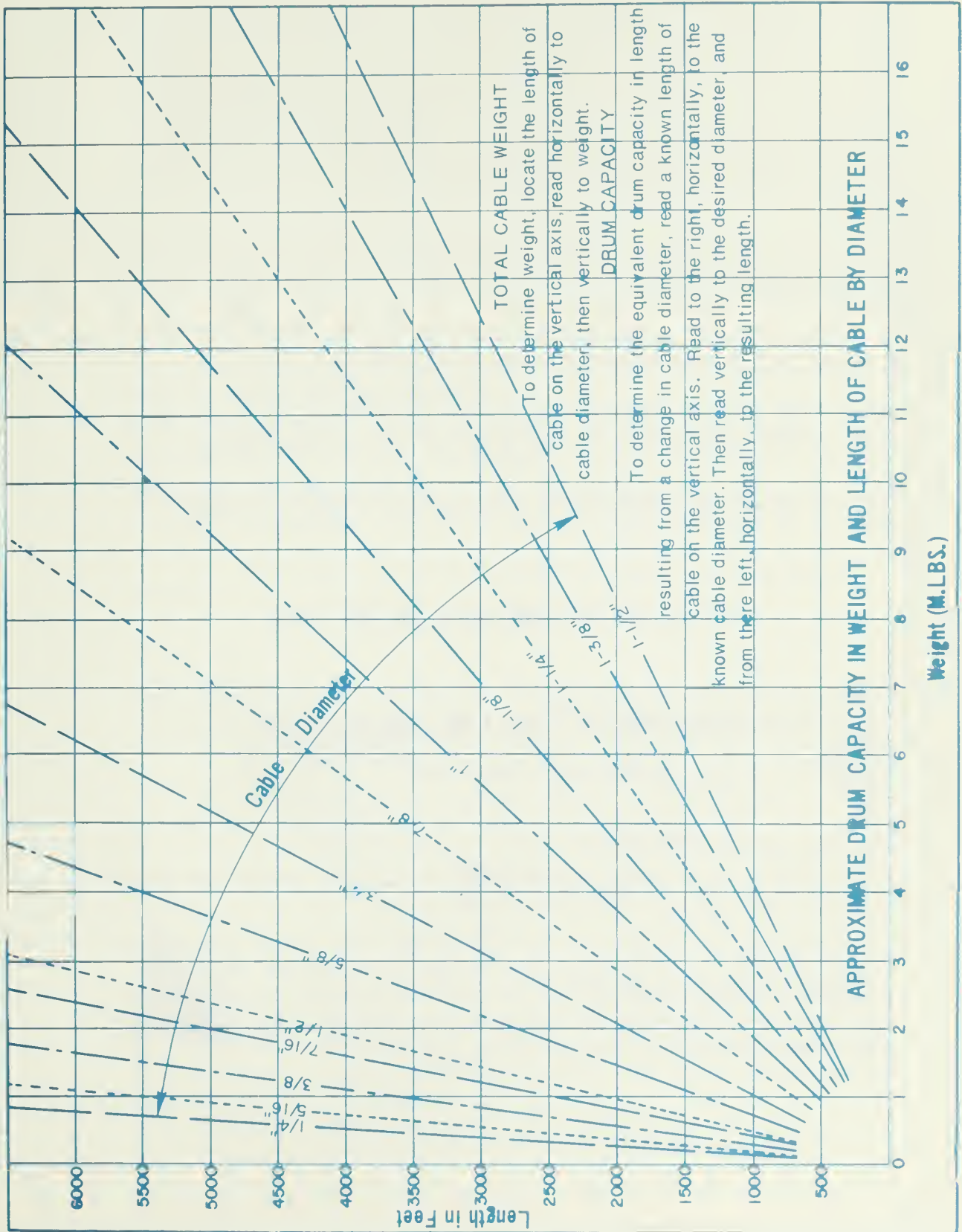

43.3 - Wire Rope Connections and Fittings43.31 - End Splicing

Wire rope can be joined end to end by splicing. State safety codes have specific requirements concerning splicing. Long splices are required for permanently joining regular lay running lines. Short splices, eye to eye splices, cats paws, knots, molles, and rolled eyes are prohibited except for temporary purposes. Short splices are used in loading lines, crotch lines, etc.

A long splice takes up a minimum of 4' for every 1/8" of rope diameter. The splice is stronger when more than the minimum length of rope is used in splicing.

On endless line, multispan systems, both ends of the endless line have to be pulled and held while the line is spliced.

When a rope is to be cut, even if it is preformed, it should be carefully "seized" to prevent the strands unlaying. Place at least three firm seizings on each side of the point of cut, as shown below.

When cutting larger ropes larger, longer and more seizings should be used. It is important that the lay of the rope is not disturbed.

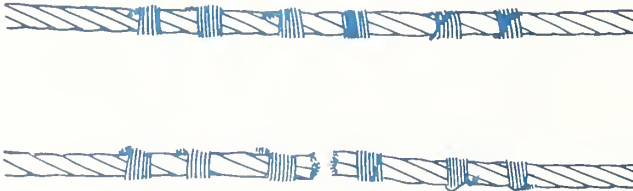

**ROPE SEIZED FOR CUTTING**

43.31a - Tucked Long Splice

This splice is used more often than the rolled long splice (see below). It is a faster and more positive splice.

This splice wears faster than the rest of the rope if the line is run through sheaves, or a carriage runs on the line, because the tucked strands are crossed over the top of the rope strands, increasing the rope diameter, thus exposing them to added contact. This splice doesn't spool smooth because of the increased line diameter. The ends of the tucked strands stick out, exposing jagers.

If the core is tucked and the splice is properly made, there is very little reduction if any, in the rope's strength. If the core isn't tucked, the strength loss is approximately equivalent to the strength of the core (7% to 15% depending on core construction).

### 43.31b - Rolled Long Splice

In this splice the core is cut out and is replaced by the strands. If the splice is done right, and is properly hammered in, the rope diameter is not appreciably increased.

The rope strength is reduced approximately by the strength of the core. The longer the length of the strands that are rolled in the better the splice holds. Strength is also increased by leaving distance between the rolled in points.

The splice should be broken in with light loads for a while until the strands seat themselves properly.

A rolled long splice may be needed if a carriage is used which has a skyline clamp with a close tolerance.

Following are figures showing a few of the different stages in making a rolled long splice:

1. The hooked end of the tucker is placed over the top of strand B.

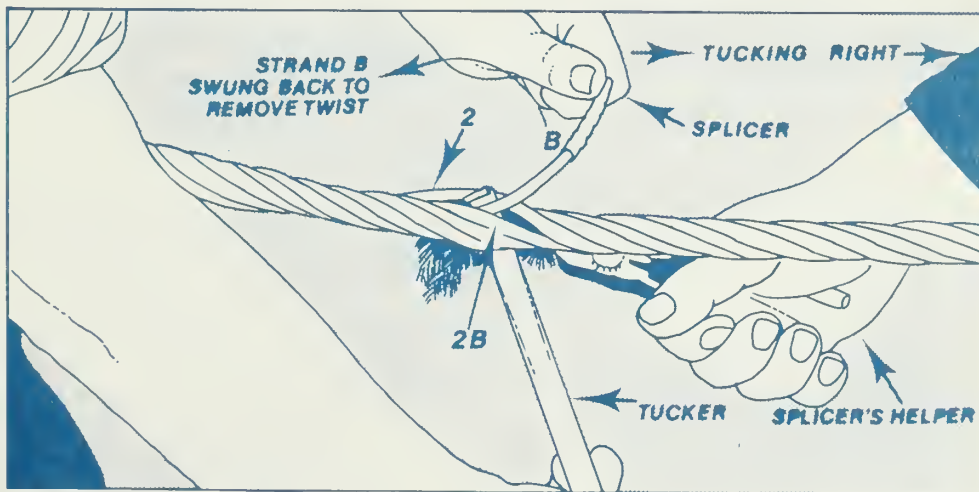

2. The start of the tuck is shown here, with the splicer handling the tucker and his helper pulling out the fiber core with a pair of pliers.

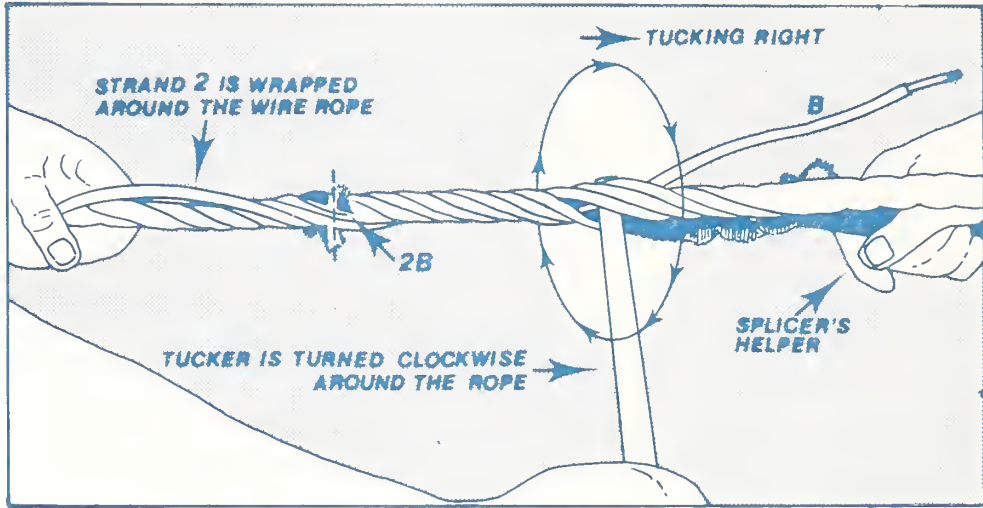

3. Strand B has been tucked into the center of the rope, except for 1-inch still to be inserted. Notice that the seizing on the end of the strand is not removed, and is tucked-in with the strand.

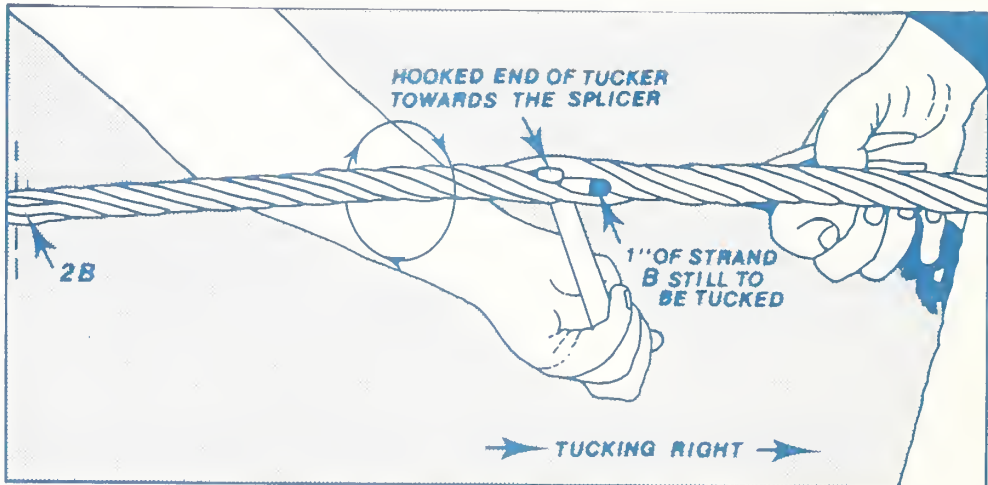



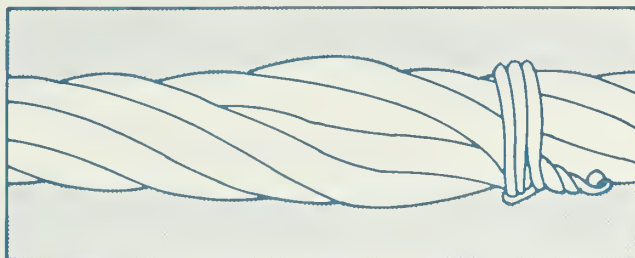

***DISTORTED ROPE AFTER A STRAND HAS BEEN ROLLED IN***

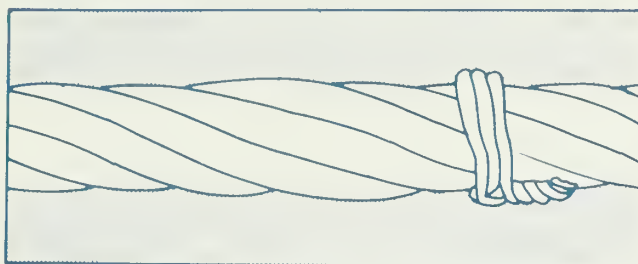

***ROPE AFTER STRAND DISTORTION IS CORRECTED***

### 43.31c - Jump Splice (ladies' splice, Russian jump)

When a short splice is permissible, a jump splice can be made faster than a long splice. Since the core is tucked, the rope cross section area is not reduced. However, a jump splice won't pass through grooved sheaves, or spool properly on a drum.

A jump splice is tucked like a logger's eye splice.

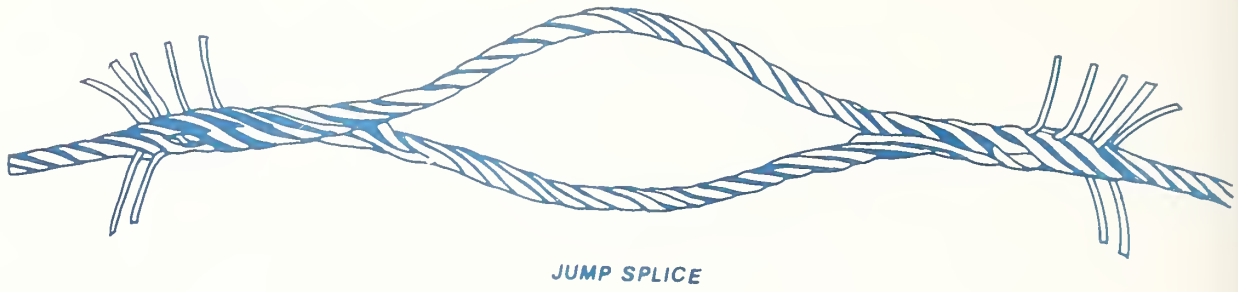

43.32 - Eyes

Eyes are formed in wire rope by:

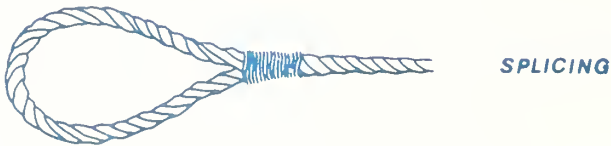

If care is not used in swaging wire strands can be damaged, reducing the strength of the connection.

State safety codes may permit knotted eyes only in tractor bull lines. An overhand knot on a bight is best.

If thimbles aren't used with eyes, the strength of the rope is greatly reduced. Thimbles are normally used only on permanent, stationary installations such as deadmen.

### **TYPES OF THIMBLES**



**LIGHT THIMBLES**



**HEAVY THIMBLES**



**HAWSER THIMBLES**



**SOLID THIMBLES**

### **43.32a - Loggers Eye Splice**



**LOGGER'S EYE SPLICE**

This is the strongest of the various eyes commonly used by loggers. Loggers don't use thimbles on eyes in running lines.

43.32b

43.32b - Farmer's Eye Splice (molly eye, flemish eye)

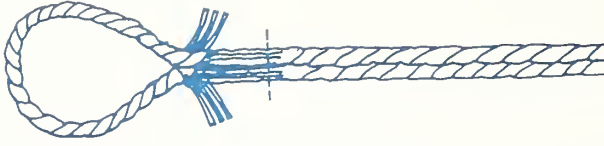

**FARMERS EYE SPLICE**

A farmer's eye is made by unwrapping 3 strands of a 6 strand wire rope. The end of the rope is now in two parts, with 3 strands each. One of the parts also contains the core. The ends are then bent back to form an eye. The eye is completed by relaying the two parts together.

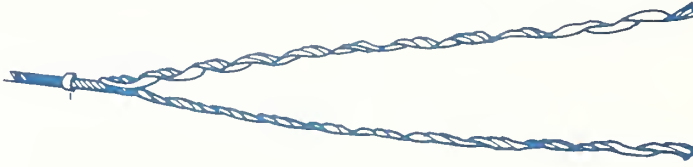

STRANDS UNWRAPPED TO FORM TWO PARTS

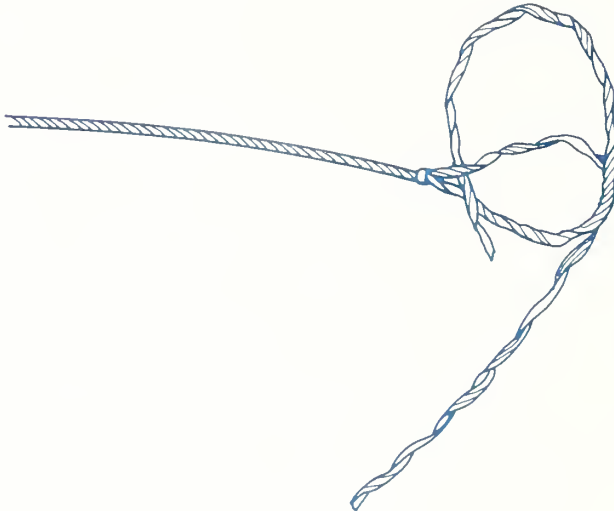

ENDS BENT TO FORM AN EYE

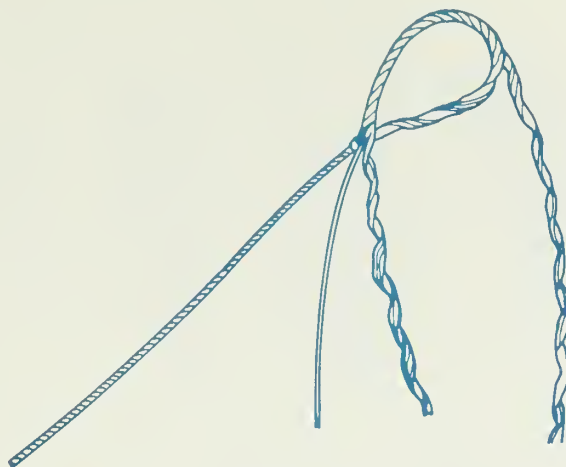

ONE PART RELAYED

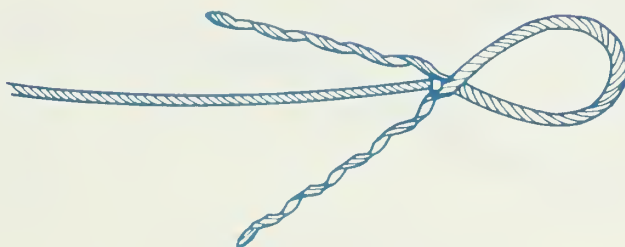

READY TO CLIP, TUCK, OR RELAY

The ends of the two parts can be left sticking out at the base of the eye, or the ends can be laid back together to form a six strand rope which is then clipped to the standing rope. The farmer's eye can also be tucked like a normal 3-tuck logger's splice. If it isn't tucked, spliced, or clipped, its strength is very poor compared with a logger's eye splice.

A farmer's eye splice with 2 clips makes a very strong eye. This is what is used on balloon rigging. This splice will not go through a block.

43.32c - Marine Eye

A marine eye has been used by some loggers in California, but is rarely used in Oregon or Washington.

On a marine eye splice the core is removed and the strands are rolled into the position previously occupied by the core. Since the core is removed, the marine eye isn't as strong as a logger's eye. However, with the strands rolled in, there are no jagers exposed.

To do a polished job, a marine eye splice can be served.

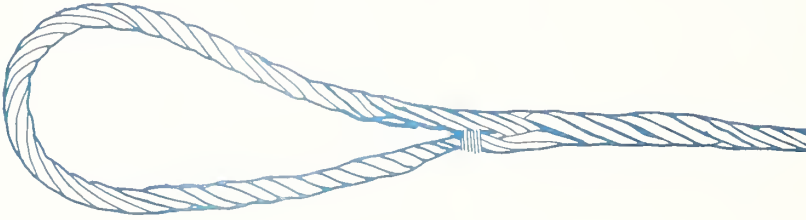

ROLLED END OF MARINE EYE SPLICE

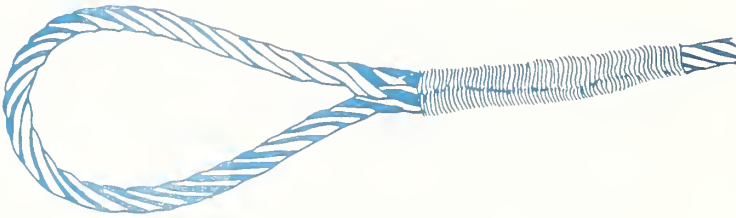

SERVED MARINE EYE SPLICE

43.33 - Wire Rope Fittings43.33a - Ferrules (nubbin)

A ferrule is a metal sleeve, or collar, fastened to the end of a wire rope that fits into a hook or socket, to secure the wire rope.

Ferrules can be attached to wire rope by:

Swaging (pressing)

Babbitting

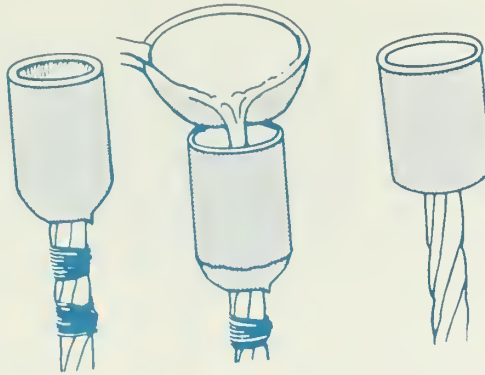

BABBITTED FERRULE

Wedging

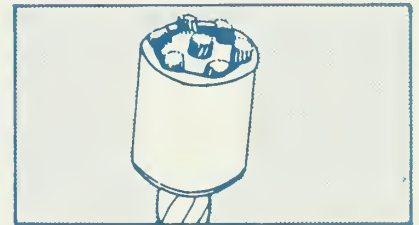

WEDGED FERRULE

Wedge ferrules may work loose if they are whipped or banged around.

### 43.33b - Hooks

Following are several types of hooks common to logging.

#### 1. Choker Hooks and Guyline Hooks

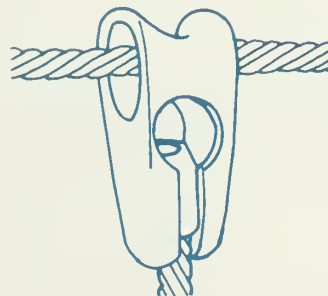
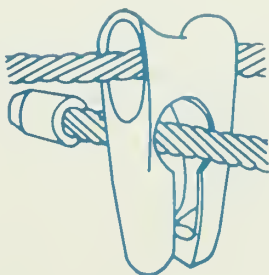

2. Screwy Choker Hook

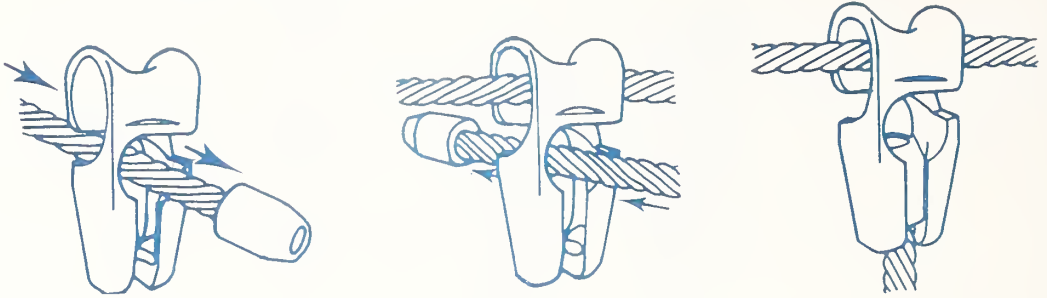

This type of hook can be quickly installed, or removed, from the choker rope after ferrules have been attached.

3. Sleeve-Type Hooks

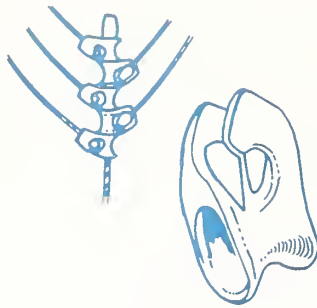

Hooks and chokers are free to slide along the skidding line.

4. Double End Guyline Hook

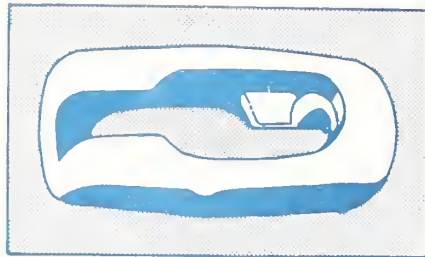

Used to connect a tower guyline to a guyline extension. Also used on a skyline to connect a skyline extension, if the carriage doesn't have to pass over the connection. A skyline carriage should not pass over a double end guyline hook as it might uncouple.





## 5. Strawline Hooks



Strawline hooks are tied into the strawline before the end is eye spliced.



## 43.33c - Sockets and Dees

Sockets are fitted on the ends of lines and straps to facilitate connecting lines to each other or to objects such as blocks, or standing rigging.

There are open sockets



and closed sockets

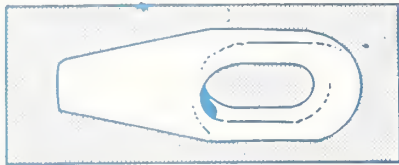

Sockets can be:

- Cast (babbitted)
- Swaged
- Wedged

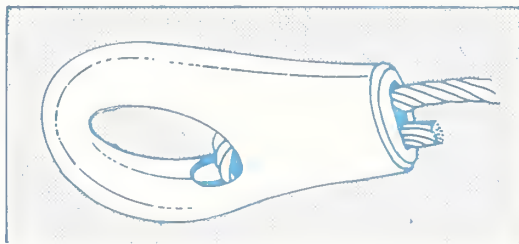

WEDGE SOCKET

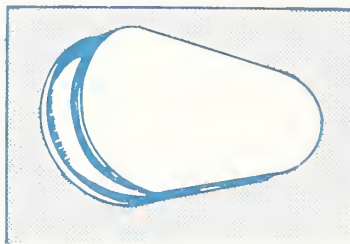

WEDGE

Open sockets are used mostly for standing rigging connections.

43.33d - Swivels

Swivels are used when lines are joined to other lines, or to rigging, to keep the lines from wrapping (i.e., between mainline and butt rigging, haulback and the butt rigging, butt hook and butt rigging, etc.). Swivels relieve the torque that builds up in a line, especially as the line wraps on and off the drum. Without a swivel, a large line will create torque in a small line to which it might be attached.

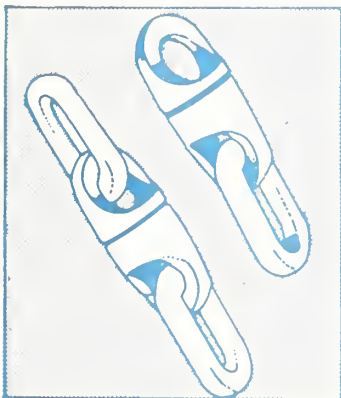

LINK SWIVEL

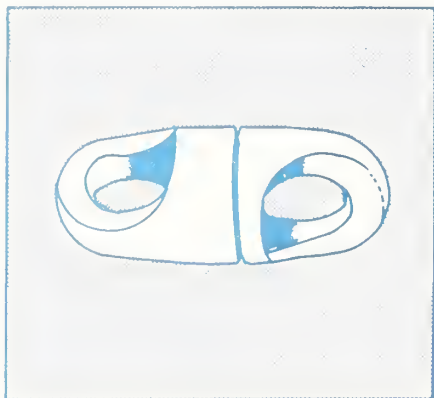

BUTT SWIVEL

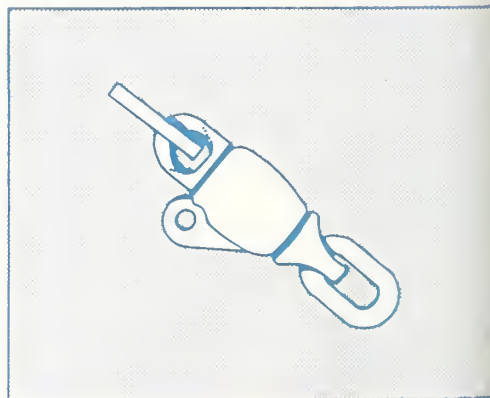

3-WAY SWIVEL

THREE TYPES OF SWIVELS

Because of high line speed, swivels are not used in balloon rigging. Swivels between the main and haulback on the balloon cause the lines to unlay. Dyform wire rope is used in balloon logging because it can operate with high line torque.

A shay swivel can be used to attach the slack pulling line to the skidding line (or mainline) on a skidder system. A short (6" to 9") line is spliced into the skidding line with a reverse lay, creating a bump for the shay swivel to ride up against so the slack pulling line can pull line off the yarder drum for lateral yarding.

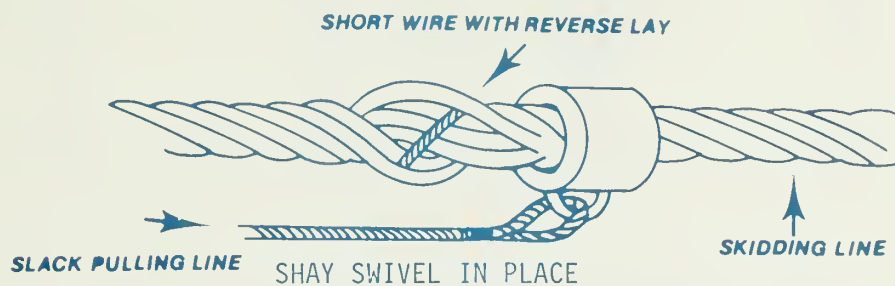

Various yarders may or may not permit the shay swivel to pass through the mainline fairlead.

An alternate means of attaching a slack pulling line to the mainline is to put an eye in the end of the mainline and shackle the lateral yarding line and the slack pulling line to it.

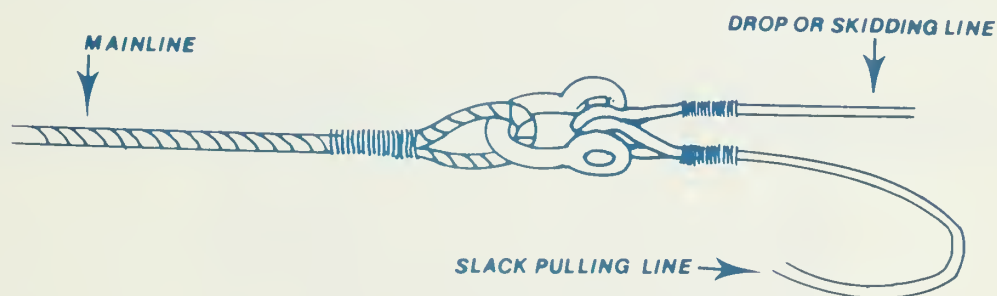

#### SLACK PULLING AND SKIDDING LINE SHACKLED TO MAINLINE

The height of the tower limits lateral skidding distance if the shackle can't pass through the tower fairlead.

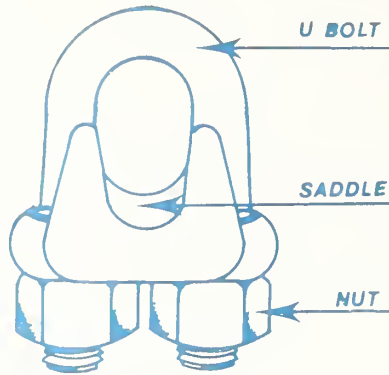
43.33e - Clips

The clip method of making wire rope attachments is widely used. When clips of the correct size are properly applied and a thimble is used, the attachment may develop as much as 85% of the rope strength.

The first clip is attached nearest the short end of the rope. The second clip is attached nearest the thimble, and the remaining clips are then attached between these two, with equal spacing that depends on the size of the rope. Tables are available that give proper spacing between clips for various sizes of the wire rope.

The short end of the rope should rest squarely upon the main body of rope. The clips should be attached so the saddle part of the clip is in contact with the main body or live side of the rope. The "U" bolt will then be in contact with the short or dead end of the rope. All clips should be applied in this manner.

RIGHT WAYWRONG WAYMETHOD OF ATTACHING WIRE ROPE CLIPS43.34 - End Preparation

Most ropes are shipped with the ends seized. Seized ropes can usually be installed without further preparation. In some cases tight openings in yarder drums and wedge sockets, or complicated reeving systems, require special end preparation: the strands must be tightly held without increasing the rope diameter. In such cases the ends are tapered and welded, tapered and speltered, or the ends fused. It is sometimes necessary to provide a loop (or becket, or link) to which a lighter line is fastened to pull the rope into place, or around sheaves. Some of these special end preparations are shown below. For larger diameter ropes a special swivel becket is recommended. This permits a new rope to be pulled through the system by the old rope being removed, without disturbing the lay or the balance of the new rope.

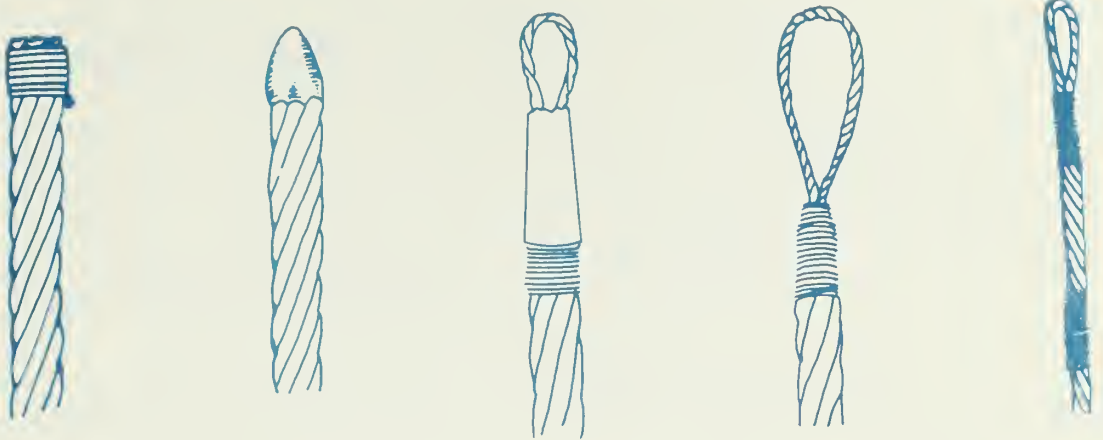
Siezed EndTapered & Welded EndTapered & Speltered End with LoopSwivel BecketSiezed End With Loop

SEVERAL TYPES OF END PREPARATIONS  
(not used much in logging)

If a tapered end is desired, build up metal on the end into a cone and grind down into the desired taper.

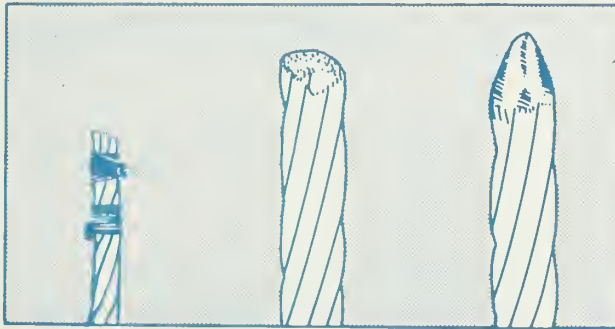

STAGES IN TAPERED END PREPARATION

43.35 - Efficiency of Wire Rope Connections

Fittings should be attached with great care as safety is the most important consideration in the operation of all equipment using wire rope. The figures below represent the efficiency of the attachment to the rope. The approximate percentage of effective rope strength available with each type of fitting depends upon the diameter, construction and grade of rope.

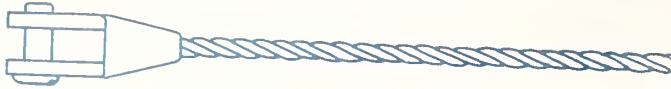

WIRE ROPE SOCKETS--SPELTER ATTACHMENT.....100%

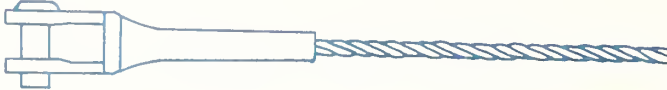

WIRE ROPE SOCKETS--SWAGED.....100%



"SWAGED-SLEEVE" LOOP OR THIMBLE ATTACHMENT  
 1-inch diameter and smaller.....95%  
 1-1/8 inch diameter and larger.....92.5%



WEDGE SOCKETS--DEPENDING ON DESIGN.....75-90%



CLIPS--(NUMBR OF CLIPS VARIES WITH SIZE OF ROPE).....75-85%

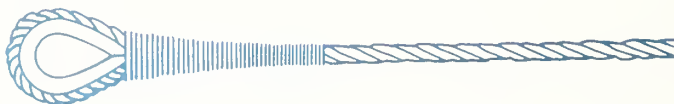

LOOP OR THIMBER SPLICE (SPLICED EYE)  
 1/4".....90%    3/8".....88%    1/2".....86%    3/4".....82%  
 5/16".....89%    7/16".....87%    5/8".....84%    7/8" and larger.....80%

Spliced eye without thimble - intermediate efficiency because of flattening of strands.

TUCKED LONG SPLICE WITH CORE TUCKED.....100%  
 LONG SPLICE WITHOUT TUCKED CORE.....85-93%

A wire rope loses some of its strength when it is bent around a sheave. Strength loss is dependent upon the sharpness of the bend and the relative sizes of the sheave and rope. Strength loss is not dependent upon degrees of bend. The following table gives the strength efficiency for ropes bent around sheaves of a given diameter as compared with the same rope when straight.

STRENGTH EFFICIENCY UNDER STATIC LOAD

<u>When Sheave Diameter is:</u>	<u>Efficiency of Rope is:</u>
10 times rope diameter	79% of strength of straight rope
12 times rope diameter	81% of strength of straight rope
14 times rope diameter	86% of strength of straight rope
16 times rope diameter	88% of strength of straight rope
18 times rope diameter	90% of strength of straight rope
20 times rope diameter	91% of strength of straight rope
24 times rope diameter	93% of strength of straight rope
30 times rope diameter	95% of strength of straight rope

(Oregon Safety Code, Chapter 16)

43.36 - Connecting Wire Rope in Yarding Practice

<u>Line</u>	<u>Means of Connection With:</u>		<u>Pass Through Grooved Sheaves</u>		
	<u>Other Lines</u>	<u>Drum on Yarder</u>	<u>Will</u>	<u>Won't</u>	
Strawline Hooks	Hooks	Eye (Run eye thru hole and put pin thru eye)	X		
		Wedge (Run line thru slot and wedge)			
Haulback	Spliced Eye and Shackle			X	
		Socket and Shackle		X	
		Swagged Eye and Shackle			X
		Ferrule			
		Clamp (Run line thru hole and clamp)			
		Wedge (Run line bight thru slot and wedge bight loop)			
Mainline	Same as for haulback				
Skyline	Eye & Shackle			N/A	
		Ferrule and Double End Hook		N/A	
	Socket and Shackle				
		Splicing	Ferrule Clamp Wedge		



Guylines on wood trees. Guylines are fastened to wood trees with guy-line sleeves, by a ferrule and hook, or with screwy guy hooks and nubs. Guylines are wrapped around a notched stump, tightened, spiked and wrapped and spiked again for a total of at least 2-1/2 wraps.

Guylines on steel towers. Guylines are fastened to drums on the tower with ferrules, clamps, or wedges, and fastened to guyline extensions with double end hooks. Guyline extensions are fastened to stumps with ferrules and hooks.

State safety codes normally do not permit standing trees to be used for guyline anchors.

## 43.4

### 43.4 - Rigging Hardware

A logging planner should have a knowledge of rigger's tools and equipment so that he is better able to understand how various rigging operations are accomplished, and whether or not proposed rigging operations are feasible.

Following are sketches of various rigging tools and equipment with comments on their use.

#### 43.41 - Rigger's Tools

##### a. Rigging Chain



Length: 3' to 9'

Weight: 8 to 22 lbs.

Used to secure a purchase on a wire rope. The chain is wrapped around the rope at least three times and then is hooked back on itself.



#### RIGGING CHAIN IN POSITION TO TAKE A STRAIN ON A WIRE ROPE

##### b. Pass Chain or Climber's Chain



Used to make sort of a bosun's chair for the climber to ride in to go up the tree. The chain wraps around the climber's legs and the hooks are secured to the center ring. Also used on the end of the pass line in rigging the tree.

c. Come-Along

A device with a mechanical advantage used to pull objects such as wire rope, telephone lines, fences, etc. They may operate like a block and tackle, chain hoist, or utilize a crank and ratchet.

d. Splicing Tools

Wire rope manufacturers have publications available that give instructions on making splices.

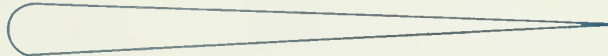
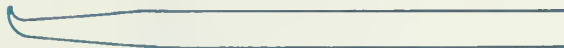
Splicing NeedlesMarlin SpikeDaggerTuckerTOOLS FOR SPLICING WIRE ROPE

e. Claw Bar



Length +55"  
Weight 20 to 30 lbs.

Long handled bar used to pull guy stump spikes, or spikes in stumps used to hold lines being spliced.

f. Riggers Bar



Length 3-1/2'  
Weight + 14 lbs.

Shorter bar used to pull stump spikes.

g. Power Saw Winch

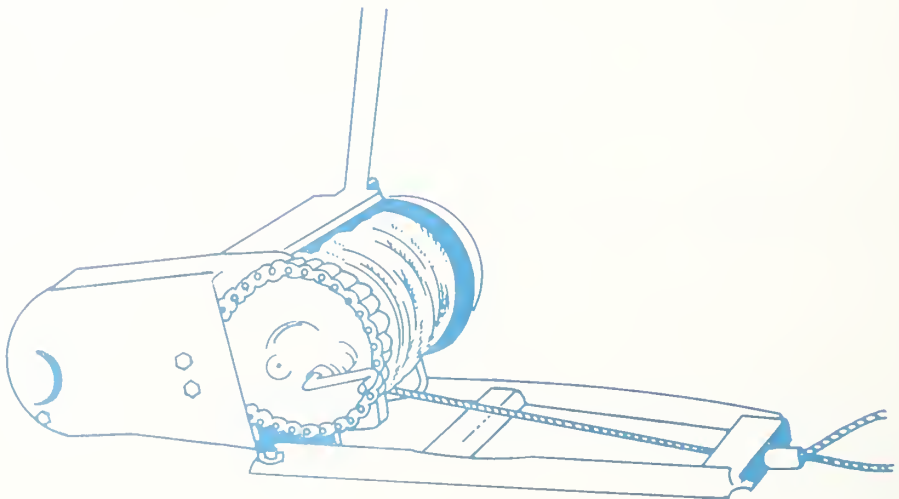

Used for miscellaneous rigging jobs such as tightening guylines, lifting tail tree hardware into position, skidding tail tree hardware to the next tail tree, etc.

h. Molly (Molly Hogan)

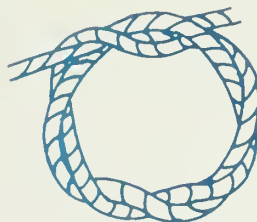

A molly is a circle of strands of wire twisted with the lay to make them smooth. It is used for a temporary link connecting eye splices to permit towing lines, or to replace a cotter key. Mollys are usually made from strands of mainline.

43.42 - Rigging Equipment

The size of rigging must be such that it will safely withstand the strains that will be applied. A safety factor of two is required by some state safety codes.

43.42a - Blocks

Block Nomenclature

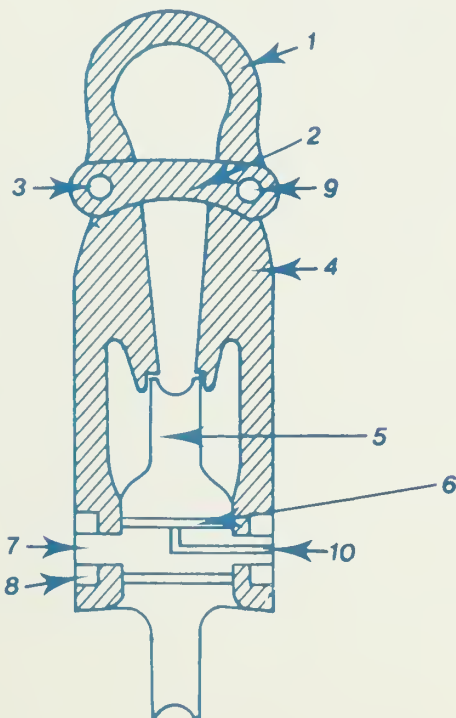

43.42a--1

1. Yoke
2. Line Guard
3. Draw Pin
4. Block Side (shell)
5. Sheave
6. Bushing
7. Sheave Pin
8. Sheave Pin Nut
9. Fixed Pin
10. Grease Plug

State safety codes require blocks hung on spar trees, or tail trees, to have bolts through the shells below the sheaves. Main line blocks must not have less than two such bolts.

Sheaves come "grooved," (with three-sided support for the wire rope) and "open" (with one side support). Open sheaves will pass shackles and connectors, but extensive use passing shackles and connectors will nick and chip the sheaves. Open sheaves also provide much less support to running lines, resulting in shorter line life.



GROOVED SHEAVE



OPEN SHEAVE

For strength efficiency of wire rope bent around various sized sheaves see Section 43.35.

Sheave diameter and groove size must be matched with wire rope size. Section 43.35 gives the desired sheave diameter for various sizes of wire rope. When sheave diameter is too small, rope wear increases.

Most operating ropes are in contact with the grooves of sheaves. As the rope works the individual wires and strands slide upon each other in an effort to adjust themselves to the curvature of the sheave. To provide for this movement grooves should be slightly larger than the rope diameter. A tight groove will not only pinch and damage the rope, but the pinching prevents the necessary adjustment of the wires and strands. A groove which is too large will not give the rope sufficient support. The rope will flatten and thereby restrict the free sliding action of the wires and strands.

Gauges made with the plus tolerance for wire rope should be used to measure grooves.

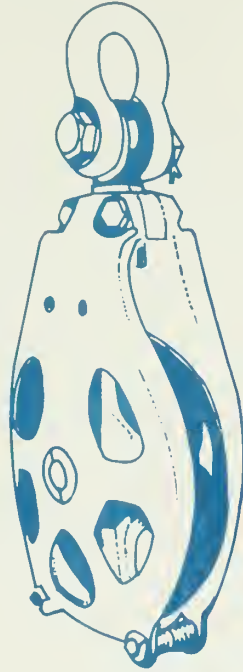
HIGH LEAD BLOCK (BULL BLOCK)

Sheave Size: 18" to 42"  
 Weight: 300 lbs. to 2,000 lbs.

This is the main line block used on a spar tree.

The sheave diameter on main line blocks should be 20 times the main line diameter.

The safety strap can be passed through the throat of the block and then be shackled to a guylines.

Haulback Block - Spar Tree (Head Trip Block)

This is the haulback block on the spar tree. They are similar in construction to the high lead block.

Sheave Size; 10" to 22"  
 Weight 80 to 220 lbs.

43.42a--3

Haulback Blocks - Brush Blocks



Sheave Size: 10" to 22"  
Weight: 25 lbs. to 115 lbs.

Used as tail blocks and corner blocks.

Knock Down Haulback Block

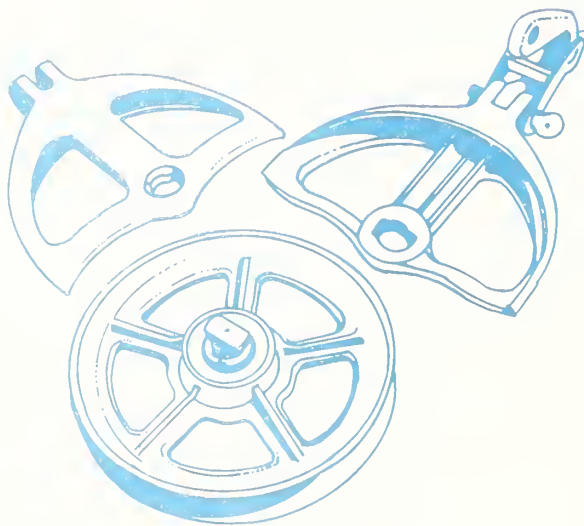

Sheave Size: 14" to 22"  
Weight: 80 lbs. to 215 lbs.



A haulback block that can be readily disassembled for packing across country.

Pass Block (Riggers Block, Pass Line Block)

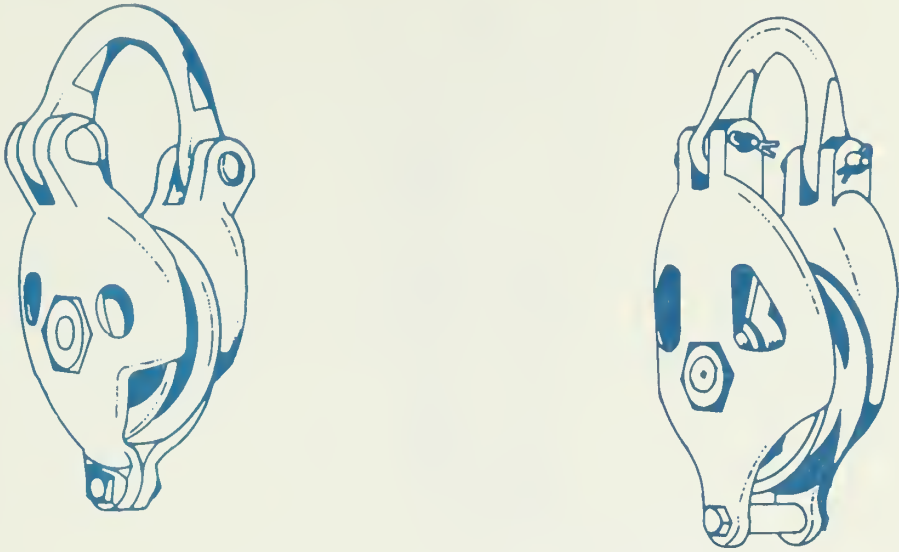

Sheave Size: 6" x 3" to 10" x 4"  
Weight: 20 lbs. to 55 lbs.

A light block carried up the spar tree by a rigger and hung at the top. Used to haul up the bull block and other gear in rigging the tree. Designed with a wide, long throat to pass splices and fittings needed in rigging. State safety codes limit the sheave diameter. A bolt under the sheave is required.

43.42a--5

Fall Block



Sheave Size: 12" to 20"  
Weight: 250 lbs. to 900 lbs.

Used in the bight of the line with the north bend, south bend and similar skyline systems. Also used in loading and as a single sheave skyline carriage. It is balanced so most of the weight is below the sheave.

"Tommy Moore" Block

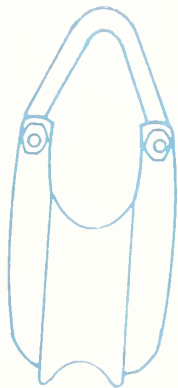

Weight: 30 lbs. to 300 lbs.

Block with a wide throat, capable of passing shackles. Original Tommy Moore blocks had a throat wide enough to pass the butt rigging. A groove in the sheave is very desirable to reduce line wear.

### Skyline Block or Moving Block

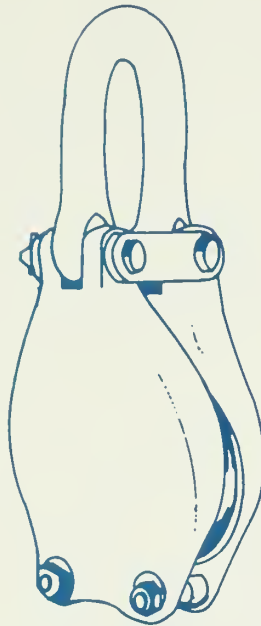

Sheave Size: 12" to 16"  
Weight: 250 to 520 lbs.

A heavy block used as a carriage in a skyline system. Also used for moving sled yarders.

### 43.42b - Shackles (Clevis)

Shackles have two principle parts; a pin and a bail. Bails vary from straight, to slightly belled, to heavy belled.

Shackles are used to join or secure, lines. They come in many sizes and shapes depending on intended use. State safety codes specify shackle size required for various line sizes. Shackles subject to a block purchase shall have additional strength.

### Screw Pin Shackle

43.42b--1

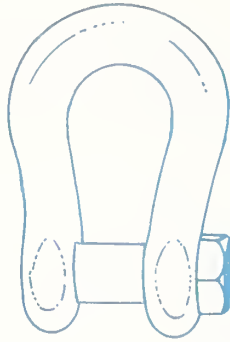

Weight Range: 9 to 30 lbs.

This shackle has a threaded pin.

Safety Pin Shackle

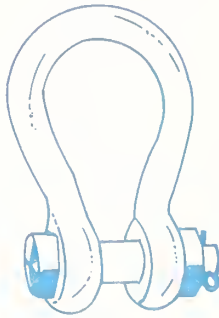

This shackle has a threaded pin which is secured with a nut and cotter key, or molly. A safety pin shackle is required on blocks, jacks, or rigging in a tree.

Flush Pin Shackle

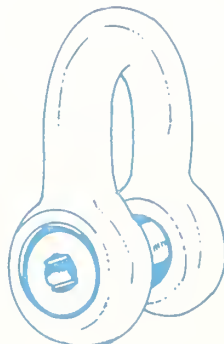

Used where shackles go through blocks, carriages or fairleads.

### Knock-Out Pin Shackle

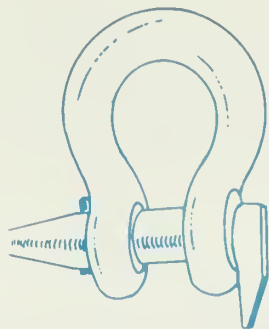

Usually used on tail holds when lines that are to be unshackled are under tension. The rigger must stand where he won't be hit by the released line.



STAND HERE

### Guyline Sleeve



A wide throated shackle with a push pin (pin is not threaded) used to hold guylines on a spar tree.

43.42c

43.42c - Miscellaneous

Butt Rigging

A combination of shackles, swivels, rigging plates and hooks that are positioned between the mainline and haulback on a high lead system. Chokers are fastened to the butt hooks to yard in the turn of logs. The butt rigging normally flies between two and four chokers.

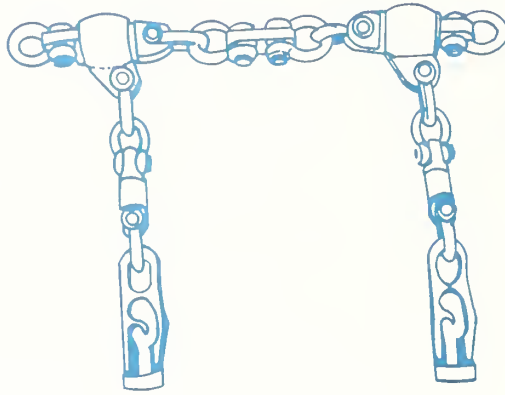

Rigging Plate



A heavy steel plate for attaching lines. Used to be used in high lead to attach the mainline, haulback and butt rigging. A complex type of rigging plate is presently used in the balloon system to secure the two tether lines to the butt rigging.

### Skyline Tree Jack, or Shoe

Shoe Size: 22" x 3" to 48" x 4"  
 Weight: 210 lbs. to 640 lbs.

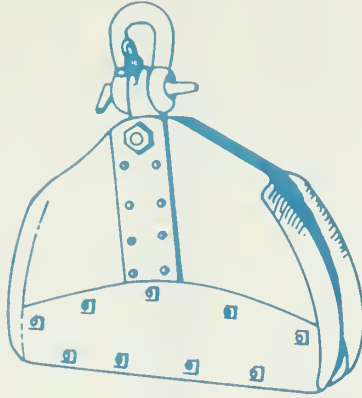

A hanger to support a skyline in a spar tree. It has a hard wood shoe to reduce line wear. It cannot be used with a live skyline.

### Strap

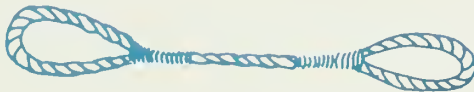

A short piece of line with two eyes, sockets, or a hook and eye used to fasten lines together, or to hold blocks in position. Straps used for blocks in spar trees have "D" (socket) ends. Brush straps, (i.e., for haulback blocks) have spliced eyes.

State safety codes require that the tree strap breaking strength be twice that of the pulling line it supports.

"D"s are preferred to eyes in a strap as they have greater efficiency (see Section 43.35).

### Tree Irons (tree plates)

Length: 3' to 4'  
 Weight: 35 to 100 lbs.



Heavy iron plates having one or two hooks. They are spiked to a spar tree to support the top guys and to keep them from cutting into the spar. The high lead block can be hung in the hooks. They are also used to keep other straps from cutting the spar.

When guylines are tightened they hold the tree irons tight against the spar and prevent the vertical load that is applied from pulling the tree irons down the spar tree.

The spar tree must be barked before the tree irons are spiked in.



43.5 - Rigging Practice43.51 - Stringing Strawline

The strawline is used to pull out the haulback, which in turn pulls out the mainline, or skyline. If strawline is to be strung downhill from the yarder several men, depending on the distance to go, will pull the strawline right off the drum. When the bottom of the unit is reached, the strawline will be unhooked at the yarder, and strawline will again be pulled downhill, off the drum, to the bottom of the unit. The two lengths of strawline will then be hooked together at the bottom of the unit. This avoids pulling strawline back up the hill from the tail block.

If strawline is to be strung uphill, it can be pulled off the drum for a short distance. After that it is easier to drag or pack single sections of strawline up the hill, then hook them together.

To indicate the work involved, the weight of 300' sections of strawline is tabulated below.

<u>Diameter</u> <u>(Inches)</u>	<u>Weight</u> <u>(Pounds)</u>
3/8	78
7/16	105
1/2	138

The longer the distance to the tailhold the more important it is to lay the strawline out in a straight line, especially in a partial cut. This can be done by running a compass line, or by sighting through a 1/2" x 2' water pipe on a jake staff.

The strawline must be located so that the "waist line" (haulback between yarder and tail block) will run clear of the ground or other obstacles, if possible. Dragging wears line and in season is a fire hazard.

Sufficient corner and tail blocks are needed to distribute the stress on anchors and attachments.

Running lines must be arranged so that workmen are not required to work in the bight. If logs are located in a bight, the rigging crew must move out of the area before lines are moved.

The decision on whether to yard toward or away from the haulback must be made before stringing strawline.

Corner and tail blocks and straps for the first rig up have to be packed to position if access isn't available. Stumps have to be notched, straps hung and blocks rigged. Knockdown haulback blocks lighten the load when blocks have to be packed in. On tough shows it may be possible to rig the strawline lay with lighter riggers blocks, then yard the regular corner and tail blocks out with the strawline.

Blocks, straps and other rigging hardware can be yarded out by the rigging, before changing roads, to permit rigging ahead.

It may be possible to use a hold down haulback block (like a sucker down block in balloon yarding) to hold the haulback in position when topography is such that the haulback will whip up through tree crowns during each yarding cycle. However, this hold down block can foul when it flops up and down. This might be solved by tying the block upside down.

State safety codes may require that stumps be used for corner or tail block anchors when the haulback exceeds a given size.

#### 43.52 - Rigging Head Trees

The size requirement for wood spars depends on several variables. Among them are:

- Size of trees available (probably most important variable)
- Tree species
- Needed deflection (therefore, tree height)
- Tree condition (presence of defect)
- Size of logs to be yarded
- Yarding distance
- Size of yarder and cable

160' to 180' Douglas-fir trees were common in the days of sled yarders, and 200' + trees were used on occasion.

24" to 30" top diameters are very desirable. 18" top diameters have been used successfully. Trees under 18" top diameter shouldn't be considered for yarding old growth. A smaller tree can be used if necessary, but payloads and yarding production rate must be lowered to avoid overloading the spar.

Rigging a spar tree for high lead logging involves the following operations:

1. Climb, limb and topping - No more than 16' nor less than 6' of the topped tree should extend above the top guys.
2. Hang the Pass Block - The strap must be short enough to prevent the block from sliding down when it is loaded. The block could be hung in a choker. The pass line diameter is specified by state safety code. Pass line equipment can't be used for any other purpose.
3. Install the Tree Irons (plates) - Tree plates are spiked into position. The spar must be barked where the plates are installed.
4. Hang the Top Guys - The spar tree must be barked where guy-lines are placed. Guylines are passed alternately around the tree in opposite directions to prevent twisting the tree. The top guylines are held up by the top dogs on the tree irons.

5. Hang the Buckle Guys (State safety codes state when buckle guys are required) - The spar must be barked at the buckle guys. Buckle guys are held in place by guyline sleeves and eyes, or ferrules and hooks. The tension of the tightened guyline tightens the guyline around the tree. Tree plates may be used with the buckle guys, and are very desirable on slackline and standing skyline spars.

6. Tighten all guys

7. Hang the Bull Block and Haul Back Block - The bull block is held up by a strap which passes around the spar and is hung in the bottom dogs on the tree irons. The haulback block is held up by a strap which may, or may not, be hung right above the buckle guys. The haulback block strap may be spiked to hold it in position if the block isn't hung above the buckle guys. Safety straps are required on mainline lead and skyline blocks.

8. Thread the Tree Blocks

Checking the weight of the rigging hardware gives an indication of some of the problems involved in rigging a spar.

The rigger travels up and down the tree in a pass chain which is hung on the pass line, and is powered by a yarder or tractor. However, when he is positioning and securing the plates, blocks and guylines, the rigger uses his climbing spurs and belt for support. He is out of the pass chain.

A yarder or tractor supplies the power for lifting the tree plates, blocks and guys into position for hanging.

If there is no satisfactory spar tree at the desired location, a spar tree can be yarded to the site and raised. The figure on the following page shows one way to rig up to raise a spar. A footblock, which is mortised and laced to the spar with used haulback, acts to prevent the raised spar from settling in the ground and loosening the guys. The tree hangs in a "V" as it is raised. The back guys are held by the haulback or some other means of power snubbing as the spar is raised. Snubbing lines can be shackled to eyes in the end of the guylines. When the tree is vertical the back guys are spiked down and then the front guy is tightened and spiked down. Tree rigging is then completed. The pass block and a pass line should be hung before the tree is raised to save the climber the work of climbing up to hang them.

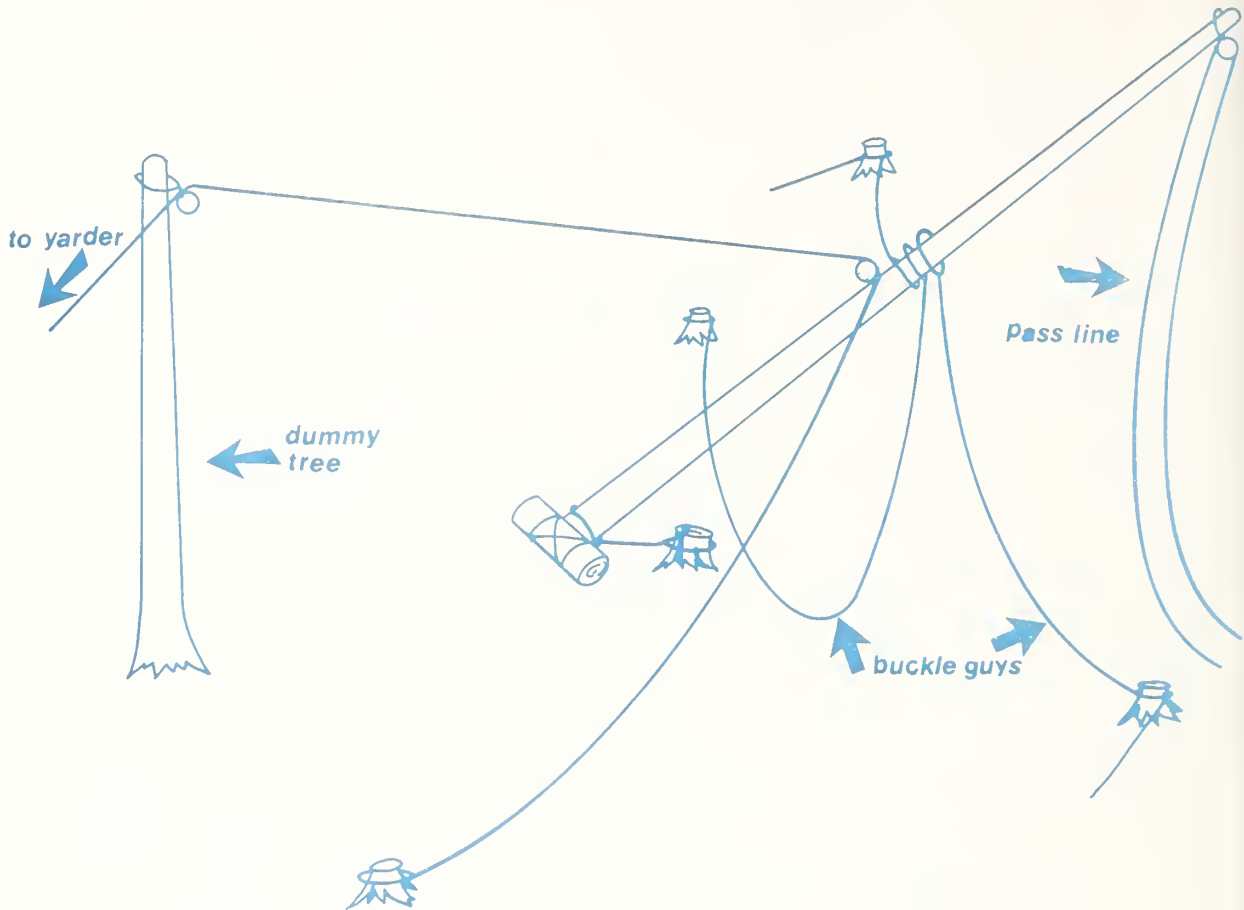

### RAISING A SPAR TREE

Either the top guys or buckle guys can be used to raise the spar. The spar can be fully or partially rigged before raising.

An alternate way of raising the spar is to secure the raising line to the base of the dummy tree instead of a stump (as shown above). This puts a block purchase on the spar.

Dummy trees have to be topped and guyed.

If it is desired to move a rigged spar a short distance, to improve yarding conditions on a new lead, it can be "jumped" into position. A short chunk (foot block) is fastened to the base of the spar to facilitate sliding the base of the spar. To move, loosen the top guys, then the base of the spar is pulled toward the new position. Then the guylines are adjusted to pull the tree vertical. This procedure is repeated until the spar is in position.

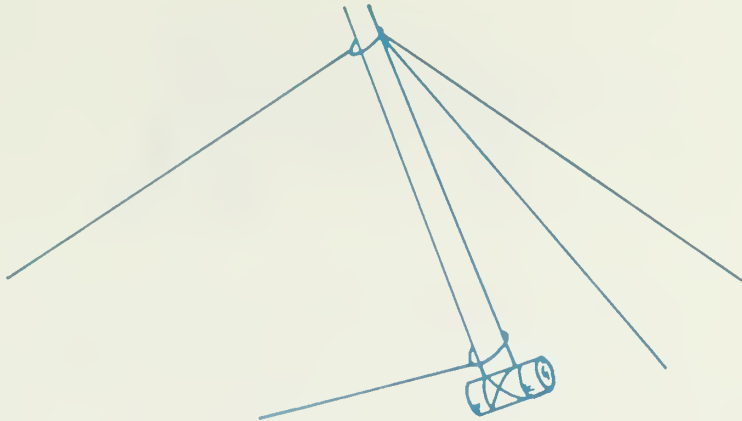

### JUMPING A SPAR TREE

#### 43.53 - Rigging Tail Holds

Access to the tail hold, to facilitate rigging, is important in long span skyline sales. Tail holds have been located over 1000' beyond the cutting line to get them near access, or to get needed deflection.

It is slow, hard work stringing strawline uphill. Therefore, it is that much more desirable to have access to tail holds that are located above the landing.

3/8" strawline can pull 1-3/8" skyline downhill, but 9/16" strawline is needed to pull 1-1/2" skyline uphill.

Tractors and small sled yarders have been moved cross country, to tail hold locations, to be used to pull out skylines. 9/16" to 5/8" lines will readily pull skyline.

Tail holds can be rigged ahead of time to minimize yarder down time. If a tail hold is remote, a helicopter can carry rigging hardware and strawline to the site. A light helicopter can lift 500 to 600 pounds. If rigging can't be dropped at the site, at least 1/2 acre is needed (100' x 200') to land a small helicopter safely.

If the line to be anchored has an eye, or socket, it can be anchored with a strap and shackle.

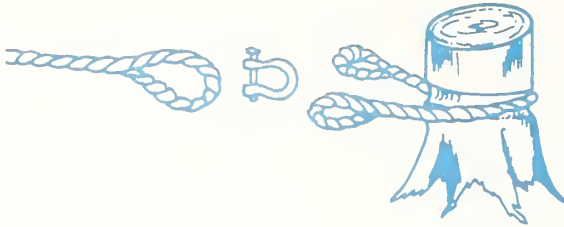
43.54 - Rigging StumpsSTUMP ANCHOR SECURED WITH STRAP AND SHACKLE

If the line to be tied off has a ferrule and hook, the line is passed around the stump and hooked.

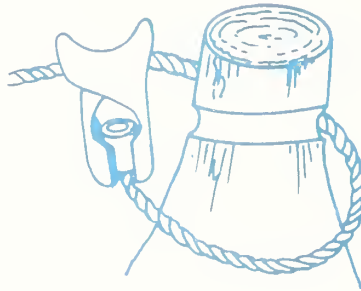
STUMP ANCHOR SECURED WITH FERRULE AND HOOK

Section 43.36 discusses anchoring a line by wrapping and spiking.

If stumps are small or the soil is shallow or wet, the stumps may have to be tied back. See Section 44.2 for a discussion on stump anchors.

If a power source isn't available to tighten a stump tie back, tightening can be done with a "twister" (or swifter) as follows:

1. Take four or more wraps around both the tail hold stump and the tie back stump with strawline. Two wraps with 1/2" line will be satisfactory.
2. Insert a stick, 3" to 4" in diameter, between the wraps and twist.
3. Secure the stick.

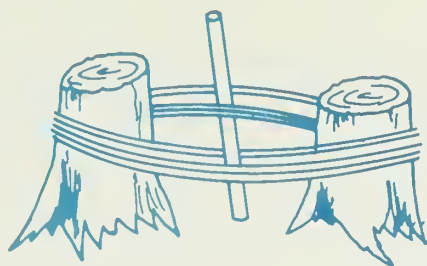

### STICK INSERTED TO MAKE A TWISTER TIE BACK

#### 43.55 - Rigging Tail Trees

Stationary skylines should be hung in a tree jack, and shall be securely anchored to a stump or deadman. The end of the skyline should not be anchored to a spar tree or tail tree. Many loggers use old bull blocks for hanging skylines, however, they will flatten the skyline if the line position at the block isn't changed frequently.

Live or standing skylines should be anchored directly to the base of standing trees only if no part of the tree, if pulled over, will enter the work area (cutting unit). The base should be considered to be no more than three feet above the highest ground.

Rigging a tail tree involves the following operations:

1. Climb, limb and top
2. Hang the pass block
3. Hang tree plates (if needed)
4. Hang and tightening the guys
5. Hang the tree jack and/or haulback block (if used), with the skyline and haulback threaded.

The tree jack, tree plates and guylines for yarding old growth are too heavy to move to the site by man power. Access to the tail tree is very desirable not only to facilitate stringing line and to get the rigging hardware to the tree, but to provide access for a power source (tractor, rigging yarder, etc.) to rig the tree. If there is no access to the tail tree the rigging hardware will have to be yarded to the tail tree with the strawline, or haulback, after the tail and corner blocks are packed out and the strawline strung. The haulback can also be used to lift tail tree rigging into position. Yarding is shut down whenever the haulback is used in rigging. A power saw winch, or come-along, can also be used to lift the rigging into position and to tighten the guylines. Checking the weight of these items will indicate some of the difficulty the rigger will have getting the rigging in position and secured.

If the skyline is not hung with the jack it will have to be hung in a separate operation. The skyline cannot be pulled through a pre-rigged tail tree jack for any distance without damaging the wood shoe. To avoid this problem, a skyline extension can be anchored to the tail hold stump and hung in the jack. The extension is shackled to the skyline when it is pulled out. This may create a problem if the carriage will have to pass over the shackle.

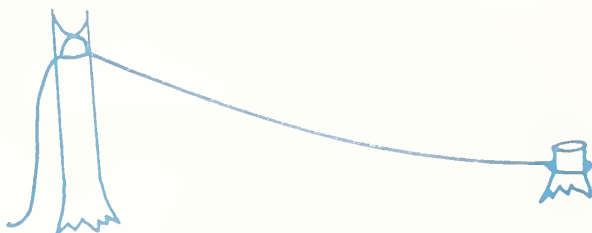

SKYLINE EXTENSION HUNG IN A TREE JACK

Another way to hang the skyline in a prerigged jack is to hang a wide throated rigger's block above the tree jack and secure the yoke on the block with a molly. The skyline is pulled through the block to the anchor. Then the molly is cut, dropping the skyline into the jack.

Whenever lines which have been pulled uphill have to be disconnected from the pulling line they will have to be anchored, or tied down, to keep from sliding back downhill. A rigger's chain, choked to a stump, will do this job. If there is an eye in the line it can be shackled to a second line that is already anchored.

State safety codes may require that tail trees used to support skylines be topped and guyed with not less than two guylines. If the skyline is under a given diameter, the tail tree may not have to be topped, provided the skyline passes through a block, or jack, on the tree before being anchored. A variance may be obtained from the safety inspector to avoid topping trees rigged with a slightly larger skyline.

Tail tree guylines must be the same size as the skyline. With the safety inspector's approval, two or more smaller guylines, that together are equal in strength to the skyline, may be used in place of the required guylines. This permits using lighter guylines that can be rigged manually.

Tail trees should be guyed for the angle of the load. The load can be figured for two guys using the pythagorean theorem. See Section 48.7.



Between 24" and 30" is a desirable top diameter for Douglas fir tail trees when yarding old growth. Trees under 16" top diameter shouldn't be considered for yarding old growth. When marginal tail trees are used, payloads and yarding production rates will have to be reduced.

Tail hold trees that don't have to be felled must be protected if possible. They can be protected by using tree plates or nylon straps, State Safety Code permitting.

Small shop built tree plates have been used successfully on thinning sale tail trees. A RR spike holds the plate up. A choker rope is passed through the loop on the plate. When the skyline is loaded, the choker rope tightens around the plate and the dogs bite into the tree.

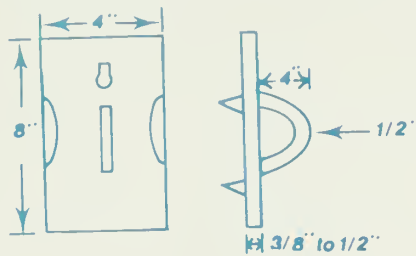

#### TREE PLATE FOR THINNING SALE TAIL TREE

Tree plates used for hanging a jack, or blocks are held in place by spiking and by the tightened guylines. The spikes can't hold the plates in place by themselves. It is possible under a heavy load that two guylines aren't enough to hold the tree plates in position, four guylines may be desirable. The tree has to be barked if tree plates are used.

Reusing topped tail trees on later sales is hazardous as bark slips in one year.

Rigging hardware can be pulled between tail holds with the strawline. A power saw winch can also be used, but this doesn't seem to be a common practice.

There are computer programs for determining the top diameter needed for a tail tree. The programs consider the effect of the various lines (i.e., skyline, mainline, haulback) hung in the tree, and of the guylines. The forces on a tail tree can be considerable in complex situations such as yarding to and swinging from the same spar.

The following tables can be used to determine the size of guylines needed on tail trees.

# TAILRLE ANALYSIS

BACKLINE UPHILL YARDING

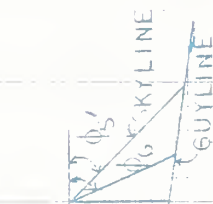

$$\Delta H = T(1 - \cos \phi_s)$$

$$T_G = \frac{\Delta H}{\cos \phi_g}$$

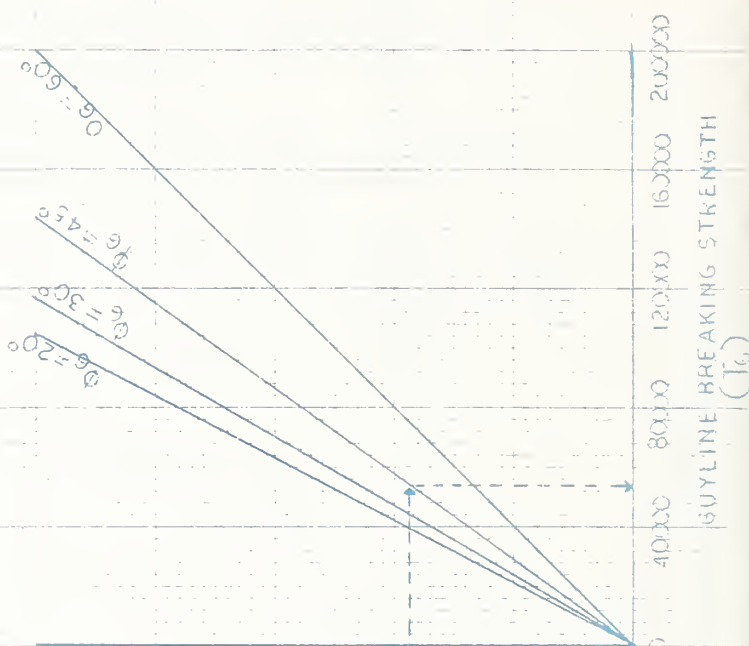
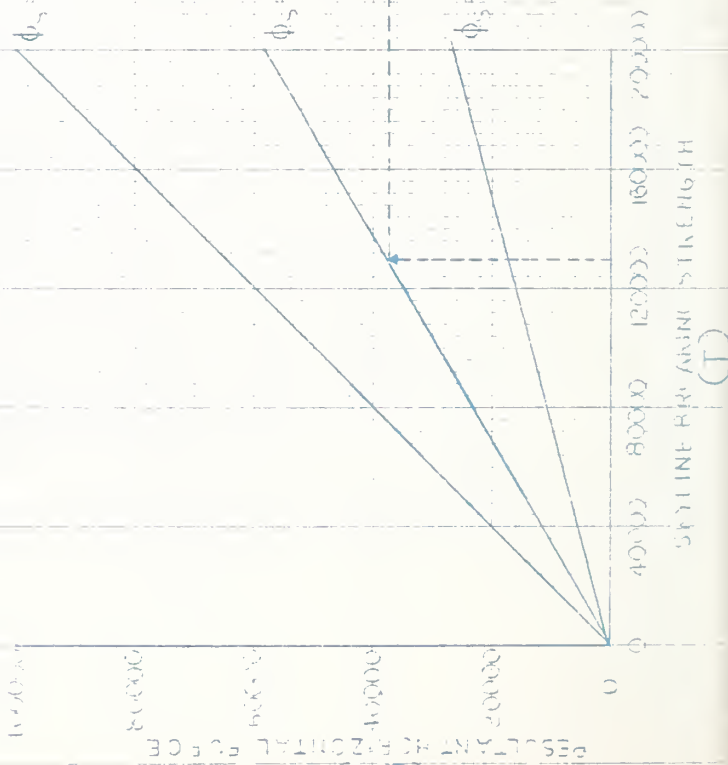

TAILTREF ANALYSIS

BACK GUYLINE DOWNHILL YARDING  
 (RIGHT GUYLINE NOT NEEDED IF  $\phi_5' > 60^\circ$ )

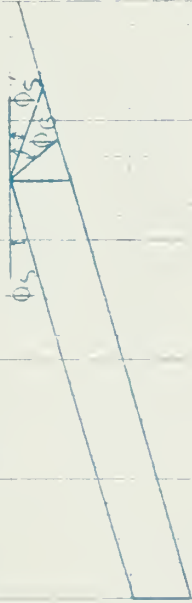

$$\phi_5' = \phi_5$$

$$\Delta H \equiv T(\cos \phi_5 - \cos \phi_5')$$

$$T_6 = \frac{\Delta H}{\cos \phi_6}$$

RESULTANT HORIZONTAL FORCE

$H_5 = H_5' = 52,000$   
 $H_6 = 65,000 = 23,000$

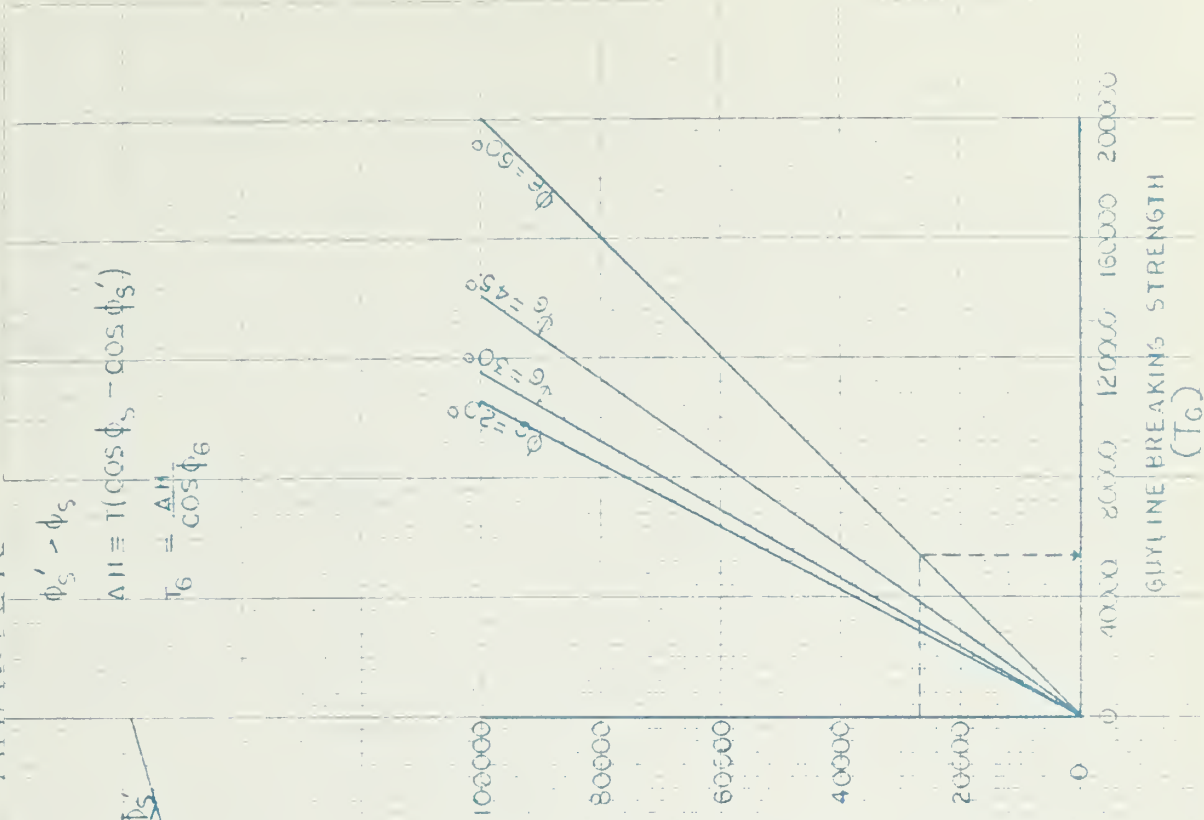
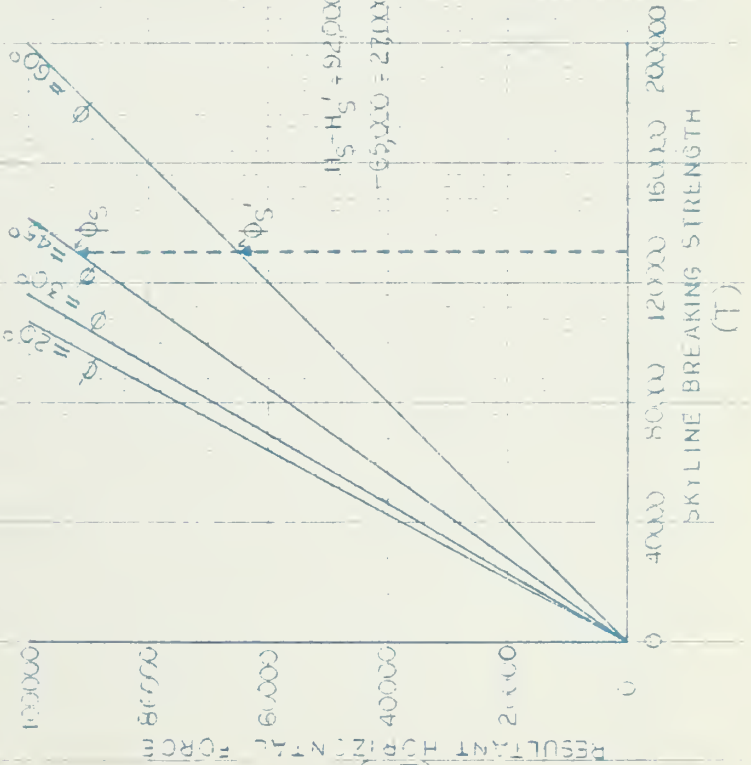

WIND TREE ANALYSIS

FRONT GUYLINE DOWNHILL YARDING

(FRONT GUYLINE NOT NEEDED)

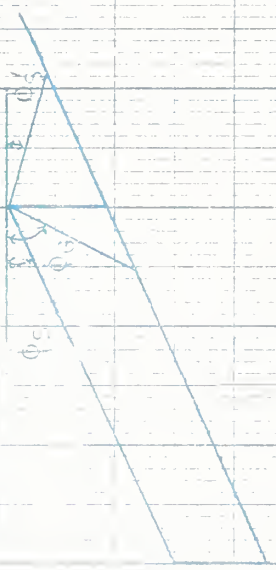

$\phi_5 > \phi_6$   
 $\Delta H = T_6 \cos \phi_5 = 50000$   
 $T_6 = \frac{\Delta H}{\cos \phi_6}$

( $\Delta H$ )  
 100000  
 80000  
 60000  
 40000  
 20000  
 0

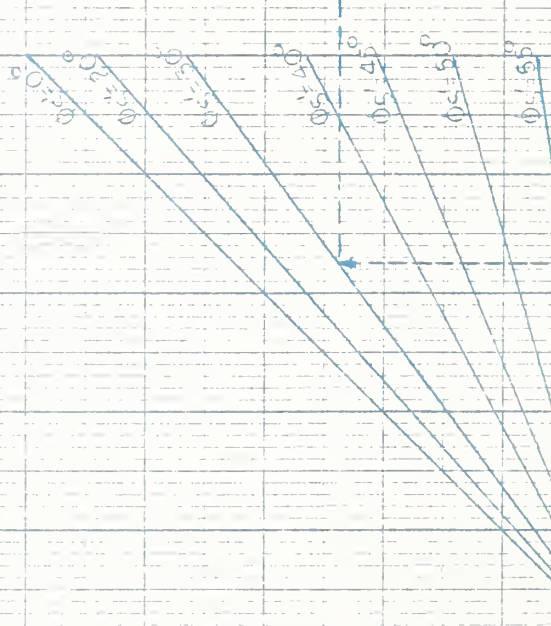

40000 80000 120000 160000 200000  
 SKYLINE BREAKING STRENGTH (T)

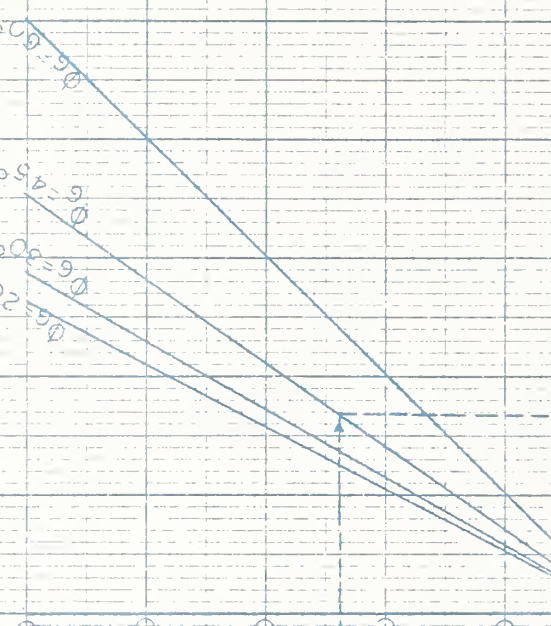

40000 80000 120000 160000 200000  
 GUYLINE BREAKING STRENGTH (T)

# TAILTREE ANALYSIS

SIDE GUYLINE FOR LATERAL YARDING  
(ONE EACH SIDE OF TREE RIGHT ANGLE TO SKYLING)



IF M UNKNOWN ASSUME 15

$$C = \frac{M}{\text{LAT. YRD. DIST.}}$$

$$\tan \phi_L = C$$

$$\Delta H = T_M \cos \phi_L$$

$$T_b = \frac{\Delta H}{\cos \phi_G}$$

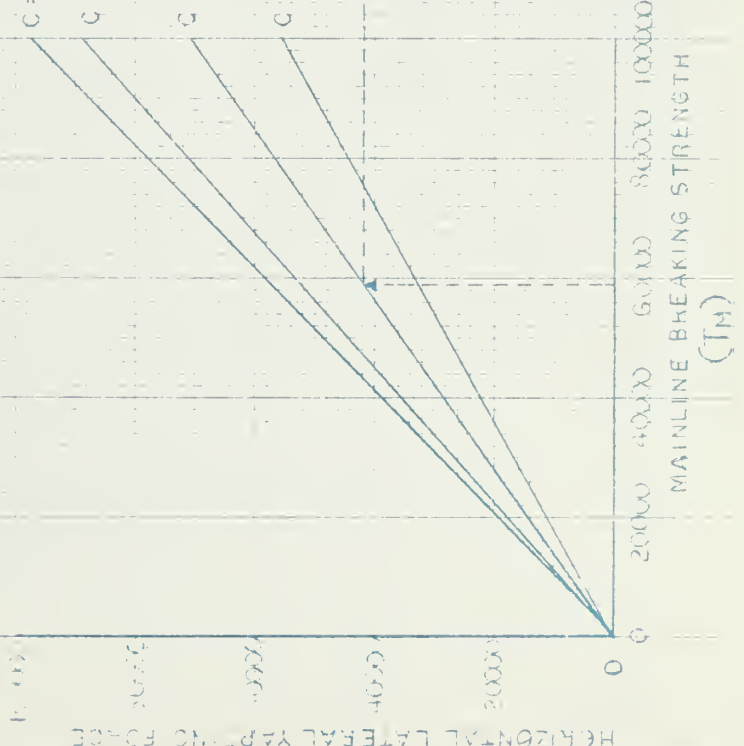
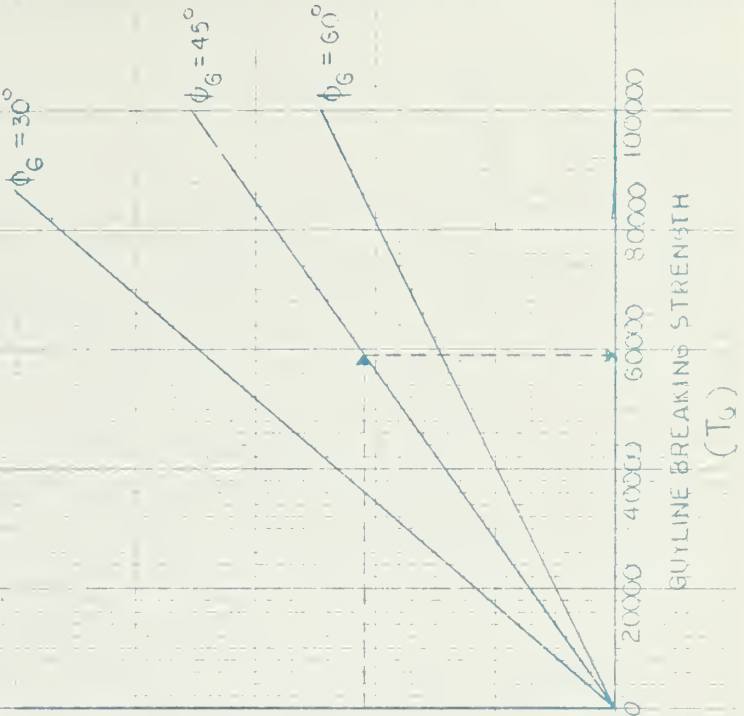

HORIZONTAL LATERAL YARDING FORCE

CRITICAL DIAMETER TO PREVENT BUCKLING IN TAILTREES

DOWNHILL YARDING

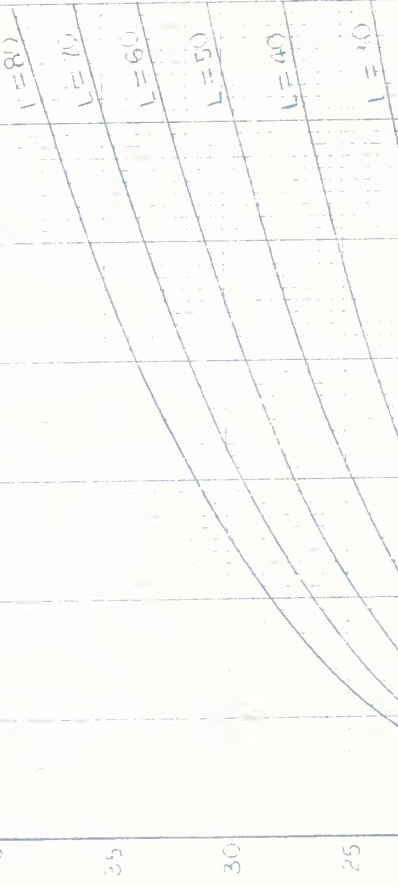

30000 60000 90000 120000 150000 180000  
SKYLINE BREAKING STRENGTH

TREE DIAMETER IN INCHES

UPHILL YARDING

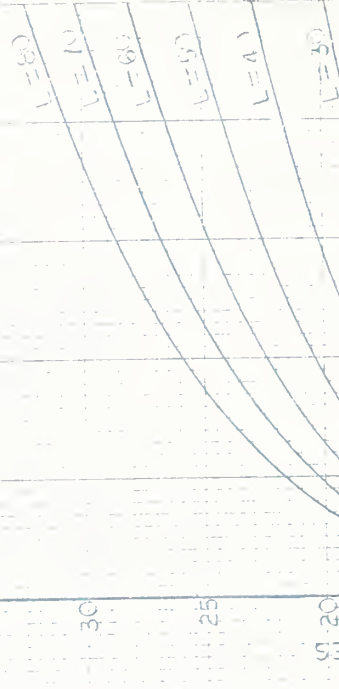

40000 80000 120000 160000 200000  
SKYLINE BREAKING STRENGTH

TREE DIAMETER IN INCHES

### 43.56 - Yarding Beyond Drum Capacity

There is usually enough haulback capacity to yard 200' to 300' beyond the mainline capacity. There are several ways of increasing yarding distance for long reaches:

1. Use a smaller mainline.
2. For a little volume in a long corner double yard by shackling on a mainline extension. Yard the logs from the long corner part way and deck them. Then rerig the tail and corner blocks and yard the decked logs the rest of the way in.
3. If the ground is too steep to deck, double yard using two butting rigging: one between the mainline and mainline extension, and one between the extension and the haulback. The rear butt rigging brings the logs within reach of the front butt rigging. The logs are unhooked, the rear butt rigged is sent back to the woods, the front butt rigged is positioned over the logs and the logs yarded to the landing.

Double yarding doubles the yarding cost.

There may be rare occasions when additional haulback is needed. If a smaller diameter haulback won't do the job, additional haulback can be spliced on. The haulback may have to be cut when roads are changed, unless the haulback can be tight lined to its new location, or the strawline can be rigged to drag the haulback extension to the new location.

Skyline length beyond the yarder, or single drum, capacity is usually shackled on. Splicing would require cutting the rope when changing landings. Most carriages can pass over long splices. However, carriages with Tommy Moore sheaves are required to pass over shackles. Carriages cannot pass over double end connectors.

When moving, up to 200' of additional skyline can usually be spooled on the drums above the flanges on yarder-tower machines. On sled yarders excess skyline can be coiled down, in six-foot loops, on the yarder when roads are changed. If there is too much line to spool on the drums on a steel tower it may be possible to pull the surplus down the road with a truck, skidder, strawline, etc., toward the next skyline road.

## 44 - Anchors

### 44.1 - Introduction

Good anchoring cannot be overemphasized in planning a skyline operation. There have been many instances where carriages and other equipment have been damaged or destroyed because of anchor failures. Presently, the only way to estimate an anchor's capacity is by experience--usually gained the hard way.

Two types of anchors are commonly used in logging, stumps and deadman. Rock bolts have had limited use in logging. Earth anchors have been used successfully in other industries and may find some application in logging.

Considerations in anchor selection are soil type and depth, stump diameter and density, rock type, magnitude of the load to be applied to the anchor, and cost of rigging the anchor. Stumps are generally more economical to rig; but in areas of shallow soils and small or scattered stumps, rock bolts or deadman anchors may be more economical.

Anchors should be located and identified during ground reconnaissance so that they can be found when profiles are run, and if requested shown to the logger prior to felling operations. This is especially necessary in multispan sales or if high stumps are needed for rigging.

The holding power of an anchor has to exceed the breaking strength of the skyline to utilize the maximum load carrying capacity of the system.

The cost of rigging an anchor depends to a great extent on accessibility. See Section 43.5 for a discussion of rigging practices. In an area with no access to the tail hold, many hours or even days may be required to hand carry rigging and support equipment to the anchor location. Actually rigging the anchor may take only a few hours.

### 44.2 - Stump Anchors

Stumps are an unknown quantity because of the great variability between stumps, and in stump environment.

If available stumps would make questionable anchors, it may be desirable to plan for a deadman. Deadmen are more of a known factor.

State safety codes may permit anchoring skylines to standing trees if no part of the tree will enter the work area if pulled over. The skyline shouldn't be attached over three feet above the highest ground level.



Anchor requirements vary with the size of and volume of timber being logged. On flyer sides, if available anchors are in the same size range as the largest trees being logged, they should serve adequately.

High lead sides can generally get by with smaller stump anchors than are needed with a flyer.

Side block systems haul a lot more wood over the line and put more strain on anchors. The longer period of use may be enough to work a stump loose. These systems require stouter anchors than needed on high lead or flyer sides.

A sale can't be logged by cable if adequate anchors are not available.

The best way to learn about stump anchors is to observe the anchors being used, note where they are used, and how effective they are. A knowledge of the area builds up the ability to estimate the adequacy of anchors.

Shallow rooted species make poor anchors. In wet, or swamp areas expect all trees to be shallow rooted. Some areas may be wet only seasonally.

Stumps are tight rooted in rocky areas; however, rocky areas may have shallow rooted stumps.

Often older stumps can be used if the root collar is sound.

Four foot to five foot stumps are desired to anchor long span, large diameter skylines. They should be tied back. Four foot guyline stumps are also desired on long span skylines.

Skyline units adjacent to old clearcuts present a problem in finding suitable stump anchors. Douglas-fir stumps are generally sound for ten years. Hemlock stumps generally can't be used after five years. The percent of sapwood is greater in young trees, therefore, stumps from young trees will deteriorate at a more rapid rate. An axe, or chain saw should be used to check the soundness of old stumps.

If stump anchors will be needed in the future they should be protected. Cutting the top at an angle to facilitate water drainage and treating with a preservative or capping the stump will help. However, nothing can be done to preserve the roots. Future sales should be scheduled to use the stumps while they are still sound.

On balloon shows single stump anchors should not be less than 30". If available stumps are smaller, the minimum acceptable stump would be 20" with three of them tied into a multiple stump anchor. Multiple stumps anchors have to be rigged to equalize the pull between stumps.

Stump anchors are usually easier to rig at the bottom of a unit than at the top (providing that they are equally accessible) because of deeper soils and generally larger stumps. When large stumps are not available, a series of smaller stumps may be rigged to provide suitable anchorage.

Since there is no present method of predicting load-bearing capacity of stumps, this section is limited to the mechanics of rigging stump anchors. However, a few general rules concerning the holding power of stumps are in order:

1. Holding power tends to increase with soil depth.
2. Holding power tends to increase with soil density.
3. Holding power increases approximately with the square of the stumps diameter. (Wyssen Skyline Manual).

Example: A 48-inch diameter stump will hold approximately four times as much as an 24-inch stumps.

4. Stumps have greater holding strength on uphill pulls than on downhill pulls as there normally are larger roots on the down hillside of the stump.

5. Holding power tends to decrease as soil moisture increases.

To anchor at the top of a ridge, a more secure hold may be achieved by going over the break of the ridge, as shown in figure 1. In figure 1, the pull on stump no. 1 would be on the weaker root structure, where the pull on stump no. 2 would be on the stronger root structure.

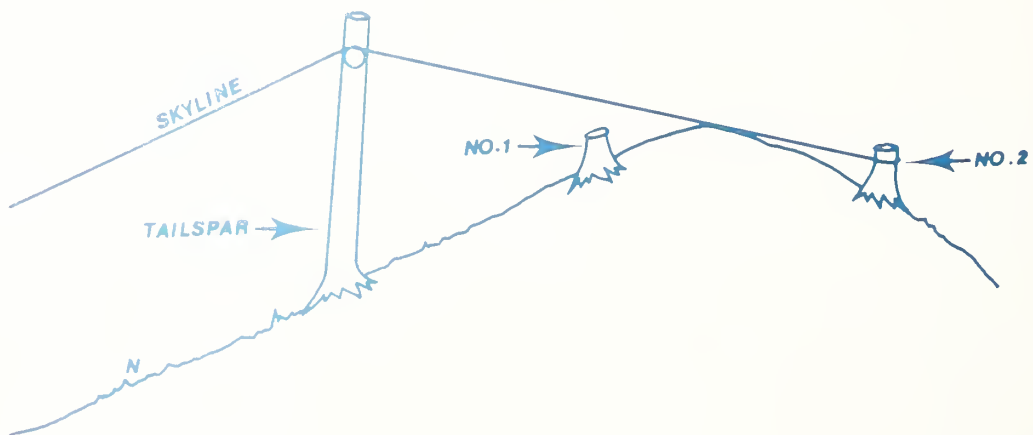

FIGURE 1 - STUMP ANCHOR AT RIDGETOP

Friction between the skyline and the ground reduces the load on the stump.

Some additional common rigging practices are as follows:

1. Notch stumps to prevent lines from slipping off.
2. When making multiple stump anchors, use stumps which are aligned as closely as possible with the skyline (tieback lines should make small angles with the skyline).
3. To achieve better load distribution on multiple stump anchors, use blocks on the tieback lines rather than a cable wrapped around the stump.
4. Use at least one tieback stump on main anchor stumps, even large deep-rooted stumps. The tieback stump helps prevent the main stump from working loose when it is subjected to the large dynamic loads common in skylines.
5. For a series of stumps rigged as shown in figure 7, the line tension between the main stump and the second stump will be approximately one-third of the skyline tension. Additional stumps will have negligible load.

See Section 43.54, "Rigging Stumps," for additional information.

#### 44.21 - Stump Anchor Mechanics

Two typical rigging plans are shown in figures 2 and 3. The three stump anchors of figure 2 can be used where stumps are large and strong; but in areas of small or weak stumps, the multispan anchor employing as many as 30 stumps may be used (figure 3).

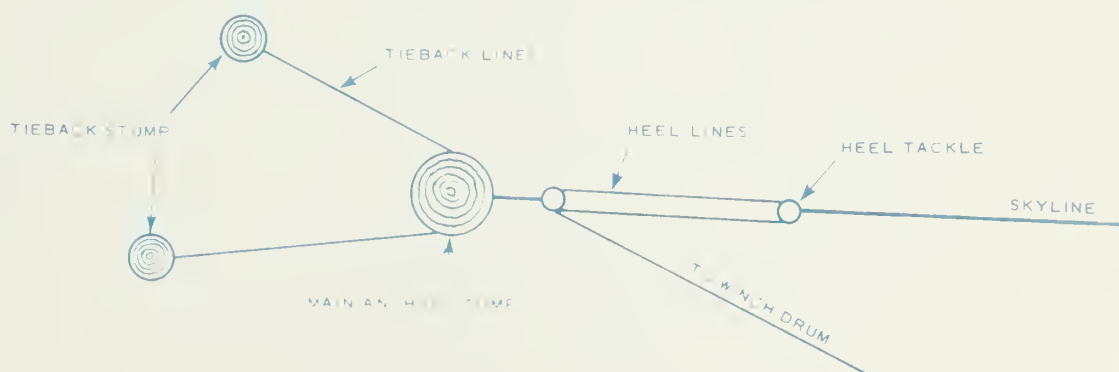

FIGURE 2 - PLAN VIEW OF A TYPICAL SKYLINE ANCHOR USING LARGE STUMPS

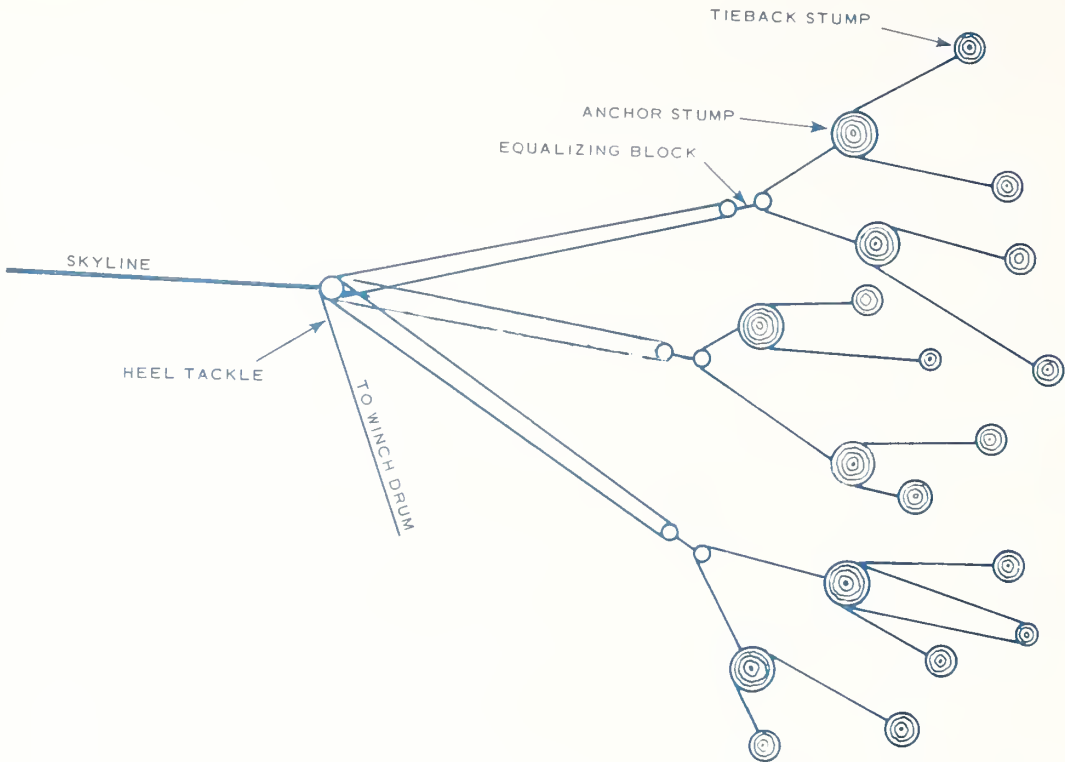

FIGURE 3 - PLAN VIEW OF A TYPICAL SKYLINE ANCHOR USING SMALL STUMPS

One of the important considerations and one frequently overlooked, is the relationship between the angle made by the tieback lines and the skyline, and the actual load on the stump as shown in Figure 4.

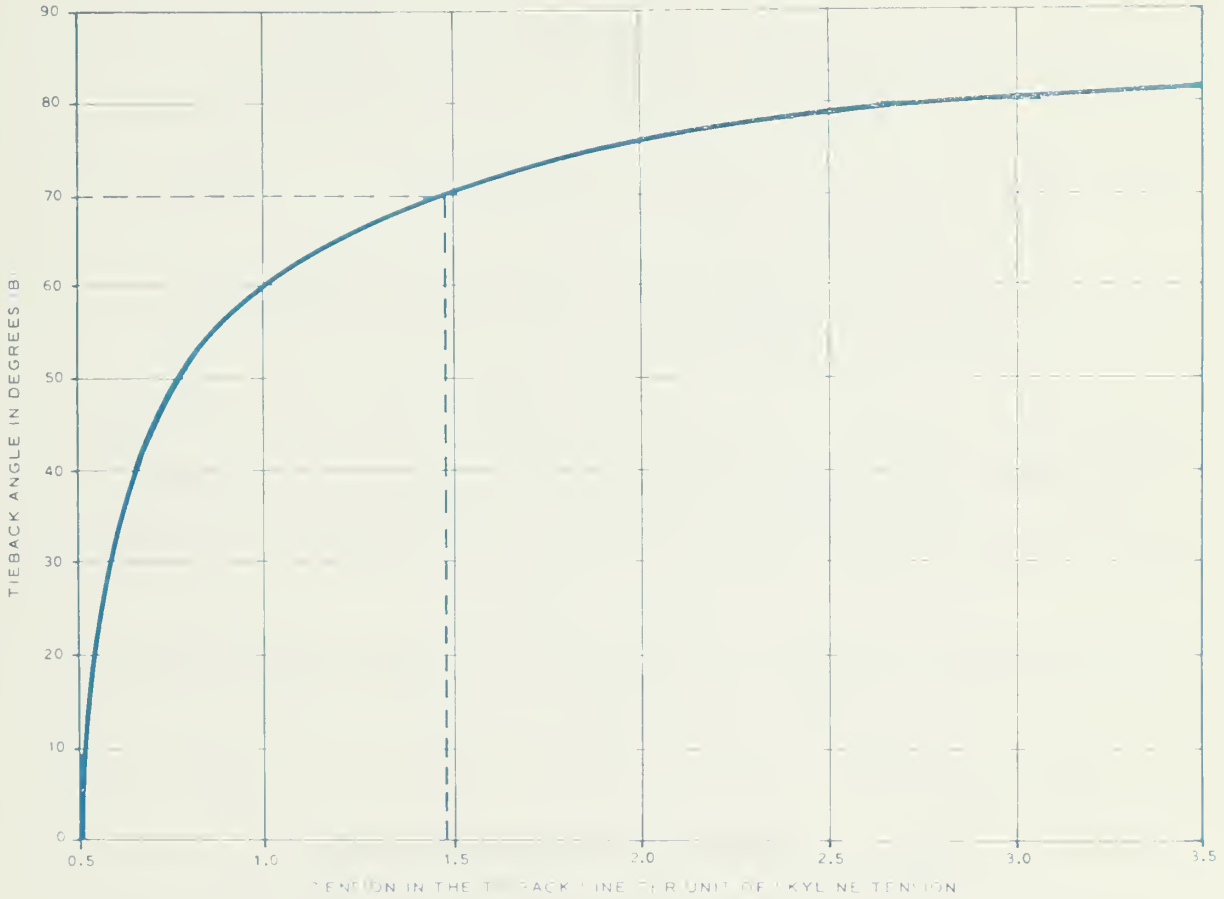
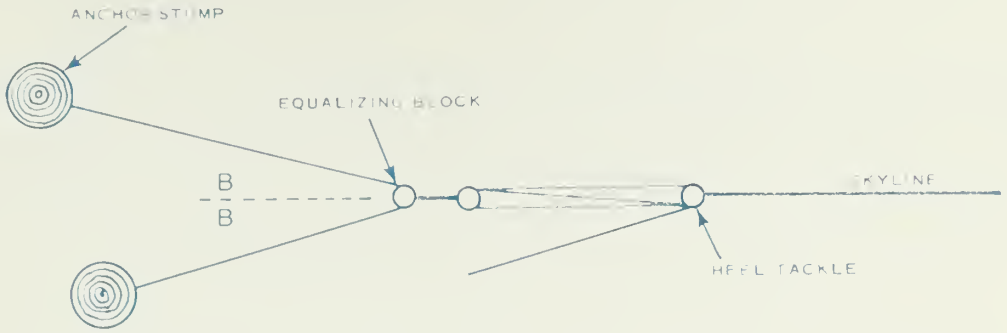

FIGURE 4 - RELATIVE TIEBACK LOAD VS. TIEBACK ANGLE

## EXAMPLE

Find: The load on each stump when the skyline tension = 50 kips and  $B = 70^\circ$ .

Solution: From the graph for  $B = 70^\circ$ , tension per unit of load = 1.47. Load on each stump =  $50 \times 1.47 = 73.5$  kips.

The graph shown in figure 4 was developed from the following analysis of the two-stump anchor shown.

A summation of forces in both the x and y direction produces:

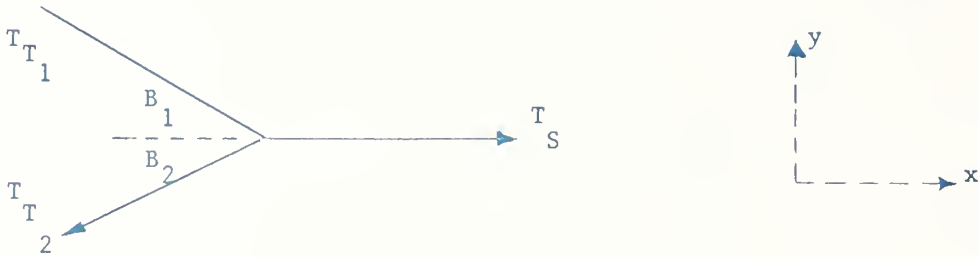

$T_S$  = tension in skyline

$T_T$  = tension in tieback line

$$\sum F_y = 0 \quad T_{T1} \sin B_1 - T_{T2} \sin B_2 = 0$$

$$T_{T1} = T_{T2} \quad \text{Hence, } \sin B_1 = \sin B_2 \quad \text{Eq. 5.1}$$

and  $B_1 = B_2$

$$\sum F_x = 0 \quad T_S - T_T \cos B - T_T \cos B = 0$$

$$T_S = 2T_T \cos B$$

$$T_T = \frac{T_S}{2 \cos B} \quad \text{Eq. 5.2}$$

From equation 5.2 it can be seen that: When  $B$  is small,  $\cos B \approx 1$  and

$$T_T = \frac{1}{2} T_S$$

When  $B$  is larger,  $\cos B \rightarrow 0$  and small  $T_S$  produce a very large  $T_T$ .

As the example of figure 4 indicates, a 50-kip skyline tension transferred from the skyline to a pair of stumps, produces a force of nearly 74 kips on each stump when the tieback is at a  $70^{\circ}$  angle to the skyline. This is nearly 50% more load per stump than there is tension in the skyline. The importance of minimizing the tieback angle is illustrated in figures 5a and 6 where force reductions on the stump of 20% to 55%, respectively, are achieved by reducing the angle of the tieback.

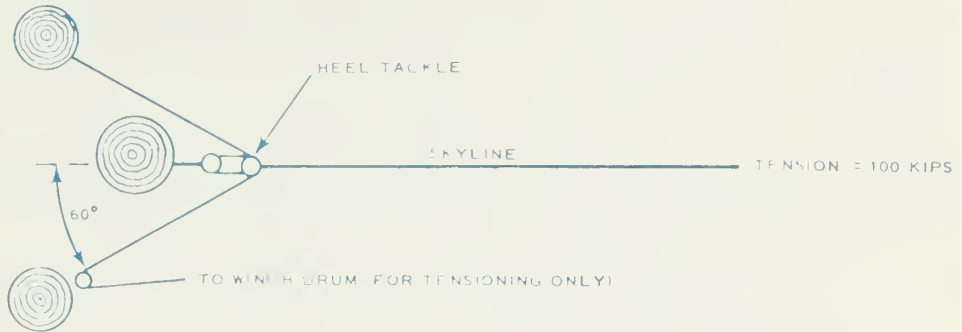

FIGURE 5a - PLAN VIEW OF TYPICAL THREE-STUMP ANCHOR

Given: Stump anchor plan shown in figure 5a, 100 kip-skyline tension.

Find: Load on all stumps.

Solution: The problem can be solved by drawing a free body diagram (figure 5b) and balancing forces as follows:

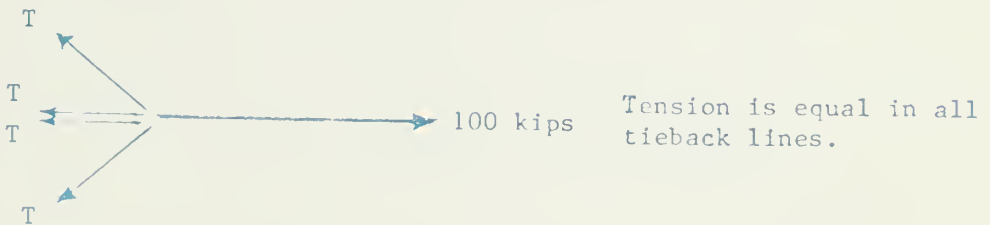

FIGURE 5b - FORCE DIAGRAM

Summation of forces shown by vectors in figure 5b.

$$\begin{aligned}\Sigma F &= 0 \quad T+T+T \cos 60^{\circ} + T \cos 60^{\circ} - 100 = 0 \\ 2T + 0.5T + 0.5T &= 100 \\ 3T &= 100 \\ T &= 33.3\end{aligned}$$

Therefore, the load on the outside stumps is 33.3 kips each. There are two tieback lines to the main anchor stump; therefore, that stump has to resist a load of 66.6 kips.

Now in comparison, if the tieback angle is reduced by lengthening the heel lines (figure 5c) we get the following:

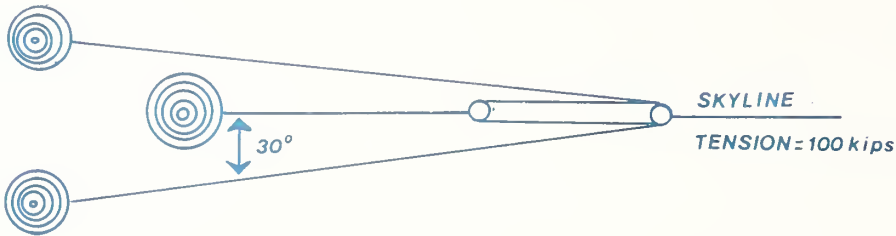

FIGURE 5c - PLAN VIEW OF THREE-STUMP ANCHOR WITH LONG HEEL LINES

Following the same procedure and summing forces, we get:

$$\begin{aligned} \Sigma F = 0 \quad 2T + 2T \cos 30^{\circ} &= 100 \\ 2T + 2T \times 0.866 &= 100 \\ 3.732T &= 100 \\ T &= 26.8 \text{ kips} \end{aligned}$$

Analysis shows that by reducing the tieback angle we have reduced the load to the outside tieback stumps to 26.8 kips each, and the load on the main anchor stump to 53.6 kips.

The effect of minimizing the tieback angle is even more pronounced with a two-stump anchor than with a three-stump anchor.

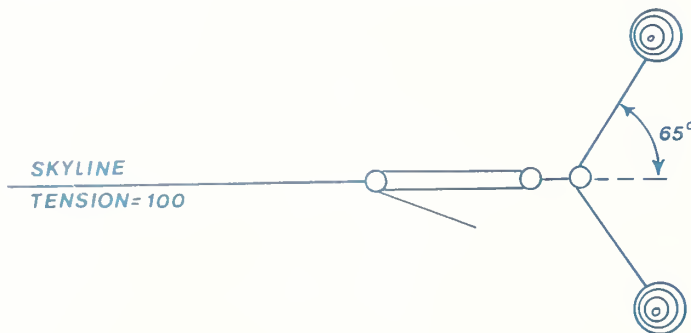

FIGURE 6a - PLAN VIEW OF TWO-STUMP ANCHOR



Given: The two-stump anchor shown and a 100-kip skyline tension (Figure 6a)

Find: Load on all stumps.

Solution: The problem can be solved by drawing a free body diagram and balancing forces (Figure 6b).

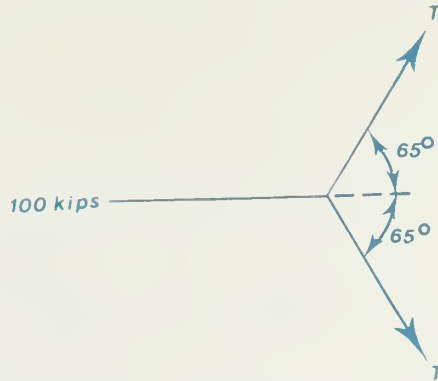

FIGURE 6b - FORCE DIAGRAM

$$\begin{aligned} \Sigma F = 0 \quad & 2 T \cos 65^\circ - 100 = 0 \\ & 2 T 0.423 = 100 \\ & 0.846 T = 100 \\ & T = 118.3 \text{ kips} \end{aligned}$$

The load on each stump is then 118.3 kips

This problem can be solved with the aid of the graph of figure 4: Enter the graph with  $65^\circ$  and determine that a unit tieback load will produce 1.18 units of tension in the tieback line, or  $100 \times 1.8 = 118$  kips of load on each stump.

Now, again in comparison, reduce the tieback angle to say,  $22^\circ$  (figure 6c).

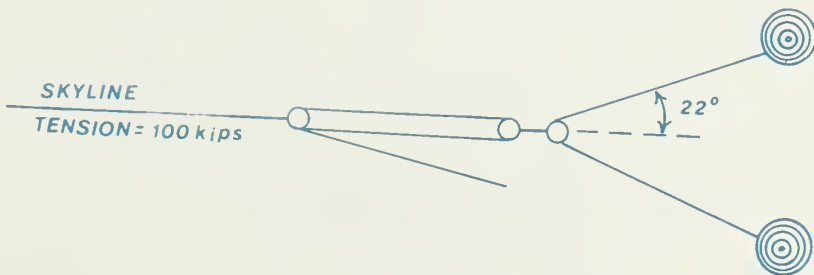

FIGURE 6c - PLAN VIEW OF TWO-STUMP ANCHOR

The problem can be solved by use of the graph of figure 4. The tieback tension per unit of skyline tension at  $22^{\circ}$  is 0.54.  $0.54 \times 100 = 54$  kips. As a result of lengthening the heel lines, a reduction in the load on the stumps of 55 percent has been achieved.

The examples have demonstrated the need to keep the tieback angle to a minimum. This is as important in the vertical direction as in the horizontal. Figures 7 and 8 show riggings which are common on skyline operations.

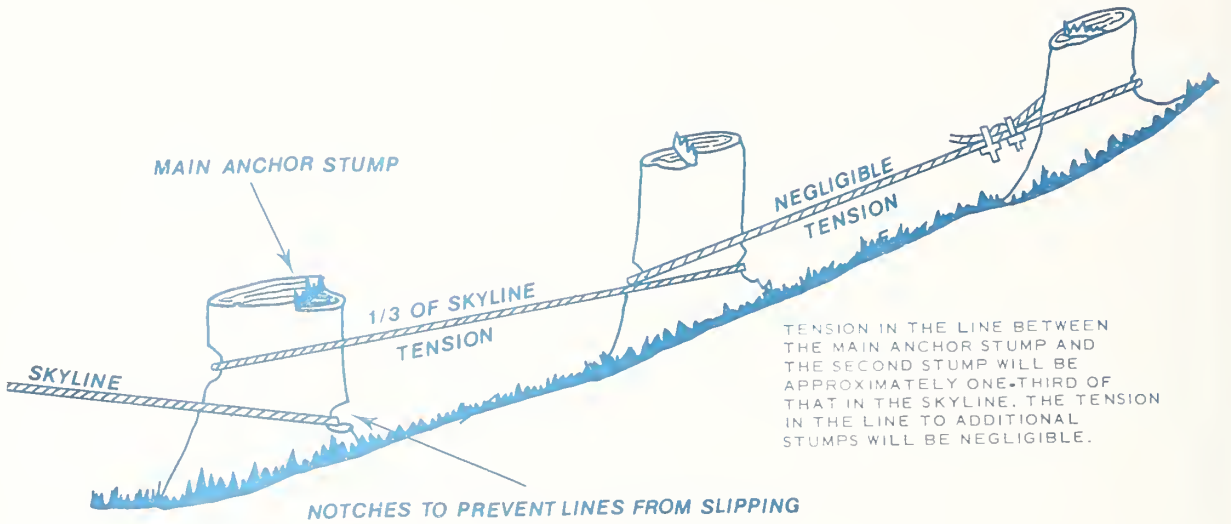

FIGURE 7 - PROFILE OF COMMON THREE-STUMP ANCHOR

An analysis of figure 8a will show why this rigging method should be used with caution on steep slopes.

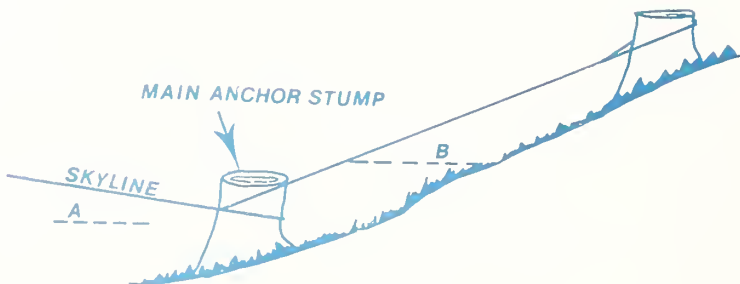

FIGURE 8a - PROFILE OF A COMMON TWO-STUMP ANCHOR

Example:  $a = 30^{\circ}$        $B = 60^{\circ}$       Skyline tension = 60 kips

To determine the load on the main anchor stump, draw a load diagram (Figure 8b) and find the horizontal and vertical components of load, (Figure 8c) then combine these to find the resultant load on the stump (Figure 8d).

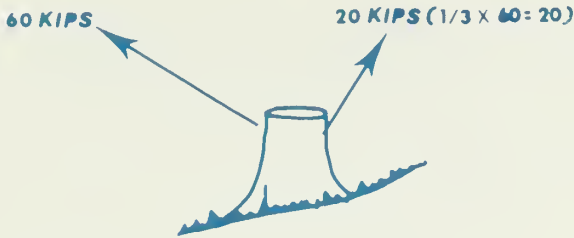

FIGURE 8b - LOAD DIAGRAM

Horizontal component of skyline tension is

$$60 \times \cos 30^{\circ} = 60 \times 0.866 = 52.0 \text{ kips}$$

Vertical component of skyline tension is

$$60 \times \sin 30^{\circ} = 60 \times 0.5 = 30 \text{ kips}$$

Horizontal component of tieback tension is

$$20 \times \cos 60^{\circ} = 20 \times 0.5 = 10 \text{ kips}$$

Vertical component of tieback tension is

$$20 \times \sin 60^{\circ} = 20 \times 0.866 = 17.32 \text{ kips}$$

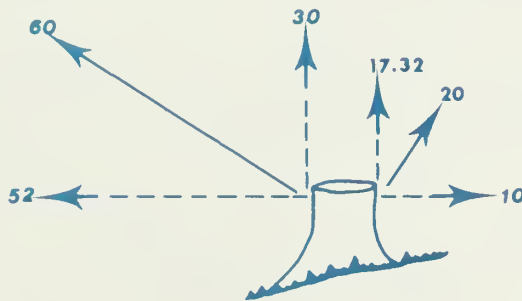

FIGURE 8c - LOAD COMPONENTS

Combining the skyline and tieback tensions both horizontally and vertically yields:

$$\sum F_x = 10 - 52 = -42.0$$

$$\sum F_y = 30 + 17.3 = 47.3$$

Now these horizontal and vertical forces can be combined to produce one resultant force on the stump.

The resultant of the horizontal and vertical forces can be found by use of the Pythagorean theorem where:

$$\begin{aligned} \text{Resultant load} &= ((\text{ver. comp.})^2 + (\text{horiz. comp.})^2)^{\frac{1}{2}} \\ &= ((47.3)^2 + (42.0)^2)^{\frac{1}{2}} \\ &= (2237.3 + 1764.0)^{\frac{1}{2}} \\ &= (4001.3)^{\frac{1}{2}} \\ &= 63.3 \text{ kips} \end{aligned}$$

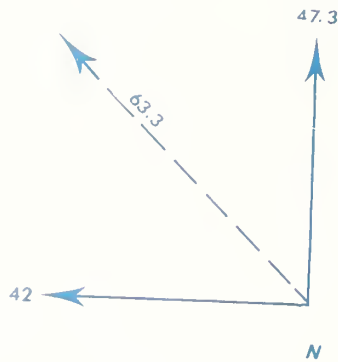

FIGURE 8d - RESULTANT LOAD

It has been demonstrated that the actual load on the stump is 63.3 kips, or 3.3 kips more than the skyline tension. Clearly, some other rigging configuration is called for. An alternate method of rigging to reduce the load on the stump is shown in figure 9a.

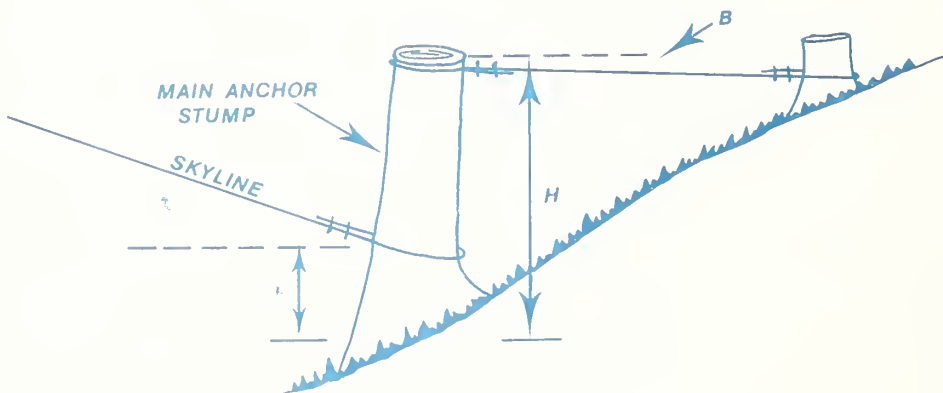

FIGURE 9a - HIGH STUMP ANCHOR

To demonstrate the advantages of rigging with a high stump, assume the following:

$$a = 30^{\circ} \quad B = -10^{\circ} \quad h = 4 \text{ feet} \quad H = 8 \text{ feet}$$

Skyline tension = 60 kips (see figure 9b)

The same procedure that was used to solve for the load on the stump of figure 8 will be used.

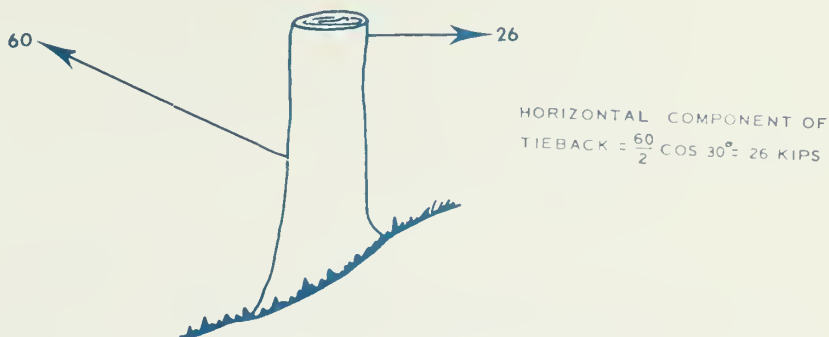

FIGURE 9b - SKYLINE AND TIEBACK FORCES ON THE STUMP

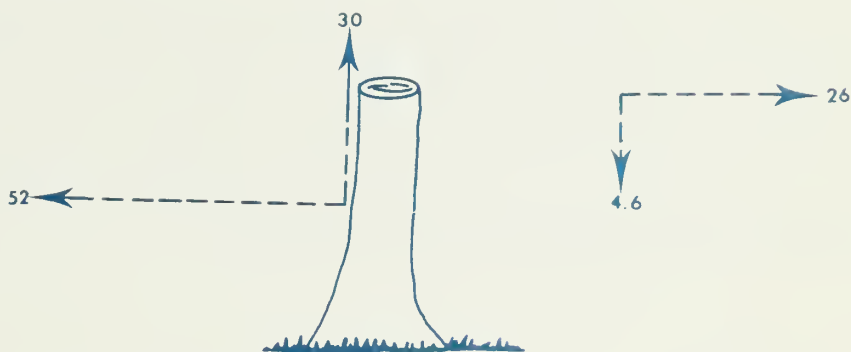

FIGURE 9c HORIZONTAL AND VERTICAL COMPONENTS OF LOAD

Horizontal component of skyline tension =  $60 \cos 30^{\circ} = 52$  kips  
 Vertical component of skyline tension =  $60 \sin 30^{\circ} = 30$  kips  
 Vertical component of tieback tension =  $26 \tan 10^{\circ} = 4.6$  kips  
 Summing the horizontal and vertical component we get:

Horizontal	$26 - 52 = -26$ kips
Vertical	$30 - 4.6 = 25.4$ kips

The resultant of these forces will be the load on the stump (Figure 9d).

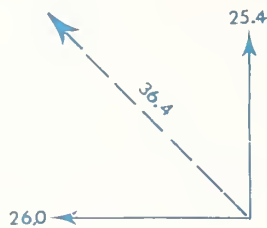

FIGURE 9d - RESULTANT LOAD DIAGRAM

$$\begin{aligned}
 \text{Resultant} &= [(25.4)^2 + (26.0)^2]^{\frac{1}{2}} \\
 &= [(645.2) + (676)]^{\frac{1}{2}} \\
 &= [1321.2]^{\frac{1}{2}} \\
 &= 36.4 \text{ kips}
 \end{aligned}$$

In the two examples just examined, rigging to a tall stump with tiebacks achieved a reduction in the load on the main anchor stump of 43 percent. It should be pointed out that several tieback stumps could have been rigged, but for the sake of simplicity, only one was used.

Rigging in this manner (Figure 9a) introduces bending moment in the stump. The bending moment will increase with increasing stump height and decrease with stump diameter. As a result, there will be a limiting value of stump height for a particular load and stump diameter.

To find the limiting height, consider the load diagram (Figure 9e). The maximum bending moment will occur when the skyline is tied one-half way from the tieback line to the ground.

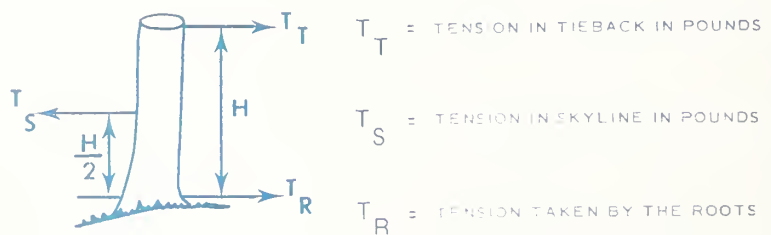

FIGURE 9e - LOAD DIAGRAM

Assumptions:

1. For small skyline slopes, the horizontal component of tension is approximately equal to the skyline tension. This assumption will produce conservative results.

2. The stump will act as a simple beam since the stump will not deflect enough for the roots to apply a resisting moment.

$$\begin{aligned} \Sigma M_{T_R} = 0 \quad T_S \frac{H}{2} - T_T H = 0 \\ T_T = \frac{1}{2} T_S \end{aligned} \quad \text{Eq. 5.3}$$

$$\Sigma F_x = 0 \quad T_S - T_T - T_R = 0$$

Since  $T_T = \frac{1}{2} T_S$  it follows that  $T_R = \frac{1}{2} T_S$  Eq. 5.4

$$\text{Moment in the stump} = \frac{T_S H}{4} \quad \text{Eq. 5.5}$$

$$\text{The resisting moment} = \frac{\sigma I}{c} \quad \text{Eq. 5.6}$$

Where  $\sigma$  = allowable fiber stress  
 $I$  = moment of inertia  
 $c$  = distance from the neutral axis to the outer fiber

$$I = \frac{\pi D^4}{64} \quad \text{and} \quad c = \frac{D}{2}$$

Where  $D$  = diameter of the stump in inches at the point where the skyline is tied on.

Setting equation 5.5 equal to equation 5.6 and solving, we get

$$\frac{T_S H}{4} = \frac{\sigma I}{c} \quad \text{and} \quad H = \frac{80 \pi D}{64 T_S} = \frac{\pi D}{8 T_S}$$

Figure 10 is a graph of this equation with  $\sigma = 1,200$  p.s.i.

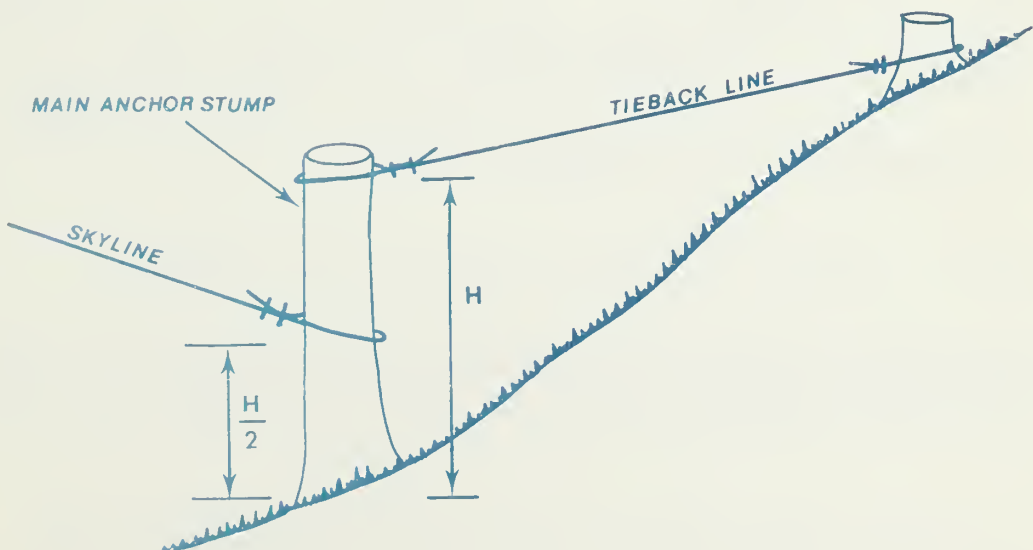

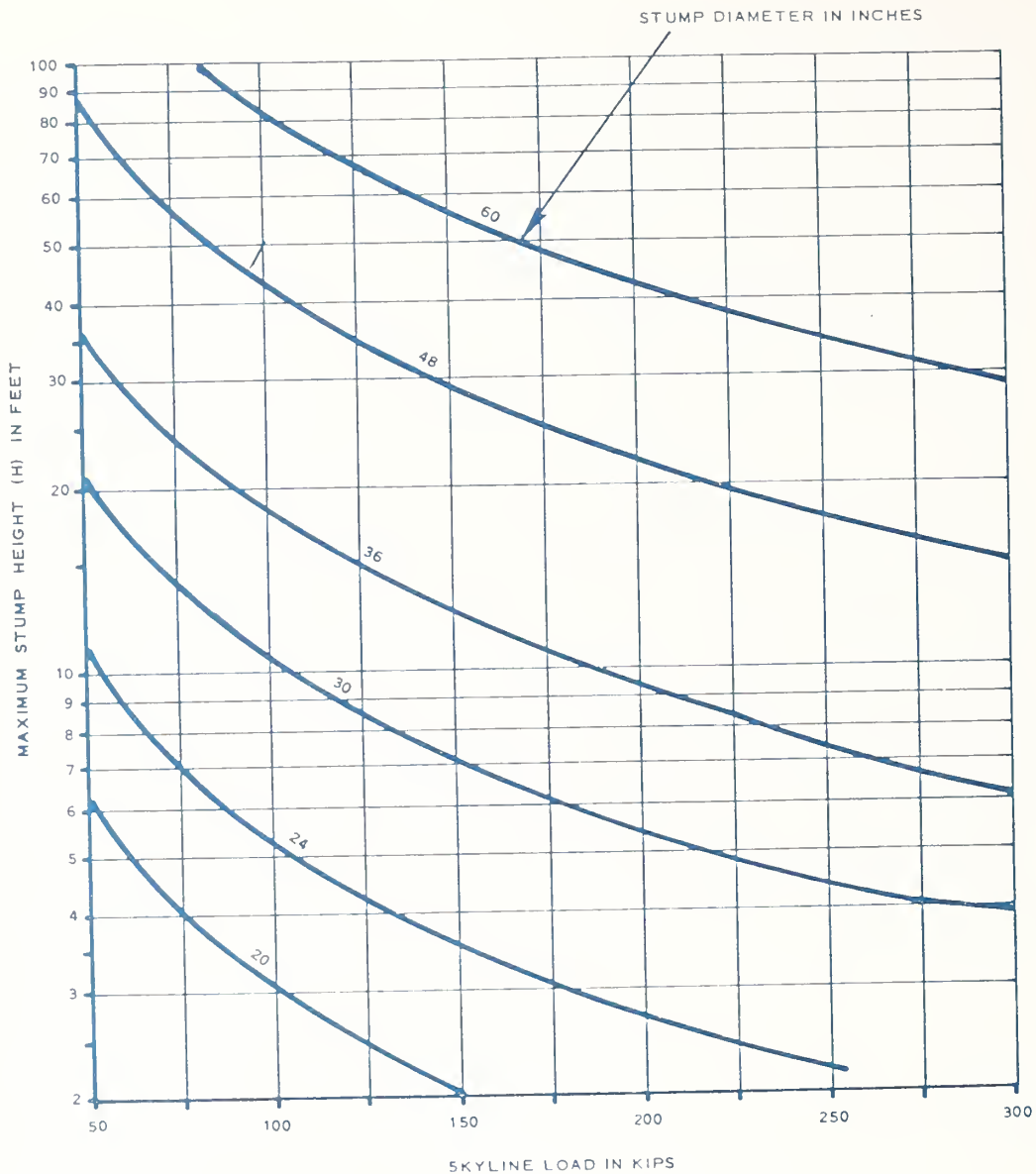

FIGURE 10 - MAXIMUM STUMP HEIGHT VS. LOAD AND STUMP DIAMETER

As an example, from figure 10, the maximum stump height from the ground to the tieback line, for a 36-inch diameter tree used to anchor a 1-1/2 inch Extra-Improved Plow Steel wire rope (breaking strength, 228 kips) is eight feet. A shorter stump could be used, but a taller stump would fail.

An advantage of this rigging method is that when the height of the skyline on the stump or tree is adjusted, the load to the tieback stump can be varied when the skyline is tied at the center of the stump and the main stump.



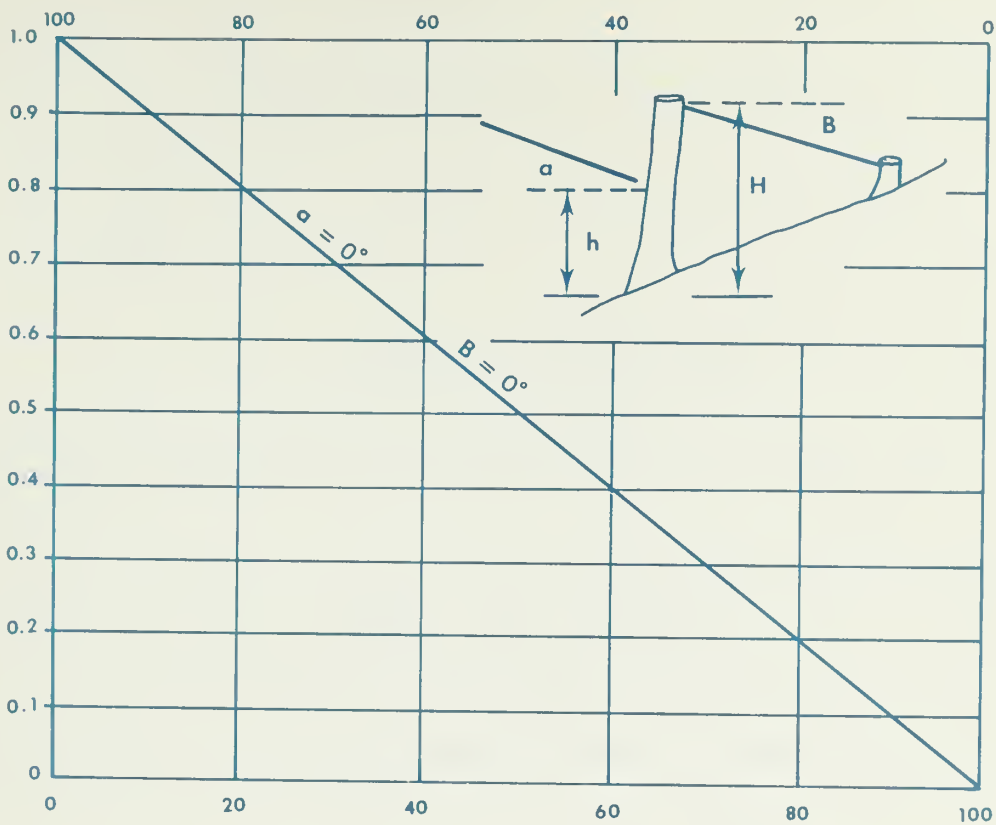

FIGURE 11 - LOAD DISTRIBUTION FOR VARIOUS RIGGING HEIGHTS

Another common rigging method is shown in figure 12a, where two and sometimes more stumps are wrapped in a bundle. This method has the disadvantage that the individual stumps must carry more load than if they were hooked individually. To demonstrate this, consider figure 12a with a 50-kip skyline tension.

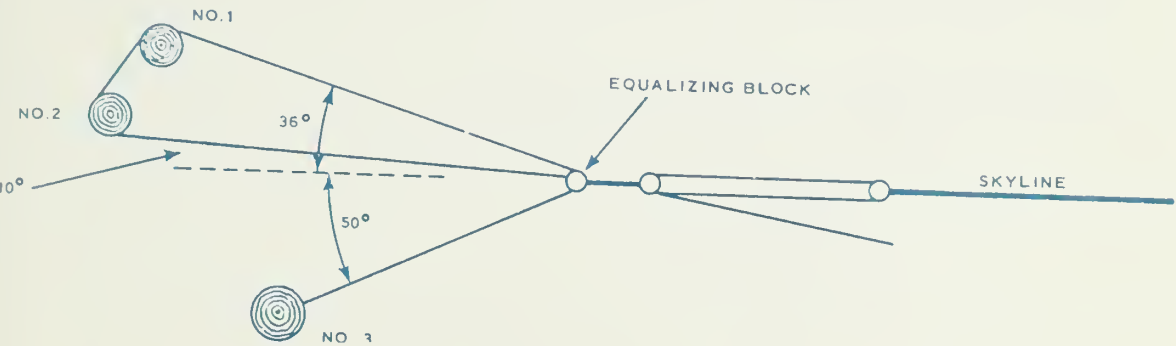

FIGURE 12a - PLAN VIEW OF STUMP ANCHOR WITH TWO STUMPS BUNDLED TOGETHER

Use a force diagram and sum forces (figure 12b)

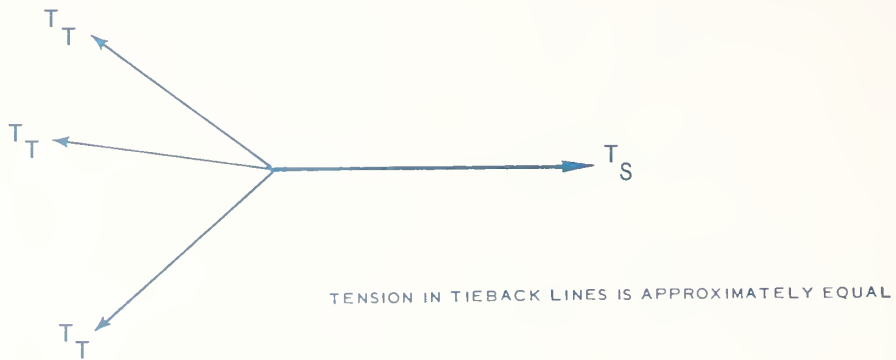

FIGURE 12b - FORCE DIAGRAM

$$\sum F_x = 0 \quad T_T \cos 50^\circ + T_T \cos 10^\circ + T_T \cos 36^\circ - T_S$$

$$(.64279 + .98481 + .80902) T_T = T_S$$

$$2.4366 T_T = T_S \text{ or}$$

$$T_T = .4104 T_S$$

Substituting  $T_S = 50$  kips

Then  $T_T = 20.5$  kips

Stump No. 3 has one line pulling on it, so the load on stump No. 3 is 20.5 kips.

On the other hand, stumps one and two have, in fact, two lines pulling on them, as shown in figures 12c and 12d.

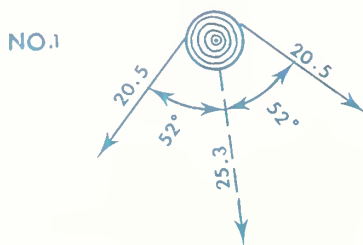

$$\text{RESULTANT FORCE} = 2(20.5) \cos 52^\circ = 25.3 \text{ KIPS}$$

FIGURE 12c - RESULTANT FORCE ON STUMP NO. 1

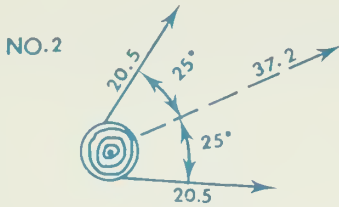

$$\text{RESULTANT FORCE} = 2(20.5) \cos 25^\circ = 37.2 \text{ KIPS}$$

FIGURE 12d - RESULTANT FORCE ON STUMP NO. 2

The actual loads on stumps one and two are 25.3 kips and 37.2 kips respectively, which is much more than if the stumps had been rigged separately.

It is hoped that this information on the mechanics of skyline anchoring will greatly reduce future anchor failures and thereby improve the economics of cable yarding systems.

#### 44.22 - Non Design Stump Anchor Practices

Loggers have used the following three techniques on occasion when tail holds were felt to be inadequate.

1. If the tail hold is not as stout as desired, the strain on the tail hold can be reduced by bending the skyline around a rub tree.



#### SKYLINE BENT AROUND RUB TREE TO REDUCE LOAD ON THE TAIL HOLD

2. Another technique is to wrap one stump and tieback to a second stump.

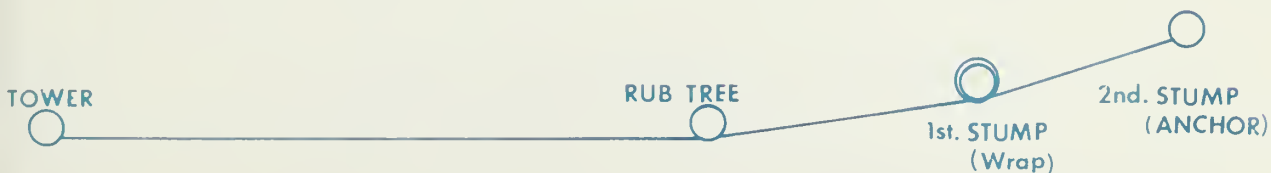

#### SKYLINE WRAPPED AROUND FIRST STUMP AND ANCHORED TO SECOND STUMP

3. An "Oregon Lead" has been used to increase the holding power of an anchor by creating friction points that reduce the skyline tension on the anchor.

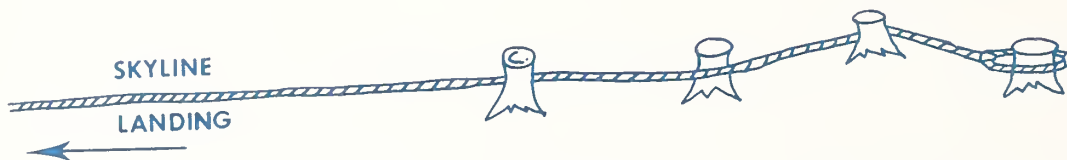

### OREGON LEAD

#### 44.3 - Deadmen

Deadmen can be used for both guyline and skyline anchors. Maximum benefit is derived from a deadman when the excavated area is held to a minimum. This is best accomplished by using a backhoe. Rubber tired, and track mounted, backhoes are readily available at equipment rental firms. It must be possible for the backhoe to get to the site. This may require construction of some kind of access spur. The amount of construction depends on the gradeability of the backhoe and whether it is to be moved across the slope, or up and down the slope.

#### 44.31 - Guide for Designing Deadmen Anchors

1. Determine skyline tension (P) from skyline worksheets.
2. Select cable size (for Extra-Improved Plow Steel cable with safety factor of three):

<u>Safe Working Load (P) (kips)</u>	<u>Cable Diameter (inches)</u>
13.7	5/8
19.6	3/4
26.5	7/8
34.5	1
43.3	1 1/8
53.3	1 1/4
64.0	1 3/8
76.0	1 1/2

3. Determine angle of pull on deadman (chord slope from horizontal).

4. From Chart No. 1 - Determine correction factor to be applied to the safe working load (P).

Corrected (P) = working load (P) x correction factor.

5. Using corrected (P) and known soil conditions at deadman location, determine log diameter and length from Chart No. 2A or 2B.
6. From Chart No. 3, determine necessary depth of burial.
7. Refer to "Suggestions for Deadman Installation" for burial recommendations.

#### 44.32 - Suggestions For Deadman Installation

1. Select deadman log from strong species such as firs, Ponderosa pine, larch, and lodgepole pine. Avoid cedar, spruce, and other species of low strength and density if possible.
2. Excavate trench at right angle to pull. Excavate wall as vertical as possible in the direction of pull.
3. Use a minimum of three bearing plates between the cable and log to prevent cutting. Refer to State safety codes for fastening requirement.
4. Excavate for the cable exit, to prevent bending in cable and vertical lifting of deadman.
5. Use good backfilling techniques as for culvert installation; i.e., layer placement and tamp with mechanical compactor.

#### 44.33 - Deadman Design

##### DEADMAN DESIGN EXAMPLE NO. 1

1. (P) from skyline worksheet = 30 kips. Extra-Improved plow steel cable diameter required = 1 inch.
2. Burial is to be in spur road with downward pull ( $-\theta$ ) at 10%. Using Chart No. 1: Corrected (P) = 30 kips x 0.98 = 29 kips.
3. Soil in spur road is a "firm" gravel. From Chart No. 2A, select a 30-inch diameter log - 26 feet long.
4. From Chart No. 3, minimum trench depth =  $2 \times (30") =$  5 feet. Located trench at least  $4 \times (30") =$  10 feet back from original ground lines.

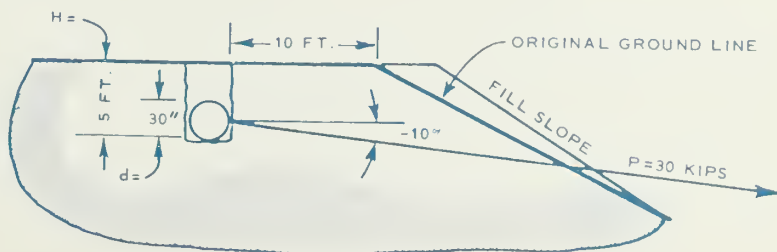

FIGURE 13

DEADMAN DESIGN EXAMPLE NO. 2

1. (P) from skyline worksheet = 57 kips. Extra-Improved plow steel cable diameter required = 1-3/8 inch.

2. Pull is upward (+) at 25%. Ground slopes downward - 30%. Using Chart No. 1, Corrected (P) = 57 kips x 1.5 = 85 kips.

3. Soil is a "soft" to "firm" clay. From Chart No. 2B: Select a 48-inch diameter log - 38 feet long.

4. There are no 48-inch diameter logs in the area, but there are 24-inch diameter logs available. How many 24-inch diameter deadmen are required? How long should they be? How should they be placed?

5. From Chart No. 2B select a 24-inch diameter log - 18 feet long, and for "soft" to "firm" clay find: Maximum corrected (P) = 20 kips.

6. Using Chart No. 1, if 25% is used as the approximate positive angle of pull (+  $\theta$ ), maximum working load (P) per deadman =

$$\frac{20 \text{ kips}}{\text{Correction factor for } +25\%} = \frac{20 \text{ kips}}{1.5} = 13 \text{ kips}$$

$$\text{Minimum number of 24" x 18' deadmen required} = \frac{57 \text{ kips}}{13 \text{ kips}} = 4.4$$

Use four deadmen and resize length of 24-inch log:

$$\text{Corrected (P) per deadmen} = \frac{57 \text{ kips}}{4} \times 1.5 = 21.5 \text{ kips}$$

From Chart No. 2B, select a 24-inch diameter log 20 feet long.

7. Trial design using four 24-inch deadmen placed as shown in sketch. Since burial is on 30% sideslope, from Chart No. 3: Minimum trench depth =  $3.2d = 3.2(24") = \underline{6.4 \text{ feet}}$ .

Minimum horizontal distance of undisturbed soil between deadman and trenches =  $4d = 4(24") = \underline{8.0 \text{ feet}}$ .

8. Distribute load as uniformly as possible to the four deadmen through the use of equalizer blocks.

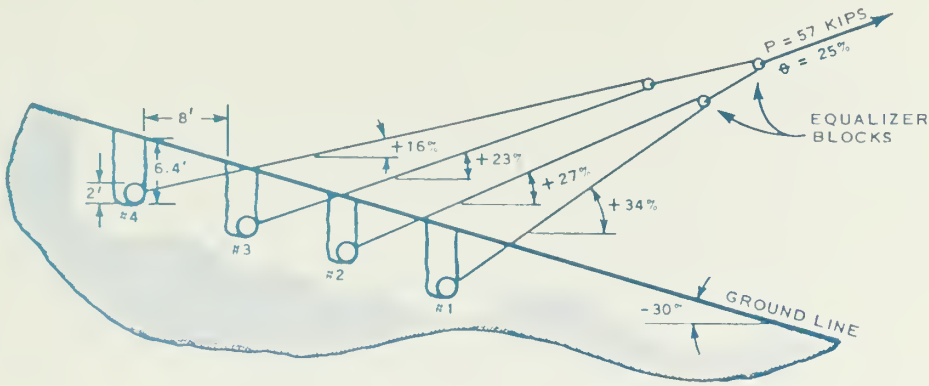

FIGURE 14

Deadman #1:  $P_1 = \frac{21.5 \text{ kips}}{1.8} = 11.9 \text{ kips}$   
 ( $\theta = +34\%$ )

Deadman #2:  $P_2 = \frac{21.5 \text{ kips}}{1.5} = 14.3 \text{ kips}$   
 ( $\theta = +27\%$ )

Deadman #3:  $P_3 = \frac{21.5 \text{ kips}}{1.4} = 15.4 \text{ kips}$   
 ( $\theta = +23\%$ )

Deadman #4:  $P_4 = \frac{21.5 \text{ kips}}{1.2} = 17.9 \text{ kips}$   
 ( $\theta = +16\%$ )

59 kips - ok

9. Test another possible design:

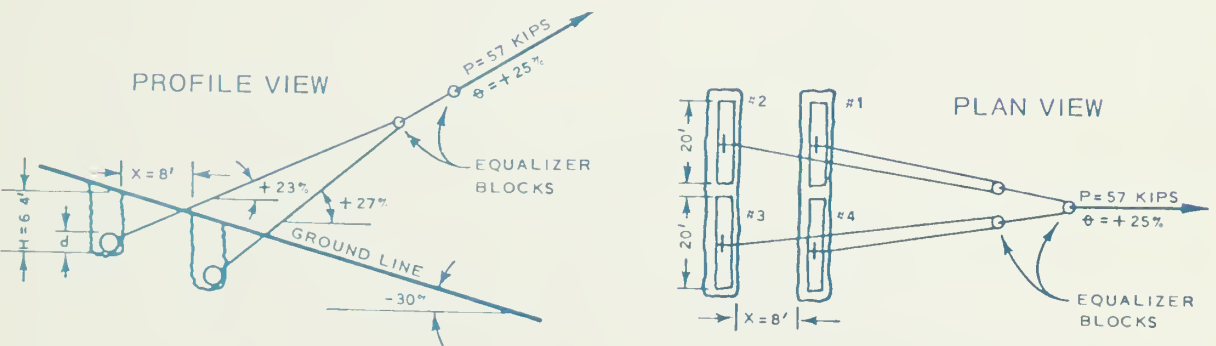

FIGURE 14A

$$\text{Deadman \#1: } P_1 = \frac{21.5 \text{ kips}}{1.5} = 14.3 \text{ kips}$$

( $\theta = +27\%$ )

$$\text{Deadman \#2: } P_2 = \frac{21.5 \text{ kips}}{1.4} = 15.4 \text{ kips}$$

( $\theta = +23\%$ )

$$P_1 + P_2 \quad 29.7 \text{ kips}$$

$$P_3 + P_4 \quad \underline{\quad \times 2 \quad}$$

59 kips, OK





CHART NO. 2A GRANULAR SOILS - (P) CORRECTED V.S. DEADMAN LOG DIMENSIONS  
 (For use with Inorganic Silt, Sand and Gravel above the watertable)

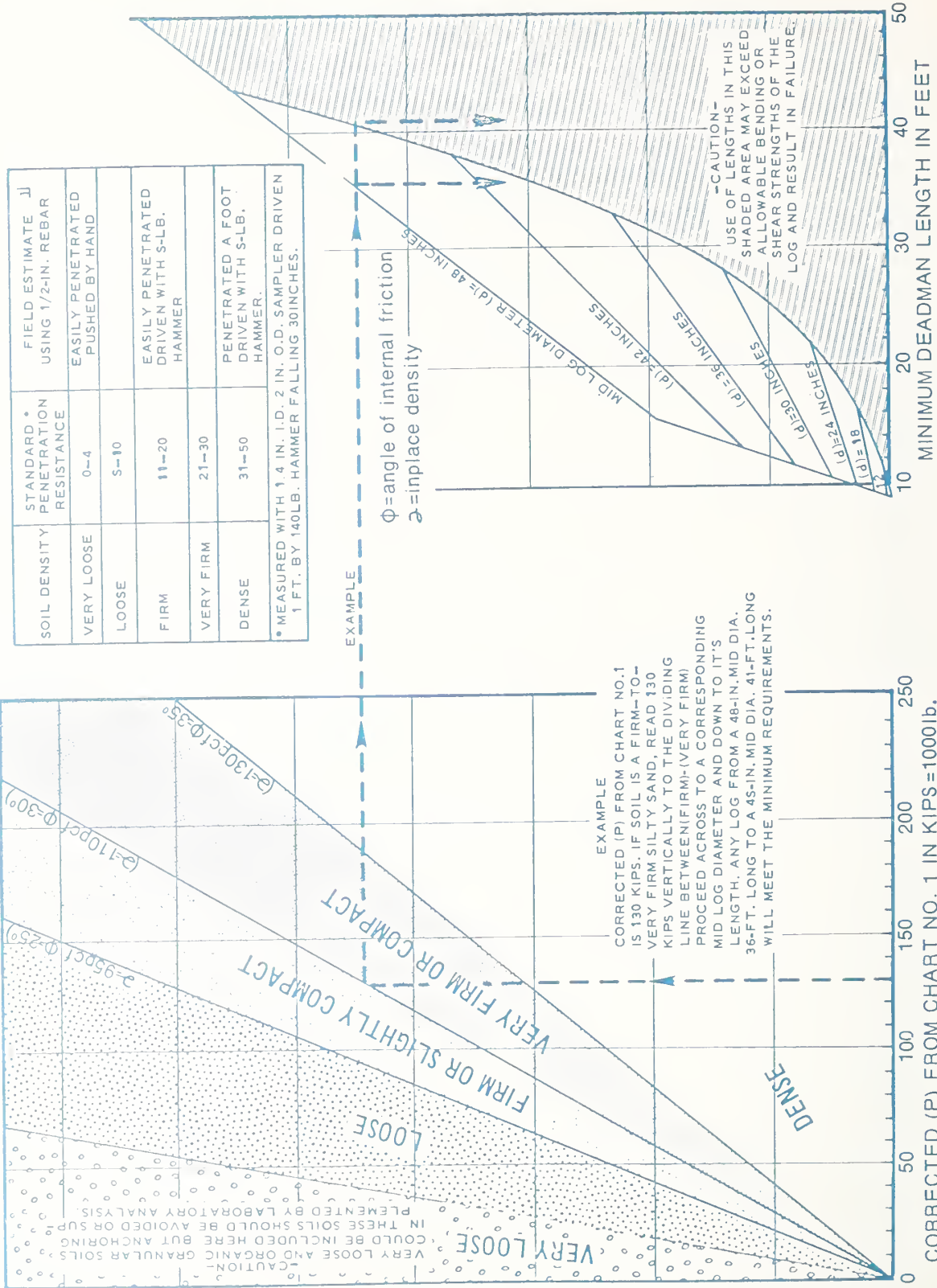
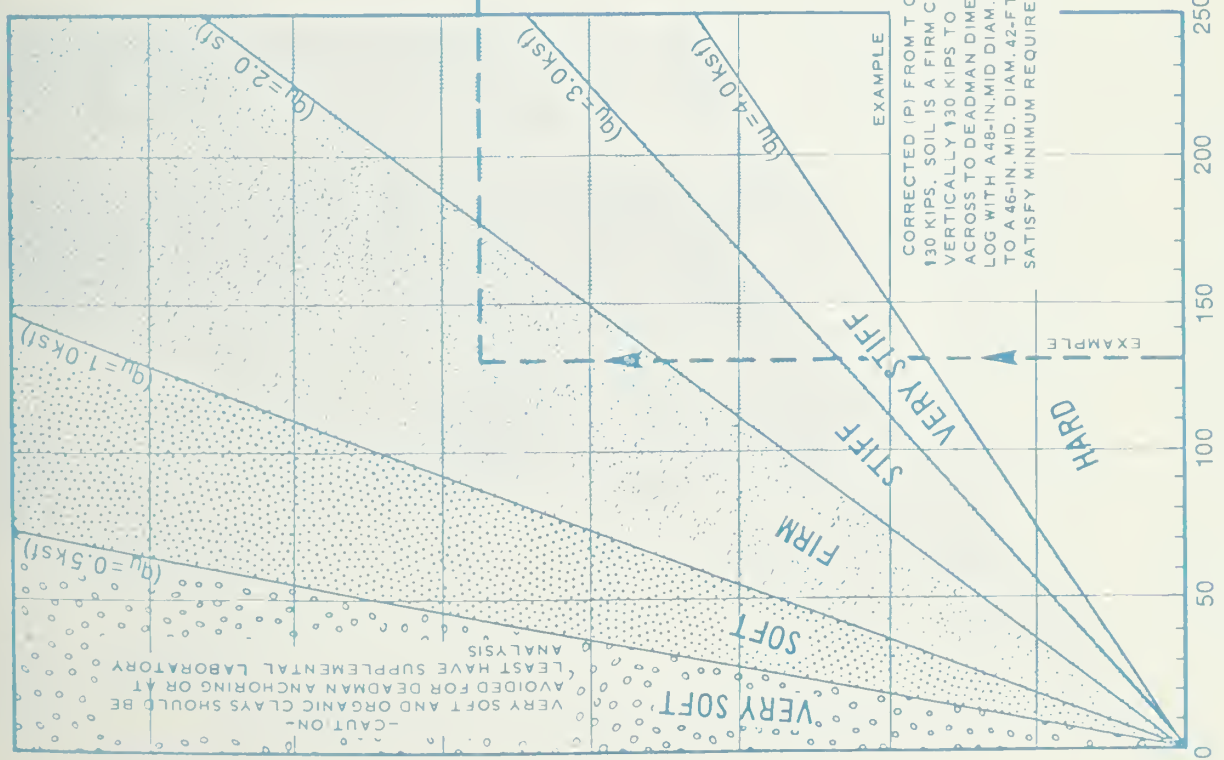
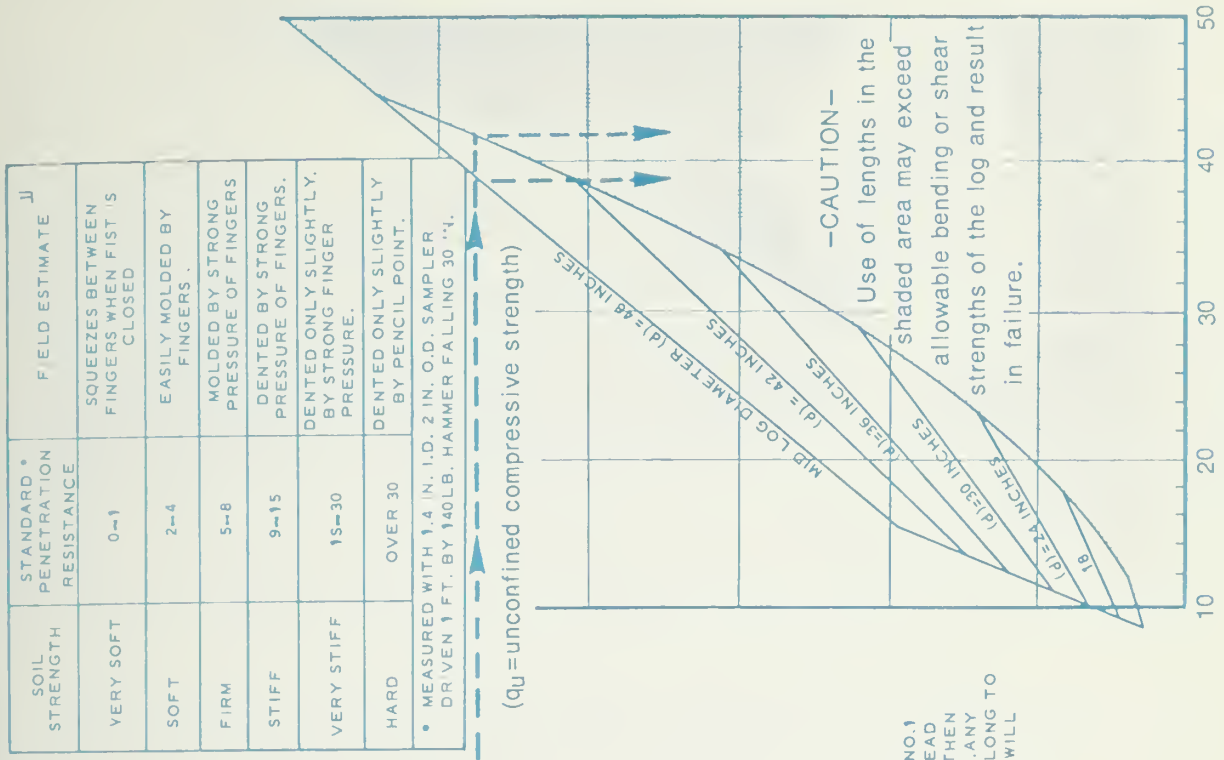

Figure 16

**CHART NO. 2B CLAYEY SOILS (P) CORRECTED V.S. DEADMAN LOG DIMENSIONS**  
 (For use with Inorganic Clays above the watertable)



SOIL STRENGTH	STANDARD * PENETRATION RESISTANCE	FIELD ESTIMATE
VERY SOFT	0-1	SQUEEZES BETWEEN FINGERS WHEN FIST IS CLOSED
SOFT	2-4	EASILY MOLDED BY FINGERS.
FIRM	5-8	MOLDED BY STRONG PESSURE OF FINGERS
STIFF	9-15	DENTED BY STRONG PESSURE OF FINGERS.
VERY STIFF	15-30	DENTED ONLY SLIGHTLY BY STRONG FINGER PESSURE.
HARD	OVER 30	DENTED ONLY SLIGHTLY BY PENCIL POINT.

\* MEASURED WITH 1.4 IN. I.D. 2 IN. O.D. SAMPLER DRIVEN 1 FT. BY 140 LB. HAMMER FALLING 30 IN.

EXAMPLE  
 CORRECTED (P) FROM T CHART NO. 1  
 130 KIPS. SOIL IS A FIRM CLAY. READ  
 VERTICALLY 130 KIPS TO FIRM) THEN  
 ACROSS TO DEADMAN DIMENSIONS. ANY  
 LOG WITH A 48-IN. MID DIAM. 39-FT. LONG TO  
 A 46-IN. MID. DIAM. 42-FT LONG WILL  
 SATISFY MINIMUM REQUIREMENTS.

Corrected (P) From Chart No. 1 in Kips=1000lbs.  
 (factor of safety 3.0)

UJ SOWERS G.B. AND SOWERS G.F. INTRODUCTORY SOIL MECHANICS AND FOUNDATIONS) MACMILLAN CO. 1961. P 108 & 359

Figure 17

### DEADMAN BURIAL

Spur Road, Level Ground, or Ground Sloping Upward  
in Direction of Pull

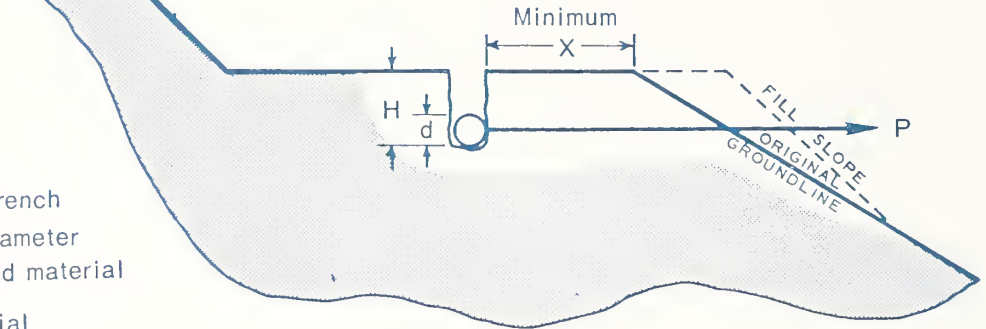

LEGEND

H= depth of trench  
d= mid log diameter  
X=undisturbed material

Minimum Burial  
H=2d  
X=4d

### CHART NO. 3 Ground Sloping Downward in Pull Direction

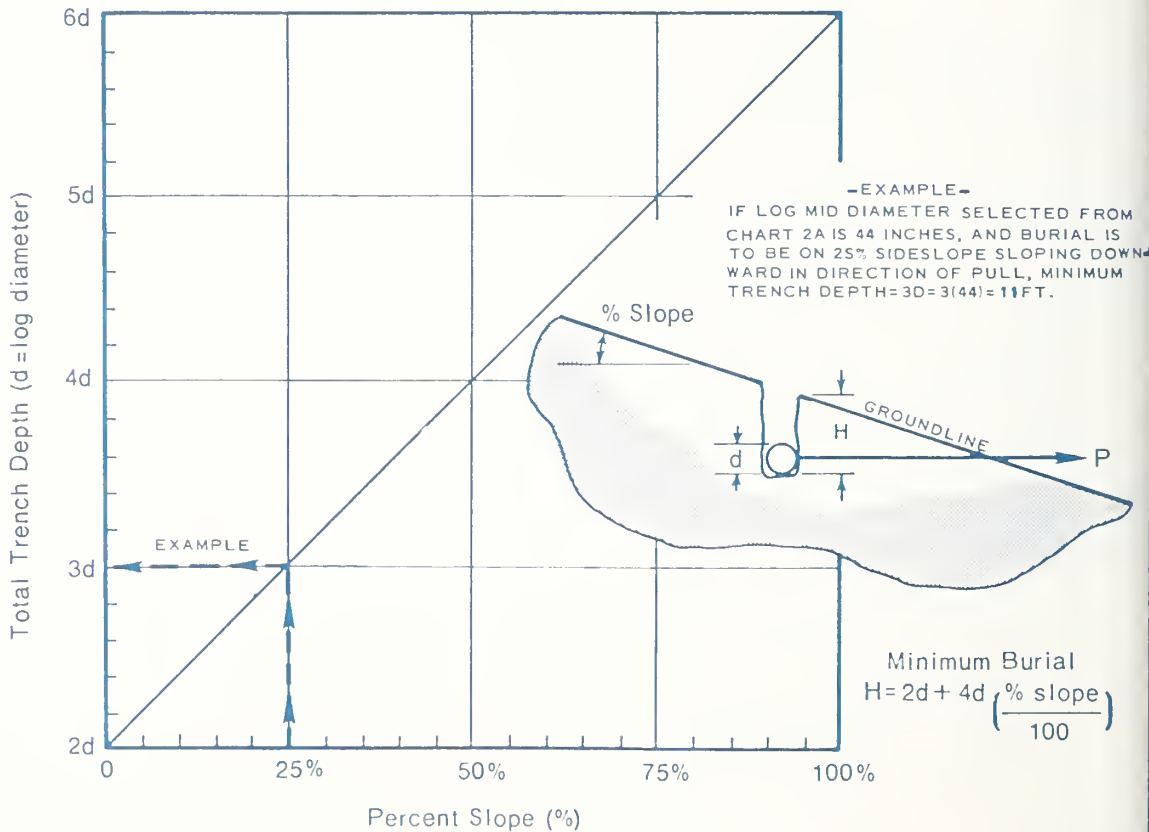

Figure 18

#### 44.4 - Rock Bolts

Rock bolts have been used very little in logging. This is probably due to logger's skepticism and to scarcity of suitable rock at desired locations. Rock bolts come in two types; expansion bolts and grouted bolts.

Expansion bolts are held in place by the friction developed between the malleable shell (see figure below) and the rock. Grouted bolts are held in place by a combination of grout and friction of a malleable shell. Expansion bolts are more suited to use as logging anchors as there is no grout cure time to wait on.

Expansion bolts are very good anchors for guylines and skylines when good rock is available at the right place. These bolts are rather inexpensive, and the installation cost is reasonable.

Wagon drills or crawler drills can be used for drilling holes for rock bolts. Portable drills that can be packed across country are available. However, holes drilled with portable drills are not drilled true. This affects the holding capacity of the bolt. The use of portable drills for rock bolt installation is not recommended.

The number of bolts needed is determined by dividing the breaking strength of the skyline by the safe working load of the bolt. Equalizing blocks, or turnbuckles, can be used to equalize the load on two or more rock bolts. If turnbuckles are used and one bolt pulls loose, other bolts will still have a hold on the skyline.

Bolts are high in tensile strength, but are not strong on shear (about one half the tensile strength). Therefore, it is recommended that the pull on a bolt be kept at as small an angle as possible. The bolt should point in the direction of the pull.

Information is obtained during the drilling process about rock hardness and the presence of holes, or fractures, in the rock. Fractured rock should be avoided for anchors. If a hole drilled in a fractured rock must be used, drill past the fracture to an adequate depth in sound rock. Grout may fill a fracture if the drilled hole must be used. It takes a week for the grout to dry.

Drilled holes must be tested before use. The bolt must be torqued before testing. When torquing the cone should be only halfway into the shell. This can be determined by counting the number of turns of the bolt.

Information of rock bolt diameters, lengths, strengths, etc., are available from dealers.

A safety factor of three should be used in determining rock bolt specifications.

Rock bolts exert a conical force on the rock.

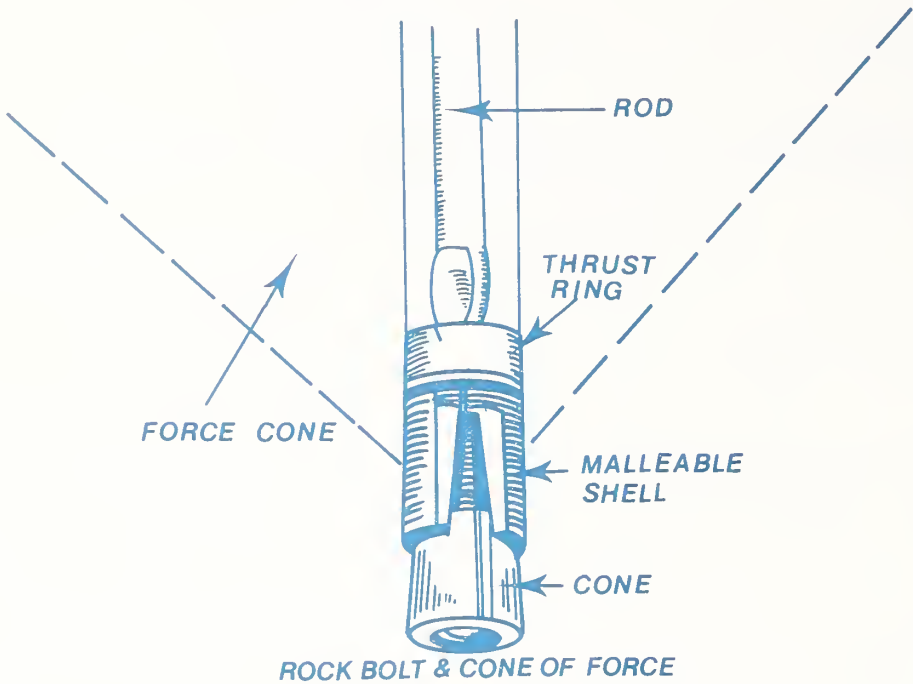

There are several reasons that rock bolts aren't as attractive as they once appeared.

a. It is hard to get a true cylindrical hole with a portable drill. Elliptical holes don't have the holding power of round holes.

b. Rock Bolts are designed to put rocks in compression. When used as a skyline anchor, the rock would be in tension.

c. When rock bolts experience dynamic loads, they might be worked out.

d. the rock bolt and the cable must be in line as the high carbon steel used in rock bolts doesn't bend. Rock bolts would break before they would bend.

e. Safety people in Oregon and Washington are questioning the suitability of rock bolts for logging anchors.

f. There is no fail safe design for rock bolts when used as anchors in tension.

Tent pegs are steel bars that are set in holes drilled at right angles (approximately) to the direction of force. Tent pegs have had little use in logging, but are mentioned as a possible type of anchor that might be developed.

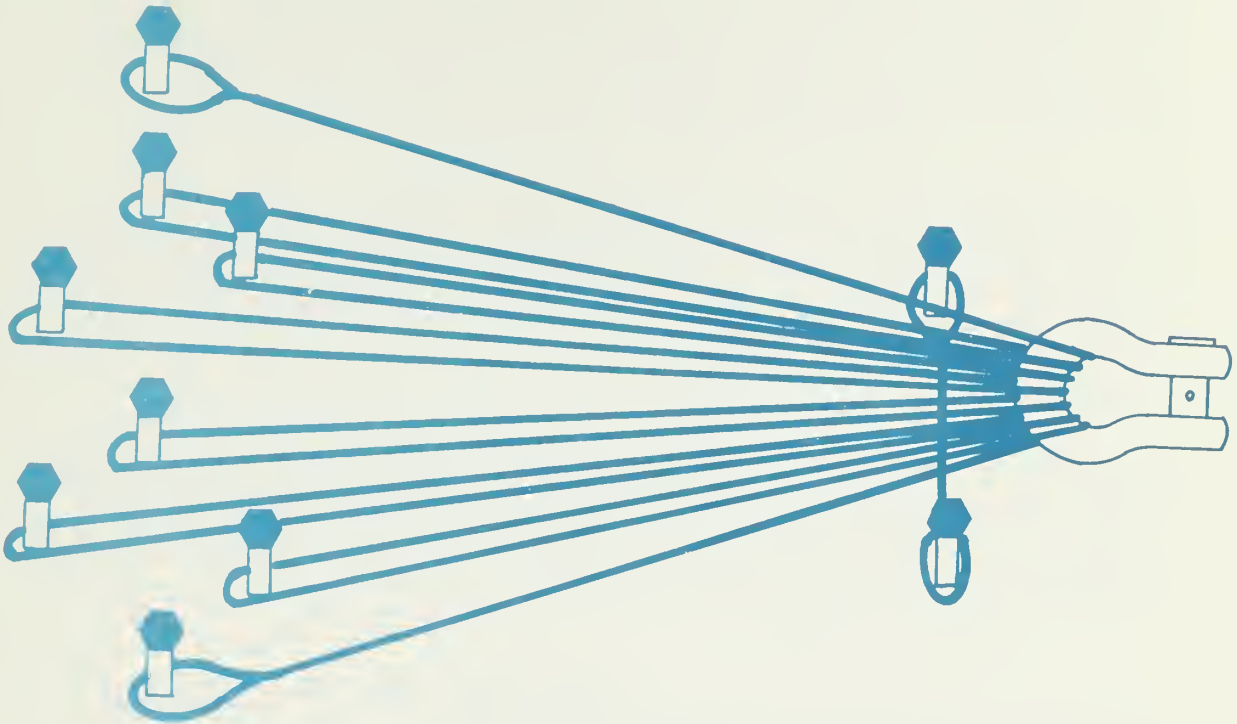

MULTIPLE STEEL BAR ANCHOR

#### 44.6 - Earth Screws

Earth screws have not been used in logging. They are another type of anchor that might be developed in the future.

Earth anchors are essentially deadmen that tie up earth vertically instead of horizontally. They work on the principle of a wood screw and the holding power is evaluated by the torque required to install the anchor.

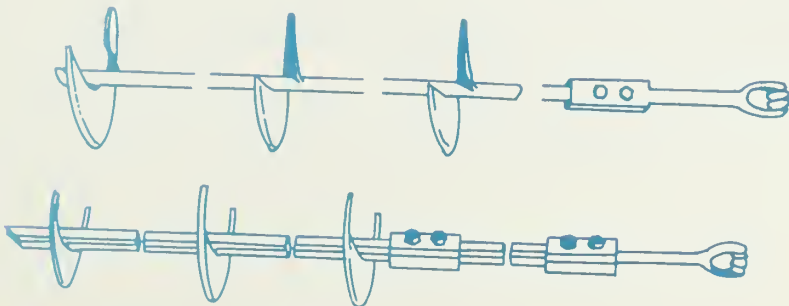

EARTH SCREWS

Earth anchors were developed for use where high loads are required.

Two, three or four helixes are stacked on a single square steel shaft, in combinations and vertical spacing that have been thoroughly tested for maximum holding power and installation ease. The individual helixes act substantially as separate anchors so that the one Multi-Helix Anchor will have a holding capacity approximating the total capacity that could be achieved with two, three or four separate anchors.

The Multi-Helix Anchors are driven into the ground with a power digger using a socket type of wrench. With a heavy down pressure on the anchor shaft, the helixes work together so that normally only a relatively small amount of torque is required to install the anchor. Extension shafts are coupled to the helix shaft and driven into the ground until firm anchoring soils are reached.

The anchor is designed for deep settings, and can be installed regardless of surface water conditions. The screw helixes compact the earth as they are installed so that the installation is not affected by ground water seepage which limit the holding power of plate and expanding anchors.

#### 44.7 - Equipment Anchors

Equipment, usually in the form of a landing cat, is occasionally used for an anchor for smaller yarders and mobile towers. The tractor can be wedged up against a stump for extra strength.

The best way of anchoring with a tractor is to face the tractor toward the direction of pull and run the bull line under the tractor and over the blade. Tension on the line forces the blade in the ground, increasing the holding power.

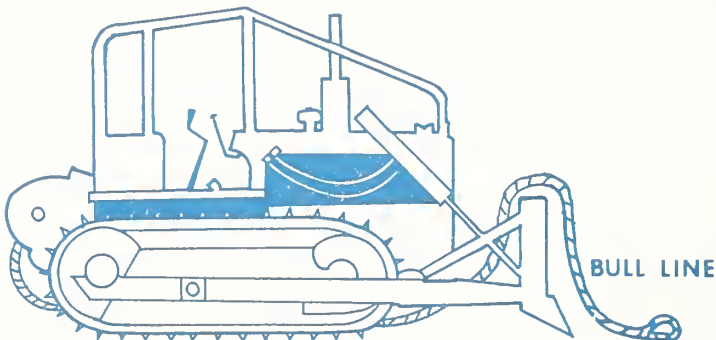

TRACTOR ANCHOR



## 45 - Guylines

### 45.1 - Introduction

Guylines are wire ropes used to hold spar trees or towers against an overturning force. This force may be imposed by stresses in the mainline, a skyline or haulback line, or by the wind. Force exerted by wind depends upon diameter, height and shape of the tower. Wind force will not be considered here because its magnitude is small, compared to forces exerted by the skyline, mainline, or haulback line.

Adequate anchors for guylines must be available to have a loggable cable landing. Stumps are presently the most common type of guyline anchor. However, with the increasing acreage of cut over land, many future landings will have to be in cut over areas. (See Section 44.2 for a brief discussion of stump life and stump diameter requirements.) This means that if stump life isn't given consideration in sale scheduling, suitable stumps will become scarce and deadman guyline anchors will become common. Some areas may not be loggable because of the lack of adequate anchors for guylines. Most loggers prefer deadmen to multi-stump anchors, or rockbolts, because they are more of a known quantity.

The first rock bolt used as an anchor in logging was used as a guyline anchor, because there were no stumps available at the right location in the rock cut used for the landing.

### 45.2 - State Safety Code Requirements

Following are some requirements concerning guylines that are fairly common among the different logging safety codes.

Required guy numbers depend upon the type of spar and its height. Most portable steel spars used in highlead logging require six guys. Heavy-duty skyline towers require seven or eight guys. The state safety codes require spars over a specified height to be equipped with a certain number of guys. For example, the Oregon State Safety Code requires that vertical portable steel spars, 55 feet or more in height from the base or trunion, be equipped with at least six guys, if the guys meet the strength requirements. Leaning-type portable steel spars, 55 feet or more long, require at least three back guys. Leaning spars of less than 55 feet require at least two back guys arranged to form an angle between  $70^{\circ}$  and  $90^{\circ}$  with each other and opposite to the direction of stress.

Boom-type machines used for yarding need not be guyed if they are specifically designed for use without guys.

When compressive stresses are placed on the top of a wood spar tree, the spar will tend to deflect laterally at the mid-point. At least three buckle guys are required on wooden spar trees over 110 feet high.

## 45.3

Occasionally, landings are so situated as to create very steep guyline angles. Guyline angles should never exceed 60 degrees or 173 percent, and preferably should be less than 45 degrees or 100 percent. Stress bearing guylines should be anchored so as to provide a guyline angle no steeper than 45 degrees from horizontal. Stress bearing guys are guys opposite the pull.

Standing trees cannot be used for guyline anchors. In partial cut sales, guyline trees should be picked out in cooperation with the logger before trees are cut, so that an adjustment can be made in trees to be left to carry out the intent of the cutting prescription. The timber sale planner doesn't know who will buy the sale, or the type of equipment he will have. The hooker is responsible for the crew's safety and he will have strong opinions on which trees should be picked. Avoiding six guyline towers reduces leave tree problems in partial cuts.

### 45.3 - Mechanics of Guylines

Factors contributing to the effectiveness of guys are:

1. Number of guys.
2. Spacing of guys.
3. Direction of applied force.
4. Angles of guys with the horizontal.

Guy spacing around the tower depends primarily upon where the anchors can be located. The guys should be spaced uniformly, whenever possible, to equalize the stresses. However, if yarding will be all on one side of a spar or tower, the guylines will give more support if the number of guys opposite the lead are increased, instead of spacing them equally around the spar. The number of guylines opposite the lead must be increased on long span skyline set ups. There should be at least four.

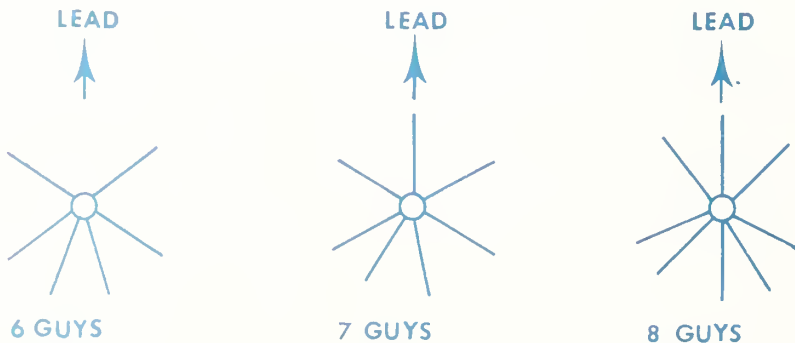

SPACING FOR VARIOUS NUMBERS OF GUYS TO INCREASE SPAR  
SUPPORT OPPOSITE THE LEAD

Guyline anchors should never be above the elevation of the tower guyline ring. Anchors above the guyline ring would result in a vertical lifting force on a tower.

It is desirable to have guylines all approximately the same length. Guylines should not be more than twice as long as the adjacent guylines. With uneven guyline lengths the slack will come out of the short guyline before it is out of an adjacent long guyline, resulting in all of the strain being placed on the short guyline.

It can be difficult to adequately tension long guylines. For lack of better information, a rule of thumb used by some planners is "Guyline length from top of tower to anchor should not exceed five times tower height."

The direction of the force applied to the top of the tower by loading the skyline is very important. The tower should be erected and guyed to resist the most critical situation, which is when the direction of the applied force results in maximum stresses in the fewest number of guys. There are computer programs that give the resultant of two or more forces acting on a tower or spar. When the resultant is known, guys can be anchored in the most effective locations.

The following table lists guy factors for various number of guys and positions of applied force.

<u>Number of guys equally spaced</u>	<u>Critical position of applied force</u>	<u>Guy Factor</u>
3	30° from any guy	.866
4	Opposite any guy	1.000
5	180° from any guy	1.539
6	30° from any guy	1.732
7	120° from any guy	2.190
8	Opposite any guy	2.414
9	100° from any guy	2.836
10	180° from any guy	3.078

These factors apply to the horizontal pull at the same elevation as the guyline circle. The horizontal component of the applied force is found and divided by the load factor. The result is the maximum horizontal pull in any one guy.

#### EXAMPLES

Given: A tower with six equally spaced guys supports a 1-½ inch diameter skyline (figure 1). The skyline enters the tower at a vertical angle of 20 degrees from the horizontal. It makes a horizontal angle of 30 degrees with the nearest guy. Assume that the guys and skyline are on the same horizontal plane. The guy makes an angle of 40 degrees with the horizontal.

Profile

FIGURE 1

Plan

Find: The tension in the most critical guy.

Solution: Let  $S_H$  = horizontal force due to the tension in the skyline.

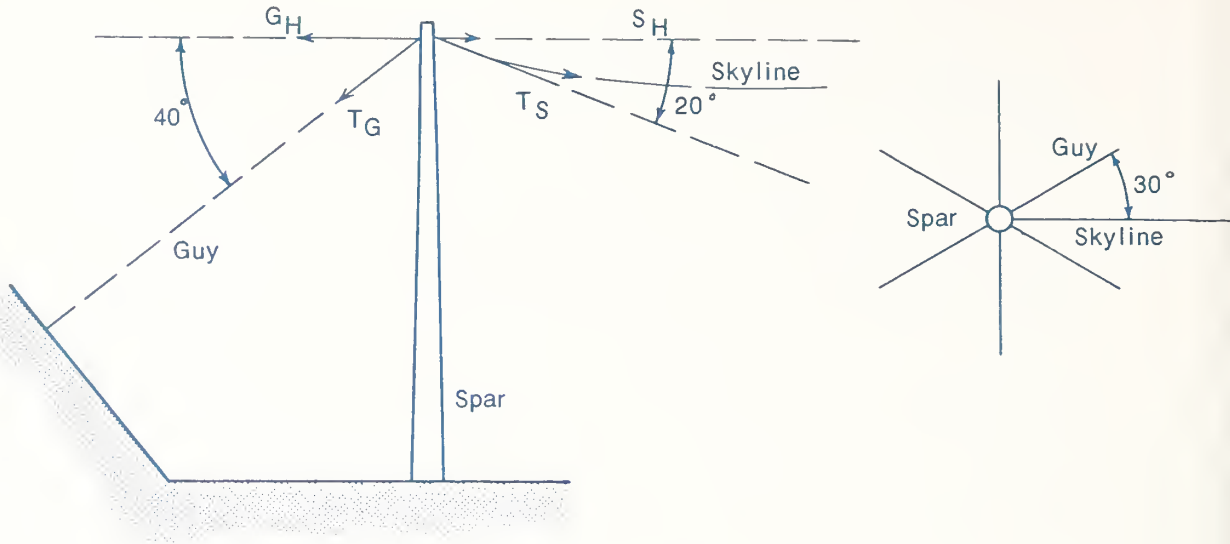
$G_H$  = horizontal force due to the tension in the guy.

$T_G$  = Tension in guy.

$T_S$  = Tension in skyline

The maximum stress in the skyline is equal to its breaking strength. For 1½-inch diameter Extra-Improved Plow Steel the breaking strength is 228,000 pounds.

Therefore:  $S_H = 228,000 (\cos 20^\circ) = 228,000 (.93969) = 214,249.32$  lbs.  
The guy factor for six guys with the force applied at 30 degrees from any guy is 1.732.

Therefore:  $G_H = 214,249.32 \div 1.732 = 123,700.43$   
The stress in the guy will be:

$$T_S = \frac{G_H}{\cos 40^\circ} = \frac{123,700.53}{.766} = 161,488.94$$

Therefore 1-3/8-inch diameter guys would be needed.

The following table may be used as a guide in determining the applied force that can be resisted by all guys.

<u>Number of guys equally spaced</u>	<u>Applied Force is</u>	<u><math>G_H</math> will resist a force, <math>S_H</math> equal</u>
3	Opposite one guy	100% of the horizontal force of one guy
4	Halfway between 2 guys	140% of the horizontal force of one guy
5	Opposite one guy or halfway between 2 guys	160% of the horizontal force of one guy
6	Opposite one guy	200% of the horizontal force of one guy
7	Opposite one guy or halfway between 2 guys	225% of the horizontal force of one guy
8	Halfway between 2 guys	260% of the horizontal force of one guy
9	Opposite one guy or halfway between 2 guys	290% of the horizontal force of one guy
10	Opposite one guy	223% of the horizontal force of one guy

In the above example, if the skyline were rigged opposite one guy, all six guys will resist an applied horizontal force  $S_H$ , equal to 200 percent of the horizontal force  $G_H$ , of one guy. If 1-1/8-inch diameter guys are used, the horizontal component of a guy rigged at 40 degrees with the horizontal is:

$$G_H = 130,000 \times .766 = 99,580 \text{ lbs.}$$

$$\text{Then: } S_H = 200\% \times 99,580 = 199,160 \text{ lbs.}$$

Assuming the skyline enters the tower of an angle of 20 degrees with the horizontal, the tension in the skyline will be:

$$T_S = \frac{199,160}{\cos 20^\circ} = 211,942 \text{ lbs.}$$

Therefore, assuming the six guys are equally spaced and that each makes an angle of 40 degrees with the horizontal, they can resist a tension in the skyline of 211,942 lbs. This would be equivalent to a 1-3/8-inch diameter skyline. Actually, the mainline is also exerting a force on the tower in approximately the same direction as the skyline. Therefore, in the above example, the 211,942 lbs. is equivalent to a 1-1/8-inch diameter skyline and a 7/8-inch diameter mainline. This assumes that both lines are stressed to their breaking strength at the same time.

The angle that the guyline makes with the horizontal is referred to as the effective guy line. The following table is a guide to determine the effectiveness of guys:

Effective Angle  
Degrees

60-45  
45-30  
30-10

Effectiveness of  
Guys

50%-75%  
75%-85%  
85%-95%

The percent effectiveness in the above table is an approximation of the cosine of the angle.

For example, if a 1-1/8-inch diameter guy makes an angle of  $40^{\circ}$  with the horizontal, the horizontal component  $G_H$  will be:

$$G_H = 130,000 \times .766 = 99,580 \text{ lbs. or we can say that the guy is only 76.6\% effective.}$$

A standing skyline may be rigged with the skyline passing across the top of the tower through a banjo fairlead. The loads imposed on the tower with this type of rigging may be different in magnitude and direction from those imposed by a highlead or a live skyline system. Consider the rigging situation as presented in figure 2. The tension in the skyline will be the same on both sides of the fairlead. However, if the skyline angles with the horizontal, entering and leaving the tower, are not equal; the horizontal components of tension will not be equal. The tower must be guyed to compensate for this difference in tension.

It can readily be seen that if the horizontal component on the back side of the tower is greater, more load will be imposed on the front guys than on the back guys.

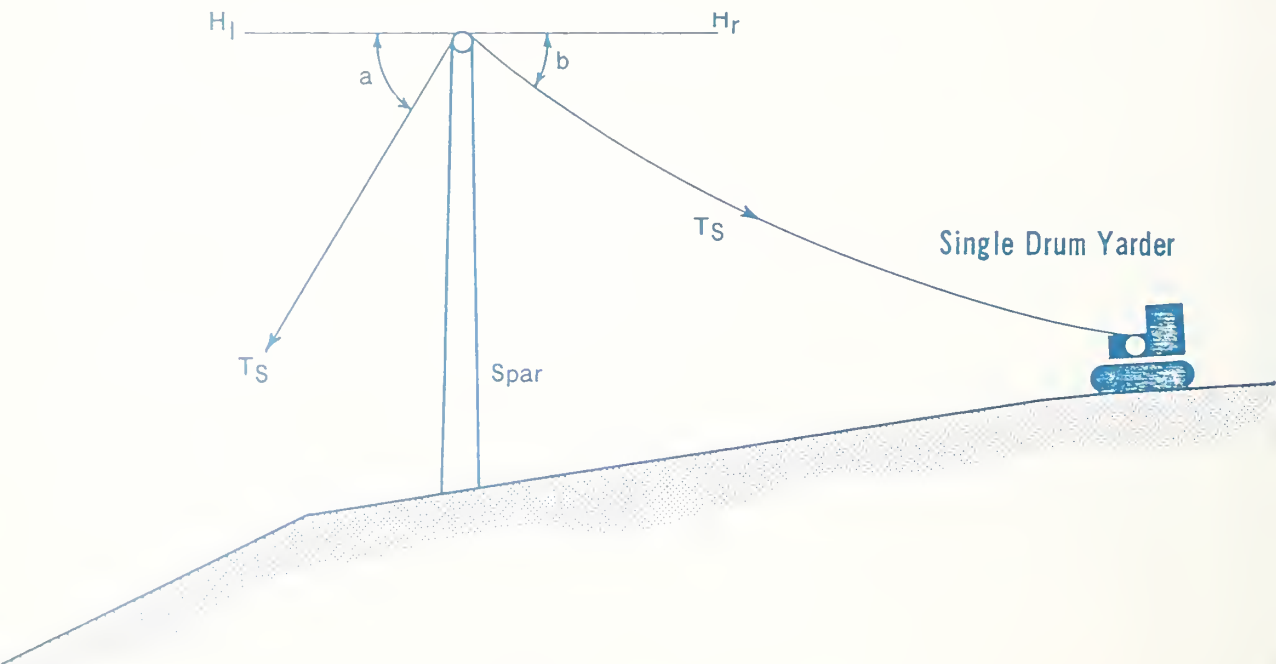

FIGURE 2

## EXAMPLE

Given: A 1½-inch diameter skyline passes across a tower as illustrated above.

$$\begin{aligned} \text{angle } a &= 60^{\circ} \\ \text{angle } b &= 40^{\circ} \end{aligned}$$

$$T_S = 228,000 \text{ lbs.}$$

Find: The horizontal forces acting on the tower

$$\text{Solution: } H_L = 228000 \cos. 60^{\circ} = 228000 (.5) = 114,000 \text{ lbs.}$$

$$H_R = 228000 \cos. 40^{\circ} = 228000 (.766) = 174,648 \text{ lbs.}$$

From this example it can be seen that the resultant horizontal force on the tower is acting in a direction to push the tower over backwards. Therefore, the front guys will be resisting this force. If the skyline were rigged with angle (b) greater than angle (a), then the back guys would have to resist the resultant horizontal force.

Each setting should be investigated to insure that the guys will be effective. It is possible to rig a tower so that the guys were adding to the forces acting on the tower instead of resisting them.

Another method of determining guyline length is given in reference 50-4.

See Section 48.75 for additional examples of forces on spars.

## 46 - Yarder Towers and Undercarriages

Yarders, towers and undercarriages are sold in various combinations. Some manufacturers list the components separately (yarder, tower, undercarriage and options) from which a "package" can be made to meet the purchaser's needs. Other manufacturers provide the "package" as an integral piece of equipment. Most provide options of trailer-mounting, self-propelled, rubber-tires, or self-propelled crawler mounted undercarriage.

Region 6's Proposed Chapter 415.82, "Cost Guides for Emperical Appraisals" lists and briefly describes some of the yarders, towers and undercarriages offered by several equipment manufacturers. Brochures are available that give specifications for the various yarders, towers and undercarriages. See Appendix, Section 91, for data on various yarders.

### 46.1 - Yarders

A rudimentary appreciation of yarder operation is of assistance in understanding the problems a yarding engineer has in running a yarder to operate the various cable yarding systems. This is of special concern when a skyline payload is marginal. There may be a difference between theoretical maximum payload and the actual maximum payload as governed by yarder and logging system limitations. Some yarding systems are very demanding and require a very skilled yarding engineer to operate them effectively.

Yarders come with either a swinging boom or a fixed boom. Most swinging booms have a limited height of 50 feet to 60 feet.

Swinging booms permit a wider skyline road and thereby reduce the number of yarder moves. This is are a big advantage when grapple yarding.

Section 42.51b discusses considerations involved in landing logs with a swing boom yarder.

A swing boom yarder will provide more deflection for uphill yarding than is available to a fixed tower of the same height if the fixed tower has to set a log length back of the fill slope.



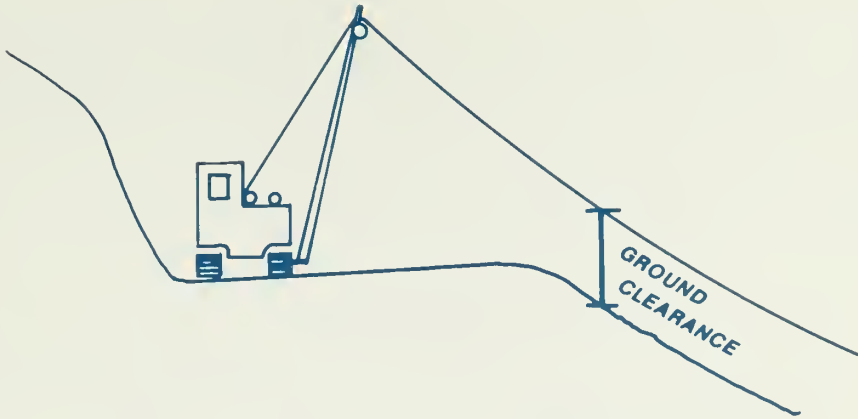

GROUND CLEARANCE IS REDUCED WHEN FIXED BOOM  
YARDERS ARE SET BACK FROM THE SLOPE BREAK

When proposing downhill yarding to narrow landings along a road, it is essential to check the effect of the cut bank on deflection and safety of the landing crew and equipment.

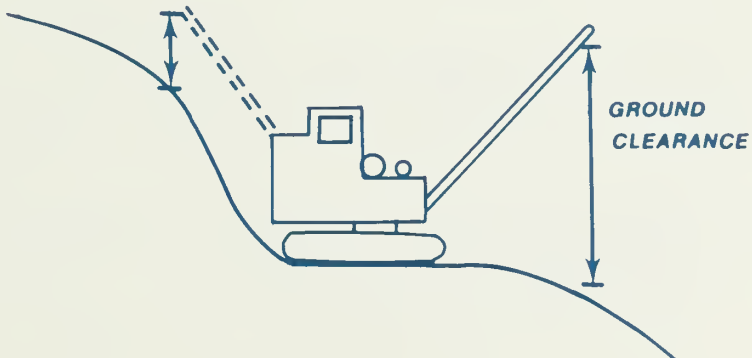

SWING BOOM YARDERS HAVE LESS GROUND CLEARANCE  
ON THE CUT BANK SIDE

46.11 - Horsepower

Daily yarding production is directly related to yarder horsepower. The following formulas can be used to estimate horsepower requirements. The formulas assume a coefficient of friction between the log and the ground of 1. This is a conservative figure. The coefficient of friction on a proposed sale area could be 0.6 or 0.7.

The most accurate estimate can be made if line speed and line pull is known.

$$HP = \frac{\text{LINE SPEED X LINE TENSION}}{33,000}$$

Line speed is in feet/minute  
Tension is in pounds.

If line speed and tension are not available, horsepower can be roughly estimated using speed along the chord slope. The speed along the chord must be converted to vertical speed.

For flying logs clear of the ground:

$$HP = \frac{(\text{Weight of logs} + \text{Carriage}) \times (\text{Vert. Speed})}{33,000}$$

For dragging logs:

$$HP = \frac{(\text{Weight of Logs} + \text{Carriage}) \times (\text{Vert. Speed})}{33,000} + \text{drag}$$

Drag can be roughly estimated as:

$$\frac{(1/2 \text{ log weight}) \times (\text{Horizontal Speed})}{33,000}$$

Example:

GIVEN: 20,000 pound load  
30% chord slope  
logs dragging  
500 feet/minute speed along chord  
2,000 pound carriage weight

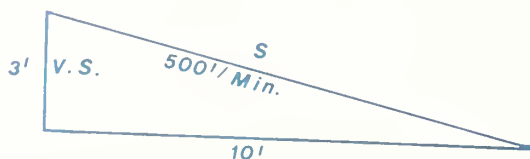

$$S^2 = 3^2 + 10^2$$

$$S = 10.4$$

Vertical Speed solution:

$$\frac{V.S.}{500} = \frac{3}{10.4}$$

$$V.S. = 144 \text{ feet/minute}$$

Horizontal Speed Solution

$$\frac{H.S.}{500} = \frac{10}{10.4}$$

$$H.S. = 481 \text{ feet/minute}$$

$$HP = \frac{(22,000 \times 144) + (10,000 \times 481)}{33,000}$$

$$H.P. = \underline{242}$$

#### 46.12 - Transmissions

Some old yarders had only one or two speeds. Newer yarders have up to six speeds. An increase in the number of speeds will reduce turn time if a yarder has enough horsepower to adequately utilize them.

Most newer transmissions have torque convertors which provide a much smoother operation than geared transmissions. Torque convertors operate similar to fluid drive transmissions in automobiles.

#### 46.13 - Interlocks

Interlocks are necessary for efficient operation of running skylines and of North Bend, South Bend, block in the bight and similar systems. Reference 50-3 discusses the use and operation of interlocks.

46.14 - Frictions (Clutches)

Clutches and brakes are mechanically similar but they perform different functions: clutches transmit power, brakes disipate power.

Power is transmitted to the drums through a friction or clutch. Frictions can be mechanical, air, or hydraulically operated. The three most common frictions are cone, disc and expanding. A cone friction transmits power by pressing one cone shape inside another as diagramed below. Coneclutches are very effective in transmitting power but they have a tendency to stick. They are not used on newer yarders.

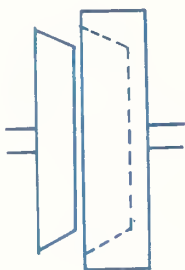

Disc (plate) clutches operate like the clutch on an automobile where a driving plate is forced against another plate, thereby turning the second plate. Some newer yarders have air operated, multiple plate clutches operate by a hand control level. With air operation the control can be set for a desired maximum air pressure. When the friction is on, the drum will pull up to the set pressure. The friction can be put on gradually up to the set maximum air pressure.

Expanding clutches operate similar to shoe brakes on an automobile, the power is transmitted by a friction surface being pressed out against the inside of a drum. Since they are hydraulically operated they can be set to slip at a given pressure. They are also used on newer yarders.

One of the latest yarders designed has no clutch. This is a development that has been used on loaders and backhoes. The drums are controlled by hydraulics.

46.15 - Drums

Drums consist of a spool and flanges, which are welded together.

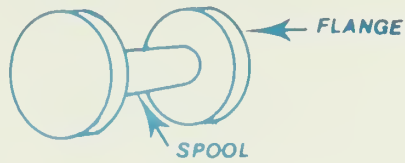

### DRUM PARTS

Some drums have lagging bolted on the spool to insure proper spooling of line.

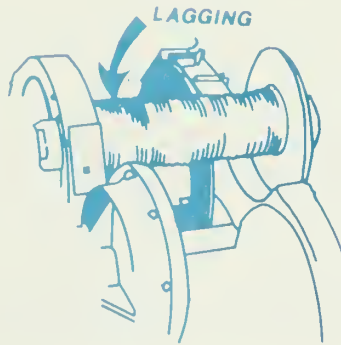

### DRUM WITH LAGGING BOLTED TO THE SPOOL

If drums are narrow and deep, there is a considerable loss in line pull and increase in line speed as the drum fills up. Wide, shallow drums minimize the change in line speed and line pull as lines wind and unwind. The ratio of flange height to spool length is an important consideration in interlock design.

A level wind, similar to that on fishing reels, is used on balloon yarder drums to assure proper line spooling because of the high line speeds involved.

### 46.15a - Drum Brakes

Drum brakes are either band or disc. Water cooled disc brakes are quite common on recent yarders and air cooled caliper disc brakes are used on a few yarders. They facilitate riding the brakes to tight line or to operate a Grabinsky running skyline, North Bend, etc., with minimal brake wear. Most yarders that have disc brakes also have band brakes. Extra braking power is needed in skyline operations to keep the turn

## 46.15b

suspended or partially suspended. Band brakes are more effective than disc brakes in holding a skyline in a fixed position. Antifreeze is required in water cooled brakes for winter work. Most yarders have two brake controls, a hand lever and a foot pedal.

Brakes can be mechanical or air operated. Mechanical brakes permit the engineer to develop a feel for the amount of brake being applied. With air operation brakes are either all on or all off, unless the operator is very skilled and even then the man has a problem. The difference between empty and loaded, light and heavy turns and hot or cold brakes all affect the feel.

Brakes may have to be adjusted five or six times a day to keep them running smooth. Mechanical brakes are adjusted with a screw. Pressure is adjusted on air brakes.

The main drum brakes on some older high lead yarders have to be beefed up if they are to be used to operate a flyer carriage. Different brake lining may be required.

### 46.15b - Drum Capacity

Drum capacity is discussed in Section 43.29a.

When figuring skyline requirements in sale layout planning consideration must be given to the amount of line needed to:

1. Make at least two wraps around the drum.
2. Go from the drum through the tower fairlead and back to the ground.
3. Span the slope distance from the tower to the tail hold.
4. Go from the ground through the tail tree shoe, or sheave, and back to the ground.
5. Reach to the skyline anchor.

At times the skyline can be extended to permit anchoring at a distance exceeding the drum capacity. See Section 43.5 for a discussion.

When it is planned to extend the skyline for long yarding distances, the mainline and haulback drum capacities must be checked.

### 46.16 - Fairleads

Fairleads are mounted on a sled yarder or steel tower to permit a change in direction of a running line. They also prevent the lateral or vertical movement of a running line.

The most common fairleads in logging practice have rollers or grooved sheaves.

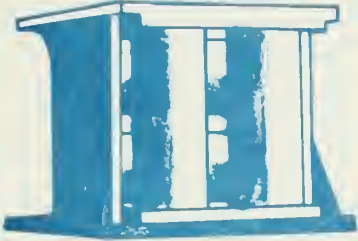

ROLLER FAIRLEAD

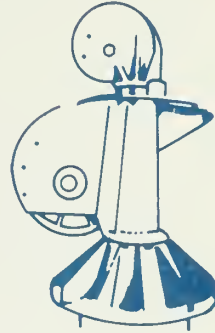

FAIRLEAD WITH GROOVED SHEAVE

Fairleads have a direct effect on line life. Roller fairleads provide very little support. They have a small diameter. Under a strain, lines experience internal friction as the strands tend to flatten against the roller.

Grooved fairleads on sheaves of adequate diameter give the best line life. See Section 43.35 for the strength efficiency of lines that are bent around sheaves of various diameters.

Some fairleads are self-aligning to permit changing the direction of running lines without moving the yarder. This reduces line wear as lines stay in the groove when the lead is changed. Fairleads on steel towers are self-aligning. Self-aligning deck mount fairleads are used on the front of sled yarders to control the direction of pull on the sled when the yarder is moved across country under its own power.



SELF-ALIGNING DECK MOUNT FAIRLEAD

The strawline can be run through the self-aligning deck mount fairlead when roads are rigged up or changed, or it can be run through a separate self-aligning fairlead like the one below.

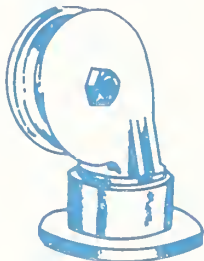

#### FLANGE MOUNT FAIRLEAD

Banjo fairleads are adapted to the top of a steel tower after the haulback fairlead has been removed. This fairlead serves a skyline that is wound on a single drum, and permits a two drum yarder to operate a standing skyline. Since a single drum can spool considerably more skyline than a standard yarder (+ 5000' to 7000' of 1½' line), use of a banjo fairlead facilitates yarding a longer skyline road. It also permits positioning the single drum so that the angle of the skyline to the horizontal is approximately the same on both sides of the tower. This minimizes the horizontal force on the tower due to loads on the skyline.

The banjo fairlead has an aluminum sheave to reduce skyline wear.



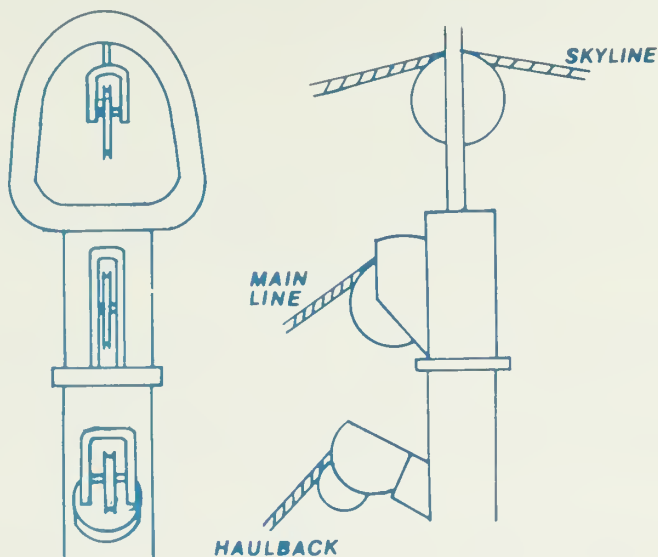

BANJO FAIRLEAD

### 46.17 - Yarder Operation

Proposed line sizes must be compatible with the yarder, tower, carriage capability and manufacturer's recommendations for line sizes, rigging and guying.

When high leading with a slackline yarder, the skyline is normally not used as the mainline unless the large line size is needed. The skyline drum speed is slower than the skidding drum and it generally is not interlocked with the haulback.

The strawline should not be proposed for use to convert a high lead yarder to a slackline yarder since:

1. The brake and clutch are not designed for the strain; they will slip under the load.
2. The drum is not positioned for pull, the shaft will bend, the flanges could spread.
3. The fairlead will not spool the line properly.

A logging specialist should have an understanding of the operations a yarding engineer has to perform to make the yarder meet the demands of various logging systems. Yarding systems that are difficult to operate can increase turn time and yarding costs.

## 46.17a

Yarder drums are controlled by frictions (clutches) and brakes. The friction connects the drum to the power source. When the friction is on the drum turns, when the brake is on, the drum is held in position. If the brake is off, and the friction is off, and there is no tension in the line, the engine can run and the drum won't turn.

### 46.17a - High Lead Operation

To operate high lead rigging, the engineer rides (engages) the friction on the drum he wants to wind up. He idles the drum that isn't winding (brakes and frictions are both disengaged). When neither line is moving both drums are idled.

To run a Grabinsky, or to tight line, the operator rides both the main friction and the haulback brake. The haulback brake is slipped enough to permit the yarder to go ahead on the mainline but is rode heavy enough to tension the lines and lift the butt rigging. This strains rigging, reduces effective (yarding) horsepower, pulls tail blocks, increases fuel consumption and wears out brakes.

An interlock facilitates tight lining or Grabinsky operation, by eliminating the need to ride the haulback brakes. There would still be tension on the corner block.

### 46.17b - Flyer Operation

#### To Outhaul

1. The skyline is tightened by disengaging the brake and engaging the friction. This takes the belly out of the skyline and provides clearance for the carriage. The skyline brake is engaged when the desired ground clearance is obtained.

2. The brake and friction are disengaged on the mainline to let the carriage roll down the skyline by gravity.

3. When the carriage approaches the turn, the brake is engaged on the mainline to stop the carriage and the skyline brake is slacked to lower the chokers to the ground.

#### To Inhaul

1. The skyline friction is engaged to tighten the skyline.

2. The skyline band brake is set to keep the turn suspended.

3. The mainline friction is engaged to wind in the turn.

4. As the turn approaches the landing the skyline brake is eased off to lower the turn to the ground while the main line friction is kept engaged until the turn is on the landing.

When yarding with a flyer up the side slope on the far side of a draw, the skyline can be tightened to get the carriage to the logs.

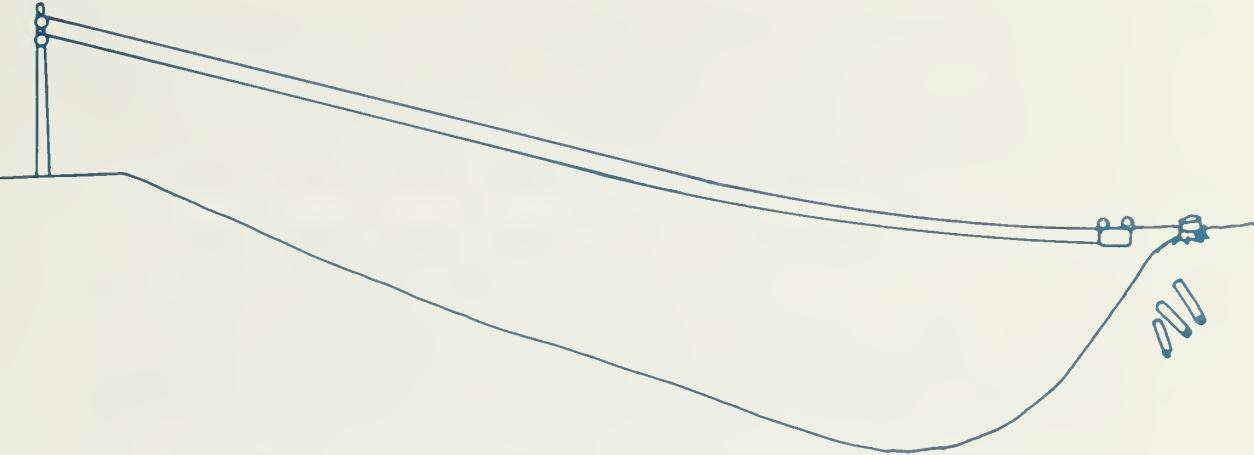

TIGHTEN THE SKYLINE TO REACH LOGS ACROSS  
A DRAW WITH A FLYER CARRIAGE

When the turn is yarded in the skyline has to be slacked to provide deflection to safely suspend the turn. This means the carriage and turn will coast back down the skyline to the belly when the turn is lifted free of the ground. The mainline has to be wound up rapidly as the carriage rolls toward the belly to keep it spooled properly on the drum. If the main line is crossed on the drum it will wear.

46.17c - Slackline Operation

To Outhaul

Steps

1. Engage the skyline (baloney line) friction to tighten the skyline.
2. Engage the skyline brake to hold the skyline in position during outhaul.
3. Engage the haulback friction to pull the carriage out to the woods. If there is a lot of skyline clearance the skyline brake can be eased to lower the carriage as it approaches the turn in the woods.
4. The skyline brake may have to be eased further to lower the chokers to the ground.

### To Inhaul (without an interlock)

The operator has to ride both the baloney and main frictions and the haulback brake (if the carriage will move down the skyline by gravity to the landing). When the skyline is up the skyline band brake can be dogged.

When going ahead on both the baloney and main lines, the engineer has to drop to a lower gear for the mainline as it takes more power to operate both drums simultaneously. This means slower turns. If the engineer wants to maximize deflection to bring in big turns the baloney line is raised in stages. The operator will have to shift down when lifting the baloney line and shift back when just pulling on the mainline.

It isn't physically practical to ride both baloney and mainline frictions and the haulback brakes in such a manner that turns can be yarded all the way in downhill with one end suspension. Ground slopes are such that the baloney line length would have to be constantly changed. This in turn would affect haulback braking. The variation in the power demand for the baloney line would affect the power to, and speed of, the mainline. This again would affect haulback braking.

It isn't practical to maintain a constant carriage clearance for one end suspension when yarding uphill. Variations in the terrain and the caterary curve of the skyline would require constant winding and unwinding the skyline. This would also affect line pull on the mainline as discussed above.

### To Inhaul with an Interlock

An interlock eliminates the need to brake the haulback to maintain tension in the mainline.

### Side Blocking With a Slackline

Running the carriage out when side blocking with a slackline is a slow operation. To keep the carriage in the air the engineer has to ride the baloney and skidding line brakes and go ahead on the haulback friction. To stop the engineer has to hit all three brakes at one time. This is done with a combination of foot pedals and hand levers.

46.15 discusses the problems involved in precision brake operations.

Bringing the turn in the engineer applies the baloney and skidding line frictions and rides the haulback brakes. When the turn is in the skid road the baloney line can be dogged when the desired carriage clearance is reached.

Effective side blocking is limited to about 100 feet. It is hard to spot the carriage as the engineer has to run three pedals (brakes) and the haulback friction simultaneously. If the carriage misses the spot desired by the rigging slinger other frictions have to be operated to reposition the carriage. This is generally too time consuming and the rigging slinger will pick up a turn wherever the carriage stops.

An interlock doesn't help during side blocking as the combined length of the haulback and mainline is increased as the carriage is pulled toward the tailblock.

#### 46.17d - Fall Block Systems (bight up or bight down)

The baloney line doesn't have to be slacked to place the carriage over the turn to lateral yard, therefore, wider roads can be logged. Roads up to 500' wide have been yarded by side blocking with a bight up system, but turn times are slow.

The rigging slinger still has difficulty spotting the carriage so that the fall block can be pulled over the logs desired for the turn.

An interlock doesn't help during lateral yarding, as discussed above.

#### 46.17e - Slack Pulling Carriage Operation

Like the fall block systems, these systems are easier to operate than a slackline as the skyline doesn't have to be slacked to get the chokers to the turn. The only time the engineer plays with the baloney line is when it is adjusted for deflection as the turns are brought in, or when it is raised to run the carriage out from the landing to the woods. Carriage positioning isn't as critical as with the fall block systems, as the lateral skidding line is manually pulled to the turn.

#### 46.17f - Skidder System

The inhaul and outhaul operations are simplified as the skidding and slack pulling drums can be locked together, therefore, the engineer really only operates two drums; the locked drums and the haulback. The baloney line is only adjusted for deflection as the turns are brought in or the carriage run out.

46.2 - Towers

Wood spar trees are still used on occasion. See Section 43.52 for comments on wood spars.

Towers are offered in lengths ranging from 45 to 120 feet. Some are fixed length and others telescope. Towers may be standard duty (for highlead) or heavy duty (for skylines). Usually, a seventh or eighth guyline is recommended for skylines. Guyline drums are considered part of the tower and the guylines and raising or hoisting lines are generally provided with the tower.

Some of the manufacturers provide the option of an underslung or third fairlead, on the tower for use with a shotgun, or flyer. Slackline yarders have a skidding fairlead located below the mainline fairlead.

Towers are designed for a given line size which should not be exceeded. Smaller line can be used but they aren't as well supported in the fairlead sheave grooves and will experience wear.

Truck road alignment may limit movement of yarder-towers because of yarder length and tower overhang. These limitations are discussed in a Reference in Chapter 100, FSH 2409.24, R-10. (Proposed)

46.3 - Undercarriages

Undercarriages for steel towers are designed for efficiency in yarding but they also have to be designed to meet highway loading and to traverse steep, narrow, winding logging roads. The larger the yarder and tower the more complicated the design. Some of the largest machines have to be equipped with jeeps and pups, or be disassembled to meet highway loading and to traverse winding roads. A loader or crane is needed to disassemble a yarder tower.

TRAILER MOUNTED UNDERCARRIAGE

State Safety Codes require that yarders be securely anchored to prevent movement during yarding.

Yarders come mounted on several different types of undercarriages for various reasons.

#### 46.31 - Trailer Mounted (TRLM) Undercarriages

These undercarriages cost the least amount of money, however, they require a log truck or highway tractor to move them any distance. They can be moved short distances by a crawler tractor if they are equipped with a fifth wheel dolly.

#### 46.32 - Self-Propelled Rubber Mounted (SPRM) Undercarriage

These undercarriages speed up moves to new landings, units or sales. They eliminate the need for a log truck or highway tractor to make the move. However, they cost more than TRLM or SPCM undercarriages. On long highway moves SPRM yarders can be pulled by a highway tractor to speed up the move.

Gradeability in the SPRM carriers is normally considered to be 25 percent and the minimum turning radius is approximately 50 feet. They have been moved on slopes up to  $\pm$  35 percent on occasion. A smooth grade with very little side slope is needed when moving a SPRM yarder tower off regular truck roads.

#### 46.33 - Self-Propelled Crawler Mounted (SPCM) Undercarriages

These machines are a little less expensive than SPRM but more than TRLM undercarriages. They are designed to facilitate short moves. However, a lowboy is needed to make long moves.

Early crawler undercarriages were surplus army tanks. Tanks really weren't the answer and most undercarriages are now built from crawler tractors.

#### 46.34 - Truck Mount

Some small yarders are mounted on rebuilt trucks. This provides the efficiency of easy moves and the economy of rebuilt equipment. Size is limited by the need to meet highway loading.

#### 46.35 - Sled Mount

Wood sleds are still used with yarders that have to be moved across country to swing landings. Sled size will vary with the size of logs being yarded. A sled for large old growth would have runners that are four feet to five feet in diameter at the large end (sled front end). The sled would be  $\pm$  12 feet wide and  $\pm$  60 feet long. Sleds have been used with both high lead and slackline yarders.

# WOOD SLED

One Builders Design

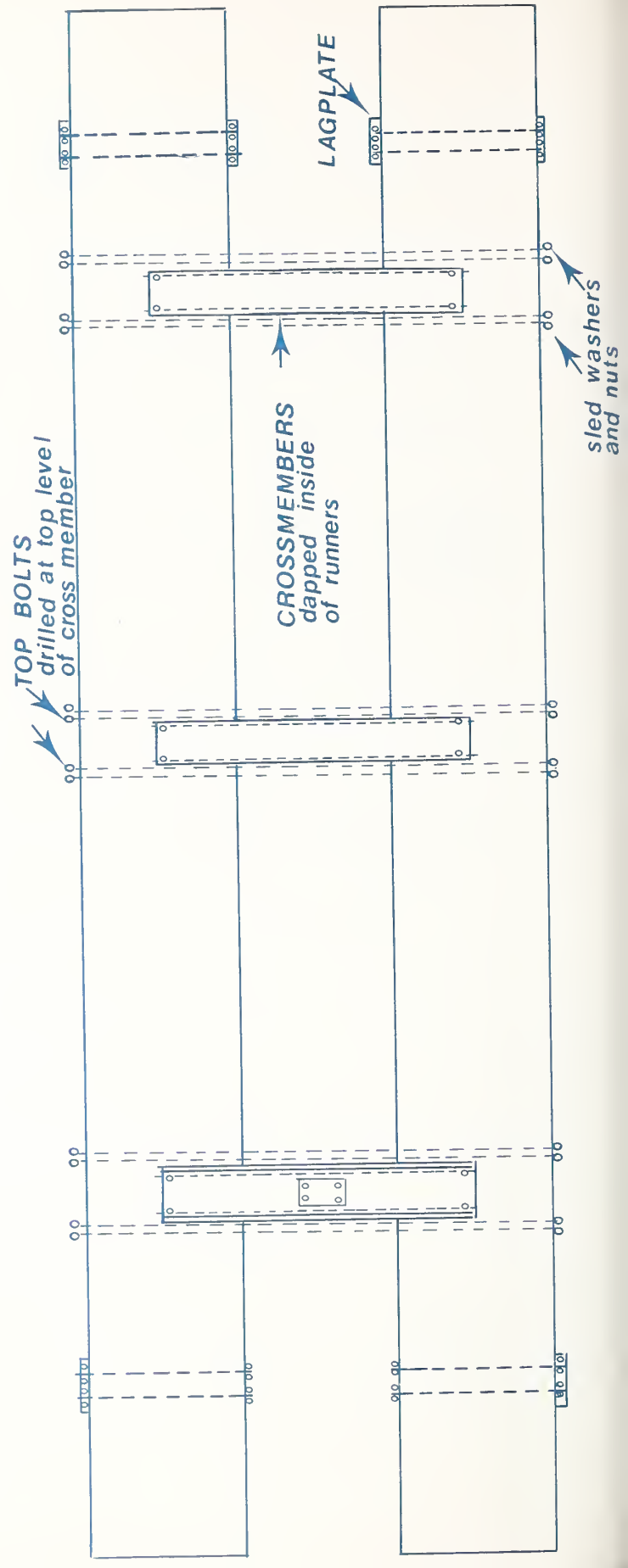
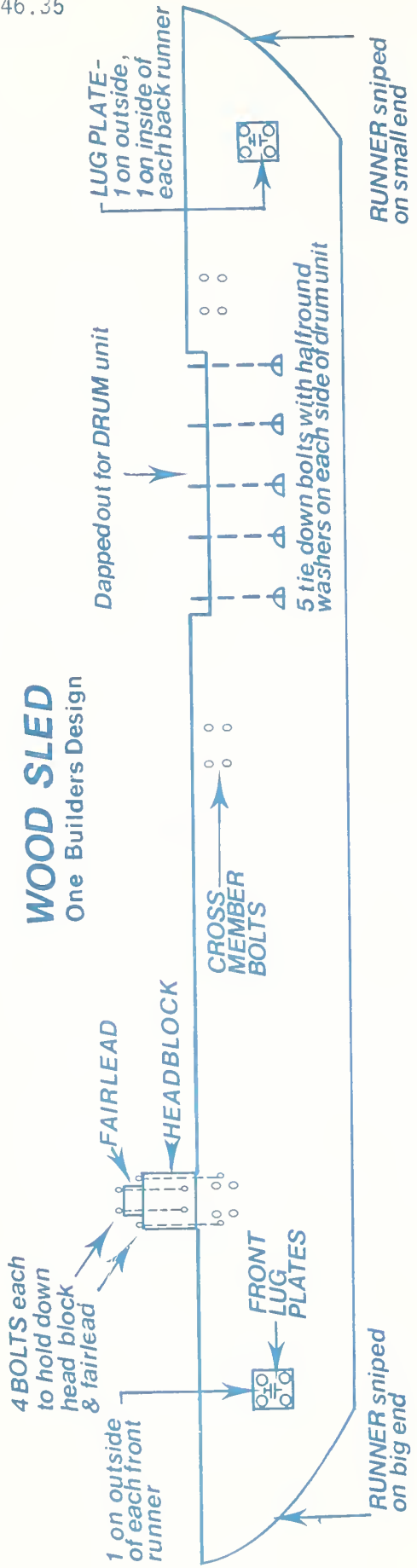



## 47 - Carriages

A skyline carriage is a wheeled device for yarding which rides back and forth on the skyline. A skyline-crane carriage is the same as a skyline carriage, but it also provides a means for slackpulling and lateral skidding to the carriage.

Following are some of the factors to consider when determining what carriage, or type of carriage, will meet the requirements of a proposed timber sale.

1. Is the carriage compatible with the size of the proposed skyline?
2. Will the carriage weight (including lines, if any) permit handling an economic pay load?
3. Does it have lateral yarding capability, if required?
4. Is it possible to pull slack for downhill yarding, if required?
5. Does it clamp to the skyline, or is it held in place by the haulback, if required?
6. Is a haulback required for operation?
7. Will the skidding line or chokers reach the ground?
8. Does it require a live skyline?
9. How many drums on the yarder are required for operations?
10. Does it require an interlocking yarder?
11. Will it pass over an intermediate support jack, if required?

Region 6's FSH 2409.22, Proposed Chapter 415.82, gives a description, specifications and price for the most commonly used carriages.

Skyline carriages fall into two basic classes: Clamping and nonclamping. This basic subdivision is needed to identify which method should be used to determine the load-carrying capability of a skyline.

### 47.1 - Clamping

If a carriage is to be used in a partial cut it is essential that the carriage be held in position during lateral yarding to minimize damage to the residual stand. This is readily accomplished with a skyline clamp. Clamps can be activated by radio, be applied manually or clamping can be accomplished mechanically with "stops" on the skyline. The skyline must be lowered to the ground to clamp a carriage manually. Manual operation increases yarding cycle time.

47.2 - Non-Clamping

Some slackpulling carriages (see Section 47.23) are non-clamping. They are held in position on the skyline by the haulback.

Flyer or shotgun carriages are non-clamping. They can come with extra wide (Tommy Moore) sheaves for passing over shackles that are used to fasten on skyline extensions.

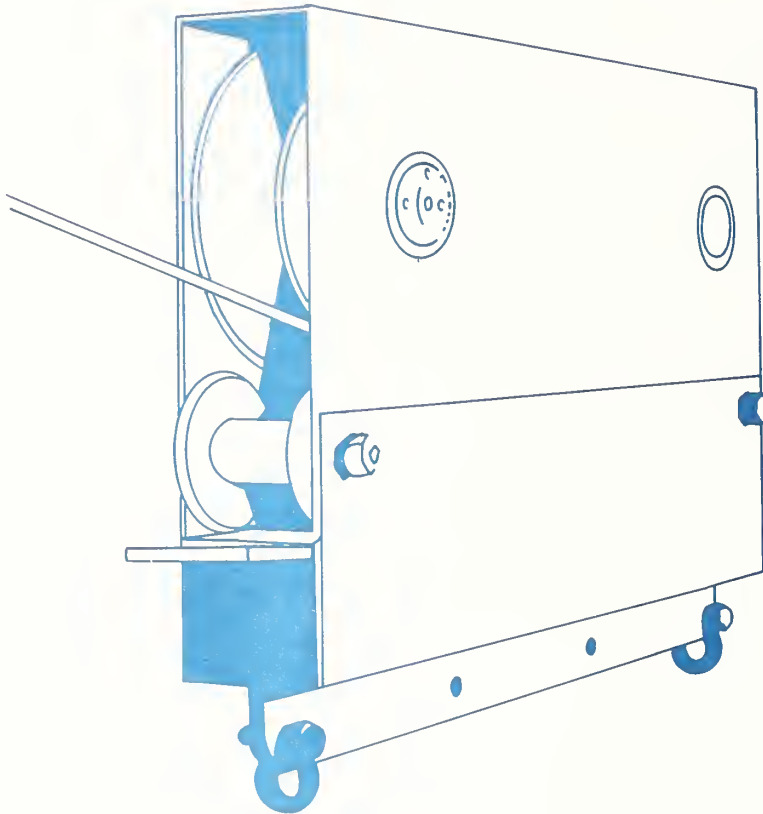

FLYER CARRIAGE WITH TOMMY MOORE SHEAVES

Flyer carriages are built by a number of manufacturers and can also be shop built. Four chokers are normally attached to the carriage. The yarder must have a live skyline drum, preferably one that will allow inhaul and raising the skyline at the same time. Lateral capability is restricted by the choker length. Yarding is uphill only.

Some operators like heavy (several kips\*) flyer carriages to provide fast outhaul and to facilitate landing logs by being able to overcome the weight of the skyline (putting a bight in it).

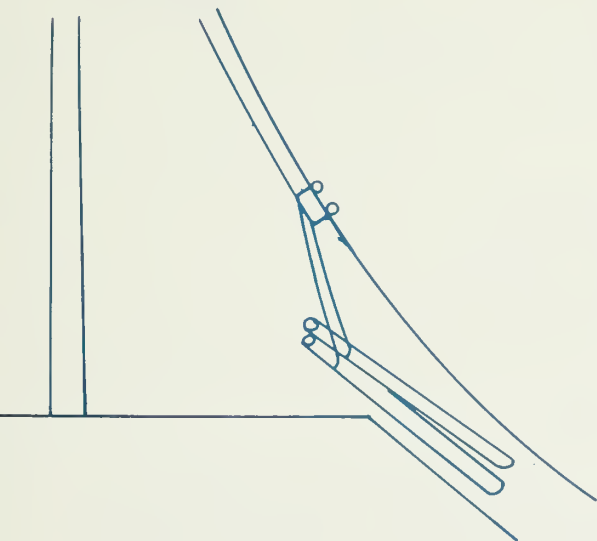

LIGHT CARRIAGE - NO  
BIGHT IN THE SKYLINE

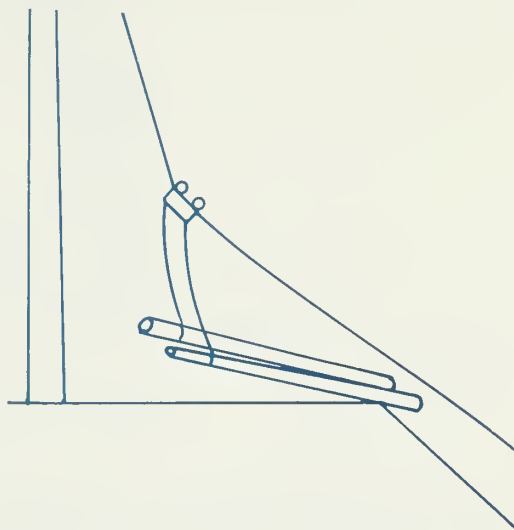

HEAVY CARRIAGE PUTS A  
A BIGHT IN THE SKYLINE

Other logging systems using non-clamping carriages are slackline, North Bend, South Bend, and other fall block systems. Both flyer and slackline carriages can be used with these systems.

\* 1 kip = 1000 pounds

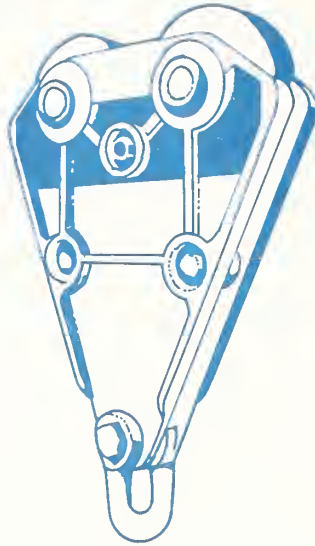

#### SLACKLINE CARRIAGE

##### 47.3 - Grapple, Non-Slackpulling, Slackpulling

Skyline carriages may also be classified as grapple, non-slackpulling, and slackpulling.

##### 47.31 - Grapple

The design of grapple carriages is similar to some of the mechanical slackpulling carriages in that they must provide a means to open or close the grapple. This can be done with a line from the yarder or by using an engine or power device in the carriage. The grapple carriage cannot yard laterally unless it is sideblocked; therefore, it is often classified as a non-slackpulling carriage.

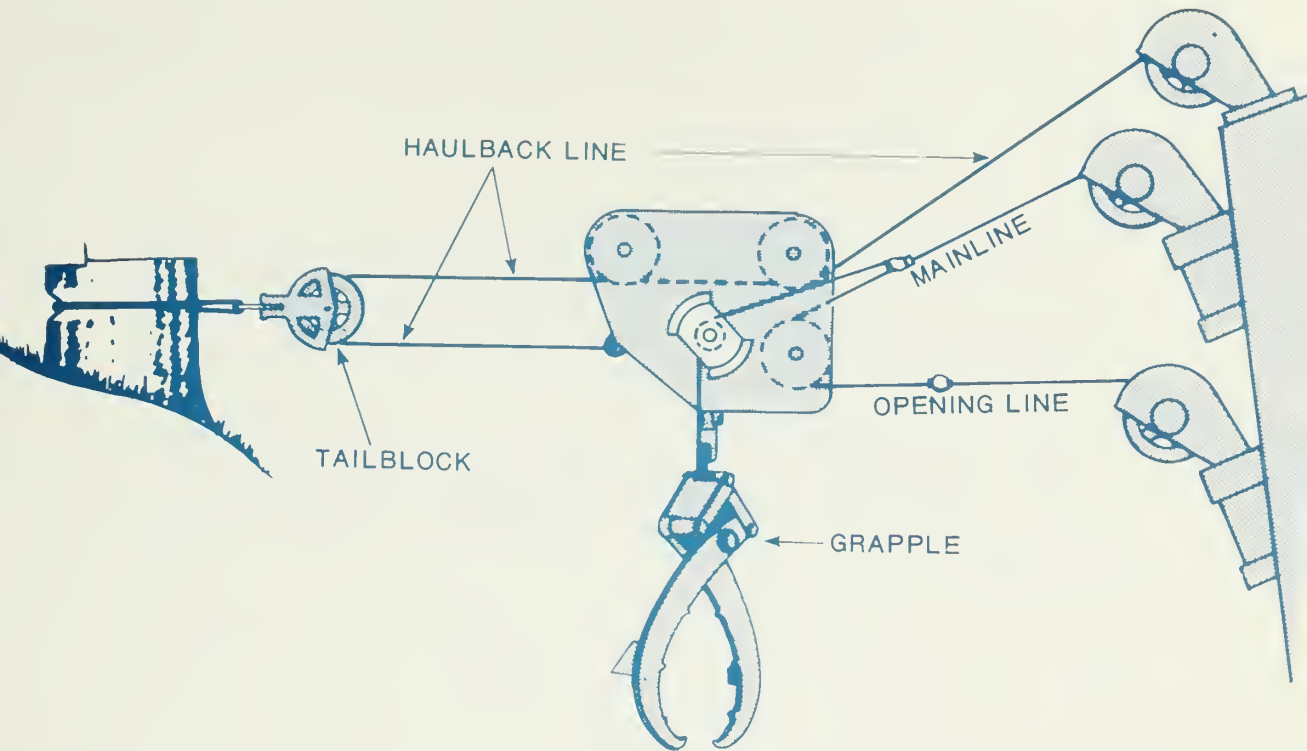

GRAPPLE CARRIAGE

#### 47.32 - Non-Slackpulling

This type of carriage has no means of allowing a skidding line to be contained in or pass through it. It may be moved laterally with a dutchman (See Section 48.41c) line or by sideblocking. The chokers usually are shackled directly to the carriage. Flyer (shotgun), slackline, fall block systems and grapples are examples of non-slackpulling carriages.

Non-slackpulling carriages, because of their inability to laterally yard without damaging leave trees, should only be used in clear cuts. Attempts to use these carriages in partial cuts in the past have had dismal results.

Fall block systems do yard laterally, however, the carriage isn't held in position on the skyline. Fall block systems damage leave trees in a partial cut when the turn is laterally yarded to the skyline. Also, in the case of the North Bend and South Bend, the mainline goes from the yarder fairlead to the fall block. This would create havoc with leave trees.

47.33 - Slackpulling

This type of carriage can have a self-contained skidding line or have the skidding line pulled through it either by hand or mechanically. The carriage may be further classified as to how the slack is actually pulled.

47.33a - Slackpulled By Hand

This type of carriage uses a two drum yarder. The mainline passes through the carriage and becomes the skidding line. The carriage, after it is clamped to the skyline, acts as a block through which the mainline is pulled by the man in the brush. A slack-kicker may be used on the yarder to help strip line from the drum. The carriage is usually manually clamped.

This type of carriage is limited to uphill yarding (using a gravity outhaul) as it is too difficult to pull slack uphill. It also requires a live skyline to lower the carriage to the ground. It is generally used on thinnings due to the difficulty of manhandling a heavy mainline.

ESTIMATE OF SLACKPULLING FORCE REQUIRED BY MANUAL SLACKPULLING CARRIAGE

NOTES

1. ENTER FIG.1 WITH % SLOPE AND COEF. OF CABLE FRICTION ( $\mu$ ) FOR  $C_1, C_2$
2. FIND "C"  
 $C = C_1 - C_2$  DOWNHILL PULL  
 $C = C_1 + C_2$  UPHILL PULL
3. ENTER FIG. 2 WITH "C" AND MAINLINE DIAM. (in)
4. GO TO FIG. 3 WITH SLOPE YARDING DIST. (L)

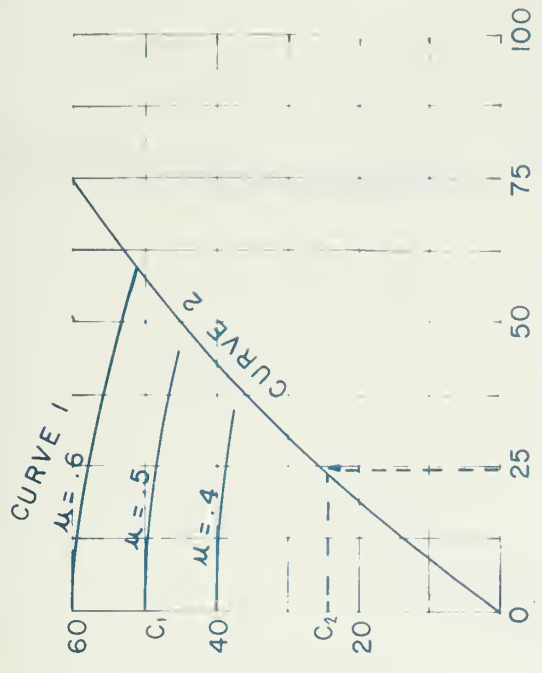

FIG. 1

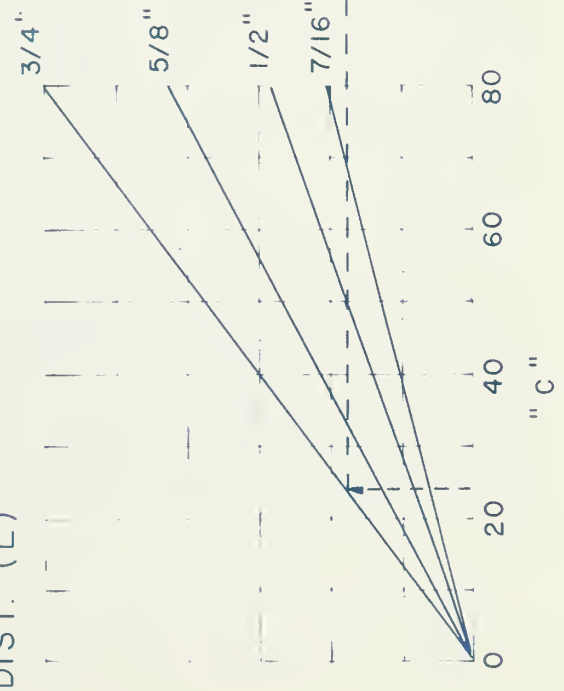

FIG. 2

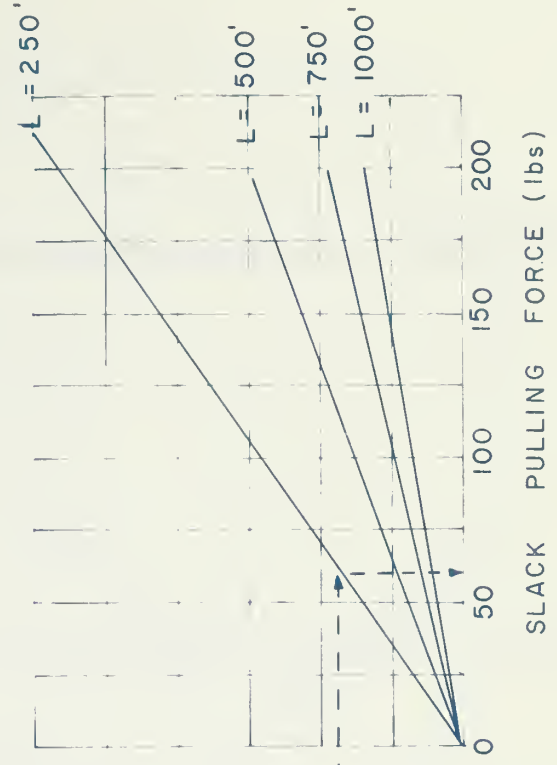
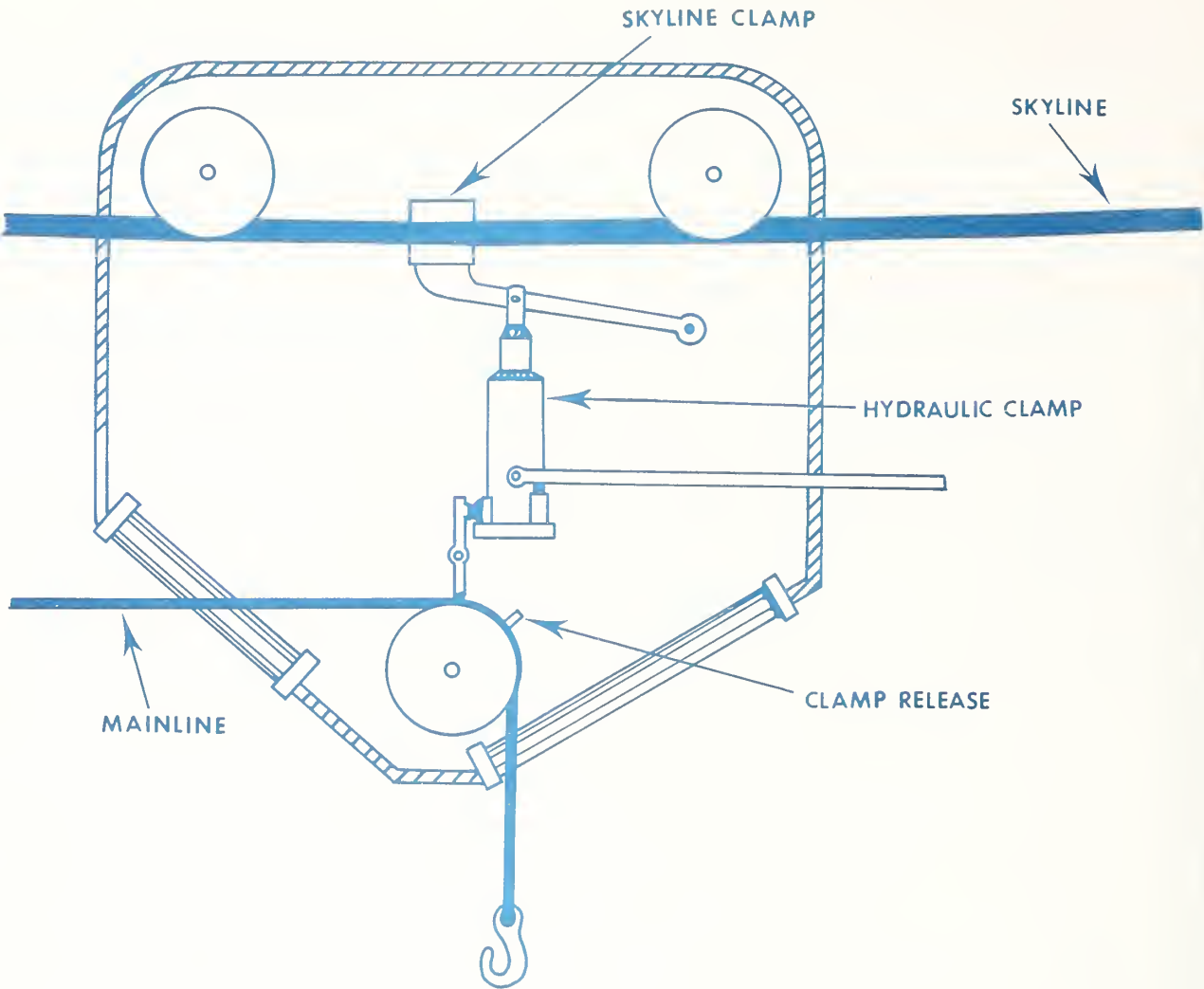

FIG. 3



MANUALLY OPERATED SLACKPULLING CARRIAGE

47.33b - Slackpulled By Yarder

This type of carriage is designed so that the slackpulling line from the yarder pulls the skidding line out of the carriage. The skidding line may be contained on a drum in the carriage, or it may be attached to the mainline from the yarder. The carriage may have a radio-controlled clamp or be held in position by the haulback.



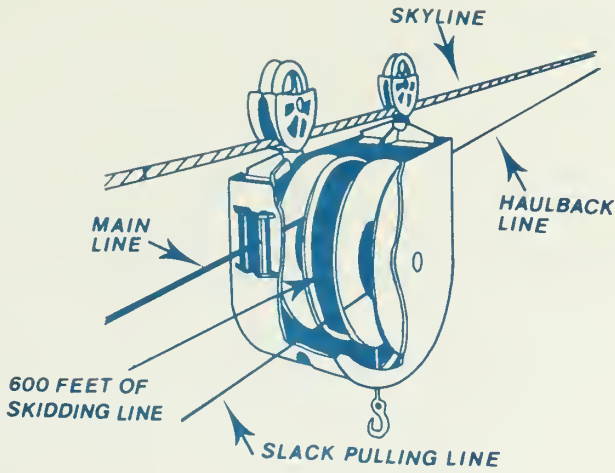

YARDER PULLS SLACK OFF DRUM IN CARRIAGE  
(CARRIAGE HELD IN POSITION BY HAULBACK)

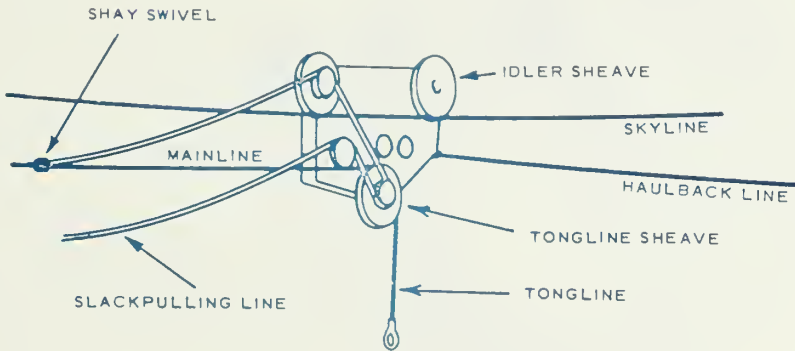

YARDER PULLS SLACK OFF MAINLINE DRUM  
(SKIDDER SYSTEM)

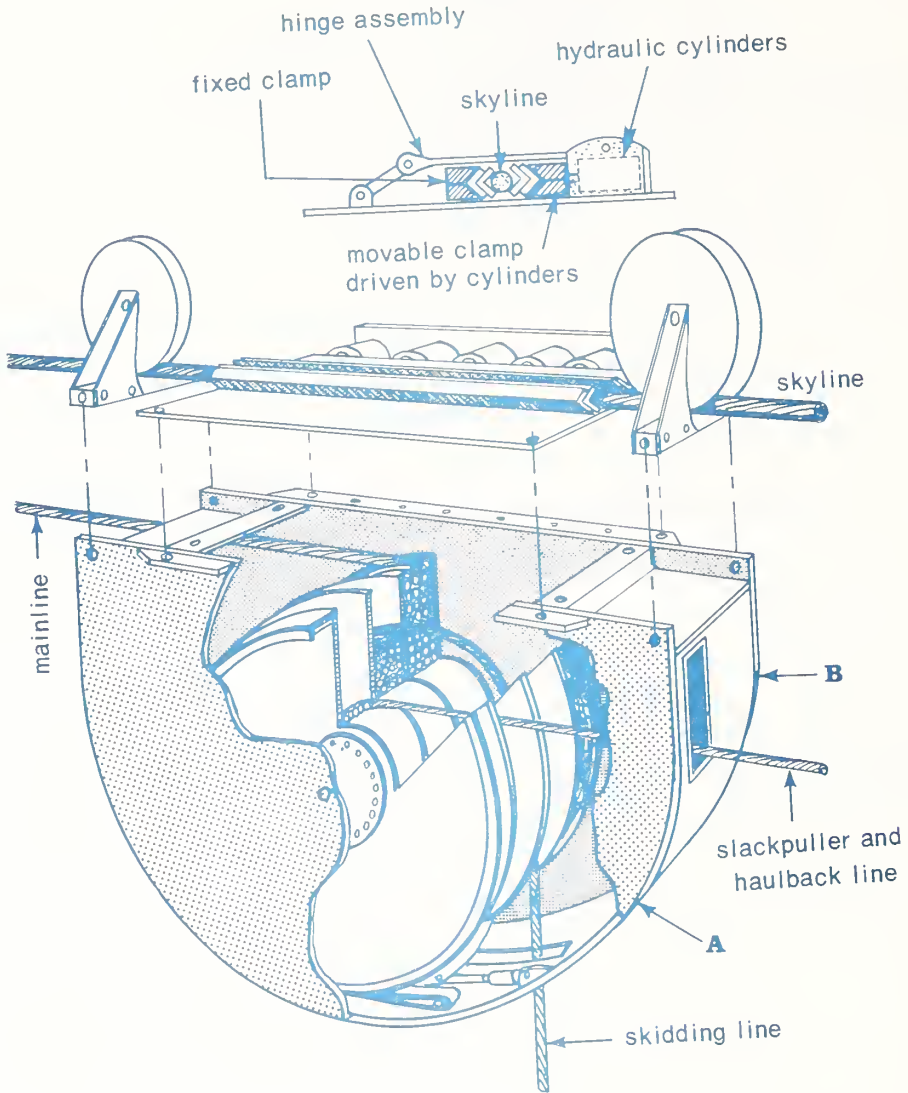

YARDER PULLS SLACK OFF DRUM IN CARRIAGE  
(CARRIAGE CLAMPS TO SKYLINE)

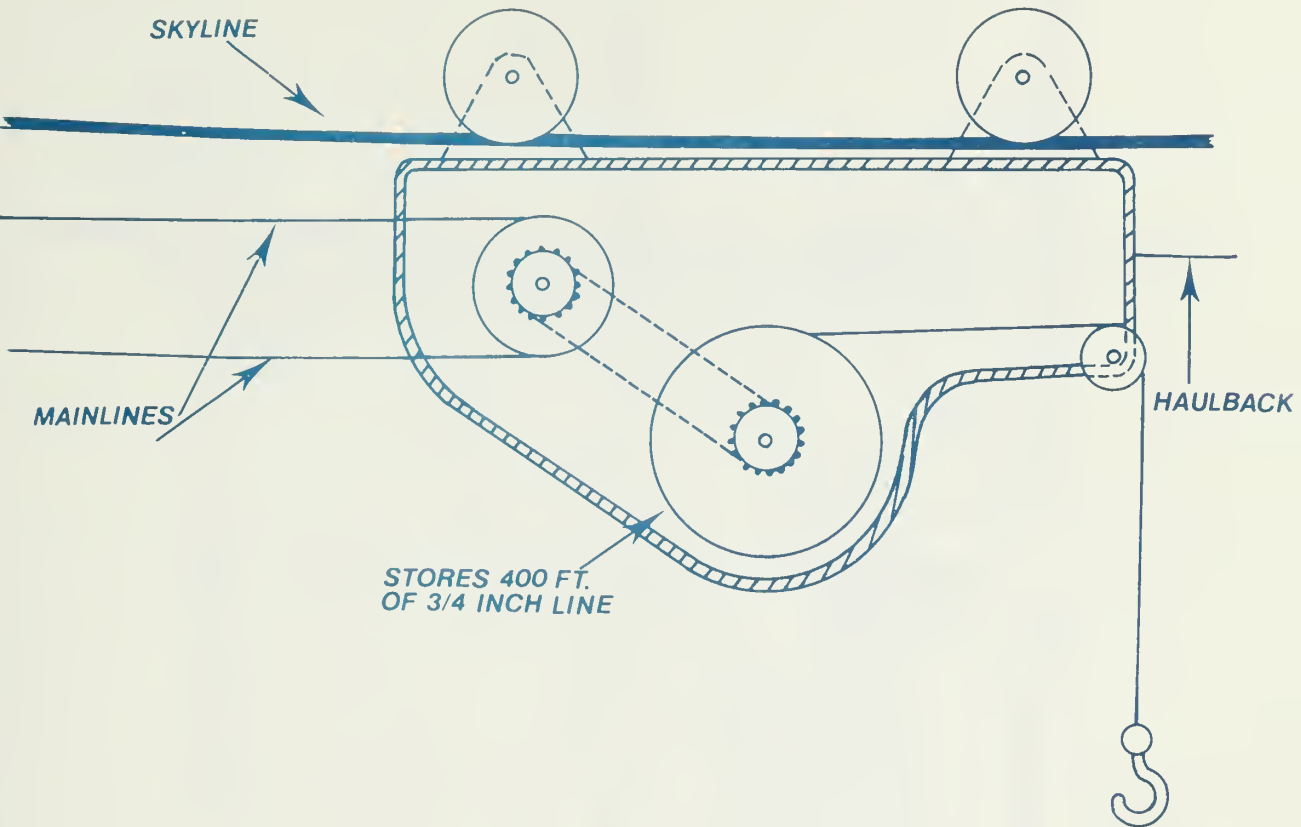

YARDER PULLS SLACK OFF DRUM IN CARRIAGE  
(CARRIAGE CLAMPS TO SKYLINE)

#### 47.33c - Slackpulled By Carriage

This type of carriage uses some type of power device in the carriage for pulling slack. The power may be in the form of mechanical springs, hydraulic motors, or diesel or propane-fueled engines. The carriage will clamp to the skyline and is remotely-controlled by radio or by mechanical springs.

If mechanical springs or a propane engine is used, yarding is limited to level or uphill, due to the difficulty in pulling the mainline uphill.

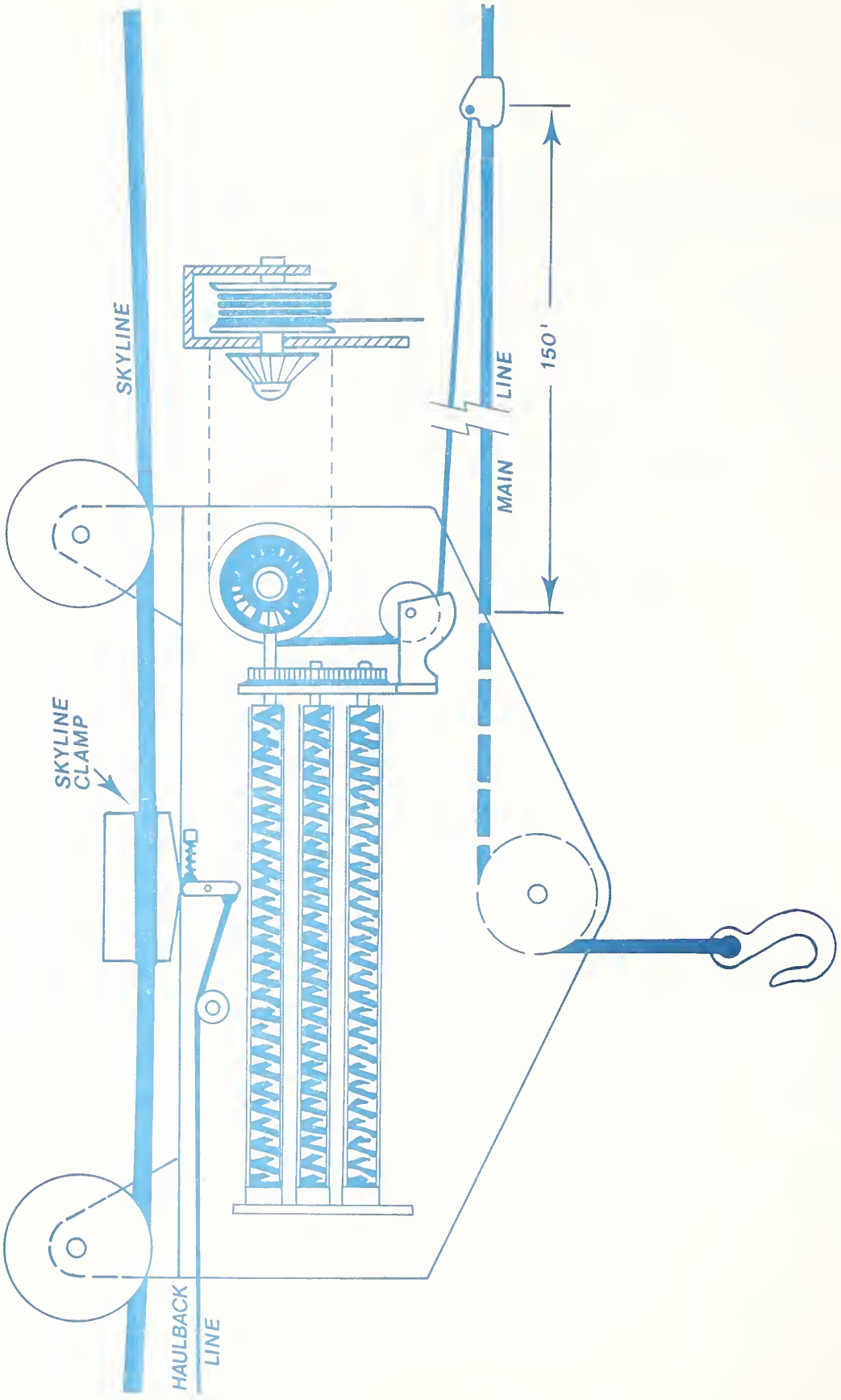

SPRINGS IN THE CARRIAGE PULL SLACK OFF THE MAINLINE DRUM

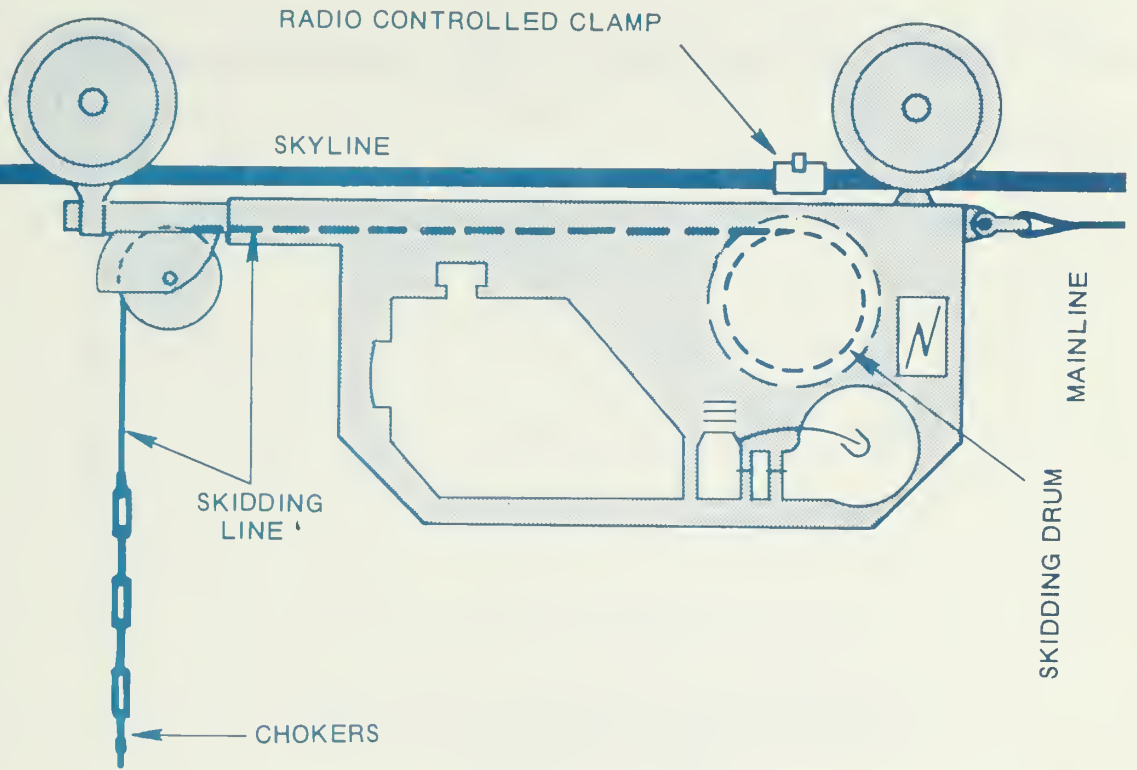

DIESEL ENGINE IN CARRIAGE OPERATES SKIDDING DRUM IN CARRIAGE

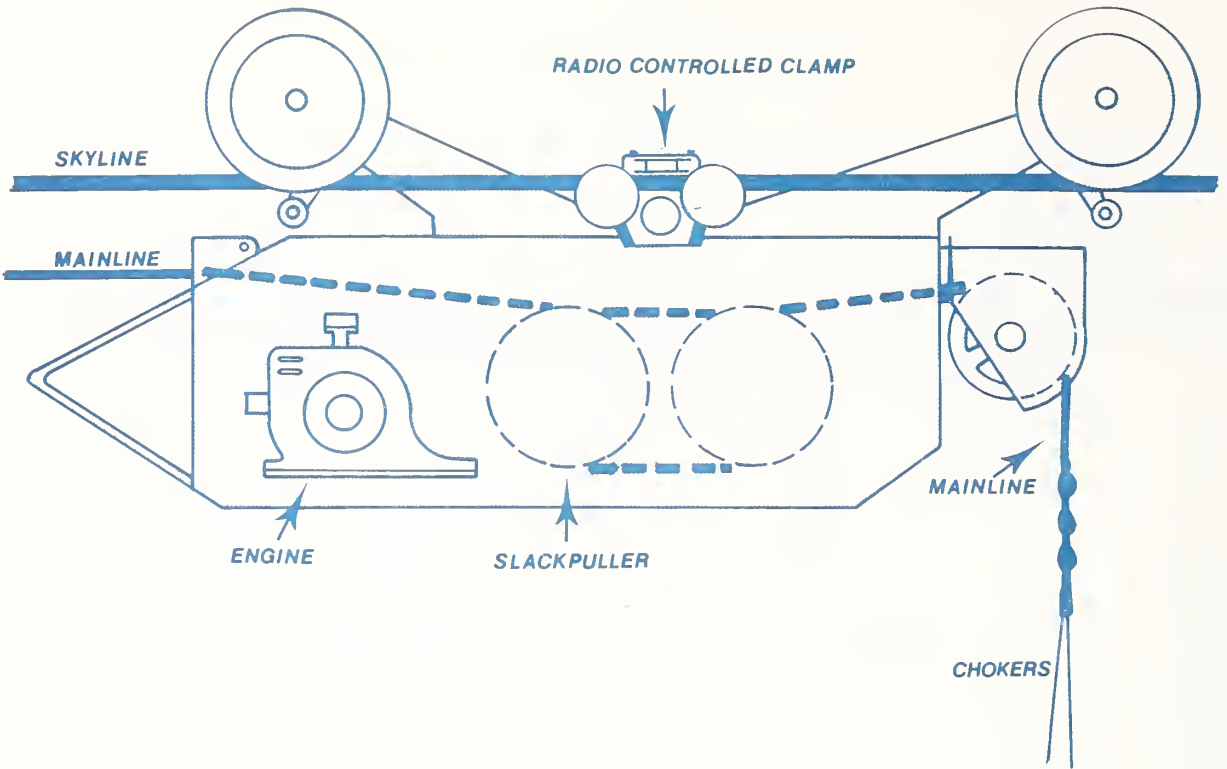

PROPANE ENGINE IN CARRIAGE PULLS SLACK  
OFF MAINLINE DRUM

## 48 - Types of Cable Systems

A brief description of the various rigging configurations for different cable logging systems are presented in this Section. A description of each is accompanied by illustrations of that cable system. It would be impossible to show all of the cable systems that have been used. Most are variations of a basic rigging configuration. Therefore, only the basic or more common cable systems are described, beginning with the relatively simple single-drum jammer with tongs, and progressing to the more sophisticated running skyline and balloon systems.

See the Chapter on constructed appraisals in FSH 2409.22 for a discussion on yarding production, crew size, logging equipment and logging costs.

### 48.1 - Jammer

#### 48.11 - Introduction

Jammers were developed in pine country to yard short distances. Many of them are shop built. They come both with, and without a haulback.

#### 48.12 - System Description

The jammer sits on the road. Tongs are used to yard in the logs. There are four ways of getting the tongs to the woods.

1. The tongsetter can pull the line from the yarder out to the log. A mechanical slackpuller may be mounted on the boom to aid in pulling slack.

2. The tongs can be "thrown" out by swinging the boom back and forth and releasing the brake on the skidding line drum at precisely the right moment.

3. A tight line can be rigged between the yarder and a stump. The tongs are then slid down the line to the tongsetter. This is sometimes referred to as "clotheslining". The haulback can be used as the clothesline.

4. The tongs are yarded out by a haulback.

The yarder is either a:

1. A single drum mobile loader used for yarding with 5/8-inch to 3/4- inch skidding line, or

2. A two-drum yarder with 1/2-inch to 9/16-inch mainline and 1/2-inch haulback line.

# JAMMER WITH WOOD BOOM

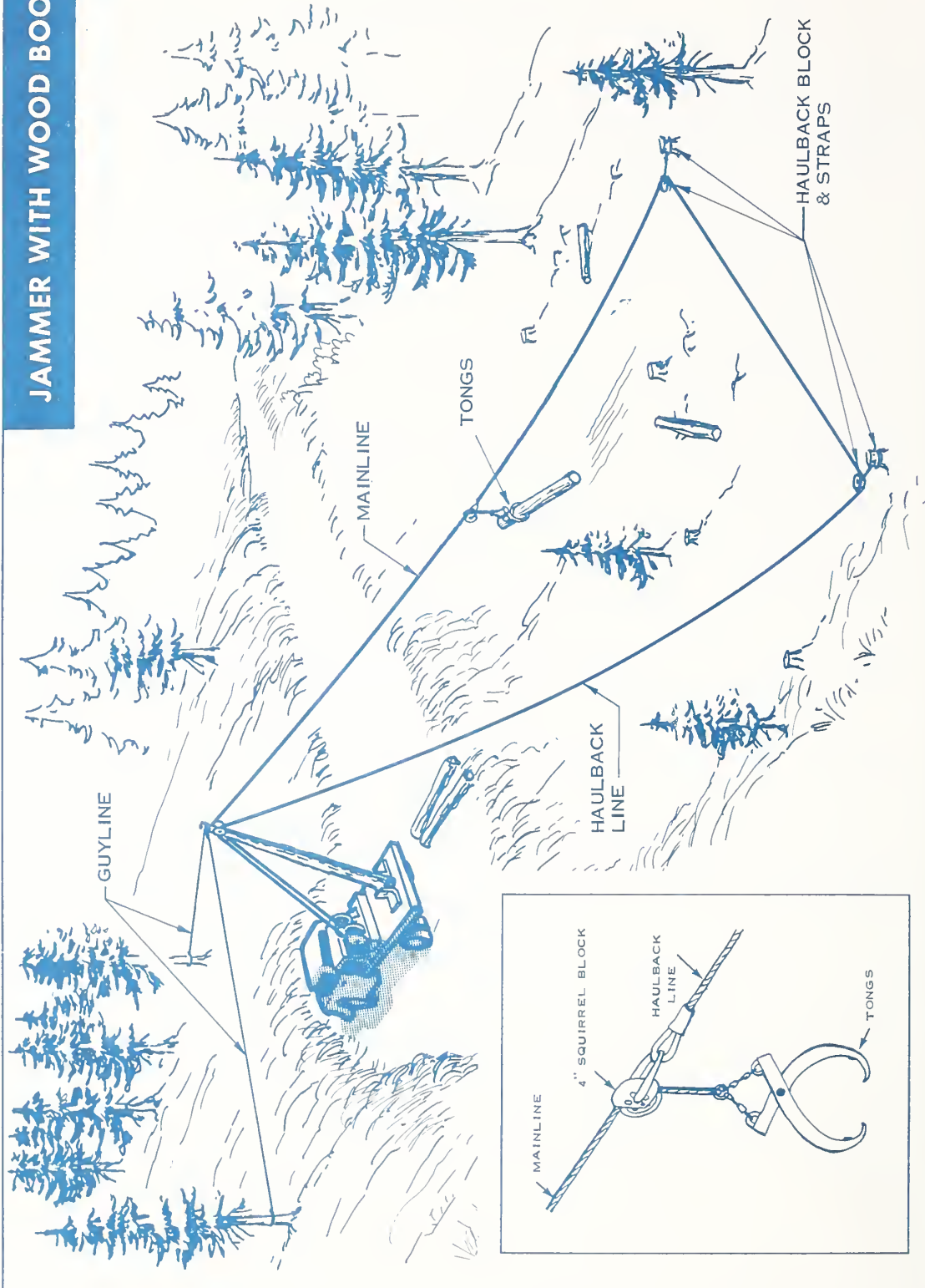



SHOVEL LOADER JAMMER



## 48.13

The tower structure can vary from a wood spar to a steel lattice tower, or boom, to a heelboom.

The undercarriage can be either rubber-tired or tracked, or the tower can be truck mounted.

### 48.13 - Requirements and Limitations

The system is limited to uphill yarding.

Without a haulback, maximum yarding distance is between 100 feet and 300 feet. With a haulback the maximum yarding distance is between 300 feet and 700 feet.

The two drum jammer is not recommended for partial cuts. Lateral yarding is limited to  $\pm 30$  feet due to the physical difficulty of manhandling the tongs. A 30 foot lateral yarding distance isn't adequate for a partial cut due to the high rig up costs and the damage potential to the leave timber. If the lateral yarding distance exceeded 30 feet, the lateral excursion of the lines would damage leave trees.

The yarder cannot brake the haulback drum to tight line the logs, therefore, the logs are yarded with a ground lead.

### 48.14 - Operation

The yarder requires a 10 foot to 12 foot wide truck road to operate. Landing space requirements would be in addition to this.

Skid road spacing is 200 feet to 300 feet without a haulback and 300 feet to 500 feet with a haulback.

If logs are yarded with a shovel loader, the yarder also loads out trucks.

A single drum yarder can operate in either a clearcut or a partial cut.

The crew consists of a yarder operator and a tong setter.

Production averages 80 to 120 pieces per day with a single drum yarder and 120 to 200 pieces with a two drum yarder.

### 48.15 - Advantages

1. Low investment and operating costs.
2. Mobility.
3. Suited to operator maintenance.

48.16 - Disadvantages

1. Short maximum yarding distance requires closely spaced truck roads.
2. Ground lead slows production, disturbs soil and results in hangups.

48.2 - Highlead48.21 - System Description

Highlead has been the most widely used cable yarding system in the United States. Highlead equipment comes in a variety of sizes, from the wooden-boom jammer to the modern steel tower and yarder. The system consists of a two-drum yarder, with an auxiliary drum used for rigging and a spar or tower.

The butt-rigging is hauled back to the woods with the haulback line. The chokers are attached to the logs. The logs are yarded to the landing with the mainline where they are unhooked.

The term "highlead" refers to the location of the mainline block which is elevated above the ground by the spar. The high block (bull block) provides the vertical lift which helps the logs to override obstacles. Conversely, in the "groundlead" system the logs either force their way through obstacles, are forced around them or the choker breaks.

In highleading the vertical lifting force depends upon:

1. The height of the mainline block. The higher the block, the greater the lift.
2. The ground profile from the spar to the log. The more concave the slope, the greater the lift.
3. The distance of the log from the spar. The greater the distance, the smaller the lifting force.
4. The braking capacity of the haulback drum which provides the necessary lifting force to tightline a turn. This may also be accomplished by interlocking drums.

The mainline size varies from 5/8-inch to 1½-inches; the haulback varies from ½-inch to ± one-inch. Strawline is usually 3/8-inch or 9/16-inch. The haulback line should be large enough to tight line the turn to lift the logs over obstacles.

Towers range in height from 23 feet to 120 feet. The taller towers are usually telescoping with six to eight guylines. The undercarriage may be tracked or rubber mounted; and self-propelled, or trailer mounted. The yarder may also be mounted on a sled.

On mobile yarders, the tower is a straight lattice boom or heelboom which, with the drum set, is mounted on a turntable. The undercarriage may be rubber tired or tracked. Two guys are used. Due to the short tower height there is very little lift to the logs.

HIGHLEAD

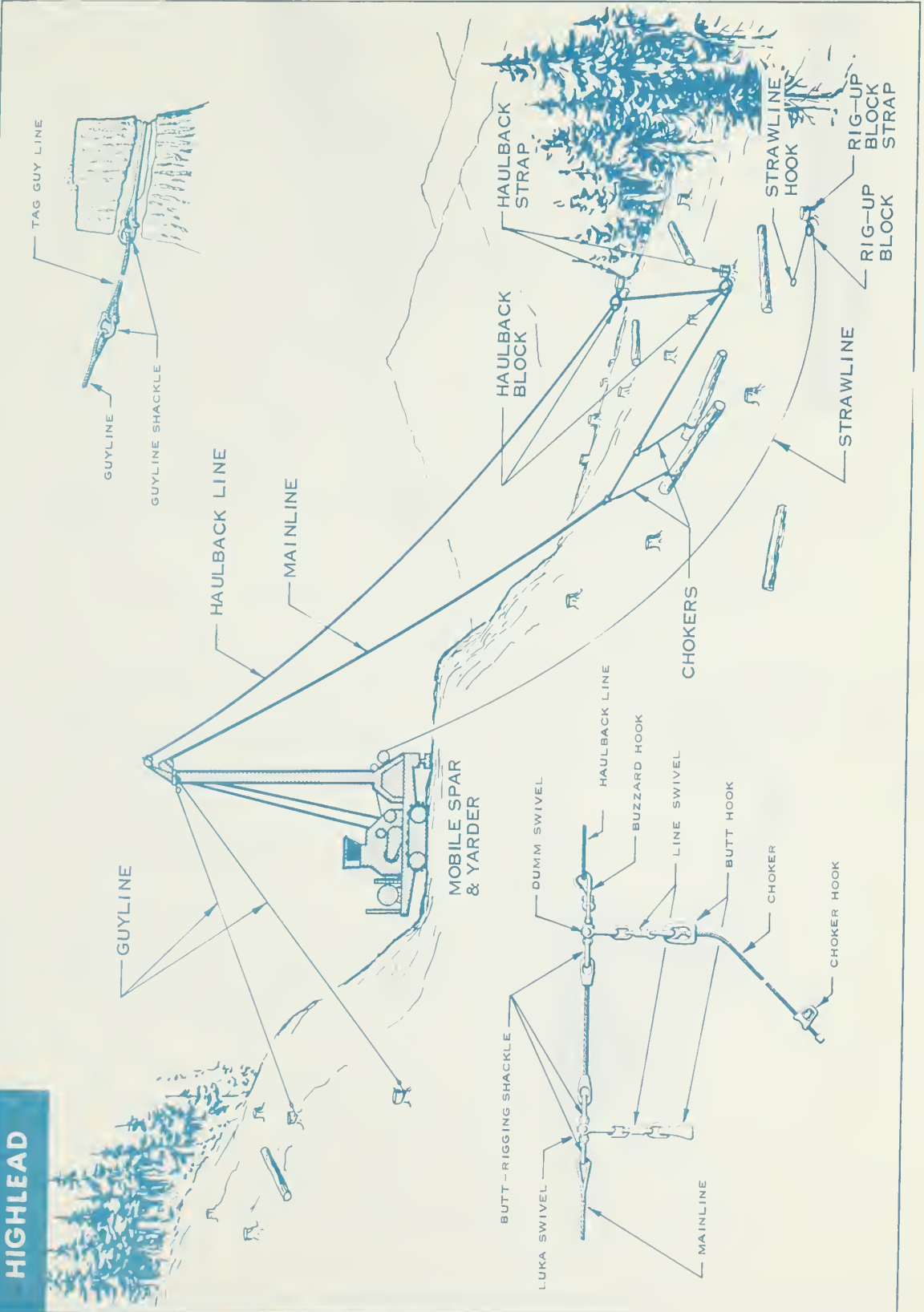

# MOBILE SHOVEL YARDER

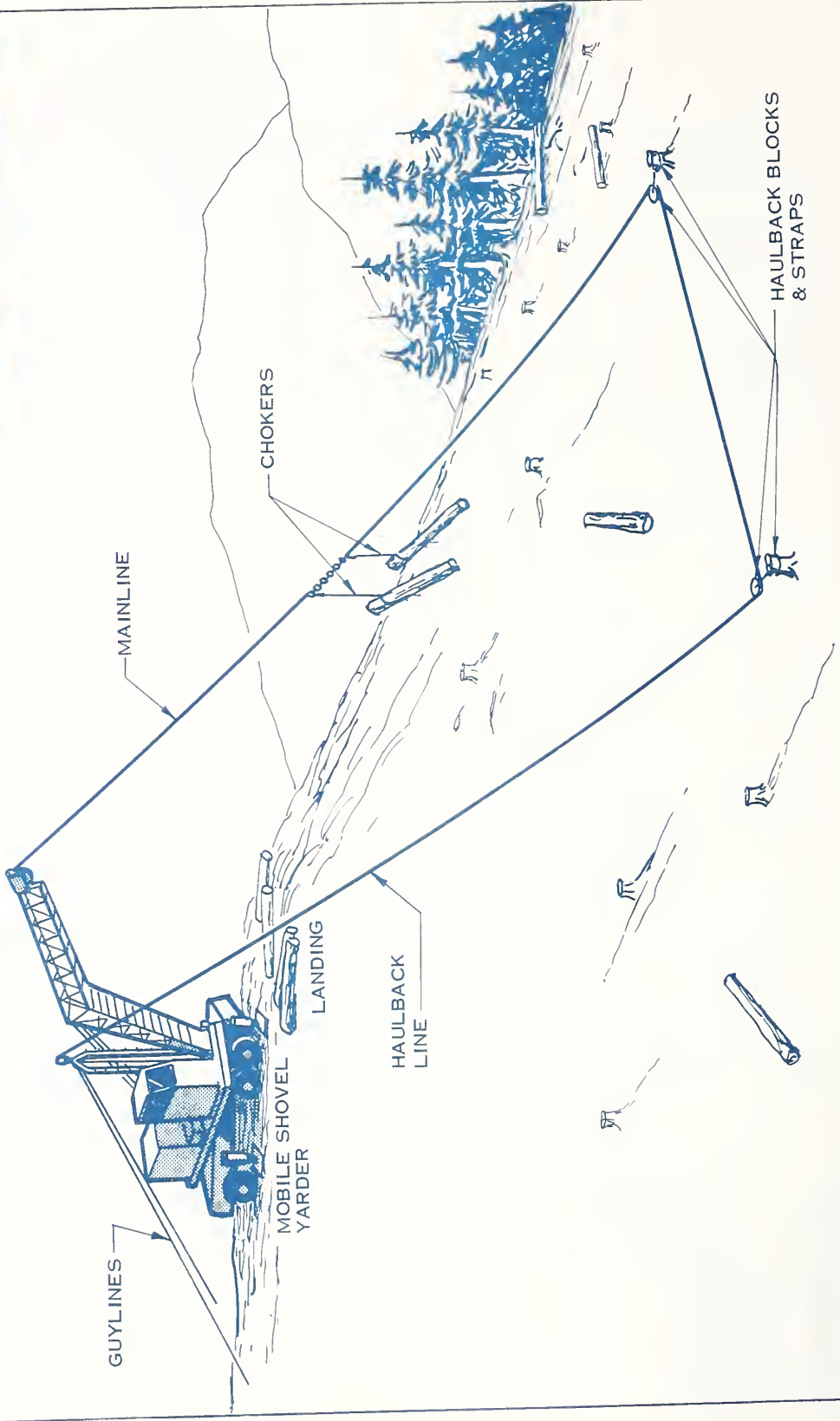

See Section 46 for further information on yarders, towers and under-carriages.

## 48.22 - Requirements and Limitations

### 48.22a - Cutting Prescription

High lead is primarily used in clear cuts because of the lack of ability to lateral yard and the lack of lift on logs distant from the tower.

High lead has been used successfully to yard in a shelterwood. Road changes are more difficult and the leave trees do get skinned up some. However, if the final removal cut is made in ± five years, there is little if any volume loss due to logging damage in the first cut.

### 48.22b - Direction of Yarding

High lead is most effective when yarding uphill due to the lift provided by the spar or tower. This lift helps logs to ride up over, or around stumps and other obstacles.

Sidehill yarding occurs when logs are pulled parallel to the contour. As the logs are moved they roll downhill, causing the chokers to lodge behind stumps. Closer landing spacing may be a solution to this problem.

Dwonhill yarding is possible, but requires the following for safety and economics:

a. An adequate landing area in front of yarder to assure control of logs around men and equipment. The area must be large enough for loose logs and debris to stop before reaching men and equipment. The size of the area depends upon the steepness of slope, direction of yarding and the size of the timber. See Section 42, Landings, for further information.

b. An adequate guyline angle opposite direction of yarding (Reference: State Safety Codes).

The distance capability for downhill yarding in any given situation will depend upon the ground conditions, but is usually 1/3 to 1/2 of the uphill capability. The following figure illustrates the hangups that may occur during downhill or sidehill yarding.

# HANG - UPS

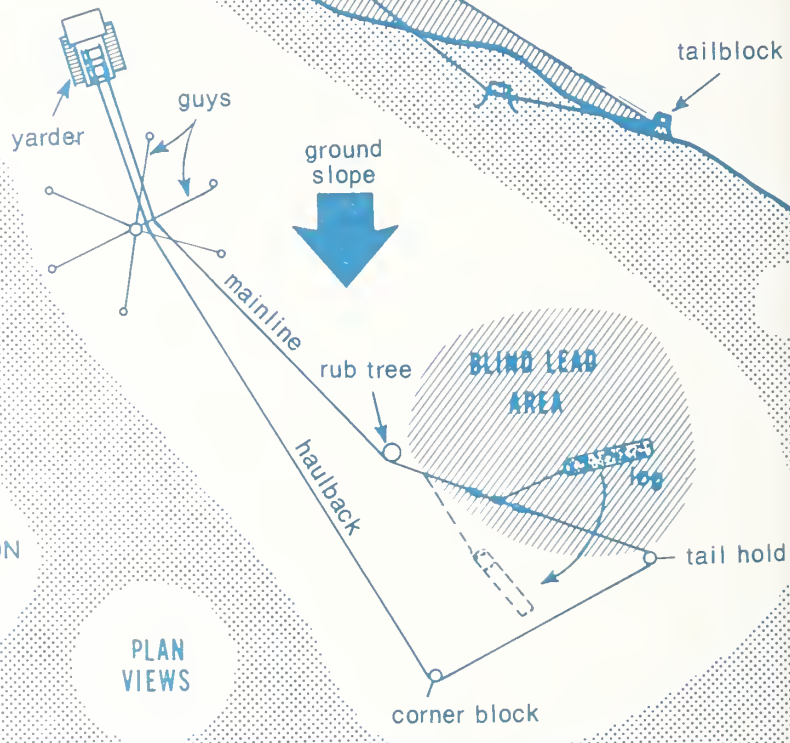
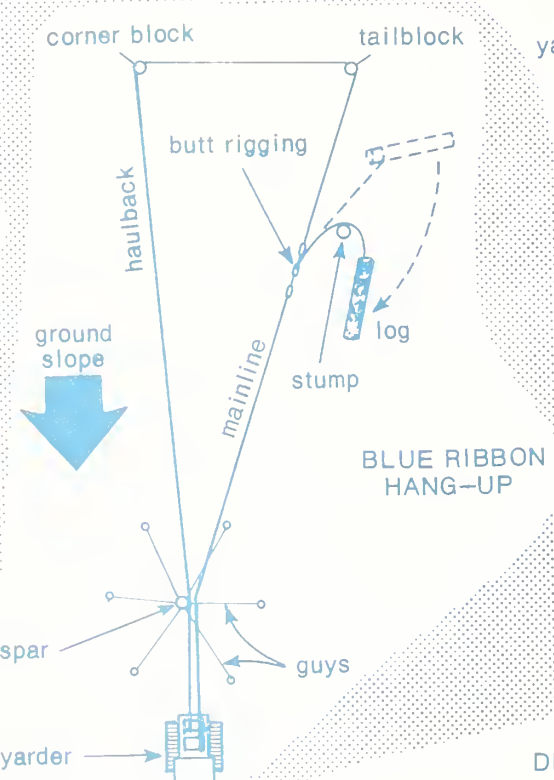
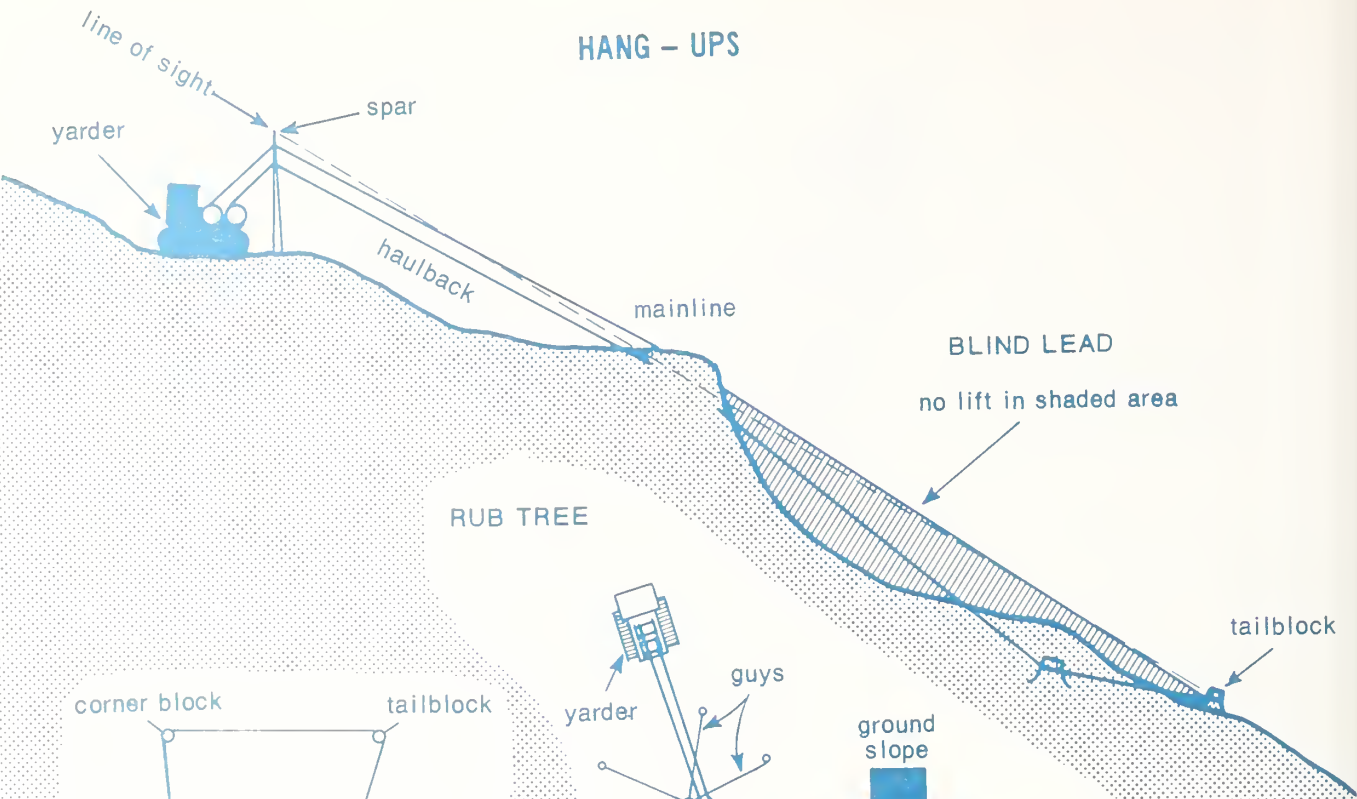

PLAN VIEWS

BLIND LEAD AREA

BLIND LEAD  
no lift in shaded area

RUB TREE

tailblock

ground slope

ground slope

ground slope

yarder

spar

haulback

mainline

corner block

tailblock

butt rigging

haulback

mainline

stump

log

ground slope

BLUE RIBBON HANG-UP

yarder

guys

ground slope

mainline

haulback

rub tree

BLIND LEAD AREA

tail hold

corner block

PLAN VIEWS

DEAD HANG-UP

corner block

haulback

butt rigging

mainline

stump

tailblock

log

yarder

guys

ground slope



48.22c - Topography

The ground slope on the skid road directly affects yarding distance regardless of the direction of yarding. A concave slope is most desirable as it provides the most deflection for lifting logs over obstacles. A convex slope results in a blind lead at a distance from the landing (see Figure below).

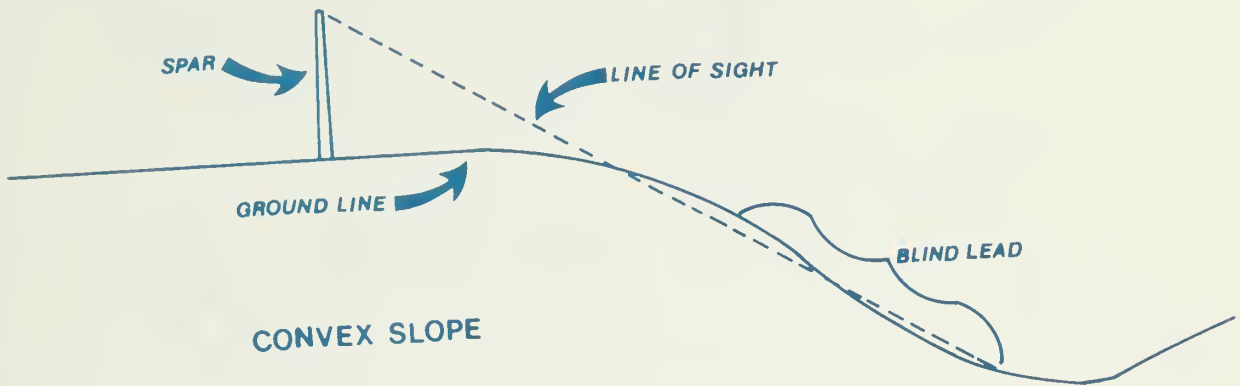
CONVEX SLOPE

A Grabinsky, or rider block on the haulback, can be used to facilitate lifting logs over obstacles if there is sufficient deflection.

### HIGH LEAD WITH RIDER BLOCK ON HAUL BACK

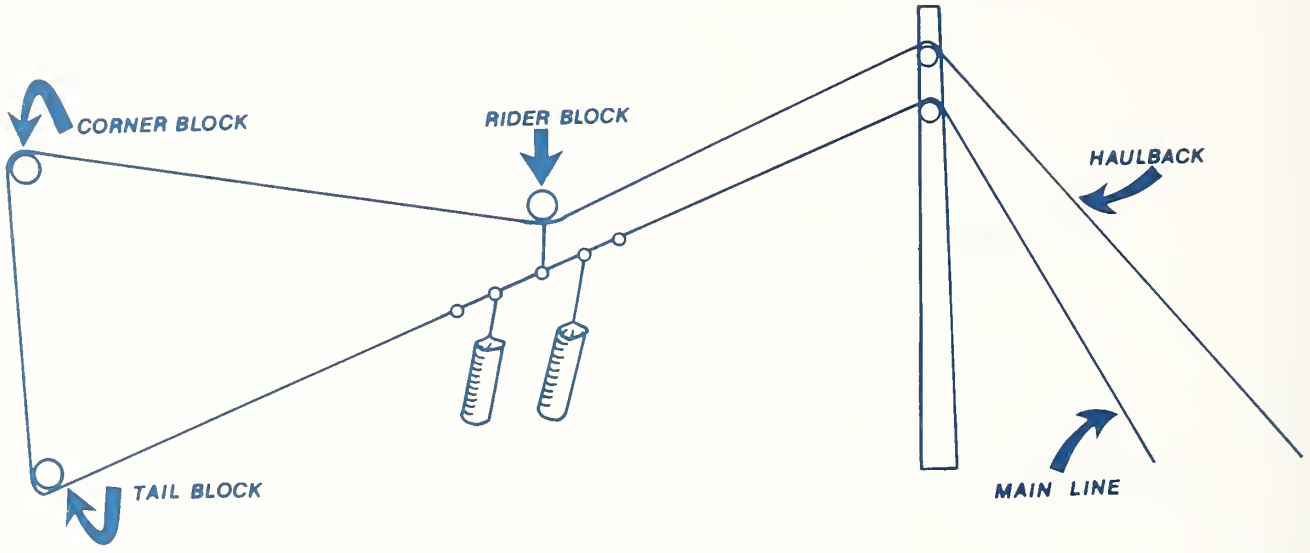

A taller spar or additional landings can sometimes be used to overcome blind lead problems.

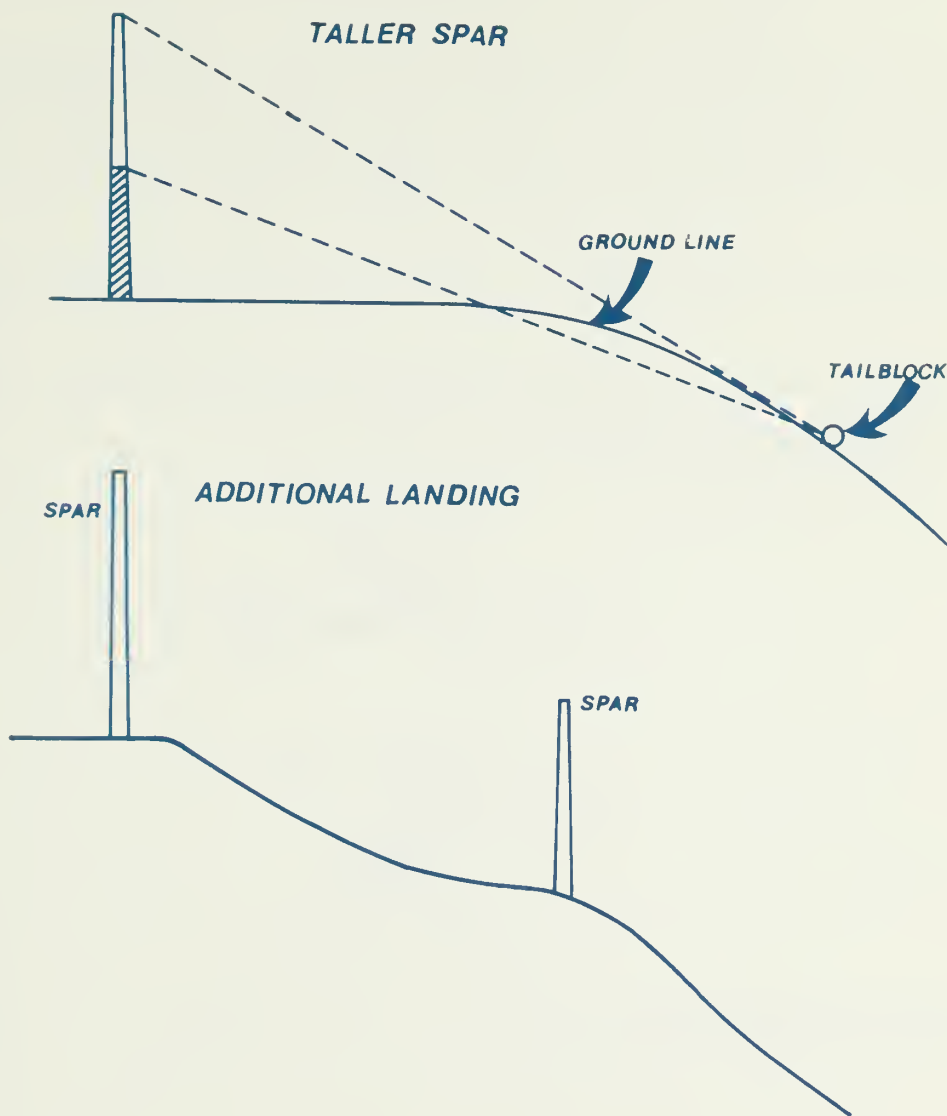

A TALLER SPAR OR ADDITIONAL LANDINGS MAY  
OVERCOME A BLIND LEAD

#### 48.22d - Yarding Distance

Large highlead systems can yard 1,200 to 1,400 feet; however, distance should be limited to 800 feet for good yarding production. Mobile yarders can yard 800 feet to 1,000 feet with a preferred distance between 500 and 700 feet.

The mobile jammer systems operate most efficiently at distances of less than 450 feet.

Yarding distance decreases sharply when blind leads (rock bluffs convex slopes, intervening ridges, etc.), sidehill yarding (every stump a potential hangup), or larger timber are encountered. Several profiles should be run through each unit to check deflection.

Blind leads create a ground-lead situation causing trenching and concentrating runoff water which will carry soil into streams.

Yarding distance is also limited by the drum capacity of the yarder. See Section 43.56 for a discussion on yarding beyond drum capacity.

Downhill yarding capability is dependent on ground conditions, but is usually  $1/3$  to  $1/2$  of the uphill capability.

Since less time and cost are required to move and rig a steel tower, the landings may be spaced closer than for wood spars.

#### 48.22e - Soil

The tower or spar normally doesn't provide lift to the logs at a distance greater than approximately three times the height of the spar.

The impact on the soil, created by high lead yarding, depends on many factors, such as log size, volume per skid road, soil series, etc. Topography stable enough for uphill yarding may not be stable enough for downhill high lead.

The following figures illustrates the affect of the direction of yarding on surface water runoff.

**DOWNHILL YARDING**

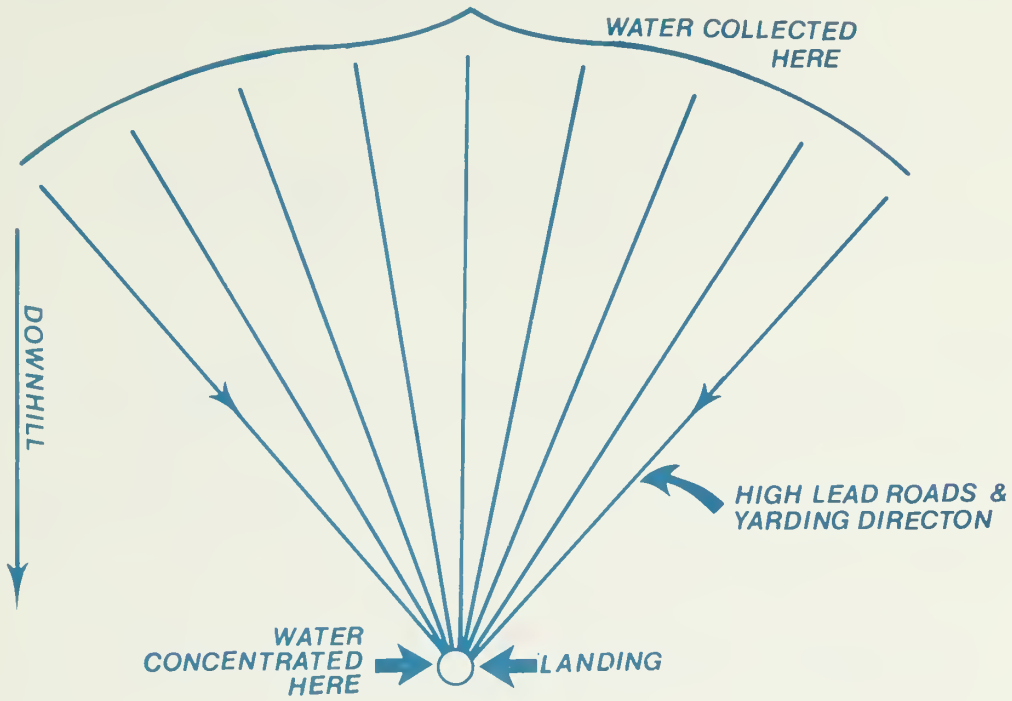

**UPHILL YARDING**

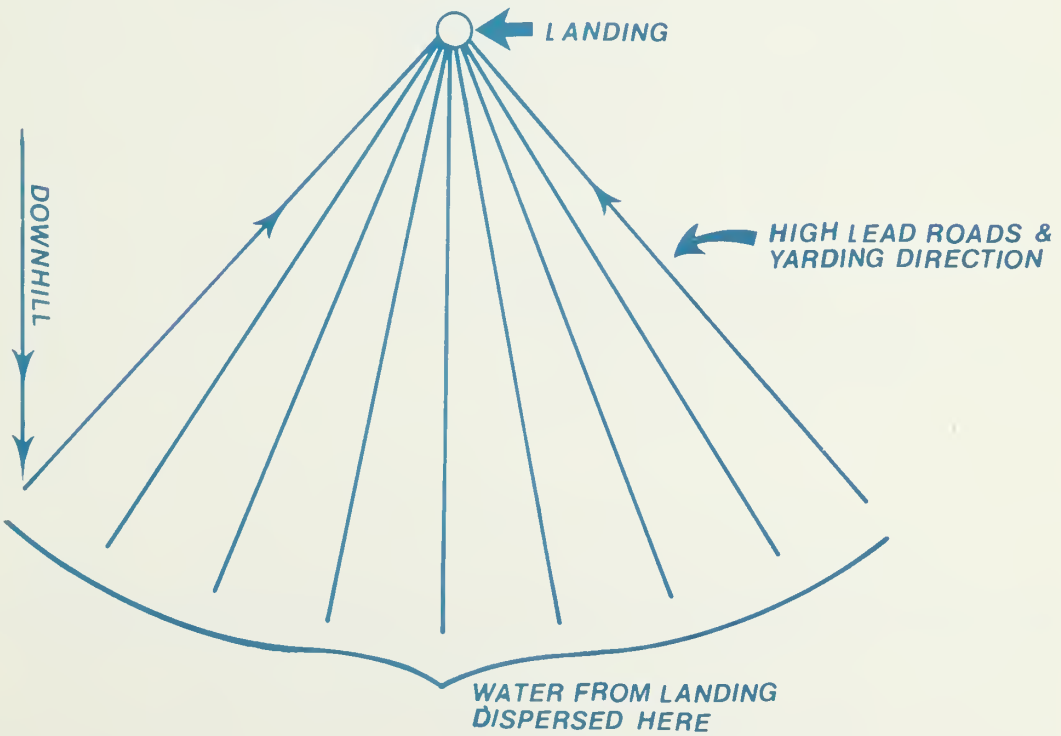

**EROSION HUB**

48.23 - Operation

Lateral yarding is limited by the length of the chokers.

Fire hazard is great because the haulback line frequently is on the ground and line speeds are great.

Crew size varies with the size of the equipment. A regular high lead side has five or six men; yarding engineer, chaser, rigging slinger, choker setters and hooker.

Rig Up Procedure

To rig up, the strawline is strung from the yarder to the tail block, to the corner block where it is disconnected. Strawline is then strung from the yarder to the corner block, where the strawlines are connected.

The haulback is hooked to the strawline which pulls it through the corner blocks, to the tail block and back to the yarder. The strawline is unhooked from the haulback and the haulback is shackled to the butt rigging.

Roads are changed by taking the haulback out of the first tail block, putting it in the second tail block, and tight lining the lines into position on the new road.

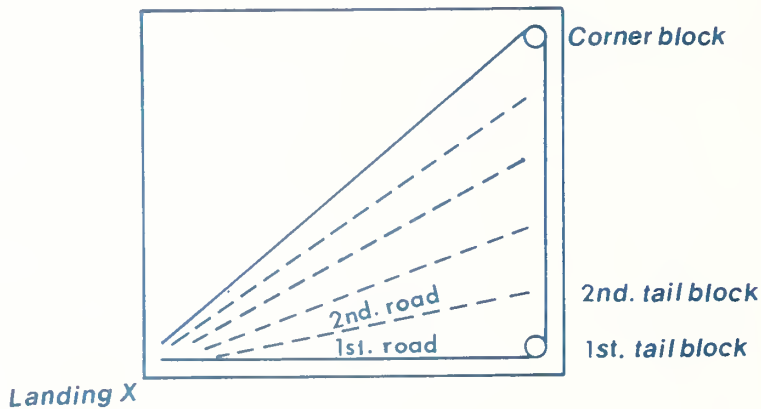
HIGH LEAD LAYOUT YARDING TOWARD THE CORNER BLOCK

Lines that hang up and break when they are tight lines are a menace to the crew. If the ground is such that the haulback will hang up, as it is tight lined across to the second road, another procedure is used. Strawline is strung from the yarder to the second tail block. The mainline is pulled to the landing and the haulback is unshackled from the butt rigging. The haulback is pulled out to the second tail block where it is fastened to the strawline from the yarder. The strawline pulls the haulback back to the yarder where the strawline is unhooked and the butt rigging is shackled back onto the haulback.

Road changes, as described above, progress towards the corner block. Yarding can also progress away from the corner block.

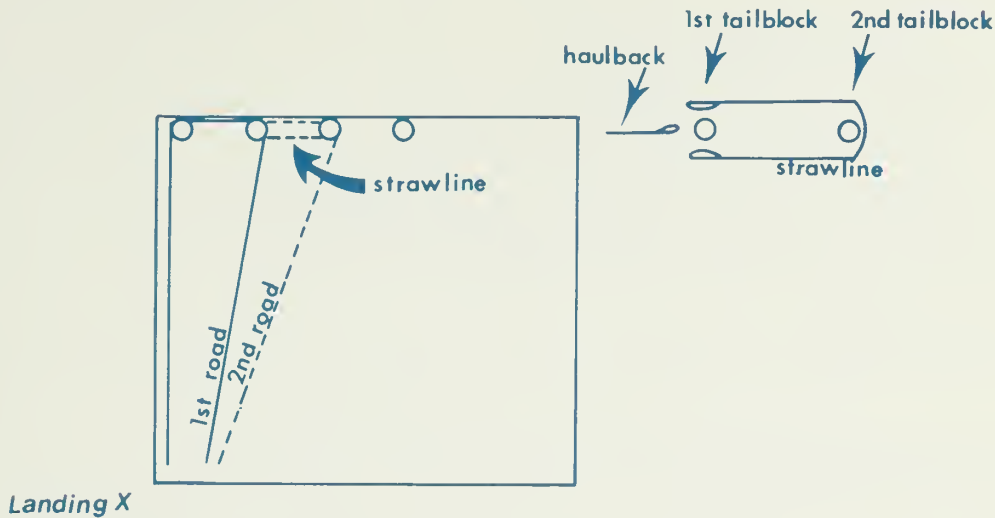

Landing X

#### HIGH LEAD LAYOUT FOR YARDING AWAY FROM THE CORNER BLOCK

After the first road is logged, a loose section of strawline is strung from the first tail block to the second tail block and back to the first tail block. The mainline is pulled in, butt rigging dropped off, and the strawline is pulled out to the first tail block with the haulback. The first tail block is removed. The strawline from the yarder is unhooked from the haulback and is hooked into one end of the section of strawline that goes through the second tail block. The other end of the strawline (through the second tail block) is hooked onto the haulback. The haulback is then pulled through the second tail block and into the yarder with the strawline, where the strawline is unhooked and the butt rigging hooked up. The haulback is tight lined into position on the second road.

If obstacles prevent tight lining the haulback, strawline will have to be strung from the yarder through the second tail block and over to the first tail block, where it can be hooked into the haulback. The strawline then pulls the haulback through the second tail block and back to the yarder, where it is shackled to the butt rigging. This increases road change time and reduced yarding production.

#### 48.24 - Layout Recommendations

1. Maximize uphill yarding.
2. External yarding distances and long corners should be field checked to assure that they do not exceed the capacity of the yarder drums.
3. Field check to assure these are no blind leads.

48.25

48.25 - Advantages

1. Equipment is commonly available.
2. Loggers are used to the system.
3. It is one of the simplest cable systems.
4. Equipment costs less than more sophisticated systems.
5. Facilitates regeneration by scarifying the site.

48.26- Disadvantages

1. May cause unacceptable impact on critical soils.
2. Yarding distance is limited in comparison to skyline, balloon and helicopter systems.
3. Downhill and sidehill yarding distances are generally less than uphill distances due to less deflection and higher hangup potential.



## 48.3 - Standing Skylines

### 48.31 - Introduction

A standing skyline is a skyline whose length cannot be changed during the yarding cycle. The older standing skylines were anchored to stumps on both ends and the skyline length couldn't be adjusted without pulling the spikes. With the development of the line horse, or single drum, the skyline length became adjustable. Use of a line horse makes it possible to take advantage of topographic variations to increase payloads when the critical point on the skyline profile is on the landing side of mid span. (See discussion on increasing payload in FSH 2409.24, R-10, Chapter 200, Section 222.31).

Line horse speeds are slow and it isn't feasible to adjust skyline length during each yarding cycle.

The ability to raise and lower the skyline once or twice a day is essential when yarding with a radio controlled carriage, to permit servicing and repairs. Therefore, these skylines must be wound on a line horse or a yarder drum.

#### 48.31a - Yarding Distance

Yarding distance is limited to something less than one-half of the length of the haulback on those systems that require a haulback. Reducing the haulback diameter permits winding more haulback on the drum. Many standing skyline systems utilize tension in the haulback to lift the turn and, if yarding is downhill, to hold the carriage back. therefore, there is a definite limit to the amount that the haulback diameter can be reduced. When yarding old growth, 7/8" is about the minimum desirable size for the haulback. Operators that used to use 3/4" haulbacks prefer 7/8" or 1" for the greater strength.

On very long spans additional haulback can be spliced on (see Section 43.56 for a discussion on the problems of splicing on additional haulback). The cost must be recognized in the appraisal. When not in use the extra line can be stored on a spool.

#### 48.31b - Operation

Standing skylines all have lateral yarding capability. This is accomplished by locating the tail block off to the side of the skyline (see Section 46.17 for a discussion of the problems involved in yarder operation when side blocking), or by using a carriage with lateral yarding capability. Lateral yarding reduces the number of tail holds required and puts more volume under the line, but it increases the strain on tail hold anchors. The more an anchor stump is worked, the greater the opportunity for failure.

## 48.31c

When wider spaced tail holds are used, there is less down time for changing skyline roads.

If an obstacle is encountered, the fallblock can be raised by holding the haulback line tight while pulling in on the mainline. Full log suspension can be obtained by keeping adequate tension on the haulback line.

All of the standing skyline systems can be used for swinging.

Standing skyline systems, other than those utilizing a slackpulling carriage that can be held in place on the skyline, are not suited to partial cutting because of lateral movement of the mainline and haulback.

If the yarder has enough drums, the skyline can be wound on the yarder. If the skyline drum and the mainline drum can wind at the same time the system becomes a live skyline system.

Logs above the level of the skyline can't be laterally yarded. This results in hang ups, breaks the line and is a hazard to the crew.

Considerable length can be tagged onto the skyline in order to get adequate deflection. Loggers have tagged on 2000' to 3000'.

Convex slopes are especially tough for these systems as the haulback rubs along ground resulting in wear and causing a fire hazard.

It helps considerably if there is enough belly in the skyline to allow it to drift over the turn so that the turn won't have to be ground led laterally to the carriage. This speeds lateral yarding time and reduces the strain on the carriage and the skidding line.

There are one or two operators using a double skyline. This will permit the use of a smaller diameter skyline but it requires a special carriage, special tower fairleads and a special yarder or linehorse.

Units should be laid out so that there is access to the tail hold to facilitate rigging. See Sections 43.5 for a discussion on rigging practice and Section 44 for a discussion on anchors.

### 48.31c - Advantages

1. Long spans reduce road construction mileage.
2. Long extensions can be attached to the skyline to:
  - a. Improve deflection.
  - b. Reach suitable anchors.
  - c. Make the anchor accessible for rigging.

3. Long skyline roads have more wood under the skyline, this reduces the frequency of moves.

4. When deflection is adequate, logs can be flown across creeks, through or over buffer strips and over sensitive soils.

5. Skylines may be able to reach areas that are inaccessible to high lead equipment.

48.31d - Disadvantages

1. Equipment is more expensive to purchase and maintain.

2. Equipment is usually larger and is more difficult to move.

3. The equipment requires certain ground and timber conditions for economic operation. It generally isn't competitive with high lead equipment on favorable high lead ground.

4. Use of long spans may make future intensive management un-economic.

5. Suspended logs don't help with site preparation when brush is a problem, or the duff needs scarification.

6. Sale layout costs are higher due to the necessary logging feasibility checks.

7. Stronger tail holds are necessary because of the greater loads on them and usually a greater volume of timber yarded on each skid road.

48.32 - North Bend

The North Bend was designed primarily as a system to swing logs from remote highlead landings to a landing where the logs could be loaded onto a truck. Recently, the North Bend is being more widely used where one-end suspension of the log is required. By holding tension on the haulback line during inhaul, the turn can be lifted, and if enough deflection and clearance is available, it may be completely suspended.

The North Bend is adapted to uphill, level or moderate downhill slopes. The South Bend is used for downhill yarding because of the increased lift which helps the logs ride up over objects.

A highlead yarder may be used if the haulback drum has sufficient brakes to tightline the turn. If the skyline is stored on the yarder, a three-drum or slackline yarder is needed.

The carriage is in two parts. A block carriage, such as a shotgun carriage, rides on the skyline. The mainline is attached to the bottom of the carriage. A fallblock rides on the mainline, with butt-rigging and haulback line attached to it.

The haulback line pulls the fallblock and butt-rigging back to the woods. The mainline pulls the carriage and turn into the landing. The standing skyline provides lift to the carriage and turn of logs.

North Bend rig up procedure is the same as for slackline.

# NORTH BEND SYSTEM

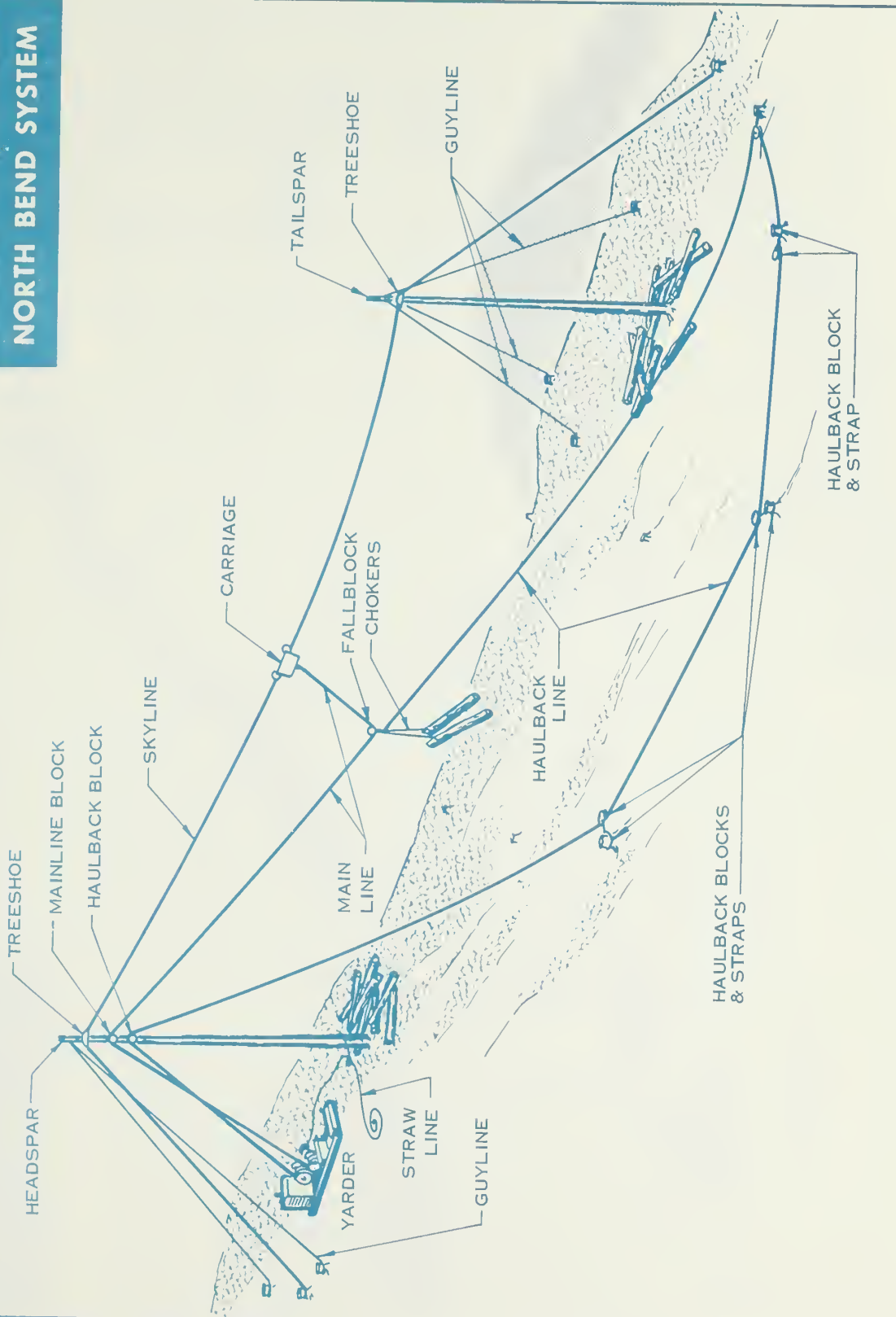

48.33 - South Bend or Modified North Bend, or Bight Down

The rigging is the same as used for the North Bend System except for the carriage. Instead of the mainline attaching to the carriage, it passes through a sheave in the carriage and is attached to the fall-block. This provides an extra purchase on the carriage for more lift when downhill yarding.

Making a 180<sup>o</sup> bend around the sheave in the carriage increases line wear.

The system also puts a greater load on the skyline (less on the mainline).

South Bend rig up procedure is the same as for slackline.

# SOUTH BEND SYSTEM

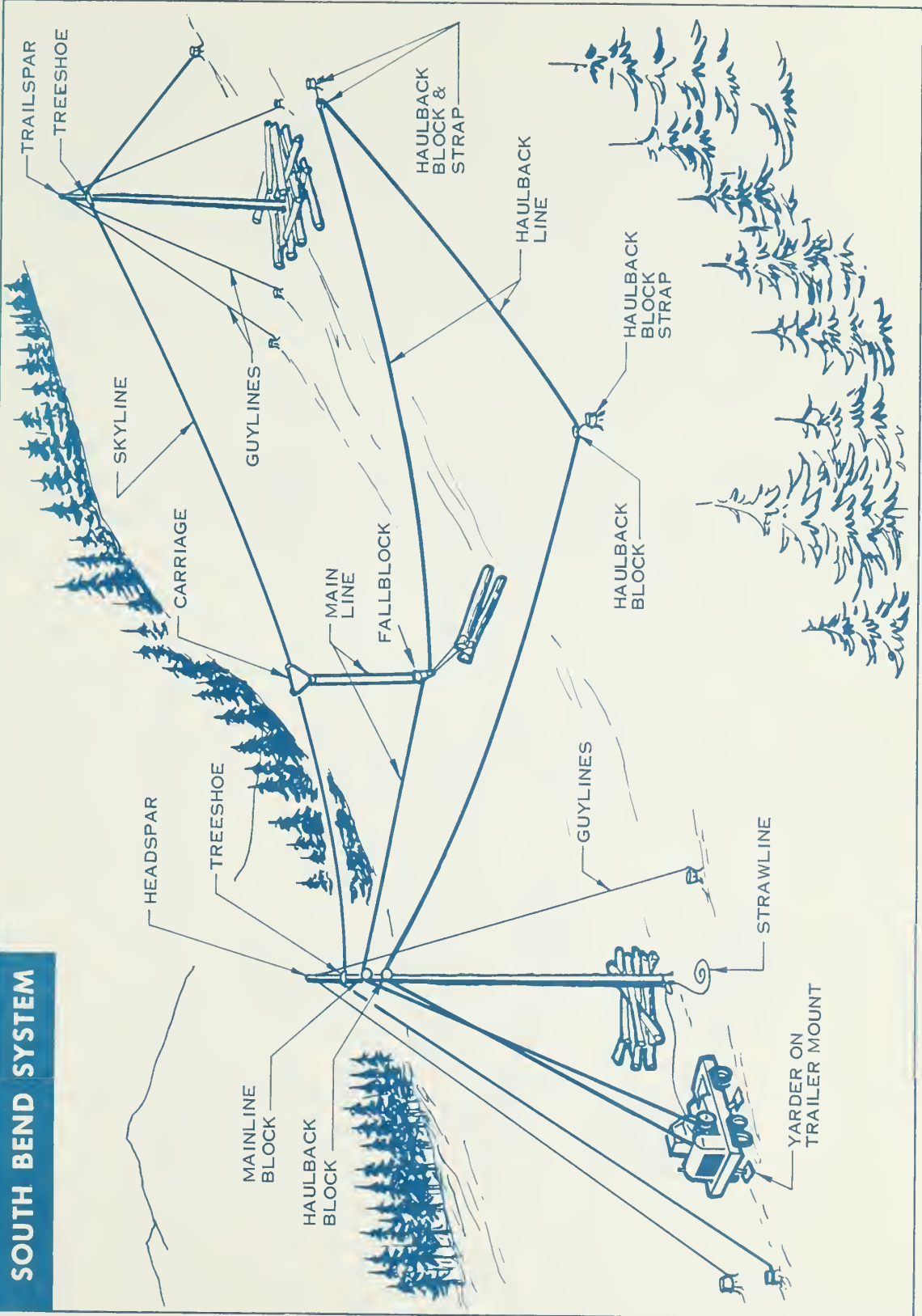

48.34 - Block In The Bight (or Bight Up)

The rigging is the same as used for the North Bend system except for the carriage. The mainline goes directly to the carriage (from the yarder) where it passes over a sheave, down around the fall block and back up to be shackled to the carriage. The fall block rides in the bight in the mainline. This system is an alternate for the North Bend or South Bend. It is more effective when it is necessary to side block extensive distances (up to 500'). This side blocking capability permits yarding behind obstacles that would be in a blind lead if the logs had to be yarded directly to the tower.

Production is slower when side blocking long distances, but the cost could be less than alternate systems that could do the job.

This side blocking capability is valuable when the cost of rigging tail holds is high.

When logging uphill it is easier to get slack at the landing for unhooking chokers than it is with the North or South Bend. It is necessary with this system to use rubber tires as bumpers on the skyline to prevent the carriage from damaging itself or the tower fairlead.

Block in the bight rig up procedures are the same as for slackline.



# Block in the Bight

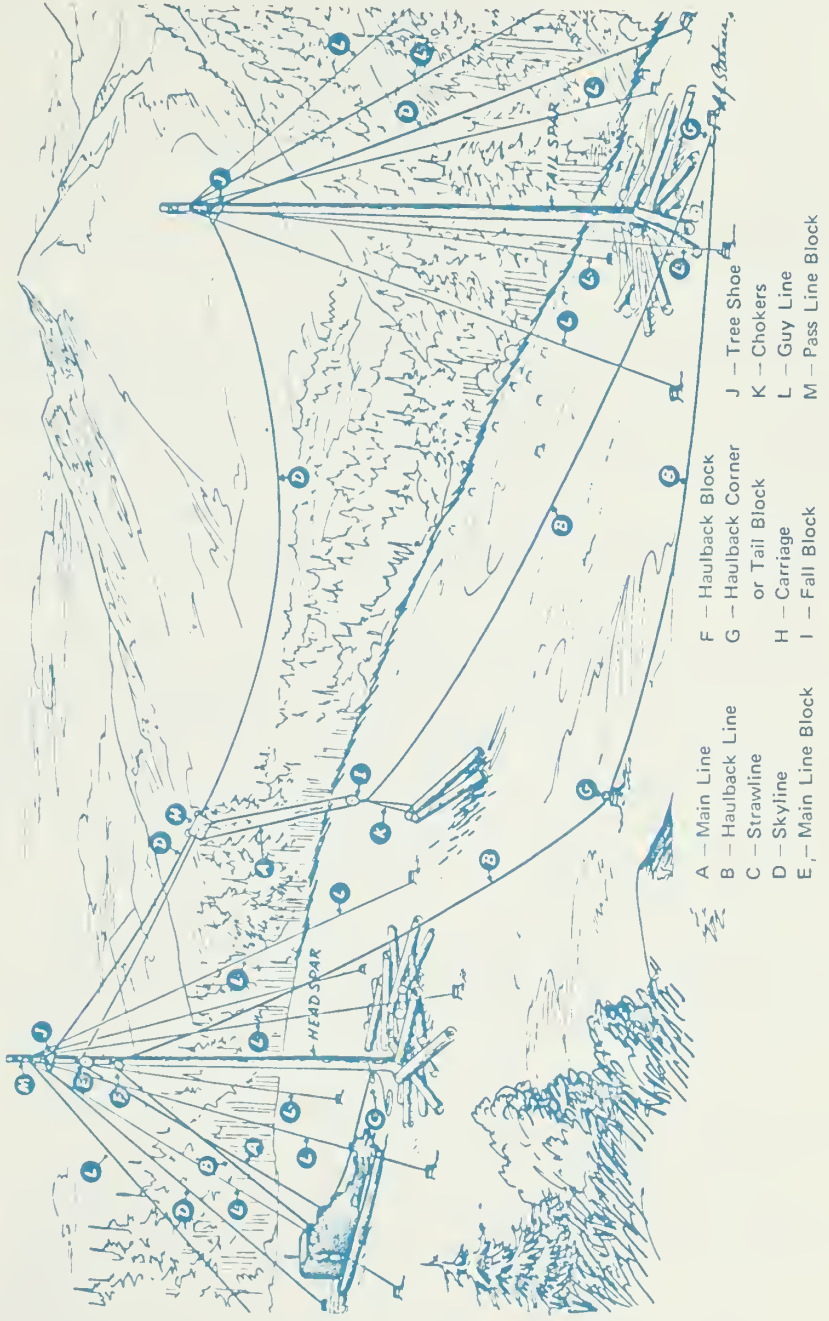

48.35 - Skidder

The system was developed for use with a three drum yarder and a standing skyline. The skyline was anchored to stumps at both ends. Now, one of the stump anchors can be replaced with a line horse. There are also several makes of four drum yarders that can operate the system.

Yarding direction: Uphill or downhill

Cutting prescription: Thinnings, partial cuts, or clearcuts

Carriage description: The carriage is mechanically operated. The slackpulling line pulls the mainline through the carriage. The logs are attached to the end of the mainline.

System description: The system relies on the haulback line to hold the carriage in place during lateral yarding. The slackpulling line does not carry any load and, therefore, can be smaller than the mainline. In some cases, a slackline yarder is rigged as a skidder by using the strawline for a slackpulling line.

Operational characteristics: Even if the skyline is attached to a drum on the yarder, this system is operated as a standing skyline; the inhaul is stopped when the skyline is raised or lowered.

A carriage containing the skidding line on a drum may be used. The yarder mainline and slackpulling line are both fastened to drums on the same shaft as the skidding line, in the carriage. In this arrangement the carriage is pulled out to the woods and then held in position by the haulback line. The skidding line is payed out of the carriage by pulling in on the slackpulling line. This operation also winds the mainline on one of the drums in the carriage. After the logs are choked the mainline is pulled in to the yarder. This turns the carriage drum shaft and winds in the skidding line.

Another type of carriage that contains a skidding drum has two mainlines that power the skidding line in and out and that pull the carriage to the landing. The two mainlines and the haulback are interlocked.

Use of a slackpulling carriage permits presetting chokers, which can improve yarding production.

Today this system is used mainly on small yarders to log thinning sales. However, some equipment manufacturers have come out with four drum (+ strawdrum) yarders that can operate a skidder system in old growth.

In a partial cut the lines all have to be pulled back to the yarder and restrung. In a clearcut unit, the system would be rigged up the same as the slackline system.

# SKIDDER SYSTEM

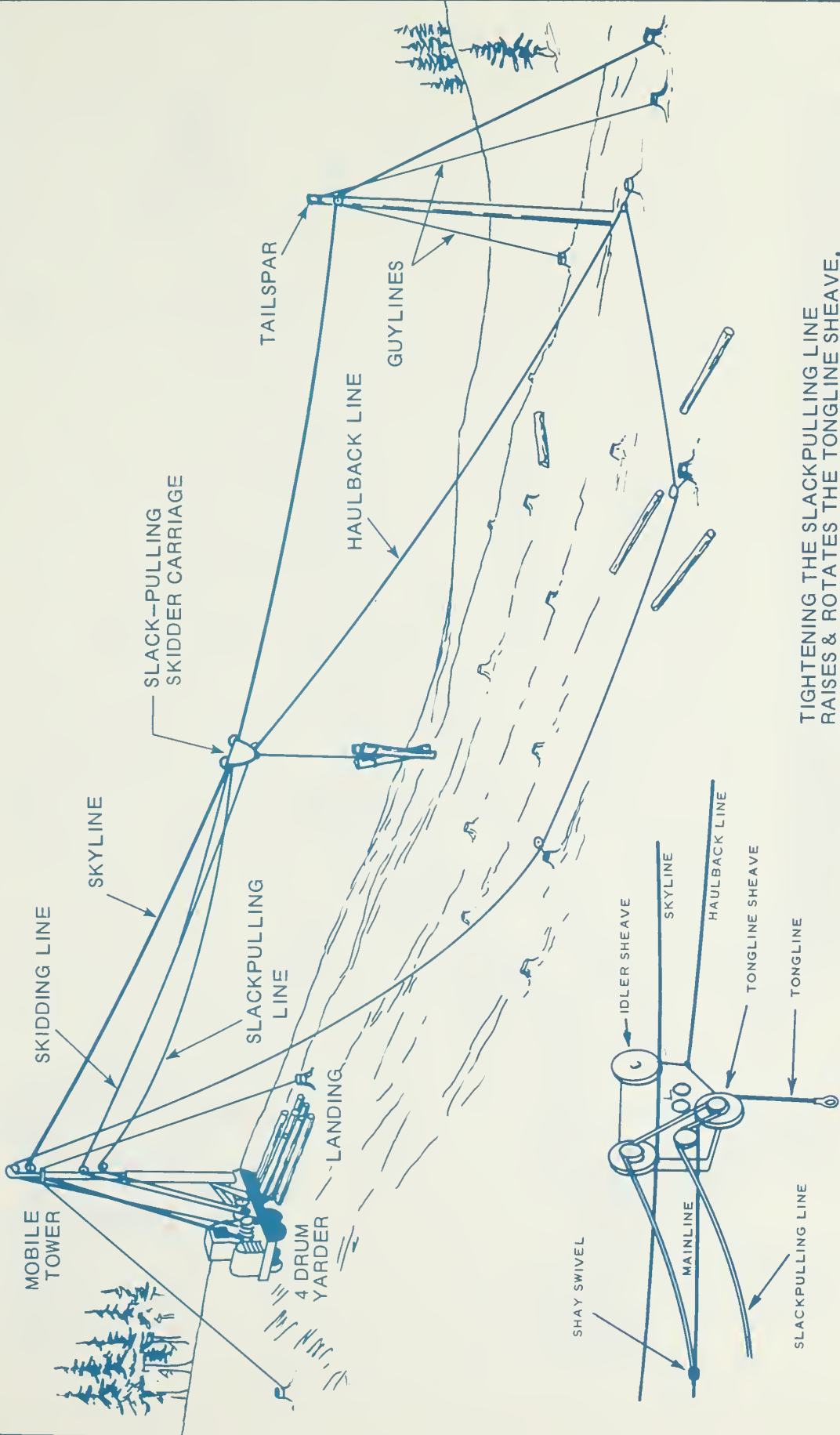

TIGHTENING THE SLACKPULLING LINE RAISES & ROTATES THE TONGLINE SHEAVE, MAKING CONTACT WITH THE IDLER SHEAVES, RESULTING IN A VISE LIKE GRIP ON THE TONGLINE. APPLYING A LOAD TO THE TONG LINE RELEASES THE GRIP.

# SIDE MOUNT TOWER with mechanical slack pulling carriage

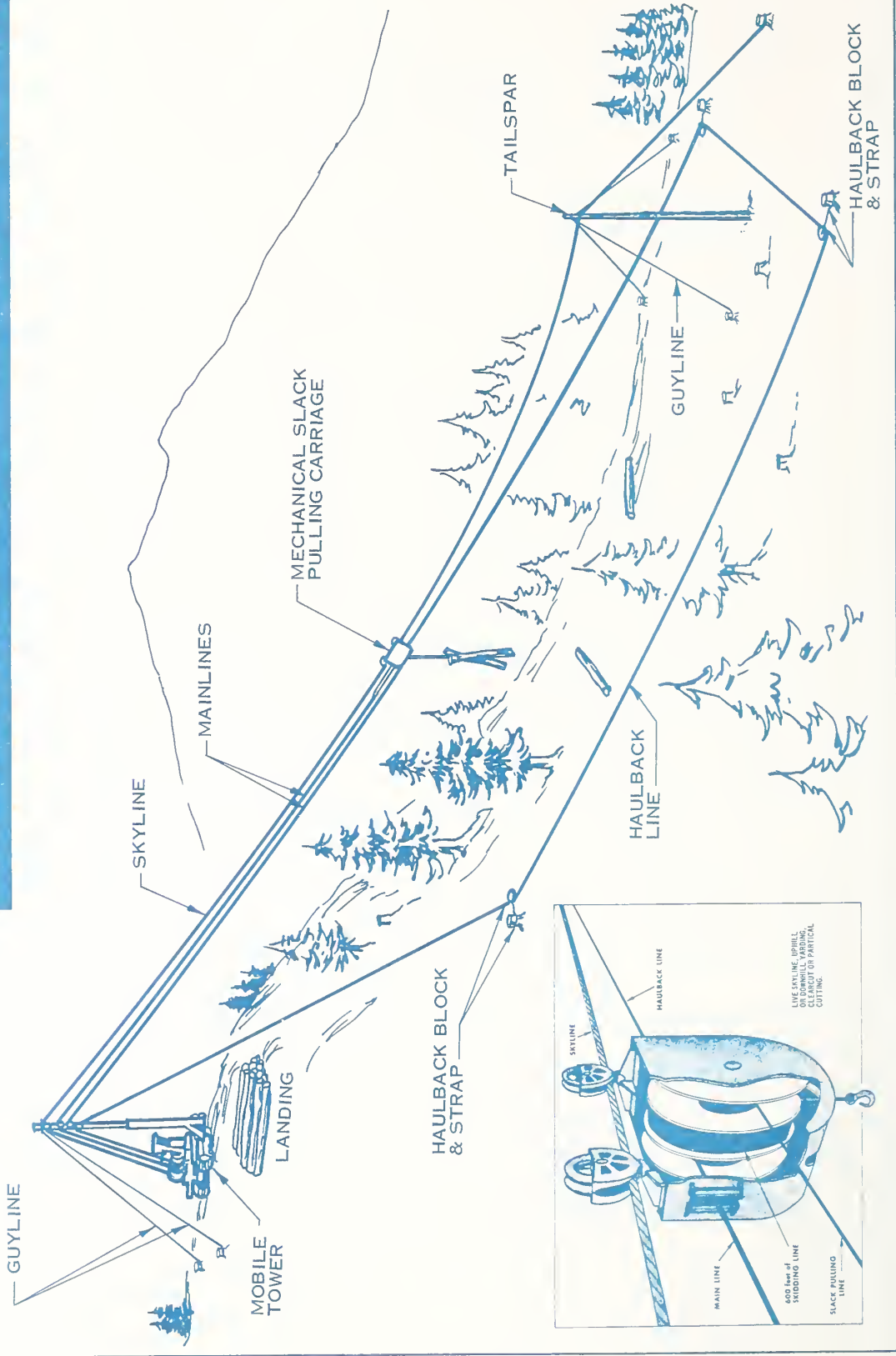

# SKYFLYER SYSTEM

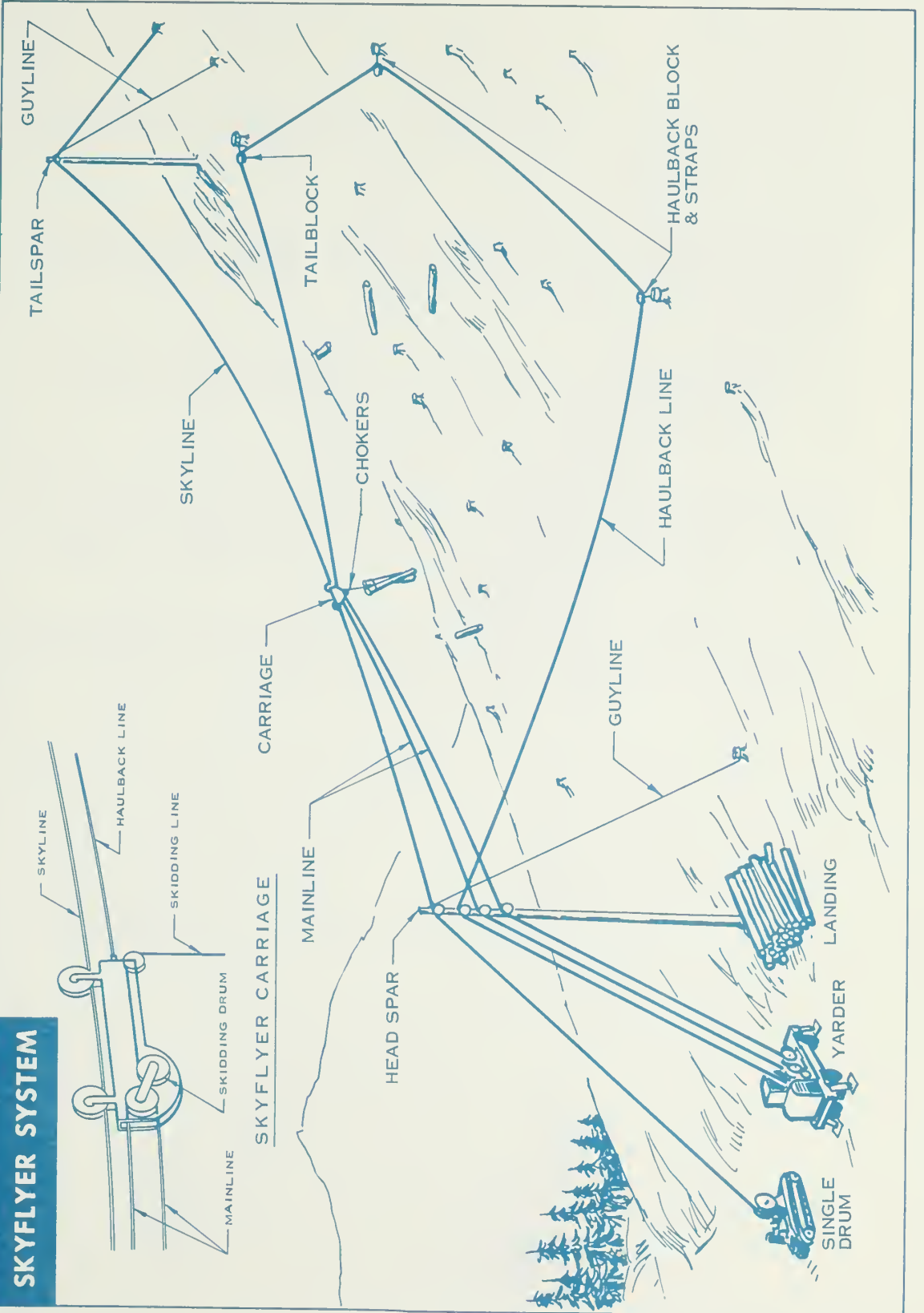

48.36 - Tyler

Yarding direction: Uphill and downhill.

Yarder description: A three-drum or slackline yarder is used with a separate standing skyline. The main and haulback lines provide travel to the carriage. The lifting (Tyler) line holds the logs up to the carriage.

Carriage description: The carriage contains two sheaves on which the lifting line rides. A fallblock rides in the bight of the lifting line, under the carriage. The butt-rigging, haulback, and mainlines are attached to the fallblock.

System description: The standing skyline provides the lift for the carriage and logs. The lifting line is stationary during inhaul and is tensioned to hold the logs off the ground. The mainline and haulback pull the carriage in and out.

Operational characteristics: This system is used to swing logs across creeks and canyons. Operation is slow because of the way the lifting line passes through the carriage. The system is hard on wire rope because of the reverse bend on the lifting line between the sheaves in the carriage and the fallblock.

When the system is used to yard downhill, the mainline can be omitted if the belly in the skyline is such that the turn will gravity down to the landing. It is then called a downhill Tyler.

# TYLER SYSTEM Uphill Swing

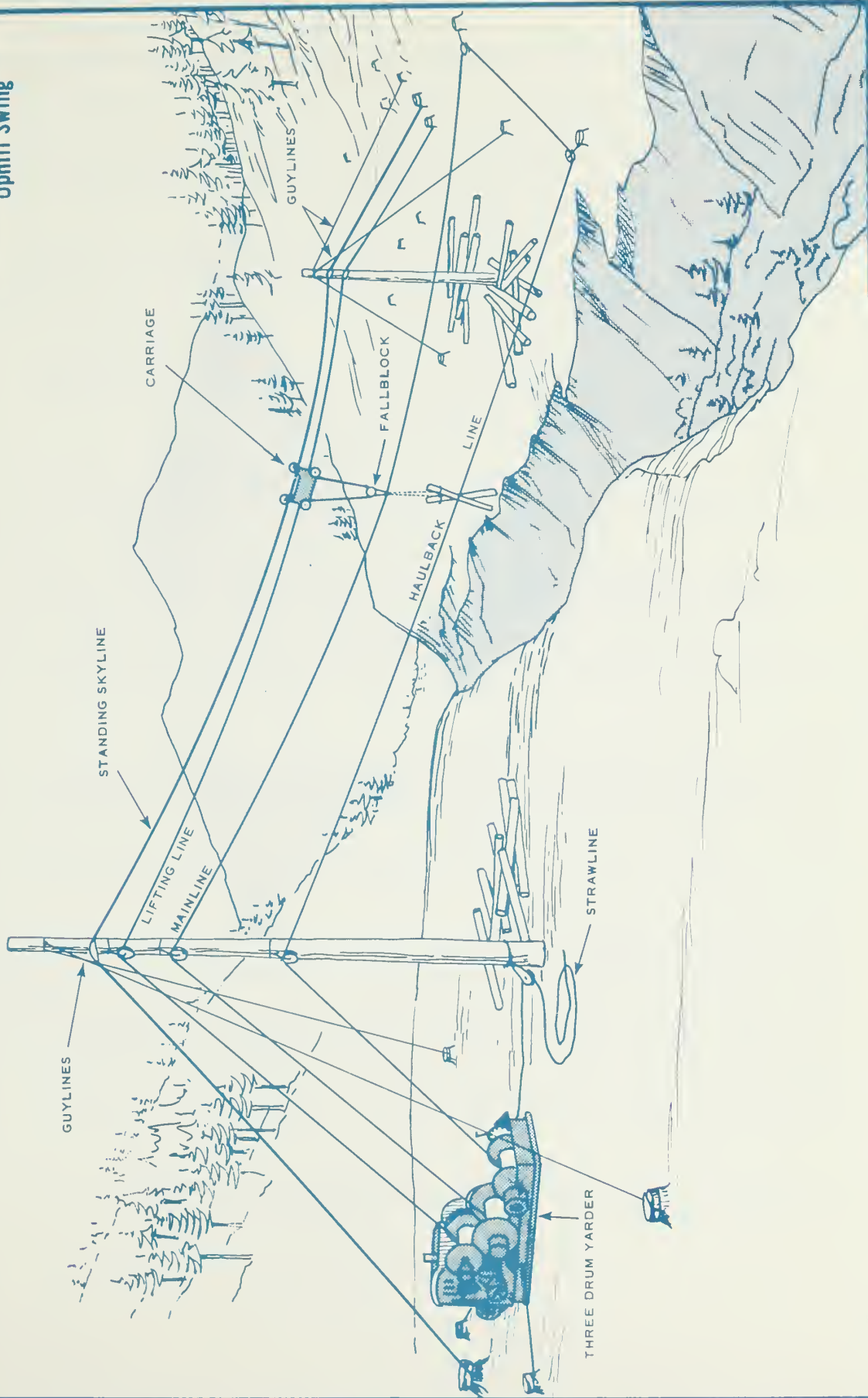

48.37 - Standing Skylines With Radio Controlled Carriages48.37a - System Description

The yarder can be a two-drum highlead machine. The gear ratio on the mainline drum is usually changed to increase line speeds. A single drum is used to spool and tension the skyline.

For downhill yarding, the yarder must have sufficient brakes to lower the turn to the landing. Older highlead yarders may require **beefed up** brakes.

Either a wood spar or a steel tower can be used. A heavy duty tower with eight guylines is recommended to handle a 1½" skyline. The tower will have to be equipped with a banjo fairlead for the skyline. See Section 46.16 for comments on banjo faileads.

The line horse, if used, can be placed behind the head spar or tail spar, but should be in line with the tail anchor and head spars (see comments in Sections 42.4 and 42.51 about **positioning a line horse**).

Line horses are usually shop built of surplus parts. Buying one from an equipment manufacturer is very expensive as they are not stock items.

The yarder moves the carriage up or down the skyline. The carriage either contains the dropline on a drum, or pulls slack off the mainline drum on the yarder, to yard laterally.

48.37b - Requirements and Limitations

This equipment can yard both uphill and downhill. It can be used in clearcuts or partial cuts and it can yard up to 5,000', yarder permitting, (if a haulback isn't needed).

Radio carriages spool between 300' and 440' of 7/8" dropline, depending on the specific carriage.

Lateral yarding distance is affected by the height of the skyline above the ground and whether the dropline is dragged downhill or pulled uphill. Effective lateral yarding distance, across the slope, is **limited** to three times the height of the skyline **because of hangup problems**. Lateral outhaul and inhaul time increases with lateral yarding distance. There is a point where it is more economic to change skyline roads than it is to pull drop line. If the ground is right, and the skyline has the proper deflection, a radio carriage can yard 300' laterally.

If the skyline is too high, the dropline can't reach the ground, or the skyline road may be too narrow to be economic.



The skyline must be wound on a line horse to permit servicing and repairing the carriage.

If the radio carriage is designed to pull slack off the yarder drum, it is limited to yarding uphill. The mainline is too heavy to pull uphill through the carriage for downhill yarding.

If the skyline is over  $1\frac{1}{2}$ " , a wood spar should be planned as very few steel towers are designed for lines over  $1\frac{1}{2}$ ".

There must be a place to locate and anchor the single drum so that it can effectively serve the skyline. It must be possible to get the single drum to this location.

#### 48.37c - Operation

Using a line horse permits a longer yarding distance as a  $\pm$  1" mainline can be used on the high lead yarder.

If there is adequate deflection it may be possible to place the line horse so that logs can be yarded without a spar or tower.

Since large rigging is used ( $1\frac{1}{4}$ -inch to 2-inch skyline) the tailholds and skyline anchors must be extremely well rigged. Quite often this requires deadman anchors where adequate stumps are lacking. See the discussion on rigging tail holds in Section 43.5 and Section 44 on anchors for additional discussion.

#### 48.37d - Layout Recommendations

It is very desirable to operate the yarder without the haulback when possible. Using a haulback cuts yarding production approximately 25 or 30 percent, and cuts maximum yarding distance in half.

When yarding downhill, access to the tail hold is desirable to permit locating the yarder at the top of the unit.

Sales should be designed so that there is equipment access to the tail hold to facilitate rigging. See Section 43.5 for a discussion on rigging.

When yarding across deep draws, make sure the carriage drop line can reach the ground.

# STANDING SKYLINE - RADIO CONTROLLED CARRIAGE

mobile tower  
Gravity Outhaul

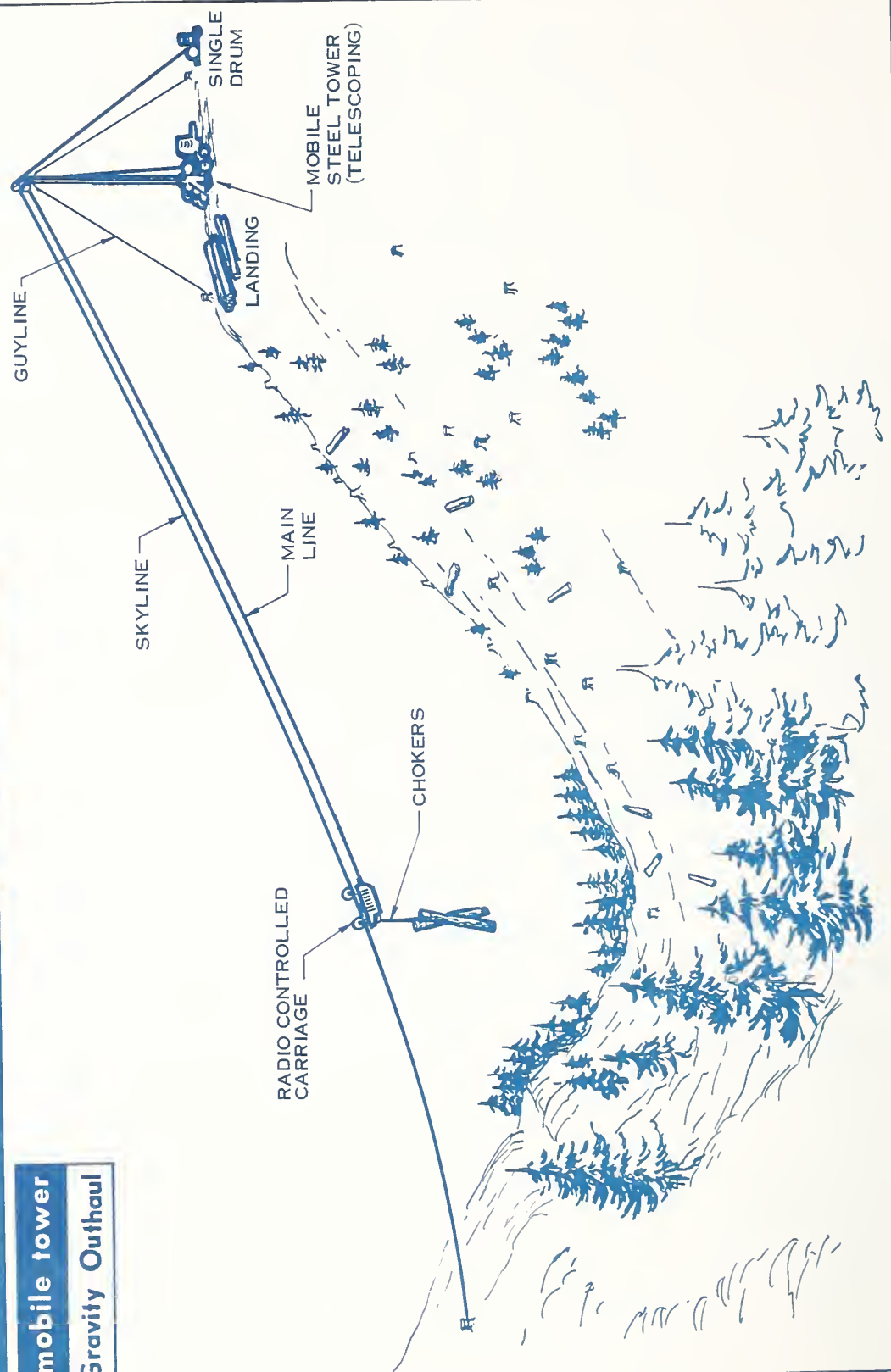

# STANDING SKYLINE - RADIO CONTROLLED CARRIAGE

## sled-mount yarder

### Snubbing the Turn Downhill

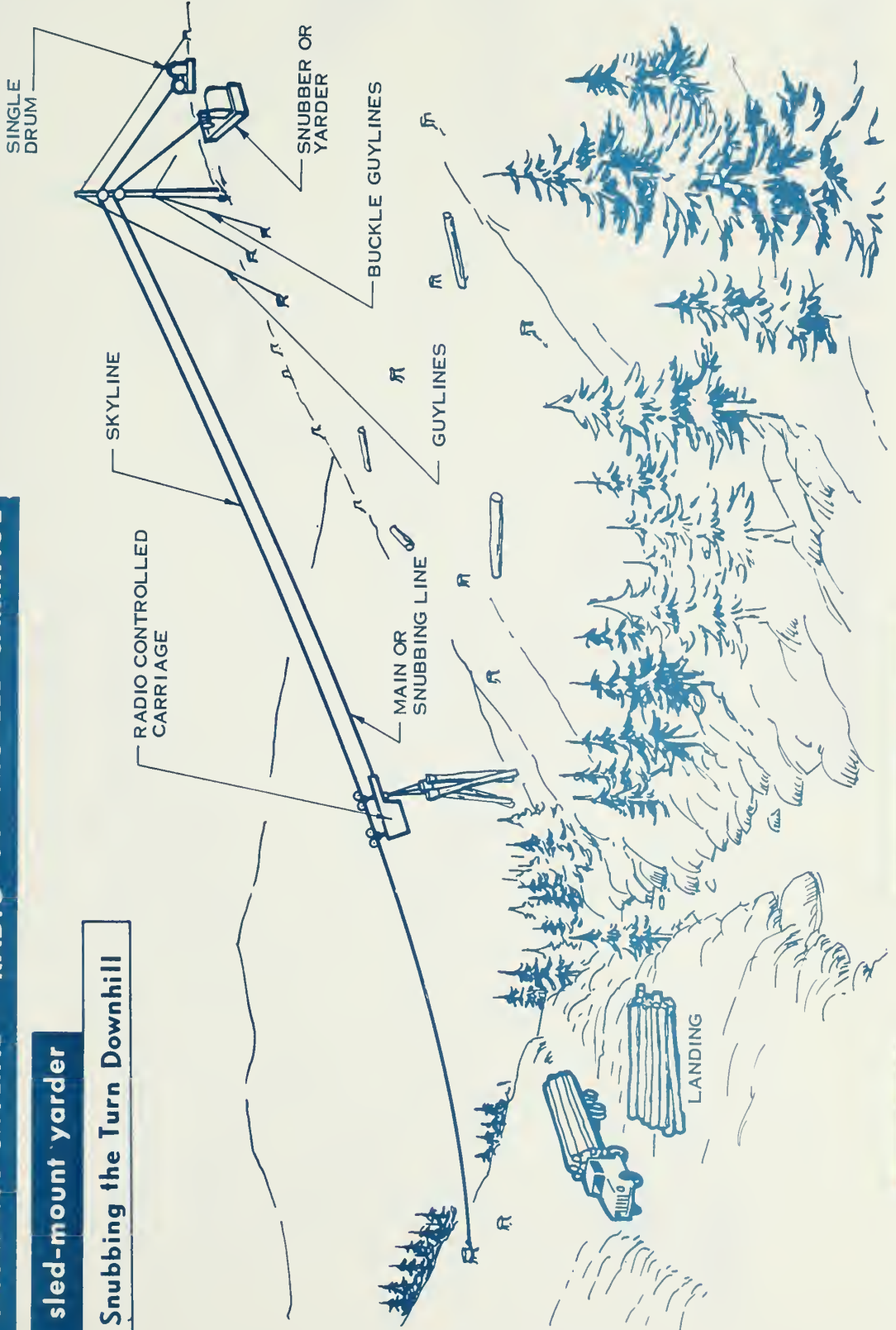

# STANDING SKYLINE with radio controlled carriage

## Yarding without a Tower

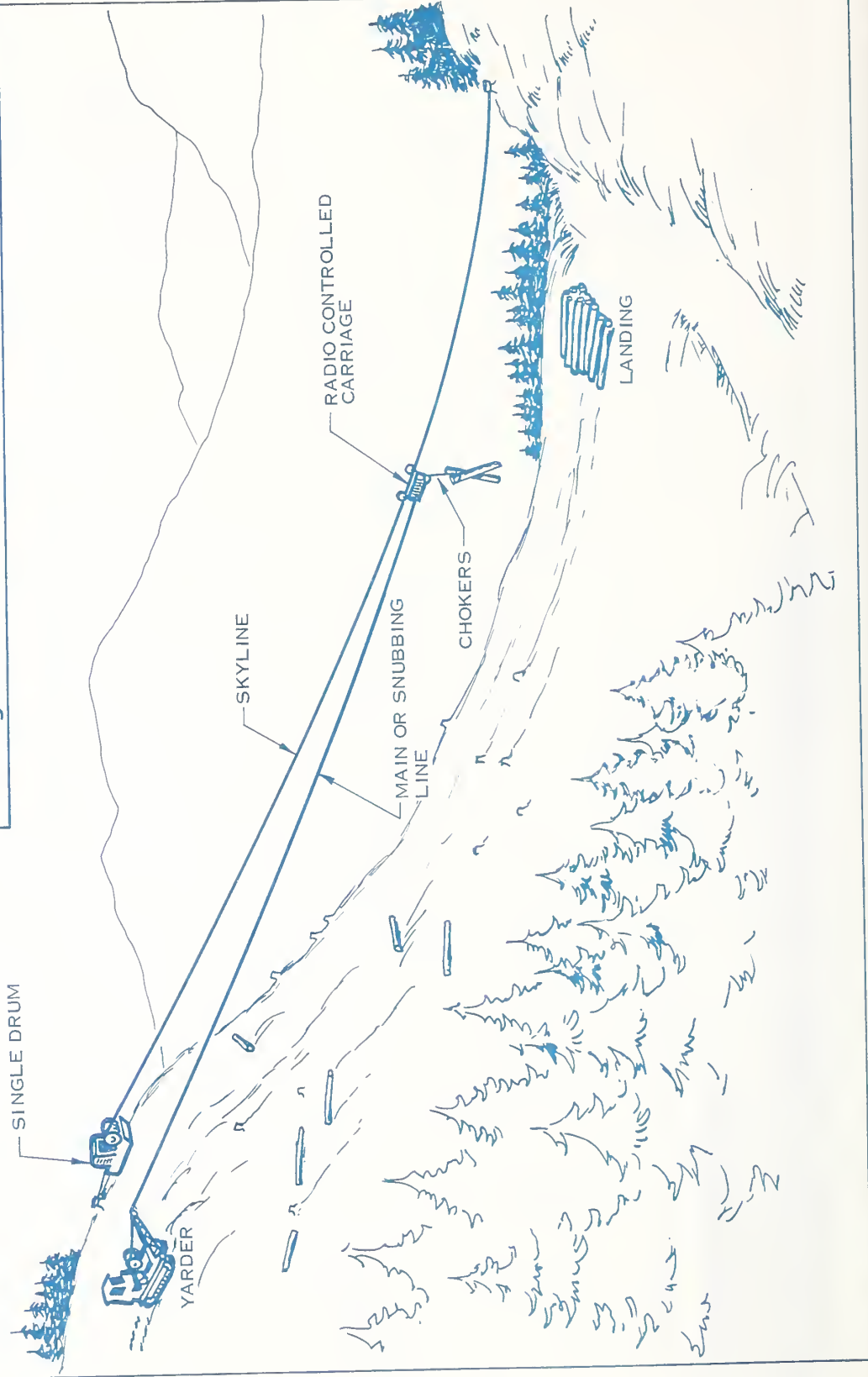

# STANDING SKYLINE - radio controlled carriage

## Yarding with a Reverse Flyer



# STANDING SKYLINE - radio controlled carriage

## Yarding with both Mainline and Haulback

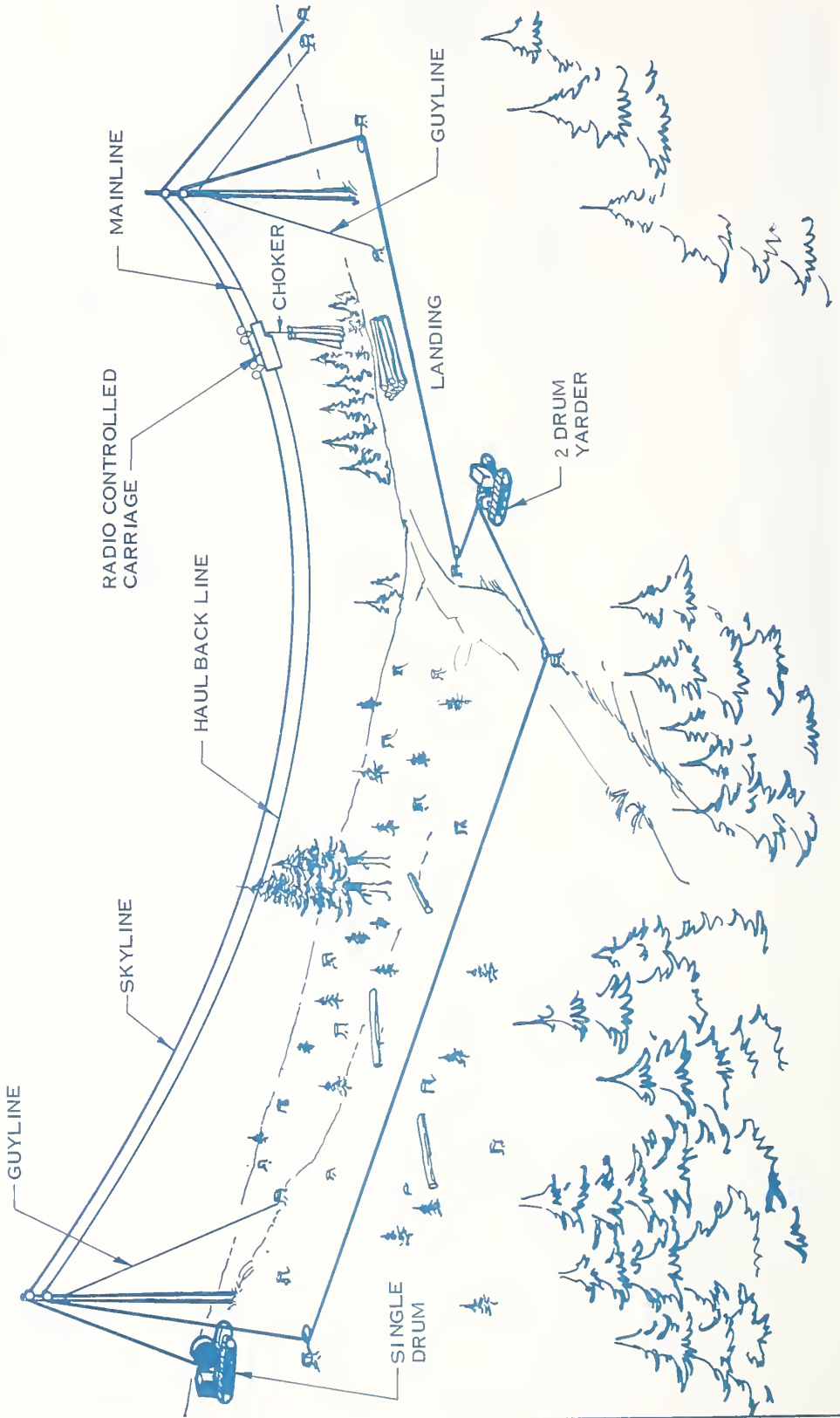

48.37e - Advantages

See advantages listed in Section 48.31c.

1. Chokers can be preset if operating without a haulback.
2. There are less lines to rig if the haulback can be eliminated.
3. There is less wear on the mainline than when using a fallblock system.
4. Rigup options are numerous, permitting using of the equipment to its advantage.

48.37f - Disadvantages

See disadvantages listed in Section 48.31d.

1. Initial investment is high.
2. Maintenance and repair is high.
3. Skilled maintenance personnel are needed.
4. The carriage is readily damaged by rough handling.
5. The carriage must operate on a drum wound (powered) skyline to permit maintenance and repairs.

## 48.4 - Live Skylines

A live skyline is a skyline who's length can be changed during the yarding cycle. The ability to change the skyline length is accomplished by winding the line on a yarder drum.

High lead and slackline yarders can operate live skyline systems.

Yarding distance is normally limited by the capacity of the yarder drums. See Section 43.56 for a discussion on yarding beyond drum capacity.

Skyline length can also be increased by locating a line horse at the tail hold and shackling the skyline from the yarder to the line from the line horse. This makes the line from the line horse part of a live skyline. This is desirable when the alternative is a long skyline extension which would create handling problems.

### 48.41 - Flyer (or Shotgun)

#### 48.41a - System Description

The most common live skyline system is the shotgun or flyer. It is strictly an uphill system. The mainline on a highlead yarder is used as a skyline and the haulback is used as a skidding line, or mainline, to move the carriage up and down the skyline. Most highlead yarders, including the mobile yarders, can be modified for this type of logging. Modifications usually include adding a fairlead below the mainline fairlead so that the haulback line comes out under the mainline. This prevents the haulback from sawing the mainline while used in the **shotgun** configuration.

Other modifications, which are not necessary on most modern highlead yarders may include:

1. Adding a larger engine to increase power.
2. Changing the gear ratio on the haulback drum to increase line speed.
3. Adding a hydrotarder or water-cooled brake to the haulback drum to provide a retarding force for lowering the carriage downhill with or without a turn of logs.
4. Adding larger brakes to the skyline drum.

A shotgun carriage weighs 900 to 2,300 lbs. It consists of two skyline sheaves with weighted sideplates. Chokers are attached to the bottom of the carriage.

The carriage moves down the skyline by gravity to the woods. It is lowered to the ground to allow the logs to be choked. The carriage is raised by the skyline and brought to the landing by the mainline.



LIVE SKYLINE - shotgun or flyer system

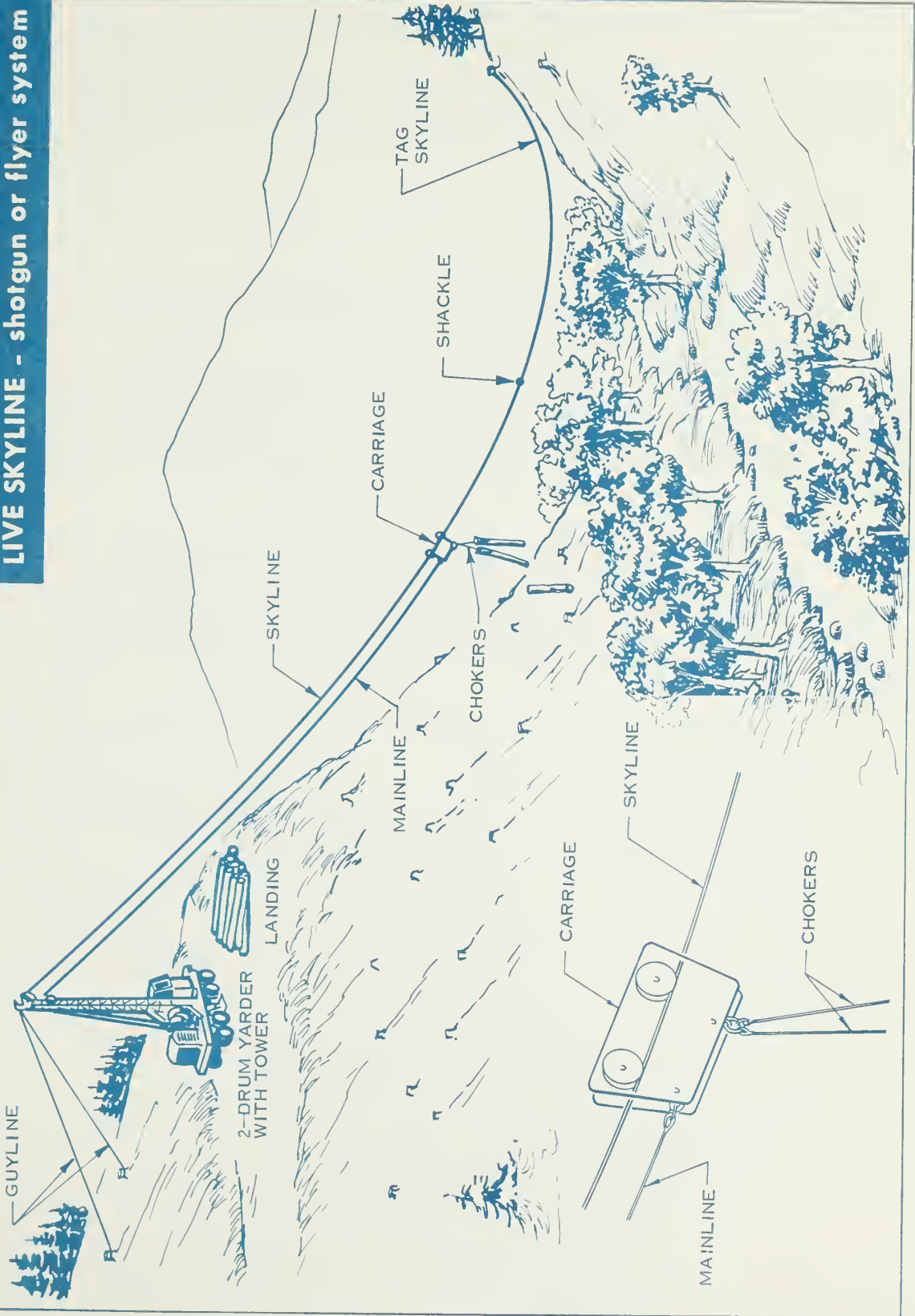

48.41b - Requirements and Limitations

The flyer is a clearcut yarding system. The lack of lateral yarding capability makes the system unsuited for partial cuts.

Yarding distance is normally limited by the length of the skyline. Skyline extensions 3,000' long have been used successfully. When an extension is shackled on the skyline, the carriage must have Tommy Moore sheaves (see Section 47.2 for a carriage with Tommy Moore sheaves) to pass over the shackle.

See Section 43.3 for a discussion of wire rope connections suitable for skyline extensions.

Lateral yarding distance is limited to the length of the chokers. Chokers 40' to 50' and even 70' long are used. Long chokers reduce, or eliminate, the opportunity for log suspension.

Since the shotgun system relies on gravity for carriage outhaul, yarding cannot be accomplished beyond the point where the carriage will no longer move under its own momentum. If yarding is done beyond this point, a haulback line will be needed to pull the carriage further out the skyline.

Twenty percent is about the minimum chord slope for effective flyer logging. Flatter slopes reduce the speed of the carriage during outhaul to the point where a high lead may make faster turn times. The flatter the skyline chord the closer the skyline belly is to mid span, thereby reducing the flyer yarding distance. The tail hold will have to be beyond the cutting boundary if the belly is to be at the cutting boundary.

The heavier the carriage and the steeper the slope, the farther and faster the carriage will go.

The heavier the mainline the shorter the distance the carriage will travel. The sag and drag of the mainline retards the carriage runout. This becomes more critical as the chord slope flattens out.

Resistance of the mainline drum shortens the carriage run out distance

There are computer programs which determine the distance a flyer carriage will travel out a skyline.

The following theoretical formula can be used as a guide to determine how far a flyer carriage will travel when the tail hold is across a draw and up the opposite slope. This distance gets critical when the chord gets flat.

$\mu$  = Coefficient of friction  
 WC = Weight of the carriage  
 WM = Weight of the mainline/foot

$$a = \mu + \text{Tan. } \phi 3$$

$$b = -2 \left( \frac{WC}{WM} \right) \text{Tan. } \phi 1$$

$$c = -d^2 [\text{Tan. } \phi 2 + \text{Tan. } \phi 3]$$

$x$  = Distance carriage will roll

$$x = -\frac{b \pm \sqrt{b^2 - 4ac}}{2a}$$

Example

$$\begin{aligned} d &= 1,200' \\ wc &= 3,500 \text{ lbs.} \\ wm &= 1.42 \text{ lbs.} \\ \tan.\phi_1 &= .10 = 10\% \\ \tan.\phi_2 &= .60 = 60\% \\ \tan.\phi_3 &= .60 = 60\% \\ u &= 3 \end{aligned}$$

$$\begin{aligned} a &= 0.9 \\ b &= -493 \\ c &= -1,728,000 \end{aligned}$$

$$x = \frac{493 \pm \sqrt{(493)^2 + (4)(0.9)(1,728,000)}}{1.8}$$

$$= 1,686 \text{ feet}$$

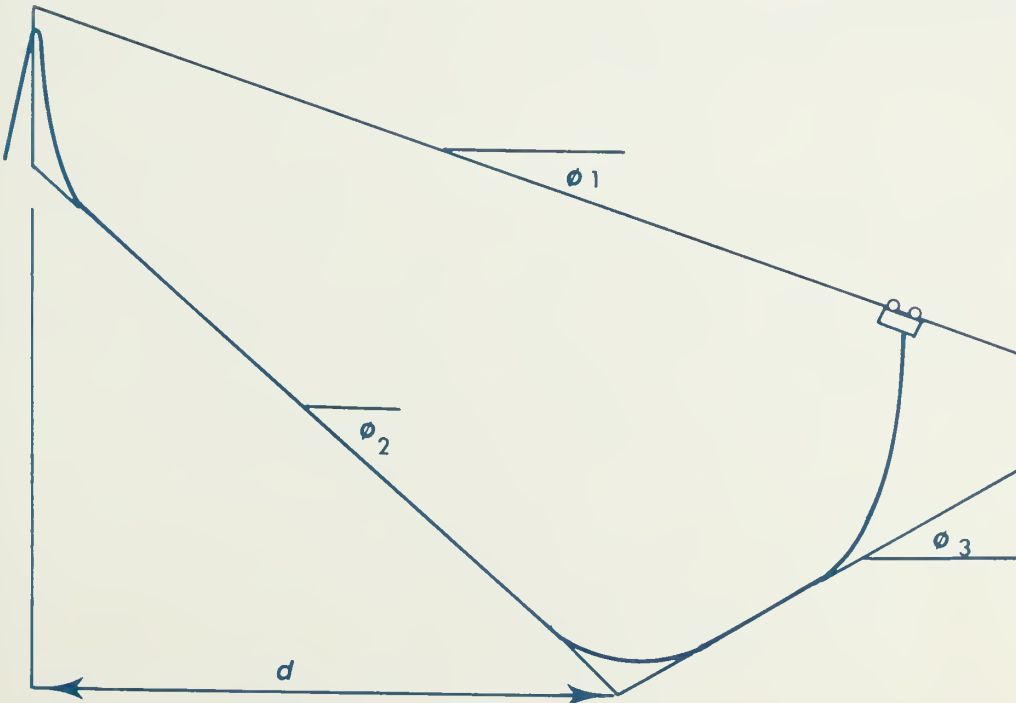

The formula is intended for use with a clamping carriage. If a carriage doesn't clamp to the skyline when it stops rolling out, it will roll back toward the belly of the skyline before the skyline can be lowered to drop the carriage to the ground. When the loaded carriage is unclamped, the turn will roll back to the belly of the line under gravity. The mainline will have to be wound in rapidly to keep it from dragging on the ground, possibly wrapping around a stump and to keep the mainline wound properly on the drum.

#### 48.41c - Operation

Many loggers hang a block on a guyline to position the haulback below the mainline on a high lead yarder. This is considerably cheaper than installing a third fairlead.

When the chord slope is flat (i.e., 10 percent) and the carriage is heavy (i.e.,  $\pm 7000\#$ ) the carriage may take the belly of the line with it and come to rest at some point beyond the belly of the unloaded skyline. This permits yarding past midspan with a flyer, but turn times will be slow.

If a skyline lies too flat at the back end for flyer operation, the strawline can be used as a haulback to get the carriage to the last few turns.

If the landing isn't at the top of the unit, it may be possible to operate a reverse flyer. This is done by running the mainline to a block at the tail hold and then to the carriage. The carriage and turn are lowered to the landing by letting out the mainline. There are several problems with this system:

1. The carriage has to weigh enough to overcome the drag of the mainline between the yarder and the tailhold.
2. Increasing the weight of the carriage reduces the net payload.
3. The drag of the mainline reduces cycle time.
4. The landing has to be between the belly of the skyline and the tail hold.
5. The turns have to fly clear of the ground.

The width of a flyer road can be increased by adding a dutchman to sideblock the skyline (see Figure below). This requires a three-drum or slackline machine. The skyline and mainline are rigged as in the shotgun system. The haulback line is then run around the unit and attached to a dutchman block on the skyline. During the yarding cycle the skyline is slacked and the dutchman line is tensioned to pull the skyline to the side, to center the carriage over the logs to be picked up. Once the log is grappled or choked, the dutchman line is slackened and the skyline is tensioned to move the skyline back to its normal position and to lift the log from the ground.

If one end suspension is required in a unit that is primarily a flyer unit, the corners that aren't operable with a flyer can be yarded with a Grabinsky if adequate deflection is available. This permits appraising the sale for a two-drum yarder rather than a slackline machine. See Section 48.54 for a discussion on the Grabinsky.

### Rig-Up Procedure

To rig up, the strawline is strung to the tail hold and back to the yarder. If the strawline is stout enough, it can pull the skyline out to the tail hold. If it isn't, the haulback is pulled to the tail hold and back to the yarder by the strawline. The strawline is unhooked, the haulback is shackled to the mainline and the mainline is pulled to the tail hold where it is anchored to a stump or tree.

See Section 43.55 for a discussion on rigging tail trees.

**STANDING SKYLINE-radio controlled carriage**  
**Reverse Shotgun**

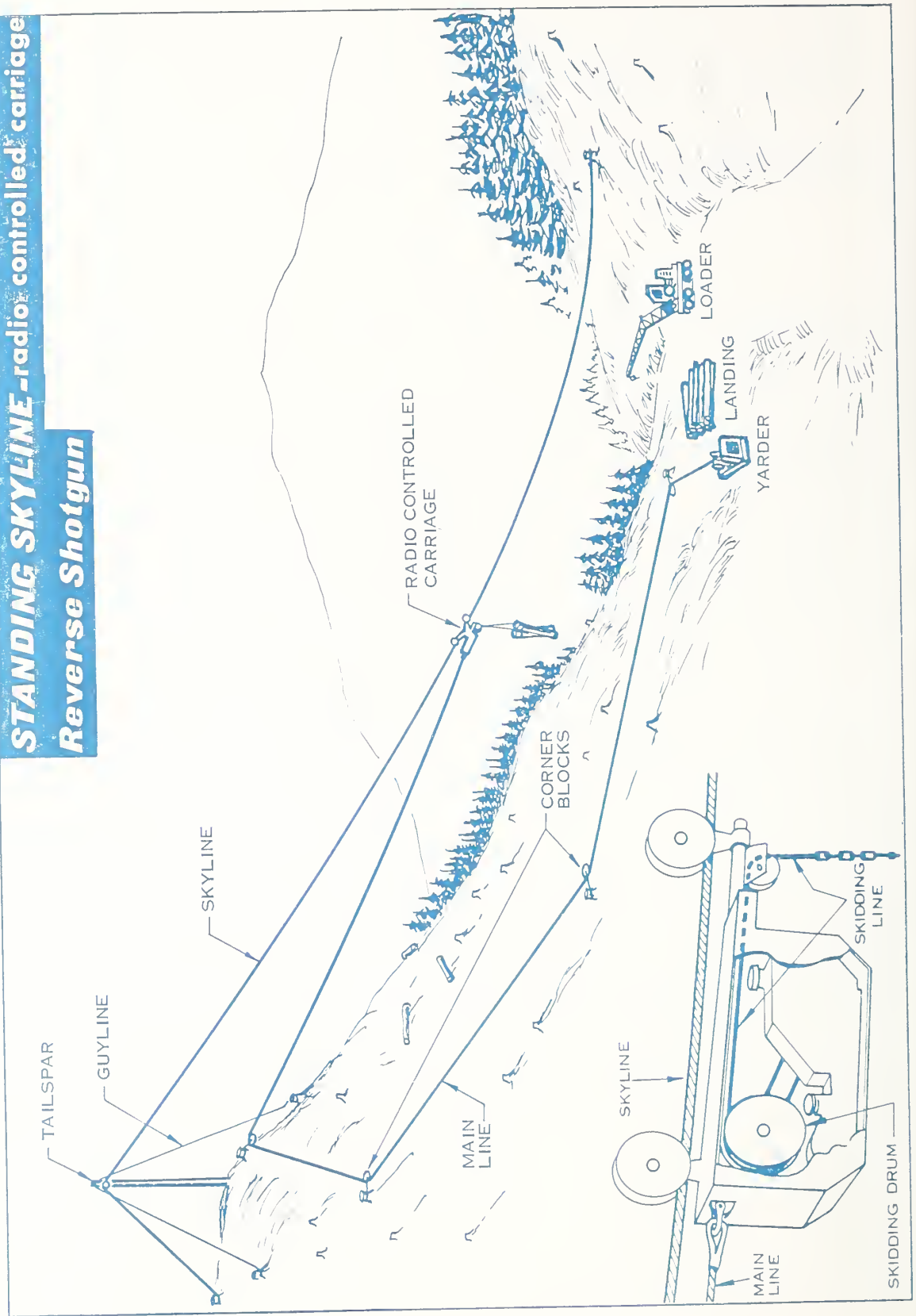

**LIVE SKYLINE with Dutchman**

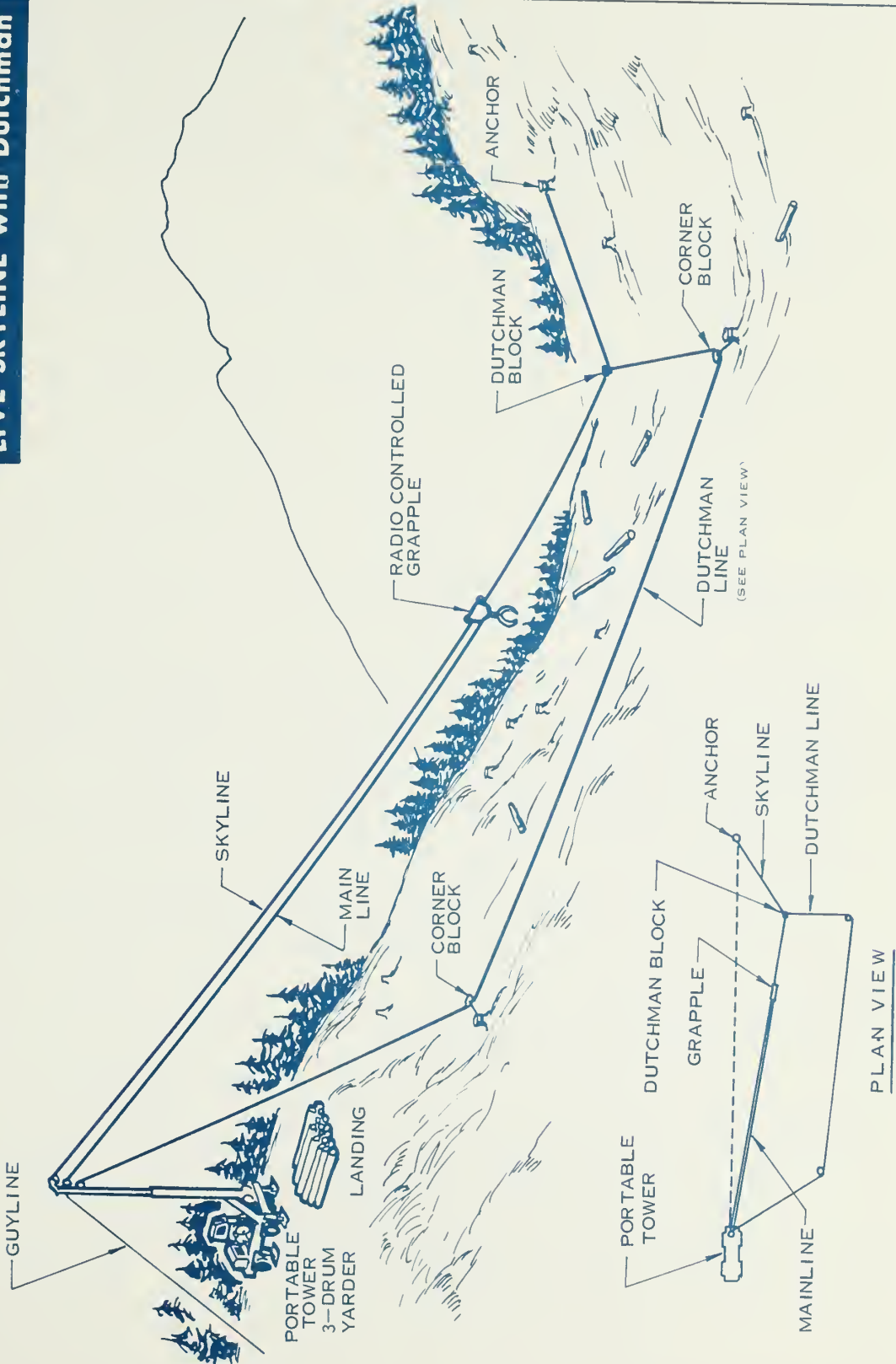

**PLAN VIEW**

Roads can be changed by pulling the strawline out to the old tail hold with the carriage and to the new tail hold as discussed in Section 48.23 for high lead road changes. The skyline is tight lined across to the new road with the strawline or the haulback. If tight lining won't work, all lines can be pulled back to the yarder and then re-strung to the new tail hold. If the terrain is such that the skyline can be tight lined to the next anchor point the method described in Section 50.31 for changing inverted skyline system roads could be used for changing shotgun roads.

#### 48.41d - Layout Recommendations

1. Make sure the carriage can reach the back of the unit.
2. Locate the landing as high in the unit as possible.

#### 48.41e - Advantages

1. Fire hazard is reduced because the haulback line is eliminated.
2. Choker setters are not working in the bight of a line.
3. Lighter chokers are used than for highlead, because less hang-ups are encountered.
4. Cycle times are faster, due to less hang-ups and faster line speeds on both inhaul and outhaul. With adequate cord slope and deflection, a flyer will out produce high lead by 25 percent to 30 percent. The difference between flyer production and high lead production increases with an increase in yarding distance.
5. There is less yarding breakage due to log suspension, which improves utilization and reduces slash.
6. Soil disturbance is minimized because of log suspension.
7. Skid road changes are relatively simple.

#### 48.41f - Disadvantages

1. The cord slope must be adequate.
2. It's not always possible to locate the landing at the top of the unit.
3. The yarder may have to be modified (see 48.41a).
4. Stronger tail holds are required than for high lead.



43.42 - Slackline48.42a - System Description

Yarding direction: Uphill or downhill

Cutting prescription: Clearcut

Maximum yarding distance: 2,000 to 2,500 feet up, 1,000 feet down.

Yarder description: Three drums: haulback, main and skyline. Skyline size ranges from 1-inch to 1½-inch diameter. Capacity ranges from 1,500 feet to 2,500 feet. Some highlead yarders provide for adding a third drum.

Tower and undercarriage description: Towers are 45 feet to 120 feet tall. The taller towers are heavy duty with either seven or eight guylines. Undercarriage may be self-propelled track or rubber, or may be a trailer.

Carriage description: A block carriage, similar to the shotgun carriage, is used.

Yarding cycle: The carriage is pulled out by the haulback line. The skyline has to be lowered to allow the logs to be choked to the carriage. The skyline is raised and the turn is brought to the landing with the mainline.

48.42b - Operation

Slackline yarders generally have greater line capacity than high lead yarders. However, it is incorrect to assume that a slackline machine can high lead yard efficiently beyond the reach of high lead yarders, due to the lack of lift available at a distance from the tower or tree. There must be good deflection for a slackline to operate effectively.

Some lateral capability may be obtained by setting the tailblock to the side, thus pulling the carriage off to the side. The skyline has to be slacked at the same time.

When logging big old growth a big yarder (+ 180,000#) is desirable, to provide the line capacity, horse power and line speed to operate efficiently.

Slack line yarders can operate the several fall block systems (North Bend, South Bend and Bight Up) as live skylines, however, there are physical limitations to this procedure. See Section 46.17 "Yarder Operation" for a discussion of the limitations.

If a separate standing skyline is rigged, a slackline yarder can operate a Tyler system. However, it can't operate a skidder systems as the mainline and haulback drums won't both turn the same direction at the same time.

**SLACK LINE SYSTEM**

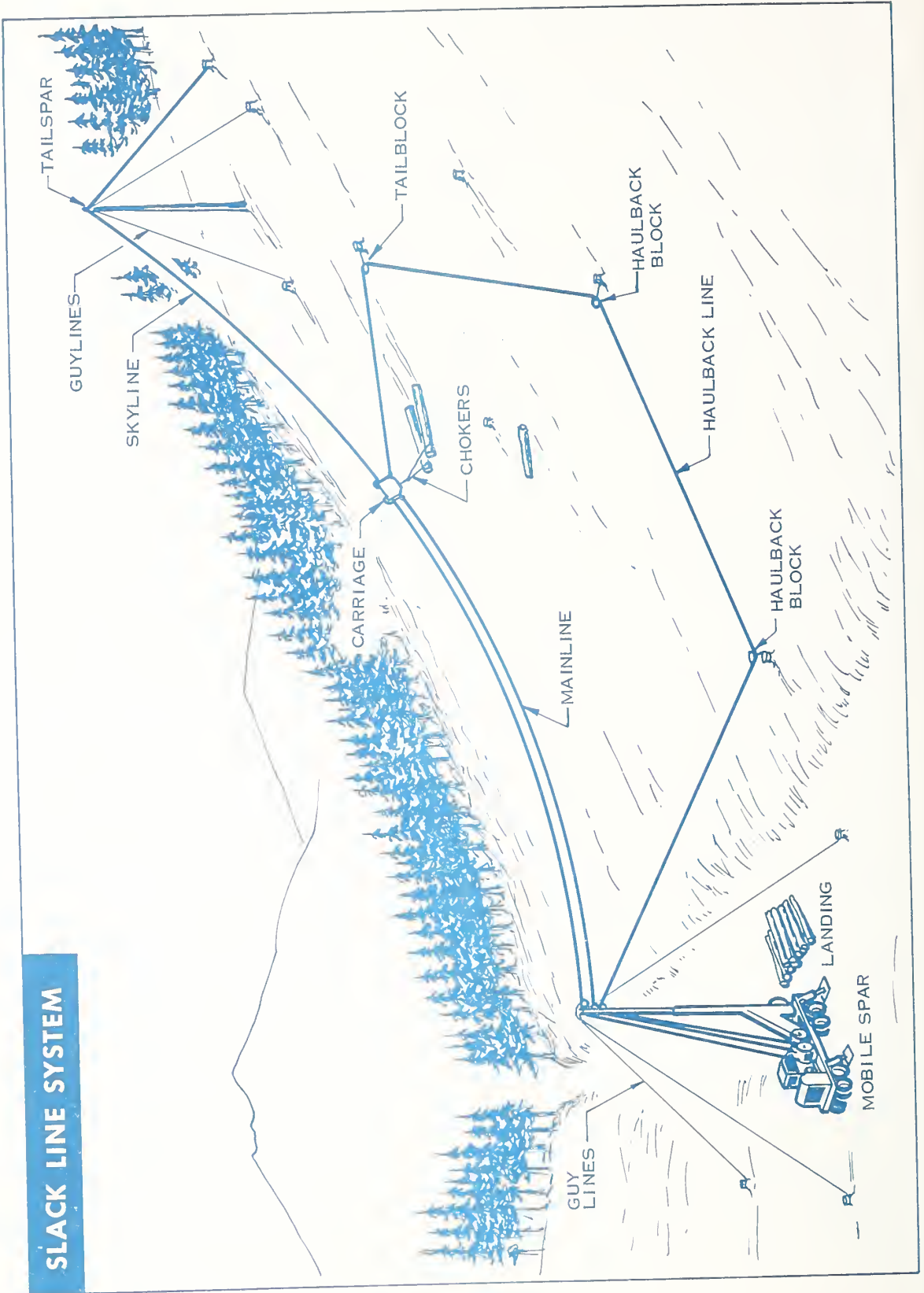

The slackline carriage can be replaced with a radio controlled slack-pulling carriage to increase the skyline road width. See Section 48.43 for a discussion.

A slackline yarder isn't designed to operate with the skyline as a running skyline. The skyline isn't interlocked with the mainline and haulback, and the mainline and haulback can't both wind the same direction at the same time.

### Rig Up Procedure

To rig up, the strawline and haulback are strung the same as for high lead. Then, leaving the strawline still hooked to the eye in the haulback, the haulback is shackled to the slackline (baloney line) and the slackline and strawline are yarded to the tail hold, where the slackline is anchored. The strawline then pulls the haulback back to the yarder where the mainline and butt rigging are connected to the haulback.

To change roads the skyline can be tight lined across to the new road, if ground conditions permit. To do this, pull the mainline in and drop off the carriage and mainline. Hook on the strawline and pull it out to the old tail hold with the haulback. String a loose section, or so, of strawline from the old tail hold to a block at the new tail hold and back to the old tail hold. Unhook the haulback from the strawline from the yarder and hook it into the strawline to the new tail hold. Hook the strawline from the yarder to the other end of the strawline to the new tail hold.

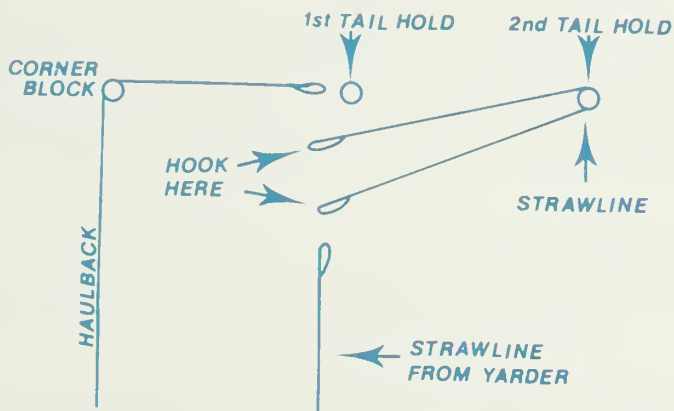

### STRAWLINE LAYOUT TO CHANGE ROADS ON A SLACKLINE

Pull the haulback to the new tail hold and back to the old tail hold. Keeping the strawline fastened to the haulback, fasten the haulback to the skyline and tight line the skyline to the new tail hold. Pull the haulback to the yarder with the strawline, drop the strawline, shackle on the mainline and tight line the haulback to the new road.

If conditions are such that the skyline or haulback can't be tight lined to the new road, the lines will have to be pulled back to the yarder and be restrung to the new tail hold.

The above procedure is used if yarding progresses away from the corner block. Yarding can also progress toward the corner block, like high lead logging. In this latter procedure, the mainline is yarded in and dropped off. The haulback pulls the strawline to the first tail hold where the haulback is removed from the tail block and the skyline is shackled to the haulback. The haulback then pulls the skyline and strawline to the second tail hold where the skyline is anchored, and then tight lined into position on the new road.

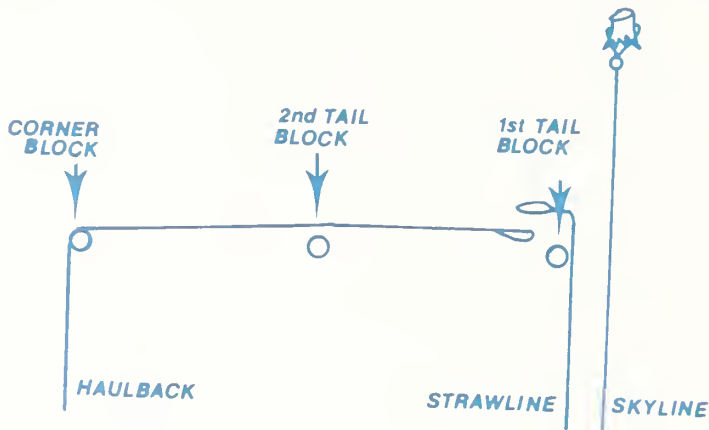

#### LAYOUT TO CHANGE SLACKLINE ROADS WHEN YARDING TOWARD THE CORNER BLOCK

The strawline then pulls the haulback back to the yarder, where the mainline is shackled on. If the skyline can't be tight lined to the new road, it will have to be pulled into the yarder and then out on the new road.

#### 48.42c - Layout Considerations

The more volume that is moved over the road, the stronger the anchor must be, as repeated use weakens tree roots.

When the Bight Up system is used, it is possible to laterally yard as much as 500', with adequate deflection. Of course, this increases cycle time and yarding costs.

When yarding old growth on long roads, a straight lead is desirable to reduce the lateral forces on the tower. This increases the size of the needed landing.

48.42d - Advantages

1. A slackline yarder is a versatile machine. It can be used to high lead or to operate a flyer, a slackline, the fall block systems, or a radio carriage.
2. The yarders generally have a large drum capacity.
3. When a radio carriage is used, a slackline yarder can be used to log partial cuts.

48.42e - Disadvantages

1. Some of these big yarders, require breaking down to make legal highway loads. They take a flat area big enough to work in and a minimum of 1½ days to assemble and 1½ days to break down for legal highway moves. The loader, or a wrecker can be used to help with the assembly and disassembly. Some older model slack line yarders take 3 days to break down for legal moves.
2. The large machines may exceed road width and Forest Service bridge capacities.
3. The large machines may not be able to negotiate some of the curves in logging roads.
4. Large machines require bigger landings, especially on a straight lead.

48.43 - Live Skyline with Radio Controlled Carriage

48.43a - System Description

Yarding direction: Uphill and downhill

Cutting prescription: Clearcut, partial cut, thinnings.

Maximum yarding distance: 1,500 to 2,000 feet. More if a gravity out-haul is possible (see 48.41a).

Yarder description: Uphill yarding can be done with a two-drum highlead yarder with adequate brakes on the main drum to hold a carriage and turn of logs in the air. Downhill yarding requires a three-drum yarder.

Tower and undercarriage description: The tower height is usually 90 feet to 120 feet with 6 to 8 guylines. The undercarriage is self-propelled rubber tire or track, or a trailer.

Carriage description: The carriages contain a power plant either driving a skidding drum in the carriage, or a slackpulling device that pulls the mainline through the carriage. The carriages also have hydraulic clamps to hold them in place during the lateral yarding operation, if needed.

Yarding cycle: The carriage is returned to the woods by the haulback (or under gravity) clamped to the skyline by radio signal, and the skidding line is played out. If the mainline passes through the carriage and becomes the skidding line, the yarder pulls the logs to the carriage, the clamp is released, and the carriage is brought to the landing.

48.43b - Operations

Skyline roads up to 300' wide may be yarded depending on ground slope, skyline height and length of drop line.

If the carriage does not contain enough skidding line to reach the logs, it is possible with the live skyline to lower the carriage; however, this operation will increase the cycle time. Some yarders have insufficient power to raise the skyline and bring in the turn of logs simultaneously.

Some operators have used radio carriages to pull trees where directional falling was required to keep trees out of streams.

Slackpulling carriages can be run through buffer strips to yard logs in units on the other side.

**LIVE SKYLINE with radio controlled carriage**

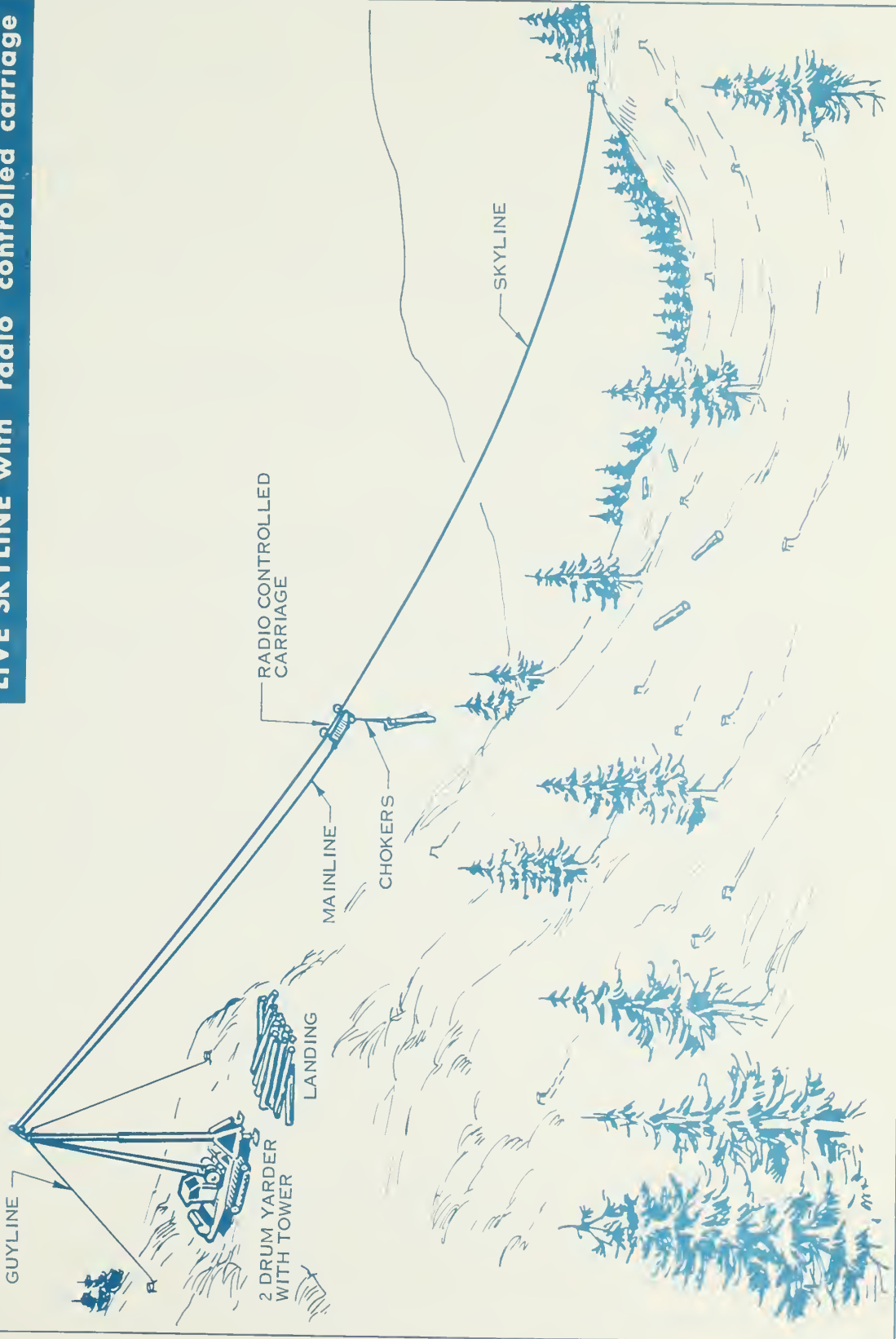

48.43c - Advantages

1. Wide skyline roads are possible.
2. Three drum yarders can operate the system for downhill yarding, two-drum yarders uphill.
3. Can be used in clearcuts, partial cuts and overstory removal.
4. Fewer tail holds to rig (lower rig up costs).
5. Can be effective when tail holds are scarce or scattered.
6. Possible to preset chokers.

48.43d - Disadvantages

1. High cost of the carriage.
2. High carriage maintenance.
3. A lot of carriage down time.
4. High damage potential when carriages are dropped.
5. Potential fire hazard if carriage dropped.



48.44 - Live Skyline with Mechanical Carriage48.44a - Two-drum yarder

Yarding direction: Uphill

Cutting prescription: Thinning

Maximum yarding distance: 1,000 feet

Yarder description: A two-drum mobile yarder, with the capability of reaching 1,000 feet with 5/8-inch skyline and ½-inch to 5/8-inch mainline.

Tower and undercarriage description: Usually a 40 foot to 70 foot stiff boom is used with a gantry. Two live guys from the gantry or one guy from the top of the tower is used. The undercarriage may be rubber or track and usually has a turntable. The tower may have a slackpuller mounted on it.

Carriage description: The carriage has a hand operated hydraulic clamp holding it to the skyline. Slack is pulled through by hand. A locking device on the carriage holds the mainline during inhaul.

System description: The carriage is returned under gravity. The skyline must be lowered to allow the choker setter to release the mainline and clamp the carriage. Slack is pulled by hand. The carriage is raised up before lateral yarding. When a knob on the mainline contacts the carriage, the clamp is released. This ability to manually pull slack for lateral yarding is what limits the system to thinning sized timber. Large mainlines are too hard to pull out.

Operational characteristics: Small lines are used; therefore, rigging is relatively easy. There are no running lines other than the mainline, which is suspended. Nylon straps may be used to protect tailtrees. Lateral yarding distance is 75 feet. Chokers may be pre-set.

LIVE SKYLINE with mechanical carriage

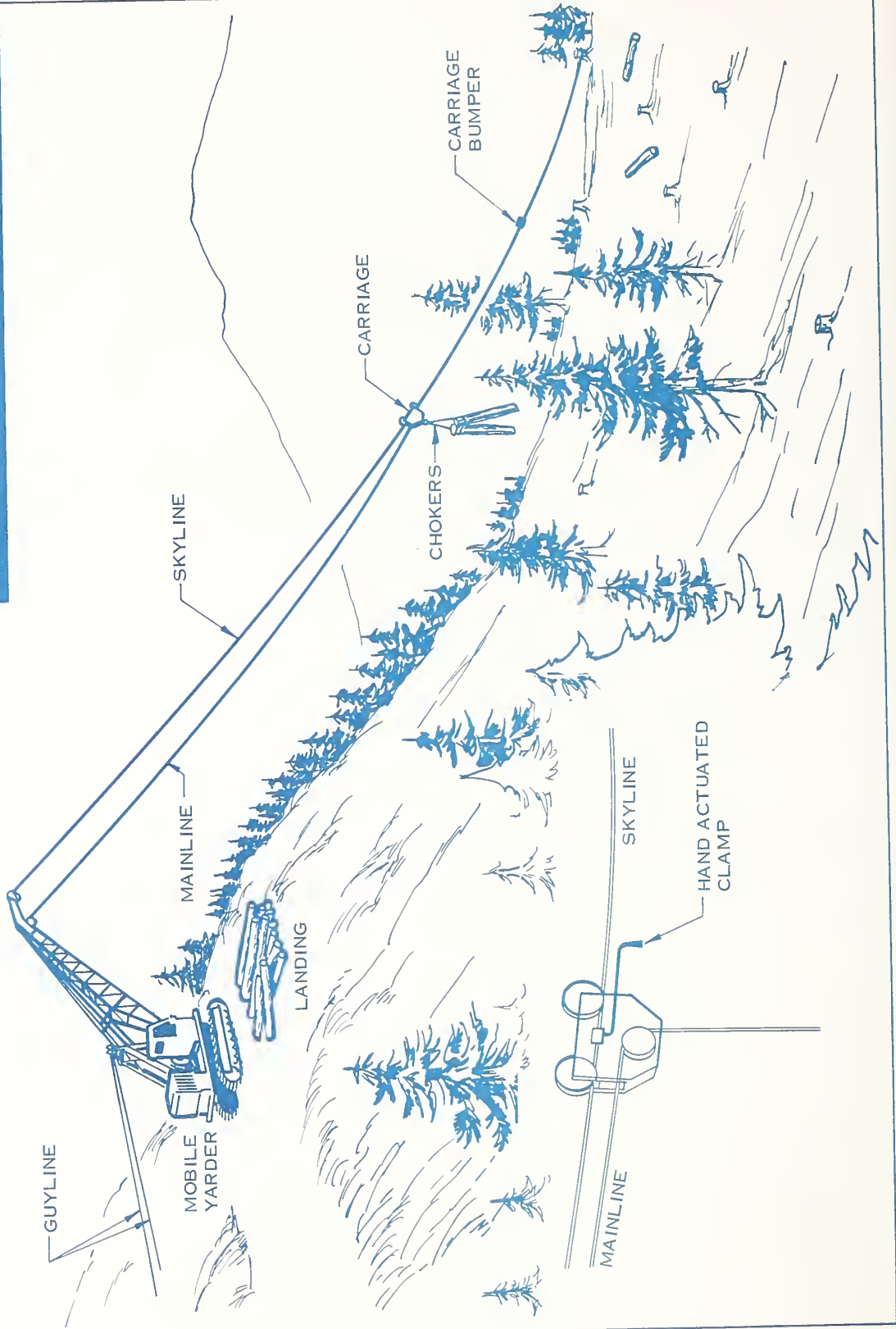

48.44b - Four drum yarder (plus straw drum)Yarding direction: Uphill and downhillCutting prescription: Clearcut and partial cutMaximum yarding distance: Small machine; 1200' to 1500' (depending on line size). Large machine; ± 2,000'Yarder description: Four-drum yarders were described under Section 48.35, Standing Skyline - Skidder. There are several makes of four-drum yarders.

They come in two size classes; a small machine for second growth and small mature timber, and larger machines for old growth.

Tower and undercarriage description: The small yarders have a 50' tower on a track, or rubber tired trailer mounted undercarriages. Two or three guylines are required.

The larger machines have 90' towers with six or 8 guylines. Undercarriages come rubber, track. or trailer mounted.

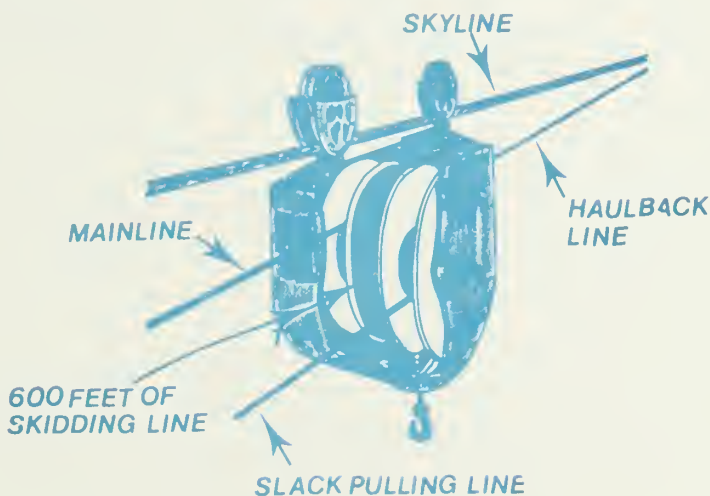
Carriage description: The machines readily operate a mechanical, non-clamping, slackpulling carriage (see below).MECHANICAL, SLACKPULLING, NON-CLAMPING CARRIAGE

Advantages

1. Wide skyline roads can be yarded (200' to 300').
2. Both clearcuts and partial cuts can be logged.
3. Fewer tail holds to rig.
4. Chokers can be pre-set.
5. Initial investment, maintenance and repair are a fraction of the costs for a radio controlled carriage.
6. The carriage can take rougher handling than a radio controlled carriage.

Disadvantages

1. The carriage lines occasionally foul.
2. Maximum yarding distance is less than for a radio carriage operated without a haulback.

48.45 - Live Skyline with Radio Controlled Grapple

System description: The carriage is returned to the woods by gravity or the haulback. The carriage is lowered over the log and the grapple is closed. The skyline picks up the carriage and log, and the main-line brings them to the landing.

Operational characteristics: There is no lateral capability. Only the logs directly under the carriage are picked up. Therefore, tree felling perpendicular to the skyline is important. A choker is usually attached to the carriage for the "hard to get" logs. Skyline roads must be rigged every 30 or 40 feet.

Advantages

1. Two man crew: spotter and yarding engineer.
2. Safety: the spotter is usually 50' to 100' from the log being grappled. There is no chaser.
3. It is possible to run a night shift, if flood lights are used.

Disadvantages

1. Cost of the carriage.
2. Narrow skyline roads.
3. Deflection is essential.

**LIVE SKYLINE with radio controlled grapple**

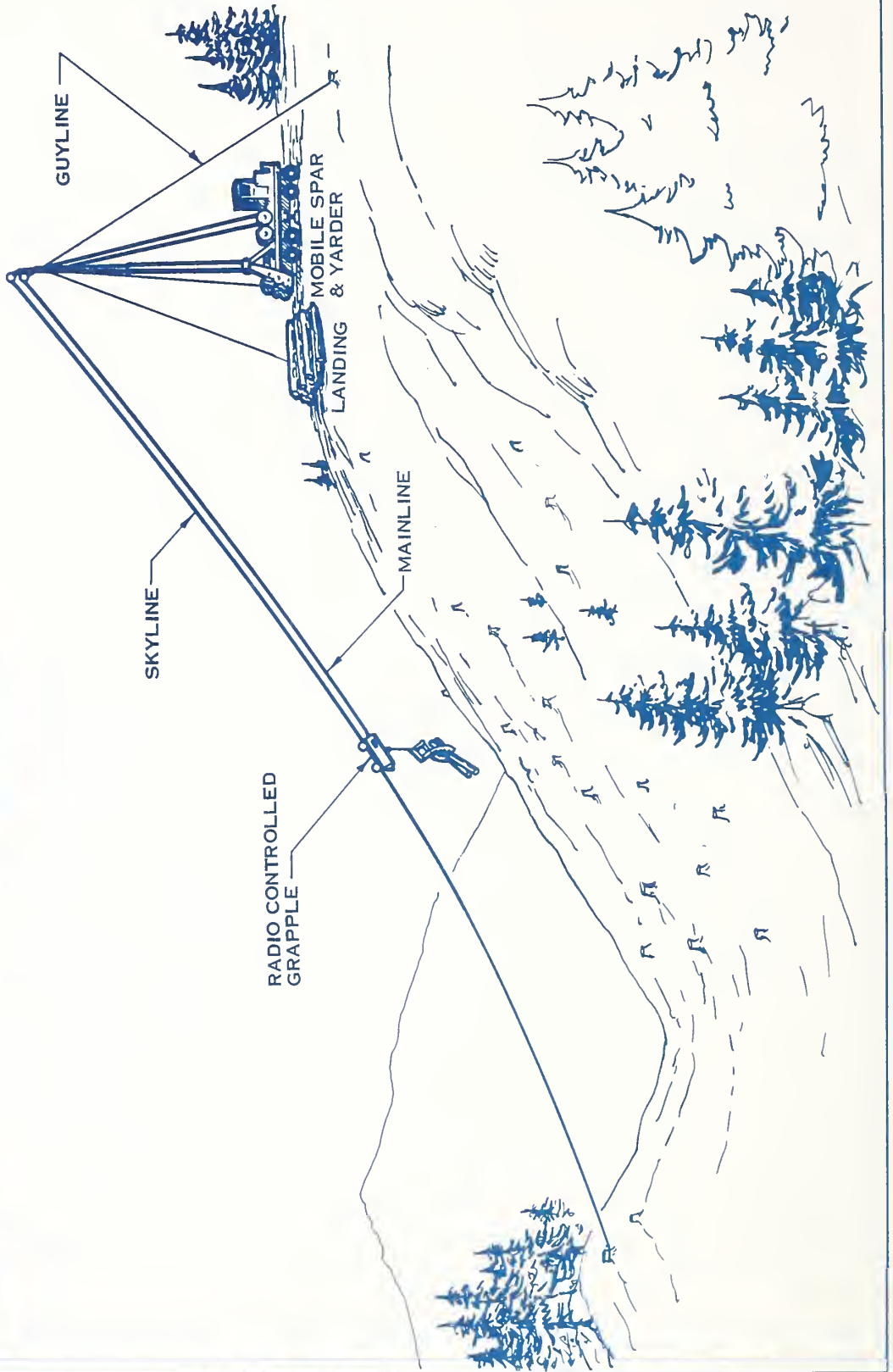

## 48.5 - Running Skyline

### 48.51 - System Description

A running skyline is a live skyline with the carriage riding on the haulback. In the running skyline system, the carriage is supported by the mainlines and the haulback, therefore these lines can be smaller in diameter than live or standing skylines, for a given payload. A comparison between the payload capability of a running skyline and other skylines can be made by comparing the breaking strength, the weight, or the cross section area of the lines.

Most yarders designed for running skyline operation have two mainlines that can operate together or independent of each other. The second mainline can be used to open or close a grapple; or to operate a mechanical, slackpulling carriage. A two-drum yarder can operate a running skyline system but there would be no lateral yarding capability. The chokers would be fastened directly to the carriage.

A 50' leaning lattice tower is commonly used with a running skyline. A mobile tail-spar may be employed to gain additional deflection. The yarders have two or three guylines, instead of the six to eight guylines normally needed by the larger portable towers. This makes them quite mobile and easy to move.

The undercarriage has either rubber tires or tracks and is generally equipped with a turn table on which the yarder and tower are mounted.

The machine can yard uphill and downhill.

### 48.52 - Requirements and Limitations

Most older running skyline yarders have a maximum yarding distance of approximately 1,000 feet uphill and 600 feet downhill. There are several newer running skyline yarders that can reach 1500' to 2000'.

The maximum haulback tension that a yarder is capable of developing may be less than the haulback safe working load. For instance, the maximum haulback tension a yarder is capable of developing may be twenty-five kips. If the breaking strength of the haulback is 100 kips (safe working load of 33 kips), the system is limited by the yarder to 25 kips.

### 48.53 - Operation

The success of the system is dependent on proper tensions in the lines. This may be accomplished through an interlock device on the yarder. This device maintains the proper relationship in drum speeds so the haulback line travels at the same speed as the mainlines. The interlock operates through gears or hydraulics. Reference 50-3 discusses the operation of an interlock.

Some of the newer interlocking yarders adjust the length of the running lines to the weight of the load. Their interlock system maintains a reasonably constant tension in the receding lines. This permits turns to be yarded to the landing with one end suspension. When skyline clearance increases the operating lines are lengthened as the constant tension in the receding lines isn't sufficient to fly the logs. When skyline clearance reduces the operating lines shorten, as the constant tension is sufficient to permit one end suspension.

Interlocking yarders utilize the energy which holds back the outwinding drum to help rotate the inwinding drum. This is much more efficient than keeping tension in the haulback by riding the haulback brakes. This latter procedure is hard on band brakes.

A slackline yarder isn't suited to operate a running skyline system that requires two mainlines. The mainline and haulback drums are not synchronized to wind in and out, in the same direction, at the same rate of speed. Also, the skyline isn't interlocked with the mainline and haulback. It would be possible to operate a slackline yarder in a running skyline configuration by using water-cooled brakes to maintain line tension but it wouldn't be efficient.

A two-drum yarder can be converted to operate a running skyline by splitting the main drum with a separator. One mainline is run through a hydraulic line shortener to operate the yo-yo-line. This hasn't been a common practice.

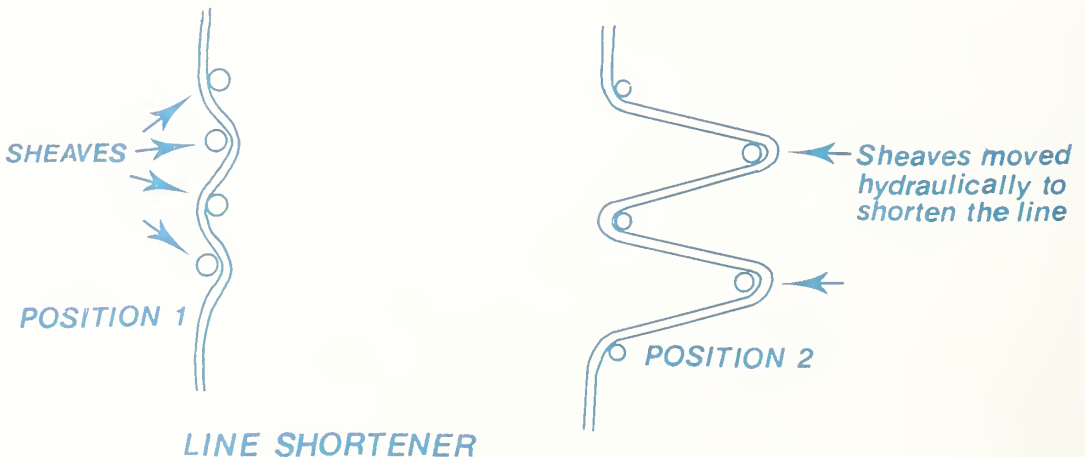



An extension can be added behind the tail block on a running skyline to permit using a distant anchor to gain deflection. The tail block may have to be secured to keep it from wrapping the operating lines. This extension does not increase yarding distance.

A running skyline mobile yarder, with a swinging boom does not require a large central landing. It can work its way down a road, decking logs alongside as it proceeds.

Tying up, the strawline is strung to the tail hold and back. It then pulls the haulback to the tail hold and back.

Roads are changed the same as with the flyer system.

State safety codes state that the running (Grabinsky) skyline system shall not be anchored directly to the tail tree. At least one additional block shall be rigged behind the tree.

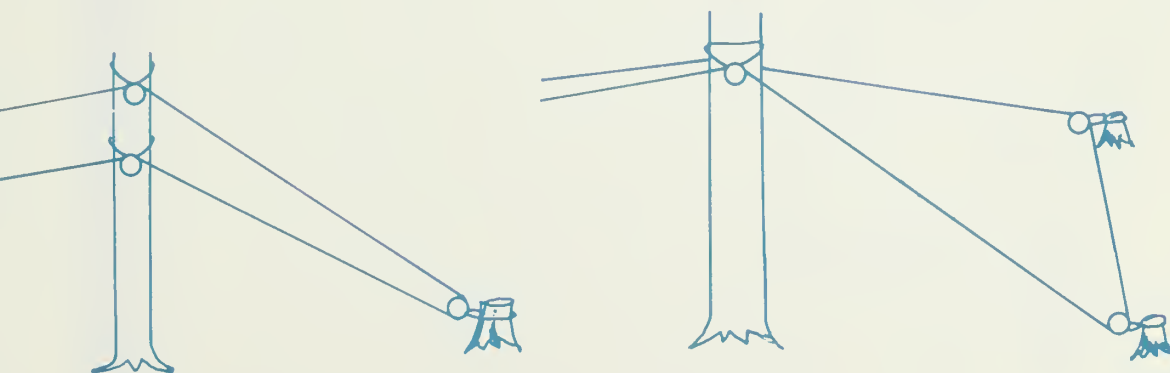
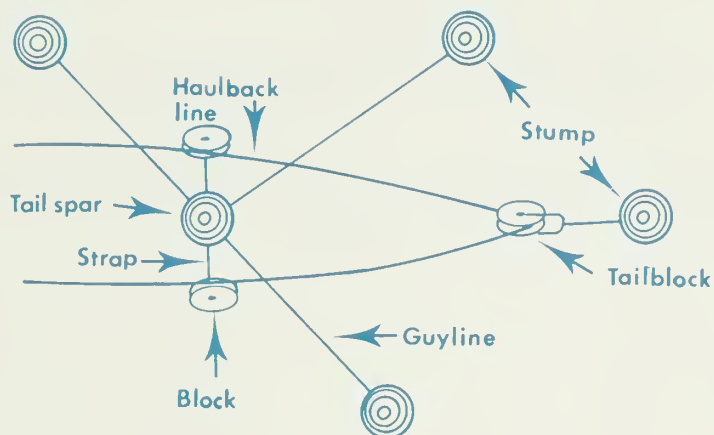

THREE POSSIBLE RUNNING SKYLINE TAILHOLD LAYOUTS

48.54 - Grabinsky

A Grabinsky is a running skyline operated by a high lead yarder. It has no lateral yarding capability. Tension is maintained by riding the haulback brakes, or by an interlock.

Yarding direction: Uphill or downhill.

Cutting prescription: Clearcuts

Maximum yarding distance: 1,500 feet uphill, 600 feet downhill.

System description: A block rides on the haulback line and is shackled to the high lead butt rigging. The system operates similar to the highlead, except that braking the haulback provides some additional lift to the logs. This provides better control for downhill yarding.

Water-cooled disc brakes are superior to band brakes in operation of the system due to band brake wear.

Riding the haulback brakes to maintain line tension reduces effective yarding horse power and increases fuel consumption.

A Grabinsky is a good system to use to meet a log suspension requirement when there is a corner requiring downhill yarding in a unit that is otherwise suited to flyer logging.

**RUNNING SKYLINE with chokers** (GRABINSKI)

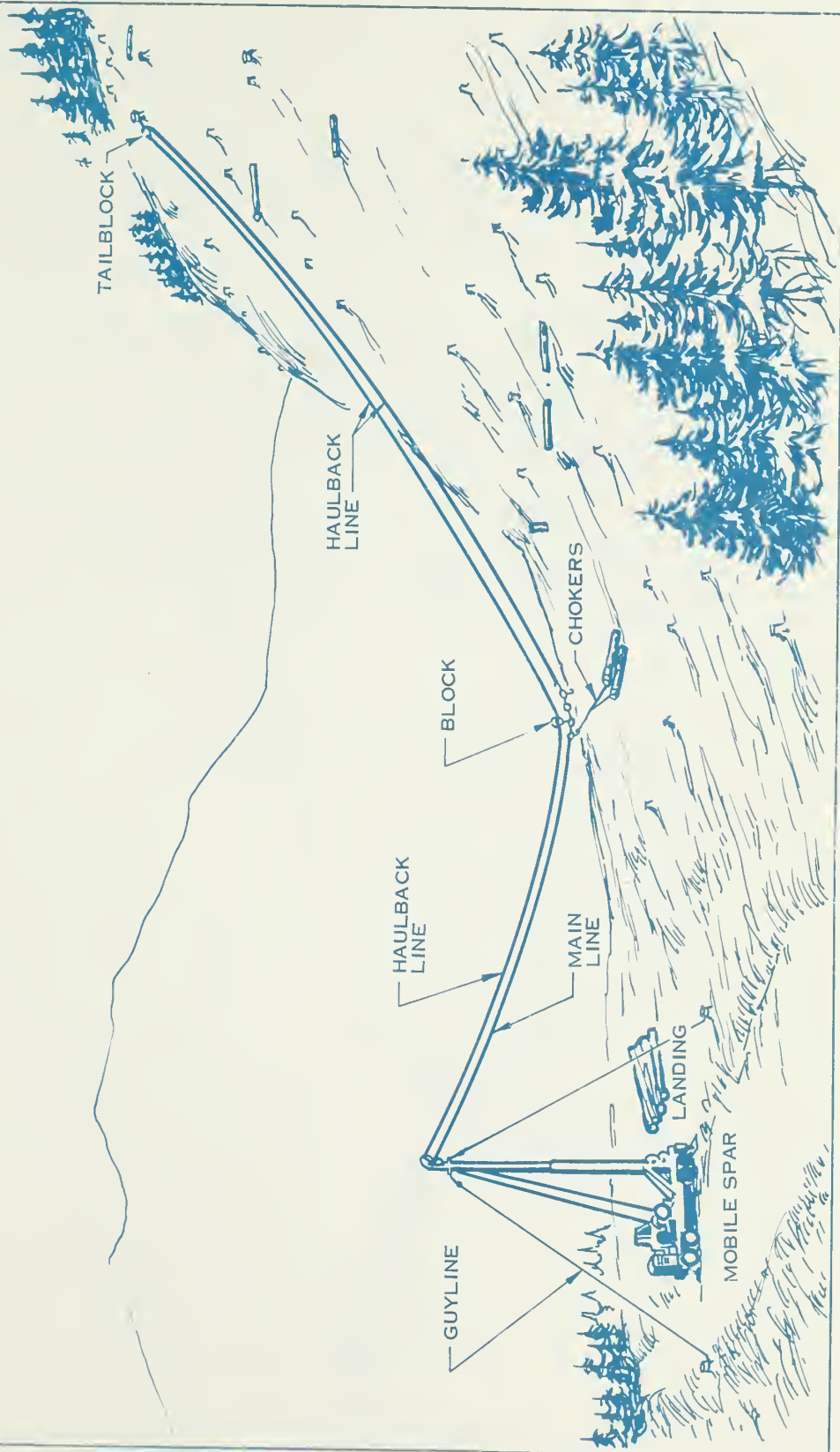

48.55 - Running Skyline with Mechanical Slackpulling Carriage

Cutting Prescription: Thinning, overstory removal, or clearcut.

Maximum yarding distance: 1,000-2,000 feet depending on the particular yarder.

Yarder description: The skidding line is either stored in a drum in the carriage, or attached to the mainline as shown below. In either case, the slackpulling line, or lower mainline, is used to pull out the skidding line, and the upper mainline is used to pull the turn of the logs in to the carriage.

System description: The carriage is pulled back to the brush with the haulback line. It is held in place by the haulback while the lateral skidding is accomplished. The two mainlines are operated in opposite directions to pay out the skidding line. The directions are reversed to pull in the skidding line. The turn of logs is brought to the landing by pulling on both mainlines.

Lateral yarding distance may be limited by the connection (swivel, shackle, etc.) used to join the mainline with the skidding line if the connection can't pass through the yarder fairlead. Another limitation is the undesirability of wrapping the connecting hardware on the mainline drum.

# RUNNING SKYLINE with mechanical slack pulling carriage

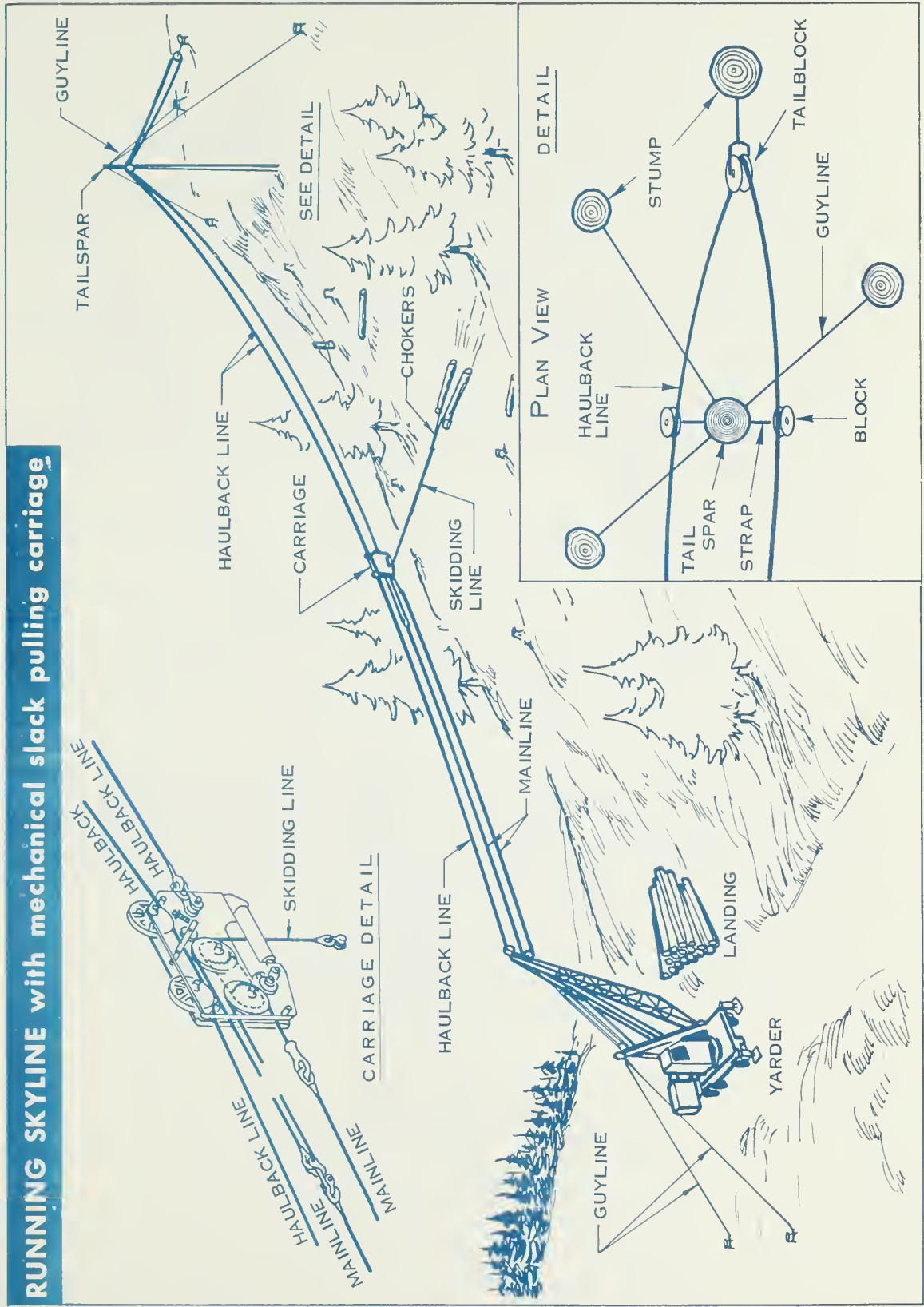

48.56 - Running Skyline with Mechanical Grapple

Yarding direction: Uphill or downhill

Cutting prescription: Clearcut

Maximum yarding distance: 1,000-2,000 feet depending on yarder.

Yarder description: The yarder has three operating drums: a haulback and two mainlines. The grapple operating line is shackled to one mainline.

Carriage description: The mechanical grapple carriage is held in place with the haulback line. One mainline acts as a grapple-opening line the other pulls the carriage to the landing. The grapple closes under its own weight. Power-closing grapples are available.

System description: A spotter in the brush radios the yarder-engineer instructions on when to lower the grapple and close it. The spotter is also responsible for moving the tailblock, which is usually mounted on a crawler tractor.

Operational characteristics: The swing-boom type yarder has three advantages over the fixed-tower type yarder:

1. It is easier to position the grapple over the logs.
2. Hangups are reduced during inhaul by swinging the boom.
3. Logs can be landed and decked to the side of the yarder, instead of directly in front.

Two men are needed for yarding. The crew consists of a yarder operator and a spotter in the brush, who remotely positions the grapple over the logs to be yarded. With lights mounted on the spar of the yarder, grapple yarding can be continued at night. Night production generally has been equal to daytime production (150 to 200 pieces per shift) because the day crew prepares the area for the night shift.

The running skyline grapple system with a 1,000-foot reach is compatible with future management activities. Lightweight equipment used for thinning requires the same road and landing development.

**RUNNING SKYLINE with mechanical grapple**

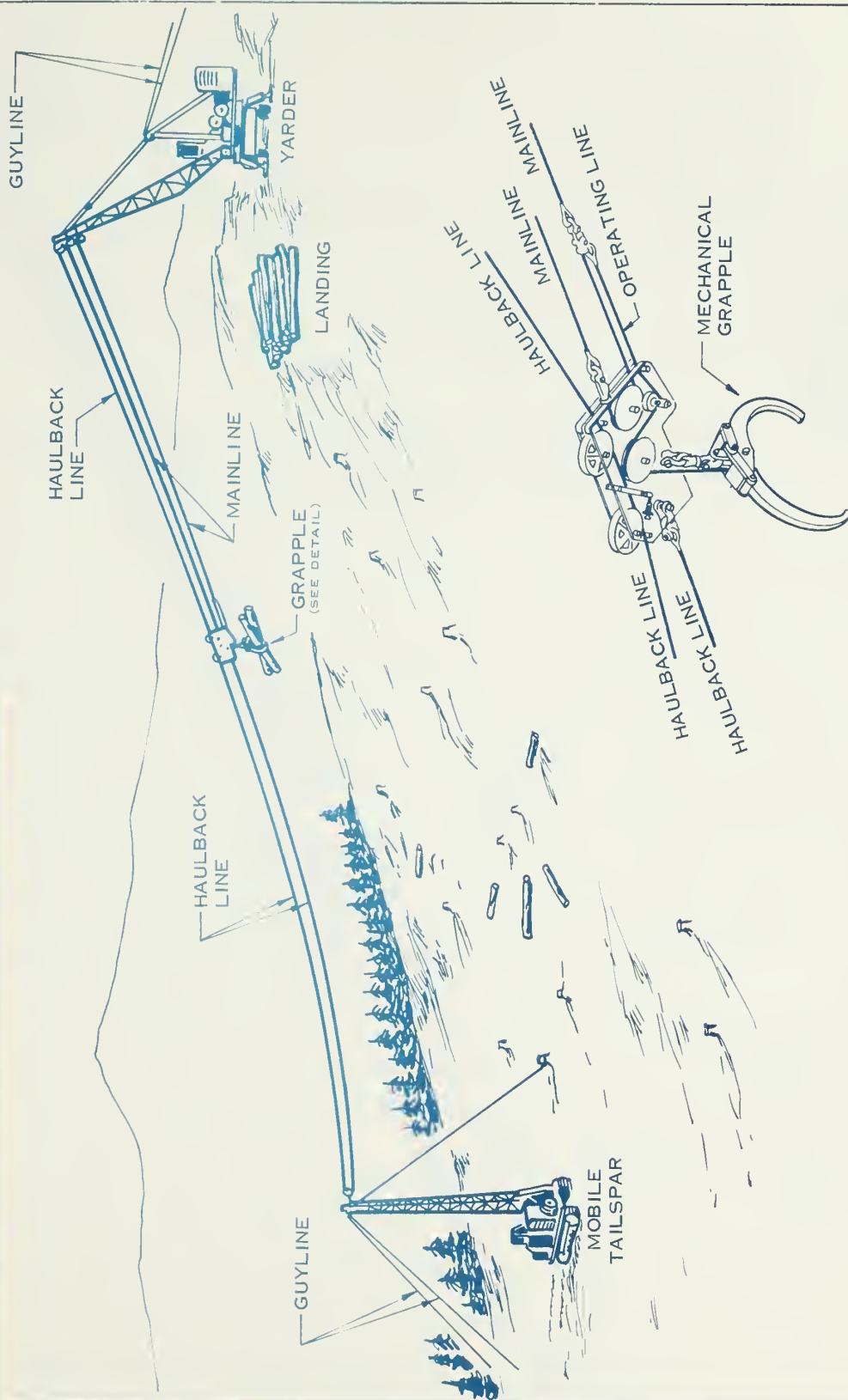

DETAIL

48.57 - Running Skyline with Radio Controlled Grapple

Yarding direction: Uphill or downhill

Cutting Prescription: Clearcut

Maximum yarding distance: 1,000-2,000 feet depending on yarder.

Yarding description: A two-drum, highlead yarder can be used if it has sufficient drum brakes or an interlocking device to maintain line tension to suspend the logs.

Carriage description: The carriage contains power; engine, batteries or mechanical device, to operate the grapple. The power is remotely-controlled by radio.

System description: The carriage is returned to the brush by the haulback line and lowered over the log. The spotter radios the yarder engineer when to stop and lower the carriage. The spotter's radio also controls grapple opening, closing and rotation.



**RUNNING SKYLINE with radio controlled grapple**

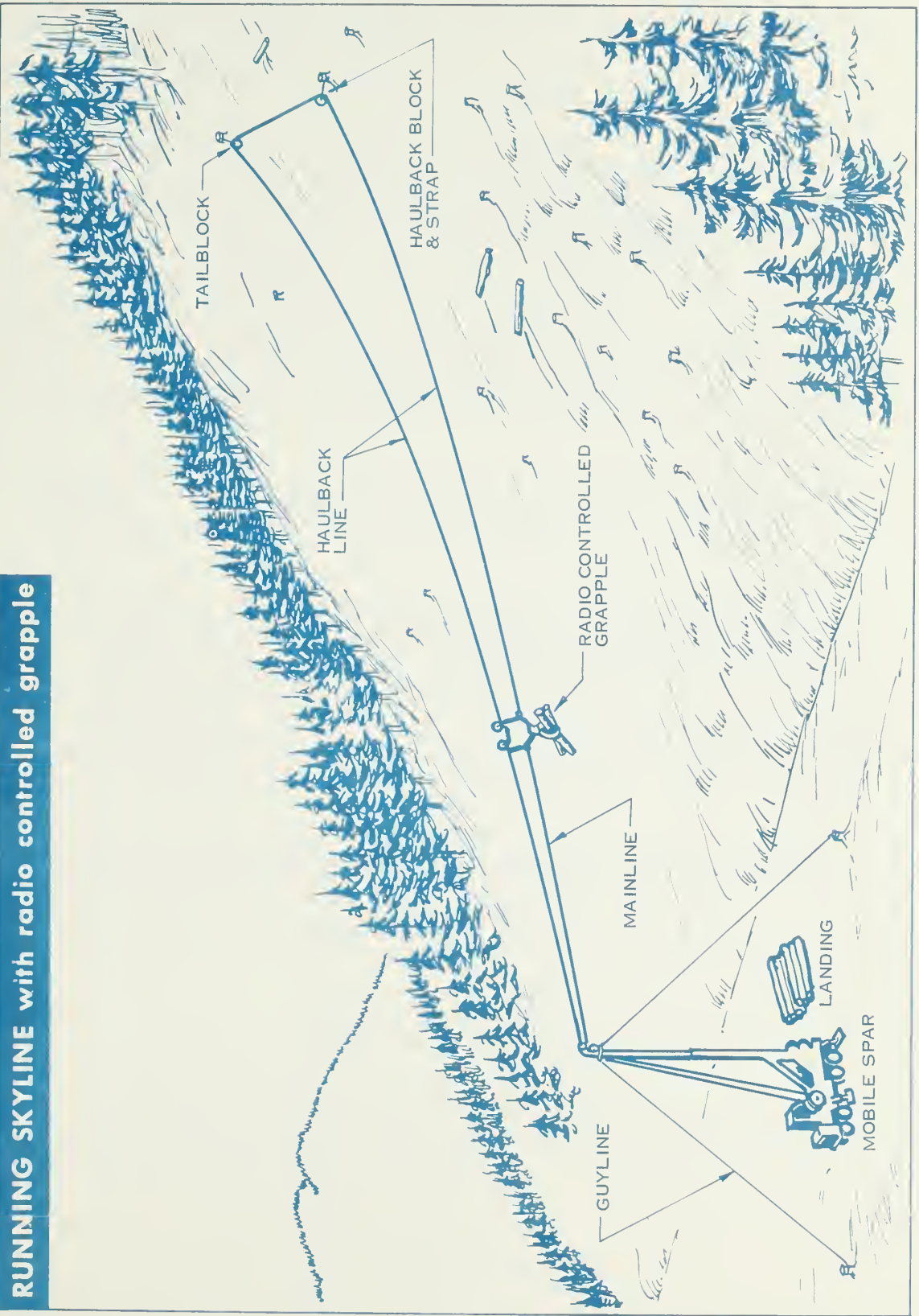

## 48.6 - Cable Swings

McCulloch, in "Woods Words", defines swing as "taking logs to a landing from a distant tree to which they have been yarded".

Proposed swing landings and the proposed route for moving a yarder to the landing must be field checked.

Logs should be swung flying clear of the ground, unless a small volume is involved and the impact of dragging logs is acceptable. Dragging logs has generally proved to be unacceptable because of the ditch formed when yarding a large volume down the same road.

Deflection must be checked to make sure it is adequate. A ground profile should be run unless the swing is across a draw and deflection is obvious. Yarding across a draw generally gives more deflection permits longer swings, and eliminates the ditch problem.

A wood spar will have to be used if a tower cannot be moved across country to the proposed landing.

Track mounted tower yarders, triple drum yarders (tractor rigged with high lead drums) and sled yarders have all been moved across country to swing landings. Track mounted tower yarders have been moved down  $\pm$  30% slopes on prepared roads.

In the past, sled yarders have been moved up and down slopes that many present day yarding engineers refuse to traverse and State Safety Inspectors would frown on. At that time, it was a way of life if the timber was to be yarded. Today it seems reasonable to assume a sled yarder could be moved up and down slopes equivalent to those that have been fire trailed by tractor in the recent past. This would be slopes up to 60 percent or 65 percent. An occasional short 70 percent pitch might be acceptable, terrain being otherwise favorable.

When moving uphill, the mainline is run through a fairlead on the front of the sled (see Fairleads, Section 46.16) and up to a stump where it is secured. The haulback is run through a fairlead on the front of the sled, back under the sled and then it is anchored to a stump behind the sled. The mainline pulls the sled ahead and the haulback helps hold the sled in position.

When moving downhill, the line behind snubs the sled down while the line in front controls the direction of travel.

With the trend to small patch clearcuts, there are going to be increasing numbers of moves with sleds on the ground instead of on down timber. In these cases, stumps on the sled road will have to be cut as low as possible. The yarder road must be wide enough to safely

accommodate the yarder. On steep slopes this means full bench width, if the yarder is to be moved across the slope. Yarders have least impact when they are moved straight up and down slopes. When moves are planned straight up and downhill sharp topographic breaks may have to be smoothed out.

A right-of-way wide enough to accommodate the yarder must be felled if the sled is to be moved through standing timber.

Both tower mounted yarders and sled yarders are limited in the amount of side tip they can tolerate. A level road will have to be built if a tower mounted yarder has to be moved across slopes steeper than +15 percent. A sled mounted yarder could probably be moved across slopes up to +25 percent.

Generally, it isn't possible to get a tractor to the site to build a swing landing, therefore, it is desirable to find a flat or gentle area in the desired location. There have been cases where trees were felled behind high stumps to build a crib to level the yarder.

If there isn't enough suitable decking area, the logs will have to be swung hot.

If ground conditions permit, it may be desirable to use a tractor to help snub a sled on steep slopes.

There are very few triple drums, sled yarders, and sled yarder engineers left. However, an economic analysis would probably show that cable swinging is considerably cheaper than helicopter yarding and swinging should be a viable logging alternative.

Slack line sled yarders are scarcer than high lead sled yarders. However, this should not be a deterrent if a logging and economic analysis show a slack line sled yarder is the best way to go.

The swing yarding system must be capable of reaching the decked logs which may be on the opposite side of the spar tree from the swing yarder. This can be done with the following systems:

- North Bend
- South Bend
- Bight Up
- Tyler
- Skidder
- Slack Pulling Carriages

If logs are being swung from, or to, a deep draw the skyline may be too high in the air to pick up, or land, logs if a standing skyline is used. Therefore, the feasibility of swinging with a live skyline may have to be checked out.

See Section 42.8 for a discussion of swing landings and a possible swing system layout.

If cold decks are proposed, State Safety codes require that it must be feasible to place logs in, and remove them from the cold deck in a straight and orderly manner which will eliminate, as far as possible, the hazards from rolling and shifting logs. There must be enough flat ground to safely hold the cold deck volume.

Balloon yarding might be competitive with swinging if ground conditions and yarding distance permit balloon yarding.

Skyline logging with intermediate supports may be an alternative in some cases, however, multispans also have limitations. See the write up on multispans in Section 48.7.

#### Advantages

1. With the high cost of road construction, it will often be cheaper to swing logs than to build some tough road.
2. A swing may have less environmental impact than tough road construction.
3. Swinging can reach some timber that is not accessible by road.

#### Disadvantages

1. Opportunity for intensive management is reduced.
2. Deflection for swinging clear of the ground is not always available.
3. It's not always possible to move the sled to the desired location.

## 48.7 - European Systems and Multispan Skylines

European skyline systems are often used with intermediate supports. Therefore, multispan skylines will be included in this section on European systems.

When deflection on a single span skyline is inadequate to carry an economic payload, it may be possible to raise the skyline at the critical point to obtain the necessary deflection by using an intermediate support.

Multispan logging started in this country on the Okanogan National Forest about 1955. Between 1959 and 1962, multispan sales were operated at Cascade Head (Siuslaw NF), Blue River (Willamette NF), Jefferson Creek (Olympic NF) and Viola Creek (Mt. Baker-Snoqualmie NF).

To date, the Okanogan and Wenatchee Forests are the only Forests that have developed a continuing multispan skyline program.

MULTISPAN SYSTEM

Yarding direction: Downhill. Uphill yarding may be accomplished if the angle across the intermediate support is not too great. If there is slack in the lower span, the loaded carriage has trouble riding up and over the intermediate support.

Carriage description: The carriage must have open-sided sheaves so that it will pass across the intermediate support. If the carriage clamps to the skyline, the skyline clamp must swing away from the skyline.

System description: Most of the European Systems can be rigged for multispans operation. Production is decreased because the carriage has to be slowed down to cross the intermediate support. The squirrel carriage slackpuller, a block hung on the skyline to which the mainline is attached, is used to keep the belly out of the mainline to facilitate pulling slack by hand. See the second figure below.

EUROPEAN SKYLINE SYSTEM (Wyssen and Baco)

Yarding direction: Downhill, may yard uphill if distances are less than 2,000 feet.

Cutting prescription: Overstory, shelterwood, clearcuts.

Maximum yarding distance: 4,000 to 5,000 feet.

Yarder description: A single drum which stores the mainline is powered by a diesel engine which ranges in horsepower from 15 to 200. An air fan on the yarder is used as a braking force to retard the load down the skyline to the landing.

Tower and undercarriage description: The yarder is sled-mounted. Spars are rigged trees. The yarder is designed to pull itself up the hill with its mainline.

Carriage description: The carriage is either mechanically or hydraulically operated. It clamps to the skyline and allows the mainline to be pulled through it. The butthook on the end of the mainline locks into the carriage and releases the clamp. The carriage operates on an automatically-timed cycle.

Crew size Four or five men.

System description: The yarder acts as a snubber to lower the carriage and turn of logs to the landing. Once the carriage reaches the landing, it must go through an automatically-timed cycle to clamp it to the skyline and lower the logs to the ground.

Operational characteristics: Used mainly as a downhill system because the yarders do not have enough power to bring the logs uphill. Lateral yarding is accomplished by pulling the mainline through the carriage.

#### 48.71 - Present Equipment

##### 48.71a - American Equipment

Several American carriages can be modified by changing the sheaves to open sided sheaves, to permit them to pass an intermediate support.

One U.S. manufacturer has a radio controlled slackpulling carriage with open sided sheaves.

Many American built yarders can operate, or be adapted to operate, a multispan skyline.

If available equipment can be adapted to fit the requirements of a proposed sale, it would be reasonable to design and appraise for American built equipment. This has the advantages of more readily available maintenance and repair services and the familiarity of American workers with the equipment.

##### 48.71b - European Equipment

European skyline systems are basically of two types: (1) Gravity-operated systems lowering the turn of logs down the skyline to the landing with the yarder usually placed at the top of the setting, and (2) endless line systems allowing the yarder to be placed at either top or bottom of the setting with the turn of logs being yarded up or downhill. Carriages operated with an endless operating line are equipped with mechanical slackpulling devices. The endless line is wrapped around a parabolic drive pulley referred to as a "cat head". It, in turn, drives a skidding line drum allowing the skidding line to either be paid-out or wound-in during lateral skidding.

European carriages are held in place on the skyline by either a skyline clamp (Wyssen or Baco) or a stop which is clamped to the skyline (Vinje). The one exception is the Jobu, which operates with two endless lines; one for the skidding line operation, the other to move and hold the carriage.

EUROPEAN SKYLINE SYSTEM

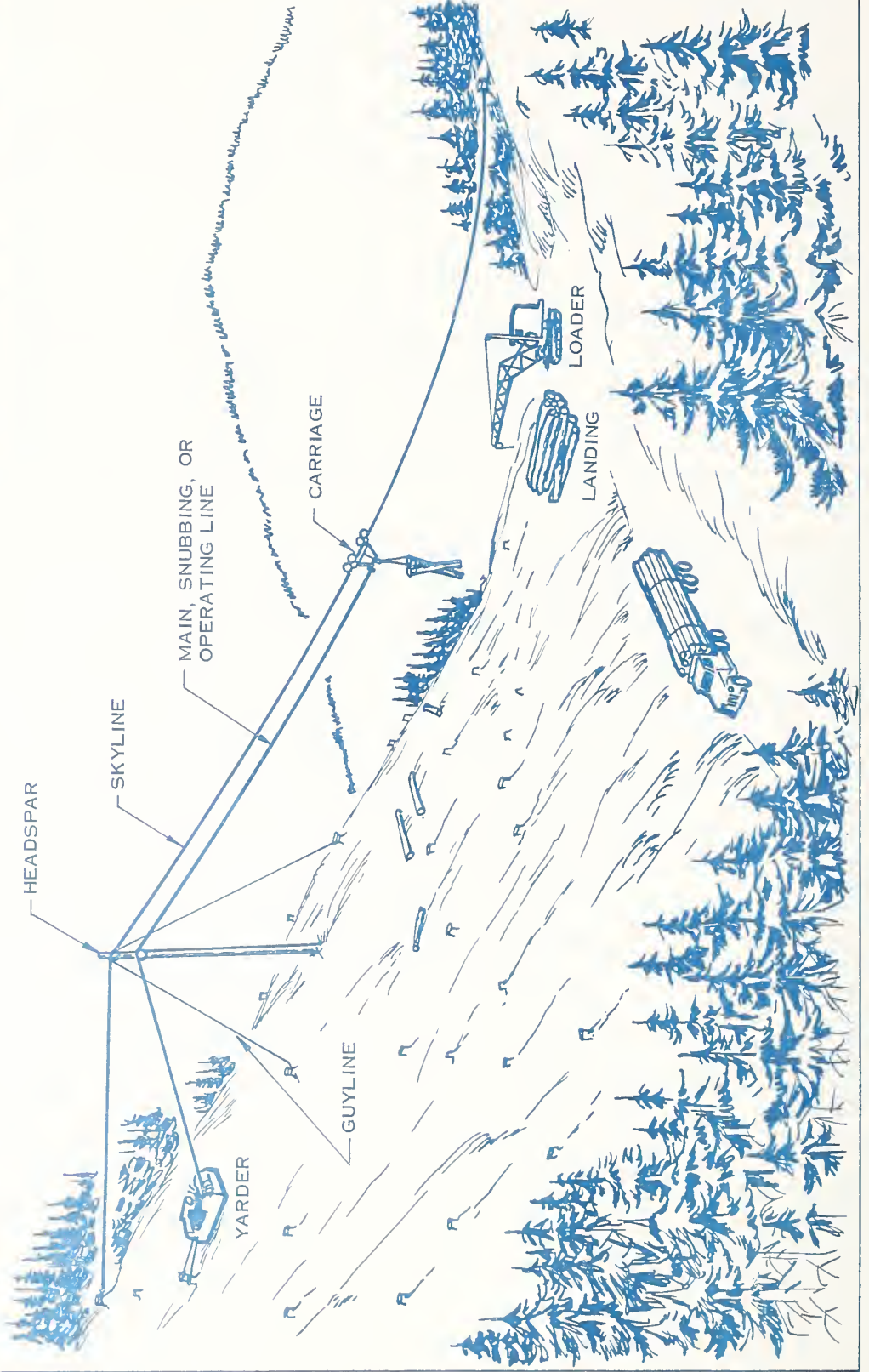



# MULTISPAN SKYLINE

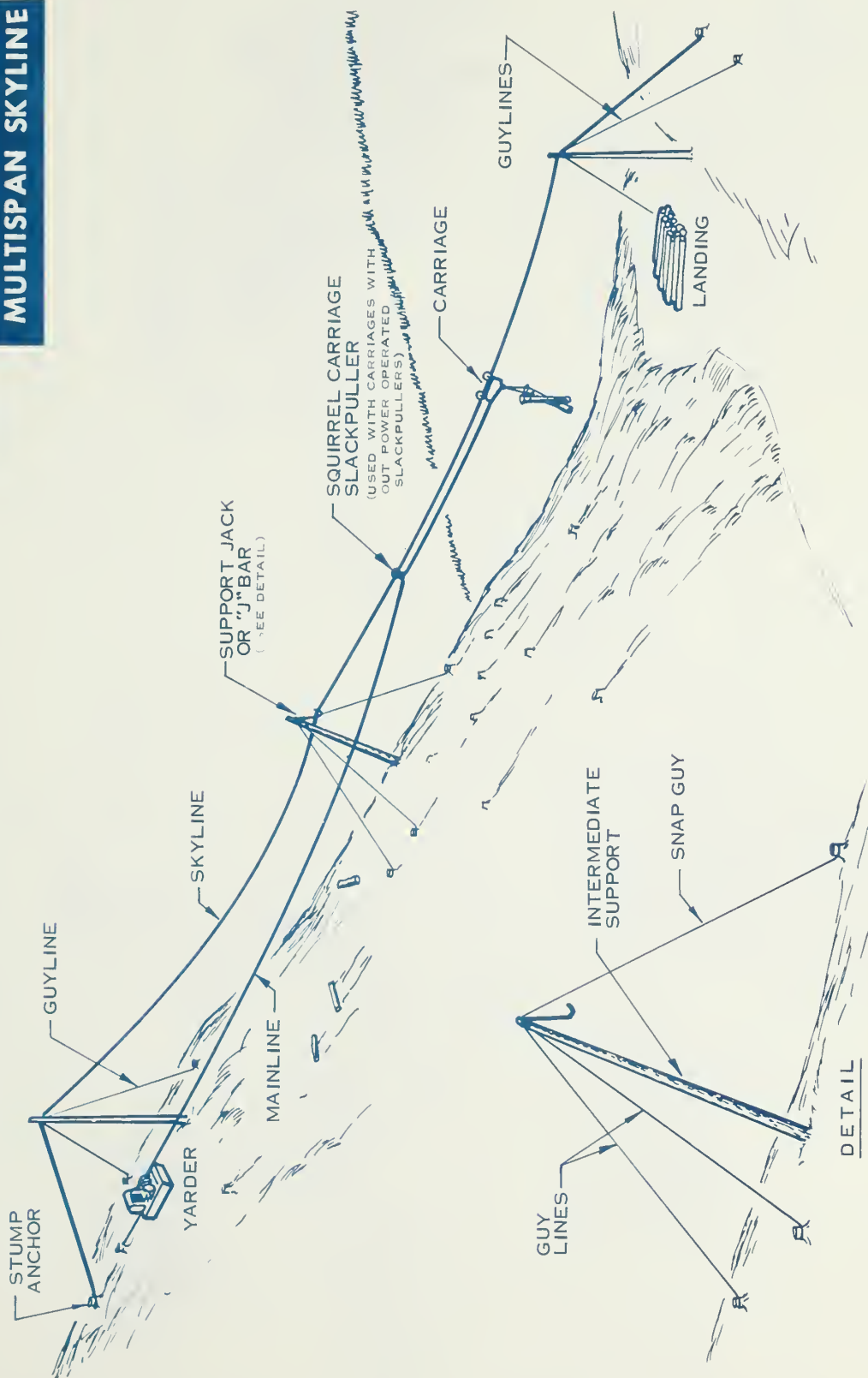

# SWISS YARDING SYSTEMS

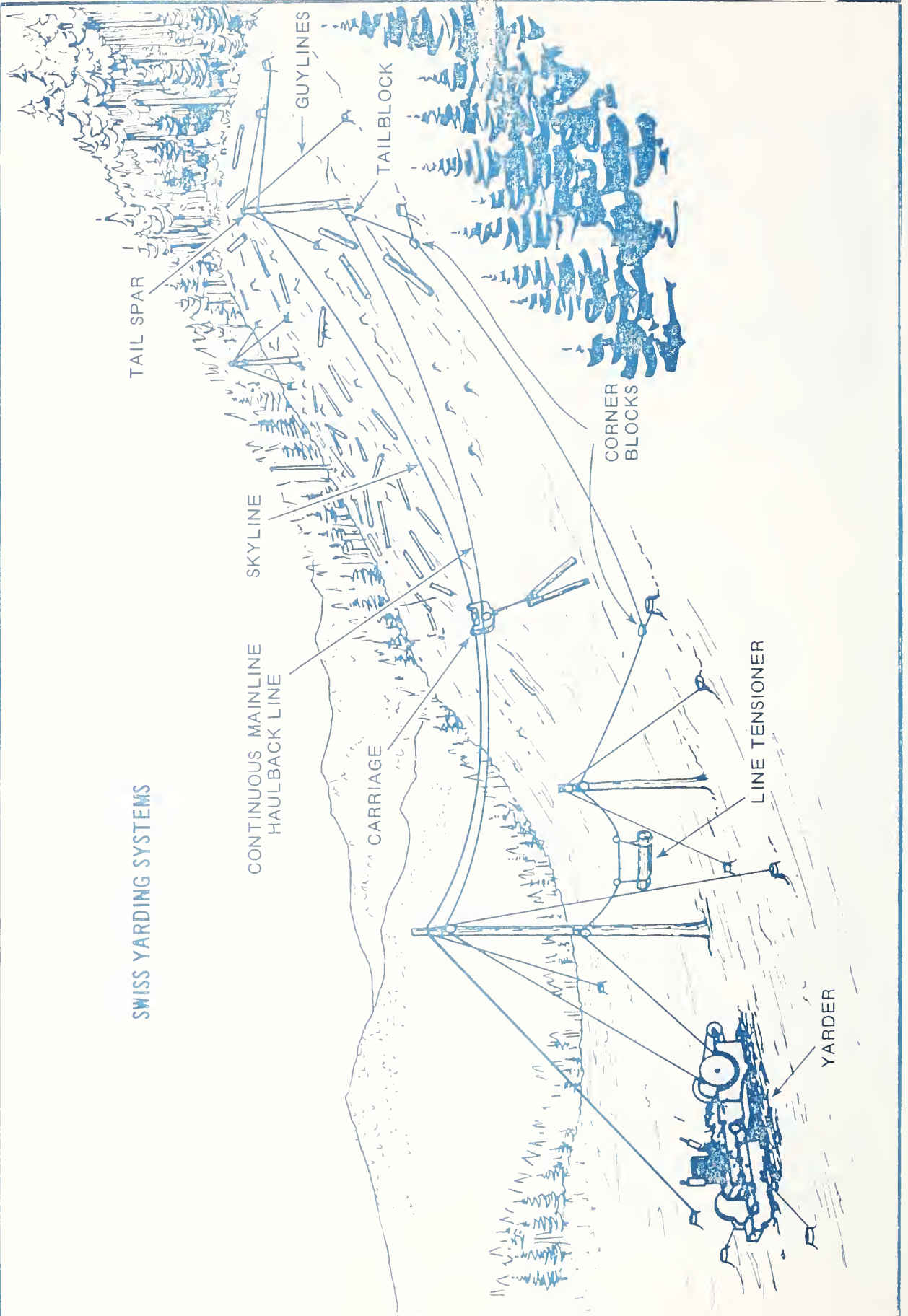

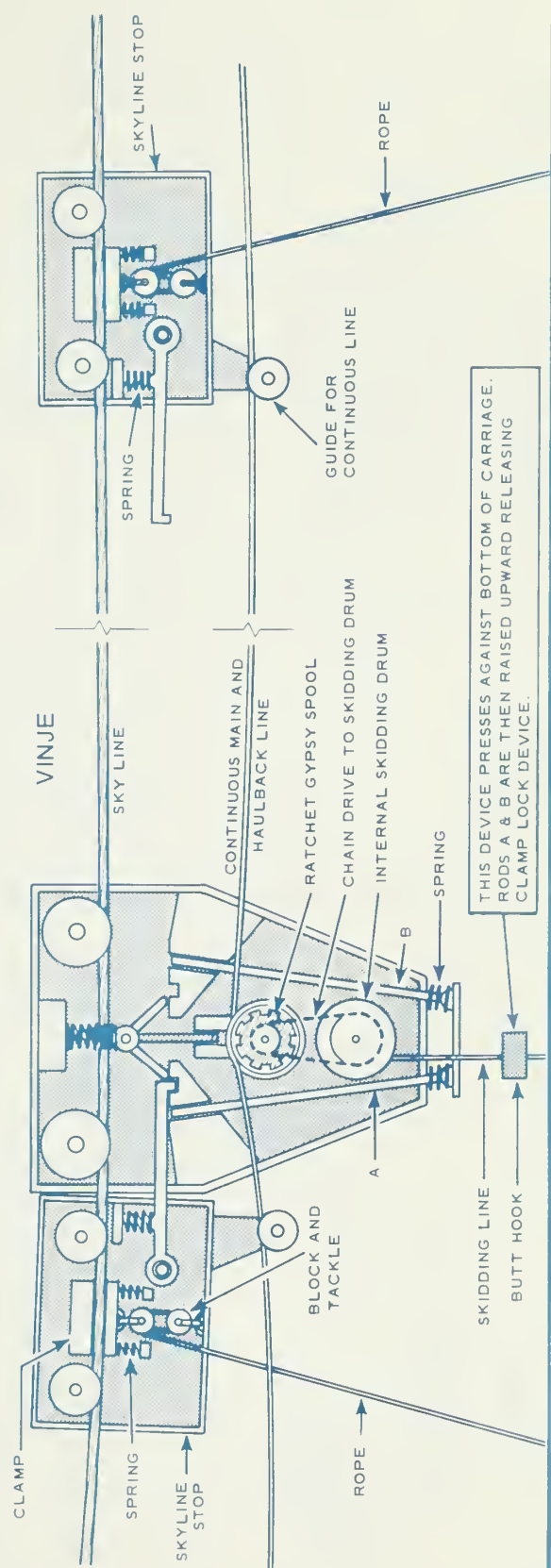
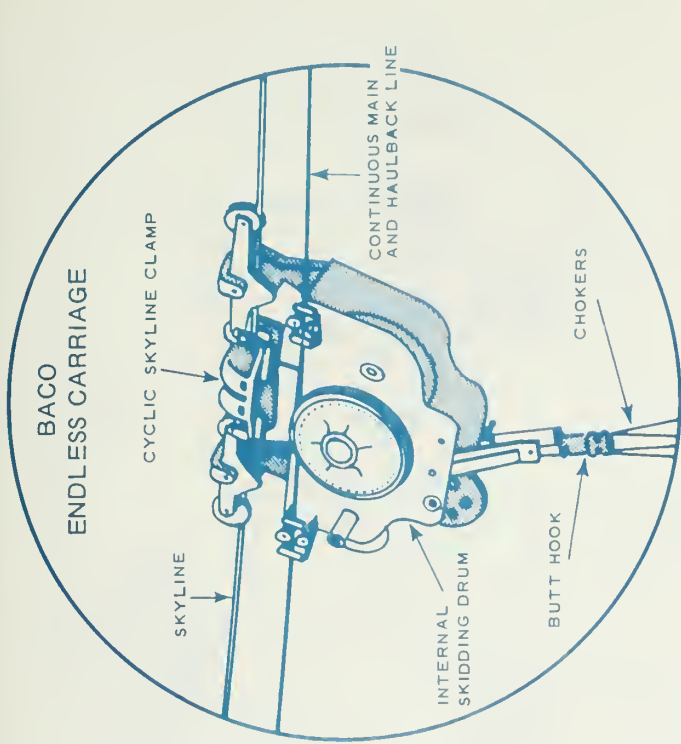
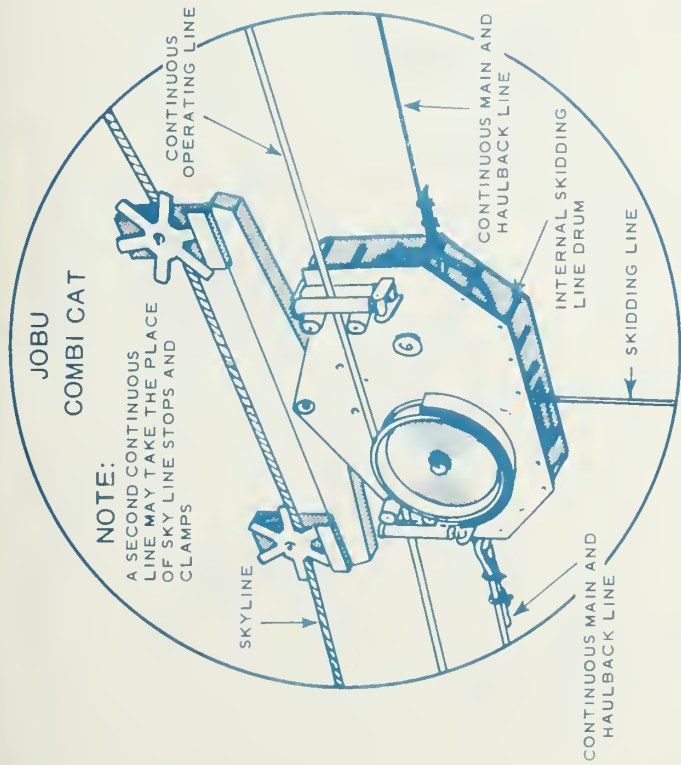

# VINJE Norwegian Cable Crane With One Endless Line

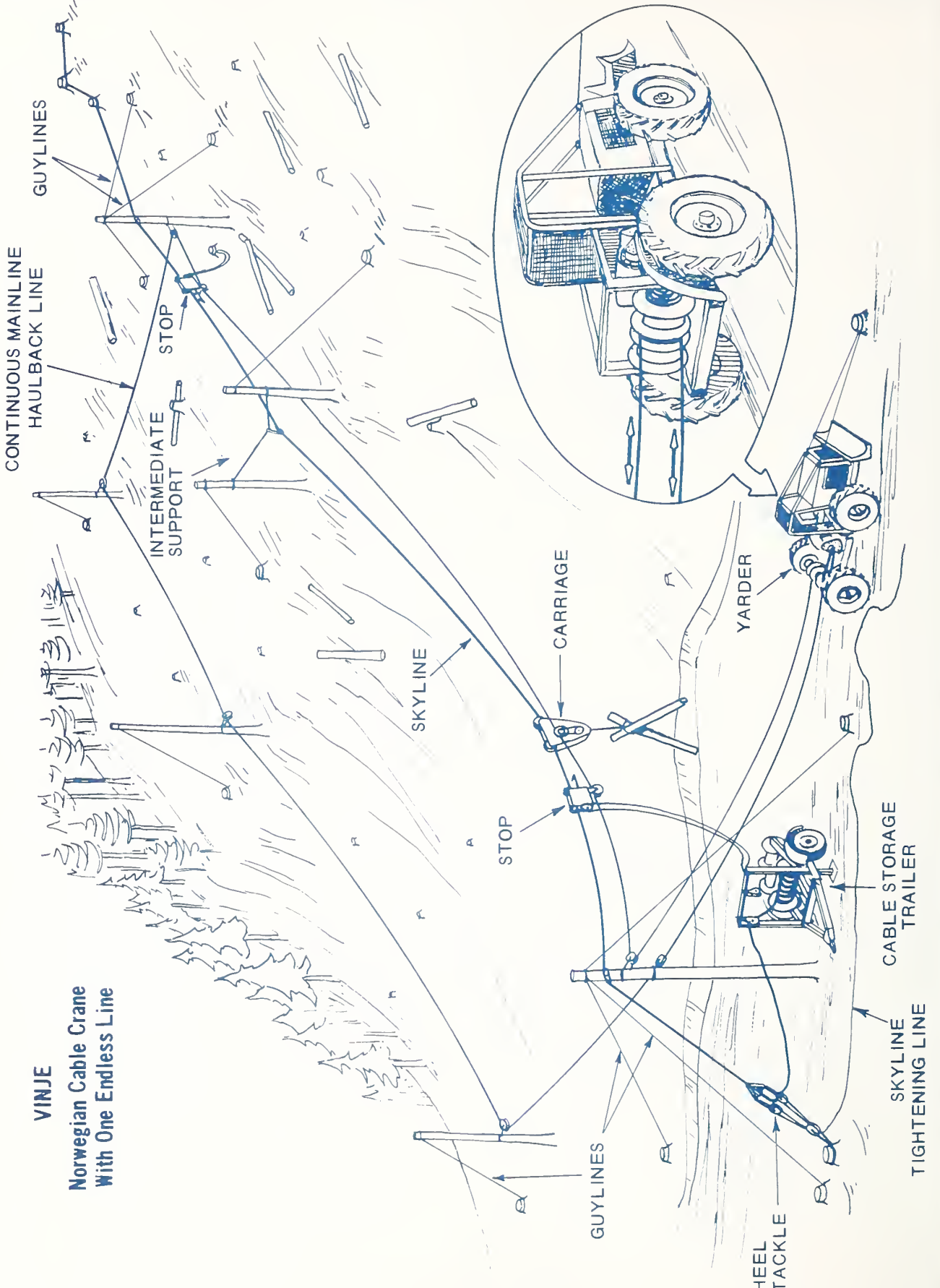

# Norwegian Cable Crane With Two Endless Lines

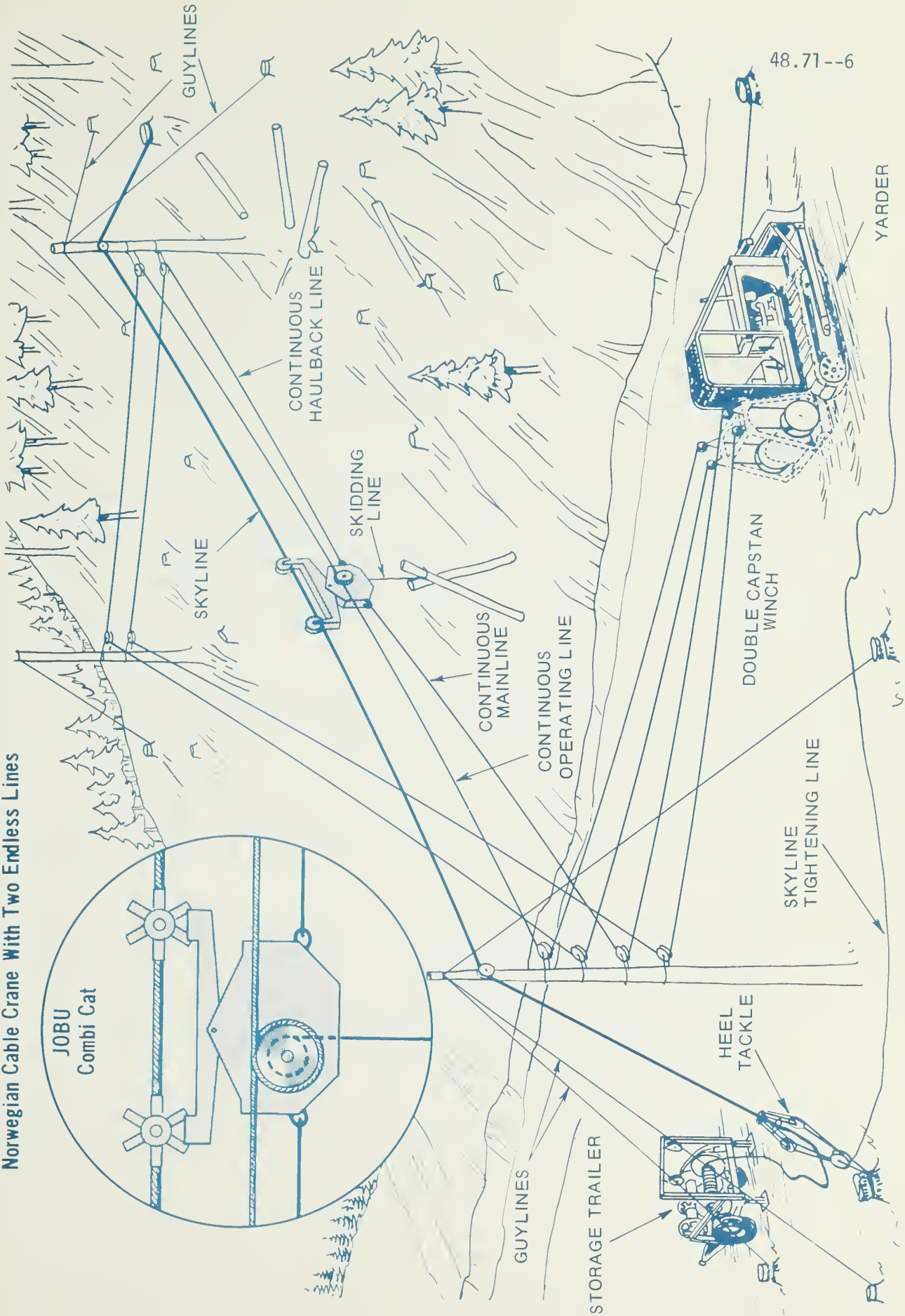

JOBU  
Combi Cat

GUYLINES

CONTINUOUS  
HAULBACK LINE

SKYLINE

SKIDDING  
LINE

CONTINUOUS  
MAINLINE

CONTINUOUS  
OPERATING LINE

DOUBLE CAPSTAN  
WINCH

SKYLINE  
TIGHTENING LINE

HEEL  
TACKLE

GUYLINES

STORAGE TRAILER

YARDER

Carriages that clamp to the skyline also have a locking device on the drive mechanism to the skidding line. When the carriage is clamped, the lock is disengaged, allowing the endless line to be moved in either direction, rotating the skidding line drum to either pay out or wind in the the skidding line.

Yarders used for endless line operation have one operating drum with a grooved or capstan-type drive assembly. The yarder may be located at any position and, if enough power is available, logs can be yarded uphill as well as down. The Swiss yarding systems (Wyssen and Baco) were originally designed to be used as gravity systems, however, the yarders may be converted to the endless line system. Skyline sizes may be one-inch, or larger and the endless line, depending on size of yarder, ranges from 3/8-inch to 9/16-inch diameter. Rigging these systems requires splicing the endless line for each setting. Also, the proper tension must be maintained in this line.

Initially, the endless line is tensioned by moving the yarder until the line becomes tight. During operation, tension may be maintained by suspending a weight, usually a log, on the line. Baco and Wyssen equipment are functionally the same except in the carriage clamp device functions. Baco's clamp is operated mechanically, while Wyssen's clamp combines hydraulic and mechanical operation. Yarding distances range up to 5,000 feet. If access is not available to the back end for rigging, small helicopters may be used to drop the strawline and blocks.

Norwegian yarders (Vinje or Jobu) are controlled remotely by radio or by remote cables similar to those used to operate shop cranes. These systems require a minimum of two men, contrasted with possibly four men for non-remote-controlled yarders.

The Vinje radio-controlled cable system yarder may be mounted on a 100-hp farm tractor or a 1-1/2-ton truck powered by a 100-hp diesel engine. The system may be used as a single span as well as in multi-span installations and logs may be transported either uphill or downhill.

The Jobu has two endless operating lines. One line operates the skidding line drum on the carriage, while the other either holds the carriage in a fixed position, or moves it up and down the skyline. The yarder is controlled by the chaser through a panel connected by electrical cable to the yarder. Normally, the yarder is positioned at some distance from the landing. The system can be used in stands up to 16 inches DBH. Its major disadvantage is the difficulty of rigging two endless lines.

The two most common European skyline systems used in the United States are the Wyssen and Baco. These can yard distances up to 5,000 feet with lateral skidding distances of 200 feet. However, 150 feet of lateral skidding on either side of the skyline is considered optimum. With both Baco and Wyssen systems, the yarder or snubber is located at the top of the unit and the logs are lowered downhill by gravity. Intermediate supports can be used with either; however, operation with a single span is more economical.

These systems have not been particularly popular in the United States, primarily because of their low production and relatively high manpower requirements. They require a five or six-man crew which normally produces 20,000 to 25,000 board feet daily. On most logging shows, the equipment operates from five days to a month on a single setting. Then it is down for five to eight days while the skyline is moved and rigged. Yarding production over an extended period will average 10,000 to 15,000 board feet per day or 1-1/2 to 2-1/2 million board feet per year.

With this relatively low production, loading is a serious problem. Cost is extremely high if a loader is kept on the landing at all times. Loaders can handle 20 to 24 loads per day, while the yarding equipment can produce only two or three load per day-and in some cases, four. Two alternatives are to make large coldecks for later loading or to use self-loading trucks.

Since they are designed for downhill yarding with the yarder or snubber at the top of the unit, the yarders are designed to be self-winch up the hill, without roads. The normal procedure has been to lay out the units with the road and landing at the bottom. If access is not provided to the top of the unit, then the yarder is moved up the hill under its own power. There are several problems with this type of setting:

1. Several days may be required to move the yarder to the top of the unit and into position.
2. With no road to the top of the unit, the equipment cannot be serviced in case of breakdown.
3. The yarder operator must walk to and from work daily. In many cases, this means overtime pay. Or he must camp at the yarder location. The exception is to use the endless system and position the yarder at the landing.

It is recommended that road and trail access be provided to the top of the units if at all possible. This not only reduces logging costs, but also provides access for fire protection and reforestation.

Even with their low annual production, Wyssen and Baco systems fill a need in the harvest operation. They are probably the only economical means of logging areas with a relatively low skyline volume

served by a valley road system. The Wyssen system has been used mostly in the pine region in 7,000 to 10,000 board-feet-per-acre partial cuts.

The light line used on most European multispan systems makes stringing them relatively easy. One manufacturer of continuous line equipment recommends stringing a 2.1mm construction line around the unit. This line is light enough to back pack. The construction line is used to pull an 8mm mainline off the yarder drum and around the unit. The mainline pulls the skyline to the tail hold.

#### 48.72 - Skyline Jacks

The skyline rests in a "jack" that is hung from the intermediate support.

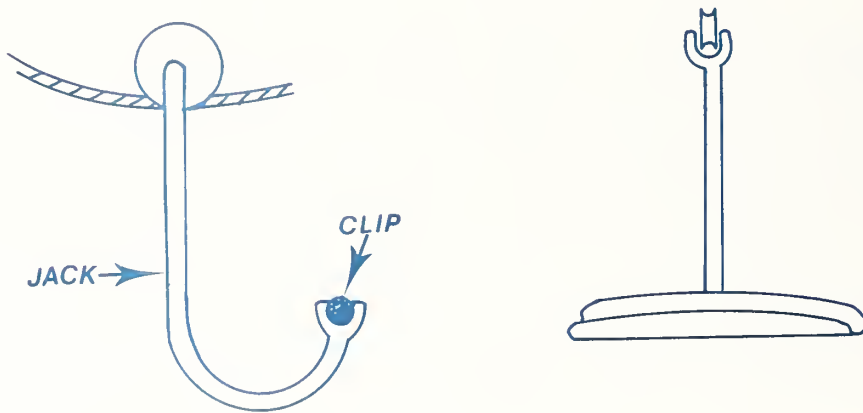

#### SKYLINE JACK

The skyline is not secured to the jack but is free to slide through it.

If the skyline and jack are lifted into position on the intermediate support in one operation, it is desirable to secure a "clip" to the jack to hold the skyline in position during the lifting operation. The clip is not intended to keep the skyline in the jack if it lifts during the yarding cycle.

On some proposed layouts there may be times when the skyline would be lifted out of the jack during the yarding cycle. This voids the intermediate support location.



## 48.73 - Pulling Slack

Slack for lateral yarding is pulled manually through the carriage and off the yarder drum, or by a slack pulling carriage. Slack can be pulled manually only when the yarder is at the top of the skyline road. It requires too much effort to pull slack uphill from a yarder located at the foot of the slope. See Section 47.33a for a set of curves that estimate this effort. The choker hook on some carriages is quite heavy, making it hard work to pack it to the logs for lateral yarding.

Pulling slack downhill gets to be work when lateral yarding is distant from the yarder, especially with large mainlines.

A common European technique for pulling slack ahead of time, without a slackpuller, is by hooking the mainline back on itself with a hook. This operation is done at the landing when the carriage is at the tower. When the logs are unhooked the mainline is fastened to a ring on the tower base. The carriage is then run out, by gravity or the haulback. This pulls mainline off the yarder drum and through the carriage. When sufficient mainline is pulled through the carriage the carriage is held in position on the skyline and the mainline is slacked until the belly can be reached from the ground at the tower. The mainline is unhooked from the ring on the tower and is hooked back on itself at the belly.

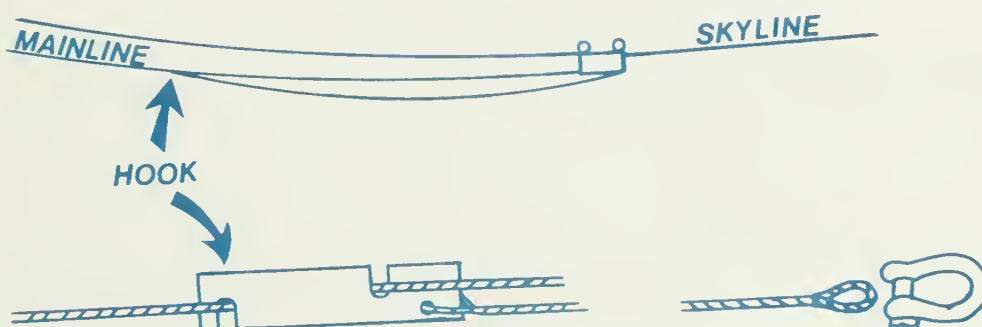

HOOK USED TO HOLD SLACK THAT IS PULLED AHEAD OF TIME

The strap on the slackpulling hook is shackled to the butt rigging.

### 48.74 - Multispan Landings

Cycling carriages, used on European yarders, can not be controlled as closely as noncycling carriages. Therefore, they require larger landings.

On a downhill gravity system, if there is a lot of belly in the mainline when the carriage is at the landing, it will be difficult for the chaser to unhook the turn because of the mainline tension.

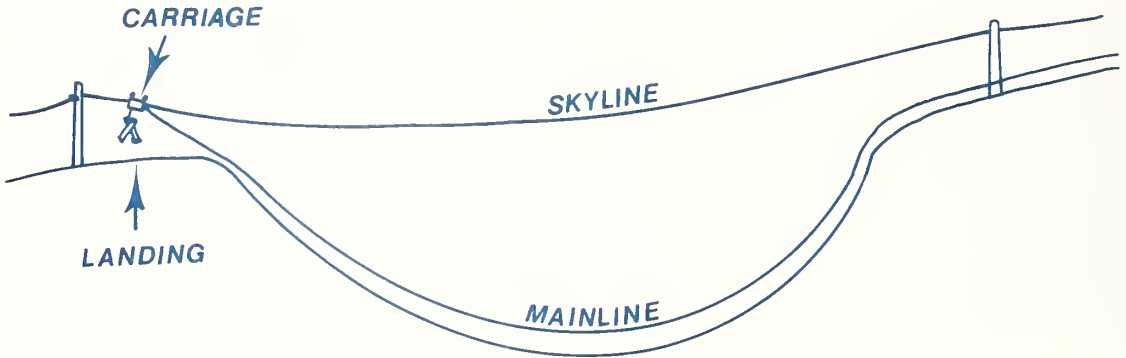

### MAINLINE WEIGHT PREVENTS LANDING THE TURN

A squirrel carriage will alleviate this but may create yarding problems at the back end (see Section 48.77).

### 48.75 - Design Criteria

#### a. Ground Slope

(a) Uniform slopes offer the best conditions for multispan logging.

(b) Second best is a slightly concave slope. If the slope is too concave, the skyline will lift off the jack. The computer programs tell when this will happen.

(c) The worst slope is a very convex slope. It requires the most intermediate supports and makes carriage passage difficult. Sometimes, even though the ground slope is broken, intermediate support locations and height can be designed so that the chord slope is close to uniform.

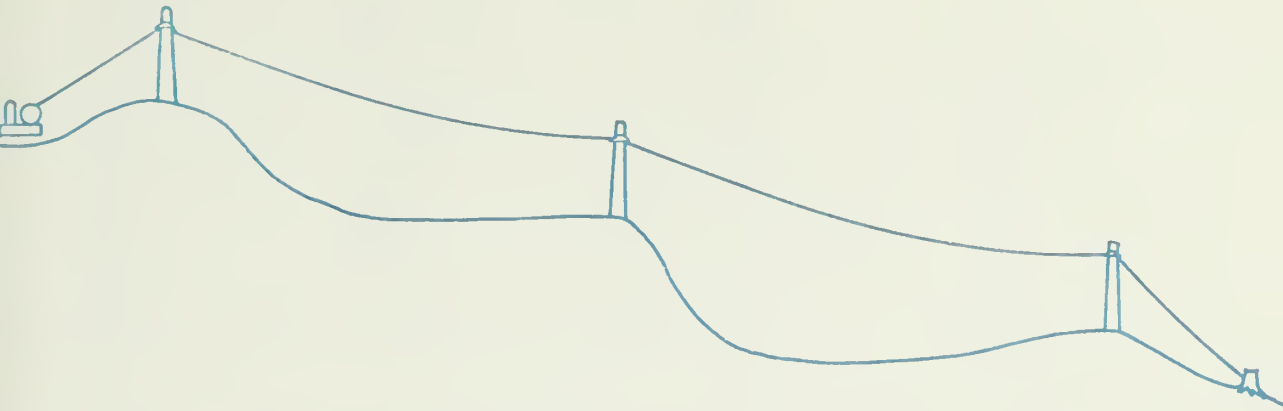

### A UNIFORM CHORD SLOPE MAY BE POSSIBLE ON UNEVEN GROUND

#### b. Intermediate Supports

Probably the most difficult aspect of multispan design is locating support devices. Intermediate supports are usually trees rigged with a support jack and guylines. These must be aligned with the anchorpoints. They must be limbed, topped and notched at the base so as to be leaned to an angle of approximately  $14^{\circ}$ . This allows carriage passage. The support jack is hung and the guys rigged and tensioned before the tree is leaned.

If a tree cannot be found on line between the anchorpoints, one may be cut elsewhere and raised at the proper location. If there is no equipment access to the site, all rigging must be done by hand. This may take two days or longer with a crew of three men.

An alternative to raising a tree for an intermediate support, is to rig a cable traverse between two trees. The support jack with skyline is then hung from the traverse cable. The traverse cable must have enough deflection to carry the weight of the logs, carriage, skyline, and operating line. Rigging a traverse cable may be very time consuming. However, once it is rigged, it may serve as an intermediate support for more than one skyline road.

When small timber is being yarded, an intermediate support jack can be suspended from a cable which is hung between two closely spaced trees.

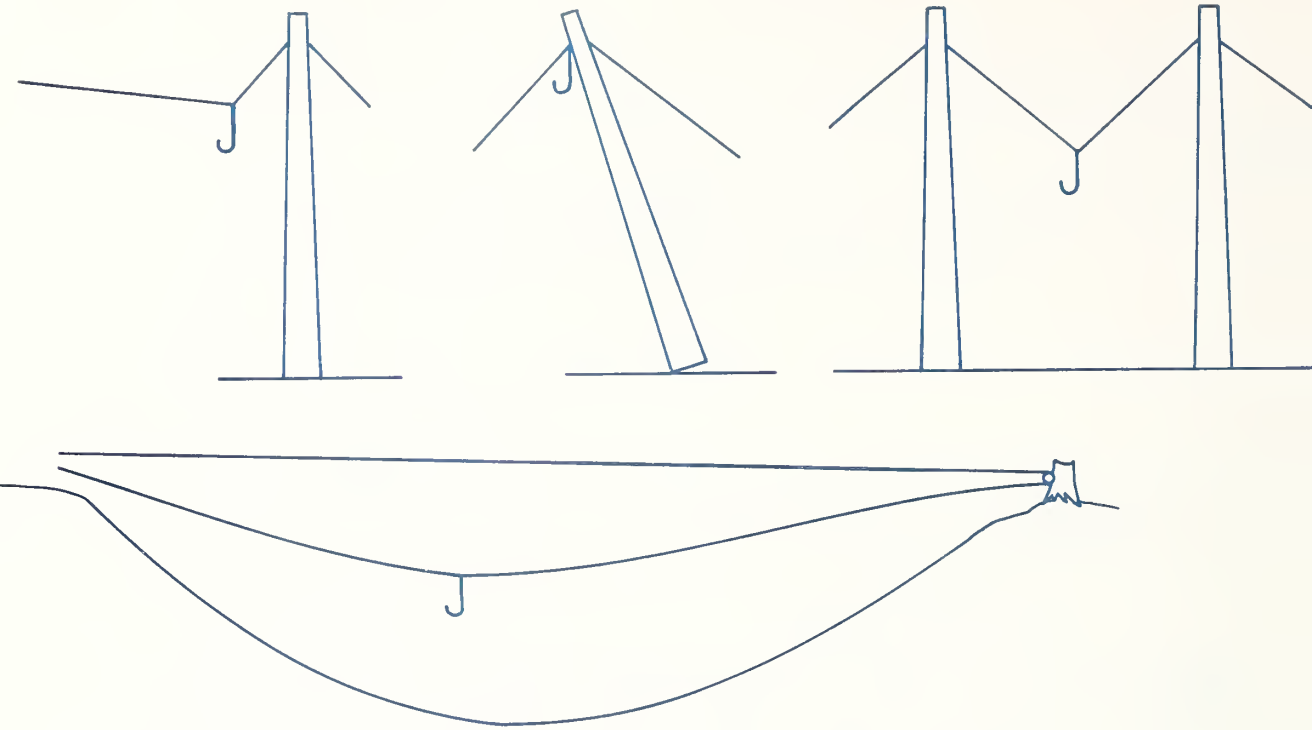

#### **FOUR TYPES OF INTERMEDIATE SUPPORTS**

Intermediate support trees must be adequately guyed and, if the trees are notched, secured at the base.

The more intermediate supports used, the smaller the skyline diameter can be, as the percent deflection is increased by shortening the span.

As the carriage approaches a jack, the weight of the carriage and turn will pull deflection out of adjacent spans and increase deflection in the loaded span. If this results in the carriage being lower in elevation than the jack to be crossed, the carriage may have trouble passing the jack, when yarding downhill.

The lower the percent deflection of the skyline, the less trouble the carriage has passing the jacks. Six percent is a good deflection to shoot for. A compromise has to be worked out between deflection, span distance and payload.

It is important from both a rigging and a cost standpoint to keep the rigging simple. One of the simplest supports is to hang the jack between a pair of trees. This is easier than raising a support tree, or leaning one. The jack rides on a block on the supporting line. The support line can be anchored by wrapping and spiking or clipping, or wrapping on a drum with a dog.

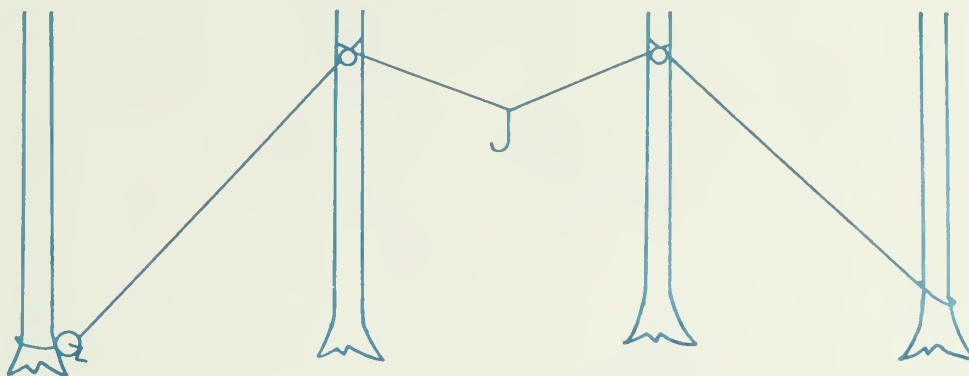

### SIMPLE JACK SUPPORT

In a clearcut, it is quite important to leave several trees at each intermediate support location to be sure that adequate support will be available after the unit is cut.

The line supporting the jack requires a certain amount of deflection to avoid overloading, the same as a skyline span. The two support trees may have to be guyed. The jack is cranked up to a height that has been predetermined in the design.

Intermediate supports must be designed to be sure the available trees are of adequate size, are in the correct location, and to see if the jack can be positioned as needed. The following example demonstrates a design procedure for a two tree intermediate support:

GIVEN:

1. Support trees are 40 feet apart.
2. The computed maximum load on the support will be 19,000 pounds.

FIND:

1. The block height for the jack support line.
2. The minimum acceptable support tree guyline diameter.
3. The minimum diameter for the support tree.

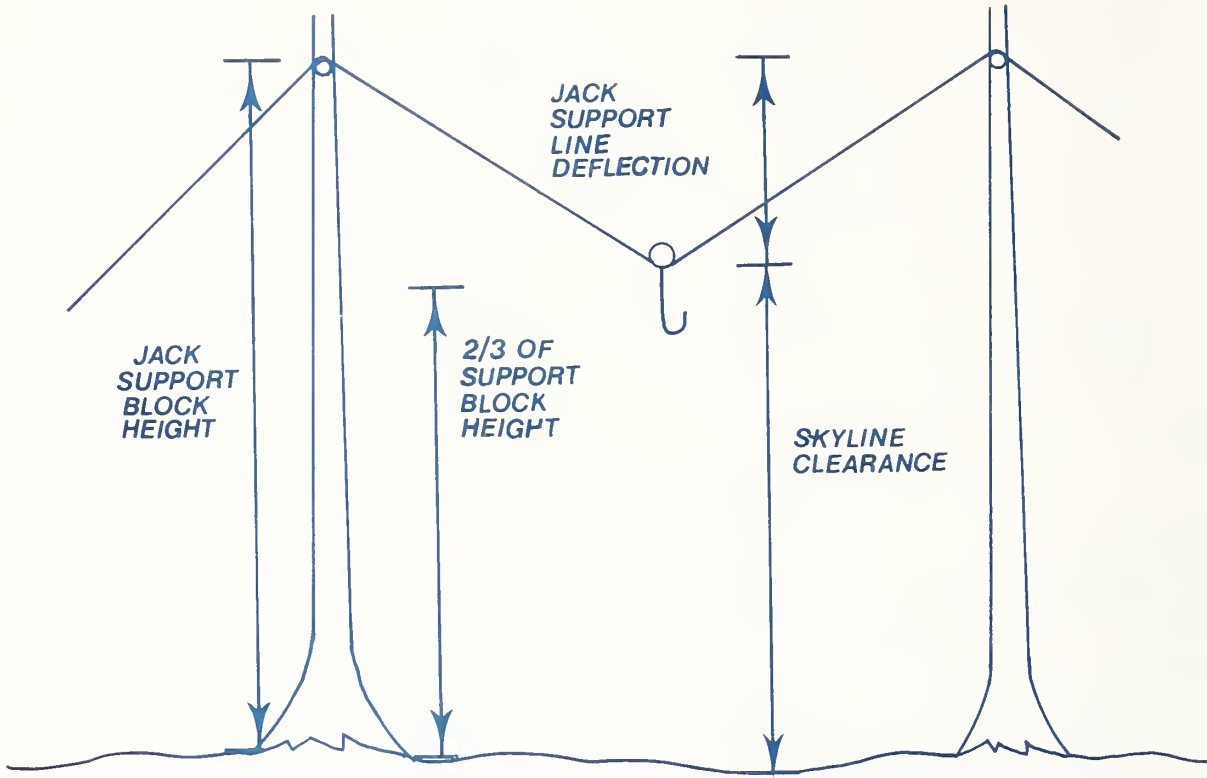

HEIGHTS INVOLVED IN INTERMEDIATE SUPPORT DESIGN

ASSUME:

1. A 5/8" improved plow steel support line.
2. A 50-foot skyline clearance.
3. Modulus of elasticity for support tree of 1,500,000 p.s.i.

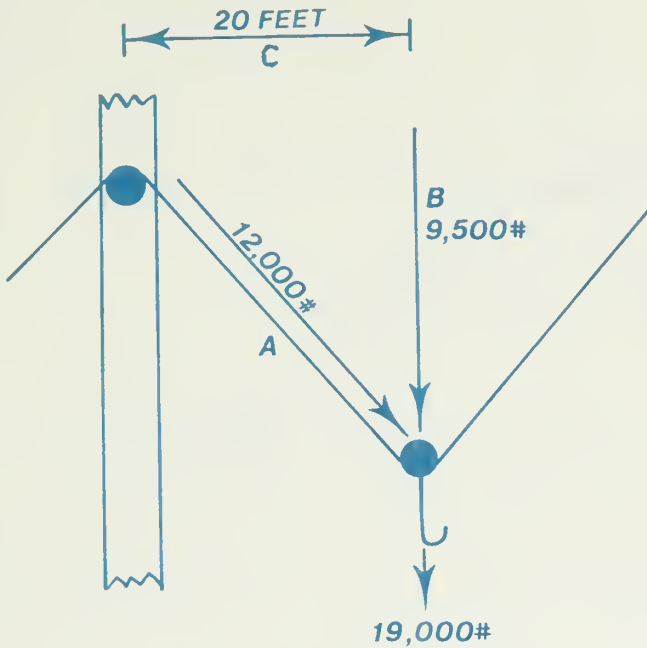

### JACK SUPPORT LINE BLOCK HEIGHT SOLUTION

The safe working load for 5/8" IPS line is 12,000#. Only 1/2 of 19,000# is supported by line A.

What is the horizontal vector for the 12,000# load?  $C = \sqrt{A^2 - B^2}$   
(pythagorean theorem)

$$C = \sqrt{12,000^2 - 9,500^2}$$

$$C = 7,331 \text{ pounds}$$

$$\frac{\text{Height of B}}{20 \text{ feet}} = \frac{9,500\#}{7,331\#}$$

Height of B = 25.9 feet = Jack support line deflection

Support block height = 25.9 feet + 50 feet clearance = 76 feet

The strap will have to be fastened high enough in the tree to support the block at 76 feet.

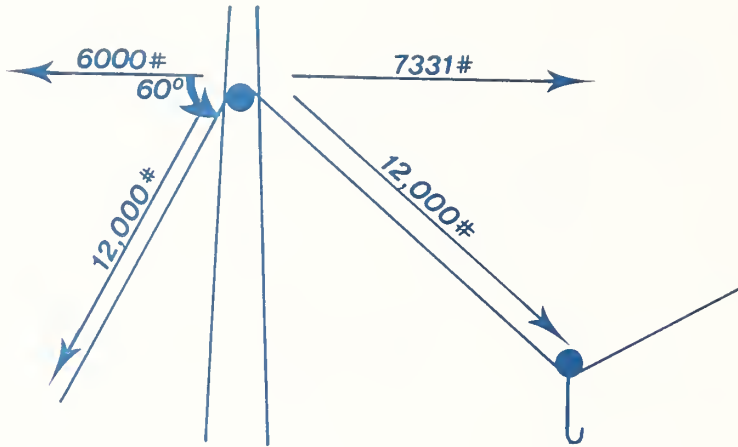

#### A POSSIBLE GUYLINE DIAMETER SOLUTION

The adjacent leg of a  $60^\circ$  triangle is  $\frac{1}{2}$  the length of the hypotenuse. Therefore, the horizontal force component, to the left of the spar, is 6,000#. This means there is a 1,331# force tipping the support tree to the right when the load on the jack is 19,000#. A guyline capable of resisting this horizontal force of 1,331# is required to balance the forces on the support tree.

If the guy were also rigged at  $60^\circ$  from the horizontal, the guyline tension would be 2,662#.

A 5/8" IPS line is adequate to guy the support tree in the example. When the load on the guy would be light, local experience may indicate that the guy is not needed.

As shown by the example, the angles the support line makes with the tree determines the horizontal forces on the tree.



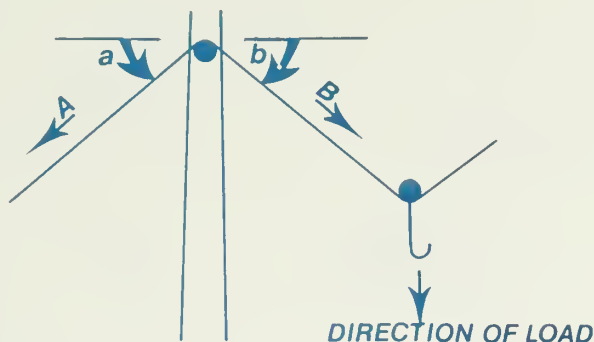

### DIRECTION OF FORCES ON SUPPORT LINE AND TREE CAUSED BY THE SKYLINE LOAD

If  $\angle a = \angle b$  the horizontal forces are equal and no guy is needed.

If  $\angle b$  is bigger than  $\angle a$  the horizontal component of force A is greater than the horizontal component of force B and the tree will be pulled away from the skyline.

If  $\angle a$  is bigger than  $\angle b$  the tree will be pulled toward the skyline.

In the same way the angles that a skyline makes with the horizontal, on both sides of a spar tree, determine the horizontal and vertical forces that the skyline exerts on the spar tree.

### Support Tree Diameter

This diameter can be determined by the following formula:

$$P = 0.04 \frac{ED^4}{L^2}$$

P = Maximum load in pounds that the tree can take with a safety factor of 3.

D = D.I.B. of the support tree in inches, at 2/3 of the height of the strap for the support block.

E = Modulus of elasticity of the tree in p.s.i. (varies by species. See Forestry Handbook for values).

L = Height of the support block in inches.

In the example, P is the vertical component of the force exerted by the support line and the guyline.

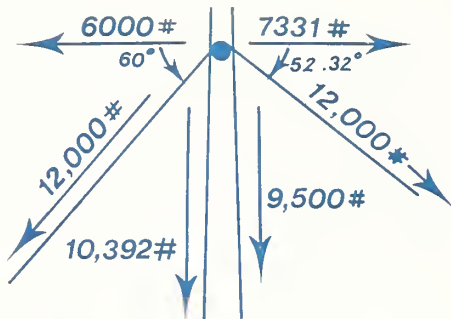

SUPPORT LINE FORCES

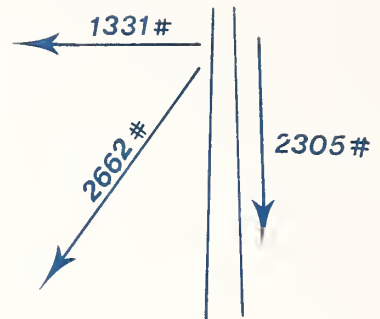

GUYLINE FORCES

The vertical component of the support line to the right of the tree is 9,500#. The vertical component of the support line to the left of the tree is:

$$12,000^2 = 6,000^2 + x^2$$

$$x = 10,392\#$$

The vertical component of the guyline is:

$$2,662^2 = 1,331^2 + x^2$$

$$x = 2,305\#$$

The total vertical load on the tree (P) = 22,197#

9,500	
10,392	
2,305	
22,197	

$$22,197 = \frac{0.04 \times 1,500,000 \times D^4}{(76 \times 12)^2}$$

D = 24" at 2/3 of the height of the support block (2/3 X 76') or 50' +. To convert to d.b.h. consider tree form class.

If available trees are not large enough, the skyline load will have to be lighter or the support block lowered. The support line and guylines will have to be redesigned.

c. Passing Intermediate Supports - Downhill Yarding

When yarding downhill by gravity, if the loaded carriage deflects the skyline below the elevation of the jack, it is impossible to cross the

jack without the use of momentum. The force angle given in the PNW 31 multispan program show when this situation occurs. If the printed force angle is  $90^{\circ}$  or more, the load will not cross the jack without momentum. This force angle measures the angle from the horizontal at which a force must be applied to deflect the skyline into the loaded position (the load as given on the computer printout).

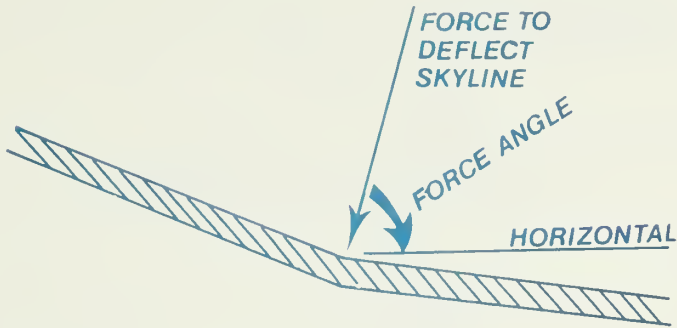

SKYLINE DEFLECTED INTO A LOADED POSITION BY A FORCE

The force to deflect the skyline bisects the angle formed in the deflected line. If the force angle is over  $90^{\circ}$  the carriage would have to move uphill to pass over the jack.

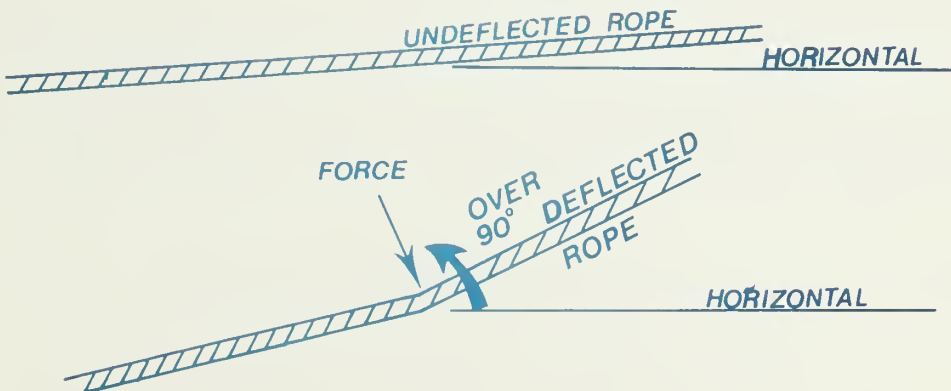

FORCE ANGLE OVER  $90^{\circ}$

The computer uses this force angle to compute the load on the skyline at the indicated point. The force deflecting the skyline can be divided into two components; a vertical load component and a horizontal force component.

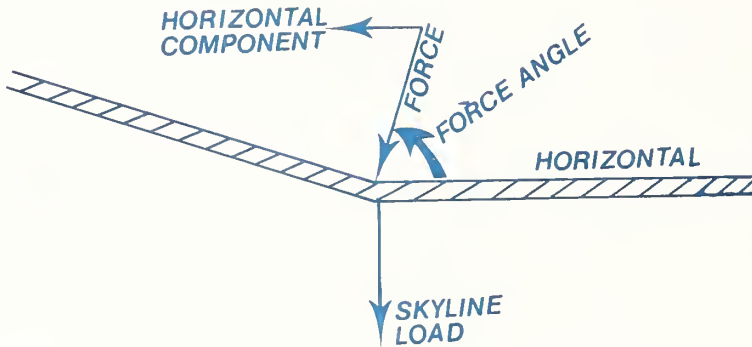

#### FORCES ON A LOADED SKYLINE

The above horizontal component is the horizontal force the mainline must exert to hold the carriage in position. When the mainline brakes are released, the carriage and load will move down the skyline under the force of gravity minus rolling friction and mainline drag.

If the force angle is close to  $90^{\circ}$ , the horizontal component of the load is very low and the turn would move quite slowly down the skyline, under gravity, especially if mainline drag is significant. For effective skyline operation, it is suggested that the force angle be sufficiently smaller than  $90^{\circ}$  so that mainline tension is greater than mainline drag. Mainline tension is given on the version of PNW 31 at Ft. Collins.

Mainline drag can be computed with the following formulas.

Force to drag cable downhill

$$F = [(W) (L)] [U\cos\phi - \sin\phi]$$

Force to drag cable uphill

$$F = [(W) (L)] [U\cos\phi + \sin\phi]$$

Where:

F = force in pounds  
 L = slope distance  
 W = cable weight in pounds/foot  
 U = coefficient of friction  
 $\phi$  = ground slope (degrees)

If the chord slope is moderately steep, the mainline must snub the turn downhill, as a free running carriage might jump the jack. Snubbing turns requires adequate yarder brakes.



#### CARRIAGE WILL NOT PASS JACK WITHOUT MOMENTUM

The chain and board is not accurate enough to model this situation; however, computer programs will indicate when the load will not pass the jack because there is too much slack.

Logs must be suspended free of the ground to yard downhill under gravity. Pulling logs downhill with one end dragging will result in a ditch being developed. The size of the ditch will be affected by the volume and size of timber being yarded and soil conditions.

The break in chord slope at the intermediate support can be as much as 60%, depending on deflection, when yarding downhill.

#### d. Passing Intermediate Supports - Uphill Yarding

Logs can drag when yarded uphill without creating much soil impact.

The problem in yarding uphill is to get the carriage over the jack. The break in the span chord must be kept under 35 percent ( $16^{\circ} 42'$ ) for satisfactory operation.

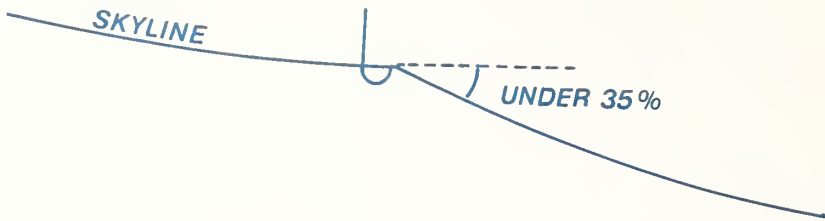

THE BREAK IN THE SPAN CHORD MUST BE UNDER 35 PERCENT TO SATISFACTORILY PASS A CARRIAGE WHEN YARDING UPHILL

It may be necessary to rig two trees, close together, to keep the slope change under 35 percent.

The angle of the mainline with the skyline will affect the carriage passage over the jack. The mainline should be as close as possible to parallel with the skyline.

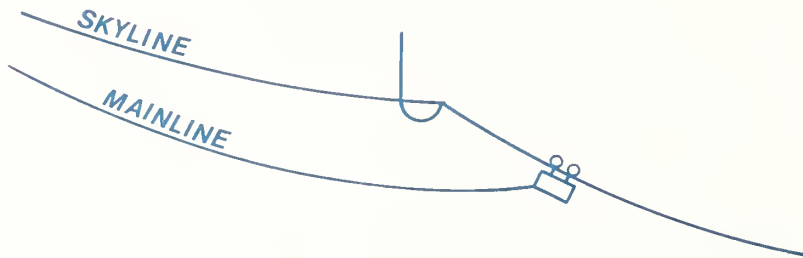

THE MAINLINE SHOULD BE NEARLY PARALLEL TO THE SKYLINE

The weight of the carriage and turn pulls the slack out of adjacent spans as the carriage moves from one span to the next. This action makes it difficult to yard large old growth logs uphill over a jack. Even if the mainline and skyline are parallel, as the turn approaches the jack, the direction of pull in the mainline is below the jack. This results in the carriage being hung up in a bight in the skyline. Keeping skyline deflection as low as possible and the mainline parallel to the skyline will reduce the problem. Uniform chord slopes help keep the mainline parallel.

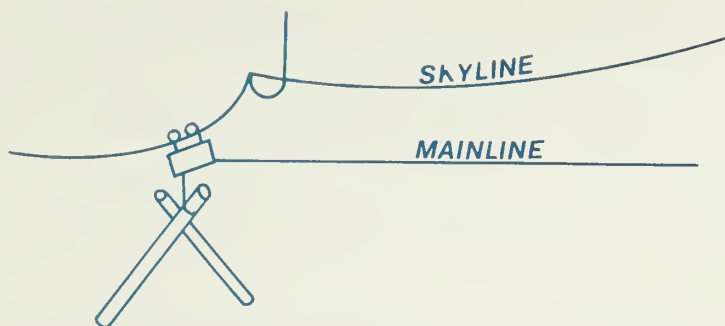

THE MAINLINE CAN PULL THE CARRIAGE BELOW THE JACK

This does not appear to be such a problem when yarding second growth as long as the mainline and skyline can be kept close to parallel.

Tension in an unloaded skyline can be determined by striking the skyline and measuring the time needed by the wave to make a round trip.

$$\text{Tension} = \frac{4L^2W}{GR^2}$$

Where: L = span length in feet  
 W = weight of cable in lbs/ft.  
 G = 32.2 feet/second<sup>2</sup>  
 R = round trip time for wave in seconds

e. Line Size

The maximum skyline length for multispan for the present is 5,000'.

Design for 1 3/8" skyline, or smaller. Larger lines are too hard to handle.

f. Number of Supports

On first sales, design multispan roads with not more than two supports, when stump rigged at each end.

If head and tail spars are required, design for only one intermediate support on initial sales.

Plan on logging both ways from an intermediate support, if possible.

g. Payload Determination and Design Aids

Do not use PNW-39 for determining payload on multispans, use a computer program.

When looking at the Ft. Collin's multispans computer printout, the following must be checked:

(a) The force at the jack must be negative (the cable is pushing down).

(b) The force on a load between intermediate supports must be positive (when the cable can not support its own weight the force is shown as negative).

(c) It is recommended that force angle at the point of load should be sufficiently less than  $90^{\circ}$  so that mainline tension is greater than mainline drag.

h. Skyline Profiles

Skyline profiles must run on the ground.

i. Miscellaneous Tips

1. Avoid large old growth timber. Large logs have trouble passing over a jack. Deflection is low which means low pay loads. Fifty inch d.b.h. is the maximum. Thirty-five inch to 40 inch material is more desirable.

2. Full suspension is required for downhill yarding as logs are lowered by gravity. If logs hit the ground as they pass over a jack, they will dig holes, hit the bottom of the carriage, or hang up.

3. Power is required to tighten guylines when large guylines are used. A come-along isn't effective.

4. Cross support skylines for intermediate supports work quite well but they take a lot of design work. They are a little beyond the present state of the art.

5. The first intermediate support is the hardest to rig. The carriage can be used to rig succeeding supports.

6. It might be possible to fly a mini-yarder to the site, by helicopter, to rig an intermediate support.

7. A strawline can be used to raise the intermediate support.



7. Maximum skyline length (slope distance) should be 5,000 feet with 3,000 to 4,000 feet preferable when no top access is provided.
8. Maximum spacing between skyline roads should be 300 feet. An occasional road 400 feet wide can be logged if the added move would be more expensive than the slower production resulting when choker setters must pull the skidding line and carry the heavy butt-hook 150 to 200 feet to either side.
9. Either adequate landings for cold decks must be provided, or the increased loading costs of hot decking be recognized and allowed for.
10. Keep intermediate supports few in number. Mix single spans with multispans to keep costs down. Avoid more than two supports in a single span.
11. Avoid "clean yarding" fuel treatments.
12. Try to design uniform chord slopes.
13. Try to get access to supports and top of span.
14. Good maps should be used for the preliminary plan but the final design must be made on the ground.
15. Try to close skyline profile traverses frequently with the unit boundary traverse, or an adjacent skyline profile traverse, to make it easier to locate "bulls" in the profile traverse.
16. Thoroughly investigate every span; to be sure of your intermediates. Profiles must be run on the ground on every skyline road, or plotted from good quality topographic mapping. Ground profiles require an abney and tape.
17. Be careful about production estimates.
18. Do not plan on moving an intermediate support spar into position as this is a difficult and costly operation.
19. Start sale programs with sales having the best chance of success by minimizing problems.

	<u>Uphill</u>	<u>Downhill</u>
Drag Logs	yes	no
Max. Cord Slope Break	35%	60% depending on deflection
Deflection	6%	Depends on Momentum*

\*Momentum can be used to roll a turn over the jack, however, too much momentum will result in a failure to properly cross the jack.

48.76 - Constructed Appraisal Procedures

Constructed appraisals for multispan skyline sales will be coordinated with the Regional Office appraisal section:

48.77 - Sale Program Development

If multispan sales are to be developed, there is a need for the following activities.

- a. A long range sale program for developing logger experience. 5mm to 10mm per year in an area.
- b. American made machinery needs to be developed.
- c. Training programs are needed for sale designers and for loggers.
- d. Start sales in small timber to learn the problems.

## 49 - SUMMARY OF CABLE SYSTEMS

Cable System	Fig. 9-	Harv. Meth.		Yard. Dist. UP (Ft.)	Dist. Down (Ft.)	Skyline Size (In.)	Carriage Type	Yarder Type
		CC	OR TH					
1. Ground Lead								
a) Shovel Loader	1	x	x	300	0	1/2-3/4 5/	Tongs	Single drum loader, heelboom
b) Jammer w/wood boom	2	x		700	0	1/2-3/4 5/	Squirrel block & Tongs	Two-drum, truck mounted
c) Mobile Shovel Yarder	3	x		700	0	5/8-1 5/	Butt rigging	Two-drum, converted loader
d) Highlead	4	x		1,000	600	3/4-1-1/2 5/	Butt rigging	Two-drum, main & haulback
2. Live Skyline								
a) Mechanical Carr.	5		x	1,000	0	5/8-1	Hydraulic clamp; slackpulled by hand	Two-drum, mobile yarder
b) Shotgun (flyer)	6	x		2,000	2/	3/4-1-1/2	Block	Two-drum, skyline & main
c) Slackline	7	x	3/	2,500	1,000	1-1-1/2	Block	Three-drum, skyline, main & haulback
d) Remote-control Carriage	8	x	x	2,000	2/	1-1-1/2	Self-contained radio-controlled	Two or three drums
e) Radio-Controlled Grapple	9	x		2,000	2/	1-1-1/2	Grapple	Two-drum
f) Side Mount	11	x	x	1,000	500	1-1-1/8	Slackpulling held by haulback	Four-drum, skyline, main haulback & slackpulling
3. Standing Skyline								
a) North Bend	12	x		2,000	1,500	1-1/8-1-1/2	Block	Three-drum
b) South Bend	13	x		1,500	1,500	1-1/8-1-1/2	Block	Three-drum
c) Tyler	14	x		2,000	1,500	1-1/8-1-1/2	Block	Three drums plus skyline
d) Skidder	15	x	x	1,500	1,500	1-1-1/2	Mech. Slackpull.	Four-drum
e) Skyflieger	16	x	x	4,000	4,000	1-3/4	Mech. Slackpull.	Three drums plus skyline
f) European	17&18	x	x	2,000	5,000	1-1/4-1-3/4	Wyssen, Baco	Single drum, Sled mounted
g) Long span	19,20						Self-contained radio	Two-drum plus skyline
	21,22	x	x	5,000	5,000	1-3/8-2	Self-contained radio	Two-drum plus skyline

## SUMMARY OF CABLE SYSTEMS Continued

System	Fig. 9-	Harv. Meth.		Yard. Dist. UP (Ft)	Dist. Down (Ft)	Skyline Size (In.)	Carriage Type	Yarder Type
		CC	OR					
4. Running Skyline	23	x	x	1,000	600	5/8-1 1/8	Mechanical	Three-drum yarder (interlock or Wichita brakes)
a) Slackpulling Carriage				(2,000)	(1,000)			
b) Grapple	24	x		1,000	600	5/8-1 1/8	Grapple	Three-drum yarder (interlock or Wichita brakes)
				(2,000)	(1,000)			
c) Remote Grapple	25	x		1,500	600	3/4-1 1/2	Radio-Controlled Grapple	Two-drum yarder (interlock or Wichita brakes)
d) Grabinski	26	x		1,500	600	3/4-1 1/2	Butt rigging & Rider Block	Two-drum yarder (interlock or Wichita brakes)
5. Balloon								
a) Haulback	27	x		0	4,000	1	None	Two-drum interlock yarder
b) Inverted Skyline	28	x		0	4,000	1	Block	Two-drum interlock yarder

- 1/ Maximum yarding distance. The yarding distance will vary with cable capacity of the yarder and topography. External yarding distance is approximately 1/2 to 3/4 of the cable capacity of the yarder.
- 2/ Can yard downhill with yarder at upper end. Turn must be yarded free of the ground.
- 3/ This system can operate in a partial cut if a slackpulling carriage is used.
- 4/ There are two running skyline systems which are capable of yarding 2,000 feet.
- 5/ This is a ground lead system which utilizes a main line in place of a skyline.
- CC Clearcut.
- OR Overstory removal.
- TH Thinning

#### 49.1 - Advantages of Skyline Logging

1. Less Breakage Than Ground Leading
2. Capable of Reaching Long Distances
3. Less Soil Disturbance
4. Logs Can Be Flown Over Streams
5. Faster Yarding Cycles on Long Roads, Especially if Fully Suspended
6. Readily Works With Slackpulling Carriages Which
  - a. Reduce Rigging Costs
  - b. Improves Yarding Production in Partial Cuts
  - c. Permits Presetting Chokers
  - d. Makes Wider Skyline Roads (Fewer Corridors)
  - e. Requires Fewer Tail Trees
  - f. With Adequate Deflection, Reduces Damage to the Residual Stand in Partial Cuts.

#### 49.2 Disadvantages of Skyline Logging

1. When logs are yarded fully suspended, a lot of slash is brought to the landing as limbs are not broken during yarding.
2. The yarding action does very little site preparation, brush competition isn't reduced and little mineral soil is exposed.
3. When yarding with a skyline system and slack pulling carriage, with one end suspension, if there are no obstructions to the skyline, the skyline will drift over the turn during lateral yarding. During inhaul, the turn will be yarded mainly toward the landing with a gradual drift back toward the unloaded skyline position. This means that about every turn yarded will drag along a different path. This might be disastrous in a final removal sale, or if the unit is on the far side of an established plantation.
4. Generally, stronger anchors are required due to a greater load on the tail load and more volume is yarded per road.
5. Generally, higher yarding cost.
6. Longer spans may make intensive management too costly.
7. Specialized equipment may be required to meet yarding requirements.

50. - Balloon50.1 - System Prescription

The balloon logging system is a cable system that uses a lighter than air (LTA) vehicle to "fly" logs free of the ground from the woods to the landing. Several types of balloons have been tried.

1. Aero Dynamic balloons (dynamic lift balloons)

All "Vees" act in the same manner as an aircraft by developing lift as it is pulled ahead. They also have some dynamic lift.

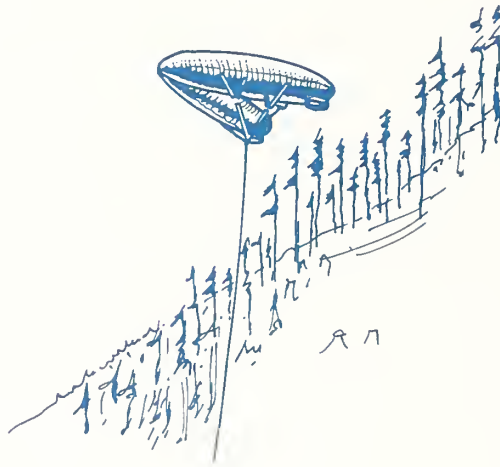

VEE BALLOON

2. Static and Dynamic Lift Balloons

These are single hulled balloons that operate with about half static and half dynamic lift.

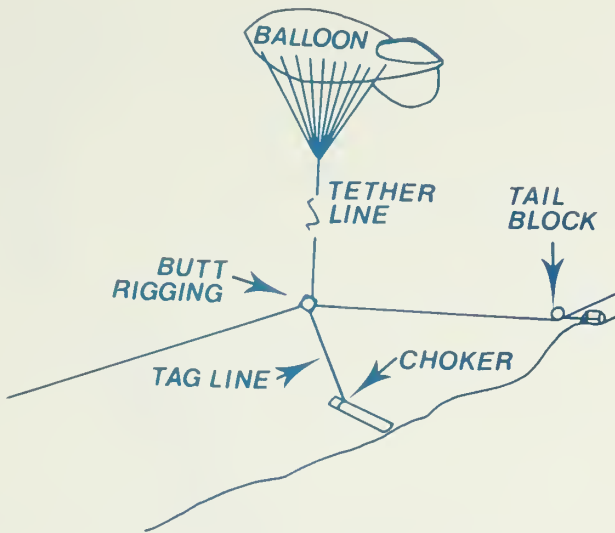

SINGLE HULLED BALLOON

### 3. Static Lift Balloon

This natural shaped balloon derives all of its lift statically. It experiences some dynamic drag as it is pulled ahead. The drag also acts as lift in this mode of using balloons.



STATIC LIFT BALLOON

Static balloons with volume of 250K (250,000), 530K and 620K cubic feet have been designed, tested and are presently available. The net lift is approximately 11,000, 20,000, and 25,000 pounds at 5000' for these balloons. The balloon diameters are 81', 90' and 100' respectively.

In figuring net lift, the weight of the lines, rigging hardware, straps and fabric must be considered.

The lower parts of the balloon are covered by a fabric skirt which protects the under portion of the balloon.

The earlier yarding balloons were made of neoprene coated dacron. The later balloons are made of urethane coated dacron, which is more impermeable.

A two-drum interlocking yarder capable of storing 5,500 feet of 1-inch mainline and 7,000 feet of 1-inch haulback line has been used with the haulback and inverted skyline configurations. The yarder is track-mounted and weighs approximately 172,000 pounds.

The Yo-Yo system uses two single drum yarders, each spooling about 7,500' of 1" line and 15,000' of 7/16" strawline.

Dye formed wire rope, made in England or Japan (see Section 43.28c) is used with balloon yarders.

Balloon yarding uses about 5 gallons of diesel/MBF yarded.

Yarding begins at the top of the unit and progresses down the skyline road. This eliminates the hazard of logs rolling down the hill onto the crew. A sucker down (or a pulldown) block, which guides the haulback line, is moved down the hill as the yarding progresses. This acts as a tailblock, pulling the butt-rigging down to the ground and overcoming the lift of the balloon in order to hook the turn.

#### 50.11 - Haulback Configuration

Yarding direction: Downhill

Cutting prescription: Clearcut

Maximum yarding distance: 3,000 feet

Cycle description: The system is rigged in the highlead configuration with a haulback and mainline. The balloon suspends the butt-rigging. Logs are lifted vertical and flown free of the ground.



# BALLOON LOGGING - haulback configuration

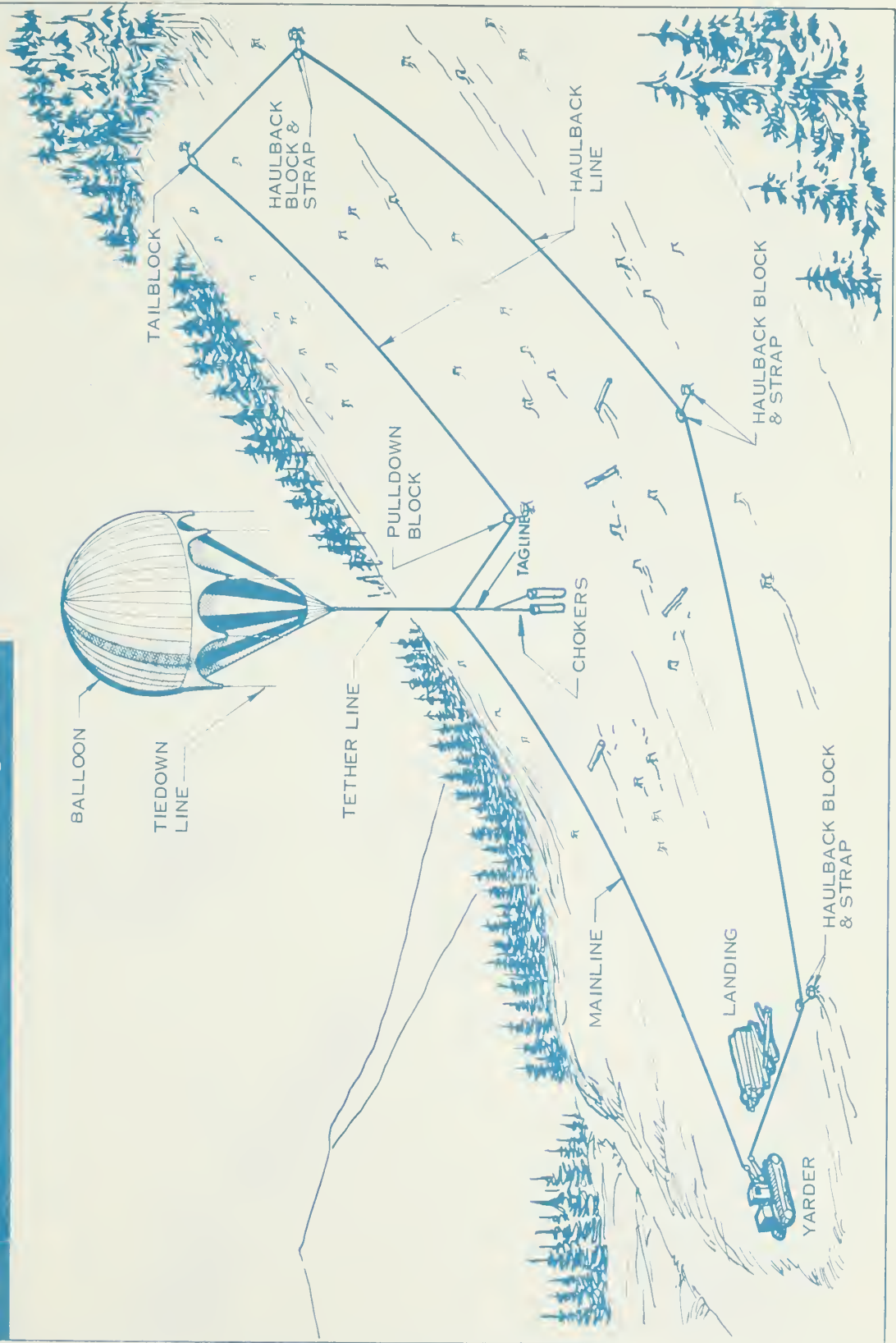

50.12 - Inverted Skyline Configuration

Yarding direction: Downhill

Cutting prescription: Clearcut

Maximum yarding distance: 4,000' or 5,000' depending on the yarder. 3,000' is more desirable for production.

Carriage description: The block carriage is held under the skyline by the lifting force of the balloon. The tagline to the ground is attached to the bottom of the carriage.

Cycle description: When the tension is released in the mainline, the carriage runs up the skyline due to the lifting force of the balloon. At the point of loading, the balloon is pulled down by tensioning the skyline until the chokers reach the ground. The logs are lifted by releasing the tension in the skyline. The turn is brought to the landing by pulling in the mainline.

This rigging configuration eliminates the haulback line, thus reducing the fire hazard.

**BALLOON LOGGING - inverted skyline configuration**

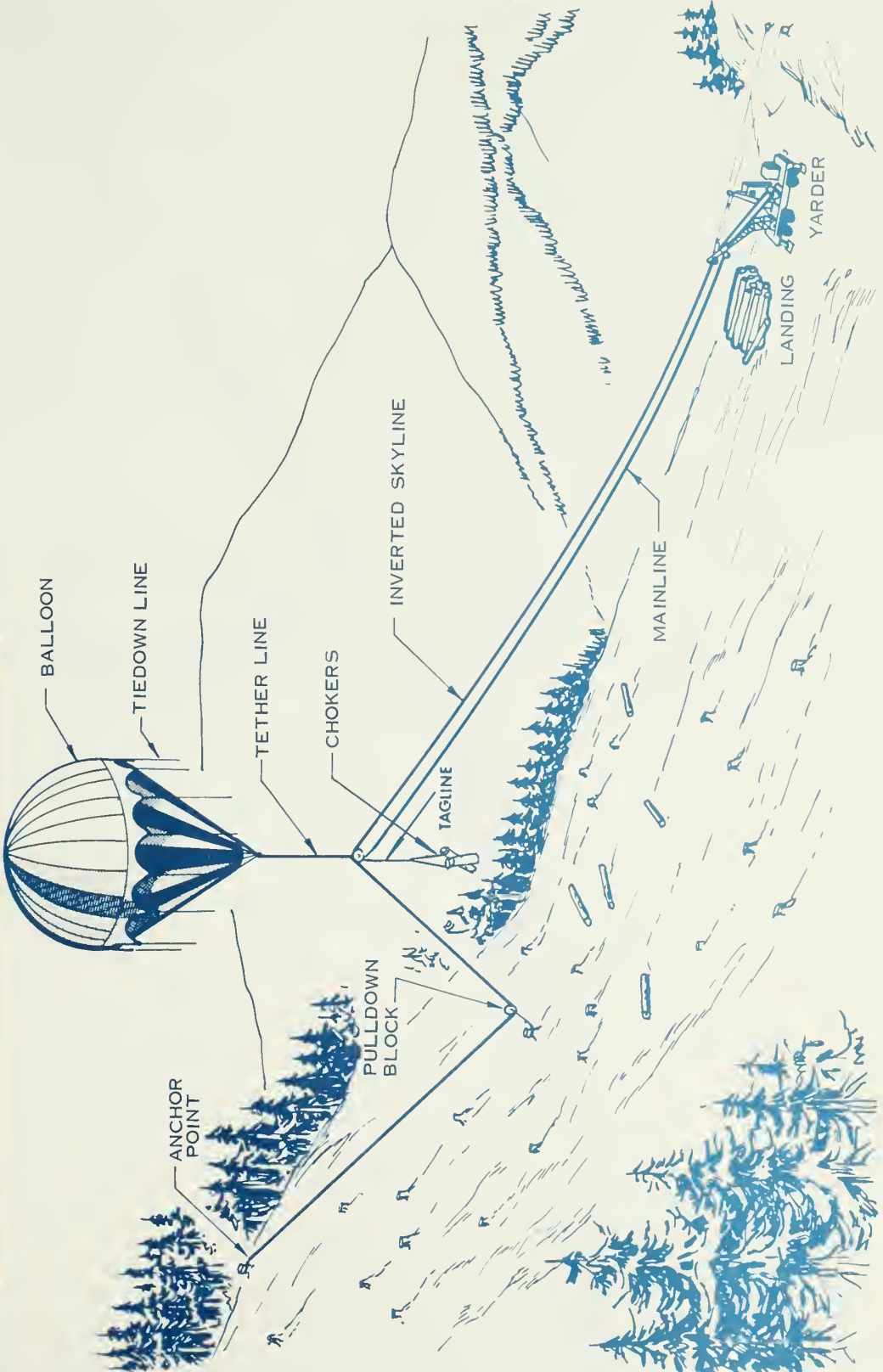

50.13

50.13 - Yo-Yo Configuration

Yarding direction: Uphill and downhill

Cutting prescription: Clearcut

Maximum yarding distance: 5,000 feet slope distance if there is a truck road at each end of the yarding road.

Cycle description: The line from one yarder is the mainline. The line from the second yarder is the haulback. A road block, which is used similar to a tail block, is placed between the sucker down block and the haulback yarder, to control the location of the balloon road. The road block is moved down along the unit boundary to permit yarding 200' to 300' roads. At times, a corner block may be used to change the direction of the haulback between the road block and the haulback yarder. This permits keeping the haulback in the same position through an uncut area below the haulback yarder, as the road block is moved down the hill.

The two yarders can also sit side by side and operate the high lead or inverted skyline systems.

It is estimated that the two single drum yarders will cost about as much as one big two drum machine.

The system can yard both up and downhill. Part of a yarding road could be taken uphill and part downhill by moving the balloon to the other side of the sucker down block.

**BALLOON LOGGING - yo yo configuration**

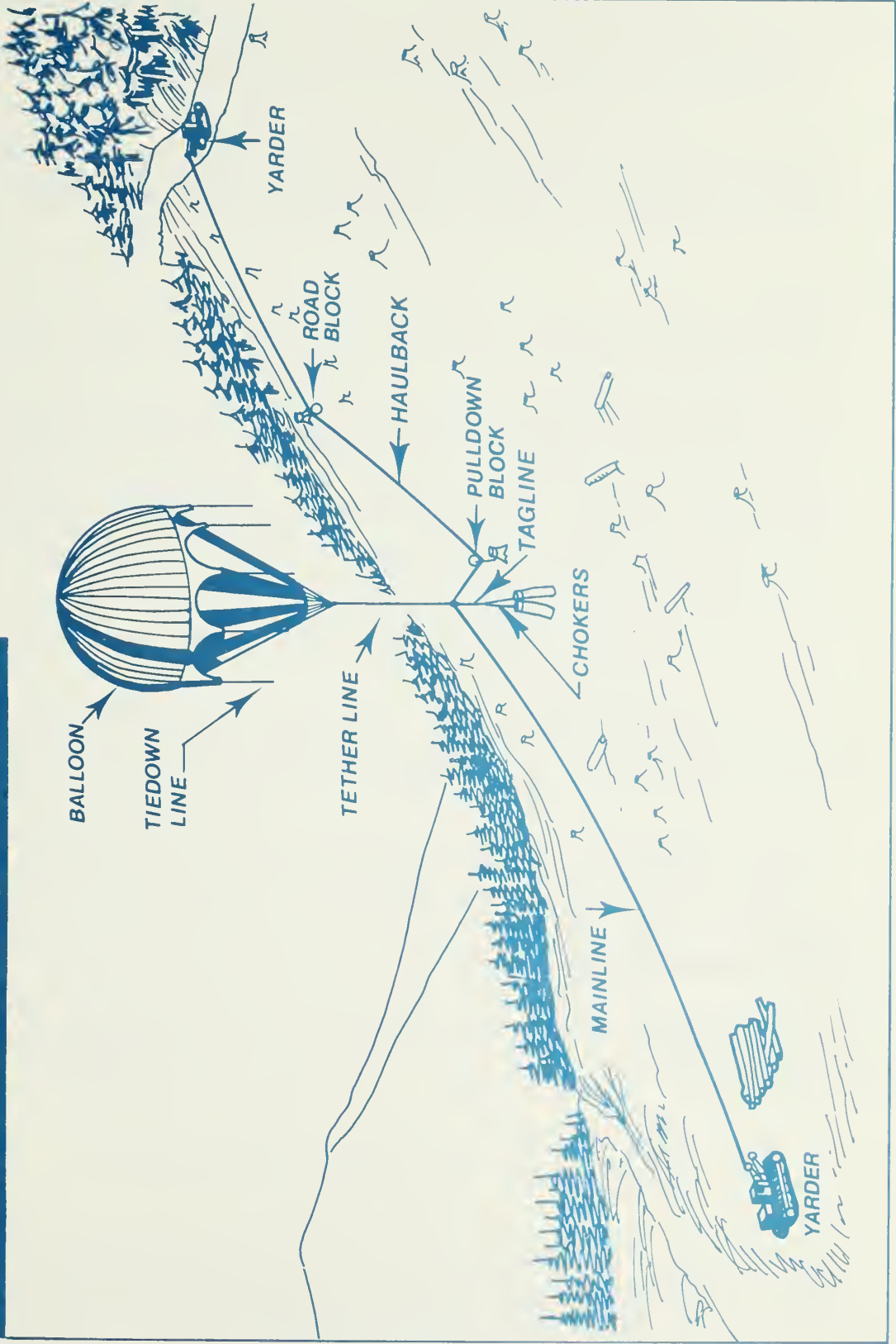

## 50.2 - Requirements and Limitations

Tag lines vary from 100' to 400' long. The longer the tag line the more difficult it is to accurately place logs on the landing.

Lateral yarding distance varies with ground slope, the same as for skylines. Balloon roads can be up to 300' wide at the back end if roads are perpendicular to the contour. Roads across the slope are narrower, depending on ground slope, 200' being a reasonable width at the back end.

### Weather

Weather plays an important role in logging with the balloon. Some important conditions are:

1. Wind. In 25 to 30-mph wind, resistance to the wind's dynamic force becomes greater than the balloon's designed static lift. This causes erratic movement and loss of control which is of paramount importance in balloon logging. Balloons have been operated in steady 40 MPH winds. However, there is trouble in yarding in gusty 35 MPH winds. The direction of the wind is a big factor. If it is from the yarder to the balloon, it increases cycle time. If it is across the balloon road, the balloon will drift sideways.

2. Rain. Water clinging to the balloon's fabric can decrease the static lift 1,000 pounds or more.

3. Snow. Heavy wet snow, accumulating on top of the balloon can create a heavy puddle which can settle the balloon to the ground. The present practice is to get on top of the balloon and sweep the snow off. Future balloon designs may overcome some of this problem.

4. Temperature. The balloon expands with an increase in temperature, therefore it can operate with less helium in the summer than in winter. It also means that the balloon can only be  $\pm$  90 percent inflated on a summer morning to allow room for gas expansion in the afternoon. There is also more lift on a warm afternoon than there is on a cool morning.

Since temperature drops with an increase in elevation, balloons lift less at higher elevations. One cubic foot of helium at sea level has 0.065 pounds of lift. There is a lift loss of about 3 percent for every 1000' of elevation gained.

Statistics can be obtained from the National Weather Service to determine if balloon logging is feasible for a given area.

### Landing

Landing size for the balloon system should be approximately 70 x 100 feet. A landing this large is required because of the difficulty in landing logs precisely, especially in gusty winds.

## Bedding Area

A 150 to 180 foot diameter bedding area is needed for laying out the balloon for inflation, for servicing and to tie the balloon down during high winds. A ground cloth is necessary to protect the balloon's fabric during inflation. One bedding area may serve more than one sale.

Every six weeks, to two months, the balloon must be brought down to the bedding ground for inspection and servicing. Because the balloon fabric is not absolutely impermeable, there is some helium loss daily which must be replenished during the servicing period.

It is desirable to have the bedding area as close as possible to the sale area so that the balloon can be tied down at the approach of adverse weather; within two or three miles if possible, less is desirable. It is much better if the bedding area can be reached on unsurfaced roads. If the road is surfaced, the track mounted transfer vehicle has to be loaded on a lowboy for the move. If a rubber-tired transfer vehicle is developed, this problem will be averted.

Hazardous trees around the bedding area must be cut. In the wind a balloon can lean  $45^{\circ}$  from the tie down point. The 530K balloon is 112' tall.

A typical bedding area requires a large deadman anchor in the center with six or eight stumps (or deadmen) around it.

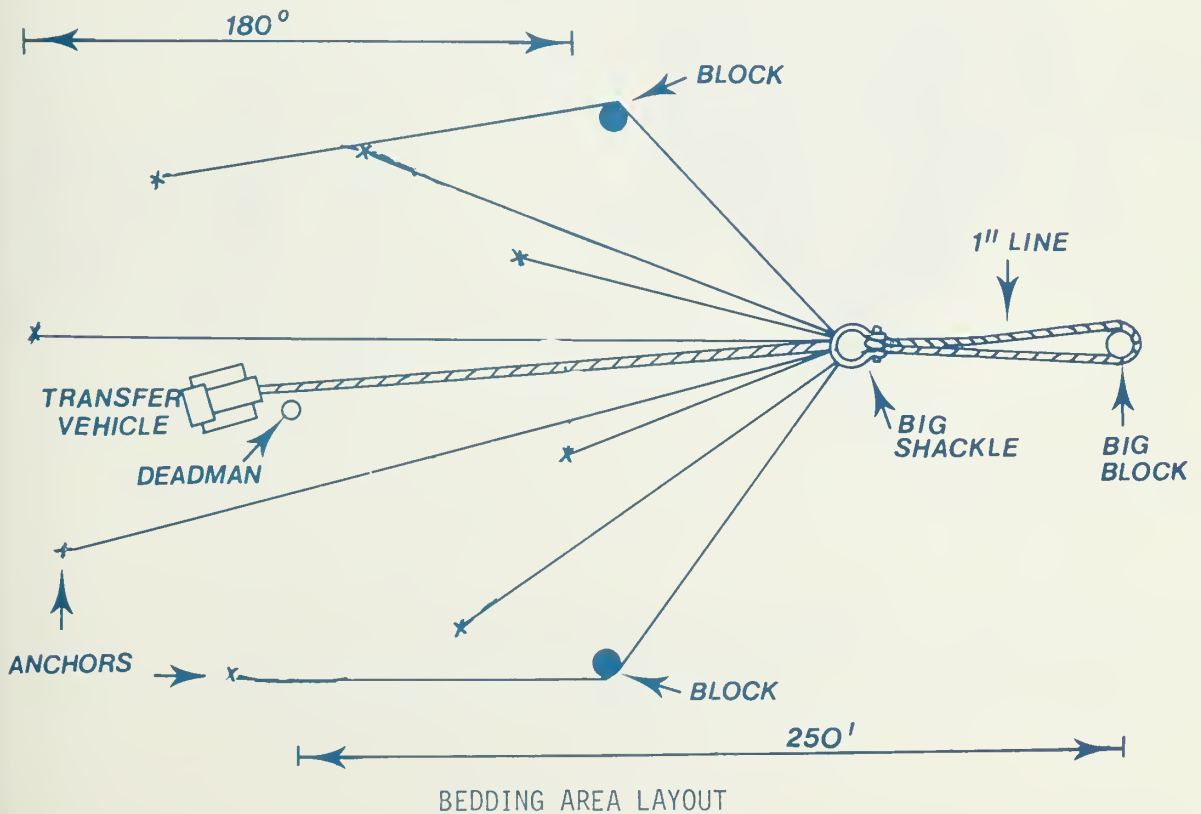

The following procedure is used when tying down a balloon.

a. The transfer tractor pulls the balloon tether line down (see figure below) until the handling lines can be placed in blocks which are attached to the anchors that form a ring around the center deadman.

b. The handling lines (nylon) are attached to 5/8" wire rope extensions which are in turn all secured to a big shackle which is on the end of a 1" wire rope. The 1" rope is secured to the tractor.

c. The tractor then lets the balloon tether lines up until the handling lines are taut.

d. The tractor pulls the handling lines (and the balloon) down by walking forward (away from the center deadman) and slacking off the tether lines, until the rigging plate at the base of the balloon can be shackled to the center deadman strap.

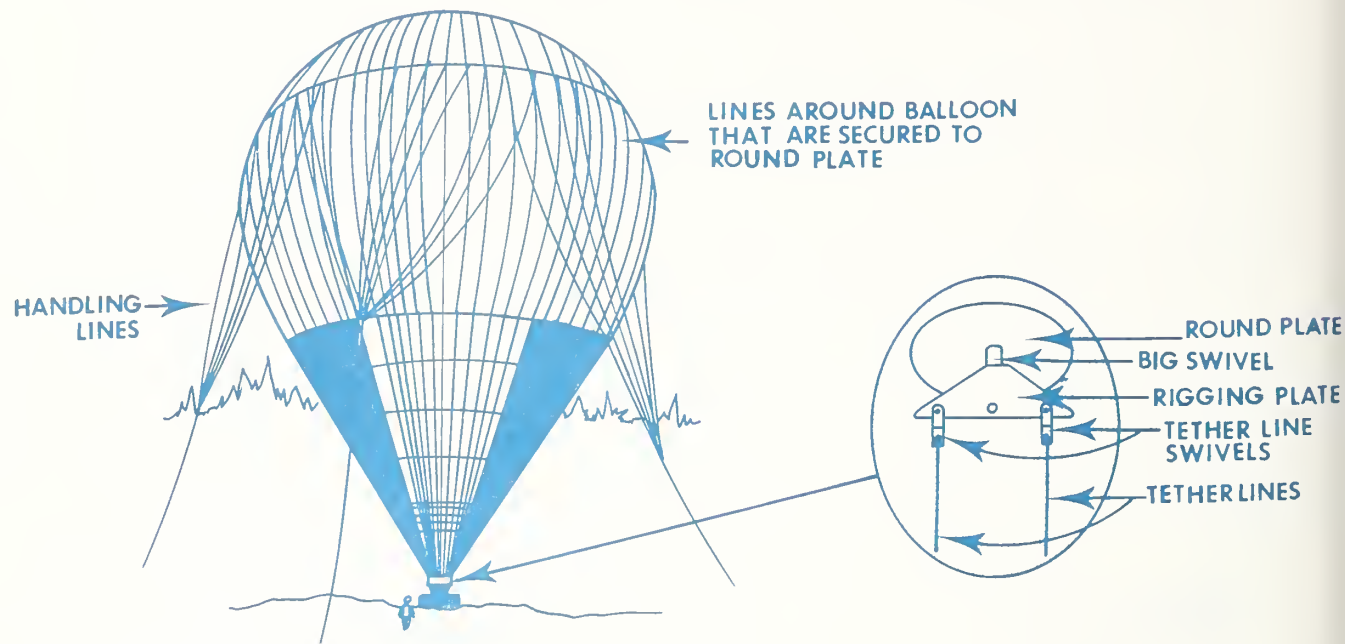



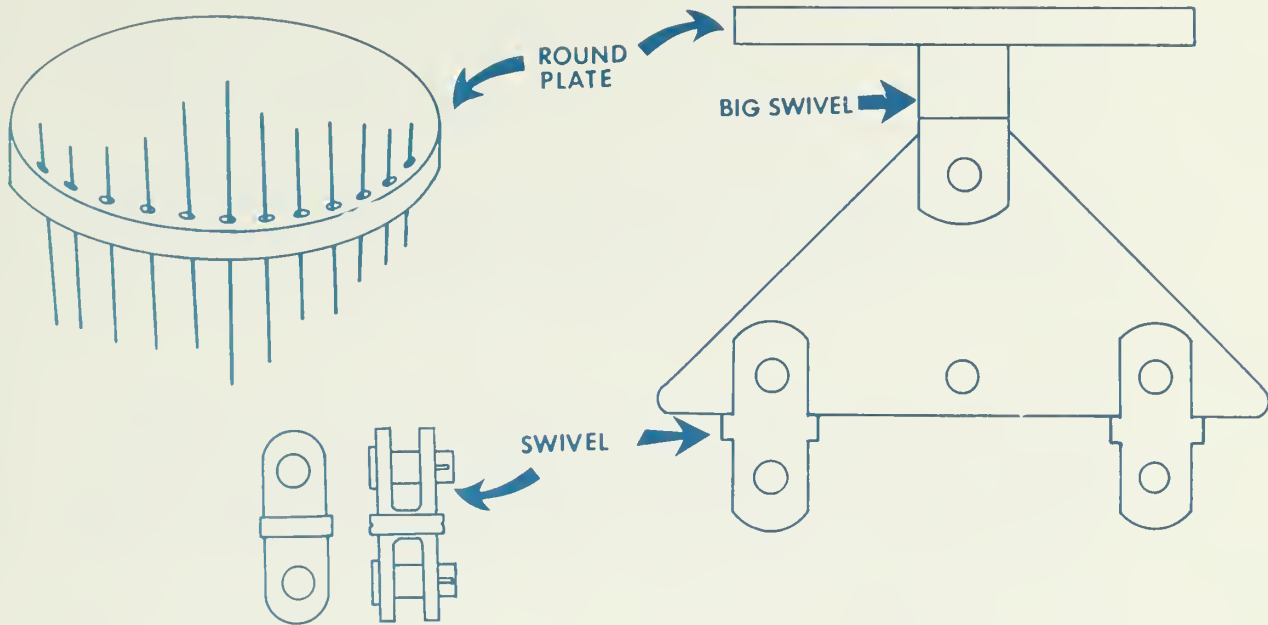

### BALLOON RIGGING--Part 2

#### Haulback Configuration

The length of the haulback limits the yarding distance of the high lead configuration to an absolute maximum of 3,300' horizontal distance. This means sales should be planned for 3,000 foot maximum slope distance, as there are bound to be some longer corners and the haulback does not go in a straight line to the tail block.

Uphill yarding using the high lead configuration is not desirable:

- a. Because of the hazard of pulling out the tail hold. A free rising empty balloon would rise at such a fast rate that it would snap the 1" haulback after a few seconds of free flight.
- b. It is very hard on the gear system in the yarder to pull the balloon back downhill empty.
- c. Cycle time would be longer as the balloon would rise slowly when it is loaded with a turn of logs.

#### Inverted Skyline

The maximum slope distance for yarding with an inverted skyline is 5,000'. At this distance the cycle time is increased enough to appreciably affect daily yarding production. A 3,000' maximum reach is more desirable.

The absence of the haulback permits the balloon to operate longer in fire weather.

The steeper the slope the more effective the system works. A minimum chord slope of 40 percent is needed to operate effectively.

The inverted skyline has a belly, the same as a flyer system, which limits yarding distance. The steeper the slope the further out the balloon can go. The tail hold must be located far enough above the unit to permit the balloon to reach the unit boundary.

### Yo-Yo

There will be longer cycle times when yarding uphill with the yo-yo system due to the slow rate of lift of the balloon when loaded and more time to pull down an unloaded balloon. The heavier the turn the slower the lift. Yarder fuel consumption will be higher because of the longer cycle time and the work in pulling the unloaded balloon downhill

## 50.3 - Operation

### Moves

The balloon is moved between sale areas inflated if possible. Travel routes should be checked for overhead obstruction such as powerlines and truss bridges. Load limits on bridges must also be checked to confirm that they can support a 172,000-pound yarder.

If a balloon has to be deflated to be moved to the sale area, the move-in cost has to cover the cost of helium, to reinflate the balloon. This means the volume in the sale should be sufficient to make the cost/M for helium acceptable. As a minimum there should be volume for a full season's logging. Two or three seasons is better.

It is possible to recapture the gas when the balloon is deflated but at present time suitable storage tanks are expensive and scarce.

Balloons are very easily damaged when they are only partially inflated it they are free to blow about. Special rigging is needed to restrict movement as a balloon is deflated.

A balloon can pass over powerlines if the power is cut and a hydraulic chair can reach high enough to pass the balloon tether lines over the powerlines. The balloon has been passed under powerlines that are 150' high.

The U.S. Army did move a dirigible shaped balloon with a helicopter at speeds up to 60 knots. The balloon was weighted down with a load heavier than the balloon lift.

### Log Loading

A heelboom loader cannot operate adjacent to the yarder due to the lack of precise control over the logs as they are landed. Rubber-tired skidders swing the logs from the landing to the loading area. Logs are commonly loaded with a heelboom. The use of Batson bunks could cut loading costs.

### Line Tension

A gauge in the yarder is used by the yarder engineer to keep tension in the mainline and haulback within a safe operating range. Line tension is increased when the balloon is pulled down to pick up logs the same way line tension is increased in a loaded skyline when deflection is reduced. Therefore, after the turn is picked up the balloon is allowed to rise (to increase deflection) to reduce line tension as the turn is yarded.

There is maximum tension in the lines when the balloon is not loaded. This keeps the belly out of the lines except when the balloon approaches the yarder or tail block, where the winding line assumes more of the load than the unwinding line. This can result in part of the unwinding line dropping to the ground.

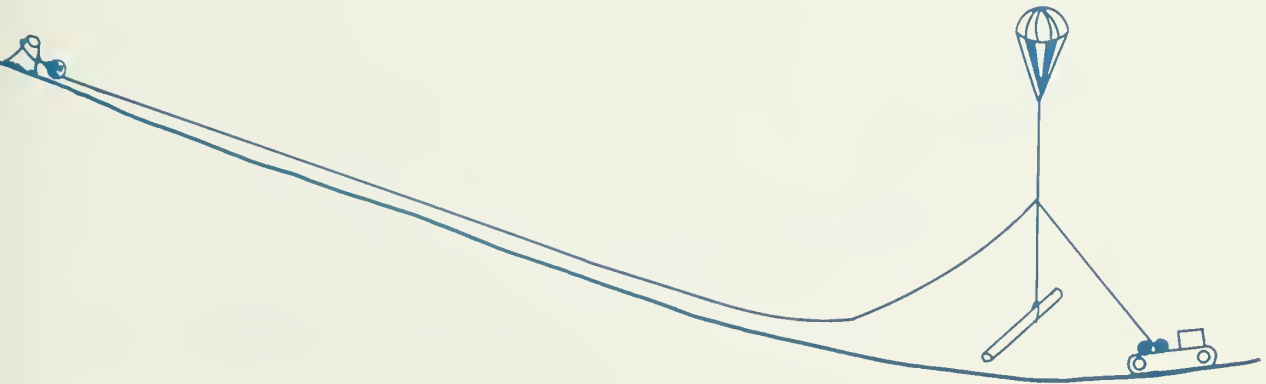

THE HAULBACK WILL LAY ON THE GROUND WHEN LANDING LOGS

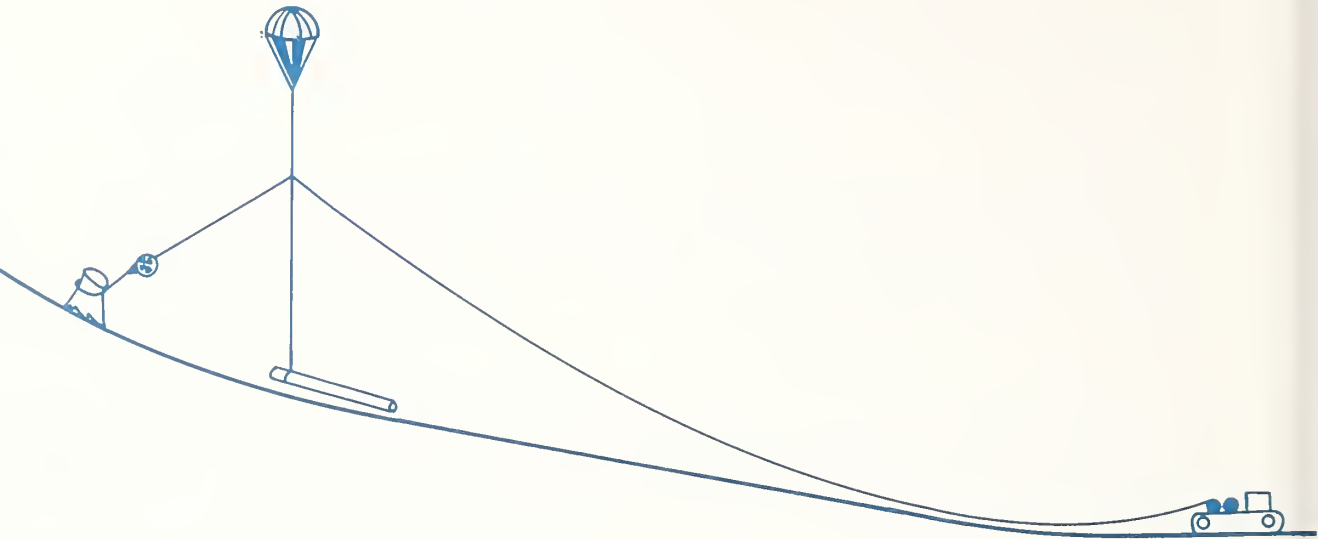

THE MAINLINE WILL LAY ON THE GROUND WHEN PICKING UP A TURN

The ratio of the yarding distance to the length of the drop line effects the amount of line that will drop to the ground when the balloon is pulled down. See figures below.

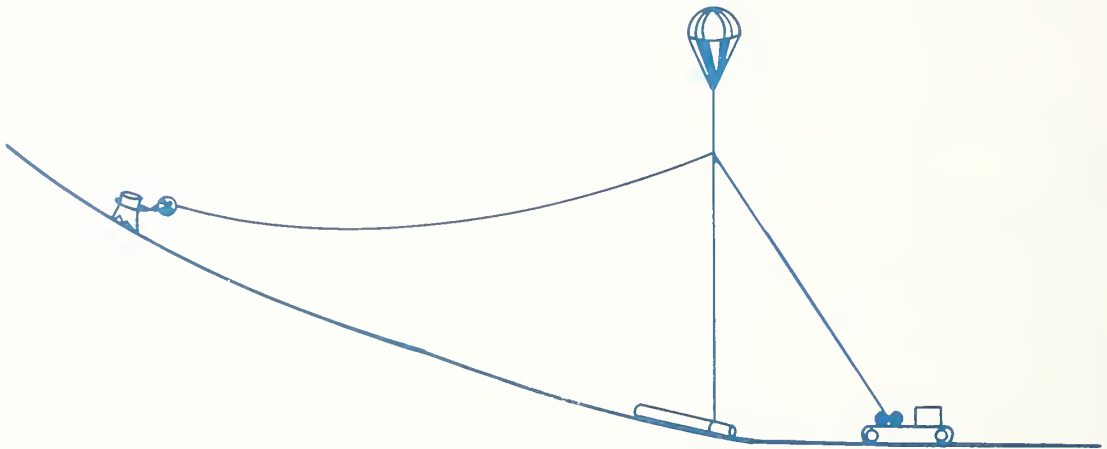

WHEN THE SPAN IS SHORT AND THE TAG LINE LONG, THE OPERATING LINES ARE IN THE AIR



WHEN THE SPAN IS LONG AND THE TAG LINE SHORT, THE  
OPERATING LINES DROP TO THE GROUND

If the turns are significantly elevated when logs are yarded, the mainline and haulback will be in the air while the lines are moving. The lines may drop to the ground when turns are picked up or landed.

The land form has a decided effect on whether or not the lines will drop to the ground.



SMOOTH

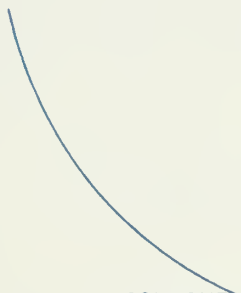

CONCAVE



CONVEX

THREE BASIC LAND FORMS

The worst condition for dropping the lines to the ground occurs when yarding a long distance, with a relatively flat slope, to reach logs behind a ridge.

There is an HP 9830 computer program which tells when the balloon mainline or haulback will be on the ground.



HAULBACK DROPS TO THE GROUND WHEN YARDING LONG, FLAT  
ROADS OVER A RIDGE

50.31 - Rig Up Procedure

Seventeen inch, 170 pound corner blocks are used when balloon yarding. A fifteen inch, 70 pound sucker down (pull down) block is used (See 2nd figure below).

The waist line (haulback between yarder and tail block) must be located so that it doesn't drag on the ground. Fast line speeds would wear a dragging line in a hurry and would be a serious fire hazard.

The sucker down block has to be moved downhill as yarding progresses downhill. This is normally accomplished by tying the balloon to the yarder and slacking the haulback so that the haulback is laying on the ground at the new sucker down block location.

The balloon is secured to the rigging as shown below.

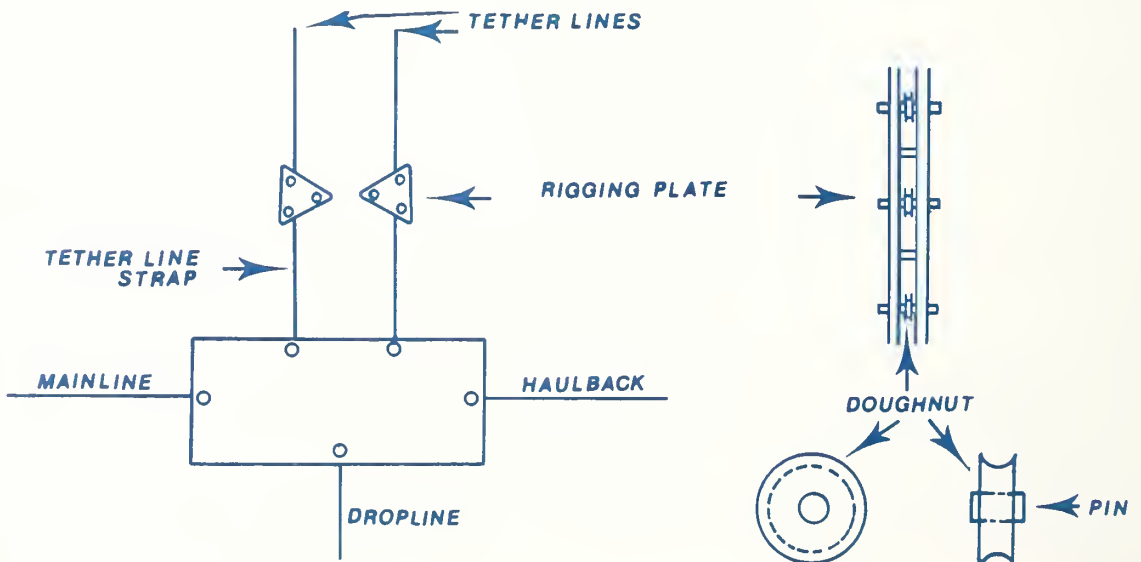

LINES USED IN BALLOON LOGGING

When the balloon is transferred to the yarder or transfer vehicle, two lines are kept secured to the balloon at all times. The transfer tractor has a hydraulic drum in addition to the standard winch drum so it can handle the two lines.

The balloon transfer to the transfer vehicle is accomplished as follows:

1. Pull the butt rigging to the yarder.
2. Shackle the two tractor lines to the third hole in each of the rigging plates on the tether lines, one tractor line to each hole.
3. Suck one tractor line down to take the strain off one tether line strap and unhook the strap.
4. Suck the other tractor line down and unhook the other tether line strap.

### High Lead Configuration

Rig up and road changes are the same as with high lead (Section 48.2) plus hanging the sucker down block. The sucker down block can be yarded into position after the lines are rigged.

The balloon is shackled to the yarder during road changes.

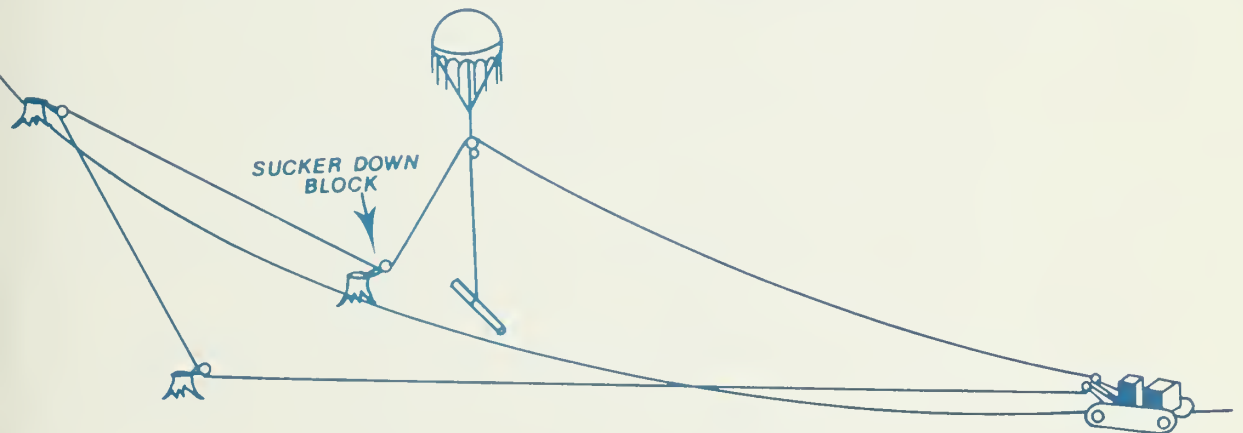

BALLOON HIGH LEAD LAYOUT

## Inverted Skyline

See Section 50 for a figure showing inverted skyline layout.

The inverted skyline can be rigged up and road changes made the same as with the flyer system. Another way of changing roads that is faster, is to pull the skyline through several tail blocks when first rigging up. See the figure below.

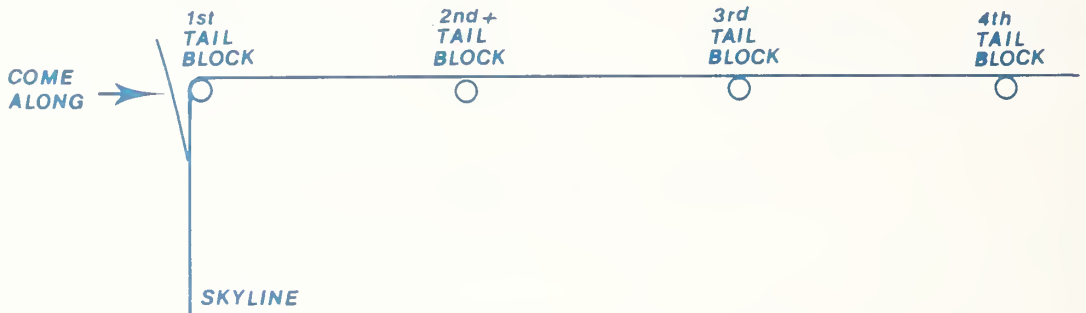

### SEVERAL TAIL BLOCKS RIGGED AHEAD ON INVERTED SKYLINE

To change roads:

1. Pull the balloon to the yarder.
2. Secure a come-along to the skyline in front of the tail block using a rope.
3. Tighten the come-along to take the strain off the tail block.
4. Remove the skyline from the first tail block.
5. Cut the come-along rope.
6. Let the balloon out from the yarder easy, and it will swing the skyline to the new tail hold.

When the inverted skyline is rigged the tail hold must be far enough beyond the unit boundary so that the belly of the line will be beyond the unit boundary. On steep ground this is around 200'. The distance increases with gentler slopes.

## Yo Yo System

To rig up, strawline is pulled downhill from the top yarder (if there is a difference in elevation), through the road block, to the second yarder (See figure in Section 50). The strawline then pulls the mainline or haulback, back to the first yarder. The mainline and haulback are connected and the balloon is hooked on. The balloon has to be on the landing side of the road block.



Roads can be changed as follows:

1. String a section of strawline from the old road block through the new road block and out to the balloon road. See figure below.
2. Pull the strawline off the mainline yarder to point 1.
3. Hook the strawline from the mainline yarder to the strawline through the new road block.
4. Tie off the balloon at the mainline yarder and unhook the haulback.
5. Pull the haulback out to point 2 on the balloon road.
6. Take the haulback out of the old road block.
7. Hook the haulback to the strawline and pull the haulback through the new road block to the mainline yarder.
8. Hook the mainline to the haulback, hook on the balloon and start yarding.

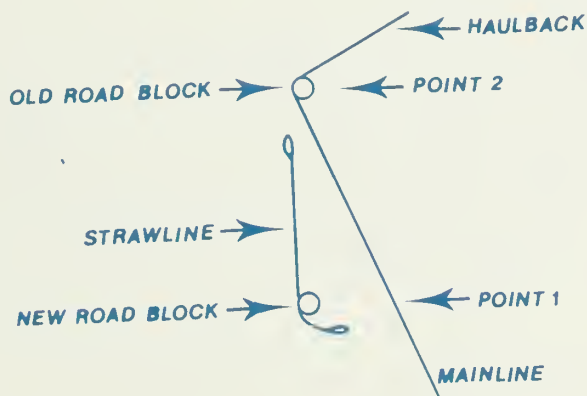

ROAD CHANGE DIAGRAM FOR YOYO SYSTEM

### 50.4 - Layout Recommendations

Balloon logging is geared to logging clearcuts. As in other logging methods requiring expensive equipment and machinery, high yarding production is necessary for economic operation. Logging costs are affected by the frequency of moves (down time). Large units (more volume) tend to reduce moving costs. Fan shaped landings require fewer moves for the same volume than parallel landings.

Frequently, topography will determine unit size and whether fan shaped or parallel landings can be used.

If there will be a buffer strip between the unit and the landing, and the landing is set up for radial skid roads, the yarder should set as close to the buffer as possible; possibly right of the buffer. This arrangement will minimize the size of the opening that will be needed in the buffer for mainline movement.

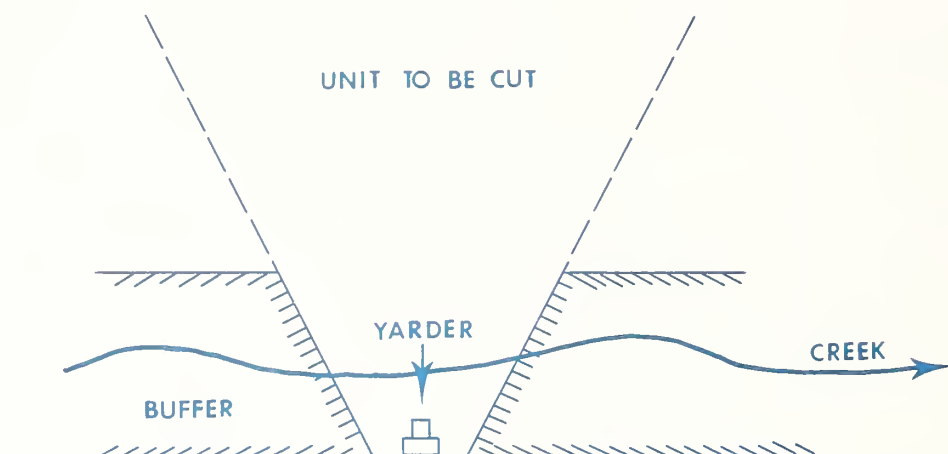

LESS BUFFER MUST BE CUT IF THE YARDER CAN SET  
IN THE BUFFER

Also, the yarder can be moved as the unit is logged, to further reduce the opening through the buffer.

With the yo-yo system, the balloon can be side blocked with bends as much as 90° at the road block. Therefore, a large drainage (too big for one clearcut unit) could have pie shaped cut and leave units with the unit apexes at the yarder, and the back of the unit at the road block locations. If more than two landings are available, the drainage cut pattern can have more variety. If the units do not run from road to road, a corridor for the haulback is needed from the road block through the leave strip to the yarder.

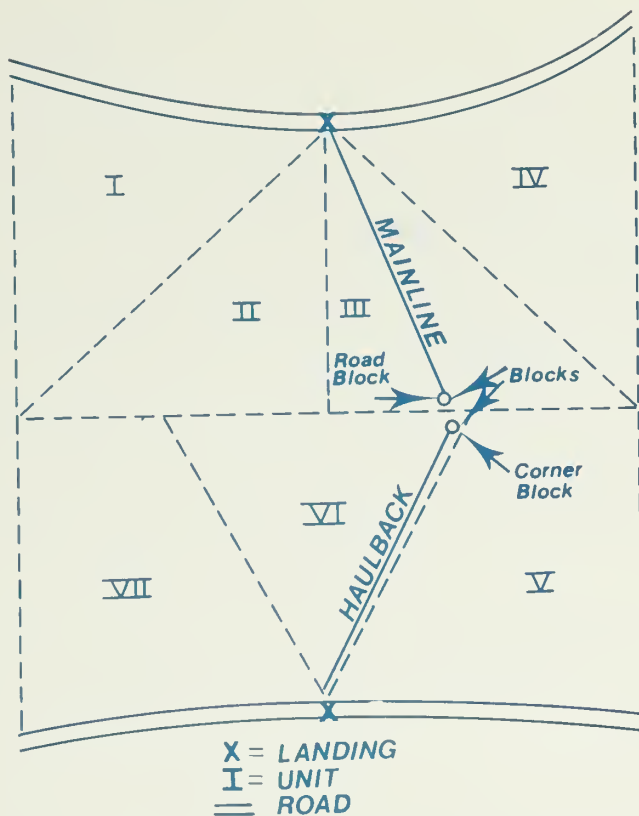

AREA PLAN SHOWING POSSIBLE YO-YO UNIT LAYOUT

### 50.5 - Advantages

1. Long yarding distances:

Haulback Configuration:	3000'
Inverted Skyline	: 3000' to 5000'
Yo-Yo	: 3000' to 7000'

2. Logs are flown free of the ground;

No soil disturbance  
Less breakage

3. Less affected by convex slopes than single span skylines.

4. Small landings are possible if a short tag line is used.

5. Light chokers can be used.

50.6 - Disadvantages

1. High cost of yarders.
2. High loading cost (both skidder and loader required).
3. Not suited to partial cutting.
4. More susceptible to weather shut downs than cable systems.
5. Shorter operating season.
6. Log suspension eliminates the opportunity of using logs to do site preparation.

## 60. - HELICOPTER

### 61. - Introduction

The first trial of helicopters in logging was in Scotland in 1955. This initial operation, along with numerous other experimental programs through the late 50's and 60's showed the potential of aerial logging. Two factors slowed the use of helicopters for logging--the first was high cost of moving logs in relation to market values. The second was the development of dependable turbine engines for helicopters. The reality of helicopter logging was made possible by the increased reliability of engines and higher timber values.

Helicopter logging was initially started in the United States, by Columbia Construction Helicopter of Portland, Oregon, on a timber sale purchased by Erickson Lumber Company of Marysville, California. This initial commercial venture proved without a doubt that vertical logging was indeed an economic reality.

Based on the success of the Lights Creek operation, a program of sales was developed throughout the West with an annual sale program of Forest Service timber, which approaches 300 MBF.

### 62. - System Description

A helicopter of adequate payload capability is used to carry logs from the woods to the landing. A typical yarding cycle consists of flying from the landing to the pickup area, hovering over the load while the hooker attaches chokers to the helicopter hook on the end of the tag line, climbing out of the pickup area, returning to the landing, setting the logs down and automatically (via an electric hook) releasing the load. Then the cycle is repeated. A light utility helicopter usually returns the chokers to crews on the slopes as required. It is more cost effective to use a small ship to ferry crews and chokers when a Class 1 size ship is used for yarding. A Class 1 helicopter has a lift capacity of approximately 20,000#, and a Class 2 helicopter has approximately 10,000#, of lift capacity. It should be noted that elevation, temperature, pilot skill, and aircraft condition are factors which limit lift capacity. Figure I illustrates a typical cycle operation.

Radio communications are maintained between air and ground crews to facilitate safe operation and log pickup. The "command" pilot leans out the left window of the helicopter to see the "hook" in order to judge hover heights during pickup and release of the loads.

The overall operation attempts to do two things; maximize turn efficiency by having the log weight approach the load carrying capacity on each "turn", and minimize cycle time. These goals necessitate careful planning in the falling and bucking areas. Trees should be bucked to aid in selecting optimum loads for the helicopter with consideration for log grade and market requirements.

Since maximum weight is so important, the turn markers must determine the bucking lengths and combinations of logs for load makeup. Chokers are preset in advance of yarding. Loads are planned to be close to optimum payload, thereby reducing the number of aborts and light loads. (An abort is a load which exceeds the lift capacity of the helicopter.) Miscalculations in load planning will affect the economics of the operation.

To maximize the log-carrying capacity of the aircraft, a full fuel load is not carried. Only enough fuel for 40 minutes flight time, plus a 10-minute reserve is carried. Refueling is done at 30 minute intervals without shutting down. The helicopter is shut down every two hours for a maintenance inspection and a crew rest. Flight crews are changed after four hours of flying.

### PERSONNEL REQUIRED

The following personnel are needed for full operational capacity of a Class I. or 20,000# lift helicopter.

#### Falling and Bucking Crew

3 log weight estimators  
3 to 5 crews of fallers and buckers  
3 or 4 turn markers

#### Yarding Crew

4 choker setters  
2 hookers  
2 to 4 chasers  
4 pilots

#### Landing Crew

1 Loader operator (rubber-tired)  
1 Swing boom loader operator  
(used on high production sides)  
1 Project manager

#### Maintenance Crew

4 Maintenance personnel

Log weight estimators, fallers and buckers are used ahead of, and during yarding operations. Maintenance personnel generally work during non-yarding periods.

### EQUIPMENT

A normal helicopter logging operation for a Class 1, or 2, helicopter sale consists of at least :

- 1 - Logging Helicopter
- 1 - Rubber-tired, front-end loader
- 1 - Swing boom loader (on high production sales)
- 1 - Small utility helicopter
- 1 - Bulk fuel handling system
- Maintenance support equipment (as needed for helicopter maintenance)
- Chokers

\*A Class 1 helicopter has a lift capacity of approximately 20,000#, and a Class 2 helicopter has approximately 10,000#, of lift capacity. It should be noted that elevation, temperature, pilot skill, and aircraft condition are factors which limit lift capability.

TABLE 1--Basic characteristics of commercially available and FAA-certified helicopters<sup>1/</sup>

Characteristics	Class 1 (Large) <sup>3/</sup>		Class 2 (Medium) <sup>3/</sup>		Class 3 (Small) <sup>3/</sup>		
	S-64E	S-64F	214B	107-II	S-61N&L	212	S-58T
<b>Performance:</b>							
Maximum Speed (miles per hour)	127	115	115	167	150	132	150
Service Ceiling (feet)	10,000	16,000	11,300	10,000	12,500	17,400	15,000
Fuel Consumption (gallons per hour)	395	395	200	180	150	---	110
<b>Engines</b>							
Number	2	2	1	2	2	1	2
Maximum Horsepower	4,500	4,800	2,930	1,350	1,500	900	910
<b>Weights (pounds)</b>							
Gross Weight	42,000	47,000	16,000	19,000	19,000	11,200	13,000
Approximate Payload <sup>4/</sup>	20,000	25,000	7,400	8,000	8,500	4,200	5,000
<b>Dimensions (nearest foot)</b>							
Fuselage Length	70	70	45	45	61	42	39
Fuselage Width	22	22	9	7	7	9	6
Overall Length (with rotors)	89	89	61	83	73	57	51
Overall Height	25	25	14	17	18	13	16
Main Rotor Diameter	72	72	50	50 <sup>2/</sup>	62	48	56
Tail Rotor Diameter	16	16	10	--	10	8	10
Tread	20	20	--	13	14	--	12
Wheelbase	24	24	9	25	24	8	28

<sup>1/</sup> Stevens, P.M., Clarke, Edward,; HELICOPTER LOGGING CHARACTERISTICS, OPERATIONS AND SAFETY CONSIDERATIONS, PNW 20, 1974.

<sup>2/</sup> Two main rotors, each 50 feet in diameter.

<sup>3/</sup> Class I - 12,000 pound lift and above. Class 2 - 6,000 to 11,999 pound lift. Class 3 - up to 5,999 pound lift

<sup>4/</sup> Based on external lift at sea level.

FIG. 1  
HELICOPTER YARDING CYCLE

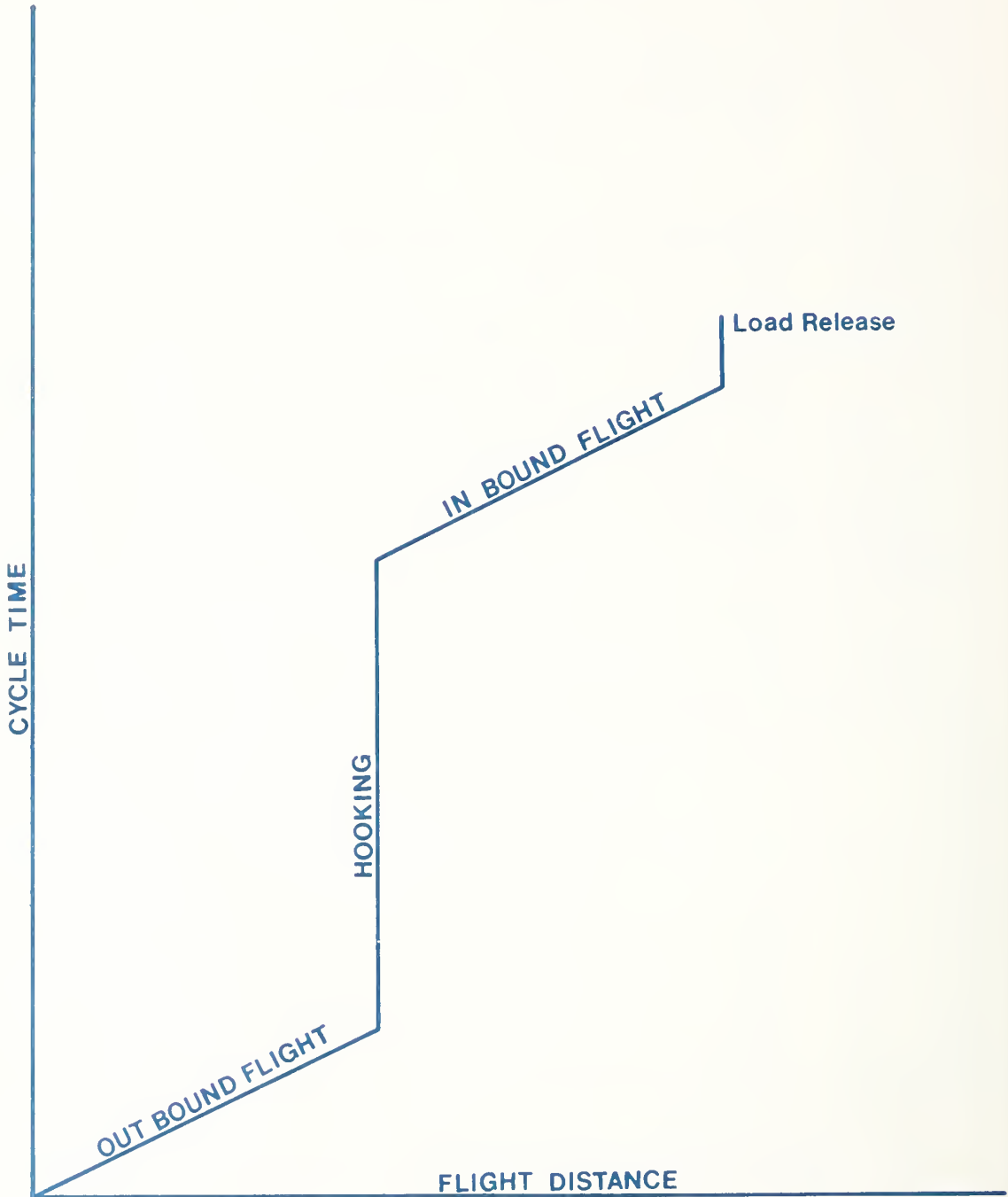



Lift capabilities and basic characteristics of helicopters suited to logging are listed in Table 1.

### 63. - Requirements and Limitations

#### 63.1 - Yarding Cycle Variables

1. Length of Load Line. Residual tree height is the primary factor in determining length of tag line needed. A clearance of not less than 25 feet (7.62 meters) is needed between residual treetops and the helicopter (most pilots prefer 50 feet). The effect of ground slope should be considered when estimating tag line lengths. Picking up logs near the edge of the unit may require longer tag lines because of proximity to an uncut stand. Tag line lengths that have been used range between 100 feet (30.48 meters) and 300 feet (91.44 meters); lengths over 200 feet (60.96 meters) significantly increase turn times and thus logging costs.

2. Log Size. Trying to assemble a large number of small logs to meet optimum load capability increases cycle and log handling time at the landing. Logs that exceed the lift capability of the helicopter must be bucked shorter or split. This will reduce log value and increase bucking costs.

3. External Yarding Distance. There is a direct relationship between yarding distance and cycle time. External yarding distance is the flight path of the aircraft and not necessarily a straight line from the unit to the landing.

4. Stand Characteristics. Stand density is an important parameter and must be considered in relation to distribution of the volume, the size of logs, yarding distances and terrain conditions. In stands with low volume per acre, individual trees designated for cutting should be within merchantable tree length of each other, or in groups to facilitate log pickup. The trees should be distributed over the area so that, after felling, a maximum payload can be picked up on every turn. In addition, the hooker must be able to negotiate the terrain and locate the turn before the helicopter returns.

#### 63.2 - Landings

A landing is an area where the logs are deposited, decked and/or stored preparatory to loading and transportation to the mill. The landing area is composed of a drop pad, decking area, and loading area. A landing area must be large enough to safely land, store and load logs.

The landing is not a designated place to land a helicopter unless an emergency should occur. The service area, not necessarily located adjacent to the landing, is used as a heliport for the ship where fueling and maintenance operations are performed. It may become a part of the Forest's permanent heliport system.

### Locations

Landing should be located to serve as much of the area's timber resource as possible.

Landing and service areas should be located with safety of operation in mind. Landings are usually located on ridge tops or valley bottoms. The important consideration is that the difference in elevation between log pickup and landings should not exceed 1,320' downhill with yarding distances less than 3,300'. Yarding distances should be computed as a function of the flight path, and not as a straight line from the landing to the unit. When yarding uphill, elevation differences from log pickup to landing should not exceed 1,000'. When vertical differences in elevation exceed the above, increased time adjustments for yarding cycles should be considered.

### Landing Surfaces

The surface of both the landing and service areas should be kept free of dust and small particles that could be picked up by the rotor downwash. Water is the most effective surface treatment for reducing dust. Normally, there is enough time to water the landing while the helicopter is refueling. A rock surfacing will usually be needed for stability, especially on the area that the front-end loader is working. If water is not available, dust oil is an alternative; however, depending on the volume flown to the landing, more than one application may be needed. A rubber-tired, front-end loader tends to knead the dust oil into the ground, and it soon becomes ineffective for controlling dust. The postsale use of the landing may have an effect on the decision to use dust oil. If, for example, the landing area is to be planted after the sale, then the residual oil must be disposed of.

Landings should be well drained. Drainage should not flow into live streams.

### Size

Landing size is affected by many variables. A minimum size can be determined by analyzing the effect on the variables on each component of the landing. Figures 2 and 3 are diagrams of two landing configurations that have been used on helicopter sales. The drop pad should be large enough to handle the largest log that will be yarded, and also provide

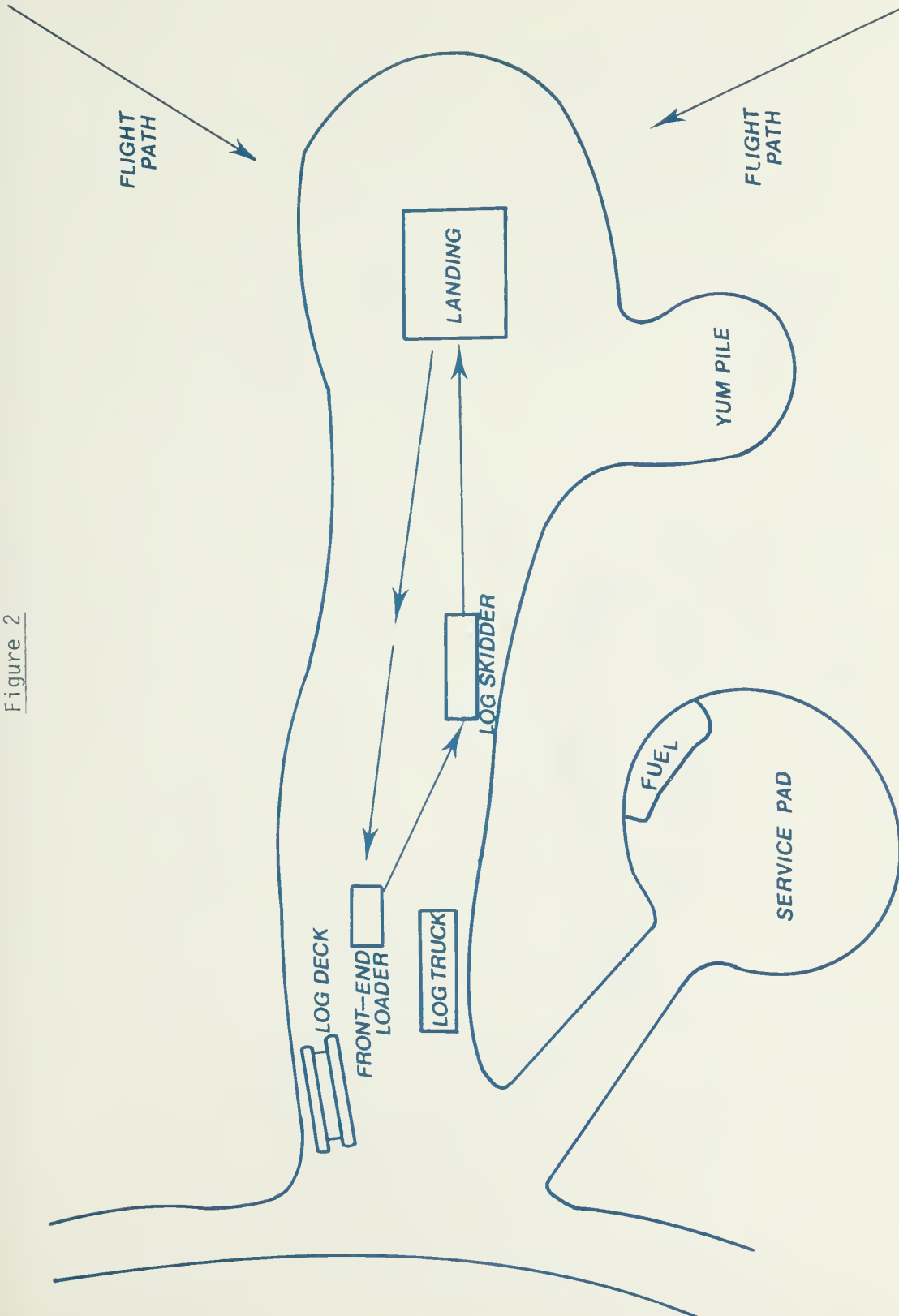
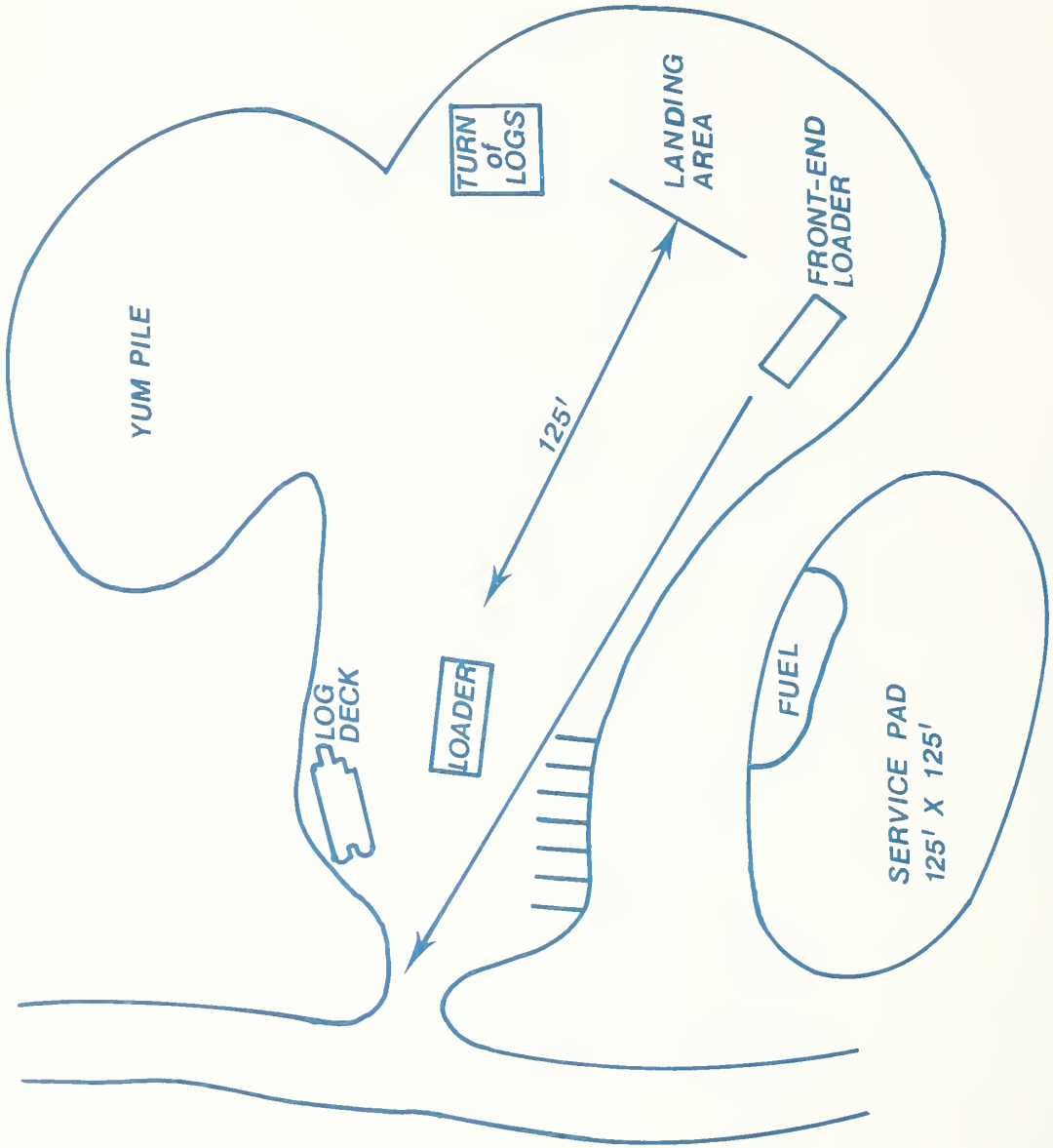

Figure 2

LANDING CONFIGURATION FOR 8,500# LIFT HELICOPTER  
NOT LESS THAN 1.5 ACRES IN SIZE

Figure 3



LANDING CONFIGURATION FOR 20,000# LIFT HELICOPTER  
1½ to 2 ACRES IN SIZE

Figure 4

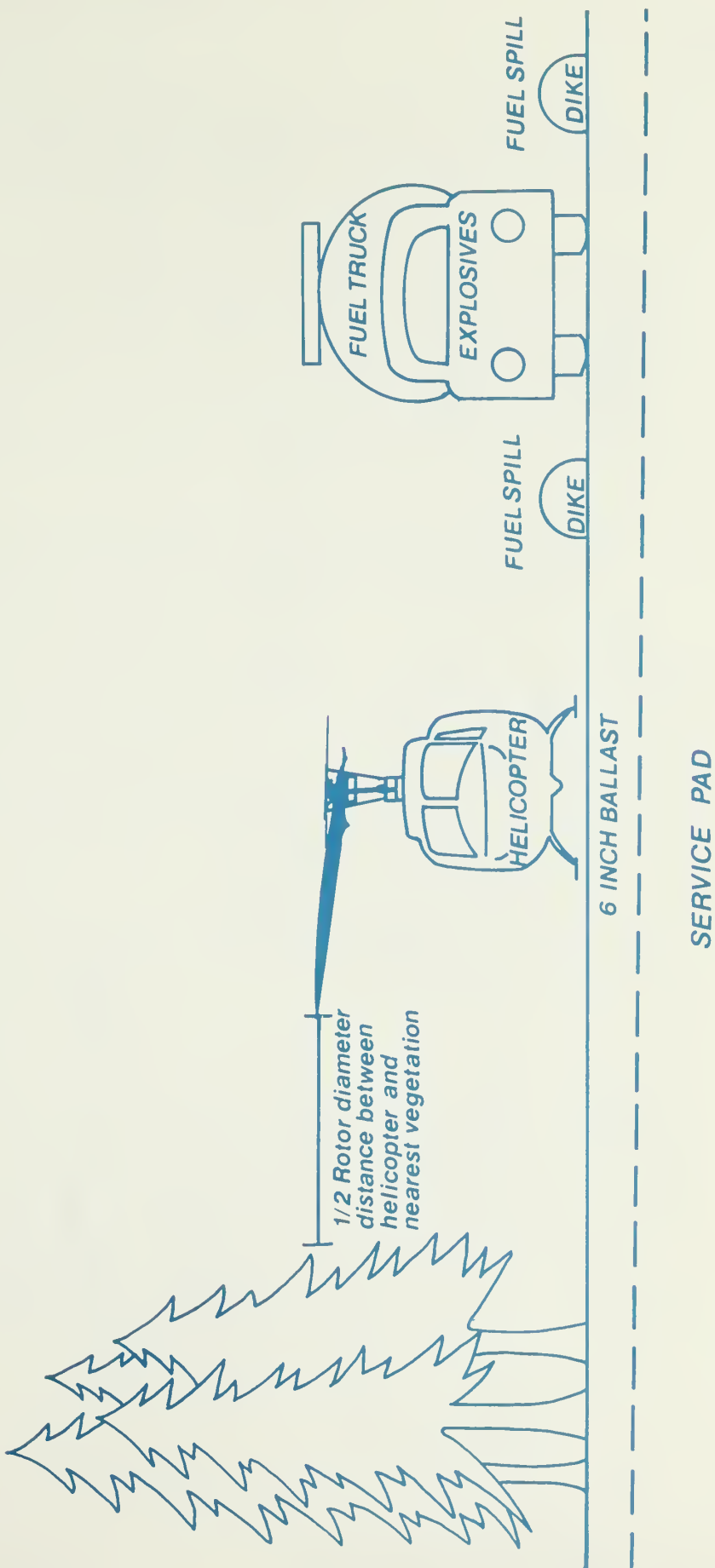
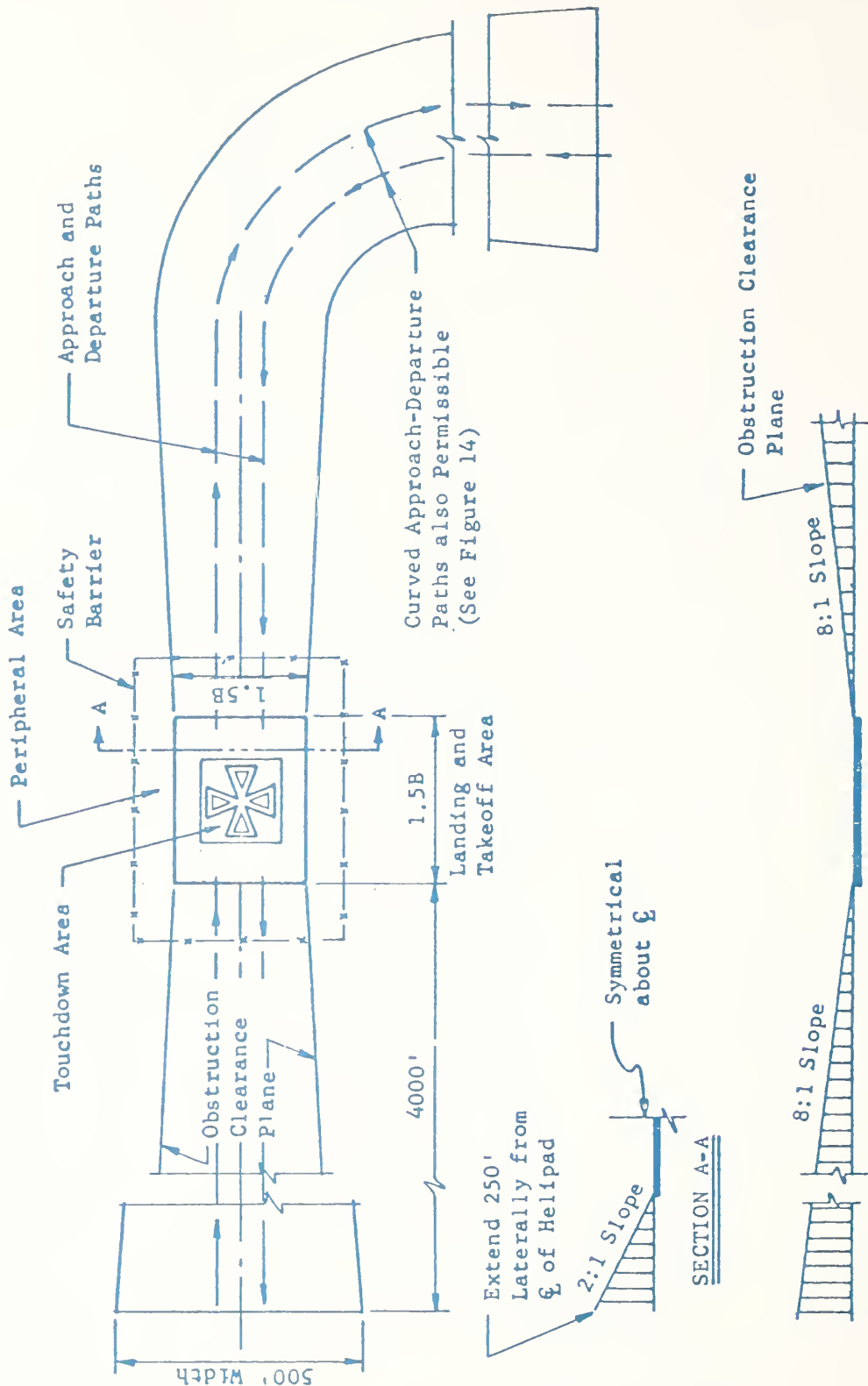

Figure 5--Drop zone and service pad layout



NOTE: Dimension B Equals Overall Length of Helicopter

Example of Private Heliport Layout.

a margin of safety for sliding logs, early jettisoning, and pilot error. A minimum drop pad diameter would be  $2\frac{1}{2}$  times the longest log yarded. Equipment should be kept at least 50 feet (15.24 meters) from the drop areas. The front-end loader should have a safe area to park while the load is being unhooked.

The decking area is located immediately adjacent to the drop pad, and should be large enough to deck  $1\frac{1}{2}$  to 2 days' work production, provide room for the front-end loader to maneuver, and in some cases, provide an area for a heel boom loader to load trucks. A minimum area of approximately 100 feet by 150 feet (30.48 meters by 45.72 meters) will be needed to deck and load. The S-64E normally produces 150 to 200 + MMBF per day while the BV-107's or S-61's produce 75MBF to 125MBF per day. If YUM required, an additional area is needed to handle this material.

A landing pad for the support helicopter is needed on an S-64E operation in the vicinity of the landing. This must be an unobstructed area of approximately two times the rotor diameter of the support helicopter. Normally, this would be an area with a diameter of approximately 80 feet (24.39 meters).

An area for the water bucket shall be provided near the landing. There must be ample room for the ship to safely hover while the bucket is being attached. A parking area for choker setters, hookers, and fallers near the landing is needed if they are to be ferried by the support ship. A truck turnaround and a storage area for 4 to 6 trucks is needed to avoid congestion at the landing. These areas should not be located under the flight paths.

### Grade

The maximum gradient on landings should not exceed 6 percent for safe operation of rubber-tired, front-end loaders and not less than 2 percent for adequate drainage.

### 63.3 - Service Area

The service area should be located to minimize the flight time from the landing or service pad. If room is available, it can be located adjacent to the landing; however, the increased congestion may decrease the overall efficiency of the operation. One centrally located service area may serve several landings or perhaps the entire sale. It should be located at the same elevation as the landings or below them to facilitate an emergency landing of the helicopter. The service pad must be large enough to safely land the helicopter. Federal Aviation Administration recommends a minimum length and width of the landing area

of  $1\frac{1}{2}$  times the overall length of the helicopter. (See figure 5.) For an S-64E, an area of 135 feet (41.14 meters) square is needed. In addition, a peripheral area surrounding the landing and takeoff area of one-fourth the overall length of the helicopter is needed as an obstruction-free safety zone. Therefore, a total of 160 feet (48.77 meters) square is needed to land the S-64E. The dimension of the actual touchdown area should be based on the rotor diameter, e.g., an S-64E would need 72 feet. (See Table I for dimensions of other aircraft.) The service area must be large enough to accommodate fuel trucks or tanks, pumps, starting generator, maintenance van, and parking for three to five vehicles. This is in addition to the area needed to land the helicopter. Fuel tanks located on the service area should have dikes around them to contain any fuel spills. (See figure 4.)

### 63.4 - Flight Path

Flight path to landing areas must be planned so that log landings are into the wind. When wind patterns are such that downwind landings are a major portion of the projected yarding time, the landing area should not be considered.

Normally, wind flows are either up or down canyon. Approaches with landings located in valley bottoms will allow operations, if approaches can be made as diagrammed in Figure 5. At least two approach and departure paths for the helicopter may be needed to account for changing wind patterns. These paths should be aligned as directly as possible into the prevailing winds. The maximum out-of-wind approach would be crosswinds or the winds at right angles to the flight path of the helicopter.

Obstruction clearance planes, aligned with the direction of the approach-departure paths, extend outward and upward from the edge of the landing or service area at an angle of 8 feet (2.44 meters) horizontal and 1 foot (30.48 centimeters) vertical. The path need not be a straight line, but can curve to avoid obstructions such as groups of trees, ridges, structures, etc. The path should be straight for approximately 300 feet (91.44 meters) from the drop pad and then curve. The radius of curve of the path should be approximately 700 feet (213.36 meters). For example, a tree taller than 100 feet (30.48 meters) located in the flight path 800 feet (243.83 meters) horizontal distance from the edge of the landing would have to be removed. The flight path should not be over personnel or equipment. If the loaded flight path crosses a road, flagmen will be required.

### 63.5 - General Safety

Last, but not least, the general arrangement of landings must be such that all aspects of the operation are conducted with minimum hazard. This includes flight operations, as well as ground operations. Blind spots and awkward locations of loading in relation to decks and log landings areas must be avoided.



Snag top trees standing adjacent to log pickup and unhook areas are a safety hazard and should be felled prior to the yarding operation. Rotor downwash or hitting the tree while lifting the turn may dislodge the top or dead limbs. Individual trees that are significantly taller than the surrounding stand are dangerous to helicopter flight.

#### 64. - Sale Layout Recommendations

Sale layout is discussed in FSH 2409.14, R-10, Chapter 100, Planning and Preparing the Timber Sale.

#### 64. - Advantages

1. Ease of move in and out.
2. No soil disturbance due to yarding.
3. Minimum yarding impact to residual vegetation.
4. Low road density required.
5. Long yarding distance capability.
6. Not much effected by ground slope and shape.
7. Minimum yarding breakage.
8. Large daily production.
9. Log in both clearcuts and partial cuts.

#### 66. - Disadvantages

1. High yarding cost.
2. High fuel consumption.
3. No site preparation by dragging logs.
4. Large landing and service area requirements.
5. Affected by weather; poor visibility and strong winds result in a lot of down time.
6. Generally poor utilization due to high yarding cost.
7. YUM yarding costs generally prohibitive.
8. Difficult to achieve MM fuel rating.
9. Minimum opportunity for intensive management of future stands because of access and cost.

## 70--REFERENCES

10 - LOGGING - GENERAL

- |  |  |         |
|--|--|---------|
| 1 - "Logging and Pulpwood Production,"<br>Ronald Press Co., New York | Pearce and Stengel   | 1972    |
| 2 - "Logging - Principles and Practices,"<br>John Waley & Sons, Inc. | Brown  | 1934    |
| 3 - Oregon State Safety Code, Chapter 16<br>Logging                  | Workman's Compen-<br>sation Board                            | 1969    |
| 4 - Safety Standards for Logging Operations,<br>State of Washington  | Department of Labor<br>and Industry                          | 1972    |
| 5 - Wood Products Code, Subchapter 7,<br>Article 1, Logging          | Alaska Divsion of<br>Occupational Safety<br>Health           | 1976    |
| 6 - "Woods Words",   | McCulloch, Oregon<br>Historical Society                      | 1958    |
| 7 - A Glossary of Logging Terms,                                     | Robt. Kennedy, Ore-<br>gon Workman's Com-<br>pensation Board | 1975    |
| 8 - Glossary of Cable Logging Terms,                                 | PNW  | 1969    |
| 9 - Cable Logging Terms For Region 6                                 | R6   | 1975    |
| 10 - Logging Systems Terminology, Region 6                           | R6   | 1975    |
| 11 - Willamette Logging Systems Guide                                | McGonagill, R10  | 1976    |
| 12 - Loggers Handbooks   | Pacific Logging Congress                                     |         |
| 13 - Oregon Logging Congress, Official Proceedings                   |  |         |
| 14 - Western Conservation Journal                                    | Seattle, WA  |         |
| 15 - Forest Industries<br>Miller Freeman Pub.                        | San Francisco, CA  | Monthly |

20 - ANIMAL LOGGING

- |  |                                    |      |
|--|------------------------------------|------|
| 1 - "Tips for Horse Loggers", Circular #8,<br>Institute of Forest Products, Univ. Of Wisconsin |                                    | 1950 |
| 2 - Skidding with Horses to Thin Young Stands<br>in Western Washington                         | Norman P. Worthing-<br>ton PNW-138 | 1957 |

- 3 - A Commerical Thinning in Douglas-fir with a Horse Alan B. Berg  
O.S.U. Research Paper 6 1966
- 4 - Horse Logging on Bitterroot N.F. Ken Andrews, R1
- 30 - TRACTOR AND SKIDDER LOGGING
- 1 - Caterpillar Performance Handbook 1970
- 2 - Handbook for Ground Skidding and Road Building in the Kootnay Area of British Columbia Forest Engineering 1976  
Research Institute of Canada, Vancouver, B.C.
- 40 - RIGGING AND WIRE ROPE
- 1 - Construction and Lifetime of Wire Ropes Richard Wettsleen  
Switzerland 1971
- 2 - Bethlehem Wire Rope Bethlehem Steel  
Bethlehem, Pennsylvania
- 3 - Handling and Care of Wire Rope " "
- 4 - Splicing Wire Rope " "
- 5 - Wire Rope Handbook Broderick & Bascom Rope Co.  
Seattle, Washington
- 6 - Riggers Handbook " "
- 7 - Edwards Guide to Wire Rope Selection E.H. Edwards Co.  
Seattle, Washington
- 8 - Edward Wire and Rope Data & Tables " "
- 9 - Wire Rope Use & Abuse " "
- 10 - Splicing and Fitting Edwards Wire Rope " "
- 11 - Rigging Equipment, Catalog #221-A Esco Corp.,  
Portland, OR
- 12 - Wedge Type Ferrules, Catalog #284 " "
- 13 - Swage Fittings, Catalog #285 " "
- 14 - Leschen Red Strand Wire Rope Leschen Wire Rope Co.  
St. Joseph, Missouri
- 15 - Skookum Blocks & Rigging, Catalog #SC72 The Skookum, Co.  
Portland, Oregon

- |  |  |
|--|--|
| 16 - Tiger Brand Wire Rope Engineering Handbook                      | U.S. Steel<br>Pittsburg, Pennsylvania        |
| 17 - Tiger Brand Wire Rope   | U.S. Steel<br>Pittsburg, Pennsylvania        |
| 18 - Blocks, Carriages, Fairleaders, Rigging                         | Washington Iron Works<br>Seattle, Washington |
| 19 - Blocks and Rigging  | Young Corporation<br>Seattle, Washington     |
| <br><u>50 - CABLE LOGGING</u>  |  |
| 1 - Mechanics of Running Skylines                                    | Mann PNW-75 1969                             |
| 2 - Understanding Interlock Yarders<br>Part 1 - Description          | Carson and Jorgensen<br>PNW 1973             |
| 3 - Understanding Interlock Yarders                                  | W.W. Carson PNW-221 1974                     |
| 4 - Training Outline for High Lead Logging                           | Jim Leabaugh, Siuslaw N.F.                   |
| 5 - Cable Logging On Tomorrow's Forest Equipment                     | Hitlon Lysons 1971                           |
| 6 - Double Skyline   | Dennis Caird, Willamette N.F.                |
| 7 - European Skyline Systems, Potential Use in United States Forests | V.W. Binkley                                 |
| 8 - Skyline Logging - Symposium Proceedings                          | Oregon State Univ. 1969                      |
| 9 - Skyline Logging Symposium - Proceedings                          | Univ. of Washington 1974                     |
| 10 - Skyline Logging Symposium - Proceedings                         | Univ. of British Columbia 1976               |
| 11 - Cable Logging in the East, Symposium Proceedings                | Virginia Polytechnic Institute 1973          |
| 12 - European Multispan Layout and Operational Problems              | John Malone<br>Wenatchee N.F.                |
| 13 - Drum Capacity For Various Yarders                               | Bruce Smith, Gifford<br>Pinchot              |
| 14 - Cable Logging Systems   | D. Studier, 1974<br>VW Binkley, R6           |

60 - BALLOON LOGGING

- |  |  |      |
|--|--|------|
| 1 - Balloon Trans-Air, Inc.                              | Flying Scotsman Brochure<br>Oregon             |      |
| 2 - Logging Test Of a Single-Hull<br>Balloon             | Lysons, Binkley, Mann<br>PNW-30                | 1966 |
| 3 - Compatibility Of Balloon Fabrics With<br>Ammonia     | Lysons<br>PNW-42                               | 1966 |
| 4 - An Operational Test Of A Natural<br>Shaped Balloon   | Binkley and Carson<br>PNW-87                   | 1968 |
| 5 - Gross Static Lifting Capacity<br>of Logging Balloons | Carson & Peters<br>PNW-152                     | 1971 |
| 6 - Balloon Logging Systems Phase I<br>Analytic Study    | Goodyear Aerospace<br>Corporation              | 1964 |
| 7 - Balloon Logging Systems Phase II<br>Logistics Study  | Goodyear Aerospace<br>Corporation              | 1964 |
| 8 - Tethered Balloon Handbook<br>(Revised)               | Meyers, Goodyear<br>Aerospace Corpor-<br>ation | 1969 |

91 - YARDER STATISTICS

Highlead (Small 1-1/8" mainline or less)

Edco Portospar with Wildcat Yarder

335-hp Cummins diesel

1,350 feet of 1-1/8" mainline

3,050 feet of 3/4" haulback line

3,000 feet of 3/8" strawline

Line Speeds:

1,100 ft/min (main drum, half drum)

2,400 ft/min (haulback, half drum)

Line Pull:

96,000 pounds (main drum)

75-foot fixed length tower (6-3/4" guys)

Yarder and tower mounted on truck chassis

Weight without lines: 74,600 pounds

Berger Marc I Tower-Yarder

300-hp engine

1,350 feet of 1-1/8" mainline

3,000 feet of 3/4" haulback line

3,500 feet of 3/8" strawline

Line Speeds:

700 ft/min (main drum, Half drum, low gear)

1,800 ft/min (haulback drum, half drum, high gear)

Line Pull:

85,000 pounds (main drum, half drum, low gear)

17,000 pounds (haulback drum, half drum, high gear)

50-foot fixed length tower (3 guys 660 feet of 7/8")

Undercarriage: D8 tractor

Weight without lines: 78,500 pounds

Berger M-1 Yarder

300-hp engine

1,350 feet of 1-1/8" mainline

3,000 feet of 3/4" haulback line

3,500 feet of 3/8" strawline

Line Speeds:

160 ft/min (main drum, half full, low gear)

1,800 ft/min (haulback drum, half fell, high gear)

Line Pulls:

85,000 pounds (main drum, half full, low gear)

17,000 pounds (haulback drum half full high gear)

Weight without lines: 21,000 pounds

Skagit BU-70

250-hp engine

1,325 feet of 1-1/8" mainline

3,550 feet of 3/4" haulback line

3,850 feet of 3/8" strawline

## Wichita brakes

Optional skidding drum holds 1,500 feet of 7/8" line  
This yarder is no longer manufactured.

## Skookum K-75

250-350-hp engine  
1,250 feet of 1-1/8" mainline  
3,250 feet of 3/4" haulback line  
3,450 feet of 3/8" strawline  
Weight: 28,000 pounds  
This yarder is no longer manufactured

## Skookum K-105

150-300-hp engine  
1,200 feet of 1" mainline  
3,000 feet of 3/8" strawline  
3,000 feet of 5/8 haulback line  
Weight: 17,000 pounds  
This yarder is no longer manufactured

## Skookum-Tyee K-168

470-hp engine  
1,300 feet of 1-1/8" mainline  
3,200 feet of 3/4" haulback line  
3,450 feet of 3/8" strawline  
Line Speeds:  
700 ft/min (main drum, half full)  
2,000 ft/min (haulback drum, half full)  
Line Pull:  
65,000 pounds (main drum, half full, stall)  
22,000 pounds (haulback drum, half full, stall)

Weight without lines: 35,000 pounds  
Regenerative brakes  
Truck-mounted undercarriage  
Width (overall) 11 feet  
75-foot or 90-foot spar  
1-1/8" maximum main line  
Total weight with yarder and lines: 104,800 pounds

## Skagit SJ2-R Mobile Thinning Machine

1,000 feet of 3/4" skyline  
1,000 feet of 5/8" skidding line  
50-foot tower with two powered guyline drums  
360° swing  
Rubber tire undercarriage  
Weight with lines: 50,000 pounds

## Skagit SJ-4RT Mobile Yarder-Loader

840 feet of 3/4" mainline  
1,900 feet of 1/2" haulback line  
2,090 feet of 5/16" strawline  
2 guylines  
This yarder is no longer manufactured

## Skagit SJ-5R Mobile Yarder-Loader

700 feet of 1" mainline  
 1,630 feet of 5/8" haulback line  
 2,500 feet of 5/16" strawline  
 2 guyline drums  
 Line Pull:  
     82,000 pounds (main drum)  
     16,200 pounds (haulback drum)  
 Line Speed:  
     730 ft/min (main drum)  
     1,960 ft/min (haulback drum)  
 This yarder is no longer manufactured

## SJ-7R Mobile Yarder-Loader

1,000 feet of 1" mainline  
 2,200 feet of 5/8" haulback line  
 2,975 feet of 3/8" strawline  
 Four hydraulic outriggers  
 This yarder is no longer manufactured

## Washington TL-15 Trakloader

900 feet of 1-1/8" mainline  
 1,700 feet of 5/8" haulback line  
 5,500 feet of 1" strawline  
 Line Speeds:  
     720 ft/min (mainline)  
     2,400 ft/min (haulback line)

## Line Pulls:

98,000 pounds stall pull (mainline)  
 38,000 pounds stall pull (haulback line)

## Washington TL-6 Trakloader

250-hp engine  
 800 feet of 1" mainline  
 1,140 feet of 3/4" haulback line  
 530 feet of 7/16" strawline  
 Line Speed:  
     1,230 ft/min (main drum)  
     1,230 ft/min (haulback drum full)

## Line Pulls:

78,000 pounds (main drum, bare)  
 77,500 pounds (haulback drum, bare)  
 Width over outside tires: 10'9-3/4", outside tracks, 12'10"  
 Maximum gradeability: 24%  
 Weight without lines: 120,000 pounds

## Madill 3-400

400-hp engine  
 1,650 feet of 1-1/8" mainline  
 3,600 feet of 3/4" haulback line  
 Mounted on self-propelled, rubber-tired undercarriage with a  
 75-foot fixed-length spar



Highlead (large, mainline larger than 1-1/8")

## Berger L-2 Planet - Lok

450-hp engine  
 1,700 feet of 1-1/4" mainline  
 3,840 feet of 1" haulback line  
 4,500 feet of 7/16" strawline  
 This yarder is no longer manufactured

## Berger M-2 Yarder

425-hp engine  
 1,750 feet of 1-3/8" mainline  
 4,000 feet of 7/8" haulback line  
 4,500 feet of 3/8" strawline  
 Line Speeds:  
     180 ft/min (main drum half full, low gear)  
     1,800 ft/min (haulback drum, half full, high gear)  
 Line Pulls:  
     105,000 pounds (main drum, half full, low gear)  
     14,500 pounds (haulback drum, half full high gear)  
 Weight of yarder without lines: 32,000 pounds  
 Optional skidding drum: 2,000 feet of 1" line

## Berger Marc IV Tower-Yarder

The M-2 yarder mounted on a D9 tractor frame with a 110-foot telescoping tower and six guylines (360 feet of 1" line)  
 Total Weight, including lines: 160,000 pounds  
 Self-propelled

## Berger Marc III Tower-Yarder

425-hp engine  
 1,400 feet of 1-1/4" mainline  
 4,000 feet of 3/4" haulback line  
 4,500 feet of 7/16" strawline  
 Line speeds:  
     180 ft/min (main drum, half full, low gear)  
     1,800 ft/min (haulback drum, half full, high gear)  
 Line Pulls:  
     110,000 pounds (main drum, half full, low gear)  
     24,000 pounds (haulback drum, half full, high gear)  
 90-foot tower (6 1" guys, 360 feet)  
 D8 undercarriage  
 Total weight with lines: 118,250 pounds

## Berger Marc II

The M-2 yarder mounted on a rubber tire undercarriage with a 110-foot telescoping tower.  
 Total Weight: 102,000 pounds

## Skagit BU-80C

350-hp engine

1,450 feet of 1-1/4" mainline

3,350 feet of 7/8" haulback line

2,750 feet of 7/16" strawline

Line Speeds:

412 ft/min (main drum, half full, 5th gear)

1,527 ft/min (haulback drum, half full, 5th gear)

Line Pulls:

96,400 pounds (main drum, half full, low gear, stall)

27,400 pounds (haulback drum, half full, low gear, stall)

Weight without lines: 25,000 pounds

Wichita brakes

Optional skidding drum holds 1,240 feet of 1" line

## Skagit BU-84

450-hp engine

1,450 feet of 1-1/4" mainline

3,550 feet of 7/8" haulback line

3,800 feet of 7/16" strawline

Wichita brakes

Optional skidding drum holds 1,240 feet of 1" line

This yarder is no longer manufactured

## Skagit BU-90

575-hp engine

1,350 feet of 1-3/8" mainline

3,580 feet of 7/8" haulback line

3,900 feet of 7/16" strawline

Weight without lines: 32,000 pounds

## Skagit BU-90G

525-hp engine

1,650 feet of 1-3/8" mainline

4,000 feet of 7/8" haulback line

7,000 feet of 7/16" strawline

Weight without lines: 30,000 pounds

Designed for tropical logging

## Skagit BU-94

450-hp engine

1,350 feet of 1-3/8" mainline

5,205 feet of 7/8" haulback line

3,890 feet of 7/16" strawline

Line Speeds:

401 ft/min (main drum, half full, 5th gear)

1,395 ft/min (Haulback drum, half full, 5th gear)

Line Pulls:

81,700 pounds (main drum, half full, low gear, stall)

32,900 pounds (haulback drum, half full, low gear, stall)

Weight without lines: 35,600 pounds

Wichita brakes

## Skagit BU-99II

575-hp engine  
 1,750 feet of 1-3/8" mainline  
 4,680 feet of 7/8" haulback line  
 3,900 feet of 7/16" strawline  
 Weight without lines: 32,000 pounds

## Skagit BU-99G

525-hp engine  
 2,000 feet of 1-3/8" mainline  
 5,000 feet of 7/8" haulback line  
 5,000 feet of 7/16" strawline  
 Weight without lines: 32,000 pounds  
 Designed for tropical logging

## Skookum-Tyee K-168A

470-hp engine  
 1,050 feet of 1-1/4" mainline  
 2,350 feet of 7/8" haulback line  
 2,550 feet of 7/16" strawline  
 Line Speeds:  
     600 ft/min (main drum, half full)  
     1,800 ft/min (haulback drum, half full)  
 Line Pulls:  
     75,000 pounds (main drum, half full, stall)  
     25,000 pounds (haulback drum, half full, stall)  
 Weight without lines: 35,000 pounds  
 Regenerative brakes

## Skookum-Tyee K-166

470-hp engine  
 1,300 feet of 1-3/8" mainline  
 3,200 feet of 7/8" haulback line  
 3,400 feet of 7/16" strawline  
 Line Speeds:  
     1,730 ft/min (main drum, half full, 5th gear)  
     3,500 ft/min (haulback drum, half full, 5th gear)  
 Line Pulls:  
     100,000 pounds (main drum, half full, low gear, stall)  
     48,000 pounds (haulback drum, half full, low gear, stall)  
 Weight without lines: 40,000 pounds  
 Regenerative brakes

## Skookum-Tyee K-114A

450-550-hp engine  
 1,400 feet of 1-3/8" mainline  
 3,500 feet of 7/8" haulback line  
 3,400 feet of 7/16" straw line  
 Regenerative brakes  
 Optional skidding drum holds 1,800 feet of 1" line  
 This yarder is no longer manufactured

## Skookum-Tyee K-65A

350-470-hp engine  
 1,400 feet of 1-3/8" mainline  
 3,500 feet of 7/8" haulback line  
 3,400 feet of 7/16" strawline  
 Regenerative brakes  
 Optional skidding drum holds 1,800 feet of 1" line  
 This yarder is no longer manufactured

## Skookum K-65

350-450-hp engine  
 1,400 of 1-1/4" mainline  
 3,300 feet of 7/8" haulback line  
 3,400 feet of 7/16" strawline  
 Weight: 36,000 pounds  
 This yarder is no longer manufactured

## Skookum K-75A

250-350-hp engine  
 1,250 feet of 1-1/4" mainline  
 3,200 feet of 3/4" haulback line  
 3,450 feet of 3/8" strawline  
 Weight: 30,000 pounds  
 This yarder is no longer manufactured

## Washington 158

335-hp engine  
 1,470 feet of 1-1/4" mainline  
 3,600 feet of 1" haulback line  
 3,900 feet of 7/16" strawline  
 Interlock  
 Line Speeds:  
     905 ft/min (main drum, half full, 4th gear)  
     1,265 ft/min (haulback drum, half full, 4th gear)  
 Line pull:  
     30,500 pounds (main drum, half full, low gear)  
     21,900 pounds (haulback drum, half full, low gear)  
 This yarder is no longer manufactured

## Washington 157

320-hp engine  
 1,500 feet of 1-1/4" mainline  
 3,400 feet of 7/8" haulback line  
 3,700 feet of 3/8" strawline  
 Line Speeds:  
     930 ft/min (main drum, half full, high gear)  
     2,540 ft/min (haulback drum, half full, high gear)  
 Line Pull:  
     20,600 pounds (main drum, half full, low gear)  
     4,950 pounds (haulback drum, half full, low gear)  
 Weight: 25,000 pounds  
 This yarder is no longer manufactured

## Madill 3-500

300-550-hp engine  
 1,450 feet of 1-1/4" mainline  
 3,400 feet of 7/8" haulback line  
 3,500 feet of 3/8" strawline  
 Wichita brakes  
 Line Pull:  
     97,000 pounds (main drum, half full)  
     35,100 pounds (haulback drum, half full)  
 Line Speed:  
     1,200 ft/min (main drum, half full)  
     2,820 ft/min (haulback drum, half full)  
 Self-propelled model weighs 94,350 pounds with lines.

## Madill 3-600

500-hp engine  
 1,580 feet of 1-1/2" mainline  
 4,000 feet of 1" haulback line  
 4,500 feet of 7/16" strawline  
 Line Speeds:  
     1,570 ft/min (main drum, half full, high gear)  
     3,340 ft/min (haulback drum, half full, high gear)  
 Line Pulls:  
     121,000 pounds (main drum, half full, low gear, stall)  
     57,000 pounds (haulback drum, half full, low gear, stall)  
 Weight without lines: 54,000 pounds

## Lynnwood Porta-Tower 90

Manufactured by Lynnwood Equipment Company  
 90-foot square spar mounted on a crawler tractor such as a D9, TD-24, or  
 an HD-19  
 1,200 feet of 1-3/8" mainline  
 3,000 feet of 3/4" haulback line  
 Equipped with 6 guyline drums  
 31 feet, overall length on a D9 tractor  
 Designed for a maximum of 1-3/8" mainline  
 Total weight: 117,000 pounds

## Washington 208

500-hp engine  
 1,650 feet of 1-3/8" mainline  
 3,600 feet of 1" haulback line  
 4,000 feet of 7/16" strawline  
 Interlock  
 Line Speeds:  
     1,415 ft/min (main drum, half full, 4th gear)  
     2,060 ft/min (haulback drum, half full, 4th gear)  
 Line Pulls:  
     34,400 pounds (main drum, half full, low gear)  
     23,800 pounds (haulback drum, half full, low gear)  
 Weight: 35,500 pounds

## Washington 207

430-hp engine

1,650 feet of 1-3/8" mainline

3,400 feet of 7/8" haulback line

3,900 feet of 7/16" strawline

Line Speeds:

905 ft/min (main drum, half full, high gear)

2,320 ft/min (haulback drum, half full, high gear)

Line Pulls:

36,600 pounds (main drum, half full, low gear)

7,600 pounds (haulback drum, half full, low gear)

Weight: 28,000 pounds

Slackline

## Madill 071 (West Coast Tower)

220-hp engine

1,930 feet of 1" skyline

1,885 feet of 5/8" mainline

4,200 feet of 1/2" haulback line

1,900 feet of 3/8" strawline

Wichita brakes on haulback and main drums

Main line pull: 6,700 pounds

Main line speed: 2,120 ft/min (3rd gear)

49-foot tower

4 guylines

Track undercarriage (Terex C-6)

Weight without lines: 72,780 pounds

## Madill 5-500

550-hp engine

1,850 feet of 1-3/8" skyline

2,000 feet of 1-1/8" mainline

4,000 feet of 1" haulback line

4,500 feet of 7/16" strawline (2 strawline drums)

Wichita brakes

Line Speeds:

2,900 ft/min (mainline, high gear)

4,100 ft/min (haulback line, high gear)

Line Pulls:

76,000 pounds (mainline, low gear)

54,000 pounds (haulback line, low gear)

## Skagit BU-98

450-hp engine

1,700 feet of 1-1/2" skyline

1,350 feet of 1-3/8" mainline

5,000 feet of 7/8" haulback line

4,000 feet of 7/16" strawline

Line Speeds:

474 ft/min (skyline drum, half full, 5th gear)

460 ft/min (main drum, half full, 5th gear)

1,755 ft/min (haulback drum, half full, 5th gear)

Line Pulls:

78,900 pounds (skyline drum, half full, low gear, stall)

87,600 pounds (main drum, half full, low gear, stall)

32,000 pounds (haulback drum, half full, low gear, stall)

Weight without lines: 51,000 pounds

Wichita brakes on main and haulback drums

## Skagit BU-99

635-hp engine  
 2,420 feet of 1-1/2" skyline  
 1,780 feet of 1-3/8" mainline  
 5,410 feet of 7/8" haulback line  
 7,529 feet of 7/16" strawline

## Line Speeds:

857 ft/min (skyline drum, half full, 6th gear)  
 884 ft/min (main drum, half full, 6th gear)  
 1,842 ft/min (haulback drum, half full, 6th gear)

## Line Pulls:

84,800 pounds (skyline drum, half full, low gear, stall)  
 85,300 pounds (main drum, half full, low gear, stall)  
 40,900 pounds (haulback drum, half full, low gear, stall)

Weight without lines: 52,000 pounds

Wichita brakes on main and haulback drums

## Washington 208E

500-hp engine  
 1,650 feet of 1-3/8" skyline  
 2,000 feet of 1-1/4" mainline  
 3,600 feet of 1" haulback line  
 4,000 feet of 7/16" strawline

## Line Speeds:

1,392 ft/min (skyline drum, half full, 4th gear)  
 1,364 ft/min (main drum, half full, 4th gear)  
 1,950 ft/min (haulback drum, half full, 4th gear)

## Line Pulls:

270,000 pounds (skyline drum, empty, low gear, stall)  
 270,000 pounds (main drum, empty, low gear, stall)  
 190,000 pounds (haulback drum, empty, low gear, stall)

Weight with self-propelled, 110-foot spar, lines and fuel: 182,200 pounds

## Washington 217D

525-hp engine  
 2,650 feet of 1-1/2" skyline  
 2,020 feet of 1-3/8" mainline  
 4,700 feet of 7/8" haulback line  
 3,900 feet of 7/16" strawline

## Line Speeds:

1,056 ft/min (skyline drum, half full, 5th gear)  
 1,500 ft/min (main drum, half full, 5th gear)  
 2,274 ft/min (haulback drum, half full, 5th gear)

## Line Pulls:

348,900 pounds (skyline drum, empty, low gear, stall)  
 228,500 pounds (main drum, empty, low gear, stall)  
 168,000 pounds (haulback drum, empty, low gear, stall)

Weight with 110-foot self-propelled undercarriage with fuel and lines:  
 212,000 pounds

## Skookum-Tyee 114CS

460-hp engine

1,700 feet of 1-3/8" skyline

2,200 feet of 1" mainline

4,200 feet of 7/8" haulback line

6,300 feet of 7/16" strawline

## Line Speeds:

1,400 ft/min (skyline drum, half full, 5th gear)

1,350 ft/min (mainline drum, half full, 5th gear)

4,300 ft/min (haulback drum, half full, 5th gear)

## Line Pulls:

125,000 pounds (skyline drum, half full, low gear, stall)

72,000 pounds (mainline drum, half full, 2nd gear, stall)

40,000 pounds (haulback drum, half full low gear, stall)

## Skookum-Tyee K-177

318-hp engine

1,200 feet of 1" skyline

1,400 feet of 3/4" mainline

3,100 feet of 5/8" haulback line

3,000 feet of 3/8" strawline

## Line Speeds:

2,500 ft/min (skyline drum, half full, 5th gear)

2,500 ft/min (main drum, half full, 5th gear)

4,600 ft/min (haulback drum, half full, 5th gear)

## Line Pulls:

61,000 pounds (skyline drum, half full, 1st gear, stall)

35,000 pounds (main drum, half full, 2nd gear, stall)

33,000 pounds (haulback drum, half full, 1st gear stall)

Weight without lines: 25,000 pounds

Regenerative brakes

## Timber Tower

Undercarriage: Timberjack 404 wheel skidder with dual wheels on rear axle

Yarder: 1,600 feet of 7/8" or 1,250 feet of 1" skyline

1,700 feet of 5/8" mainline

2,300 feet of 5/8" haulback line

Tower: 55-foot, one-piece with 4 power guyline drums holding 300 feet of 1" line

## Skookum-Tyee D114 DS

500 HP at 2100 R.P.M.

2300 feet of 1 3/8" skyline

2200 feet of 1 1/8" skidding line

5500 feet of 7/8" haulback

2500 feet of 5/8" slackpuller

6300 feet of 7/16" straw

Line pull (lbs.) half full drum, and speeds

Skidding: 6,000 lbs at 2100 FPM to

30,000 lbs. at 400 FPM to

85,000 lbs. at stall

Regenerative brake on main and haulback



Running Skyline

Berger Planet-Lok L-1

300-hp engine  
 2,200 feet of 7/8" mainline  
 2,300 feet of 5/8" slackpulling line  
 4,400 feet of 7/8" haulback line  
 4,500 feet of 7/16" strawline  
 Line Speeds:  
     425 ft/min (main drum, half full, low gear)  
     1,800 ft/min (haulback drum. half full, high gear)  
 Line Pulls:  
     62,000 pounds (main drum, half full, low gear)  
     29,000 pounds (haulback drum, half full, high gear)  
 Yarder weight with line: 42,000 pounds  
 May be mounted on a Marc I, self-propelled tower

Washington 108 Skylok

315-hp diesel engine  
 Two mainline drums holding 1,100 feet of 7/8" line each  
 2,200 feet of 3/4" haulback line  
 2,300 feet of 3/8" strawline  
 Line Speeds:  
     1,730 ft/min (haulback drum, full)  
     1,300 ft/min (main drum, full)  
 Line Pulls:  
     24,700 pounds (haulback drum, empty)  
     96,000 pounds (main drum, empty)  
 2 guyline drums  
 50-foot swing boom  
 Weight with lines and fuel: 106,600 pounds  
 Gradeability: 25%  
 Crawler or rubber-tired undercarriage

Washington 98 Skylok

180-hp diesel engine  
 Two mainline drums holding 1,000 feet of 5/8" line each  
 2,100 feet of 3/4" haulback line  
 Line Speed: 900 ft/min  
 45-foot swinging boom  
 This yarder is no longer manufactured

Washington 78 Skylok

185-hp diesel engine  
 Two mainline drums holding 1,200 feet of 5/8" line each  
 2,250 feet of 3/4" haulback line  
 2,400 feet of 5/16" strawline  
 Line Speeds:  
     1,502 ft/min (haulback drum, full)  
     1,350 ft/min (main drum, full)  
 Line Pulls:  
     17,000 pounds (haulback drum, empty)  
     52,600 pounds (main drum empty)  
 2 guyline drums containing 150 feet of 3/4" line each

Weight lines and fuel: 88,500 pounds  
 37-foot swinging boom  
 Track width: 11' 2"

#### Skagit GT-5

320-hp engine  
 Two mainline drums hold 1,100 feet of 1" line each  
 2,200 feet of 1" haulback line  
 2,780 feet of 3/8" strawline  
 55-foot swinging boom  
 Wichita water-cooled brakes on all drums  
 Approximate weight: 153,000 pounds

#### Skagit GT-4

320-hp engine  
 Side-by-side mainline drums each holding 1,000 feet of 7/8" line  
 2,600 feet of 7/8" haulback line  
 2,700 feet of 7/16" strawline  
 Line Speeds:  
 1,691 ft/min (haulback drum, half full, 5th gear)  
 987 ft/min (main drum, half full, 5th gear)  
 Line Pulls:  
 56,300 pounds (haulback drum, half full, low gear, stall)  
 96,500 pounds (main drums, half full, low gear, stall)  
 55-foot swing boom  
 Track undercarriage, 13' 1/2" overall width  
 Mechanical interlock (air clutches)  
 Weight with lines: 144,600 pounds

#### Skagit GT-3 Grapple Yarder

220-hp engine  
 Two side-by-side mainline drums hold 1,200 feet of 5/8" line each  
 2,200 feet of 3/4" haulback line  
 3,200 feet of 3/8" strawline  
 140 feet of 7/8" guyline  
 Line Speeds:  
 1,410 ft/min (main drums, full)  
 2,275 ft/min (haulback drum, full)  
 Line Pulls:  
 71,000 pounds (main drums, empty)  
 35,700 pounds (haulback drum, empty)  
 44-foot swinging boom  
 Track undercarriage - 12'6" overall width  
 Weight without lines: 95,040 pounds  
 30% gradeability  
 Mechanical interlock on haulback and main drums

#### Madill 6-500

535-hp diesel engine  
 1,760 feet of 1" mainline  
 2,300 feet of 7/8" haulback line  
 1,400 feet of 5/8" tagline

## Madill 052

535-hp engine  
 4,100 feet of 1-1/8" haulback line  
 2,300 feet of 1-1/8" mainline  
 2,200 feet of 1" slackpulling line  
 6,000 feet of 7/16" strawline  
 90-foot steel tower  
 Weight: 185,000 pounds

## Washington 118

318 HP at 2100 RPM  
 1620 feet of 7/8" mainline  
 1620 feet of 7/8" front drum  
 3300 feet of 7/8" haulback  
 4450 feet of 3/8" strawline  
 Line speeds, maximum:  
 1440 FPM full (main, front and haulback)  
 1245 FPM empty (main, front, haulback)

Line pull (pounds) maximum:

<u>drum</u>	<u>full</u>	<u>empty</u>
main	74,500	86,600
front	36,700	42,300
haulback	19,800	25,000

2 Guylines - 180' of 7/8" each  
 Mechanical interlock - front, main and hauback  
 Undercarriage - rubber or crawler  
 Gradability 25%  
 Main sheave height - 53' 8"  
 Weight  
     crawler - 114,000 lbs.  
     rubber-tired - 118,000 lbs.

European Yarders

## Unimog-Urus 300-2.5

100-hp engine  
 1,148 feet of 1/2" mainline  
 2,133 feet of 1/2" haulback line  
     985 feet of 7/8" skyline  
 2,297 feet of 3/16" strawline  
 Mainline Pull: 5,500 pounds average  
 Tower Height: 28-1/2'  
 Three Guys: 164 feet of 3/4"  
 Mounted on Mercedes-Benz truck  
 Total Weight: 14,630 pounds

## Baco SWU 40L

90-hp engine  
 7,218 feet of 7/16" mainline  
 Brakes: Air fan  
 Traction Power: 11,000 pounds  
 Working Speeds:  
     uphill 26 ft/sec.  
     downhill 40 ft/sec.  
 Weight: 4,851 pounds  
 Sled-mounted

## Baco SWU 80L

150-hp engine  
 6,562 feet of 5/8" mainline  
 Brakes: Air fan  
 Traction Power: 17,800 pounds  
 Working Speeds:  
     uphill 26 ft/sec.  
     downhill 40 ft/sec.  
 Weight: 6,615 pounds  
 Sled-mounted

## Baco SWU 125L

320-hp engine  
 7,218 feet of 7/8" mainline  
 Brakes: Air fan  
 Traction Power: 33,400 pounds  
 Working Speeds:  
     uphill 26 ft/sec.  
     downhill 40 ft/sec.  
 Weight: 17,640 pounds

## Wyssen W-30

42-hp engine  
 5,400 feet of 7/16" mainline  
 Brakes: Air fan and friction  
 Load Capacity: 4,400 pounds  
 Weight: 2,700 pounds  
 Sled-mounted

## Wyssen W-60

53-hp engine  
 3,100 feet of 5/8" mainline  
 Brakes: Air fan and friction  
 Load Capacity: 11,000 pounds  
 Weight: 3,700 pounds  
 Sled-mounted

## Wyssen W-90

80-hp engine  
 5,900 feet of 5/8" mainline  
 Brakes: Air fan and friction  
 Load Capacity: 11,000 pounds  
 Weight: 4,000 pounds  
 Sled-mounted

## Wyssen W-200

200-hp engine  
 5,200 feet of 1" mainline  
 Brakes: Air fan and friction  
 Load Capacity: 26,400 pounds  
 Weight: 15,000 pounds  
 Sled-mounted

OTHER YARDERS

Manufac.-Model High Lead (2 Drum)	Lines - Size and Length						Yarder			Comments	
	Skyline		Mainline		Haulback		Straw Diam,"Lgth".	Weight Lbs.	Length Ft.-In.		Width Ft., In
	Diam,"Lgth"	Diam," Lgth"	Diam," Lgth"	Diam," Lgth"	Diam,"Lgth".						
Skagit BU-15	3/4	595	7/16	1,750	5/16	650	5,400	6 10	5 0		
Skagit BU-20	3/4	100	7/16	2,650	1/4	2,950	9,100	7 6	6 0		
Skagit BU-30	1	850	5/8	1,850	3/8	3,000	10,500	9 1	7 2		
Skagit BU-50	1	1,050	5/8	2,250	3/8	3,050	11,800	9 1	7 6		
Skagit BU-75	1-1/8	1,000	5/8	2,700	3/8	3,500	14,500	10 5	7 10		
Skagit BU-85	1-1/8	1,200	5/8	3,450	3/8	3,050	14,500	10 0	7 10		
Skagit BU-100	1-1/4	1,000	3/4	2,300	3/8	3,500	17,300	10 11	8 2		
Skagit BU-125	1-1/4	1,440	3/4	3,000	3/8	3,600	18,260	11 3	8 6		
Skagit BX-130	1-1/4	1,440	3/4	3,000	3/8	3,600	25,000	12 3	8 11		
Skagit BU-135	1-3/8	1,250	7/8	2,500	3/8	3,600	19,800	11 9	8 10		
Skagit BX-140	1-3/8	1,350	7/8	2,500	3/8	3,600	27,000	12 6	9 0		
Skagit BX-200	1-1/2	1,560	7/8	4,000	3/8	4,560	42,000	13 6	10 2		
Skagit BX-300	1-1/2	1,690	1	3,700	7/16	5,000	58,000	17 0	10 7		
Skagit BX-500	1-5/8	1,770	1	4,400	7/16	5,000	67,000	20 6	11 0		
Skagit IJ-80	1-1/4	1,550	7/8	3,160	7/16	4,330	37,500	14 4	12 3	Interlock	
Skagit IJ-90	1-3/8	1,560	1	3,000	7/16	4,330	40,000	14 10	12 3	Interlock	
Skagit PT-4-Y	1-1/8	1,300	3/4	2,900	5/16	3,200	45,000				

Manuf. - Model Slackline (3 drum)	Lines - Sizes and Length						Yarder				Comments				
	Skyline		Mainline		Haulback		Straw		Weight			Length		Width	
	Diam"	Lgth'	Diam"	Lgth'	Diam"	Lgth'	Diam"	Lgth"	Diam"	Lgth"		Lbs.	Ft.	In.	Ft.
Skagit BU-70	1-1/8	1,325	7/8	1,500	3/4	3,350	3/8	3,850	18,000	11	0	10	3	Wichita Brakes	
Skagit BU-80	1-1/4	1,450	1	1,240	7/8	3,350	7/16	2,750	25,000	12	2	11	0	Wichita Brakes	
Skagit BU-90	1-3/8	1,350	1-1/8	1,200	7/8	3,580	7/16	3,250	30,500	13	10	10	6	Wichita Brakes	
Skagit BU-95	1-3/8	1,800	1-1/8	1,500	7/8	4,680	1/2	2,980	32,000	13	10	11	2	Wichita Brakes	
Skagit BU-97	1-1/2	2,000	1-1/4	1,470	1	3,580	9/16	2,700	34,000	14	0	11	6	Wichita Brakes	

## 92 - HELICOPTER LIFT CAPABILITY

Helicopters have two factors that limit load carrying capability; increase in temperature and increase in altitude. The following tables give the approximate load carrying capabilities of several helicopters at different elevations and temperatures.

These tables have been supplied by helicopter manufacturers. These factors are developed for average machine rigged in logging configurations. Helicopter net lift is affected by many factors such as base weight of the machine, temperature, wind, hover height, and fuel load.

It is the intent that the following tables be used only as a reference guide. Actual lift capability must be determined by personnel who have aircraft weights, elevation, and temperature data at the logging site.

The tables are based on hovering out of ground effect. No wind effect is considered.

The Bell 214B helicopter is now available. It has a lift of ± 8000 pounds at sea level.

Be11 Model 212

Logging Configuration Weight Empty 5,912 lbs.  
 Thirty Minutes Fuel 350  
 Pilots 400  
 Load, Line, Hooks, Chokers 250  
 TOWG W/O Payload 6,912 lbs.

TEMPERATURES DEGREES F

	-20	-10	0	+10	+20	+30	+40	+50	+60	+70	+80	+90
	NET EXTERNAL LOAD (LBS)											
8,000	3,672	3,594	3,515	3,438	3,360	3,278	3,186	3,088	--	--	--	--
7,000	3,798	3,725	3,650	3,576	3,503	3,427	3,348	3,265	3,137	--	--	--
6,000	3,910	3,845	3,775	3,706	3,635	3,567	3,496	3,426	3,348	3,218	--	--
5,000	4,031	3,965	3,898	3,830	3,762	3,698	3,628	3,558	3,489	3,418	3,256	--
4,000	4,145	4,076	4,008	3,940	3,877	3,818	3,753	3,688	3,621	3,553	3,488	3,303
3,000	4,251	4,186	4,119	4,050	3,988	3,928	3,883	3,806	3,741	3,678	3,616	3,546
2,000	4,288	4,288	4,231	4,166	4,100	4,039	3,977	3,918	3,857	3,798	3,738	3,668
1,000	4,288	4,288	4,288	4,278	4,211	4,150	4,091	4,038	3,977	3,918	3,858	3,795
0	4,288	4,288	4,288	4,288	4,288	4,261	4,198	4,138	4,078	4,023	3,968	3,913
	HOVER OUT OF GROUND EFFECT											

GROUND ELEVATION ABOVE SEA LEVEL IN FEET



Be11 Model 214B

Logging Configuration Weight Empty  
 Thirty Minutes Fuel  
 Pilots  
 Load, Line, Hooks, Chokers  
 TOWG W/O Payload

7437 lbs.  
 475  
 400  
 250  
 8562 lbs.

TEMPERATURES DEGREES F.

	-20	-10	0	+10	+20	+30	+40	+50	+60	+70	+80	+90
	HOVER OUT OF GROUND EFFECT											
	NET EXTERNAL LOAD (LBS)											
8,000	6,456	6,336	6,219	6,105	5,994	5,887	5,781	5,679	5,392	4,926	4,461	3,997
7,000	6,664	6,541	6,422	6,307	6,195	6,086	5,980	5,877	5,776	5,456	4,969	4,483
6,000	6,874	6,749	6,628	6,511	6,397	6,287	6,180	6,075	5,973	5,874	5,468	4,959
5,000	7,085	6,958	6,835	6,716	6,601	6,489	6,380	6,274	6,171	6,071	5,953	5,425
4,000	7,298	7,170	7,045	6,924	6,806	6,692	6,582	6,474	6,370	6,268	6,169	5,882
3,000	7,438	7,382	7,256	7,133	7,014	6,898	6,786	6,676	6,570	6,467	6,366	6,268
2,000	7,438	7,438	7,438	7,344	7,223	7,105	6,991	6,880	6,772	6,667	6,565	6,466
1,000	7,438	7,438	7,438	7,438	7,433	7,314	7,199	7,086	6,976	6,870	6,766	6,665
0	7,438	7,438	7,438	7,438	7,438	7,438	7,407	7,293	7,182	7,074	6,968	6,865

GROUND ELEVATION ABOVE SEA LEVEL IN FEET

BOEING-VERTOL Model 10711

Logging Configurations Weight Empty 9,530 lbs.  
 Thirty minutes fuel 465  
 Pilots 400  
 Load, Line, Hooks, Chokers 250  
 TOGW W/O Payload 10,645 lbs.

°F	NET EXTERNAL LOAD IN POUNDS											HOVER OUT OF GROUND EFFECT																
	-30	-20	-10	0	+10	+20	+30	+40	+50	+60	+70	+80	+90	+100	-30	-20	-10	0	+10	+20	+30	+40	+50	+60	+70	+80	+90	+100
10,000	7,805	7,555	7,255	6,985	6,755	6,455	5,955	5,455	5,375	4,875	4,275	3,675	2,975	2,215	7,805	7,555	7,255	6,985	6,755	6,455	5,955	5,455	5,375	4,875	4,275	3,675	2,975	2,215
9,000	8,585	8,355	8,055	7,755	7,495	7,155	6,645	6,190	6,025	5,500	4,900	4,215	3,525	2,825	8,585	8,355	8,055	7,755	7,495	7,155	6,645	6,190	6,025	5,500	4,900	4,215	3,525	2,825
8,000	9,365	9,130	8,825	8,555	8,220	7,925	7,455	6,965	6,675	6,125	5,525	4,875	4,215	3,375	9,365	9,130	8,825	8,555	8,220	7,925	7,455	6,965	6,675	6,125	5,525	4,875	4,215	3,375
7,000	10,145	9,925	9,605	9,350	8,965	8,645	8,175	7,655	7,325	6,775	6,150	5,415	4,650	3,925	10,145	9,925	9,605	9,350	8,965	8,645	8,175	7,655	7,325	6,775	6,150	5,415	4,650	3,925
6,000	10,935	10,705	10,395	10,115	9,735	9,395	8,905	8,495	7,975	7,425	6,775	6,075	5,225	4,500	10,935	10,705	10,395	10,115	9,735	9,395	8,905	8,495	7,975	7,425	6,775	6,075	5,225	4,500
5,000	11,355	11,355	11,155	10,395	10,455	10,125	9,655	9,245	8,775	8,075	7,375	6,675	5,800	5,050	11,355	11,355	11,155	10,395	10,455	10,125	9,655	9,245	8,775	8,075	7,375	6,675	5,800	5,050
4,000	11,355	11,355	11,355	11,355	11,185	10,855	10,355	9,855	9,475	8,775	7,975	7,275	6,375	5,600	11,355	11,355	11,355	11,185	10,855	10,355	9,855	9,475	8,775	7,975	7,275	6,375	5,600	
3,000	11,355	11,355	11,355	11,355	11,355	11,355	11,105	10,625	10,175	9,525	8,700	7,815	6,975	6,175	11,355	11,355	11,355	11,355	11,105	10,625	10,175	9,525	8,700	7,815	6,975	6,175		
2,000	11,355	11,355	11,355	11,355	11,355	11,355	11,355	11,355	10,875	10,250	9,425	8,575	7,675	6,775	11,355	11,355	11,355	11,355	11,355	10,875	10,250	9,425	8,575	7,675	6,775			
1,000	11,355	11,355	11,355	11,355	11,355	11,355	11,355	11,355	11,355	10,975	10,125	9,275	8,375	7,475	11,355	11,355	11,355	11,355	11,355	10,975	10,125	9,275	8,375	7,475				
0	11,355	11,355	11,355	11,355	11,355	11,355	11,355	11,355	11,355	11,355	10,875	9,975	9,075	8,175	11,355	11,355	11,355	11,355	11,355	11,355	10,875	9,975	9,075	8,175				

GROUND ELEVATION ABOVE SEA LEVEL IN FEET

Sikorsky Model S-58T

Logging Configuration Weight Empty 7,240 lbs.  
 Thirty Minutes Fuel 360  
 Pilots 400  
 Load, Line, Hooks, Chokers 250  
 TOWG W/O Payload 8,250 lbs.

TEMPERATURES DEGREES F

	TEMPERATURES DEGREES F											
	-20	-10	0	+10	+20	+30	+40	+50	+60	+70	+80	+90
	NET EXTERNAL LOAD (LBS)											
8,000	4,300	4,200	4,050	3,900	3,750	3,550	3,330	3,050	2,750	2,450	2,200	1,850
7,000	4,700	4,650	4,550	4,400	4,200	3,750	3,750	3,500	3,250	2,900	2,550	2,250
6,000	4,750	4,750	4,750	4,750	4,700	4,250	4,250	3,950	3,650	3,350	3,000	2,650
5,000	4,750	4,750	4,750	4,750	4,750	4,750	4,750	4,450	4,150	3,750	3,450	3,100
4,000	4,750	4,750	4,750	4,750	4,750	4,750	4,750	4,750	4,550	4,250	3,900	3,550
3,000	4,750	4,750	4,750	4,750	4,750	4,750	4,750	4,750	4,750	4,750	4,350	3,950
2,000	4,750	4,750	4,750	4,750	4,750	4,750	4,750	4,750	4,750	4,750	4,750	4,400
1,000	4,750	4,750	4,750	4,750	4,750	4,750	4,750	4,750	4,750	4,750	4,750	4,750
0	4,750	4,750	4,750	4,750	4,750	4,750	4,750	4,750	4,750	4,750	4,750	4,750

GROUND ELEVATION ABOVE SEA LEVEL IN FEET

Sikorsky Model S-61'N

Logging Configuration Weight Empty 10,800 lbs.  
 Thirty Minutes Fuel 500  
 Pilots 400  
 Load, Line, Hooks, Chokers 250  
 TOWG W/O Payload 11,950 lbs.

TEMPERATURES DEGREES F

	-20	-10	0	+10	+20	+30	+40	+50	+60	+70	+80	+90
	HOVER OUT OF GROUND EFFECT											
	NET EXTERNAL LOAD (LBS)											
8,000	7,050	7,050	6,950	6,650	6,350	5,950	5,550	5,050	4,450	3,750	3,050	2,350
7,000	7,050	7,050	7,050	6,950	6,950	6,650	6,250	5,750	5,150	4,450	3,750	2,950
6,000	7,050	7,050	7,050	7,050	7,050	7,050	6,950	6,450	5,580	5,150	4,350	3,550
5,000	7,050	7,050	7,050	7,050	7,050	7,050	7,050	7,050	6,550	5,850	5,050	4,250
4,000	7,050	7,050	7,050	7,050	7,050	7,050	7,050	7,050	7,050	6,550	5,650	4,850
3,000	7,050	7,050	7,050	7,050	7,050	7,050	7,050	7,050	7,050	7,050	6,350	5,550
2,000	7,050	7,050	7,050	7,050	7,050	7,050	7,050	7,050	7,050	7,050	7,050	6,250
1,000	7,050	7,050	7,050	7,050	7,050	7,050	7,050	7,050	7,050	7,050	7,050	7,050
0	7,050	7,050	7,050	7,050	7,050	7,050	7,050	7,050	7,050	7,050	7,050	7,050

Sikorsky Model S-61L

Logging Configuration Weight Empty 10,100 lbs.  
 Thirty Minutes Fuel 500  
 Pilots 400  
 Load, Line, Hooks, Chokers 250  
 TOWG W/O Payload 11,250 lbs.

TEMPERATURES DEGREES F

	NET EXTERNAL LOAD (LBS)											HOVER OUT OF GROUND EFFECT												
	-20	-10	0	+10	+20	+30	+40	+50	+60	+70	+80	+90	-20	-10	0	+10	+20	+30	+40	+50	+60	+70	+80	+90
8,000	7,750	7,750	7,650	7,350	7,050	6,650	6,250	5,750	5,150	4,450	3,750	3,050	7,750	7,750	7,750	7,750	7,750	7,750	7,750	7,750	7,750	7,750	7,750	7,750
7,000	7,750	7,750	7,750	7,750	7,350	6,950	6,950	6,450	5,850	5,150	4,450	3,650	7,750	7,750	7,750	7,750	7,750	7,750	7,750	7,750	7,750	7,750	7,750	7,750
6,000	7,750	7,750	7,750	7,750	7,750	7,650	7,650	7,150	6,550	5,850	5,050	4,250	7,750	7,750	7,750	7,750	7,750	7,750	7,750	7,750	7,750	7,750	7,750	7,750
5,000	7,750	7,750	7,750	7,750	7,750	7,750	7,750	7,750	7,250	6,550	5,750	4,950	7,750	7,750	7,750	7,750	7,750	7,750	7,750	7,750	7,750	7,750	7,750	7,750
4,000	7,750	7,750	7,750	7,750	7,750	7,750	7,750	7,750	7,750	7,250	6,350	5,550	7,750	7,750	7,750	7,750	7,750	7,750	7,750	7,750	7,750	7,750	7,750	7,750
3,000	7,750	7,750	7,750	7,750	7,750	7,750	7,750	7,750	7,750	7,750	7,050	6,250	7,750	7,750	7,750	7,750	7,750	7,750	7,750	7,750	7,750	7,750	7,750	7,750
2,000	7,750	7,750	7,750	7,750	7,750	7,750	7,750	7,750	7,750	7,750	7,750	6,950	7,750	7,750	7,750	7,750	7,750	7,750	7,750	7,750	7,750	7,750	7,750	7,750
1,000	7,750	7,750	7,750	7,750	7,750	7,750	7,750	7,750	7,750	7,750	7,750	7,750	7,750	7,750	7,750	7,750	7,750	7,750	7,750	7,750	7,750	7,750	7,750	7,750
0	7,750	7,750	7,750	7,750	7,750	7,750	7,750	7,750	7,750	7,750	7,750	7,750	7,750	7,750	7,750	7,750	7,750	7,750	7,750	7,750	7,750	7,750	7,750	7,750

GROUND ELEVATION ABOVE SEA LEVEL IN FEET

Sikorsky Model S-64E (Skycrane)

Logging Configuration Weight Empty 19,100 lbs.  
 Thirty Minutes Fuel 1,800  
 Pilots 400  
 Load, Line, Hooks, Chokers 300  
 TOWG W/O Payload 21,600 lbs.

TEMPERATURES DEGREES F

	NET EXTERNAL LOAD (LBS)											HOVER OUT OF GROUND EFFECT													
	-20	-10	0	+10	+20	+30	+40	+50	+60	+70	+80	+90	-20	-10	0	+10	+20	+30	+40	+50	+60	+70	+80	+90	
8,000	15,030	14,880	14,680	14,480	14,280	13,980	13,780	13,480	12,880	11,980	11,280	10,980	8,000	15,030	14,880	14,680	14,480	14,280	13,980	13,780	13,480	12,880	11,980	11,280	10,980
7,000	16,080	15,900	15,700	15,480	15,280	15,180	14,880	14,680	14,280	13,680	13,180	12,480	7,000	16,080	15,900	15,700	15,480	15,280	15,180	14,880	14,680	14,280	13,680	13,180	12,480
6,000	17,130	16,930	16,730	16,480	16,280	16,080	15,680	15,680	15,480	15,280	15,080	14,280	6,000	17,130	16,930	16,730	16,480	16,280	16,080	15,680	15,680	15,480	15,280	15,080	14,280
5,000	18,130	17,930	17,700	17,480	17,280	16,980	16,580	16,580	16,280	16,080	15,780	15,580	5,000	18,130	17,930	17,700	17,480	17,280	16,980	16,580	16,580	16,280	16,080	15,780	15,580
4,000	18,980	18,930	18,680	18,480	18,180	17,880	17,380	17,380	17,180	16,880	16,680	16,380	4,000	18,980	18,930	18,680	18,480	18,180	17,880	17,380	17,380	17,180	16,880	16,680	16,380
3,000	18,980	18,980	18,980	18,980	18,980	18,980	18,180	18,180	17,980	17,680	17,580	17,280	3,000	18,980	18,980	18,980	18,980	18,980	18,980	18,180	18,180	17,980	17,680	17,580	17,280
2,000	18,980	18,980	18,980	18,980	18,980	18,980	18,980	18,980	18,980	18,580	18,380	18,080	2,000	18,980	18,980	18,980	18,980	18,980	18,980	18,980	18,980	18,580	18,380	18,080	18,080
1,000	18,980	18,980	18,980	18,980	18,980	18,980	18,980	18,980	18,980	18,980	18,780	18,580	1,000	18,980	18,980	18,980	18,980	18,980	18,980	18,980	18,980	18,980	18,780	18,580	18,580
0	18,980	18,980	18,980	18,980	18,980	18,980	18,980	18,980	18,980	18,980	18,980	18,980	0	18,980	18,980	18,980	18,980	18,980	18,980	18,980	18,980	18,980	18,980	18,980	18,980

GROUND ELEVATION ABOVE SEA LEVEL IN FEET

93 - RAFT NOMENCLATURE

There are four types of logs rafts: flat, bundle, Davis and cigar.

Flat rafts are formed of unbundled logs. Logs are held in place by boom sticks and swifters. See the figure below. These rafts aren't used much now as bundle rafts are more compact for a given volume of logs and aren't as subject to log loss.

Davis rafts are formed by binding logs with a cable into a cylinder shaped raft. Davis rafts are no longer used.

Cigar rafts are similar to Davis rafts except they are formed into a point (cigar shape) at the ends. Cigar rafts are no longer used.

Bundle rafts are formed of bundled logs that are held in position by boom sticks and swifters.

Bag booms are formed by chaining boom sticks into a "bag" shape. Logs are sometimes held in bag booms before they are rehandled.

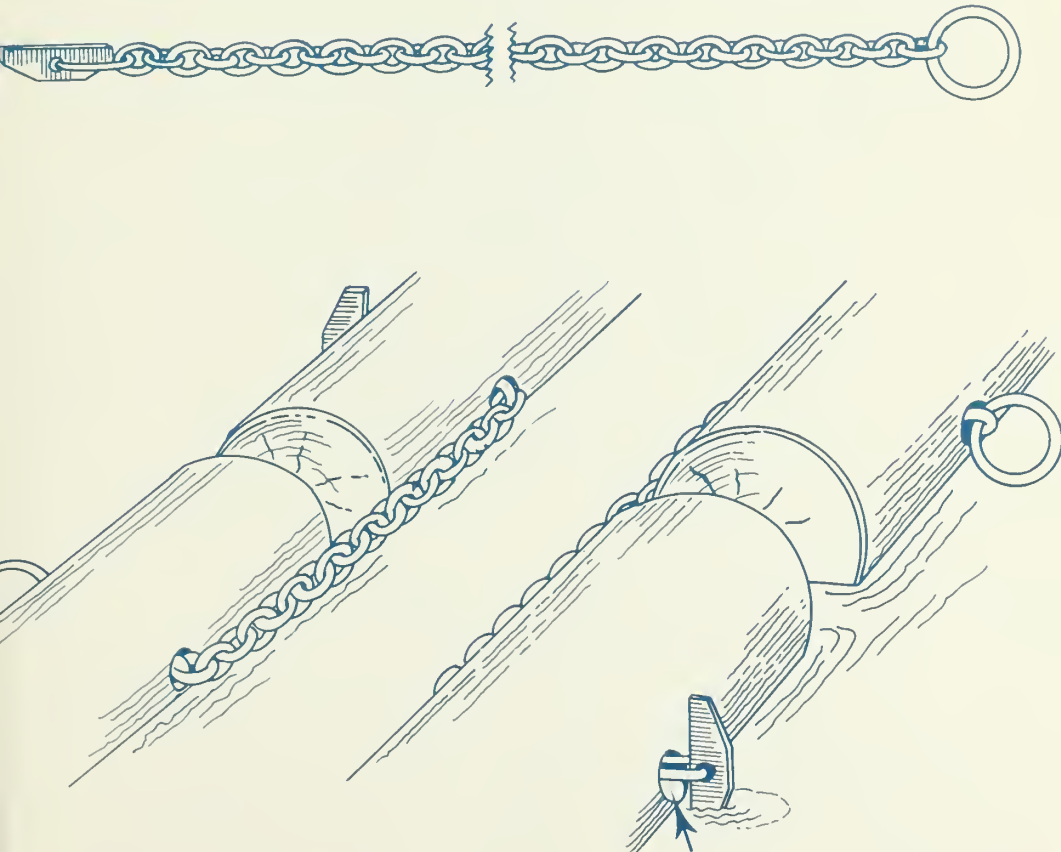

**BOOM CHAIN & METHOD OF HITCHING**

U.S. Department of Agriculture  
Forest Service  
Region 10  
P.O. Box 1628  
Juneau, AK 99802

POSTAGE AND FEES PAID  
U. S. DEPARTMENT OF  
AGRICULTURE  
AGR 101



OFFICIAL BUSINESS  
PENALTY FOR PRIVATE USE, \$300

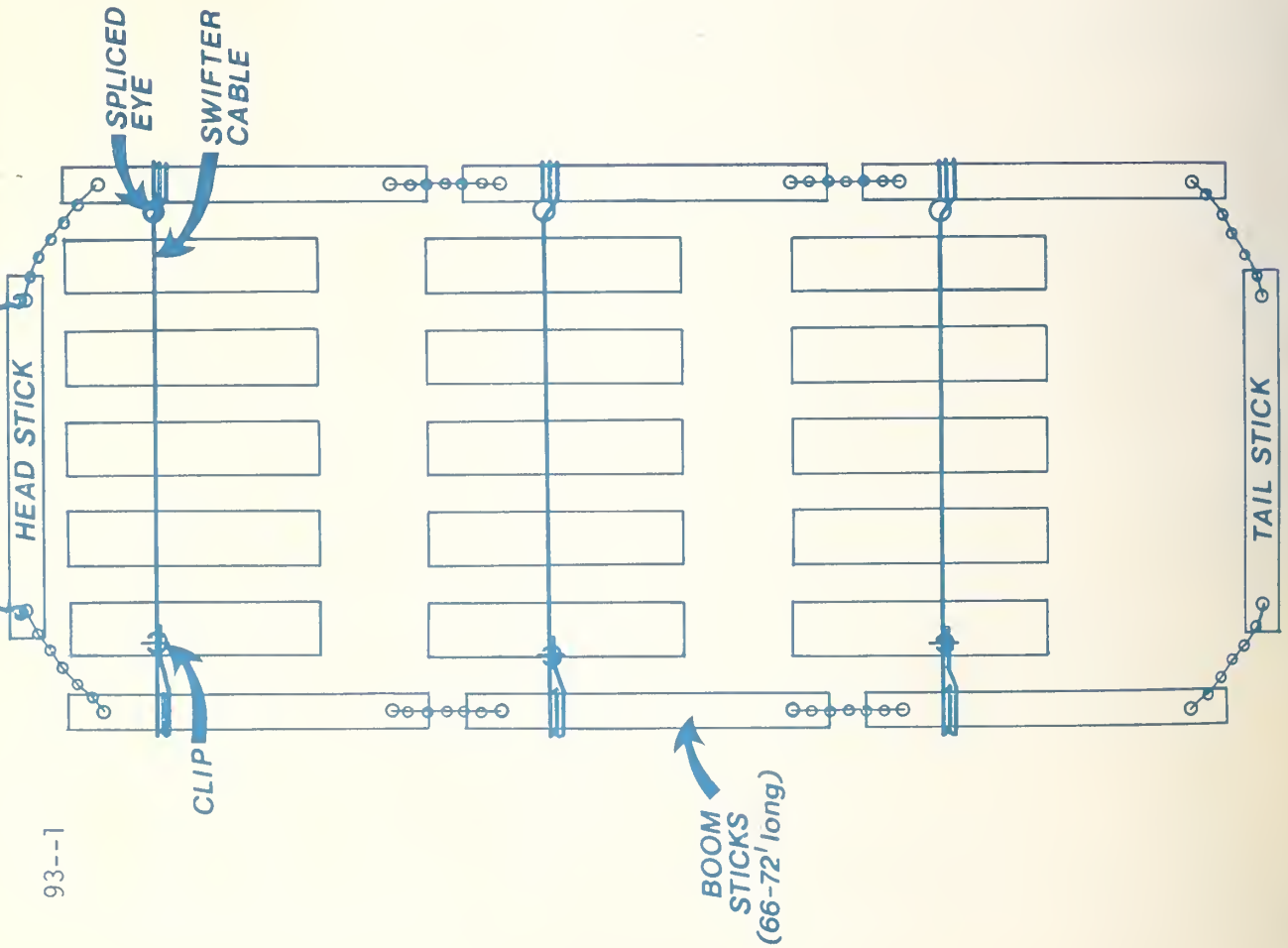

BUNDLE RAFT