

Historic, Archive Document

Do not assume content reflects current scientific knowledge, policies, or practices.

62112
MICHELL'S 1899....

Our First Aim is
QUALITY.

WHOLESALE
PRICE LIST OF BULBS AND SEEDS

FOR FALL PLANTING.

AND SUPPLIES FOR THE FLORIST.

<i>Strictly the Very Best. All First Quality.</i>	<i>25 of Any One Variety at 100 Rates.</i>
<i>Same as Supplied to Retail Trade.</i>	<i>250 " " " " " 1000 "</i>

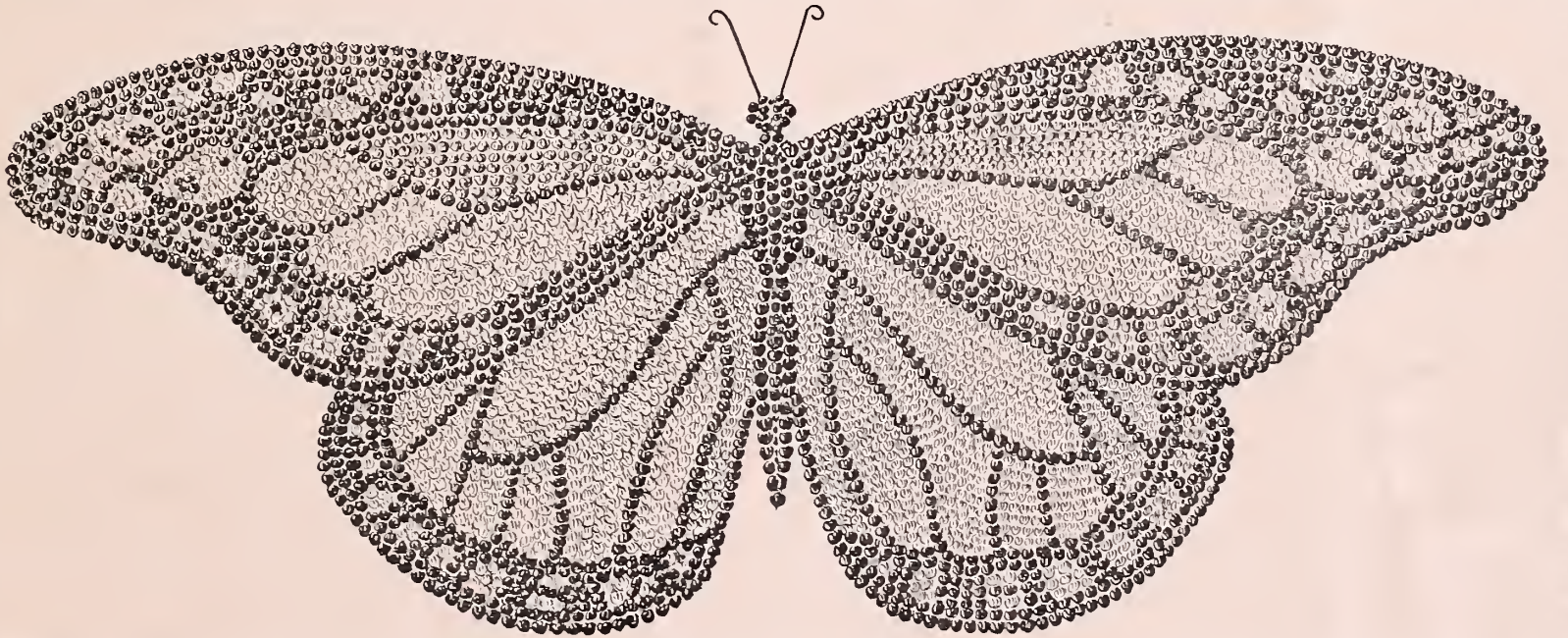

Butterfly Bed containing 4480 Tulips, planted last Autumn at Clifton Park, Baltimore, Md., under direction of N. F. Flitton, Supt. of Public Parks and Squares. ALL BULBS SUPPLIED BY US. The varieties used were 200 Vermilion Brilliant, 2070 Belle Alliance, 500 La Reine, 1650 Chrysolora. During the blooming season last Spring, this was one of the FINEST DISPLAYS of bulbs EVER SHOWN in the Park.

Henry F. Michell
Fred. J. Michell

HENRY F. MICHELL,

Telephone
...3-55-43 A.

SEEDS, BULBS AND IMPLEMENTS

1018 MARKET STREET, PHILADELPHIA.

MICHELL'S HIGHEST QUALITY BULBS



Lilium Harrisii.

True Bermuda Easter Lily. Our "Superior Strain." Grown by the most reliable Grower in Bermuda.

This stock is selected with the greatest care. No flowers have been cut from these bulbs, and the bulbs have not been weakened in consequence.

	Contents of original case.	Per doz.	Per 100.	Per 1000
5 to 7 in.,	400 bulbs	\$.75	\$5.00	\$45.00
7 to 9 in.,	200 "	1.50	10.00	95.00
9 to 11 in.,	100 "	3.00	20.00	190.00

One of many testimonials received from our customers praising the high quality of our bulbs:

Landscape Gardening, Road Making and Grading. Designs and Cut Flowers.
PARK NURSERIES.

Carnations a Specialty. CARL E. TAUBE, PROPRIETOR,
Wholesale and Retail.

POTTSVILLE, PA., April 10th, 1899.

MR. HENRY F. MICHELL,

Dear Sir:—I take the pleasure to inform you regarding the Harrisii Lilies. I was never so pleased with anything that I bought from you, as I was with those bulbs. They were really the finest looking lot of lilies I ever saw in my life; they bore from two to nine flowers on a stem, and the loss by disease was no more than two per cent.; the height of them being from three to four feet.

Trusting that you will furnish me with 1000 as good a bulb for next year.

Yours truly,
CARL E. TAUBE.

Lilium Longiflorum (Bermuda).

	Contents of original case.	Per doz.	Per 100	Per 1000
5 to 7 in.	400 bulbs	\$.75	\$5.00	\$45.00
7 to 9 in.	200 "	1.50	10.00	95.00
9 to 11 in.	100 "	3.00	20.00	190.00

Lilium Longiflorum (Japanese).

Ready about October 5th.

	Per doz.	Per 100	Per 1000
5 to 7 in.	\$.50	\$3.50	\$32.50
6 to 8 in.75	5.00	45.00
7 to 9 in.	1.00	6.50	60.00
9 to 10 in.	1.50	12.00	110.00

Lilium Candidum (or Annunciation Lily).

	Per doz.	Per 100	Per 1000
First size bulbs	\$.40	\$2.50	\$23.00
Extra Large Bulbs50	3.50	32.00

Lilium Auratum (Golden Banded).

	Per doz.	Per 100.	Per 1000.
8 to 9 in.,	\$.75	\$5.00	\$45.00
9 to 11 in.,	1.00	7.50	70.00
11 to 13 in.,	1.75	13.00	

Speciosum (lancifolium) Album.

8 to 9 in.75	5.50	50.00
9 to 11 in.	1.00	7.00	65.00

" " "

Roseum.

8 to 9 in.75	5.00	45.00
9 to 11 in.	1.00	7.00	65.00

" " "

Rubrum.

8 to 9 in.75	5.00	45.00
9 to 11 in.	1.00	7.00	65.00

" " "

Melpomone.

8 to 9 in.	1.00	6.50	60.00
--------------------	------	------	-------

The above varieties of Japan Lilies will arrive in October.

C
A
L
L
A



L
I
L
I
E
S

Calla Lilies (White).

Well Matured Dry Bulbs. Now Ready.

	Per doz.	Per 100	Per 1000
Mammoth bulbs	\$1.50	\$10.00	\$95.00
Extra selected size	1.25	8.00	75.00
First size	1.00	6.50	60.00
Second size75	5.50	50.00
Third size60	4.50	40.00
LITTLE GEM CALLA75	6.00	
SPOTTED FOLIAGE CALLA (1st size only)60	5.00	

25 BULBS OF ANY ONE VARIETY AT 100 RATES; 250 OF ANY ONE VARIETY AT 1000 RATES.

Highest Quality BULBS

All prices include duty. We do not charge for Packing or Cartage.



Roman Hyacinths (French).

	Per doz.	Per 100	Per 1000	Original case lots only. Per 1000
11 to 12 cm., 1st size	\$.25	\$1.50	\$12.50	\$12.00
12 to 15 cm., all selected sizes30	1.75	15.00	14.50
13 to 15 cm., mammoth bulbs35	2.25	20.00	19.00
Rose or Pink (French)25	1.50	14.00	
Blue (French)30	1.60	15.00	
Italian White30	1.80	16.00	

Best Miniature, or Dutch Roman Hyacinths.

NAMED VARIETIES. FIRST SIZE BULBS.

Profitable for growing in pots or pans, blooming later than the French Romans.

	Per doz.	Per 100	Per 1000
Gigantea , light pink	\$.35	\$2.75	\$25.00
Gen. Pelissier , dark red35	2.25	20.00
Chas. Dickens , deep pink40	3.00	28.00
Baroness van Thuyll , pure white35	2.50	24.00
Grand A'Merveille , blush white35	2.50	24.00
Queen Victoria , pure white35	2.50	24.00
Mad. Vander Hoop , creamy white35	2.50	24.00
Czar Peter , light blue35	2.75	26.00
Baron van Thuyll , purple35	2.50	24.00
Grand Maitre , rich porcelain35	2.50	24.00
King of the Blues , deep blue35	2.50	24.00

Dutch Roman Hyacinths.—Continued.

	Per doz.	Per 100	Per 1000
Red Shades , our selection30	2.25	22.00
Pink , our selection30	2.25	22.00
Pure White , our selection30	2.25	22.00
Blush White , our selection30	2.25	22.00
Light Blue , our selection30	2.25	22.00
Deep Blue , our selection30	2.25	22.00



Dutch Hyacinths.

IN SEPARATE COLORS. VERY BEST QUALITY.

For bedding out doors, and also for forcing. They do not, however, produce as fine large spikes as the Second and First size named varieties. We specially recommend the Second size named varieties for forcing, as they are more profitable and certain to produce large flower heads.

	Per doz.	Per 100	Per 1000
Single Red , all shades	\$.55	\$4.00	\$38.00
“ Pink55	4.00	38.00
“ Deep Red55	4.00	38.00
“ White , all shades55	4.00	38.00
“ Pure White55	4.00	38.00
“ Blush White55	4.00	38.00
“ Blue , all shades55	4.00	38.00
“ Light Blue55	4.00	38.00
“ Deep Blue55	4.00	38.00
“ Yellow , all shades55	4.00	38.00
“ All Colors, Mixed50	3.75	37.00
Double Red , all shades55	4.00	38.00
“ Pink , all shades55	4.00	38.00
“ White , all shades55	4.00	38.00
“ Blue , all shades55	4.00	38.00
“ Mixed, All Colors50	3.75	37.50

Dutch Hyacinths in Separate Colors for Bedding.

These are smaller bulbs than the above, are of good quality, and will do for bedding.

	Per 100	Per 1000
Single Red, Pink, White, Blue	\$3.50	\$34.00
Double Red, Pink, White, Blue	3.50	34.00

MICHELL'S HIGHEST —QUALITY BULBS

First size Named Hyacinths

Our Selection. 90c. per doz., \$7.00 per 100, \$65.00 per 1000.

Second size Named Hyacinths

Especially for Forcing.

OUR OWN SELECTION,

70c. per doz., \$5.50 per 100, \$52.50 per 1000.



Second Size Named Hyacinths.

SECOND SIZE.

For Forcing and Fancy Outdoor Bedding where Correct Designs are Wanted.

The following sorts have proven to be the very best for the florist for growing in pots. They produce well shaped, full and compact spikes, and every pot will bring the best price, on account of its fine quality. It pays the florist to plant only the named sorts, as they are far superior to the regular separate color quality.

Single Pink Varieties.

	Per doz.	Per 100	Per 1000
Baron Von Thuyl	\$.75	\$5.50	\$52.50
Gertrude70	5.25	51.50
Chas. Dickens75	5.50	52.50
Norma70	5.25	51.50
Gigantea75	5.50	52.50

Single Red Varieties. SECOND SIZE—Continued.

	Per doz.	Per 100	Per 1000
Gen'l Pelissier	\$.80	\$5.75	\$55.00
Robt. Steiger70	5.25	51.50
Lord Macauley75	5.50	52.50

Single White Varieties.

Alba Superbissima (Pure)	\$.75	\$6.00	\$55.00
Baron Von Thuyl (Pure)75	6.00	55.00
Mad. Vander Hoop (Pure)85	6.50	60.00
La Grandesse (Pure)90	7.00	67.50
Grandeur A. Merville (Blush)75	5.75	55.00

Single Blue Varieties.

Chas. Dickens (Light)	\$.70	\$5.25	\$51.50
Baron Von Thuyl (Deep)70	5.25	51.50
Czar Peter (Light)80	6.00	59.00
King of the Blues (Deep)75	5.50	54.00
Leonidas (Light)75	5.50	54.00
Grand Maitre (Rich)80	6.00	59.00

25 BULBS OF ANY ONE VARIETY AT 100 RATES; 250 OF ANY ONE VARIETY AT 1000 RATES.

...Michell's Highest Quality Bulbs...



TULIPS===Early Single. NAMED VARIETIES.

True to color and name. All strictly first-class Bulbs.

	Per 100	Per 1000
Artus, Scarlet.....	\$0.75	\$ 6.50
Belle Alliance. The best scarlet.....	1.00	9.00
Canary Bird. Light yellow.....	1.40	13.00
Chrysolora. Yellow. Bedding.....	1.30	12.00
Cottage Maid. Pink and white.....	1.25	11.00
Coulour de Cardinal. Scarlet. Forcing.....	1.75	16.50
Crimson King.....	.70	6.00
Duchesse de Parma. Red and yellow.....	.70	6.00
Duc van Thol. Scarlet.....	.80	7.50
“ “ Yellow.....	1.50	14.00
“ “ White.....	1.25	11.00
“ “ Red and yellow.....	.70	6.50
Joost van Vondel. Crimson and white.....	1.10	9.00
Kaiserkroon. Red and gold.....	1.25	10.00
L'Immaculee. Pure white.....	.80	7.00
La Reine. Blush white.....	.85	7.50
Pottbaker. Yellow.....	1.50	14.00
“ White.....	1.40	13.00
“ Scarlet.....	1.15	10.00
Proserpine. Bright pink, large.....	1.70	15.50
Rose Grisdelin. Pink.....	1.50	14.00
Rose Mundi. Bright pink. Good for forcing.....	1.25	10.00
Snowball. White.....	1.00	9.00
Yellow Prince.....	1.30	12.00
All colors, choice mixed, Early Single.....	.60	5.00
Superfine. Selected, mixed.....	.70	6.00
Late Single Gesneriana. Rich scarlet.....	1.10	10.00
“ “ Bizards. Yellow grounds.....	.75	6.50
“ “ Bybloomens. White grounds.....	1.00	9.00

Early Double Tulips.

	Per 100	Per 1000
Duc Van Thol. Red and yellow.....	.65	5.50
Duke of York. Red with white edge.....	.85	8.00
Gloria Solis. Red and gold.....	.85	7.50
Imperator Rubrorum. Rich scarlet. Excellent for forcing.....	1.65	15.50
La Candeur. Pure white.....	.90	8.75
Murillo. Pink. Forcing.....	2.25	21.00
Le Blazon. Pale pink.....	1.50	12.00
Rex Rubrorum. Scarlet.....	1.50	14.00
Rose Blanche. White. (pure).....	.90	8.00
Titian. Red, yellow border.....	.90	8.00
Tournesol. Red and yellow.....	1.60	15.00
“ Yellow.....	3.00	28.50
Yellow Rose.....	.90	8.00
Choice mixed, early double.....	.65	5.50
Extra choice mixed, early double, selected; very best.....	.75	7.00
Late Double Mixed.....	.65	6.00

Parrot Tulips.

	Per 100	Per 1000
Choice Mixed.....	\$0.90	\$8.50

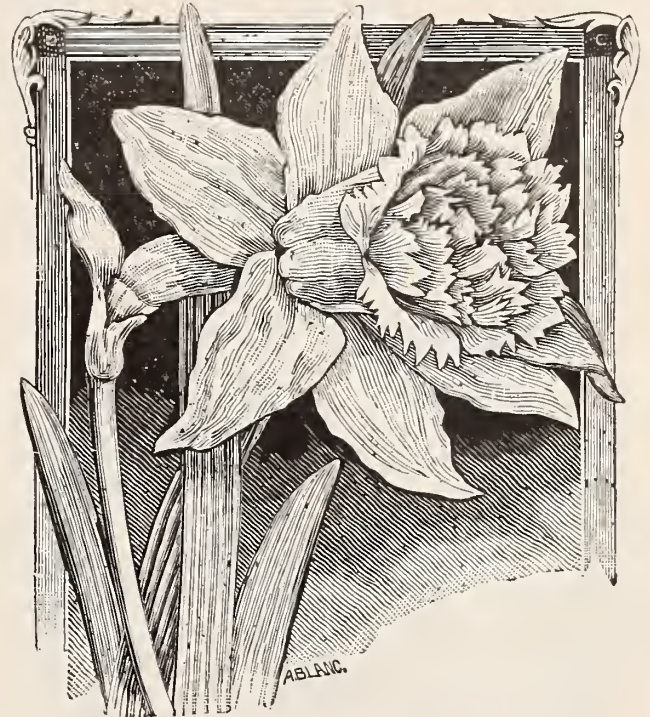

NARCISSUS.

BEST HOLLAND GROWN STOCK.

	Per 100	Per 1000
Double Von Zlon. First size bulbs.....	1.50	14.00
“ “ Extra large. Double spike bulbs.....	2.00	18.00
(Will produce on an average 175 flowers per 100 bulbs.)		
Paper White.....	.90	7.75
Paper White Grandiflora, extra size.....	1.00	9.00
Paper White Giant (Multiflora).....	1.50	12.50
Double Roman.....	1.00	9.00
Grand Soleil de Or' Rich yellow.....	1.75	15.00
Trumpet Major. Single yellow trumpet-shaped flowers, (Best Holland grown.).....	1.25	10.00
Von Sion. Large single yellow trumpet.....	1.50	12.00
Campernelle.....	.60	5.00
Poeticus, Single.....	.45	4.00
“ Double (Alba Plena Odorata).....	.85	7.00
“ Ornatus.....	1.00	9.50
Single Mixed. (Very best).....	.75	6.50
Double Mixed. “ “.....	.75	7.00

Chinese Sacred Lily.

Ready in October.

Extra strong bulbs. 75c per doz.; \$1.60 per basket of 30 bulbs; \$6.00 for 4 baskets; per 1000 \$48.00.

Allium Neapolitanum.

	Per 100	Per 1000
Very desirable white flowers for forcing.....	\$0.60	\$5.00

Crocus.

First Size Bulbs.

	Per 100	Per 1000
White.....	\$0.35	\$3.00
Blue.....	.35	3.00
Striped.....	.35	3.00
Yellow, extra large.....	.75	6.00
“ regular size.....	.35	3.00
Cloth of Gold.....	.40	3.50
Mixed, all colors.....	.30	2.50
Named Varieties.....	.60	4.75

Dielytra Spectabilis.

(Bleeding Heart.)

	Per 100	Per 1000
Strong Clumps, per dozen, \$1.25.....	\$9.00	\$85.00

Michell's Highest Quality Bulbs

Freesia Refracta Alba.

	Per 100	Per 1000
Selected.....	\$0.75	\$6.00
First size.....	.50	4.50
Extra mammoth bulbs.....	1.25	10.00

Gladiolus "Bride".

	Per 100	Per 1000
Excellent white variety for forcing.....	\$0.60	\$5.00

Lily of the Valley.

Selected Berlin 3-year-old Pips.			
Per 100, \$1.25	Per 1000, \$10.50	Case of 2,500, \$25.00	Per case of 2500
Michell's Excelsior XXX (3-year-old.) Very	Per 100	Per 1000	
large spikes.....	\$1.50	\$14.00	\$32.00
Hamburg. (3-year-old.) Late.....	1.00	9.75	23.00

Oxalis.

	Per doz.	Per 100	Per 1000
Bermuda Buttercup, large yellow, very popular, extra large bulbs.....	\$0.20	\$1.15	\$9.00
Mixed all colors.....	.10	.50	4.50
Separate colors, pink, white, yellow, red.....	.20	1.00	

Ornithogalum Arabicum.

	Per doz.	Per 100	Per 1000
Large white flowers in clusters.....	\$0.25	\$1.60	\$15.00

Spirea Astilbe. Selected Strong Clumps.

	Per doz.	Per 100	Per 1000
Japonica.....	\$0.50	\$3.50	\$30.00
Compacta Multiflora, strong clumps.....	.65	4.50	40.00
Astilboides Floribunda.....	.60	4.00	37.50

Ranunculus.

	Per doz.	Per 100	Per 1000
Double Turkish Mixed	\$.10	\$.50	\$3.50
Double Persian Mixed10	.50	3.00
Double French Mixed10	.50	3.00

Anemones.

Double, Mixed, all colors15	1.00	7.50
Single, " " "10	.60	5.00
Fulgen's Rich Scarlet25	1.75	15.00

Amaryllis.

Belladonna, Pink	1.25	10.00
Johnsoni, Red and White	2.50	20.00
Formosissima, (Jacobean Lily)35	2.50
New Seedlings, extra choice30	3.00

Chionodoxa.

Lucilla, Glory of the Snow15	.75	6.00
Gigantea15	1.00	7.50

Crown Imperial.

Mixed colors60	4.50
------------------------	-----	------

Begonia

(Tuberous Rooted.)

Very choicest large flowering type. Extra fine large bulbs.

READY IN NOVEMBER.

	Per doz.	Per 100	Per 1000
Single Crimson	\$.45	\$3.00	\$25.00
" Scarlet45	3.00	25.00
" Pink45	3.00	25.00
" White45	3.00	25.00
" Yellow45	3.00	25.00
" Mixed40	2.50	20.00
Double Crimson	1.25	7.50	72.50
" Scarlet	1.25	7.50	72.50
" Pink	1.25	7.50	72.50
" White	1.25	7.50	72.50
" Yellow	1.25	7.50	72.50
" Mixed	1.00	7.00	67.50

Gloxinia Crassifolia Grandiflora.

READY IN NOVEMBER.

Extra large bulbs, of finest erect flowering varieties. Richest colors, containing also the tigered and spotted. 60c. per dozen; \$4.00 per 100; \$35.00 per 1000.

Iris.

	Per doz.	Per 100	Per 1000
English Mixed	\$.15	\$1.00	\$8.00
Spanish "10	.40	2.50

Ixia.

Choice Mixed10	.50	4.00
------------------------	-----	-----	------

Lachenalia.

Pendula	1.25
-------------------	------

Scilla.

Siberica (Squill)10	.60	5.00
-----------------------------	-----	-----	------

Snowdrops.

Single10	.60	5.00
Double15	1.00	9.00
Elwees Giant15	.70	5.50

Sparaxis.

Mixed10	.50	4.00
-----------------	-----	-----	------

Zephyranthes.

Pink30	2.00
White30	2.00

Tuberose.

EXCELSIOR PEARL (for forcing.)

Extra Large, all Ready in November.

Blooming Bulbs, \$1.00 per 100; \$7.50 per 1000.

Gladiolus.

For forcing. White and Light colors, \$2.00 per 100; \$18.00 per 1000.

For forcing. Choice Mixed. \$1.25 per 100; \$10.00 per 1000.

••• Flower Seeds for sowing in August, _____ September and October

Browallia Speciosa Major. A very choice Winter blooming plant, producing large, rich, blue flowers. Per trade pkt. 25c.
Antirrhinum, (Snapdragon.) Queen of the North. Large, flowering, pure white, good forcer and ready seller. 15c per trade pkt., 50c per oz.; also all other varieties.
Asparagus Plumosa Nana. \$1.25 per 100 seeds, \$10.00 per 1000 seeds.
Asparagus Sprengeri. 75c per 100 seeds, \$6.00 per 1000 seeds.

CALCEOLARIA.

Extra Choice Strain; Mixed Colors.

	Retail pkt.	Trade pkt.
Compacta. Dwarf	\$0.27	\$0.60
Grandiflora17	.60
Rugosa (Shrubby)34	.60
James' Superb English Strain. Per pkt. 75 cts.		
Sutton's Perfection Mixed. Per pkt. 75 cts.		



Michell's Giant Prize Cineraria

CINERARIA.

SCHOOL LANE, GERMANTOWN.
 The Cineraria seed I had from you has given excellent results. The colors were all that could be desired, while many of the blooms measured 11 inches in circumference. It is the best strain of Cineraria seed I have handled.
 Yours very truly,
 JOHN McCLEARY,
 Gardener to Wm. Weightman, Esq.

Please accept a testimonial of praise from the undersigned for Michell's Giant Prize Cineraria seed. My plants have over 100 flowers on each and measure the enormous size of 4 inches in diameter, or 12 inches in circumference.
 Respectfully,
 PAUL REINHART,
 Gardener to H. T. Mason, Esq.
 Germantown, Phila.

Dwarf Giant Prize, Mixed. All colors; best sort as pot plants. ½ trade pkt., 60 cts.; trade pkt. \$1.00.
Medium Tall Giant Prize. Mixed. Desirable to grow as a decorative plant, also for cutting. ½ trade pkt., 60 cts.; trade pkt., \$1.00.
Stellata. Sutton's new type, mixed. 65c per original pkt.
James' English Giant Strain. Per ½ trade pkt. 60c., per trade pkt. \$1.00.
Sutton's English Superb Strain. 60c per pkt.
Dwarf Mixed. Very desirable, producing large heads; flower not quite as large as the "Prize." Trade pkt. 50c.
Tall Mixed. Same as above, but taller in growth. Trade pkt. 50c.
Choicest Double Mixed. Beautiful. Pkt. 50c.

All of new Crop and can be Strictly
 . . . relied upon . . .



CYCLAMEN GIGANTEUM.

Grown by one of the leading growers in Europe, who has a world-wide reputation for this strain.

	Per 100	Per 1000
Mixed, of four colors	\$1.00	\$7.00
Red (Rubrum)	1.00	7.50
White (Album).	1.00	7.50
White, with Red Eye (Roseum)	1.00	7.50
Pink	1.00	7.50
Persicum, Wiggins' best Mixed. Trade pkt. 50c.; oz., \$3.00.		

Bush Hill Pioneer. New feathered type. 60c. per original pkt. 5 pkts. for \$2.50.

DOUBLE DAISY.

Bellis Perennis.

Sow in August and September, and treat similar to Pansies.

Snowball. Per trade pkt. 30c.
Giant White. ½ trade pkt. 30c., trade pkt., 50c.
Giant Mixed. ½ trade pkt., 30c.; trade pkt. 50c.
Longfellow Red. Double. Per trade pkt. 30c.
Choicest Double Mixed. Per trade pkt. 30c.

DRACAENA INDIVISA.—Narrow Leaved.

Sow now to make saleable plants for next year.

Per pkt., 15c. Oz., 40c.

Dracaena Australis. Broad green foliage. 25c. per trade pkt. \$1.00 per oz.
Fern Spores or Seeds. (Fresh). Choice, mixed, all varieties, 30c. per trade pkt. We can also supply Fern Spores of nearly all the good popular sorts of Adiantum Pteris, etc., grown by a most careful, reliable fern grower. 40c per liberal trade pkt.
Grevillea Robusta. Trade pkt., 15c.; oz., 40c.

= = Michell's Reliable Flower Seeds = =

Hollyhock.

THE FINEST DOUBLE.

	Trade pkt.	Per oz.
Chater's Improved Snowball, Pure White	\$.20	\$.75
“ “ Brilliant Scarlet20	.75
“ “ Bright Pink20	.75
“ “ Salmon20	.75
“ “ Yellow20	.75
“ “ Choice Mixed20	.60
“Allegheny”, New Fringed Pink25	4.00
“ “ “ Red25	4.00
“ “ “ Mixed25	4.00



Allen's New Defiance Mignonette.

Mr. Allen's own growth, and in his own original packets containing 2000 seeds, \$1.00.

MIGNONETTE.

ALLEN'S DEFIANCE. New, Large Flowering.

Out-door grown, carefully selected seed. One of the greatest acquisitions of recent introduction. Selections have done as noble work with the Mignonette as with any other florists' flower, and this strain is beyond question the acme of perfection. Per trade pkt., 25 cts., per oz. \$1.00.

	Per trade pkt.	Per oz.
Gabriele Mammoth Dwarf	\$.15	\$.50
Machet. Improved. Selected from the best specimens of blooms15	.50
Miles' Spiral10	.20
Bird's Mammoth. Very long spikes25	.60

MYOSOTIS (Forget=Me=Not).

Alpestris Victoria (*New Forget-Me-Not*). This is, without exception, the proper sort for florists. The plants are compact, the flowers are of a rich blue with a white centre. Per trade pkt., 25 cts.; per oz., \$1.00.

Eliza Fonrobert (*Robusta Perfecta*). A general favorite for spring blooming, it also forms a compact bush, and is very large flowering. Per trade pkt. 20c., per oz. 75c.

Alpestris (*Alpine Forget-Me-Not*). Blue. Per trade pkt., 25 cts., per oz., 40 cts.

Palustris. The best sort for cut flowers. Per trade pkt., 25 cts., per oz., \$2.00.

POLYANTHUS.

Choice Mixed per trade pkt., 30 cts.



Michell's Prize Fringed Primula.

PRIMULA.

We have just received a very choice strain from the leading Primula Specialist, and florists may rely upon this strain to be of the very best. Size of flowers very large. Beautifully fringed, and of the brightest colors only.

Michell's Choicest European Mixture.

Per 1/2 trade pkt., 60 cts., per trade pkt., \$1.00, per 1/2 oz., \$2.50.

KERMESSINA SPLENDENS—Fringed.

Bright Crimson with Large Eye.

Per 1/2 trade pkt., 60 cts., per trade pkt., \$1.00.

	Per trade pkt.	
Coccinea. Scarlet, fringed, fancy	\$.75	
Alba Magnifica. White, fringed fancy75	
Holborn Blue. Blue, fringed, fancy75	
Globosa. Crimson, fringed, fancy75	
“ Striped, fringed, fancy75	
“ White, fringed, fancy75	
“ Mixed, fringed, fancy75	
Fern Leaved. Mixed, fringed, fancy75	
Double. White, fringed	1.00	
“ Mixed, fringed	1.00	
Forbesi. New Baby Primrose30	
Stellata. Sutton's New Star. Original pkt. \$1.25.		
Veris. Cowslip. Per pkt. 15c., per oz. 50c.		
Vulgaris (English). Per pkt. 30c., per oz. \$1.50.		
Obconica Grandiflora. Per trade pkt. 30 cts.		



*
Michell's
Reliable
Flower
Seeds.
 *

MICHELL'S GIANT EXHIBITION

SPECIAL SELECTED STOCK FOR FLORISTS **PANSY SEED**

NEW CROP OF SEED JUST RECEIVED.

We have received a large number of unsolicited testimonials from florists, stating that they never before had such fine colors and immense size blooms in Pansies. It is a mixture composed of the very best of the **German, French, Scotch** and **American** Strain which insures the best results—the seed as per test made by us germinated 97 per cent.

Trade pkt., 50c.; $\frac{1}{8}$ oz., \$1.00; $\frac{1}{4}$ oz., \$1.50; $\frac{1}{2}$ oz., \$2.50; oz., \$5.00.

- | | |
|--|--|
| <p>Bugnot's Giant French Mixed. Per trade pkt., 50c.; per $\frac{1}{4}$ oz., \$2.00; per oz., \$6.00.</p> <p>Cassier's Fancy Mixed. Per trade pkt., 50c.; per $\frac{1}{8}$ oz., 75c.; per oz., \$5.00.</p> <p>Trimardeau Giant. Choicest mixed. Per trade pkt., 25c.; per oz., \$1.50.</p> <p>Trimardeau Giant. Yellow. Per trade pkt., 50c.; per oz., \$2.25.</p> <p>Trimardeau Giant. White. Per trade pkt., 50c.; per oz., \$2.50.</p> <p>Snow Queen. Large White. Per trade pkt., 20c.; oz., 80c.</p> <p>Golden Yellow, with eye. Per trade pkt., 20c.; per oz., 80c.</p> <p>Faust. Black. Per trade pkt., 20c.; per oz., 80c.</p> <p>Yellow Gem. Per Trade pkt., 20 cts.; per oz., 80c.</p> <p>Lord Beaconsfield. Purple violet. Per trade pkt., 25c.; per oz., 80c.</p> | <p>Emperor William. Light, ultramarine blue. Per trade pkt., 20 cts., per oz. 80 cts.</p> <p>Striped. Light or sky blue. Per trade pkt., 20c.; per oz., 80c.</p> <p>Purple. Silver edged. Per trade pkt., 20c.</p> <p>Mahogany Color. Per trade pkt., 20c.; per oz., 80c.</p> <p>Gold Margined. Per trade pkt., 20c.; per oz., 80c.</p> <p>Silver Edged. Per trade pkt., 20c.; per oz., 80c.</p> <p>Very Large-flowering. <i>German.</i> Choicest mixed. Per trade pkt., 25c.; per oz., \$1.00.</p> <p>Choice Mixed. First quality. Per trade pkt., 20 cts.; per oz., 75 cts.</p> <p>Michell's Giant Exhibition. See description and illustration above. Choicest mixed. Per trade pkt., 50c.; per $\frac{1}{8}$ oz., \$1.00; per $\frac{1}{4}$ oz., \$1.50; per oz., \$5.00.</p> |
|--|--|

Michell's Reliable Seeds..

SMILAX SEED.

New crop just received. Per trade pkt. 15c., per oz. 35c., per lb. \$3.50.

Sweet Peas.

For Autumn Sowing and Forcing
ECKFORD'S MAMMOTH.

Extra Early Blanche Ferry (True). The most profitable variety for forcing; bright pink, with upper petals white. Per oz. 5 cts., per lb. 50 cts.

Katharine Tracy. Light but brilliant pink, very large flowers. Excellent for forcing. Per oz. 5 cts., per lb. 50 cts.

	Per oz.	Per lb.
Emily Henderson. Large white	\$.05	\$ 40
Queen of England. White05	.40
Lottie Eckford. White, blue border05	.40
Blanche Burpee. Large Pure White10	.60
Countesse of Radnor. Best lavender05	.50
Mars. The best deep pink10	.60
Also all other named varieties in our regular catalogue	.05	.50
Mixed Eckfords. All colors10	.40

STOCKS. (Ten Week.)

The seed we offer is all grown in pots, and will produce over 70 per cent. very double flowers.

	½ trade pkt.	Trade pkt.	Oz.
Pure White	\$.30	\$.50	\$2.50
Blood Red30	.50	2.50
Crimson30	.50	2.50
Purple and Blue30	.50	2.50
Mixed of all colors30	.50	2.00
Princess Alice (Cut and Come Again). Without exception the best for outdoor culture, the flowers are very double and pure white30	.50	3.00
Snowflake (True). The sort used principally for pot culture. Pure white, wall-flowered leaved.30	.50	8.00
Wall-flower leaved, choice mixed30	.50	3.00
“ “ White30	.50	3.50
“ “ Blood Red30	.50	3.50
“ “ Purple30	.50	3.50

TORENIA.

Fournierii Grandiflora. The best variety for the florist. Per trade pkt., 30c.

Bailloni. Yellow. Per trade pkt., 20c.

VERBENA.

Michell's Mammoth. Choicest mixed Our own special stock. Per trade pkt., 40 cts.; per oz., \$1.50.

Mammoth Scarlet. Per trade pkt., 40 cts.; per oz., \$1.50.

“ White. Per trade pkt., 40 cts.; per oz., \$1.50.

“ Pink. Per trade pkt., 40 cts.; per oz., \$1.50.

VINCA.

	Trade pkt.	Oz.
Rosea. Pink	\$0.20	\$0.75
Abba Oculata. White with red eye20	.75
Abba Pura. Pure White20	.75
Mixed, all colors20	.75

WALLFLOWER.

	Trade pkt.	Oz.
Extra Fine Mixed Strain of Double	\$0.30	\$2.00
Single Mixed10	.15

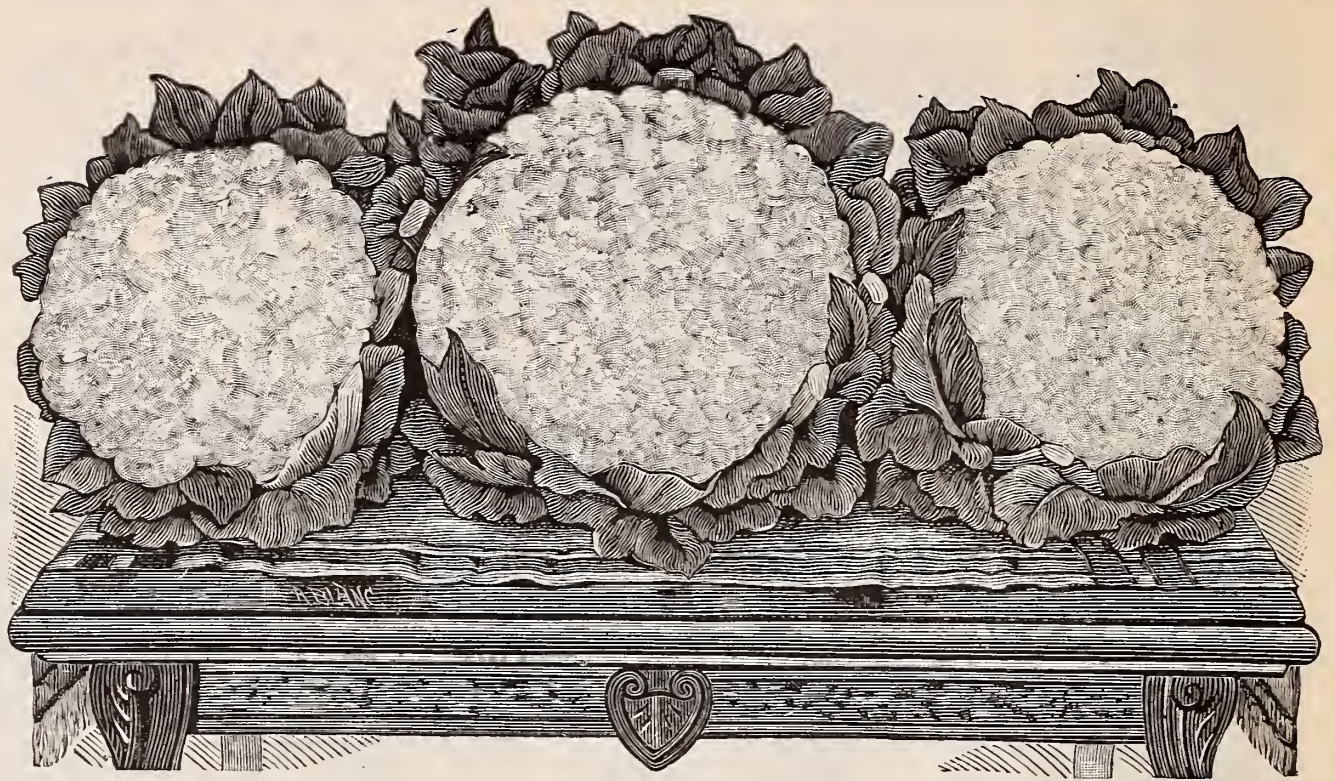

MICHELL'S SPECIAL STRAIN SELECTED ERFURT CAULIFLOWER.

Mr. H. F. MICHELL. Dear Sir—I herewith send you a sample, the result of the Cauliflower Seed you sent out last Fall as MICHELL'S SPECIAL SELECTED ERFURT; it is a fine as we ever had. Gardener to Hon. E. H. Fittler. Very truly, JACOB PRINCING. Torresdale, Pa.

CAULIFLOWER SEED.

Earliest Snowstorm. The earliest and best of all for forcing; must be kept growing constantly; will not stand a check at any period of its growth. Per pkt., 20 cts.; per ¼ oz., 75 cts.; per oz., \$5.00; per ½ lb., \$15.00.

Early Snowball. Per pkt., 15 cts.; per ¼ oz., 65 cts.; per oz., \$2.50; per ½ lb. \$7.50.

Michell's Selected Dwarf Erfurt. Per pkt., 15 cts.; per ¼ oz. 65 cts.; per oz., \$2.50; per ½ lb., \$7.50.

Lenormand's Short Stem. Per pkt., 10 cts.; per oz., 50 cts.

Veitch's Autumn Giant. Per pkt., 10 cts.; per oz. 40 cts.

CABBAGE SEED.

Early Jersey Wakefield. The best for early use; of excellent quality, good size and sure to head; extra fine selected stock. Per oz., 20 cts.; per lb., \$2.00.

Large Jersey Wakefield. Per oz., 20 cts.; per lb., \$2.00.

Henderson's Early Summer. A second early sort with large, solid heads, coming in a few days later than the Wakefield. Per oz., 20 cts.; per lb., \$1.75.

Also all other varieties.

CUCUMBER SEED.

English Prize.

Tender and True. Per pkt., 20 cts.

Long Gun. (Pierson's.) The best of all. Per pkt., 20 cts.

Telegraph. Per pkt., 20 cts.

Also all other varieties.

CORN SALAD SEED.

Large Seeded. Per ¼ lb, 15 cts.; per lb, 40 cts.; 5-lb. lots, \$1.75.

KALE SEED.

Dwarf Green Curled. Very hardy; leaves numerous, frilled, and of excellent quality. Per pkt., 5 cts.; per oz., 10 cts.; per ¼ lb., 15 cts.; per lb., 50 cts.

New Imperial, or Long Standing. A beautiful curled and crimped sort. Per oz., 5 cts.; per ¼ lb., 15 cts.; per lb., 50c.

LETTUCE SEED.

Forcing Emperor. Per oz., 20 cts.

Early Tennisball. Per oz., 15 cts.; per ¼ lb., 35 cts.; per lb., \$1.00.

Boston Market. Per pkt., 5 cts.; per oz., 15 cts.; per ¼ lb., 35 cts.; per lb., \$1.25.

Early Dutch Butter, Spotted. (True Stock.) Per oz., 15 cts.; per ¼ lb., 40 cts.; per lb., \$1.50.

Early Cabbage, or White Butter. Per pkt., 5 cts.; per oz., 15 cts.; per ¼ lb., 40 cts.; per lb., \$1.00.

Also all other varieties.

"There is no motive to make a product if you cannot find somebody to take it. The maker must find a taker."—WILLIAM MCKINLEY.

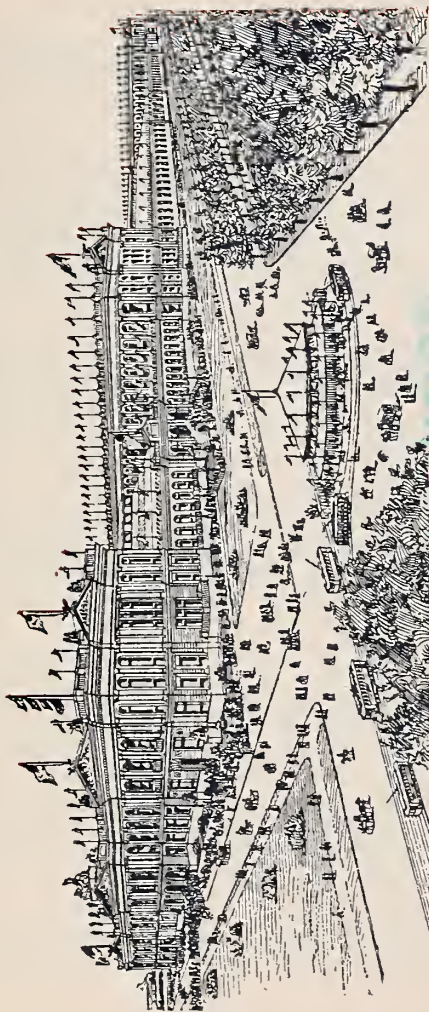

MAIN BUILDING, NATIONAL EXPORT EXPOSITION

"Expositions of American Industries have always been successful and of incalculable benefit to our manufactures."

—CHAUNCEY M. DEPEW.

NATIONAL EXPORT EXPOSITION



*** For the advancement of
American Manufactures and
the extension of Export Trade.
Philadelphia, September 14 to
November 30, 1899.*

The National Export Exposition is an Exposition of American Manufactures for the Extension of Export Trade, and it will be the first National Exposition of that character ever held in the United States.

It is under the joint auspices of the Philadelphia Commercial Museum and the Franklin Institute, two great public institutions in Philadelphia, whose standing is such as to assure its success. The Franklin Institute, during its career of seventy-five years, has conducted thirty successful exhibitions.

Sanction and financial support have been given to the Exposition by the National Government, the State of Pennsylvania and the City of Philadelphia.

Every line of American manufactured products which is, can or might be exported, from locomotives and the heaviest machinery to the smallest novelties, is to be exhibited.

There is also a department of foreign manufactured goods, consisting of collections of samples made in the commercial countries of Europe and successfully sold in all foreign markets.

Commissioners of the Exposition now abroad, aided by the entire consular service of the United States, are selecting and purchasing these samples. They will show our manufacturers just what competition they must meet, as well as the peculiarities in the demands of every foreign market.

A third department will show how American goods must be packed, labeled and shipped, in order to meet the requirements of foreign trade.

On October Tenth an International Commercial Congress will convene in the Exposition Auditorium, in connection with the meeting of the International Advisory Board of the Philadelphia Commercial Museum.

Delegates from Chambers of Commerce and other commercial organizations all over the world will be present. Every foreign government has been invited, through the State Department at Washington, to send an official representative.

The Philadelphia Commercial Museum has also invited 20,000 foreign business houses with which it is in close correspondence, to send representatives to the Exposition.

An epitome of the manufactured products of this country, of the highest grade and quality which American genius, skill and experience can produce, will be displayed at the Exposition for the inspection and study of these foreign delegates and buyers.

Thousands of articles made in the United States, the result of the genius and ingenuity of its people and considered indispensable by them, have never been heard of in many parts of the world.

In the Main Building, which is 1,000 feet long, there are 12 acres of floor space. A special building for exhibits of Agricultural Implements and Machinery, Vehicles and Furniture, contains 72,000 square feet of space.

Four tracks in the Transportation Building furnish 1,800 lineal feet for exhibits. Fifty acres are available for detached structures, special exhibits and amusement features.

A sample copy of the illustrated weekly *Bulletin* of the Exposition will be sent to your address, upon application to the Department of Publicity and Promotion.

Blank applications for space and special information of every character can be procured from

W. P. WILSON, Director-General

233 South Fourth Street

PHILADELPHIA, PA.



MUSHROOM SPAWN.

"Michell's Superior Brand"

Fresh shipments are received every month from the best maker in England.

We have received a large number of testimonials from our customers stating that they never had such good, quick, large crops of the finest quality mushrooms as from spawn they purchased from us.

Per brick	\$0.15
Per dozen bricks	1.75
Per 50 lbs.	4.00
Per 100 lbs.	6.50
Per 1000 lbs.	60.00

Original case lots containing about 250 lbs. at 1000-lb. rate.

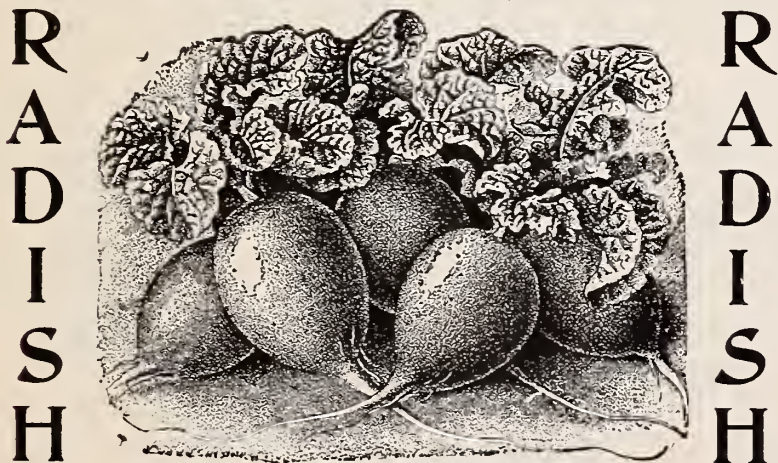

RADISH SEED.

- Cardinal Globe.** (*True.*) Per oz., 5c.; per lb., 60c.; 5 lbs. for \$2.75.
- Round Red Forcing, or Button.** Per oz., 5c.; per 1/4 lb., 20c.; per lb., 60c.
- Round White Forcing.** Per oz., 5c.; per 1/4 lb., 20c.; per lb., 60c.
- Fireball.** Per oz., 5c.; per 1/4 lb., 20c.; per lb., 60c.
- Early French Breakfast.** Per oz., 5c.; per 1/4 lb., 15c.; per lb., 15c.
- White Box.** (*True.*) Per oz., 5c.; per 1/4 lb., 20c.; per lb., 60c.

TOMATO SEED.

For Forcing.

- Lorillard.** The best. Per pkt. 10.; per oz., 25c.
- Livingston's Stone.** Excellent. Per pkt. 10c.; per oz., 15c.
- Mayflower.** (*True.*) Pkt. 10c.; oz., 25c.. 1/4 lb., 75c.
- Sutton's.** (*Imported.*) **Best of all.** Per original large pkt. 40c. We can especially recommend this as the very best forcing tomato.

Also all other varieties.

SPINACH SEED.

(Ten to twelve pounds are required for an acre.)

- Bloomsdale Round-seeded Savoy.** Best home-grown seed. Per lb., 25c.; per peck, \$2.00; per bu., \$8.00.
- Long Standing Round-seeded.** Per lb., 25c.; per peck, \$1.75; per bu., \$7.00.
- Victoria Long Standing.** 25c. per lb.; \$2.00 per peck; \$7.50 per bu.

Grass and Clover Seeds.

GRASS SEEDS.

- Michell's Evergreen Lawn Grass.** Our very best mixture. (20 lbs to the bushel.) Qt., 20c.; peck 85c.; bu., \$3.25.
 - Fairmount or Central Park Lawn Grass.** Excellent mixture of short growing grasses and white clover (15 lbs. to the bushel.) Qt., 10c.; peck, 60c; bu. \$2.25.,
 - Fine Mixed Lawn Grass.** (15 lbs. per bu.) \$2.00 per bu.
 - Permanent Pasture Mixture.** (20 lbs. to the bu.) \$2.50 per bu.
- | | Per peck. | Per bushel. | Per 100 lbs. |
|---|-----------|-------------|--------------|
| Herd, or Red Top. Bu. of 10 lbs. . . | \$0.25 | \$0 80 | \$6.00 |
| Fancy Cleaned Red Top. Free from chaff. 32 lbs. per bushel . . . | 1.30 | 4.50 | 12.00 |
| Kentucky Blue. Fancy triple cleaned .50 | .50 | 1.65 | 10.50 |
| Natural Green. 14 lbs. to the bu. .50 | .50 | 1.75 | 11.00 |
| Wood Meadow. Per qt. 25c. | 1.25 | 4.00 | 26.00 |
| Sweet Vernal. (Annual.) 20c. per lb. | 1.00 | 3.50 | 15.00 |
| Sweet Vernal. (Perennial) Per lb. 40c | 1.50 | 5.50 | 35.00 |
| Orchard Grass. | .50 | 1.75 | 11.50 |
| English Perennial Rye. 24 lbs. to bu. | .50 | 1.75 | 7.00 |

Also all other varieties of grass seed.
Special prices will be quoted to large buyers.

Clover Seeds.

	Prices may fluctuate.		
	Per lb.	Per 10 lbs.	Per bushel.
White Dutch Clover. Extra clean.	\$0.20	\$1.90	\$10.20
Scarlet, or Crimson Clover.10	.90	5.00
Alsike Clover.15	1.25	6.50
Lucerne Clover.15	1.25	6.50
Red Clover. (Ex. choice.)10	.90	4.80

Millet Seed.

- German, or Golden.** Best quality. about \$1.50
- Hungarian** " 1.00

Timothy Seed.

- Extra Prime** about \$1.75

- SEED WHEAT.** Best quality at lowest market prices.
- SEED RYE.** " " " " " "



**Best Quality
Standard
FLOWER POTS.**

Full Inside Measurement.

P. S.—The prices herewith quoted are subject to discount of 5 per cent. for cash with order, or if paid within 30 days.

	Per 100	Per 1000		Per 100	Per 1000
1 3/4 inch . . .	\$0.35	\$3.15	8 inch . . .	\$7.00	\$70.00
2 "40	3.60	9 " . . .	10.00	100.00
2 1/4 "45	4.05	10 " . . .	13.50	135.00
2 1/2 "55	4.95			
2 3/4 "60	5.63	11 inch . . .	\$18.00	
3 "70	6.30	12 " . . .	25.00	
3 1/2 "85	7.65	13 " . . .	37.50	
3 3/4 "90	8.10			
4 " . . .	1.10	9.90	14 "50	Each
4 1/4 " . . .	1.25	11.25	15 "75	
4 1/2 " . . .	1.50	13.50	16 " . . .	1.00	
5 " . . .	2.00	18.00	18 " . . .	1.50	
5 1/2 " . . .	2.50	22.50	20 " . . .	2.00	
6 " . . .	3.00	27.00	22 " . . .	3.00	
6 1/2 " . . .	4.00	40.00	24 " . . .	4.00	
7 " . . .	5.00	50.00			

The above prices are subject to 5 per cent. discount for cash with order, or if paid within 30 days.

BULB PANS, (EARTHENWARE).

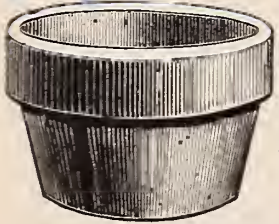

Height	Width	Per doz.	Per 100
3 x 6		\$0.50	\$3.00
3 1/2 x 760	4.00
4 x 875	5.00
4 1/2 x 9		1.00	7.00
5 x 10		1.25	9.00
6 x 12		1.75	12.50
7 x 14		3.50	25.00
8 x 16		6.00	50.00
9 x 18		9.00	75.00

**FLOWER POT SAUCERS.
(EARTHENWARE.)**

Size	per 100
4 inch	\$0.90
5 "	1.12
6 "	1.50
7 "	2.00
8 "	3.00
9 "	\$4.00
10 "	5.00
11 "	6.00
12 "	7.50
14 "	12.50



**Reduced Prices
OF
FLORISTS'
...VASES**

Made of Indurated Wood Fibre.

FOR DISPLAYING CUT
FLOWERS.

No.	Diam., inches inside	Depth, inches inside.	Each.	Per doz.
0	8	13	\$0.40	\$4.35
1	5 1/2	10	.35	3.80
2	4 1/2	9	.30	3.25
3	4	6	.25	2.75
4	3	4 1/2	.20	2.20
22	4 1/2	15	.40	4.35
33	4	12	.35	3.80
44	3	9	.30	3.25
00	9	21	.75	8.75

Wood Fibre Pot Saucers.

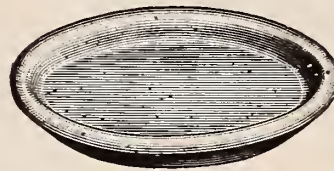

Indurated Fibre Flower Pot Saucers are light. Not easily broken. Far cheaper in the end and better in every way than the earthenware article. Are not porous, and will protect woodwork, tables, etc., on which plants are to stand.

Inch	Per doz.	Per 100
4	\$0.75	\$6.00
580	6.25
685	6.75
790	7.10
895	7.60
9	1.05	8.20
10	1.10	8.70
11	1.15	9.10
12	1.25	10.00
13	1.50	12.00
14	2.00	15.00

INDURATED FIBRE WARE

ROLLING STANDS.

FOR HEAVY PLANTS AND PALMS.

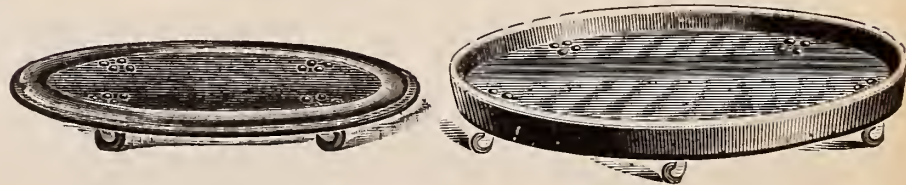

Will not soak or rust.

Casters have Ball Bearings.

Every heavy plant sold needs one to save carpets and floors, and to enable carpets and floors to be readily cleaned.

	Each.	Per doz.
13-inch, 3 casters	\$.60	\$7.20
17 " 4 "75	9.00
(Will take pot)		
18-inch (16-inch dia.) 4 casters	\$1.00	\$12.00
20 " (18 " " ") 4 "	1.25	15.00
22 " (20 " " ") 5 "	1.50	18.00

These larger sizes (18, 20 and 22 inch) are very heavy, and will carry safely 200 lbs.

"Neponset" Paper Flower Pots.

They are the cheapest flower pots on the market. Made from the well-known NEPONSET WATER-PROOF FABRIC, and for lightness, cleanliness, and cheapness have no equal. Especially valuable for shippers of small plants.

Size	Per 100	Per 1000	Weight per 1000 pots
2 1/4	\$.25	\$2.20	20 pounds.
2 1/230	2.40	23 "
345	3.90	33 "
3 1/260	5.15	44 "
480	6.90	38 "
5	1.20	10.35	56 "
6	1.65	14.55	74 "

Not less than Original Crates at 1000 Rates

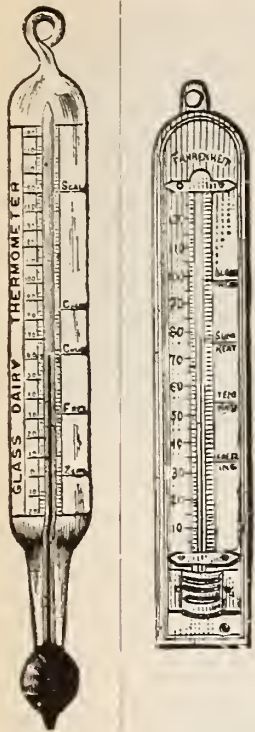

Mushroom Bed Thermometers. Very best quality, with Brass Tip, \$1.50 each.

Florists' Thermometers. 8 in., tin, 15c. each; doz., \$1.60; 10 in., tin, 20c. each; doz. \$2.00.

Maximum and Minimum. Registers the coldest and warmest point of temperature during the previous night.
8 in. . . . \$2.25 each; \$6.00 per 1/4 doz.
10 " 2.50 " 6.75 per 1/4 doz.

Sundries.

Peat, (Jersey) bbl., \$1.15
Moss, Sphagnum " 1.15
" Green (lump) " 1.25
" Green (Sheet) " 1.50

Tin Foil. Per lb., 15c.; 4 lb. 50c.; 10 lbs. \$1.20.

Twine (Bouquet). Per lb. 40c.; 3 lbs. \$1.00.

Bouquet Wire. All sizes, per lb. 10c.; per stone of 12 lbs. 80c. to \$1.50.

Improved Bouquet Wire. All sizes already cut in lengths. Per box of 12 lbs. \$1.20.

RAFFEA, Fresh and Strong. Best material for tying up plants. 17c. per lb.; 10 lbs. \$1.50; \$14.00 per 100 lbs.

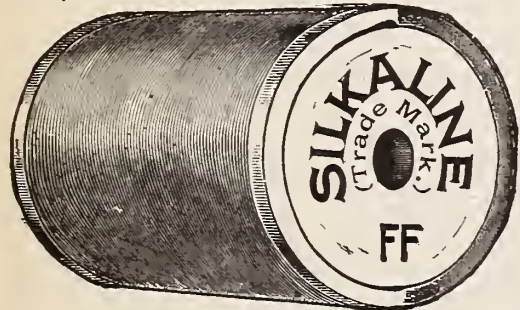

Green Silkline.

For stringing Smilax and Asparagus. Fast color and will not fade; very strong and will not break. Coarse or fine, put up on 2 oz. spools, 8 in a box, 16 oz. of

Silkline guaranteed. Price, \$1.25 per lb.; per spool, 20c.

TWINE. (Jute). 2, 3 or 4-ply. 10c. per lb.
TWINE. All kinds at lowest prices.



SCOLLAY'S PUTTY DISTRIBUTOR.

The best appliance for distributing putty. It has been used by a large number of the leading florists, who have proven its merits. One day's work by the old method of glazing can easily be done in four hours by the use of the Distributor.

Price, each 75 cts.
By mail 85 cts.

Waters' Improved Tree Pruners.

With Poie Attached.

Considered to be the most practical as well as the cheapest.

4-foot pole	\$.80
6 "90
8 "	1.00
10 "	1.10
12 "	1.20
14 "	1.30

Extra cutting blade 25 cts.

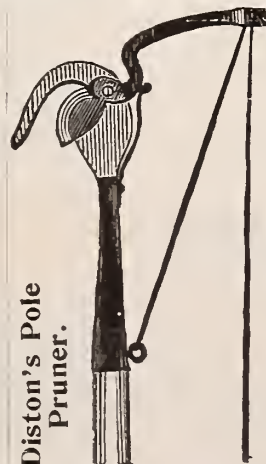
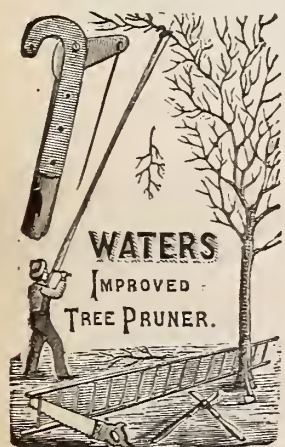

Diston's Pole Pruner.

PLANT STAKES.

PRICES SUBJECT TO CHANGE

Galvanized Steel Plant Stakes. Used by nearly all the largest florists for Roses, Carnations, etc. They are neat and durable.

	Per 100	Per 1000		Per 100	Per 1000
2 feet long	\$.55	\$4.75	4 feet long	\$1.00	\$9.40
2 1/2 "65	5.90	4 1/2 "	1.10	10.50
3 "75	7.10	5 "	1.20	11.65
3 1/2 "90	8.25	6 "	1.40	13.80

GALVANIZED WIRE. In rolls of 12 lbs. each, Nos. 14, 16, 18, 20, at 75c. per roll.

Bamboo or Cane Plant Stakes. 8 to 10 feet long \$.75 \$5.00

Bamboo or Cane Plant Stakes. Extra fine and large. 9 to 12 feet long. \$1.00 per 100; \$6.00 per 1000.

Unpainted Stakes or Dowels.

36 inches long, 3/8 inch diameter	\$.60	\$5.50
36 " " 1/4 " "50	4.00
36 " " 3/8 " "50	4.00
42 " " 1/4 " "60	5.00
42 " " 3/8 " "65	5.25
42 " " 1/2 " "85	7.00

We can supply these Dowels, dyed green, at 50c. per 1000 additional.

GREEN PAINTED TAPERING PLANT STAKES.

	Size—1 1/2 ft.	2 ft.	2 1/2 ft.	3 ft.	3 1/2	4 ft.
Per doz.	\$.12	\$.22	\$.33	\$.40	\$.52	\$.60
Per 10080	1.40	2.10	2.65	3.35	3.85

GREEN PAINTED HEAVY OR DAHLIA STAKES.

	Size—3 ft.	3 1/2 ft.	4 ft.	5 ft.	6 ft.
Per doz.	\$.60	\$.70	\$.80	\$1.00	\$1.20
Per 100	3.85	4.50	5.15	6.40	7.65

P
L
A
N
T

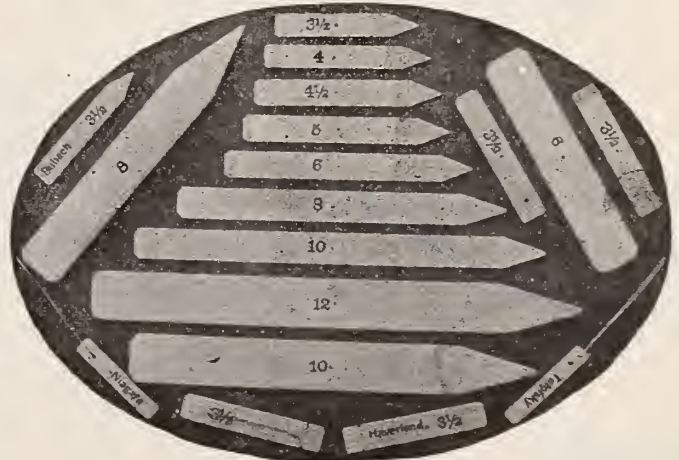

L
A
B
E
L
S

POT LABELS, PAINTED.

	Per 1000		Per 1000
3 1/2 inch	\$.60	6 inch	\$1.25
4 "65	8 "	2.50
4 1/2 "70	10 "	3.50
5 "90	12 "	4.50

Tree Labels, Notched. Iron Wired90
" " " Copper Wired 1.00

Indelible or Permanent Hanging Labels. The best and most durable made. Send for sample. Per doz. 15c.; per 100, \$1.00
Glass Labels. (Permanent). 50c. per doz.; \$3.00 per 100.

DISSTON'S LITTLE GIANT PRUNER

Price, \$1.00; with saw, \$1.30.

GERMAN HAND PRUNING SHEARS

Steel blades, coiled steel spring, which cannot drop out. 8-inch, 65c.; 8 1/2-inch, 90c.

AMERICAN HAND PRUNING SHEARS

Price, 30c. each.

HEDGE SHEARS

8-inch, \$1.50; 9-inch, \$1.75; 10-inch, \$2.00.



PRUNING AND BUDDING KNIVES

A large assortment, 50c. to \$1.25 each.

TRANSPLANTING DIBBLE

The best and cheapest. Price, 40c.



PRUNING SAWS (DISSTON'S)

Best quality, 70c. to \$1.25.

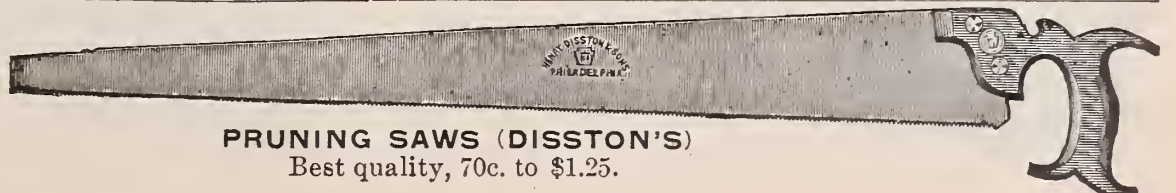

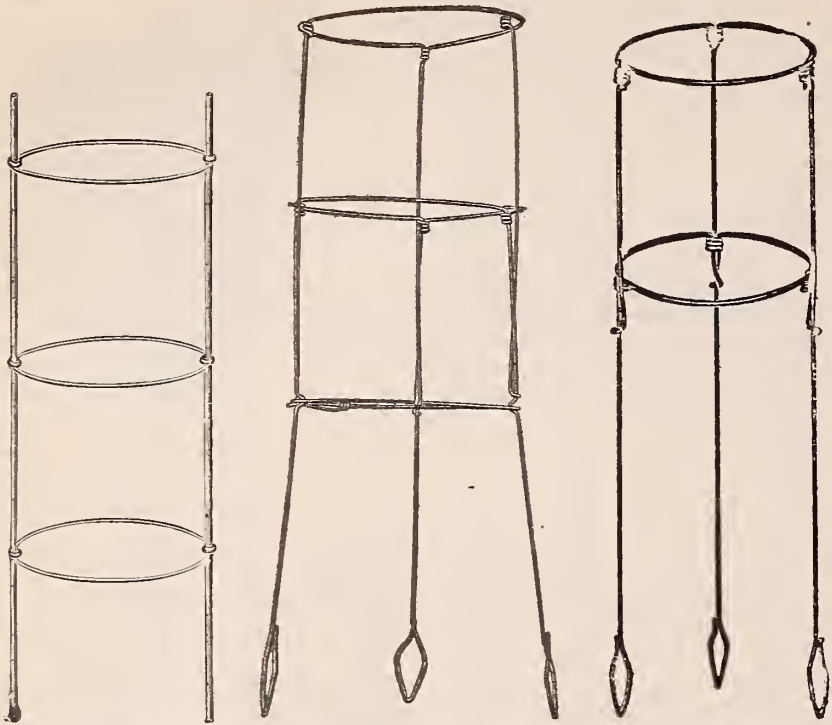

"MICHELL'S PRACTICAL." "MODEL" THREE RING. "MODEL" TWO RING.

CARNATION SUPPORTS.

		Doz.	100	1000
Michell's Practical.	24 inch, 2 rings	\$.30	\$2.25	\$20.00
"	" 30 " 3 "	.35	3.00	27.50
" Model."	2 rings	.35	2.75	25.00
"	3 "	.45	3.00	27.50
" Haines."	Consisting of one cypress wood stake and three copper wire rings	.30	2.00	20.00

UNIVERSAL GLAZIERS' DIAMOND

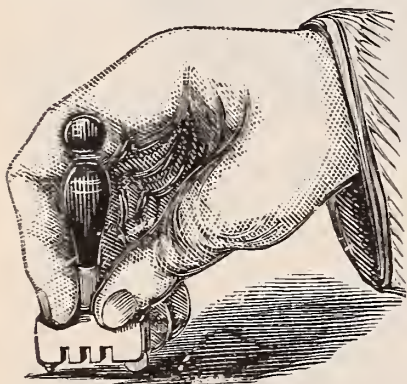

Hold the Diamond as shown in Cut (against the ruler.) Place it perpendicular on the glass, so that it rests on the Diamond and Guide Wheel—the Wheel towards you. Press on it gradually; until it makes a singing sound, not a harsh noise.

Draw over the glass slowly and uniformly, never cut twice in the same place. \$2.50.

IMPROVED COLUMBIA

Plant Tubs

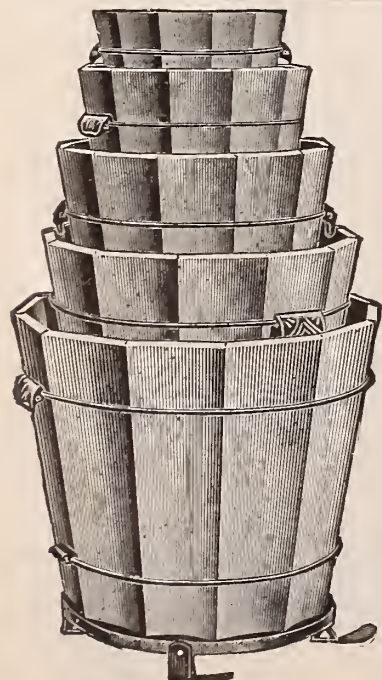

12 inch diameter	\$.90 each.
15 " "	1.35 "
18 " "	1.80 "
21 " "	2.25 "
24 " "	2.70 "

Improved White Cedar Plant Tubs.

Made of white cedar and bound with extra heavy iron hoops. Drop handles of special pattern serving as hooks. Substantial iron feet of original design, removable perforated bottoms.

Painted green outside, and brown inside.



Machine Made.

No.	Outside diam.	Length of stave.	
0	27 in.	24 in.	\$6.00
1	25 in.	22 in.	4.75
2	23 in.	20 in.	4.00
3	21 in.	18 in.	3.50
4	18 in.	16 in.	3.10
5	16 in.	14 in.	2.40
6	14 in.	12 in.	2.15
7	13 in.	11 in.	1.90
8	12 in.	10 in.	1.65

Hand Made.

No.	Outside diam.	Length of stave.	
0	27 in.	24 in.	\$4.75
1	25 in.	22 in.	4.35
2	23 in.	20 in.	3.75
3	21 in.	18 in.	3.15
4	19 1/2 in.	16 in.	2.50
5	18 in.	14 in.	2.25
6	16 1/2 in.	13 in.	2.00
7	15 in.	12 in.	1.75
8	14 in.	10 in.	1.50

MASTICA

FOR GLAZING GREENHOUSES.

(NEW OR OLD.)

Elastic, adhesive, easy to apply. Used now extensively and highly recommended by all the up-to-date gardeners and florists. Immense quantities were used last season.

One gallon will cover about 300 running feet, one side. Per gal. \$1.25; half gal. 60c.; 5 gals. \$5.75. 10 gallons and over, \$1.10 per gallon.

Machines for applying Mastica \$1.00.

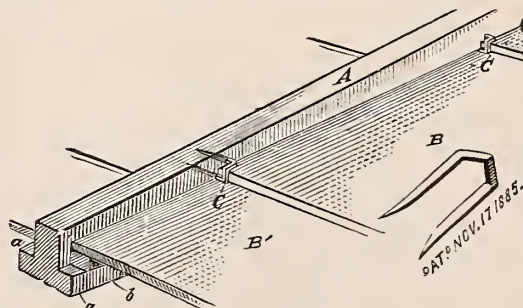
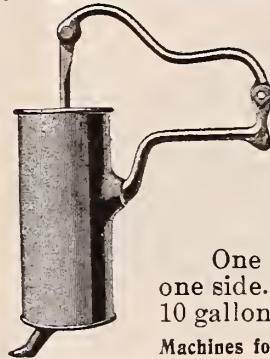

The Van Reyper Perfect Glazing Points.

Made of steel wire and galvanized, having double points and lap over the glass in such a manner as to positively keep it from sliding. They may be used on either side of the sash bar, thus preventing the annoyance of rights and lefts.

Per box of 1000, 60c. 5000 lots at 55c. per 1000. Pincers for driving, 50c.

OILED MUSLIN OR FIBRE CLOTH.



Light grade, 4c. per yd.; piece of about 65 yards, 3 1/2 c. per yd. Medium grade, 8c. per yd.; piece of about 60 yards, 7c. per yd. Heavy grade, 10 1/2 c. per yd.; per piece of about 40 yards, 10c. per yd. These goods are now extensively used by florists for shading the greenhouses in preference to the old style of whitewashing the glass.

PALMER'S HOT BED MATS

FROST PROOF.

Made expressly for winter covering of hot beds, cold frames, plants and seeds of all kinds.

Indestructible, Cheap and Warm

Will not harbor mice or vermin. Easy handling. Have now been in practical use three years. Costing less than

half as much as old fashioned straw mats and entirely taking their place. Size 76x76 inches, fully covering two regular size hot bed sash, \$1.25 each; \$18.50 per doz. Size 40x76 inches, fully covering one hot bed sash, 75c. each; \$8.50 per doz.

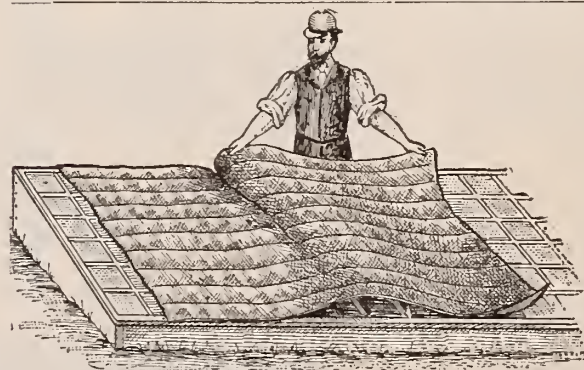

MICHELL'S WHOLESALE PRICE LIST.

Guaranteed

FERTILIZERS

Strictly Highest Grade

Native Pondrette. We can recommend this very highly for a general greenhouse fertilizer. Per 100 lbs. \$1.50, 500 lbs. for \$6.25, \$20 per ton.

Bowker's Greenhouse Chemicals. One of the very best all around fertilizers for forcing and producing bloom. 5 lbs. 45c., 25 lbs. \$1.25, 100 lbs. \$4.50.

"Jadoo" Fibre. The great new fertilizer and prize winner. 5c. per lb., 10 lbs. for 45c., 25 lbs. \$1.00. Per sack containing 100 lbs., 2½c. per lb., per ¼ ton, \$7.50, per ton, \$27.50.

"Jadoo" Liquid. For feeding plants. 2 gallons, \$1.30, 5 gallons, \$3.25. 25c. per pint bottle.

Michell's Pure Bone Meal. (Pierson's Brand). This grade is the purest article on the market. It is prepared from fresh bones only, and contains not a particle of vegetable, ivory or oyster shell, often found in cheaper grades. Per ton, \$28.00, per sack of 200 lbs. \$3.25, per 100 lbs. \$1.75, per 50 lbs. \$1.00.

Canada Unleached Hard Wood Ashes, Pure. Per bbl. of 250 lbs. \$2.50, per ton, \$18.00, \$12.00 per ton, f. o. b. Canada.

Bone Flour. Ground perfectly fine. An excellent fertilizer for pot plants or beds where an immediate effect is wanted. 100 lbs. \$2.25, bag or bbl. of 200 lbs. \$4.00, per ton, \$36.00.

Guano (Peruvian), Per 5-lb. bag, 20c., 25-lb. bag, 90c., 100-lb. bag, \$2.75, 200-lb. bag \$4.50, per ton, \$40.00.

Nitrate of Soda, Pure. Per lb. 5c., 10 lbs. 40c., 25 lbs. 90c., 100 lbs. \$3.00, 200 lbs. \$5.50, per ton, \$42.50.

Pulverized Sheep Manure. Best quality (Elliott's Brand). 5 lbs. 20c., 25 lbs. 75c., 100 lbs. \$2.00, per ton \$32.50, or \$30.00 per ton f. o. b. factory.

Horn Shavings. Per bag of 20 lbs. \$1.00, per 100 lbs. \$4.00.

SPECIAL NOTICE.—We carry on hand or can supply all other FERTILIZERS at the very lowest wholesale prices. Quotations will be made on request. Also Horse and Cow Manure.

INSECTICIDES OR INSECT DESTROYERS.

Ant Exterminator. A most effectual preparation for destruction of Ants in greenhouses and flower beds. 25c., 50c., \$1.00 per package.

Bordeaux Mixture. In liquid form. Per qt. 40c., per gal. \$1.00.

Copperdine (For black spots, etc.) Per qt. 50c., per gal. \$1.50. Special price on large quantities. One quart makes 25 gallons wash.

Fostite (For preventing mildew). 5 lbs. 50c., 25 lbs. \$2.00, 50 lbs. \$3.50, 100 lbs. \$6.50.

Fir Tree Oil. Per qt. \$1.25, per ½ gal. \$2.00.

Fir Tree Oil Soap. 2 lb. can, 65c., 5-lb. can, \$1.50.

Grape Dust. (For mildew). 5-lb. package, 30c., \$5.00 per 100 lbs.

Hellebore. Per lb. 20c.

Kerosene Emulsion. 15c per lb. can. Sufficient for 10 gallons of spray; 60c. per 5-lb. can. Makes 50 gallons of spray; 25-lb. can. \$2.50.

Kraft's Palm Wash 75c per qt., \$2.65 per gallon.

Kraft's Plant Tonic. 75c. per qt., \$2.65 per gallon.

Lemon Oil. 75c. per qt., \$1.25 for 2 qts., \$2.00 per gal., \$9.00 per 5-gallon keg.

Nikoteen. The very best material for killing green fly, etc. Much better and as cheap as tobacco stems. Per pt. \$1.50, 10 pts. for \$13.00. Outfit of pans, etc., \$3.00.

Paris Green. Per lb. 20c., 10 lb. lots at 18c. per lb.

Persian Insect Powder, Pure. Per lb. 35c.

Rose Leaf Extract of Tobacco. Very extensively used now by all the leading growers for fumigating, doing away to a great extent with smoking with tobacco stems. Per gal. \$1.25, 5-gal. can, \$4.25.

Rose Brand Sulpho Tobacco Soap. A valuable and effective insecticide for nearly all purposes. Dissolve 2 ounces to the gallon of water. 10-lb. box, \$3.00.

Seal Oil Soap. Recommended very highly for destroying Scale and all other insects. 22c. per lb., 10 lbs. for \$1.90.

Sulphur. Per lb. 6c., 5 lbs. 25c., 25 lbs. \$1.10, 100 lbs. \$3.50, full bbl. lots at 3c. per lb.

Slug Shot. 5 lbs. 25c., 100 lbs. \$3.50, per bbl. in bulk 3c. per lb.

Tobacco Dust. Best quality. 5 lbs. 20c., 100 lbs. \$2.25.

Tobacco Stems. In bales of 250 lbs. \$1.50, \$11.00 per ton.

Whale Oil Soap, Pure. Lb. 10c., 10 lbs. 90c., 100 lbs. \$7.00.



MAC MICHAEL'S "PEERLESS" SULPHUR BLOWER.

Price \$4.75 Each.

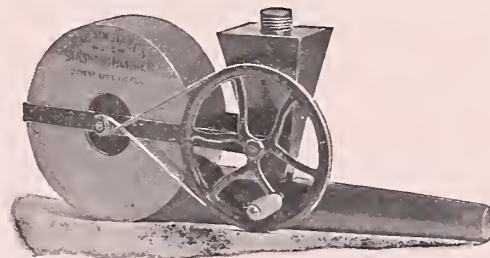

This Sulphur Blower has no equal for applying sulphur to the foliage in rose houses. It does the work quickly and perfectly, the distribution of the sulphur being so even that every leaf receives its due proportion, and none being wasted, thus making it more economical than the bellows.

The blower will also distribute with equal facility and thoroughness Tobacco Dust, Slug Shot, Lime, or any other powdery substance used in greenhouses. It is a great labor saver, as a 200-foot rose house can be sulphured in less than five minutes.

It is easily handled, is strong and durable, and is *Guaranteed for Ten Years.*

Read the following Letters from Leading Growers who have used the Blower:

PHILADELPHIA, PA., September 13, 1898.

The MacMichael Sulphur Blower purchased of you and which we are now using, is the best apparatus for the purpose we have ever used; does the work very quickly and well.

ROBERT CRAIG & SON,
Forty-ninth and Market Sts.

SOUTHAMPTON, PA., September 1898.

Permit me to say the MacMichael Sulphur Blower is giving me entire satisfaction. It is not only what you claimed for it when I purchased it of you, as a saver of sulphur, but it is a saver of labor as well. I consider it a great improvement on the old-fashioned bellows. The sulphur can be put on much more evenly and with much less trouble.

STEPHEN MORTENSEN.

JENKINTOWN, PA., September 14, 1898.

With MacMichael's Sulphur Blower which we purchased of you, we now only use one-half of the quantity of Sulphur and Grape Dust, and do the work in about half the time; the work is also better done. Thank you for calling my attention to it.

JOSEPH HEACOCK.

DEAR SIR:

We have one of your Sulphur Blowers and consider it the best thing we ever had to apply Sulphur in the greenhouses

CHICAGO, May 18, 1898.

Respectfully,
GEO. WITTBOLD.
Per L. W.



Lemon Oil Insecticide.

The Best and Cheapest Insecticide in the Market. Used now by nearly all the leading growers. It effectually destroys Mealy Bug, Scale, Thrip and Red Spider.

Half Pint, 25c.	Pint, 40c.
Quart, 75c.	Half Gal., \$1.25
Gal., \$2.00	5 Gal. Kegs, \$9.00
10 Gallon Kegs, \$17.50	

Lemon Oil.

WOODASON'S SULPHUR BELLOWS \$1.50

WOODASON'S POWDER BELLOWS.

No. 1, 5c. each; No. 2, \$1.65 each; No. 3, \$2.50 each.

PERFECTION FUMIGATOR.

Will fumigate and vaporize at the same time. The tank should be filled with water; when the stems are lighted the water boils and emits a dense mass of moistened smoke or steam.

Made in two separate bodies, detachable, does not become heated when in operation, harmless to the most tender plants.

No. 1 holds 1 peck of stems	\$2.75
No. 2 holds ½ bushel of stems	3.25
No. 3 holds ¼ bushel of stems	3.75
No. 4 holds 1 bushel of stems	5.00

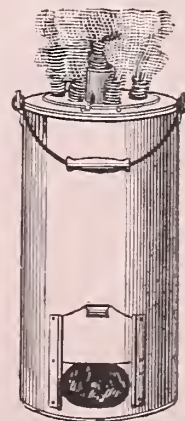

EUREKA FUMIGATOR.

Made of extra heavy galvanized iron. No. 1, \$1.00; No. 2, \$1.50; No. 3, \$2.00; No. 4, \$3.00.

WOODASON'S LIQUID INSECTICIDE BELLOWS.

No. 1, \$1.00 each; No. 2, \$1.65 each.

MICHELL'S WHOLESALE PRICE LIST.

HOSE

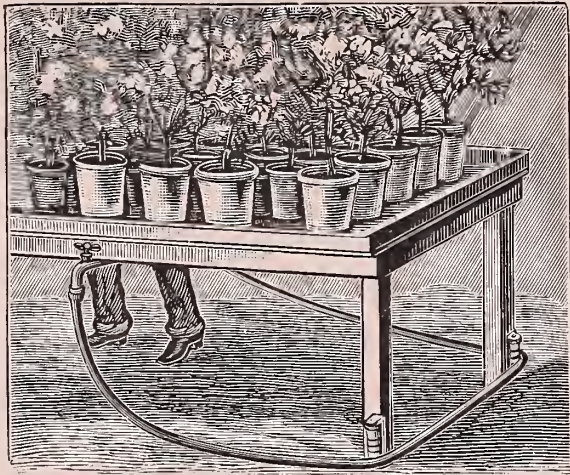

PROTECTOR

SCHUCK'S HOSE PROTECTOR.

The best invention for protecting hose from breakage around greenhouse benches. 25c. each; \$2.50 per doz.



"Sphincter Grip"
..Armored Hose..

SPHINCTER GRIP ARMORED
SPRING STEEL GALVANIZED. Pat. 1882, '85, '86, '88, '90, '91.

In 25, 30 and 50 foot lengths. Per foot, 15 cents.

RUBBER HOSE—EXTRA QUALITY.

Made especially for us by the most reliable manufacturer. Quality guaranteed by us. 3 ply, per foot, 10c.; 4 ply, per foot, 12½. A number of the leading florists who are now using this grade of hose praise its quality and use our hose exclusively.

HOSE MENDERS (Woodson's.) One of the best. Each 5c.; per doz, 50c

THE NEW "COOPER" HOSE MENDERS. Specially recommended for mending old hose. Exhibited and sold largely at the Florists' Convention at Providence, 1897. 10c. each; 90c. per doz.

Hudson's Practical Hose Mender.

For mending rubber hose. One box contains 6 tubes, 20 bands, 1 pair pliers.

60c. for whole outfit.

Tubes and bands sold, also, separately.

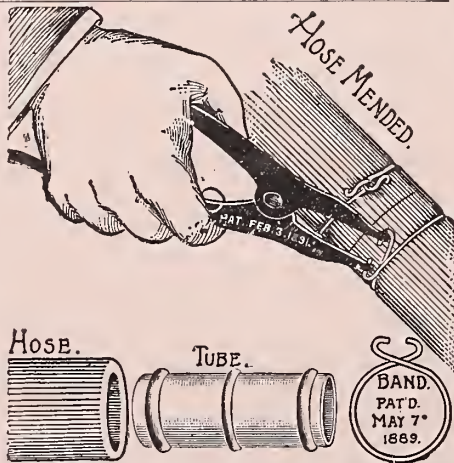

Water Tight Hose Coupler and Spigot Attachment.

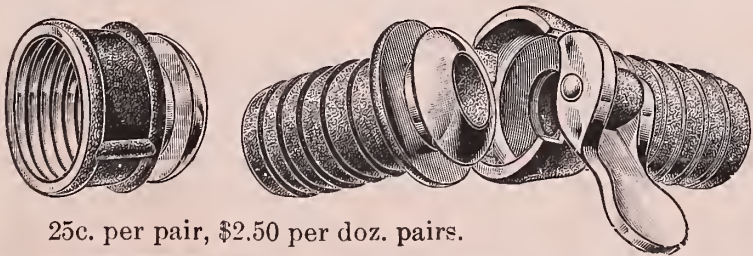

25c. per pair, \$2.50 per doz. pairs.

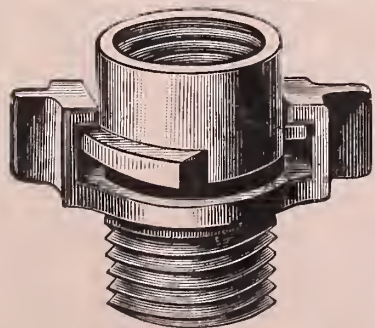

THE "SIMPLICITY" HOSE ATTACHMENT OR COUPLER.

There is no simpler or more practical device for attaching hose to hydrant; one part is attached to hose, the other to the hydrant; by a slight turn the fastening is made.

Complete, 25c.; \$3.00 per doz.; parts separate, \$1.50 per doz.

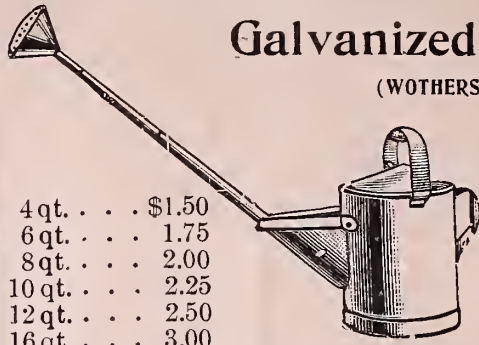

Galvanized Water Pots.

(WOTHERSPOON'S MAKE.)

The best and most durable Water Pot made. Each has two roses—one fine and one coarse.

4 qt. . . . \$1.50
6 qt. . . . 1.75
8 qt. . . . 2.00
10 qt. . . . 2.25
12 qt. . . . 2.50
16 qt. . . . 3.00

Iron Clad Watering Cans. Sizes 1 to 4 gallons; 40c. to \$1.25 each.

DEAKIN'S BRASS GARDEN SYRINGES.

Length of Barrel, 13½ in.; diam, 1 1/8



No. A. 1 stream and spray rose, 12x1 in. . . . \$1.90
No. C. 1 " " " 14½x1½ in. . . . 3.00
No. 2. 1 " " " 13½x1 5/8 in. . . . 3.75
No. 5. 1 " " " 18x1½ in. . . . 5.75

Zinc Syringes, \$1.10 each.

RAIN-MAKER NOZZLE.



One of the best for spraying greenhouses or flower beds, taking the place of using the thumb. Each, 40c.

THE BOSTON HOSE NOZZLE OR SPRAY ROSE.

This is the best nozzle for the florist. Having a flat face, it throws the water exactly where it is wanted without spreading. It is made of copper—strongly made—and will last a lifetime.

Fine or Coarse Spray, 50c. each. "Gem" Nozzle, 30c. each.



THE "SUCCESS" SPRAY PUMP

FOR SPRAYING, PLANTS, &c., &c.

We can very highly recommend this pump. Perfect satisfaction guaranteed, or can be returned to us. Price \$4.00.



Scollay's Rubber Sprinkler

Large size, price each 75c., \$7.80 per dozen.

Small size, 50c. each, \$5.20 per dozen.