

The Madras Observatory

ELECTRIC TELEGRAPH

POPULARISED.

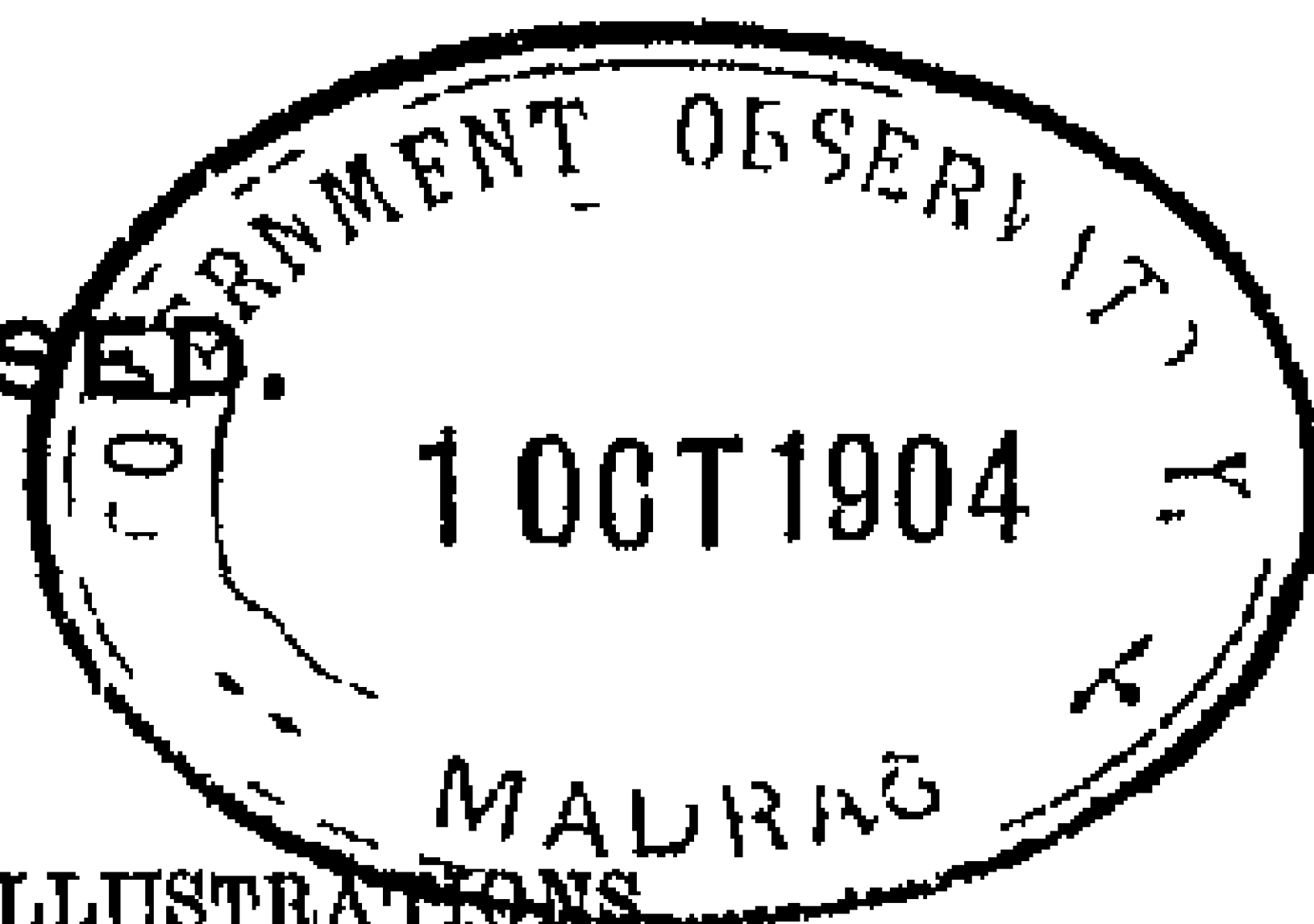

WITH ONE HUNDRED ILLUSTRATIONS.

By DIONYSIUS LARDNER, D.C.L.,

Formerly Professor of Natural Philosophy and Astronomy in University College London

FROM

"THE MUSEUM OF SCIENCE AND ART"

LONDON

WALTON AND MABERLY,

UPPER GOWER STREET AND IVY LANE, PATERNOSTER ROW

1856

IIA Lib, 1

LONDON

DR. EDWARD AND LYANG JUNIANG WILSON 1989

PREFACE

IN the composition of this volume my purpose has been to render intelligible to all who can read, irrespective of any previous scientific acquirements, the various forms of telegraph in actual operation in different parts of the world, and the manner in which their marvellous effects are produced. Since the instrument in one form or another involves all the great laws governing electrical and magnetical phenomena, the discovery of which will render for ever memorable the researches of the eminent scientific men of the last half century, it was necessary to include in the exposition of each piece of apparatus such an account of the physical principle upon which its use depends, as should render its application and effects understood. Descriptions of such apparatus, however clearly expressed, would have been obscure without graphic illustrations to correspond with them. These have accordingly been supplied, as will be seen, with no sparing hand.

No two countries agree in adopting the same form of telegraphic instrument, and even in the same country different forms of telegraph are used by different companies and for

PREFACE

different purposes. Since these various instruments are always different in the details of their construction and often totally distinct in their principle and mode of operation, it was necessary to explain each in succession, and to do so correctly it was necessary to seek and obtain authentic documents, descriptions, and drawings from those who were placed in the direction and superintendence of the telegraphs in various parts of the continent of Europe and in the United States.

The reader of this little volume will find in its pages abundant evidence that no pains or cost have been spared in these researches.

The history of the invention of the Electric Telegraph is a subject upon which I have not judged it expedient to enter. The details of such a narrative, necessarily numerous and complicated, involving several questions of disputed priority and contested claims, besides filling a much larger volume than the present, would present few attractions for the large masses to whom our work is addressed.

The Electric Telegraph is not the invention of an individual. As it now exists, it is the joint production of many eminent scientific men and distinguished artists of various countries, whose labours and experimental researches on the subject have been spread over the last twenty years. Not being prepared to engage in a complete account of the progressive results of these labours, I have in the following work generally abstained from the mention of

PREFACE

inventors, from a desire to avoid the risk of appearing to put forward some in undue preference to others who might be supposed to have better claims to notice. There can, however, be no risk of committing an injustice by stating that in England Professor Wheatstone, in the United States Professor Morse, in Bavaria M. Steinheil, in Prussia Dr. Siemens, and in France MM. Breguet and Floumont, have severally stood in the leading ranks of invention. Besides these eminent persons may be mentioned, Mr. Bain, the inventor of the electro-chemical telegraph, Mr. Henley and the Messrs. Bright, who have improved the magnetic telegraph, Messrs. Brett, to whose genius and enterprise the world is indebted for submarine telegraphs, Messrs. Newall and Co., who have been signalised by the construction of submarine cables, Mr. Walker of the South Eastern Telegraph Company, and Mr. House of the United States, the inventor of a printing telegraph in extensive operation.

CONTENTS

* * * *As this Book is not paged, the figures in the Table of Contents and Index refer to Paragraphs, and not to Pages*

CHAPTER I

1 SUBJUGATION of the powers of nature to human uses — 2 Locomotion twenty years since — 3 Circulation of intelligence then — 4 Supposed prediction of succeeding improvements — Railway locomotion — 5 Electric telegraphy — 6 Fabrication of diamonds — sun pictures — gas lighting — electro metallurgy — 7 Such predictions would have been deemed incredible — 8 Electric telegraphy the most incredible of all — 9 Remarkable experiment by Messrs Levenier and Lardner — 10 Velocity of electric current — 11 No limit to the celerity of telegraphy — 12 Physical character of electricity — 13 Not essential to the explanation of electro telegraphy — 14 Electricity a subtle fluid — 15 Properties available for telegraphy — 16 Voltaic battery — 17 It is to the electric telegraph what the boiler is to the steam engine — 18 Means of transmitting the fluid in required directions — 19 Conductors and insulators — 20 Conducting wires — 21 Voltaic battery — 22 Transmission and suspension of the current — 23 Current established by earth contact — 24 Theories of

earth contact — 25 The return of the current through the earth — 26 Various bodies evolve electricity — 27 Common plate battery of zinc and copper — 28 Why zinc and copper are preferred — 29 Charcoal substituted for copper — 30 Elements not essential — 31 Various chemical solutions used — 32 Daniel's constant battery — 33 Same modified by Pouillet — 34 Grove's and Bunsen's batteries — 35 Necessary to combine many elements

CHAPTER II

36 COMMON plate battery — 37 Combination of currents — 38 Loss of intensity by imperfect conduction — 39 Cylindrical batteries — 40 Pairs, elements, and poles defined — 41 Origin of term *voltare pile* — 42 Use of sand in charging batteries — 43 To vary intensity of current — 44 Batteries used for English telegraphs — 45 Amalgamating the zinc plates — 46 The line wires, material and thickness — 47 Objection to iron wires — 48 Manner of carrying wires on posts — 49 Good insulation — 50 Expedients for

obtaining it —51 Forms of insulating supports —52 Dimensions and preparations of the posts —53 Forms of support used in England —54 Winding posts —55 Supports in France —56 In America —57 In Germany —58 Wire insulated by superficial oxidation —59 Leakage of the electric fluid by the conduction of the atmosphere —60 Effects of atmospheric electricity on the wires —61 Lightning conductors —62 Those of Messrs Walker and Biagnet —63 Conducting current into stations —64 Underground wires —65 Methods of insulating them —66 Testing posts

CHAPTER III

67 Wires of Magneto electric Telegraph Company —68 Mr Bright's method of detecting faulty points —69 Such failure of insulation rare —70 Underground method recently abandoned in Prussia —71 Underground wires of the European and Submarine Company —72 Imperfect insulation in tunnels —73 Mr Walker's method of remedying this —74 Overground system adopted through the streets of cities in France, and in the United States —75 Telegraphic lines need not follow railways —76 Do not in America, nor in certain parts of Europe —77 Submarine cables —78 Cable connecting Dover and Calais —79 Failure of first attempt—Improved structure —80 Table of submarine cables and their dimensions —81 Dimensions and structure of the Dover and Calais cable —82 Holyhead and Howth cable —83 First attempt to lay cable between Portpatrick and Donaghadee—its failure —84 Dover and Ostend —85 Portpatrick and Donaghadee —86, Orfordness and the Hago.

CHAPTER IV

87 Cause between Spezzin and Corsica —88 Other cables, European and American —89 Objections brought by scientific authorities to the submarine cables —Answers to these by practical means —90 Example of a cable injured by the action of the sea —91 Precautions necessary in laying the cable —92 Accident in laying the Calais cable —93 Imperfections attributed to the Belgian cable —94 Transatlantic Ocean Telegraphy —95 Underground wires between the Strand and Lothbury —96 Effect of the inductive action of underground or submarine wires —97 Possible influence of this on telegraphic operations —98. Examples of overground wires extended to great distances without intermediate support —between Turin and Genoa —99 Telegraphic lines in India —100 Difficulties arising from atmospheric electricity—height and distance of posts—mode of laying underground wires—extent of line erected in April 1851 —101 Intensity of current decreases as the length of wire increases —102 Also increases with the thickness of the wire —103 And with the number of elements in the battery —104. Result of Pouillet's experiments on the intensity of current —105 Intensity produced by increasing the power of the battery —106 How the current produces telegraphic signals —107 Velocity of the current —108 Transmission of signals instantaneous

CHAPTER V

109 Current controlled by making and breaking the contact of conductors —110 Instruments for controlling the current—Commutators —111 General principle

CONTENTS

of the commutators —112 Its application to telegraphic operations —113 To transmit a current on the up line only —114 On the down line only —115 On both lines —116 To reverse the current —117 To suspend and transmit it alternately —118 How to manage a current which arrives at a station —119 To make it ring the alarm —120 Station with two alarms —121 Notice of the station transmitting and receiving signals —122 When signals not addressed to the station the current is passed on —123 How to receive a despatch at the station, and stop its farther progress —124 How several despatches may be at the same time sent between various stations on the same line —125 Secondary lines of wire then used —126 Recapitulation —127 Signals by combinations of unequal intervals of transmission and suspension —128 Key commutator —129 Horological commutator for a current having equal and regular pulsations —130 Case in which the pulsations are not continuous or regular, —131 No limit to the velocity of the pulsations —132 Application of a toothed wheel to produce the pulsations —133 By a sinuous wheel —134 Method of diverting the current by a short circuit, its application to the alarm —135 Effects of the current which have been used for signals —136 Deflection of magnetic needle

CHAPTER VI

137 RELATION of the deflection to the direction of the current —138 Galvanometer or multiplier —139 Method of covering the wire —140 Method of mounting the needle —141 Method of transmitting signals by the galvanometer —142 How the current may pro-

duce a temporary magnet —143 Electro magnet constructed by Pouillet —144 Electro magnets formed by two straight bars —145 They acquire and lose their magnetism instantaneously —146 Magnetic pulsations as rapid as those of the current —147 How they are rendered visible and counted —148 Extraordinary celerity of the oscillations thus produced —149 They produce musical sounds by which the rate of vibration may be estimated —150 How the vibrations may impart motion to clock work —151 Their action on an escapement —152 How the movement of one clock may be transmitted by the current to another —153 How an electro magnet may produce written characters on paper at a distant station —154 How the motion of the hand upon a dial at one station can produce a like motion of a hand upon a dial at a distant station —155 How an agent at one station can ring an alarm at another station —156 Or may discharge a gun or cannon there —157 —Power of the bell or other signal not dependent on the force of the current —158 Mechanism of telegraphic alarm —159 Various alarms in telegraphic offices —160 Magneto electricity —161 Method of producing a momentary magneto electric current —162 Application of an electro magnet to produce it

CHAPTER VII

163 MOMENTARY currents alternately in contrary directions —164 Method of producing momentary currents all in the same direction —165 Magneto electric machine —166. Its effects in producing shocks and currents —167. Method of applying it to telegraphs —168 Chemical property

CONTENTS

of the current —169 Decomposition of water —170 Application of this property to produce written characters at a distance —171 Methods of moving the paper under the style —172 Telegraphic characters marked upon it —173 Use of relay magnets in cases of feeble currents —174 Form and application of them —175 Telegraphic lines constructed by companies in England and America, and chiefly by the state on the continent —176 Various forms of instruments used —177 Influence of national feeling —178 —Mention of various inventions sometimes neglected —179 Needle instruments generally used in England —180 Single needle instrument —181 Double needle instrument —182 Old aerial telegraph —183 French state telegraph

CHAPTER VIII

184 Form of commutator of French state telegraph —185 Its operation —186 Method of sending and receiving a dispatch —187 Batteries —188 French railway telegraph —189 French railway portable telegraph —190 German railway telegraph —191 Siemen's instrument —192 Its mode of operation —193 How errors are corrected —194 Explanation of the mechanism —195 Comparison with the French telegraph —196 Indicating mechanism —197 Simplicity greater than the French instrument —198 Requires greater intensity of current —199 Belgian railway telegraph —200 Defects imputed to the French and German instrument

CHAPTER IX

201. Defects of the French and German instrument removed by

Lippens' instrument —202 Description of it —203 Its wheel commutator —204 Transmission of despatches by it —205 Froment's alphabetic telegraph —206 Morse's telegraph —207 Froment's writing telegraph —208 Bain's chemical telegraph —209 Method of writing —210 Plectro chemical pen —211 Metallic desk

CHAPTER X

212 OPERATION of Bain's telegraph, —213 Its commutator —214 Its extraordinary speed of transmission —215 Obstructions to its practical application —216 Its prospects —217 Autograph telegraph —218 House's printing telegraph —219 Its operation —220 Henley's magnetic telegraph —221 Biot's printing telegraph —222 Celerity of telegraphic communication —223 Circumstances which affect it —224 Comparative ability of telegraphists —225 Each telegraphist known by his manner of transmitting —226 Easier to transmit than to receive —227 Pauses in transmission —228 Rate of transmission with double needle instruments worked by voltaic current —229 Rate with magneto electric current

CHAPTER XI

230 ILLUSTRATION of the efficiency of the needle instruments —231 Rate of transmission with the French state telegraphs —232 With the French railway telegraphs —233 With the Morse telegraph —234 Discrepancy of reports —235 Causes of its celerity —236 Rate with Bain's telegraph —237. Transmission of

CONTENTS

music —238 Rate of transmission with House's telegraph — 239 Distance sometimes affects celerity —240 Examples of distant transmissions in U S —241 Advantages of uniform organisation — 242 Uses of the electric telegraph —243 Subject of despatches — 244 Effect of the tariff —245 Uses of the telegraph in railway business —246 Portable railway telegraph —247 Practical uses on railways —248 Its economical advantages

CHAPTER XII

249 PREVENTION of accidents —250 Its uses in the detection of crime —251 Personal and domestic messages —252 Electric news rooms 253 Telegraph extensively used in the United States —254 Much used for commerce —255 Sums paid for telegraphic despatches by mercantile firms —256 Extensively used by American newspapers —257 Illustration of the utility for political purposes — 258 Illustrations of its domestic and general use —259 Secrecy of dispatches not generally sought for —260 Verbal ciphers of mercantile firms —261 Ciphers for newspaper reports —262 Association of New York journals — 263 Spurred enterprise of New York "Herald"—264 Use of electric telegraph in determining longitudes —265 In producing horological uniformity

CHAPTER XIII

266 SIGNAL time balls —267 Electric connection of observatories of Greenwich, Brussels, and Paris — 268 Uses of electric telegraph in astronomical observations —269 In regulating the observatory

clocks —270 In fixing with precision the time of an astronomical phenomenon —271 Telegraphic lines of the United Kingdom — 272 Their extent in 1854 —273 Electric Telegraph Company — 274 Table of its lines, stations, &c —275 Present Tariff (1854)

CHAPTER XIV

ERRATIC Telegraph Company's present tariff (continued) —276 Magnetic Telegraph Company — 277 Chartered Submarine Company —278 The Submarine Telegraph Company between France and England —279 European and American Telegraph Company — 280 Origin of the submarine companies enterprises —281 Wonderful celerity of international correspondence —282 Organisation of electric communications with the continent —283 Mediterranean Electric Telegraph Company —284 General table showing the places on the continent of Europe, which are in electric connection with each other, and with England, and the cost of despatches sent between them severally and London —285 Telegraphic lines in the United States —286 Vast projects in progress or contemplation

CHAPTER XV

287 TELEGRAPHIC lines in British America —288 Belgian lines — 289 Their extent and cost —290 Correspondence transmitted on them —291 Large proportion of foreign despatches —292 Classification and proportion of despatches —293 Tariff —294 Paris telegraphic congress and convention —295 Telegraphic instruments used in Belgium —296

CONTENTS

Language of despatches — 297
French telegraphic lines — 298
Instruments used on them — 299
Their connection with those of
other states — 300 Repetition ne-
cessary at intermediate stations —
301 Case of despatches between
France and England — 302 Ad-
vantages of increased number of

wires — 303 Of instruments re-
quiring only one wire — 304 Or-
ganisation of the French telegraphic
administration — 305 Austral-
Germanic Union — 306 Stations,
and tariff — 307 Netherland
telegraphic lines — 308 Swiss
telegraphic lines — 309 Italian
telegraphic lines



INSTRUMENT ROOM, ELECTRIC TELEGRAPH OFFICE, CHANNING CROSS

THE ELECTRIC TELEGRAPH.

CHAPTER I.

- 1 Subjugation of the powers of nature to human uses —2 Locomotion twenty years since —3 Circulation of intelligence then —4. Supposed prediction of succeeding improvements—Railway locomotion.—5. Electric telegraphy —6 Fabrication of diamonds—sun pictures—gas lighting—electro metallurgy.—7 Such predictions would have been deemed incredible —8 Electric telegraphy the most incredible of all. —9 Remarkable experiment by Messrs. Leveurier and Laidner, —10. Velocity of electric current —11 No limit to the celerity of telegraphy.—12 Physical character of electricity.—13. Not essential to the explanation of electro-telegraphy.—14. Electricity a subtle fluid.—15. Properties available for telegraphy.—16. Voltaic battery —17 It is to the electric telegraph what the boiler is to the steam engine.—18. Means of transmitting the fluid in required directions. —19. Conductors and insulators.—20. Conducting wires.—21 Voltaic battery.—22 Transmission and suspension of the current —23 Current established by earth contact.—24. Theories of earth contact.—25. The return of the current through the earth.—26 Various bodies

THE ELECTRIC TELEGRAPH.

evolve electricity — 27. Common plate battery of zinc and copper. — 28. Why zinc and copper are preferred — 29. Charcoal substituted for copper. — 30. Elements not essential. — 31. Various chemical solutions used. — 32. Daniel's constant battery — 33. Bunsen modified by Pouillet. — 34. Grove's and Daniell's batteries. — 35. Necessary to combine many elements.

1. Each succeeding age and generation leaves behind it a peculiar character, which stands out in relief upon its annals, and is associated with it for ever in the memory of posterity. One is signalled for the invention of gunpowder, another for that of printing, one is rendered memorable by the revival of letters, another by the reformation of religion; one is marked in history by the conquests of Napoleon, another is rendered illustrious by the discoveries of Newton.

If we are asked by what characteristic the present age will be marked in future records, we answer, by the miracles which have been wrought in the subjugation of the powers of the material world to the uses of the human race. In this respect no former epoch can approach to competition with it.

The author of some of the most popular fictions of the day has affirmed, that in adapting to his purpose the results of his personal observation on men and manners, he has not unfrequently found himself compelled to mitigate the real in order to bring it within the limits of the probable. No observer of the progress of the arts of life, at the present time, can fail to be struck with the prevalence of the same character in their results as that which compelled this writer to suppress the most wonderful of what had fallen under his eye, in order to bring his descriptions within the bounds of credibility.

2. Many are old enough to remember the time when persons, correspondence, and merchandises were transported from place to place in this country by stage-coaches, vans, and waggons. In those days the fast-coach, with its team of spanking blood-horses, and its bluff driver, with broad-brimmed hat and dark box-seat, from which a dozen capes were pendant, who "hauled the ribbons" with such consummate art, could pluck a fly from the ear of the off-leader, and turn into the gateway at Charing Cross with the precision of a geometricalian, were the topics of the unbounded admiration of the traveller. Certain coaches obtained a special celebrity and favour with the public. We cannot forget how the eye of the traveller glistened when he mentioned the Brighton "Ago," the Glasgow "Mall," the Shrewsbury "Wonder," or the Exeter "Defiance," — the "Ago," which made its trip in five hours, and the "Defiance," which required its time by completing the journey between London and Exeter in less than thirty hours.

WONDERS OF SCIENCE

8. The rapid circulation of intelligence was also the boast of those times. How foreigners stared when told that the news of each afternoon formed a topic of conversation at tea-tables the same evening, twenty miles from London, and that the morning journals, still damp from the press, were served at breakfast within a radius of thirty miles, as early as the frequenters of the London clubs received them.

Now let us imagine that some profound thinker, deeply versed in the resources of Science at that epoch, were to have gravely predicted that the generation existing then and there would live to see all these admirable performances become obsolete, and consigned to the history of the past, that they would live to regard such vehicles as the "Age" and "Defiance" as clumsy expedients, and their celerity such as to satisfy those alone who were in a backward state of civilisation!

4. Let us imagine that such a person were to affirm that his contemporaries would live to see a coach like the "Defiance," making its trip between London and Exeter, not in thirty, but in five hours, and drawn, not by 200 blood-horses, but by a moderate sized stove and four bushels of coals!

5. Let us further imagine the same sagacious individual to predict that his contemporaries would live to see a building erected in the centre of London, in the cellars of which machinery would be provided for the fabrication of *artificial lightning*, which should be supplied, *to order*, at a *fixed price*, in any quantity required, and of *any prescribed force*, that *conductors* would be carried from this building to all parts of the country, along which such *lightning* should be sent at will, that in the attics of this same building would be provided certain small instruments like barrel-organs or pianofortes, that by means of these instruments, the aforesaid lightning should, at the will and pleasure of those in charge of them, deliver messages at any part of Europe, from St Petersburg to Naples, and, in fine, that answers to such messages should be received instantaneously, and by like means, that in this same building offices should be provided, where any lady or gentleman might enter, at any hour, and for a few shillings send a message by *lightning* to Paris or Vienna, and by waiting for a few moments, receive an answer!

Might he not exclaim after the inspired author of the book of Job

"Canst thou send lightnings, that they may go, and say unto thee, Here we are?" *Job xxviii, 35.*

But, suppose that his foresight should further enable him to pronounce that means would be invented by which any individual in any one town or city of Europe should be enabled to take in

THE ELECTRIC TELEGRAPH

his hand a pencil or pen, the point of which should be in any other town or city, no matter how distant, and should, with such pen or pencil, write or delineate in such distant place, such characters or designs as might please him, with as much promptitude and precision as if the paper to which these characters or designs were committed lay upon the table before him, or that an individual pulling a string at London should ring a bell at Vienna, or holding a match at St Petersburg should discharge a cannon at Naples!

6 Suppose he should affirm that means would be discovered for converting charcoal into diamonds, that the light of the sun would be compelled, without the intervention of the human hand, to make a portrait or a picture, with a fidelity, truth and precision, with which the productions of the most exalted artistic skill would not bear comparison, and that this picture should be produced and completed in its most minute details in a few seconds—nay, even in the fraction of a second, that candles and lamps would be superseded by flame manufactured on a large scale in the suburbs of cities, and distributed for use in pipes, carried under the streets, and into the houses and other buildings to be illuminated, and that the precious and other metals being dissolved in liquids, would form themselves into the articles of ornament and use by a spontaneous process, and without the intervention of human labour!

No authority however exalted, no attainments however profound, no reputation however respected, could have saved the individual rash enough to have given utterance to such predictions some forty years ago, from being regarded as labouring under intellectual derangement. Yet all these things have not only come to pass, but the contemplation of many of them has become so interwoven with our habits, that familiarity has blunted the edge of wonder.

7 Compared with all such realities, the illusions of oriental romance grow pale, fact stands higher than fiction in the scale of the marvellous, the feats of Aladdin are tame and dull, and the slaves of the lamp yield precedence to the spirits which preside over the battery and the boiler.

8 Of all the physical agents discovered by modern scientific research, the most fertile in its subserviency to the arts of life is incontestably electricity, and of all the applications of this subtle agent, that which is transcendently the most admirable in its effects, the most astonishing in its results, and the most important in its influence upon the social relations of mankind, and upon the spread of civilisation and the diffusion of knowledge, is the Electric Telegraph. No force of habit, however long continued,

REMARKABLE TELEGRAPHIC EXPERIMENT

no degree of familiarity can efface the sense of wonder which the effects of this most marvellous application of science excites

9 Being at Paris some years ago, I was engaged to share with M. Leverrier, the celebrated astronomer, and some other men of science, in the superintendance of a series of experiments to be made before committees of the Legislative Assembly and of the Institute, with the view of testing the efficiency of certain telegraphic apparatus. On that occasion operating in a room at the Ministry of the Interior appropriated to the telegraphs, into which wires proceeding from various parts of France were brought, we dictated a message, consisting of about forty words, addressed to one of the clerks at the railway station at Valenciennes, a distance of 168 miles from Paris. This message was transmitted in two minutes and a half. An interval of about five minutes elapsed, during which, as it afterwards appeared, the clerk to whom the message was addressed was sent for. At the expiration of this interval the telegraph began to express the answer, which, consisting of about thirty-five words, was delivered and written out by the agent at the desk, in our presence, in two minutes. Thus, forty words were sent 168 miles and thirty-five words returned from the same distance, in the short space of four minutes and thirty seconds.

But surprising as this was, we soon afterwards witnessed, in the same room, a still more marvellous performance.

The following experiment was prepared and performed at the suggestion and under the direction of M. Leverrier and myself —

Two wires, extending from the room in which we operated to Lille, were united at the latter place, so as to form one continuous wire, extending to Lille and back, making a total distance of 336 miles. This, however, not being deemed sufficient for the purpose, several coils of wire wrapped with silk were obtained, measuring in their total length 746 miles, and were joined to the extremity of the wire returning from Lille, thus making one continuous wire measuring 1082 miles. A message consisting of 282 words was then transmitted from one end of the wire. A pen attached to the other end immediately began to write the message on a sheet of paper moved under it by a simple mechanism, and the entire message was written in full in the presence of the Committee, each word being spelled completely and without abridgment, in *fifty-two seconds*, being at the average rate of *five words and four-tenths per second*!

By this instrument, therefore, it is practicable to transmit intelligence to a distance of upwards of 1000 miles, at the rate of 19500 words per hour!

THE ELECTRIC TELEGRAPH

The instrument would, therefore, transmit to a distance of 1000 miles, in the space of an hour, the contents of about forty pages of the book now in the hands of the reader!

But it must not be imagined, because we have here produced an example of the transmission of a despatch to a distance of 1000 miles, that any augmentation of that distance could cause any delay of practical importance.

10 Although the velocity of the electric current has not been very exactly measured, it has been established beyond all doubt that it is so great that to pass from any one point on the surface of the earth to any other, it would take no more than an inappreciable fraction of a second.

11 If, therefore, the despatch had been sent to a distance of twenty thousand miles instead of one thousand, its transmission would still have been instantaneous.

Such a despatch would fly many times round the earth between the two beats of a common clock, and would be written in full at the place of its destination more rapidly than it could be repeated by word of mouth. When such statements are made, do we not feel disposed to exclaim—

“Are such things here as we do speak about?
Or have we eaten of the insane root,
That makes the reason prisoner?”

In its wildest flights the most exalted imagination would not have dared, even in fiction, to give utterance to these stubborn realities. Shakspeare only ventured to make his fairy

“Put a girdle round the earth
In forty minutes.”

To have encircled it several times in a second, would have seemed too monstrous, even for Robin Goodfellow.

The curious and intelligent reader of these pages will scarcely be content, after the statement of facts so extraordinary, to remain lost in vacant astonishment at the power of science, without seeking to be informed of the manner in which the phenomena of nature have been thus wonderfully subdued to the uses of man. A very brief exposition will be enough to render intelligible the manner in which these miracles of science are wrought.

12 The World of Science is not agreed as to the physical character of Electricity. According to the opinion of some it is a fluid infinitely lighter and more subtle than the most attenuated and impalpable gas, capable of moving through space with a velocity commensurate with its subtleness and levity. Some regard this fluid as simple. Others contend that it is compound,

ELECTRIC FLUID

consisting of two simple fluids having antagonistic properties which when in combination neutralise each other, but which recover their activity by decomposition. Others again regard it not as a specific fluid which moves through space, but as a phenomenon analogous to sound, and think that it is only a series of undulations or vibrations that are propagated through a highly elastic medium which produce the various electrical effects just as the pulsations of the atmosphere produce all the effects of sound.

13 Happily these difficult discussions are not necessary to the clear comprehension of the laws which govern the phenomena, upon which electric telegraphy depends. It will nevertheless for the purposes of explanation be convenient to use a system of language, which implies the existence of a certain fluid which we shall call the electric fluid, capable of moving over certain bodies, and being obstructed or altogether stopped by others, and which by its presence or proximity produces certain definite effects, mechanical and chemical.

14 Whether the electric agency be or be not a material fluid for our present purpose is unimportant. It is enough that it comport itself as such, and that the properties or effects which we shall impute to it are such only as it is ascertained by observation and experiment to possess or produce.

15 However various the forms may be which invention has conferred upon electric telegraphs, their efficiency in all cases depends on our power to produce at will the following effects —

1st To produce or develop the electric fluid in any desired quantity, and of the necessary quality.

2nd, To transmit it with celerity to any required distance, without injuriously dissipating it.

3rd To cause it upon its arrival at any assigned point to produce some sensible effects, which may serve the purpose of written or printed characters.

16 The electric fluid is deposited in a latent state in unlimited quantity in the earth, the waters, the atmosphere, and in all bodies upon the earth, whether solid, liquid, or gaseous. It is disengaged and rendered active by various causes, natural and artificial. The mutual friction of bodies, contact and pressure, the contiguity or contact of bodies having different temperatures, the chemical action of bodies one upon another, the action of magnetic bodies on each other, and on bodies susceptible of magnetism, are severally causes of the development of the electric fluid in greater or less quantity.

Founded upon these phenomena, various apparatus have been contrived, by means of which the electric fluid may be evolved

THE ELECTRIC TELEGRAPH

and collected in any desired quantity, and with any required intensity. Among these, that which has proved to be the most efficient for telegraphic purposes is the GALVANIC OR VOLTAIC BATTERY.

17 This apparatus is to the electric telegraph what the boiler is to the steam-engine. It is the generator of the fluid by which the action of the telegraphic machine is produced and maintained. It supplies the fluid in any required quantity and of any desired intensity. As the boiler is supplied with expedients by which within practical limits the quantity and pressure of the steam may be varied, according to the exigencies of the work to which the engine is applied, so the voltaic battery is provided with expedients by which the quantity and intensity of the electric fluid it evolves can be varied according to the distance to which the intelligence is to be transmitted, and the form, whether visible, oral, written, or printed, in which it is required to be delivered at the place of its destination.

18 The electric fluid being thus produced in sufficient quantity, it is necessary to provide adequate means of transmitting it to a distance without exposing it to any cause of injurious dissipation or waste.

If tubes or pipes could be constructed with sufficient facility and cheapness, through which the subtle fluid could flow, and which would be capable of confining it during its transit, this object would be attained. As the galvanic battery is analogous to the boiler, such tubes would be analogous in their form and functions to the steam-pipe of a steam-engine.

19 The construction of such means of transmission has been accomplished by means of the well-known property of the electric fluid, in virtue of which it is capable of passing freely over a certain class of bodies called CONDUCTORS, while its movement is arrested by another class of bodies called NON-CONDUCTORS or INSULATORS.

The most conspicuous examples of the former class are the metals, the most remarkable of the latter being resins, wax, glass, porcelain, silk, cotton, dry air, &c.

20 Now if a rod or wire of metal be coated with wax, or wrapped with silk, the electric fluid will pass freely along the metal, in virtue of its character of a conductor, and its escape from the metal laterally will be prevented by the coating, in virtue of its character of an insulator.

The insulator in such cases is, so far as relates to the electricity, a real tube, inasmuch as the electric fluid passes through the metal included by the coating, in exactly the same manner as water or gas passes through the pipes which conduct it, with this

VOLTAIC CURRENT

difference, however, that the electric fluid moves along the wire more freely, in an almost infinite proportion, than does either water or gas in the tubes which conduct them.

If, then, a wire, coated with a non-conducting substance, capable of resisting the vicissitudes of weather, were extended between any two distant points, one end of it being attached to one of the extremities of a galvanic battery, a stream of electricity would pass along the wire—*provided the other end of the wire were connected by a conductor with the other extremity of the battery*.

21 How the fluid transmitted to a distant station is made to produce the effects by which messages are expressed will be explained hereafter, meanwhile it will be necessary first to explain the form and principle of the voltaic batteries used for telegraphic operations, and secondly the expedients by which the current is transmitted and suspended, and turned in one or another direction at the will of the operator at the station from which despatches are transmitted.

To comprehend the principle of the voltaic battery, let us suppose that two strips cut, one *z z* from a sheet of zinc, and the other *cc* (fig 1) from a sheet of copper, are immersed without touching each other in a vessel containing water slightly acidulated. To the upper edges *p* and *n* of the strips let two pieces of wire *p p* and *n n*, be soldered. In this state of the apparatus no development of the electric fluid will be manifested, but if the ends *p* and *n* of the wires be brought into contact, an electric current will set in, running on the wires from *p*, the point where the wire is soldered to the copper *c c*, to *n*, the point where the other wire is soldered to the zinc *z z*. This current will continue to flow so long as the ends *p* and *n* of the wires are kept in mutual contact, and no longer. The moment the ends *p* and *n* are separated, the current ceases.

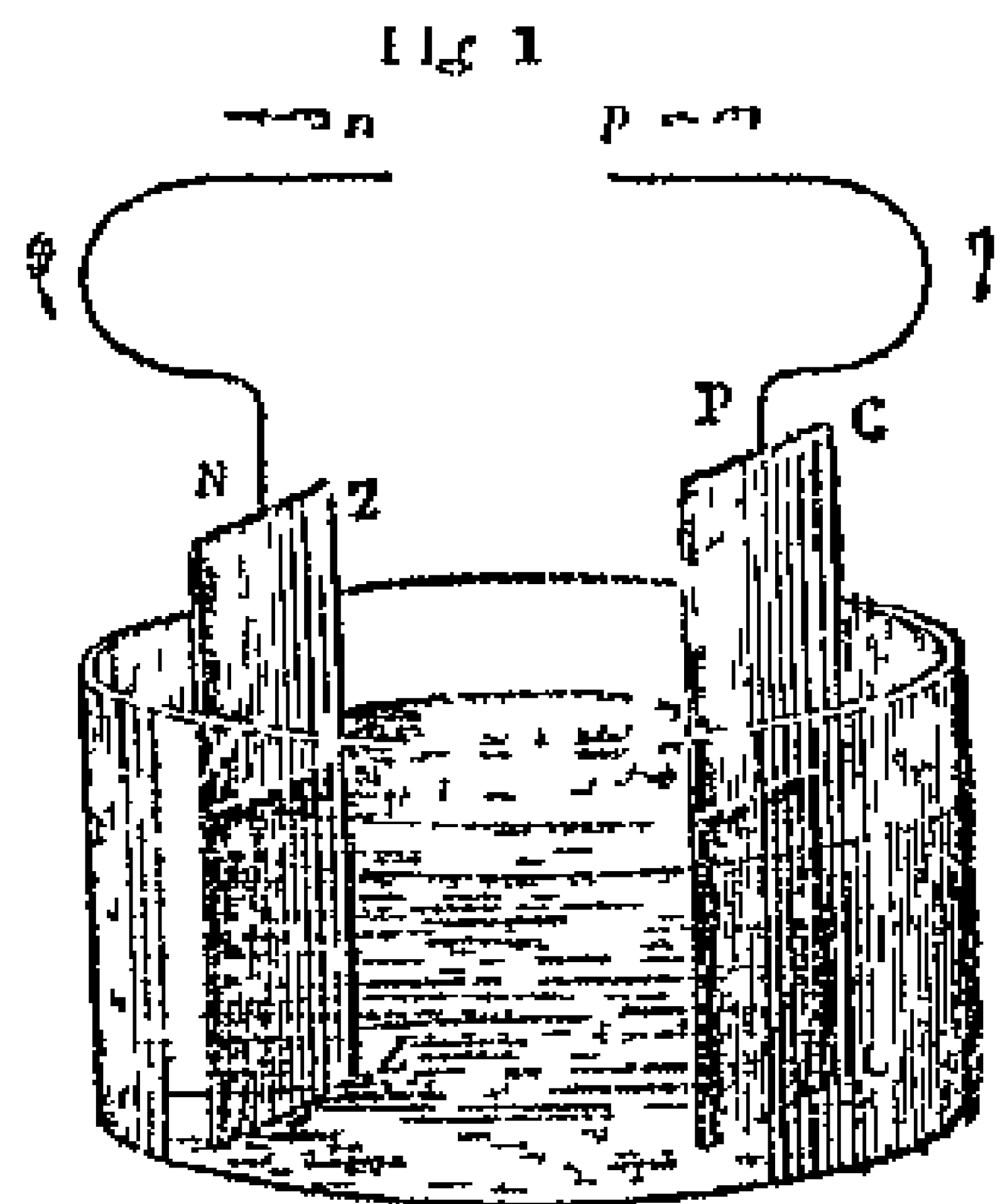

22 The commencement of the current upon the contact of the wires, and its cessation upon their separation, are absolutely *instantaneous*, so much so, that if the ends *p* and *n* were brought into contact and separated a hundred times in a second, the flow and suspension of the current being simultaneous with the

THE ELECTRIC TELEGRAPH

contacts and separations, would also take place a hundred times in a second

The existence of the current established in this case is independent of the length of the wires p and n . Whether their length be 10 feet, 10 miles, or 100 miles, the current will still flow upon them when their extremities p and n are brought into contact. The only difference will be, that the intensity of the current will be less in the same proportion as the length of the wires is augmented.

23 There is another condition of great importance, whether regarded theoretically or practically, on which the current will be established and maintained.

Instead of bringing the wires p and n into contact, let them be continued downwards, as represented in fig 2, and connected with two plates of metal p' and n' , buried in the earth, or

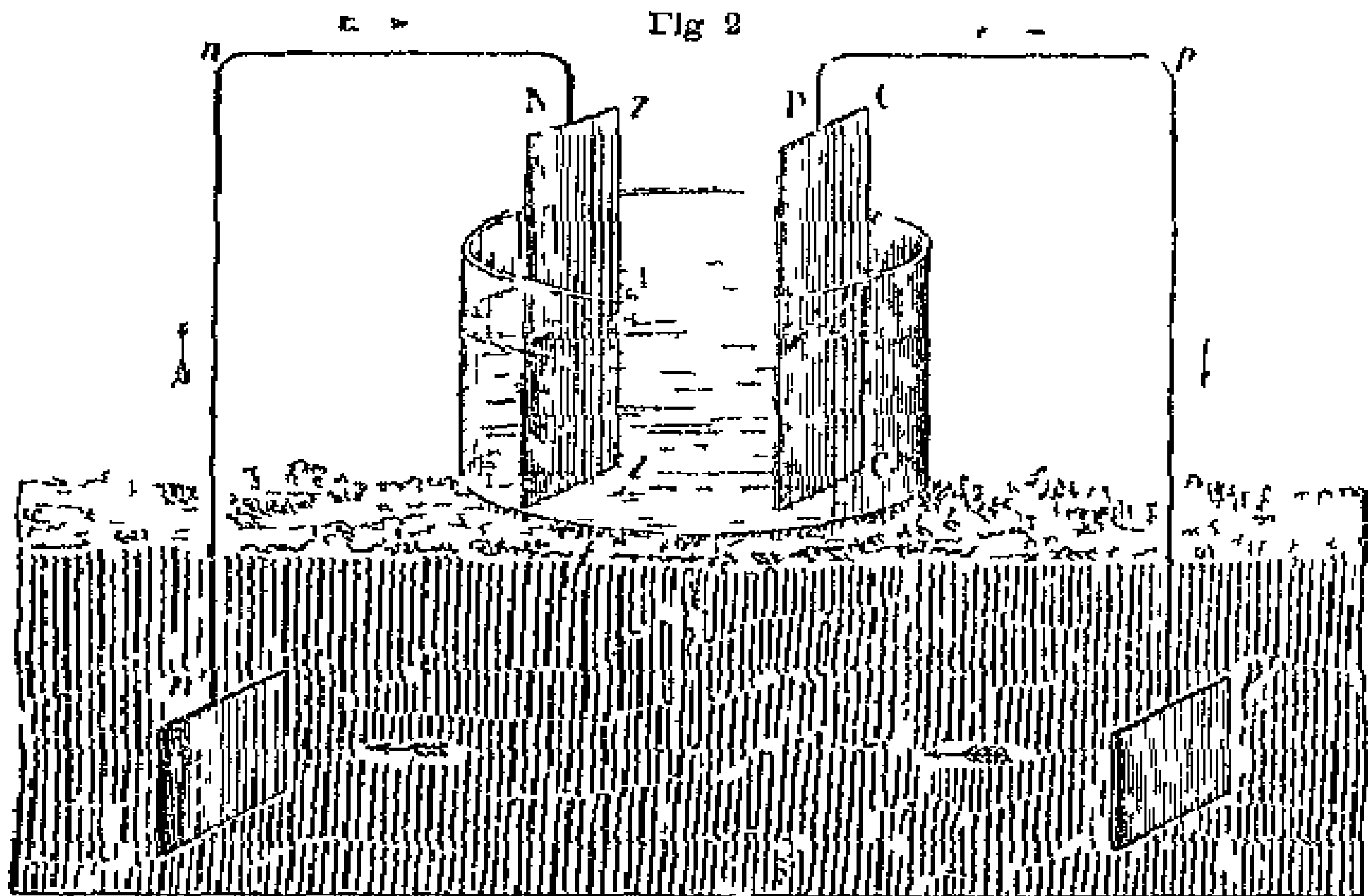

with masses of metal or other good conducting body of any form whatever thus buried. In that case the current will be established as before, flowing along the wire soldered to the copper from p to p' and along that soldered to the zinc from n' to n .

Thus, in both cases the current starts from the copper, and, following the course of the wires, returns to the zinc. In the former case, however, it is continuous, but in the latter it is apparently broken, terminating at p' , and recommencing at n' .

EARTH CONTACT

24 In the electric theories it is assumed that the course of the current, when it exists at all, must in all cases be continuous and unbroken from P to N, as it is in fact under the conditions represented in fig 1, when the ends p and n are in contact. It is therefore assumed that in the case represented in fig 2, the stratum of the earth which is interposed between p' and n' plays the part of a metallic wire joining these points, and that the current which arrives by the wire $p p'$ at p' flows through the earth, as indicated by the arrow, to n' , from whence it flows along the wire $n' n$ to N.

It is found also in this case that the existence of the current is independent of the lengths of the wires, which do not affect it otherwise than by diminishing its intensity. Whether the wires are 10 feet, 10 miles, or 100 miles in length, the current still flows from P to p' and returns from n' to N.

25 Thus, admitting the generally acknowledged principle that the stratum of the earth intervening between p' and n' plays the part of a conducting wire, uniting the ends p' and n' of the wires buried, it will follow that the current at p' , though separated, as it may be, by a distance of several hundred miles from the point n of its return to N, finds its way nevertheless through the earth unceasingly and instantaneously to that point.

Of all the miracles of science, surely this is the most marvellous. A stream of electric fluid has its source in the cellars of the Central Electric Telegraphic Office, Lothbury, London. It flows under the streets of the great metropolis, and, passing on wires suspended over a zigzag series of railways, reaches Edinburgh, where it dips into the earth, and diffuses itself upon the buried plate. From that it takes flight through the crust of the earth, and *finds its own way* back to the cellars at Lothbury!!!

Instead of burying plates of metal, it would be sufficient to connect the wires at each end with the gas or water pipes, which, being conductors, would equally convey the fluid to the earth, and in this case, every telegraphic despatch which flies to Edinburgh along the wires which border the railways, would fly back, rushing to the gas-pipes which illuminate Edinburgh, from them through the crust of the earth to the gas-pipes which illuminate London, and from them home to the batteries in the cellars at Lothbury!

26 To derive all the necessary instruction from what has been explained above, it will be necessary to distinguish what is essential from what is merely optional, and which admits of modification or change without affecting the result.

27 It will be seen that the electric fluid is evolved by the combination of three bodies, the zinc, the copper, and the acidu-

THE ELECTRIC TELEGRAPH

lated solution in which they are immersed. The production of the current depends on the chemical action of the solution on the zinc. That metal being very susceptible of oxydation, decomposes the water which is in contact with it. One constituent of the water combining with the zinc, produces a compound called the oxyde of zinc, and this oxyde entering again into combination with the acid which the water holds in solution, forms a soluble salt. If the acid, for example, be sulphuric acid, this salt will be the sulphate of the oxyde of zinc, and as fast as it is produced it will be dissolved in the water in which the slips of metal are immersed.

Meanwhile, the copper not being as susceptible of chemical action as the zinc, remains comparatively unaffected by the solution, but the hydrogen evolved in the decomposition of the water collects upon its surface, after which it rises and escapes in bubbles at the surface of the solution.

It is to this chemical action upon the zinc that the production of the electric current is due. If a like action had taken place in the same degree on the copper, a similar and equally intense electric current would be produced in the opposite direction, and in that case the two currents would neutralise each other, and no electric effect would ensue.

From this it will be seen that the efficacy of the combination must be ascribed to the fact, that one of the two metals immersed in the solution is more oxydable than the other, and that the energy of the effect and the intensity of the current will be so much the greater as the susceptibility of oxydation of the one metal exceeds that of the other.

28 It appears, therefore, that the principle may be generalised, and that electricity will be developed, and a current produced by any two metals similarly placed, which are oxydable in different degrees.

Zinc being one of the most oxydable metals, and being also sufficiently cheap and abundant, is generally used by preference for voltaic combinations. Silver, gold, and platinum are severally less susceptible of oxydation, and of chemical action generally, than copper, and would therefore answer voltaic purposes better, but are excluded by their greater cost, and by the fact that copper is found sufficient for all practical purposes.

29 It is not, however, absolutely necessary that the more oxydable element of the combination should be a metal at all. It is only necessary that it be a good conductor of electricity. In certain voltaic combinations, charcoal properly solidified has therefore been substituted for copper, the solution being such as would produce a strong chemical action on copper.

30 In the above illustration, we have supposed that the

VOLTAIC COMBINATIONS

metallic elements of the combination are thin rectangular slips cut from sheet metal. The form, however, is in no manner essential to the production of the electric current. So long as the magnitude of the surfaces exposed to contact with the solution is the same, the current will have the same force. The pieces of metal may therefore have the form here supposed of thin rectangular plates, or they may be formed, as is often found convenient, into hollow cylinders, that of the copper being so much less in diameter than that of the zinc, that it is capable of being placed within it without mutual contact.

The simple arrangement first adopted by Volta consisted of two equal discs of metal, one of zinc, and the other of copper or silver, with a disc of cloth or bibulous card, soaked in an acid or saline solution, between them. These were usually laid, with their surfaces horizontal, one upon the other.

The late Dr. Wollaston proposed an arrangement, in which the copper plate was bent into two parallel plates, a space between them being left for the insertion of the zinc plate, the contact of the plates being prevented by the interposition of bits of cork or other non-conductor. The system thus combined was immersed in dilute acid, contained in a porcelain vessel.

Dr. Haie of Philadelphia contrived a voltaic arrangement, consisting of two metallic plates, one of zinc and the other of copper, of equal length, rolled together in the form of a spiral, a space of a quarter of an inch being left between them. They are maintained parallel without touching, by means of a wooden cross at top and bottom, in which notches are provided at proper distances, into which the plates are inserted, the two crosses having a common axis. This combination is set into a glass or porcelain cylindrical vessel of corresponding magnitude, containing the exciting liquid.

This arrangement has the great advantage of providing a very considerable electro-motive surface with a very small volume.

The exciting liquid recommended for these batteries when great power is desired, is a solution in water of 2½ per cent of sulphuric, and 2 per cent of nitric acid. A less intense but more durable action may be obtained by a solution of common salt, or of 3 to 5 per cent of sulphuric acid only.

31 It is not essential that the water in which the metals are immersed be acidulated, as we have supposed, by sulphuric acid. Any acid which will promote the oxydation of the zinc without affecting the copper will answer. Nor is it indeed necessary that any acid whatever be used. A saline solution is often found more convenient. Thus common salt dissolved in the water will produce the desired effect.

THE ELECTRIC TELEGRAPH.

Of the various voltaic combinations which have been applied in scientific researches, four only have been found available to any considerable extent in the working of electric telegraphs, the zinc and copper plate combination described above, Daniel's constant battery, Grove's battery, Bunsen's modification of it, and the magneto-electric apparatus

32 Daniel's combination, which is extensively used in working the telegraphs on the continent, consists of a copper cylindrical vessel *cc*, fig 3, widening near the top *a d*. In this is placed a cylindrical vessel of unglazed

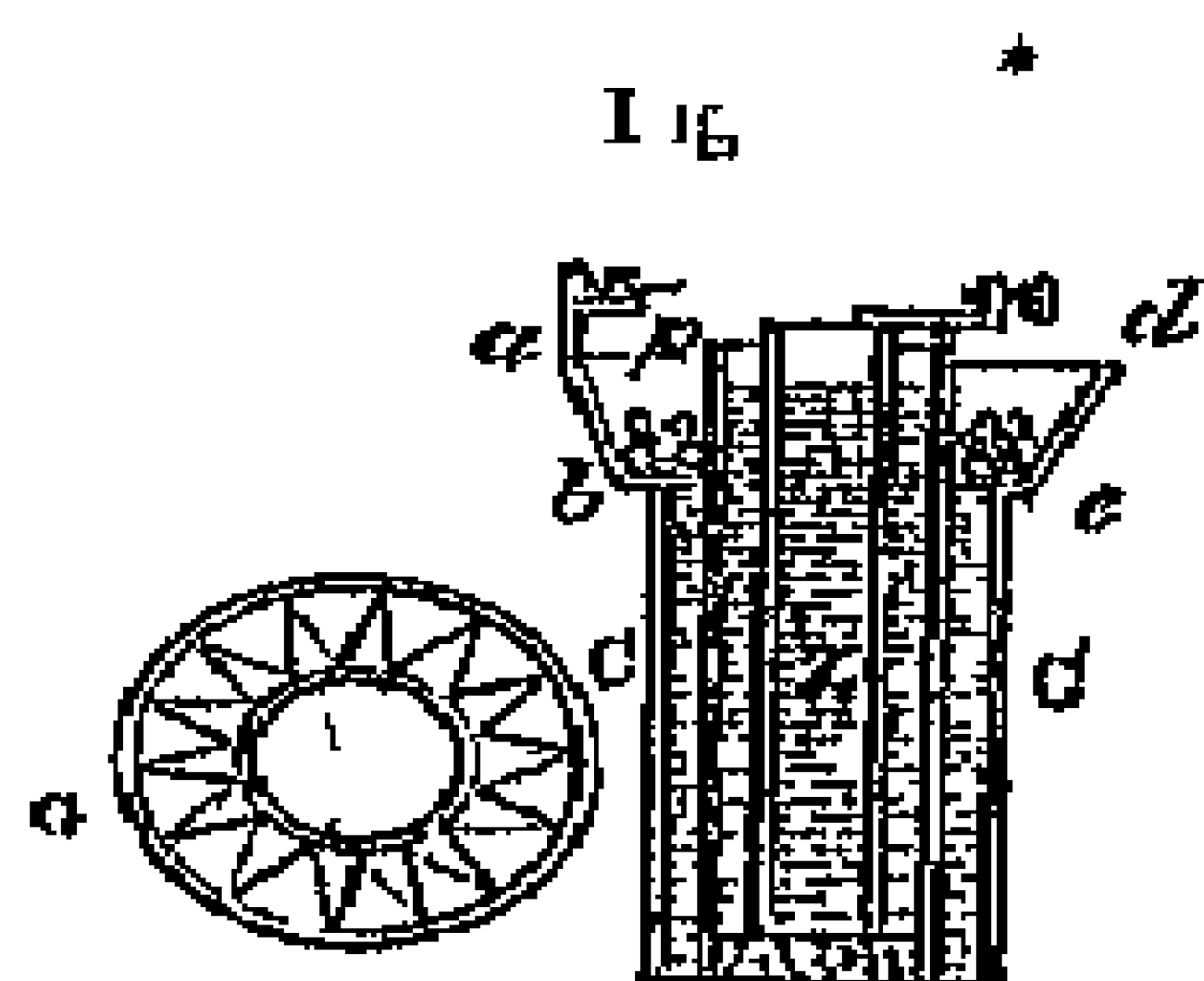

porcelain *p*. In this latter is placed the hollow cylinder of zinc *z*, already described. The space between the copper and porcelain vessels is filled with a saturated solution of the sulphate of copper, which is maintained in a state of saturation by crystals of the salt placed in the wide cup *a b c d*, in the bottom of which is a grating composed of wire carried in a zig-zag direction between two concentric rings, as represented in plan

at *a*. The vessel *p*, containing the zinc, is filled with a solution of sulphuric acid, containing from 10 to 25 per cent of acid when greater electric-motive power is required, and from 1 to 4 per cent. when more moderate action is sufficient.

33 The following modification of Daniel's system was adopted by M. Pouillet in his experimental researches, and is the form and arrangement used in France for the telegraphs. A hollow cylinder *a*, fig. 4, of thin copper, is ballasted with sand *b*, having

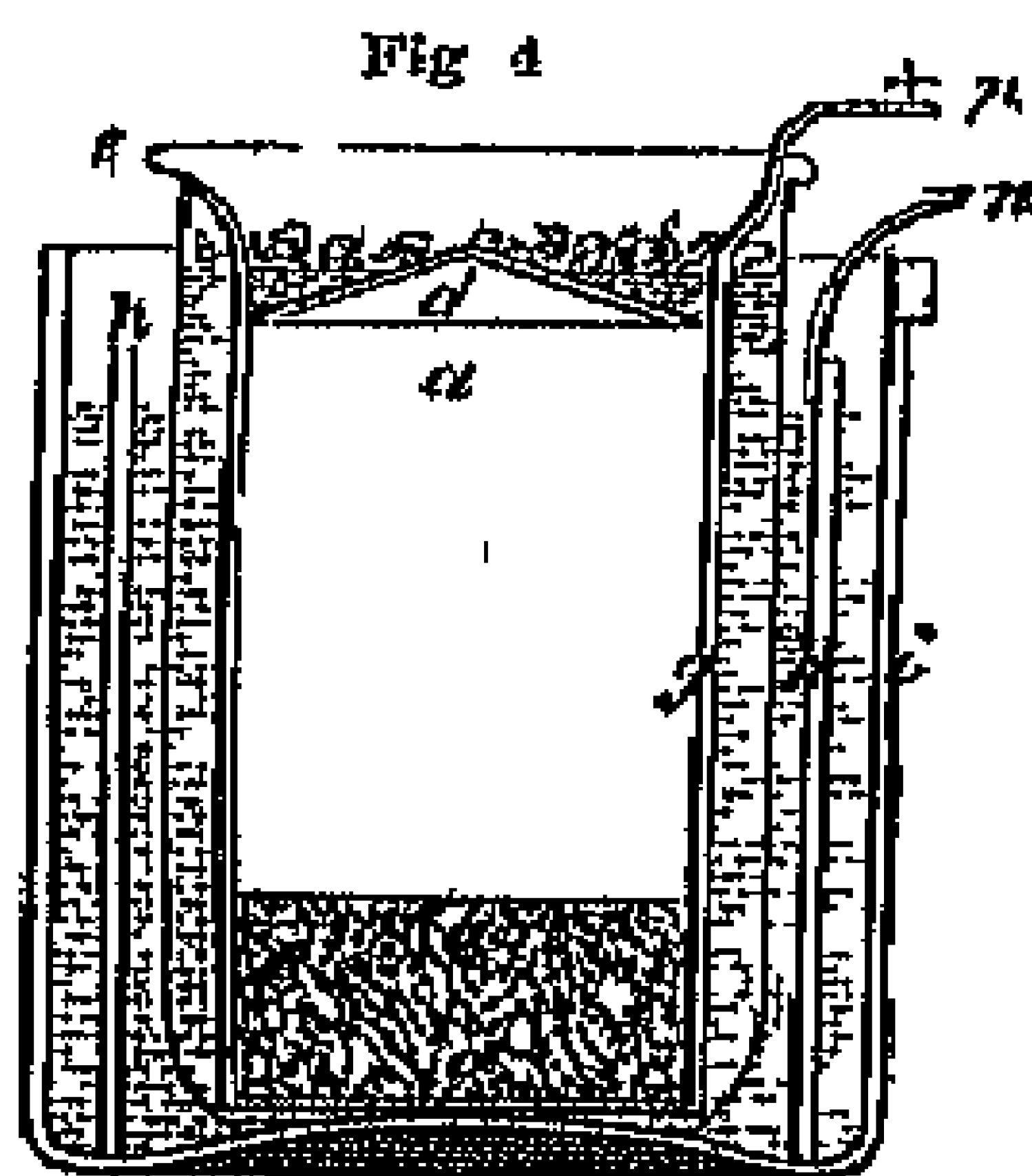

a flat bottom *c*, and a conical top *c*. Above this cone the sides of the copper cylinders are continued, and terminate in a flange *e*. Between this flange and the base of the cone, and near the base, is a ring of holes. This copper vessel is placed in a bladder which fits it loosely like a glove, and is tied round the neck under the flange *e*. The saturated solution of the sulphate of copper is poured into the cup above the cone, and, flowing through the ring of holes, fills the space between the bladder and the copper vessel. It is maintained in its state of saturation by crystals of the salt deposited in the cup.

This copper vessel is then immersed in a vessel of glazed

VOLTAIC COMBINATIONS

reclaim *a*, containing a solution of the sulphate of zinc or the chloride of sodium (common salt). A hollow cylinder of zinc *b*, lit down the side so as to be capable of being enlarged, or connected at pleasure, is immersed in this solution surrounding the added. The poles are indicated by the conductors *p* and *n*, the positive proceeding from the copper, and the negative from the zinc.

M. Pouillet states that the action of this apparatus is sustained without sensible variation for entire days, provided the cup above the cone *d* is kept supplied with the salt, so as to maintain the solution in the saturated state.

In the batteries used for the telegraphs on the French railways, the liquid in which the zinc cylinder is immersed is pure water, and this is found to answer in a very satisfactory manner.

The current flows from the copper cylinder and returns as usual to the zinc.

34. Grove's battery consists of two liquids, sulphuric and nitric acids, and two metals, zinc and platinum, arranged in the following manner —

A hollow cylinder of zinc *z*, fig. 5, open at both ends as already described, is placed in a vessel of glazed porcelain *v v*. Within this is placed a cylindrical vessel *v v*, of unglazed porcelain, a little less in diameter than the zinc *z*, so that a space of about a quarter of an inch may separate their surfaces.

This vessel *v v*, is inserted under *c c* of platinum, open

at the ends, and a little less than *v v*, so that their surfaces may be about a quarter of an inch asunder. Dilute sulphuric acid is then poured into the vessel *v v*, and concentrated nitric acid into *v v*, a proceeding from the platinum will then

be the positive, and *n* proceeding from the zinc the negative pole.

Bunsen contrived a battery which has taken his name, and which, while it retains all the efficiency of Grove's, can be constructed at much less expense, the platinum element being replaced by the cheaper material of charcoal.

In the vessel *v v* is inserted, instead of a hollow cylinder of platinum, a solid cylindrical rod of charcoal, made from the residuum taken from the retorts of gas-works. A strong porous mass is produced by repeatedly baking the pulverised coke, to which the required form is easily imparted. Dilute sulphuric acid

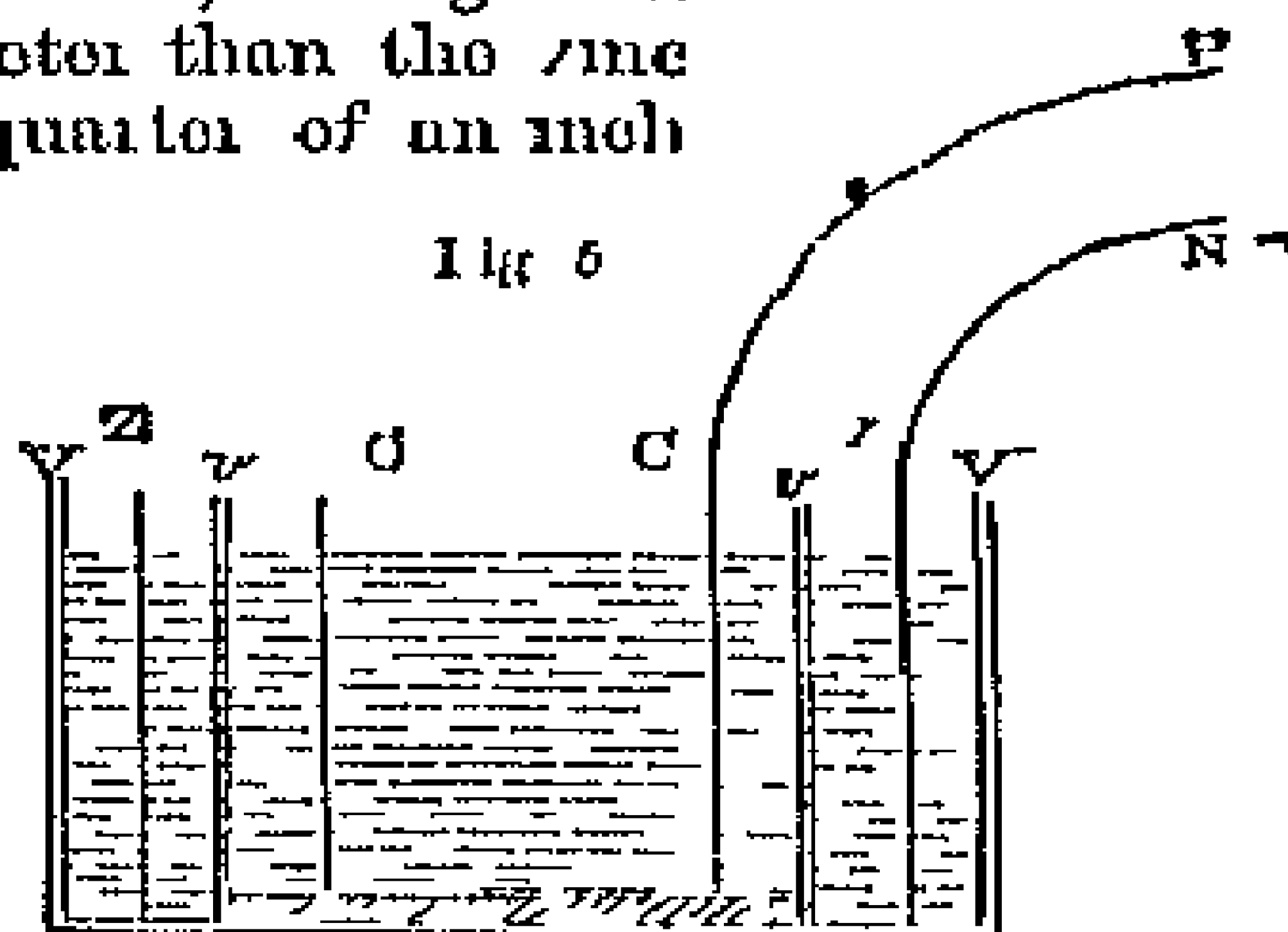

THE ELECTRIC TELEGRAPH

is then poured into the vessel *v v*, and concentrated nitric acid is added into *v v*. The electric fluid issues from a wire connected with the charcoal, and returns by one connected with the zinc.

Messrs Deleuil and Son, of Paris, have fabricated batteries on this principle with great success. I have one at present in use consisting of fifty pairs of zinc and carbon cylinders, the zinc being $2\frac{1}{2}$ inches diameter, and 8 inches high, which perform very satisfactorily.

The chief advantage of Daniel's system is that from which it takes its name, its *constancy*. Its power, however, in its most efficient state, is greatly inferior to that of the carbon or platinum systems of Bunson and Grove. A serious practical inconvenience, however, attends all batteries in which concentrated nitric acid is used, owing to the diffusion of nitrous vapour, and the injury to which the parties working them are exposed by respiration, if, from my own experiments with Bunson's batteries the assistants have been often severely afflicted.

In the use of the platinum battery of Grove, the nuisance produced by the evolution of nitrous vapour is sometimes avoided by enclosing the cells in a box, from the lid of which a tube proceeds which conducts these vapours out of the room.

In combinations of this kind, Dr O'Shaughnessy substitutes gold for platinum, and a mixture of two parts by weight of sulphuric acid to one of saltpetre for nitric acid.

The method of producing the electric fluid by the mutual action of magnets and bodies susceptible of magnetism will be described hereafter.

35 Although each of the simple combinations described above would produce an electric current, which, being transmitted upon a conducting wire, would be attended with effects sufficiently distinct to manifest its presence, such a current would be too feeble in its intensity to serve the purposes of a telegraphic line, and no other simple voltaic combination yet discovered would produce a current the necessary intensity, the object has been attained by placing in connection a series of such combinations, in such a manner that the currents produced by each of them being transmitted in the same direction, on the same conducting wire, a current having an intensity due to such combination may be obtained.

Such a series of simple voltaic combinations, so united, is called a VOLTAIC BATTERY.

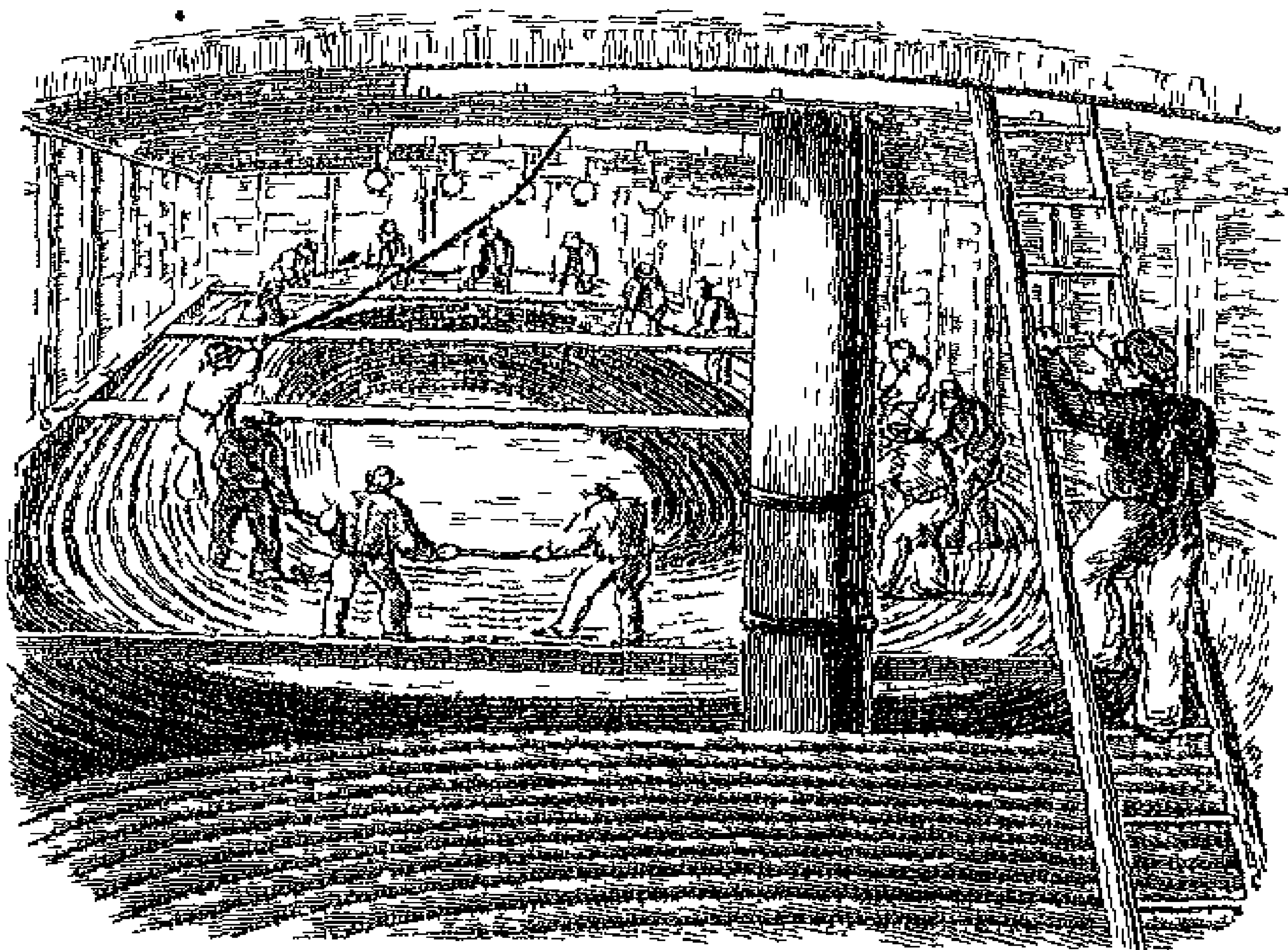

CABLE IN THE HOLD OF THE VESSEL

THE ELECTRIC TELEGRAPH.

CHAPTER II

- 36 Common plate battery — 37 Combination of currents — 38 Loss of intensity by imperfect conduction — 39 Cylindrical batteries — 40 Pans, elements, and poles defined — 41 Origin of term *voltare pile* — 42 Use of sand in charging batteries — 43 To vary intensity of current — 44 Batteries used for English telegraphs — 45 Amalgamating the zinc plates — 46 The line wires, material and thickness — 47 Objection to iron wires — 48 Manner of carrying wires on posts — 49 Good insulation — 50 Expedients for obtaining it — 51 Forms of insulating supports — 52 Dimensions and preparations of the posts — 53 Forms of support used in England — 54 Winding posts — 55 Supports in France — 56 In America — 57 In Germany — 58 Wire insulated by superficial oxydation — 59 Leakage of the electric fluid by the conduction of the atmosphere — 60 Effects of atmospheric electricity on the wires — 61 Lightning conductors — 62 Those of Messrs Walker and Heguet — 63 Conducting current into stations — 64 Underground wires — 65 Methods of insulating them — 66 Testing posts

THE ELECTRIC TELEGRAPH

36 ONE of the most simple forms of voltaic battery is that represented in fig 6, which consists of a glazed earthen

FIG 6

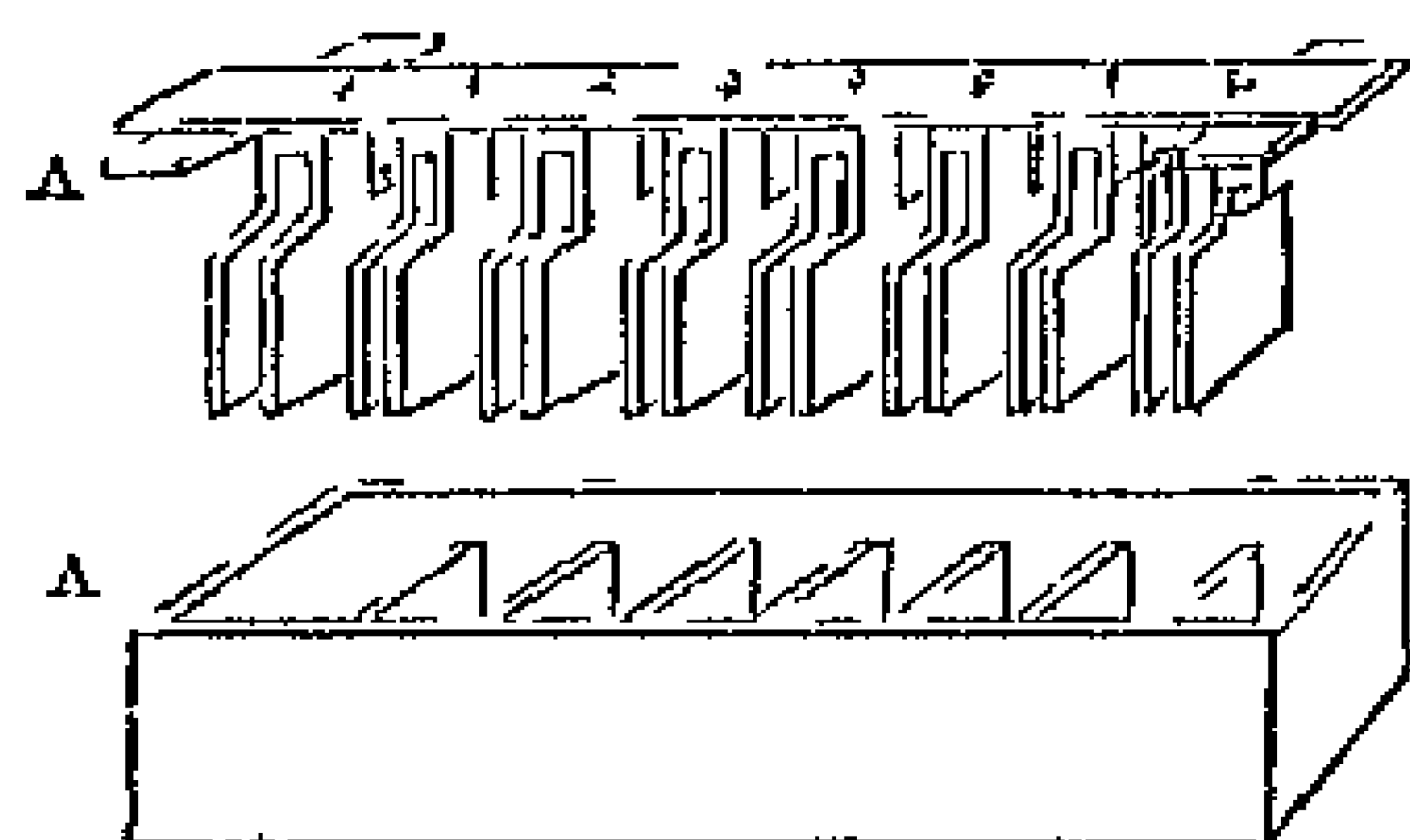

ware trough, divided by partitions into a series of parallel cells, and a series of zinc and copper plates, A' B' of shape and magnitude corresponding with the cells attached to a wooden rod each copper plate being connected at the top, under the wood, by a band of metal, with the zinc plate which immediately succeeds

it in the series. For brevity, let us designate the first copper plate c_1 , the second c_2 , the third, c_3 , and so on, proceeding from A towards B', and let the first zinc plate, which is connected with C by a metal band, be called z_2 , the next, which is similarly connected with c_2 , be called z_3 , and so on from A' towards B'. Now, the intervals between the plates being so arranged as to correspond with the width of the cells, the series of plates may be let down into the cells so that a partition shall separate every pair of plate which are connected by a metal band. Thus, the first partition will pass between c_1 and z_2 , the second between c_2 and z_3 , the third between c_3 and z_4 , and so on. It appears, therefore, that the first cell proceeding from A towards B will contain only the copper plate c_1 , the second will contain c_2 and z_2 , the third, c_3 and z_3 , and so on, the last cell at the extremity B of the series containing only the last zinc plate, which we shall call z_n .

Now, it is evident that as the arrangement thus stands, the first and last cells of the series would differ from the intermediate ones inasmuch as, while each of the latter contains a pair of plates each of the former contains only a single plate, the first copper c_1 and the last zinc z_n . To complete the arrangement, therefore it will be necessary to place a zinc plate, which we shall call z_1 , in the first cell to the left of c_1 , and so as not to be in contact with it and in like manner a copper plate, which we shall call c_n , in the last cell B to the right of z_n , and so as not to be in contact with it. Let wires be soldered to the upper edges of these terminal plate z_1 and c_n , and let them be carried to any desired distances, but finally connected with plates, or any other masses of metal, buried in the ground at x' and y' , fig 7.

These dispositions being made, let us suppose the cells to be filled with a weak acid solution, such as has been already described but so that the liquid in one cell may not overflow into the next

VOLTAIC BATTERIES

A current of electricity will now be established along the wire passing as indicated by the arrows, from the last copper plate at P,

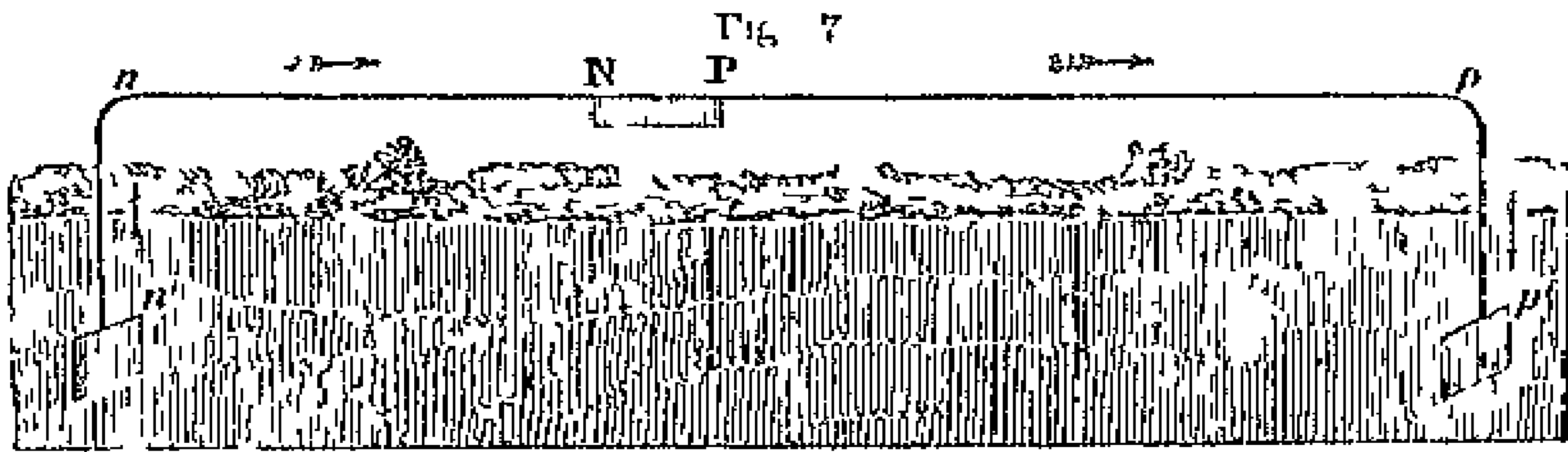

to the earth at p' , and returning by w' to the first zinc plate z_1 , at n .

This current is produced by the combined voltaic action of all the pairs of plates contained in the cells of the trough.

37 The current produced by the combination $z_1 c_1$, in the first cell, will flow from the plate c_1 by the band of metal to the plate z_2 , in the second cell. It will follow this course because of the conducting power of the metals, and the insulating power of the wood and earthenware, which prevents its escape. From the plate z_2 it will pass through the acidulated water to the plate c_2 , for although this water has not a conducting power equal to that of metal, it has nevertheless sufficient to continue the current to c_2 . From c_2 it will pass by the band of metal to z_3 , and from that through the liquid in the third cell to c_3 , and from that by the metal to z_4 , and so on until it arrives at the last plate c_n of the series, from which it will pass, by the conducting wire, from n to p' .

It is evident, therefore, that the current produced by the voltaic combination in the first cell must pass successively through the plates and liquid in all the cells before it can arrive at p' .

In the same manner it may be shown that the current produced in the second cell containing z_2 and c_2 must pass through all the succeeding cells before it can reach p' , and so of all the others.

38 Now, if the metals and liquid were perfect conductors, each of these currents would arrive at p' with undiminished force, and then the current upon the wire $p p'$ would be as many times more intense than a current produced by a single voltaic combination as there are cells. But this is not so. The metals copper and zinc, though good conductors, are not perfect ones, and the acidulated water is a very imperfect one. The consequence is, that the currents severally produced in each of the cells, suffer a considerable loss of force before they arrive at the conducting wire $p p'$, and mathematical formulæ, based on theoretical principles and practical data, have been contrived to express in each case the effects of this

THE ELECTRIC TELEGRAPH

diminution of force due to the imperfect conducting power, or the *resistance*, as it has been called, of the elements of the battery.

Without going into the reasoning upon which these investigations are founded, it will be sufficient for our present object to state, that in all cases, a current of greater or less force is transmitted to the terminal plate of the series from each of the cells, no matter how numerous they may be, and in some cases batteries have been constructed and brought into operation, in scientific researches, which consisted of as many as two thousand pairs of plates.

39 To simplify the explanation, as well as because the form described is very generally used for telegraphic purposes, we have here selected the plate battery to illustrate the general principle upon which all voltaic combinations are founded. In fig 8 is

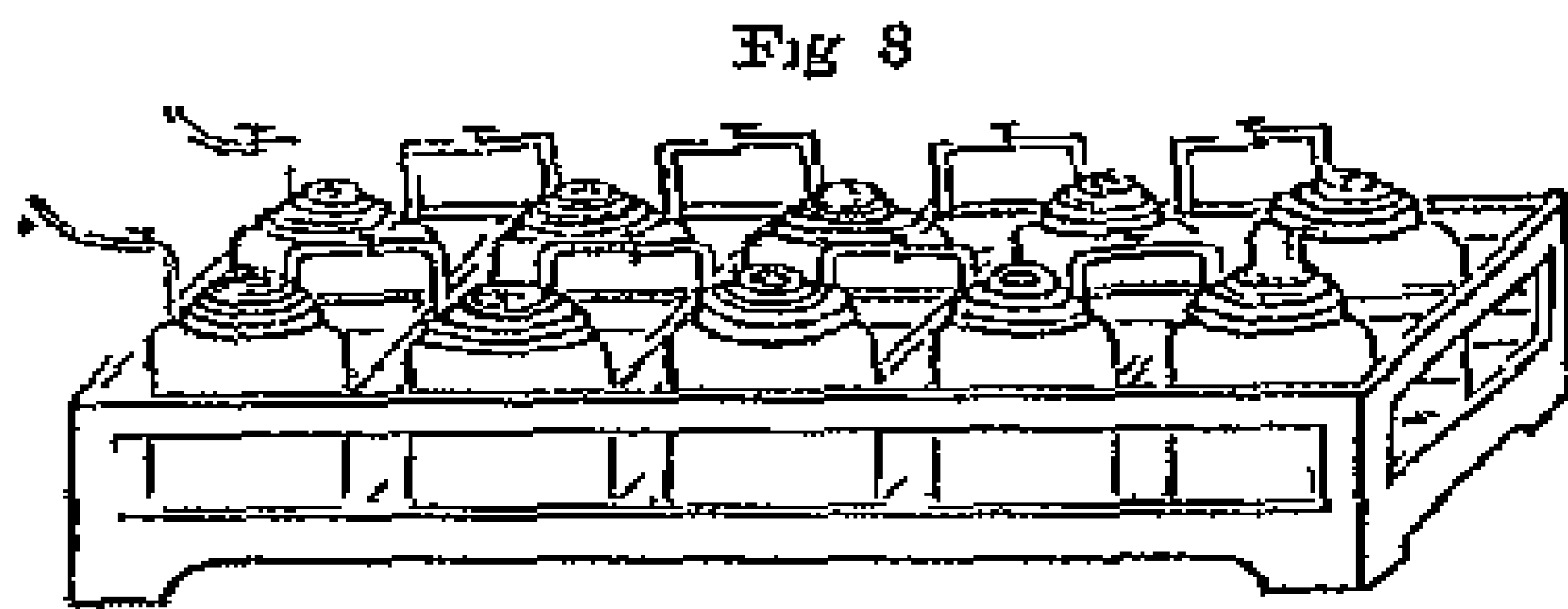

Fig 8

represented the disposition of the cylinders in a battery formed on the principles of Daniell or Grove, where the metallic connection of each copper or char coal element of one pair, with the zinc element

of the succeeding pair, is represented by a rectangular metallic bar or wire.

40 Each combination of two metals, or of one metal and charcoal, which enters into the composition of a battery, is usually called a **PAIR**, and sometimes an **ELEMENT**. Thus, a battery is said to consist of so many **PAIRS**, or so many **ELEMENTS**.

The end of the battery from which the current issues is called its **POSITIVE POLE**, and that to which it returns is called its **NEGATIVE POLE**. Thus, in the batteries explained above, **P** is the positive, and **N** the negative pole.

Since in the most usual elements, zinc and copper, the current issues from the last copper plate, and returns to the first zinc plate, the positive pole is sometimes called the **COPPER POLE**, and the negative the **ZINC POLE**.

41 The voltaic battery is sometimes called the **VOLTAIC PILE**. This term had its origin from the forms given to the first voltaic combination by its illustrious inventor.

The first pile constructed by Volta was formed as follows — A disc of zinc was laid upon a plate of glass. Upon it was laid an equal disc of cloth or pasteboard, soaked in acidulated water. Upon this was laid an equal disc of copper. Upon the copper were laid, in the same order, three discs of zinc, wet cloth, and copper, and the

VOLTAIC PILE

same superposition of the same combinations of zinc, cloth, and copper, was continued until the pile was completed. The highest disc (of copper) was then the positive, and the lowest disc (of zinc) the negative pole, according to the principles already explained.

It was usual to keep the discs in their places by confining them between rods of glass.

Such a pile, with conducting wires connected with its poles, is represented in fig. 9.

12. As the batteries used on telegraphic lines are liable to frequent removal from place to place while charged with the acidulated water, or other exciting liquid, it has been found desirable to contrive means to prevent such liquid from being spilled, or thrown from cell to cell. This has been partially accomplished by the simple expedient of filling the cells with silicious sand, which is kept saturated with the exciting liquid so long as the battery is in operation.

13. It is often necessary, in telegraphic operations, to vary the intensity of the current. This is accomplished, within certain limits, without changing the battery, in the following manner:—

If it be desired to give the full force of the battery to the current, the wires are attached to the terminal plates, so that the entire battery is between them. But if any less intensity is desired, the wires, or one of them, is attached to intermediate plates, so that they shall include between them a part only of the battery. The part included between them is alone active in producing the current, all the elements which are outside the wires being passive. The battery, in effect, is converted into one of fewer elements.

Provisions are made, which will be explained hereafter, by which the operator can, by a touch of the hand, thus vary the force of the battery.

41. The batteries generally used for the English telegraphs are those described in (36). They are usually charged with sand, wetted with water mixed with sulphuric acid, in the proportion of about one part of strong acid to fifteen of water. A more intense current could be produced by using a stronger solution, but it is found preferable to augment its intensity by increasing the number of plates in the battery. The dimensions

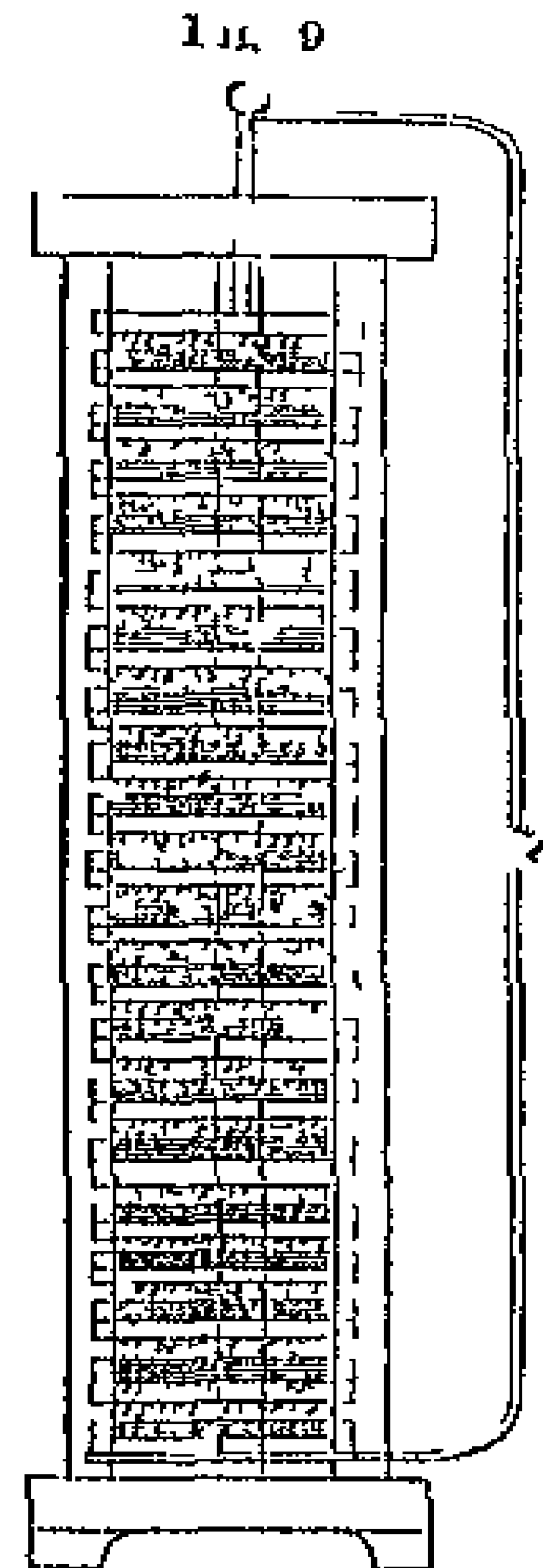

THE ELECTRIC TELEGRAPH

of the plates are generally four to five inches wide, and three to four inches deep. The thickness of the zinc plates is something less than a quarter of an inch. The cells are filled with sand to within an inch of the top, and the joints of the plates above the sand are varnished as a protection against corrosion, and to keep them clean. In general, the troughs are made either of glazed earthenware or some compact wood, such as oak, or teak, made water-tight by cement or marine glue. When the trough is wood the partitions of the cells are slate, the width of each cell being one inch and a quarter to one inch and a half. The troughs contain, some twenty-four, and some twelve cells.

Batteries of this sort, consisting of twenty-four cells, give a current of sufficient force for a line of wire of 15 miles. For 50 miles, 48 cells, and for 75 miles, three troughs of 24 cells are required. Mr Walker considers that these batteries give superfluous force, but that it is necessary to provide against the contingency of leakage by accidental defects of insulation.

15 The durability of these batteries is increased by amalgamating the zinc plates. This is effected by first washing them in acidulated water, and then immersing them in a bath of mercury for one or two minutes. The mercury will combine with the zinc and form a superficial coating of the amalgam of zinc. When they are worn by use, they may be restored, by scouring them, and submitting them to the same process, and this may be continued until the zinc becomes too thin to hold together.

Mr Walker states that new batteries, when carefully put together, will, with care, do duty for six or eight months, when the work is not very heavy, and by washing the sand out with a flow of water, and refilling them, they have frequently remained on duty ten or twelve months, or even more, without having been sent in for re-amalgamation.*

46 Having explained, generally, the manner in which the electric current is produced and maintained, I shall now proceed to explain the various expedients by which it is conducted from station to station, along the telegraphic line, and by which injurious waste by leakage or drainage is prevented or diminished.

The conducting wires used for telegraphic lines are of iron, usually the sixth of an inch in diameter. On all European lines they are submitted to a process called galvanisation, being passed through a bath of liquid zinc, by which they become coated with that metal. This zinc surface being easily oxydable, is soon, by the action of air and moisture, converted into the oxyde of zinc, which, being insoluble by water, remains upon the wire, and protects the iron from all corrosion.

LINE WIRES

When a great length of wire is to be stretched between two distant points without intermediate support, steel wire is often preferred to iron, in consequence of its greater strength and tenacity.

Copper being a better conductor of electricity than iron, as well as being less susceptible of oxidation, would on these accounts be more eligible for telegraphic purposes. Its higher price, and the possibility of compensation for the inferior conducting power of iron, by using greater battery power, has rendered it preferable to use that metal.

47 Mr Highton, the inventor of some important improvements in telegraphic apparatus, affirms that, when galvanised iron wires pass through large towns where great quantities of coal are burnt, the sulphureous acid gas resulting from such combustion acting upon the oxide of zinc which coats the conducting wire, converts it into a sulphate of zinc, which being soluble in water, is immediately dissolved by rain, leaving the iron unprotected. The wire consequently soon rusts, and is corroded. Mr Highton says, that in some cases he has found his telegraph wires reduced by this cause to the thickness of a common sewing needle in less than two years.

The wires used on the American lines are of iron, similar to the European, but are not galvanised. They soon become coated with their own oxide. A pair of galvanised wires have been placed between New York and Boston, and I have been informed by Mr Shaffner, the secretary of the American Telegraph Confederation, that at certain times during the winter, it has been found that they were unable to work the telegraph with these wires, while its operation with the wires not galvanised, was uninterrupted. Mr Shaffner also states that several anomalous circumstances have been manifested upon some extensive lines of wire erected on the vast prairies of Missouri. Thus, in the months of July and August, it is found that the telegraph cannot be worked from two to six in the afternoon, being the hottest hours of the day. These circumstances are ascribed to some unexplained atmospheric effects.

48 The manner in which the conducting wires are carried from station to station is well known. Every railway traveller is familiar with the lines of wire extended along the side of the railways, which, when numerous, have been not unaptly compared to the series of lines on which the notes of music are written, and which are the metallic wires on which invisible messages are flying continually with a speed that surpasses imagination. These are suspended on posts, erected at intervals of about sixty yards, being at the rate of thirty to a mile. They therefore supply incidentally a convenient means by which a passenger can ascertain the speed

THE ELECTRIC TELEGRAPH

of the train in which he travels. If he count the number of telegraph posts which pass his eye in two minutes, that number will express in miles per hour the speed of the train.

49 Since the current of electricity which flows along the wire has always a tendency to pass by the shortest route possible to the ground, it is evident that the supports of the wires upon the posts ought to possess, in the highest attainable degree, the property of insulation, for even though the entire stream of electrical fluid might not make its escape at any one support, yet if a little escaped at one and a little at another, the current would, in a long line, be soon so drained that what would remain would be insufficient to produce those effects on which the efficiency of the telegraph depends. Great precautions have therefore been taken, and much scientific ingenuity has been expended in contriving supports which shall possess, in the highest attainable degree, the property of insulation.

50 To each of these posts or poles are attached as many tubes or rollers, or other forms of support, in porcelain or glass, as there are wires to be supported. Each wire passes through a tube, or is supported on a roller, and the material of the tubes or rollers being among the most perfect of the class of non-conducting substances, the escape of the electricity at the points of contact is impeded.

Notwithstanding various precautions of this kind, a considerable escape of electricity still takes place in wet weather. The coat of moisture which collects on the wire, its support, and the post, being a conductor, carries away more or less of the fluid. Consequently, more powerful batteries are necessary to give effect to the telegraph in wet than in dry weather.

In England, and on the Continent, the material hitherto used for the supports of the wires is principally a sort of earthen or stone ware. In the United States it is generally glass.

51 The forms of these insulating supports are various. Tubes, rings, collars, and double cones, are severally used. The material used most commonly in England, a sort of brown stoneware, has the advantage, besides being a good insulator, of throwing off wet, as water falls from a duck's wing, leaving the surface dry. A pitcher of this ware, plunged in water, scarcely retains any moisture upon it.

52 The posts vary generally from 15 to 30 feet in height, the lowest wire being about ten feet above the ground, except in cases where greater height is required to allow vehicles to pass under it, as when the wires cross a common road, or pass from one side of the railway to the other. The poles are about 6 inches square at the top, and increase to 8 inches at the bottom. In some cases they are impregnated with certain chemical solutions, to preserve them from rotting, and are generally painted, the parts

POST FOR WIRES

which are in the ground being charred and tanned. The manner of treatment, however, varies in different countries.

53 In figs 10 and 11 are represented different forms of supports used in England. To cross-pieces of wood, A & A', bolted upon the post (fig 10), are attached balls, b, of stoneware, as described above, in which grooves or slits are formed to receive and support the wires. These supports are protected from rain and from the deposition of dew by hoods of zinc-coated iron placed over them. Glass being so much better an insulator, balls of that material are recently being substituted for the stoneware.

Another form of support, sheltered by a sort of sloping roof, is represented in fig 11. On the front of the post is a wooden arm to which a series of stoneware rings are

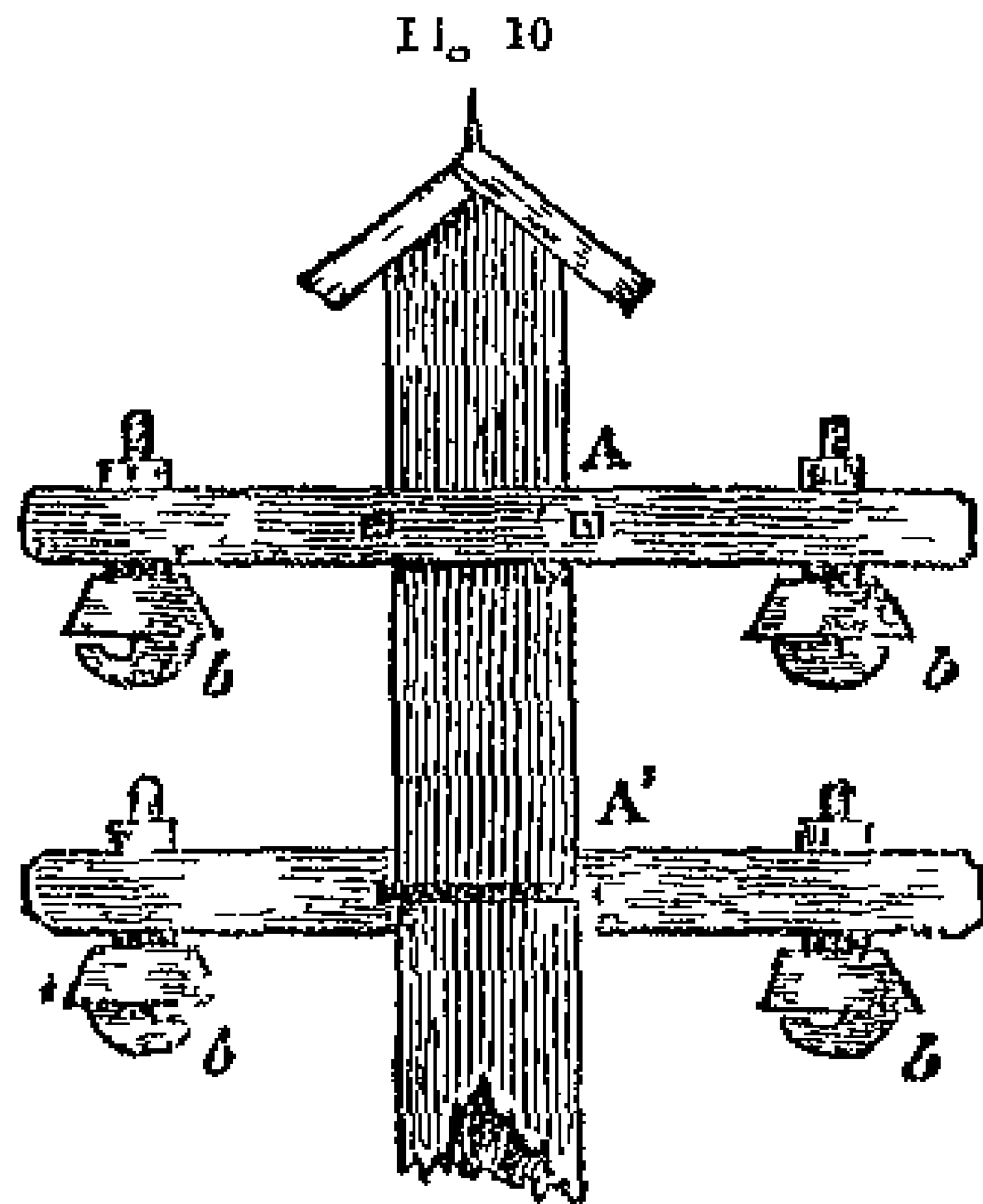
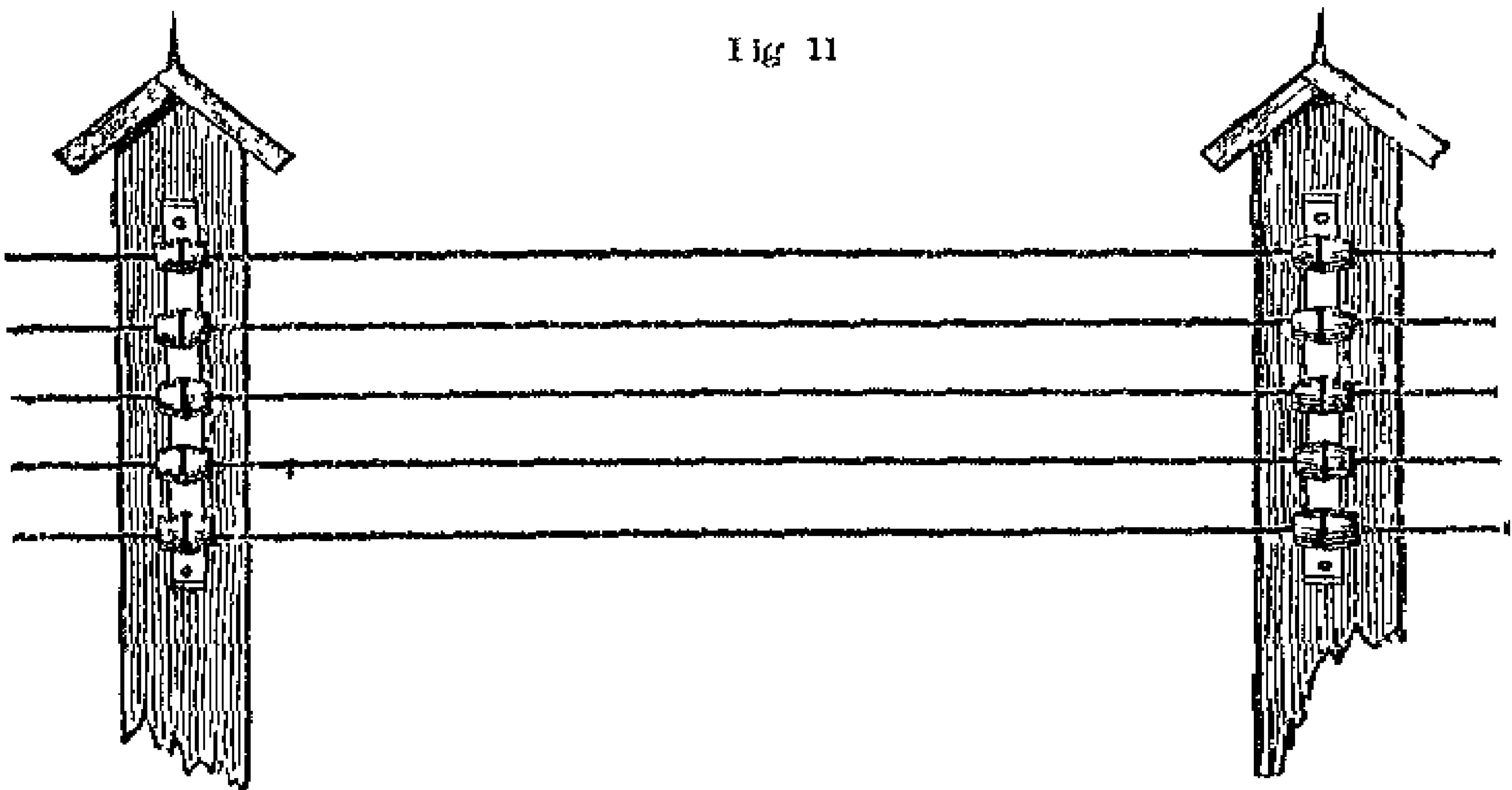

Fig 11



attached, through which the wires pass. These rings have the form of two truncated cones placed with their larger bases in contact.

It is usual, where the wires are numerous, as on some of the lines near London, to attach these supports both to the front and

THE ELECTRIC TELEGRAPH

back of the post. So many as thirteen of these supports may be seen upon some of the posts of the North-Western line near London. The wires supported on some of these are continued to Liverpool and Manchester, and some even to Glasgow.

54 If the same wire were carried over a succession of supports for a certain distance, they would after a certain time become slack and hang in curves between post and post. This would be attended with great inconvenience and confusion, inasmuch as one wire—especially when agitated by wind—would come in contact with another, so that the currents running along them would pass from one to another, and the proper signals conveyed by such currents would no longer reach their destination.

To prevent this, apparatus for tightening the wires are on all such lines provided at convenient distances, such as half-a-mile, upon posts which are thence called *winding posts*. These posts are of larger dimensions than the ordinary posts. A grooved drum, on which the wire is wound, is attached to them by a bolt, which passes through the post, but clear of the wood. Upon this bolt is fixed a ratchet wheel by which the drum may be turned in one direction, so as to coil the wire upon it, with a catch which prevents its recoil in the other direction, and therefore maintains the tension of the wire. The bolt is kept from contact with the post by passing through a stoneware collar.

The current passes through the winder and the bolt, these being metallic, but in case of any interruption arising from the

Fig. 12

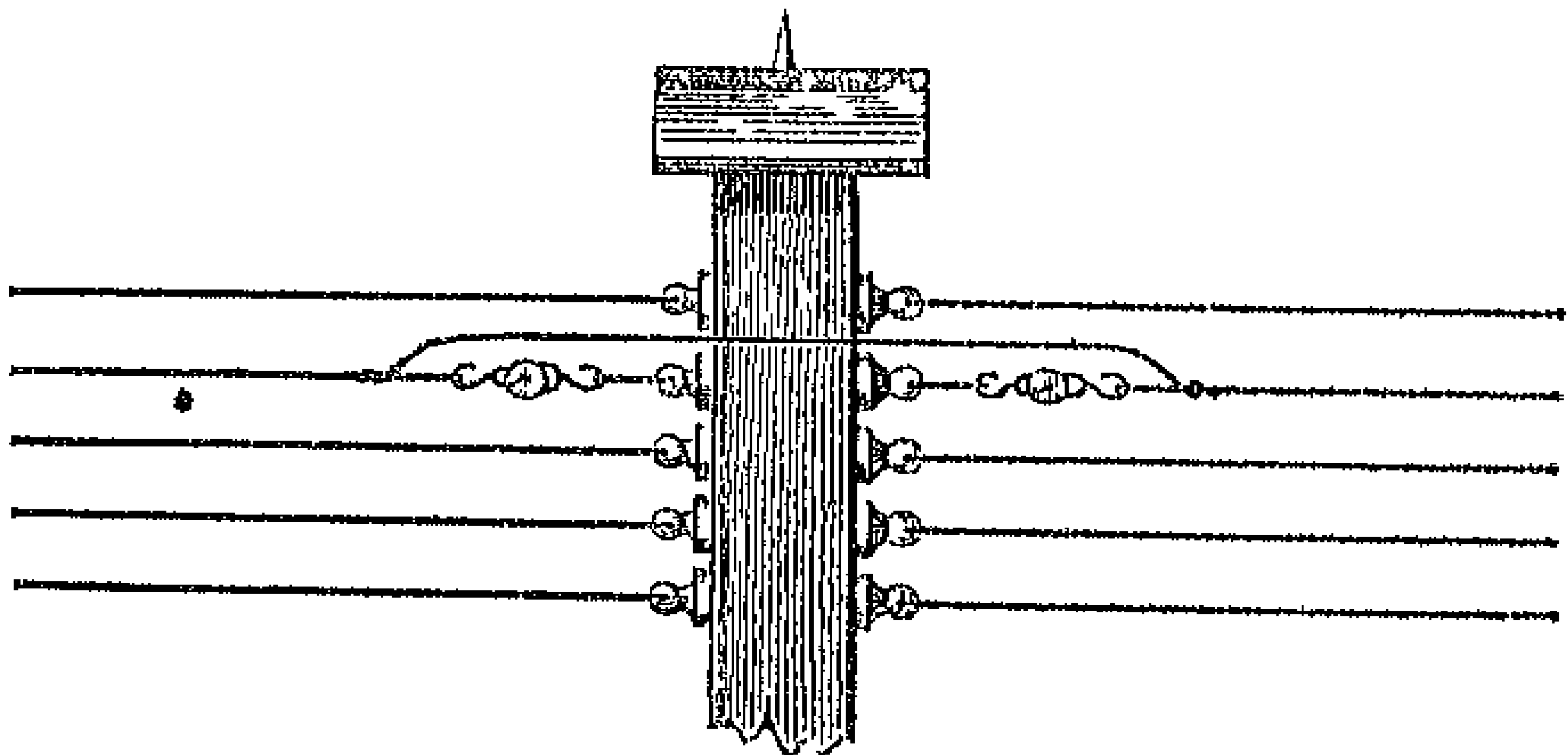

oxidation of their surfaces a supplemental piece of conducting wire is provided, which connects the main wires at points taken above and below the winding post, as represented in fig. 12.

INSULATING SUPPORTS

55 In France the posts are from twenty to thirty feet high, placed at distances varying from sixty to seventy yards asunder, and sunk to a depth of from three to seven feet in the ground. They are impregnated with sulphate of copper to preserve them from rotting by damp.

The conducting wire rests in an iron hook, which is fastened by sulphur into the highest part of the cavity of an inverted bell, formed of porcelain, from which two ears project, which are screwed to the post.

A section of this apparatus is given in fig 13, and a side view in fig 14, the figures being one-fifth of the actual magnitude.

The winding posts are placed at distances of a kilometre (six-tenths of a mile). The apparatus used for lightening the wire consists of two drums or rollers, each carrying on its axis a ratchet wheel with a catch. These drums are mounted on iron forks formed at the ends of an iron bar, which is passed through an opening in a porcelain support, and secured in its position by pins, the porcelain support being attached to the post by screws passing through ears projecting from it.

Fig 13, 14

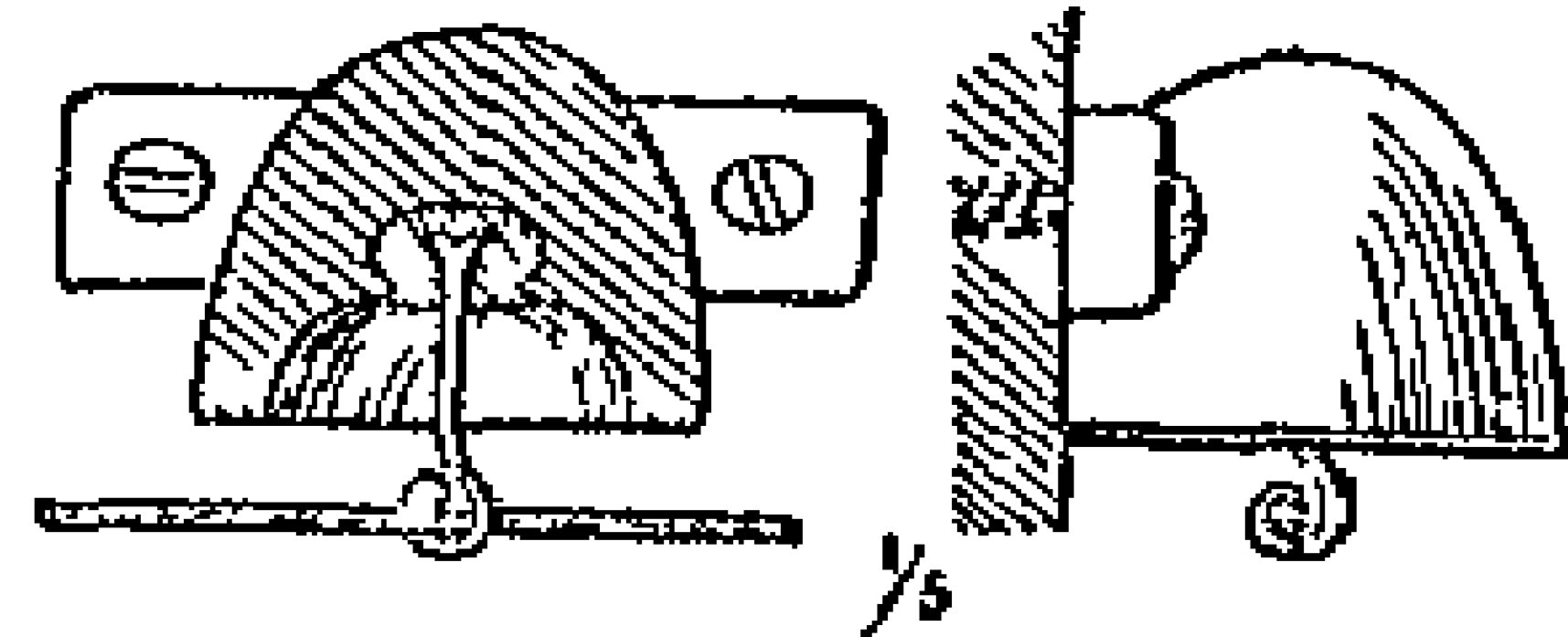

A front view of this winding apparatus is given fig 15, a

Fig 15

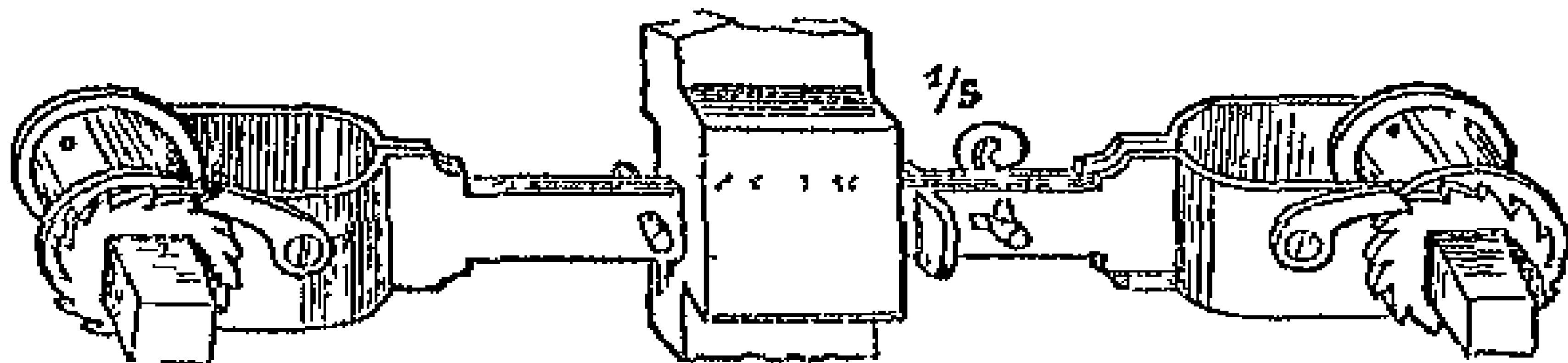

side view of the porcelain support showing the opening through which the iron bar is passed, and the screws by which it is attached to the post, is given in fig 16. These figures are one-fifth of the real magnitude of the apparatus.

The conducting wires used in France are similar to those used on the English lines.

56 The insulating supports of the wires used on the American lines are very various in form.

The supports upon the principal Morse lines consist of a glass knob,

Fig 16

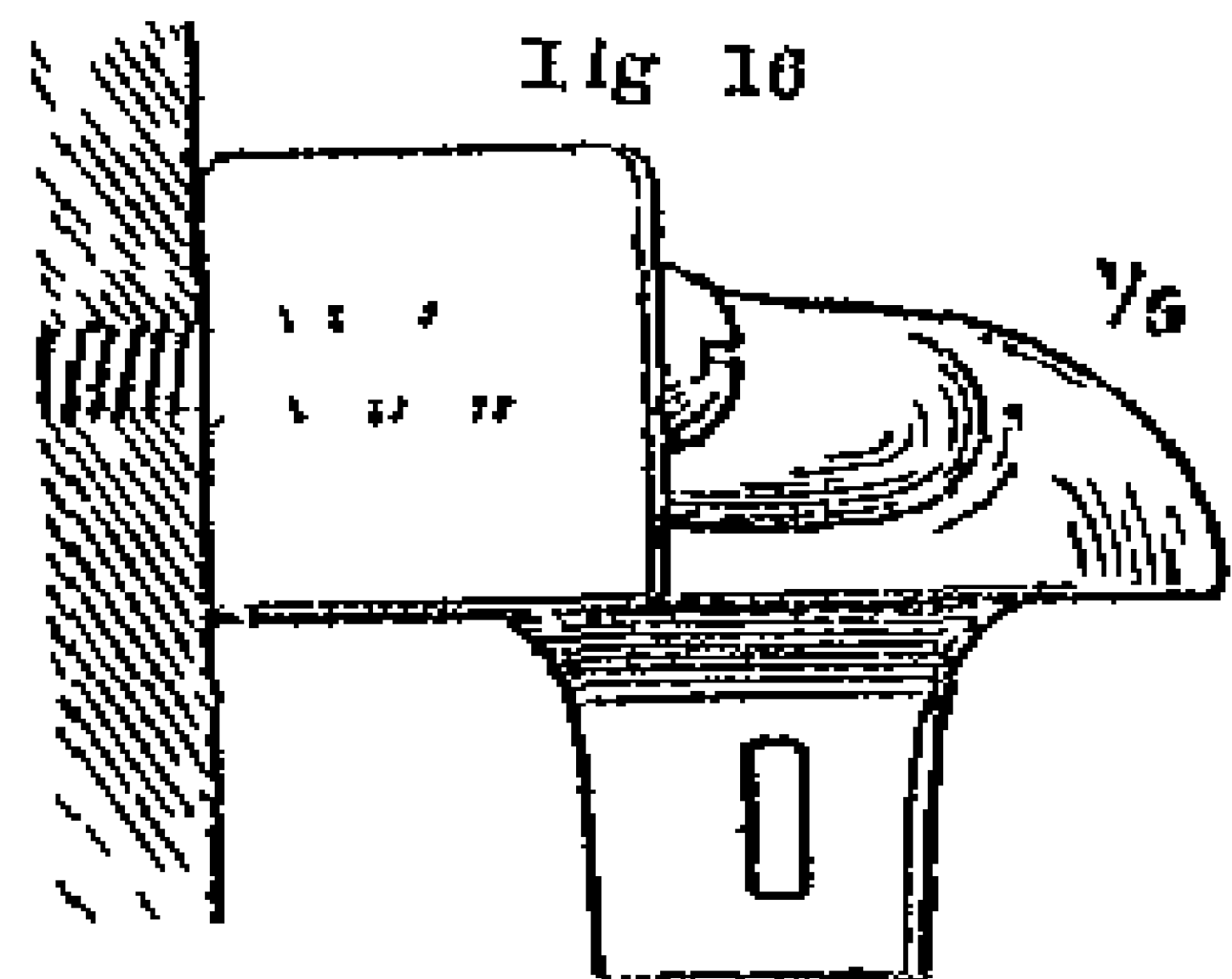

THE ELECTRIC TELEGRAPH

fig 17, upon which two projecting rings are raised in the groove between which the wire is wrapped. This glass knob

Fig 17

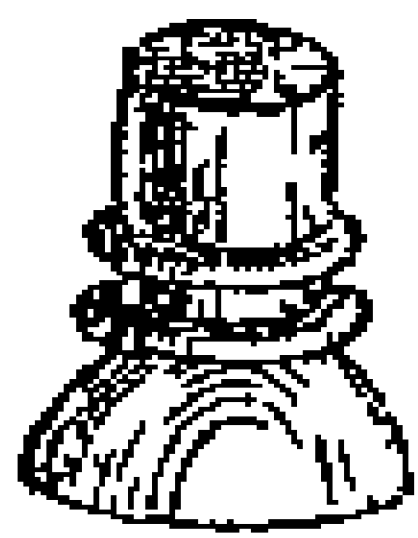

is attached to an iron shank as represented in fig 18, which is driven into the post.

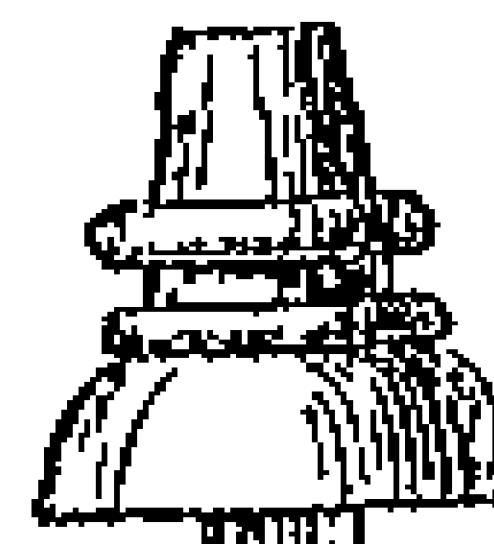
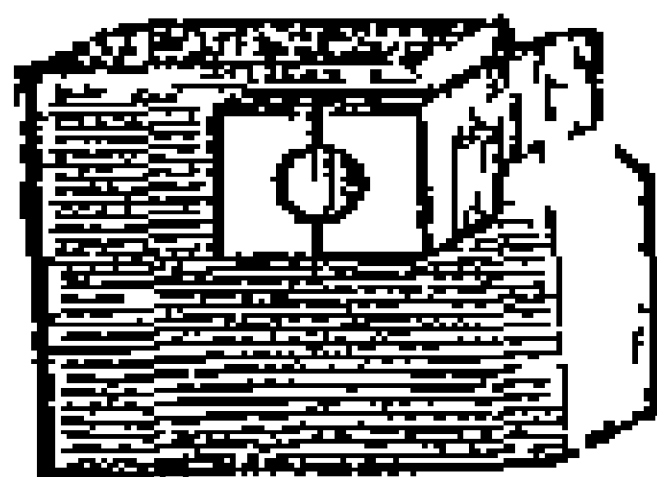

Fig 18

Another form of support used on these lines is represented in fig 19, which consists of two rectangular blocks of glass, in each of which is a semi-cylindrical groove corresponding with the thickness of the conducting wire, so that the wire being laid in the groove of one of them, and the other being laid upon it, will be completely

Fig 19



enclosed within the block of glass produced by their union. These blocks of glass are surrounded and protected by a larger block of wood, as represented in the figure, where the white part represents the glass, and the shaded part the wood.

The supports are sometimes attached to the sides of the posts, and sometimes placed upon an horizontal cross bar, as represented in fig 20.

Fig 20

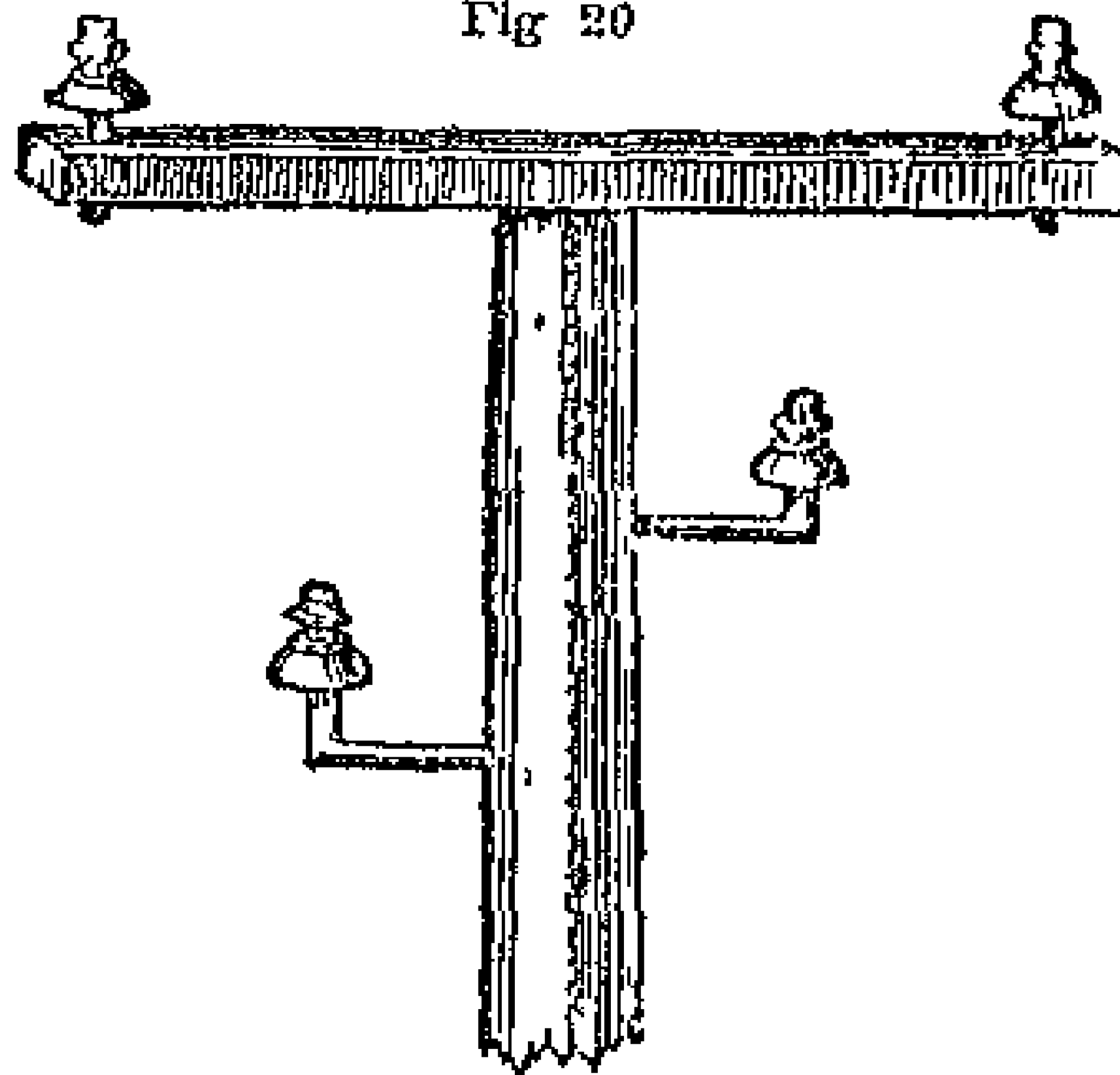

The supports used in House's lines consist of a glass cap about five inches in length and four inches in diameter, having a coarse screw-like surface out inside and out. This glass cap (2) fig 21 is screwed and cemented into a bell-shaped iron cap (1) from three to four pounds, in weight, projecting an inch below the lower edge of the glass, protecting it from being broken, this is fitted with much care to the top of

INSULATING SUPPORTS

the pole (3), and is covered with paint or varnish. The conducting wire is fastened to the top of the cap by projecting iron points, and the whole of the iron cap is thus in the circuit, as the wire is of iron and not insulated. To prevent the deposit of moisture, the glass is covered by a varnish of gum-lac dissolved in alcohol, and the ring-like form of the glass is to cause any moisture to be carried to the edge and there drop off.*

The wires on the American lines are not usually galvanised.

57 One of the forms of insulating support used on the German lines is represented in fig. 22, and consists of an insulating cap placed on the tapering end of a post. The post terminates in a point *e*, an inch and a half in length and about six lines in diameter, this pole is covered with a porcelain cap *d d*, a sort of reversed cup, on its summit *e*, there is a hole inland with lead, in which the conducting wire *b b* enters, this insulator is then covered with a roof.

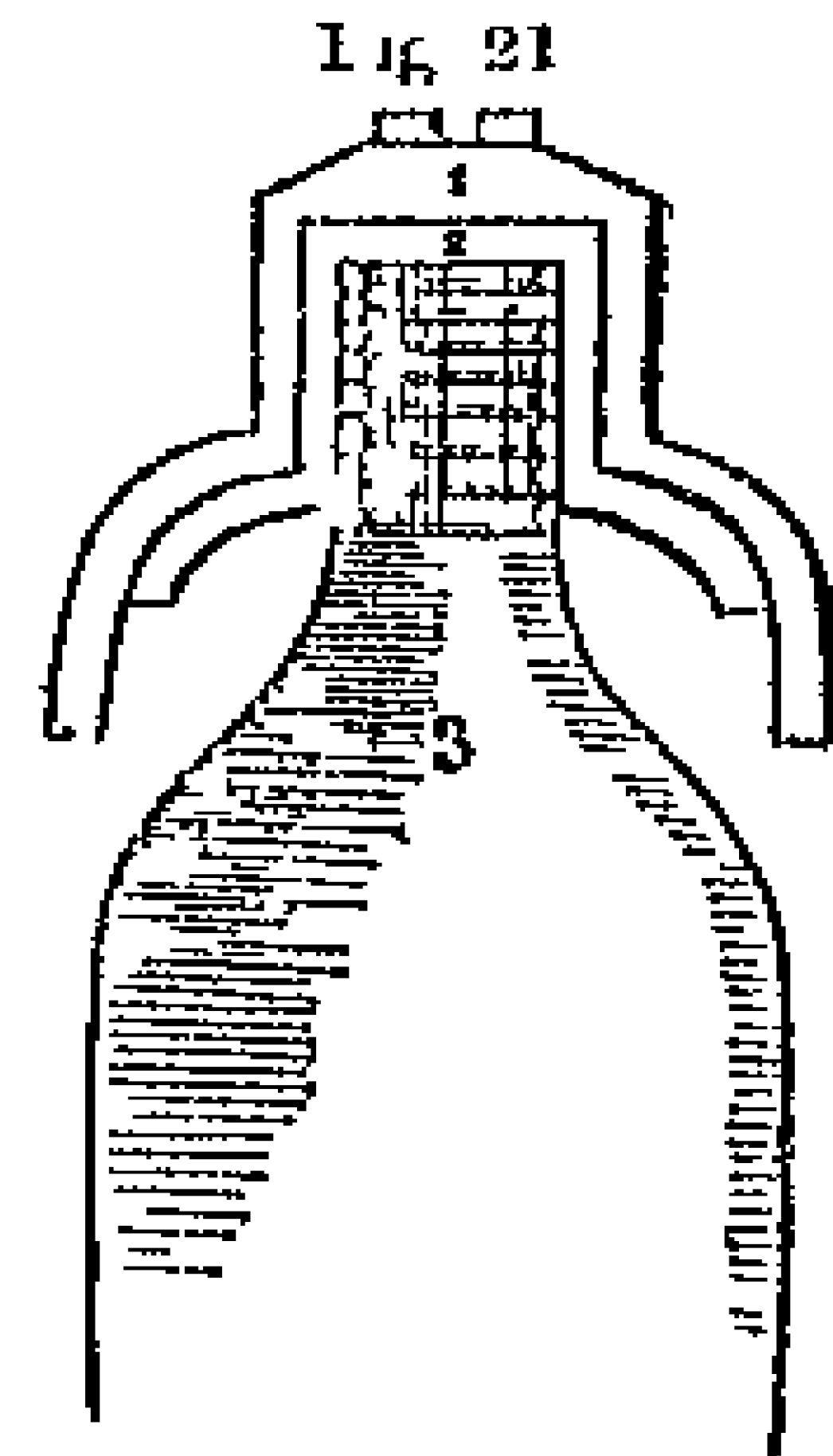
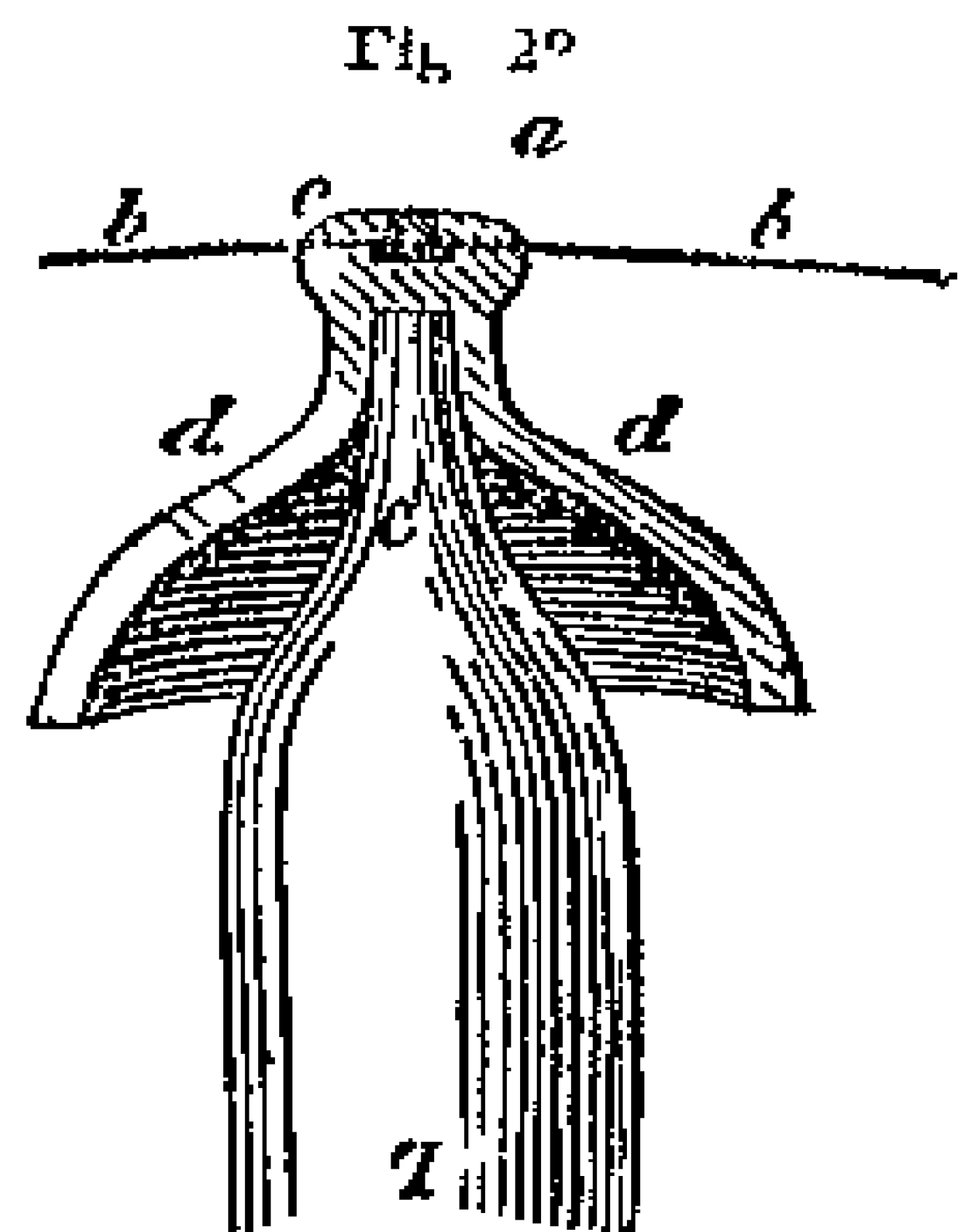

Fig. 21

58 It may be asked what prevents the escape of the electric fluid from the surface of the wire between post and post? In general when wires are used on a smaller scale for the transmission of electric currents, the escape of the fluid is prevented by wrapping them with silk or cotton thread, which thus forms a non-conducting cover upon them, but on the scale on which they are used on telegraphic lines the expense of this, independently of the difficulty of protecting such covering from destruction by weather, would render it inadmissible.



59 The atmosphere, when dry, is a good non-conductor, but this quality is impaired when it is moist. In ordinary weather, however, the air being a sufficiently good non-conductor, a metallic wire will, without any other insulating envelope except the air itself, conduct the stream of electricity to the necessary distances. It is true that a coated wire, such as we have

* Turnbull on the Electric Telegraph, p. 176 Philadelphia, 1853

THE ELECTRIC TELEGRAPH

described, would be subject to less waste of the electric fluid *en route*, but it is more economical to provide batteries sufficient powerful to bear this waste, than to cover such extensive lengths of wire with any envelope.

60 Atmospheric electricity having been found to be generally attracted to the wires, and to pass along them, so as to disturb the indications of the telegraphic instruments, and sometimes even to be attended with no inconsiderable damage to those employed in working the apparatus, various expedients have been contrived for removing the inconvenience and averting the danger. The current produced by this atmospheric electricity is often so intense as to render some of the finer wires used in certain parts of the apparatus at the stations, red hot, and sometimes even to fuse them. It also produces very injurious effects by demagnetising the needles, or imparting permanent magnetism to certain bars of iron included in the apparatus, which thus become unfit for use.

61 One of the expedients used for the prevention of the inconvenience and injurious effects is to place common lightning conductors on the posts. The points of these are shown upon the posts in figs 10, 11, and 12.

62 Mr Walker of the South Eastern Company and M. Haugnet of Paris, have each invented an instrument for the better protection of telegraphic stations from atmospheric electric discharges. Both these contrivances have been found in practice to be efficacious, and though differing altogether in form they are similar in principle. In both, a much finer wire than any which lies in the regular route of the current is interposed between the line wire and the station, so that an intense and dangerous atmospheric current must first pass this fine wire before reaching the station. Now it is the property of such a current to raise the temperature of the conductor over which it passes to a higher and higher point in proportion to the resistance which such conductor offers to its passage. But the resistance offered by the wire is greater in the same proportion as its section is smaller. The safety wire interposed in these contrivances is, therefore, of such thinness that it must be fused by a current of dangerous intensity. The wire being thus destroyed all electric communication with the station is cut off, and the extent of the inconvenience is the temporary suspension of the business of the line until the breach has been repaired.

Expedients are used on the American lines to divert the atmospheric electricity from the wires, consisting merely of a number of fine points projecting from a piece of metal connected with the earth by a rod of metal. These points are presented to

UNDERGROUND WIRES

a metal plate, or other surface, attached to the line wire at the place where it enters the station. It is found that these points attract the atmospheric electricity, which passes to the ground by the conductor connected with them, but do not attract the electricity of the battery current.

63 The wires extended from post to post are continued in passing the successive stations of the line. The expedients by which the current is turned aside from the main wire, and made to pass through the telegraphic office of the station, differ more or less in their details on different lines and in different countries, but are founded on the same general principles. It will therefore be sufficient here to describe one of those commonly used on the British lines.

The conducting wire of the main line in passing the station is cut and the ends jointed by a shackle, as represented in fig 12, in the case of a winding post. This shackle breaking the metallic continuity would stop the course of the current. A wire is attached to the line wire below the shackle so as to receive the current which the latter would stop, and is carried on insulating supports into the telegraphic office and put in connection with the telegraphic instrument. Another wire connected with the other side of the instrument receives the current on leaving it, and being carried back on insulating supports to the line wire, is attached to the latter above the shackle, and so brings back the current which continues its progress along the line wire.

64 Although the mode of carrying the conducting wires at a certain elevation on supports above the ground has been the most general mode of construction adopted on telegraphic lines, it has been found in certain localities subject to difficulties and inconvenience, and some projectors have considered that in all cases it would be more advisable to carry the conducting wires underground.

This underground system has been adopted in the streets of London, and of some other large towns. The English and Irish Magnetic Telegraph Company have adopted it on a great extent of their lines, which overspread the country. The European Submarine Telegraph Company has also adopted it on the line between London and Dover, which follows the course of the old Dover mail-coach road by Gravesend, Rochester and Canterbury.

65 The methods adopted for the preservation and insulation of these underground wires are various.

The wires proceeding from the central telegraph station in London are wrapped with cotton thread, and coated with a mixture of tar, resin, and grease. This coating forms a perfect insulator. Nine of these wires are then packed in a half-inch leaden pipe, and four or five such pipes are packed in an iron pipe about three inches in diameter. These iron pipes are then laid

THE ELECTRIC TELEGRAPH

under the foot pavements, along the sides of the streets, and are thus conducted to the terminal stations of the various railways, where they are united to the lines of wire supported on poles along the sides of the railways, already described.

66 Provisions, called *testing posts*, are made at intervals of a quarter of a mile along the streets, by which any failure or accidental irregularity in the buried wires can be ascertained, and the place of such defect always known within a quarter of a mile.

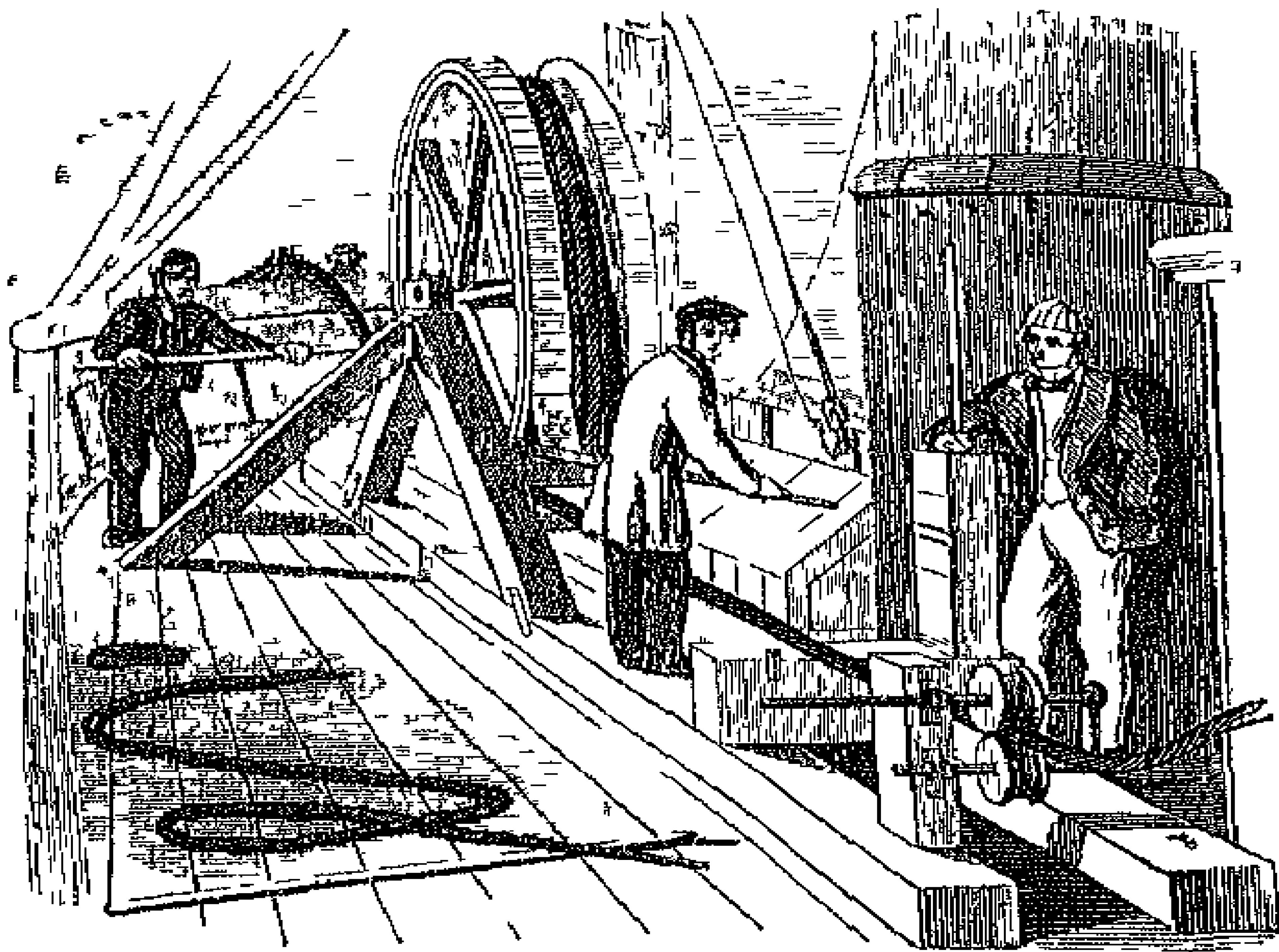

Fig 81—LAYING THE CABLE FROM THE DECK OF THE SHIP

THE ELECTRIC TELEGRAPH

CHAPTER III

67 Wires of Magneto electric Telegraph Company — 68 Mr. Bright's method of detecting faulty points — 69 Such failure of insulation rare — 70 Underground method recently abandoned in Prussia — 71 Underground wires of the European and Submarine Company — 72 Imperfect insulation in tunnels — 73 Mr. Walker's method of remedying this — 74 Overground system adopted through the streets of cities in France, and in the United States — 75 Telegraphic lines need not follow railways — 76 Do not in America nor in certain parts of Europe — 77 Submarine cables — 78 Cable connecting Dover and Calais — 79 Failure of first attempt—Improved structure — 80 Table of submarine cables and their dimensions — 81 Dimensions and structure of the Dover and Calais cable — 82 Holyhead and Howth cable — 83 First attempt to lay cable between Portpatrick and Donaghadee—its failure — 84 Dover and Ostend — 85 Portpatrick and Donaghadee — 86 Orfordness and the Hague

67 The wires of the Magnetic Telegraph Company are laid and protected in the following manner.

THE ELECTRIC TELEGRAPH

Ten conducting wires are enveloped in a covering of gutta serena, so as to be completely separated one from another. If prepared they are deposited in a square creased wooden tray measuring three inches in the side, so that nearly a square of its cross section is allowed for each of the wires. The tray is deposited on the bottom of a trench cut two feet deep, on one side of the common coach road. A galvanic iron nail, of an eighth of an inch thick, is then fastened on by cheap center hooks, and the trench filled in.

A section of the trough in its actual position is given in figure 21.

Fig. 21—Galvanic deposit of Gutta Serena from Wire Case

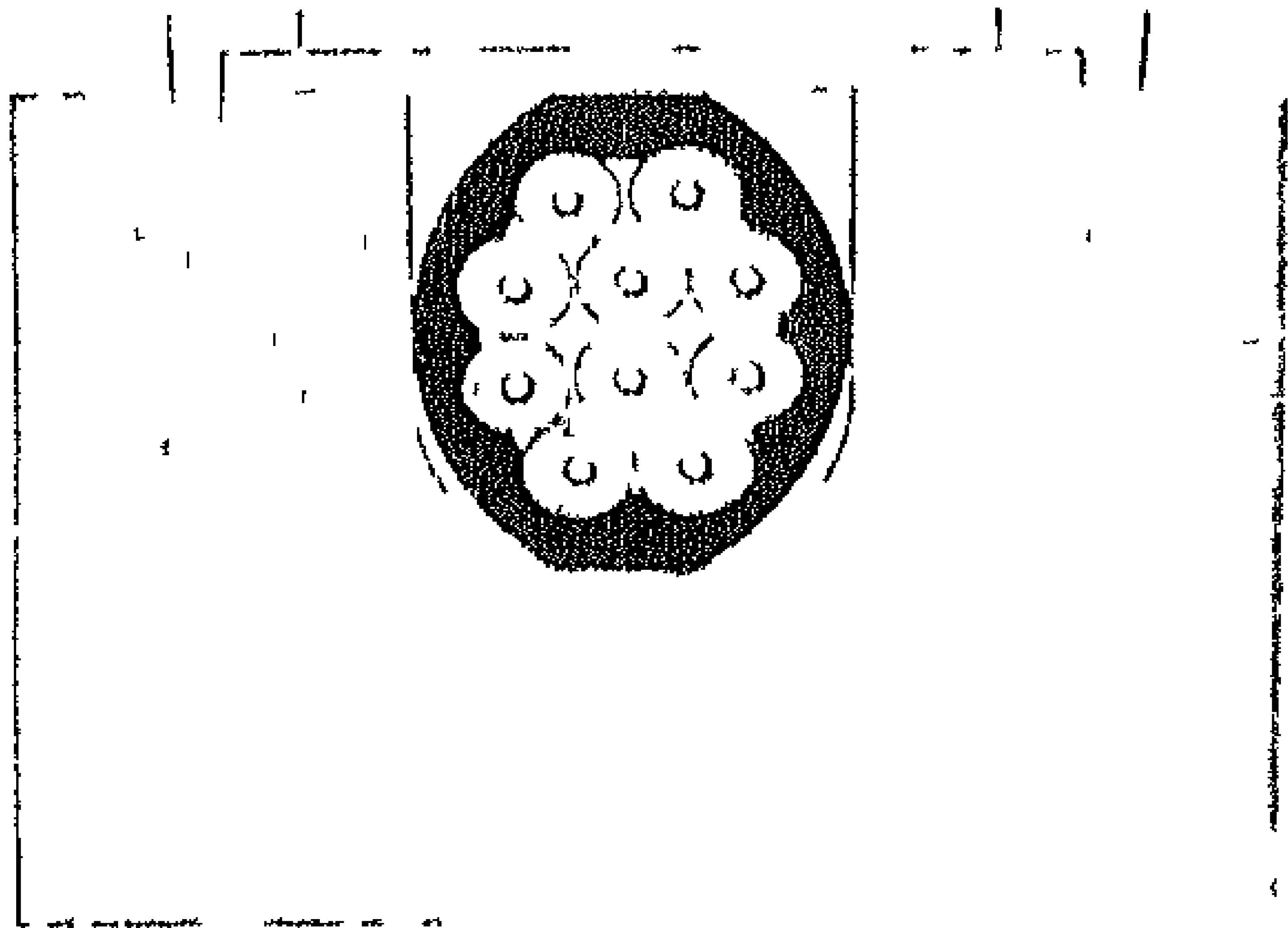

Cross-section of wire case

The method of laying the wires in the street is adopted by the company is a little different. In this case iron pipe case is used, they are split longitudinally. The under halves are laid in the trench, and the gutta serena covered wire is hung on the upper halves of the pipe and secured in their places by means of screws through flanges left out side of the pipe case.

To deposit the tops of gutta serena covered wire through the trough it is first coiled upon a large drum, which is then rolled along slowly and uniformly over the trench, the tops of wires are payed off easily and evenly into its bed.

So well has this method of laying the wires been adopted that at Liverpool the entire distance along the streets from Whitehall to

UNDERGROUND WIRLS

Railway station to the Telegraph Company's offices in Exchange Street, East, was laid in eleven hours, and in Manchester the line of streets from the Salford Railway station to Ducie Street, Exchange, was laid in twenty-two hours. This was the entire time occupied in opening the trenches, laying down the telegraph wires, refilling the trenches and relaying the pavement.

68 One of the objections against the underground system of conducting wires, was, that while they offered no certain guarantee against the accidental occurrence of faulty points where their insulation might be rendered imperfect, and where, therefore, the current would escape to the earth, they rendered the detection of such faulty points extremely difficult. To ascertain their position required a tedious process of trial to be made from one testing post to another, over an indefinite extent of the line.

A remedy for this serious inconvenience, and a ready and certain method of ascertaining the exact place of such points of fault without leaving the chief, or other station at which the agent may happen to be, has been invented and patented by the Messrs. Bright of the Magnetic Telegraph Company.

Instruments called Galvanometers, which will be more fully described hereafter, are constructed, by which the relative intensity of electric currents is measured by their effect in deflecting a magnetic needle from its position of rest. The currents which most deflect the needle have the greatest intensity, and currents which equally deflect it have equal intensities.

The intensity of a current diminishes as the length of the conducting wire—measured from the pole of the battery to the point where it enters the earth—is augmented. Thus, if this length be increased from twenty miles to forty miles, the intensity of the current will be decreased one half.

The intensity of the current is also decreased by decreasing the thickness of the conducting wire. Thus the intensity, when transmitted on a very thin wire, will be much less than when transmitted on a thick wire of equal length, but the thick wire may be so much longer than the thin that its length will compensate for its thickness, and the intensity of the current transmitted upon it may be equal to that transmitted on the shorter and thinner wire.

The method of Messrs. Bright is founded upon this property of currents. A fine wire wrapped with silk or cotton so as to insulate it and prevent the lateral escape of the current, is rolled upon a bobbin like a spool of cotton used for needle-work. A considerable length of fine wire is thus comprised in a very small bulk.

The wire on such a bobbin being connected by one end with the wire conducting a current, and by the other end with the earth,

THE ELECTRIC TELEGRAPH

will transmit the current with a certain intensity depending on its length, its thickness, and, in fine, on the conducting power of the metal of which it is made

Now let us suppose that a certain length of the wire of the telegraphic line be taken, which will transmit a current of the same intensity. A galvanometer placed in each circuit will then be equally deflected. But if the length of the line were less or greater than the exact equivalent length, the galvanometer will be more or less deflected by it than it is by the bobbin wire, according as its length is less or greater.

It is, therefore, always possible by trial to ascertain the length of line wire, which will give the current the same intensity as that which it has upon any proposed bobbin wire.

Bobbins may therefore be evidently made carrying greater or less lengths of wire upon which the current will have the same intensity as it has upon various lengths of line wire.

Suppose then a series of bobbins provided, which in this case represent various lengths of line wire from 100 feet to 300 miles, and let means be provided of placing them in metallic connection in convenient cases.

Such an apparatus is that by which the Messrs. Bright detect the points of fault.

Let n be the station battery, g a galvanometer upon the line wire, i the point of fault at which the current escapes to the

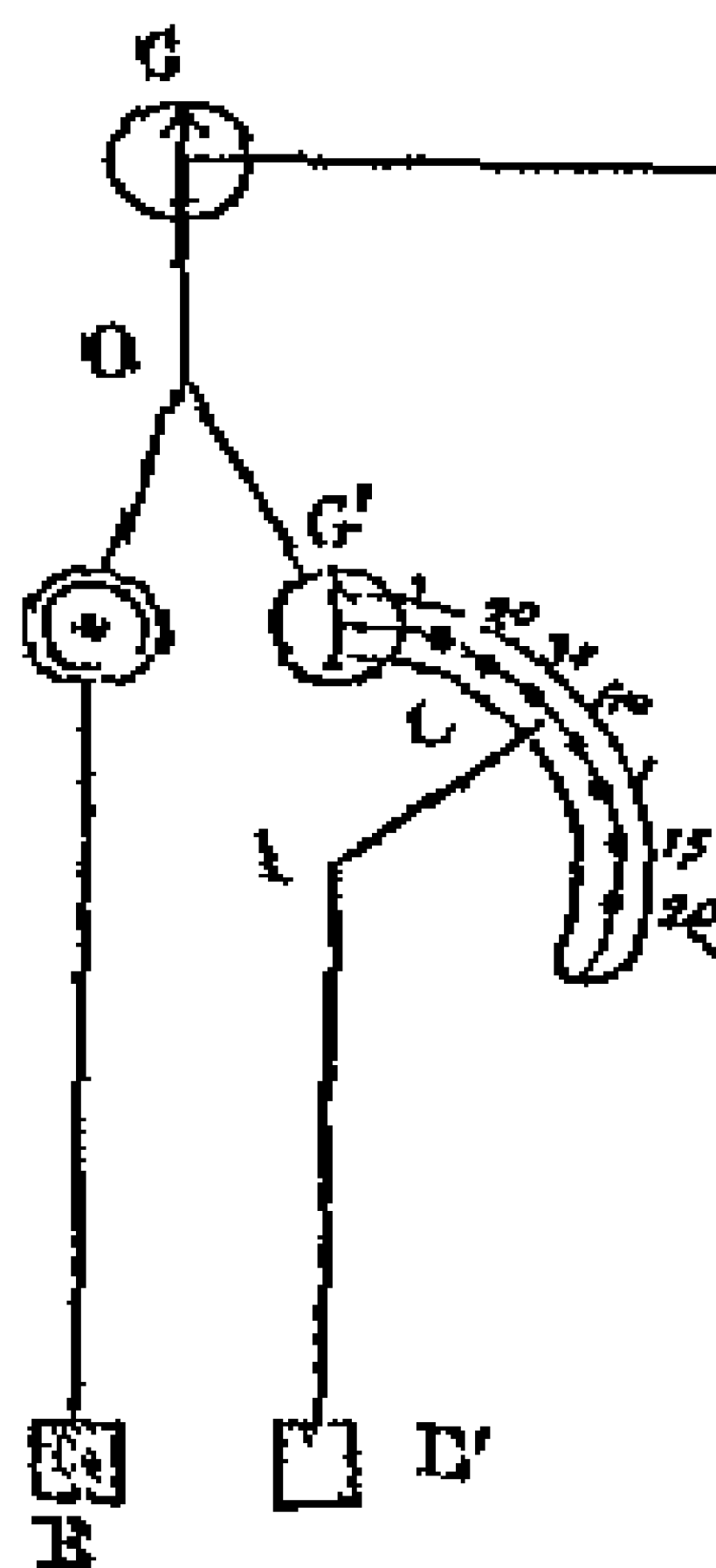

Fig 91

earth, in consequence of an accidental defect of the insulation. Let a wire be attached to the line wire of the station, at o , and let it be connected with the first of a series of bobbins such as are described above, let a galvanometer, similar to g , be placed upon it at g' . Let a metallic arm c , turning on the point v , be so placed that its extremity c shall move over the series of bobbins, and that by moving it upon the centre v , the end c may be placed in connection with the wire of any bobbin of the series. Let v be connected by a conducting wire with the earth at e' , the negative pole of the battery n being connected with the earth at e .

The apparatus being thus arranged, let us suppose that the wire a o is placed in connection with the first bobbin, representing 10 miles of the line wire, and that the distance o i of the point of fault is 145 miles. In that case the battery current will be

DETECTOR OF FAULTS

divided at o , between the two wires $o\ g$ and $o\ g'$, but the chief part will flow by the shortest and easiest route, and the galvanometer g' will be very much, and g very little, deflected. This will show that i must be very much more than 10 miles from the station. The arm ac will then be turned successively from bobbin to bobbin. When directed to the second bobbin, the current on $o\ g'$ will have the same intensity as if it flowed on 20 miles of line wire, when turned to the third the same as if it flowed on 30 miles of line wire, and so on. The needle of g' will, therefore, continue to be more deflected than that of g , although the difference will be less and less, as the number of bobbins brought into the circuit is increased. When the bobbins included represent 110 miles, g' will be a little more, and when they represent 150 miles it will be a little less deflected than g , from which it will be inferred that the point of fault lies between the 110th and the 150th mile from the station. A closer approximation may then be made by the introduction of shorter bobbins, and this process may be continued until the place of the fault has been discovered with all the accuracy necessary for practical purposes.

69 It appears nevertheless, that in the practical working of the telegraphic lines, occasions for the application of these expedients are of extremely rare occurrence. During the four winter months of November, December, January, and February 1853-54, distances of 300 miles of underground wire, without any break of circuit, have been in constant operation under the Magnetic Telegraphic Company, and notwithstanding an unusual prevalence of unfavourable weather, with frequent and continued snow-storms, no stoppage whatever has taken place.

70 The Prussian underground lines of wire have been attended, however, with occasional failures, which have produced some public inconvenience. This circumstance has been ascribed to the faulty method of laying the wires. The gutta-percha enveloping them was mixed with sulphur, a process called *Fulcanisation*. Upon being deposited in the ground the sulphur was soon abstracted, leaving the gutta-percha brittle and porous.

71 The under-ground line of the European and Submarine Company, from London to Dover, is laid down in nearly the same manner as that of the Magnetic Company. There are six conducting copper wires encased in gutta-percha. To detect the more easily the place of any accidental breach of continuity, a box is placed at the end of each mile, in which a few yards of the continuous line of wire are coiled, so that in case of any accidental interruption occurring to the flow of the current, the particular mile in which that interruption exists can always be ascertained by putting the coils at the end of each successive mile in

THE ELECTRIC TELEGRAPH

connection with a portable battery. The current will fail at the particular mile within which the fault has taken place.

72 In passing through tunnels the overground wires have been subject to great inconvenience, owing to the quantity of water percolating through the roof, constantly falling on the wires and their supports, and thus injuring their insulation. It has been found that from this cause the current transmitted along one wire has been subject to leakages, a part of it passing by the moisture which surrounds the supports to an adjacent wire, so that being thus divided, part either returns to the station from which it has been transmitted, or goes on to a station for which it is not intended.

73 This inconvenience would be removed by adopting for tunnels the under-ground system. Mr Walker, to whom great experience in the practical business of electric telegraphy, and considerable scientific knowledge must give much authority on such a subject, has adopted apparently with very favourable results a method of covering the wires, which pass through tunnels, with a coating of gutta-percha. The conducting wire thus treated is copper wire No 16. The gum being well cleaned and macerated by steam, is put upon the wire by means of grooved rollers. The diameter of the covered wire is a quarter of an inch. Mr Walker states that in all the wet tunnels under his superintendence he has substituted this gutta-percha-covered wire for the common line wire, and has thus "accomplished telegraphic feats which could not have been attempted on the old plan."

74 In France and in the United States the wires, even in the cities and towns, are conducted on rollers at an elevation, as on other parts of the lines. In Paris, for example, the telegraphic wires proceeding from the several railway stations are carried round the external boulevards and along the quays, the rollers being attached either to posts or to the walls of houses or buildings, and are thus carried to the central station at the Ministry of the Interior.

75 In Europe, the telegraphic wires have until very lately invariably followed the course of railways, and this circumstance has led some to conclude that, but for the railways, the electric telegraph would be an unprofitable project.

76 This is however a mistake. Independently of the case of the Magnetic Telegraph Company already mentioned, the wires in the United States, where a much greater extent of electric telegraph has been erected and brought into operation than in Europe, do not follow the course of the railways. They are conducted, generally, along the sides of the common coach-roads, and sometimes even through tracts of country where no roads have been made.

POSTS AND WIRES ON COMMON ROADS

It has been contended in Europe that the wires would not be safe unless placed within the railway fences. The reply to this is, that they are found to be safe in the United States, where there is a much less efficient police, even in the neighbourhood of towns, and in most places no police at all. It may be observed, that the same apprehensions of the destructive propensities of the people have been advanced upon first proposing most of the great improvements which have signalised the present age. Thus, when railways were projected, it was objected that mischievous individuals would be continually tearing up the rails, and throwing obstructions on the road, which would render travelling so dangerous that the system would become impracticable.

When gas-lighting was proposed, it was objected that evil-disposed persons would be constantly cutting or breaking the pipes, and thus throwing whole towns into darkness.

Experience, nevertheless, has proved these apprehensions groundless, and certainly the result of the operations on the electric telegraph in the United States goes to establish the total inutilty of confining the course of the wires to railways. Those who have been practically conversant with the system both in Europe and in America, go further, and even maintain that the telegraph is subject to less inconvenience, that accidental defects are more easily made good, and that an efficient superintendence is more easily insured on common roads, according to the American system, than on railways.

These reasons, combined with the urgent necessity of extending the Electric Telegraph to places where railways have neither been constructed nor contemplated, have led to the general departure of the telegraphic wires from the lines of railway in various parts of the continent. In France, particularly, almost all the recently-constructed telegraphic network is spread over districts not intersected by railways, and even where railways prevail, the wires are often, by preference, carried along the common road.

77. When channels, straits, arms of the sea, or rivers of great width intervene between the successive points of a telegraphic line, the conducting wires are deposited upon the bottom of the water, protected from the effects of mechanical and chemical action by various ingenious expedients. A considerable number of such subaqueous conductors have been fabricated for telegraphic lines in various countries, and others are in progress or contemplated. Before June 1851, wire ropes had been made for the lines between Dover and Calais, Dover and Ostend, Dublin and Holyhead, Donaghadee and Portpatrick, England and Holland, the Zuyder Zee, the Great Belt (Denmark), the Mississippi, New Brunswick and Prince Edward's Island, and Piedmont and Corsica.

THE ELECTRIC TELEGRAPH

78 The earliest attempt to transmit a voltaic current under water for telegraphic purposes, is attributed to Dr. O'Shaughnessy, who is so well known for his successful exertions to establish the electric telegraph in India. He succeeded in 1839 in depositing an insulated conducting wire, attached to a chain cable, in the river Hoogly, by which the electric current was transmitted from one bank of that river to the other.

The first important project of this kind which was executed in Europe, was the connection of the coasts of England and France by the submarine cable, deposited in the bed of the channel between Dover and Calais. A concession being obtained from the French government on certain conditions, a single conducting wire, invested with a thick coating of gutta-percha, was sunk by means of leaden weights across the channel, and the extremities being put into connection with telegraphic instruments, messages were transmitted from coast to coast. One of the conditions of the French concession being that this should be effected before September, 1850, this object was attained, but nothing more, for the action of the waves near the shore constantly rubbing the rope against the rocky bottom, soon wore off the insulating envelope and rendered the cable useless.

79 It is right to state that the projectors themselves did not expect from this first trial permanent success, and regarded it merely as the experimental test of the practicability of the enterprise. It was, therefore, immediately resolved to resort to means for the effectual protection of the conducting wires from the effects of all the vicissitudes to which they would be exposed. With this view, Messrs. Newall and Co., the eminent wire-rope makers of Gateshead, were charged with the difficult and unprecedented task of discovering expedients, by which a cable of gutta-percha containing the conducting wires could be invested with an armour of iron, at the same time so strong as to resist the action of the forces to which it would be exposed, and yet not too ponderous or too rigid to allow of being deposited in the bed of the channel. The result was the invention of the form of submarine cable, which has since been successfully adopted upon the various lines of international electric communication which will be presently described.

The conducting wires inclosed in these cables are usually copper wires, having a diameter of the sixteenth of an inch. Each wire is first separately covered with two coatings of gutta-percha. Each successive coating increases the thickness by a certain fraction of an inch. The object of laying on this succession of coats of the gum, is to guard against accidental defects which might render the insulation imperfect. If such a

SUBMARINE CABLES

defect happened to exist at any point of the first coat it would be covered by the second, the chances against a defect occurring at the same point of both coatings amounting to an impossibility

80 The conducting wire thus invested, or so many of them as it is intended to deposit, are then twisted together, and surrounded with a mass of spun yarn, soaked with grease and tar, so as to form a compact rope. Around this rope are then twisted a number of stout iron wires, sometimes coated on the surface with zinc, or as it has been called, galvanised. The cable is then complete, and is fabricated in one continued length sufficient to extend from shore to shore, or from bank to bank. Perspective side views of the several cables, and transverse sections of them in their full size, are given in the figures indicated in the first column of the following table, the number of conducting wires insulated by the gutta-percha and included within the cables, the number of surrounding iron wires, the total length from coast to coast, and the weight of the cables per mile respectively being indicated in the other columns.

	FIGS	No of cop per wires	No of iron wires	Total length —Miles	Weight per mile—Tons
Dover and Calais	25, 26	1	10	25	7
Holyhead and Howth	27, 28	1	12	70	1
Dover and Ostend	31, 32	6	12	70	7
Portpatrick and Donaghadee (Magnetic Comp)	35, 36	6	12	20	7
Oxfordness and the Hague	37, 38	1	10	135	2
Across the Great Belt (Denmark)	11, 12	3	9	16	5
Across the Mississippi	15, 16	1	8	2	2
Across the Zuyder Zee	13, 14	6	10	5	7½
Newfoundland & Prince Edward's Island	39, 40	1	9	150	1½
Portpatrick and Donaghadee (British Comp)	35, 36	6	12	27	7
Spezia and Corsica	35, 36	6	12	110	8
Corsica and Sardinia	35, 36	6	12		8

THE ELECTRIC TELEGRAPH

Fig. 25

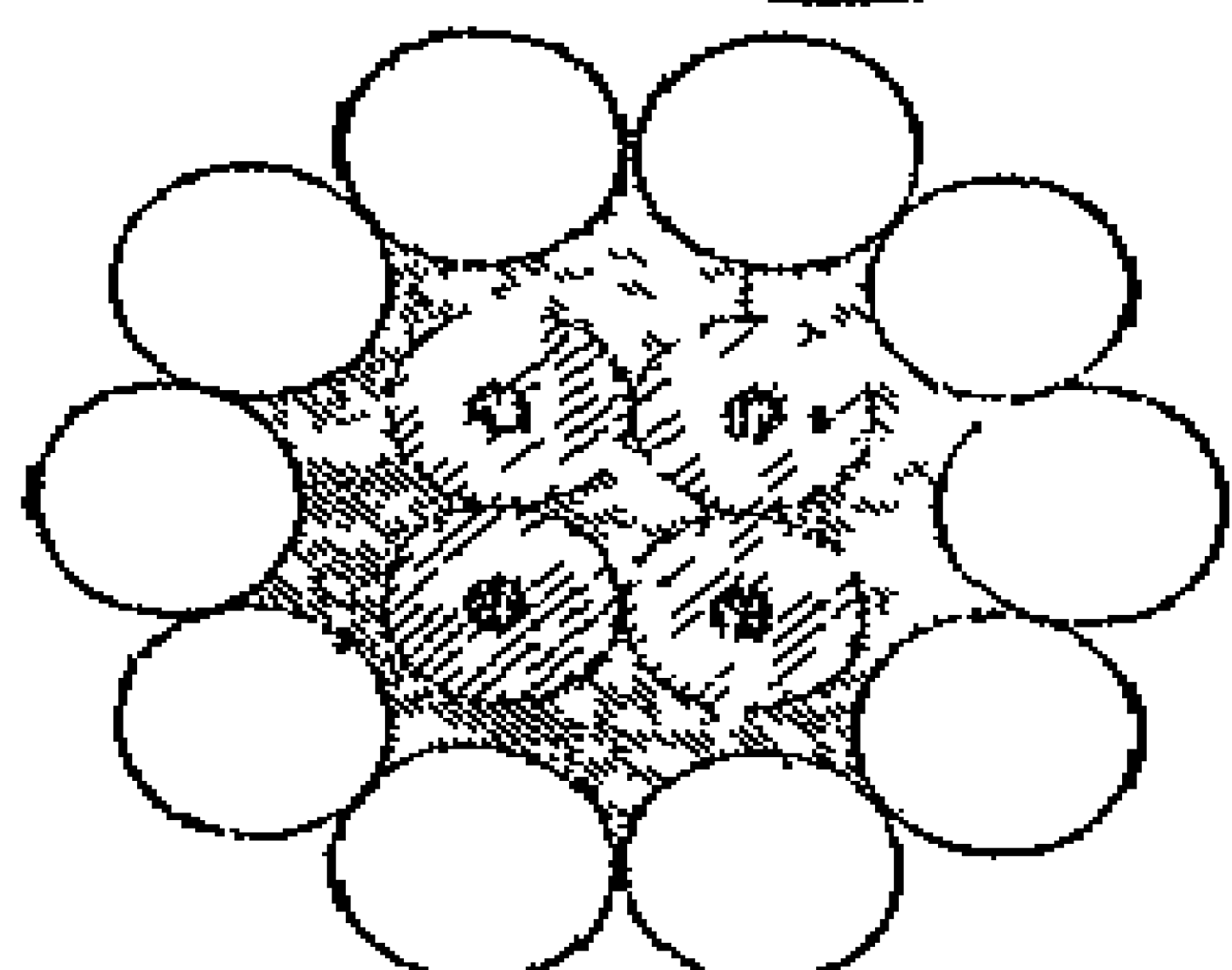
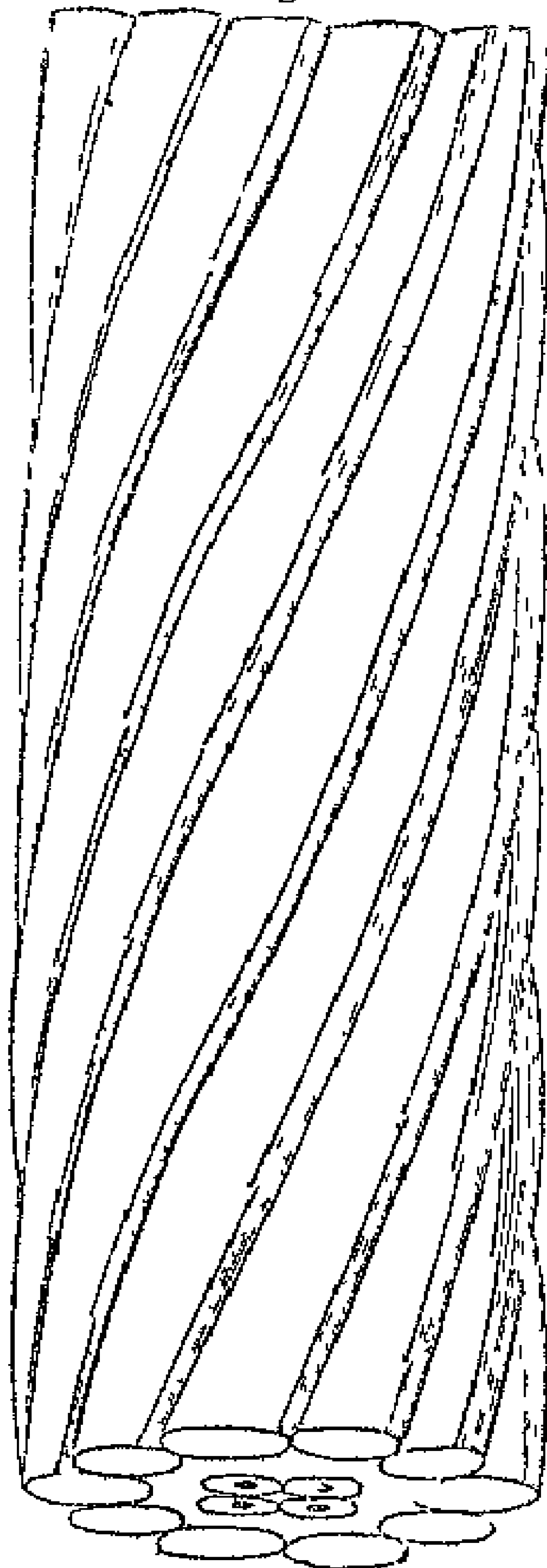

Fig. 26 —Dover and Calais

81 In the Dover and Calais cable, which was the first fabricated and laid, each of the four copper wires are surrounded by gutta-percha, which in fig 26 is indicated by the light shading round the black central spot, representing the section of the copper wire. The four wires thus prepared were then enveloped in the general mass of prepared gun yarn, represented by the darker shading. The ten galvanised iron wires were then twisted around the whole, so as to form a complete and close armour. The external form and appearance of this helical coating is represented in fig 25.

This cable which was completed by Messrs Newall and Co, in three weeks, measured originally 21 miles in length. Owing to the manner in which it was laid down this was found insufficient to extend from coast to coast, although the direct distance is only 21 miles. It was therefore found necessary to manufacture an additional mile of cable, which being spliced on to the part laid, the whole was completed, and the electric communication between Dover and Calais definitively established on the 17th October, 1851.

The cost of the cable itself was 9000*l*, being at the rate of 360*l* per mile. The total cost for cable and stations at Dover and Calais was 10,000*l*.

82 The next submarine cable laid down was that which connected Holyhead on the Welsh with Howth on the Irish coast. While several companies which had been formed for the purpose, were occupied in raising the capital necessary for the project, they were surprised by the

SUBMARINE CABLES.

announcement that the project was already on the point of being realised by Messrs Newall and Co, on their own account

The distance between the points to be connected being 60 miles, the cable was made with a length of 10 additional miles, to meet contingencies

In this cable, which enclosed only one conducting wire, the external wires enclosing the insulating rope were made thicker at the parts near the shores than for that which lies in deep water, the former being subject to much greater disturbing forces. A side view of the part immersed in deep water is given in fig 27, and a cross-section in fig 28. A side view of the shore ends is given in fig 29, and a cross-section in fig 30, all being in their full size.

The gutta-percha rope was fabricated by the Gutta Percha Company in the City-road, London, from whence it was sent to Gateshead, where it received the iron wire envelope at the works of Messrs Newall and Co, in the short space of four weeks. Loaded on twenty waggons, it was next sent by railway across England to Marseport, where it was embarked on board the "Britannia," and transported to Holyhead. On the morning of the 1st June, 1852, one of its extremities being established at Holyhead, it was laid in the bed of the channel. This was done as follows — The cable was very carefully coiled in the hold of the steamer, one end was then passed several times round a brake-wheel, and was conveyed on shore, when it was attached to a telegraph instrument. The other or lower end of the cable was attached to another instrument in the cabin of the steamer, so that any message passing from instrument to instrument, was conveyed through the entire



Fig 28
Holyhead and
Howth
Deep sea part

instrument

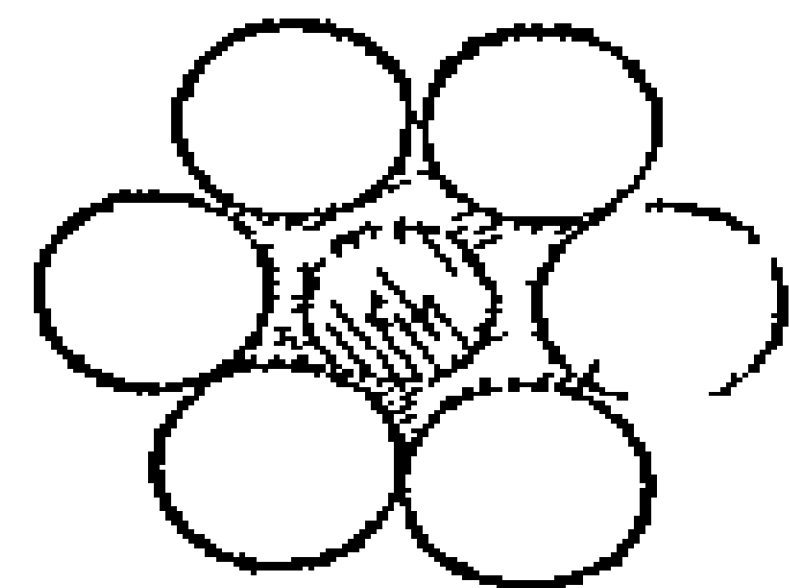
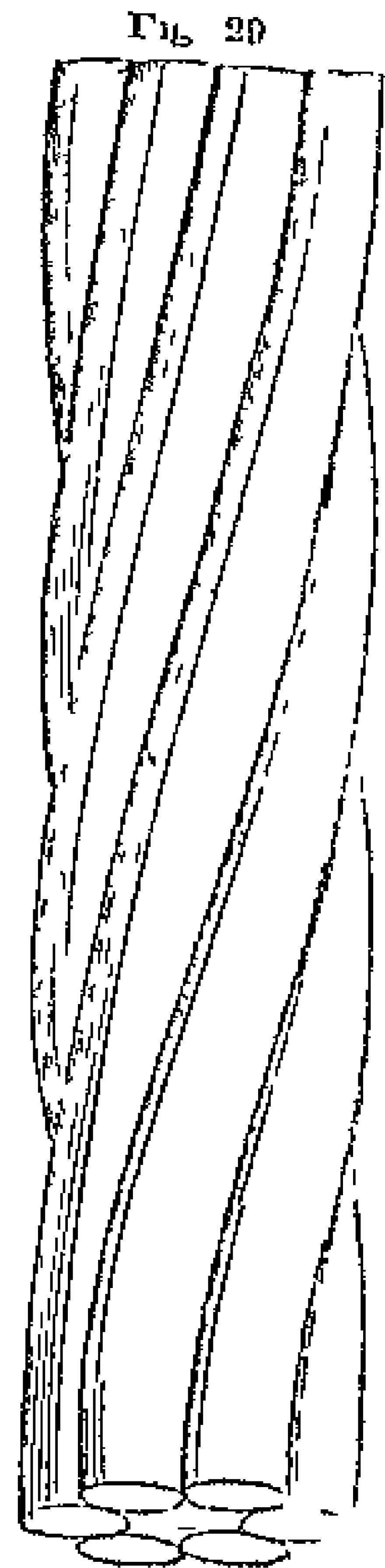

Fig 30
Holyhead and
Howth
Shore ends

THE ELECTRIC TELEGRAPH

cable in the hold, and round the brake-wheel as the cable paid out off in the process of submersion. The shore end having been made fast securely, the steamer was put in motion, and a certain strain was put on the cable by means of the brake-wheel, so that it was laid straight on the ground, or bottom of the sea.

The cable is seen as it rises from the hold in the foreground, (fig 34, p 115,) guided between rollers to the drum, and it again appears in the back ground, as it passes over the stern. A counter and indicator was applied to the shaft of the drum by which the length of cable which at any moment had been delivered off into the sea was shown.

The wind and tides have the effect of drawing the vessel out of her course, so that the quantity of cable expended must always be greater than the distance between the two points in a straight line. In the case of the Holyhead and Howth cable, the quantity expended was 64 miles. The depth of water is 70 fathoms, being more than twice that of Dover.

The entire process of laying it down was completed in 18 hours. In another hour the cable was brought ashore, and put in connection with the telegraphic wires between Howth and Dublin, and immediately afterwards London and Dublin were connected by means of instantaneous communication.

This cable was lighter considerably than that between Dover and Calais, its weight being a little less than one ton per mile, and consequently its total weight did not exceed 80 tons, while the Dover and Calais cable weighing 7 tons per mile, its total weight was 180 tons.

From some cause, which could not be ascertained, this cable, after being worked for three days, became imperfect. It was supposed to have been caught by the anchor of some vessel, for on being taken up lately, it was found broken near Howth, and the gutta percha and copper wire stretched in an extraordinary manner.

83 On the 9th October, 1851, Messrs Newall and Co attempted to lay a cable across the narrowest part of the Irish channel, between Port Patrick and Donaghadee. This cable contained six conducting wires, similar to fig 43. The distance across is the same as between Dover and Calais, viz, 21 miles, and 25 miles of cable were placed on board the "Britannia" steamer. The process of submersion was carried on until 16 miles had been successfully laid down, when a sudden gale came on, which rendered it impossible to steer the vessel in the proper course, and Mr Newall was reluctantly compelled to cut the cable, when within 7 miles of the Irish coast, and having 9 miles of cable remaining on board.

The whole of this 16 miles of cable has been recovered in

SUBMARINE CABLES

June, 1851, after being nearly two years submerged. This proved a most arduous undertaking. The depth of the water in this part of the Irish channel is 100 fathoms, or 900 feet, and from this depth the cable was dragged by means of a powerful apparatus worked by a steam engine placed on the deck of a steamer. The operation occupied four days, for from the great force of the tide, which runs at the rate of 6 miles an hour, it was found impossible to work except at the times of high and low water. The cable was also imbedded in sand, so that the strain required to drag it up was occasionally very great.

The recovery of this cable has so far solved the question of the durability of submarine telegraphs. It was found nearly as sound as when laid down. There was a slight corrosion in certain parts which appeared to have been imbedded in decaying sea weed—the parts imbedded in sand were quite sound, and on other parts, which appeared to have rested on a hard bottom, there were a few zoophytes. The cable on being tested was found as perfect in insulation as when laid down.

81 The next great enterprise of this kind, of which the accomplishment must render for ever memorable the age we have the good fortune to live in, was the deposition in the bed of the Channel of a like cable connecting the coasts of England and Belgium, measuring SEVENTY MILES IN ONE UNBROKEN LENGTH! This colossal rope of metal and gutta-percha was also constructed at the works of Messrs Newall and Co.

The probable extension of these extraordinary media of social, commercial, and political communication between countries separated by arms of the sea, may be conceived, when it is stated that during the winter of 1852-53 Messrs Newall and Co executed under contracts not less than 150 miles of such cable.

The cable laid between Dover and Calais includes, as already stated, four conducting wires. That between Dover and Ostend contains six wires insulated by the double covering of gutta-percha, manufactured, under Mr S Statham's directions, by the Gutta Percha Company. The gutta-percha laid into a rope is served with prepared spun-yarn, and covered with twelve thick iron wires, of a united strength equal to a strain of 10 to 50 tons—more than the proof strain of the chain cable of a first rate man-of-war.

A side view and section of this cable in its natural size are given in figs 31 and 32 (page 158).

The Belgian cable weighed 7 tons per mile, so that its total weight was about 500 tons. Its cost was 33,000*l*. It took 100 days to make it, and 70 hours to coil it into the vessel from which it was let down into the sea, and 18 hours to submerge it.

THE ELECTRIC TELEGRAPH

Fig 31

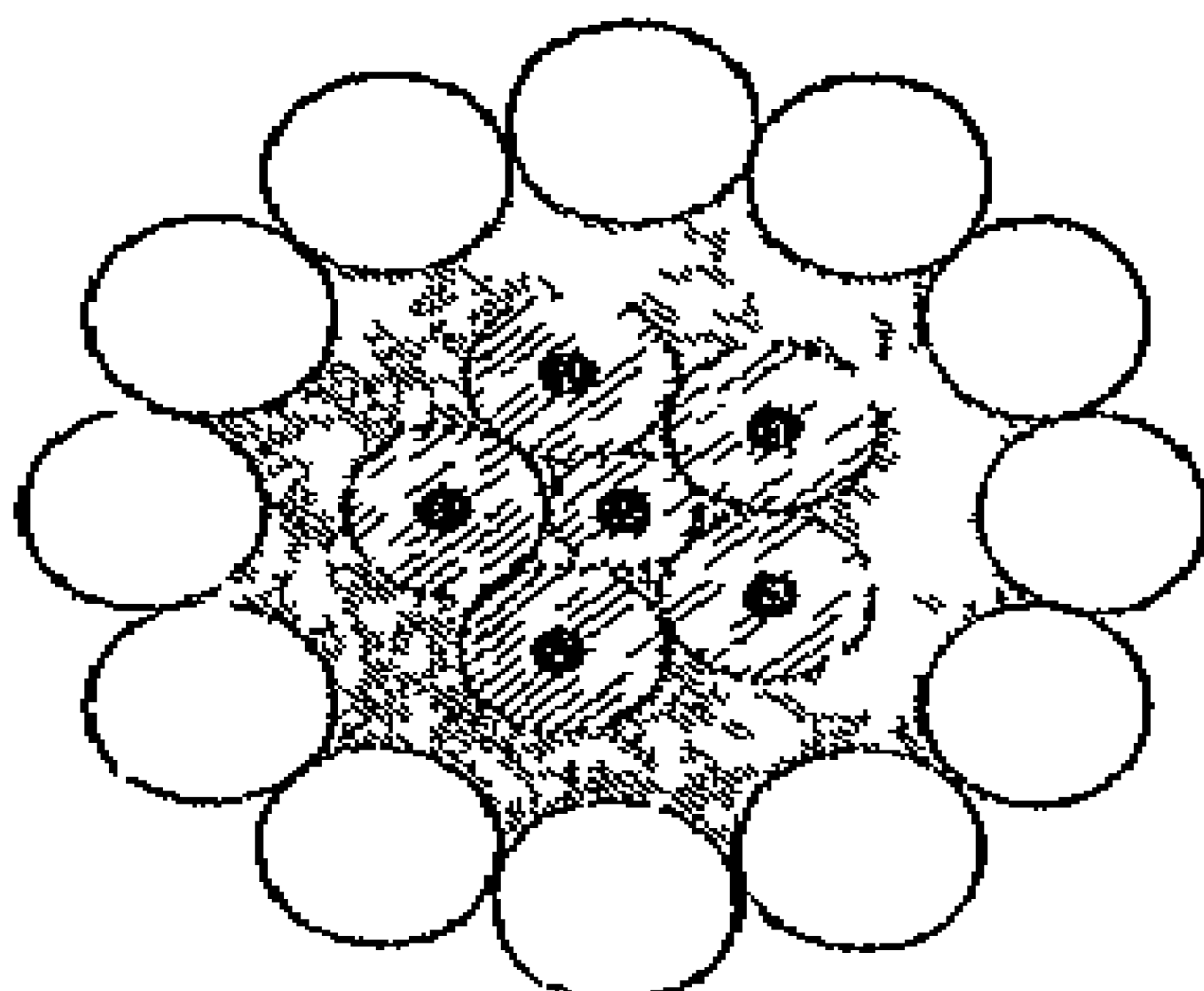
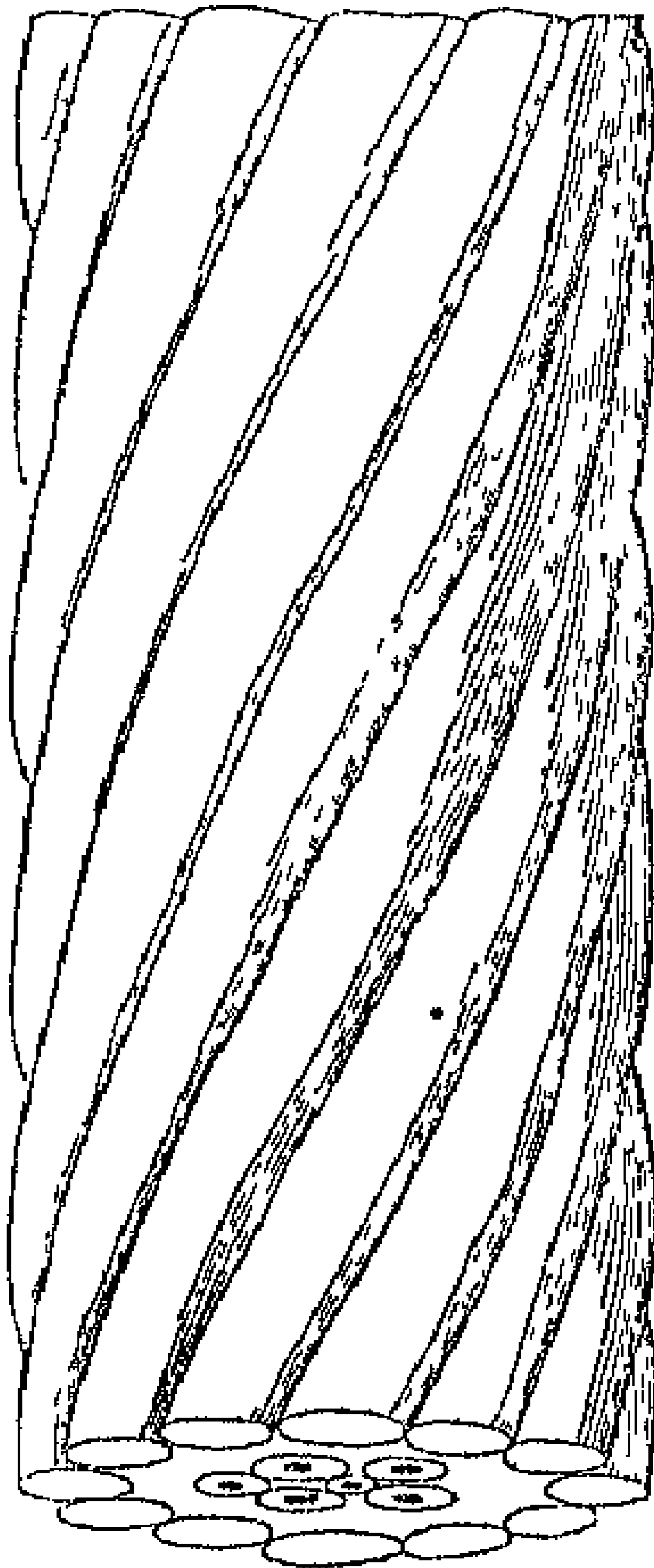

Fig 30 —Dover and Ostend
158

The form in which it was coiled in the hold of the vessel is represented in fig 33 (p 129) *

On the morning of the Wednesday, the 4th May 1853, the vessel called the "William Hutt," Capt Palmer, freighted with the cable, being anchored off Dover, near St Margaret's, South Foreland, the process of laying the cable was commenced. This vessel was attended and aided by H M S "Lizard," Capt Rickots, R N, and H M S "Vivid," Capt Smithott. Capt Washington, R N, was appointed, on the part of the Admiralty, to mark out the line and direct the expedition.

At dawn of day about 200 yards of the cable were given out from the "Hutt," and were extended by small boats to the shore, where the extremity was deposited in a cave at the foot of the cliff. There telegraphic instruments were provided by means of which, through the cable itself, a constant communication with the vessel was maintained during the arduous process, corresponding telegraphic instruments being placed on board the "Hutt."

At 6 o'clock, the process of laying commenced, the "Hutt" being taken in tow by the steam tug "Lord Warden."

The manner in which the cable was "payed out," as the vessel proceeded in its course, is represented in fig 31 (p 149), the cable as it came up from the hold, being

* This illustration, as well as that of the deposition of the cable, have been taken from the *Illustrated London News* of the 11th of May, 1853, by the consent of the publishers of that journal.

SUBMARINE CABLES

passed several times round a large brake-wheel, by means of which the cable was kept from going out too fast, and its motion maintained so as to be equal to the progress of the vessel. Men are represented in the figure applying the brake to the wheel.

On arriving off Middlecote, on the Belgian coast, a boat sent from shore took from 500 to 700 yards of the cable on board, for the purpose of landing it. The boats of the British vessels taking her in tow, the end of the cable was safely landed, and deposited in a guard-house of the Custom House, where the telegraphic instruments brought in the "Hut" being erected, and the communications made, the following despatch was transmitted direct to London —

*Union of Belgium and England,
twenty minutes before one, p m 6th
May 1853*

80 The next submarine cable laid, was that of the Magnetic Telegraph Company, connecting Donaghadee with Port Patrick, also manufactured by Messrs Nowall and Co.

This cable, which contains six conducting wires, is represented in its proper section in figs 35, 36, and corresponds in weight and form to the Belgian cable. But in the details of its construction and composition, some improvements were introduced. This rope was manufactured in 21 days, and cost about 13,000/.

The cable laid down by the British Telegraph Company between the same points, is precisely similar to this.

86 It is proposed to connect Orfordness, on the Suffolk coast, with the Hague, by seven separate submarine cables, each containing a

Fig 32

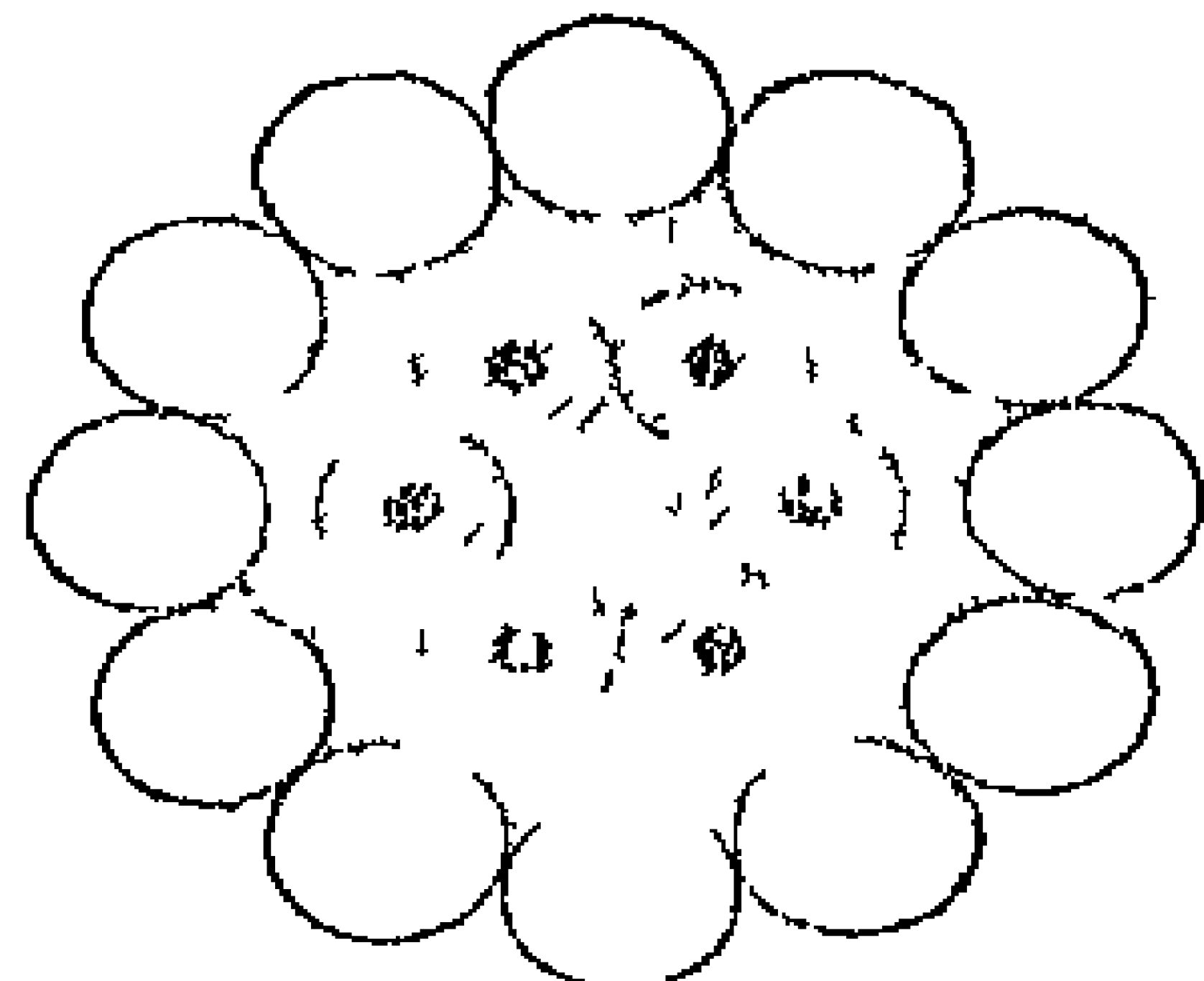
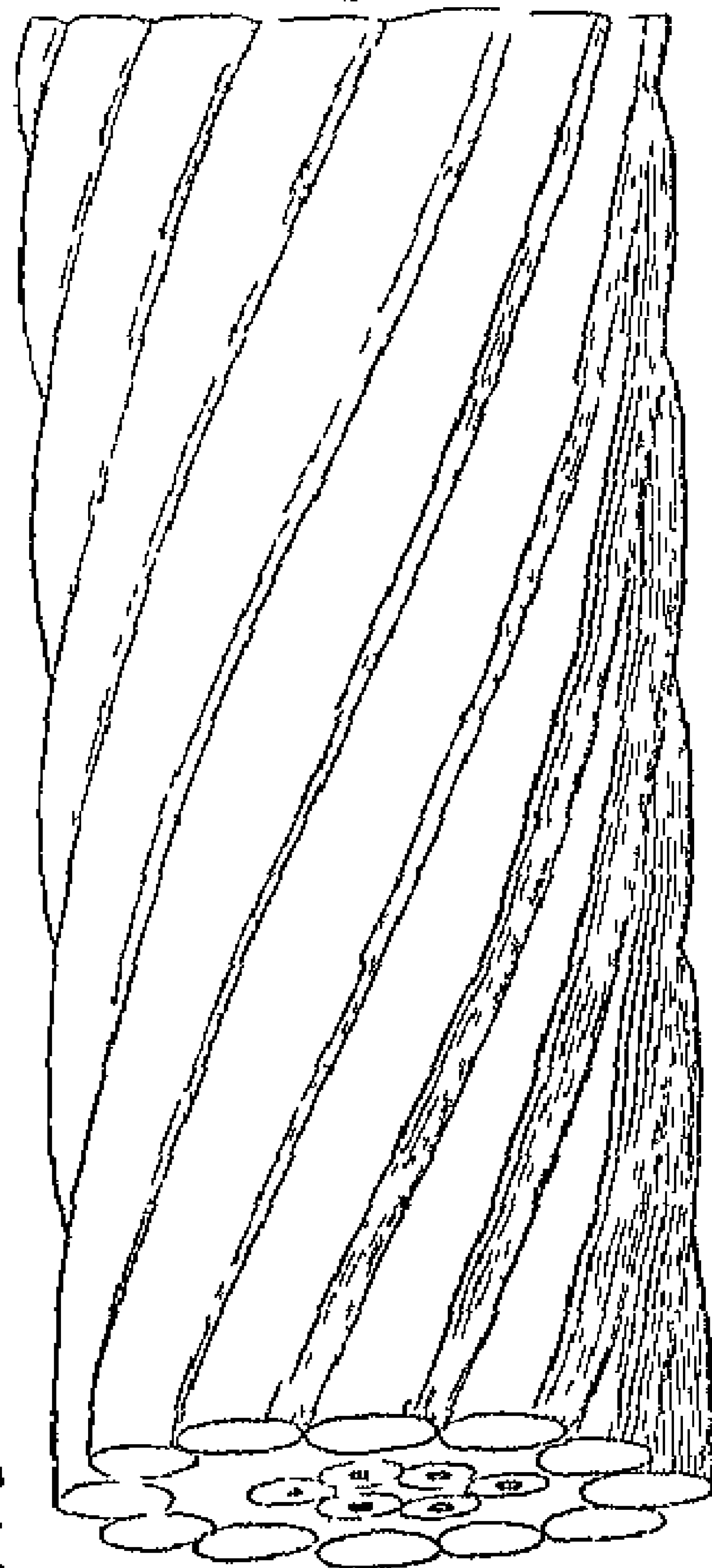

Fig 36 — Donaghadee and Portpatrick
(Magnetic Telegraph Company)

Fig 37

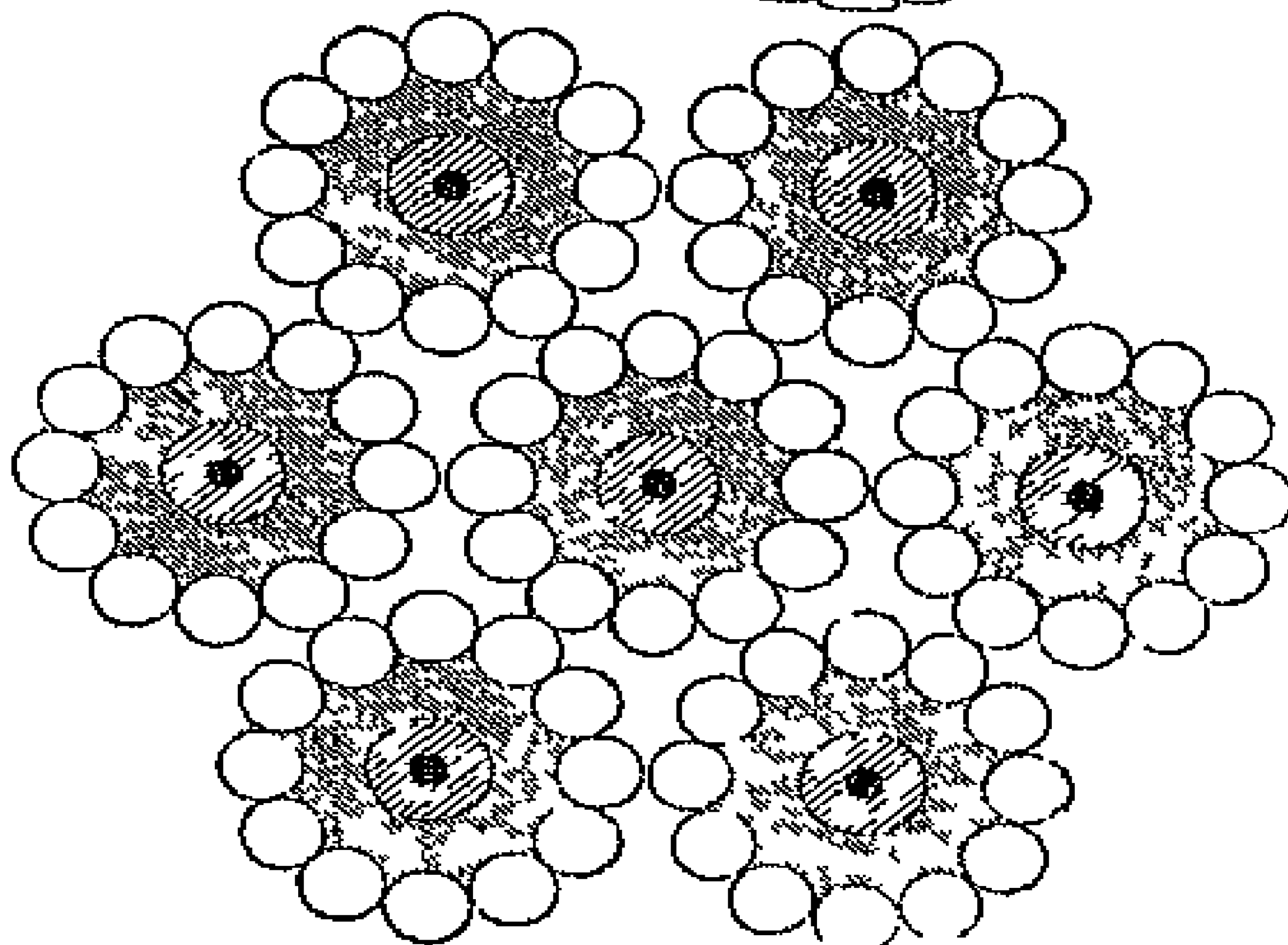
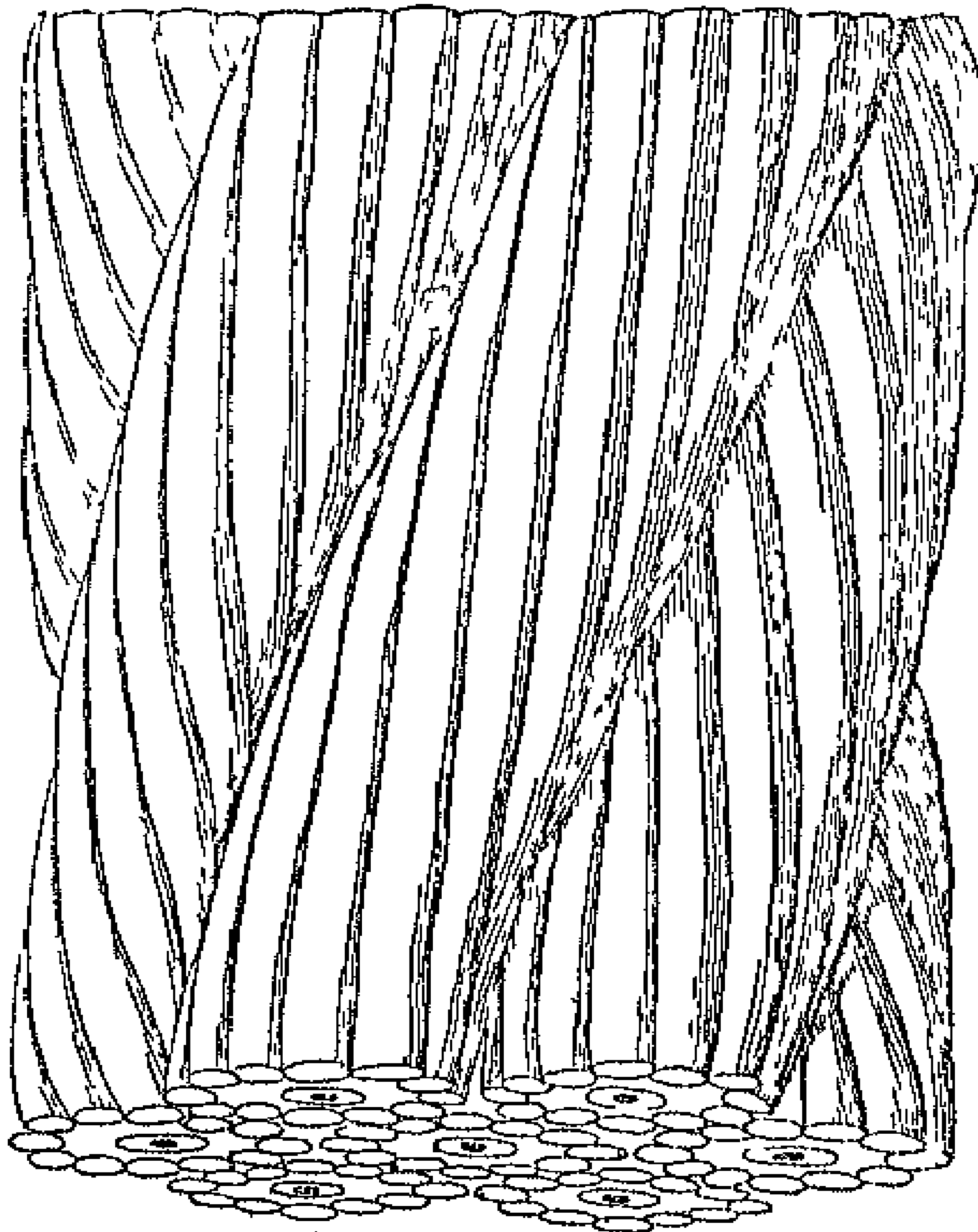

Fig 38 — Orfordness and the Hague

single wire. Near the shore on each side these will be brought together and twisted into a single great cable, as represented in figs 37, 38.

Of these, only three have been laid down. The distance from Orfordness to the Hague being 120 miles, the cables were made 135 miles in length. They were laid down separately at a little distance one from another. At 34 miles from the shore they were brought together. When the telegraphic business increases the other four will be deposited.

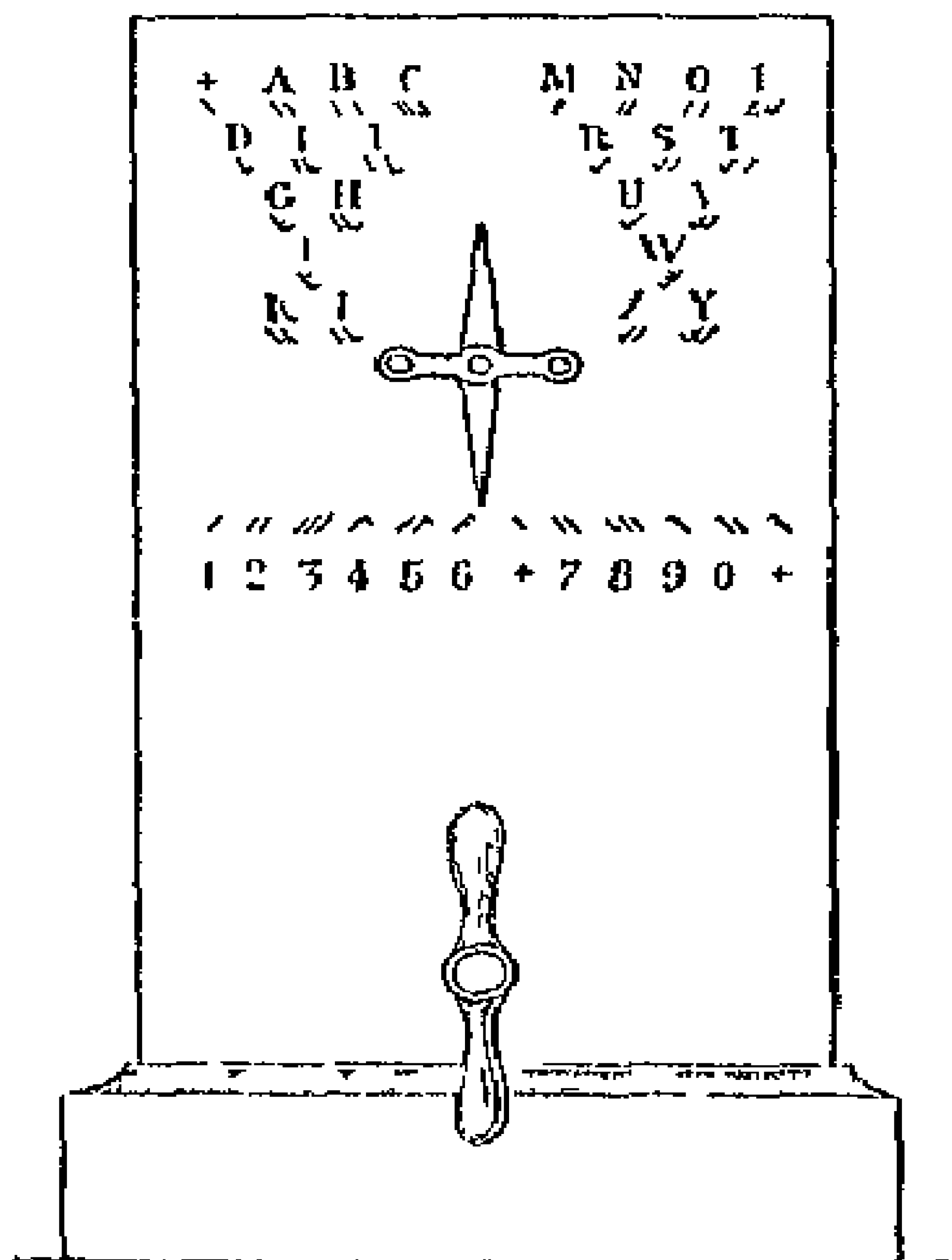

Fig. 68.—THE SINGLE NEEDLE TELEGRAPH.

THE ELECTRIC TELEGRAPH

CHAPTER IV

- 87 —Cable between Spezia and Corsica —88 Other cables, European and American —89 Objections brought by scientific authorities to the submarine cables—Answers to these by practical men —90 Example of a cable uninjured by the action of the sea —91 Precautions necessary in laying the cable —92 Accident in laying the Calais cable —93 Imperfection attributed to the Belgian cable —94 Transatlantic Ocean Telegraph —95 Underground wires between the Strand and Lothbury —96 Effect of the inductive action of underground or submarine wires —97 Possible influence of this on telegraphic operations —98 Examples of overground wires extended to great distances without intermediate support—between Turin and Genoa —99 Telegraphic lines in India —100 Difficulties arising from atmospheric electricity—height and distance of posts—mode of laying underground wires—extent of line erected to April 1851 —101 Intensity of current decreases as the length of wire increases —102 Also increases with the thickness of the wire —103 And with the number of elements in the battery —104 Result of Pouillet's experiments on the intensity of current —105 Intensity produced by

THE ELECTRIC TELEGRAPH

increasing the power of the battery —106 How the current produced telegraphic signals —107 Velocity of the current —108 Transmission of signals instantaneous

87 It is proposed to connect Europe with the islands of the Mediterranean and the African continent, by extending the wires which are already run continuously to Genoa from the United Kingdom and the Northern States of Europe to Spezzia, and from that point to lay a submarine cable to Corsica, another between Corsica and Sardinia, and another between Sardinia and Bona. The latter place would be connected with Alexandria by underground wires extending along the coast.

It is even regarded as within the scope of probability that Alexandria may be put in electrical connection with Bombay, and as the latter place is already connected by a telegraphic line with Calcutta, a continuous line of communication between London and Calcutta would thus be established.

The distances between Spezzia and Bona on the coast of Algeria are —

Spezzia to Corsica (submarine)	Miles 76
Across Corsica (underground)	125
Corsica to Sardinia by the straits of Bonifacio (submarine)	7
Across Sardinia (underground)	203
Sardinia to Bona, on the coast of Algeria, (submarine) about	125
	530

There would thus be 208 miles of submarine cable in three lengths of 76, 7, and 125 miles, and 331 miles of overland wires necessary to connect the southern coast of Europe with the northern coast of Africa.

This is the proposed plan, and the cables from Spezzia to Corsica, and from Corsica to Sardinia are already laid and in operation; but it will be obvious on inspecting the map that the object would be attainable with a less extent of submarine cable by continuing the overland line to Piombino, in the Grand Duchy of Tuscany, connecting that place with the Island of Elba by a submarine cable of 8 or 10 miles, and connecting the westernmost point of Elba with Bastia, in Corsica, by another cable of 35 to 40 miles. This method would have the further advantage of including in the line several important places on the Italian coast, such as Carrara, Massa, Lucca, Pisa, and Leghorn.

A preference has been given to the course above described in consideration of the benefit conferred upon the company by the concession and guarantee granted by the government of Sardinia, which would not have been given had the other course been followed.

The cable now deposited contains six conducting wires, and is in all respects similar to that represented in figs 30, 36

SUBMARINE CABLES

Fig 10 40

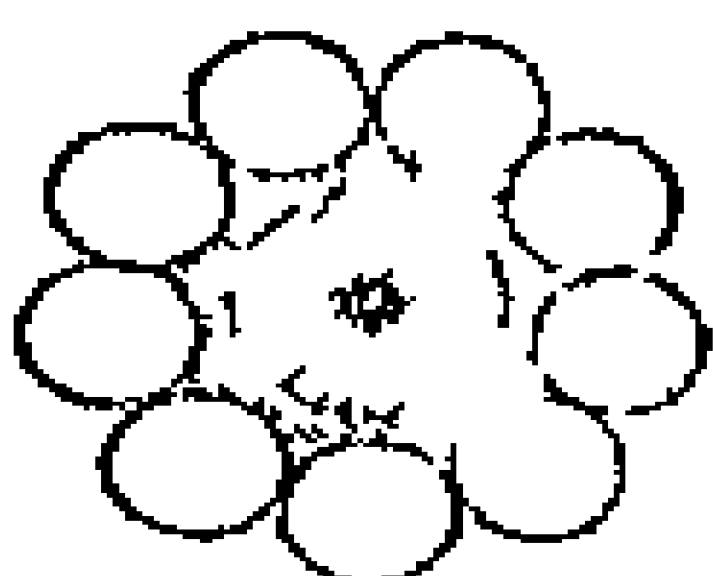
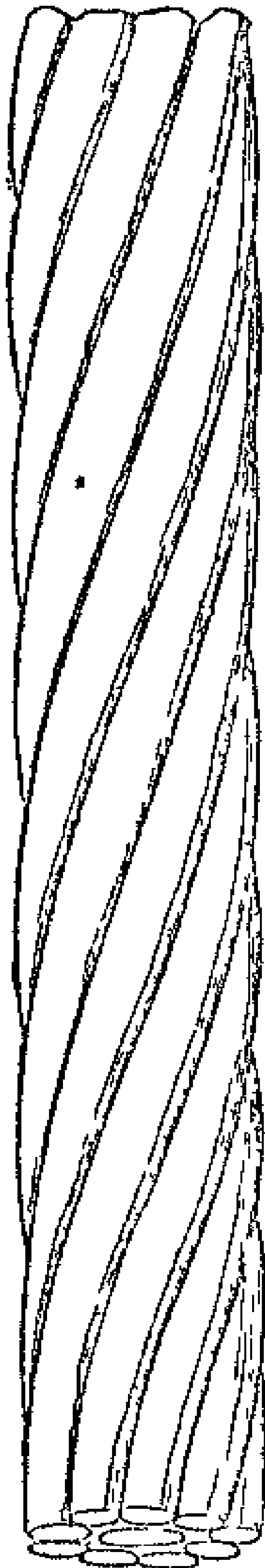

P Edward's Island
and N Brunswick

88 The short submarine cable laid down between Prince Edward's Island, and the coast of Nova Scotia (figs 9, 10), is intended as part of a more extended submarine line connecting Newfoundland with Canada. The other sections would make up a total length of 110 miles, but the project is reported to be arrested for the present by the refusal of the House of Assembly of Nova Scotia to grant a charter to the company to cross that province.

The Danish submarine cable (figs 11, 12), is carried across the Great Belt from Nyborg to Korsø the nearest point of the opposite coast of Zealand.

The cable laid across the Zuyder Zee is shown in its proper size in figs 13, 14 (p 161)

Subaqueous cables have been laid across several of the American rivers. The difficulties supposed to attend the deposition and preservation of these conductors appeared to telegraphic engineers and projectors so formidable, that the wires were at first carried across the rivers between the summits of

x 2

Fig 11

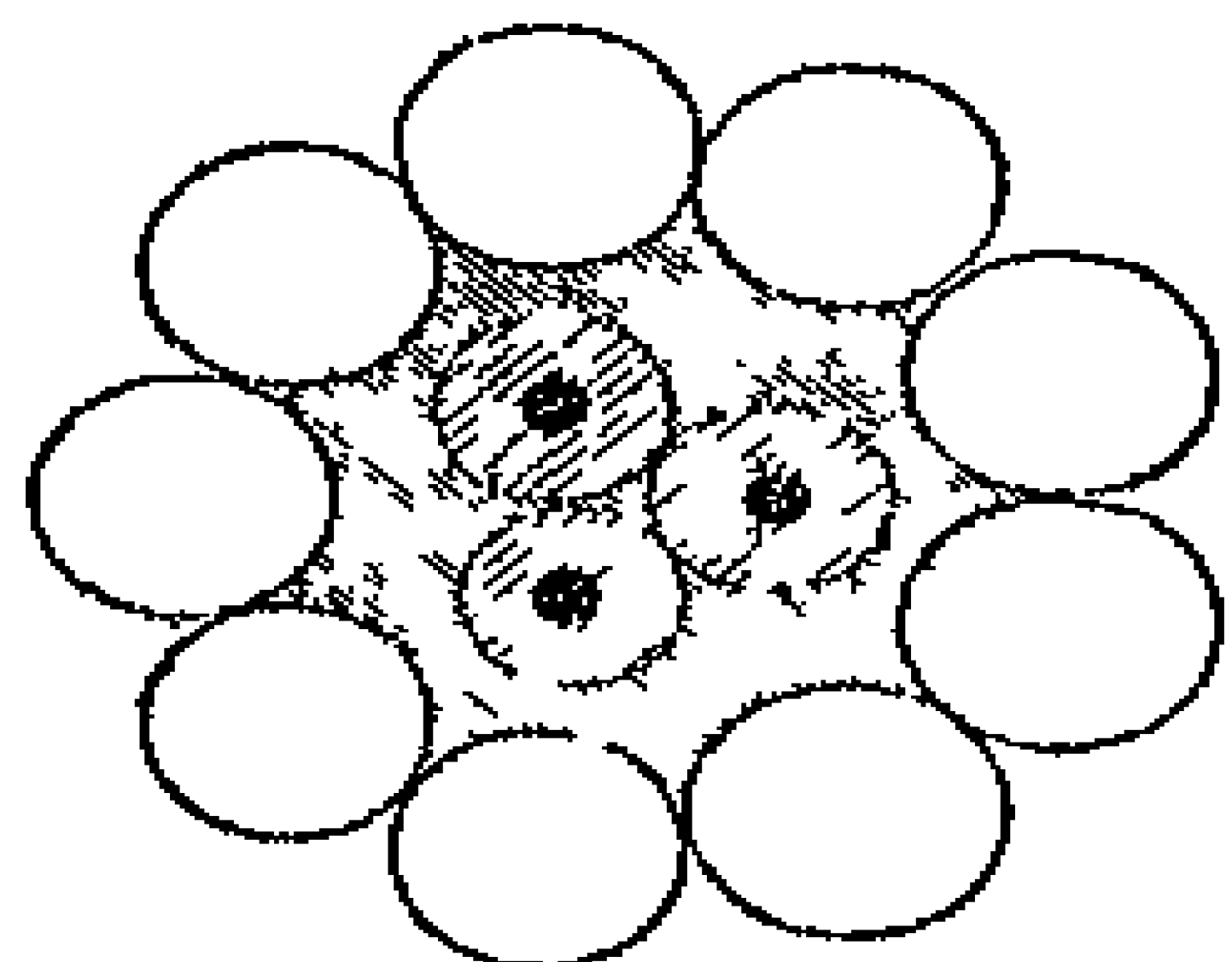
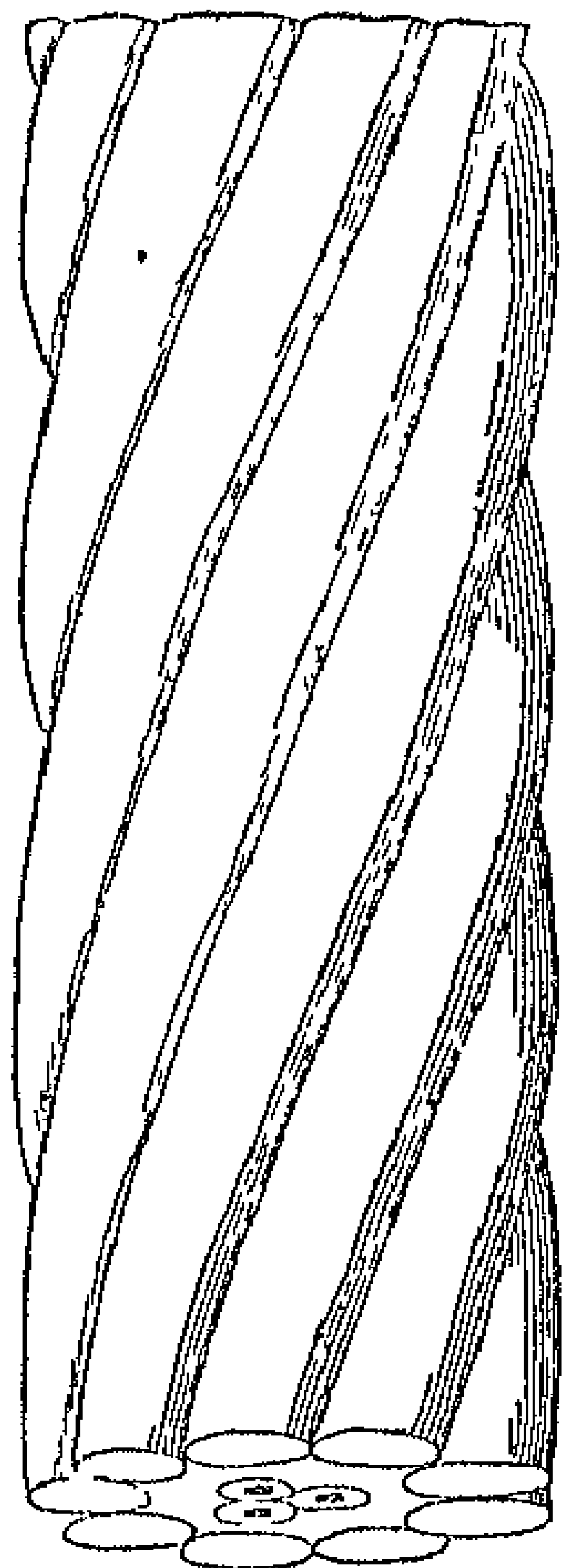

Fig 12 — Great Belt
103

THE ELECTRIC TELEGRAPH

Fig 43

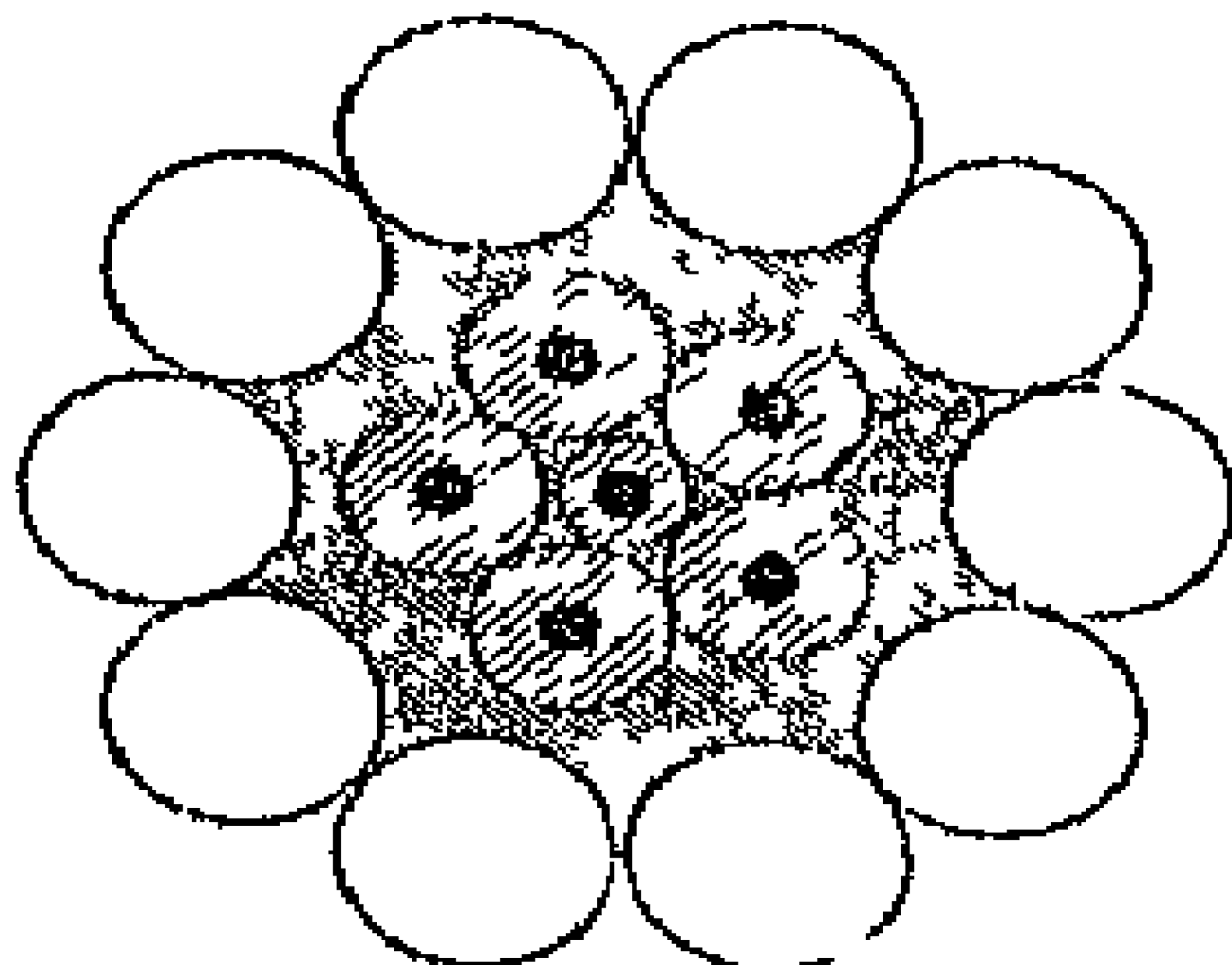
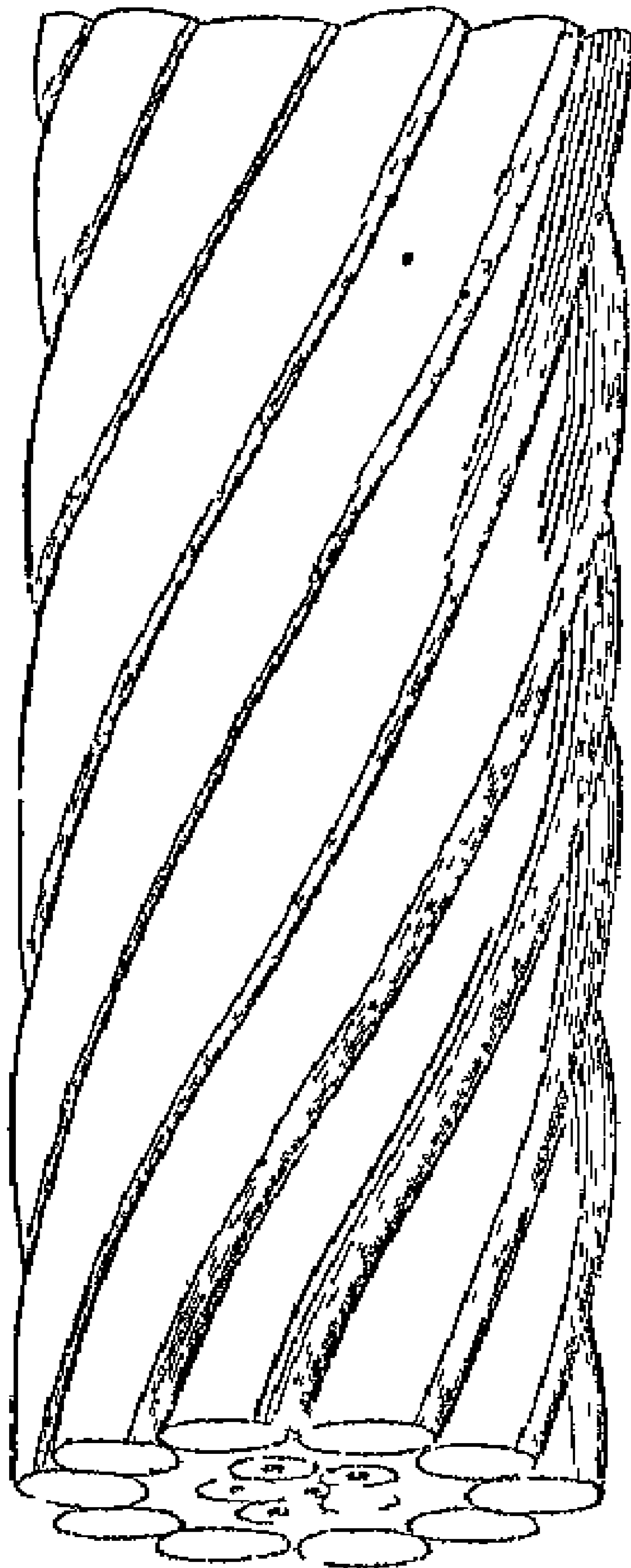

Fig 44 — Zuyder Zee

lofty masts erected on their banks. This method, however, was found to be attended with such effects as to render the maintenance of the wire impracticable. The masts were blown down by the violent storms and tornadoes incidental to the climate, and were not unfrequently destroyed by lightning.

The project of depositing the conducting wires in the bottom of the river was then resorted to, and has been carried into effect in several cases. The Ohio is crossed at Paducah by a cable containing one conducting wire, of which the following description is given in the American journals.

“It is composed of a large non wire, covered with three coatings of gutta serena, making a cord of about five-eighths of an inch in diameter.

“To protect this from wear, and for security of insulation, there are three coverings of strong Osnaburg, saturated with an elastic composition of non-electrics, and around this are eighteen large non wires, drawn as tight as the wire will bear, and the whole is then spirally lashed together with another large wire, passing around at every $\frac{1}{2}$ of an inch. The whole forms a cable of near two inches in diameter.”

This cable is 4200 feet in length, being the longest yet laid down in the United States. It was constructed by Messrs Shaftner and Sleeth.

Mr Shaftner has also constructed and deposited subaqueous cables in the following places —

Across the Tennessee river, four miles above Paducah, near its

SUBMARINE CABLES

junction with the Ohio Length, 2200 feet, same construction, deposited in 1851

Across the Mississippi, at Cape Girardeau, in the State of Missouri Length 3700 feet, deposited in 1853

Across the Merimmac river, where it falls into the Mississippi, twenty miles below St. Louis Length, 1600 feet, deposited in 1853

All these are similar to the Paducah cable

Across the Mississippi at St. Louis, three cables for different lines, each enclosed by 11 lateral external wires Length, 3500 feet Deposited in 1852-3

Across the Ohio at Maysville, Kentucky, a cable containing two conducting wires, enclosed by 28 lateral external wires, constructed like the former Length, 2700 feet Deposited in 1853

Across the Ohio at Henderson, Kentucky Length, 3200 feet Deposited in 1851

Cables constructed by Messrs Nowall and Co have also been deposited in the following places —

Across the Mississippi at New Orleans, containing one conducting wire Length, 3000 feet Deposited in 1853 Shown in figs 45, 46

Across the Hudson, 10 miles above New York, similar construction Length, 3600 feet Deposited in 1851

Across the Straits of Northumberland, at the mouth of the St. Lawrence, similar construction Length, 10 miles Deposited in 1853

At certain places on the great western rivers serious difficulties have been and are still encountered in the preservation of these subaqueous conductors At St. Louis on the Mississippi, and at Paducah on the Ohio, for example, several cables have been successively swept away by floods Large trees carried down the stream are, one after another, stopped by being caught in the cable, and the number thus accumulated becomes at length so great that the force of the current, acting upon them, breaks it

Another frequent cause of destruction to these cables in the Western Continent is the attraction they offer to atmospheric electricity They are frequently destroyed by lightning Mr. Shaffner

Fig 45

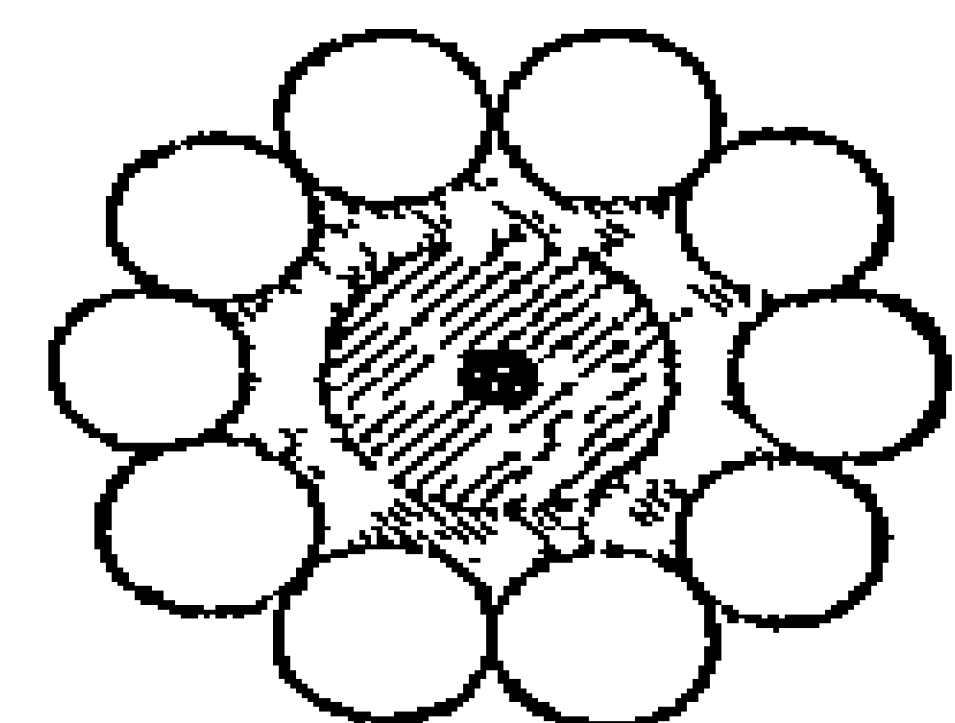

Fig 46 — Mississippi

THE ELECTRIC TELEGRAPH

tells me that he has sometimes found a longitudinal incision measuring ten feet in length, made in the gutta-percha, by the lightning, and cut as clean as if it had been done with a razor. At other times he has found the gutta-percha swelled, rough and porous, and sometimes pierced with countless numbers of openings like pinholes.

These appearances are supposed by Mr. Newall to arise from imperfection in the covering of the wire. The slit, he thinks, is caused, by an getting in behind the rim, which holds the mandril through which the copper wire passes before leaving the cylinder, and the porous covering arises from air mixed with the gutta-percha. Mr. Newall has ascertained that a wet hair, or a hole of equal size is sufficient to destroy the insulation of the wire.

89 Some eminent scientific authorities express doubts as to the durability of the submarine cables. In the case of the Dover and Calais cable it has been observed that the bottom of the channel at that part of the strait is proved by the soundings to be subject to undulations, so considerable that the summits of some of its elevated points rise to such a height that the water which covers them is not deep enough to secure them from the effects of the tumultuous agitation of the surface in violent storms. It is here well to remind the reader that the agitation of the ocean, which seems so awful in great tempests, has been found to extend to a very limited depth, below which the waters are in a state of the most profound repose. The objection we now advert to is, therefore, founded upon the supposition that the crests of some of the elevations upon which the submarine cable rests are so elevated as to be within that limit of depth, and it is feared that such being the case, the violence of the water in great tempests may so move the cable against the ground on which it is deposited with a motion to and fro, as to wear away by frequent friction its metallic armour, and thus expose the conducting wires within it to the contact of the water, and destroy their insulation.

But it has been most satisfactorily proved by a part of the experimental wire which was laid down between Dover and Calais, in 1850, and which was picked up two years afterwards in as perfect a state as when laid down, that the action of the waves does not affect the bottom of the Channel there. The greatest depth is 30 fathoms, and the bottom shelves regularly from Dover to near Cape Grinez, where there is a ledge of rocks rising suddenly from the bottom.

It has been also feared that, notwithstanding the effect of the galvanisation of the surface of the surrounding wires, the corrosive action of the sea water may in time destroy them, and it has been suggested that some better expedient for protection against this

SUBMARINE CABLES

effect might be contrived upon the principle suggested by Davy, for the preservation of the copper sheathing of ships, by investing the cable at certain intervals with a thick coating or glove of zinc, which would increase the efficiency of the thinner coating of that metal given to it in the process of galvanisation *

To this practical men who have had as much experience as is compatible with the recent date of these novel and extraordinary enterprises, reply that the results of their observations give no ground for apprehension of any injurious effects from tidal or tempestuous action, and that the fine iron used in the wire is not affected by sea water, as larger masses of coarser iron, such as anchors, are. They cite as proof of this, the slightly decayed state in which nails and small iron-nails have been found when recovered from vessels long sunk. They further state that the tar contained in the layer of hemp within the protecting wires acts as a preservative, whether the wires be galvanised or not. It has been found for example that, in the case of the submarine conductor between Donaghadee and Portpatrick, a perfect concrete of tar and sand has been already formed, upon which masses of shell-fish attach themselves at all parts that are not buried in sand, and it is apparent that in a few years a calcareous deposit will be formed around it, which will cement it to the bottom, and altogether intercept the action of the sea water.

90 In the deposition of submarine cables great care should be taken to select suitable points on the shore for beaching them. Sandy places are always to be sought. If this precaution be taken, it is assumed that they are not subject to tidal action. A cable was partly laid by the Magnetic Telegraph Company in 1852 near Portpatrick (83), but abandoned in consequence of the vessel employed to deposit it being exposed in the process to a violent storm. The wire was left exposed upon the beach down to and beyond low water mark, and was in June, 1854, still in a perfect state, the galvanised iron wires, even to their zinc coating, being absolutely in the same state as when they were deposited.

91 It is contended by practical men that the great and only risk of failure in the submarine cables is from defects produced in the process of their deposition, or from original faults in the principle of their construction.

The greatest care is necessary in conducting the process of delivering out the cable into the sea, or "paying it out," as it is technically called. All sudden bending of the cable is to be specially avoided. "Kinks" or "hitches" are apt to occur in

* Pouillet, "Traité de Physique," vol. 1 p. 709 Ed. 1853

THE ELECTRIC TELEGRAPH

the process, by which the gutta percha covered wires within the cable are strained

92 In laying the Calais cable it was found too short to extend to the opposite coast, and it became necessary to splice a supplementary piece to it. The joint thus formed afterwards failed, and it was found necessary to splice it anew, and to insert a fresh piece. Since this was done the cable appears to have continued in excellent order.

93 It is said that the Belgian cable has been subject to some imperfection arising from the position of the wires within the case. The sixth wire being in the axis of the cable, surrounded by the other five (see fig. 32), it was found that when the outer casing of the protecting wires was laid around it, the pressure on the centre wire rendered it imperfect, while the five surrounding it suffered to some extent.

Similar defects are said to exist in other cables constructed upon the same principle.

A hempen case well tarred in the centre is considered to form the best safeguard for the gutta percha covered wires in the process of making the cable, since it will yield to any compression itself without affecting injuriously the wire.

94 This notice of subaqueous telegraphy ought not to be concluded without some mention of the project for the deposition of an electric cable across the Atlantic, so as to put the Old World in instantaneous communication with the New. Such a scheme is regarded now pretty nearly as that for the electric connection of the British islands with each other and with the European continent was regarded some years ago. The sanguine consider the project practicable, and its speedy realisation probable. The more phlegmatic notice it only with ridicule. Men of science generally admit the possibility of the enterprise while men of finance more than doubt the possibility of a remunerative result.

The width of the Atlantic between the nearest points of British America and the west coast of Ireland is about sixteen hundred miles. Twelve cables, each as long as those which have been laid down between Orfordness and the Hague, would be sufficient to extend from coast to coast. That cable could be spliced to cable was practically proved between Calais and Dover, such a splice having been successfully made in the cable near the French coast.

Lieutenant Maury, of the United States, so well known for his hydrographical researches, caused a series of regular soundings to be made with the view of determining the form and condition of the bed of the ocean between the coasts of British America and

SUBMARINE CABLES

Ireland He found that between Newfoundland, or the mouth of the river St Lawrence, and the west coast of Ireland, the bottom consists of a plateau, which, as he says, "seems to have been placed there especially for the purpose of holding the wires of a submarine telegraph, and of keeping them out of harm's way. It is neither too deep nor too shallow, yet it is so deep, that the wires but once landed, will remain for ever beyond the reach of vessels, anchors, icebergs, and drifts of any kind, and so shallow that the wires may be readily lodged upon the bottom.

"The depth of this plateau is quite regular, gradually increasing from the shores of Newfoundland to the depth of 1500 to 2000 fathoms, as you approach the other side."*

Lieutenant Maury concludes that this line of deep sea soundings is quite decisive of the question, as to the practicability of a submarine telegraph between the two continents in so far as the bottom of the ocean is concerned. A cable laid across would pass to the north of the great banks, and would be deposited upon the plateau above described, where the waters of the ocean are proved to be "as still as those of a millpond."

This inference Lieutenant Maury deduces from the fact, that all the specimens of the bottom brought up have been found to consist of microscopic shells without the admixture of a single particle of gravel or sand. Had there been currents at those depths, these shells would have been thrown about and abraded, and mixed more or less with the *debris* of the natural bed of the ocean, such as ooze, sand, gravel, and other matter. "Consequently a telegraphic cable once laid there, there it would remain as completely beyond the reach of accident as if it were buried in an tight cases."

Imperfectly informed persons have expressed an opinion that the cable would not sink below a certain depth, at which the increasing density of the sea water would render it bulk for bulk as heavy as the cable. The well known physical properties of water prove such a supposition to be groundless. Although not incompressible in an absolute sense, water is susceptible of compression, even at the greatest depths of the ocean, in so small a degree, that the cable must always greatly exceed it in specific weight.

Putting out of view the financial part of the question, there appears then to be no good reason for pronouncing the project to construct such a cable, and to deposit it in the bed of the ocean, impracticable in an absolute sense.

* Report of Lieutenant Maury to the Secretary of the U S Navy, Feb 22, 1854

THE ELECTRIC TELEGRAPH

It may be asked whether, if deposited, an electric current could be transmitted through it so as to produce telegraphic signals?

There can be only two reasons for doubting this—*first*, the length of the conducting wire, and, *secondly*, the inductive effect of the water upon the cable.

The intensity of the current transmitted by a battery of given power upon a wire, is in the direct ratio of the conducting power of the wire and the magnitude of its transverse section, and in the inverse ratio of its length. A length so great as 1500 or 16000 miles, would of course considerably attenuate the current.

But it will be recollected that, in the experiments described in Chap. I par. 9, made by M. Lenoir and myself, messages were transmitted over a space of 1000 miles of wire without intermediate battery power, and with a terminal battery of very limited power. In that case 336 miles of the wire upon which the current was transmitted were iron, a very indifferent conductor, and the remaining 743 miles were copper wire of extremely small diameter. It is certain, therefore, that by reason of the inferior conducting power of the one part, and of the very small transverse section of the other part, this length of 1082 miles offered a much greater resistance to the transmission of the current than would 1600 miles of copper wire, such as is usually selected for submarine cables.

But independent of these considerations, nothing would be easier than to give the copper wire enclosed in the cable such a thickness, and to apply to it such batteries, as would ensure the transmission of a current of sufficient intensity.

The effects of the recoil currents produced by the inductive action of the water upon the cable, cannot be so certainly appreciated with our present knowledge and experience, but although the effects of these are sensible in the cases of the submarine and underground wires already laid down, they have not produced any obstruction to the efficient performance of the telegraphs, and the managers of the Magnetic Telegraph Company, which work so well several hundred miles of wire partly subaqueous and partly underground, assure me that no inconvenience or obstruction whatever is found to arise from this cause. If no other objection were raised against the project of a Transatlantic cable save this, it may be safely pronounced that there would be nothing to be apprehended which the resources of science and art would not easily surmount.

It does not appear, therefore, that any part of the great problem of subatlantic telegraphy remains to be solved, except that which is involved in the financial view of the question. If it be undertaken as a commercial enterprise with a view to a

RECOIL CURRENTS

remunorative return, *will it pay?* Or, on the other hand, may it not be regarded as one of those vast international enterprises to which the influence and resources of states should be applied? These are questions which we have neither the space nor the vocation to discuss.

95 In 1852, the conducting wires which connect the Branch Telegraph Office, established in the Strand, opposite Hungerford Market, with the General Post-office, were laid down. In this case the conducting wires are galvanised brass instead of copper. They are as usual laid in iron tubes, and are carried along the kerb stones of the foot pavement of the Strand, Fleet-street, Ludgate-hill, and St. Paul's Church-yard to Cheapside, where they cross over to Foster-lane, and passing through the branch office in the hall of the General Post-office, are carried thence to the central telegraph station in Lothbury, at the rear of the Bank of England.

From this central office, at all hours by day and by night, despatches are transmitted to and received from every seaport and every considerable town in England, Scotland, and Wales, by the submarine wires, by Holyhead and Portpatrick, from all parts of Ireland, and by Dover, from all parts of the Continent of Europe where electric telegraphs have been constructed.

96 After the underground and submarine wires had been constructed and laid upon a considerable scale, the attention of Dr. Faraday was called by some of the parties engaged in their management to peculiar phenomena which had been manifested in the telegraphic operations made upon the lines thus laid. After experiments had been made upon a large scale with lines of sub-aqueous and subterranean wires, extending to distances varying from 100 to 1500 miles, it was found that the electricity supplied by the voltaic battery to the covered wire was in great quantity arrested there, by the attraction of electricity of an opposite kind evolved from the water or earth in which the wire is sunk, the attraction acting through the gutta serena covering exactly in the same manner as that in which the electricity developed by a common electric machine, and deposited on the inside metallic coating of an electric jar, acts through the glass upon the natural electricity of the external coating, or of the earth in connection with it. The two opposite electricities on the inside and outside of the coating of the wire by their mutual action neutralise each other, and under certain circumstances a person placing his hands in metallic connection with both sides of such coating, may ascertain the presence of a large charge of such neutralised fluid, by receiving the shock which it will give like that of a charged Leyden jar.

97 It is apprehended that this unforeseen phenomenon may

THE ELECTRIC TELEGRAPH

interfere more or less with the practical working of all telegraphs having underground conducting wires, and I have been informed by the agents engaged in bureaux of the Paris telegraph, that they are sensible of its effects in all direct communications between that capital and London.

On the other hand the Magneto-Electric Telegraph Company, who at the present time (May, 1851), have nearly 900 miles of underground wire in operation, report that they sometimes pass their signals without any difficulty through 500 miles of underground wire without any break or delay in the circuit, and that they have in constant operation continuous underground lines connecting towns above 300 miles apart.

The only defect complained of in the underground wires is that which proceeds from accidental failures of complete insulation produced by defects in the gutta serena or other coating which allow moisture to penetrate in wet weather and to reach the conducting wire, or it may arise from accidental fracture of the wire. In any such cases the flow of the current to its destination is interrupted, and the telegraph conveys no signal.

The use of underground wires, and the discovery of the phenomenon of inductive action above described, are too recent to justify any certain inference as to their effects on telegraphic operations. Time and enlarged experience alone can settle the questions which have been thus raised.

98 Although as a general rule the overground lines of telegraphic wire are sustained by supports at intervals of about sixty yards, many exceptional cases are presented in which they are extended between supports at much greater distances asunder. Every recent visitor to Paris may have observed the long lines of wire which are in several cases extended along the boulevard and across the river.

But the most surprising examples of long lines of wires without intermediate support, are presented on the telegraphic line passing north and south through Piedmont between Turin and Genoa. There, according to a report published in the "Piedmontese Gazette," in the course of the line passing through the district intersected by the chain of the Bochetta, the engineers, M. Bonelli, had the boldness to carry the wires from summit to summit across extensive valleys and ravines at immense heights above the level of the ground. In many cases the distance between these summits amounted to more than half a mile, and in some to nearly three-quarters of a mile. In passing through towns, this line is carried underground, emerging from which it is again stretched through the air from crest to crest of the Maritime Apennines, after which it finally sinks into the earth,

INDIAN TELEGRAPHIC LINES

passing through Genoa under the streets and terminating in the Ducal palace

It is stated that the insulation of the wires on this picturesque line has been so perfect, notwithstanding the adverse circumstances of its locality, that although it was constantly at work day and night during the first winter, no failure of transmission or extraordinary delay ever occurred

99 Efforts have recently been made to extend the system of telegraphic intercommunication to India. Dr O'Shaughnessy of the East India Company's medical department, in constructing an experimental line through a distance of 80 miles from Calcutta, used, instead of wires, iron rods, being the only obtainable materials. These were fastened together and supported on bamboos

By experiments thus made, he found that the wires employed in Europe would be quite inadequate to the Indian telegraph. In England, where the lines are carried along railways, and where there are no living obstacles to contend with, the thin iron wire, called No. 8 gauge, answers its purpose well, but no sooner were the rods mounted on their bamboo supports in India than flocks of that largest of all birds, the adjutant, found the rods convenient perches, and groups of monkeys congregated upon them, showing clearly enough that the ordinary wire would be insufficient to bear the strains to which these telegraphic lines would be subjected. It was found also that not only must the wire be stronger, but that it must be more elevated, to allow loaded elephants, which march about regardless of roads or telegraphic lines, to pass underneath

100 The telegraphic communication thus practically effected, is subjected to attacks to which the telegraphs in this country are but little exposed. Storms of lightning destroyed the galvanometer coils, and hurricanes laid prostrate the posts. Undaunted by the opposition of the elements, Dr O'Shaughnessy contrived a lightning conductor for the instruments, and strengthened the supporting posts

Dr O'Shaughnessy returned to England, and at Warley, near Brentwood, made arrangements for producing 3000 miles of thick galvanised wire, to be shipped for India, one of the earliest lines undertaken, to be from Calcutta to Bombay. One of the peculiar characteristics of the railway lines intended for India, as contrasted with the English lines, is the greater distance between the posts, which are higher and stronger than those generally used. The thick wire is raised to a height of fourteen feet, on posts nearly the eighth part of a mile apart. To obtain the necessary strength to bear the strain, the posts are fixed with screw

THE ELECTRIC TELEGRAPH

piles. To show the strength of the wires thus extended, a rope was, for experiment, hung to the centre of the wire of large span, and a soldier climbed up it, the weight of his body producing but a slight curvature. The common deflection arising from the weight of a wire of a furlong span does not exceed eighteen inches.

Dr O'Shaughnessy's plan of underground communication when such a mode of laying down the wires is desirable, is very economical. The copper wires coated with gutta serena, instead of being incased in iron tubes, are inlaid in wooden sleepers, well saturated with arsenic, to protect them from the white ant, and they are then laid in a trench about two feet deep. An underground system of two wires may thus be laid down for 35¢ the mile.

The plan adopted for joining the lengths of the thick galvanic wire is to have the two ends turned, so as to link into one another, which are then introduced into a mould, like a bullet-mould, and an ingot of zinc being cast over them, they form a most substantial joint, and perfect metallic connection.*

It appears from reports received in May, 1854, that at that date a telegraphic line was in full operation from Calcutta to Agra, a distance of 800 miles, and it was then expected that the entire line to Bombay, a distance of 1500 miles, would soon be completed and put in operation.

This line is reported to have been completed and brought into operation since the preceding paragraphs were in type.

101 To produce the effects, whatever these may be, by which the telegraphic messages are expressed, it is necessary that the electric current shall have a certain intensity. Now, the intensity of the current transmitted by a given voltaic battery along a given line of wire will decrease, other things being the same, in the same proportion as the length of the wire increases. Thus, if the wire be continued for ten miles, the current will have twice the intensity which it would have if the wire had been extended to a distance of twenty miles.

It is evident, therefore, that the wire may be continued to such a length that the current will no longer have sufficient intensity to produce at the station to which the despatch is transmitted those effects by which the language of the despatch is signified.

102 The intensity of the current transmitted by a given

* Year Book of Facts, 1853, p. 150

INTENSITY OF CURRENTS

voltare battery upon a wire of given length, will be increased in the same proportion as the area of the section of the wire is augmented. Thus if the diameter of the wire be doubled, the area of its section being increased in a fourfold proportion, the intensity of the current transmitted along the wire will be increased in the same ratio.

103. In like, the intensity of the current may also be augmented by increasing the number of pairs of generating plates or cylinders composing the galvanic battery.

Since it has been found most convenient generally to use iron as the material for the conducting wires, it is of no practical importance to take into account the influence which the quality of the metal may produce upon the intensity of the current. It may be useful nevertheless to state that, other things being the same, the intensity of the current will be in the proportion of the conducting power of the metal of which the wire is formed, and that copper is the best conductor of the metals.

104. M. Pouillet found by well conducted experiments, that the current supplied by a voltare battery of ten pairs of plates, transmitted upon a copper wire, having a diameter of four-thousandths of an inch, and a length of six-tenths of a mile, was sufficiently intense for all the common telegraphic purposes. Now if we suppose that the wire instead of being four-thousandths of an inch in diameter, has a diameter of a quarter of an inch, its diameter being greater in the ratio of $0.2\frac{1}{2}$ to 1, its section will be greater in the ratio of nearly 1000 to 1, and it will consequently carry a current of equal intensity over a length of wire 1000 times greater, that is, over 2100 miles of wire.

105. But in practice it is needless to push the power of transmission to any such extreme limits. To reinforce and maintain the intensity of the current, it is only necessary to establish at convenient intervals along the line of wires intermediate batteries, by which fresh supplies of the electric fluid shall be produced, and this may in all cases be easily accomplished, the intermediate telegraphic stations being at distances, one from another, much less than the limit which would injuriously impair the intensity of the current.

106. Having thus explained the means by which an electric current may be conducted from any one place upon the earth's surface to any other, no matter what be the distance between them, and how all the necessary or desired intensity may be imparted to it, we shall now proceed to explain the expedients by which such a current may enable a person at one place to convey instantaneously to another place, no matter how distant, signifying the purposes of written language.

THE ELECTRIC TELLGRAPH

It may be shortly stated that the production of such signs depends on the power of the agent transmitting the current to transmit, suspend, intermit, divert and reverse it at pleasure. These changes in the state of the current take place for all practical purposes simultaneously upon all parts of the conducting wire to whatever distance that wire may extend, for although strictly speaking there is an interval, depending on the time which the current takes to pass from one point to another, that interval cannot in any case exceed a small fraction of a second.

107 Although there is some discordance in the results of experiments made to determine the velocity of the current, they all agree in proving it to be prodigious. It varies according to the conducting power of the metal of which the wire is composed, but is not dependent on the thickness of the wire. On copper wire, its velocity, according to Professor Wheatstone's experiments, is 288000 miles, and according to those of MM. Fizeau and Gonelle, 112680 miles per second. On the iron wire used for telegraphic purposes, its velocity is 62000 miles per second, according to Fizeau and Gonelle, 28000 according to Professor Mitchell, of Cincinnati, and about 16000 according to Professor Walker of the United States.

108 It is evident therefore that the interval which must elapse between the production of any change in the state of the current at one telegraphic station, and the production of the same change at any other however distant, cannot exceed a very minute portion of a second, and since the transmission of signals depends exclusively on the production of such changes, it follows that such transmission must be practically instantaneous.

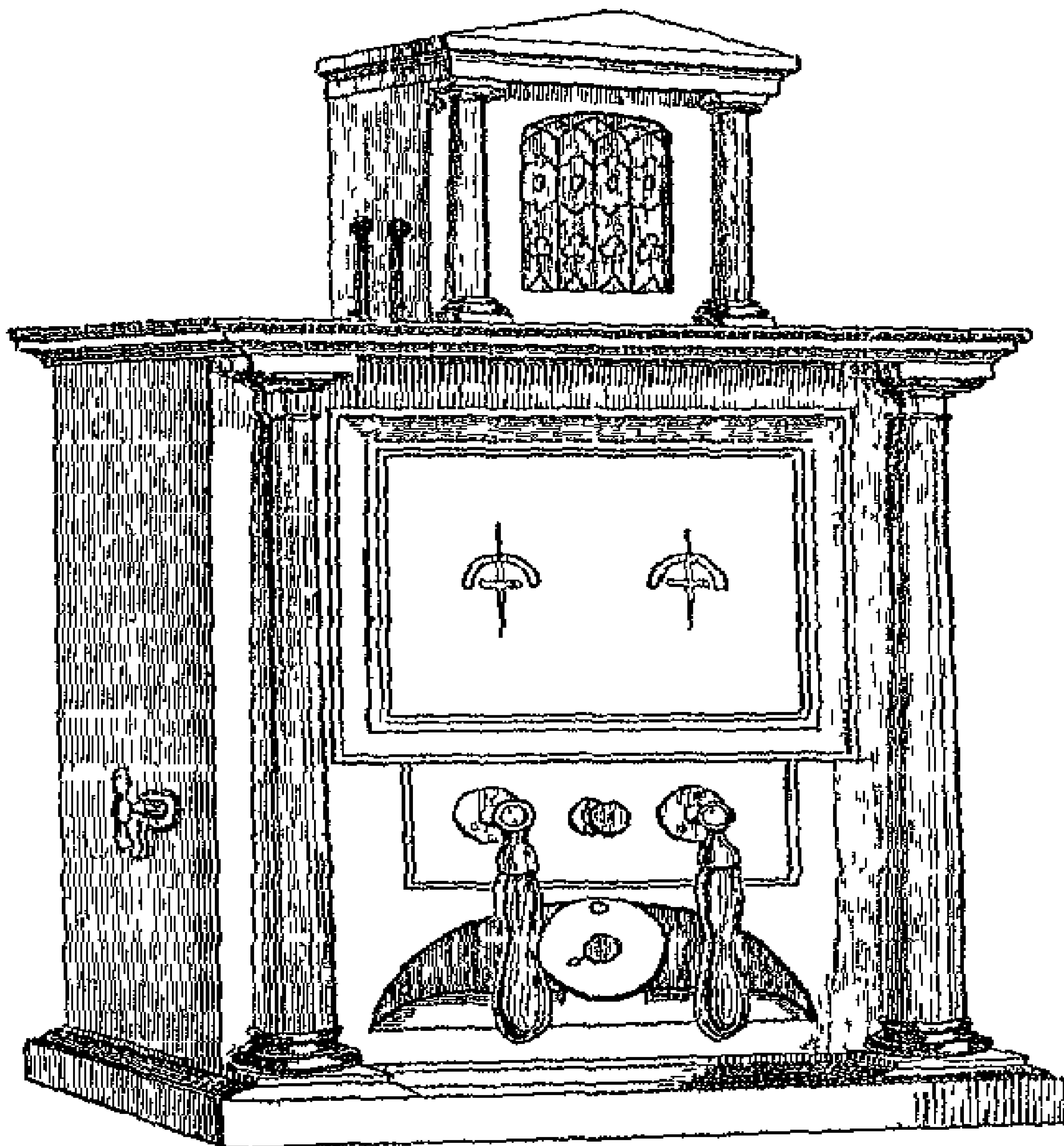

FIG. 68.—THE DOUBLE NEEDLE TELEGRAPH.

THE ELECTRIC TELEGRAPH

CHAPTER V

- 100 Current controlled by making and breaking the contact of conductors — 110 Instruments for controlling the current — commutators — 111 General principle of the commutator — 112 Its application to telegraphic operations — 113 To transmit a current on the up line only — 114 On the down line only — 115 On both lines — 116 To reverse the current — 117 To suspend and transmit it alternately — 118 How to manage a current which arrives at a station — 119 To make it ring the alarm — 120 Station with two alarms — 121 Notice of the station transmitting and receiving signals — 122 When signals not addressed to the station the current is passed on — 123

THE ELECTRIC TELEGRAPH

How to receive a dispatch at the station, and stop its farther progress —124 How several dispatches may be at the same time sent between various stations on the same line —125 Secondary lines of wire then used —126 Recapitulation —127 Signals by combinations of unequal intervals of transmission and suspension —128 Key commutator —129 Horological commutator for a current having equal and regular pulsations —130 Case in which the pulsations are not continuous or regular —131 No limit to the celerity of the pulsations —132 Application of a toothed wheel to produce the pulsations —133 By a sinusoidal wheel —134 Method of diverting the current by a short circuit, its application to the alarm —135 Effects of the current which have been used for signals —136 Deflection of magnetic needle

109 SINCE all telegraphic signals depend on the power of the agent who makes them, to transmit, control, and modify the current at will, it must be apparent how important it is for those who desire to understand this interesting subject, to comprehend in the first instance the means by which this power is obtained and exercised.

It is necessary to remember that the current will flow along a line of conducting wire so long as, and no longer than, a voltaic battery is interposed at some point on the line, the wire being attached to its poles, and the remote ends of the wire connected with the earth, as explained in (23) and (36), and in that case the current will flow along the wire from earth to earth in such a direction as to enter the battery at the negative, and to leave it at the positive pole, and that provided the battery have adequate force, it does not matter how distant from its poles the points may be at which the wires are connected with the earth.

If at any point of the line the wire is broken, the current instantly ceases along the entire line. If it be reunited the current is instantly re-established. If the connection of the wire with the poles of the battery be reversed, so that the end which was connected with the positive is transferred to the negative pole, and *vice versa*, the direction of the current along the entire line is reversed—since it must always flow *from* the positive and *to* the negative pole. If at any point the wire, being broken, be connected with another wire proceeding to the earth in any other direction, the current will be diverted to the latter wire, deserting its former course. If the wire conducting the current be connected at the same point with two wires both connected with the earth, it will be distributed between the two, the greater part, however, following that wire which offers the easier road to the earth.

These few principles, which are clear and simple, supply an easy key to the whole art of electro-telegraphy.

110 The class of mechanical expedients by which the agent who desires to transmit signals is enabled to control and modify the current in the manner here described, are called by the general

COMMUTATORS.

name of "COMMUTATORS," and are very various in form and arrangement according to the purposes to which, and the conditions under which they are applied. Not only do apparatus of this class differ in different countries where telegraphs have been established, but they vary upon different lines, and even on different parts of the same line. Without attempting to follow these endless variations, many of which are quite unimportant, and all of which are mere varieties in the application of the general principles explained above, we shall here confine ourselves to such an illustration of them as will at the same time render intelligible their structure and operation, and convey a general notion of the manner of transmitting and receiving signals.

111 Let us suppose that around the edge of a disc of ivory, wood, or any other insulating material, are inserted at convenient intervals pieces of metal, *p*, *u*, *r*, *n*, &c., fig 17, which we shall call *contact pieces*, their purpose being to make and break the metallic contact which controls the current. At the back of the disc near these contact pieces are clamps or tightening screws by which conducting wires can be attached to them.

To an axis in the centre of the disc let two metallic hands, *A* *A'* be attached, so that they can be turned round the disc like the hands of a clock, but having motions independent of each other. These hands may be supposed to be formed of elastic strips of metal bent at the ends towards the surface of the disc, so as to press upon it with some force and let one of them move over the other without disturbing it, as the minute hand of a watch moves over the hour hand. Let *A''* be another similar hand, turning on a centre fixed upon the contact piece *r*, so that it can be turned at pleasure upon one or other of the contact pieces *p* or *n*.

Now it is evident that by turning the hands *A* and *A'* upon any two of the contact pieces, they will be put in metallic connection, so that a current flowing from either of them will pass by the hands to the other, and in like manner by means of the hand *A''*, either of the contact pieces *p* or *n* can be put in metallic connection with *r*.

112 To convey a general notion of the application of such an apparatus to telegraphic purposes, we shall for example suppose conducting wires connecting the several contact pieces in the following manner —

- 1 *p*, with the positive pole of the battery
- 2 *n*, with its negative pole
- 3 *r*, with the earth
- 4 *u*, with the *up-line* wire
- 5 *d*, with the *down-line* wire
- 6 *b*, with a bell or alarm

THE ELECTRIC TELEGRAPH

It may be necessary to state here that it is customary to call the wire which proceeds to the chief terminal station of a line the *up wire*, and that which proceeds to the secondary terminal station the *down wire*. Thus, if a line of telegraph be extended between

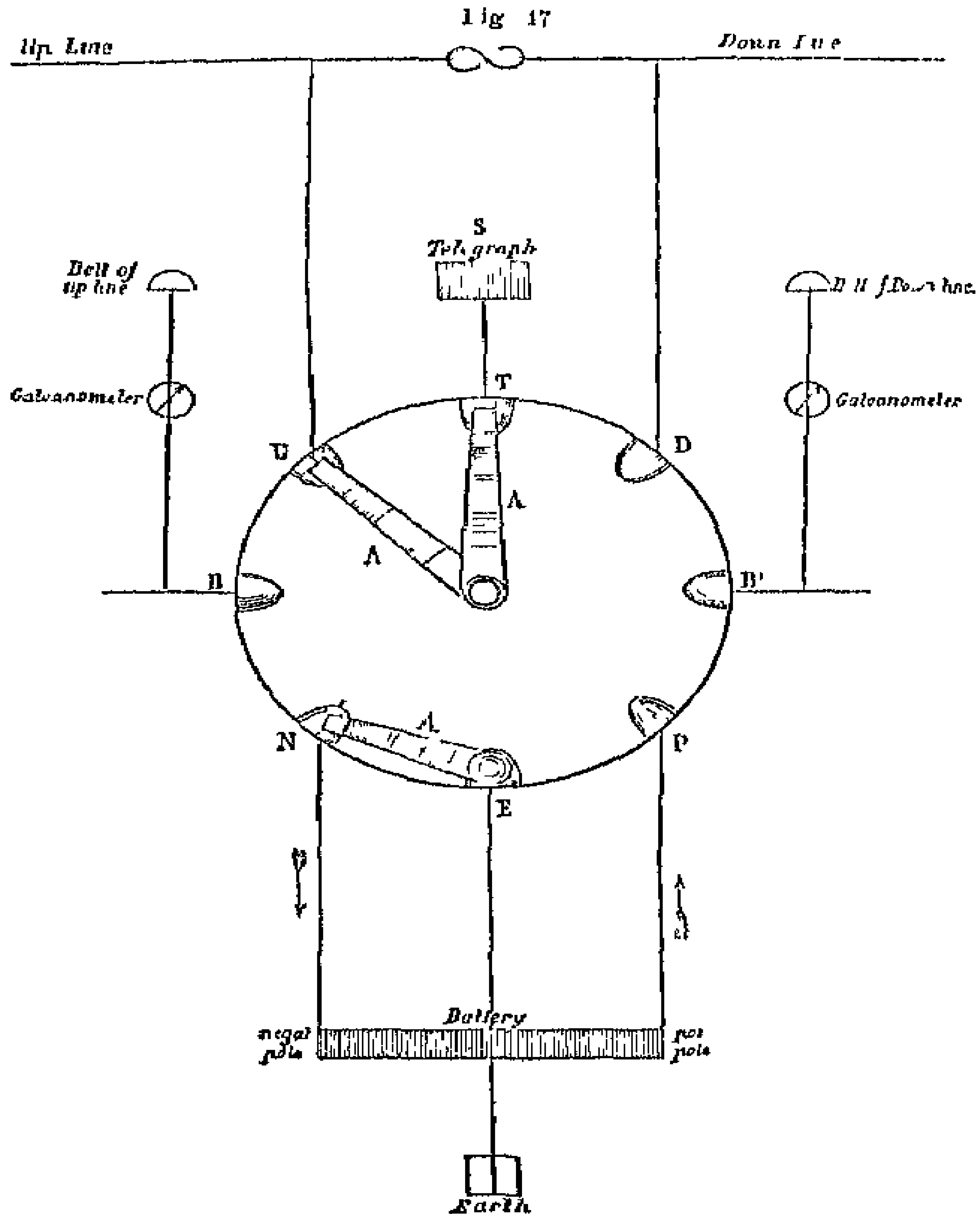

London and Dover, the wire which would connect London with any intermediate station would at that station be the *up wire*, and

TRANSMISSION OF SIGNALS

the wire which would connect it with Dover would be the *down wire*

The manner in which the current arriving at any station is made to ring a bell or alarm at that station, will be explained hereafter

In explaining the manner in which the agent at a station is enabled to control a current by means of the commutator, two cases are to be considered—first, when he desires to transmit signals, and, secondly, when he expects to receive them

In the former case, he takes the current from his own battery, in the latter, he receives it on its arrival by the up or down line wire

We shall first consider the case in which he desires to transmit signals

113 *To transmit a current on the up line only*—Let the hand A" be placed on N, A on P, and A' on U. The negative pole N of the battery being then in connection with the earth ϵ by the hand A", and the positive pole P in connection with the up wire U by the hands A and A', while the up wire itself at the station at which it arrives is in connection with the earth, the current will flow from ϵ by A and A' along the up wire to the station at which the wire goes to the earth

114 *To transmit a current on the down line only*—Let A" and A be placed as before, and let A' be moved to D. The current will then flow on the down line, as may be explained in the same manner

115 *To transmit a current along the entire line from terminus to terminus*—Let A' be turned upon U, and A upon N, and let two similar hands at the back of the disc be at the same time turned upon V and D, the hand A" being removed from both N and ϵ . In that case, the current will flow from the positive pole P along the hands at the back of the disc to D, and thence on the down wire to the terminal station, where it will take the earth, by which it will pass to the earth plate at the up terminal station, and from thence by the up wire to U, and from U by the hands A' and A to the negative pole N

Thus it appears that it will pass along the entire line from terminus to terminus, flowing from the up station downwards

116 *To reverse the direction of the current*—To accomplish this, it is obviously sufficient to reverse the connections with the poles of the battery. Thus, if the current be transmitted on the up line only, the hand A' will be upon U, A on P, and A" on N, when, as already explained (113), the current will flow from U towards the up station. If A" be removed to ϵ , and A to N, the direction will be reversed, the course of the current then being as follows—From the positive pole P to ϵ by the hand A", from the earth ϵ to the earth plate at the upper station, from that to the up wire, from thence to U, and from U by A' and A to N

THE ELECTRIC TELEGRAPH

Thus, by alternately moving the hands λ'' and λ between the contact pieces P and N , the current may be changed from one direction to the other on the up wire as often and as rapidly as may be desired.

The same reversion may be made in exactly the same manner on the down wire, if the hand λ' be turned upon D .

The reversion may be made with equal facility and rapidity if the current be established along the entire line by merely interchanging the position of the hands directed upon λ and λ' , as described in 115.

117 *To suspend and transmit alternately the current during any required intervals*—Whether the current be established on the up line or on the down line, or on both, this is easily accomplished by removing any one of the hands from the contact piece on which it rests, and restoring it to its place after the required intervals. When it is withdrawn, the current is suspended; when restored, the current is re-established. The intervals of such suspension and transmission may be as long or as short as may be desired. They may be equal or unequal. They may succeed each other with any degree of rapidity whatever. Thus there may be ten thousand intervals of suspension and a thousand of transmission in a minute. The instantaneous character of the propagation of the electric fluid already noticed will sufficiently explain this.

118 Having thus explained how the agent controls the current in transmitting signals to a distant station, we shall now show how he treats the current which arrives from a distant station, as to allow it to produce before him the intended signals.

The current must arrive either by the up wire or by the down wire, and therefore at either of the contact pieces, U or D .

119 *To make the arriving current give the alarm*—When the agent at a station is not engaged in transmitting signals, he must always be prepared to receive them. A contrivance called an alarm is provided, to give him notice when signals are about to be transmitted. The alarm, which will be fully explained hereafter, is an apparatus so constructed, that whenever the current passes through it, a bell is rung, by which the attention of the agent is called.

The contact piece B is here supposed to be connected with a wire leading to such an apparatus.

When not engaged in transmitting signals, the agent connects both the up and down wires with his alarm. To accomplish this, he turns λ' upon U , and λ upon B . The contact piece B being supposed to be connected with the wire which enters the alarm, the wire which issues from it is connected with B' . Thus

RINGING THE ALARM

hands, which are behind the disc, are placed one on *v'* and the other on *D*. In this case, if a current comes down the line to *v*, it will pass by the hands *A* and *A'* to *B*, and thence through the alarm wire to *v'*, whence it passes by the hands at the back of the disc to *D*, and thence along the down wire.

If, on the other hand, the current arrive by *D*, it passes in the same manner through the alarm to *v*, and so along the up wire.

From whatever part of the line the current may be transmitted, whether on the up or the down line, it must therefore pass through the alarm, and give notice.

120 In some cases a station is provided with two distinct alarms, one for the down and the other for the up line, having different tones, so that the agent, on hearing them, knows from which direction the signals are about to come.

In that case the wire of the up line alarm is attached to *B*, and that of the down line to *v'*, the wires which issue from the two alarms being always in such case connected with the earth.

When the agent is not engaged in transmitting, he places the hands *A'* and *A* on *v* and *B*, and the hands behind the disc on *D* and *v'*. If a current arrive by *v*, it passes by *B* through the alarm to the earth, and gives notice. If it arrive by *D*, it passes in like manner through the alarm *v'* to the earth, and gives notice.

It is, however, more usual to have a single alarm at each station, acting as above described.

The connections being so arranged that the current shall pass along the entire line from terminus to terminus, all the alarms at all the stations will be rung the moment the current is transmitted. General notice is therefore given that a dispatch is about to be sent from some one station along the line to some other.

121 It is necessary, however, to inform the agents at each station of the place from whence the dispatch is about to be sent, and the place to which it is to be addressed. To learn this, the agent transfers the connections from the alarm to his telegraphic instrument. This is accomplished by removing the hand *A* from *B* to *1*, and connecting the wire coming from the telegraphic instrument by the hands at the back of the disc with *D*. By this change the current passes from *v* to *1*, from *1* through the telegraphic instrument to *D*, and from thence down the line. The signals transmitted appear upon the telegraphic instrument, informing the agent whence the dispatch will come, and where it is desired to transmit it.

122 If he find that it is not to be addressed to himself, his arrangements will depend on the position which his own station holds in relation to the two stations between which the dispatch is about to be transmitted. If his station lie between them, he

THE ELECTRIC TELEGRAPH

turns the hands λ and λ' upon the contact pieces u and v , so as to allow the current to pass between the up wire and the down wire along the hands without interruption, and also without spending any part of its force in needlessly working his telegraphic instrument.

123 If he find that the dispatch is intended for himself, and that it proceeds from a station on the up line, for example, he places the hand λ' upon u , λ upon v , and by the two hands behind the disc he connects the wire issuing from the instrument with u . By this arrangement, the current arriving at u passes by the hands λ' and λ to v , thence through the telegraphic instrument to r by the hands behind the disc and to the earth.

In this case the course of the current is limited to the part of the line wire which is included between the station from which it is transmitted and that to which it is addressed. By connecting the telegraphic instrument with the earth by r , the down line wire is free, so that while the up line wire is employed in conveying the dispatch in question, other dispatches may be transmitted between any stations on the down line.

124 If we express for example the chief terminal station by s , and the series of stations upon the line proceeding from it downwards by $s_1, s_2, s_3, s_4, \&c$, we can conceive various dispatches to be *at the same time* transmitted between them by the arrangement here explained, being made at each station which receives a dispatch. Thus, if s sends a dispatch to s_1 , and s_1 cuts off its communication with the down wire by putting its telegraphic instrument in connection with the earth, the current transmitted from s stops at s_1 . A dispatch may therefore be at the same time sent between s_2 and s_3 , another between s_4 and s_5 , and so on.

Thus, the same line of conducting wire may be at the same time engaged in the conveyance of several dispatches, the only limitation being that when a dispatch is being transmitted between two stations, no other dispatch can at the same time be transmitted between any of the intermediate stations.

It follows from this as a necessary consequence that if, as generally happens in thickly peopled tracts of country, the terminal and one or two of the most populous of the intermediate stations keep the telegraph in constant work, separate and independent wires, and instruments must be provided to serve the secondary intermediate stations, just as upon railways, second and third-class trains are provided to serve those lesser stations on the line, which are passed by the first-class trains without stopping.

Every great telegraphic line presents an example of this. Thus upon the Dover line separate wires and instruments are appropriated to the transmission of dispatches between the terminal stations, London and Dover, and the intermediate stations, Tonbridge,

TELEGRAPHIC STATIONS

Ashford, and Folkestone. The conducting wire passes through the telegraph offices at these three intermediate stations, but does not enter any of those of inferior importance, such as Godstone, Penshurst, Maiden, Staplehurst, &c., to the service of which other conducting wires and instruments are appropriated.

125 Since, however, telegraphic communication must be provided between *all* the intermediate stations, and since the chief wires passing the chief intermediate stations do not enter the secondary ones, it follows that the wires of the secondary stations must be carried not only to the terminal stations, but also through all the chief secondary stations. Thus the wires, which pass through the stations of Godstone and Penshurst, must also pass through those of Tonbridge, Ashford, and Folkestone, since otherwise there could be no communication between the latter and the former.

From what has been already explained, it will be understood that every two secondary stations along the line can communicate at the same time with each other, no stations being compulsorily silent, except such as may lie between two communicating ones. To illustrate this, let us suppose the secondary stations from terminus to terminus of the line to be expressed by the small letters, and the chief stations, terminal and intermediate, by the capitals, in the following order:

a, b, c, d, e, f, g, h, i, k, l, m, n, o

Now, by the secondary wires A and b, b and c, c and d, and so on, may at the same moment hold communication. But if A and d communicate, b and c can communicate neither with each other, or with any other station. They are compulsorily silent. In like manner, if A and m communicate, b, c, d, e, f, g, h, i and l are all compulsorily silent.

Hence it will be apparent how necessary it is to put chief intermediate stations like i and k on the primary wires, since if they could communicate with A and o only by the secondary wires, frequent interruptions to the communications of all the secondary stations with each other would take place.

It will be also apparent that on lines of great intermediate business, a third or even fourth system of wires would be necessary.

This will render it easily understood why such a multiplicity of wires are seen stretching along the parts of the lines near London.

Lines of telegraph, like lines of railway, often have branches which are connected either with the primary or secondary wires of the main line, or with both, according to their importance. For example, on the main line between London and Dover, there are branches which go to Maidstone on the one side, and to Tonbridge Wells on the other. Sometimes these branch wires are provided with means of connection with the main line wires, so that the

THE ELECTRIC TELEGRAPH

stations on the main line can communicate *directly* with those on the branch line. Sometimes no such connection is provided, and a dispatch from the main line must be repeated at the branch station. This is a defect which ought never to be allowed to remain, inasmuch as simple and efficient commutators may always be provided for connecting the branch and main lines, which in the telegraph play a part similar to the *switches* by which trains are turned from the main to the branch line, or *vice versa*.

It will be evident from what has been said that a dispatch transmitted upon the secondary line of wires may be delivered at the same time at all the stations from terminus to terminus along the line, or it may be allowed to pass any one or more stations without entering them, by the more management of the commutators provided at the stations severally.

126 In what has been said, we have adverted to signals produced by the current, without explaining the nature of these signals, or the particular means by which they are produced, because all the circumstances attending their transmission from station to station, which have been explained, are quite independent of the particular character of the signals, and the way of producing them. We shall hereafter explain the character of the signals which are used, and the instruments by which they are produced.

From all that has been stated meanwhile, it may be inferred generally that by the commutating apparatus which has been described above, or by any of the endless variety of equivalent contrivances which telegraphic inventors have proposed, any of the following effects may be produced by an agent at any station, at which a current arrives — 1 Such a current may be made to pass through the alarm, and give notice to the agent of its arrival. 2 It may be made to pass through the instrument and give signals. 3 It may be made to pass the station and continue its course along the line without affecting any part of the telegraphic apparatus at the station. 4 If it pass through the alarm, or through the instrument, it may be turned into the earth, and so be prevented from going further along the line. 5 If it pass through the alarm or through the instrument, it may after leaving them be directed along the line, so as to continue its course to the other stations below or above that at which it is supposed to arrive.

127 In some forms of telegraph, the system of signs transmitted to a distant station depends entirely upon the current being alternately suspended and transmitted for longer and shorter intervals, and this succession of long and short intervals, variously combined like the notes in music, is converted into a sort of telegraphic language, which by practice is expressed and understood by the

KEY COMMUTATOR

agent with as much facility and promptitude as ordinary written or spoken language.

128 In such forms of telegraph, the alternate suspension and transmission of the current is produced by a commutator, which has the form of the key of a pianoforte and is played upon in a very similar manner by the agent who transmits the dispatch.

One of the forms of these keys and the mechanism connected with it, is represented in fig. 18. It is fixed upon a wooden block

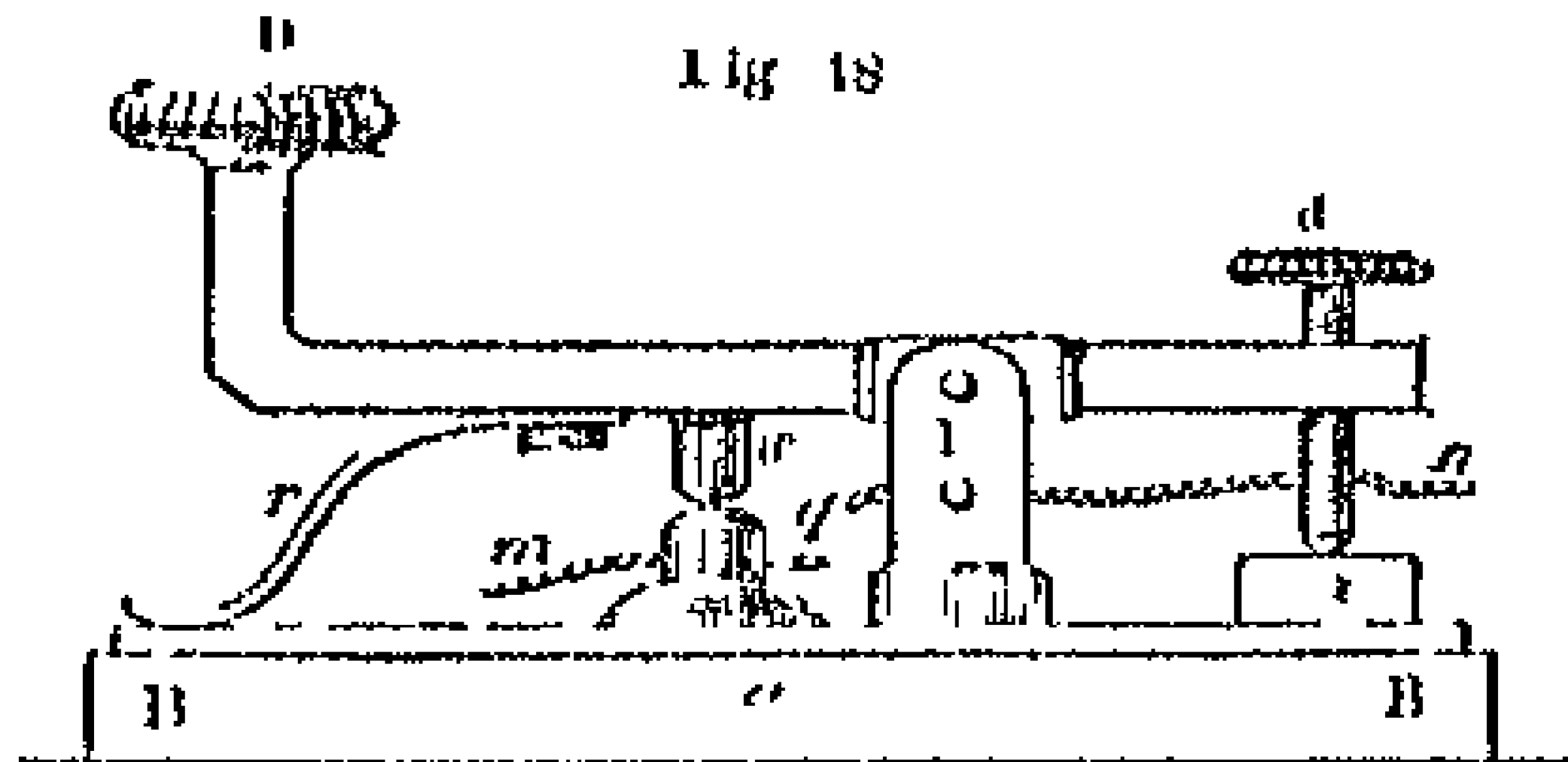

BB. The key plays upon a contact c . To the lower side of the longer arm (r d) is attached a projecting piece of metal v , called the HAMMER, under which is a fixed piece of metal of corresponding form and magnitude called the ANVIL.

The action of the key upon the current is the same precisely as that already described (117) which is produced by the alternately removing and restoring the hand to the contact piece in fig. 17. The hammer in the present case represents the hand, and the anvil the contact piece. One of the line-wires m , is attached to the anvil, and the other n to the metallic support t of the hammer and key. When the hammer is in contact with the anvil, the current passes, and when it is raised from that contact, the current is suspended.

The button b is faced with ivory to be pressed down by the finger, and the screw d passing through the short arm of the key is pressed upon the block t by the reaction of the spring s , when the key is not pressed down by the finger on b . The hammer v , and anvil q are both faced with platinum to prevent oxidation, which would obstruct that complete metallic contact which is necessary to ensure the transmission of the current.

An expert manipulator can work the key b with as much celerity and correctness as can a performer on the pianoforte and can express in that way in telegraphic language any dispatch which is placed in manuscript before him, so as to transmit it to any distant station. This will be explained more fully hereafter. When no dispatch is being transmitted from the station at which

THE ELECTRIC TELEGRAPH

the key is placed, it is necessary to leave a free passage for the current along the line-wires $m n$. To effect this, the screw d , which passes through the short arm of the key, is turned so as to raise the short arm, and consequently lower the arm $i n$ until the hammer v is brought into permanent contact with the anvil q . When that takes place, the metallic continuity between m and n will be established, and the current will flow without interruption on the line-wire. Whenever it is desired to transmit a dispatch, the screw d is turned so as to lower the arm d , and to raise $i n$, and thus to raise the hammer from its contact with the anvil. The key is then ready for the transmission of the dispatch in the manner already described.

129 In some telegraphic apparatus it is necessary to make the intervals of transmission and suspension of the current absolutely equal in duration, and to succeed each other with chronometric regularity. There are many expedients by which this can be accomplished, of which the following is an example.

A metallic wheel put in connection with clock-work, so as to

Fig. 19

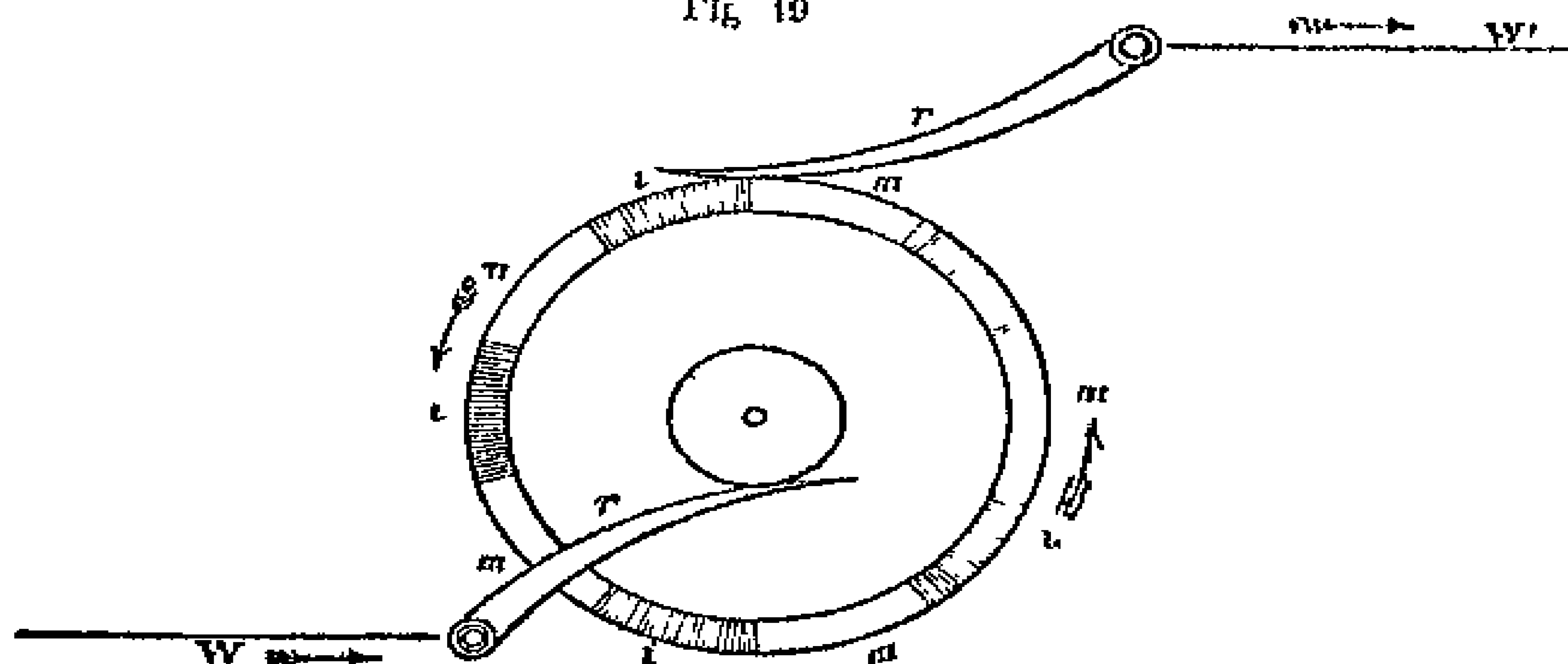

receive a regular motion of rotation, has its edge divided into equal parts by pieces of ivory, or some other non-conductor inlaid upon it, as represented in fig. 19, where m represents the metal, and i the ivory. A metallic spring r' connected with one end of the conducting wire w' , presses constantly upon its edge, and another r connected with the other end of the wire w , presses constantly on the metallic axle of the wheel which is otherwise insulated.

Now, if the wheel be supposed to have an uniform motion of revolution, the alternate divisions of ivory and metal on its edge will pass in succession under the spring r' , while the spring r will be in constant metallic contact with the axis. If a current flows on the wire w , it will be transmitted by the spring r to the axle, and

WHEEL COMMUTATORS

thence by the metal of the wheel to z' , when z' is in contact with any of the metallic parts m of the edge of the wheel, but will be suspended while it is in contact with the ivory parts z of the edge.

If the wheel, being impelled by clock-work, be moved at such a rate that each of the divisions marked m and z shall move under the spring in one second, the current will be transmitted and suspended also during intervals of one second. It will in fact be subject to a regulated pulsation, the rate of which will be controlled and determined by the horological mechanism which impels the wheel.

130 In some cases, the motion to be imparted to the wheel is not either regular or continuous. In such cases, it may be moved either directly by hand, or by a strap, or even by clock-work, which is subject to a check which will suspend it at certain positions of the wheel. In all these cases the pulsations of the current in number, length, and continuance, are governed by the motion imparted to the wheel.

131 As the suspension and transmission of the current are instantaneous upon the breach and re-establishment of the metallic contact of the spring z' and the wheel, there is no practical limit to the rapidity which can be given to its pulsations. The wheel may be turned, for example, so that 500 divisions of its edge may pass under the spring z' in a second, in which case there would be 250 intervals of transmission, and 250 intervals of suspension in a second.

It might perhaps be imagined that in so short an interval of time the current could not be stopped or established along the entire length of the conducting wire. It has however been shown that even with the longest continuous wires, practically used in telegraphs, the ten-thousandth part of a second is more than enough either to establish or stop the current.

132 The intervals of the suspension of the current may be produced by a common toothed-wheel, as represented in fig. 50, without ivory or other inlaid non-conducting matter. In this case, a piece of wedge shaped metal connected with the up line wire is attached to the under side of a wooden lever, while the axle of the wheel is kept in constant metallic connection with the down wire. When a tooth of the wheel comes against the metal attached to the lever, metallic contact is established, but when the metal falls between the teeth, and the surface of the wooden lever rests on one of them, and the metallic contact being broken, the current is suspended.

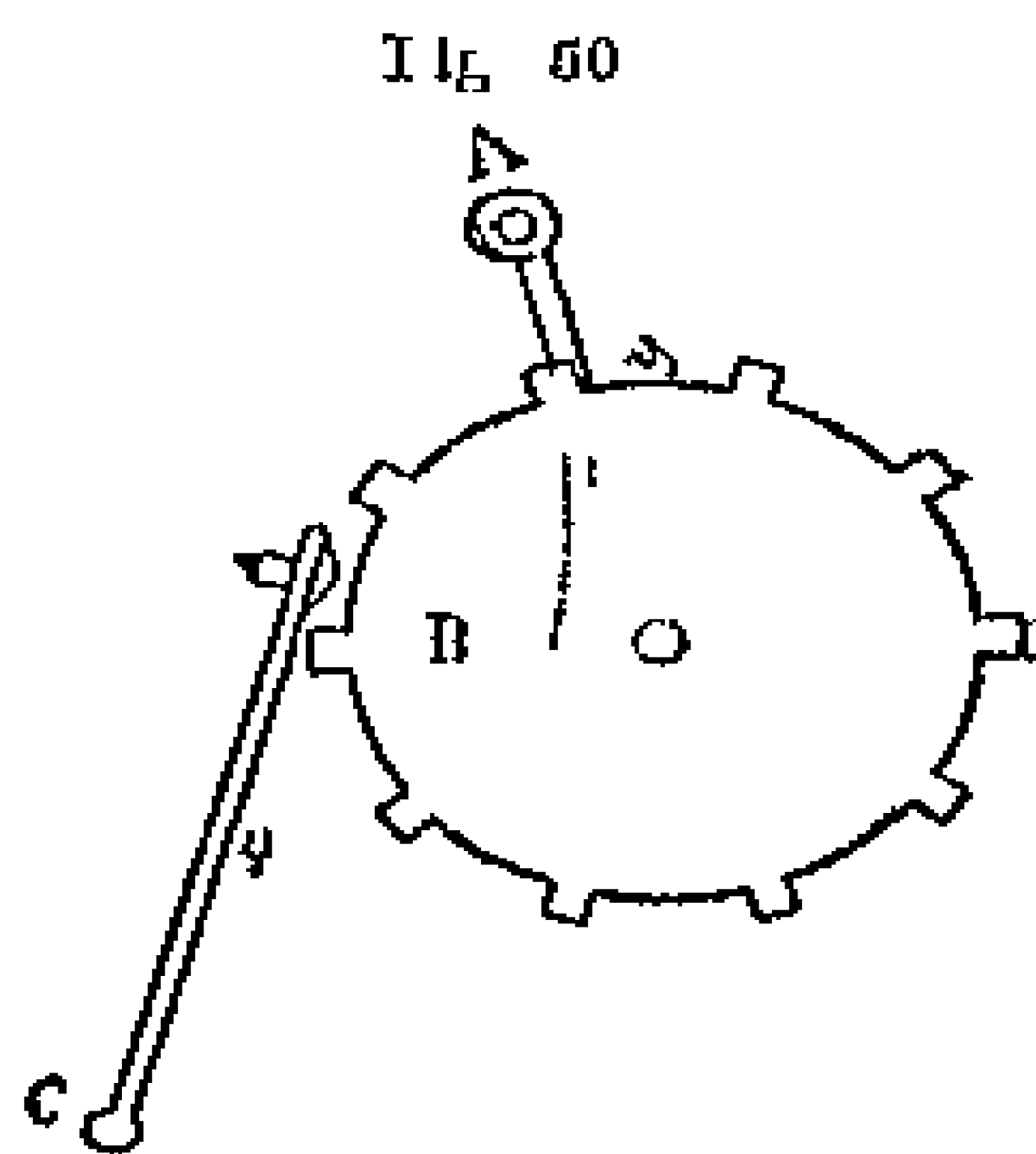

THE ELECTRIC TELEGRAPH

It is evident that during each revolution of the wheel there will be as many pulsations of the current as there are teeth, and since the rotation of the wheel may be as rapid as may be desired, and the teeth as numerous, there is no practical limit to the possible rapidity of these pulsations

133 Another contrivance, by which pulsations are imparted to the current, consists of a metallic wheel around the face of which a sinuous groove is cut, in which a pin, projecting from the arm of a metallic lever is inserted, so that when the wheel is turned upon its axis, the pin attached to the lever receives from the sinuosities of the groove a motion alternately right and left, which is imparted to the other arm of the lever. This latter arm plays between two metallic stops, one of which is connected with the wire w , along which the current flows. When the arm of the lever comes in contact with it, the current is transmitted on the lever to the sinuous groove of the wheel, and from thence to the line-wire w' . When the lever oscillates to the other side, the contact with the wire w is broken, and the current is interrupted.

This will be more clearly understood by reference to the fig. 51, where $A B$ is the wheel, $c c c$ the sinuous groove, $c o \pi$ the lever

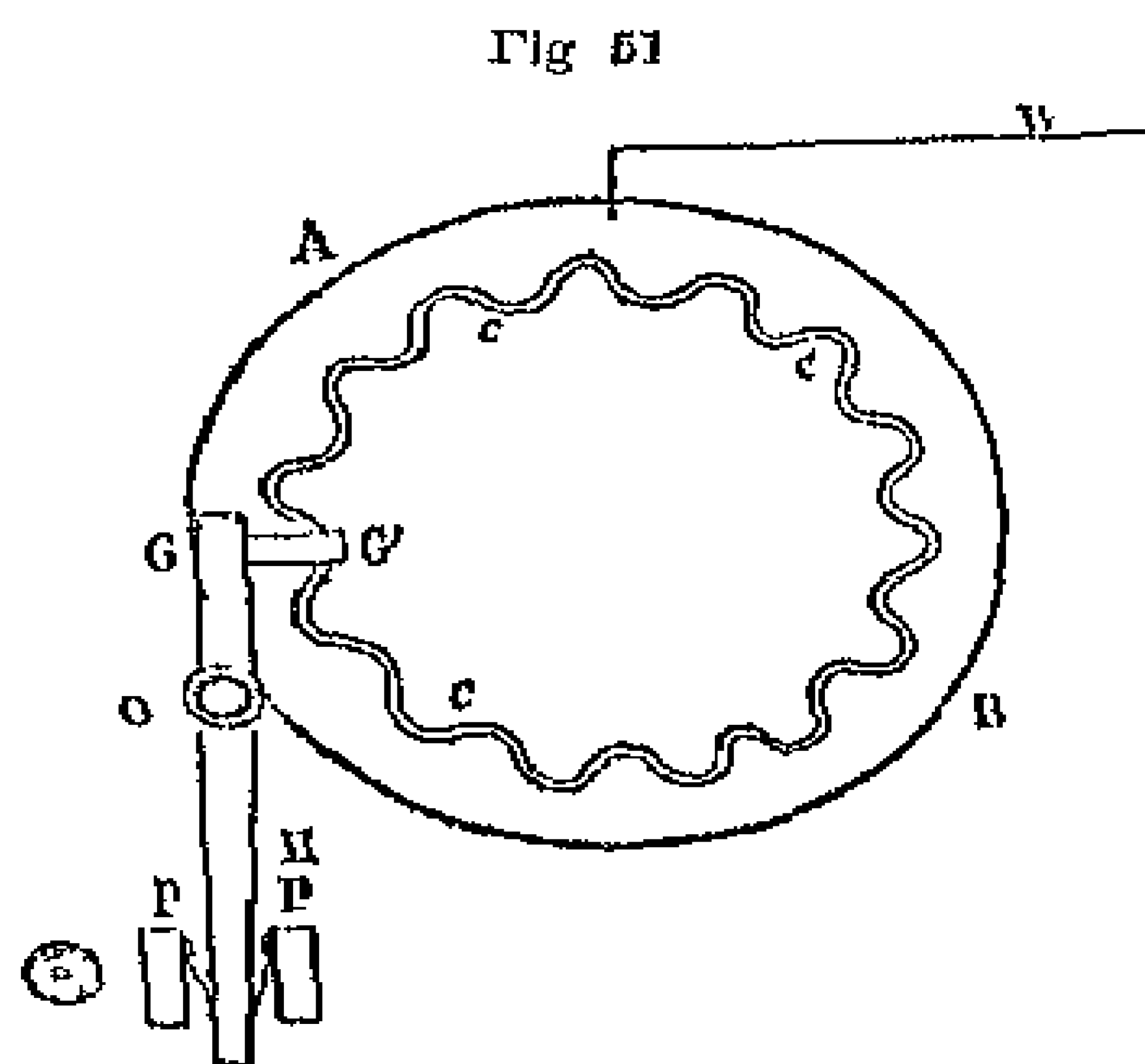

playing on the axis o . From G , a short projecting piece, $G G'$, passes in front of the wheel across the groove, and from this piece a pin projects, which enters the groove. The arm π plays between two stops, P and P' , provided with springs to ensure the contact with the lever. The stop P is connected with the conducting wire w , and the groove c is connected with the wire w' . When the wheel is turned, the pin at c' is driven by the sinuosities of the groove alternately right and left, by which

a corresponding motion is imparted to the arm π of the lever, so that its end is driven alternately against the stops P and P' . When it is thrown against P it is in metallic connection with the wire w . When it is thrown against P' that connection is broken.

Now, if a current flow along w , it will pass to the lever when π falls against P , and will pass by the lever and the groove $c c$ to the wire w' . When the arm π is thrown against P' , the contact with P being broken, the current is suspended. Thus, as the lever is

ALARUM BY SHORT CIRCUIT

made to oscillate between r and r' , by the motion of the wheel and the action of the sinuous groove, the current will be alternately transmitted and suspended, and will, in fine, receive a succession of pulsations corresponding exactly with the sinuosities of the groove. Thus, if there be sixty undulations of the groove in the circumference of the wheel, the current will receive sixty pulsations in one revolution of the wheel, and if the wheel revolve at the rate of sixty revolutions per minute, the current will have 3600 pulsations per minute.

131 An expedient has been sometimes adopted in telegraphic apparatus for diverting the electric current from its direction, which differs in principle from the commutator, and which depends on the tendency of the current to follow the shortest and widest route open to it between one point and another.

Let w , fig. 52, be the line-wire, B the bell-apparatus, and r the telegraphic instrument. The line-wire is bent upwards in the direction m to the bell B , and then downwards, and by m' and w' to the telegraph r .

The current would, according to this arrangement, first pass by the wire m to the bell B , which it would ring, and then by the wire $m' w'$ to the telegraph r . If the dispatch were then transmitted, the current constantly passing through B during its transmission, the bell would be constantly ringing, which would be inconvenient as well as unnecessary.

This is prevented, and the current transmitted directly to r , without passing through B , by the following very simple expedient.

A thick piece of metal, $a b$, turns on an axis c , so that when it is placed in the horizontal position, the ends a and b are brought into close contact with the conducting wire at e and f . The current, on arriving at e divides itself into two parts, one going by $a b$ to f , and thence to r , and the other as before, by m , through the bell. But as $a b$ is much shorter and thicker than the wire $m m'$, the greater part of the current will go by $a b$, and the part which passes along $m m'$ will be too inconsiderable to exercise the force necessary to ring the bell.

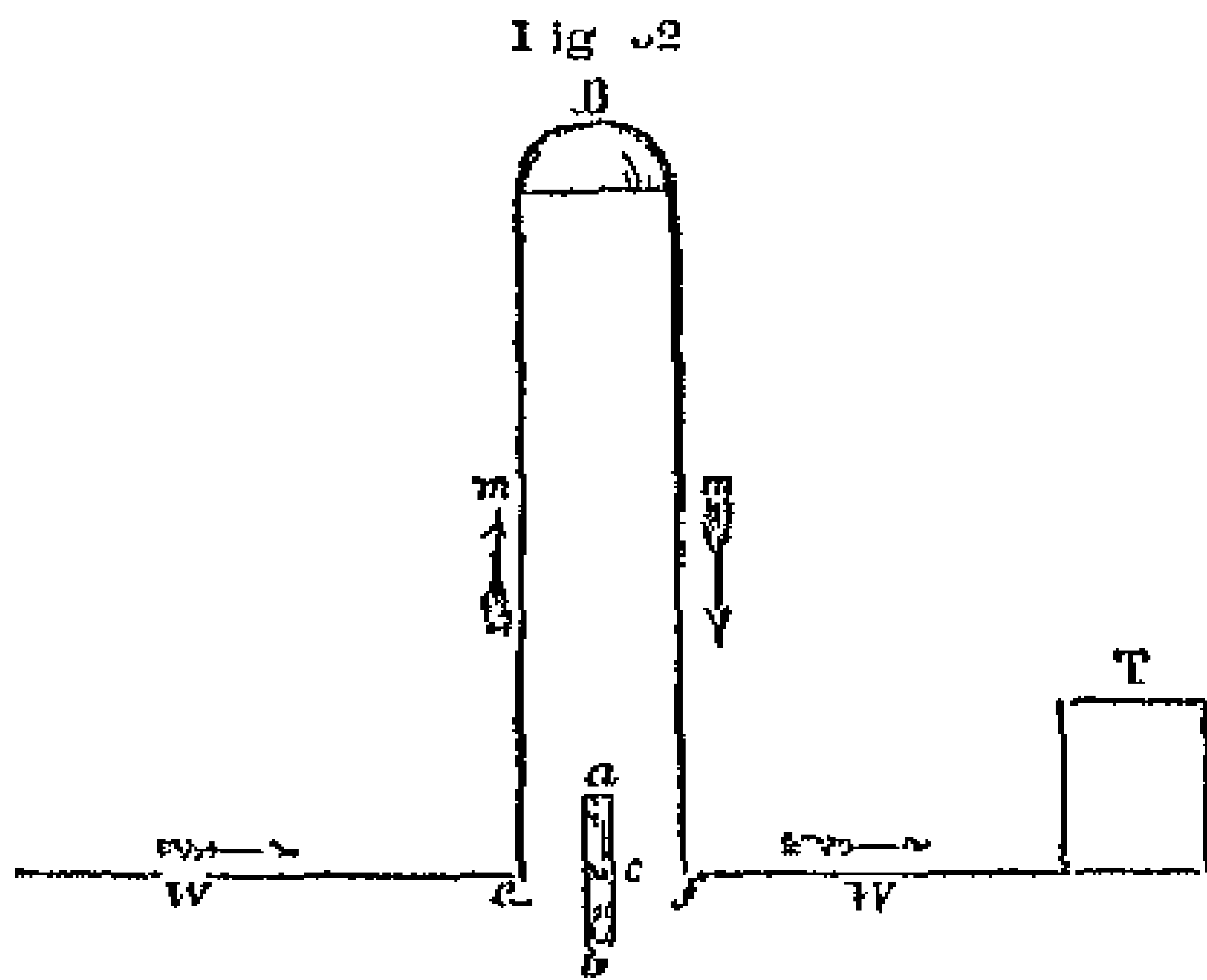

THE ELECTRIC TELEGRAPH

The agent, therefore, at the station, receiving the dispatch, being warned by the bell that the agent at the station *s* is going to send a dispatch, turns the piece *a b* into the horizontal position, and the bell ceases to ring, the telegraph receiving the dispatch.

135 The manner in which the pulsations of the current are produced, controlled, and regulated, by the operator at the station *s* being understood by these examples and illustrations, it will next be necessary to show how they are made to produce signals at the station to which the dispatch is transmitted, by which the operator or observer there can be enabled to understand and interpret the communication.

The effects of the current which have been found most convenient for this purpose are—

1st Its power to deflect a magnetic needle from its position of rest, and to throw it into another direction.

2nd Its power to impart temporary magnetism to soft iron, this magnetism suddenly deserting the iron when the current is suspended.

3rd Its power to produce the chemical decomposition of certain substances.

136 All forms of electric telegraph depending on one or other of these properties of the current, it is indispensably necessary to understand them before the reader can hope to comprehend the mode of operation of these wonderful instruments.

If a wire be extended over and under a compass-needle which directs itself to the magnetic north and south, parallel to the needle, and as close to it as it can be placed without actually touching it, as represented in fig 53, the needle will remain undisturbed in its position.

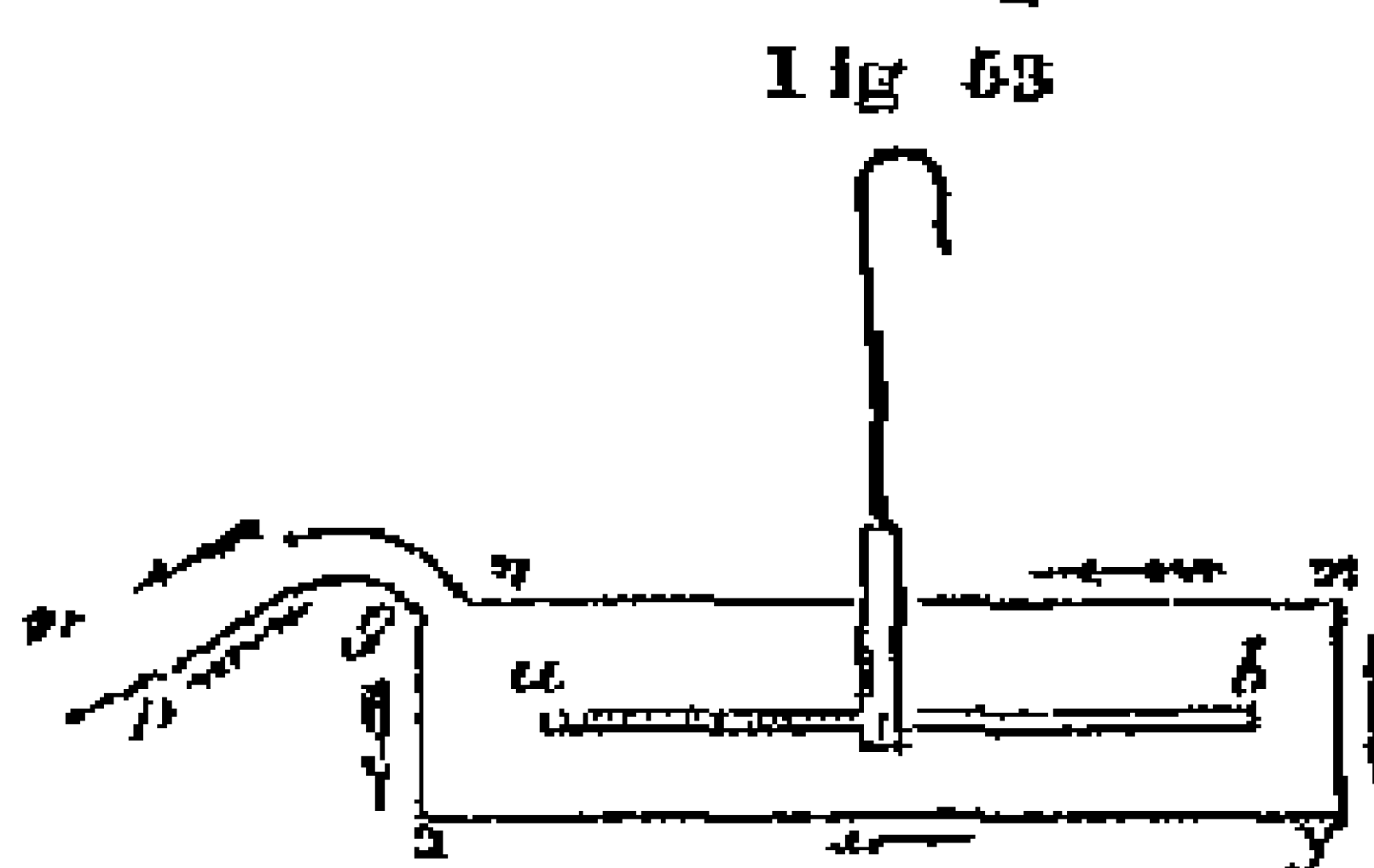

Let the ends *p* and *n* of the wire be then attached to the poles of a voltaic battery, so that a current of a certain intensity shall be transmitted upon it. The moment the current is established upon the wire, the magnetic needle *a b* will be thrown out of its usual direction, and instead of pointing north and south, it will point east and west.

If the direction of the current upon the wire be reversed, the direction of the deflexion of the needle will be reversed.

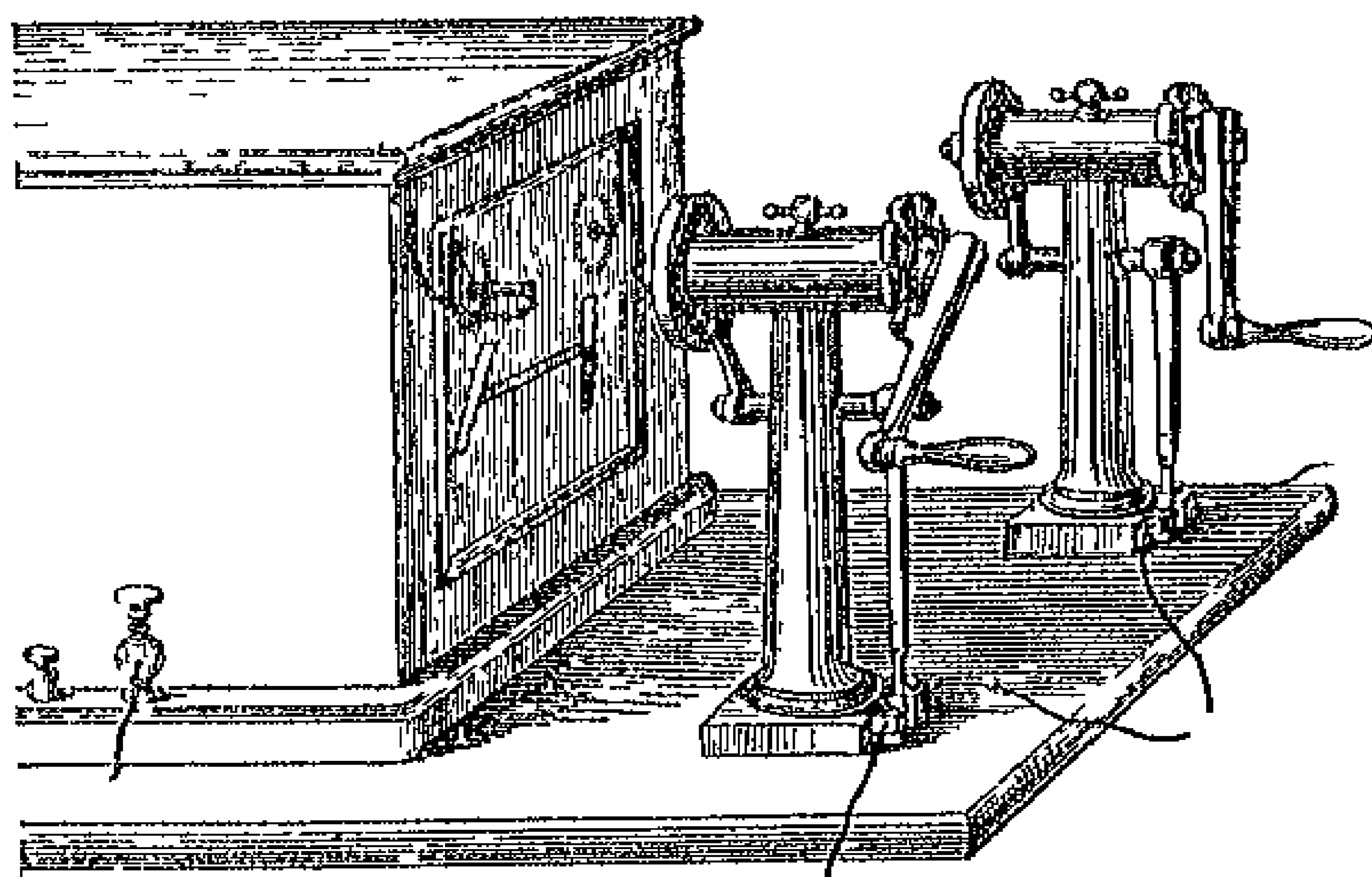

Fig. 73.—FRENCH STATIC TELEGRAPH

THE ELECTRIC TELEGRAPH

CHAPTER VI

- 137 Relation of the deflection to the direction of the current—138 Galvanometer or multiplier—139 Method of covering the wire—140 Method of mounting the needle—141 Method of transmitting signals by the galvanometer—142 How the current may produce a temporary magnet—143 Electro magnet constructed by Pouillet—144 Electro magnets formed by two straight bars—145 They acquire and lose their magnetism instantaneously—146 Magnetic pulsations as rapid as those of the current—147 How they are rendered visible and counted—148 Extraordinary celerity of the oscillations thus produced—149 They produce musical sounds by which the rate of vibration may be estimated—150 How the vibrations may impart motion to clock work—151 Their action on an escapement—152 How the movement of one clock may be transmitted by the current to another—153 How an electro magnet may produce written characters on paper at a distant station—154 How the motion of the hand upon a dial at one station can produce a like motion of a hand upon a dial at a distant station—155 How an agent at one station can ring an alarm at another station—156 Or may discharge a gun or cannon there—157 Power of the bell or other signal not dependent on the force of the current—158 Mechanism of telegraphic alarm—159 Various alarms in telegraphic offices—160 Magneto electricity—161 Method of producing a momentary magneto electric current—162 Application of an electro magnet to produce it

THE ELECTRIC TELEGRAPH

137 To explain the manner in which the deflection of the needle depends on the direction of the current, let us suppose the needle to be placed on an horizontal axis *o*, fig 51, so as to

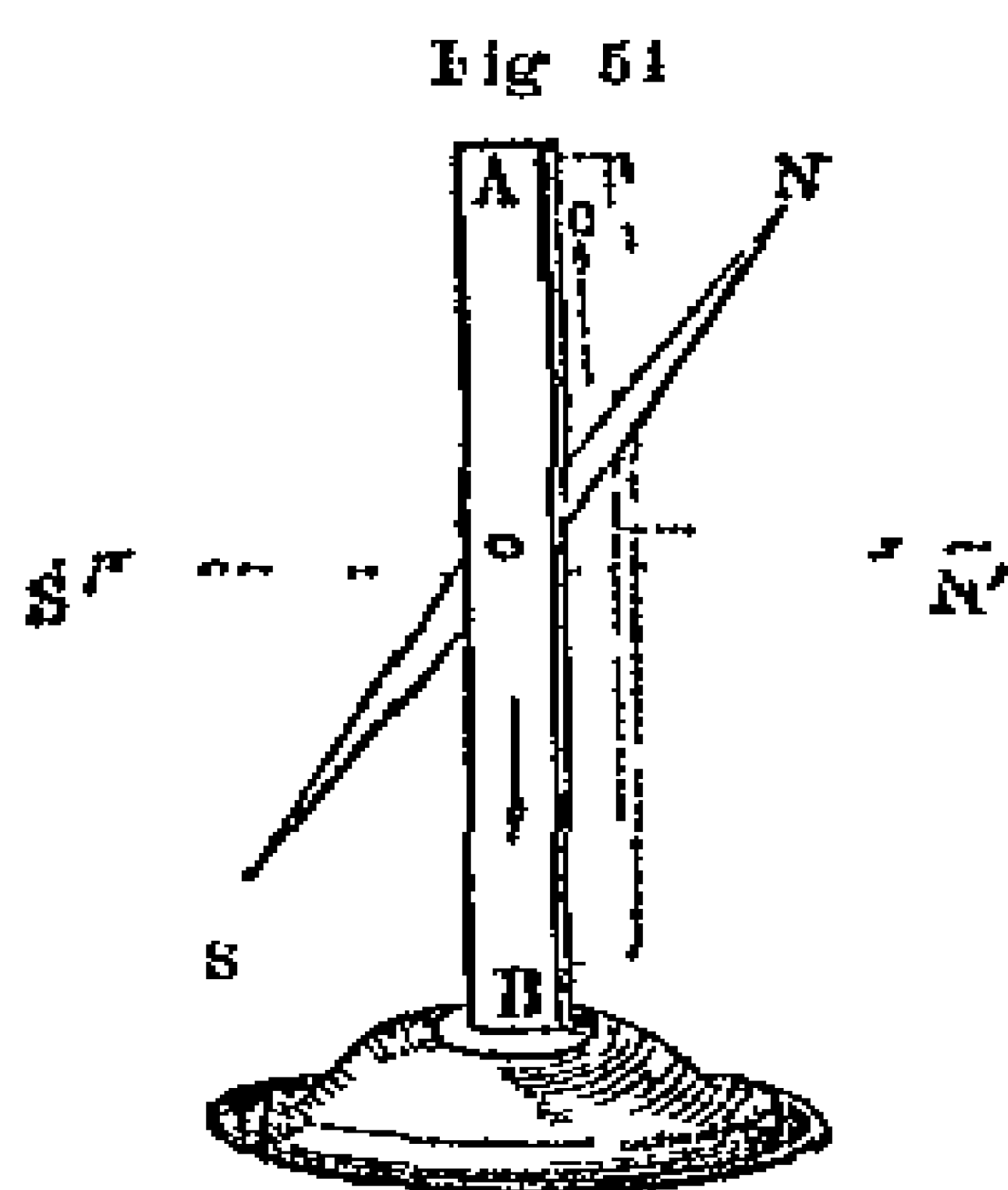

play in a vertical plane, and to be maintained in the vertical direction when not affected by the current, by giving a slight preponderance to the arm on which the south pole of the needle is placed. By this arrangement the needle, when undisturbed, will rest in the vertical position, the north pole *N* being directed upwards, and the south pole *s* being directed downwards.

Now if the current which is before the needle be directed *downwards* and that which is behind it *upwards*, the *north* pole *N* will be deflected to the *right*, and consequently the *south* pole *s* to the *left*, as represented in the figure. But if the direction of the current be reversed so that *before* the needle, it shall be directed *upwards* and *behind* it *downwards*, the north pole *N* will be deflected to the left and the south pole *s* to the right.

If the intensity of the current be great, and the preponderance given to the lower arm of the needle small, the deflective force of the current will be sufficient to throw the needle completely at right angles to its position of rest, that is, to give it the horizontal direction, but it is important to observe, that no greater intensity of the current can affect it further. The north pole, for example, cannot be deflected downwards, or the south pole upwards. In fine, the needle cannot be more affected by any increase of force of the current after it has once been thrown into the horizontal direction.

If the intensity of the current be insufficient to throw the needle into the horizontal direction, it will nevertheless take a position intermediate between that and the vertical direction at which it will rest. Its deflection from the vertical will be more and more considerable as the current is more intense, and certain mathematical conditions have been discovered by which the relative intensity of the current may be determined by the amount of the deflection of the needle which it produces.

138 It is evident that the sensibility of the needle will be so much the greater as the preponderance of the arm *s* is diminished and the intensity of the current increased. An expedient has, however, been ingeniously contrived, by which the most feeble current can be made to affect the needle. This is accomplished by

GALVANOMETER.

winding the wire which carries the current several times round the needle, each coil being still parallel to the needle. By this contrivance, each successive coil of the wire produces a separate effect upon the needle, and if there be fifty such coils passing successively before and behind the needle, each portion of the wire thus carrying the current producing an independent deflecting force, there will be a total deflecting force an hundred times greater than that which a single portion of the wire, passing once over or under the needle would produce.

In this manner the deflecting power of the most feeble current may be so *multiplied* as to produce upon the needle as powerful an effect as would be produced by a current of great intensity.

An apparatus consisting of wire thus coiled round a magnetic needle is called a *MULTIPLIER*, inasmuch as it multiplies the deflecting power of the needle. It is also called a *MICROSCOPE*, or *PROSMETER*,* and sometimes a *GALVANOSCOPE*, or *GALVANOMETER*, inasmuch as it indicates the presence, and by certain arrangements, measures the intensity of a galvanic or voltaic current.

139. When the conducting wire is thus coiled round a needle, it is necessary that it should be covered or coated by some substance which is a non-conductor of electricity, since otherwise the coils being necessarily in contact one with another, the current, instead of following the continuous thread of wire, would pass from coil to coil. In such cases, therefore, the wire is wrapped with silk or cotton, which being a non-conductor, confines the current within it just as water would be included in a pipe.

140. As the wire coiled in the manner above-described, and the frame which carries it, would prevent the play of the needle from being easily and conveniently observed, the needle included within the frame is fixed upon the axis which supports it, so that the axis turns with it. This axis passes through the side of the frame, on which the wire is coiled, and upon the end of it which projects beyond the frame a hand is fixed, so as to be parallel to the needle, the play of which will necessarily correspond with that of the needle. This hand plays upon a sort of dial, by which its deviations to the right or to the left, from its position of rest are indicated.

This will be more clearly understood by reference to fig. 55 (p. 196), which represents a section of the mounting of the needle, the coil of wire and their appendages, made by a vertical plane through the axis of the needle. The needle within the coil is represented at *a b*, in its position of rest. The axis of the needle

* From two Greek words, *peos* (peos) a current, and *μετρον* (metron) a measure.

passing through the frame supporting the coil, and through the dial plate, supports in front of the dial the hand *a b*, which is

Fig 65

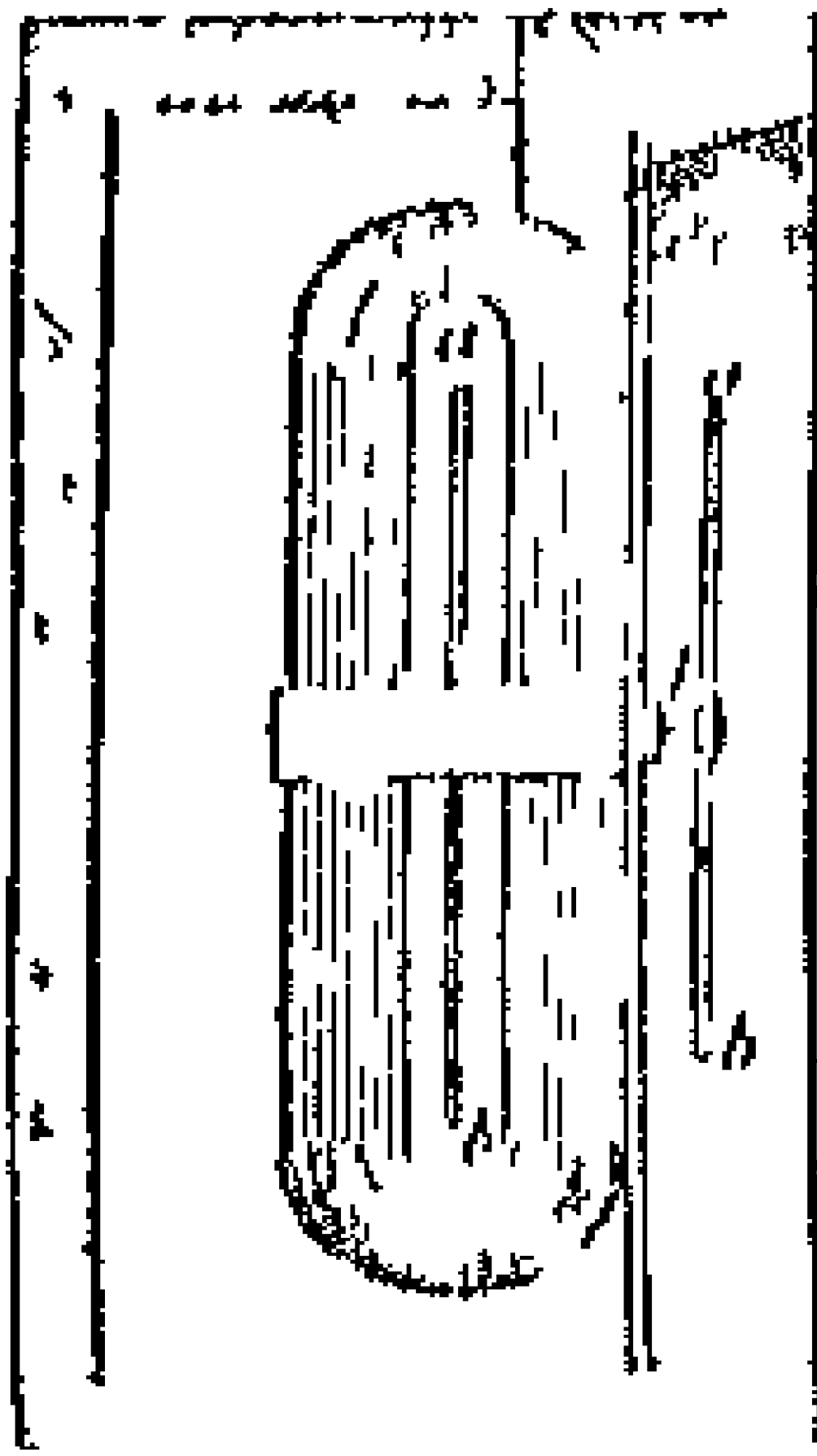

fixed upon the axis in a position parallel to the needle *a b*, so that it must play before the dial in a manner corresponding exactly with the play of the needle *a b* within the coil.

111 In order to govern the play of the needle, it is necessary that the agent at the station from which the signal is transmitted should have the power, 1st To suspend and transmit the current at the receiving station, and 2nd To change its direction upon the conducting wire. The former is necessary, to enable him to bring at all times the needle to its position of rest, and the latter, to deflect it to the right or to the left, according to the exigencies of the telegraphic communications.

The general principle on which the change in the flow and direction of the current is effected, has been already explained (111). It may be maintained, that by very simple mechanism the movement of a lever or arm may make or break the contact of the conducting wires, or to transmit or suspend the current at pleasure. And by a simple motion of such an arm the hands, *x* and *x'*, fig. 15, or any equivalent piece, may be moved from *r* to *s* and from *s* to *r*, or to reverse the current upon the wire to which the arm *x'* is directed.

If then an agent at the station, *s*, for example, be provided with any means of suspending or reversing the current which passes along the wire, between *s* and *s'*, he can at will bring a needle, mounted at *s*, to its position of rest, that is, to the vertical position, by suspending the current or deflect it to the right by causing the current to flow in one direction on the conducting wire, or to the left, by reversing the direction of the current.

The particular manner in which these several operations subserve to telegraphic purposes will be presently explained.

Fig 70

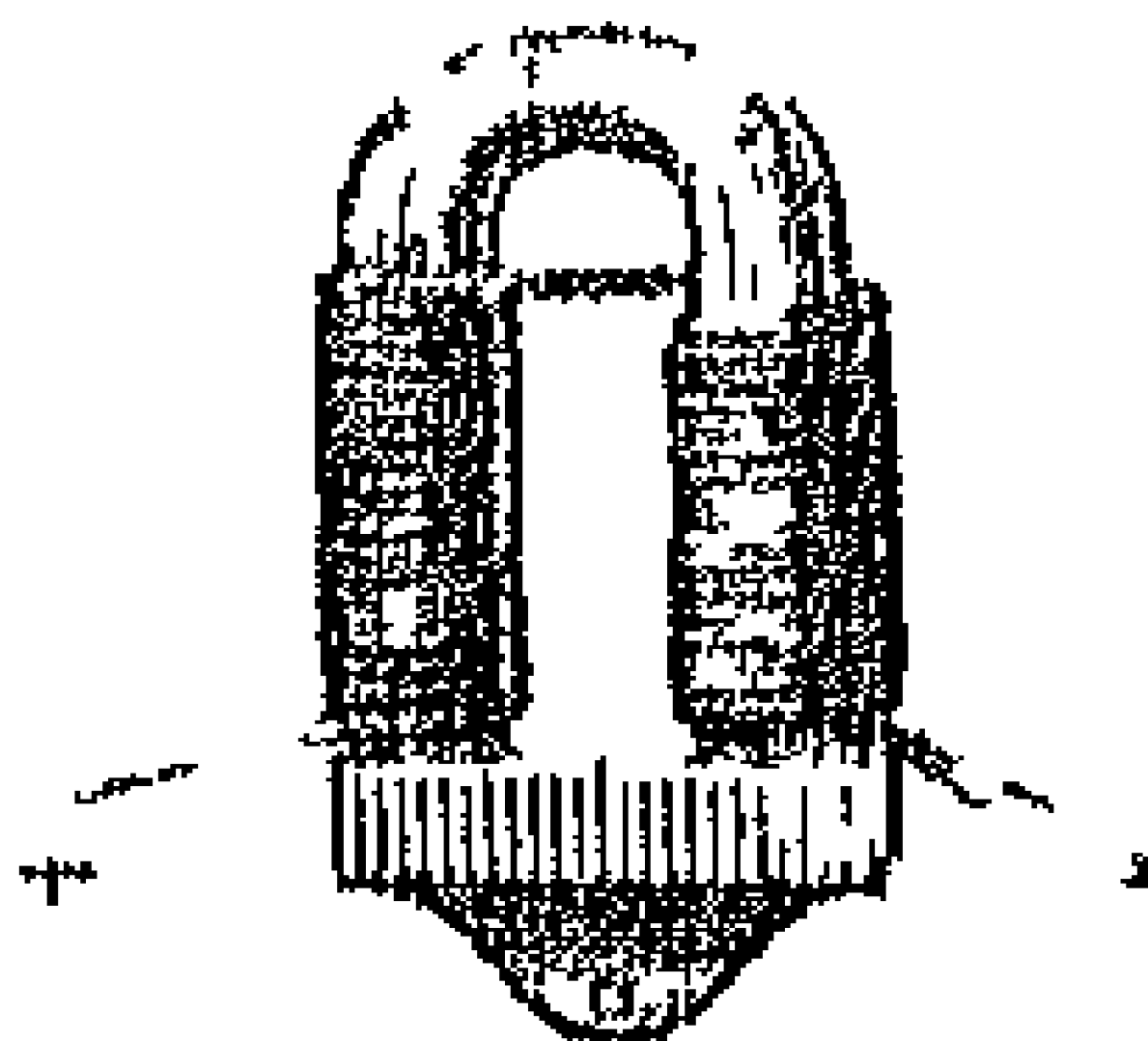

112 To explain the manner in which the electric current can impart temporary magnetism to soft iron, let us suppose a copper wire wrapped with silk, to prevent the metallic contact of contiguous convolutions, to be coiled round a rod of soft iron, bent into the form of a horseshoe, as is presented in fig. 56, care being taken, that in carrying the wire from one arm to the other, the

ELECTRO-MAGNETS

direction of the convolutions shall be the same as if the coils had been continued round the bend

So long as no electric current passes along the convolutions of the wire the horse-shoe will be free from magnetism. But if the ends of the wire, marked + and —, be put in connection with the poles of a voltaic battery, so that a current flow round its convolutions, the horse-shoe will instantly become a magnet, and will be so much the more powerful as the current is more intense, and the coils more multiplied

If an armature loaded with a weight be presented to the ends of the horse-shoe while the current passes on the wire, it will adhere to them, and the weight, if not too great, will be supported

113 In 1830 an electro-magnet of extraordinary power was constructed under the superintendance of M Pouillet, at Paris. This apparatus, represented in fig 57, consists of two horse-shoes, the legs of which are presented to each other, the bends being turned in contrary directions. The superior horse-shoe is fixed in the frame of the apparatus, the inferior being attached to a cross-piece which slides in vertical grooves formed in the sides of the frame. To this cross-piece a dish or plateau is suspended in which weights are placed, by the effect of which the attraction which unites the two horse-shoes is at length overcome. Each of the horse-shoes is wrapped with 10,000 feet of covered wire, and they are so arranged that the poles of contrary names shall be in contact. With a current of moderate intensity the apparatus is capable of supporting a weight of several tons.

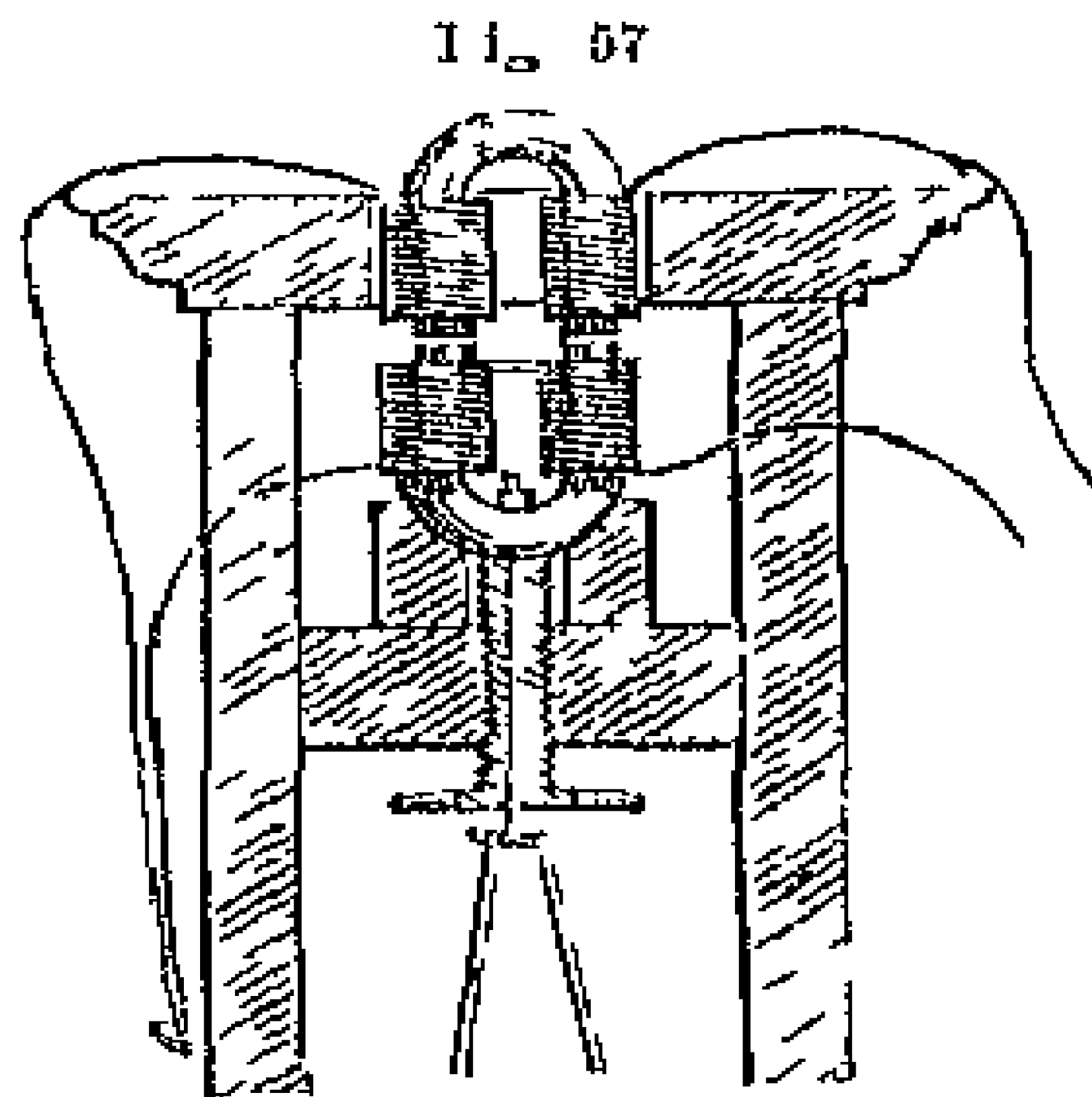

114 It is found more convenient generally to construct electro-magnets of two straight bars of soft iron, united at one end by a straight bar transverse to them, and attached to them by screws, so that the form of the magnet ceases to be that of a horse-shoe, the end at which the legs are united being not curved but square. The conductor of the helical current is usually a copper wire of extreme tenacity.

115 In whatever form these magnets are constructed, the circumstance which in their telegraphic use is of most importance to notice, is that if proper conditions be observed in their preparation, their acquisition of the magnetic virtue upon the

THE ELECTRIC TELEGRAPH.

establishment of the current, and then loss of it upon the suspension of the current, are, for all practical purposes, instantaneous. The moment the extremities of the wire coiled round the horse-shoe are put into connection with the poles of the battery the horse-shoe becomes a magnet, and the moment the connection with the battery is broken it loses the magnetic virtue.

146 It has been already shown, that by means of very simple expedients, the current may be interrupted hundreds or even thousands of times in a second, being fully re-established in the intervals. The acquisition and loss of magnetism by the horse-shoe accompany these pulsations with the most perfect and absolute simultaneity. If the pulsations of the current be produced, at the rate of a thousand per second, the alternate presence and absence of the magnetic virtue in the horse-shoe will equally be produced at the rate of a thousand per second. Nor are these effects in any way modified by the distance of the place of interruption of the current from the magnet. Thus, pulsations of the current may be produced by an operator in London, and the simultaneous pulsations of the magnetism may take place at Vienna, provided only that the two places are connected by a continuous series of conducting wires.

147 It remains to show how these rapid pulsations of the magnetism of the bar can be rendered sensible, and how they may even be estimated and counted.

Let two straight rods of soft iron be surrounded by a succession of convolutions of covered wire, such as has been already described, and let the ends, m, m' , fig. 58, of these rods be connected

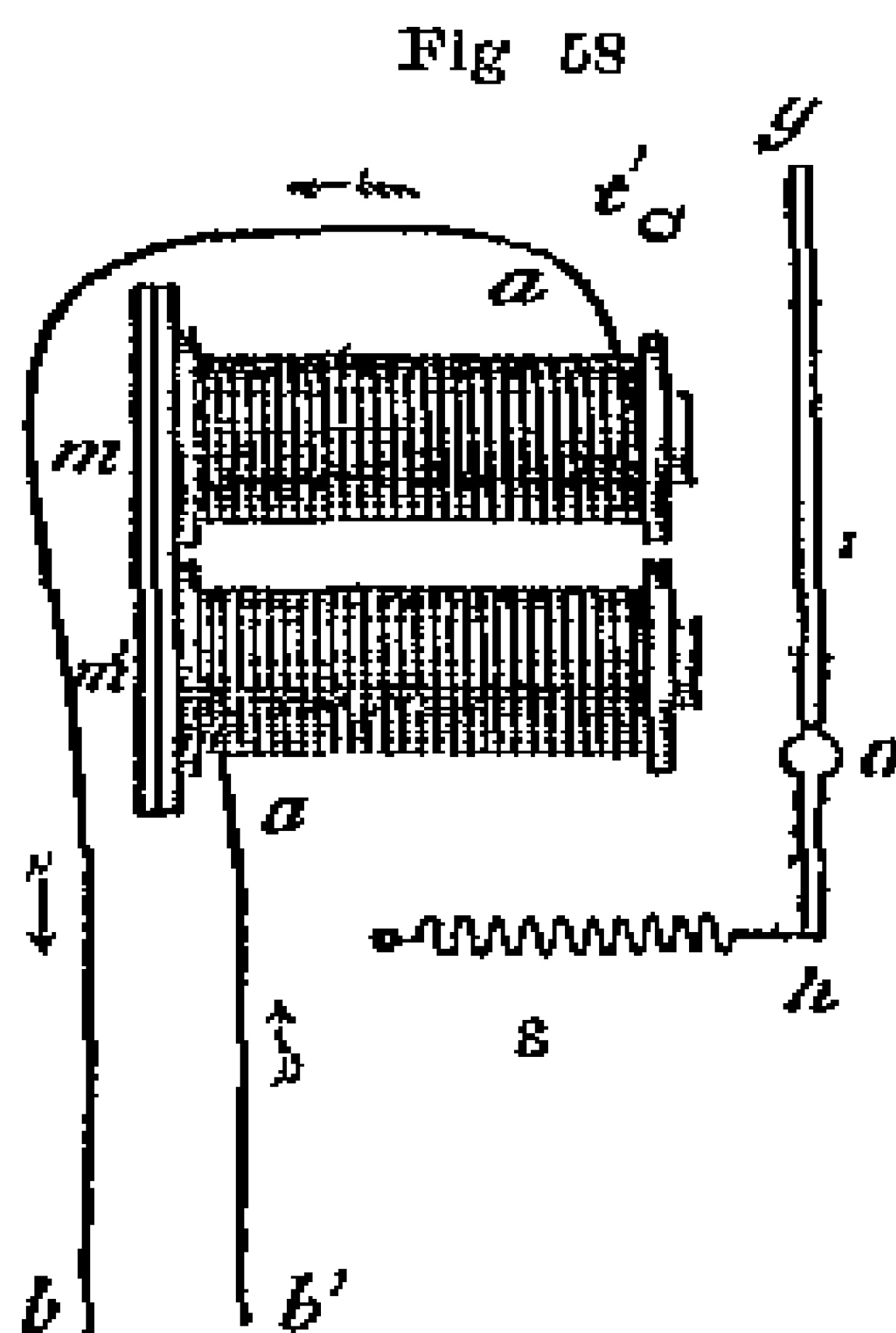

by a straight bar of soft iron, attached to them by screws and nuts. Let the wire, $a b$, proceeding from a distant station, s , be put in metallic connection with the extremity of the wire coiled upon the rod, m , and let the wire, $a' b'$, connected with the extremity of the last convolution of the wire on the rod, m' , be put in metallic connection with the earth. If a current flow along $a b$, it will therefore circulate round the rods, m and m' , and will pass to the earth by the wire, $a' b'$. So long as this current flows, the rods will be magnetic, and they will lose their magnetism in the intervals of its suspension.

Let $g h$ be a light iron bar, supported on a pivot, at o , on which it is capable of playing, so that its arm, $o g$, may move freely to

ELECTRO-MAGNETIC PULSATIONS

the right or left. Let t t' be two stops, placed a small distance to the right and left of its extremity, g , so as to limit the range of its play. Let s be a spring attached to the extremity, h , by which that extremity will be constantly drawn to the left, and therefore the opposite extremity, g , thrown to the right against the stop, t . When the current is suspended, and the rods, $m m'$, divested of magnetism, the lever yielding to the action of the spring, s , the end, g , will rest against the stop, t . But when the current passes on the wire, the rods, $m m'$, becoming magnetic, will attract the arm, $o g$, of the lever, and this attraction exceeding the force of the spring, the arm, $o g$, will be drawn towards the electro-magnet, until it encounters the stop, t' , against which it will rest so long as the current continues to flow. But the moment the current is suspended, the bars, $m m'$, suddenly losing their magnetism, the lever, $o g$, is abandoned to the action of the spring, and it is again thrown back upon the stop, t , where it rests until the current is re-established.

Let us suppose that an agent at the station, s , to which the wire, $a b$, extends, and which may be at any distance, 500 miles for example, from s'' , is supplied with any of the means which have been explained, by which he can at will control the pulsations of the current. When he causes the current to flow, he imparts magnetism to the bars, $m m'$, and throws the lever, $o g$, against the stop, t' . When he suspends the current he deprives the bars, $m m'$, of their magnetism, and leaves the lever, $o g$, to the action of the spring, s , by which it is thrown against the stop, t .

It appears, therefore, that with each pulsation which the current receives from the agent at s , the lever, $o g$, at s'' , 500 miles distant from him, will perform a vibration between the stops, t and t' . As the transmission and suspension of the current, and also the acquisition and loss of the magnetic power, by the rods, $m m'$, are both instantaneous, there is no practical limit to the velocity of the pulsations of the current and those of the magnetism alternately acquired and lost by the rods, $m m'$. The oscillations of the lever, $o g$, produced by these pulsations are limited, however, by the weight of the lever, the force of the spring, and the distance between the stops, t and t' . The greater the weight of the lever, the force of the spring, and the distance between the stops, the slower will be the motion of the lever from t to t' , produced by a current of given intensity. The greater the weight of the lever, and the distance between the stops, and the less the force of the spring, the slower will be the motion from t' to t .

The stop, t' , is so placed as to prevent the absolute contact of the arm of the lever with the electro-magnet, but to allow it to

THE ELECTRIC TELEGRAPH II

approach the latter very closely. Absolute contact is to be avoided, because it is found that in that case the arm adheres to the magnet with a certain force after the current ceases to flow, but so long as absolute contact is prevented, it is immediately brought back by the spring, *s*, when the current is suspended.

118 It is evident, therefore, that the limit of the possible velocity of vibration to be imparted to the lever, *o g*, by the pulsations of the current will depend on the nice adjustment of the weight and play of the lever, and the force of the spring, *s*.

The velocity of oscillation, however, which can in this way be imparted to the lever, is such as can scarcely be credited without actually witnessing its effects. When that velocity does not exceed a certain limit the oscillations may be registered and counted, by causing the lever to give motion to the anchor of an escapement, connected with a train of wheel-work, by which a hand or index, moving on a graduated dial, is governed. But these oscillations are susceptible of velocities so great that it would be difficult to apply this expedient for counting them. M. Gustave Trombet, of Paris, suggested and applied to this purpose with complete success, a method of ascertaining the velocity depending on the laws which govern the vibrations of musical strings.

119 It is well known that the pitch of any musical note is the consequence of the rate of vibration of the string by which it is produced, and that the more rapid the vibration the higher the note will be in the musical scale, and the slower the vibration the lower it will be. Thus the string of a pianoforte which produces

the bass note  vibrates 132 times in a second, that

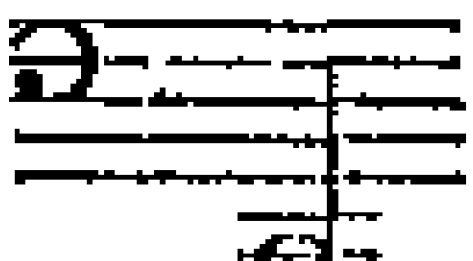
which produces the note  vibrates 66 times in a second,

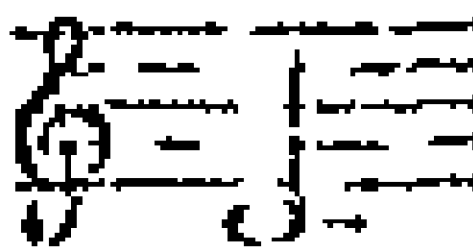
and that which produces the note  vibrates 264 times per second.

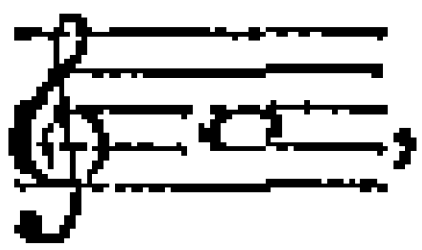
On a seven octave pianoforte the highest note in the treble is three octaves above , and the lowest note in the bass is four octaves below it. The number of complete vibrations corresponding to the former must be 3520, and the number of vibrations per second corresponding to the latter is 27½.

If, therefore, the lever, *o g*, have any rate of vibration more rapid than 27½ vibrations per second, and less rapid than 3520 per

PULSATIONS MEASURED BY MUSICAL SOUNDS

second, it will produce by its motion some definite musical sound, and if the note formed upon a pianoforte, which is in unison with it, be found, the rate of vibration of the string producing that note, will be the same as that of the lever.

When it is stated that the vibrations imparted by the pulsations of the current to levers, mounted in the manner here described, have produced musical notes nearly two octaves higher than the highest note on a seven octave piano, tuned to concert pitch, it may be conceived in how rapid a manner the transmission and suspension of the electric current, the acquisition and loss of magnetism in the soft iron rods, and the consequent oscillation of the lever, upon which these rods act, take place. The string which produces the highest note, on such a piano, vibrates 3020 times per second. A string which would produce a note an octave higher would vibrate 7040 times per second, and one which would produce a note two octaves higher would vibrate 14080 times per second.

It may, therefore, be stated, that by the marvellously subtle action of the electric current, the motion of a pendulum is produced, by which a single second of time is divided into from twelve to fourteen thousand equal parts!

150 It has been already shown how the motion of clock-work may be applied to control and regulate the pulsations of the electric current. We shall now show how, on the other hand, the pulsations of the current may be made to govern the motion of wheel-work. This expedient must be regarded with the more interest inasmuch as it has been applied with the greatest effect in several of the varieties of electric telegraph, which have been proposed or brought into operation.

151 If we suppose the lever $g h$, fig. 58, to be put into connection with the anchor of the escapement wheel of a system of clock-work, it will be easy to see how that clock-work can be regulated by the pulsations of the electric current.

In fig. 69 (p. 202), $w w'$ is the escapement wheel which is constantly impelled by the force of a descending weight or mainspring in the direction of the arrows. The anchor $A B C$, of the escapement, is connected with an axis D , by the straight rod $B D$. This rod $B D$ may be either the vibrating arm of a lever, such as $g h$, fig. 58, kept in oscillation by the current acting on an electro-magnet, or it may be connected with such a lever in any convenient manner, so as to oscillate simultaneously with it, and to have the extent of play necessary for the action of the pallets A and C of the anchor on the teeth of the escapement wheel.

When the anchor is not in a state of oscillation, a tooth of the wheel will rest upon one of its pallets, and the wheel and clock-work connected with it will be stopped. When the anchor moves

THE ELECTRIC TELEGRAPH.

from left to right, the tooth of the wheel, which was previously stopped by the upper surface *n'* of the pallet *o*, is allowed to *escape*, and in obedience to the power of the spring or weight, which moves the clock-work, it advances towards *m'*. Meanwhile the pallet *A* enters the space between two teeth of the wheel, one of which coming against its lower surface, it stops its motion. When the anchor moves back from right to left, the pallet *o* comes under the next tooth of the wheel. In this manner every movement of the anchor to the right lets a tooth, which was stopped by the pallet *o*, advance, and afterwards the pallet *A* stops the advance of another tooth, while every movement to the left lets the tooth stopped by *A* advance, and afterwards the

Fig 59

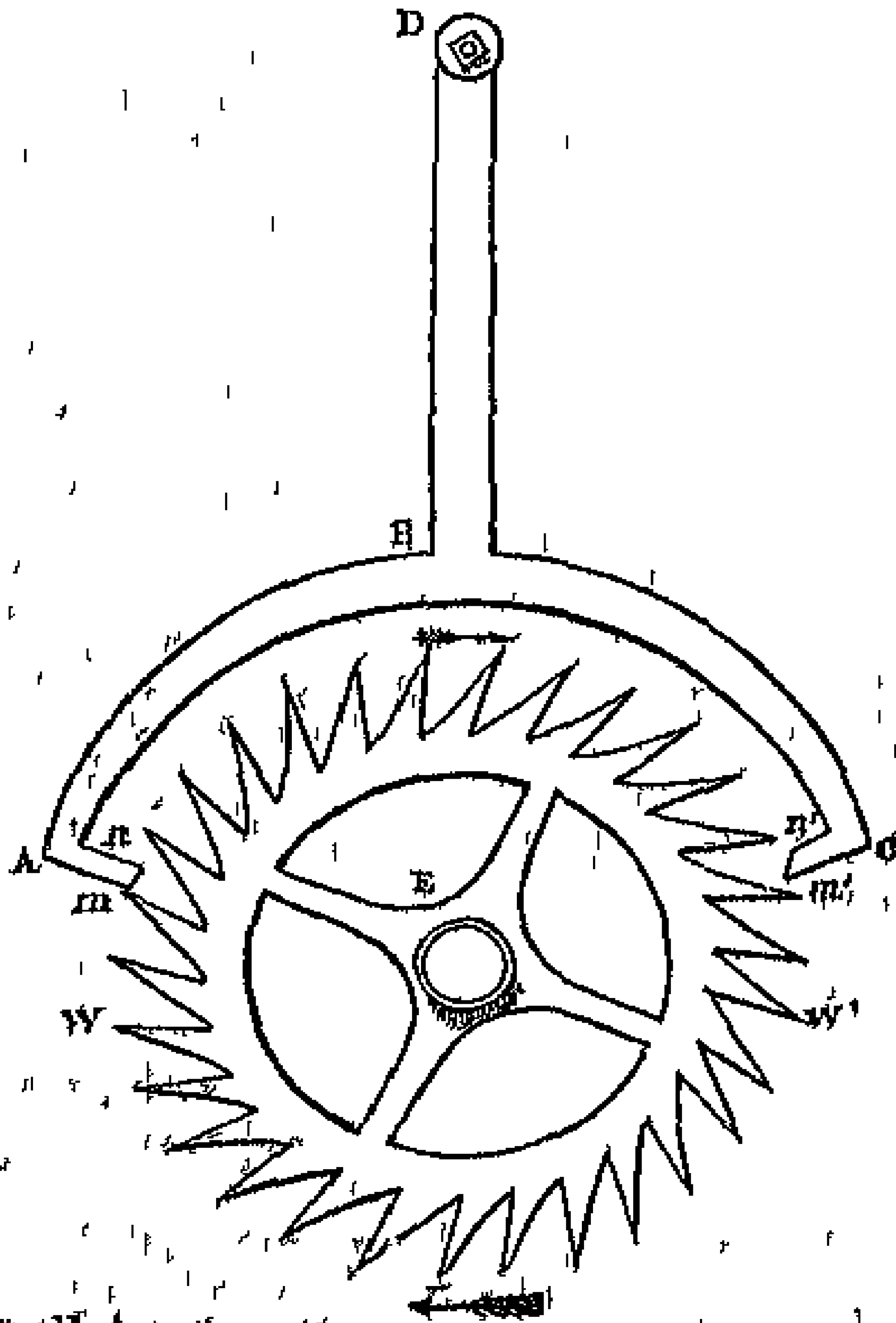

pallet *o* stops the next tooth which advances on that side.

Thus each complete oscillation of the anchor, consisting of a motion to the right and a motion to the left, lets one tooth of the escapement wheel, and no more, pass.

Now if we suppose the pulsations of the current to impart to the anchor by the intervention of the electro-magnet and its appendages a motion of vibration, a tooth of the escapement wheel, and no more than one tooth, will pass the anchor for each pulsation of the current. If the current be suspended, the movement of the escapement wheel and the clock-work connected with it will be also suspended, and when the pulsation of the current recommences, the oscillations of the anchor, and consequently the motion of the escapement wheel, and the clock-work connected with it, will also recommence.

152. If the pulsations of the current be regulated (as they may

PULSATIONS PRODUCE WRITTEN CHARACTERS

be according to what has been already explained (129), by the pendulum of a clock at any station, the motion of the anchor of the escapement established at any other station to which the current is transmitted, will be synchronous with that of the pendulum of the clock which governs the pulsations of the current, and thus a regular motion may be imparted by one clock to another, provided that between them there be established a conductor, and the pendulum of the one clock regulates the pulsations of the current, which govern the movement of the anchor of the escapement of the other.

158 If the extremity of the lever, og , fig. 58, carry a pencil, which presses upon paper, when the lever is drawn towards the electro-magnet, and if at the same time the paper is moved under the pencil with an uniform motion, a line will be traced upon the paper by the pencil, the length of which will be proportionate to that of the interval during which the lever og is held in contact with the stop t' . Now as the agent at s can regulate this interval at will, by controlling the flow of the electric current, making that current act for a short interval if he desire to make a short line upon the paper, for a long interval if he desire to make a long line, and for an instant if he desire to make merely a dot, it will be understood how he can at will mark a sheet of paper at s'' , 500 miles distant, with any desired succession of lines of various lengths or of dots, and how he may combine these in any way he may find suitable to his purpose.

We have here supposed the pencil attached to the end of the lever to be alternately pressed against the paper, and withdrawn from it by the motion of the lever. If, however, the paper be so placed that the lever shall oscillate parallel to it, the pencil presented to the paper will remain permanently in contact with it, and will trace upon the paper a line alternately right and left, whose length will be equal to the play of the end g of the lever, to which the pencil is attached. If while this takes place the paper be moved under the pencil in a direction at right angles to the line of its play, the pencil will trace upon the paper a zigzag line, the form of which will depend on the relation between the motion of the paper and that of the pencil. When the current is in this case suspended, the paper being moved under the pencil at rest, a straight line will be traced upon it.

Thus the paper will be marked either with a zigzag line, or a straight line according as the current is transmitted or suspended.

If the current be alternately transmitted and suspended during intervals of unequal length, at the will of the agent, at s , the paper at s'' will be marked by a line alternately zigzag and

THE ELECTRIC TELEGRAPH

straight, the length of the zigzag and straight parts being varied at the will of the operator at *s*

How these subservo to telegraphic purposes will be presently more fully explained

154 In the same manner, if a toothed wheel, moved by the agent at *s*, produce a pulsation of the current by the passage of each successive tooth, these pulsations will produce simultaneous oscillations of the lever *og*, at the station *s''*, and if these oscillations act upon the anchor of an escapement wheel attached to clock-work at *s''*, that wheel will be advanced in its revolution, tooth for tooth, with the wheel at *s*, and if each of these wheels govern the motions of hands upon dial plates, like the hands of a clock, the hand of the dial at *s''* will have the same motion exactly as the hand on the dial at *s*, so that if at the commencement of the motion both hands point to the same figure or letter of the dial, they will continue, moving together, to point always to the same figures or letters

Thus if the operator at *s* desire to direct the hand on the dial at *s''*, to the hour of 3 or 5, he will only have to turn the hand upon the dial, at his own station, to the one or the other of these hours

It will presently also be apparent how important this is in the art of electric-telegraphy

155 If the lever *og*, fig 58, be connected with the tongue of an alarm bell, so that when *og* is put into vibration the bell will ring, and will continue to ring so long as the vibration is continued, it is evident that the operator at *s* can, at will, ring a bell at *s''*, by producing pulsations of the current in any of the ways already described

An operator at *s''* may in like manner ring a bell at *s*

By this mutual power of ringing bells, each operator can call the attention of the other, when he is about to transmit a dispatch, and the other by ringing in answer can signify that he is prepared to receive the dispatch, as already stated

156 If the lever *og* were in connection with the lock or other mechanism, by which the powder charging a cannon is fired, the operator at *s* could at will discharge a cannon at *R*, no matter what may be the distance of *R* from *s*

157 It will be observed that when a bell is rung, or any similar signal produced at the station *s''*, by means of an electric current transmitted from a distant station, *s*, it is not directly the force of the current which acts upon the object by which the signal is made. The current is only indirectly engaged, producing the result by liberating the mechanism which makes the signal and leaving the force which moves it free to act. Thus in the most usual case of a bell, it is acted upon while it rings, not by the

ELECTRO-MAGNETIC ALARM

current, but by the force of a mainspring or descending weight, transmitted to the hammer or tongue in the same manner exactly as that in which the force of a mainspring or weight of a clock is transmitted to the striking apparatus. The current does nothing more than disengage a catch by which the motion of the wheelwork acted on by the mainspring or weight, is arrested. The catch once disengaged, the action of the current on the bell ceases, and the ringing is continued by the action of the mainspring or weight, and it may in like manner be stopped by the current again throwing the catch between the teeth of one of the wheels.

It will, therefore, be apparent that since the force which impels the bell is independent of the current, a bell of any desired magnitude may be acted upon by a hammer of any desired weight, without requiring any more force from the current than that which is sufficient to enable the electro-magnet to disengage the catch by which the mechanism of the bell is arrested.

158. Although the bell mechanism used for telegraphs differs in nothing which is essential from that of a common alarm clock, it may not be without interest to show one of the varieties of mechanism in practical use.

In fig 60 is given a view of the bell mechanism, as used on the telegraphic line of the South-Eastern Railway Company *

A is the electro-magnet

B its armature

b e a lever attached at the upper end to the armature, and having at the lower end a catch, *e*, which when the armature is not attracted towards the magnet is pressed by a spring, *f*

d a wheel having a tooth in which the catch *e* is engaged by the pressure of the spring *f*, when the armature *B* is not attracted towards the magnet, but which is liberated from the catch *e*, when the armature *B* is drawn towards the magnet

a a cylindrical box containing a strong mainspring, by which the train of wheelwork is kept in motion so long as the catch *e* is not engaged in the tooth of the wheel *d*

fig 60

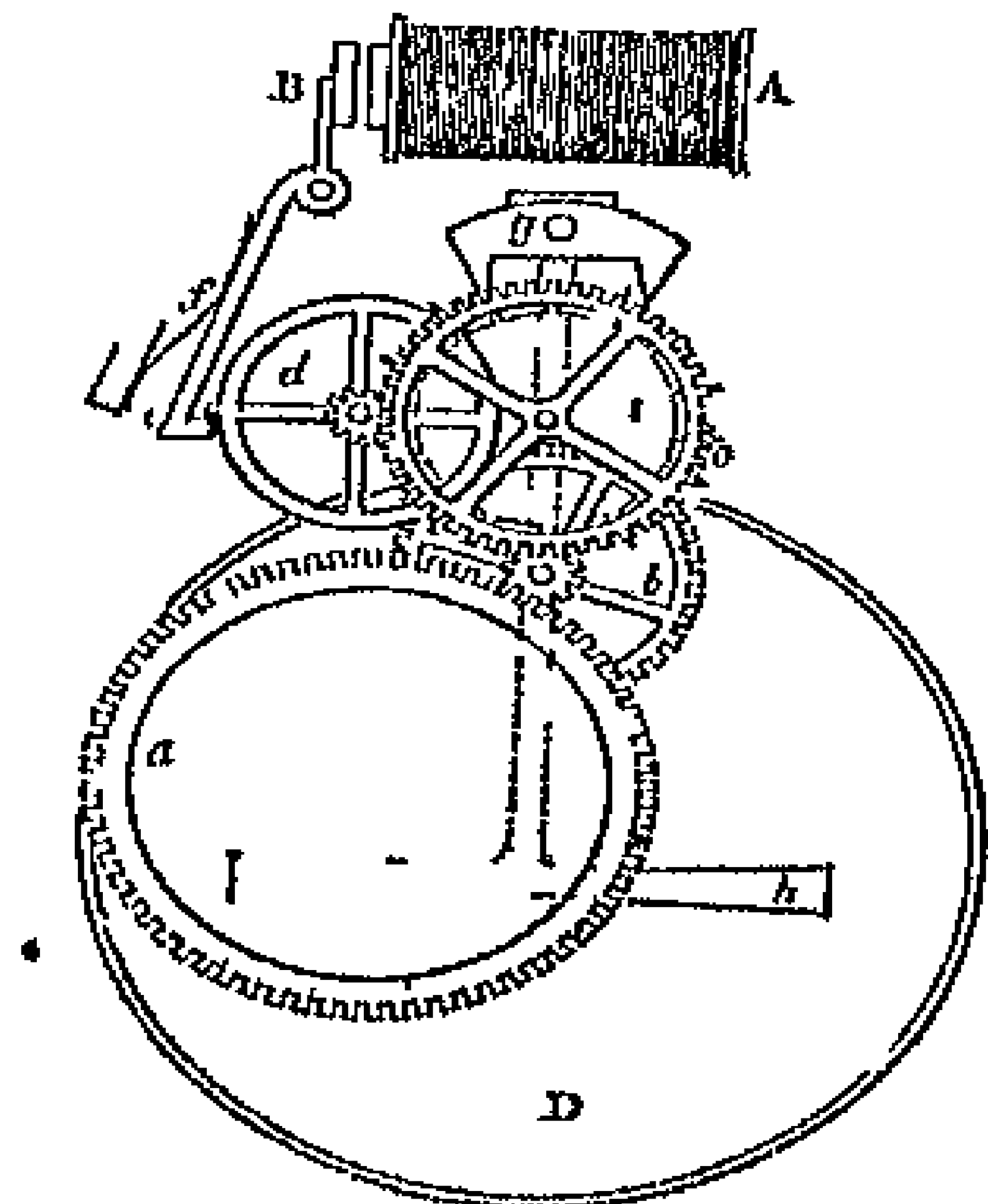

* Elect. Tel. Manip., p. 23

THE ELECTRIC TELEGRAPH

The actual contact of the armature B with the poles of the electro-magnet is prevented by two small ivory knobs screwed into the surface which is presented to the magnet. The play of the armature B is so limited that the catch e shall be just disengaged from the tooth of the wheel d , when the ivory knobs come into contact with the poles of the magnet.

When the wheel-work is liberated by the magnet withdrawing the catch e from the wheel d , the mainspring in the cylindrical box a causes the toothed wheel attached to the box to revolve. This wheel drives a pinion on the axle of the wheel b . The wheel b drives a pinion on the axle of the wheel c . The teeth of the wheel c are engaged with those of a pinion on the wheel d . The movement of the train is stopped, when the catch e falls under the tooth of the wheel d . The wheel i , which is engaged in the anchor of the escapement g , is fixed upon the axle of the wheel c , turns with the latter, and thus gives an oscillating motion to the anchor, which is imparted to the hammer h of the bell n . The bell is therefore acted upon by the hammer so long as the magnet A keeps the catch e from falling under the tooth of the wheel d .

159 Since the magnitude, loudness or pitch of the bell is independent of the force of the current, the telegraphic offices are provided with various bells for special purposes.

Sometimes a special wire is appropriated to the bell which is acted upon by a special current.

In other cases the regular current intended to work the telegraph is diverted to the bell apparatus by the commutator. In other cases again, the object is accomplished by the expedient explained in (134), which is known as the *short circuit*.

160 Having explained the form and construction of electro-magnets, we are prepared to show the manner in which an electric current may be produced by the mere action of magnets without any intervention of a voltaic battery.

The electricity thus produced has been called **MAGNETICALLY**

161 Let a silk or cotton covered wire be coiled heliacally on a roller or bobbin having a hollow core of sufficient magnitude to allow a cylindrical bar to be passed into it. Let the covered wire be coiled constantly in the same direction, beginning from $A B$, (fig 61), and terminating at $C D$. Let the extremities $m n$ of this wire be joined to those of a wire $m o n$ of any required length, stretched to any required distance. Now let the north pole N of a magnet $S N$ be suddenly passed into the core of the

MAGNETO-ELECTRIC CURRENTS

bobbin. An electric current will then be transmitted on the wire $m o n$, the presence of which may be rendered manifest by a galvanometer. This current, however, will be only momentary, being manifested only at the moment the pole of the magnet enters the core of the bobbin. It ceases immediately after that entrance.

Now if the magnetic bar after entering be as suddenly withdrawn, another current will be produced upon the wire $m o n$, which will also be only momentary, but its direction on the wire will be contrary to that produced by the entrance of the magnetic pole.

Thus if upon the entrance of the pole N a current is produced, running in the direction $m o n$, the withdrawal of the pole N will produce a current running from $n o m$.

If the south pole s be passed into the core and withdrawn, momentary currents will in like manner be produced, but they will have contrary directions.

If the wire $m o$ terminated at o , no matter what may be the distance of o from m , were put at o in metallic communication with the earth, or with a plate or other mass of metal buried in the earth, and if the extremity n of the wire of the coil were put in metallic connection with the earth in the same manner at n , the transmission of the instantaneous currents would take place exactly in the same manner as above described, because in that case the earth would play the part of a conductor between the end of the wire $m o$ at o , and the end of the coil wire n .

But if the metallic continuity either of the wire $m o n$, in case it

Fig 61

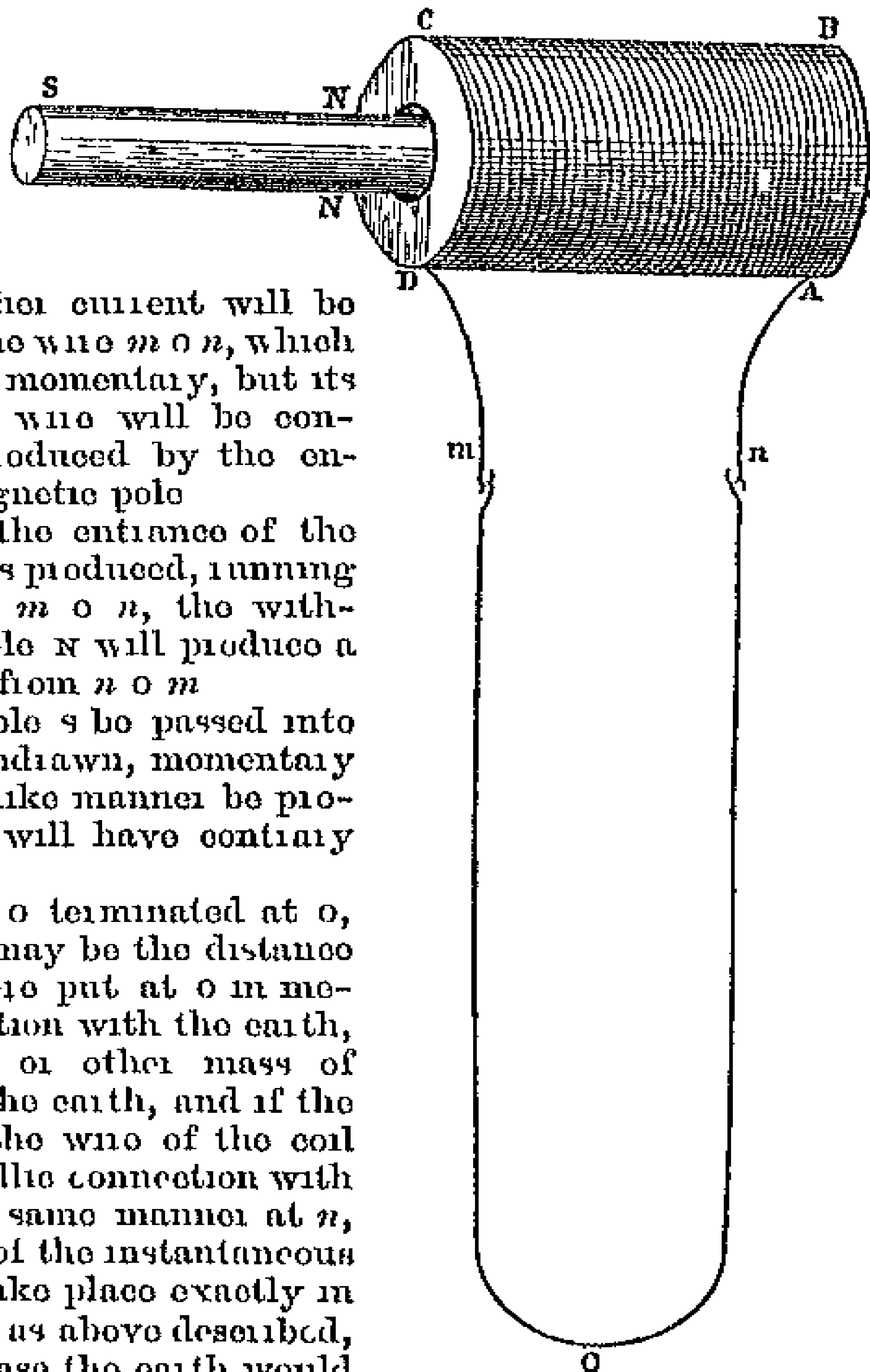

extended from *m* to *n*, or of *m* *o* if it were as described above in connection with the earth at *o*, were anywhere broken, no current would be produced by the entrance or withdrawal of the magnet. It is therefore essential to the production of the α phenomena that the extremities *m* and *n* of the coil wire shall be in electric communication with each other, by being united either with a continuous metallic connection, or by means of the earth in the manner already described.

The property in virtue of which soft iron acquires magnetic properties, when the poles of a permanent magnet are brought into proximity with it, supplies a very convenient method of exhibiting the play of the phenomena of momentary current as above described.

162. Let *s* *o* *N* (fig. 62), be a powerful permanent horse shoe magnet, having its poles *s*, *N*, presented to and in close proximity

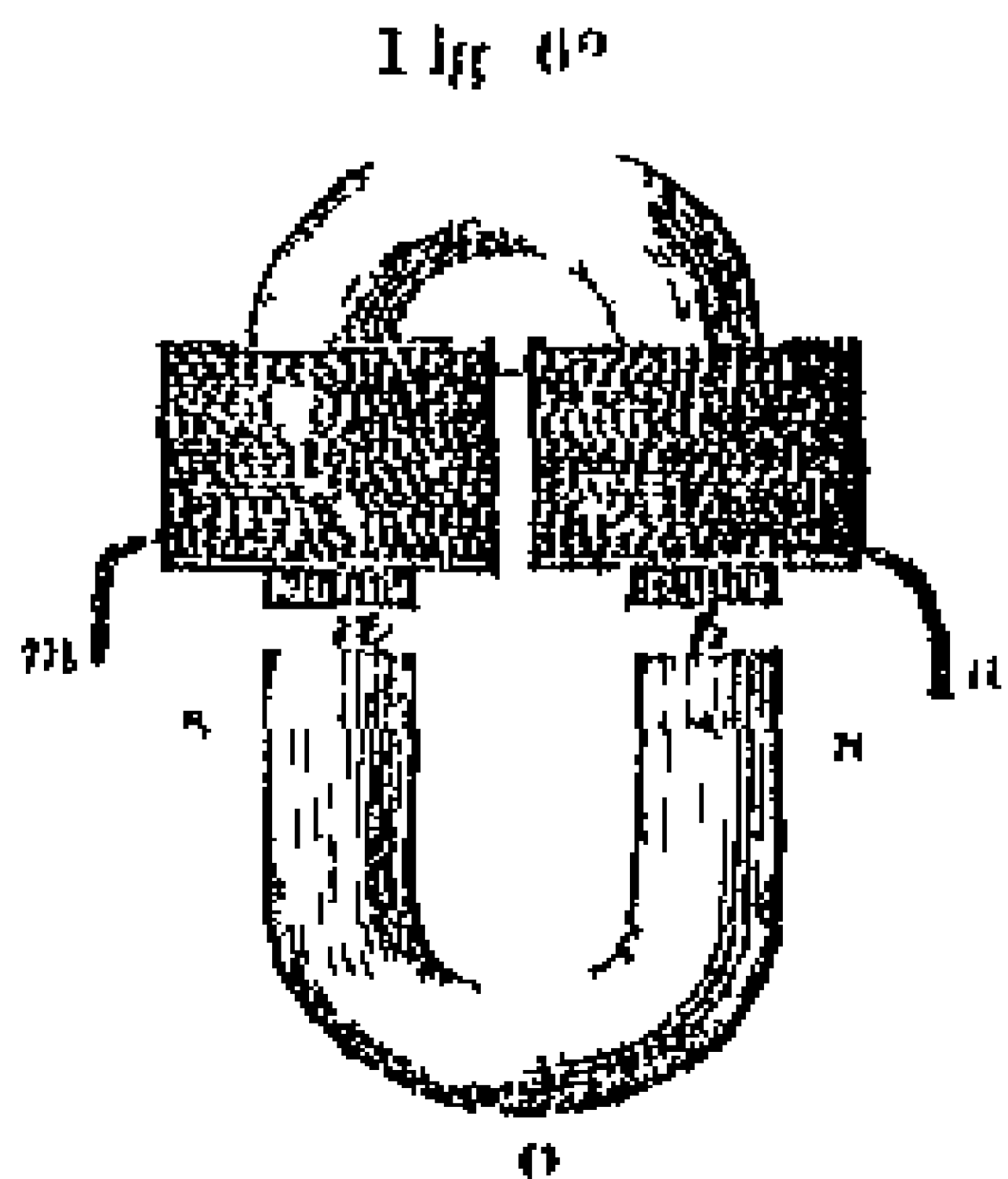

with a similar horse shoe *a* *b* of soft iron, wrapped with insulation of covered wire in the manner already described. Let the extremities *m* and *n* of the coil be supposed to be placed in connection with two wires, which may be extended to any distance, and whose extremities are in metallic communication with the earth in the manner already explained.

When the poles *s* and *N* are brought into proximity with the ends *a* and *b* of the horse-shoe *a* *b*, the latter will, by the inductive action of the magnet *s* *o* *N*, acquire magnetic polarity, the end *a*, near the south pole *s*, having northern, and the end *b*, near the north pole *N*, having southern polarity. This magnetic polarity, however, of *a* *b* will only continue so long as the poles *s* and *N* of the permanent magnet are kept near to *a* and *b*. If they be removed, that instant the polarity of *a* *b* will cease. If the poles be reversed, *N* being presented to *a*, and *s* to *b*, then *a* will acquire south, and *b* north polarity.

It appears, therefore, that by presenting the poles of the magnet *N* *o* *s* to the horse-shoe the same effect is produced as if the poles of a magnet were suddenly passed into the axis of the coil, and by withdrawing the poles *N* and *s* from *a* and *b*, the same effect is produced on the coil as if the poles of the magnet which had been passed along the axis were suddenly withdrawn.

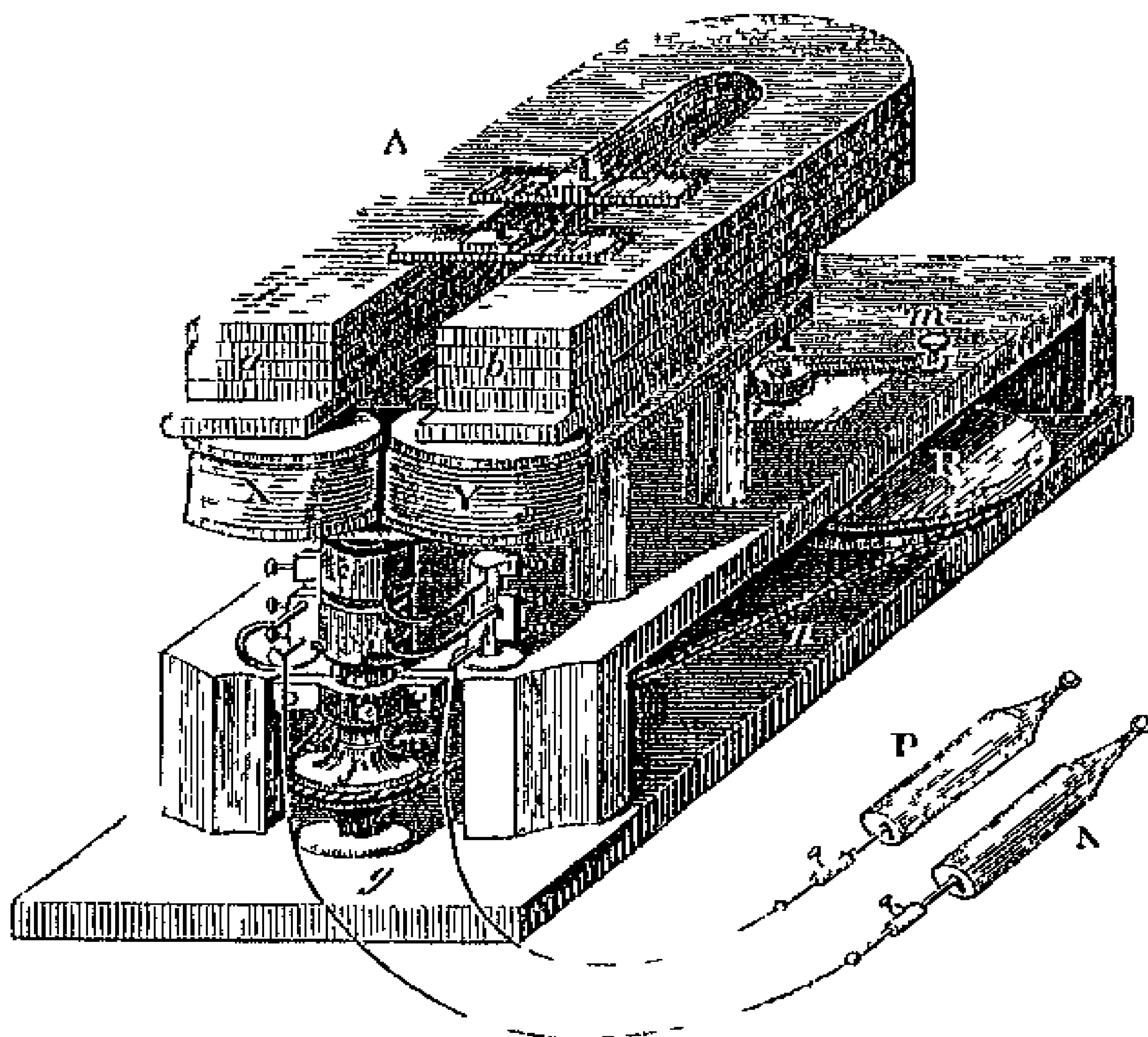

Fig. 61 —MAGNETO ELECTRIC MACHINE

THE ELECTRIC TELEGRAPH

CHAPTER VII

- 163 Momentary currents alternately in contrary directions —164 Method of producing momentary currents all in the same direction —165 Magneto electric machine —166 Its effects in producing shocks and currents —167 Method of applying it to telegraphs —168 Chemical property of the current —169 Decomposition of water —170 Application of this property to produce written characters at a distance —171 Methods of moving the paper under the style —172 Telegraphic characters marked upon it —173 Use of relay magnets in cases of feeble currents —174 Form and application of them —175 Telegraphic lines constructed by companies in England and America, and chiefly by the state on the continent —176 Various forms of instruments used —177 Influence of national feeling —178

THE ELECTRIC TELEGRAPH

Mentioned inventions sometimes neglected —179 Needle instruments generally used in England —180 Single needle instrument —181 Double needle instrument —182 Old aerial telegraph —183 French State telegraph

163 THE momentary currents in the one direction or in the other will, therefore, be produced upon the wire connected with the extremities of the coil, such as have already been described, each time the poles, N and s , are presented to and withdrawn from the ends, a and b , of the horse-shoe of soft iron. If the magnet, $N O S$, were mounted so as to revolve upon an axis passing through the centre of its bend, and therefore midway between its legs, its poles might be made to pass the ends of the horse-shoe, the latter being stationary. During each revolution of the magnet, $N O S$, the polarity imparted to the horse-shoe would be reversed.

When the pole N approaches b , and consequently s approaches a , south polarity will be imparted to b , and north polarity to a , and when N passes a , and consequently s passes b , south polarity will be imparted to a , and north polarity to b .

The momentary currents produced by these changes of magnetism in a and b will be easily understood by what has been explained. When N approaches b , and s approaches a , the commencement of south polarity in b , and north polarity in a , will both impart to the wire a current in the same direction, because the coils of the spiral as presented to s will be the reverse of those presented to N . When N departs from b , and s from a , the cessation of south polarity in b , and of north polarity in a , will impart currents in the same direction to the wire, but this direction will be opposite to that of the former currents.

When N approaches a , and consequently s approaches b , currents will be imparted to the wire whose direction will be the same as that of those produced by the departure of N from b , and of s from a . When N departs from a , and s from b , currents will be produced in the same direction as when N approaches b and s approaches a .

If the direction of the currents produced when N approaches b , and s approaches a , be indicated by an arrow directed to the right, and that of those produced when N departs from b , and s from a , by an arrow directed to the left, the changes of direction which take place in each revolution of the magnet $N O S$, will be such as are indicated in fig. 63, where b and a represent the ends of the horse-shoe, $b a$, N the position of the pole in approaching, and N' in departing from b , and N'' its position in approaching, and N''' in departing from a . The arrows directed to the right express the direction of the two

MAGNETO-ELECTRIC INSTRUMENT

currents which are produced upon the conducting wire, while N makes the half revolution $N''M'N$, and the arrows directed to

FIG. 63

M



M

left express the direction of the two currents produced, while N makes the half revolution $N' M N''$

Thus it appears that in each revolution of the magnet, $N O S$, four momentary currents are produced in the wire, two in one direction during one semi-revolution, and two in the contrary direction during the other semi-revolution. In the intervals between these momentary currents there is a suspension of voltaic action.

161 It has been already shown how electric currents may be instantaneously suspended, re-established, and reversed in their direction by means of commutators (111). By such an expedient properly adapted, it is easy to understand that by suspending the currents in one of the two contrary directions, while the other is allowed to pass, an intermitting current always running in the same direction may be obtained. Or if the commutator be so adapted that while the momentary currents in one direction are allowed to run without interruption, those in the other direction shall be reversed, we shall then have in each revolution four momentary currents flowing in a common direction. The current thus produced will be intermitting, that is, it will pass upon the wire by a succession of pulsations or intervals of transmission and suspension, but since in each revolution of the magnet there are two pulsations,—that is, two intervals of transmission and two of

THE ELECTRIC TELEGRAPH

suspension,—and since the rotation of the magnet may be made with any desired rapidity, it follows that the pulsations will succeed each other with such celerity, and the intervals of suspension will be so brief that for all practical purposes the current will be continuous.

165 Such are the principles on which is founded the construction of magneto-electric machines, one form of which is represented in fig 64 (page 1). The purpose of this apparatus is to produce by magnetic induction an intermitting current constantly in the same direction, and to contrive means by which the intervals of intermission shall succeed each other so rapidly that the current shall have practically all the effects of a current absolutely continuous.

A powerful compound horse-shoe magnet, λ , is firmly attached by bolts and screws upon a horizontal bed, beyond the edge of which its poles a and b extend. Under these is fixed an electro-magnet $x y$, with its legs vertical, and mounted so as to revolve upon a vertical axis. The wire is coiled in great quantity on the legs $x y$, the direction of the coils being reversed in passing from one leg to the other.

The two extremities of the wire proceeding from the legs x and y are pressed by springs against the surfaces of two rollers, c and d , fixed upon the axis of the electro-magnet. These rollers themselves are in metallic connection with a pair of handles P and N , to which the current evolved in the wire of the electro-magnet $x y$ will thus be conducted.

If the electro magnet $x y$ be now put in rotation by the handle m , the handles P and N being connected by any continuous conductor, a system of intermitting and alternately contrary currents will be produced in the wire and in the conductor by which the handles P and N are connected. But if the rollers c and d are so contrived that the contact of the ends of the wire with them shall be only maintained during a semi-revolution in which the intermitting currents have a common direction, or so that the direction during the other semi-revolution shall be reversed, then the current transmitted through the conductor connecting the handles P and N will be intermitting, but not contrary, and by increasing the velocity of rotation of the electro-magnet $x y$, the intervals of intermission may be made to succeed each other with indefinite celerity, and the current will thus acquire all the character of a continuous current.

The forms of commutators by which the rollers c and d are made to break the contact, and re-establish it with the necessary regularity and certainty, or to reverse it during the alternate semi-revolutions are various.

166 All the usual effects of voltaic currents may be produced

ELECTRO-CHEMICAL EFFECTS

with this apparatus. If the handles P and N be held in the hands, the arms and body become the conductor through which the current passes from P to N. If N be made to revolve, shocks are felt, which become insupportable when the current has a certain intensity.

If it be desired to give local shocks to certain parts of the body, the hands of the operator, protected by non-conducting gloves, direct the knobs at the ends of the handles to the parts of the body between which it is desired to produce the voltaic shock.

167 For telegraphic purposes it will be sufficient to place the line wire in connection with one of the handles P or N, while the other handle is in connection with the earth. A current will then be transmitted on the line wire which will be intermitting, but which may be rendered continuous by a combination of magneto-electric machines.

168 It remains, in fine, to show how the chemical properties of the electric current can be made to supply the means of transmitting signals between two distant stations.

When a current of adequate intensity is made to pass through certain chemical compounds it is found that these are decomposed, one of their constituents being carried away in the direction of the current, and the other in the contrary direction.

169 One of the most striking examples of the application of this principle is presented in the case of water, which, as is well known, is a compound of the gases called oxygen and hydrogen.

Let us suppose that a series of cups, *oh*, fig 65, containing water are placed so that an electric current shall pass successively through them, commencing at the wire P and passing at *o* into the first

Fig 65

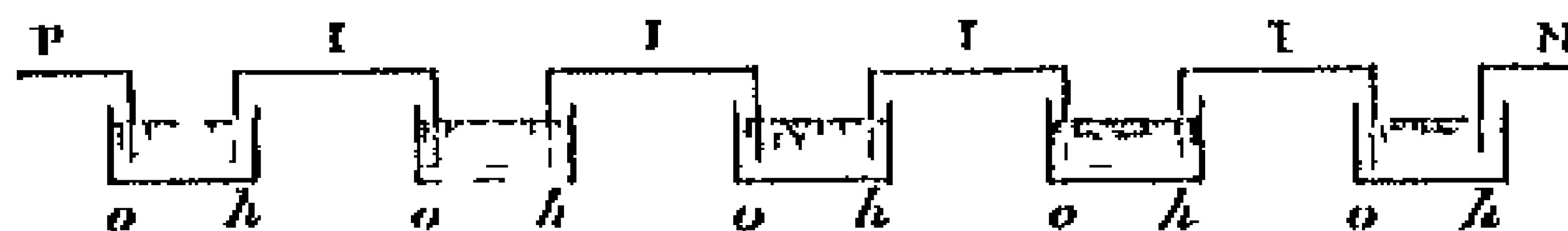

cup, thence through the water to *h*, and from *h* along the wire *I* to *o* in the second cup, thence in like manner through the water to *h*, and then along the wire *I'*, and so on to *N*, the wire *P* being supposed to be connected with the positive pole of a battery, and the wire *N* with its negative pole. The current will therefore flow from *P* to *N* passing through the water in each of the cups.

Under such circumstances the water will be gradually decomposed in each of the cups the particles of oxygen moving against the

THE ELECTRIC TELEGRAPH

course of the current, and those of hydrogen moving with it, the former are evolved at the points *o*, and the latter at the points *h*.

170 To show how this property of the current may be made to produce visible marks or signs, let us suppose a sheet of paper wetted with an acidulated solution of ferro-prussiate of potash to be laid upon a plate of metal, and let the point of a metallic style be applied to it so as to press it gently against the metallic plate without piercing it. Let the style be now put in metallic connection with the wire which leads to the positive pole of a voltaic battery, and let the metallic plate upon which the paper is laid be put in connection with the wire which leads to the negative pole. The current will, therefore, flow from the style through the moistened paper to the metallic plate, and it will decompose the prussiate, one of the constituents of which deposited on the paper will mark it with a bluish spot.

If the paper be moved under the style while the current flows, this decomposition being continued under the point of the style a bluish line will be traced upon the paper.

If while the paper is thus moved uniformly under the style, the current is permitted to flow only during intervals long or short, the paper will be marked by lines long or short, according to the intervals during which the current flows, and, since no decomposition takes place during the suspension of the current, the paper then passes under the style without receiving any mark. If the current be permitted to flow only for an instant, the paper will be marked by a dot. The long or short lines and dots, thus traced upon the paper, will be separated one from another by spaces more or less wide according to the lengths of the intervals of suspension of the current.

It is evident that the same effects will be produced, whether the style be at rest and the paper moved under it as is here supposed, or the paper be at rest and the style moved over it.

171 The paper may be moved under the style by various and obvious mechanical expedients. Thus it may be coiled upon a cylinder or roller, which being kept in constant and uniform revolution by clock-work or other means, the paper would be carried continually under the style, and unrolled from the cylinder after receiving the marks. Or the cylinder covered with paper might, while it revolves, receive a slow motion in the direction of its axis, so that the course of the style upon it would be that of the thread of a screw or helix. The paper might be cut into the form of a large circular disc, and laid upon a metallic disc of equal magnitude, to which a motion of revolution round its centre in its own plane might be imparted by clock-work, while the style might receive a slow motion directed from the

RELAY MAGNETS

centre of the disc towards its edge. In this case the style would trace a spiral curve upon the paper, winding round it continually, and at the same time acting constantly but slowly from its centre towards its edge.

172. Whichever method might be adopted, the paper would be marked with a continuous succession of combinations of lines of varying lengths and dots, separated by spaces more or less wide. These marks depending altogether on the succession of intervals of suspension and transmission of the current, which intervals can be varied and combined at will by an operator supplied with the means of controlling the current which have been already explained, it will be easily conceived that an agent at *s* can trace upon paper placed at *s'* in the manner here described such a succession of characters composed of lines and dots as he may desire, and that an operator at *s'*, being supplied with a key, may interpret these characters, and thus translate the communication into ordinary language.

It is also easy to conceive that the agent at *s* can stop the clock-work which moves the paper at *s'* or set it going at will, in the same manner as he can ring a bell or discharge a cannon.

173. It has been already explained that the intensity of the current transmitted by a given voltaic battery along a wire of given thickness must decrease in the same proportion as the wire increases in length. This loss of intensity due to the length of the wire is increased in the practical operation of the telegraphs by the loss of electricity arising from imperfect insulation and other inevitable causes. It has therefore become a matter of great practical importance to discover expedients by which the intensity of the current may be re-established, or by which the apparatus may be worked by a very feeble current.

It was obvious that the intensity might be maintained at the necessary degree of force by providing, as already stated, relay batteries at intermediate stations sufficiently near each other to prevent the current from being unduly enfeebled. But the maintenance of such numerous batteries in cases where great distances must be traversed is expensive, and it was desirable to discover some more economical expedient.

174. The properties of the electro-magnet have supplied the means of accomplishing this.

The lever *g h* (fig. 58) may be constructed so light and so free, that it will be capable of being moved by a current of extremely feeble intensity. But if this lever were charged with any of the functions by which it would become an instrument for giving signals, such as the ringing of a bell or the motion of a style or pencil, it would be necessary to impart to the electro-magnet and

its other appendages much greater power. So long, however, as no more is required than to make it oscillate between the stops t and t' , it may be constructed and mounted so as to be moved by the most feeble degree of magnetism imparted to $m m'$ by a current of extremely low intensity.

Now let us suppose the axis o of the lever $q k$ to be in metallic connection with a voltaic battery placed near to it at the station s' , and let the stop t' be in connection with the conducting wire which extends to another more distant station s'' . When the end q of the lever is brought into contact with the stop t , the current produced by the battery at s' will flow along the conducting wire to s'' , and when the lever descends the stop t , and is thrown upon t' , the contact being broken, the current is suspended.

Now it is evident that by this means the original current flowing from the battery at the station s to the station s' is the means of calling into action another current, which flows from the relay battery at the station s' along the conducting wire to the station s'' , and that the intensity of this current will not be affected in any way by that of the original current from s to s' , but will depend solely on the power of the relay battery at s' , and the length of the conducting wire from s' to s'' .

In the same manner another relay battery may be provided at s'' , and so on.

In this succession of independent currents, those only which have signals to work need to have a greater intensity than that which is sufficient to give motion to a light lever, such as we have described above.

It will be evident also by what has been stated that the pulsations given to the original current at s , and the succession of intervals of transmission and suspension will be reproduced with the most absolute precision in all the succeeding currents, so that all signals which depend on these intervals of transmission and suspension will be made at the final station as promptly and exactly as if the original current from s to s had been continued throughout the entire line of communication with all the necessary intensity.

175 The lines of electric telegraph which have been constructed and brought into operation in different parts of the world, like the lines of railway, have been established in some by private companies, and in others by the state. In the United Kingdom and its dependencies and in the United States they have been in all cases established by the enterprise and capital of joint stock.

NATIONAL TELEGRAPHIC LINES

companies chartered or incorporated by the legislature, subject to certain conditions. On the continent of Europe generally they have been constructed and are exclusively worked by the state, but are placed under specified conditions and subject to regulated tariffs at the service of the public.

176 The forms of telegraphic instruments to which a preference has been given, in different countries are very various. In the United Kingdom and the United States, the several joint-stock companies by whom telegraphic lines have been constructed, have been generally formed by the friends and partisans of the inventors of particular telegraphic instruments, of which the companies have become severally the patentees. To these instruments they naturally have given a preference, in some cases irrespective of their merits, and as a necessary consequence every such company is more or less opposed, as well by interest as by prejudice, to other inventions and improvements. It has been a matter of complaint that such companies have sometimes become the purchasers of patented inventions for no other purpose than that of their suppression, and it is easily conceivable that a company having an extensive establishment in profitable operation may find it more advantageous to maintain their existing apparatus than to put them aside for others even of very superior efficiency. This is, after all, no more than what has occurred in the progress of all great inventions and improvements.

177 National feeling has, however, also had a considerable influence on the selection of the forms of telegraph adopted in different countries. Thus we find the telegraphs adopted in England exclusively English inventions, those generally adopted in France, French inventions, and those adopted in the United States, generally American inventions.

178 Amidst those conflicting motives directing the choice of companies and of governments, several inventions of great merit have necessarily been either wholly neglected, or bought up and wilfully suppressed, or in fine, brought into operation on a very limited scale.

The vast resources supplied by the discoveries by which physical science has been enriched since the beginning of the present century, and the fertility of genius directed to the application of these resources in all countries, has produced a swarm of inventions, even the least efficient of which possess great merits on the score of ingenuity and address in the application of physical principles. Our limits, the purposes to which this series is directed, and the large and various classes to which it is addressed, compel us to pass without notice many forms of telegraph which have been contrived and constructed. We shall

THE ELECTRIC TELEGRAPHY

therefore confine our observations to those apparatus which have been actually employed on the telegraphic lines established in different countries, and a very few others which appear to claim more especial attention

On the claims of various projectors on the score of original invention, we must generally decline to enter. To discuss such questions so fully as to render justice to the claimants would require much more space than we can devote to the subject, and however interesting such a discussion might be to the inventors themselves and their partisans, it would offer but few attractions to the masses to whom our "Museum" is addressed

We shall therefore first explain briefly the forms of telegraph generally applied in this country, and next those which are in operation elsewhere

179 The telegraphic instruments used almost exclusively in this country are galvanometers (138), which make their signals by means of the deflections of magnetic needles, produced by the electric current

These instruments are of two forms, the first, and most simple, consisting of one needle with its appendages and accessories, and the other of two independent needles, each accompanied by its own appendages

III SINGLI NEEDLE INSTRUMENT

180 This instrument consists of a galvanometer and a commutator, mounted in a case resembling in form and size that of an ordinary table time-piece

A front view of it is given in fig 66 (vol iii p 161). On the upper part is a dial, in the centre of which the indicating needle appears, like the hand of a clock, fixed upon an axis. Its play to the right and left is limited by two ivory studs inserted in the face of the dial, a short distance on each side of its upper arm

The handle which works the commutator, also fixed upon an axis, is presented at the lower part of the case, under the dial

Upon the dial are engraved the letters of the alphabet, the ten numerals, and one or two arbitrary symbols, under each of which is engraved a mark, indicating the motions of the needle, by which the letter or figure is expressed

The galvanometer, constructed as already explained (110), is attached to the back of the dial, the axis of its magnetic needle passing through the dial and carrying the indicating needle in front

The latter is also usually magnetic, its poles being reversed in their direction with relation to those of the interior needle, the

SINGLE NEEDLE TELEGRAPH

effect of which is, that the current transmitted through the galvanometer has a tendency to deflect both needles in the same direction. The indicating needle, however, need not be magnetic. If it be sufficiently light, being free from magnetism, it will be carried by the axis to the right or left against the studs by the deflections of the galvanometric needle which plays within the coils of the galvanometer, to which it is always parallel.

In connection with the instrument there are, as usual, an alarm and a galvanic battery.

By the commutator, the current produced by the battery may be transmitted upon the line-wire, or suspended or reversed in its direction, according to the position given to the handle. If the handle be vertical, as represented in the figure, the current is suspended, the arrangement of the commutator being then such as to cut off all communication between the battery and the line-wire. If the upper arm of the handle be turned to the right, the battery will be connected with the line-wire, on which accordingly the current will be transmitted. If the upper arm be turned to the left, the battery will still be connected with the line-wire, but with its poles reversed, so that the direction of the current on the line-wire will be reversed.

The mechanical form of the commutator, by which these changes of connection are made is different from that explained in (111), but the principle is the same, and the variation of the details are unimportant.

To comprehend the practical operation of the instrument, we are to consider that similar instruments, with similar accessories, are placed at each of the stations, between which dispatches are to be transmitted. To render the explanation more clear, let s and s' , fig. 67, be the two stations, o and o' the dials, c and c'

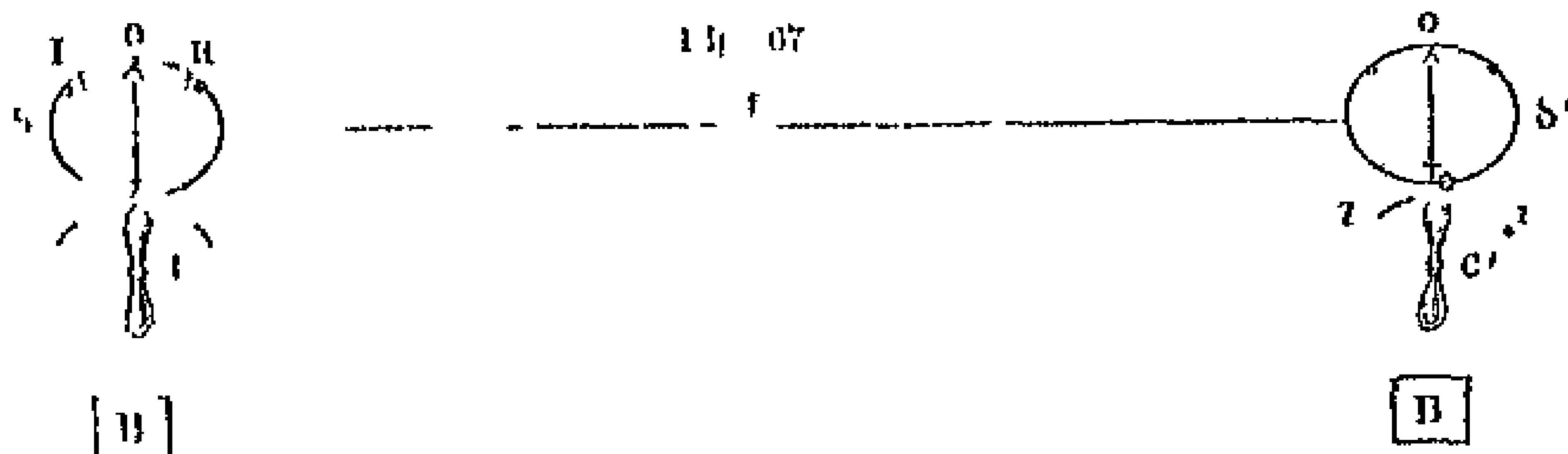

the handles of the commutators, and b and b' the galvanic batteries. If it be intended to send a dispatch from s' to s , the arm of the commutator, c , is left in its vertical position, so that no current can pass from the battery, b , to the line-wire, f .

THE ELECTRIC TELEGRAPH.

When the arm of o' is vertical, no current can pass from b' to r , and consequently the needle of o will remain in the vertical direction, without deflection. If the upper arm of o' be turned to the right, r , the current from b' , passing along r , will flow through the coil of the galvanometer at s , and will deflect the indicating needle to the right, so that it will lean upon the right hand stud, n . If o' be then turned back to the vertical direction, the current will be suspended, and the needle at s will return to the point o . If the upper arm of o' be then turned to the left, l , the current will be again transmitted upon the line-wire, r , but in a direction contrary to its former course, and thus passing through the galvanometer at s , in a contrary direction, the needle, which was before deflected to the right hand stud, n , will now be deflected to the left hand stud, r .

Thus, it appears, that according as the upper arm of o' is turned to the right or left, or placed in the vertical position, the needle on the dial at s , is also turned to the right or left, or placed in the vertical position.

In a word, whatever position is given to the handle of the commutator at s' , a corresponding position is assumed by the indicating needle at s , and these changes of position of the indicating needle at s , are absolutely simultaneous with the changes of position of the handle of the commutator at s' .

The manner of expressing the letters and figures, is by making repeated deflections of the needle right and left, making a short pause at the end of each letter signal. Thus two deflections to the left express A, three, B, four, C, while one expresses the completion of a word. One to the right expresses M, two, N, three, O, and four, P. In the same manner, I is expressed by four deflections, which are, successively, right, left, right, and left.

As these signs are purely arbitrary, and may be changed in every independent telegraph, it is not necessary here to notice them further.

Besides the signals which express letters and figures, it is usual to adopt others to express words or phrases of very frequent occurrence, such as, *I don't understand*, *I understand*, *want*, *go on*, *repeat*, &c.

It is usual, though not necessary, for the agent who sends a dispatch, to pass the current through his own instrument, so that his indicating needle shows exactly the same deflections as the indicating needle of the station he addresses. Thus, when s' addresses s , his own indicating needle, o' , speaks as well as the indicator, o , of the station, s .

All that has been stated in (111) *et seq.* of the transmission of the same despatch through a series of stations, of cutting off the

DOUBLE NEEDLE TELEGRAPH

transmission from all stations except that to which it is exclusively addressed, of the use of the alarm, &c, is applicable, without any important modification to this form of telegraphic instrument

THE DOUBLE NEEDLE TELEGRAPH.

181 This is nothing more than two single needle telegraphs, such as has been just explained, mounted in the same case, their indicating needles playing side by side upon the same dial, and the handles of their commutators placed so that they can be conveniently worked at the same time, by the right and left hand of the telegraphic agent. Each instrument is altogether independent of the other, having separate accessories, and transmitting its current upon a separate line-wire.

The purpose of this form of instrument is merely to accelerate the transmission of dispatches, by enabling the agent to produce the signals expressing letters and figures in more rapid succession. In the single instrument there are only *two* signs made by one deflection of the needle, viz, a deflection to the right and one to the left. In the double instrument there are *eight* such signs, viz, two with each needle, as in the single instrument, and four obtained by combining the deflections of the two needles. Thus, *o* express the position of the needle without deflection, *r*, a right hand, and *l* a left hand deflection, and *rr* the right hand, and *ll* the left hand needle, the following eight signals may be made in the time of a single motion of either needle.

<i>r</i>	<i>rr</i>
<i>r</i>	<i>ro</i>
<i>l</i>	<i>lo</i>
<i>o</i>	<i>rl</i>
<i>o</i>	<i>ll</i>
<i>r</i>	<i>rl</i>
<i>l</i>	<i>ll</i>
<i>r</i>	<i>ll</i>
<i>l</i>	<i>rr</i>

With a single needle two deflections can only make four signals, viz, *rr*, *ll*, *rl*, *lr*. But with two needles, these being combined

THE ELECTRIC TELEGRAPH

with single deflections and with each other, a greater number of different signals can be obtained than are sufficient to convey the letters and numerals, each beam, made in the same manner, by two deflections of a single needle.

A front view of a double needle telegraph is given in fig. 68 (vol. iii. p. 177)

The small case at the top contains the platinum and the small handle at the side of the large case is the commutator by which the current is turned on and off the platinum. The two long handles which appear in front are those of the commutator, which produce the changes of direction of the current, and when inclined to the right or left the needles acted on by the current assume a like position.

FRENCH STATE TELEGRAPH

182 When the establishment of lines of electric telegraphs was proposed in France, the old aerial telegraph was and had been for more than half a century, in operation and formed a department in the public administration of considerable importance, employing an extensive body of agents, dispersed throughout the country, most of whom were specially instructed and qualified for the business.

The commission appointed by the government required that the electro-telegraphic instruments should exhibit the same appearance as had been already used in the case of the former telegraph.

The old telegraph consisted of a long straight beam, *see fig. 69*, called a regulator, to the extremities of which two shorter beams, *see fig. 70*, called indicators, were attached by pins or pivots, so that each indicator was capable of turning on its pivot, round the beam, to any desired angle with the regulator.



If we suppose the circle described by each indicator to be divided into eight equal arcs of 10° , and that any convenient mechanism is provided, by which the agent who conveys the signals can at will give to each indicator any of these eight positions, each indicator would be capable of making eight signals, and by combining these in pairs, the two indicators worked together would be capable of giving sixty-four signals.

It is evident that even this large number of signals might be

FRENCH STATE TELEGRAPH

further multiplied, by giving to the regulator itself a motion round its centre, so that it might at will assume the horizontal or vertical position, or might take an intermediate direction.

In transferring this system of signal, to the electric telegraph, the regulator is supposed to be placed permanently horizontal, and the two indicators to be capable of receiving any of the eight positions here explained.

183 The telegraph contrived by M. Breguet, to exhibit such a system of signals, consists, like the double needle telegraph, of two distinct and perfectly similar instruments, one for each of the indicators. They are mounted side by side with their accessories in the same case, at a distance apart sufficient to allow the indicators to revolve without mutual obstruction, and sufficiently near each other to allow the same person to work both at the same time with his right and left hand.

Each instrument consists of an indicating apparatus and a commutator.

If s and s' be two stations, between which dispatches are transmitted, the commutator at s moves the indicator at s' , and the commutator at s' moves the indicator at s .

A view of the indicating apparatus is given in fig. 70. The two indicators are fixed upon axes placed in the same horizontal

Fig. 70

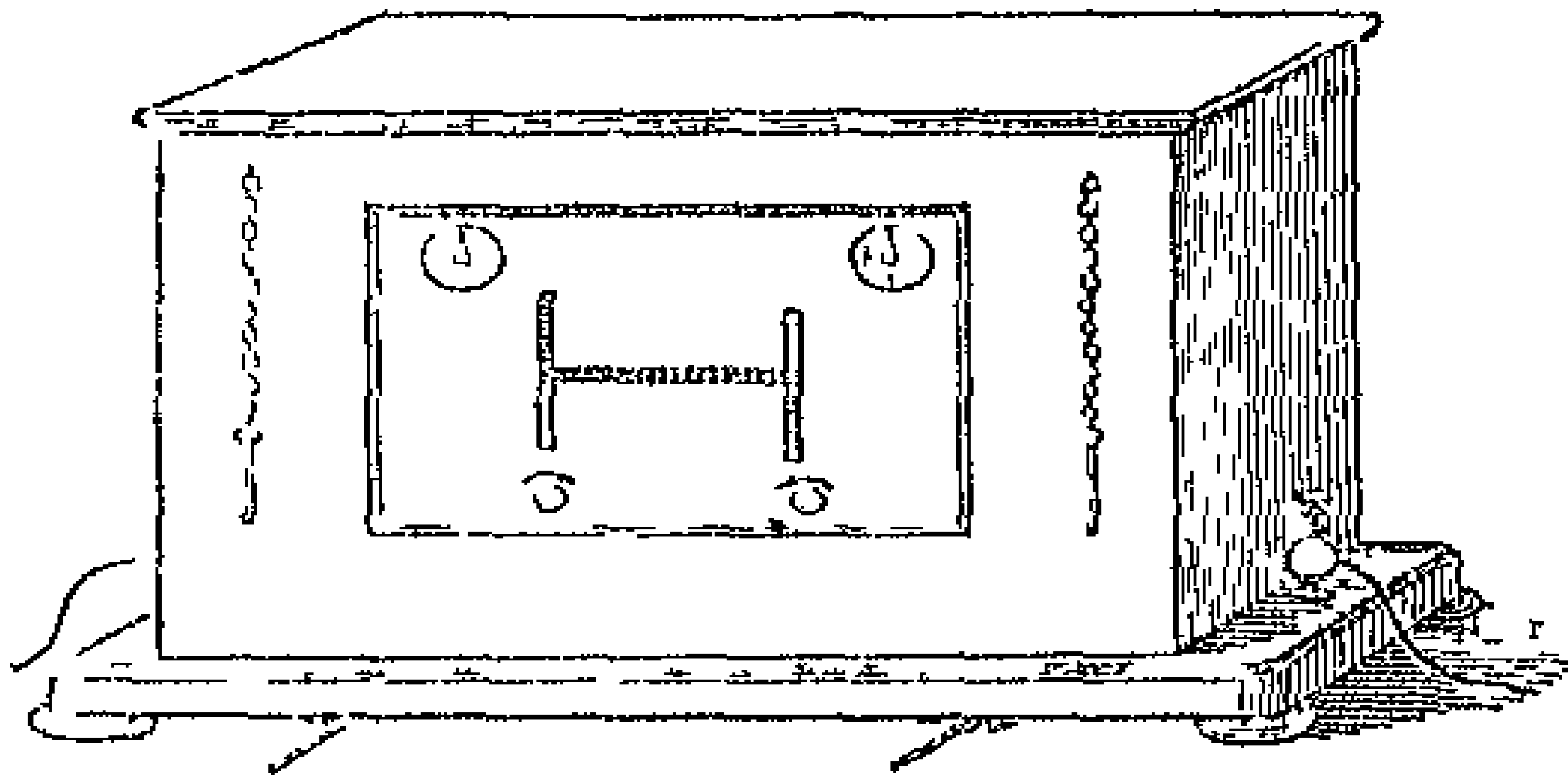

line upon the dial. These axes, passing through the dial, carry behind it two escapement wheels, which are controlled by two anchors, as described in 151. These anchors are moved by the armatures of two electro-magnets, from which they receive vibrations, like those of a pendulum. The escapement wheels are impelled by the force of two main-springs, transmitted to them by two similar trains of clock-work.

THE ELECTRIC TELEGRAPH

Thus, for each swing of the anchor, the indicators make one motion forward, and as the escapement wheels have each only four teeth at equal distances, one complete revolution of the wheels must cause the indicators to make a complete revolution by eight distinct motions, produced by the four swings of the anchor to the right, and the four swings to the left.

During a revolution of each of the escapement wheels, therefore, each of the indicators takes successively the eight positions required in the proposed system of signal, and since the motions of the indicators are governed by the anchor, the motion of the anchors by the armature of the electro-magnets, and these of the electro-magnets by the successive pulsations of the electric current, it follows that if it can be contrived that a current sent at one of the stations shall govern the pulsations of the current at the other, they will necessarily govern the motion of the indicators at that other station.

At the upper corners, right and left of the front of the case, are two dials, in the centre of which are axes, which rest, when turned, upon the springs which draw back the armatures of the two electro-magnets, and near them keys for their adjustment are suspended by chains. The springs are raised or relaxed, according as the keys are turned in the one direction or the other.

Under the indicating arms are two axes with pinions, by which the two systems of clock-work can be wound up, which is done by the same keys.

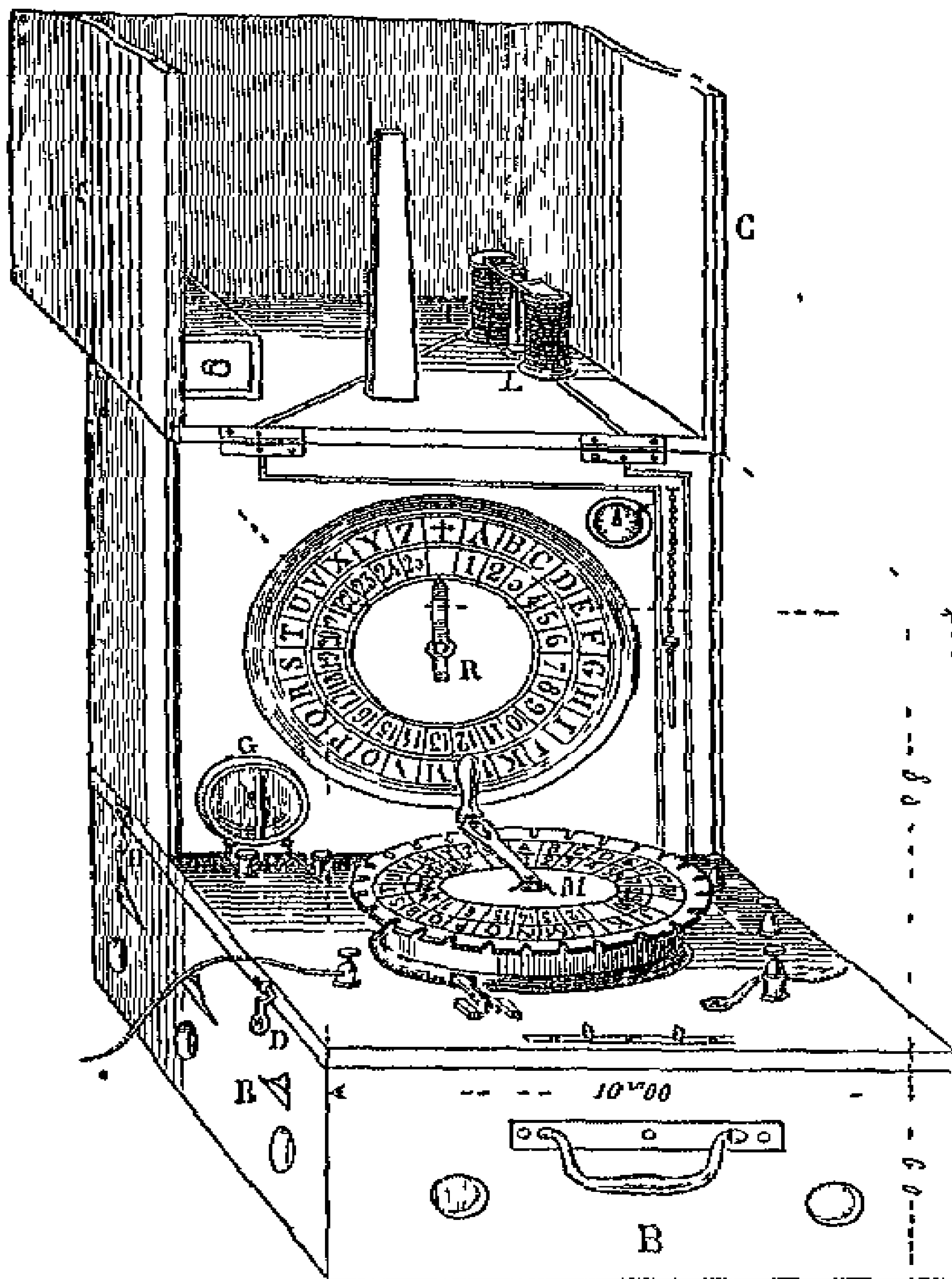

Fig 71 — FRENCH RAILWAY TELEGRAPH

THE ELECTRIC TELEGRAPH

CHAPTER VIII

- 184 Form of commutator of French state telegraph — 185 Its operation —
 186 Method of sending and receiving a despatch — 187 Batteries —
 188 French railway telegraph — 189 French railway portable tele-
 graph — 190 German railway telegraph — 191 Siemens' instrument

THE ELECTRIC TELEGRAPH

—192 Its mode of operation —193 How errors are corrected —194 Explanation of the mechanism —195 Comparison with the French telegraph —196 Indicating mechanism —197 Simplicity greater than the French instrument —198 Requires greater intensity of current —199 Belgian railway telegraph —200 Defects imputed to the French and German instrument

181 It remains, therefore, to show the manner in which the pulsations of the current are governed by the commutator.

One of the commutators is represented in fig 71

The handle *M* is fixed upon an axis which turns in the centre of a fixed disc *D*, the edge of which is divided into eight equal parts

Fig 71

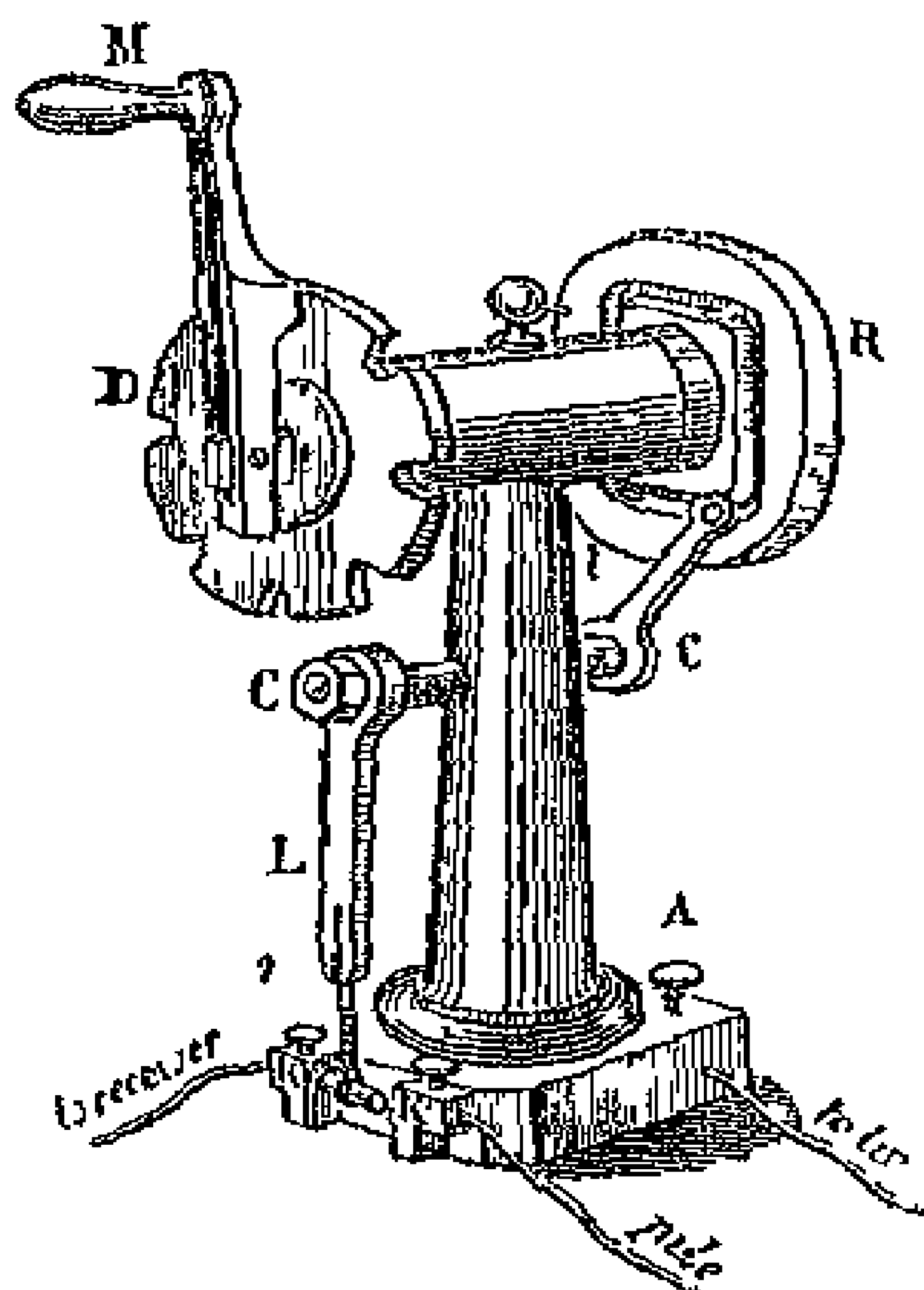

by small notches. A short pin projects from the handle which falls successively into these notches, but which can be withdrawn from them when it is required to turn it. On the remote end of this axis a disc is fixed, which turns with it, in the face of which a square groove is cut, rounded at the corners, in which a pin projecting from a short lever *l* is moved. This lever *l* is fixed on the axis *c c*, upon the other end of which is fixed the lever *r*, the lower end of which carries a small piece of metal *r*, which, when the lever vibrates right and left, is thrown alternately against the contact-pieces *κ* and *κ'*.

Supposing that the commutator is placed at the station *s*, the line-wire which comes from the station *s'* enters the foot, and is

held there by a tightening screw *A*. This wire is in metallic connection, through the pillar, with the lever *r*, and consequently with the piece of metal at its lower end, which oscillates between the contact-pieces *κ* and *κ'*. This piece of metal, *r*, may therefore be considered as virtually the extremity of the conducting wire between the stations *s* and *s'*.

Attached in like manner, by tightening-screws, to the two contact-pieces *κ* and *κ'* are two wires, one of which is connected with the battery, and the other with one end of the coil-wire of the electro-magnet, in the indicating instrument of the station *s*.

FRENCH STATE TELEGRAPH

The other end of this coil-wire is either connected with the line-wire which proceeds to the succeeding station, or with the earth, at the option of the agent, a commutator being provided by which this change of direction may be made.

185 Let us see, then, in what manner the agent at *s*, provided with such a commutator, can govern the motion of an indicator at *s'*.

The arrangement of the apparatus is such, that when the handle *x* of the commutator is presented vertically upwards, as represented in the figure, the pin being in the highest notch, the lever *r* presses against the contact-piece *k*.

Let the highest notch be supposed to be numbered 1, and the others proceeding round the disc, in the direction of the motion of the hand of a clock, be numbered successively 2, 3, 4, 5, 6, 7, and 8.

It must be remembered, that at the other station, *s'*, there is another commutator precisely similar, the corresponding points of which we shall express by the letters *m'*, *n'*, *k'*, &c.

Let us see, then, how the agent at *s*, by moving round the handle *x* from notch to notch, can govern the motion of the indicator at *s'*.

The commutator and indicator at the station *s'*, when not employed in the transmission of a despatch, are placed respectively with the arm *m'*, having its pin in the notch 1', and the hand of the indicator directed vertically upwards.

186 The arm *x* being, as represented in the figure, in the notch 1, let it be moved to the notch 2. The lever *r*, being moved to the right, the piece *z* will be thrown upon *k'*. Being then in connection with the battery-wire, the current will pass by *z* and *r* to *a*, and thence by the line-wire to the corresponding point *a'* of the commutator at the station *s'*, and thence through the pillar to the lever *r'* and the piece *z'*. But since, as has been just explained, *m'* is in the notch 1', the piece *z'* must rest against *k*. The current, therefore, arriving at this point, will pass from *k* by the wire to the coil of the electro-magnet at *s'*, to which it will impart magnetism, so that it will attract the armature, and move the anchor of the escapement, so as to make the indicator move from the vertical position 45° in the direction of the hand of a clock.

If the handle *x* be now moved from notch 2 to notch 3, the lever *r* will be thrown back to *k*, and the contact with *a'* being broken, the current will be suspended, and the electro-magnet at *s'* losing its power, the armature will recoil from it by the action of the spring (117) and the anchor of the escapement being again moved, the indicator will be advanced through another angle of 45° , and will be then in the horizontal position pointing to the right.

THE INDICATOR TELEGRAPH

In like manner, it may be shown that when the arm s is moved from the notch B to the notch A , the indicator at s' will be moved from the horizontal position to one which will make an angle of 135° , with its original direction, or what is the same, to, with the position in which it would point directly downwards.

Without pursuing this explanation further, it will be easy to see that the successive positions assumed by the hand of the indicator at s' correspond with those given to the arm s of the commutator at s .

We have here explained the action of one commutator at s upon one indicator at s' . The action of the other commutator at s upon the other indicator at s' is precisely the same. It must be understood, that the two commutators at s are connected with separate and independent line-wires, are supplied with separate and independent batteries, and act upon separate and independent indicators at s' . The right-hand commutator at s is connected with the right-hand indicator at s' , and the left-hand commutator with the left-hand indicator.

From what has been explained, the process necessary, as well for receiving as for transmitting a despatch will be understood. In the reception of a despatch, the agent has only to place the handle of his commutator in notch A , and to see that his indicator is vertical. After that he has only to observe the successive attitudes assumed by the two indicators upon the dial before him, and to write down the letters they successively express.

Since this form of telegraph gives 26 signs while 26 are sufficient for the alphabet, and 10 for the numerals, there are 16 signs disposable for abridgements, such as syllables, words, and phrases of most frequent occurrence.

187. The battery employed in working the telegraph at present invariably that of Daniell (32). Formerly Bunsen's battery (31) was used at chief stations, where great power was often required, but this has now been discontinued.

Between the point n and the battery a commutator is placed, by means of which the agent can bring into action a greater or less number of the pairs composing the battery, so as to proportion the power to the distance to which the current is to be transmitted, or to the resistance it may have to overcome.

A perspective view of the telegraphic instrument, showing the two indicators and two commutators, in their respective positions, is given in fig. 72 (vol. iii. p. 103).

INDICATOR TELEGRAPH

188. The telegraphs which convey letters or words by conventional signals, like those described above, require a staff of agents

FRENCH RAILWAY TELEGRAPHY

engaged in their management, who have been specially instructed and practised, as well in working the instruments as in interpreting their signs. That this is deemed a matter of great practical importance in telegraphic economy is manifested by the fact already mentioned, that the French government, before it resolved to establish the electric telegraph, caused instruments, on the new principle, to be constructed, by which the same system of symbols could be used as that which had been previously adopted in the semaphore.

Nevertheless, in cases like that of a system of telegraphs in which not only the business of the state, but that of the public, is to be transacted, and where, therefore, a permanent staff is employed exclusively in the management of the apparatus, no very serious difficulty can be encountered, even if the necessity of having a new telegraphic vocabulary is imposed upon these agents.

For a short time the service will be slow, and less satisfactory, but the inconvenience is temporary, and constant practice in the manipulation of the apparatus, and in the interpretation of the signs, whatever they may be, renders the agents sufficiently expert.

The case is different with telegraphs used, not for state or commercial purposes, but exclusively for railway business. The telegraphs even of principal railway stations, and still less those of secondary stations, are not in that constant requisition, and consequently do not occupy a permanent and exclusive class of agents. They are managed by any persons who happen to be employed in the respective offices—by the station-masters, clerks, railway police, guards, or, in short, by any railway agent who may happen to be at hand. Now it is evident that telegraphic instruments, the use of which would require special instructions, and much previous practice, would not answer such a purpose.

These considerations have prevailed, with the administrations of the lines of railway in all parts of the continent, and have led them to adopt telegraphic instruments which satisfy the conditions explained above, more completely than do the apparatus which have been adopted for state and public communications.

In general the railway telegraphs are of the class called "letter or alphabetic telegraphs." The agent who transmits a message is supplied with a hand which moves upon a dial, round which the letters of the alphabet are engraved, as are the hours round the dial of a clock. At the station to which the message is sent, there is a similar dial, having upon it a similar hand, and the mechanism is so contrived that, when properly adjusted, the two hands must always point to the same letter. Thus, if the agent sending the message turns the hand to the letter *x* upon the dial before him,

THE ELECTRIC TELEGRAPH

the hand upon the dial at the station to which the message is sent will also turn to the letter *m*, and in this way, by merely directing the hand successively to the letters of a word, pausing a little while at each letter the word will be spelled to the agent at the distant station.

All alphabetic telegraphs, whatever be their form or construction, convey the communications in this manner.

The French railway telegraph is in its principle identical with the state telegraph. The indicator in the latter makes a complete revolution by eight successive steps, moving in each step through an angle of 45° . If the alphabet consisted of only eight letters, this would at once become an alphabetic telegraph by fixing the indicator in the centre of a dial upon which, at equal distances asunder, the eight letters are engraved. But since the French alphabet consists of 26 letters, and since an additional sign is found convenient, the dial is divided into 26 equal arcs instead of eight, and the indicator makes a complete revolution by 26 equal motions, at the termination of these motions respectively pointing to the letters engraved upon the dial.

To accomplish this, the escapement wheel is constructed with 13 teeth instead of 4, the groove upon the moveable disc of the commutator has 13 sinuous undulations instead of 4 sides with rounded corners, and the fixed disc upon which the handle of the commutator moves, has 26 notches instead of 8.

The grooved disc, by the motion of which the oscillations right and left are imparted to the lever which makes and breaks the connection with the battery, is fixed immediately behind the notched disc, and the sinuous groove has the form represented in fig. 51, and acts upon the lever in the manner described in 133.

The commutator, with its appendages, is represented in fig. 73. The fixed disc has at its edge 26 notches, into which the pin projecting from the handle falls, as in the state telegraph. Engraved upon the face of the disc are, on the outside, the numbers from 0 to 25, and on the inside the 26 letters (*W* being omitted, not being generally used in the French language), the 26th place having the mark $+$.

A part of the dial is broken away, to disclose the face of the moveable disc, with the sinuous groove behind the fixed disc. The lever *G* is visible, with its pin in the groove, and the oscillation of the end of the lower arm *II* between the contact-pieces, *P* and *P'*, is exactly the same as that described in 133 and in 184.

The handle of the commutator is keyed upon an axis which, passing through the centre of the fixed dial, is itself keyed into the centre of the moveable grooved dial behind it, so that when

FRENCH RAILWAY TELEGRAPH

the handle is carried round the fixed dial, the moveable dial behind is carried round with it

Upon the upper part of the board carrying the dial are placed two supplementary commutators, E and E' , the hands of which play upon the contact-pieces, s , s' , l , and s' , s' , l' , as well as upon an oblong plate of metal, upon which the words "COMMUNICATION DIRECTE" are engraved

The terminals o and z communicate with the copper and zinc ends of the battery, or what is the same, with its positive and

Fig 78

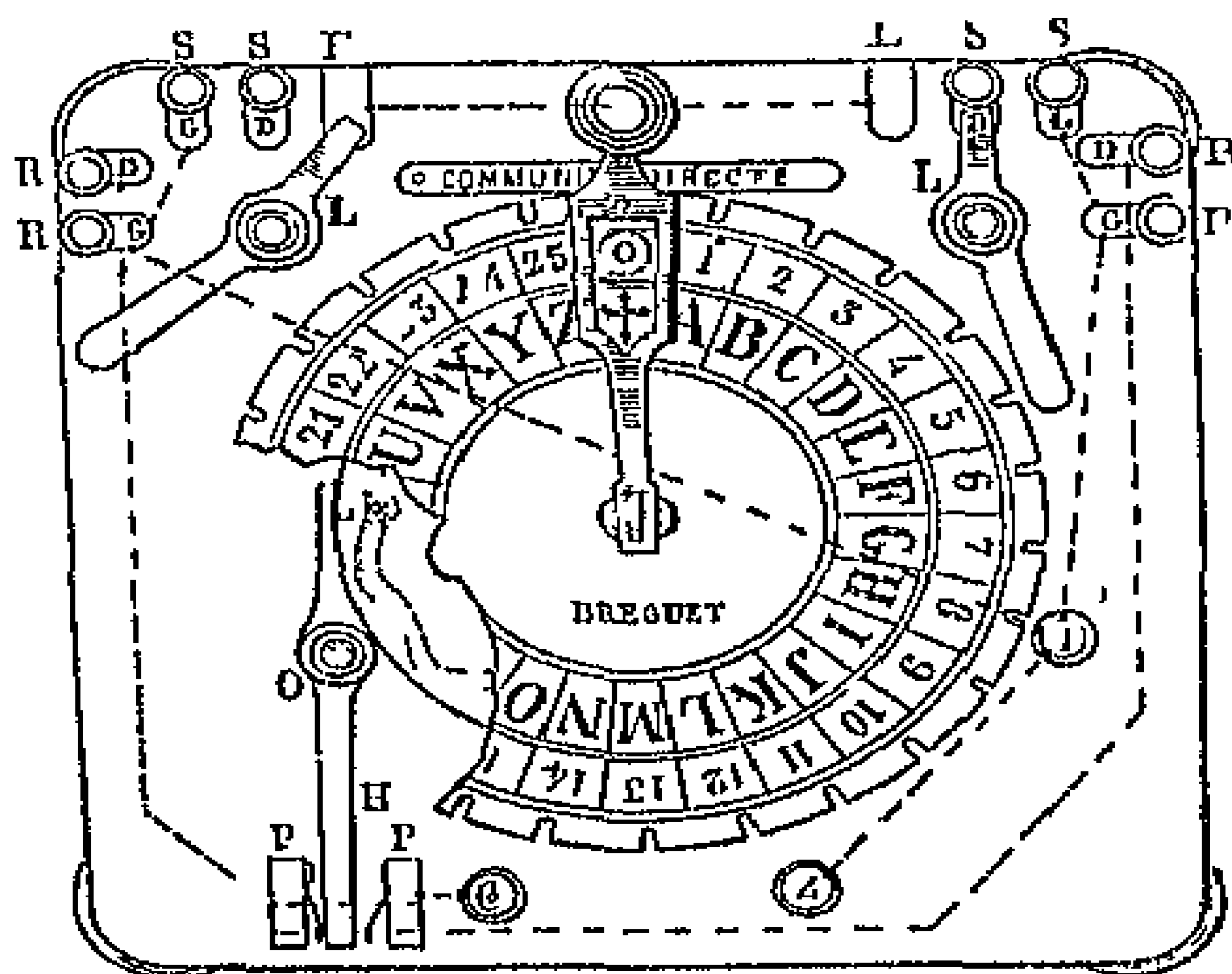

negative poles, r communicates with the earth. The contact pieces s s' are connected with alarms, r r with the indicators, and the axes of the arms r r' with the line-wires. The dotted lines indicate the positions of slips of metal inlaid in the back of the frame, by which the several pieces are put in metallic connection one with another.

After the general explanation of the manner in which the course of the current is in all cases governed, it will not be necessary here to explain the application of these commutating apparatus, which are nothing more than particular applications of the general principle so fully developed in 111.

A perspective view of the commutator and indicating apparatus mounted in the same case, is given in fig 71 (p 17). The commutator is fixed upon a horizontal desk, that being the most convenient position for its easy and rapid manipulation. The

THE ELECTRIC TELEGRAPH

indicator, which corresponds with it in form, is placed like the dial of a clock in front of a vertical case

If we suppose the commutator (fig 73) at the station *s*, and the indicator at *s'*, the aim of the commutator and that of the indicator being upon the mark $+$, any motion of the former made in the direction of the hand of a clock, will produce a corresponding motion of the hand of the latter, so that whatever letter or number the one points to, the other will at the same time point to

By this means the agent at *s* may spell word after word to the agent at *s'*

There are various conventional signs, made by two or more complete turns of the handle of the commutator, which, being altogether arbitrary, and matters of local convenience, need not be noticed here

It is found that moderately well-practised hands can transmit with this instrument forty letters per minute, while the most expert can send as many as sixty

A side view of the wheel-work and electro-magnet, *1*, of the indicating apparatus is given in fig 75

The armature, *1*, is alternately attracted and dismissed by the

Fig 75

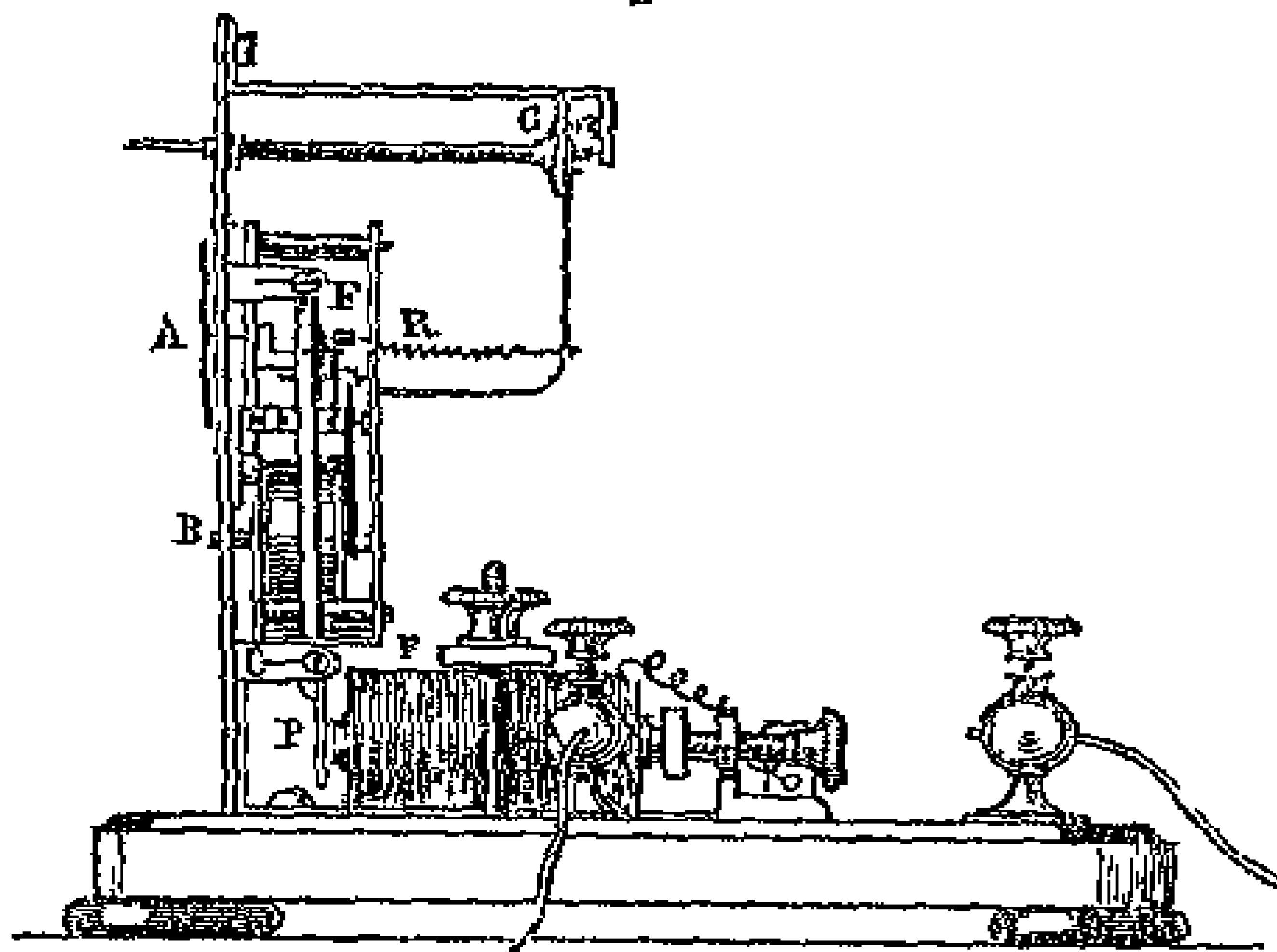

magnet, acted on by the pulsations of the current, and imparts this motion to the escapement at *F*, by which the hand *A* of the indicator is advanced from letter to letter upon the dial, so that the motion of the hand *A* at the station *s'* shall correspond exactly with that of the hand of the commutator at the station *s*.

FRENCH RAILWAY TELEGRAPH

189 The telegraph which is represented in fig 74 is a portable telegraph constructed for the French railways by M Bieguet This instrument, in size and arrangement, is adapted to be carried in the guard's van upon the train, so that, in case of accident, it may be immediately put in connection with the line-wires, and notice of the circumstance may be instantly transmitted to the two stations between which the accident has taken place

Portable instruments for a like purpose have been constructed in England and elsewhere

The apparatus consists of a stout oaken case, containing in the lower part, B B, a Daniel's battery of 18 pairs, a commutator, M, and an indicating apparatus, R A small galvanometer is placed at G, to show the existence and force of the current, and a small electro-magnet, L R

The dimensions of the instrument are indicated on the figure When not in use the top, C C, attached by hinges to the case, can be turned down over the commutator and indicator, so as to close the entire apparatus

A long rod of metal terminated in a copper hook, is provided, by which the end of the coil r can be put in connection with the line-wire, the end of the coil a being put in connection with the earth by means of a wire terminating in a small iron wedge, which is driven with a hammer into the joint between two of the rails

To explain the manner of applying this apparatus, let us suppose an accident to happen between the stations s and s', and consequently the train to be stopped The guard takes out the portable telegraph, and raising its cover C C, he puts the wire of r in connection with the line-wire, and that of a within a joint of the rails, in the manner described above He then makes one or two complete turns of the handle M of his commutator, observing whether the galvanometric needle G is deflected If it is, he knows that he has transmitted a current to the line wires This current divides itself at the hook, and a part goes to each of the stations s and s', at each of which it rings the alarm After a short interval a current is transmitted back from one or other of the stations, the arrival of which is indicated by the deflection of the galvanometric needle, G The guard then informs the stations, one or both, of the accident, its place, the nature of the aid he requires, &c

In comparing this with the state telegraph, it must not be forgotten that while this requires only one conducting wire, the state telegraph requires two In fact, the French state telegraph, like the English double-needle telegraph, is in reality two independent telegraphs, whose signals are combined for the purpose of

THE ELECTRIC TELEGRAPH.

obtaining greater celerity of communication by means of a greater variety of signals

GERMAN RAILWAY TELEGRAPH

190. The telegraphic apparatus used for the service of the Prussian railways, and for most of those of the German states, is one for which a patent was obtained by M. Siemens, of Berlin

191. This apparatus consists of an indicating dial surrounded by the alphabet, upon which a hand moves, similar in form and external appearance to the indicating dial of the French railway telegraph already described (188), but placed upon a horizontal table instead of being vertical, as in the French telegraph. This dial is surrounded by a circular key-board, as shown in fig. 76, having as many keys like those of a piano-forte as there are characters upon the dial, the letter engraved upon each key being identical with that with which it corresponds in position upon the dial

192. A lever, $a b$, is placed upon the table, turning upon the centre b , and limited in its play by two stops, r and n . When it is turned against r , the line-wire is put in connection with the indicating apparatus, and when it is turned against n , that wire is put in connection with an alarm. A current, therefore, which is transmitted along the line-wire can be made to pass through the indicating apparatus or through the alarm at will, by giving to the lever $a b$ the one position or the other

The usual means are also provided by which the current may be allowed to pass the station without going through either the alarm or the indicating apparatus, or by which it may be stopped at the station and turned into the earth. In fine, all the provisions common to telegraphs in general, which have been explained in 112, *et seq.*, are provided

When no current passes upon the line-wire, and the instruments are not in operation, the lever $a b$ at each station along the line is placed against n , so that the line-wire is everywhere in connection with the alarm

If it be desired to transmit a despatch from any station, s , the agent at that station puts the line-wire in connection with the poles of his battery, so that a current may be transmitted to all the stations upon the line. This current rings all the alarms, inasmuch as the arms $a b$ are placed against n at all the stations. The agents at the stations being thus called, remove the arms, $a b$, of their several instruments, and place them against the stops, r , the agent at the station s doing the same

Previously to this, when the instruments were in repose the

Fig 76

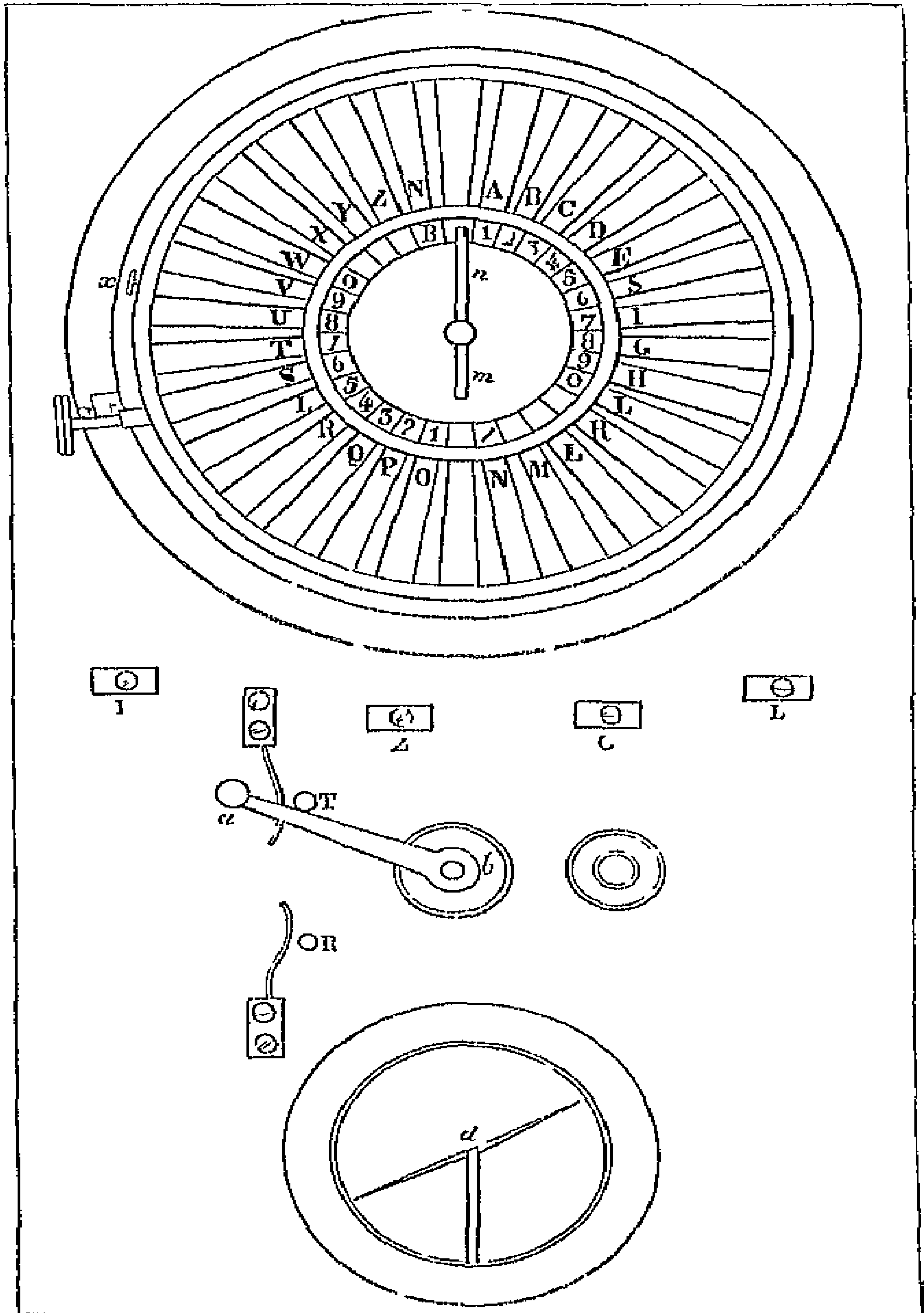

THE ELECTRIC TELEGRAPH

indicating hands, n , in all of them were placed upon the division of the dial marked $+$. The moment the arms, a b , or any of them, are placed against the stops r , the current transmitted upon the line-wire passing through the several indicating instruments, the indicating hands in all the instruments will commence simultaneously to move round the several dials. They will move from letter to letter with a starting and interrupted, but regular motion, like that of the seconds hands of a clock, but much more rapidly. The rate at which they are moved will depend on the force of the current, but, whatever be the rate, it will be common to all, all making successive revolutions of the dial precisely in the same time, and moving together from letter to letter with the most absolute simultaneity, and since they all started from the same point $+$, and move together from letter to letter, it follows that, whether their motion be quick or slow, they will all at each moment point to the same letter.

Now, it is important here to observe, that this common rotation of all the hands upon all the dials is produced and maintained by the current alone, without any manipulation whatever on the part of any agent at any station, and it would continue to be maintained indefinitely, provided that the battery were kept in action.

We have supposed the battery at the station s , from which the despatch is about to be transmitted, to be alone put into connection with the line-wire. But, in order to strengthen the current, each agent on the line, when he receives the signal, also puts his battery in like connection with the line-wire, so that the current acquires all the intensity which the combined action of all the batteries on the line is capable of producing.

The apparatus is so arranged that, in all cases, the galvanometer, d , is in connection with the line-wire, so as to indicate at all times at each station the state of the current.

It now remains to show how a despatch can be transmitted from any one station to all or any of the other stations on the line.

The apparatus is so constructed, that if the agent at any station presses down any one of the keys surrounding the dial, the indicating needle, upon arriving at that key, will be stopped, and at the same moment the current upon the line-wire will be suspended. This suspension of the current will also, at the same moment, stop the motion of all the indicating hands upon all the dials on the line. The agents at all the stations will therefore see and note the letter on which the transmitting agent has put his finger. The transmitting agent, after a sufficient pause, transfers his finger to the key of the next letter he desires to transmit. The moment he raises his finger from the first key the current is re-established on the line-wire, and all the indicating

GERMAN RAILWAY TELEGRAPH

plate as before, passing again simultaneously from letter to letter until they arrive at the second letter upon which the transmitting agent has put his finger, when they again stop, and

in this manner an agent at any station can stop the indicating hand at any or all the other stations successively, on their letters of the words he desires to communicate.

If by reason of inattention or otherwise any letter or letters omitted escape the attention of the agent at any of the stations in the despatch is addressed, such agent immediately signifies

by putting his finger on one of the keys of his own instrument which he stops the hand upon the dial of the transmitting instrument a letter, which tells him to repeat the last letter or word in case may be. This signal is understood at all the other stations, so that no confusion ensues.

Having thus shown how a despatch is transmitted and received by those to whom it is addressed, I shall now explain the mechanism by which these effects are produced.

On the dial of each instrument an electro-magnet, such as shown in Fig. 77) is placed, upon the coil of which the current transmitted from the batteries passes. This magnet, then, as usual,

has its armature g , which comes against the stop t' . Now the armature is so arranged, that when the current is sent, the circuit of the current is broken, and consequently the current is suspended.

This deprives the electro-magnet m of its magnetism; and g is no longer attracted, it is drawn down from the stop t' by the spring s , and recoils upon the stop t . Here the connection with the line-wire is re-established, and the current is re-established in the electro-magnet having thus received its magnetism, g is again attracted and drawn into contact with t' , the connexion is again broken, and g is drawn back to t by the spring s so on.

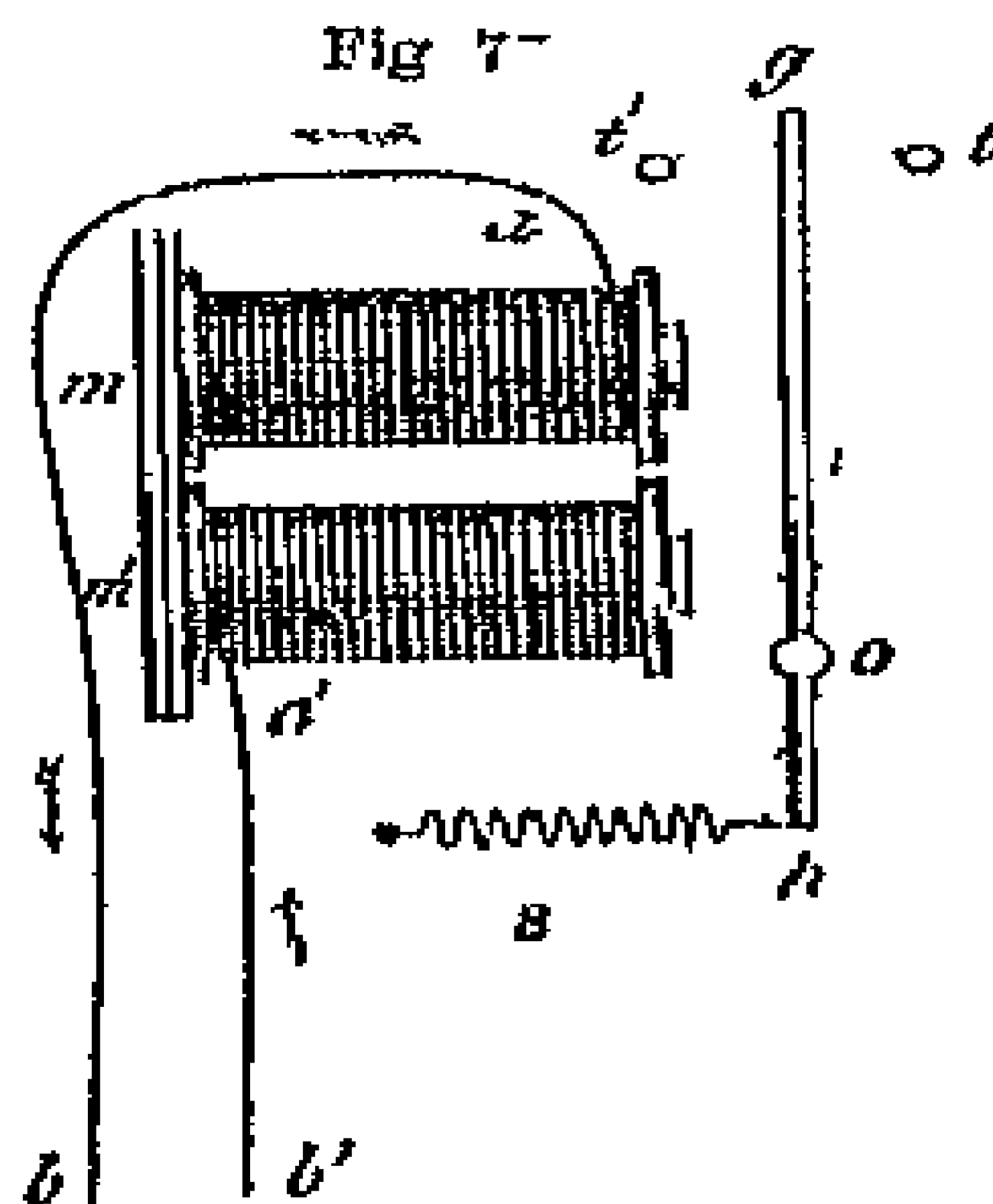

As the intervals of transmission and suspension of the current are the same throughout the entire line, and since the intervals of transmission are those in which the armature moves towards the magnet, and the intervals of suspension those in which it moves from the magnet, it follows that the oscillations of the armature of all the electro-magnets at all the stations are absolutely simultaneous.

THE ELECTRIC TELEGRAPH

In each instrument the armature is in connection with a toothed wheel, upon the axis of which the hand *m n* (fig 76) is keyed, so that each vibration of the armature puts forward one tooth of the wheel, and advances the hand *n* from one letter to another.

195 Upon comparing this arrangement with that of the French telegraph it will be perceived that here the manspring and wheel-work which moves the indicator are altogether omitted, and the armature of the electro-magnet, which in the French instrument only *regulates* the motion of the indicator, here both *moves and regulates* it. In fine, the armature here discharges at once the functions of the manspring, and of the pendulum of a clock.

It will also be observed that the manipulation of the transmitting agent, by which he moves the indicators on the dials of the distant stations, is dispensed with, the current itself, through the intervention of the armature of the electro-magnet, imparting to the indicator a constant motion of rotation without any manipulation whatever.

That part only of the manipulation by which the indicator is stopped for a moment successively at the letters of the word intended to be transmitted, is retained, and that is effected by the action of the keys surrounding the dial.

196 Under the dial, a radius or arm is keyed upon the axis on which the indicating hand is fixed, so as to be always immediately under that hand and parallel to it, revolving simultaneously with it. This radius is a little longer than the indicating hand, and extends under the keys surrounding the dial. From the under surface of each key a pin projects, the length of which is such that when the key is not pressed down, the radius passes freely under it, but when the key is pressed down, the pin comes in the way of the radius, and stops it when the indicating hand *n* arrives at the letter engraved on the key. By the action of the same pin the armature *o g* (fig 77) of the electro-magnet is arrested in its return from *t'* to *t*, so as to be prevented from arriving at *t*. The current, therefore, is prevented from being re-established on the line-wire, as it would be if *g o* were permitted to come into contact with *t*.

Thus it will be understood how by putting down a key the two desired effects are produced. 1st, the stoppage of the indicating needles at the letter engraved on the key of the indicator on which such key is put down, and 2nd, the simultaneous suspension of the current along the entire telegraphic line, by which the indicating needles of all other instruments are stopped at the same letter.

197 This apparatus, compared with the French telegraph, to which it has an obvious analogy, has the advantage of greater simplicity. By dispensing with the manspring and its necessary

BELGIAN RAILWAY TELEGRAPH

train of wheel-work, and with the rather complicated commutator worked by the hand of the transmitting agent, many moving parts are rejected, and there are proportionately less chances of derangement and less causes of wear or fracture. But on the other hand the moving power which impels the indicator, being transferred from the mainspring to the current, a proportionately greater force of current is necessary. This force is, however, obtained without augmenting the magnitude of the batteries at any one station by the expedient of bringing the piles of both the terminal stations, and, if necessary, of any or all the intermediate stations, into the circuit.

198 In the batteries used with the French railway telegraph, the use of acid, as has been stated, is found altogether unnecessary. In the German telegraph, however, pure water does not give a sufficiently strong current, and it is acidulated with about one and a half per cent of sulphuric acid. The battery at each station consists usually of from 15 to 20 pairs. The usual speed imparted to the indicator by the current is about 30 revolutions per minute.

M. Siemens invented mechanism by which the indicating apparatus was connected with one by which the letters of the despatch as they arrived were printed by ordinary type upon a band of paper. Since, however, this has not been brought into practical use, it will not be necessary to explain it.

When the electric telegraph was first opened to the general service of the public in Prussia, this apparatus of Siemens was generally used, but it has since been superseded by that of Morse, its speed of transmission being found insufficient for the public service.

BELGIAN RAILWAY TELEGRAPH

199 When the electric telegraph was first brought into use on the Belgian railways, the French and German apparatus described above were tried in succession. In 1851 they were, however, both superseded by a form of telegraph invented and constructed by M. Lippens, mathematical instrument maker of Brussels.

200 M. Lippens attributes to the French and German railway telegraphs certain defects, which he claims to have removed. For the efficient performance of these telegraphs, it is evident that a certain relation must always be maintained between the force of the spring *s* (fig. 77), which produces the recoil of the armature *o*, and the attractive force of the magnet, or what is the same, between the spring and the intensity of the current, with which the attraction of the magnet must vary. Now the intensity of the current is subject to variation, depending on the state of the battery, the number of pairs which are brought into operation, the length of

THE ELECTRIC TELEGRAPH

the line-wire upon which it is transmitted, the more or less perfect state of the insulators, and in fine on the weather.

If the current become so feeble that the attraction of the magnet is less than the force of the spring s , the armature $g o$ will remain upon the stop t , from which the magnet is too feeble to remove it. If, on the other hand, the spring have not sufficient force to overcome the friction and inertia of the armature $g o$, and the small portion of magnetism which may be retained by the electro-magnet after the current has been suspended, the armature will remain upon the stop t' , the spring being unable to produce its recoil.

Since therefore the forces against which the spring s acts, and which it ought to exceed, and those which act against it and which ought to exceed it, are variable, it is clear that the maintenance of the efficiency of the apparatus requires that the spring s shall from time to time be adjusted, so as to be kept in that relation to its antagonistic forces, which are necessary for the due performance of the telegraph.

It has been already shown that very sufficient and very simple means of adjustment for this purpose have been supplied in the French telegraphs. The hands which appear in the upper corners of the instrument (fig 70) are intended for this purpose, and being turned by the key, the springs connected with them are increased or diminished in their force, according as the key applied to them is turned the one way or the other. Similar adjustments are provided in the German instruments.

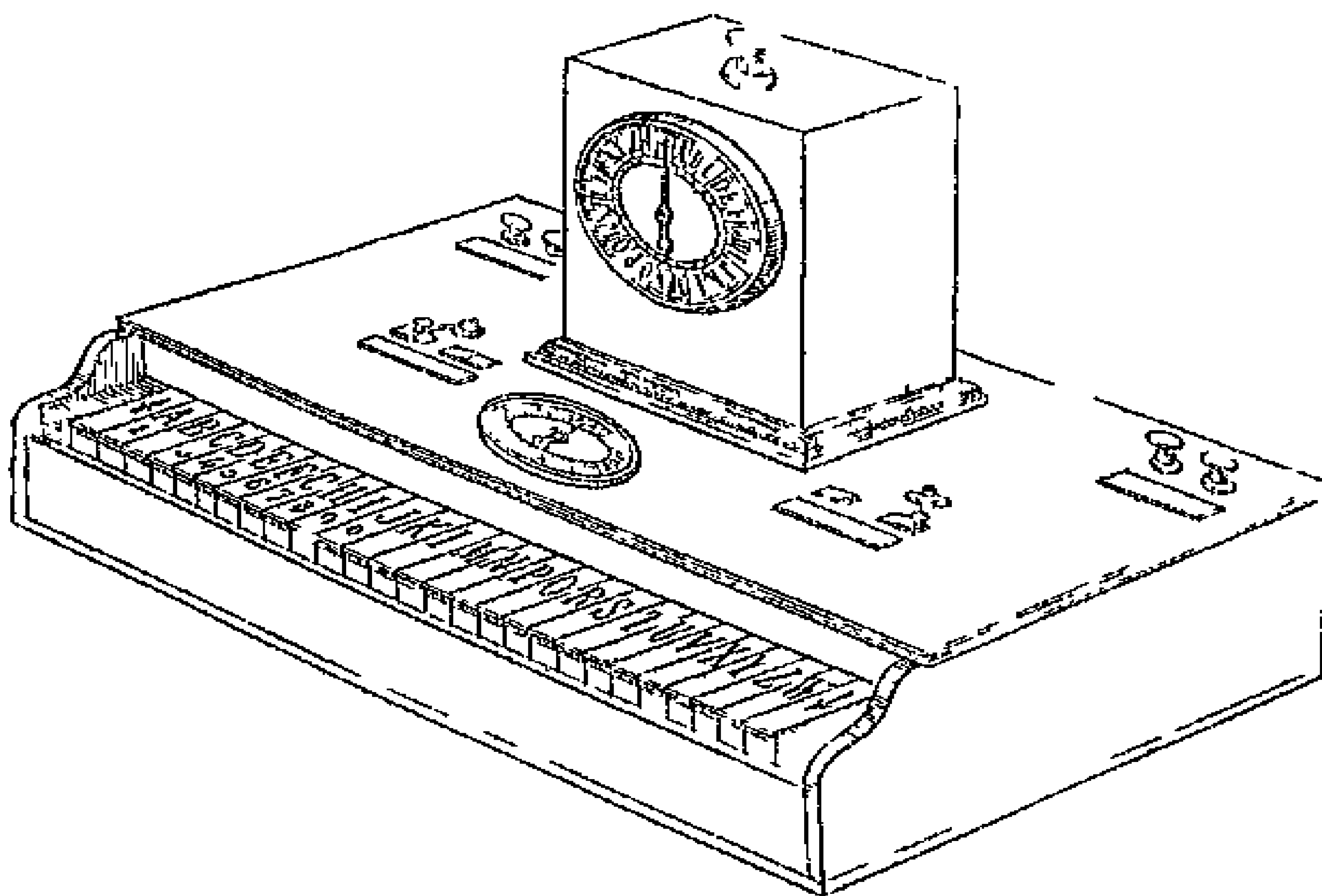

Fig 51 — LIPPENS'S ALPHABETIC TELEGRAPH

THE ELECTRIC TELEGRAPH.

CHAPTER IX

- 201 Defects of the French and German instrument removed by Lippens' instrument — 202 Description of it — 203 Its wheel commutator — 204 Transmission of despatches by it — 205 Lippens's alphabetic telegraph — 206 Morse's telegraph — 207 Lippens's writing telegraph — 208 Bain's chemical telegraph — 209 Method of writing — 210 Electro chemical pen — 211 Metallic disk

201 M Lippens and the Belgian railway and telegraph authorities by whom he has been supported, however contend, that although the permanent staff of the state and public telegraphs constantly occupied and practised in the manipulation of such apparatus may be relied upon for the due management of such adjustments, the agents of various grades employed on the railways, whose duties do not permanently connect them with the telegraph, and who are only called to it from time to time, cannot be depended on to perform adjustments requiring not only constant practice, but some address and some special knowledge of the principle and mechanism of the apparatus

THE ELECTRIC TELEGRAPH

The apparatus of M Lippens, which is now used for the service of the Belgian railways, is exempt from these defects

Like M Siemens, M Lippens rejects the manspring and its appendages adopted in the French telegraphs, and charges the current itself with their functions. He retains, however, the commutator, and imparts the pulsations to the current by the hand of the agent applied to a lever or winch, which is moved exactly like the arm of the commutator of the French instruments

He rejects the spring *s* (fig 77), which produces the recoil of the armature, and substitutes for it a second magnet placed on the other side of the armature, substituting at the same time a permanently magnetic bar of steel for the armature of soft iron used in the other instruments

202 To explain the principle of Lippens' apparatus, let *a b* and *a' b'* (fig 78) be two electro-magnets made precisely alike, the

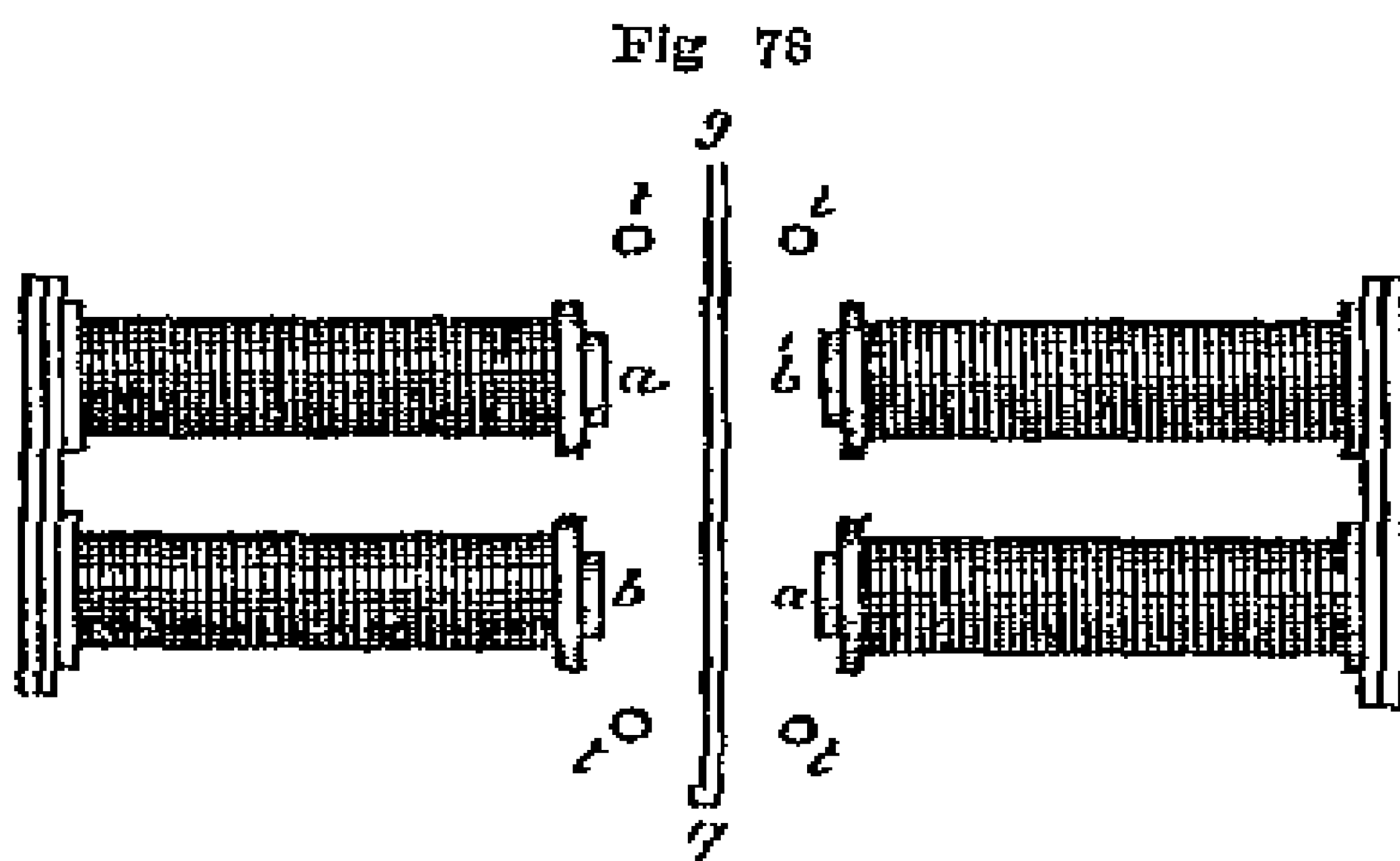

coil of covered wire upon them being one continuous wire carried from one to the other, and rolled in such a manner that their polarity shall always have contrary positions in whichever direction the current may be transmitted on the wire. Thus, if *a* be a north

pole, *b'* opposed to it will be a south pole, and in that case *a'* will be a north and *b* a south pole. If the current upon the coil be reversed, all these four poles will at once change their names—*a* becoming a south and *b'* a north pole, and *a'* a south and *b* a north pole.

Let *g g'* be a steel bar which is permanently magnetised, *g* being its north and *g'* its south pole, and let it be supported midway between the electro-magnets, having free play towards the one or the other until it encounters the stops *t t* or *t' t'* by which it is arrested.

Now let a current be transmitted upon the wire, by which *a* will become a north pole, and consequently *b* and *b'* will be south poles, and *a'* a north pole. Since *g* is a north and *g'* a south pole, they will be attracted by *b'* and *a'*, and repelled by *a* and *b*, and consequently the armature *g g'* will be moved towards *b' a'* until it is stopped by *t' t'*. If the current be then reversed, *a* and *a'* will become south, and *b* and *b'* north poles, and the armature

BELGIAN RAILWAY TELEGRAPH

will be attracted by a and b , and repelled by b and a' , and will accordingly move towards the latter until it is stopped by $t t$

If the direction of the current be reversed rapidly, suppose, for example, ten times per second, the armature $g g'$ will be made to oscillate ten times per second between the stops $t t$ and $t' t$

It is evident that the expedient adopted by Siemens, by which the transmission of the current is arrested by the contact of the armature with one stop and re-established by its contact with the other, might be easily modified so as to reverse the direction of the current by each contact with $t t$ and $t' t$, and in that case the telegraph of Siemens would without other change be rendered exempt from the defects imputed to it, as well as the French instruments, by Lippens. But M Lippens, either prevented from adopting this obvious expedient by the patent of Siemens, or giving a preference to the hand commutator for other reasons, has contrived an ingenious commutator worked by hand, by which he reverses the current with the greatest facility, rapidity, and precision

203 This is a wheel commutator formed on the principle explained in 129, but there are two wheels such as are there described placed one upon the other upon a common axle, with a disc of gutta percha between them, so that one is insulated from the

Fig 79

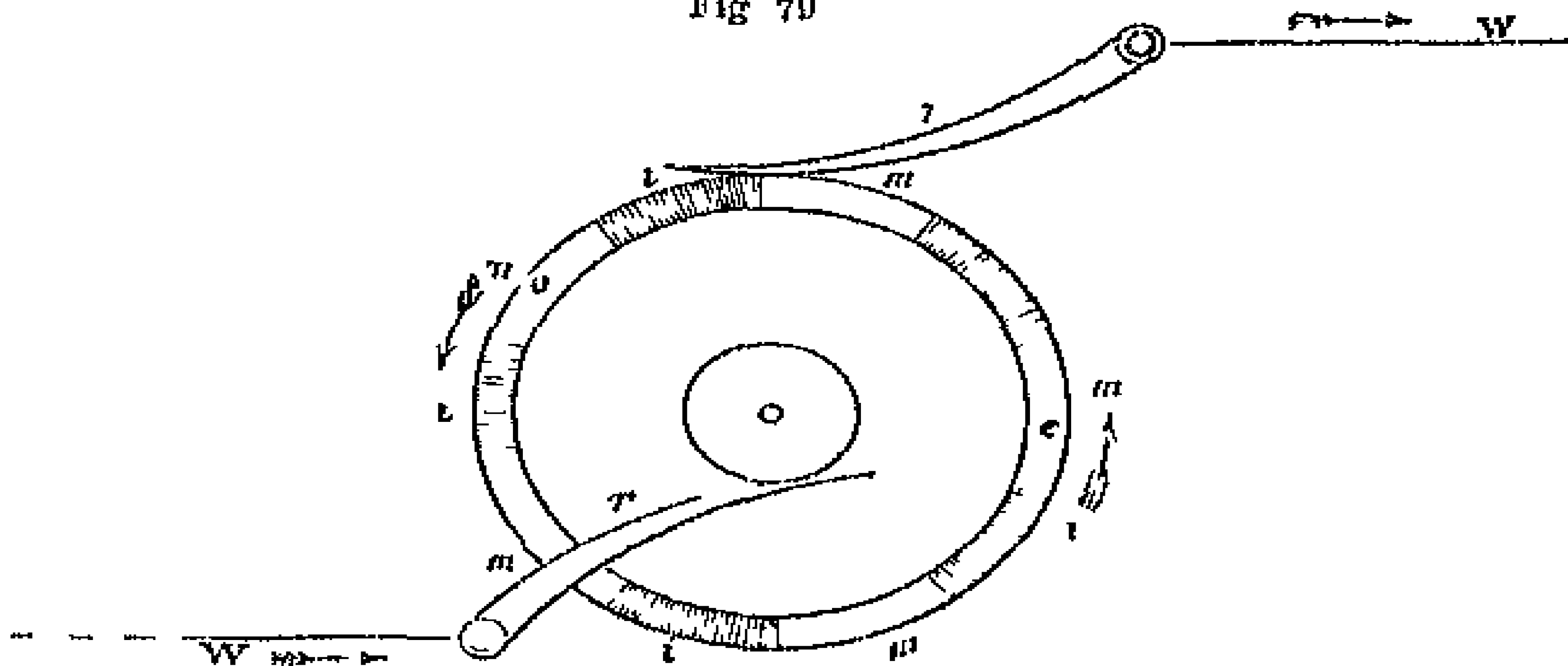

other. The edges of both are divided into a series of conducting and non-conducting arcs, but the position of these relatively to each other is alternate, the conducting arcs of each disc corresponding in position with the non-conducting arcs of the other.

We may imagine the shaded arcs of fig 79 to represent the conducting arcs of the upper, and the white arcs the conducting arcs of the lower disc, the one, however, being separated from all contact with the other by the interposed disc of gutta percha.

THE ELECTRIC TELEGRAPH

When the wheel is made to revolve, the spring s' comes alternately into contact with the conducting arcs of the one and of the other disc. Another similar spring is applied to another part of the edge of the wheel, so as to be in contact with the conducting arcs of the upper disc, while the spring s' is in contact with those of the lower, and *vice versa*.

One of the two discs is in connection with the copper, and the other with the zinc end of the battery, so that one may be considered as its positive and the other as its negative pole. One of the springs is in connection with one end, and the other with the other end of the conducting wire, which forms the coils, and which passes along the telegraphic line. By causing the wheel to revolve, therefore, the conducting wire will be alternately connected with contrary poles of the battery, and the current upon it will be reversed.

If the edge of the wheel be divided into ten equal parts by the conducting arcs, this reversion will take place ten times in each revolution, and if a revolution be imparted to the wheel in each second, the current will be reversed ten times per second.

In the apparatus of Lippens the oscillations thus imparted to the armature, $g g'$, fig. 78, are made to act by the intervention of toothed wheels upon the indicating hand which moves upon the dial around which the letters are engraved, as in the French telegraph, and this hand is moved from letter to letter in the same manner as in the French railway telegraph and that of Siemens.

Upon the axle of the commutating wheel above described a winch is fixed by which the agent who transmits the despatch turns it.

A plan of this instrument is drawn in fig. 80. The handle of the commutator BB' is keyed upon the axis of the wheel already described, which is under the table of the instrument. This wheel, and the springs which press upon it, are indicated in the figure. The handles qq are those by which the current is conducted from the up or down line through the indicating apparatus, or through the alarm, as already explained in the case of the German telegraph. Several other batteries are provided for establishing connections with the line wires, the battery poles, the alarms, and the earth, and differ in nothing essential from similar adjustments in other telegraphic instruments.

204 When the agent at any station, s , desires to transmit a despatch to any other station or stations, s' , he first, as in other telegraphs, calls the attention of the agents at s' by means of the alarm. The current being then directed through the instruments severally by means of the adjustments provided for that purpose, the transmitting agent at s turns the handle BB' of his

BELGIAN RAILWAY TELEGRAPH

commutator, by which he produces the pulsations of the current, and puts the indicating hands upon the dials at s' , as well as upon his own in motion. These hands as usual, when properly

Fig. 80

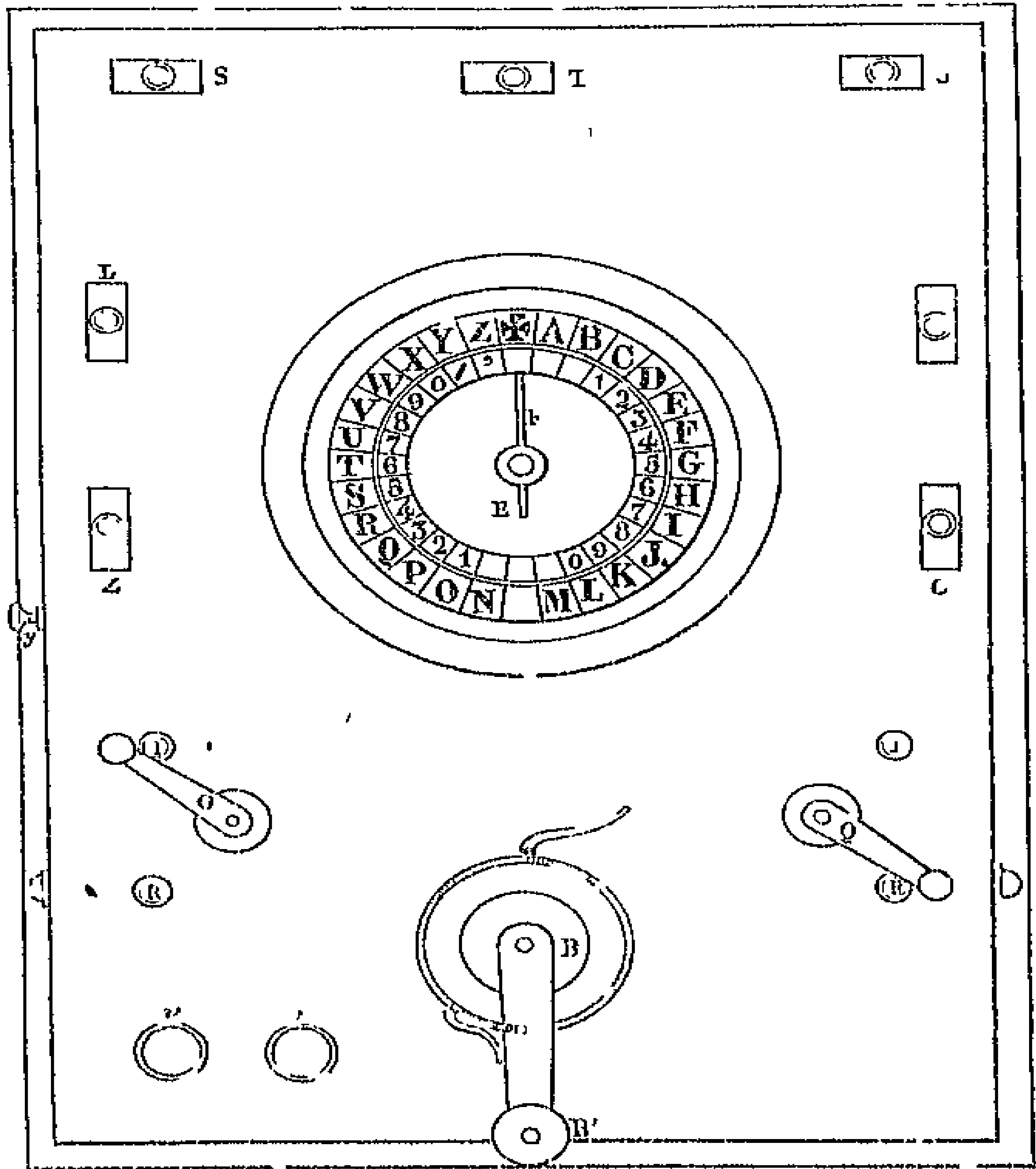

adjusted always point to the same letters. The transmitting agent stops the handle BB' when he sees the hand x upon his dial point successively to the letters which spell the word he

THE ELECTRIC TELEGRAPH

desires to transmit, and by continuing to operate thus, he transmits the entire despatch.

Such is the Belgian railway telegraph, and although it must be admitted that it supplies a certain improvement on the French telegraph, it ought also to be stated that the difficulty and inconvenience which M. Lippens claims to have removed, has not been found to offer any practical obstruction to the satisfactory performance of the French instruments.

It appears that M. Lippens has lately made considerable improvements in the practical details of his telegraph, by which its operation is rendered much more convenient. He has also substituted the magneto-electric for the voltaic current, and thus dispensed with the voltaic battery. This last improvement has not yet (July, 1851) been applied on the telegraphic lines, but will be in operation, probably, before these pages come into the hands of the reader.

ROMAN'S ALPHABETIC AUTOGRAFIC

205 The external appearance of this instrument, represented in fig. 81 (p. 33), is that of a small piano-forte, having, however, no black keys. On each of the keys a letter of the alphabet is engraved, the first key being marked with a cross, and the last with an arrow. On the first ten keys are also engraved the numerals. This part of the apparatus is the commutator, by which the agent at the station where it is placed, is enabled to transmit signals to any distant station.

Upon it is placed the indicating apparatus, which is acted upon by the commutator of the apparatus at a distant station, and by which a despatch is received. This indicator is similar in form and in the manner of giving its signals to that of the French railway telegraph already described. The dial of the indicator is marked with the letters of the alphabet, and the cross and arrow corresponding with the characters engraved upon the keys of the commutator.

At the back of the case containing the indicating apparatus the alarm is attached, and commutators are placed upon the case by which this alarm can be put in connection at pleasure with the line-wire. As usual it is always kept in connection with it when the instrument is not in use, so that notice may be given of the approaching arrival of a despatch. On the ringing of the alarm the agent at the station turns off the commutator from the alarm and throws it into connection with the indicating apparatus.

To explain the transmission of a despatch, let us suppose an apparatus, such as that represented in the figure, to be erected

FROMENT'S ALPHABETIC TELEGRAPH

at two stations, *s* and *s'*, connected as usual by a conducting wire, the instrument, being unemployed, the line-wire at both is in connection with the alarm. Now let us suppose that *s* desires to transmit a despatch to *s'*. In that case *s* having first turned on the current, puts down any key whatever of his commutator, the effect of which is that a current is transmitted upon the line wire to *s'*, which rings the alarm, then *s'* replies by transmitting a return current in the same way to *s*, by which *s's* alarm is rung. All being then prepared for the transmission of the despatch, *s* puts down with his fingers successively the keys of his commutator upon which the successive letters spelling the words of the despatch are engraved, and simultaneously with this the indicator upon the dial of *s'* points to the same letters, which are taken down by *s'*. At the end of each word, *s* puts down the key marked with the cross.

When it is intended to transmit numerals, *s* puts down the arrow just before he begins them, and the cross when he ends them. Thus if it be desired to transmit the number 1851, *s* first puts down the arrow, and then the keys marked λ , π , γ , and δ successively, after which he again puts down the cross to indicate that the number is finished. It remains now to explain how these effects are produced.

Within the case, and at some distance below the key-board, a steel rod is extended, parallel to the line of keys, the length of which corresponds with that of the row of keys. From this rod, and at right angles to it, proceeds a series of short steel arms, one under each key. In the bottom of each key, and at right angles to it, is inserted a short projecting pin, which corresponds precisely in position with the short steel arm just mentioned. The length of the arm, and that of the pin, taken together, is a little less than the distance between the bottom of the key and the steel rod when the key is not put down by the finger, the necessary consequence of which is that in that position of the key the rod may revolve, carrying the arm round with it unobstructed. But when the key is put down by the finger, the bottom of it is brought to a distance from the rod which is less than the sum of the lengths of the projecting arm and the pin, and consequently if the rod revolves, carrying with it the projecting arm while the key is thus held down, the pin coming in the way of the arm arrests it, and stops the further revolution of the steel rod.

It is evident that if the projecting arms were all inserted in the steel rod at the same side, or to speak with still more precision, if their points of insertion lay in a line along the side of the rod parallel to its axis, the pins of all the keys would arrest the revolution of the rod in exactly the same position, and, as it

THE ELECTRIC TELEGRAPH

will presently appear, that the position in which the rod is stopped determines the signal transmitted, it would follow as a consequence that in such case all the keys would transmit the same signal, and the indicator at the station to which the dispatch is to be transmitted would always return to the same letter upon the dial.

To prevent this, and to vary the signal in the necessary manner, the projecting arms are inserted in the steel rod according to a spiral or helical line, surrounding it like the thread of a screw, so that if, for example, the rod be placed so that the first projecting arm corresponding to the key marked with the cross, points directly upwards, the fourteenth which corresponds to the key *m*, will point directly downwards, and the intermediate arms will point at angles more and more inclined from the upward direction, each being deflected from the upward direction more than the preceding one by the fourteenth part of the half circumference.

In like manner, in proceeding from the arm corresponding with the key *m*, which points downwards, each successive arm will be more and more deflected from the downward direction, each being more deflected from it than the preceding one by the fourteenth part of half the circumference.

Thus the twenty-eight projecting arms divide the circumference of the rod into twenty-eight equal parts, and consequently in a revolution of the rod, the arms come successively to the position in which they point upwards and in which they would encounter the pin projecting from the bottom of the key if that pin were thrown in their way by the key being pressed down by the finger.

It will be evident, therefore, that if from any cause the steel rod be made to revolve, its motion may be stopped at twenty-eight different points of its complete revolution by means of the depression of the twenty-eight keys. We shall now show how a motion of revolution is imparted to this rod.

To its right-hand extremity is fixed a ratchet-wheel, which is in connection with a train of clockwork, moved in the usual manner by a mainspring. This clockwork is contained within the case of the apparatus. If it be wound up, and if nothing obstructs its action, a motion of continuous rotation will be imparted to the ratchet-wheel, and by it to the steel rod, and this motion will be more or less rapid according to the force of the mainspring, and the adjustment of a fly which is connected with it. They are so adjusted as to cause the rod to revolve two or three times in a second. But in the teeth of the ratchet-wheel, a catch is inserted, which counteracts the mainspring and prevents the motion, which can only take place when this catch is withdrawn. A bar is suspended parallel to the keys, and under them, by a contrivance called in mechanics a parallel motion, by means

MORSE'S TELEGRAPH

of which any of the keys when pressed by the finger will lower it. This bar rests upon the arm of the catch engaged in the teeth of the ratchet-wheel, so that whenever any key is put down by the finger, the bar is depressed, the catch disengaged, the wheel liberated, and a motion of revolution imparted.

On the left hand extremity of the steel rod is fixed a commutating wheel, similar in principle to that already described in the railway telegraph. This wheel, being fixed upon the rod, turns with it, moving when it moves, and stopping when it stops. Since the position in which the rod stops is determined by the key put down, the position in which the wheel thus fixed on the rod stops, is similarly determined. This wheel determines the pulsation of the current, and these pulsations determine the position of the indicator at the station to which the despatch is transmitted, in a manner which is substantially the same as that already described in the case of the railway telegraph.

MORSE'S TELEGRAPH

206 This apparatus, which is applied on an extensive scale in America, and with some slight modifications in the Germanic States, is constructed upon the principle already explained in 103.

Fig. 81

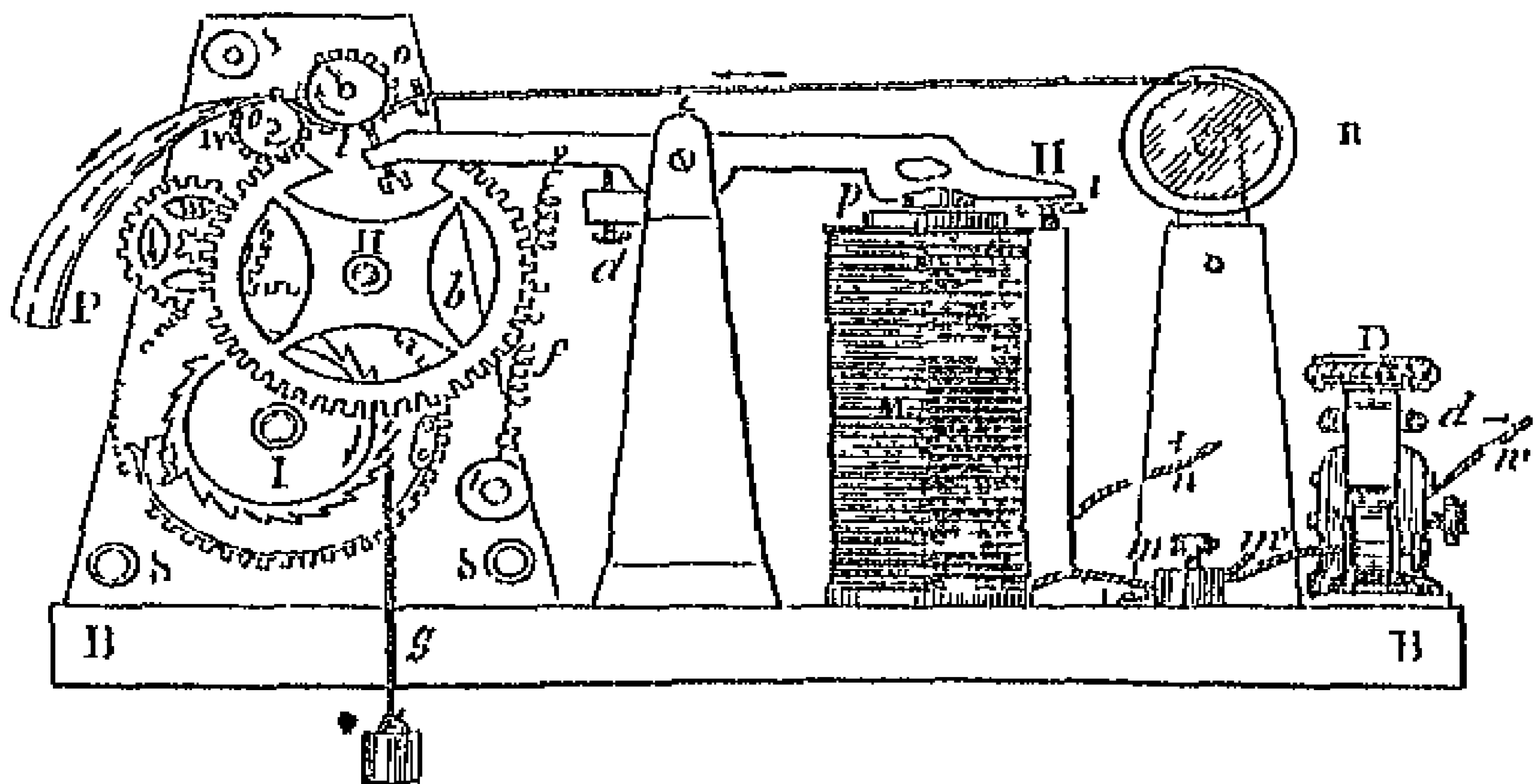

A general view of the instrument in its most usual form is given in fig. 82.

M is the electro-magnet, *n* is an armature working on the centre *c*, *t* an adjusting screw to limit the play of the armature, and prevent its contact with the electro-magnet at *p*, *d* another adjusting screw to limit its play in the other direction, *t* a metallic

THE ELECTRIC TELEGRAPH

style which marks by pressure a band or ribbon of paper drawn from the roll *n*, and carried between the rollers *o* and *o'* the ribbon of paper discharged from the rollers *o* *o'*, after being impressed by *t* with the telegraphic characters, *a*, *b*, &c, clockwork from which the rollers *o* *o'* receive their motion, by which motion the ribbon of paper is drawn from the roller *n*, *f* the spring which draws the arm *π* of the electro-magnet from the armature, *s* *s* the upright pieces supporting the clockwork, *π* *π* the base supporting the instrument, *D*, the key commutator, by which the current transmitted along the line-wire is alternately transmitted and suspended, *m*, *n*, *m'*, *n'*, wires by which the coil of the electro-magnet and the poles of the station battery are put in connection with the line-wires

The general principle of this and all similar apparatus has been already so fully explained in 153, *et seq*, that little more need be said here to render it intelligible. If it be desired to transmit a despatch to a distant station, the battery at the transmitting station is put in communication with the line-wire, and by the action of the key *D* the current is alternately transmitted and suspended during longer and shorter intervals, which are determined by the conventional telegraphic letters. The action of the style *t* against the ribbon of paper which passes over it at the station receiving the despatch, corresponds exactly with the action of the key *D* at the station from which the despatch is transmitted, and combinations of longer and shorter marks or lines and dots are produced upon the ribbon of paper by its pressure, as is shown in the figure

The particular combinations of lines and dots used to express the letters are obviously arbitrary. As a matter of convenience and means of expedition, the letters of most frequent occurrence are expressed by the most simple signs, and consequently the selection of signs for the different letters will vary with the language in which the dispatch is expressed

The following are the telegraphic characters adopted by Mr. Morse for the English language —

A —	J — —	S —	Numerals	
B —	K — —	T —	1 — —	9 — —
C —	L — —	U —	2 —	0 — —
D —	M — —	V —	3 —	
E —	N —	W — —	4 —	
F —	O —	X — —	5 — —	
G — —	P —	Y —	6 — —	
H —	Q —	Z —	7 — —	
I —	R —	C —	8 —	

MORSE'S TELEGRAPH

This telegraphic apparatus being that which has been by far the most extensively brought into use, being not only adopted almost exclusively in the United States and contiguous countries, but also in all the German States, it may be useful here to present the instrument and its appendages in the form in which it has been most recently constructed in the United States, and which has been recommended by the American telegraphic confederation, as being that which it would be most advantageous to adopt generally, so that all the parts being manufactured of the same pattern and size no difficulty would be found in replacing any of them in case of fracture

A perspective view of the instrument, omitting the paper roller and ribbon, is given in fig 83 (p 44)

z The wooden base upon which the instrument is screwed,

B The brass base plate attached to the wooden base *z*

A The side frames supporting the mechanism

h, h Screws which secure the transverse bars connecting the side frames

a The key for winding up the drum containing the main-spring, or supporting the weight, according as the mechanism is impelled by one or the other power

3, 4 Clock-work

u A lock or gauge to regulate the pressure of the rollers on the paper

e The pillar supporting the electro-magnet

p The adjusting screw passing into the pillar, *e*, projecting through the armature, to enable the telegraphist to adjust the sound of the back stroke of the armature at pleasure

o The spring bar, and

d, the screw to adjust the action of the pen lever

B The apparatus for adjusting the paper rollers

f The adjusting screw of the pen lever

The form of the relay magnet recommended, is given in fig 84 (p 46), in its proper size

A B, are the helices or coils

c The supporter of the magnet lightly screwed to

w, the connecting bar of the magnets

x Rosewood or ivory ends of magnets

D Armature screwed to

r, an upright lever,

r, its axis, surrounded by a spiral spring, to perfect the connection in case of a fault at the ends of the axle

π The spring to produce the recoil of *D* and *r*,

r Its adjusting screw

II An adjusting screw to limit the play of *r* towards the magnet,

Fig 90

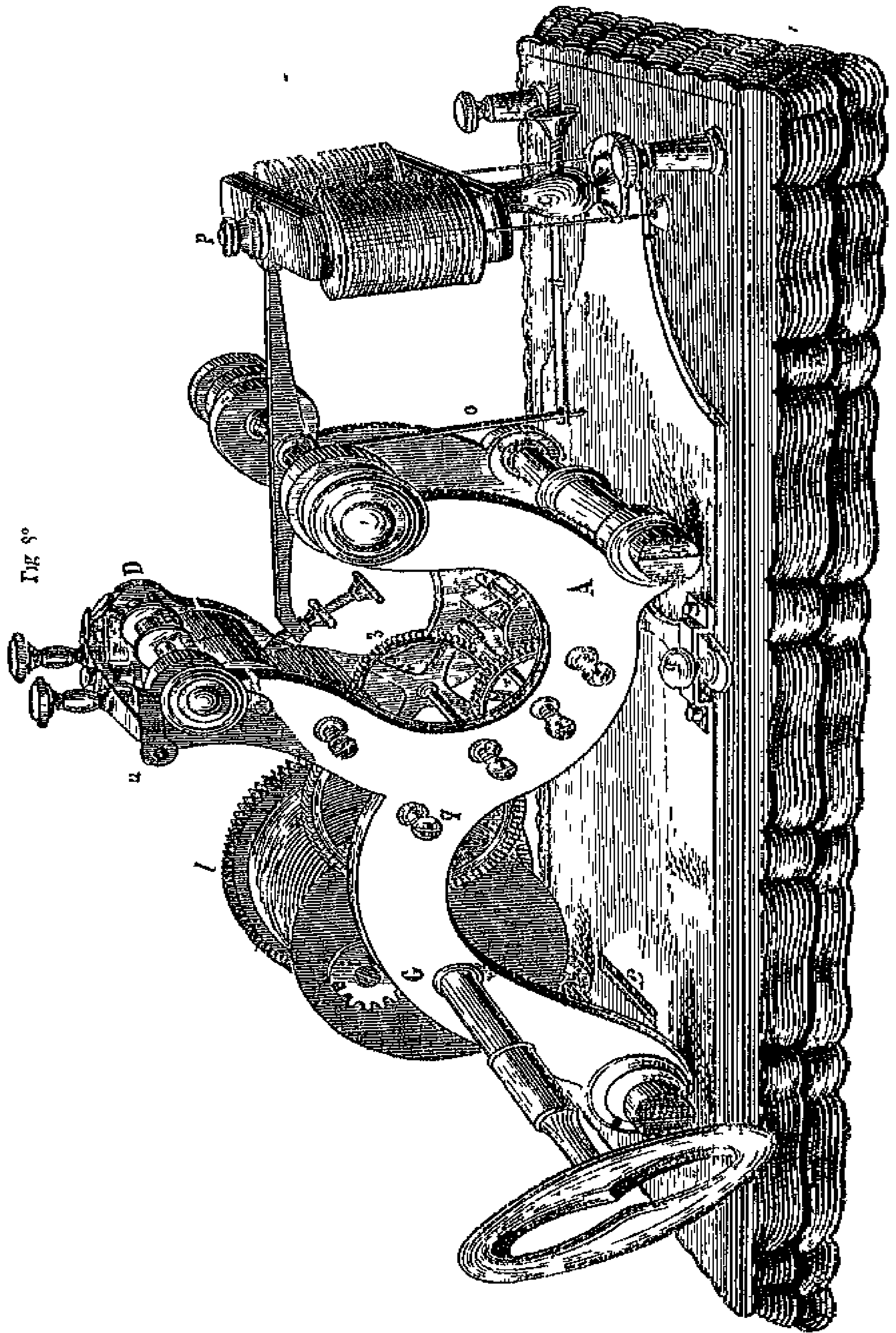

MORSE'S TELEGRAPH

r, its point of platinum

s An adjusting screw to limit the play of *r* from the magnet

t Its insulating point, in ivory

o n Screws to connect with the wires of the station battery

p q Screws to connect with the line wires

v The point where the coil wire passes through

u, the base of the magnet

The form recommended for the key commutator is represented in its proper magnitude in fig 80 (p 16) When the key is held down the circuit is perfect It is not liable to wear and to produce a doubtful connection The

whole arrangement is designed to avoid the evils heretofore existing, and perfect every questionable part The anvil of the key is well made, firm, and capable of hard wear, regardless of the adjustment of the key lever The

hammer of the key lever is also firm, and made of good platinum wire, and securely made fast in the key lever The adjusting screws of the axle are arranged according to the best mode, to secure the most perfect action The elevation of the key lever can be adjusted to suit the operator, by elevating the key frame, or otherwise.

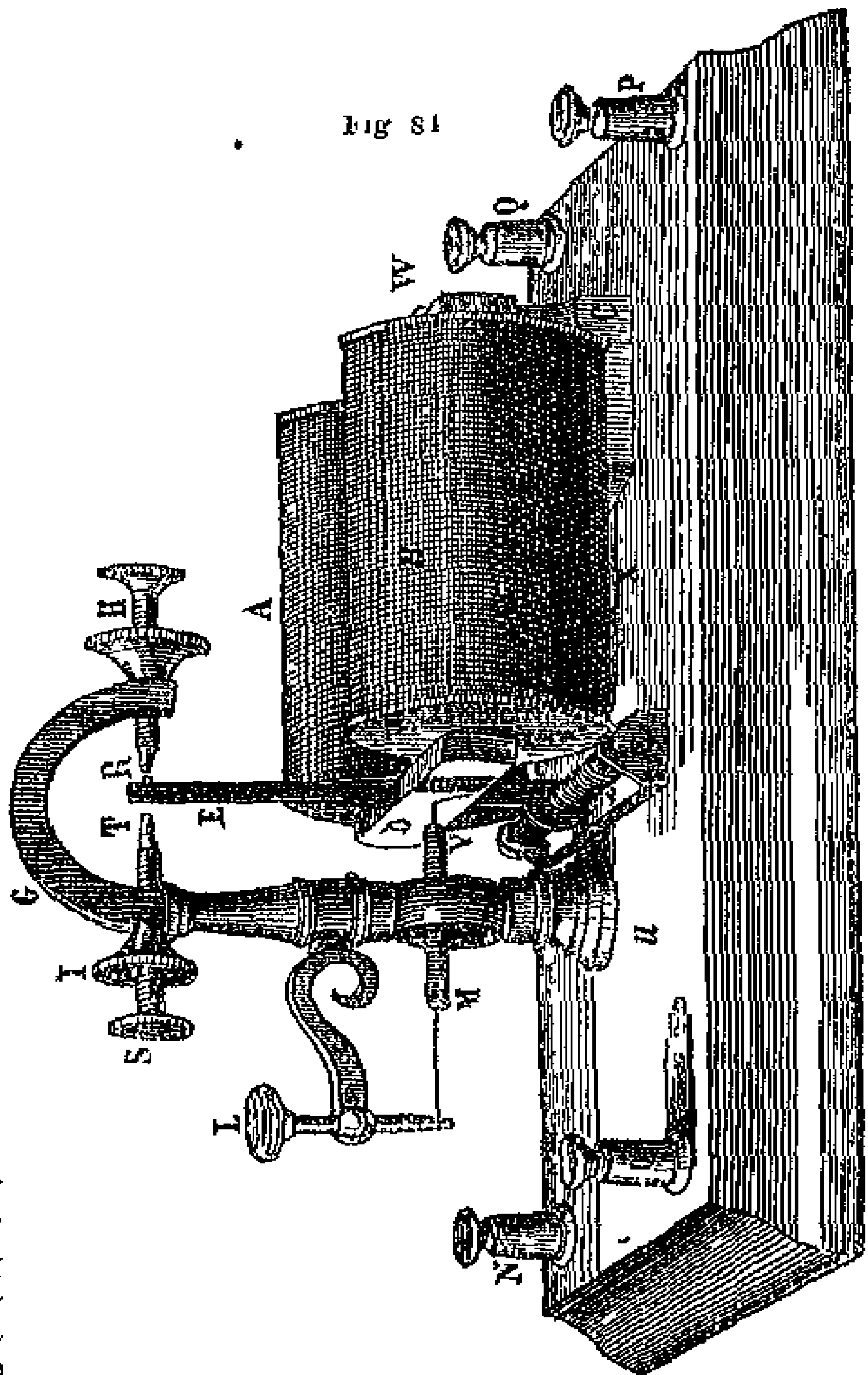

THE ELECTRIC TELEGRAPH

Fig 85

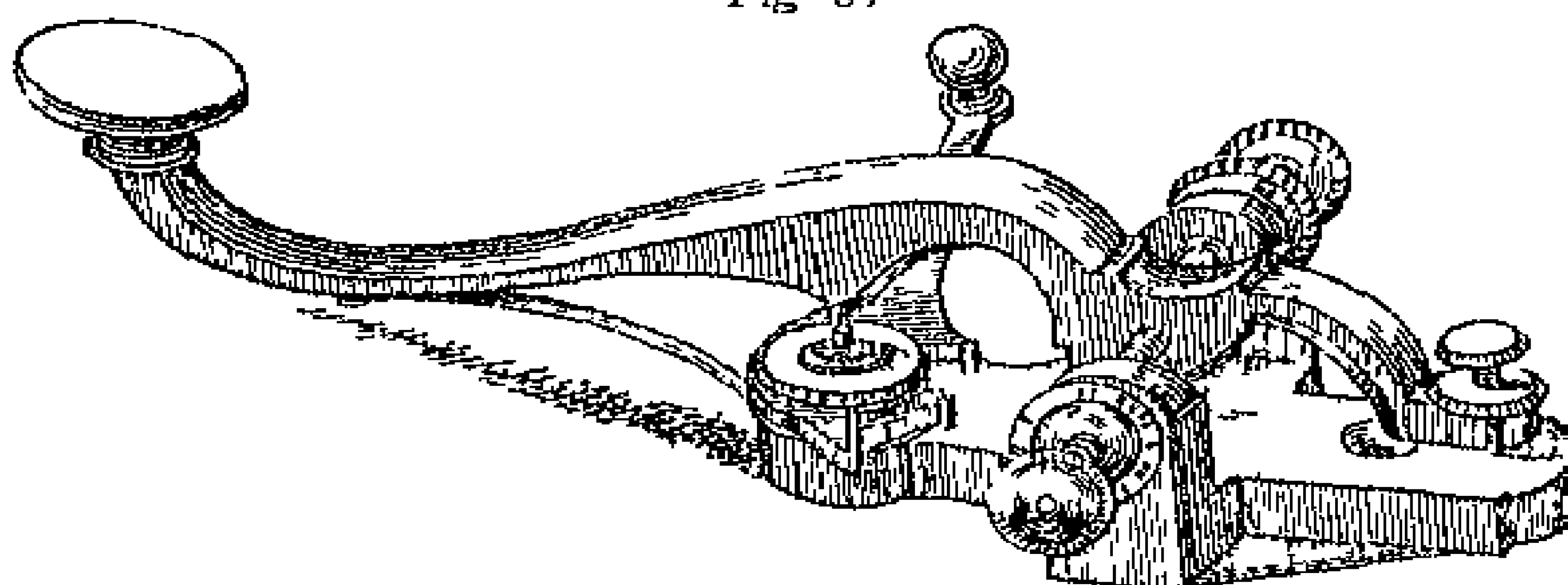

IRONI'S WRITING TELEGRAPH

207 This apparatus is represented in fig 86 (p 49), and the principle on which it acts has been fully explained in (103)

The paper upon which the telegraphic characters are written is rolled upon the surface of a drum *c*. The pencil *b* is pressed by a spring upon the paper. The drum is made to revolve by clock work in the usual manner contained in the case *k*. If the paper be moved without moving the pencil, the latter will trace a straight line, but if the pencil be moved to and fro by the action of the electro-magnet and recoil spring, a zigzag line will be formed by the vibrations imparted to the pencil by the magnet, or what is the same, by the pulsations of the current.

To equalise the wear of the pencil, a slow motion of rotation is imparted to it by wheels adapted for that purpose.

The commutator by which the pulsations which determine the signals are produced, is a wheel, at the circumference of which are five metallic divisions with intermediate spaces vacant, so that in each revolution the current is transmitted five times, and suspended five times. If it be desired to produce a single pulsation, the wheel is moved through the fifth part of a revolution, if it be desired to produce three pulsations it is moved through three-fifths of a revolution, and so on. For each pulsation, one zigzag is made by the pencil at the station to which the despatch is transmitted.

The signs adopted in this telegraph to express the letters, are various numbers and combinations of zigzag forms.

BAIN'S MICRO-CHEMICAL TELEGRAPH

208 The manner in which the decomposing power of the current is capable of producing written characters at a distance from the hand of the writer has been already explained (170)

BAIN'S ELECTRO-CHEMICAL TELEGRAPH

Of the forms of telegraph in which this principle is brought into play, the only one which has been practically applied on an extensive scale is that projected by Mr. Alexander Bain.

209 To render this instrument understood, let us suppose a sheet of writing paper to be wetted with a solution of prussiate of potash, to which a little nitric and hydrochloric acid have been added. Let a metallic disk be provided corresponding in magnitude with the sheet of paper, and let this disk be put in communication with a galvanic battery so as to form its negative pole. Let a piece of steel or copper wire forming a pen be put in connection with the same battery so as to form its positive pole. Let the sheet of moistened paper be now laid upon the metallic disk, and let the steel or copper point which forms the positive pole of the battery be brought into contact with it. The galvanic circuit being thus completed, the current will be established, the solution with which the paper is wetted will be decomposed at the point of contact, and a blue or brown spot will appear. If the pen be now moved upon the paper, the continuous succession of spots will form a blue or brown line, and the pen being moved in any manner upon the paper, characters may be thus written upon it as it were in blue or brown ink.

An extremely feeble current is sufficient to produce this effect, but it will be necessary, when the strength of the current is very much reduced, to move the pen more slowly, so as to give the time necessary for the weakened current to produce the decomposition. In short, a relation exists between the greatest speed of the pen which is capable of leaving a mark, and the strength of the current, the stronger the current the more rapidly may the pen be moved. In this manner, any kind of writing may be inscribed upon the paper, and there is no other limit to the colour with which the characters may be written, save the dexterity of the agent who moves the pen, and the sufficiency of the current to produce the decomposition of the solution in the time which the pen takes to move over a given space of the paper.

210 The electro-chemical pen, the prepared paper, and the metallic disk being understood, we shall now proceed to explain the manner in which a communication is written at the station where it arrives.

211 The metallic disk is a circular disk, about twenty inches in diameter. It is fixed on a central axis, with which it is capable of revolving in its own plane. A uniform movement of rotation is imparted to it by means of a small roller, gently pressed against its under surface, and having sufficient adhesion with it to cause the movement of the disk by the revolution of

THE ELECTRIC TELEGRAPH

the roller. This roller is itself kept in uniform revolution by means of a train of wheel-work, deriving its motion either from a weight or main spring, and regulated by a governor or fly. The rate at which the disk revolves may be varied at the discretion of the superintendent, by shifting the position of the roller towards the centre, the nearer to the centre the roller is placed, the more rapid will be the motion of rotation. The moistened paper being placed on this disk, we have a circular sheet kept in uniform revolution.

The electro-chemical pen, already described, is placed on this paper at a certain distance from its centre. This pen is supported by a pen-holder, which is attached to a fine screw extending from the centre to the circumference of the disk in the direction of one of its radii.

On this screw is fixed a small roller, which presses on the surface of the disk, and has sufficient adhesion with it to receive from it a motion of revolution. This roller causes the screw to move with a slow motion in a direction from the centre to the circumference, carrying with it the electro-chemical pen. We have thus two motions, the circular motion carrying the moistened paper which passes under the pen, and the slow rectilinear motion of the pen itself directed from the centre to the circumference. By the combination of these two motions, it is evident that the pen will trace upon the paper a spiral curve, commencing at a certain distance from the centre, and gradually extending towards the circumference. The intervals between the successive coils of this spiral line will be determined by the relative velocities of the circular disk, and of the electro-chemical pen. The relation between these velocities may likewise be so regulated, that the coils of the spiral may be as close together as is consistent with the distinctness of the traces left upon the paper.

A view of the circular disk, the chemical pen, and the clock-work is given in fig 87 (p 60), which will render the preceding explanation more easily understood.

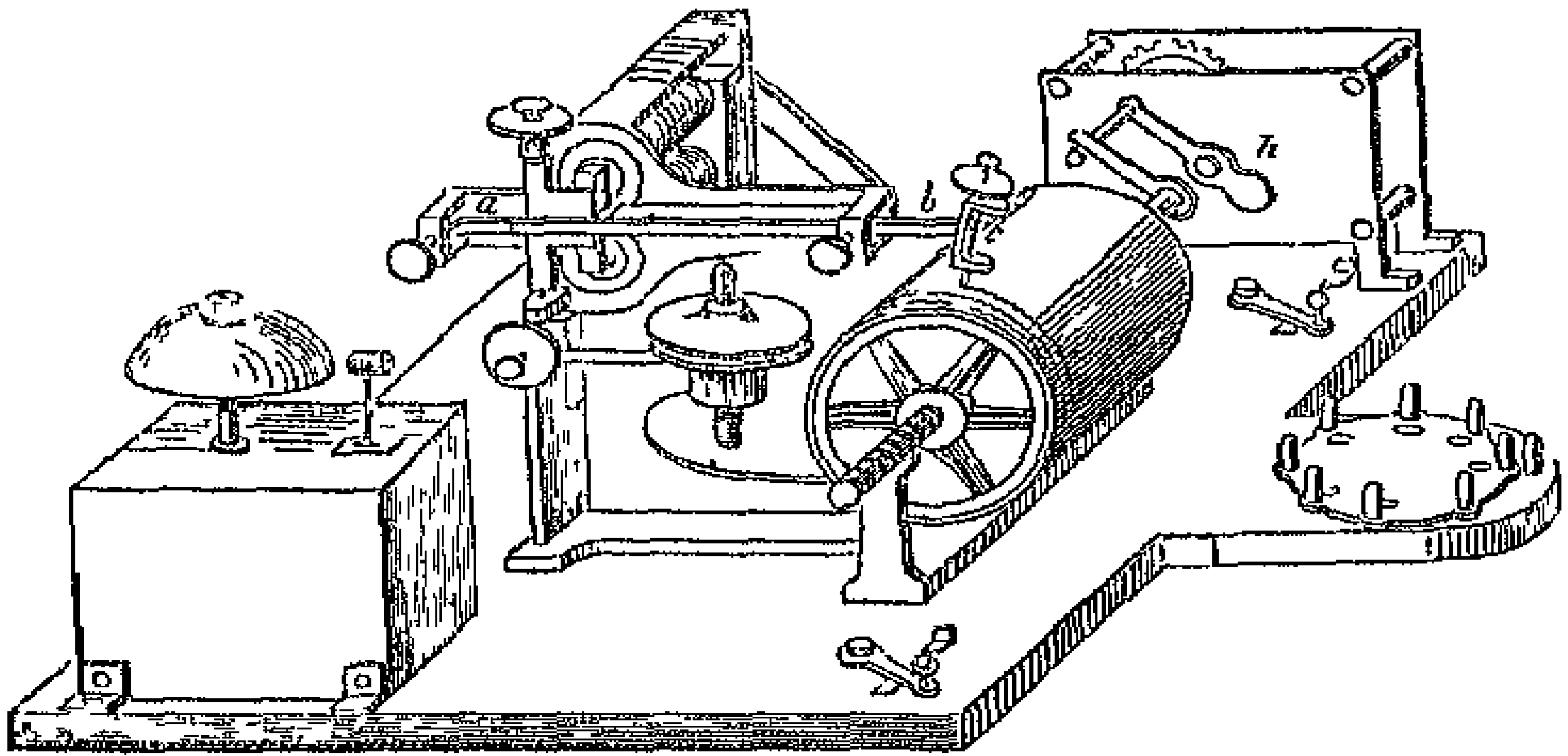

Fig 86 —FRONTS WRITING TELEGRAPH

THE ELECTRIC TELEGRAPH

CHAPTER X

212 Operation of Bani's telegraph —213 Its commutator —214 Its extraordinary speed of transmission —215 Obstructions to its practical application —216 Its prospects —217 Autograph telegraph —218 House's printing telegraph —219 Its operation —220 Menlov's magnetic telegraph —221 Brett's printing telegraph —222 Celerity of telegraphic communication —223 Circumstances which affect it —224 Comparative ability of telegraphists —225 Each telegraphist known by his manner of transmitting —226 Easier to transmit than to receive —227 Pauses in transmission —228 Rate of transmission with double needle instruments worked by voltaic current —229 Rate with magneto electric current

212 Now, let us suppose that the galvanic circuit is completed in the manner customary with the electric telegraph, that is to say, the wire which terminates at the point of the electro-chemical pen is carried from the station of arrival to the station of departure, where it is connected with the galvanic battery, and the returning current is formed in the usual way by the earth itself. When the communication between the wire and the galvanic battery at the station of departure is established, the current will pass through the wire, will be transmitted from the point of the electro-chemical pen to the moistened paper, and will,

ELECTRIC TELEGRAPH

as already described, make a blue or brown line on this paper. If the current were continuous and uninterrupted, this line would be an unbroken spiral, such as has been already described, but if the current be interrupted at intervals, during each such interval the pen will cease to decompose the solution, and no mark will be made on the paper. If such interruption be frequent, the spiral, instead of being a continuous line, will be a broken one, consisting of lines interrupted by blank spaces. If the current be allowed to act only for an instant of time, there will be a blue or brown dot upon the paper, but if it be allowed to continue during a longer interval, there will be a line.

Now, if the intervals of the transmission and suspension of the current be regulated by any agency in operation at the station of departure, lines and dots corresponding precisely to these intervals, will be produced by the electro-chemical pen on the paper, and will be continued regularly along the spiral line already described. It will be evident, without further explanation, that characters may thus be produced on the prepared paper corresponding to those of the telegraphic alphabet already described in the case of Morse's telegraph, and thus the language of the communication will be written in these conventional symbols.

There is no other limit to the celerity with which a message may be thus written, save the sufficiency of the current to effect the decomposition while the pen passes over the paper, and the power of the agency used at the station of departure to produce, in rapid succession, the proper intervals in the transmission and suspension of the current.

The succession of intervals of transmission and suspension of the current on which the production of the written characters on the prepared paper depends, may obviously be produced by the key commutator (128), and with that instrument at the station from which the dispatch is transmitted, an agent can convey in the same manner and with the same celerity as in the case of the telegraph of Morse, or that of Fiomont, and such is in fact the manner in which dispatches are usually transmitted with this apparatus.

213 But this form of commutator, though perfectly efficient so far as it goes, does not call into operation all that extraordinary celerity which forms the prominent feature of this invention, and of which a remarkable example has been already mentioned in the case of the experiments performed by M. Le Verrier and myself before the Committees of the Institute and the Legislative Assembly at Paris, which were made with these instruments, and, as we have stated, dispatches were

BAIN'S CHEMICAL TELEGRAPH

sent along a thousand miles of wire, at the rate of nearly 20000 words an hour.

We shall now explain the means by which this extraordinary feat is accomplished. The dispatch must pass through the following preparatory process —

A narrow ribbon of paper is wound on a roller, and placed on an axis on which it is capable of turning so as to be regularly unrolled. This ribbon of paper is passed between rollers under a small punch, which striking upon it makes a small hole at its centre. This punch is worked by a simple mechanism so rapidly, that when it is allowed to operate without interruption on the paper passing before it, the holes it produces are so close together as to leave no unperforated space between them, and thus is produced a continuous perforated line. Means, however, are provided by which the agent who superintends the process, can, by a touch of the finger, suspend the action of the punch on the paper, so as to allow a longer interval to elapse between its successive strokes upon the paper. In this manner a succession of holes are perforated in the ribbon of paper, separated by unperforated spaces. The manipulator, by allowing the action of the punch to continue uninterrupted for two or more successive strokes, can make a linear perforation of greater or less length on the ribbon, and by suspending the action of the punch these linear perforations may be separated by unperforated spaces.

Thus it is evident, that being provided with a preparatory apparatus of this kind, an expert agent will be able to produce on the ribbon of paper as it unrolls, a series of perforated dots and lines, and that these dots and lines may be made to correspond with those of the telegraphic alphabet already described.

Let us imagine, then, the agent at the station of departure preparing to despatch a message. Preparatory to doing so, it will be necessary to inscribe in the perforated telegraphic characters on the ribbon of paper just described.

He places, for this purpose, before him the message in ordinary writing, and he transfers it to the ribbon in perforated characters by means of the punching apparatus. By practice he is enabled to execute this in less time than would be requisite for an expert compositor to set it up in common printing type.

The punching apparatus for inscribing in perforated characters the dispatches on ribbons of paper is so arranged, that several agents may simultaneously write in this manner different messages, so that the celerity with which the messages are inscribed on the perforated paper may be rendered commensurate with the rapidity of their transmission by merely multiplying the inscribing agents.

ELECTRIC TELEGRAPH

Let us now imagine the message thus completely inscribed on the perforated ribbon of paper. This ribbon is again rolled as at first upon a roller, and it is now placed on an axle attached to the machinery of the telegraph.

The extremity of the perforated ribbon at which the message commences is now carried over a metallic roller, which is in connexion with the positive pole of the galvanic battery. It is pressed upon this roller, as represented in fig. 88, by a small

Fig 88

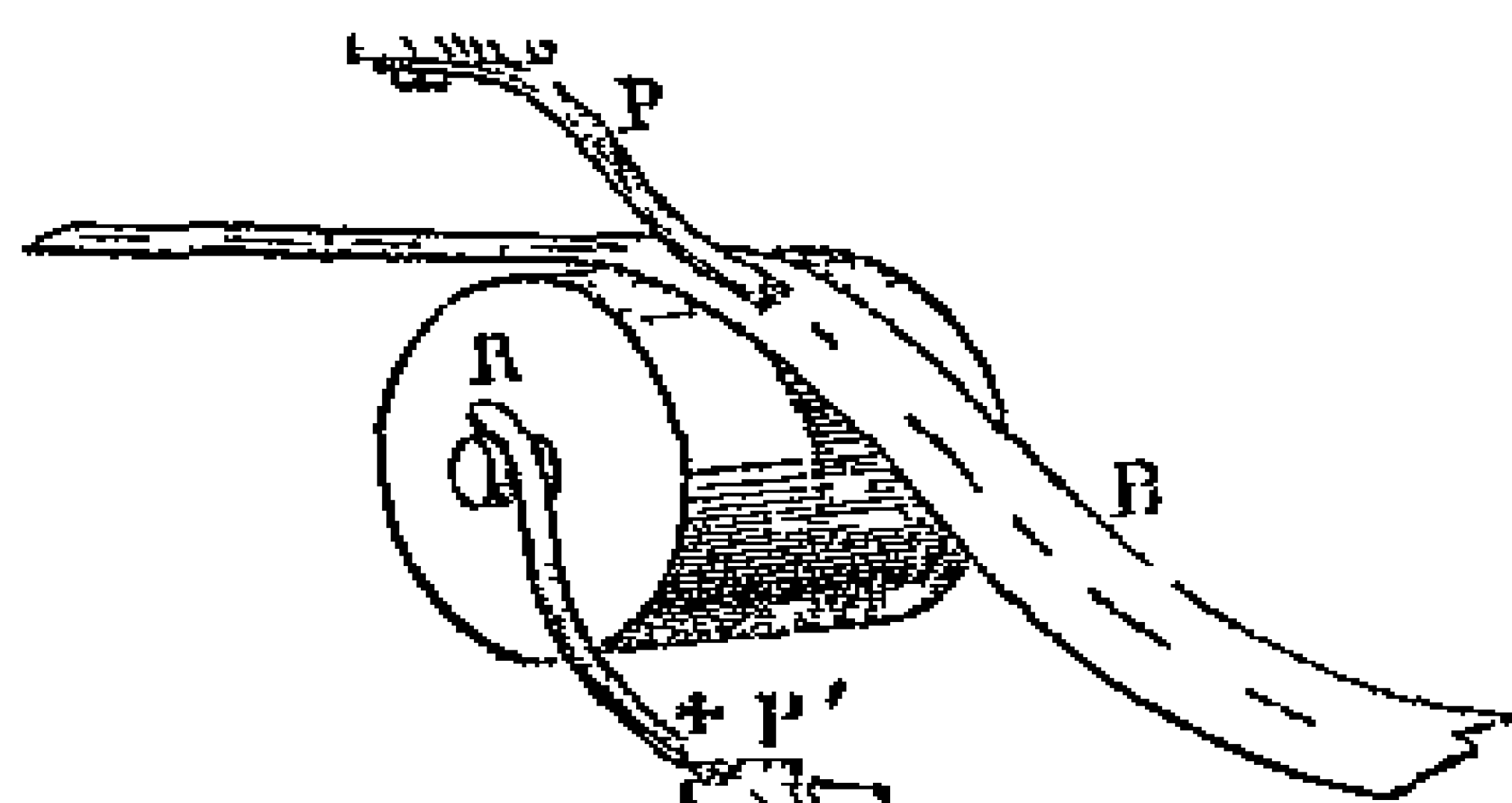

metallic spring, terminating in points like the teeth of a comb, the breadth of which is less than that of the perforations in the paper. This metallic spring is connected with the conducting wire which passes from the station of departure to the stations of arrival. When the metallic spring falls into the perforations of the ribbon of paper as the latter passes over the roller, the galvanic circuit is completed by the metallic contact of the spring with the roller, but when those parts of the ribbon which are not perforated pass between the spring and the roller, the galvanic circuit is broken and the current is interrupted.

A motion of rotation, the speed of which can be regulated at discretion, is imparted to the metallic roller by clockwork or other means, so that the ribbon of paper is made to pass rapidly between it and the metallic spring, and, as it passes, this metallic spring falls successively into the perforations on the paper. By this means the galvanic circuit is alternately completed and broken, and the current passes during intervals corresponding precisely to the perforations in the paper. In this manner the successive intervals of the transmission of the current are made to correspond precisely with the perforated characters expressive of the message, and the same succession of intervals of transmission and suspension will affect the writing apparatus at the stations of arrival in the manner already described.

214 Now there is no limit to the speed with which this process can be executed, nor can there be an error, provided only that

BAIN'S CHEMICAL TELEGRAPH

the characters have been correctly marked on the perforated paper, but this correctness is secured by the ribbon of perforated paper being examined after the perforation is completed and deliberately compared with the written message. Absolute accuracy and unlimited celerity are thus attained at the station of departure. To the celerity with which the dispatch can be written at the station of arrival there is no other limit than the time which is necessary for the electric current to produce the decomposition of the chemical solution with which the prepared paper is saturated.

215 It may be asked then why this form of telegraph, affording as it does the means of obtaining a celerity of transmission so far exceeding any other that has been projected, has not been universally adopted?

To this it may be answered that the celerity here described can only be attained after the dispatch to be transmitted has been marked in the pierced telegraphic characters on the ribbon of paper, and that the process of so marking it would not be more rapid, however expert the operator might be, than that by which the same operator would transmit the same dispatch directly by the key commutator, either with this telegraph or those described in (191, 192). If, therefore, the time necessary to commit the dispatch in telegraphic characters to the perforated ribbon of paper, be included in the estimate of the time of its transmission from station to station, this form of telegraph is not only slower and consequently less efficient than either of those described in (191, 192), but it is slower than any other form of telegraph whatever.

It must therefore be admitted, that, so long as the demands upon the conducting wires do not exceed their powers of transmission by the operation of the ordinary methods now commonly practised, the contrivance of Mr. Bain can present no very strong claims for preference over the other systems. But if the demands of the public should be greatly multiplied, as they certainly would be by lowering the tariff, then the method above described would be presented under different conditions, and might become the only expedient of all those hitherto contrived, by which such augmented demands could be satisfied.

216 If for example the time should arrive when a much more considerable share of the demands now satisfied by the post-office should be transferred to the telegraph, if instead of short and unsatisfactory dispatches conveying political and general intelligence to the journals, fully detailed circumstantial statements and reports were required, if the same full reports of speeches and debates, on occasions of great public interest, or reports of any

ELECTRIC TELEGRAPH

proceedings or events of adequate importance, taking place at a distance, which are now transmitted through the post-office were required to be sent by telegraph, it is clear that the apparatus now in common use, of whatever form, would be utterly inadequate to the satisfaction of such demands.

But how, it will be asked, would the system of Bain be more efficient? The answer is obvious. Nothing more would be necessary than to engage a greater number of persons for the purpose of committing the dispatches to the perforated ribbons. If a great number of dispatches, short or long, be brought at once into the telegraphic office for transmission, let them be immediately distributed among a proportionate number of the persons engaged in the preparation of the ribbons. A long dispatch might be divided into several portions, and distributed among several, just as a manuscript report intended for publication in a journal is distributed among several compositors. When the dispatches thus distributed should be committed to the ribbons, these ribbons might be connected together so as to form longer continuous ribbons, which being put into the telegraphic instruments would be sent to their destination at the rate of 20000 words an hour on each wire.

A mercantile firm, or the correspondent of a journal might, if they were so minded, have their own punching apparatus and their own telegraphic cipher, and instead of sending to the telegraphic-office a manuscript dispatch they would send a ribbon of paper containing the dispatch marked upon it, which being put directly into the instrument would be instantly transmitted to its destination. And this would be attended with the further advantage that the contents of the dispatch would be concealed from the agents themselves employed in its transmission. The party to whom the dispatch is addressed would in this case receive the sheet taken from the instrument written in the cipher of which he alone would possess the key.

It often happens, especially in the business of government or that of journalism, that the same dispatch is required to be transmitted to many different places in different directions. By the system of Bain this would be easily accomplished. The same ribbon which sends the dispatch in one direction may be transferred immediately to another instrument acting upon another line of wire, or even remaining in the same instrument the transmission may be repeated, changing the direction by a commutator.

If it were required no great difficulty would be presented by the process of perforating two or more ribbons at once with the same dispatch. The process would not be slower than that required for a single ribbon, and in that case the several ribbons might be

HOUSTON'S TELEGRAPH.

at the same time sent to different telegraphic stations, and their contents transmitted in various directions

In this view of the question, the system of Bain is to the common telegraph what the steam-engine is to the horse, the power to the hand-loom, the lace-frame to the cushion, the self acting mule to the distaff, or the stocking-frame to the knitting-needle

217 A modification of the electro-chemical telegraph has been contrived, by which a dispatch may be transmitted to any distant station, and then delivered in the handwriting of the person who transmits it

By this method, a person at any station, as for example at London, may write a communication in characters used in common writing or printing on paper placed at another distant station, as for example at Trieste, and this writing shall be traced on the paper with as much precision as if the person writing held the pen in his hand

We may imagine that the electro-chemical pen placed on the paper at Trieste is extended to London, and there held and directed by the hand of the writer, for this it is which almost literally takes place. The conducting wire, in connection with that part of the electro-chemical pen which is held in the hand, which extends from Trieste to London, may be considered as only forming part of this pen, and the end of such pen at London, held and directed by the hand of the writer, will communicate a motion to its point at Trieste, in exact correspondence with the characters formed by the hand of the writer

Thus, if the writer at London move the extremity of the conducting wire so as to write a phrase or his usual autograph, the point at Trieste will there inscribe on the prepared paper the same phrase with the same signature annexed, and the writing of the phrase and the signature will be identical with that of the writer

In the same manner a profile or portrait, or any other outline drawing may be produced at a distance. The methods of accomplishing this depend, like the other performances of electricity in this application of it, on the alternate transmission and suspension of the current, and on its decomposing power, but as they are at present more matters of curiosity than of practical utility, we shall not detain the reader here with any more detailed notice of them.

HOUSTON'S TELEGRAPH

218 This apparatus, which is in extensive use in the United States, is an example of the class of printing telegraphs, that is,

ELECTRIC TELEGRAPH

instruments which print in the ordinary letters the dispatch at the station to which it is addressed, by means of a power worked at the station from which it is transmitted. In a certain sense, this is accomplished by the three forms of telegraph described in (202, 203, and 204), but in these cases the dispatch is printed or written in cipher, which is attended with the inconvenience of being understood only by those who possess, and are sufficiently familiar with the key. The process of deciphering it, and writing it in common characters, occupying more or less time, for some purposes, such for example as that of journalism, this time must be taken into account in estimating the practical celerity of communications, inasmuch as the dispatch until so interpreted, is not available to the parties to whom it is addressed.

A telegraph which instead of impressing on paper characters in cipher, would impress the characters of common letter-press, even though these should be transmitted and impressed at a slower rate than that of the transmission of the characters in cipher, might nevertheless be, in effect, more expeditious, more time being saved by superseding the process of interpreting the cipher than is lost by the relative slowness of the transmission.

It is evident that these observations, being general, are applicable, not only to the instrument we are now about to describe, but to all others of the same class.

219 House's printing telegraph, like all other telegraphic instruments, consists of two distinct parts, a commutating apparatus to govern the transmission of the current, and a printing apparatus upon which the current arriving from a distant station operates.

The manner in which the transmission of the current is controlled by the keys of the finger-board, is substantially the same as in Froment's telegraph already described. The wheel, however, that produces by its revolution the pulsations of the current, is moved, not as in Froment's by clock-work, but by the foot of the operator, acting upon a treadle like that of a lathe which is seen under the case of the commutator in the fig. 89 (p. 81).

The rotation of this wheel is arrested at the point corresponding to any desired letter, by putting down with the finger the key upon which that letter is engraved, in exactly the same manner and by the same mechanical expedient as in Froment's telegraph.

The keys, upon the key-board of this instrument, govern by means of the pulsations of the current the motion and position of a dial or wheel at a distant station, inscribed with similar characters in the same manner as has been already explained in

HOUSE'S TELEGRAPH,

the case of the French railway telegraphs, and in that of the telegraph explained in (201)

Let us then suppose that by putting down any key, that inscribed with A for example at the station s, a certain dial or wheel at s', having upon it letters corresponding with those of the key-board at s, is so moved that the letter A is brought into a certain position. The letters upon this wheel are formed in relief like type, and when successively brought into the necessary position by the action of the current, having previously passed in contact with an inking apparatus, a band or ribbon of paper is pressed against them by means provided at the station s', and the impression of the letter is made upon the paper. By the next action of the current, the succeeding letter transmitted is brought to the same position, the ribbon of paper being meanwhile drawn forward, another impression takes place, and so on.

The apparatus by which the ribbon of paper is moved, the type inked, and the paper pressed against it is not worked by the current. That process is effected by mechanism put in operation by the agent at the station at which the dispatch is received.

In the figure, the ribbon of paper is represented at 1, upon a roller from which it is gradually drawn, as letter by letter the words of the dispatch are impressed upon it. The black band which appears upon another roller is an endless strap by which the types are inked.

In the mechanism as well of the transmitting as of the receiving apparatus, there are many details showing much ingenuity of contrivance, and resources of invention, which, however, are too complicated to admit of any clear exposition without numerous plans and sections, and which we must pass over.

The printing apparatus, at the station at which the dispatch is received, is put in operation by the action upon the treader, in the same manner as in the transmitting apparatus at the other station.

The galvanic apparatus, which supplies the current for working this apparatus, is the battery of Grove, described in (34). About thirty cylindrical pairs are necessary for a distance of 100 miles.

The first line operating with this apparatus was established between New York and Philadelphia in 1849.

ELECTRIC TELEGRAPH

MAGNETIC NEEDLE INSTRUMENT

220. The Magnetic Telegraph Company, retaining the needle indicators generally used in England, have rejected the galvanic battery, and substituted the magneto-electric for the voltaic current. The instruments they have adopted are those which

* Fig 90

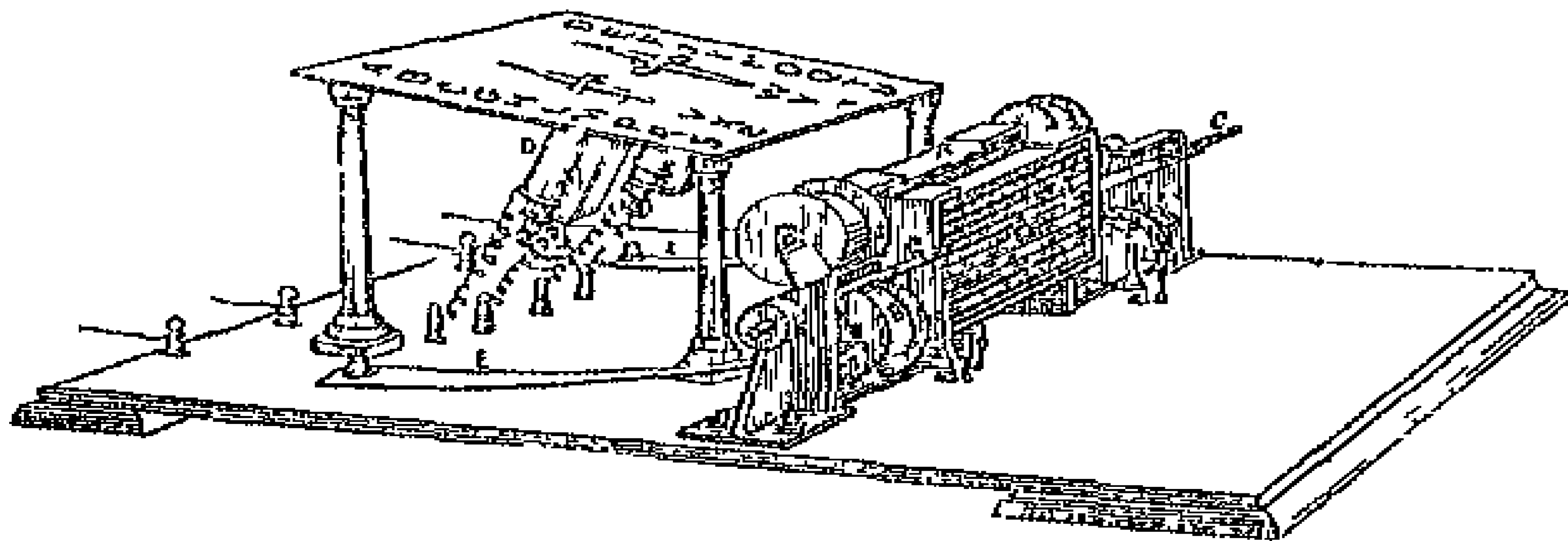

were patented by Messrs Henry and Forster, with some modifications.

This form of telegraph, enclosed in its case, is shown in fig 91 (p 97), and divested of its case in fig 90.

The current is produced by electro-magnets, whose poles are moved in close proximity with those of strong compound permanent magnets. These latter are represented at *v* (fig 90). At their poles a straight piece of soft iron is placed, by the inductive influence of which the magnetism of the several bars composing the compound magnet is collected and combined. The electro-magnets are formed in the usual way, and are mounted on centres on which they are turned by levers, which project from either side of the case, so that the agent can work one with each hand. When they have been pressed down by the hand they are raised to their former position by springs which are fixed on their axle.

When these levers are pressed down, the electro-magnets are reversed in the relation of their poles to those of the permanent magnets, and momentary currents are transmitted on the conducting wires, and when the levers are observed to rise to their former position, momentary currents are again transmitted, but in a contrary direction.

The currents thus transmitted on the line-wires are received at the station to which the dispatch is transmitted upon the coils of electro-magnets, which are placed under the desk upon which the indicating needles are placed, and they impart temporary

HENLEY AND BRETT'S TELEGRAPH

magnetism to these. These electro-magnets act upon a small permanent magnet suspended under the desk, on the axis of the indicating needle, and parallel to it. They deflect this needle on the one side or the other, at the moment they receive the magnetism from the current, and then deflection is continued by the effect of the induced magnetism produced by the permanent magnet on the electro-magnet.

When the handle is raised, the momentary current being reproduced, but in the contrary direction, the polarity of the electro-magnet at the distant station is reversed, and the needle is deflected in the same manner to the other side.

BRETT'S PRINTING TELEGRAPH

221 Mr Brett, who has obtained such well-merited celebrity by his successful exertions in establishing electric communication by submarine cables between the United Kingdom and the continent of Europe, and more recently between the continents of Europe and Africa, took out, conjointly with Mr House, a patent for a printing telegraph, the original form of which is represented in fig. 92 (p. 113).

The apparatus, like that of House's American telegraph, already described, consists of a key-board, which is the transmitting apparatus or commutator, and does not differ in any important particular from that already described. The receiving and pointing apparatus is also very similar, and stands upon the key-board. In front of it is an indicating dial, the hand upon which points successively to the letters printed upon the scroll of paper by the apparatus behind the dial. The printing apparatus, with some modifications, is similar to that of House.

This telegraph is, or was, lately exhibited at work in the Panopticon of Science, in Leicester Square.

The Messrs Brett are understood, however, to be engaged upon the construction of an instrument which is expected to attain the same objects in a more satisfactory manner.

CHARACTER OF TRANSMISSION.

222 Although it be true that the signals made at any one telegraphic station are rendered instantaneously apparent at another, no matter how distant, it must not therefore be inferred that the transmission of messages by the telegraph is equally instantaneous. Not only is this not the case, but the celerity with which messages are conveyed between station and station, so as to be rendered practically available for the purposes of intercommu-

ELECTRIC TELEGRAPHY

mentation, differs very much when one form of telegraphic instrument or one pair of operators is compared with another.

The profitable result of the operation of any telegraph is evidently measured by the number of words which it is capable of transmitting in such a shape as to be intelligible by the party to whom the message is addressed, in a given time. This, which we shall call the celerity of transmission, and which is quite distinct from the velocity with which electric signals are conveyed from station to station, is therefore a most important element in the estimation of the value of any telegraphic apparatus.

223 This celerity of transmission depends upon a great number of circumstances, several of which are independent of the telegraphic apparatus. The principal of these are —

- 1 The skill and agility of the transmitting agent
- 2 The quickness of eye, activity and attention of the receiving agent,
- 3 The instrument used for transmission
- 4 The instrument used for reception
- 5 The distance to which the dispatch is transmitted
- 6 The insulation more or less perfect of the line wires
- 7 The weather

With all and each of these conditions and qualities the celerity with which the dispatches are received and rendered available at their place of destination, varies, and with some of them this variation extends to very wide limits.

224 Different telegraphists have very different powers as to celerity. These powers depend on practice as well as upon natural ability and aptitude, and on manual dexterity. Not only is it necessary to transmit the signals in quick succession, but to do so with such distinctness that they shall be readily interpreted, and such correctness as to render repetitions unnecessary. In this respect telegraphists having equal practice differ one from another as much as do clerks, some writing rapidly and legibly, some rapidly but not legibly, some legibly but not rapidly, and some neither rapidly nor legibly. The relative ability of telegraphists in this respect is partly mental and partly mechanical, depending as much upon quickness of intelligence, attention, and observation, as upon manual dexterity and address.

The great liability to delay, arising from the failure of the transmitter to render himself understood by the receiver, is rendered manifest by the fact that in all telegraphs conventional signs are established for the words, "wait," "repeat," "not understood," "understood," "proceed," and the like. When the transmitter is going on faster than the receiver can take down the words or understand them, then the latter remits the sign to

CELERITY OF TRANSMISSION

“wait,” and if this sign is several times repeated, the necessity of proceeding slower is apparent. If the receiver mistakes a sentence, word, or letter, he emits the sign to “repeat.” At the end of each sentence, he emits the sign “understood,” and so on. Now it will be easily conceived that this necessity for frequent interchange of signs between the receiver and transmitter must affect, in an important degree, the celerity of transmission, and that its frequency must depend, not only on the abilities of the telegraphic agents, but also on the character of the signs transmitted by the instruments, according as they are more or less obvious and unequivocal.

225 It is a remarkable and very curious circumstance, that, independently of the mere celerity, clearness, and correctness of transmission with certain telegraphic instruments each telegraphist has a manner and character, which is so peculiar to himself, that persons receiving his dispatch at a distant station, recognise his personality with as much certainty and facility as they would recognise the handwriting of a correspondent, or the voice and utterance of a friend or acquaintance, whom they might hear speak in an adjacent room. The agents habitually engaged at each of the telegraphic stations, in this way, soon become acquainted with those of all the other stations on the same line, so that, at the commencement of a dispatch, they immediately know who is transmitting it.

While the aptitude of the transmitter is partly manual or mechanical, that of the receiver of a dispatch is not at all so. In some telegraphic instruments, as we have seen, the presence of a receiving agent is unnecessary, the dispatch being written or printed by the apparatus itself. In all instruments, however, which merely exhibit arbitrary signals, expressing letters, numbers, or words, the celerity must depend on the skill, aptitude, and quickness of eye of the receiver, to catch and commit to paper the succession of letters or words, as fast as the signals expressing them are produced before him.

226 In general, it is much more easy to transmit rapidly than to receive rapidly. The transmitter knows beforehand what signs he is about to produce, while each of them comes upon the receiver altogether unawares, and if, in the celerity of their succession, one or more of them escape his eye, he is obliged either to guess at the missed letter or letters, which he can sometimes do with all the requisite clearness and certainty, or he must arrest the transmitter, which he does by giving the sign, “repeat,” and so delay arises.

In telegraphs which work by a series of visible signs, whether they be deflections of the needle, as in the English instruments,

ELECTRIC TELEGRAPH.

attitudes of the arms, as in the French State instruments, or pointers directed to the letters or figures on a dial, as in the railway instruments, the celerity of the transmission must be determined by the power of the less able of the two agents, the transmitter and receiver. If the transmitter be able to send the letters more rapidly than the receiver can read and take them down, he must moderate his pace to the limit determined by the power of his correspondent. If the receiver be capable of reading and taking down faster than the transmitter is able to send the letters, his superior force is useless. He can only write the dispatch as fast as he receives it. To send dispatches with the greatest advantage of celerity, the agents yoked to corresponding instruments ought to be selected of as nearly equal ability as possible, since the slower of a pair necessarily neutralises the superior skill of his fellow, and the dispatch would proceed with equal celerity if he were yoked with a less able correspondent.

As quickness of hand is essential to the transmitter, quickness of eye is necessary to the receiver.

227. In all forms of telegraph which express the letters by signals, such as the needle telegraph, and the French State telegraph, a certain pause is necessary between letter and letter, to prevent the signals being confounded one with another. In the single needle instrument, the letters being expressed by from one to four deflections of the needle, and in the double needle, from one to two, the mean time of each letter is that of two and a half deflections in the one, and one and a half in the other, the interval between letter and letter being the same in both. Owing to the slowness of transmission of the single needle instrument, it is only used between secondary stations, where there is but little business. It must, however, be remembered, in comparing the relative celerity of different instruments, that the double needle instrument, as well as the French State telegraph, is, in fact, two independent telegraphs, having not only separate and independent transmitting and indicating apparatus, with their respective accessories, batteries, &c., but separate and independent conducting wires. It is, in effect, as if two equally powerful and independent steam engines were united in the same work, in order to obtain double power.

228. In 1850, Mr Walker made some calculations, with the view to determine the average celerity of transmission at that time with the double needle instrument in the hands of competent operators, and published the results in his work on electric telegraph manipulation. Eleven messages were timed, all of more than the usual length, the shortest consisting of 73 and the longest of 361 words. The total number of words was 2638, and

CELERITY OF DOUBLE-NEEDLE TELEGRAPH

consequently, their average length was 210 words. The total time of transmission was 162 minutes, and, consequently, the average number of words transmitted, per minute, was $16\frac{1}{2}$. The greatest speed of transmission was $20\frac{1}{2}$, and the least $8\frac{1}{2}$ words per minute. As it might be considered probable that four or five years' general experience and practice might have improved the ability of the operators, I applied to the secretary of the Electric Telegraph Company, Mr. Fouldner, requesting him to cause a sufficient number of messages, transmitted in the ordinary course of business with the double needle instrument, to be timed, which he was so obliging as to do, in June, 1854, and the following were the results —

11 Messages — Number of words in the addresses	84
" " " " " " " " " " " "	160
Total number of words transmitted	244
Total time of transmission	680 seconds
Average number of words transmitted per minute	21 $\frac{1}{2}$

It appears, therefore, that the average celerity of transmission with this instrument has increased in the ratio of about 16 to 21. The greatest celerity of transmission was, in this case, $21\frac{1}{2}$, and the least $16\frac{1}{2}$ words per minute.

229 The manner in which the magnetic electric current affects the needle in the arrangement adopted by the Magnetic Telegraph Company, being somewhat different from that produced in the common needle instruments, worked by the Electric Telegraph Company, although the systems of telegraphic signals are not essentially different, it appeared to me to be not impossible that the difference between the instruments might more or less affect the celerity of transmission. I therefore requested Mr. Bright, the Secretary of the Magnetic Company, to time a series of dispatches transmitted in the ordinary course of business. This was accordingly done on the 28th of June, 1854, and the following were the results —

74 Messages	Total number of words	2702
	Time of transmission	102 ^m 8 ^s
Average number of words per minute		27 $\frac{1}{2}$

The greatest celerity of transmission attained in this series of messages was $37\frac{1}{6}$ words per minute.

The entire series consisted of messages transmitted from London to Liverpool, on a pair of double needle instruments, at different times of the day, and were carefully tabulated. In the series, several messages were included, the transmission of which was exceptionally slow, owing either to the difficult nature of the communications, consisting of long words in private cipher, or of the names

THE ELECTRIC TELEGRAPH

of foreign towns, or, in fine, from the inaccuracy or slowness of the transmitting clerk in London. It would seem, therefore, that this series of messages includes fair conditions for an average result.

It would, therefore, appear that the needle instruments worked by the magneto-electric current used by this company are, *ceteris paribus*, susceptible of greater celerity of transmission than the instruments in which the needles are affected by the common voltaic current, in the ratio of about 27 to 21, or 9 to 7.

One of the causes which has been assigned to this increased efficiency, is the fact that the needles of the magnetic instruments have a *dead beat*, while those of the voltaic instruments, in striking the stops, have a recoil, and vibrate two or three times before they come to rest. Whether this be the real cause of the difference, further experience must prove, but it is difficult to imagine that it can be due to any cause independent of the instruments, seeing the large number of messages from which the average has been computed.

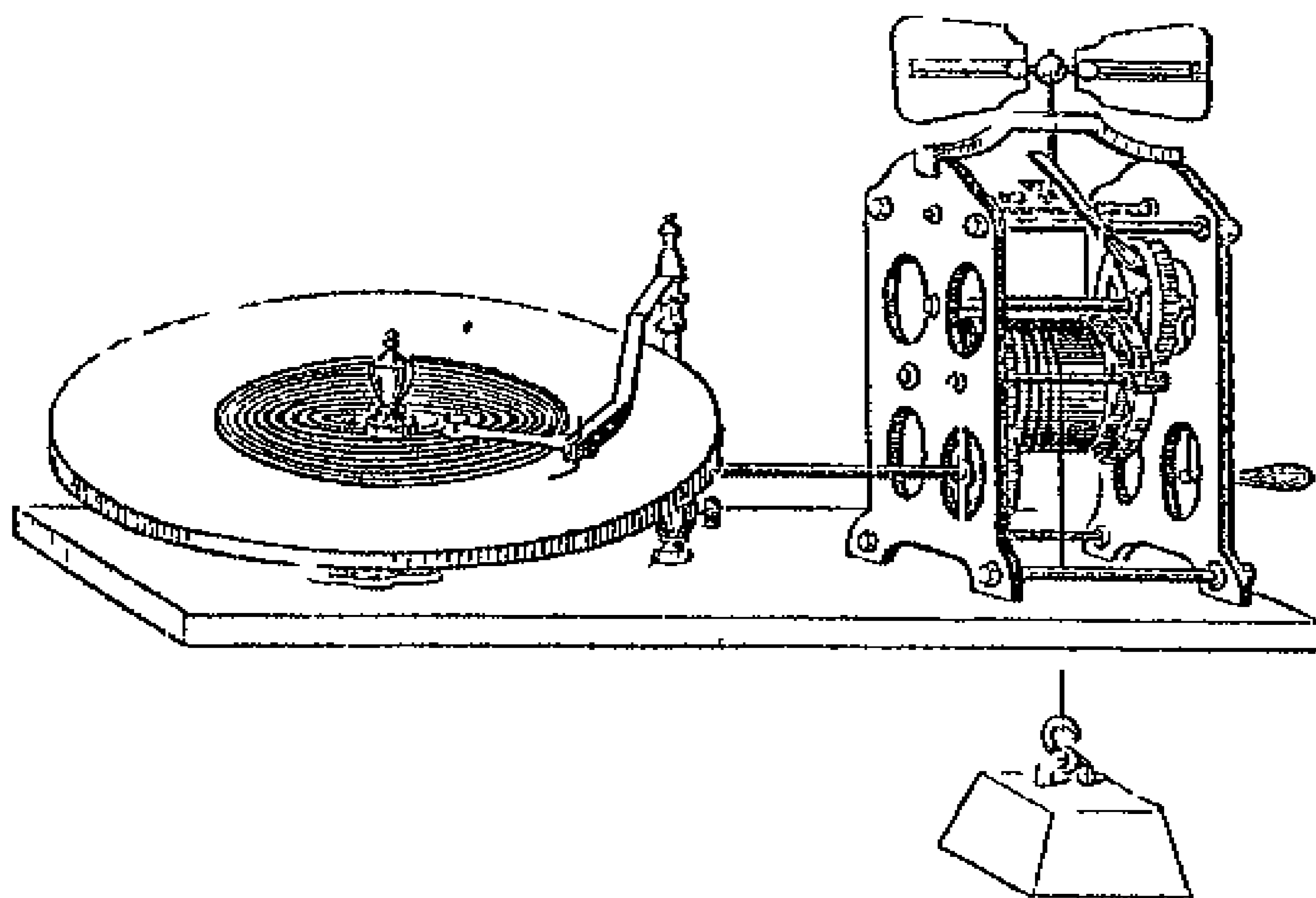

Fig. 87.—BAIN'S ELECTRO-CHEMICAL TELEGRAPH

THE ELECTRIC TELEGRAPH

CHAPTER XI

230 Illustration of the efficiency of the needle instruments —231 Rate of transmission with the French state telegraphs —232 With the French railway telegraphs —233 With the Morse telegraph —234 Discrepancy of reports —235 Causes of its celerity —236 Rate with Bain's telegraph —237 Transmission of music —238 Rate of transmission with House's telegraph —239 Distance sometimes affects celerity —240 Examples of distant transmissions in U S —241 Advantages of uniform organisation —242 Uses of the electric telegraph —243 Subject of dispatches —244 Effect of the tariff —245 Uses of the telegraph in railway business —246 Portable railway telegraph —247 Practical uses on railways —248 Its economical advantages

230 Mr. Walker, writing in 1850, gives the following illustration of the efficiency which has been attained in the working of the needle system, and in the management generally of the telegraphic business —

“The rate at which newspaper dispatches are transmitted from Dover to London, is a good illustration of the perfect state to which the needle telegraph has attained, and of the apt manipulation of the officers in charge. The mail, which leaves Paris

THE ELECTRIC TELEGRAPH

about mid-day, conveys to England dispatches containing the latest news, which are intended to appear in the whole impression of the morning paper. To this end, it is intended that a copy be delivered to the editor in London about three o'clock in the morning. The dispatches are given in charge to us at Dover soon after the arrival of the boat, which of course depends on the wind and the weather. The officer on duty at Dover, having first hastily glanced through the manuscript to see that all is clear to him and legible, calls 'London' and commences the transmission. The nature of these dispatches may be daily seen by reference to 'The Times'. The miscellaneous character of the intelligence therein contained, and the continual fresh names of persons and places, make them a fair sample for illustrating the capabilities of the electric telegraph as it now is. The clerk, who is all alone, placing the paper before him in a good light, and seated at the instrument, delivers the dispatch, letter by letter, and word by word, to his correspondent in London, and although the eye is transferred rapidly from the manuscript copy to the telegraph instrument, and both hands are occupied at the latter, he very rarely has cause to pause in his progress, and as rarely also does he commit an error. And, on account of the extremely limited time within which the whole operation must be compressed, he is not able, like the printer, to *correct his copy*.

"At London there are two clerks on duty, one to read the signals as they come, and the other to write. They have previously arranged their books and papers and, as soon as the signal for preparation is given, the writer sits before his manifold book, and the reader gives him distinctly word for word as it arrives, meanwhile, a messenger has been dispatched for a cub, which now waits in readiness. When the dispatch is completed, the clerk who has received it reads through the manuscript of the other, in order to see that he has not misunderstood him in any word. The hours and minutes of commencing and ending are noted, and the copy being signed is sent under official seal to its destination, the manifold facsimile being retained as our office copy, to authenticate verbatim what we have delivered. This copy and the original meet together at the chief telegraph office at Tunbridge, early in the day, and are compared. When the work is over, and the dispatches have reached their destination, the clerks count over the number of words and the number of minutes, and find the rate per minute."

231 The signals adopted to express the letters in the French State telegraph being each made by a single motion of the arms, they necessarily are produced with greater celerity than the multiplied deflexions of the needle-instruments. Like the double needle-instrument, the French telegraph is composed in fact of two

CELERITY OF MORSE'S TELEGRAPH

completely independent telegraphic instruments, with two independent conducting wires, and its celerity of transmission is due to their combined powers.

It is stated by the directors of the administration that the average transmitting powers of these telegraphs is nearly 200 letters or signs per minute.

232 The alphabetical telegraphs, of which the French railway telegraph may be taken as an example, are much slower in their rate of transmission. M. Bieguet, who has constructed those worked in France, and superintended and directed their operation, says, that their average rate of transmission, when fairly worked, is about 10 letters per minute.

233 The writing and printing telegraphs are independent of a receiving agent, the receiving apparatus in all these being automatic. All these instruments have an advantage over the English and French telegraphs, inasmuch as they employ only one conducting wire, and those who print the dispatch in the common letter-press characters, have the further advantage of being wholly independent of the skill of any agent to interpret or decipher them.

The celerity of transmission attainable with the Morse telegraph, which of all the forms of telegraphic apparatus hitherto invented is the most extensively used, is very considerable, but varies perhaps still more than the needle-instruments, with the skill of the telegraphist.

In this instrument, it will be remembered that the transmitting agent plays upon a key-commutator, the letters being severally expressed by repeated touches of the key succeeding each other, after longer or shorter intervals. At the station receiving the dispatch, the armature of the electro-magnet moves simultaneously with the transmitting key, and at each of its motions towards the magnet, it produces a distinctly audible click. The receiving agent acquires by practice such expertness and quickness of ear, that by listening to this clicking he is able to interpret the dispatch, and to write it down or dictate it to a clerk without using the apparatus for impressing it upon the paper ribbon.

Different telegraphists acquire this power of oral interpretation of the dispatches with different degrees of facility and precision, but all are more or less masters of it. So much so, that in most cases on the American lines, it is by the clicking of the magnet that the messages are taken down, being afterwards corrected, if necessary, by comparison with the indented paper ribbon.

The telegraphist is placed at a table, upon which the instrument stands, having before him the paper upon which the message is to be written, and at his left a provision of blacklead pencils ready

THE ELECTRIC TELEGRAPH

out and pointed, usually half a dozen. When the transmission of the message commences, the electro-magnet dictates it to him, letter by letter, at the same time indenting it upon the paper ribbon. He writes it down, and, in general, it is delivered by the magnet as fast as he can write it, availing himself of all such abbreviations as are intelligible to those who may have to read it. As the points of the pencils are successively worn he lays them on the table at his right hand. A person engaged exclusively in that process, visits his table from time to time, re-points the pencils lying on his right, and replaces them on his left. This person passes round the telegraph office, from table to table, keeping up a constant supply of properly pointed pencils at the hand of each telegraphist.

The most expert telegraphists are able to take down the messages in this manner by ear, without any reference to the ribbon, and so correctly that there is no need of subsequent verification.

When the message is concluded, the sheet on which it is written is handed to another clerk, who is provided with a stock of envelopes, in one of which he encloses it, and, writing the address upon it, delivers it to a messenger, who forwards it to the party to whom it is addressed. Meanwhile the paper ribbon, on which the message has been indented in the telegraph cipher, is cut off, folded up, and preserved for reference.

It is only, however, the most expert class of telegraphists that can operate in this way. Others, less able, are always obliged to verify and correct what they have taken down, by comparison with the indented ribbon, after the message has been concluded, while others less able still, cannot trust themselves to take down *by ear*, and sit before the ribbon as it is discharged from the roller, writing out the message from it *by eye*.

The salaries allowed to different agents vary according to the skill they attain in these operations. One who acquires the power of taking down rapidly and correctly *by ear* will receive twice the amount allowed to him who can only take down *by eye*, the latter being always much slower than the former.

It often happens that the power of interpreting easily and correctly *by ear* is very important, as in the case in which the mechanism of the instrument for moving and indenting the paper may have been accidentally deranged and disabled, or in which the office may be deficient in its supply of paper ribbon.

By the oral method of reception the entire receiving apparatus, except the electro-magnet and its armature, is dispensed with.

If a mistake is committed by the transmitting agent, in consequence of which a word or phrase is unintelligible, the receiving agent intercepts the current, and signifies that the word is to

CCELERITY OF MORSE'S TELEGRAPH

be repeated, and at the same time tears off the erroneous part of the ribbon. This, however, is a circumstance of rare occurrence.

When a very long dispatch is transmitted, and arrives with greater celerity than that with which an agent can transcribe it, the ribbon may be divided, and two agents put to work at once at its transcription. The reports of congress and public meetings transmitted to the journals, afford examples of this.

These reports may be, by one operation, transmitted to all the towns upon the same telegraphic line.

In some cases long dispatches, such as those addressed to the journals, are expedited by two or more instruments on different wires. The dispatch is, in this case, divided into two or more parts, marked 1, 2, 3, or A, B, C, &c, and these parts are simultaneously transmitted to their destination, being reunited there after their arrival. This expedient, however, can only be resorted to where there are two or more line wires, which is a rare case in the United States.

234 If the celerity of transmission of the Morse instrument be compared with that of the English and French telegraphs, it must not be forgotten that the latter require two wires, while the former requires but one. In the transmission and reception of a dispatch both, however, employ the same number of agents.

There is great discrepancy in the reported estimates of the celerity of transmission of the Morse telegraph, owing probably to the varying skill of the telegraphists on whose performance such estimates have been based.

According to Mr. Turnbull, the average celerity of transmission of this telegraph is from 135 to 150 letters per minute.

In a report made by Mr. O'Reilly, the director of one of the most extensive of the New York Companies, it is stated that the average rate of transmission is from 20 to 23 words per minute. Since it is generally estimated that the average length of telegraphic words is five letters and a half, this would amount to 110 to 127 letters per minute.

Mr. O'Reilly adds, however, that a "higher rate of transmission could be obtained, but as nearly all operators copy from their instruments, and reduce the messages to ordinary writing as they arrive, the rate of 20 to 23 words is considered rapid enough, as an expert operator can indent his Morse characters faster than most men can write the words they express with a pen or pencil."

We may perhaps take 150 letters as a fair estimate of the rate of transmission, and it follows therefore that this telegraph is more rapid than the double needle-telegraph in the ratio of about 3 to 2, and since the latter employs two wires with their accessories, while the former employs only one, it follows that the transmitting

THE ELECTRIC TELEGRAPH

power of each wire with the Morse telegraph is three times as great as with the double needle instrument

235 The causes of this greater celerity are twofold first, the greater celerity with which the ciphers are impressed upon the ribbon of paper, compared with that with which the visible signals are exhibited and succeed each other in the English and French telegraphs, and secondly, the removal of those delays of transmission which arise from the want of attention or quickness of eye on the part of the agent receiving the dispatch, rendering it necessary to repeat words which have been missed or misunderstood

In the American offices of the Morse lines, it is stated in the published reports that "there are a number of attendants, each one of whom has his respective department, they are divided into 'copyists, book-keepers, battery-keepers, messengers, line inspectors, and repairers' The usual charge of transmission is 25 cts, equal to a shilling, for ten words exclusive of the address and the signature sent 100 miles the messages vary in price from 10 cts, or 5*d*, to 100 dols, or 20*l* The amount of business which a well-conducted office can perform, and the net proceeds arising therefrom, may well excite surprise, a single office in that country, with two wires, one 500, the other 200 miles in length, after spending three hours in the transmission of public news, telegraphed, in a single day, 400 private messages, averaging 25 words each, besides the address and signature, sixty of which were sent in rotation, without a word of repetition"

236 All that has been said above relating to Morse's telegraph may *mutatis mutandis* be applied to other telegraphic instruments, which write in cipher the dispatches by self-acting machinery, such as those described in 191, 192, and 193

When dispatches are transmitted by means of a key-commutator, with Bann's telegraph, the operation being precisely similar to that of Morse, the celerity of transmission by operators of equal skill ought to be the same Nevertheless, as these instruments of Bann's, with some modifications, are at present used on certain lines by the Electric Telegraph Company, Mr Foudrimer has, at my request, caused a series of messages to be timed, of which the following is the summary of the results —

63 Messages	—Total number of words in the addresses	156
" "	" " "	001
	Total number of words transmitted	157
Total time of transmission		4 15 1 seconds
Average number of words transmitted per minute		19½

It appears, therefore, that as this telegraph is worked in

CELERITY OF BAIN'S TELEGRAPH

England, its rate of transmission is slower than the double needle telegraph

The advantage which attends its use is that it writes the dispatch in cipher, which is preserved in the telegraphic office, so that the labour of a clerk to copy the dispatch for reference is saved

It would follow from the comparison of this result with the reports of the American telegraph, that the operators with Bain's system in England are not as expert as those of Morse's in America. But when the method of transmitting by a previously-prepared perforated ribbon, described in 194, is resorted to, the apparatus is rendered absolutely automatic, no agency being required either in the transmission or reception, save that required for the perforation of the transmitting ribbon, and the interpretation and transcription of the dispatch delivered in the telegraphic cipher

Whatever may be thought of the practical difficulties which at present obstruct the application of this method of rapid telegraphic transmission, we cannot help thinking that it has before it a great future, and that when, like the steam-engine as improved by Watt, and the power-loom, it shall have had time to attain a greater degree of practical perfection, and to surmount prejudice and the opposing influence of counter-interests, it may be the means of transferring, to the telegraph, a large part of that business now done by the post-office

237 It is an amusing fact, that music has actually been transmitted in this way by means of its rhythm. The following is related by an eye-witness of the experiment at New York —

“We were in the Hanover Street office when there was a pause in business operations. Mr W. Porter, of the office at Boston, asked what tune we would have. We replied ‘Yankee Doodle,’ and to our surprise he immediately complied with our request. The instrument commenced drumming the notes of the tune as perfectly and distinctly as a skilful drummer could have made them at the head of a regiment, and many will be astonished to hear that ‘Yankee Doodle’ can travel by lightning. We then asked for ‘Hail, Columbia!’ when the notes of that national air were distinctly beat off. We then asked for ‘Auld lang syne,’ which was given, and ‘Old Dan Tucker,’ when Mr Porter also sent that tune, and, if possible, in a more perfect manner than the others. So perfectly and distinctly were the sounds of the tunes transmitted, that good instrumental performers could have had no difficulty in keeping time with the instruments at this end of the wires.”*

*That a pianist in London should execute a fantasia at Paris,

THE ELECTRIC TELEGRAPH.

Brussels, Berlin, and Vienna, at the same moment and with the same spirit, expression, and precision as if the instruments, at those distant places, were under his fingers, is not only within the limits of practicability, but really presents no other difficulty than may arise from the expense of the performances. From what has been just stated, it is clear that the *time* of music has been already transmitted, and the production of the sounds does not offer any more difficulty than the printing of the letters of a dispatch.

238 A great celerity of transmission is claimed for the printing telegraph of House, so great, that if the claim be well founded, it is a matter of surprise that it has not superseded the Morse telegraph in the United States, where competition is so sharp and action so free. According to Mr. Turnbull, who ought to be considered an impartial assessor, at least between inventors who are both American, the ordinary rate of transmission of the improved House instrument is from 30 to 35 words, printed in full, per minute, which would be from 165 to 200 letters. He adds, that business-messages are sent at the rate of 200 to 250 letters per minute, and that in one case 365 letters, transmitted from New York, have been printed at Utica, distant 240 miles, in one minute.

In a written estimate supplied by the directors of the House lines to Mr. Jones,* it is also stated that, accidents apart, the average number of words transmitted on a single wire per minute and printed in full by the telegraph at their place of destination, is from thirty to thirty-five, but when as in newspapers abbreviations are allowed, the rate is fifty. It is stated for example that the proceedings of the democratic state convention in the autumn of 1850, containing 7000 words, were transmitted from Syracuse to Buffalo in two hours and ten minutes, being at the rate of 5½ words per minute. It is evident that in this telegraph, like others, much depends on the ability of the telegraphist, for it is stated that one telegraphist on the line has transmitted 365 letters in a minute, being at the rate of six per second.

When it is considered that this telegraph delivers its messages printed in the ordinary Roman characters, while all the others in practical operation deliver them either in visible signs or written ciphers, which must be interpreted and taken down in ordinary writing before they can serve any useful purpose, the vast superiority of this system of House must be conspicuously manifest, supposing of course that the reports and estimates above produced are verified by the actual performance of the instrument.

* Jones. *The Tel.*, New York, 1852, p. 112.

CELERITY OF HOUSES TELEGRAPHY

239 Although the distance to which the dispatch has to be sent cannot be said directly to affect the celerity of transmission, there are circumstances nevertheless which in practice render the transmission to great, slower than to lesser distances. In Europe, for example, stations separated by great distances, are generally in different countries, and the telegraphic line which connects them often passes through several different states in which different telegraphic systems are used, and where it is not practicable to put the wires proceeding from one direction in immediate connection with those which proceed in another. In such cases the messages which arrive must be taken down and retransmitted in the direction in which they are intended to be forwarded, and on this account alone, the time of transmission is augmented, at least in the ratio of the number of such repetitions which are necessary. But besides this, it rarely happens that a message on arriving at such intermediate station can be at once forwarded. It must wait its turn unless the wires happen to be unoccupied.

And even though it may be practicable to establish a direct communication between two distant stations by putting the wires in immediate connection, more or less delay must necessarily take place. The telegraphist who transmits, must first send a message along the line to all the intermediate stations to require the wires to be united for direct communication. At these intermediate stations, the wires may be employed, and the message must wait until they are free.

Thus, although it be true that so far as the electric fluid and the apparatus by which it is transmitted are concerned, they are capable of sending a message from pole to pole in an inappreciable interval, yet the machinery of telegraphy as practically constructed presents causes of delay which prevent in many cases this vast celerity from being called into action.

Until very recently, a message transmitted from Milan to Paris, being necessarily sent round by Trieste, Vienna, Berlin, and Brussels, was more than twenty-four hours in reaching its destination.

Besides these causes of delay, there are, however, others. It has been stated that the intensity of the current is diminished, *ceteris paribus*, as the distance is augmented. When transmission therefore to great distances is required, various expedients, at intermediate stations, such as relay batteries or relay magnets, or both, are required, and notice must be given to apply these even when they are provided.

The chances of interruption by reason of defective insulation or accidents to the wires, are also increased in proportion to the distance.

THE ELECTRIC TELEGRAPH

210 As may be naturally expected, the most frequent examples of direct telegraphic communication to great distances are supplied by the United States

On the lines of the O'Reilly Company of New York,* messages are daily transmitted without any intermediate repetition to a distance of 1100 miles, that is from New York to Louisville in Kentucky

“To do this, it is found necessary to place two batteries in the circuit at a distance of 100 miles apart, for the purpose of renewing the electric current, part of which escapes from defective insulation and atmospheric causes. There is no doubt but that, in a more advanced stage of telegraphing—which may be but a short time hence—New Orleans and New York will be placed in instantaneous communication with each other. To enable this to take place, requires, in the first place, a line substantially built and thoroughly insulated. It may be remarked, that it is but two years since, when to telegraph 300 miles on a single or unbroken circuit, was considered a feat, now, from improvements made since then in telegraphs, we can send over 1100 miles easier than we could 300 at that time. In our Cincinnati office, two years ago, and until very lately, they used a separate battery for each line. From a series of experiments made, one single battery, of no greater strength than those formerly used, now works eight distinct and separate lines, with no apparent diminution of strength, and at a great saving of expense to the office.” †

A report of the directors of the New York Bain lines states that messages are transmitted by them, without being rewritten, from New York to Buffalo, a distance of 600 miles. This is done without any intermediate relay batteries or magnets.

The directors of the Morse lines at New York report that their telegraph messages have in some cases been actually transmitted without intermediate repetition to a distance of 1000 miles.

211 The promptitude with which dispatches are expedited, and the celerity with which they are transmitted, will be greatly promoted in all cases by an uniform system and organisation being established upon the lines over which they are transmitted. No greater cause of delay can exist than that which arises from diversity of telegraphic instruments and language. Much

* The American Telegraph Companies are subject to such constant changes, that it may be necessary to state here, once for all, that the names and denominations to which we refer are those which were current in 1853-4, but which may be changed before these sheets come into the hands of the reader.

† Report of Mr. O'Reilly. Jones's Ill. Tel., p. 101.

CELERITY OF AMERICAN LINES

inconvenience, expense, and delay also arise even in cases where similar instruments and ciphers are used, from a want of uniformity in the various parts of the apparatus, and in the systems of abridgments which are adopted in the language. Where the instruments and the parts of apparatus have been constructed of varying patterns and sizes, they cannot be readily replaced in cases of wearing out or accidental fracture. By the adoption of one uniform size and pattern, depots of all the parts may be provided, from which any station which may be stopped by an accident can be immediately supplied with the part or parts which require to be replaced. Another advantage incidental to such uniformity is greater economy in the maintenance of the apparatus and lines.

Impressed with these considerations, a large majority of the American telegraph companies have formed themselves into a confederation, which meets annually at Washington, and which is permanently represented there by a permanent committee and secretary.

This body has published reports containing many important and interesting statistical facts, and has adopted measures with a view to the establishment of a central depot for the supply of all articles necessary for the maintenance of the lines and stations, of good quality and at fair prices. The secretary of the convention, Mr. J. P. Shaffner, has commenced the publication of a monthly periodical devoted to subjects directly and indirectly connected with electric telegraphs, and as not less than nine-tenths of all the American lines, as well as those of contiguous states, are worked with Morse's instrument, it is proposed to reduce it as speedily as possible to one uniform pattern, so that its parts, as well as those of the batteries, may be always ready to be supplied in cases of failure or breakage, the like parts fitting indifferently all instruments and all apparatus.

The batteries invariably used by the American telegraphs are those of Grove, each element of which consists of a cup of unglazed earthenware, placed in a glass tumbler of equal height and greater diameter. A zinc cylinder is let down between the glass and the earthenware cup, and a platinum cylinder is let down into the earthenware cup. The space between the cups is then filled with acidulated water, and the earthenware cup is filled with pure nitric acid.

Such being the batteries, the articles of consumption in the working of the telegraphs are enumerated as follows by the secretary of the convention—Nitric and sulphuric acids, zinc, quicksilver (for amalgamating the zinc, &c.), skeleton forms for messages, ink, envelopes, pencils, and pens.

ELECTRIC TELEGRAPH

From statistical data collected by the secretary, it was found that in 1853 the annual consumption and cost of these materials was as follows —

	Quantity	Cost
Nitric acid	199680 lb	£110
Sulphuric acid	50000 lb	500
Zinc cylinders	16500 lb	100
Mercury	3000 lb	600
Forms for messages	10,000,000	5000
Envelopes	6,000,000	2080
Pens	570000	120
Pencils	50000	500

These returns, including only the results of the lines worked by the Morse instruments, about nine-tenths of the whole, would require to be increased by a ninth to obtain the total consumption.

It appears, therefore, that on the lines of the United States, the number of telegraphic messages transmitted in 1853 exceeded **TWENTY MILLIONS!**

THE USES OF THE ELECTRIC TELEGRAPH

212 To form an estimate of the uses to which the electric telegraph subscribes, it would be necessary to obtain a report of the subjects of the messages classified, with the relative number of each class, which are transmitted from and received by the chief telegraphic stations. Although we have not been able to procure to any great extent such data, some notion may be collected as to the way in which this new social, commercial, and political agent is employed, from such scattered statements and notices as we have been enabled to collect from various sources.

It appears that the prevailing subjects of the dispatches vary according to the station from or to which they are sent. Thus, as might naturally be expected, in large commercial ports, such as Liverpool and Glasgow, they are chiefly engrossed by messages of mercantile firms and business. Their prevailing subjects also vary much with the season of the year. Thus, in summer, the messages of tradesmen are greatly multiplied in consequence of the number transmitted by dealers in perishable articles, such as fish, fruit, &c., which must be supplied in a regulated quantities with the greatest promptitude.

We have obtained from the manager of the English and Irish magnetic telegraph company, the following classification of

USES OF THE ELECTRIC TELEGRAPH

nearly 5000 dispatches which passed through the Liverpool office in the early part of the present year, 1851

General merchants	1951
Stock and share transactions	1111
Ship insurers, brokers, &c	339
Banking messages	315
Coin dealers	272
Betting	233
Personal and domestic	201
General brokers	117
Tradesmen	50
Cotton brokers, &c	31
Law	31
Political	6
	4998

243 Mr Walker gives the following list of the subjects of dispatches sent through the office of the Electric Telegraph Company, as a specimen of the uses which the public make of this mode of communication

Accidents	Customs	Markets	Post horses, &c
Announcements	Deaths	Medical aid	Reporters
Appointments	Departures	Meteorology	Remittances
Arrivals	Dispatches	Missing trains	Respite
Arrests	Elections	Murders	Robberies
Bankers	Elopements	News	Royal movements
Beds	Expresses	Nurses	Sentences
Bills	Bunds and Shares	Orders	Shipping news
Births	Government	Passengers	Ship stores
Commodions	Health	Payments	Tariff
Counsel	Hotels	Police	Witnesses
Councillors	Judgments	Political	Wrecks
Corps	Lost luggage		

It is obvious that the uses, whether personal or commercial, of the telegraph, are restricted by the tariff, and by the necessity of disclosing the contents of the dispatches to the telegraph agents. In England, the latter obstacle may in some cases be surmounted by the use of a cipher. The cipher must, however, always consist of a transposition of the letters, since the telegraphic signs only express letters, and besides this, it can never be used on sudden emergencies, inasmuch as it supposes a previous concert between the corresponding parties.

244 The obstacle to the extension of the uses of the telegraph, created by the tariff, has been of late greatly lessened by the considerable reduction of the prices of transmission, and it may be hoped that ere long the companies and the public will discover that the interest of the one and the convenience of the other will

THE ELECTRIC TELEGRAPH

be best promoted by a still further reduction of price, and a still larger use of this mode of intercommunication.

It is probable and desirable that something approaching to the uniform postage system may eventually be realised in the telegraph. Already a certain step towards such a system has been made, since for a fixed sum messages of a prescribed length can be transmitted to all distances exceeding a certain limit.

In the absence of exact statistical reports of telegraphic business, it may not be uninteresting to give some examples of the uses of this mode of communication.

245 In the management of railway business in all countries, but more especially upon our own ever crowded and over-worked lines, the telegraph has become an indispensable accessory, without which this mode of locomotion would be deprived not only of its efficiency but its safety. Consequently the railways in most countries have been provided with lines of telegraph expressly and exclusively for their own use, independently of those which are appropriated to the public service, and on the continent such telegraphs are usually alphabetic, that is, such as convey their messages by pointers, which are successively directed to the letters of the words, so that any of the railway officials who can read, may be able to interpret a message which arrives, or to transmit one to a distant station.

To illustrate the vast utility of the telegraph to the railway, Mr Walker states that on the lines of the South Eastern Company, in the space of three months, upwards of 4000 messages have been occasionally transmitted, being at the average rate of nearly 30 per day. He gives the following as a rough classification of their subjects—

		Messages
1	Concerning ordinary trains	1165
2	" Special trains	129
3	" Carriages, trucks, goods, sheets, &c	795
4	" Company's servants	607
5	" Engines	150
6	" Miscellaneous matters	102
7	" Messages forwarded to other stations	199
Total		4110

216 It has been already stated that portable telegraphs are provided in some parts of the continent, and in France in particular, with which the conductors are provided. Such telegraphs have also been contrived in this country, but we are not aware of their practical adoption. By these the conductor of a train can, whenever the train is stopped between stations, whether from accident or other

USES OF THE TELEGRAPH TO RAILWAYS

cause, give immediate notice to the preceding and succeeding stations, so as to prevent a collision by a following train overtaking that which is accidentally stopped, or if necessary he can call for an engine to carry on the train, or any other aid that may be required.

217 Notices of the passing, starting, and arrival of trains are however transmitted from station to station, quite independent of any accidents that may arise, so that all the station-masters, so far as relates to the movement upon the line, are endowed with a sort of omnipresence, so conscious are they of the possession of this power and its value, that their language is that of persons who actually *see* what is going on at vast distances from them. Thus, as Mr Walker observes, they are in the common habit of saying—"I just saw the train pass such or such a station," fifty miles distant perhaps, when in reality all he saw was the deflection of the needle of their telegraph.

"If trains are late, the cause is known, if they are in distress, help is soon at hand—if they are heavy, and progress but slowly, they ask and have more locomotive power either sent to them or prepared against their arrival, if there is anything unusual on the line they are forewarned of it, and so forearmed, if overdue, the old plan of sending an engine to look after them has become obsolete—a few deflections of the needle obtain all the information that is required" *.

The utility of special trains is well known. News of the utmost importance, or a government courier bearing dispatches of the greatest urgency arrives at one of our ports and demands a train *instantly* to convey him to London. Now in such cases it does not often happen that a disposable engine is found at the station where the demand is presented, but the telegraph sends a dispatch along the line, calling one from the nearest station at which one can be found, and when the engine has been obtained the special cannot start with safety unless the line is cleared for it.

The telegraph again interposes its aid, and sends a notice along the line of the moment of starting, from which, combined with the known speed of the train, the exact moment when it will pass every station upon the line is known, and of course the line is cleared for it, and all danger of collision removed. How frequent are the occasions for appealing to the telegraph for this aid without which special trains would not only be less rapid, but infinitely less safe, as well for themselves as others, may be seen by reference to the analysis of dispatches we have given above, from which it appears that in three months, upon the South-

* Walker, p 81

THE ELECTRIC TELEGRAPH

Eastern lines, there were not less than 429 messages respecting special trains, that is at the rate of about five per day.

248 In the general management of the traffic upon an active line of railway, an incalculable amount of capital and current expenditure is saved by the telegraph. Without a rolling stock would require to be provided in much greater quantity, and a far greater unprofitable wear and tear by useless trips, of what in railway language are called "empties," would take place. By the telegraph, as we have stated, each station-master is ubiquitous so far as the line is concerned. He knows where carriages, waggons, trucks, sheets, and engines are to be found, and how many of them, and he calls by the telegraph so many, and no more than he wants, and at the time he wants them, from the nearest or most convenient station where they are to be obtained.

Before the establishment of the telegraph, some of these objects were imperfectly attained by means of pilot engines, that is engines taking no vehicle, which habitually run along the line to carry messages from station to station. As an evidence of the immense saving effected by the telegraph in the practical working of railways, Mr. Walker states, that the cost of maintaining and working a single one of those pilot engines, (all of which have been superseded by the telegraph,) amounted to a greater sum than is now required to defray the expense of the entire staff of telegraph clerks, and the mechanics and labourers employed in cleaning and repairing the instruments and maintaining the integrity of the line wires.

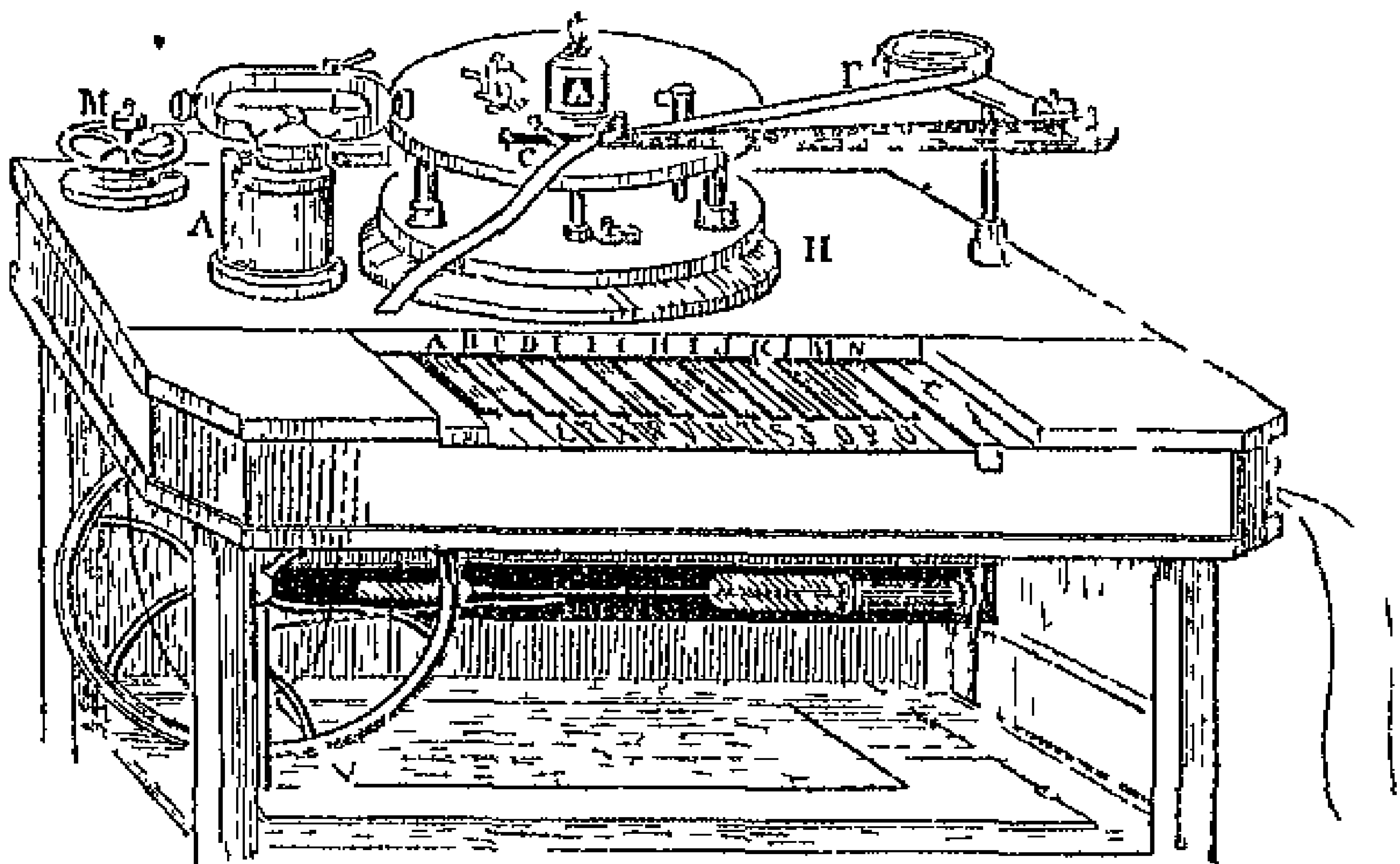

Fig. 80 —HOUSE TELEGRAPH

THE ELECTRIC TELEGRAPH

CHAPTER XII

249 Prevention of accidents — 250 Its uses in the detection of crime —
 251 Personal and domestic messages — 252 Electric news rooms —
 253 Telegraph extensively used in the United States — 254 Much
 used for commerce — 255 Sums paid for telegraphic despatches by
 mercantile firms — 256 Extensively used by American newspapers —
 257 Illustration of the utility for political purposes — 258 Illustra-
 tions of its domestic and general use — 259 Secrecy of despatches not
 generally sought for — 260 Verbal ciphers of mercantile firms — 261
 Ciphers for newspaper reports — 262 Association of New York
 journals — 263 Spirited enterprise of New York "Herald" — 264
 Use of electric telegraph in determining longitudes — 265 In pro-
 ducing horological uniformity

249 AMONG the serious railway accidents which might have
 been, or actually were prevented by the telegraph, the following
 have been mentioned —

In a storm, the wind blew a first-class railway carriage, which

THE ELECTRIC TELEGRAPH

stood in an open shed at a second-class station, and putting it in motion upon a very level line, sent it flying with accelerated speed to the terminal station. No telegraph at that time existed to warn either the intermediate or terminal stations of the event and the approaching danger. The vehicle was actually *blown* over twenty-one lines of railway, but the trip it thus took occurring fortunately at an hour of the night when little business was going on, it came to rest without any calamitous result.

Mr. Walker mentions the following —

“On New Year's Day, 1850, a catastrophe, which it is fearful to contemplate, was averted by the aid of the telegraph. A collision had occurred to an empty train at Gravesend, and the driver having leaped from his engine, the latter started alone at full speed to London. Notice was immediately given by telegraph to London and other stations, and while the line was kept clear, an engine and other arrangements were prepared as a buttress to receive the runaway. The superintendent of the railway also started down the line on an engine, and on passing the runaway, he reversed his engine and had it transferred at the next crossing to the up-line, so as to be in the rear of the fugitive, he then started in chase, and on overtaking the other, he ran into it at speed, and the driver of his engine took possession of the fugitive, and all danger was at an end. Twelve stations were passed in safety — it passed Woolwich at fifteen miles an hour — it was within a couple of miles of London before it was arrested. Had its approach been unknown, the mere money value of the damage it would have caused might have equalled the cost of the whole line of telegraphs. They have thus paid, or in a large part paid, for their erection.

“As a contrast to this, an engine, some months previously, started from New Cross toward London. The Brighton Company have no telegraphs, and its approach could not be made known. Providentially, the arrival platform was clear, it ran in, carrying the fixed buffer before it, and knocked down, with frightful violence, the wall of the parcels office.”

250 Among the general uses of the telegraph to the public, many examples of the detection of crime are mentioned. It is generally known that the notorious Tawell, after the commission of the murder, started for London from Slough, by the Great Western Railway. Notice of the crime, and a description of his person, however, flew with the speed of light along the wires and arrived at Paddington so much earlier than the murderer himself, that upon his arrival he was recognized, tracked

USES OF THE TELEGRAPH

from place to place, finally apprehended, tried, convicted, and executed.

One night at ten o'clock, the chief cashier of the bank received a notice from Liverpool, by electric telegraph, to stop certain notes. The next morning the descriptions were placed upon a card and given to the proper officer, to watch that no person exchanged them for gold. Within ten minutes they were presented at the counter by an apparent foreigner, who pretended not to speak a word of English. A clerk in the office who spoke German interrogated him, when he declared that he had received them on the Exchange at Antwerp six weeks before. Upon reference to the books, however, it appeared that the notes had only been issued from the bank about fourteen days, and therefore he was at once detected as the utterer of a falsehood. The terrible Forrester was sent for, who forthwith locked him up, and the notes were detained. A letter was at once written to Liverpool, and the real owner of the notes came up to town on Monday morning. He stated that he was about to sail for America, and that whilst at an hotel he had exhibited the notes. The person in custody advised him to stow the valuables in his portmanteau, as Liverpool was a very dangerous place for a man to walk about with so much money in his pocket. The owner of the property had no sooner left the house than his adviser broke open the portmanteau and stole the property. The thief was taken to the Mansion-House, and could not make any defence. The sessions were then going on at the Old Bailey. Though no one who attends that court can doubt that impartial justice and leniency are administered to the prisoners, yet there is no one who does not marvel at the truly railway-speed with which the trials are conducted. By a little after ten the next morning—such was the speed—not only was a true bill found, but the trial by petty-jury was concluded, and the thief sentenced to expiate his offence by ten years' exile from his native country.

I take the following illustration of this from a recent article on the subject which appeared in the "Quarterly Review."

The following is extracted from the telegraph book preserved at the Paddington station —

"Paddington, 10 20 A M — 'Mail train just started. It contains three thieves, named Sparrow, Buell, and Spurgeon, in the first compartment of the fourth first-class carriage.'

"Slough, 10 48 A M — 'Mail train arrived. *The officers have cautioned the three thieves.*'

"Paddington, 10 50 A M — 'Special train just left. It contained two thieves — one named Oliver Martin, who is dressed in black, *orange on his hat*, the other named Fiddler Dick, in black trousers

THE ELECTRIC TELEGRAPH

and light blouse Both in the third compartment of the first second-class carriage ”

“ Slough, 11 16 A. M. — ‘ Special train arrived Officers have taken the two thieves into custody, a lady having lost her bag, containing a purse with two sovereigns and some silver in it, one of the sovereigns was sworn to by the lady as having been her property It was found in Fiddler Dick’s watch-fob ’

“ It appears that, on the arrival of the train, a policeman opened the door of the ‘ third compartment of the first second-class carriage,’ and asked the passengers if they had missed anything ? A search in pockets and bags accordingly ensued, until one lady called out that her purse was gone ‘ Fiddler Dick, you are wanted,’ was the immediate demand of the police-officer beckoning to the culprit, who came out of the carriage thunderstruck at the discovery, and gave himself up, together with the booty, with the air of a completely beaten man The effect of the capture so cleverly brought about is thus spoken of in the telegraph book —

“ Slough, 11 01 A. M. — ‘ Several of the suspected persons who came by the various down-trains are lurking about Slough, uttering bitter invectives against the telegraph Not one of those cautioned has ventured to proceed to the Montem ’

“ Ever after this the light-fingered gentry avoided the railway and the too intelligent companion that ran beside it, and betook themselves again to the road—a retrograde step, to which on all great public occasions they continue to adhere ” *

251 One of the consequences of the high price of transmission is that personal and domestic messages are most generally confined to cases of urgency, and often of distress, painful or ludicrous, as the case may be Persons in easy circumstances, it is true, often resort to the telegraph to gratify a caprice or to obtain some object of gratification for which they are impatient The mixture of subjects which the agents in rapid succession read from the needles, is most curious “ We have,” says Mr Walker, “ ordered a turbot, and also a coffin, a dinner, and a physician, a monthly nurse, and a shooting-jacket, a special engine, and a chain-cable, an officer’s uniform, and some Wenham-lake ice, a clergyman, and a counsellor’s wig, a royal standard, and a hamper of wine, and so on Passing over the black leather bag which some one every day appears to leave in some train, passengers have recovered luggage of most miscellaneous character by means of the telegraph

* Quarterly Review, No CLXXXIX, p 120

USES OF THE TELEGRAPH

In the trains have been left a pair of spectacles, and a pig, an umbrella, and *Layard's Nineveh* a purse, and a barrel of oysters, a great-coat, and a baby, and boxes and trunks, *et id genus omne*, without number."

252 Independently of the direct use made of the electric telegraph by the general public, for the transmission of private despatches, the several companies have established, in various principal places, news rooms, where intelligence is from hour to hour posted, as it arrives from all parts of the world.

The Electric Telegraph Company, soon after its establishment, opened subscription news rooms in the chief towns of England especially those of the northern counties, in which intelligence of every description which could interest the general public was posted from hour to hour during the day, immediately on its transmission from London. These establishments did not, however, receive the necessary public support, and with one or two exceptions they have been discontinued. There is, however, in the Lothbury establishment, besides the private message department, a general intelligence office, in which the news published in the morning journals is condensed and transmitted to the exchanges of Liverpool, Bristol, Manchester, Glasgow, and other chief provincial centres of business.

On the evenings of Fridays, the London news is collected, condensed, and transmitted to the offices of upwards of 120 provincial Saturday papers, which thus receive during the night before their publication the most recent intelligence of every sort received by telegraph from all parts of Europe besides the current news of London to the latest moment. An example of the extraordinary efficiency of this department is given in the case of one of the Glasgow Saturday journals, which often receives as much as three columns of the debates, transmitted while the Houses are still sitting. A superintendent and four clerks are exclusively engaged in the business of this department, and in the latter days of the week their office presents all the appearances of the editor's room of a widely circulating journal. "At seven in the morning the clerks are to be seen deep in 'The Times' and other daily papers, just hot from the press, making extracts and condensing into short paragraphs all the most important news, which are immediately transmitted to the country papers to form second editions. Neither does the work cease here, for no sooner is a second edition published in London than its news, if of more than ordinary interest, is transmitted to the provinces." Arrived at the chief places in direct communication with London "swifter than a rocket could fly the distance, like a rocket it bursts and is

THE ELECTRIC TELEGRAPH

again carried by diverging (branch) wires into a dozen neighbouring towns" of less magnitude and importance *

Besides this organisation for the general transmission of despatches from one quarter of the great metropolis to another, there are some curious special arrangements made for the satisfaction of the wants of particular classes. Thus a wire is exclusively appropriated to communications between the Octagon Hall of the Houses of Parliament and the telegraphic station in St James-street, the centre of the West-end clubs. This particular wire should be called the "whipper-in" of the House, for it is nothing more than a call-wire for members. The company employ reporters during the sitting of Parliament to make an abstract from the gallery of the business of the two Houses as it proceeds, and this abstract is forwarded at very short intervals to the office in St James's-street, where it is set up and printed, additions being made to the sheet issued as the MS comes in. This flying sheet is sent half-hourly to the following clubs and establishments —Athol's, Carlton, Oxford and Cambridge, Brookes's, Conservative, United Service, Athenæum, Reform, Travellers', United University, Union, and White's. Hourly to Boodle's Club and Prince's Club, and half-hourly to the Royal Italian Opera. The shortest possible abstract is of course supplied, just sufficient in fact to enable the after-dinner M P so to economise his proceedings as to be able to finish his claret and yet be in time for the ministerial statement, or to count in the division. The following, for instance, is a fac-simile of the printed abstract of the debate on the Address to her Majesty on the declaration of war —

THE ELECTRIC TELEGRAPH COMPANY

(INCORPORATED 1846)

HOUSE OF COMMONS, FRIDAY MARCH 9th 1861

TIME		REMARKS
H	M	
4	0	House made
4	30	Private business and Petitions
4	40	Mr Napier brought up report of Dungarvan Election Committee. Magazine duly elected, and attention called to state of law upon the withdrawal of Petitions
5	0	Notices
5	30	Lord John Russell moving reply to message of Her Majesty
		<p style="text-align: center;">HOUSE OF LORDS</p> Lord Aberdeen stated, in reply to Lord Roden, that it was intended to appoint a day for solemn prayer for a blessing on Her Majesty's arms by sea and land Earl of Clarendon moved

* Quarterly Review, No CLXXXIX, p 138

USLS OF THE TELEGRAPH

TIME		REMARKS
6	0	Stating various transactions and negotiations which have taken place with Russia
6	30	Mr Layard approved of the sentiments expressed
7	0	Still speaking
7	30	Compared the language and opinions of different Members of the Cabinet, and called attention to various articles in the "Times," which he maintained to be written with a full knowledge of the contents of the secret and confidential correspondence
8	0	Mr Bright replied to Mr Layard, adverse to policy of the Government
8	30	Still speaking
9	0	Still speaking
9	30	Mr J Ball was prepared to support the war, though not agreeing in the reasons put forward to justify it
10	0	The Marquis of Granby expressed his regret at the language used by certain members of the Government with respect to the Emperor of Russia, whose conduct regarding Turkey he vindicated
		Lord Dudley Stuart
10	30	still speaking
11	0	Lord Palmerston vindicating the policy of the Government
11	30	Mr Disraeli supported the address, but severely criticised the conduct of different Members of the Cabinet
12	0	Analysing the secret and confidential correspondence to show that a plan for the partition of Turkey was assented to by the English Government in 1844, when the Earl of Aberdeen was Secretary for Foreign Affairs
12	30	Lord John Russell replying to Mr Layard, and the observations of other speakers
12	40	Colonel Sibthorp observations
		The Address to Her Majesty agreed to, and on the motion of Lord John Russell, and seconded by Mr Disraeli, to be presented by the whole House
1	0	HOUSE ADJOURNED

the address in reply to the Queen's message
 Earl of Derby observations
 (7 30) Earl of Aberdeen replied to Lord Derby
 (7 45) Earl of Malmesbury regretted the tone taken by the Prime Minister
 (8 20) Earl Granville observations
 Lord Brougham ditto
 Earl Grey ditto
 (8 50) Earl of Hardwicke wished for a larger Naval Reserve
 (8 55) Marquis of Lansdowne said it was necessary to check Russia
 (9 5) Address agreed to, to be presented on Monday

ORDS ADJOURNED, 9 25

Saint James's Street Branch Station, No 69, at the End of Pall Mall, opposite Saint James's Palace

THE ELECTRIC TELEGRAPH

“The wire to the Opera is a still more curious example of the social services the new power is destined to perform. An abstract of the proceedings of Parliament similar to the above, but in *writing*, is posted during the performance in the Lobby, and Young England has only to lounge out between the acts to know if Disraeli or Lord John Russell is up, and whether he may sit out the piece, or must hasten down to Westminster. The Opera-house even communicates with the Strand-office, so that messages may be sent from thence to all parts of the kingdom. The government wires go from Somerset-house to the Admiralty, and thence to Portsmouth and Plymouth by the South-Western and Great Western Railways, and these two establishments will shortly be put in communication, by means of subterranean lines, with the naval establishments at Deptford, Woolwich, Chatham, Sheerness, and with the Cinque Ports of Deal and Dover. They are worked quite independently of the company, and the messages are sent in cipher, the meaning of which is unknown even to the telegraphic clerks employed in transmitting it. In addition to the wires already spoken of, street branches run from Buckingham Palace and Scotland Yard (the head police-office) to the station at Charing-cross, and thence on to Founder's-Court, whilst the Post-office, Lloyd's, Capel-court, and the Coin Exchange communicate directly with the central office.”*

The Magnetic Telegraph Company have made arrangements by which the correspondents of the press are allowed to forward messages upon an entirely different basis, the charge for intelligence so transmitted, amounting to only one-tenth of the charge to the public, the matter being more voluminous, and passing through the wires at a time when they are not otherwise occupied.

The company also supplies the press and news-rooms in various parts of the United Kingdom, and especially throughout Ireland, with news by *contract*, at the rate of about one half-penny per line of ten words, and are enabled to do so, by making manifold copies of the information (whatever be its nature) for the use of *all* the press, &c, in each town or district, through which such news passes.

Under such arrangements, intelligence to the amount of two closely printed newspaper columns, or more, daily, is transmitted between all the stations, conveying information of the various share, corn, cotton, coal, iron, cattle, provision, and produce markets, fairs, shipping arrivals, foreign and domestic information, Gazette news, Parliamentary reports, &c, &c. Each piece of news, whatever its nature, obtained in *one* town being conveyed

* Quarterly Review, No CLXXXIX, pp 139—141

USLS OF THE TELEGRAPH

all the rest, the arrival of vessels in Queenstown, the result of market in Cork, or of a cattle fair at Ballinastoe, affording intelligence for the whole of the United Kingdom, and *vice versa*

In order to carry out this system, the company employs paid agents, news collectors, parliamentary reporters, &c

253 It is a fact well known that the electric telegraph is much more extensively used for all purposes, political, commercial, and domestic, in the United States, than in this or any other part of Europe

Before the reductions which have within the last year or two taken place in the tariffs, this might fairly be explained by the comparatively small cost of transmission in America; but since those reductions were effected, it may be questioned whether there is any difference of cost sufficiently considerable to explain the vast difference in the extent to which the public, on different sides of the Atlantic, avail themselves of this mode of tele-communication

We shall notice the question of the tariffs hereafter

Meanwhile, whatever be the cause, it is certain, that the practical use of the telegraph is much more extended among our transatlantic correspondents

The tariffs vary on different lines, but it has been estimated that the cost of a message of 10 words, exclusive of address and nature, sent 10 miles, is about 5*d*, and for greater distances the cost may be taken at about 0.035*d* per word per mile

The classes of messages entitled to precedence, are government messages, and messages for the furtherance of justice in detection of criminals, &c; then death messages, which includes cases of sickness when the presence of a party is sent for by the sick and dying

Important press-news comes next, if not of extraordinary interest, it takes its turn with the mercantile messages

254 Commercial houses resort largely to the telegraph

For example—a merchant purchasing goods in New York, gives his reference to the merchant—such reference being perhaps 700 or 800 miles away from him

By the aid of the telegraph the merchant can ascertain the standing of his customer, even before the purchase is completed

There are bankers, brokers, &c, that receive and send, on an average, six to ten messages per day, throughout the year

255 The manager of House's line at New York states that some commercial houses pay to the company as much as 200*l* a-year, and that the average annual receipts from twenty mercantile houses amount to 100*l* each

The directors of Bann's New York line report that the telegraph is used by commercial men to almost as great an extent as the mail

This can be better illustrated by the number of messages sent and received between cities whose commercial relations are

THE ELECTRIC TELEGRAPH

intimate, during the hours from 10 A M to 5 P M For instance there are transmitted daily, between the cities of New York and Boston, between 500 and 600 messages, two-thirds if not three-fourths of which are transmitted between the hours above named Some houses pay from 12% to 16% per month to the telegraph The amount paid by a commercial house is governed by the excitement there is in the market of the particular article they may be dealing in If there are "ups and downs" in the market, money is lavished upon the telegraph freely

The directors of the Morse New York lines, state that the annual telegraph outlay of several houses amounts to 600%

It often happens that a party desires to "converse" with another 100 or 500 miles off An hour is appointed to meet in the respective offices, and they converse through the operator Cases may be mentioned of steamboats being sold over the wires—the one party being in Pittsburg, the other in Cincinnati Each party wrote down what they had to say, higgled awhile, and finally concluded the sale Their correspondence was filed away, like other messages, and kept for reference, if ever called in question It is often used by parties, when from home, corresponding with their families Sometimes it is the messenger of woe, and anon, that of pleasure In the early part of 1852, the Astor House of New York, and the Bunnet House of Cincinnati, had a series of telegraphic parties An account of one of them was published in the "Cincinnati Gazette," the parties conversing being about 750 miles apart

256 The following example of the activity of journalism is given by Mr Jones, who was himself a telegraphic agent for the newspapers—"Some time back the Asia arrived at Quarantine, near New York, about 8 A M, was detained an hour by the health officer The agent of the New York Associated Press and of the New Orleans Merchants' Exchange, Mr Jones, to gain but a few minutes, had a boat in readiness when the Asia brought to A small bag containing the latest news was handed over the steamer's side, to the small boat By great exertions she gained New York half an hour ahead of the Asia The bag was opened—a copy of her news was handed to us, addressed to the Merchants' Exchange, New Orleans, signed *Jones*—to work we went It was being transmitted over the wires amid the thundering of the Asia's cannon, as she rounded the point, and a complete synopsis of her commercial and political news was received in Louisville, 1100 miles in the interior, before the ship had actually reached the city "

The managers of the Morse line at New York state that, during the sittings of conventions, or elections, or the arrival of

USES OF THE TELEGRAPH

steamers, often from 2000 to 8000 words are reported. On some occasions of market excitement, the private messages are nearly doubled.

Debates of Congress are received at an average of about 4000 words per day, and transmitted at the rate of 1600 words per hour.

On the assembly of the Legislature of the State of New York at Albany, in 1847, the governor's message, consisting of 25000 letters, was transmitted to New York, 150 miles, and printed by the telegraph itself in two hours and a half.

257 In his reports to Congress, Mr. Morse has supplied various examples of the use made of the telegraph by all classes of persons. During the Philadelphia riots of 1814, the mayor of that city sent an express by railway, to the President of the United States at Washington. On the arrival of the train at Baltimore, the contents of the express transpired, and the telegraph, which was then just put in operation between Baltimore and Washington, not being yet established elsewhere in the States, sent on the substance of the despatch. The President held a cabinet council while the despatch itself was coming, and had his answer prepared and delivered to the messenger who brought the despatch at the moment of his arrival, who returned with it instantly to Philadelphia.

258 Nothing is more frequent in the United States than electric medical consultations. A patient in or near a country village desires to consult a leading medical practitioner in a chief city, such as New York or Philadelphia, at four or five hundred miles distant. With the aid of the local apothecary, or without it, he draws up a short statement of his case, sends it along the wires, and in an hour or two receives the advice he seeks, and a prescription. Cases are recorded in which electric marriages have been contracted between parties separated one from another by many degrees of latitude. A correspondent of the author of a paper in Chambers's Collection states, that in the United States, "The telegraph is used by all classes, except the very poorest—the same as the mail. A man leaves his family for a week or a month, he telegraphs them of his health and whereabouts from time to time. If returning home, on reaching Albany or Philadelphia, he sends word of the hour that he will arrive. In the towns about New York the most ordinary messages are sent in this way—a joke, an invitation to a party, an inquiry about health, &c. In our business we use it continually. The other day two different men from Montreal wanted credit, and had no references, we said 'Very well, look out the goods, and we will see about it.' Meanwhile we asked our friends in Montreal—'Are Pump and Proser good for one hundred dollars each?' The

THE ELECTRIC TELEGRAPH

answer was immediately returned, and we acted accordingly, probably much to our customers' surprise. The charge was a dollar for each message, distance about 500 miles, but much further by telegraph, as it has to go a round to avoid water. If my brother goes to Philadelphia, he telegraphs, 'How is the family? What is doing?'—I answer, 'All well. Sales so much,' and so on."*

It has been contended by some, with much reason, that one of the most serious drawbacks to the general extension of the use of the electric telegraph is the impracticability of preserving that secrecy which the seal confers on written correspondence, the absence of which would utterly annihilate the utility of the post-office. The imperious necessity of guarding this secrecy inviolate is apparent in the heavy penalties attached to the rupture of the seal, which can only be effected with impunity by a special authorisation of a secretary of state. To confer on the electric telegraph all the public utility of which it is susceptible, means must be adopted, and will, no doubt, be ultimately adopted for the attainment of this object, the vital importance of which is implicitly acknowledged by the heavy penalties, the smallest of which is dismissal, imposed in all countries on the agents who disclose the contents of private telegraphic correspondence.

Such expedients must nevertheless be ineffectual, for it would contradict all the results of the common experience of life, if what must inevitably be communicated to half a dozen persons at least, and a copy of which is retained and filed in a public office, could remain secret from any parties who might have a sufficiently strong motive to come to the knowledge of it. But even though the disclosure of private communications to parties not employed in the telegraphic offices should be effectually prevented by the present expedient of swearing the clerks to secrecy, and inflicting the consequent penalties for the violation of their oath, still individuals communicating in private confidence one to another, wives to husbands, sisters to brothers, or children to parents, have things to say which it would be utterly intolerable, as is most justly observed by the reviewer already quoted even "to see strangers read before their eyes. This is a grievous fault in the telegraph, and it must sooner or later be remedied by some means or other."

The object might be accomplished by the use of any species of cipher, but this supposes that the parties corresponding have previously prepared the cipher, and are mutually possessed of its key. Such a condition could only be practically fulfilled by

* "Chambers's Papers for the People," vol. ix. No. 71

USLS OF THE TELEGRAPH

correspondents having habitual need of intercommunication, such as mercantile establishments interchanging news of the markets, stocks, sales, and other commercial details, but for the occasional communications of domestic life it would be quite unavailable

It is hinted by 'the Quarterly Reviewer,' that Mr Wheatstone has invented a cipher which will be applicable to general purposes, and which will attain this object, and that it will be soon placed at the disposition of the public

If the same privacy as is afforded by the post office can be thus secured to telegraphic communications, and if by the multiplication of their wires, and the improved efficiency of their instruments, the companies are enabled to reduce their tariff to a still lower limit, and to base it on some uniform principle similar to the admirable penny postage system of Mr Rowland Hill, it is difficult to foresee the extent of the revolution which this noble gift of science to mankind may effect. Great as the benefits have been which the post-office has conferred, they will sink to nothing compared with those of the telegraph. In estimating the importance of the part reserved for this vast agent of civilisation, it must not be forgotten that it is still in its early infancy, and that its most wondrous powers are not yet developed by time and growth

259 The necessity of disclosing the contents of private despatches to the telegraphists is sometimes avoided in the United States by the adoption of a cipher, or by a conventional change of the signification of the letters of the alphabet. In some cases, with the telegraph of House, the manipulation of which is easy and simple, the party plays upon the keys of the instrument himself. It is, however, only in rare instances that these expedients are resorted to. The public confidence has been won by the general secrecy observed by the telegraphic agents, and in general no apprehension of disclosure prevents persons from sending the most private and confidential despatches in the usual manner. One of the directors, who for four years has had the superintendence of extensive lines, states, that in that interval he never heard of an instance of the contents of a despatch being divulged

Another circumstance which experience has made manifest has given security to the public on this point. It appears that the agents who are for many hours labouring at the machine in the transmission of despatches, word by word, rarely are able to give that kind of attention to the sense and purport of the whole which would be necessary to the clear understanding of it. Their attention is engrossed exclusively in the manipulation necessary to transmit letter after letter, and they have neither time nor attention to spare for the subject of the whole despatch. The case

THE ELECTRIC TELEGRAPH

is very analogous to that of compositors in a printing-office, who, as is well known, go through their work mechanically, without giving the least attention to the subject.

260 A sort of verbal cipher, or abbreviations, are much in use, however, by mercantile houses. This is practised more for the sake of economy than secrecy, although the latter purpose is also attained. The firm and its correspondents have a key in which are tabulated a number of single words, each of which expresses a phrase or sentence, such as is of frequent occurrence in such communications. The following example of such a commercial despatch is given by Mr Jones. The despatch to be sent consisted of 68 words, as follows —

“Flour Market for common and fair brands of western is lower, with moderate demand for home trade and export. Sales, 8000 bbls. Flour see at 5 dols 12. Wheat, prime in fair demand, market firm, common description dull, with a downward tendency, sales, 4000 bushels at 1 dol 10. Corn, foreign news unsettled the market no sales of importance made. The only sale made was 2500 bushels at 67 c.”

This despatch, when converted into the verbal cipher, was expressed in nine words, as follows —

“Bad came aft keen dark acho lam fault adapt.”

261 Complicated systems of cipher were invented for the transmission of parliamentary and law reports, and those of public meetings. When the tolls, however, were reduced by competition, this system was abandoned, and the reports were sent in full, or with such abbreviations only as are obvious.

262 The large quantity of telegraphic news which is published daily in the New York journals is explained by the fact, that seven of the principal journals of that city formed an association to telegraph in common, sharing the expense. Each journal was, however, at liberty to order for itself any extra intelligence, giving the others, or any of them, the option of sharing it.

263 Mr Jones relates that one of the earliest telegraph feats, after the extension of the telegraph lines west to Cincinnati, was brought about by the agency of the “New York Herald,” and before any regular association of the press was formed in New York.

“It became known that Mr Clay would deliver a speech in Lexington (Ky), on the Mexican war, which was then exciting much public attention. Mr Bennett, editor and proprietor of the ‘Herald,’ desired us to have Mr Clay’s speech reported for the paper. We at once proceeded,” says Mr Jones, “to make arrangements to carry it into effect. We had a regular and efficient reporter already employed in Cincinnati, a Mr G. Bennett, we also had a Mr. Thompson in Philadelphia in co-operation with us.

USLS OF THE TELEGRAPH

for some paper there, and which agreed, if the speech was first received, to share the expense with the 'Herald' The 'Tribune' in New York, and the 'North American' in Philadelphia, agreed to start for a report of the speech, in opposition From Lexington to Cincinnati was eighty miles, over which an express had to be run Horses were placed at every ten miles by the Cincinnati agent An expert rider was engaged, and a short-hand reporter or two stationed in Lexington When they had prepared his speech it was then dark The express-man, on receiving it, proceeded with it for Cincinnati The night was dark and rainy, yet he accomplished the trip in eight hours, over a rough, hilly, country road The whole speech was received at the 'Herald' office at an early hour the next morning, although the wires were interrupted for a short time in the night, near Pittsburg, in consequence of the limb of a tree having fallen across them An enterprising operator in the Pittsburg office, finding communication suspended, procured a horse, and rode along the line amidst the darkness and rain, found the place, and the cause of the break, which he repaired, then returned to the office, and finished sending the speech "

The Philadelphia "North American," upon whom the "Tribune" chiefly depended, failed to get its report, and the latter purchased a copy from the "Herald"

The expense of securing the speech by express and telegraph, amounted to about 100/

The telegraphs have derived a very large share of their revenue from the press The whole expense, for telegraph reports of all kinds, have some years cost the New York Associated Press (six in number) probably about 1000/ each, or a total of 6000/ per annum The average for the past five years probably has not been less than about 5000/ to 6000/ per annum During long sessions of Congress it exceeded this amount

Sometimes a single paper availed itself of the privilege of ordering long and expensive reports of meetings, speeches, conventions, &c, in which its associates participated or declined as best suited their estimate of the value of the news In case the other papers refused to receive it, the whole expense was borne by it The "Herald" is the only one of its associates which publishes a Sunday paper—hence it takes all the telegraph news which is received on Saturday afternoon and night, and pays the whole expense of the tolls *

261 The electric telegraph, an offspring of science, has rendered to its parent great and important services

From the moment that it was discovered that the pulsations of

* Jones, p 139

THE ELECTRIC TELEGRAPH

the electric current could, by means of the conducting wires, be transmitted to any distances, its use in the important problem of the determination of longitudes, became conspicuously apparent. By reference to our *Treatise on Latitudes and Longitudes*, it will be seen that the difference of the longitudes of two places upon the earth's surface is nothing more nor less than the difference of the hour of the day or night, as shown by two well-regulated clocks at the two places. Thus, if while it is 3 o'clock at one place, it is 4 o'clock at the other, the latter is one hour of longitude east, and the former one hour west of the other, or if it be preferred to express the longitude in degrees, the one place is 15° east or west of the other.

Now since the machinery of the electric telegraph supplies the means of making all the time-pieces of whatever kind, or wherever placed, which are brought into connection with the same system of wires, move in exact accordance, it is capable of making all the time-pieces in the United Kingdom move in exact accordance with the standard chronometer of Greenwich Observatory, or, to take a still larger view of the principle, it is capable of governing the movement of all the time-pieces of whatever sort, and wherever situated within the range of the vast net-work of telegraphic wires, which overspreads the European continent, so as to make them move in accordance with any standard time-piece, which may by common consent be adopted as the common regulator.

Now, if such an uniformity of chronometers were established, the longitudes of all places would be determined by ascertaining by observations on the sun, which are always easy and susceptible of great precision, the local time, that is to say the time which would be shown by a well-regulated clock on the present system. The difference of the two times, that shown by the common standard regulator and that shown by the local clock, would be the difference of longitude between the place in question and the place where the standard regulator would show local time.

265 In places at great distances asunder, and in different countries, such horological uniformity would, at first, for civil purposes be attended with some inconvenience, since the hour of noon would vary with the longitude. Thus, at a place 15° east of the standard station, the hour of noon would be one o'clock, and at a place 15° west it would be 11 o'clock. Such an inconvenience would, however, only be felt at the moment of the change of custom. It is obvious that it would be as easy and simple to mark the moment at which the sun passes the meridian by 11 or 1, as by 12.

Incidentally to such an horological uniformity would arise, however, the convenience that the hour of noon at all places would express their longitude with relation to the standard station.

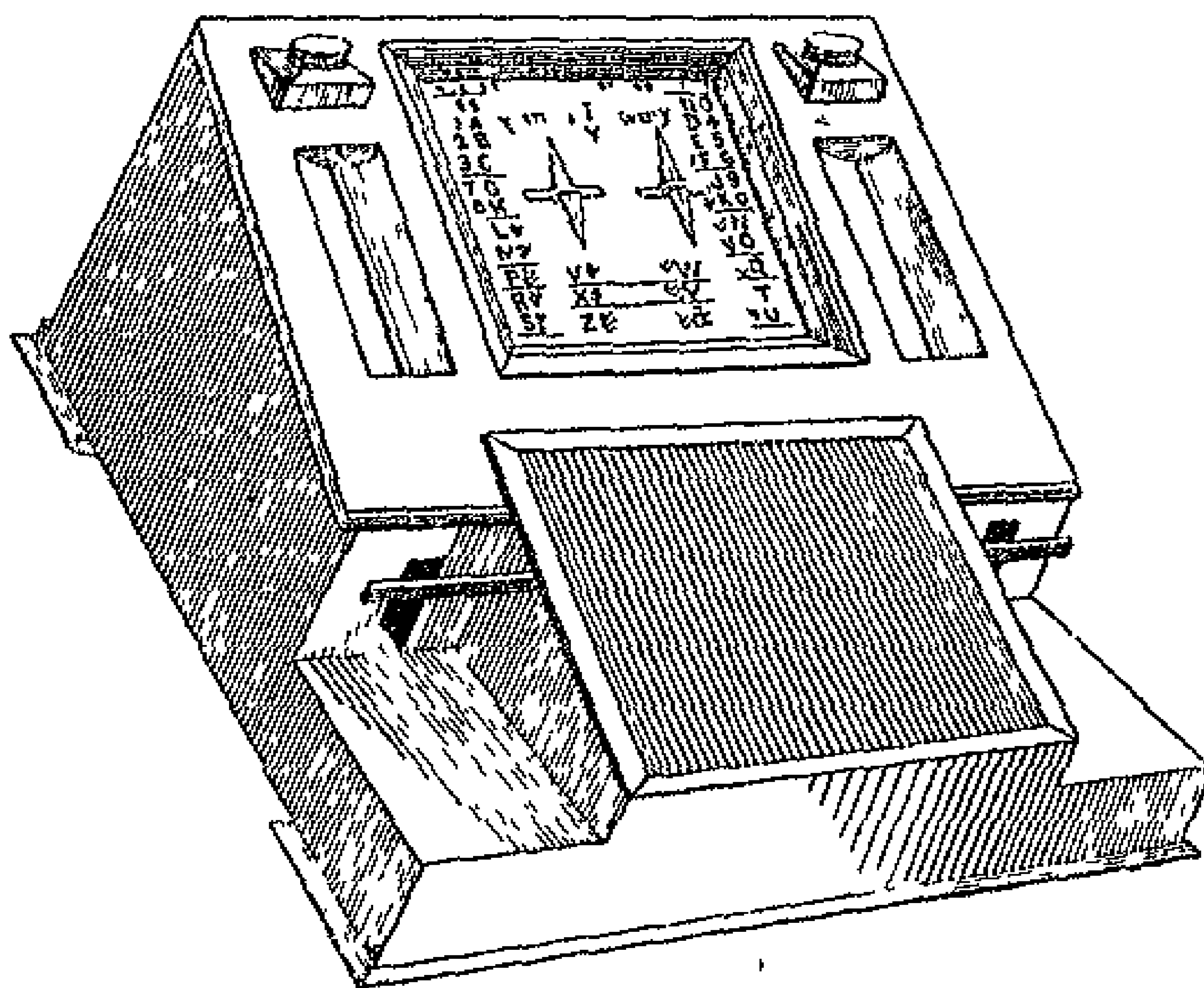

Fig 91 —HENRY'S MAGNETIC NEEDLE TELEGRAPH

THE ELECTRIC TELEGRAPH

CHAPTER XIII

266 Signal time balls —267 Electric connection of observatories of Greenwich, Brussels, and Paris —268 Uses of electric telegraph in astronomical observations —269 In regulating the observatory clocks —270 In fixing with precision the time of an astronomical phenomenon —271 Telegraphic lines of the United Kingdom —272 Their extent in 1851 —273 Electric Telegraph Company —274 Table of its lines, stations, &c —275 Present tariff (1851)

266 By concert between the Astronomer Royal and the several Electric Telegraph Companies, the Greenwich local time is announced at certain hours of the day, at conspicuous places in different parts of the country, so that navigators who happen to be in any of our ports, may avail themselves of these means of regulating their chronometers We have already explained the

THE ELECTRIC TELEGRAPH

signal given daily at one in the afternoon, by the fall of a large ball upon the dome of the Royal Observatory at Greenwich^a This being generally visible from a considerable extent of the river below London-bridge, masters of vessels observing it can regulate their time-pieces or note their errors This system of signals is in progress of extension By means of a galvanic clock at the Observatory, and the conducting wires which connect that building with the station of the Electric Telegraph Company at Lothbury, hourly signals giving accurately Greenwich time are transmitted to the offices of the company at Lothbury, and in the Strand opposite Hungerford-market Similar signals are transmitted several times a day to Tunbridge, Deal, and Dover by the wires of the South-eastern Company Signal balls are let fall over the dome of the Telegraph Office in the Strand and at an elevated station, Liverpool, at the same instant with the fall of the ball over the Greenwich Observatory Besides this time-signals are transmitted on the wires twice a day, at 10 in the forenoon, and 1 in the afternoon, directly from Greenwich to various chief stations upon the system of lines of the Electric Telegraph Company

267 From the first instant of the laying of the wires connecting the Greenwich Observatory with the stations of the South-eastern Railway Company and the Electric Telegraph Company, it was evident that one of the earliest and most useful applications of them would be the determination of the longitudes of several of the principal observatories in the British Isles and on the Continent During the year 1853, the earliest opportunities were accordingly taken for determining the longitudes of Cambridge, Edinburgh, and Brussels, which was accomplished with complete success, as far as regards the galvanic communications and the observations of the signals at all the observatories

The observatories of Greenwich, Brussels, and Paris are now placed in direct electric connection by the submarine cables between Dover, Calais, and Ostend, to the great advantage and advancement of astronomical science

268 In the routine of the business of an observatory, the astronomical clock is an instrument in never ceasing use A part of almost every astronomical observation consists in noting with the last degree of precision the moments of time at which certain phenomena take place, and so great is the degree of perfection to which the art of observation has been carried, that well-practised observers are able, by the combination of a quick and observant eye and ear, to *bisect a second*, and even to approach to a still

^a See Tract on Latitudes and Longitudes

ASTRONOMICAL USES OF THE TELEGRAPH

more minute division of that small interval. In order to enable the reader fully to appreciate the benefit which the telegraph has rendered to astronomy, it will be necessary here briefly to explain the manner in which this kind of observation has hitherto been made.

To determine the moment at which the visual ray proceeding from a celestial object has some definite direction, two things are necessary—1st, to ascertain the direction of such a ray, and, 2ndly, to observe the time when it has such direction. The telescope, with its accessories, supplies the means of accomplishing the former, and the astronomical clock the latter.

If t t' , fig. 93 represent the tube of a telescope, t the extremity in which the object-glass is fixed, and t' the end where the

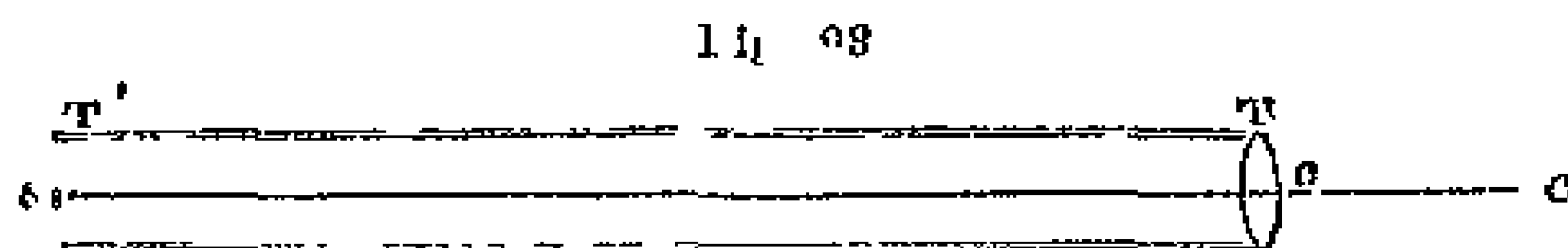

images of distant objects to which the tube is directed are formed, the visual direction of any object will be that of the line $s'c$ drawn from the image of such object formed in the *field of view* of the telescope to the centre c of the object-glass, for if this line be continued, it will pass through the object s .

But since the field of view of the telescope is a circular space of definite extent, within which many objects in different directions may at the same time be visible, some expedient is necessary by which one or more fixed points in it may be permanently marked, or by which the entire field may be spaced out as a map is by the lines of latitude and longitude.

This is accomplished by a system of fibres or wires, so thin that even when magnified they will appear like hairs. These are extended in a frame fixed within the eye-piece of the telescope, so that they appear when seen through the eye-glass like fine lines drawn across the field of view.

The system consists commonly of five or seven equidistant wires, placed vertically at equal distances, and intersected at their middle points by a horizontal wire, as represented in fig. 94. When the instrument has been adjusted, the middle wire $m m'$ will be in the plane of the meridian, and when an object is seen upon it, such object will be on the celestial meridian, and the wire itself may be regarded as a small arc of the meridian rendered visible.

The *eye* of the observer is occupied in watching the progress of the object moving over the wires in the field of view of the

telescope

His ear is occupied in noting, and his mind in counting the successive beats of the pendulum, which in all astronomical clocks is so constructed as to produce a sufficiently loud and distinct sound, marking the close of each successive second. The practical observer is enabled with considerable precision in this way to subdivide a second, and determine the moment of the occurrence of a phenomenon within a small fraction of that interval. A star, for example, is seen to the left of the wire mm'

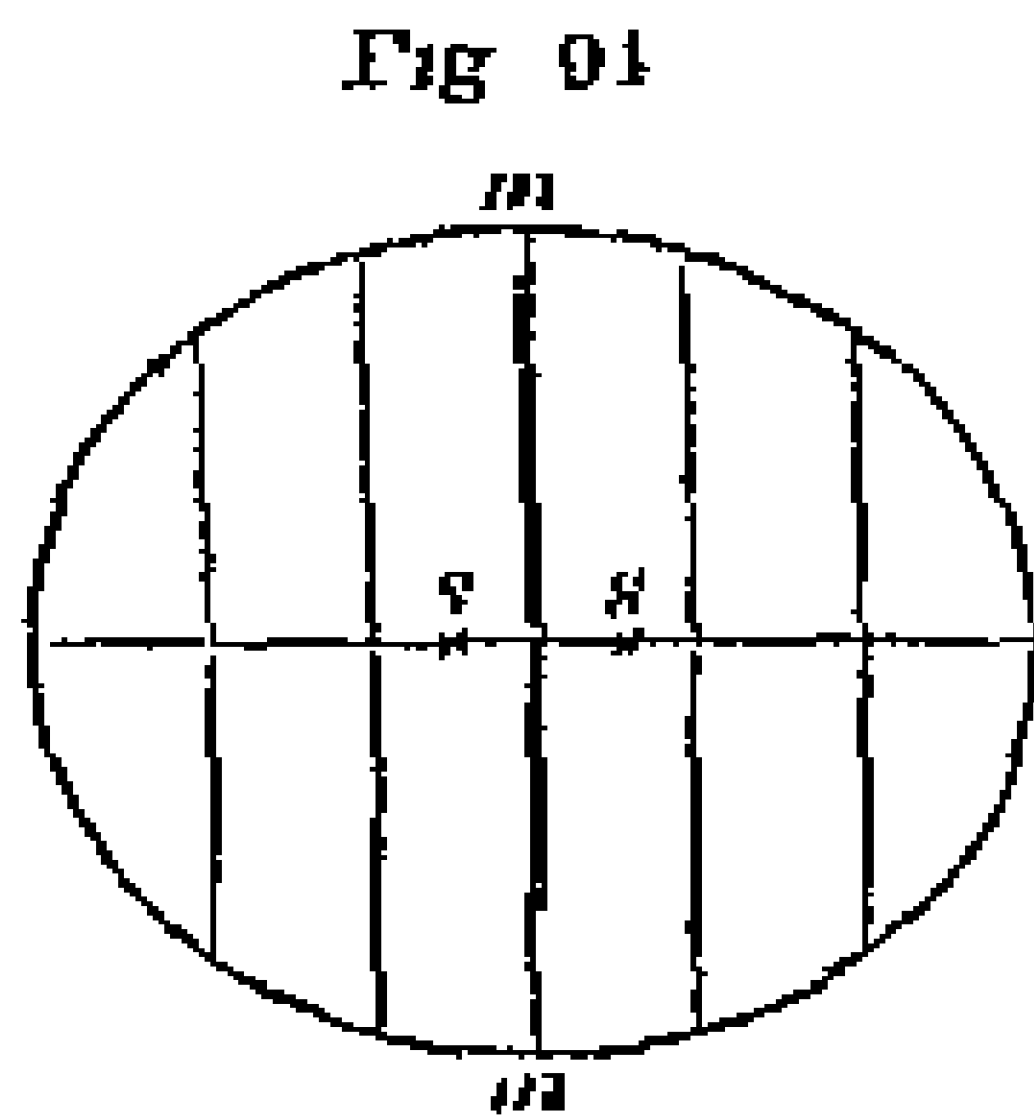

at s , fig 91, at one beat of the pendulum, and to the right of it at s' with the next. The observer estimates with great precision the proportion in which the wire divides the distance between the points s and s' , and can therefore determine the fraction of a second after being at s , at which it was upon the wire mm' .

The fixed stars appear in the telescope, no matter how high its magnifying power be, as mere lucid points, having no sensible magnitude. By the diurnal motion of the firmament, the star passes successively over all the wires, a short interval being interposed between its passages. The observer, just before the star approaching the meridian enters the field of view, notes and writes down the *hours* and *minutes* indicated by the clock, and he proceeds to count the *seconds* by his ear. He observes the instant at which the star crosses each of the wires, and taking a mean of all these times, he obtains, with a great degree of precision, the instant at which the star passed the middle wire, which is the time of the transit.

By this expedient the result has the advantage of as many independent observations as there are parallel wires. The errors of observation being distributed, are proportionately diminished.

When the sun, moon, or a planet, or, in general, any object which has a sensible disk, is observed, the time of the transit is the instant at which the centre of the disk is upon the middle wire. This is obtained by observing the instants which the western and eastern edges of the disk touch each of the wires. The middle of these intervals are the moments at which the centre of the disk is upon the wires respectively. Taking a mean of the contact of the western edges, the contact of the western edge with the middle wire will be obtained, and, in like manner, a mean of the contacts of the eastern edge will give the contact of that edge with the middle wire, and a mean of these two will give the moment of the transit of the centre of the disk, or a mean of all the contacts of both edges will give the same result.

By day the wires are visible, as fine black lines intersecting and

ASTRONOMICAL USES OF THE TELEGRAPH

spacing out the field of view. At night they are rendered visible by a lamp, by which the field of view is faintly illuminated.

These points being well understood, no difficulty will be found in understanding the manner in which the telegraph has conferred vastly increased facility and precision on such observations.

269 The first service which it has rendered is that of making all the clocks in the observatory absolutely synchronous. This has been already accomplished with regard to the solar clocks, that is, those which indicate mean or civil time. It may be, and no doubt will be, also accomplished, with still greater advantage to science, in the case of the astronomical clocks, that is, those which mark sidereal time. The several observers, occupied usually in different rooms, have each their own clock. Now, however perfect may have been the workmanship of these clocks, no two of them can be relied upon to go absolutely together for any length of time, therefore, one of the duties of the observer, and of the conditions of good observations, is to note the error of his clock—that is, its deviation from the standard chronometer of the observatory. These errors will be effaced by the expedient of putting all the clocks in the observatory in electrical connection, so that the pendulum of the standard chronometer shall regulate the pulsations of the current, and these pulsations again regulate the motion of all the other clocks.

We believe that the Astronomer Royal once contemplated this improvement, and most probably, when suitable opportunity shall be presented, he will carry it into practical effect.

270 The clocks being thus reduced to absolute accordance, the next service rendered by the telegraph to the astronomer consists in affording the means of ascertaining the instant of time at which any celestial object passes across the micrometer wires with greater facility and precision than were attainable by the use of the eye and ear in the method above described.

This improved method of observation, as it is now being prepared for the Greenwich Observatory, consists in a key-commutator placed under the hand of the observer, which governs a current transmitted to an electro-magnet, connected with a style placed over a cylinder coated with paper, upon which it leaves a puncture when it is driven down by the pulsation imparted to the current by the finger of the observer acting upon the key. The paper-covered cylinder is kept in uniform revolution at any desired rate by clock-work, and another style impelled by another current receiving its pulsations from the pendulum of the chronometer, is driven upon the paper with each beat of the pendulum, the interval between two successive marks made by this style representing one second of time.

THE ELECTRIC TELEGRAPH

Now let us suppose, for example, that by the motion imparted to the cylinder, an inch of the paper passes in each second under the style. The style moved by the clock will therefore leave a succession of marks upon the paper, at distances of an inch asunder. But the particular distance of these marks is unimportant, nor is it material that the cylinder should be moved with mathematical precision. If its motion for the short interval of a second be practically uniform, that will suffice.

When the object, a star for example, approaches the field of view, the observer, with his eye to the telescope, holds his finger over the key. He sees the star enter the field and approach the first wire. The moment it crosses the wire, he presses down the key, and the style gives a puncture to the paper on the cylinder. In the same manner, when the star crosses the second and succeeding wires, he again and again presses on the key, and thus leaves as many distinct marks on the paper as there are wires.

After the observation thus made has been concluded, the marks on the paper are examined, and their distances from the preceding and following marks made by the pendulum style are exactly measured, from which is inferred the fractional part of a second, between the moment at which the star crossed each of the wires, and the last beat of the pendulum.

In this way the time of the transit is ascertained to the hundredth part of a second.

The Astronomer Royal, noticing this method of observing, in an address delivered before the Royal Astronomical Society, said, that "In ordinary transit observations, the observer listens to the beat of a clock while he views the heavenly bodies passing across the wires of the telescope, and he combines the two senses of hearing and sight (usually by noticing the place of the body at each beat of the clock) in such a manner as to be enabled to compute mentally the fraction of the second when the object passes each wire, and he then writes down the time in an observing-book. In these new methods he has no clock near him, or at least none to which he listens. He observes with his eye the appulse of the object to the wire, and at that instant he touches with his index, or key, with his finger, and this touch makes, by means of a galvanic current, an impression upon some recording apparatus (perhaps at a great distance), by which the fact and the time of the observation are registered. He writes nothing, except perhaps the name of the object observed."

He further observed that it was expected that by this method the irregularities of observation would be greatly diminished, whether because the sympathy between the eye and the finger is more lively than between the eye and the ear, remains to

ASTRONOMICAL USES OF THE TELEGRAPH

be determined. The Astronomer Royal proposes to use the "centrifugal or conical-pendulum clock" as an instrument superior in every way to those used in America, and "considering the problem of smooth and accurate motion as being now much nearer to its solution than it had formerly been, it might be a question whether, supposing a sidereal clock made on these principles to be mounted at the Royal Observatory, it should be used in communicating motion to a solar clock."

It is worthy of remark also, that punctures can be made upon the same revolving barrel by observers employed at two or more instruments erected in different rooms, by means of keys or commutators, which complete the circuit from the same battery to the same puncturing-point. This is at present done with two instruments at Greenwich. All necessity for comparing clocks is, of course, avoided.

Some difficulties occurred at first in imparting to the cylinder a sufficiently smooth and equable motion, the motion given by common clock-work being always one made by starts like that of the seconds' hand of a pendulum. It was to surmount this difficulty that the Astronomer Royal proposed the substitution of the centrifugal pendulum (resembling the governor of a steam engine) for the ordinary oscillating pendulum. In the report of the Astronomical Society, published in February, 1854, it was announced that "The various difficulties which occurred from time to time in the mechanism of the barrel or smooth-motion clock, used for giving motion to the cylinder on which will ultimately be recorded the transits made with the transit-circle and altazimuth, according to the American method of self-registration, have been overcome. It now carries the cylinders put in connection with it with perfect regularity, its rate having all desirable steadiness."

TELEGRAPHIC LINES OF THE UNITED KINGDOM

271 The telegraphic lines established throughout these countries have been constructed altogether by private companies, chartered or incorporated by the legislature. The total extent of lines in actual operation in the beginning of 1854, was a little more than 8000 miles, upon which about 10000 miles of conducting wire were laid, which would give an average number of five conducting wires over the entire telegraphic net-work.

272 This vast machinery of electric communication has been erected by five or six different companies, but the chief part of it by two—the Electric Telegraph Company, and the English and Irish Magnetic Telegraph Company. The former possesses nearly

THE ELECTRIC TELEGRAPH

4500 miles of line, and more than 24000 miles of wire, and the latter 2200 miles of line, and 13000 miles of wire

The capital of the former is nearly 800000*l*, and that of the latter 300000*l*

It is estimated that the total amount of capital invested in the telegraphic lines of the United Kingdom may amount to about million and a half sterling

THE ELECTRIC TELEGRAPH COMPANY

273 This company was the earliest established, and was in operation for four years without any rival whatever, and for six years without any real competition. These circumstances will explain the large proportion in which the extent of this company's lines exceed all others

The consequence of the exclusive possession of this important machinery of intercommunication combined with the want of an experience as to the extent to which the public in general might be disposed to avail itself of the advantages offered to them, was naturally and very excusably the establishment of a high tariff. The use of the telegraph was regarded, so far as related to private individuals, as a luxury rather than a necessary of social life, and so far as related to men of business, as an expedient likely to be resorted to only in cases of the most pressing urgency. Conceding the justice of these views, a high tariff was not only defensible but absolutely necessary to the protection of the interests of those who had invested their capital in the enterprise

Time, experience, and habit, on the one hand, rendered the public familiar with the uses of the telegraph, and created a greater disposition to profit by it for the ordinary purposes of life and on the other, supplied to the Company that experience which its managers stood in need of, and enabled them, without imprudent risk, to develop liberal and enlightened views on the commercial management of the enterprise. Gradual reductions were made in the tariff, which were further stimulated by the establishment of competitors, and a standard of tariff has been established which, as will presently appear, can leave no reasonable ground of complaint as compared with those of other countries. Whether a still further reduction and a nearer approach to the principle of the uniform postage system would not benefit the companies as well as the public is a question that time and experience alone can solve

274 The following table, for which we are indebted to the Board of Directors of this company, shows the extent of its lines

NAME OF RAILWAY	No of Miles of Wires.	No of Wires.	No of Double needle Instruments.	No of Single needle Instruments.	No of Printing Instruments.	No of Belts.	No of Magnets.
BANGOR AND CAFRNARVON	26½	3	2	4		4	
BIRMINGHAM, SHIRWSBURY, AND STOUR VALLEY RAILWAYS							
Birmingham, Wolverhampton, and Shrewsbury	138½	4	12			1	
Birkenhead, Lancashire, and Cheshire Junction	87½	2	3				
Birkenhead Tunnel				1		2	
Sutton Tunnel				1		1	
CILSTON AND HOVEHEAD	366½	4	15				
EASTERN COUNTIES							
London to Colchester	410	8	16				
Between Braintree and Maldon	36	3	3			2	3
London to Ely	650½	9	36			26	23
Ely to Norwich			15	4		9	4
Rakenham to Norwich			11	6		10	
Norwich to Yarmouth } Lowestoft }			13	29		13	
Chesterford to Bury			7				1
Chesterford to Newmarket			6				
Ely to Peterborough	148½	5	7			6	6
March to Wisbech	27	3	2			2	2
Cambridge to St Ives	44½	3	6			6	6
Broxbourne to Hemford	21	3	2			2	2
Waterlane to Lnfild	6	2	2			2	
Shoreditch to Chatham				16		2	
Leeds to Attleborough	3½	1		2		2	
Audley End to Littlebury	4	2	2			2	
Shoreditch to Brick Lane	1	2	2			2	
Stratford to Woolwich	15	3	5			5	
Stratford to Clapton	0½	1				1	2
West Junction to Stratford Budge	2½	3	5			7	
Coal siding to Angel Lane	0½	1				2	
Forest Gate to Angel Lane	1	1				2	
Chobham Farm Lane	1	1		6			
EASTERN UNION							
Colchester to Ipswich	86½	9	6			6	5
Ipswich to Managers' office	1	2	2				
FLETCHER AND CRIBTON	83½	2	4				
FURNESS LINE							
Lindal to Dalton	2½	2	2				
Whitehaven Tunnel	0½	1		2		2	
GREAT NORTHERN							
London to York	762	4	19		2		
London to York via Boston	421	2	8				
Peterborough to Grimsby	156½	2	7				
Boston to Retford	102	2	4				

NAME OF RAILWAY	No of Miles of Wires	No of Wires.	No of Double needle Instruments	No of Single needle Instruments.	No of Printing Instruments	No of Bells	No of Masts
Lincoln to Gainsborough	33 $\frac{1}{2}$	2	2				
Gunsby to Docks	1	4	2				
Knottingley to Leeds	16	2	5				
Bawtry to Rossington	7	2	2				
GREAT WESTERN RAILWAY							
London to Bristol	827 $\frac{3}{4}$	7	22				
London to Birmingham	257 $\frac{1}{2}$	2	20				
London to Maidenhead	67 $\frac{1}{2}$	3	9	9		9	
Slough to Windsor	12	4	1				
Reading to Basingstoke	51	2	2				
Oxford to Banbury	23	1				5	
Swindon to Gloucester <i>via</i> Onnecester	90	2	8				
Tetbury to Brimscombe	8 $\frac{1}{2}$	1		2			
Box to Corsham	30	1		2			
Bath to Bristol	23	2	4				
Bristol and Exeter Railway	531	6	13				
Yatton to Clevedon	8	2	2				
Tiverton Junction to Tiverton	20	4	2				
Taunton to Yeovil	50	2	6				
LANCASHIRE AND YORKSHIRE RAILWAY							
Manchester to Normanton	355 $\frac{1}{4}$	7	31			8	
Summit Tunnel	3 $\frac{1}{4}$	2	2				
North Dean to Bradford	20	2	5				
Wakefield to Normanton	16	1			Included in C N R		
Waterloo to Southport	39 $\frac{1}{2}$	3	3			3	
Castleford to Methby	1 $\frac{1}{2}$	2			Included in C N R		
LANCASTER AND PRESTON, AND LANCASTER AND CARLISLE RAILWAY							
Lancaster to Preston	42	2	2				
Lancaster to Carlisle	138	2	5				
Oxenholm to Kendal	8	4					
LONDON, BRIGHTON, AND SOUTH COAST RAILWAY							
London to Brighton	202	4	17				
Brighton to Newhaven	29 $\frac{1}{2}$	2	4				
London to Epsom	36	2	3				
London to Croydon	21	2	8				
Croydon to Epsom	7 $\frac{1}{2}$	1		2			
Littlehampton to Ford	31 $\frac{1}{2}$	2	2				
Bricklayers Arms to Deptford	5 $\frac{1}{2}$	2	2				
Bricklayers Arms Junction to Forest Hill	5	2	5				
Balcombe Tunnel	0 $\frac{1}{2}$	1		2			
Clayton Tunnel	1 $\frac{1}{2}$	1		2			
Crystal Palace Extension	15	10	6				
LONDON AND NORTH WESTERN RAILWAY							
LONDON AND BLACKWALL	20	4	4			2	
London to Colwich	1012	8	3				

NAME OF RAILWAY	No of Miles of Wires	No of Wires	No of Double needle Instruments	No of Single needle Instruments.	No of Printing Instruments	No of Bells.	No of Magnets
Macclesfield to Liverpool	392	8	7		4		
London to Rugby	744 ¹ / ₄	9	15		3		
Bletchley to Blisworth	65	4	8			2	2
Fuston to Camden	2	2	2			2	2
Pinnose Hill Tunnel	4 ¹ / ₂	6	4			4	4
Watford Tunnel	3	3	2			2	2
Bletchley to Windsor	30	4	4			2	
Windsor to Banbury	47 ¹ / ₂	2	4			4	
Windsor to Oxford	48	2	5			2	
Windsor to Junction	4	2					
Buckingham to Goodshed	0 ¹ / ₂	2		2		2	
Blisworth to Peterborough	141 ¹ / ₄	3	10			7	7
Kilsby Tunnel	5 ¹ / ₄	3	2			2	2
Rugby to Market Harborough	35 ¹ / ₂	2	5				
Rugby to Leamington	30	2	1				
Rugby to Birmingham	208 ¹ / ₂	7	7				
Rugby to Tamworth	160 ¹ / ₂	6	2				
Tamworth to Colwich	68	4	2				
Birmingham to Manchester	595	7	17		1		
Crews to Warrington	97	4	3				
Warrington to Newton Junction	28 ¹ / ₂	6	2				
Newton Junction to Liverpool	162 ¹ / ₂	11	6		3		
Newton Junction to Preston	97	4	4				
Newton Junction to Manchester	150 ¹ / ₄	9	3		1		
Macclesfield to Stockport	29 ¹ / ₂	2	3				
Stockport to Manchester	12	2	1				
Stockport to Guidebridge	10	2					
Guidebridge to Eaton Lodge	217 ¹ / ₂	6	6				
Muswell Junction to Leeds	40	4	4				
Saddleworth to Mornden	15	3	4			4	4
Huddersfield Tunnel	1 ¹ / ₂	3	3			3	3
Morley Tunnel	6	3	2			2	2
Manchester to Hardwick	4 ¹ / ₂	6					
Warrington to Preston Brook Junction	19	4					
Edge Hill to Lime street	2 ¹ / ₂	2			2	2	
Edge Hill to Byron street	2	2			2	2	2
Waterloo to Wapping	10 ¹ / ₂	3	4			4	4
Quizon street to Biscot	19	2	2				
LONDON AND SOUTH WESTERN RAILWAY							
Waterloo to Portsmouth	378	4	17				
Waterloo to Southampton	78 ¹ / ₂	1			2		
Bishopstoke to Southampton	33	6	4				
Itchenham to Gosport	19	4	2				
Waterloo to Nine Elms	4	2	3				
Southampton to Dorchester	184 ¹ / ₂	3	8			8	
Poole Junction to Poole	7 ¹ / ₂	5				3	
Southampton to Blockenhurst	30 ¹ / ₂	2	1				

NAME OF RAILWAY	No. of Miles of Wires.	No of Wires	No of Double needle Instruments.	No of Single needle Instruments	No of Printing Instruments.	No of Bells.	No of Masts.
Brockenhurst to Osborne	64	2	4				
MANCHESTER, SHEFFIELD, AND LINCOLN SHIRE RAILWAY							
Manchester to Sheffield	165	4	10				
Denting to Glossop	4	4	1				
Sheffield to New Holland	1 1/2	2	10				
Ulesby to Great Gimsby	19 1/2	2	2				
Lincoln to Baintby	59	2	6				
Woodhead to Dunford	6	2	2				
MARYPORT AND CARLISLE RAILWAY							
Carlisle to Maryport	56	2	9			5	
MIDLAND RAILWAY							
Derby to Rugby	246 1/2	5	10			2	
Derby to Peterborough	363 1/2	5	9			6	
Peterborough to Leicester	159	3				2	
Melton Mowbray to Stamford	50 1/2	2	2			2	
Derby to Lincoln	146 1/2	3	4			4	
Derby to Sawley	6 1/2	1				1	1
Derby to Normanton	44 1/2	7	15	14		21	1
Normanton to Leeds	75 1/2	7	7			3	
Leeds to Bradford	41 1/2	3	5			4	
Leeds to Skipton	78 1/2	3	7			6	
Apperley to Shipley Cabin	6 1/2	2	2				
Skipton to Lancaster	78	2	1				
Hunslet to Hunslet Junction	0 1/2	1				2	
Hunslet Junction to Waterlane	0 1/2	1			2	2	
Sheffield to Masbrough	15	3	2			2	
Derby to Willington	13	2				1	1
Derby to Birmingham	206 1/2	5	10			5	
Birmingham to Gloucester	371	7	14			6	
Lickey to Bromsgrove		2	2				
Gloucester to Bristol	150	4	8				
MONMOUTHSHIRE RAILWAY AND CANAL							
Newport to Blaina	39	2	7				
Newport to Pontypool	17	2	3				
Risca to Nine Mile Point	2 1/2	1			2	2	
Aberbeeg to Lbbw Vale	5 1/2	1			2	2	
NORTH LONDON RAILWAY							
Camden to Stepney	70	10					
Bow to Poplar	3	2	3				
NORTH STAFFORDSHIRE RAILWAY							
Colwich to Macclesfield	308	8					
Colwich to Stone	46	4	3				
Norton Bridge to Stone	11 1/2	3	2			2	
Stone to Stoke	49	7	3			1	
Stoke to Loco Works	1	2	2				
Stoke to Burton	88 1/2	3	4			1	

NAME OF RAILWAY	No of Miles of Wire	No of Wires	No of Double needle Instruments.	No of Single needle Instrument	No of Printing Instruments.	No of Bells.	No of Magnet
Stoke to Newcastle under Lyne	3	2	2			2	
Stoke to Horcastle	50	8	4			2	
Stoke to Horcastle Tunnel	1	2	2				
Stoke to Crewe	71½	5	1			1	
Stoke to North Rod	27	3		Included above			
North Rod to Macclesfield	23½	5	3			1	
North Rod to Uttoxeter	51½	2	4			3	
Recester to Ashbourne	1½	2	2			2	
OXFORD, WORCESTER, & WOLVERHAMPTON	115	2	13			2	
Worcester to Dudley	110	4	14				
Dudley to Wolverhampton	24	4	3				
SHREWSBURY AND BIRMINGHAM RAILWAY							
Shrewsbury to Wolverhampton	118	1	9			1	
SHROPSHIRE UNION RAILWAY							
Shrewsbury to Stafford	58½	2	3				
SHREWSBURY AND CHESTER RAILWAY							
Chester to Shrewsbury	169	4	7			3	
Wheatshaf Branch	4	4	1			1	
Oswestry Branch	9	4	1				
SHREWSBURY AND HERFORD RAILWAY							
Shrewsbury to Hereford	101	2	13			6	
Ludlow Race course	1	4	1				
Ludlow Tunnel	1½	2					
Dinmore Tunnel	1	4	2			2	
NEWPORT, ABERGAVENNY, AND HERFORD RAILWAY							
Hereford Junction to Hereford Station	82	2	3				
HERFORD, ROSS, AND GLOUCESTER RAILWAY							
Grange Court to Hopobrook	10	2	2				
SOUTH DEVON RAILWAY							
Exeter to Plymouth	371	7	17			14	
Newton to Totness	17½	2	1				
Newton to Torquay	20	4	3				
Totness to Kingsbridge	9	1		3		3	
Plymouth to Kingsbridge	15	1		3		3	
WEST CORNWALL RAILWAY.							
Penzance to Truro	50	2	7				
SOUTH EASTERN RAILWAY							
London to Stood	124	4	26			23	
London to Greenwich	7½	2	4			4	
London to Observatory	7½	2		for time signals			
London to Tunbridge	164	4	9			9	
Tunbridge to Paddock Wood	25	5	2			2	
Paddock Wood to Maidstone	30	3	4			4	
Paddock Wood to Dover	168	4	2	13		15	

NAME OF RAILWAY	No of Miles of Wires	No of Wires	No of Double needle Instruments.	No of Single needle Instruments	No of Priming Instruments.	No of Bells	No of Magnets
Follstone to Harbourn	6	6	3			3	
Ashford to Margate	102	3	3			3	
Minster to Deal	27	3	3			3	
Ashford to Hastings	54	2	6			6	
Tunbridge to Robert's Bridge	84		10			8	
Robert's Bridge to Hastings	24	2	3			3	
Brighton Junction to Hastings	6	2	3			3	
Bricklayers' Arms to Junction	4	4	1			1	
Redhill to Shalford	76	4	4			2	
Shalford to Reading	51	2	7				
Meistham Tunnel to Redhill	7	2		4		4	
Redhill to Signal Pole	0½	1				2	
SOUTH STAFFORDSHIRE RAILWAY							
Bescott to Walsall	7½	5	3			2	
Bescott to Great Bridge	6	2	2				
Great Bridge to Dudley	6	3	2	2		3	1
Walsall to Brownhills	10½	2	2				
SOUTH WALES RAILWAY							
Gloucester to Haverfordwest	647	4	35				
Llandoie to Llansanttl	7	2		6		6	
Tunnel west of Llandoie	2	1		2		2	
S N wharf from S W to Taff Vale Railway	0½	1		2		2	
Loop to Swansea	14	8	2				
Cardiff Docks	5	4	1				
Gloucester to Grange Court	15½	2	1				
TALL VALE RAILWAY							
Cardiff Docks to Merthyr	19	2	5				
Aberdare to Aberdare Junction	1½	2	2				
VALLE OF NEATH RAILWAY							
Neath to Merthyr	46		5				
Huwan to Aberdare Junction	1	1	2				
Merthyr to end of Tunnel	2	1				2	
WHITEHAVEN JUNCTION							
Maryport to Whitehaven	24	2	4			4	
YORK, NEWCASTLE, AND BERWICK RAILWAY							
York to Newcastle	872½	10	18	13	1	19	1
Darlington to Newcastle	47½	1					10
Darlington to Station on Stockton Line	1	1					
Dalton to Richmond	19½	2	2			1	
Dalton to Darlington	5½	1					
Belmont to Durham	12	6	1				
Belmont to Fence Houses	3½	1				4	1
Brockley Whins to South Shields	24	3	2			3	
Newcastle to Brockley Whins	17½	5					
Brockley Whins to Sunderland	35	7	3			3	
Newcastle to Berwick	399	6	8			7	

NAME OF RAILWAY	No. of Miles of Wires	No of Wires.	No of Double needle Instruments	No of Single needle Instruments.	No of Printing Instruments	No of Bells	No of Ma-nets.
Newcastle to Benton	4	1					
Newcastle to Tynemouth	18	2	4				
Belton to Alawick	12	4	2			1	
Fatheld to Washington	4	"		1		1	
Washington to Shields Drops	8	2		1		1	
Shields Drops to Sunderland Dock	16	2		1		1	
Sunderland Dock to Sunderland Station	8	2	Included above				
YORK AND NORTH MIDLAND RAILWAY							
Harrowgate to Church Fenton	48 ¹ / ₂	3	2			2	
Hull to Milford Junction	77 ¹ / ₂	5	9			7	
Biddington to Hull	30 ¹ / ₂	3	5			5	
Scarborough to York	42 ¹ / ₂	3	8			7	
Burton Salmon to Castleford	36	9	2			2	
Castleford to Normanton	33 ¹ / ₂	9	2			1	
Milford Junction to Burton Salmon	4	2					
Milford Junction to York	30	2	"				
York to Burton Salmon	217 ¹ / ₂	13	10				
EDINBURGH, PERTH, AND DUNDEE							
Edinburgh to Tay Port	159	3	11			11	
Ladybank Junction to Perth	36	"					
Edinburgh to Scotland street	1	2					
EDINBURGH AND GLASGOW RAILWAY							
Edinburgh to Glasgow	332 ¹ / ₂	7	9		3	7	
Edinburgh to Greenhill	60	2	1				
Cowlands to Hut Tunnel end	2 ¹ / ₂	2	2			2	
Haymarket to Edinburgh Tunnel end	3 ¹ / ₂	2					
Edinburgh to Loth street work	4	4	2				
DUNDEE AND ABBROATH RAILWAY							
Dundee to Broughty	9	"	1				
Tay Port Submarine cable	4	4					
NORTH BRITISH RAILWAY							
Berwick to Edinburgh	346 ¹ / ₂	6	10			10	
Portobello to Hut Tunnel	6	"	2			2	
	120 yds						
SCOTTISH CENTRAL RAILWAY							
Greenhill to Perth	180	4	9			7	
METROPOLITAN STATIONS	500	52	71		5		

275 According to the tariff, as last arranged by the Electric Telegraph Company, all messages consisting of not more than 20 words are transmitted to distances not exceeding 50 miles for 1s, to distances not exceeding 100 miles for 2s 6d, and to all

TELEGRAPHIC LINES

greater distances for 5s. For each additional ten words, or fraction of ten words proportionate charges are made.

In certain exceptional cases the shilling charge is extended to much greater distances than 50 miles, and the half-crown charge to much greater distances than 100 miles. These exceptions include towns of the highest commercial and manufacturing importance, with which a large telegraphic business must always be transacted. Thus, between London and Birmingham (112 miles) the charge is only 1s., and between London and Liverpool (210 miles), London and Manchester (180 miles), London and Carlisle (309 miles), the charge is only 2s. 6d.

The charge for transmission is of course increased in proportion to the length of the message, but the daily experience of the telegraphic offices demonstrates that, with the exception of reports transmitted to the newspapers, the average length of the messages does not much exceed twenty words. I have obtained a return of the lengths of 74 messages transmitted, without any particular selection of subject, the total length of which, exclusive of the address, is 1151 words. The total length of the addresses is 510 words. This gives for the average length of the messages 15½ words, and of the addresses 7½ words, the average length of the messages, including the addresses, being therefore a little under 23 words.

Besides the convenience offered to the public by the transmission of messages to the various stations throughout the country, this Company has established a system of metropolitan intercommunication by means of seventeen branch stations in connection with each other and with the principal station at Lothbury. These stations are dispersed through the metropolis at points which have been found to be the most active centres of intercourse. They include the eight railway stations, the London Docks, Mining Lane, General Post-office, St Dunstan's Church, West Strand, Great George Street Westminster, St James's Palace, Knightsbridge, and the Marble Arch, Hyde Park. Of these the stations on the West Strand, and the Eastern Counties Railway, Shoreditch, are open day and night.

Messages of 20 words are transmitted between any two of these metropolitan stations for 1s.

In all cases the charge for the telegraphic message includes its delivery at the place of address, provided that such place be within a radius of half a mile round the station, 6d. being charged for each mile additional, and no charge is made for the addresses of the sender or receiver.

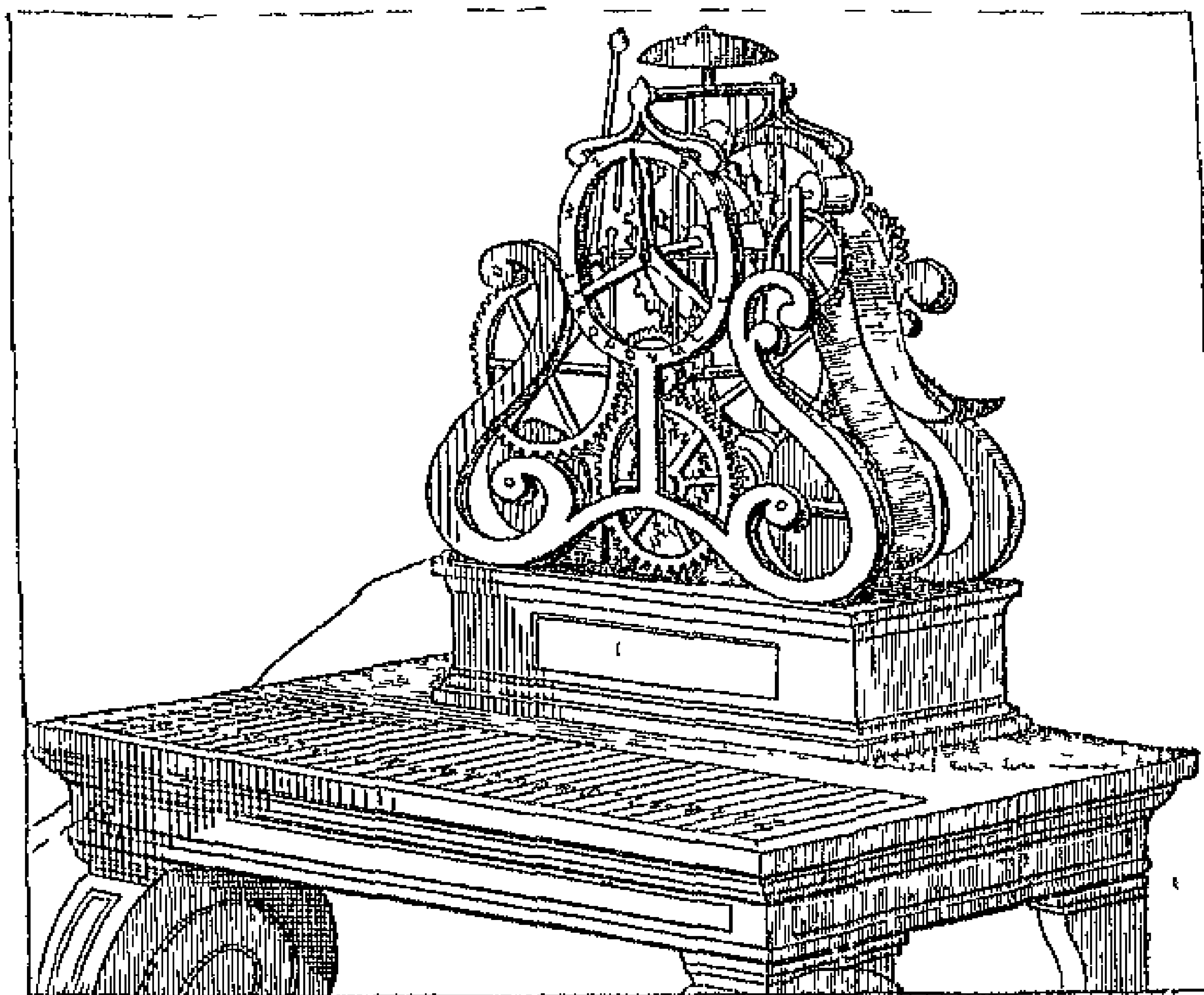

Fig 92 —HEPPE'S PRINTING TELEGRAPH

THE ELECTRIC TELEGRAPH

CHAPTER XIV

Electric Telegraph Company's present tariff (continued) —276 Magnetic Telegraph Company —277 Chartered Submarine Company —278 The Submarine Telegraph Company between France and England —279 European and American Telegraph Company —280 Origin of the submarine companies' enterprises —281 Wonderful celerity of international correspondence —282 Organisation of electric communications with the Continent —283 Mediterranean Electric Telegraph Company —284 General table showing the places on the continent of Europe, which are in electric connection with each other, and with England, and the cost of despatches sent between them severally and London —285 Telegraphic lines in the United States —286 Vast projects in progress or contemplation

According to the half yearly balance sheet of the company it appears that in the six months ending December 31, 1853, the

THE ELECTRIC TELEGRAPH

gross revenue amounted to 569197, and that the dividend was 7 per cent per annum on the capital.

The receipts would represent an average daily business of about 6200 shilling messages.

This company possesses the English patent of many forms of telegraph, including those of Baudot. It works, however, chiefly with the double needle telegraph, impelled by current from the ordinary plate battery of zinc and copper, excited by acidulated water. The transmission of each despatch, consequently, occupies two conducting wires, and two batteries with their accessories.

On certain lines, as for example between London and Liverpool, the instrument of Baudot is used. This is attended, as compared with the needle instrument, with two advantages, first, that it requires only one line wire, and secondly, that it writes its own despatch. With the needle instrument two copies of each despatch must be made, one to be delivered as addressed, and the other to be retained by the office. In using Baudot's method, that which is written in telegraphic cipher by the instrument is retained by the office, so that the time of one clerk is saved.

In the organisation of its establishment, the Electric Telegraph Company have made an innovation on our national customs, which cannot be regarded as otherwise than happy and judicious, by rendering electric-telegraphy the means of enlarging the sphere of female industry in this country. In no part of the civilized world, — except perhaps the United States, where our customs have been retained, — are females excluded from so many employments suited to them, as in England. In France they are extensively employed as clerks in various branches of commercial business. As money-takers or ticket sellers in railway offices, theatres, concert-rooms, and in short in all public exhibitions they are engaged, to the entire exclusion of the other sex. As box-keepers and box-openers in all the theatres, and in numberless other occupations in which no bodily labour is needed, they are preferred to men.

Now the working of telegraphic instruments, and the general business of telegraphic offices is precisely the kind of occupation for which they are best fitted, and we notice with great pleasure the independent and enlightened step taken by the Electric Telegraph Company in their employment, which it may be hoped will prove only the commencement of a general movement, having a tendency to improve the condition of that portion of the sex who are obliged to seek the means of living by their industry.

The battery department is not one of the least interesting objects presented in the Lothbury establishment. The columns of the building are appropriated to this generator of electric current.

ELECTRIC TELEGRAPH COMPANY

They consist of two long narrow vaults, in which upwards of 300 batteries are arranged, consisting of various numbers of pairs of plates, six, twelve, and twenty-four, adapted to carry smaller and greater distances

The entire amount of voltaic power employed by this company throughout the country consists of 96000 cells composed of 1,500000 square inches of copper, and an equal surface of zinc. These are kept in action by the consumption of six tons of acid annually

In the half year ending 31st December, 1851, the paid up capital of the company was augmented, and the tariff for the transmission of messages was reduced in the large proportion of 50 per cent upon its original rate. The extent of the line was increased 8 per cent, and that of the conducting wires nearly 30 per cent. The average number of wires upon the lines was augmented by this change from 1 to 3. The effect of this, and the gradual increase from month to month in the next half year was an increase of above 60 per cent in the amount of business, and nearly 13 per cent in the receipts, the dividends having been augmented from 4 to 6 per cent.

Among the more recent improvements in the transaction of telegraphic business which have been made by this company, the following may be mentioned

“Franked message papers,” pre-paid, are now issued, procurable at any stationer’s. These, with the message filled in, can be dispatched to the office when and how the sender likes, and the company intend very quickly to sell electric stamps, like Queen’s heads, which may be stuck on to any piece of paper, and frank its contents without any further trouble. Another very important arrangement for mercantile men is the sending of “remittance messages,” by means of which money can be paid in at the central office in London, and, within a few minutes, paid out at Liverpool or Manchester, or by the same means sent up to town with the like dispatch from Liverpool, Manchester, Bristol, Birmingham, Leeds, Glasgow, Edinburgh, Newcastle-on-Tyne, Hull, York, Plymouth, and Exeter. There is a money-order office in the Lothbury establishment to manage this department, which will, no doubt, in all emergencies speedily supersede the government money-order office which works through the slower medium of the post-office.*

* Quarterly Review, No CLXXXIX, p 149

THE ELECTRIC TELEGRAPH

The effect of the gradual reduction of the tariff upon the business, and the profits of the company, will be apparent from the following table —

Half Year Ending	Miles in operation	Increase per cent	Miles of line wire	Increase per cent	Mean Number of Wires	Number of Messages	Increase per cent	Total Receipts	Increase per cent	Average Receipts per Message	Average Receipts per Mile of Wire	Dividends paid per cent per annum
June 30, 1850	1684		6730		4	29245		£ 20436 10 0		13 11 ³ / ₄	£ 5 04	4
Dec 31, 1850	1786	6 06	7200	6 98	4	37389	27 84	23087 13 9	27 84	12 4	3 20	4
June 30, 1851	1965	10 02	7900	9 72	4	47259	26 39	25529 12 4	26 39	10 9 ¹ / ₄	3 23	6 and 2 per cent bonus
Dec. 31, 1851	2122	99	10650	34 81	5	58957	14 17	24336 8 10	14 17	90 1 ³ / ₄	2 29	6
June 30, 1852	2502	17 91	12500	17 37	5	87150	61 52	27437 4 8	61 52	6 8 ¹ / ₂	2 19	6
Dec 31, 1852	3709	48 24	19540	56 48	5 ¹ / ₂	127987	46 86	40087 18 2	46 86	6 3 ¹ / ₄	2 05	6 ¹ / ₂
June 30, 1853	4008	8 06	20800	6 34	5 ³ / ₄	138060	7 87	47265 16 3	7 87	6 10	2 27	6 ¹ / ₂
Dec. 31, 1853	4409	10 00	24340	17 02	5 ¹ / ₂	212440	53 87	56919 0 1	53 87	5 4 ¹ / ₂	2 34	7
June 30, 1854	4652	5 51	25233	3 67	5 ¹ / ₂	235867	11 03	(2355 0 0)	11 03	5 3 ¹ / ₂	2 47	

THE MAGNETIC TELEGRAPH COMPANY

THE MAGNETIC TELEGRAPH COMPANY

276 This Company has constructed lines connecting the following principal places by means of the submarine cable, extended between Donaghadee and Port Patrick —

London	Portpatrick	Kildare
Birmingham	Donaghadee	Carlow
Manchester	Belfast	Thurles
Liverpool	Armagh	Tipperary
Preston	Diagheda	Limerick
Carlisle	Navan	Waterford
Glasgow	Dublin	Mallow
Greenock	Athlone	Killarney
Edinburgh	Ballinasloe	Cork
Stranraer	Galway	Queenstown

This company has established an underground line of ten wires from London to Liverpool, by Manchester, and one of six wires from Liverpool to Portpatrick, and from thence to Belfast. The line from Belfast to Dublin, and from thence to Cork, with branches, is overground on poles. The underground system is again adopted from Cork to Queenstown.

Lines are in progress of construction along the Waterford and Limerick Railway, and six additional wires are being laid between Dublin and Belfast.

The instruments used are the needle-telegraph, and chiefly the double needle instruments, the current being produced not by galvanic batteries, but by magneto-electric machines, on the principle patented by Messrs Henley and Hoister (220) improved in various details by the Messrs Baight, the secretary and engineer of the company.

The speech delivered by the Queen on opening the parliamentary session of 1854, was supplied verbatim to the Belfast journals at 2 h 25 m, to those of Dublin at 2 h 40 m, and to those of Cork at 3 h 20 m on the afternoon of its delivery.

The tariff is regulated upon principles similar to that of the Electric Telegraph Company.

Although this company was not incorporated until the middle of 1852, it has now (July, 1854) upwards of 2000 miles of telegraphic lines, and 13000 miles of wire in active operation, and from the rapid progress it has hitherto made, and its power to extend its capital of 3000000^l to 6000000^l, it is probable that ere long its scale of operation will be much further extended, to the great benefit of the public.

THE ELECTRIC TELEGRAPH

SUBMARINE COMPANIES

277 The CHARITRED SUBMARINE TELEGRAPHIC COMPANY between Great Britain and the Continent has been formed with a nominal share capital of 150000*l*, of which the half has been for the present received, the actual amount of the subscribed capital being only 75000*l*

The operations of this company have hitherto (1851) been limited to the establishment of electric communication with Belgium, by means of the cable already described, connecting Dover with Ostend

This company has recently coalesced with the Submarine Telegraph Company

278 The SUBMARINE TELEGRAPHIC COMPANY between France and England has a nominal share capital of 100000*l*, of which about 75000*l* have been subscribed and expended, the share representing the remainder being still unallotted The operations of this company have been limited to the establishment of electric communication between France and England, by means of the submarine cable laid between Dover and Calais

279 The EUROPEAN and AMERICAN ELECTRIC TELEGRAPHIC COMPANY has been established to form a link between the cable of the two submarine companies, and London, Manchester, and Liverpool, and intermediate places This company has laid underground wires from Dover to London, and from London by Birmingham and Manchester to Liverpool Of this line, the first section between Dover and London was opened for public correspondence on 1st November, 1852, and has since been in constant operation Of the remainder, 190 miles were completed on 1st March, 1851, passing through Birmingham, Wolverhampton, Stafford, and Macclesfield, to Manchester The remaining 30 miles to Liverpool has been since completed, and the entire line is now in operation The total cost of this line, with its accessories, has been 100000*l*

By an arrangement between this and the Submarine Company, all despatches between the offices of the latter from the Continent are transmitted upon the lines of the former, being delivered and received at the offices of the latter In fact, so far as the public are concerned, the continental correspondence going or coming by France or Belgium is transmitted by these three companies, acting in common and as a single administration Offices for correspondence between England and the Continent are established in London, Birmingham, Manchester, Liverpool, Calais, Ostend, Chatham,

SUBMARINE COMPANIES

Canterbury, Deal, Dover, Calais, Paris, Brussels, and Antwerp, despatches, however, being forwarded to England from all continental stations.

The tariff for all single messages between London and the Continent is 8s, in addition to the Continental charge for transmission between the Continental station to or from which the message is transmitted, and Calais or Ostend. If the message is sent to or from any provincial town (except Dover), there is an additional charge for its transmission between London and such town.

280 The originators of the novel and bold project of submarine electric communication are stated to be the Messrs Jacob and J. W. Brett, brothers, of Hanover-square, London. Their first propositions were addressed to the English government, and were directed to the deposition of a submarine cable between Holyhead and Dublin, which they offered to undertake if the government would make them a grant of 20000*l*, for which, of course, the State would have for public purposes the free use of the line. This offer was declined.

The next propositions, addressed to the French and Belgian governments, were attended with more success. An exclusive privilege was granted by both governments, to which the English government acceded for the use of such submarine conductors as the parties should succeed in depositing, and in consequence of this, the companies were formed, by which the project has since been realized, and the cables already described between the English coast near Dover and the coasts of France and Belgium, near Calais and Ostend, were laid, by which London, Paris, and Brussels have been brought into and now are in instantaneous electric communication, and through these capitals the whole Continent, wherever telegraphic wires have been established, has been put in connection with the United Kingdom.

281 The actual celerity with which correspondence can be transmitted between London and parts of Europe more or less remote, may be judged from the fact that the Queen's speech, delivered at the opening of the parliamentary session of 1854, was delivered verbatim and enulated in Paris and in Berlin before her Majesty had left the House of Lords.

Messages have been sent from the office in Cornhill to Hamburg, Vienna, and, on certain occasions, to Lemberg, in Gallicia, being a distance of 1800 miles, their reception being acknowledged by an instantaneous reply.

282 It is satisfactory to be able to state that measures are being taken by many of the most important continental states to extend the benefits of telegraphic communication by multiplying the

THE ELECTRIC TELEGRAPH

stations, by increasing the number of conducting wires, and by lowering the tariff.

The electric communications with the continent may now be considered as secure from all chance of interruption. Accidents from the dragging of anchors may occur, by which any one of the submarine cables may be disabled for a time, but in that case the communication with the continent will be maintained by either or both of the others, such a coincidence as the simultaneous disabling of all the three not being within the bounds of moral possibility.

MEDITERRANEAN ELECTRIC TELEGRAPHIC COMPANY

283 Another company has been formed by the spirit and enterprise of the Messrs. Betti, under the auspices of the governments of France and Piedmont, for connecting the coasts of Europe and Africa by electric wires, in the manner already explained (81). This company is formed with a share capital of 300000*l*. An exclusive privilege for fifty years has been granted to it by the two governments, and a guarantee of interest of four per cent. on 180000*l*. is given by the French, and 6 per cent. on 120000*l*. by the Sardinian Government.

This enterprise is now (1851) in rapid progress of realisation, several hundred men being occupied in constructing the line across the islands of Sardinia and Corsica. It is expected that the lines to the coast of Africa will be completed and in operation soon after these pages will be in the hands of our readers.

While we write these lines (June, 1851) we learn that the cable has been laid between Spezzia and Corsica, and between Corsica and Sardinia, and is already in successful operation.

The condition and form of the bottom between coast and coast has been ascertained by soundings, and is found to present no obstacles, being free from any considerable inequalities of depth. The conducting wires within this cable have received a special form, the advantage of which is, that in case of the cable being bent by any accidental inequalities of the bottom, or accidents in the process of its deposition, the wires will not be strained, but will easily yield as a spiral spring would. In the cables already laid, it has been found that some of the wires have been more or less injured from this cause, so as to render their performance unsatisfactory.

The weight of this cable is at the rate of 8 tons per mile. It contains six conducting wires, each of which is covered with a coating of gutta serena, and the whole is surrounded with hemp, properly tanned, so as to form a compact rope, which is finally

SUBMARINE COMPANIES

enclosed like those already described in a compound heliograph amount of twelve galvanised iron wires

Until the cable and wires destined ultimately to connect Alexandria with Sardinia can be completed, it is intended to establish a special line of steamers between Malta and Sardinia, so as to be enabled to transmit intelligence instantaneously from the centre of the Mediterranean to London, Paris, and all parts of Europe. Two mercantile houses, Messrs Rubattino and Co, of Genoa, and Messrs Antonio Galen and Co, of Malta, have undertaken conjointly to place two steamers to run between Malta and Sardinia, to take the despatches coming from the East, to be transmitted to Paris and London

It is intended, however, meanwhile, to connect Malta by a cable with the nearest point of the African coast, and by this, and an underground line of wires to Bonn, to establish an electric communication with Sardinia, and thence with London

284 In the following table, collected from the most recent reports, are shown the telegraphic stations established in various countries of Europe in July, 1854. Annexed to each place is the charge at which a single message is transmitted between it and London. Of this charge 8s is the part applicable to the transit between London and Calais or Ostend, the remainder being the cost of transmission between one or other of these places, and the continental station. A single message cannot exceed 20 words if transmitted by Calais, or 25 words if transmitted by Ostend. The charge is increased in a two-fold ratio for messages which exceed this number of words, but which do not exceed 50, and in a three-fold proportion for such as exceed 50, but do not exceed 100. In general, messages exceeding 100 words are not transmitted

In some cases a message may be transmitted by different routes at the option of the person sending it. Thus, for example, a message to Vicenza may be sent *viâ* Baden, *viâ* Bavaria, *viâ* Switzerland, *viâ* Sardinia, or *viâ* Belgium. The cost of transmission in such cases varies with the route chosen. In all such cases the charge given in the Table is the lowest of those at which it can be sent

The tariff by way of the Ilago is not included in this Table

THE ELECTRIC TELEGRAPH

FRENCH STATIONS, <i>vi</i>	<i>s</i>	<i>d</i>	FRENCH STATIONS, <i>vi</i>	<i>d</i>
To ABBEVILLE	10	6	To Lorient	15 0
„ Agen	17	0	„ Lyons	16 0
„ Amiens	11	0	„ MAÇON	15 0
„ Angers	14	0	„ Mans (le)	13 0
„ Angoulême	15	6	„ Marseille	18 6
„ Arras	10	6	„ Melun	12 6
„ Auch	17	6	„ Metz	13 6
„ Auxerre	13	6	„ Mont de Marsan	17 6
„ Avignon	17	6	„ Montpellier	18 0
„ BAR LE DUC	13	0	„ Montauban	17 0
„ Bayonne	18	0	„ Monthaison	15 0
„ Beauvais	11	6	„ Moulins	14 6
„ Behobie	18	6	„ Mulhouse	15 0
„ Besançon	15	0	„ NANCY	14 6
„ Beziers	18	0	„ Nancy	13 6
„ Blois	13	6	„ Narbonne	18 0
„ Bordeaux	16	6	„ Nevers	14 0
„ Boulogne sur Mer	10	0	„ Nîmes	17 6
„ Bourges	14	0	„ Nîort	15 0
„ Brest	15	0	„ ORTANS	13 0
„ CARN	13	0	„ PARIS	12 0
„ Cahors	16	6	„ Pau	18 0
„ Calais	9	0	„ Périgueux	16 0
„ Carcassone	18	0	„ Perpignan	18 6
„ Cette	18	0	„ Portiers	14 6
„ Chalons sur Maine	12	6	„ PRIVAS	16 6
„ Chalons sur Saône	15	0	„ QUIMPER	15 0
„ Chartres (Eure et Loi)	12	6	„ RENNES	11 0
„ Chateaufoux	14	0	„ Rochefort	15 6
„ Chaumont	13	6	„ Roubaix	10 6
„ Cherbourg	12	6	„ Rouen	11 6
„ Clermont Ferrand	15	6	„ SAINT QUENTIN	11 6
„ Colmar (Alsace)	11	6	„ St Etienne	16 0
„ Creil	11	6	„ St Lo	1 6
„ DIJON	11	0	„ St Omer	10 0
„ Dyon	14	6	„ Strasbourg	14 6
„ Douai	11	0	„ TAMIÉ	18 0
„ Draguignan	18	6	„ Tonnerre	13 6
„ Dunkirk	10	0	„ Toulon	19 0
„ EYRIFUX	12	0	„ Toulouse	17 6
„ FOIX	18	6	„ TOURS	14 0
„ GRENOBLE	16	6	„ Troyes	13 0
„ HAVRE	12	0	„ VALENCIENNES	11 0
„ LAON	12	0	„ Valence	16 6
„ La Rochelle	15	6	„ Vannes	14 6
„ Lille	10	6	„ Versailles	12 0
„ Limoges	15	6	„ Vesoul	11 6

SUBMARINE AND EUROPEAN TELEGRAPHS

10	ℓ	10	s ℓ	10	s ℓ
ARAU	20 0	Brunswick	20 0	Ghent	10 0
Arboung	20 0	Brussels	12 0	Giessen	18 0
Adelsberg	22 0	Bühler	22 0	Glarus	22 0
Aeltre	10 0	CARLSRUHE	14 0	Glognitz	22 0
Agiam	22 0	Casale	24 0	Golitz	22 0
Anolo	22 0	Cassel	16 0	Gospich	22 0
Aix la Chapelle	16 0	Charleroi	12 0	Gotha	18 0
Alexandria (Sai)	24 0	Chaux de Fonds	22 0	Goutz	22 0
Altstätten	22 0	Chemnitz	20 0	Gratz	22 0
Altenbourg	20 0	Chiasso	24 0	HANNING	16 0
Altona	24 6	Cilly	22 0	Hagenau	22 0
Altolf	27 0	Cone	22 0	Hague	14 0
Amsterdam	16 0	Come	18 0	Halle	20 0
Andematt	22 0	Coutra	10 0	Han	18 0
Ansbach	18 0	Coblentz	18 0	Hamburg	22 0
Antwerp	12 0	Cologne	16 0	Hannau	18 0
Arnhem	16 0	Copenhagen	24 6	Hanover	20 0
Appenweier	18 6	Cracow	24 0	Harburg	22 0
Aschaffenburg	16 0	DANTZIG	24 0	Hasselt	12 0
Asti	22 0	Darmstadt	15 0	Hattingen	14 0
Ath	12 0	Delomont	20 0	Heidelberg	14 0
Augsburg	18 0	Delft	16 0	Heilbronn	16 0
BADEN, Baden	14 0	Dessau	20 0	Heissau	22 0
Baden (Swiss)	20 0	Deutz	16 0	Heimstadt	26 0
Bale	20 0	Dirschaw	24 0	Heinzenbuchsee	20 0
Bamberg	18 0	Dordrecht	14 0	Hof	20 0
Bautzen	22 0	Dresden	20 0	Hohenschwangau	18 0
Bellinzona	22 0	Dinglingen	14 0	Horgen	27 0
Bergamo	20 0	Duisburg	18 0	INSBRUCK	18 0
Bohm	27 0	Dusseldorf	18 0	Ischl	24 0
Berno	20 0	EMPOLI	35 0	JURBICH	12 0
Berthoud	20 0	Eisenach	18 0	KANISPADT	22 0
Beyreuth	18 0	Elberfeld	18 0	Kempten	18 0
Bieitz	26 0	Elbing	26 0	Kell	14 0
Bienna	20 0	Elmencu	24 6	Kessengen	18 0
Bodenbach	20 0	Erfurt	20 0	Klagenfurt	27 0
Bologna	26 0	Essok	28 0	Klausenberg	30 0
Borgoforte	24 0	FRIEDRICH	18 0	Kohlfurt	24 0
Botzen (in Tyrol)	20 0	Flawyl	22 0	Konigsberg	26 0
Brain le Compte	12 0	Flensburg	24 6	Korson	24 6
Breda	14 0	Fleuici	22 0	Kosel	24 0
Biegenz	18 0	Florence	36 6	Kothon	20 0
Bremen	20 0	Lossano	22 0	Kreutz	24 0
Brescia	20 0	Frankfort on M	15 6	Kufstein	20 0
Breslau	22 0	Frankfort on O	22 0	LABACH	22 0
Bugg	22 0	Frauenfeld	22 0	Landau	14 0
Buxen	20 0	Frederien	24 6	Landen	12 0
Bromberg	26 0	Fribourg (Swiss)	22 0	Landshut	18 0
Buchsul	14 0	Friburg (Baden)	14 0	Langenthal	20 0
Bugletto	12 0	Friedrichshafen	16 0	Lans le boung	20 0
Bruges	10 0	GENEVA	22 0	Fausanno	22 0
Bugg	20 0	Genoa	24 0	Leghorn	34 6
Bunn	22 0	Geirmersheim	14 0	Leipzig	20 0

THE ELECTRIC TELEGRAPH

10	s	cl	10	s	cl	10	s	cl
Lemburg	26	0	Offenburg	14	0	Saint Imier	20	0
Lenzbourg	20	0	Olmütz	22	0	Saint Trond	12	0
Loyden	16	0	Olten	20	0	St Jean de Mau		
Lichtensteig	22	0	Oos	14	0	nonno	20	0
Laego	12	0	Oppeln	24	0	Salzburg	20	0
Liegnitz	22	0	Oisowa	26	0	Samaden	24	0
Liestal	20	0	Oschersleben	20	0	Sarobittek	16	0
Ludau	16	0	Ostend	8	0	Schiedam	16	0
Linz	20	0	PADIBORN	20	0	Schaffhausen	22	0
Loiano	22	0	Padua	20	0	Schwemfurt	18	0
Loele (lc)	22	0	Parma	24	0	Schwyz	22	0
Louvain	12	0	Passau	20	0	Smolin	26	0
Lubeck	22	0	Pays Bas fir	12	0	Sion	22	0
Lucca	34	6	Pepinster	14	0	Sienna	28	6
Luccino	22	0	Pescia	35	0	Soleno	20	0
Ludwigschafen	16	0	Pesth Budo	24	0	Sonebor	20	0
Lugano	24	0	Peterwardin	24	0	Spies	16	0
MAADLBERG	20	0	Pictia Santa	32	6	Spligen	22	0
Malme;	12	0	Piano	22	0	Stettin	22	0
Manage	12	0	Pisa	32	6	Stuttgart	16	0
Mannheim	14	0	Pistoja	37	0	Süssen	22	0
Mantua	20	0	Plasance	26	0	Swinnomundo	22	0
Maiburg	18	0	Plauen	20	0	Szegedin	24	0
Massa	26	0	Poggebonst	37	0	Szolnoek	24	0
Mestre	20	0	Polu	22	0	TAMINI S	12	0
Milan	20	0	Pontadera	33	0	Tarnow	24	0
Minden	20	0	Posen	24	0	Temeswar	16	0
Misocco	22	0	Potsdam	22	0	Termonde	12	0
Modena	24	0	Prague	20	0	Teufen	22	0
Mogaduno	22	0	Priato	37	0	Thalwyl		
Mons	12	0	Priesburg	22	0	Thuisis	22	0
Monza	20	0	Pirmysl	26	0	Tillemout	1	0
Morat	22	0	QUIYRAIN	12	0	Tournay	10	0
Morigois	22	0	RACCONIGI	22	0	Tiento	20	0
Motuis	22	0	Ragaz	22	0	Tieves	16	0
Mousson	10	0	Rapperschwyl	22	0	Troviglio	24	0
Mulheim	14	0	Rastadt	14	0	Trevisa	20	0
Munich	18	0	Ratibor	24	0	Trieste	22	0
Munster	18	0	Ratisbon	18	0	Trogen	22	0
Munzschlag	22	0	Reggio	22	0	Troppau	24	0
Myslowitz	24	0	Rendsburg	24	6	Triaban	22	0
NAMUR	12	0	Rheineck	22	0	Turin	22	0
Neufchâtel	22	0	Richterschwyl	22	0	UDINI	20	0
Neuhausel	24	0	Riesa	20	0	Ulm	16	0
Niederminen	22	0	Rotterdam	14	0	Utrecht	16	0
Nieuw Diep	17	8	Roschach	22	0	Uznach	22	0
Novate	24	0	Rosenheim	18	0	VINICH	20	0
Novi	24	0	Roveredo	20	0	Vercell	24	0
Nuremberg	18	0	Rovigno	32	0	Vercena	24	0
Nyburg	24	6	Rzeszow	26	0	Vicenza	14	0
Nyon	22	0	SAINT GAYT	22	0	Vevoy	22	0
ODERBERG	24	0	Santo Giove	22	0	Vicenza	20	0
Offenbach	16	0	Saint Ghislain	12	0	Vienno	22	0

AMERICAN TELEGRAPHIC LINES

TO	s d	TO	s d	TO	s d
Wadenschwil	22 0	Winterthur	22 0	YVERDON	22 0
Wattwil	22 0	Wittenburg	22 0	ZOFFINGEN	20 0
Weimar	20 0	Worms	16 0	Zug	22 0
Weidau	20 0	Wurzburg	18 0	Zurich	22 0
Wesol	20 0	Wyl	22 0	Zwickau	20 0

* The above rates are inclusive of the usual charge for Postage for Delivery of the Messages to any part of France. No charge to other places. N.B.—The Minimum length of a Message via Belgium is Twenty five Words any other route Twenty Words.

The Public are informed that in order to provide against mistakes in the transmission of MESSAGES by the SUBMARINE and EUROPEAN TELEGRAPHIC COMPANIES every Message of consequence ought to be REPEATED by being sent back from the Station at which it is to be received to the Station from which it is originally sent—Double the usual price for transmission will be charged for repeating the Message to or from any part of France and Half the usual charge to or from any other part of Europe—The Company will not be responsible for Mistakes in the transmission of un-repeated messages from whatever cause they may arise—Nor will they be responsible for Mistakes in the transmission of a repeated Message, nor for delay in the transmission or delivery nor for non transmission or non delivery of any Message whether repeated or un-repeated—No Message that is unintelligible can be transmitted to the Continent in consequence of the regulations of the Foreign Governments—The Companies reserve to themselves the right of refusing all those Despatches which in their opinion are unintelligible—All persons sending more than one Message as a single Despatch will be held liable to pay such further sum in addition to the amount paid on transmission as would have been charged by these Companies if each message had been sent separately.

TELEGRAPHIC LINES IN THE UNITED STATES

285 Owing to the rapid progress and unrestricted freedom of enterprise in the United States, a great number of independent companies have been formed, by which the vast territory, from the Atlantic Ocean to the Mississippi, and from the Gulf of Mexico to the frontiers of Canada, is overspread with a network of wires, upon which intelligence of every description, and personal and commercial correspondence are flowing night and day incessantly from year's end to year's end in a torrent of which the old continents offer no similar example. It is almost impossible to ascertain, even with a tolerable degree of approximation, the actual extent of wires which at any given time are in operation. When we commence an investigation of the statistics, with a view to the collection of facts necessary to form the basis of a report, we are overwhelmed with statements of lines commenced, lines half completed and nearly completed, and many which undoubtedly must be completed before our report can come under the eyes of our readers. All that can be done in such a case is to give the nearest practicable estimate of the extent of these enterprises at a given epoch, indicating in a general manner such as are in progress and likely sooner or later to be completed and brought into practical operation.

THE ELECTRIC TELEGRAPH

The American lines are generally classified according to the telegraph instruments with which they work. These are those of Morse, House, and Bain, all of which transmit despatches by means of a single conducting wire, and all of which write or print the despatches they transmit, those of Morse and Bain, in a telegraphic cipher, and that of House in the common Roman capitals.

Of these three systems, that of Morse is in the most general use—a circumstance which is partly explained by the fact, that it was the earliest adopted, and had established its ground long before either of the competing systems. It must be admitted, that so far as public opinion and favour can be accepted as a test of practical excellence, the system of Morse has received not only a large majority of the suffrages in the United States, but also in the northern and eastern states of Europe.

According to a report published in 1853, the total length of telegraphic wire, at the end of 1852, then in operation in the United States, was 24375 miles, which was distributed between the three systems of telegraphs in the following proportion —

	Miles
Morse	19963
House	2400
Bain	2012
	— —
	24375

It appears by a more recent estimate, published in a report presented by Mr T P Shaffner to the Telegraphic Convention, that in March, 1854, the total extent of telegraphic wire then in operation was above 40000 miles, which were thus distributed —

	Miles
Morse	36972
House	3850
Bain	570
	— — —
	41392

The decrease of the extent of the Bain lines was owing to the coalition of some of the most extensive of them with the Morse companies.

It would thus appear that in little more than twelve months the increase of telegraphic wire amounted to 17000 miles. It is probable, however, that the estimate which we have quoted of the extent in operation at the end of 1852 may have been below the actual length.

AMERICAN TELEGRAPHIC LINES

The following estimate of the capital absorbed by these enterprises is given in Mr. Shullner's report —

	Dollars
Morse lines	5,515,800
Horse	955,000
Ban	171,000
	6,671,800

Being equivalent to 1,100,000/

Except in cases where a great commerce or intercourse prevails, each company maintains only a single conducting wire between station and station. As examples of the exceptions to this may be mentioned, Washington and Philadelphia, connected by seven Morse wires, New York and Buffalo, and New York and Boston, by three, Cleveland and Cincinnati, and Boston and Portland, by two.

In some cases, important terminal stations, such as New York and Boston, are connected by the wires of several competing companies, which follow, however, different routes, serving different intermediate stations.

The State of Ohio, a tract of country lying between the upper part of the river of that name, and the southern shore of Lake Erie, the chief part of which, within the lives of the present generation, was an uncultivated and uninhabited waste, is now overspread with between 3000 and 1000 miles of electric telegraph.

286 Stupendous as have been the projects actually realised in this application of science to the social uses of the United States, they sink into comparative insignificance when others, which are contemplated, and likely to be executed, are stated. Thus we find a report presented to Congress, in the session of 1851, by the Post-office Committee, in which a project of a line of electric telegraph to California is recommended for ultimate adoption. This report says that—

“The route selected by the committee is, according to the survey of Captain W. W. Chapman, U. S. Army, one of the best that could be adopted, possessing as it does great local advantages. It will commence at the city of Natchez, in the State of Mississippi, running through a well settled portion of Northern Texas, to the town of El Paso, on the Rio Grande, in latitude 32°, thence to the junction of the Gila and Colorado rivers, crossing at the head of the Gulf of California to San Diego, on the Pacific, thence along the coast to Monterey and San Francisco. By this route, the whole line between the Mississippi River and Pacific Ocean will be south of latitude 33°, consequently, almost entirely free from the great difficulties to be encountered, owing to the snow

THE ELECTRIC TELEGRAPH

and ice on the northern route, by the way of the South Pass, crossing the Sierra Nevada Mountains in latitude 39°. The whole distance from the Mississippi to San Francisco will be about 2100 miles.

“In a commercial point of view, the line in question assumes a gigantic importance, and presents itself not only in the attitude of a means of communication between the opposite extremes of a single country, however great, but as a channel for imparting knowledge between distant parts of the earth. With the existing facilities, it requires months to convey information from the sunny climes of the East to the less favoured, in point of climate, but not less important regions of the West, coming as they do with the products of art and enterprise. Let this line of wires be established, and the Pacific and Atlantic Oceans become as one, and intelligence will be conveyed from London to India in a shorter time than was required ten years since to transmit a letter from New York to Liverpool.

“Nor does the importance of the undertaking claim less interest, when regarded in a social point of view. California is being peopled daily and hourly by our friends, our kindred, and our political brethren. The little bands that a few centuries since landed on the western shores of the Atlantic, have now become a mighty nation. The tide of population has been rolling onward, increasing as it approached the setting sun, until at length our people look abroad upon the Pacific, and have their home almost within sight of the spice groves of Japan. Although separated from us by thousands of miles of distance they will be again restored to us in feeling, and still present to our affections, through the help of this noiseless tenant of the wilderness.”

A company is stated to be organised for carrying out this vast project, with a capital of 5,000,000 dollars.

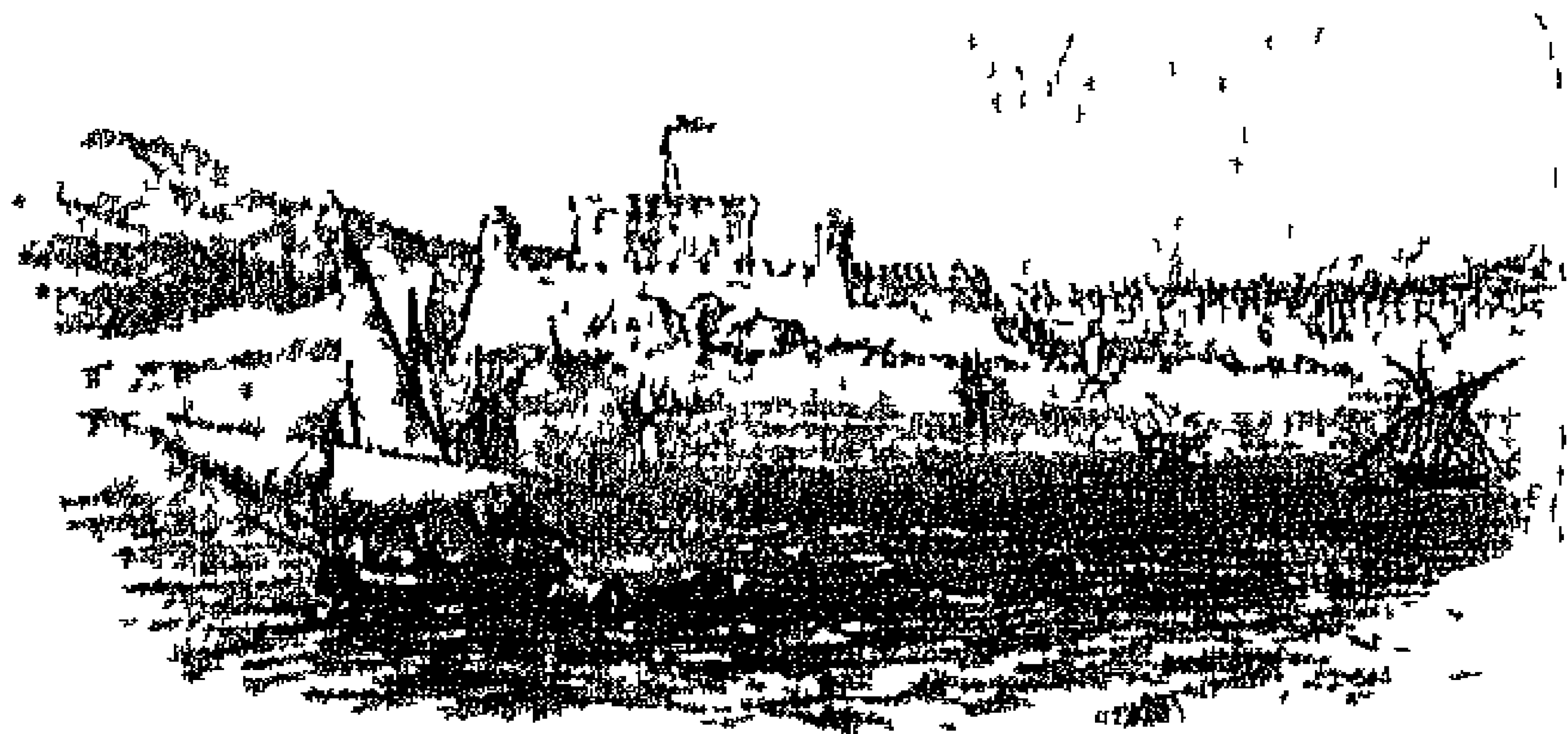

PLATE I

THE HISTORY OF THE ELECTRIC TELEGRAPH IN BRITISH AMERICA

THE ELECTRIC TELEGRAPH

CHAPTER XV

- 287 The electric line in British America 288 B. F. and line 289 The electric line in 290 The position transmitted on them 291 The electric line in 292 The location and position of dispatch 293 The electric line in 294 Paris telegraphic congress and convention 295 The electric instrument used in Belgium 296 The electric line in 297 French telegraphic lines 298 Indian telegraphic lines 299 The connection with those of other states 300 The electric line in 301 Case of dispatch of two messages on the line 302 Advantages of increased number of wires 303 The instruments requiring only one wire 304 The electric line in 305 The telegraphic administration 306 Austria telegraphic lines 307 Prussia telegraphic lines 308 Netherlands telegraphic lines 309 Russia telegraphic lines 310 Italian telegraphic lines

TELEGRAPH LINE OF BRITISH AMERICA

287 The length of lines of electric telegraph in operation in British America in 1854, was about 1000 miles

Mr. Joseph Whitworth, one of the British Commission sent to the New York Exhibition of 1854, presented a report to

LONDON: Printed by G. S. B. 1854

R

120

THE ELECTRIC TELEGRAPH

Parliament, which has been published, and which supplies some interesting particulars.

According to Mr. Whitworth, the most distant point connected by electric telegraph in North America are Quebec and New Orleans, which are 3000 miles apart, and the network of line extends to the west as far as Missouri, about 600 towns and villages being provided with stations.

There are two separate lines connecting New York with New Orleans, one running along the sea-board, the other by way of the Mississippi, each about 2000 miles long. Messages have been transmitted from New York to New Orleans, and in reverse, in the space of three hours, though they had necessarily to be written several times in the course of transmission.

When the contemplated lines connecting California with the Atlantic, and Newfoundland with the main continent, are completed, San Francisco will be in communication with St. John's, Newfoundland, which is distant from Galway but five days' passage. It is, therefore, estimated that intelligence may be conveyed from the Pacific to Europe, and *vice versa* in about six days.

The cost of erecting telegraph lines varies according to localities, but the expenses upon the whole are estimated to average about \$180 (36*l*) per mile throughout the States, the moderate amount of this estimate is, in a great measure, to be attributed to the facilities afforded by the general telegraph laws for the formation of companies and the construction of line.

The electric telegraph is used by all classes of society as an ordinary method of transmitting intelligence.

Government despatches, and messages involving the life or death of any persons, are entitled to precedence, next come important press communications, but the latter, if not of extraordinary interest, await their regular turn.

The leading newspapers of New York contribute jointly toward the expenses of daily telegraphic communications. The annual sum paid by the "Associated Press" averages \$30,000 per annum.

The following is the tariff for the press despatches:

	Under 200 miles,	1 cent per word
Between 200 and 500	"	"
" 500 " 700	"	3 "
" 700 " 1000	"	4 "
" 1000 " 1500	"	5 "
" 1500 " over	"	6 "

Assuming three cents as the average, the total amount of matter received by telegraph for the "New York Associated Press" amounts to a million words per annum, or about 600 columns.

AMERICAN TELEGRAPHIC LINES

of a London newspaper of the *Lancet* (12c), averaging, almost two columns per day.

Supposing six papers to be associated together, the share of each would annually amount to about \$5000, or 1000*l.*, for two columns of telegraphic intelligence daily.

Commercial men use the electric telegraph in their transactions to a very great extent. In 1852 there were transmitted by one of the three telegraph lines that connect New York and Boston, between 300 and 600 messages daily. The sum paid on this line by one of the principal commercial houses who used it averaged in 1852 for each from \$60 (12*l.*) to \$80 (16*l.*) per month.

On other lines the leading commercial houses were estimated to pay from \$200 to \$1000 (100*l.* to 200*l.*) per annum for telegraphic dispatches.

Interruption occurs most frequently from the interference of atmospheric electricity. In summer they are estimated to take place on an average twice a week, but many contrivances have been adopted for obviating this inconvenience, such as lightning rods, &c., which are generally known. The number of interruptions have been thereby reduced about 50 per cent.

Other accidental causes of interruption occur irregularly from the falling of the pole, the breaking of the wire by falling trees, and, particularly in winter, from the accumulated weight of snow or ice.

The electric current is made to act through long distances, by using local and branch currents, and relay magnets, in those systems where it would be otherwise too weak to operate effectively.

In Mr. Bain's system, a weak current is found sufficient for very long distances, between New York and Boston, a distance of 270 miles, no branch or local current is required. In some cases, where both Morse's and Bain's telegraphs are used by an unqualified company in the same office, it is found convenient, in certain conditions of the atmosphere, to remove the wires from Morse's instruments, and connect them with Bain's, on which it is practicable to operate when communication by Morse's system is interrupted.

It is generally believed that by laying insulated wires underneath the interruptions will be reduced so as to be altogether inconsiderable. The expense of the process, however, is regarded as a great impediment in the United States, where cheapness of construction is an object of the highest consideration.

The application of the electric telegraph is not confined to the transmission of messages from one part of the State to another. In the form of a local or municipal telegraph, it is employed as an important instrument of regulation and intelligence in the internal administration of towns.

THE ELECTRIC TELEGRAPH

No adaptation of the system can be more interesting and useful than that which is made for the purpose of conveying signals of alarm and intelligence in the case of fire.

This system has been very completely developed in Boston.

The city is divided into seven districts, each provided with a powerful alarm bell. Every district contains several stations, varying in number according to its size and population. There are altogether in the seven districts forty-two stations. All these stations are connected with a chief central office, to which intelligence of fire is conveyed, and from which the alarm is given, two telegraph wires are employed, a return wire being used to complete the circuit, and provide as completely as possible against accidental interruption or confusion.

At each of the forty-two stations, which are placed at intervals of 100 rods throughout the city, there is erected in some conspicuous position a cast-iron box containing the apparatus for conveying intelligence to the central office. The box is kept locked, but the key is always to be found in the custody of some person in the neighbourhood, whose address is painted on the box door.

On opening this door, access is gained to a handle which is directed, by a notice painted above it, to be turned slowly several times. The handle turns a wheel that carries a certain number of teeth, arranged in two groups, the number of teeth in one representing the district, in the other, the station, these teeth act upon a signal key, closing and breaking the circuit connected with the central office, as many times as there are teeth in the wheel. Signals are thus conveyed to the central office, and, by striking the signal bell a certain number of times, the district and station from which the signal is made is indicated.

An attendant is always on the watch at the central office, and on his attention being called to the signals by the striking of a large call bell, he immediately sets in motion his alarm apparatus, and by depressing his telegraph-key, causes all the alarm bells of the seven districts to toll as many times in quick succession as will indicate the district where the fire has occurred, the alarm being repeated at short intervals for as long a time as may be necessary.

The signal-boxes erected at the stations contain, in addition to the signal-handle, a small electro-magnet, an armature, and a signal-key, so that full and particular communications can be made between each box and the central station, the clicks of the armature forming audible signals. They have also an apparatus called a "Discharger of Atmospheric Electricity," for preventing the occurrence of injuries during thunderstorms.

By this system certain information is given to the central office

BELGIAN TELEGRAPHIC LINES

at the earliest possible moment of the exact locality in which a fire may have broken out, and the alarm is immediately spread over the entire city.

Every one who is aroused by the alarm is enabled to tell at once whether interest or duty calls him to the scene of action, and the exact point to which he is thus summoned. Should the alarm be given in the night, those whose attention is awakened may ascertain from the tolling of the bell the precise quarter in which danger threatens, and should they have been needlessly disturbed, may rest in peace, and find in the knowledge that they and their relatives are in safety a consolation for broken slumbers.

Telegraph wires in towns are almost universally carried along the tops of houses or on poles erected in the streets, instead of being conveyed in pipes underground. So little difficulty is met with on the part of proprietors of houses, that telegraph lines are in some cases erected by private individuals for their own particular use. An instance may be mentioned the case of a large manufacturer in New York, who has an office in one part of the city, while his works lie in a contrary direction. In order to keep up a direct communication between both, he has erected a telegraphic wire at his own expense, and carried it over the tops of the houses, not evening between his office and his works, having obtained without any trouble the permission of their various owners.

BELGIAN TELEGRAPHIC LINES

288. Although in the extent of its territory Belgium is one of the least considerable of the Continental States, it derives from its position in relation to the country, much importance, so far as regards telegraphic communications. By the submarine cable between Dover and Ostend, or rather, that, by the cable between Dover and Calais, Belgium constitutes the most direct stage in the telegraphic route to the Northern States.

The Belgian telegraph lines, as well as the railways, are constructed, maintained, and administered by the state. Separate systems of conducting wires are appropriated to the service of the railways, which is performed exclusively with the alphabetical apparatus of M. Lippenc, already described (267). There are a few exceptional cases on branch lines of railways, upon which the state has not yet constructed telegraphs for the public service, where private dispatches are sent by the railway telegraphs, but generally an extensive system of independent wires, with their accessories, are adapted to this purpose, for which a large corps of telegraphists has been formed.

THE ELECTRIC TELEGRAPH

299 The state telegraph lines, appropriated to the public service, have at present (1851) a total length of about 500 miles, upon which about 16000 miles of wire have been erected. With the exception of some short distances through Brussels, these wires are everywhere supported on posts.

The total capital absorbed in this establishment is estimated at 23000*l.*, and the gross annual receipts in 1851, were computed at 10000*l.*,* of which the net profit was 3000*l.*, being nearly 13 per cent of the capital.

Immediately on the completion of the submarine cable between Dover and Ostend, an active daily intercourse between London and Brussels commenced, and has since been sustained. The connections were completed on the 20th June, 1853, and on the 27th of the same month, 111 despatches were interchanged between the two capitals.

It is proposed to construct wires and apparatus sufficient to maintain the communications on this important line, so that even with the greatest pressure of business, the public shall not have reasonable ground of complaint on account of delay. "A telegraphic line," observes the Minister of Public Works, "should not be organised with the mere powers which suffice for the ordinary or average business, but should be such as to meet the exigencies of occasional pressure, without subjecting the public to delay, or interrupting other regular business. Besides which, it ought never to be forgotten, that in telegraphic business great pressure must always come at particular hours, when prompt expedition is indispensable. This will be easily understood in the business of the Belgian lines, which constitute the route upon which the quotations of the money markets of all the great centres of affairs—London, Paris, Amsterdam, Berlin, Antwerp, &c.—are transmitted at certain hours."

290 The business transacted by the Belgian telegraphs consists of three classes of despatches.

HOME DISPATCHES, being those transmitted between two Belgian stations.

INTERNATIONAL DISPATCHES, being those between a Belgian and Foreign station.

FOREIGN DISPATCHES, being those transmitted through Belgium in passing between two foreign stations.

Of these three classes of telegraphic business, the second has proved to be the greatest in number, and the third the most productive, as appears by the following statement of the results of the year ending 31st December, 1853.

* Report of Minister of Public Works to the Chamber, Feb. 11, 1851.

BELGIAN TELEGRAPHIC LINES

Direction	Number of Dispatches	Receipts	Number Percent of Total	Receipts percent of total
Home	4460	£1513	27.2	13.7
International	20681	1831	39.7	15.2
Foreign	17937	5727	33.1	18.1
Total	29058	£10871	100.0	100.0

90. It appears from this statement that about 10 per cent of the dispatches transmitted and received in Belgium, are interchanged with foreign countries, and that one-third of all that pass on Belgian wires is matter passing *en route* between two other places. Nearly half the gross amount received for telegraphic dispatches is produced by dispatches transmitted between foreign stations, and only passing *en route* through Belgium. This is explained by the fact that such dispatches pass always from frontier to frontier, and in the majority of cases from Ostend to the Prussian frontier, the entire length of the Kingdom, pay for the longest class of telegraphic distance. This is one of the advantages which the Belgian telegraph derives from the geographical position of the country.

91. To show the proportion in which the telegraphic service is treated by different subjects of correspondence, we shall take the detailed subject of dispatches of August, 1853, the month in which the correspondence was most active. In this month there were 5699 dispatches transmitted on the Belgian wires, which are thus classified:

Subject	Number	Percent of Total
Commerce	1247	50
Agency matter	1506	27
Private	161	11
Public	116	2
Government	110	2
Total	5699	100

In relation to length the proportion was as follows:

Length	Number	Percent of Total
From 1 to 20 words	4741	81.8
From 21 to 50 words	671	15.0
From 51 to 100 words	122	2.1
Above 100 words	15	0.1
Total	5699	100.0

TELEGRAPHIC MAP—IN THE ANNEXED MAP IS PRESENTED
A GENERAL VIEW OF THE TELEGRAPHIC NETWORK

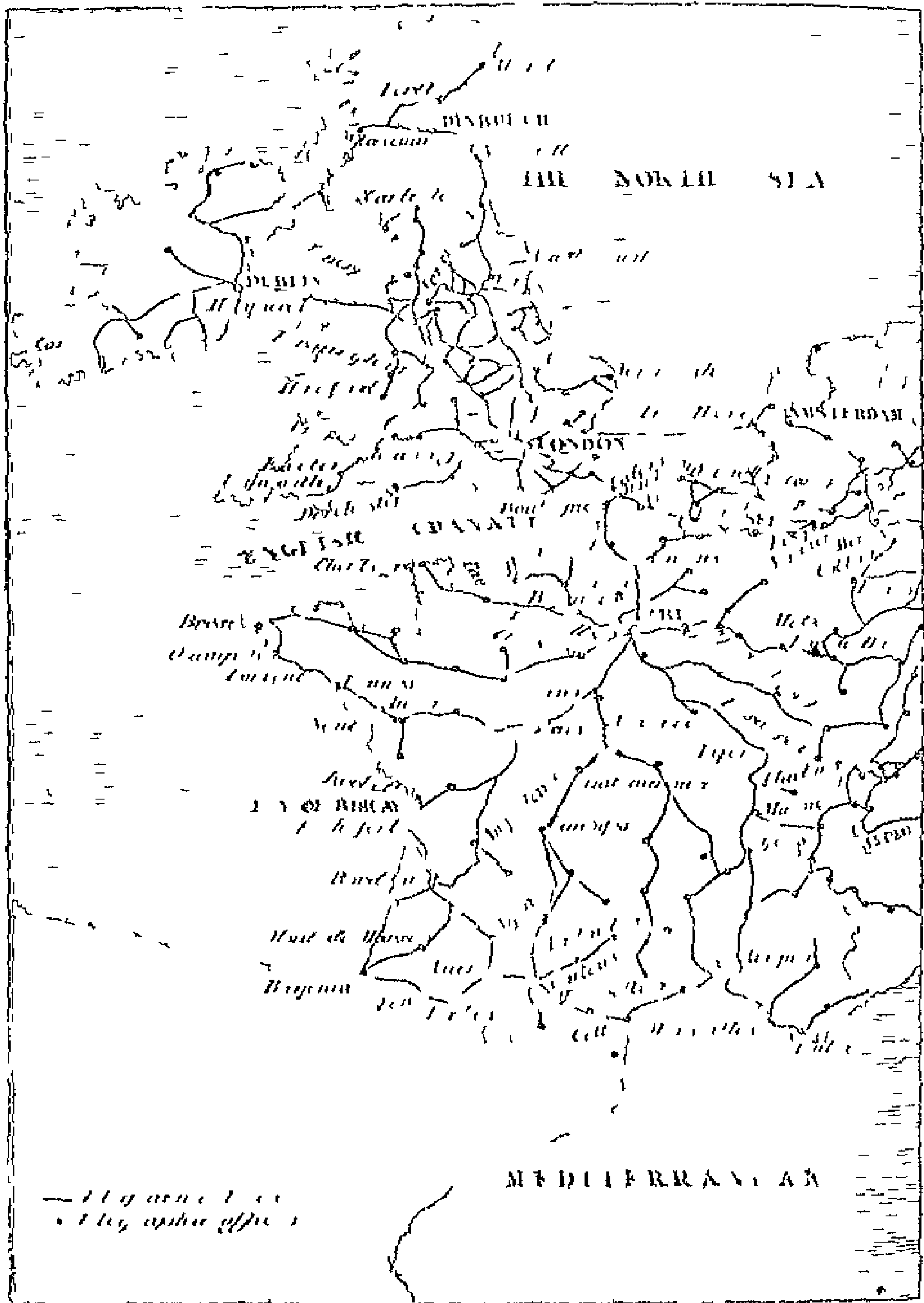

THE ELECTRIC TELEGRAPH

Thus it appears that commerce and the Stock Exchange supply 83 per cent of the whole telegraphic business, 13 per cent being personal and domestic, and the press and government each employing the insignificant proportion of one despatch in every fifty.

It is also apparent, that a very small proportion of the despatches exceed the length of 20 words, and almost none that of 50 words.

293 According to the Belgian tariff, messages not exceeding 20 words are charged 2s for distances not exceeding 60 miles 4s, from 60 to 110 miles, and 6s above 110. No distances within the limits of Belgium exceed 200 miles.

For messages of 21 to 50 words the charges are doubled, and for 51 to 100 words are tripled.

It will be seen that these charges are more than double the corresponding charges on the English lines.

294 The large proportion of international and foreign despatches transmitted upon the Belgian wires, and the necessity of prepayment for despatches, in all cases, to their ultimate destinations, rendered it necessary for the Belgian administration of telegraphs to make some general arrangement with the principal contiguous states, for such an interchange of correspondence. A telegraphic congress was accordingly convened at Paris, in September, 1850, which was attended by delegates from France, Belgium, Prussia, Austria, and the minor German States. A telegraphic convention was concluded and signed on the 11th of October, 1852, fixing definitely a general tariff for all despatches transmitted to or from the several States.

According to this convention, each telegraphic region was divided into a series of zones, measured from the Belgian frontier, according to a series of direct distances (as the bird flies), the charges to places in each successive zone, for single despatches (1 to 20 words), being fixed at 2s, 4s, 6s, 8s, and so on, an increase of 2s being made for each increase of distance.

France is, by this convention, resolved into six telegraphic zones, the tariff for single messages being 2s, 4s, 6s, 8s, 10s, and 12s. The first zone includes the chief northern towns, Arras, Douai, Lille, and Valenciennes, the second, Amiens, Boulogne, Dunkerque, &c, the third, the chief places in the nearer central parts, including Paris, Orléans, Havre, &c, the fourth, the more distant central parts, such as Châlons, Lyons, Strasbourg, &c, the fifth, the nearer southern parts, Avignon, Grenoble, Bordeaux, &c, and the sixth, the most remote southern parts, Marseilles, Bayonne, &c.

The German States, including Lombardy, are resolved into eight zones, of which the tariff is 2s, 4s, 6s, 8s, 10s, 12s, 14s, and 16s. These zones include the whole extent of Northern and

FRENCH TELEGRAPHIC LINES

Eastern Europe beyond the Rhine, as well as the north-eastern part of Italy.

The tariff for single messages crossing the channel, by the Ostend submarine cable, is 8s. For these charges, however, they are transmitted, if required, to London.

295 At the chief stations on the Belgian lines, the double needle instruments, as used in England, the French State instruments, and the Morse telegraph, as used in the German States, are provided. By the first the telegraphic correspondence with England, by the second with France, and by the third with the German States, is carried on.

296 It is intended generally to receive and transmit despatches written at the option of the sender, either in French, German, or English, at all the Belgian stations, but for the present this is only done at Brussels, Antwerp, and Ostend.

Despatches transmitted between Holland and Belgium can be transmitted and received in Dutch, and all despatches between Belgian stations may be sent in Flemish. At all stations despatches are transmitted and received in French.

If the place to which a despatch is addressed be not a telegraphic station, the despatch will be forwarded to its destination either by post or by a special messenger, at the option of the sender. If the former, the postage is 10*d*, if the place be within the State where the telegraphic station at which the despatch arrives is situate, and 20*d*, if in another State. If the latter, a charge of 10*d* is made for a distance of a kilometre (five furlongs), and 5*d* for every additional kilometre.

FRENCH TELEGRAPHIC LINES.

297 Although late in the adoption of this improved agency of intercommunication, France, having once commenced, has prosecuted the work with great vigour, and the country is now overspread with a net-work, the extent of which, in actual operation at the close of the present year, 1864, will not be less than 6000 miles. This system is everywhere erected upon posts chemically injected to insure their durability, and there are nowhere less than two conducting wires, but a greater number between all stations where an active correspondence is maintained.

298 The instruments used for the transmission of all home despatches, that is, all despatches transmitted between any two French stations, are the French State telegraphs, explained in (183). For international despatches, the double needle and Morse's instruments are used. These instruments are provided at the central station, in the Ministry of the Interior at Paris. The double needle instruments are provided also at Calais, and

Morse's instruments at Strasbourg. As the system is developed and extended, the double needle instruments will be provided in addition to the French telegraphs, at all stations which may be in direct communication with England, and Morse's instruments at all stations which may be in direct communication with the German States.

299 The French telegraphic lines communicate with those of England at Calais by the submarine cable, with those of Belgium at Lille and Douai, with those of Prussia and Northern Germany, at Metz, with the Rhenish States, Wittenburg, Bavaria, and Austria, at Strasbourg, with those of Switzerland, at Mulhouse and Mâcon, the former communicating with Bale, and the latter with Geneva, and, in line, with those of Savoy and Piedmont, at Grenoble.

Other links of electric connection will speedily be formed. Thus the present lines are continued to the Spanish frontier at St. Sebastian, and lines of wire are now being laid between that place and Madrid, so that the capital of Spain will be in electric connection with that of France, and therefore also with London, and the other capitals of Europe, most probably, before these pages are in the hands of the reader.

300 In practice the transmission of despatches is not always so direct or immediate as it would appear to be upon the inspection of a telegraphic map. Thus, by the submarine cable between Dover and Calais, Paris is in permanent direct communication with London. But when it is desired to transmit a despatch from Paris to any of the provincial towns of England, the despatch is at present received and written down at the central station in London, and then repeated and transmitted to the place of its destination in the provinces. This repetition could of course be avoided, by uniting, in the London station, the wire from Paris with the wire leading to the provincial station to which the despatch is addressed, and if the despatch were one of extraordinary length this course would be the most expeditious, but to adopt it with the ordinary class of short messages, would involve much inconvenience and more delay in general than is incurred by its repetition and retransmission. Thus, to send each message direct to its destination in the provinces, it would be necessary that, previously to the transmission from Paris, notice should be transmitted to London to connect the Paris wires with those between London and the place of destination, and as this change would have to be made separately for every provincial message, and as the wires between London and the various provincial stations must necessarily be occupied, more or less, at all times, in the transmission of home correspondence, the business of trans-

son in the direct manner would not only be far more dilatory in the process of repetition, but would, in fact, at but a time of day be totally impracticable.

101. What has been here stated respecting the Paris and London wires will be applicable, *mutatis mutandis*, not only to all international telegraphs, but in many cases to messages transmitted over home stations, which it is often more convenient and expedient to repeat and retransmit at certain intermediate stations, not only in direct but by the connection of the wires at those stations.

102. It will be understood in this book, that the necessity for a repetition of transmission, and intermediate repetition of patches, were a result of the inefficiency of the number of conducting wires in relation to the quantity of correspondence to be transmitted. In the transmission of each despatch by the Paris and French telegraphs, two wires are employed. Now, the direct correspondence between London and Paris, during a month or two hours of the day, be sufficient to employ one pair of conducting wires, another pair would be necessary to communicate with intermediate places, and if the correspondence with those places were unequal, one cup to say, a large part of it, a third wire might be required, and so on.

103. It must be, therefore, very apparent that great convenience could in such cases be gained by substituting, for the English and French telegraph, that of Morse or Bunn, or any other which are met by a single conducting wire. In that case, the four wires sustained in the submarine cable, between Dover and Calais, would be much more than double their present duty. Instead of carrying several messages simultaneously, as they do at present, they could carry four. If one wire be put in permanent connection with London and Paris, the three other could be reserved, one for direct communication with chief provincial towns, such as Birmingham, Manchester, Liverpool, Glasgow, Dublin, &c., and the two others for one or two less important stations, subject to occasional repetition. The latter would be to the telegraph line what the second and third lines are to the railway. It might be found even advantageous to fix a higher price of transmission for messages thus sent without intermediate repetition, just as a higher fare is paid for express than for ordinary trains.

104. The French government has recently re-organised the administration of the telegraphs throughout its entire territory, and by a judicious modifying and reducing the tariff, it has placed the whole upon a more efficient footing. It now constitutes an important department of the state, placed under the superintendence of a director-general, four inspectors-general, twelve chief directors, and an hundred inspectors. The director-general

THE ELECTRIC TELEGRAPH

established in Paris holds his office under the Minister of the Interior, and has authority over all the inferior functionaries. The four inspectors-general control and direct under him the entire telegraphic service throughout the empire. These inspectors, aided by scientific men nominated from time to time by the Minister, form a superior council, charged to consider and decide upon all improvements proposed to be made in the processes, or in the telegraphic apparatus.

The telegraphic lines will be distributed into twelve distinct systems or sections, over which the twelve chief directors will preside, so as to inspect, direct, and by communication with the inspectors-general and director-general, to centralise the service.

The hundred inspectors will each be charged with the direction of one or more stations, and will have under their authority deputy station-masters, telegraphists, surveyors, artisans, and labourers, charged with the maintenance of the apparatus, the conducting wires, posts, and all the accessories of the line.

In all chief places, the bureaux will be open night and day. The number of stations open on 1st November, 1853, was 78; in June, 1854, the number was 105. At the close of 1854 all the Prefectures of France will be in electric connection with the capital.

The posts, a large proportion of which had not sufficient magnitude and strength to bear the necessary number of wires, have been everywhere replaced by others of suitable dimensions, and the telegraphists are augmented in number, and measures taken to ensure their efficiency.

It is decided also to give ample trial to the telegraphic instruments of Morse and Bann, already adopted to a great extent in Germany and in the United States, and if the result of experience on a large scale is favourable to them, they will be adopted either in conjunction with the present telegraphs, or to the exclusion of them according to circumstances. In all, there are manifest signs of activity and of exemption from prejudice, national or personal, which argue favourably for the progress of this great social improvement.

AUSTRO-GERMANIC TELEGRAPHIC UNION

305 The electric telegraph had not been long in operation in the German States before it became apparent that great inconvenience and much obstruction to the progress of correspondence arose from different states adopting different telegraphic instruments and signals. The difficulties arising from this cause became at length so great as to demand prompt and effectual remedy. A telegraphic congress was accordingly convened at Vienna in October, 1851, at which deputies from all the German States

III. NETHERLANDS TELEGRAPHIC LINES

attended, and after a full discussion of the subject, it was resolved to form an Austro-Germanic Telegraphic Union. This union includes all the states of Europe east of the Rhine, and also the Austrian provinces in Northern Italy. It was agreed that a common system of telegraphic instruments and symbols should be adopted throughout all the associated states, and that for the present, Morse's telegraph, with its receiving magnets, repeaters, and uniform alphabet, should be everywhere used, so that telegraphic communication may at all times be made between any two stations of the Union without the delay and inconvenience of translating despatches at intermediate stations from one system of telegraphic symbols into another.

306. Despatches are transmitted and received at all the stations of the Union, either in German or French. They are also transmitted and received in English at such of the chief stations as are found by experience to have frequent communication with this country.

Since the convention was concluded, the Germanic lines have received considerable extension, so that many important stations have been recently established within the telegraphic connection. Thus a line of telegraphic wires has been laid extending from Bremen to Cuckstadt, and from Hanover to Lauenburg. Also from Hamburg through Denmark, by Rendsburg, Kiel, Seelowitz, to Kiel, across the Little Belt, by Odense, across the Great Belt to Copenhagen and Helsingor.

Lines are also in operation from Dantzic to Königsberg, from Troppau to Lemberg, from Vienna, by Pesth, with various branches to Klausenborg, Orsova, Semlin, Peterwardin, and Pseu,

III. NETHERLANDS TELEGRAPHIC LINES

307. Notwithstanding the dense population and active commerce of the Kingdom of the Netherlands, its limited territory has rendered a very small telegraphic net-work sufficient for its purposes. Only eight of its chief towns are connected by telegraphic wires. There are

Amsterdam (e), Rotterdam (e), the Hague (e), Utrecht, Haarlem, Breda, Dordrecht (e), and Arnhem.

They are connected at the Hague by ocean submarine wires with the English lines, at Antwerp with those of Belgium, and at Arnhem with those of the German Union.

Despatches are received in German and French at all the stations, and in English at those marked (e).

III. SWISS TELEGRAPHS

308. The natural difficulties opposed to the construction of railways in Switzerland did not offer such serious impediments

THE ELECTRIC TELEGRAPH

to the construction of telegraphic lines, an extensive net-work of which has been constructed and brought into operation. Thus Berno is connected with the French lines by wires to Besancon, and with the German lines at Bale. Lausanne is connected with Besancon by an independent line, and also with Berno on one side and Geneva on the other. Geneva is also connected with the French system at Micon, and with that of Savoy at Aix, from whence a line of wires is carried across Mont Cenis to Turin.

From Lausanne the wires are carried by Vevey and Sion through the Valais to the foot of the St. Gothard, across which they are continued by Bellinzona to Milan.

Another line passes from Bale by Taccane, Glaris, and Conc, to the Splügen, which it crosses, and is carried to meet the former line at Bellinzona, and thence to Milan.

Another line from Bale passes by Zurich and St. Gall to Innsbruck, from whence it passes by Butzen and Trento to Verona, and by Salzburg and Lanz to Vienna.

Lines have, however, been since constructed, including some other stations.

ITALIAN TELEGRAPHIC LINES

189. Italy is put in electric connection with the more northern countries of Europe at six points, Nice, Mont Cenis, the St. Gothard, the Splügen, the Tyrolic Alps, through Innsbruck, and by Trento.

The French lines are already extended to Nice, and a line between Nice and Turin will probably be completed before these pages come into the hands of the reader. The French and Swiss lines are connected with Turin by the wires over Mont Cenis already mentioned, the Swiss and Rhenish lines, with Milan by the wires over the St. Gothard, and the Splügen and the Austrian and Bavarian lines by the wires over the Tyrolic Alps, and those from Turin to round the shores of the Gulf to Venice.

From Venice to Milan a line is carried by Verona and Brescia, which is continued to Turin. From this line there are two branches going southwards, one from Verona by Mantua, Parma, Modena, Lucca, Leghorn, Florence, Sienna to Viterbo in the Papal State. This line will speedily be continued to Rome. The other branch goes from Alexandria to Genoa.

Such is the extent of Italian telegraphs completed in 1851.

INDEX

*** As this Book is not paged, the figures in the Index and Table of Contents refer to Paragraphs, and not to Pages*

- ACCIDENTS, prevention of railway, 219
- Aerial telegraph, old, 182
- Alarm, telegraphic, to call the attention of the agents, 155, how rung from one station to another, *ib*, mechanism of telegraphic, 159
- Alphabetic telegraphs, 188
- America, supports of electric wires in, 56, telegraphs used in, 206
- American inventions preferred in American telegraphs, 177
- American telegraph companies, 210
- Anecdotes of the use of the telegraph, 250
- Astronomical observations, uses of electric telegraph in, 268, extreme accuracy of, *ib*, phenomena, use of the telegraph in fixing time of, 270
- Atmospheric effects on the telegraphic wires, 17, electricity, effects of, on telegraphic wires, 60
- Austro Germanic telegraphic union, 305, stations of, 306
- Autograph telegraph 217
- BAIN'S chemical telegraph, 208
- Bairns telegraph, operation of, 212, its commutator, 213, its extraordinary speed of transmission, 214, obstructions to its practical application, 215, its prospects, 216, rate with, 216
- Batteries used for English telegraphs, 14
- Battery, common plate, 36
- Belgian telegraphic lines, 288, their extent and cost, 289, correspondences transmitted on the, 290, large proportion of foreign despatches on, 291, classification of despatches on, 292, tariff of, 293
- Belgian cable, imperfection attributed to the, 93
- Belgian railway telegraph, 199, 201
- Belgium, telegraphic instruments used in, 293
- Bells, electric ringing of, 155, mutual power of ringing, use of, *ib*
- Bombay, connexion of Alexandria with, 37
- Boston, telegraph in cases of fire at, 287
- Breguet, telegraph contrived by, 183
- Brett's printing telegraph, 221, originators of submarine communication, 280
- Bright's method of detecting faulty points in electric wires, 68
- British America, telegraphic lines in, 287
- Bunson's battery, 31
- CABLES, submarine, 77, table of the dimensions of, 80

INDEX

- Calais cable, accident in laying the, 92
- California, gigantic projected telegraph to, 286
- Catastrophe averted by aid of the telegraph, 219
- Clarity of telegraphic communication, 222, circumstances which affect it, 223, affected by distance, 239
- Chapman's survey of an electric route to California, 286
- Characters, telegraphic, table of, 206
- Charcoal substituted for copper in voltaic combinations, 29
- Cipher used in telegraphic communications, 259
- Ciphers of mercantile firms, telegraphic, 260, for newspaper reports, 261
- Coating of telegraphic wires, 65, of submarine cables, 88
- Commerce, extensive use of the telegraph in, 251
- Commutating apparatus, effects producible by, 126
- Commutator, an instrument for controlling the electric current, 110, general principles of the, 111, its application, 119
- Commutator of French state telegraph, forms of, 181, its operation, 185
- Conducting wires, 20
- Conductors, 19
- Constancy, the property of Daniell's battery, 31
- Continent, organisation of electric communication with the, 282
- Corsica, cable between Spezzia and, 87
- Cresoted deal troughing, 67
- Crime, telegraphic detection of, 259
- Current, electric, established by earth contact, 23, return of, through the earth, 25, modes of transmitting, 113, 114, 115, to reverse the, 116, to suspend and transmit it alternately, 117, to make it ring the alarm, 119, effects of, 135
- Currents, combination of, 37
- Cylindrical batteries, 30,
- DANIELL'S constant battery, 32
- Dead beat of magnetic needles, 229
- Defects imparted to French and German telegraphs, 200, in Continental railway telegraphs, how removed, *ib*
- Desk, metallic, 211
- Despatch, method of sending and receiving an electric, 186
- Despatches, telegraphic, table of subjects of, 213
- Dial at one station producing a like motion in a distant dial, 151
- Discrepancy of reports of telegraphic communication, 31
- Dover and Calais, cable connecting, 78, its dimensions, 81
- Dover and Ostend, telegraphic communication between, 81
- FERROUS current, velocity of, 10, agency, nature of, 11, fluid, terms allotted in required directions, 18, leakage of, 59, current produced without a voltaic battery, 160
- Electric messages, circumstances on which depends the clarity of, 223
- Electric telegraph, on what powers its efficiency depends, 15, independent of railways, 76, uses of the, 212
- Electric telegraph company, 273, table of its lines, stations, &c., 271
- Electricity, physical character of, 12, a subtle fluid, 11, various bodies evolve, 26
- Electric chemical pen, 210
- Electric magnet, constructed by Pouillet, 114, how it may produce written characters on paper at a distant station, 154, application of, 162
- Electric magnets formed by two straight bars, 114, acquire and lose their magnetism instantaneously, 115
- Electric telegraphy, incredible nature of, 8, independent of the physical character of electricity, 13, principles of, 109

INDEX

- Elements of a battery, 10
 England and France, despatches between, 301
 Errors, telegraphic, how corrected, 193
 European and submarine company, underground wires of, 71
 European and American telegraph company, 279

F
 FIREARM industry, sphere of, enlarged by the telegraph, 275
 Fire, telegraphic communication in cases of, 287
 Forwarding messages from the station, charge for, 296
 France, supports of electric wires in, 55
 French inventions adopted in French telegraphs, 177, railway portable telegraph, 189, telegraph, 195, telegraphic lines, 297, instruments used on, 298, their connection with those of other states, 299, telegraphic administration, organisation of, 304
 Fremont's alphabetic telegraph, 209, writing telegraph, 207

G
 GALVANO battery, 16
 Galvanometer, 137, method of transmitting signals by the, 141
 German railway telegraph, 190
 Germany, supports of electric wires in, 57
 Glasgow, Saturday journals, mode of telegraphing intelligence to, 252
 Greenwich observatory, improved method of observation at, 270
 Grove's battery, 34
 Gun, how discharged at a distant station, 156
 Gutta Serena enveloping wires, 70, rope, 82

H
 HENRY'S magnetic telegraph, 220
 Highton's improvements in telegraphic apparatus, 17
 Holyhead and Howth, cable connecting, 82
 Horological commutator, 129
 Horological uniformity produced by telegraphs, 265
 Horse shoe magnet, experiment with, 162, 163
 House's printing telegraph, 219 its operation, 219, rate of transmission with, 238, rate of printing by, 26

I
 INDIA, telegraphic communication with, 99, telegraphic lines in, 26
 Indicating, apparatus, 183, mechanism of telegraphs, 193
 Inspectors and other telegraphic officers, 304
 Insulating supports, forms of, 51
 Insulation, expedients for obtaining, 50
 Insulators, 19
 Intelligence, emanation of, twenty years since, 3
 International correspondence, wonderful celerity of, 281
 Inventions, neglect of meritorious, 178
 Iron wires, objections to, 17
 Italian telegraphic lines, 300

K
 KEY Commutator, 128

L
 LANGUAGES of Belgian telegraphic despatches, 296
 Laidner, Dr, telegraphic experiment made by, 9, 213
 Letters and figures, manner of expressing, 180, numbers of, transmitted per minute, 188
 Leverrier, telegraphic experiment made by, in conjunction with Dr Laidner, 9
 Lightning, artificial, 5
 Lightning conductor, 61, of Messrs Walker and Breguet, 62
 Line wires, material and thickness of, 16
 Lines of electric telegraph established by private companies, and by the state, 175
 Lines and dots, combinations of, to express letters, 206
 Lippen's telegraphic instrument,

INDEX

- 201, description of, 202, its wheel commutator, 203, transmission of despatches by, 204
- Longitudes, use of electric telegraph in determining, 261, 267
- Lothbury, central telegraphic station in, 95
- Magnets, magneto electric, 165
- Magnet, how the electric current may produce a temporary, 112
- Magnetic needle, deflection of, 136
- Magnetic pulsations, how rendered visible and counted, 117, celerity of the oscillations thus produced, 118, impartment to clock work, 150, action on an escapement, 151
- Magneto telegraph company, 970
- Magneto electric current, method of producing a momentary, 161
- Magneto electric machine, 165, its effects in producing shocks and currents, 166, method of applying it to telegraphs, 167
- Magneto electric telegraph company, wires of, 67
- Magneto electricity, 160
- Map showing telegraphic network, 292
- Mauzy, Tacut, hydro raphical researches of, 94
- Mechanism of telegraphs, explanation of, 191
- Medical consultations, telegraph used for, 258
- Mediterranean electric telegraph company, 283
- Mercantile firms, sums paid for telegraphic despatches by, 255
- Messager, personal and domestic telegraphic, 251, average length of, 275
- Miracles of science, telegraph most marvellous of, 25
- Morse's telegraph, 206, the most extensively used, 231, average celerity of, 234, greater celerity of, 235, his reports to congress respecting the telegraph, 257
- Multiplex, magnetic, 138
- Music, telegraphic transmission of, 217
- Musical sounds, produced by magnetic pulsations, 149
- NEEDLE, greatest sensibility of electric, 148, method of mounting the electric, 140
- Needle instruments, 149, single needle instrument, 150, double needle instrument, 181, fluctuation of the efficiency of, 140
- Needles, signals made by deflection of magnetic, 149
- Netherlands, telegraphic lines in, 307
- Not work, telegraphic map of, 292
- New York Journals, a solution of 262, Herald, spirited enterprise of, 261
- Newall and Co, description of their telegraphic cables, 79, 81
- Newspapers, telegraph extensively used by American, 256
- Newsrooms, electric, 252
- Non conductors, 19
- Numerals, how transmitted, 205
- OBSERVATIONS of Greenwich, Brussels and Paris, electric connection of, 267
- Observatory clocks, use of the telegraph in regulating, 260
- Officers attendant on a line of telegraph, 235
- Opera, who from the House of Commons to, 259
- Oxfordness and the Hague, electric communication between, 6
- Organisation of telegraphy, uniform, recommended, 211
- O'Shaughnessy, Dr, his plan of underground communication, 100
- Oxidation of metals, 24, wire insulated by impregnation, 54
- PARIS, elements and poles, defined, 40
- Paper, method of moving under the style in the telegraph, 141, moved by various expedients, *ib.*, telegraphic characters on it, 142
- Paris, telegraphic congress, 291

INDEX

- Parliament, abstracts of its proceedings reported half hourly for the clubs, 252
- Pauses necessary between letters and letters in telegraphic messages, 227
- Pen, electro-chemical, 200
- Pilot engines, 218
- Poles of a battery, 10
- Political purposes, illustration of the use of the telegraph for, 257
- Portable railway telegraph, 246
- Portpatrick and Donaghadee, cable connecting, 83, 85
- Pouillet's modification of Daniell's system, 33, experiments on the intensity of the electric current, 104
- Printing telegraph, House's, 219, Brett's, 221
- Projects for telegraphic communication, 286
- Prussia, underground wires abandoned in, 70
- Russian railways, telegraph of, 190, 198
- Pulsations of electric current, irregular, 129, regular, 130, no limit to the celerity of, 131, toothed wheel to produce the, 132, sinuous wheel to produce the, 133, of magnetism, how rendered sensible, 117, of the electric current, how governed, 184
- QUINN'S speech, rapid verbatim report of, 276
- RAILWAY expenditure, incalculable, saved by the electric telegraph, 218
- Rate of transmission with French state telegraphs, 231, with French railway telegraphs, 232, with the Morse telegraph, 233
- Relay magnets, use of, 173, their form and application, 174
- Reoscope, or Reometer, 138
- Repetition of despatches at intermediate stations, 300
- Reporting, anecdote of rapid, 263
- Routes, message may be transmitted to the same place by different, 284
- SAND, use of, in charging batteries, 11
- Secondary lines of wire, 125
- Scarcy of telegraphic despatches, public confidence in the, 250
- Shafner's report to the telegraphic convention, 286
- Shakspeare's "girdle round the earth in forty minutes," 11
- Simon's instrument, 191, its mode of operation, 192
- Signal to rectify inattention, 104
- Signal time balls, 266
- Signals, how the current produces telegraphic, 106, transmission of instantaneous, 108, notice of the station transmitting, and receiving, 121, modes of regulating, between particular stations, 122, 123, 124 system of, in connexion with the Royal Observatory, 266
- Soft iron, magnetism imputed to, 142
- Special trains, precautions respecting, 217
- State telegraph, French, 182
- Statistics of the telegraph, difficult investigation of, 285
- Strand and Totham, underground wires between the, 90
- Submarine cables, deposition of, 84, 85
- Submarine companies, origin of the enterprises, 280
- Submarine company chartered, 177, between France and England, 178
- Swiss telegraphic lines, 308
- Synchronism of astronomical clocks, 269
- TARIFF of electric telegraph company, 275
- Telegraph, construction of old French, explained, 182, speculation respecting the improvement of, 216, used for ordinary purposes of life, 273
- Telegraph in railway business, use of the, 215
- Telegraph cables, durability of, 89
- Telegraphic lines in England and America, 175, various forms of instruments used on, 176, common

INDEX

- mication in the United States, ex-
 amples of distant, 210, messages,
 in the United States, eleven mil-
 lions per annum, 241, lines of
 the United Kingdom, 271, their
 extent in 1851, 272, connection
 of European states, table of, 284
 Telegraphic line, organisation of a,
 289
 Telegraphists, comparative ability of,
 224, each, known by his manner
 of transmitting, 225, attention
 absorbed by the manipulation of
 the instrument to the exclusion of
 the subject of the despatch, 259
 Telegraphs, railway, by whom
 worked, 188
 Telegraphy, electric, 5, no limit to
 the celerity of, 11
 Testing posts, 66
 Transatlantic ocean telegraph, 14
 Transit observations, description of,
 270
 Transmission of telegraphic messages
 easier than the interpretation,
 226, pauses in, 227, rate of, 228,
 average celerity of, 26, rate with
 a magneto electric current, 229, of
 despatches, not always direct, 300
 Tunnels, imperfect insulation in, 72,
 Walker's method of remedying, 73
 Turin and Genoa, wires between,
 without intermediate support, 98

 UNDERGROUND wires, 64
 Uniformity of telegraphic charges
 suggested, 214
 Uniformity, horological, 26
 United States, extensive use of the
 telegraph in the, 253, telegraphic
 lines in the, 285

 VIBRATIONS producing musical notes,
 149

 Voltaic battery, 16, its relation to
 the telegraph analogous to that of
 the boiler to the steam engine, 17,
 21
 Voltaic pile, 41
 Vulcanisation, 70

 WALKER, Mr, instrument invented
 by, 62
 Water, decomposition of, 169
 Weight of electric cable per mile,
 288
 Wheatstone, Professor, his experi-
 ments, 107
 Whitworth's report to Parliament on
 the telegraph, 287
 Winding posts 51
 Wire, method of covering the elec-
 tric, 139, telegraphic instruments
 requiring only one, 303
 Wires, American telegraphic, not
 usually galvanised, 56, overground
 system of, in streets in France and
 America, 74, across extensive
 valleys, 98, up and down, 112,
 multiplicity of, why necessary
 125, advantages of numerous
 telegraphic, 302
 Wollaston, Dr, his arrangement of
 voltaic combinations, 30
 Writing, telegraphic, at the station
 to which a message is communi-
 cated, 210
 Writing or printing, ordinary, at a
 distant station, 217
 Written characters at a distance,
 how to produce, 170

 ZINC or straight line marked on
 paper as the current is transmitted
 or suspended, 153
 Zinc and copper, common plate bat-
 tery of, 27, why preferred, 28,
 plates, amalgamation of, 45

DR. LARDNER'S MUSEUM OF SCIENCE AND ART

A MISCELLANY OF

INSTRUCTIVE AND AMUSING TRACTS ON THE PHYSICAL SCIENCES,
AND ON THEIR APPLICATION TO THE USES OF LIFE

ILLUSTRATED BY ENGRAVINGS ON WOOD

THE purpose of the publishers of this Series is to supply a collection of instructive essays and tracts, composed in a popular and amusing style, and in easy language, on the leading discoveries in the Physical Sciences, and on their most important and interesting applications to the Arts which contribute to the convenience and ornament of life. Such papers may be read with pleasure even by those who have been disciplined in the study of the sciences. Many interesting details and incidents which are usually excluded from systematic treatises will be suitably placed among such illustrations. Persons, whose occupations exclude the possibility of systematic study, will thus be enabled to collect, without the expenditure of more time and thought than they can easily spare, the flowers and the fruits of the garden of knowledge, and may in their hours of leisure obtain a considerable amount of information on subjects of the highest interest.

To place this Series within the reach of all classes, it is published at ONE PENNY, in weekly numbers of 16 pages, large 12mo, printed on good paper, in a clear type, and illustrated, when necessary, by engravings on wood, also in Monthly Parts, price 5d, in a wrapper, in Quarterly Volumes, price 1s 6d, and in Half yearly Volumes at 3s 6d.

DOUBLE VOLUMES

* * * *Volumes I to IV may now be had strongly and handsomely bound in cloth*
TWO VOLUMES IN ONE, with Index, price 3s 6d each Double Volume

CONTENTS OF VOLS I AND II, PRICE 3s 6d CLOTH

VOLUME I Price 1s 6d, in handsome Boards	VOLUME II Price 1s 6d, in handsome Boards
<p style="text-align: center;">PART I Price 5d</p> <p>1 THE PLANETS ARE THEY INHABITED WORLDS?—Chapter I</p> <p>2 WEATHER PROGNOSTICS</p> <p>3 THE PLANETS—Chapter II</p> <p>4 POPULAR FALLACIES IN QUESTIONS OF PHYSICAL SCIENCE</p> <p style="text-align: center;">PART II Price 5d</p> <p>5 LATITUDE AND LONGITUDE</p> <p>6 THE PLANETS—Chapter III</p> <p>7 LUNAR INFLUENCES</p> <p>8 METEORIC STONES AND SHOOTING STARS—Chapter I</p> <p style="text-align: center;">PART III Price 6d</p> <p>9 RAILWAY ACCIDENTS—Chapter I</p> <p>10 THE PLANETS—Chapter IV</p> <p>11 METEORIC STONES AND SHOOTING STARS—Chapter II</p> <p>12 RAILWAY ACCIDENTS—Chapter II</p> <p>13 LIGHT</p>	<p style="text-align: center;">PART IV Price 5d</p> <p>14 COMMON THINGS—AIR</p> <p>15 LOCOMOTION IN THE UNITED STATES—Chapter I</p> <p>16 COMETARY INFLUENCES—Chapter I</p> <p>17 LOCOMOTION IN THE UNITED STATES—Chapter II</p> <p style="text-align: center;">PART V Price 5d</p> <p>18 COMMON THINGS—WATER</p> <p>19 THE POTTERS ART—Chapter I</p> <p>20 LOCOMOTION IN THE UNITED STATES—Chapter III</p> <p>21 THE POTTERS ART—Chapter II</p> <p style="text-align: center;">PART VI Price 6d</p> <p>22 COMMON THINGS—FIRE</p> <p>23 THE POTTERS ART—Chapter III</p> <p>24 COMETARY INFLUENCES—Chapter II</p> <p>25 THE POTTERS ART—Chapter IV</p> <p>26 THE POTTERS ART—Chapter V</p>

CONTENTS OF VOLS III AND IV, PRICE 3s 6d CLOTH

VOLUME III Price 1s 6d, in handsome Boards

PART VII Price 5d

27 LOCOMOTION AND TRANSPORT THEIR INFLUENCE AND PROGRESS — Chapter I

28 THE MOON

29 COMMON THINGS — THE EARTH

30 LOCOMOTION AND TRANSPORT THEIR INFLUENCE AND PROGRESS — Chapter II

PART VIII Price 5d

31 THE ELECTRIC TELEGRAPH — Chapter I

32 THE TRIUMPH OF HEAT — Chapter I

33 THE ELECTRIC TELEGRAPH — Chapter II

34 THE SUN

PART IX Price 6d

35 THE ELECTRIC TELEGRAPH — Chapter III

36 THE TRIUMPH OF HEAT — Chapter II

37 THE ELECTRIC TELEGRAPH — Chapter IV

38 THE ELECTRIC TELEGRAPH — Chapter V

39 THE ELECTRIC TELEGRAPH — Chapter VI

VOLUME IV Price 1s 6d, in handsome Boards

PART X Price 5d

40 EARTHQUAKES AND VOLCANOS — Chapter I

41 THE ELECTRIC TELEGRAPH — Chapter VII

42 THE ELECTRIC TELEGRAPH — Chapter VIII

43 THE ELECTRIC TELEGRAPH — Chapter IX

PART XI Price 5d

44 THE BAROMETR — THE SAFETY LAMP — WHITWORTH'S MICROMETRIC APPARATUS

45 THE ELECTRIC TELEGRAPH — Chapter X

46 EARTHQUAKES AND VOLCANOS — Chapter II

47 THE ELECTRIC TELEGRAPH — Chapter XI

PART XII Price 6d

48 STEAM

49 THE ELECTRIC TELEGRAPH — Chapter XII

50 THE ELECTRIC TELEGRAPH — Chapter XIII

51 THE ELECTRIC TELEGRAPH — Chapter XIV

52 THE ELECTRIC TELEGRAPH — Chapter XV

COMMENCING VOLUME V

PART XIII Price 5d

53 THE STEAM ENGINE — Chapter I

54 THE FIVE — Chapter I

55 THE ATMOSPHERE

56 LIME — Chapter I

PART XIV (Vol 1) Price 5d

57 THE STEAM ENGINE — Chapter II

58 LIME — Chapter II

59 THE FIVE — Chapter II

60 LUMBER

“DR LARDNER'S MUSEUM — one of the few works of the kind which can be recommended as at once popular and accurate — *Sir David Brewster*”

This Series besides affording popular but sound instruction on scientific subjects with which the humblest man in the country ought to be acquainted also includes that teaching of ‘Common Things’ which Lord Ashburton and every well wisher of his land are anxious to promote. Many thousand copies of this serviceable publication have been printed, in the belief and hope that the desire for instruction and improvement widely prevails, and we have no fear that such enlightened faith will meet with disappointment. — *The Times* Feb 9 1851

‘This serial which will form quarterly of its accompanying volumes is, we are disposed to think, the best literary investment of a penny a week now extant.’ — *Academy*

‘A cheap and interesting publication — alike informing and attractive. The pages combine subjects of importance with great scientific knowledge, considerable inductive powers, and a popular style of treatment.’ — *Spectator*

LONDON WALKER AND MABERLY,

UPPER GOWER STREET, AND IVY LANE PATERNOSTER ROW

