

NEW SERIES.
VOLUME II.

THE
ART-JOURNAL.



PUBLISHED (FOR THE PROPRIETORS) BY GEORGE VIRTUE, 25, PATERNOSTER ROW, LONDON;
AND 26, JOHN STREET, NEW YORK.

LONDON:
PRINTED BY JAMES S. VIRTUE, CITY ROAD.

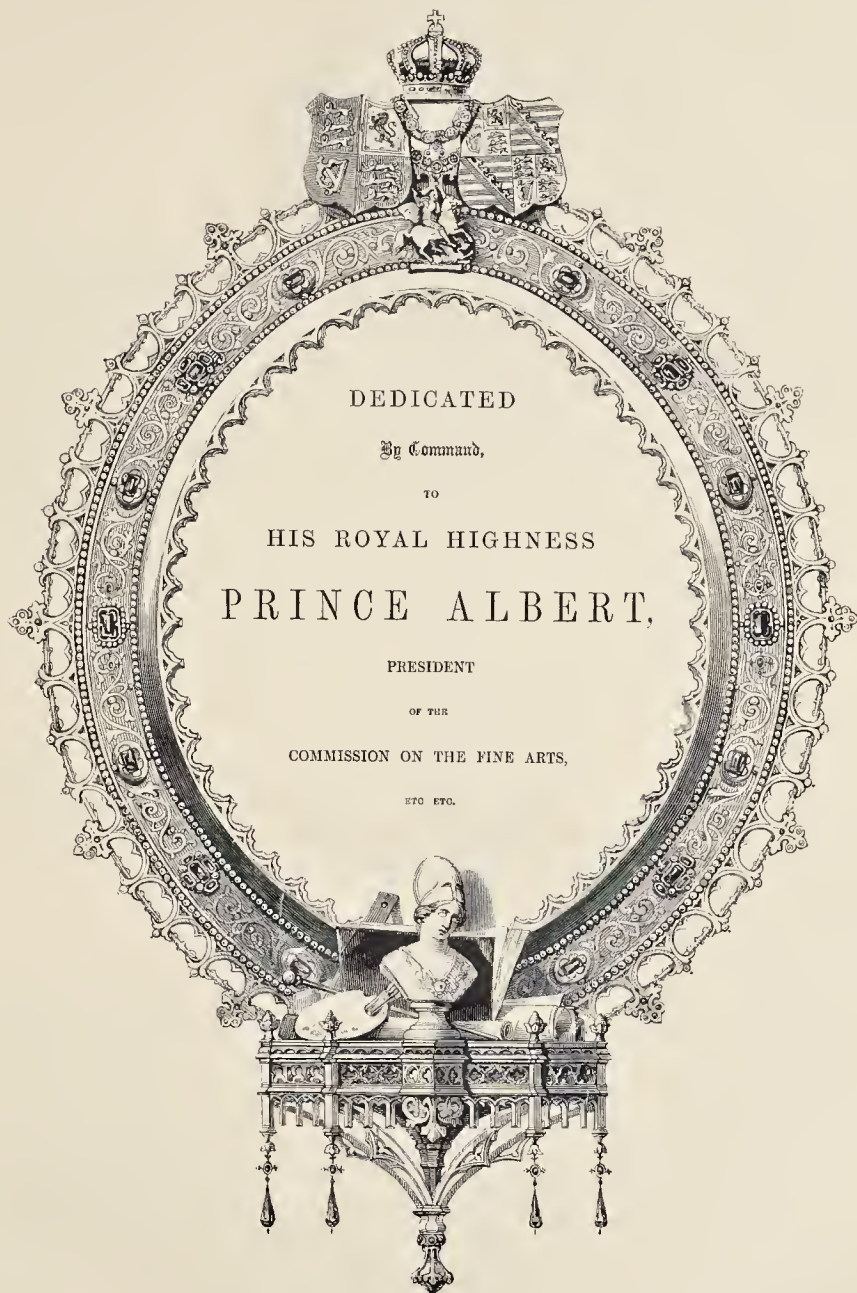

705A+7.9

4344

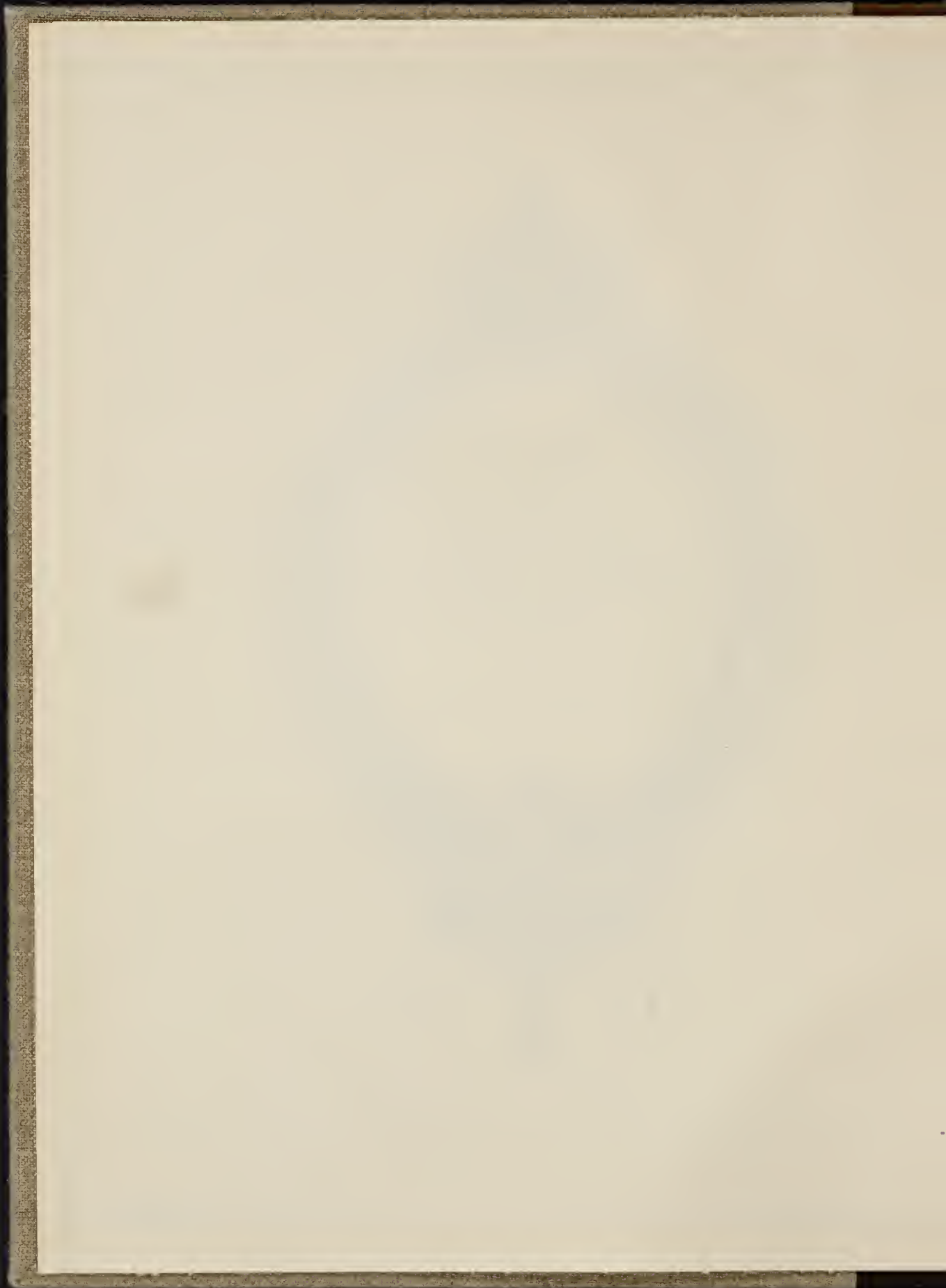

LIST OF ILLUSTRATIONS.

ENGRAVINGS FROM THE ROYAL PICTURES.

	PAINTERS.	ENGRAVERS.	PAGE
1. L'ALLEGRO	W. E. FROST, A.R.A.	<i>T. Garner</i>	4
2. THE BAY OF NAPLES	W. CALLOW	<i>R. Wallis</i>	16
3. THE WOLF AND THE LAMB	W. MULREADY, R.A.	<i>C. W. Sharpe</i>	35
4. THE WALK AT KEW	T. GAINSBOROUGH, R.A.	<i>C. H. Jeens</i>	48
5. THE TROOPERS	A. CUYP	<i>E. Haecker</i>	63
6. MIRIAM	W. HENSEL	<i>H. Bourne</i>	92
7. THE FOUNTAIN AT MADRID	D. ROBERTS, R.A.	<i>J. Cousen</i>	100
8. GENEVIEVE OF BRABANT	BARON WAPPERS	<i>J. C. Armytage</i>	124
9. THE CHILDREN IN THE WOOD	J. PEELE	<i>H. Bourne</i>	136
10. AMALFI, GULF OF SALERNO	G. E. HERING	<i>E. Goodall</i>	140
11. THE VISIT TO THE NUN	SIR C. L. EASTLAKE, P.R.A.	<i>S. Smith</i>	174
12. THE QUEEN'S HORSES	J. F. HERRING	<i>C. Cousen</i>	192
13. MILKING TIME	P. POTTER	<i>J. Godfrey</i>	200
14. MARY ANOINTING THE FEET OF CHRIST	RUBENS	<i>W. Greatbach</i>	216
15. "GO, AND SIN NO MORE"	E. CORBOULD	<i>C. H. Jeens</i>	232
16. THE STAR IN THE EAST	H. WARREN	<i>R. Brandard</i>	248
17. CONSTANTINOPLE: THE GOLDEN HORN	J. JACOBS	<i>T. A. Prior</i>	264
18. ST. CATHERINE	GUIDO	<i>J. M. St. Ee</i>	288
19. HYDE PARK IN 1851	J. D. HARDING	<i>J. B. Allen</i>	302
20. THE MADONNA	CARLO DOLCI	<i>F. Bal</i>	312
21. A FÊTE CHAMPÊTRE	J. B. PATER	<i>Polke</i>	330
22. ST. LUKE PAINTING THE VIRGIN	E. STEINLE	<i>L. Stocks, A.R.A.</i>	344
23. CHILDREN OF CHARLES I.	VAN DYCK	<i>J. Burnet</i>	360
24. CAPRI	G. E. HERING	<i>R. Brandard</i>	372

SCULPTURE.

	SCULPTORS.	ENGRAVERS.	PAGE
1. CUPID AND PSYCHE	J. GIBSON, R.A.	<i>W. Roffe</i>	20
2. SLEEPING CHILDREN	W. GEEPS	<i>J. H. Baker</i>	56
3. THE WOODMAN	SCHWANTHALER	<i>E. Roffe</i>	80
4. HAGAR AND ISHMAEL	E. S. BARTHOLOMEW	<i>J. H. Baker</i>	116
5. SPRING	B. E. SPENCE	<i>T. M. Knight</i>	148
6. RELIGION CONSOLING JUSTICE	J. EDWARDS	<i>R. A. Artlett</i>	188
7. PAUL AND VIRGINIA	W. C. MARSHALL, R.A.	<i>E. Roffe</i>	224
8. A NYMPH SURPRISED	E. G. PAPWORTH, JUN.	<i>E. Roffe</i>	250
9. THE LATE EARL OF BELFAST	P. MACDOWELL, R.A.	<i>R. A. Artlett</i>	276
10. TITANIA	F. M. MILLER	<i>J. H. Baker</i>	316
11. SUNSHINE	J. DURHAM	<i>W. Roffe</i>	352
12. THE FIRST CRADLE	A. H. DEBAY	<i>W. Roffe</i>	378

CONTENTS.

- ACADEMY Reform, 51, 261
 Album Imperial, 62
 Amalfi, Gulf of Salerno, 140
 America, Correspondence from, 233, 288, 331, 370
 Archaeological Institute, 353
 Archaeological Society, London and Middlesex, 290
 Archaeological Society, Surrey, 332
 Architects, Royal Institute of, 126, 352
 Architectural Exhibition, 29, 51
 Architectural Museum, 159, 332
 Architecture:—
 Cockerell's Lectures, 60
 Fergusson's Handbook, 31, 86
 Fergusson's Lectures, 63
 Hall's, E., Lectures, 30
 Arnour, Ancient, 45
 Art-Academy for British Students in Rome, 29
 Art in Continental States:—
 Berlin, 60, 316
 Brussels, 316
 Carlsruhe, 123
 Cologne, 123, 380
 Dresden, 60, 364
 Düsseldorf, 332
 Ehrenbreitstein, 20
 Hanover, 20
 Königsberg, 60
 Lille, 159, 263
 Lyons, 116, 224
 Munich, 60, 263, 350
 Nuremberg, 60, 350
 Paris, 20, 60, 92, 123, 148, 223, 257, 268,
 316, 332, 380
 Rome, 20, 29, 316, 352
 Turin, 263
 Ulm, 20
 Venice, 316
 Vienna, 20
 Art in the Provinces:—
 Bath, 58, 91, 124, 192
 Belfast, 8, 57
 Birmingham, 47, 57, 90, 93, 350
 Brighton, 6, 117
 Bristol, 191
 Cambridge, 90
 Cardiff, 58
 Carlisle, 8
 Cheltenham, 252, 351
 Clifton, 124, 192
 Clonmel, 351
 Cork, 58
 Coventry, 372
 Dundee, 149
 Edinburgh, 192, 252
 Falmouth, 372
 Glasgow, 57, 91, 94, 225, 280, 321, 350
 Greenock, 372
 Hartech, 8
 Leeds, 8, 91, 287
 Limerick, 58
 Liverpool, 91, 159, 252
 Manchester, 8, 57, 149, 191, 317, 318, 319,
 350, 353, 351
 Norwich, 58, 90, 252
 Oxford, 91, 323
 Paisley, 252
 Plymouth, 124, 372
 Richmond, 252
 Royston, 225
 St. Alban's, 149
 Stirling, 252
 Stoke-on-Trent, 224
 Taunton, 149
 Truro, 124
 Walsall, 58
 Warrington, 55, 92, 124
 Wolverhampton, 287
 Worcester, 8, 57, 124, 192
 Yarmouth, 351
 York, 351
 Artists' and Amateurs' Conversazione, 62, 60
 Artists' Competitions and the Palace of Adminis-
 tration, 330
 Artists' General Benevolent Fund, 125
 Artists' General Benevolent Institution, 94, 291
 Artists' Marks, 1
 Art-Manufacture Association, 322
 Art-Manufactures, Progress of:—
 Electro-Plate of Atkin Brothers, 56
 Gem Enamelled Vases of Jennens & Co., 154
 Porcelain of Kerr and Binus, 132
 Sheffield Plate of Skinner & Branson, 12
 Art-Manufactures, Projected Art-Union for, 158
 Art-Patriotic Exhibition, 354
 Art-Publications of:—
 Day & Son, 320
 Goupil & Co., 7
 Lloyd Brothers, 59
 Art-Season of 1856, 276
 Art-Studio in Birmingham, 47
 Art, Subjects for the Student in, 13, 36, 69, 101
 150, 212, 232, 265, 309, 327, 367
 Art-Union of Glasgow, 91, 94, 280
 Art-Union of London:—
 Annual Meeting, 180
 Exhibition of Prizes, 224
 Selection of Prizes, 230
 Assyrian Sculptures, 159
 BADEN, Pöte-Saloons at, 300
 Baily's Statue of "Genius," 372
 Baines, Statue of Mr. E., 8, 94
 Ballantine's Designs for Glass-Pointing in Glasgow
 Cathedral, 321, 350
 Barker's Picture of "The Allied Generals at Sebas-
 topol," 195, 226
 Barrett's Picture of "The Queen's Visit to the
 Wounded," 227
 Bath Society of Art, 58, 91, 124, 192
 Bay of Naples, 16
 Beauty, a Few Words on, 4
 Belfast, Statue of the Earl of, 276
 Bell's Statue of "Omphale mocking Hercules," 159
 Benson's Silver Plate, 28
 Berghem, Nicholas, 363
 Birmingham:—
 Art-Studio in, 47
 Art-Union, 57
 School of Art, 90, 93
 Society of Artists, 57, 350
 Bolton Abbey, Cousin's Engraving of, 227
 Bonheur's, Mademoiselle, "Horse Fair," 126
 Bookbinding, 35
 Bowyer and Marochetti, 158
 Branwer, Adrian, 210
 Brighton, A Soirée at, 6, 117
 Bristol Fine-Art Academy, 191
 British Art, Foreign Criticism on, 77
 British Artists:—
 Callest, Sir A. W., 9
 Creswick, T., 141
 Frith, W. P., 237
 Harding, J. D., 269
 Haydon, B. R., 151
 Hook, J. C., 41
 Leslie, C. R., 73, 105
 Pyne, J. B., 205
 Stone, F., 333
 Turner, J. M. W., 297
 British Association, 311
 British Industries:—
 Clays, &c., of Ireland, 67
 Compound Metals, 379
 Devonshire Marbles, 2
 Granite, 264
 Whitby Jet, 154
 British Institution:—
 Exhibition of Ancient Art, 222
 Exhibition of Modern Art, 62, 80
 Pictures sold at, 190
 British Museum:—
 Art-Director, 159
 New Librarian, 127
 Brompton, Museum at, 159, 194
 Bronzes, Antecedents of our, 278
 Brooks, Statue of Archdeacon, 252
 Buckingham Palace, New State Rooms, 192
 Burlington House, 226
 CAMBRIDGE Exhibition of Art, 90
 Capri, 372
 Cardiff Exhibition of Art, 58
 Carvings of Grinling Gibbons, 55
 Children in the Wood, 136
 Children of Charles I., 360
 Chinese Porcelain Manufacture, 197, 229
 Chromolithographies, Rowney's, 95
 Clifton and Bristol Graphic Society, 192
 Clothworkers' Company, 381
 Cockerell's Lectures on Architecture, 50
 Coldstreams' Monument, 322
 Cologne Cathedral, 380
 Colour in Pictures, On the Perception of, 66
 Compound Metals, 379
 Constantinople: the Golden Horn, 264
 Consumption, Hospital for, 195
 Copyright in Engravings, 92
 Copyright in Pictures, 126, 195
 Cornwall Polytechnic Institution, 372
 Correggio's "Reading Magdalen," 19
 Correspondence:—
 American, 225, 258, 331
 Bookbinding, 35
 Correggio's "Reading Magdalen," 19
 Durability of Water Colours, 202
 Marks of Gold and Silversmiths, 98
 Memorial of the Great Exhibition, 19
 Millin's Picture of "The Blind Girl," 236
 National Gallery, 93, 277
 Scutari Monument, 194
 Tidemand, A., 19
 Courtauld, Testimonial to Mr., 28
 Covent Garden Theatre, Destruction of, 126
 Crimean Exhibition, 123, 195
 Crystal Palace:—
 Appointment of Director, 94
 Belgian Sculpture, 323, 376
 Birmingham Court, 305
 Ceramic Court, 47, 217, 254
 Foreign Court, 345
 Improvements, 195
 India-rubber Court, 373
 Peace Trophy, 194, 258, 323, 354
 Picture Gallery, 126, 225, 258, 354
 Sheffield Court, 253
 Stationery Court, 281
 Winter Exhibition of Pictures, 381
 Cupid and Psyche, 20
 Cuypp, The Country of, 21
 DANNECKER, Recollections of, 35
 Day and Son, Art-Publications of, 320
 Death, Poetical and Artistic Conceptions of, 365
 Delaroche's "Hercycle," 60
 Department of Science and Art:—
 Exhibition at Gore House, 50
 Exhibition of Works by Pupils, 258
 Devonshire Marbles, 2
 Dow, Gerard, 210
 Drawing, Elementary Instruction in, 273
 Dresden Gallery, 364
 Du Camp on British Art, 77
 Dufferin, Statue of Lord, 5
 Durability of Water-Colours, 202
 Dutch Genre-Painters, 209, 245
 Dutch Landscape and Flower-Painters, 362
 Egg's Picture of "The Allied Generals at Balak-
 lava," 226
 Egypt, Seldou's Views in, 194
 Electro-plate Markers, 259
 Elmes, Testimonial to Mr., 91
 Enamels, Bone's, 94
 Evans's Hotel, 127
 Exhibition of 1851, Memorial of, 195, 258
 Exhibitions:—
 A Few Words on, 33, 274
 Crimean, 123
 French Pictures, 193
 Gore House, 50
 Photographic, 49
 Werner's Drawings, 195

- Expenditure on Public Works in London and Paris, 370
 Exposition of 1855, 17, 25
- FANCY-WORK, Novelty in, 139
 Faussett Collection, 340
 Fergusson's Lectures on Architecture, 63
 Fête-Champêtre, 340
 Fête-Saloons at Baden, 300
 Few Words on—
 Beauty, 4
 Exhibitions, 33, 274
 Our Neighbour's Taste and our Own, 89, 137, 300
- First Cradle, 378
 Flaxman's Bassi-rilievi at Covent Garden, 195
 Foreign Criticism on British Art, 77
 Forged Antiquities, 259
 Fountain at Madrid, 100
 Franklin's Statue, Ode for its Inauguration, 313
 French Pictures, Exhibition of, 193
 Fresco, Roman, 352
 Friend of the Clergy Corporation, 159
- GARDEN FOUNTAINS, 383
 Geert's Sculptures in the Crystal Palace, 376
 Genevieve of Brabant, 124
 Gibbons, Carvings of Grinling, 85
 Gibson's Statue of the Queen, 62
 Glasgow—
 Art-Union, 91, 94, 280
 Cathedral, Glass-Painting in, 321, 350
 Picture Dealing in, 190, 259
 Glass Pillars and Sash Bars, 30
 Glazed Bricks, 30
 "Go, and Sin no more," 232
 Godwin, Testimonial to Mr. G., 226
 Gold and Silversmiths' Marks, 93
 Goldschmidt, Madame, at Exeter Hall, 28, 95, 124
 Goldschmidt, Mr. and Madame, 291
 Goupil & Co., Art-Publications of, 7
 Government Offices, proposed New, 330
 Granite, 264
 Graphic Society, 127
 Greenwich Hospital: New Window, 126
 Gruner, Mr. Lewis, 159
 Guildhall and its Monuments, 351, 353
 Guildhall Crypt, 126
- HAGAR and Ishmael, 116
 Hall's, E., Lectures on Architecture, 30
 Impassioned Conversazione, 126
 Harbours of England, Turner's, 289
 Hart, the Picture-Dealer, 323
 Haydon, Pictures by R. B., 354
 Heraldry may have Menning, 278
 Herbert's Poems, 32, 76
 Hoheia, Plans, 20
 Holford's House in Hyde Park, 304
 Home for Gentlewomen, 259
 Home of Paul Potter, 110
 Hospital for Consumption, 95
 Houses of Parliament, 301
 Hyde Park in 1851, 302
- ILLUMINATIONS for the Peace, 225
 Industrial-Art and Art-Education, 58
 Institute of British Architects, 126, 159
 Irish Clays, Marbles, &c., 67
 Iron-work in Milan, 227
 Ivories, Antique, 354
 Ivory, Sculptures in, 227
- JET Ornaments, 154
- KENSINGTON, New Museum at, 158, 159, 194, 344
- L'ALELEGRO, 4
 Landseer, Engravings after Sir E., 29
 Landseer's "Taking the Buck," 227
 Lawlor's Statue of "The Bather," 94
 Leather, Art-imitations in, 291
 Lille Cathedral and English Architects, 159
 Liverpool:—
 Academy of Arts, 91
 Architectural and Archaeological Society, 252
 Elmes' Testimonial, 91
 Wellington Testimonial, 159
 Lloyd, Art-Publications of Messrs., 59
 Lyons, Museum of Stuffs at, 116
- MADONNA, The, 312
- Manchester:—
 Art-Treasures' Exhibition, 149, 194, 249, 290, 318, 353
 Institution, 57, 191, 319
 Mechanics' Institution, 8, 249, 290, 317, 350, 381
 Potter's Lecture at, 89
 Statue of Watt, 57
 Marine Aquarium, 145
 Mary anointing the Feet of Christ, 216
 Mansoleum of the King of Hanover, 20
 Mayer's Museum, Mr. Joseph, 195
 Meissonier's Picture of La Fontaine, 226
 McLellan Gallery, 225
 Merchant Tailors' School, 30
 Milking Time, 200
 Millais' Picture of "The Blind Girl," 236
 Minstrels of the Middle Ages, 129, 185, 203
 Miriam, 92
 Modern Painters, Ruskin's, 113, 148
 Monks of the Middle Ages, 285, 313, 341, 355
 Monument, The "Coldstreams," 322
 Monuments, Projected, 302, 332
 Mulready's Studies from the Life, 65
 Murillo's "Marriage of St. Catherine," 20
 Murillo's "Prodigal Son," 20
 Murillo's "Repentance of St. Peter," 94
 Museums, Private, 195
- NATIONAL Art and Native Artists, 248
 National Commissions, 293, 330
 National Gallery of Engravings, Proposed, 258
 National Gallery Reform Association, 195
 National Gallery, The:—
 Bellini, Picture by Giovanni, 237
 British Pictures at Kensington, 158
 Cuningham, Mr., 126
 Contemplated Removal, 29, 226
 Copies of the Old Masters, 93
 Correspondence on, 277
 Director's Report, 155
 Its Defamers, 156
 Mantegna's "Madonna and Child," 158
 New Pictures, 303
 Pictures onhung, 258
 Remarks on its proposed Site, 243
 Rogers' Bequest, 62, 94, 194
 Veronese's "Adoration of the Magi," 29, 94, 126
 National Institution: Exhibition, 121
 National Magazine, 353
 National Portrait Gallery, 99, 225
 Natural Clouds: Photography, 355
 Naval Female School, 159
 Nelson Column, 259
 Nelson Monument at Yarmouth, 351
 Nightingale, Miss:—
 Brooch, 259
 Goldschmidt's Concert, Madame, 95, 124
 Queen's Present, 62
 Testimonial Fund, 30, 291
 Nomenclature of Pictorial Art, 97, 325
 Northwick, Testimonial to Lord, 252
 Norwich Fine Arts' Association, 58
 Norwich Shawls, 30
 Nuremberg Art-Museum, 350
 Nymph Surprised, 250
- OBITUARY:—
 Braun, Dr. E., 353
 Carter, J., 27
 Chassierat, T., 332
 David (d'Augers), J. P., 36
 Delaroche, P., 377
 Ducornet, L. C. J., 224
 Gwill, G., 258
 Hopper, T., 353
 Montgomery, Rev. R., 27
 Pistracci, B., 27
 Powell, J., 353, 378
 Radclyffe, W., 72
 Rogers, Samuel, 27
 St. Eve, J. M., 316
 Varley, W. F., 148
 Werner, J. C., 332
 Westmacott, Sir R., 315
 Yarrell, W., 353
 Ormoude, Monument to the Marquis of, 381
 Ostade, A. Van, 200
 Oxford, Portraits at, 323
 Oxford Works of Art, 91
- PANOPTICON, The, 62
 Panoramas of—
 Sebastopol, 126
 St. Petersburg, 194
 Paper, Manufacture of, 349
 Paper of Straw, 30
 Paul and Virginia, 224
 Pearce Trophy at the Crystal Palace, 194, 258, 323, 354
 Peel Statue in Chesham, 194
 Peanethorne, Mr., 291
 Perspective Models, Twining's, 351
 Photogalvanography, 215
 Photographic Exhibition, 49
 Photographic Pictures of Sebastopol, 62
 Photographic Societies:—
 Edinburgh, 192
 London, 95
 Photography: Natural Clouds, 255
 Photography under Water, 227
 Pictorial Art, Nomenclature of, 97, 325
 Picture Dealing in Glasgow, 190, 259
 Picture Forgeries in Germany, 353
 Picture Sales:—
 Birch's Collection, Mr., 115
 Fairlie's Collection, Mr., 189
 Fosley's Collection, Mr., 251
 Miscellaneous, 115, 189
 Orford's Collection, Lord, 251
 Rogers' Collection, Mr. S., 185
 Turner's Drawings, 226
 Wethered's Collection, Mr., 95, 115
- Pictures:—
 Allied Generals at Balaklava, 226
 Allied Generals at Sebastopol, 195, 226
 Peace Conferences, 126
 Queen's Visit to the Wounded, 227
 Taking the Buck, 227
 Pictures, Early English, 354
 Pictures, On the Perception of Colour in, 60
 Plymouth Exhibition, 372
 Porcelain Manufacture in China, 197, 229
 Potter, Home of Paul, 110
 Princess's Theatre, 190, 320, 355
 Printing on Metallic Plates, 30
 Public Works and Buildings, 158, 371
- QUEEN, Noble's Bust of the, 258
 Queen's Horses, The, 192
- RELIGION consoling Justice, 188
 Rembrandt's Mill and Studio, 63
 Reviews:—
 Adventures of the Caliph Haroun Alraschid, 32
 Aesthetics, Introduction to the Study of, 227
 Almanac of Science and Art, 64
 Analysis of Ornament, Wornum's, 196
 Ancient Armour, 45
 Ancient Crosses in the West of Cornwall, 260
 Angelo, 31
 Angelo and Raphael, Lives of, 228
 Aphorisms in Drawing, 356
 Architecture, Fergusson's Handbook of, 31, 66
 Art and Nature at Home and Abroad, 383
 Art of Flower Painting, 128
 Art of Painting and Drawing in Water-Colours, 128
 Arts of the Middle Ages, Handbook of, 31
 Ballads and Lyric Poems, Mackay's, 324
 Bank-notes, Security and Manufacture of, 384
 Beckstein's Handbook of Birds, 160
 Bolton Abbey in the Olden Time, 259
 British Poisonous Plants, 228
 British Workman, 292
 Calisthenics, 356
 Chaik Waggoner of the Limousin, 291
 Chess-player's Annual, 64
 Chester, Handbook to, 292
 Choice Fruit, 128
 Chromolithographics, Hahart's, 292
 Chromolithographics, Rowney's, 95, 324
 Chronological Tables, Blair's, 324
 Church Building, Denison's Lectures on, 260
 Circle of the Sciences, Orr's, 326
 Collodion Process, 260
 Compensation, 260
 Cottage Pictures, 324
 Craun Britannica, 160
 Crystal Palace Almanac, 384
 Crystal Palace, Wyatt's Lecture at the, 64
 Cyclopaedia of Geography, 228

Reviews:—

Dictionary of Greek and Roman Geography, 128
 Disturbed Detected, 128
 Domestic Fowl, Hesse's, 96
 Ecclesiastes, or the Preacher, 123
 Electricity, Manual of, 32
 Elegant Arts for Ladies, 160
 Elements of Picturesque Scenery, 95
 English Poets, Bell's, 324
 Entomology, Kirby and Spence's, 260
 Eve of St. Agnes, 31
 Fern Allies, 196
 Ferns of Great Britain, 196
 Ferny Coombes; a Ramble after Ferns, 292
 Firstborn, The, 127
 Five Gateways of Knowledge, 384
 Forbes, Portrait of Professor, 64
 France, Wright's History of, 160
 Gainsborough, Life of Thomas, 250
 Giotto's Frescoes, 227
 Golden A. B. C., 160
 Grace Hamilton's School-Days, 292
 Greece and its Islands, Liutou's Scenery of, 195
 Harbours of England, Turner's, 289
 Harvest in the Highlands, 96
 Herbert, Poems of George, 32, 76
 Here and there in Portugal, 96
 Hertha, 260
 History of Sir Thomas Thunb, 64
 Hopes and Fears, 260
 "I'm a-thinking," 128
 Janfry the Knight, 324
 Keepsake, The, 32
 Kitto, Memoirs of Dr., 228
 Language of the Eye, 127
 Life in Ancient India, 354
 L'Imitation de Jesus Christ, 355
 Lithoegeographia, 160
 London in the Olden Time, 63
 Lord of the Isles, 361
 Machinery of the "Arabian" and the "La Plata," 96
 Marian Falconer, 384
 Marriage of Pochontas, 356
 Martyr Land, 31
 Microscope and its Revelations, 355
 Military Engineering, Handbook of, 356
 Miscellaneous Graphica, 128
 Modern Painters, Ruskin's, 113, 148
 Music of the Olden Time, Popular, 32
 Napoleon rebuking his Officers at Bassano, 196
 New School of Singing, 64
 Nolan's Illustrated History of the War, 64, 324
 Opening of the Great Exhibition of 1851, 259
 Operations in the Baltic, King's, 260
 Outlines of English History, 384
 Oxymerc Process in Photography, 356
 Painting with Both Hands, 292
 Paris from the Pont Royal, 128
 Parthenon, Key to its Proportions, 324
 Perspective, Burchett's Practical, 228
 Photographic Art-Treasures, 383
 Photographic Memoranda, 383
 Photographic Portraits of Living Celebrities, 292
 Photographs from the Crimea, Fenton's, 128
 Photograph Views of Sebastopol, Lefevre's, 128
 Pictures of 1856, Remarks on the, 228
 Picturesque Tourist of Scotland, 292
 Poetical Tentatives, 384
 Portraits of the Queen, Prince Albert, &c., 160
 Pre-Raphaelism, What is it? 127
 Principles of Form in Ornamental Art, 260
 Proportions of the Human Figure, 31
 Puss in Boots, 64
 Rhime of the Ancient Mariner, 384
 Roman Coins, the Northumberland Collection, 323
 Royal Academy, Ruskin's Notes on the, 196
 Sabbath Bells, chimed by the Poets, 31
 Salamandrine, The, 324
 Saltair, 64
 Scenery from the English Lakes, Photographic, 383
 Science of Beauty, Hay's, 228
 Sculptures in Ivory, 227
 Sketcher, The, 250
 Soldier's Departure and Return, 291
 Songs for Music, Mackay's, 324

Reviews:—

Songs of the Brave, 228
 Stammering, Cure of, 292
 St. David's, History and Antiquities of, 353
 Stereoscope, Prize Essay on the, 228
 Studios of Banch and Humboldt, 384
 Swiss Guide, 228
 Tales of Magic and Meaning, 31
 Talking-Bird, The, 31
 Tam O'Shanter, 63
 Tasso and Leonora, 196
 Things not generally known, 196
 Thomas, Sir, 31
 Tile-Pavements in Chertsey Abbey, 96
 Villa Fountain, The, 127
 Voyage of Life, 96, 260
 Waiting for the Deer to Rise, 32
 Walton's Complete Angler, 228
 Watt, Memorials of James, 384
 Whispers in the Palms, 32
 William of Wykeham and his Colleges, 198
 Women's Record, 64
 Rogers' Bequest to the National Gallery, 62, 94, 194
 Rogers' Collection, Sale of, 188
 Royal Academy:—
 Art-Teachers, 322
 Award of Prizes, 29
 Complaint Against, 94
 Conversazione, 290
 Copyright in Pictures, 126
 Election of Associate Engravers, 351
 Election of Officers, 29
 Exhibition, 161
 Hangers, 158
 Lectures on Architecture, 60
 Memorial of Sculptors, 50
 New Librarian, 158
 Non-Exhibiting Members, 225
 Proposals for Reform, 291
 Sculpture, 221, 259
 Royal Scottish Academy:—
 Annual Report, 30
 Exhibition, 179
 Ruskin's Modern Painters, 113, 148
 Ruskin's Notes on the Academy, 196
 Rutland, Portrait of the Duke of, 63, 127
 SALOMONS, Portrait of Alderman, 354
 Sands at Ramsgate, Frith's, 94
 Schools of Design, Inspection of, 194, 226
 Schools of Design, Reports of:—
 Belfast, 57
 Birmingham, 90, 93
 Carlisle, 8
 Clonmel, 351
 Cork, 55
 Coventry, 372
 Edinburgh, 252
 Greencock, 372
 Leeds, 91
 Limerick, 58
 Manchester, 191
 Norwich, 90, 253
 Paisley, 252
 Plymouth, 124
 Truro, 124
 Walsall, 58
 Warrington, 58, 124
 Worcester, 8, 124
 York, 351
 Scott, Portrait of Sir W., 159
 Scriptural Museum, 94
 Sculptors and Mr. Bowyer, 158
 Sculptors' Institute: Memorial to Sir B. Hall, 193
 Sculptors' Memorial to the Royal Academy, 50
 Sculpture in the City, 126
 Scutari Monument, 194, 225, 248, 354
 Sebastopol, Panorama of, 126
 Sebastopol, Photographic Views of, 62
 Seddon's Views in Egypt, &c., 194
 Ship Building, 95
 Siberian and Chinese Scenery, 354
 Slitherp Collection, 159
 Sleeping Children, 56
 Smith's Museum, C. Roach, 195
 Society of British Artists, Exhibition, 138
 Society of Water-Colour Painters:—
 Election of Members, 94, 290
 Election of President, 29
 Exhibition, 175

Society of Water-Colour Painters, The New, Exhibition, 177
 Somerset House, 226
 Soulang, Collection of M., 258, 381
 Spring, 148
 St. Alban's Abbey, Restoration of, 149
 St. Catherine, 288
 St. Luke Painting the Virgin, 344
 St. Paul's Cathedral:—
 Restoration of Thorhill's Paintings, 323
 Wood-carvings in, 226
 Star in the East, 248
 Statues of:—
 Baines, E., 8, 94
 Bathur, The, 94
 Belfast, Earl of, 276
 Brooks, Archdeacon, 252
 Burke, E., 226
 Charles L., 30
 Curran, J. P., 226
 Duferin, Lord, 8
 Fox, C. J., 354
 "Genius," Baily's, 372
 Napier, Sir C., 290
 Omphale mocking Heracles, 150
 Prussia, King of, 20
 Queen, The, 62
 Sussex, Duke of, 258
 Watt, J., 57
 Wilson, Professor, 252
 Steen, Jan, 211
 Stereoscope, Knight's Cosmoramic, 226
 Stereoscope, The, 118
 Stereoscopic Company, 63, 118, 323
 Stumps for Crayon Drawing, 127
 Subjects for the Student in Art, 13, 36, 60, 101, 150, 212, 232, 265, 309, 327, 364
 Sunshine, 352
 Surrey Gardens Company, 63
 THREAD and Fibre Gilding, 337
 Tileman, Adolphe, 19
 Titania, 316
 Treadwin's Lace, 30
 Troopers, The, 68
 Turner's Bequest, 126, 257, 354, 350
 Turner's Harbours of England, 289
 Twining's Perspective Models, 351
 UNITED STATES, Art in the, 235, 288, 331, 370
 VISIT to the Nun, 174
 WAAGEN, Dr., 195
 Wasgen, Dr., on the Giovanni Bellini, in the National Gallery, 257
 Walk at Kew, 48
 Wallace, Monument to Sir W., 252
 Ward's (E. M.) Pictures of:—
 Queen Victoria at the Tomb of Napoleon, 354
 The Installation of the Garter, 29
 War Memorials, 355
 Washington, Crawford's Monument of, 380
 Water-Colours, Durability of, 292
 Watt, Statue of J., 57
 Wellington Monuments in:—
 Guildhall, 322, 353
 Liverpool, 159, 382
 Manchester, 319
 St. Paul's, 158, 293, 322, 354, 381
 Werner's Drawings, 195
 Westminster Abbey, Statues in, 290
 Wilson, Statue of Professor, 252
 Winchester College, 106
 Winster's Tale, The, 190
 Wolf and the Lamb, 36
 Wood Carving by:—
 Gibbons, G., 85
 Machinery, 241
 Perry, 259
 Rogers, 194, 259
 Wood-Carvings in St. Paul's, 226
 Wood-Carvings, Preservation of, 62
 Woodman, The, 80
 Worcester, Society of Arts, 57
 Wyld, Decoration Conferred on W., 29
 Wyld, Pictures by W., 290
 YARMOUTH, Nelson Monument at, 351.

THE ART-JOURNAL.



LONDON, JANUARY 1, 1876.

ARTISTS' MARKS.



CASUAL glance at the present page might induce our readers to imagine it devoted to some abstruse paper on Coptic manuscripts, Egyptian hieroglyphics, or possibly on Babylonian inscriptions, aided by the research of Colonel Rawlinson himself. It is, however, sacred to no such profundities, but is intended simply to display some of those curious forms adopted by artists to stamp their own works as authentic, in the same way as the goldsmiths, silversmiths, and potters did theirs, and which it has been our province to describe in our preceding volume.



Some artists have been content to exhibit the initials of their names, combined with that of the place of their birth, as in Fig. 1, which is the mark usually adopted by Israel Van Mechlin (born 1450, died 1503). He, however, varied the marks on his works, and sometimes only adopted the large flowing I, seen in Fig. 2, at other times he formed the name *Israel* into a fanciful monogram, or used the old German letters, I. V. M., as his marks; sometimes the letter I, passed at a right angle through the M., then, occasionally, V. M. only appears; so that in the instance of this artist we find as much variety as is displayed in the marks generally adopted by one man. Fig. 3 exhibits the sort of mathematical figure used by Hans Van Aken (born 1552, died 1615), a painter of the Low Countries, and a native of Aix-la-Chapelle.



Fig. 4 is the cypher used by Albert Van Everdingen, the painter and engraver of the Netherlands (born 1621, died 1675); it is a combination of the three first letters of his name, fancifully disposed. The mark, Fig. 5, was adopted by Crispin Van den Broeck, of Antwerp (born 1530), who practised painting, and engraving on copper and wood; the combination of letters which he has adopted signifies *Crispin, inventor, Antwerp*. Fig. 6 is that used by Agostini Carneci, to mark his engravings (born 1557, died 1602); it is A. C. E., for A. Carneci,

fecit, at other times he used the A. C. alone. Fig. 7 is the monogram constructed by Spagnoletti (born 1588, died 1656), to distinguish his works, and consists of the letters of his proper name, Ribera, with the omission of the letter E. The upright line of the A. also serving for I. in his Christian name, Joseph.



There is an artist whose works were known in the middle of the sixteenth century as those of "the master of the caltrap," from his using that implement as his mark, Fig. 8. The caltrap was an instrument used in Medieval warfare, and consisted of a group of iron spikes, which were cast upon the ground, to wound the feet of horses and impede a charge of cavalry. Fig. 9 is the mark of Francis Mazzuoli, better known by his sobriquet of Parmagianino, from Parma, the place of his birth, (in 1503), which he has here adopted in combination with his Christian name. Fig. 10 is the florid initials of Johann Friedrich Greuther, a Dutch engraver, born in 1600, died 1660. Fig. 11 is the quaint combination of F's, all forming part of each other, used by Franz Friedrich Frank, another Dutch engraver, who flourished from 1627 to 1687. The last two are good examples of the florid and the formal styles of initial.

The old merchants universally adopted a series of marks to distinguish their sales of goods; and as they were not allowed, however rich they might be in the middle ages, to adopt arms, and thus rival the dignity of the gentry, these marks were used upon shields, similar to those upon which heralds emblazon their fancies. Hence many an old tomb and church window is thus decorated. Some few of the old artists adopted similar elaborations, and the mark, Fig. 12, is a good example, being that used by Jost Van Wingen, who lived from 1544 to 1603. Very frequently these old merchant-marks were combined with a figure of 4, which some



writers have considered to be a rude representation of the mast and yards of a ship, indicative of their trade, in the same way as shown in Fig. 15, which was used by the artist Raphael de Ravenna. Fig. 13 is another fanciful mark, also much like a merchantman's, used by Augustin Hirschvogel, a German engraver, born 1504, died 1560. Fig. 14 was adopted by the Italian engraver, Gabriel Gioliti, of Ferrara, who flourished in the early part of the sixteenth century.

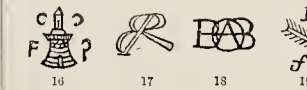

Nicholas Roser, of Modena, who lived at the same period, adopted the somewhat fanciful mark, Fig. 16, which bears no allusion to his name, but may, possibly, to his native town. The painter, Elias Rei-

dingier (born 1695, died 1767), used the quaint arrangement of his initials, engraved Fig. 17. George Bobbia, an Italian engraver of the latter part of the sixteenth century, combined the letters of his surname, as in Fig. 18. Bernhard Graet, a painter of the Netherlands (born 1628, died 1709), placed the initial of his Christian name above a *grating*, indicative of his surname, with the letter *f*, for *fecit*, beneath, as shown in Fig. 19.



The wood-engraver, John Operin, of Basle (born 1509, died 1568), combined his initials as is Fig. 20. Martinus Martini, the engraver, of the early part of the seventeenth century, used the sort of double M, seen in Fig. 21, sometimes surmounted by the bowl of a tobacco-pipe. Antonia Tempesta, the painter (born 1555, died 1620), employed the monogram, Fig. 22. The German painter, Ludwig Von Ring (born 1436, died 1547), used the flowing L, upon which a ring was hung, as shown in Fig. 23.

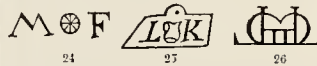

This plan of using a figure for a name was very customary in the middle ages, and such an invention was called a *rebus*; it was natural that artists should particularly prefer such pictorial nomenclature. Thus, Martin Rota, the Italian engraver, used the *rota*, or wheel, for his mark, as in Fig. 24, accompanied by the initial of his Christian name, and the word *fecit*. Ludwig Krug, the German goldsmith and engraver, placed the Jug, symbolic of his name, between his initials, as in Fig. 25. Gerard Lairese, the painter (born 1640, died 1711), adopted the fanciful double combination of initials seen in Fig. 26.



The wood-engraver, Tollot, about 1530, used the mark, Fig. 27. Another more famous practiser of the art, Hans Schaufelin (born 1492, died 1540), used the letters of his name, as in Fig. 28, or the two small *shovels*, such as are used by bakers, as in Fig. 29, which afforded a punning allusion to his name. Herman Ring, a German painter (born 1540, died 1597), adopted the ring in his initials, Fig. 30, as used by his predecessor, Fig. 23.



Albert Durer (born 1471, died 1528) used the open gates as a rebus of his name, Fig. 32, and adopted from the similarity of sound between his name and the word *thor*, or gate, in German; they generally enclose the initials of his name and the date at which each particular work was executed, as in our example. The great painter,

Corregio, used a heart, indicative of the first syllable of his name, and inscribed the rest above it, Fig. 33,—or else, as in Fig. 34, crowned his heart, as *cor regio*, placing the usual designer's word upon it.



George Hofnagel, the German painter and engraver (born 1575, died 1629), whose name literally signified *Housenail*, rejoiced in marking his works with a large nail, as in Fig. 35, sometimes entwining it with the first letter of his Christian name, as in Fig. 36, or else with the *last*, as in Fig. 37; at other times he used the great nail alone, upon which was inscribed his Christian name, latinised, as in Fig. 38.



Johann Maria Pomedello, an Italian engraver of the early part of the sixteenth century, used the mark, Fig. 39, consisting of an apple, indicative of the *pomme*, in his name; which was further "panned on" by Isabella Quatre Pomme, living at the same time, who placed the number 4 on her apple, and completed a perfect French rebus of her name, Fig. 40. The German engraver, Hopfer, at the same era, marked his plates with the small tree, Fig. 41. Francis Sebastian Scharnagel, the painter and lithographer of Bamberg (born 1791),



adopted this old custom, by placing Fig. 42 on his works, indicating the literal meaning of his name, *share-nail*. Fig. 43 is one of the most curious of these whimsical marks; it was adopted by an Italian engraver in the early part of the sixteenth century, who was hence known as "the master with the rat," his name being *Ratto*. With the same feeling, Hans Weiner, the German engraver of 1590, used the bunch of grapes, Fig. 44, indicative of the *wine maker* his name literally signified. Ulrich Pilgrim, the German wood-engraver, who flourished about



the same time, adopted the cross *bourdon*, or walking-staves of the pilgrims, Fig. 45. The Italian engraver of the fifteenth century, Lucca Fiorentino, placed his initials on a shield, as in Fig. 46. Lucas Cranach, the German engraver (born 1472, died 1553), used the winged dragon holding a ring in his mouth, Fig. 47; at other times he adopted a shield with two swords crossed; and at others the arms of the Electoral Princes of Saxony, by whom he

was patronised. Sometimes two or three of these marks are found together in one of his pictures, or engravings.



In speaking now more particularly of painters' marks, the place of honour must be given to Raphael, who sometimes used the combination of the four first letters of his name, as in Fig. 48. Philip Vonvermans combined those of his Christian name, as in Fig. 49. Paris Bordone used the mark, Fig. 50. Jacob Palma, returning again to the rebus, gave a palm branch with his initial, as in Fig. 51. John Wynants used the boldly flowing initials represented in



Fig. 52. John Vandervelde, the quaint combination of an I and two V's, seen in Fig. 53. Carl Van Mander used an equally fantastic compound of his initials, as in Fig. 54. Gerhard Terburg adopted the mark,



Fig. 55, which includes a letter for each syllable of his surname. This plan was also adopted by Daniel Lintmayer, in the scrawling initials, Fig. 56. The Italian painter, Dosso Dossi, used the large D with a bone through it, as in Fig. 57. Another mark used by Vandervelde is given, Fig. 58. That



adopted by Andrea Mantegna is shown, Fig. 59. Jost, or Justus Ammon, a wood engraver, extensively employed by the booksellers of his era, (he was born 1539, and died 1591), distinguished the myriad of curious and beautiful cuts he gave to the world by the initials engraved, Fig. 60. In Fig. 62, we have exhibited a mark used by the painter Tempesta, Fig. 61 is another, which is a combination of *A. Temp.*, an abbreviated form of his name. Hubert de Croock, a German wood-engraver of the close of the fifteenth century, used the mark, Fig. 62,



which combines the H and C of his name with the pastoral staff, or *crook* of the Romish Church. The painter, Nicholas Berghem, adopted the C B of Fig. 63, the C indicative of the familiar Dutch abbreviation of his Christian name into *Claas*. Annibale Caracci used the mark, Fig. 64. The small and modest *a. v.*, in Fig. 65, is the mode in which the great Vandyke marked his works. Fig. 66 is another variety of mark adopted by Tempesta (see also Figs. 22 and 61).

The Dutch painter and engraver, George Wachter, in the early part of the seventeenth century, used the quaint initials of

his name, Fig. 67. Johan Van Sommer, about the same time, used Fig. 68 as his mark. Theodore Kaiser, another artist of the same period, used Fig. 69. We now add a fourth instance of Tempesta's marks, Fig. 70; while Fig. 71 exhibits that of the Italian painter, Sebastian Ricci.



We have thus given fair examples of the great variety of fanciful modes adopted by artists and engravers of all grades and at all periods to identify their works, comprehending initials, monograms, and emblems. The custom of using quaint marks is now almost entirely confined to initials; there are, however, some few instances of the old practice of punning in our own day, as when Richard Doyle placed a (*Dickey*) bird for the mark to his designs in "Punch," or John Leech exhibited a *Leech* in a bottle,



for his; these were good-natured comicallities, well fitted to such works, if not a quiet satire on the practice. We conclude our series with a few examples of marks used by artists and engravers of the last and the present century. Fig. 74 is the abbreviated name of John Henry Ramberg, the German painter and engraver, (born 1763). Fig. 75 is that used by our famous mezzotint engraver, James Mac Ardell (born 1710, died 1765). Fig. 73 is used by Eugene Neureuther, of Munich, (born 1806); and Fig. 72 that adopted by his great fellow-townsmen, Peter Cornelius, (born 1786), who has done so much to elevate the Fine Art of his country.

F. W. FAIRHOLT.

BRITISH INDUSTRIES.*

No. VI.—DEVONSHIRE MARBLES.

It has often appeared to us, that we do not sufficiently value the productions of our own Islands. That which is foreign is highly esteemed, while, too commonly, that which is produced at our doors is regarded as valueless. With our increasing wealth this feeling has certainly been fully developed, and articles of taste are valued more frequently by a scale, graduated according to the distance from whence they are brought, rather than by any intrinsic excellence. To this passion we find many excellent caterers. The less wealthy, but no less industrious inhabitants of many Continental localities, seek for native productions, and moulding them to suit the prevailing tastes of England, realise large profits by materials which to them were formerly valueless. In these remarks, let it be understood there is no intention to undervalue the productions of the Continent. It is desired only to direct attention to sources at home from which articles of equal beauty could be obtained if the wealthy amongst us would but lead the way in this direction.

The black antique marble—the *Nero antico* of the Italians, the *red antique marble*, *verde antique*, the *marmo verde pagliocco*, the *Cipolino marble*, and the *rose-coloured brecc-*

* Continued from p. 258, vol. for 1855.

cia marble, have all of them been rendered famous by the works which have been executed in them; and hence, for ordinary purposes, these marbles are bought at an extravagant cost, when we have ornamental stones in our own island surpassing many of them in beauty.

The limestone formations of Devonshire and of Derbyshire produce a variety of coloured marbles of high character. Black, white, grey, red, and brown varieties are found in both these counties. Wales and Westmoreland can yield from their carboniferous and transition limestone beds several most agreeable dark marbles. The green marble of Anglesea, the Connemara marbles of Ireland, the white and variegated marbles of Scotland, and the beautiful serpentine of Cornwall, to which we have already more than once directed attention, may be quoted as a few examples of our British resources.

Although we have been long acquainted with the numerous varieties of stone produced from the limestones of Devonshire, our attention has been more especially directed to them during the past autumn. The peculiar geological character of these rock formations—the picturesque beauty of the country in which they are found—the romantic arrangement of the rocks themselves along the coast in the neighbourhood of Torquay, and the adaptability of this material to numerous purposes of decorative art—are so many inducements for us to devote an article to their consideration. This district has been so carefully examined by some of our most skillful geologists, that no apology is required for availing ourselves of the information they give us.

The following general sketch of the coast is from the pen of the late Sir Henry de la Beche—

"There is no beach to the cliffs from near the Ness-point, at the mouth of the Teign, to Hope's Nose, the northern point of Tor Bay, with the exception of the bottom of a few coves, and the Babbacombe Sands, and their continuation, the Oddicombe Sands, both misnomers, for they are single benches. The cliffs plunge directly into the sea, and are well seen only from a boat. The coast is equally bold from Hope's Nose to Torquay, with the exception of Meadfoot Sands, which are, however, backed by a high broken hill. After passing the hill, between Torquay and Tor Abbey, the coast assumes a milder character; the cliffs, where they occur, are of no great elevation; and there are extensive sands both at Paington and Goodrington, separated by Roundham Head. Further south, low cliffs intervene between Goodrington Sands and the Broadlands. Beyond the low rocky land of Galnpton Point the cliffs are bolder, and continue so to Berry Head, being in a few places broken into coves, the most considerable of which is occupied by the harbour of Brixham. This range of coast is backed by hills varying in height from 200 to 500 feet. Furland Hill, between Brixham and Dartmouth, is 589 feet above the sea."

If we look at a geological map we shall find the limestone formations commencing on the edges of the red sandstone series, and spreading in detached masses—islands as it were—amongst the clay-slate formations to Plymouth, at which place they may almost be said to terminate. It is true, that in the neighbourhood of Looe, and at some two or three other spots in Cornwall, small patches or veins of this limestone are found, but never in any quantity. The eminent geologist whom we have already

quoted, writes thus of the limestones of St. Mary Church, Babbacombe, and the northern side of Tor Bay—

"These encircle the old red sandstone, which extends from Meadfoot Sands towards Upham. The section on the south side of the Meadfoot Sands shows the limestone resting on old red sandstone. The quarry at the south-west points, opposite a rock called Shag Rock, is marked in grey and reddish compact limestone, dipping south west; beneath is an argillaceous shale, reddish in the upper part, and grey in the lower.

"The limestones in the vicinity of Torquay are much disturbed, as are also, more or less, all the stratified rocks of the district." * So much confusion exists in the vicinity of Torquay, that no regular dip of the limestones can there be determined. They dip S.S.W. at an angle of 35°, near the turnpike, and at the quarry near the baths, to the S.W. They are perpendicular, with a north and south direction, at a little hill near Tor-Moham, at the Chapel Hill, and under Torwood House. At Stantaway Hill, between Tor-Moham and Upham, the calcareous slate and limestones are much confused. On the road from Torquay to St. Mary Church, at the entrance of the rocky defile, irregular, detached, and arched strata, have a very picturesque effect, the arch appearing to be almost a work of art. The coast also, from Babbacombe to the Black Head, exhibits confused strata of limestone and argillaceous shale; at the latter place we may observe a thick bent stratum of limestone included in the solid trap; this limestone is very crystalline. Hope's Nose, with the Leadstone, Oarstone, and Thatcher Rocks lying immediately near it, are composed of limestone much contorted at the cove north of the Thatcher. This mass of limestone is detached from the limestone on the west, that is above the level of the sea; and, beneath they are probably connected with the Torquay beds, for the Thatcher Rock is composed of them. Kent's Cavern, celebrated on account of the remains of elephants, rhinoceroses, hyænas, bears, deer, wolves, &c., found in it, is situated in these limestones."

Similar caverns to Kent's have been discovered in the Plymouth limestones, and the remains of animals of the same description have been found in them. These discoveries of ossiferous caverns have been of considerable interest, as marking a period when those islands must have been the habitation of animals now found only in tropical climes. Notwithstanding the variety of bones found in Kent's cavern, and others, it is inferred from very satisfactory evidence, that the hyæna alone inhabited them, and that these predaceous creatures accumulated the bones of the other animals which have been found.

It must be borne in mind, however, that the remains of animals found in these limestone caverns, are of all ages; and Dr. Buckland has shown that it is highly probable that they may have been used as occasional places of sepulture, especially from the evidence afforded by the discovery of the remains of a woman in Paviland Cave, Glamorganshire. We have incidentally noticed these limestone caverns principally to show the geological time to which these formations must be referred. The beautiful *Madrepore* and *Encrinetic* marbles show that they are the result of influences such as those now going on in the Pacific Ocean.

These enormous masses of limestone have been, without doubt, produced by *polypti*.

The best evidence of this has been afforded by Mr. Austen, who examined with very great care not merely the limestones of South Devon, but the rocks immediately associated with them. The limestones are stated by this author to occur, in nearly every instance, in the immediate vicinity of volcanic disturbances, and to be partly included in the slates and sandstones, and partly to rest upon them.

To the former belong the broad band extending from Staple Hill to Dean Prior, the minor bands in the neighbourhood of Thorpestone and Totness, and all those which occur beyond the Dart; also the limestones of Newton and Torbay. They are said to be less pure and more slaty than the overlying limestones, and to be frequently separated by seams of shale. Transverse sections of these lands show, that the strata in some cases become thinner as they descend, and the partings of the shale increase, as near Staverton in the valley of the Dart, and at Staple Hill; but that, in other instances, as between Newton and Totness, the strata, instead of thinning off, end abruptly upon the slate, and are covered in the direction of the dip by similar slates. The strata are always inclined, but they invariably form a table land at the surface. This inclined position is conceived not to be due to dislocation, but to the beds having been deposited at the angle which they now present. The bands of limestone dip 40°, but are nowhere more than 150 feet thick, and they all contain the same description of organic remains.

In the structure of the Devonshire limestones, Mr. Austen considers that he has discovered evidences of an origin similar to that of modern coral reefs, which will explain their inclined position. At Ogwell Park the limestone forms a horizontal capping to the inclined strata, and at Bradley rests conformably against a ridge of slate, the basset edge of each bed rising to the level of the crest of the ridge. This structure agrees with that of the coral reefs in the Southern Ocean.

The stratified arrangement of the calcareous masses may be explained by the occasional deposition of sedimentary matter, which might, for a time, interrupt the labours of the *polyptus*; and thus a series of beds would be produced, varying in thickness, according to the recurrence, at shorter or longer intervals, of interfering agents, each bed rising successively to the surface-level of the water.

If the deposition of sedimentary matter were great, then the *polypti* would be destroyed, and the reef would become encased in a mechanical accumulation. In further proof of the limestone of Devonshire having been coral reefs, Mr. Ansten advances the great abundance of zoophytes found on the surface of the lower strata, embedded in the layers of sand which separate the beds; and, their absence in other parts, especially in the interior of the bands, is no objection to this view of the origin of the limestone, because, in recent reefs, all traces of organic structure are frequently obliterated.

If we refer back to the description quoted from De la Beche, or if we examine for ourselves the rocks *in situ*, we cannot but be struck with the resemblance in the conditions, to those which are constantly occurring in the Atoll of the Maldiva Islands, and the great coral reefs of the Eastern Archipelago. Masses of branching madrepores, then as now, were formed upon the coasts of a red sandstone sea; and alternations in the levels of land and water produced all the conditions of beds.

Mr. Charles Darwin, in his valuable

work on "The Structure and Distribution of Coral Reefs," has explained, with very great accuracy, all the conditions under which coral reefs are now forming in the Pacific Ocean. The conditions are precisely those which will explain all the phenomena of the limestones of Devonshire. Upon the theory that the land around which coral reefs have been formed has been gradually subsiding, and that during the subsidence there has been a constantly upward growth of the reef-constructing corals, this observer explains the progress of coral formation in some cases, and the destruction of the coral animals in others.

He has shown us at what depth the polypifers can exist, and how slight movements destroy them. Not only is the sea active in grinding up the coral reefs, and thus forming deposits, but "the number of the species *Holothuria*, and of the individuals which swarm on every part of these coral reefs, is extraordinarily great; and many ship-loads are annually freighted, as is well known, for China, with the trepan, which is a species of this genus. The amount of coral yearly consumed, and ground down into the finest sand, by these several creatures, and probably by many other kinds, must be immense. These facts are, however, of more importance in another point of view, as showing us that there are living checks to the growth of the coral reef, and that the almost universal law of 'consume and be consumed,' holds good even with the polypifers forming those massive bulwarks which are able to withstand the force of the open ocean."

By these means there was a formation of material which was eventually to receive a slaty structure; and if to this condition we add the by no means uncommon one of volcanic action pouring out its molten matter, to produce the all-involving trap rocks, the entire set of phenomena is complete.

Such then are the geographical, geological, and physical condition of the Devonshire limestone, we must now return to the economic value of these stones.

At the Marble Works of Mr. Woodley, at St. Mary Church, near Petit Tor, and Babbacombe may be inspected every variety of these limestones—worked into columns, vases, chimney-pieces, and a variety of other ornamental articles. These marbles are varied tints of grey, mingled with veins of white. Blocks composed almost entirely of fossil corals are frequently found. These are known as Madrepora Marbles. Red and yellow varieties are sometimes found near Babbacombe, but in smaller quantities. In addition to those, the following summary from the "Geological Survey of Devon and Cornwall," shows the variety which may be obtained.

"The marbles of Plymouth are not very dissimilar from those obtained at Petit Tor, with the exception of the black, a good variety of which is found at Cat Down. At Ipplepen, there is a reddish variety, which is extremely handsome; and near Totness, there are some of good appearance; indeed, throughout the limestone between Newton Bushell, Babbacombe, and Plymouth, marbles of very great varieties of colour may be obtained, though tints of grey chiefly prevail, and they deserve to be far more extensively employed than they have hitherto been; a greater demand would cause more varieties to be worked. A beautiful green marble is found in Kitley Park, and the rose-coloured dolomite in the vicinity of the same place, affords a very handsome, though hitherto neglected, material."

R. HUNT.

THE ROYAL PICTURES.

L'ALLEGRO.

W. E. Frost, A.R.A., Painter. T. Garner, Engraver.
Size of the Picture, 3 ft. 2 in. by 2 ft. 4 in.

ETTY seems to have had no small influence on the destiny of Mr. Frost, who is now almost universally considered as the legitimate successor of the former in his especial walk of Art, while it was by his advice that the painter of "L'Allegro" was placed in the school of Mr. Sass. In 1829, he was admitted a student of the Royal Academy, where, by his assiduity in availing himself of the means afforded for study, he made such progress as to secure the several medals and honorary distinctions awarded by that institution. As is the case with many other artists who ultimately aspire to historical painting, he commenced his career as a portrait painter, and during the fourteen years that followed, he painted upwards of three hundred portraits. But this field was too restricted for his genius, and as an early step towards emancipating himself from the drudgery of portraiture, if the term may be applied to the art, he sent to the Exhibition of the Royal Academy, in 1843, a picture, "Christ crowned with thorns," which met with a purchaser, and at once determined him in his future path; portraiture was abandoned.

In 1844, one of the prizes was awarded to his picture of "Una alarmed by Fauns," in the Westminster Hall Exhibition; and in 1846, Mr. Frost was elected an Associate of the Academy.

The picture of "L'Allegro," in the Royal Collection at Osborne, is copied from a portion of a larger work, entitled "Euphrosyne," painted to illustrate Milton's poem; but it has especial reference to the passage,—

"But come, thou goddess, fair and free,
In heav'n yclep'd Euphrosyne,
And by men, heart-ensuing Mirth,
Whom lovely Venus at a birth,
With two sister Graces more,
To ivy-crown'd Bacchus bare."

The picture "Euphrosyne" was painted, in 1848, for the well-known patron of English artists, Mr. E. Bicknell, in lieu of the "Una," which Her Majesty desired to possess after it had been purchased by that gentleman, and which, of course he relinquished. Her Majesty was also so much pleased with the "Euphrosyne," that she commissioned the artist to paint the passage here engraved.

From the outset of his career, Mr. Frost inclined to subjects of a sylvan character, illustrating themes such as are found in Spenser or Milton, where the grace and loveliness of the female form might be represented in pure harmony with the varied charms of natural landscape; and his indefatigable study of the human figure enables him to illustrate these great authors with surpassing ability. No painter of any epoch has treated the semi-nude with more delicacy; had his prototype, friend, and adviser always evinced the same feeling, how much more acceptable would the generality of his pictures prove to the public. Always correct, Mr. Frost is never over-free; the fervour and purity of his own refined intelligence and character suggest and influence all the productions of his graceful yet vigorous pencil, while it is impossible to praise too highly the exquisite care with which every part of his composition is made out.

"L'Allegro" is one of the "birthday presents" of the Queen to her Royal Consort. The picture is, in a remarkable degree, distinguished for those admirable qualities which give the works of the artist such superiority over those of any other living painter who professes to follow the same style; the figures are charmingly grouped, and are in most hilarious motion; they are drawn with perfect accuracy, and their faces, bright with "wreathed smiles," would charm even an anchorite, soul-stealed as he may be against the vanities of the world. In colour the work is marvelously lighted up, and the flesh is so exquisitely and truthfully painted, it seems as if it would yield to the softest touch.

A FEW WORDS ON BEAUTY.

Present—MAGISTER and AMICUS.

AMICUS.—BEAUTY, you say, is the legitimate subject for Art—would you, then, limit Art to the expression of the agreeable only? Would it not thus be deprived of many fine subjects, and often of the opportunity of inculcating a moral lesson?

MAGISTER.—At least, the more beauty there is in a subject, the more it is suitable for Art. Subjects incapable of beauty are unfitted for representation.

AMICUS.—To take a favourite subject with the painters of the middle ages—"The Fall of the Wicked"—

"hurled,
With hideous riu and combustion, down
To bottomless perdition,"

how would you rank this subject?

MAGISTER.—Pictures of pure horror are certainly not suited to our tastes at present. The "Murder of the Innocents" appears to me the most detestable subject of mediæval art, more especially as frequently represented in the most actual manner. The subject you instanced is more mythic; mysterious and removed from actual life, and thus less atrociously abhorrent. Its nature is more epic—and when presented to us as it has been by Michael Angelo and Rubens, it possesses so much beauty of composition, form, and colour, that it may be said to be dragged into the category of the beautiful.

AMICUS.—But what is the principal impression derived from it? Is it that of beauty?

MAGISTER.—Perhaps not. But each work of Art may be said to be two-fold in its nature. In the first place, there is the subject—the story told—the mental aim. In the case you mention, there is the "doom of evil" presented—a moral lesson. This may be called its theoretic quality, which speaks straight to the intellect. Secondly, there is that which addresses itself more sensually—that is—eulists in its favour those messenger senses of sight which convey it to the mind, and speaks to their predilections for graceful flowing compositions, and the charms of line, tone, and colour.

AMICUS.—May you not add a third quality as intermediate, so to speak, existing between and uniting these—viz., that represented by the ingenuities of the modes selected by the artist in adapting the subject to the powers and expression of his art, such as groups, actions, episodes, chosen by him, that speak, not by words but by visible images? Thus, firstly, we should have the mental story to be told; secondly, the artistic view of the subject that has adapted it to the arts of visible expression; and thirdly, the modes and felicities of execution, by which all this has been carried out.

MAGISTER.—I was going to say that beauty in execution would go far towards rendering any subject suitable for Art; but I readily accept your third division, and, apropos of it, would add that there is nothing in which the capacity of an artist is more shown than in the mode by which he adjusts a given subject to the powers of his own art. Thus you have set the proposition on a Delphic tripod.

AMICUS.—Truly a three-legged stool will adapt itself to any uncertainties of ground, and the reason, perhaps, that ancient priestcraft adopted it. So ours, perhaps, may stand, until some one seeks to add a fourth or fifth leg to our definition;—for in these kind of disquisitions the last speaker is uppermost, like the child's game of "hand over hand," and the edifice that looks very stable for the moment requires but a stone loose for it to be easily pulled down into ruins by another speculator, to form materials for a fresh structure, possibly equally short-lived.

MAGISTER.—But such disquisitions may be occasionally useful not only as gymnastics for the mind—to exercise its powers, and make firm its muscles, but particularly as regards the aim and means of Art.

AMICUS.—No doubt;—and if conducted in a proper spirit, they also read us a good lesson,







THE THREE GRACES

By J. M. W. Turner, Esq. R.S.A. &c.

Engraved by J. G. Thompson

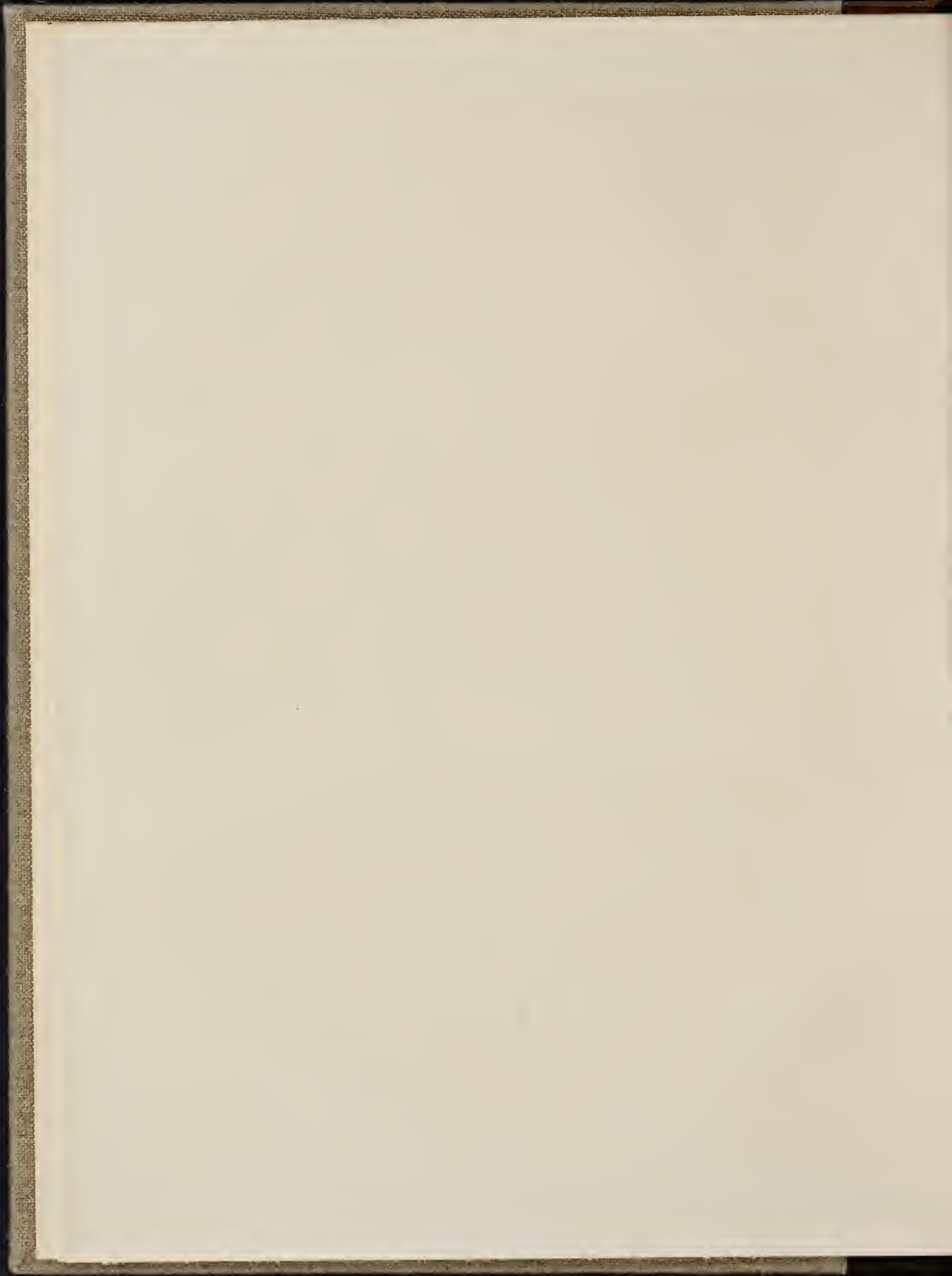

by illustrating the bounds, beyond which we cannot soar. I recollect an account of some pigeons which were taken up by an aeronaut and let out when his balloon was at its highest. The poor things seemed quite lost. They wavered their wings very vigorously, but the air was too thin for them, and it was with much ado that they got back to the car from which they started. Thus it is, not infrequently with your metaphysical gentlemen. From the very high starting point they take, they get at once into an ether too subtle for their pliuions, and they flap round and round without making any progress. Doubtless, your metaphysical requires a still stronger curb than even your poetical Pegasus.

Magister.—As simile second, such a would-be grasper at the "nature of things" may be likened to an insect, which, having always lived on one leaf, would vainly reason proudly on the whole tree, or the wood in which it stands.

Amicus.—There are no doubt very high things which can be and have been, truly, as far as we can judge, compassed and expressed by mathematical rules. For example,—what can be more lofty or ennobling than the knowledge,—to which science and the successively piled labours of great minds have enabled us to creep—of the times, orbits, sizes, and distances of the heavenly bodies. But as to the "essential nature of things" we do not seem much farther advanced than at the time of the wise men of Greece.

Magister.—For instance, we were speaking of Beauty in regard to works of Art. Beauty is always attractive, in whatever way it be manifested. It is an object of our involuntary as well as voluntary regard; and yet we can't define it. I fully believe, except in a general way. It is a part of the "to kalon" that baffled the ancient philosophers.

Amicus.—Yes!—the search after such abstractions reminds me of the pursuit which they say Swedenborg used to make about his room, with two hair-brushes, after the spirits which he deemed were ever hovering around him! We cannot catch an abstract essence as an entomologist does a beetle or a butterfly, and pin it down and look at it through a microscope!—Some Persian poet calls Beauty the perfume of the soul, and there it must rest.

Magister.—Some have thought to define it as the result of the union of fitness and proportion; but, as regards form, comparative anatomy alone were perhaps sufficient to show the inadequacy of such definition. Have you paid any attention to this last subject?

Amicus.—A little—that is—as regards general principles.

Magister.—You know one of those is, that there is a general connection and unity of plan in all animal bodies, which is especially evident in the higher and more developed classes. Especially as regards what our friend the professor would call the "osseous structure;" and that if you set up the skeleton of a horse or a lion on his hind feet beside that of a man, you find nearly all the principal details of the beast identical with that of the man, as the hoof with the heel, the stifle joint with the knee, and the knee with the wrist, &c.

Amicus.—Yes, I recollect attending a lecture of Mr. Haydon, in which these resemblances were clearly pointed out.

Magister.—And this does not stop with the quadrupeds, but ascends to the birds, in which the wing represents the arm, and nearly all the muscles of the part of the body to which it is attached are devoted to moving it. Now, an angel has ever been considered a beautiful object in Art. The Egyptian, Hebrew, Assyrian, Phœnician, Greek, Roman, and in the latter days, our most talented artists, such as Raphael and Flaxman, have delighted to represent such beings. But how is the human structure to receive and accommodate arms and wings both, which are representatives of each other? Where is the room for their attachment, and for that of the muscles to move them? And could they be so attached, would not they be very much in each other's way? So much for the fitness of an object of Art which has universally been acknowledged to be beautiful. Again, I think Pliny affords an account of a Greek picture, very

celebrated and much admired, of a family circle of Centaurs, father and mother, all at home with their little foals, and yet these represented creatures with two sets of internal vital organs.

Amicus.—To accommodate which they may have dined alternately off roast meat and cats. May be, on the occasion when they met the Lapithæ, at the marriage of Hippodamia, they had lunched previously with the steeds in the stable before completing their repast with their masters upstairs; and this disagreement of words, in accordance with what some one has said as to all great disensions being traceable to errors of digestion, may have had some part in the notable row that was got up on that occasion.

Magister.—Which afforded so favourite a subject to the artists of old. However, after all that may be said in the way of ridiculing too keen a search after precise definition, some advantages are derivable from their discussion. Many a useful discovery emanated originally from astrology and the search after the philosopher's stone; and fitness, though useless as a definition, may be, and is doubtless excellent as a quality in a work of art.

Amicus.—Especially if we give it the less pedantic name of common sense, although indeed it might be rather difficult to argue all the fine things even into that category. Unless, indeed, common sense is to be taken with a dramatic or operatic interpretation, which allows of a large licence; but even then I fear it were impossible. I am a great admirer of Milton. True enough! you will say; but perhaps not so much so, when I add that I am one of the very few who really have read *Paradise Lost* through, from beginning to end, every word. Moreover, I am ever reading it between whiles; but I must allow with Johnson, that I cannot away with the lullaby of the angels, or the gunpowder bombardment of heaven.

Magister.—Which, after all, was only a copy of Hesiod's War of the Giants and Titans.

Amicus.—That he copies too, if you recollect, separately in the second day of the fight; that is, the Pelion-ppon-Ossa part of the affair. But, doubtless, the old poet had the best of it. There was at least a dramatic fitness in making volcanoes war with heaven and beleh forth rocks and flames in the face of celestial spirits; but "villanous saltpetre" should not have been introduced into angelic fight, however much Milton may have desired to express his detestation of that agent of war. The whole struggle of spirit and matter in that great poem was an unexampled difficulty to treat; but, with this exception, the great poet throws his whole authority on the side of propriety. How fitting are all the more mortal details which really could be grasped! How characteristic the representation of our first parents and the world of turbulent thoughts out of which his Satan is created! In all be could compass, every episode and thought and description was suitable for its purpose, and it was only in those parts of this subject that are beyond all mortal power that consistency is occasionally left behind. Therefore, taken as a whole, his work adds strength to the authority for common sense in Art of the highest class.

Magister.—Those who have made fitness the father, have made proportion the mother of Beauty. But they would have to allow very protean qualities to that mother. For what two beautiful objects in nature present the same? Do the lily and the rose!—or the deer and the leopard!

Amicus.—But, in the human race, do you or not think that Beauty, as far as form goes, can be brought down to any defused ratio!

Magister.—At least it would have to vary with age, sex, and character, and it would be quite vain in the practice of Art to attempt to apply one common ratio to the forms of men, women, and infancy, or to varieties of character. Nor do I think any practically useful, except a few general ones—such as those set forth by Da Vinci or Flaxman, not according to any abstract system, but from the measurements of fine nature and of the ancient statues. Beyond this they trammel Art rather than assist her, and tend to produce what the French call *clie*.

Amicus.—Which is?

Magister.—A sort of conventionalism at variance with nature, giving to works the appearance of having been done by receipt.

Amicus.—I have, nevertheless, seen some very elaborate and ingenious theories and diagrams applied to forms of recognised beauty, such as the Portland Vase, the Medicæan Venus, and the Façade of the Parthenon; and there were really some remarkable results shown, certainly rather intricate and difficult to follow, but still fascinating, and having a slow at least of reason. Would you regard all these labours as mere *auge difficiles*, and set them down as of no service whatever to Art?

Magister.—Not so—I consider Art and the professors of it much indebted to all persons who will carefully and heartily give their own views of it. It does good to Art agitating such questions, if only by bringing it before the public in various points of view; but even further than this I am by no means inclined to deny that a good thought, even as regards practical usefulness, may occasionally be struck out by such means. But as a system on which to rest or depend, I consider such geometric schemes of beauty as illusory. I have seen some of these theories to which you allude, and I especially remember one system of beauty founded upon the proportions of the Venus de Medicis, illustrated by a vast number of lines and proportions running hither and thither all over her like a web, proposing to illustrate the science on which she was formed, and to give the key to the reproduction of such beauty in Art generally. Now, even granting that she combines all that is most beautiful in female form (which I am heretic enough to be very far from), I do not believe that she was either executed by such a process, or that the student would be advantaged by such, even in copying her. As to her original creation by such means, I believe her author, could he return to the world of Art, would be as much astounded by the theory attributed to him as Shakespeare would by many latent meanings fastened on him by his commentators. As far as Art is concerned, antiquity never walked up to her creations of beauty on the legs of a pair of compasses!

Amicus.—Sir Francis Bacon seems to have been of the same mind, when he says—"Though a painter may make a better face than ever was, that he must do it by a kind of felicity (as a musician that maketh an excellent air in music) and not by rule: a man," he adds, "shall see faces, that if you examine them part by part, you shall find never a good, and yet all together do well."

Magister.—Exactly. That is, we are to look for Beauty more in the harmony of details than in the individual beauty of parts considered by themselves.

Amicus.—By which means she produces so much the more variety, inasmuch as the number of tunes in music exceed that of notes. For my part, I do not admire scholastic restrictions that prescribe certain regulations to Beauty, as such and such features and colours in every case. I believe in a *reconnaisse* nose as well as in a Grecian one, and in red hair as well as black, or brown, or golden.

Magister.—With certain reservations, of course. However, the great master of the "Novum Organum," in the words you have just repeated, illustrates my views on this subject pretty closely. I believe, indeed, that beauty in Art arises more from a certain inspiration of harmony than from any set or definable proportion of lines or features, and that in such creations as hers, form, colours, and arrangement come into the artist's mind, like the verse and rhymes of the poet, at one birth. In nature, to which every artist looks for precept and example, how thoroughly is this harmony borne witness to! How much, as a whole, is a plant in harmony with itself in its least details, even to its smallest antler or leaflet! Nature seems never to make a mistake. Each part belongs to the others, and to change one would be like striking a false note.

Amicus.—It has been said, however, that the "Great Mother" works by mathematics.

Magister.—She may. We see she does in many

respects, and the principle of all her manifestations may be guided by these in her inmost laboratory. But we began by agreeing that we could not arrive at the *essence* of things, and that they are only *effects* we are able to reach, even when we call them *causes*. If she creates beauties by mathematics, it is in a mode we do not understand, and surely if geometry takes such part in our creations in art, it is in a latent way, as in the other provinces of nature,—the artist's mind being but an unknowing agent—as much a part of nature as any other. There are, however, doubtless, some departments of Art in which the direct use of the rule and compass, and other mechanical aids are highly essential and useful, but truly as a nurse, not a parent—as a staff, and not an index. Thus it is in architecture, and in all that extensive field of ornament which rightly belongs to its province, and wherein conventional forms and diapers, &c., are required in repetition for the decoration of surfaces. But as regards Art in general, the more intelligent, imaginative, and vital the subject, the less way on the road to it will mechanical aids accompany and assist the aspirant. No Art can thoroughly comprehend and take in but one phase of nature.

Amicus.—Except, perhaps, the dramatic, in which man himself, in his mind, person, speech, and action, is his own brushes, paint, and canvas.

Magister.—But even that "mirror held up to nature" has but one side, and no representation requires a greater amount of allowances to be made than that of the Drama. It may be wider in its range than other Arts, but the very condensation it requires is one cause of its necessary incompleteness. Its shortcomings may be different from those of other Arts, but they exist to an equal extent. But to return to the Arts of Painting and Sculpture. It were trite to repeat that each has, as it were, but one phase of nature for its province, in which we can work profitably only according to the lights that are given us, and not according to those we fancy for ourselves; and yet the artist has not a clear view of his occupation if he has not this truth before him. The creature cannot comprehend the Creator, or His mode of creation, and it is only here and there that we are permitted to peep through a gap, as it were, to see some of the principles of the wonderful machine. Nature is but one, and the whole theory of growth and existence may be pervaded and controlled by certain geometric and arithmetic proportions—as the great events and recurrences of Astronomy, but assuredly we cannot find them out. We certainly cannot find fixed ratios and regularities everywhere; on the contrary, irregularity (perhaps from our own limited powers) meets us on every side full as much as regularity. These two qualities, indeed, as far as we are able to see, are most intimately associated in nature's works—almost, one might say, in alternate stages. What regularity of structure, of fibres, and filaments, in a leaf or a flower—and yet what endless variety and irregularity exists in their distribution in a forest or a meadow! The general shape of the globe, a sphere modified by rotation, how exact its law of form—and yet how irregular the arrangement and indentation of the seas and continents, and fortuitous to our comprehension the directions of the great chains of mountains that stretch across its surface. Pursuing this to a still wider range, how geometric are the motions of the planets which form our immediate system; and yet, how without the vestige of a regular plan that our comprehension can fathom lie in the depths of space the vast drifts of innumerable worlds that we perceive in the form of stars and nebulous masses. And "*parva componere magnis*," inasmuch as this analogy may bear upon Art, it illustrates that Beauty is not to be sought for wholly in regularity, but also in a varied and subtle inspiration not to be bound by rule; and that she is not to be extracted, as some would have it, arithmetically, like a cube root! I believe that the triumphs of Art were never reached except with the assistance of a sort of "divine afflatus," which, however, never came but to the sincere, devoted, and ardent student. And that it was not till after their completion, and not in the process of their creation, that they were connected with any strict system of geometric proportion. They

were done and admired, and it was not till afterwards, and when they had gained a steadfast niche in the temple of Fame, that they were found to possess—if they do possess—one or more ratios of arithmetic proportions. But to the idea that they were originated by such means, beyond a few simple mechanical aids obeying, but not guiding the dictates of genius, I give no credence whatever.

Amicus.—I trust to your practical knowledge. But we have been talking of the planets: what think you of the "conic sections" in which they revolve, as exponents of lines of beauty? might they not be as illustrative as those chosen by Hogarth, or others?

Magister.—Something of this has been suggested—I think, at least, as regards ellipses—showing that most graceful forms arise from their combinations.

Amicus.—The parabolic curves are of most exquisite character, and the cone, cut spirally, also would afford, I can fancy, innumerable "lines of beauty."

Magister.—But these last would not be simple conic sections.

Amicus.—So much the better; you say we are not to put Beauty into too close traumas.

Magister.—But the simple sections themselves, with their combinations, are doubtless capable of a vast variety, and I can well imagine an interesting comparison being made of the most remarkable contours of beauty with those mysterious curves that guide the wondrous denizens of heaven,—that starry host—

"Ever singing as they shine,
The hand that made us is divine."*

RATIONAL ENTERTAINMENTS, A SOIREE AT THE PAVILION AT BRIGHTON.

The Brighton and Sussex Society of Arts had a *soirée* a short time since at the Pavilion. I will give a short description of this *réunion* while the impression is fresh on my mind. I must first, however, relate briefly the history of the Pavilion after it was abandoned as a royal residence by our sovereign.

The reader may perhaps recollect that an Act of Parliament was obtained for the sale of the crown property at Brighton, and that in 1850, after much consideration, the inhabitants purchased the estate for £50,000. This large outlay was afterwards increased by the necessary expenses and improvements to £70,000. The wisdom of the arrangement has been proved by the event. The improvements and alterations have rendered the estate nearly self-supporting, and a portion of the debt (£10,000) has been paid off, while the annual rate for the Pavilion has not exceeded threepence in the pound in each year. The pleasure grounds, instead of being covered with buildings, are permanently thrown open to the public, and an open space, which serves as the lungs of the town, is secured in its very centre. Many of the offices and adjacent buildings have been removed; on the land, which was let advantageously on building leases, a fine row of houses with shops has been erected; the walls around the grounds have been replaced by iron rails, which permit a view of the pleasure grounds and the Pavilion from the street. The suite of state rooms, five in number, which had been dismantled of their furniture, and even of their stoves and chimney-pieces, have been repaired and re-decorated as nearly as possible in their original style, and are used as assembly rooms for balls and concerts. They were opened for the first time under the new ownership on the 21st of January, 1851, on the occasion of a grand ball, which was attended by about 800 persons.

Of all the entertainments, however, of which this suite of rooms has been the theatre, there are few which have afforded more pleasing and rational amusement than the *conversationsi* which have been given by the Literary and

Scientific Institution, and the Brighton Fine Art Institute or Society of Arts, whichever may be its appropriate designation.

The last-mentioned society has established an exhibition of paintings by living artists.* Upon the occasion referred to, the exhibition room, formerly the palace kitchen, was lighted from the centre by gas, and thrown open to the visitors. As it is not my purpose to describe the exhibition, I shall merely observe that there were nearly 80 exhibitors, many of whom are local artists. Among the London exhibitors are Carl Haag, Lear, Gastineau, A. Fripp, Mrs. Olliver, Fanny Corbanx, Bartholomew, Stephanoff, Rivière, Raven, Hime, Tidy, Barraud, &c. In an adjoining apartment were several portfolios, containing drawings by local artists, and Talbot-type views. There were also pictures lent by gentlemen residing in the town. Mr. T. S. Robins presided over this department. The banquetting-room was temporarily fitted up as a concert-room. Here the "town band," conducted by Mr. Oury, played at intervals during the evening, the entertainments being varied by the performance of Sig. Bianchi on the pianoforte, and of Herr Zerom on a new instrument called the "Emmilynka."

The yellow drawing-room, the next of the suite, and, in its decorations, perhaps the most tasteful of the whole, was devoted to works of Art, lent by gentlemen and tradesmen of the town; and, in my opinion, this was one of the most pleasing features of the evening. There was here no distinction of ranks, but all classes vied in administering to the entertainment of the company. Among the articles of taste exhibited were the Plymouth race cup in silver, presented by the Queen; the Warwick race plate, with the legend of Earl Grey, both won by Rataplan, the latter was exhibited by Capt. Thelluson; a beautiful nautilus cup of the fifteenth century, set in gold, and two oriental pearls worked, by the addition of gold, into the forms of a bear and a bird; a French bronze, representing Louis IV. surrounded by the virtues. These were contributed by Mr. Lewis, the jeweller. Mr. Ellis sent statuettes and bronzes. Mr. Bright, the jeweller, contributed several electretypes and imitation bronzes by Méné, Clavier, Robert, and Marin; a very fine and curious antique French bronze of the 15th century; copies of Roman tazze, &c. Mr. Martin, of East Street, and Mr. Crunden, of the New Road, upholsterers, contributed several curious and ornamental articles of furniture, among which were a carved oak cabinet; a splendid cabinet of the time of Louis XV., in ebony, ivory, and gold; and a table of Florentine mosaic. Mr. Duncombe exhibited another cabinet, the open doors of which displayed specimens of old Chelsea and other china; and an antique brass watch, almost as thick as a turnip, of the date of 1660. Besides these there were carved cups of rhinoceros horn, statuettes in Parian, the latter exhibited by Mr. Hawkins, the china-man; busts sent from the studio of Mr. Pepper and his son; pictures arranged on easels; books of prints; and a very interesting collection of lithograph fac-similes of autographs of distinguished persons, each specimen headed by a portrait or vignette view connected with the author. I do not profess to enumerate nearly all the curiosities and objects of Art exhibited this evening, but merely to give a general idea of them; and I have mentioned the names of some of the exhibitors in order to show to what class of persons the visitors were indebted for their entertainment.

The rooms were opened, and the company began to arrive at the early hour of seven, and at nine tea and coffee were served in the central drawing-room.

But it is time to speak of the guests, and this is the pleasantest part of a very pleasant subject. With the exception of a small sprinkling of the higher classes, the company was composed almost entirely of professional men and their families, and tradesmen with their families. The price of admission was half a crown, and all who desired it, and who had any claim to respecta-

* The present exhibition is the fourth which has taken place in Brighton.

* To be continued.

bility, were admitted by tickets. Everybody seemed determined to be pleased, and everybody was pleased; good humour and good manners prevailed everywhere. No party feeling, no misplaced pride of station or wealth was suffered to intercept the general harmony, for those who feared contamination from the mixture of guests absented themselves; all went merry as a marriage bell, and an expression of tranquil enjoyment lighted up all faces.

But the ladies, the reader may enquire,—how were the ladies dressed? Generally speaking, with great good taste; in evening costume, but with perfect decency, by which is meant, be it understood, that they were not *décolletées*. The great size and coldness of the apartments rendered those very graceful articles of dress called opera cloaks almost universal, and their varied colours and slight diversity of form, their graceful and flowing lines, added considerably to the picturesque character of the groups.

About ten o'clock the company began to retire, and the rooms were cleared at an early hour, and thus closed one of the most agreeable *réunions* to which I was ever a party. The arrangements for the accommodation of the guests were perfect, and great credit is due on this account to the committee of management and the secretary, Mr. Edmund Scott. There was no confusion of any kind. The police, as usual on such occasions, superintended the arrival and departure of the carriages in which the company came and left.

The number of guests was about 300, not nearly so many as those who on previous occasions had assembled at the conversations given by the Brighton Literary and Scientific Institution. Had the weather, which was extremely wet, been more favourable, the attendance would probably have been much more numerous.*

And now, it may be asked, what is the use of describing this evening's entertainment? I will explain. My object in doing so was two-fold; first, to show how easily and cheaply a most pleasant and rational evening's amusement may be obtained, where all are willing to contribute their quota to the general enjoyment; and secondly, because the *soirée* I have described was a delightful instance of the amalgamation of ranks, a happy oblivion of the barriers placed by an artificial state of society between the different classes of which it is composed. From such *réunions* we may anticipate the happiest effects. Learning and science recognise none of these distinctions; all their followers are fellow students, the only honours are those awarded to the most competent. In our recreations, on the contrary, our most exclusive and aristocratic notions break forth. We consent to play double at a concert, in order to separate our own persons from the chance of contact with those who cannot afford to pay so much. Where the party excluded does not know how to behave in genteel society, the exclusion is proper and justifiable; but, it may well be asked, how are people to learn to behave if they are not admitted into the society of those who behave well? The great extension of education has led to a corresponding improvement in all ranks; cultivation refines our minds, but our manners must be polished by mixing with good society. The manners of the different ranks always take a tone from those above them, hence the obvious method of raising the general tone of society would be to afford opportunities, like those offered by the *soirées* at the Pavilion, for the occasional meeting, on equal terms, of different grades of society. At present every rank has its peculiar enjoyments; the pleasures of the educated classes are more refined than those of the uneducated. Those who cannot appreciate mental enjoyments seek delight in sensual gratifications; in one point they are unanimous, namely, the necessity of recreation. The proverb says—"all work and no play makes Jack a dull boy." It is not sufficient to educate the multitude, they must also be amused and entertained; the mind must have relaxation,

and will seek for it in the gin-palace and the beer-shop, if a taste for enjoyments of a higher class be not infused and cultivated. It has often been observed that women have a peculiar facility in acquiring the manners of those above them. This suggests one means of improving the habits and refining the enjoyments of the lower classes; yet, it is one which has been but too much neglected. Although men of different ranks, when thrown accidentally into each other's company, readily mix in conversation; with the other sex it is quite different. Women not only shun those whom they consider as of inferior rank, but their fathers, husbands, and brothers constantly enforce this distinction.

Let it not be supposed that I am advocating either what is called low company or communism; my object in promoting an occasional intermixture of the different ranks is, not to degrade the more elevated by reducing them to the level of those beneath them in intelligence and station, but to raise the lower classes by giving them opportunities of cultivating the tastes and sharing the more refined enjoyments of the higher ranks. It strikes me that this may be done effectively through the women. Give them occasionally the opportunities of mixing, as in the *soirées* before mentioned, with those of superior rank, upon equal terms, and they will take a tone from the society to which they are introduced. Let the terms of admission be inexpensive, and the only requisites respectability of character and suitable dress, and I have little doubt that in a few years, it will be found that the wives and daughters of the higher classes of mechanics will attend these meetings without exciting observations by the coarseness or peculiarity of their manners. With the characteristic quickness of their sex, they will perceive their own shortcomings in these points, and will study to attain the easy and elegant manners of the more refined classes. They will succeed, and will carry these refinements into the modest home of the mechanic and the artisan. This is the little portion of heaven which shall leaven the whole lump.

Great efforts have now been made for many years to educate the lower classes. Mechanics' Institutes are numerous all over the kingdom. These have ever in view the mental cultivation and improvement of men, while they entirely overlook that of the females of their families. Now, although I would not on any account that women should *habitually* seek their enjoyments and recreations from home, yet they ought to participate in the advantages which the men of their family enjoy. If they cannot go to the Institute to read, why should not the wife or daughter of a member, for a smaller subscription, have the privilege of reading books from the library at home? But above all, why should there not be periodical meetings at Mechanics' Institutes of the same nature as those at the Pavilion, to which members might bring their wives and daughters, and to which a tone might be given by the presence of persons of superior rank who feel an interest in the improvement of their countrymen? Exhibitions similar to those described in this paper are not so difficult to get up as some persons might imagine; some articles of taste would doubtless be lent by gentlemen; many would be supplied by the mechanics themselves. It must be recollected that although their masters furnish the materials, and perhaps the designs, that *they*, the mechanics, are in many cases the actual producers of the articles to which the master's name is attached. Many of these mechanics are engaged on works requiring taste or skill, or ingenuity, and which might be worthy of a place in such exhibitions, rendered doubly interesting by the display of the works of the members. There are also many tasteful branches of female employment which might properly obtain a place in this evening exhibition; among these may be enumerated, artificial flowers in wax, paper, and cambric, and fancy work of various kinds. Variety may be given to the entertainment by the introduction of music. But at first the task of suggesting and arranging the amusements would devolve upon those whose station in life has rendered them more familiar with the requirements of their guests,

and whose presence, while it promotes the real enjoyments of the meeting, operates as a restraint upon persons who might not be disposed to pay attention to the rules and regulations laid down by their equals, though for their own benefit.

One feature of these *réunions*, I must not omit to notice, namely, that notwithstanding the miscellaneous character and castes of the visitors, there is no more actual mixture than that which takes place upon the public esplanade, or in a fashionable church filled up with benches instead of pews. The various groups are essentially family groups, and, as such, remain undivided all the evening. The young, therefore, incur no risk of introductions to persons of whom their parents would not approve. And this leads me to observe that dancing, which necessarily separates the child from the arm of the parent, and not unfrequently from their sight, is systematically and very properly excluded from these *soirées*.

I must conclude by expressing a hope that my readers will not deem the apparently trivial subject of amusements beneath their notice; but that they will consider them as among the most efficient aids to civilisation and refinement; and as such will promote, as far as they are able, all rational entertainments, especially those which tend to elevate and refine the labouring classes, and to promote harmony and goodwill among all the grades of society.

M. M.

THE ART-PUBLICATIONS OF MM. GOUPIL, OF PARIS.

Too long a period has elapsed since we directed the attention of our readers to the high class engravings issued on the Continent; yet they have been exercising considerable influence, not only among the people for whom they are more especially published, but in England, where a very large number of foreign works circulate, and where they are undoubtedly, for the most part, productive of great good. We refer, not so much to the number of coloured lithographs, which find their way into all quarters, because of the small cost at which they are sold, as to that higher order of works, of which our issues in this country are few and far between; yet even of the former we may speak with respect, for they teach while they give pleasure; and it is sufficiently notorious that in the particular class to which we more immediately allude, our English artists are deficient: or at all events they abstain from sending forth to the world those "studies" of form and feature for which we are indebted to our neighbours of France. Our observations, however, mainly apply to those engravings of the higher order of Art—line engravings—which of late years very rarely appear as the issues of English houses: and our supply of which, now-a-days, chiefly comes to us from the Continent. Engraving in line seems, in truth, to have been for some time declining in this country; from the labour, and consequent expense, necessary to produce a line engraving, it is rarely that as a speculation a work of that class is found to answer: at present, we believe, there are not a dozen works of this order in progress throughout England, excepting those of small size, which appear monthly in "The Royal Gallery," and in the *Art-Journal*. But for these indeed, and the engravings in "The Vernon Gallery," British line engravers would have been, during the last ten or twelve years, entirely without employment, excepting the very few who may be styled the heads of the profession.

Under such circumstances, it is not to be wondered at that we resort to the continent for our supply; and it is certain that the establishment under notice gives us that supply in the largest proportion, and of the greatest merit. During a recent visit to Paris, one of our principal enjoyments was derived from a visit to this renowned house; and it is that to which, at present, we propose to direct the attention of

* Before this can appear, a second *soirée*, given by the same society, under the patronage of the Duke of Richmond, will have taken place at the Pavilion.

our readers. The house of MM. Goupil was founded in 1827; it has now a branch at Berlin, and another at New York; and its "correspondence" extends over every kingdom and state in the old and the new world; in America especially they may be said to have introduced Art, for, previously, the importation of prints was very confined, and its native produce little or nothing; a taste for Art has so largely grown "by what it feeds on," that now the United States rank among the best encouragers of fine Art, and its wealthy citizens are the most liberal buyers of first class proofs. This advantage is naturally participated in by England; but it is undoubtedly the consequence of the exertions of MM. Goupil. Some idea may be formed on this head from the fact that, according to M. Goupil's report, the sales they effected there in 1848, amounted in value to 140,000 francs; in 1851 it had reached the very large sum of 559,000 francs.

A sum of nearly 100,000*l.* is annually expended by this house in the production of engravings, and MM. Goupil give employment to all the best engravers of France; attracting also to their establishment many of the leading artists of the other continental states; while a natural prominence is given to the works of the French school of painting, their catalogue includes engravings from the most famous productions of the ancient masters—Raphael, Michael Angelo, Titian, Murillo, Paul Veronese, &c. &c.

To examine, in anything like detail, their catalogue of published engravings, would be to occupy a part instead of a page of this journal. That catalogue is a large book, containing the names of several thousand prints, a great proportion being of the cheap order, but very many of them holding rank among the highest achievements of the age in Art; and, indeed, maintaining a just claim to be placed at the head of those productions of the burin, which extend the fame, give currency to the genius, and circulate the teachings, of the painter.

A few of the works of this order we propose to bring under the notice of our readers. First is that famous print "The Hemi-cycle," of the Palais des Beaux Arts,—the great master work of the great artist, Paul de la Roche; engraved by a worthy associate, Henriquel Dupont. The picture is almost as well known in England as in France, for it is one of the lions of Paris, which no Englishman ever fails to visit. To describe it is needless; the accomplished engraver has made it common property; for all its worth excepting colour, is conveyed by the burin; and, although of large size, it is issued at so comparatively small a price as to be within the reach of ordinary purchasers.

The list of M. Goupil contains a very large number of works after Paul de la Roche; they are in various styles—all extending the renown of the great painter, and bringing to his *atelier* the homage of those who love and appreciate the excellent in Art of every country of the world; his illustrations of History are familiar: "Stafford going to Execution;" "Charles the First in the Guard-house," "The Children in the Tower;" and other passages from our English historians, have long been the favourites of our drawing-rooms: while holier thoughts and loftier inspirations are excited by the "Saint Amelie," the "Virgin Mother," and "The Entombment," and the best of our home sympathies are moved by that exquisitely touching composition "Les Joies d'une Mère," and others of its beautiful class: portrait-history being, as it were, consecrated by such works as those of "Napoleon Crossing the Alps," and "Napoleon at Fontenoy." These grand prints upon which we cannot find space to enlarge, bear the names of Dupont, Martinet, Mercury, François and Forster, as engravers.

The paintings of Scheffer have naturally been largely multiplied by MM. Goupil; perhaps no living master has so much influenced the heart as this true master; his "Christus Consolator," engraved by Henriquel Dupont, is the cherished guest of many English homes; its companion, the "Christus Remu-

nerator," (engraved by Blanchard) is only its second in public favour; while such works as "The Holy Women at the Tomb," convey the lessons of Art as pure and holy missionaries of Christianity. For giving these admirable and very beautiful productions to the world, the public incurs a debt to the publisher scarcely less than that they owe to the artist.

These are not the only great artists of the French school, whose loftier imaginative works MM. Goupil have multiplied; although these famous painters have obtained a popularity in England which very few of our own artists have achieved; their popularity indeed argues well for our own advanced and improved taste; the circulation of such publications cannot be too wide: it may, in a degree, humble us, in our own self-esteem, when we call to mind the enormous sums lavished in this country—idly or worse—upon multiplications of dogs and horses. But there is, happily, an ample "public" for a better order of things; and we cannot doubt that, if our publishers would dare the higher aspirations of Art, they would "find their account" in them—and not allow the publishers of France to obtain all the glories that are to be derived from the pure and true Art.

It is not to be supposed, however, that MM. Goupil have not ministered to the taste of the multitude in their publications. To say nothing of the thousands of coloured prints, prints in mezzotint, in aqua tinta, and in lithography;—comprising war scenes, fair-faces, landscapes, seascapes, costumes, foreign incidents and characters; objects of Art, industry, portraits of great men (dead and living), flower-pieces, studies of ornament, pictures of famous cities; in short, every topic that can be made available by Art to impart pleasure or to convey knowledge, has found a circulation to all classes through the means of these eminent and extensive publishers. And in thus endeavouring to make their works and themselves even better known than they are in England we discharge one of the pleasantest, as well as the most imperative, duties of the editor.

We shall endeavour to make amends for past neglect by occasionally drawing attention to the meritorious issues of this renowned establishment.

ART IN THE PROVINCES.

MANCHESTER.—The Mechanics' Institution of this city has recently risen to such an extent and importance as to call for the erection of a new and larger building than that hitherto used for the accommodation of the members and the business of the society. The edifice now erecting is approaching completion; and the directors of the Institute propose to open it in the ensuing autumn, with an exhibition of the Fine and Industrial Arts, of every kind,—paintings, sculpture, engravings, antiquities, scientific inventions, raw materials, industrial products, machinery, &c. In short, they hope to make the exhibition a "miniature edition," so to speak, of what has been witnessed in Hyde Park and in the Champs Elysées; only limiting it, we presume,—though we are not certain—to objects of home production, so far as the Industrial Arts are concerned at least. The floor space in the new building applicable to the purposes proposed, exceeds 20,000 feet, and the walls are well adapted to the display of pictures, drawings, engravings, &c. We are desirous of aiding the object of the directors, by calling the attention of such of our readers as are in a position to assist the undertaking to what is contemplated. There is enough of spirit and enterprise in Manchester to carry out such a project successfully, as regards the thickly populated districts in which it is situated, and particularly, as regards contributors; and it is only by the constant exhibition and comparison of works of science and skill that retrogression or progress is made manifest. We believe that the appeal which the directors are making will not be in vain; and we doubt not when the opportunity for reporting the result arrives, we shall be able to congratulate them on their success. It is right we should mention that Mr. O. Heywood, the president of the institution, or Mr. E. Hutchings, the secretary, will be glad to reply to any communications on the subject that may be addressed to them.

LEEDS.—Three competitors, Messrs. Belmes, Noble, and Milnes, have sent in models for the statue of the late Mr. E. Daines, in this town: that of Mr. Milnes was at once placed *hors de combat*, but the committee being unable to decide between the other two, have requested the sculptors to make such alterations in their models as they may consider necessary, or to produce entirely new ones. Mr. Milnes was voted the sum of 20*l.* as compensation for his labour.—The Wellington statue, by Marochetti, has arrived in Leeds, and will, ere long, be erected in the place of its destination, opposite the town-hall.

CANTON.—The annual meeting of those interested in the School of Art in this city took place at the end of November. The institution has not been in operation much longer than a year, but during that period the average number of pupils attending the central school was fifty-nine, while various public and private schools availed themselves of the services of the master, and an exhibition, opened at the central school, had been visited by upwards of two thousand persons. The number of pupils continued to increase, but the institution is in debt to the amount of 125*l.*, arising from the expenditure in fitting up the school, and furnishing it with models; to clear off this debt about 52*l.* had been subscribed. The current expenses of the institution were almost met by the receipt of 100*l.*

WORCESTER.—The friends and patrons of the School of Art, recently established in Worcester, had their annual meeting on the 30th of November. The report stated that the school continued to extend its operations and to give promise of satisfactory results. The number of pupils who attended classes during the year reached 287, and 400 children of four public schools had received regular instruction in elementary drawing, being an increase of 329 over the preceding year. In the course of a speech delivered by Lord Ward, who presided on the occasion, his lordship took occasion to remark on the success which had attended the Schools of Design in the Counties of Staffordshire and Warwickshire. Mr. Minton's beautiful display of manufactures at the Paris Exhibition, which had been all eagerly bought up, while orders had been given to the manufacturer that would take him a very considerable time to execute. This, Lord Ward said, ought to act as a stimulus to the manufacturers of Worcester to provide themselves with real artistic assistants, and also to induce them to aid their school by pecuniary contributions; it is at present in debt to a small amount, the donations and subscriptions having fallen off during the past year.

BELFAST.—Owing to some misadventure, we have only very recently received a report of the inauguration, at Belfast, of the statue erected in that city to the memory of the late Earl of Belfast, a nobleman in the truest sense of the word, whose death, at the early age of twenty-five years, was a severe loss to the country of his birth, and indeed to the whole kingdom. The statue was inaugurated by the Lord Lieutenant, the Earl of Carlisle, with due solemnity, and in the presence of a vast concourse of spectators met together to pay due honour to a man whose brief life was passed in endeavours to ameliorate the condition of others, and to promote their intellectual and moral growth. The speech delivered by his Excellency was one of the most eloquent tributes to departed excellence that we ever remember to have read. So also was that of a young nobleman, Lord Dufferin, at the banquet given subsequently, on whose shoulders the mantle of the deceased earl seems to have descended, in the ability and desire to benefit others. "Fresh generations," said Lord Dufferin, "shall tread in the streets of your town; your city itself shall increase in wealth and splendour; the names of most of us who have associated at this day's ceremony shall be forgotten; but still amongst all chance and change, that statue, standing so silent and motionless upon its pedestal, in the centre of the rushing tide of human life that ever flows to and fro around, shall still preserve the memory of Frederick Richard, Earl of Belfast." The statue is of bronze, the work of Mr. Mac Dowell, B. A., and is a fine example of portrait-sculpture. Mr. Mac Dowell is a Belfast man, and we have no doubt, exerted his utmost on a work which will do him honour as well as him whom it represents. But as we propose to engrave it among our sculpture illustrations, we postpone our remarks till we can enter upon the subject more at length.

HARLEIGH.—A favourite subject with our painters of Welch scenery, the old castle at Harlech, on the coast of Merionethshire, is being repaired at the cost of the government; the office of Woods and Forests has it in its keeping, and it is the third of the ancient castellated buildings in Wales which the authorities within the last few years have undertaken to restore.

BRITISH ARTISTS :
THEIR STYLE AND CHARACTER.

WITH ENGRAVED ILLUSTRATIONS.

No. XI.—SIR AUGUSTUS WALL CALLCOTT, R.A.



OUR recollection of the Royal Academy extends over a period of somewhat more than thirty years; yet, during that comparatively short space of time, what a change has passed over this associated body of artists. Of the thirty-eight Academicians, whose names appeared in the Catalogue of 1824, from which we date back, eight only are now living—Baily, A. E. Chalon, A. Cooper, R. Cook (an artist, by the way, whose works we have never seen), Mulready, Sir R. Smirke, J. Ward, and Sir R. Westmacott.

Of the nineteen Associates of that year, all have gone from the scenes of their labours except Leslie, Jones, and W. H. Pickersgill. Year after year, as our eyes have glanced round the walls of the Exhibition-rooms, the pleasure we felt at the sight of some rising star, whose genius seemed destined to add new lustre to our school, has been mingled with heavy regret for the loss of those luminaries whose suns had gone down—many

of them "while it was yet day." Year by year have we missed from their accustomed places the fine historical compositions of Hilton and Northcote, the wild imaginings of Fuseli, the elegant conceptions of the venerable Stothard, the classic graces of Howard, the gorgeous colourings of Esty, the courtly portraits of Lawrence, Shee, and Beechey, the vigorous, manly faces that Jackson and Phillips transferred to their canvasses, and the bounties of the inimitable Wilkie. Among the landscapes, too, have gradually disappeared the Indian jungles of Daniell, with their wild inhabitants, the corn-fields and meadows of Constable, glittering with dew and sunshine, the cottage bays and sandy shores of Collins; the scenes in England and in Italy which Callcott painted as with a pencil of silver, and those which Turner gave us from a palette laden with all the tints of the rainbow. Descending from the pictures to the Sculpture-room, we have looked in vain for the classic groups that Flaxman modelled, and the graceful forms which Chantrey was wont to present to his visitors. These are the more noted names that a few brief years have taken from us; names which will for ever be ranked amongst the brightest in the annals of our native School.

Music and Painting have through a long series of years found their homes in two families allied by marriage, and residing in a locality whose name to those unacquainted with the spot would seem to have but little harmonious association with the Arts, of any kind. Kensington Gravel Pits, such is the place alluded to, whatever it may have been in days of yore, is now adorned with some venerable picturesque mansions, such as in the present day are rarely to be found in the suburbs of London, almost concealed by stately trees of far older growth. Here, or in the immediate vicinity, for a period extending to nearly a century, lived, or now live, Dr. Callcott, William Horsley, and William Hutchins

Callcott—names well known to every lover of genuine English vocal compositions—Sir Augustus Callcott, and John Callcott Horsley, the newly-elected Associate of the Academy. Sir Augustus Callcott was born in 1779, at Kensington Gravel Pits, and resided there all his life, a period of nearly sixty-six years. He gave early indication of a taste for the Fine Arts in general, but in consequence, it may be presumed, of his relationship to Dr. Callcott, his brother, he chose music as a profession, and for some years officiated in the choir of Westminster Abbey, under the late Dr. Cooke. Whether or not he employed his pencil during this time, we are unable to state, but before he had reached his twentieth year he had studied portrait-painting under Hoppner, and had exhibited a portrait which augured considerable success in this department of Art; but he very soon turned his attention to landscape, and frequently was heard to say, that he was greatly induced to change his practice from seeing Stotbard's charming designs to "Robinson Crusoe."

It was, we believe, in 1803 that Callcott first made his *début* as a landscape-painter, in which he was so successful that, four years afterwards, he was elected an Associate of the Royal Academy. In 1810 he became a Member, sending his "Morning" as his diploma-picture; the highest honour of the profession was thus rapidly attained, and never was it more worthily bestowed; while the admiration his pictures excited, and his inestimable private character, procured for him the friendship and encouragement of all the distinguished patrons and lovers of Art of his time. In 1827, Callcott married the widow of Captain Graham, R. N., and daughter of Admiral Dundas, a lady whose extensive erudition and writings gave her a distinguished place in public favour.* With her he visited Germany, the Tyrol, and Italy, and applied to the scenes of nature and works of Art, to which his travels introduced him,

the cultivated perceptions of a mind ever alive to the suggestions derivable from both. It was this habit of constant and watchful observance that gave to his conversation such an interest, and to his criticism so much worth, from its truth and discrimination.

In 1837 her Majesty was graciously pleased to confer on Mr. Callcott the honour of knighthood, as an especial mark of his Sovereign's recognition of his merits as a painter, and of his personal excellencies. In 1843, her Majesty gave another testimony of royal approbation, by appointing him Keeper of the Royal Collections of Pictures, an office then vacant by the death of Mr. Segnier. At the time this appointment was made Sir A. W. Callcott was sinking under the pressure of disease, and, actuated by delicate and honourable feeling, he hesitated to accept so important and onerous a post; but, as both the Queen and Prince Albert graciously expressed a wish that his state of health should not interfere with the acceptance of the trust, his scruples were removed. In the due arrangement and classification of those treasures of Art which form the Royal Galleries, and of which a large majority of the most interesting the public have now the opportunity of knowing through the *Art-Journal*, he was sedulously employed till death terminated his labours, after



Engraved by]

THE BENEVOLENT COTTAGERS.

[J. & G. P. Nicholls.

he was sedulously employed till death terminated his labours, after

* Lady Callcott, when Mrs. Graham, went to India with her husband, in 1809, where she remained two years, visiting during that period many of the most remarkable places in the country, and publishing an account of her travels on her return home. At a subsequent period she made a journey to Italy, where she resided for some time; the results of this visit were two separate volumes, "Three Months in the Environs of Rome," and "Memoirs of Nicholas Pousis." In 1821 she embarked with her husband for South America, but Captain Graham died on his passage thither, and was buried at Valparaiso. In 1836 her last literary production appeared, under the title of "Essays towards the History of Painting," a most useful contribution to the library of the Art-student.

an illness of many years' duration, which was interrupted only by short intervals of comparative health, that excited the hopes, though they scarcely allayed the fears, of his numerous friends and admirers. He died on the 25th of November, 1844, and was buried at Kensal Green.



Engraved by]

TRENT IN THE TYROL.

[J. & G. P. Nicholls.

Callcott was a large and constant contributor to the Royal Academy, the rules of the Academy limit every exhibitor, and his pictures were, in very frequently sending the total number of eight paintings, to which general, readily recognised by his pure and delicate colouring. The



Engraved by]

ROTTERDAM.

[J. & G. P. Nicholls.

works of a landscape-painter scarcely admit of so detailed a criticism as do those of a painter of history or of genre subjects. His favourite themes were those wherein water occupied a prominent place; and many of his most charming pictures were made up of coast scenes: it was Sydney

Smith, we believe, who christened him "Sea-shore Callcott." He very rarely attempted figure subjects, strictly so called; but in 1832 he exhibited a picture of "Italian Girls going in procession to their First Communion;" and in the following year "Shepherd Boys with their Dogs." But his most important work of this character was "RAFFAELLE AND THE FORNARINA," exhibited in 1837, and engraved by the Art-Union of London, and which we have introduced here as an example of Callcott's ability to treat the historical class of subject.

Callcott has been called the modern Claude, so also has Turner; but Callcott's works, both in composition and colour, bear a closer resemblance to Claude's than do those of Turner. His distances are deficient in the space we find in the landscapes of the old master, but the aerial perspective is exquisitely rendered, and the general effect of the distance more pleasing. He was a close imitator of nature, observing her with the eye of a true poet, while he interpreted her with the most exact fidelity. "With a fine feeling," says Dr. Waagen, "for



Engraved by

RAFFAELLE AND THE FORNARINA.

[J. & G. F. Nicholls.

the picturesque in conception, he unites a delicacy of drawing most favourably seen in his figures and animals, which are most tastefully introduced. In his earlier pictures, the colouring is powerful, and often warm; in his later, rather too uniformly cool, and sometimes almost insipid. His execution is spirited and careful." The critic, when he spoke of "insipidity," was unconscious amid how much personal suffering and consequent prostration these works were frequently produced. His pictures, many of which were publicly exhibited after

his death, are to be found in every English private gallery of any repute.

High as Callcott stood in public estimation as an artist, those who had the pleasure of his personal acquaintance held him in still higher regard. His private character exhibited many of the most beautiful traits which pertain to the excellent of the earth, kindness, gentleness, benevolence, uprightness; he was literally a father to the fatherless, and a man of warm and generous feeling, showing itself in deeds of charity, the result of principle, not of impulse: his memory is revered by all who knew him.

SHEFFIELD PLATE.
THE PATENT ENGRAVED PLATE OF
MESSRS. SKINNER & BRANSON.

SHEFFIELD has been long famous, all the world over, for its plated goods; so famous, indeed, that its name affixed to metal productions at once indicates its character; and this supremacy it maintains, notwithstanding active competition of other British towns and in several cities of the Continent. Centuries before it acquired fame for its "plate," its steel had been renowned; Chaucer, in his "Pilgrimage to Canterbury," gives the miller "a Sheffield whittle"; but it was not until the middle of the 18th century that the "substitutes for silver" originated here. It is still "unrivalled in the extent to which this manufacture is carried, and in the elegance and durability of its productions,"—those of

Sheffield hearing a higher price in "the market," than those of any other locality. The history of this process, which has, during little more than a hundred years, grown so enormously as to give employment to nearly half a million of persons, is so very simple and may be told so briefly, as to justify its introduction here:—

"In 1742 Mr. Thomas Bolsover, an ingenious mechanic, when employed in repairing the handle of a knife, composed partly of silver and partly of copper, was, by the accidental fusion of the two metals, struck with the possibility of uniting them so as to form a cheap substance, which should present only an exterior of silver, and which might therefore be used in the manufacture of various articles in which silver had before been solely employed. He consequently began a manufacture of articles made of copper, plated with silver, but confined himself to buttons, snuff-boxes, and other light and small articles. Like many other inventors, he probably did not see the full value of his discovery, and it was reserved for another member

of the Corporation of Cutlers of Sheffield, Mr. Joseph Hancock, to show to what other uses copper, plated with silver, might be applied; and how successfully it was possible to imitate the finest and most richly-embossed plate. He employed it in the manufacture of waiters, urns, tea-pots, candlesticks, and most of the old decorations of the side-board, which, previously to his time, had been made solely of wrought silver. The importance of the discovery was soon fully understood."

The subject to which we more immediately direct the attention of our readers is an improvement very recently introduced into "Sheffield plate," by Messrs. SKINNER & BRANSON of that town; and although we associate with this notice a group of engravings of the principal objects of their manufacture, our purpose is mainly to offer some comments on the leading feature of their works, although their productions are not limited to their own particular patent. The advantage of this patent consists



THE PLATED PRODUCTIONS OF MESSRS. SKINNER AND BRANSON.

in the engraved ornamentation to which an article is subjected; being bolder, more effective, and bearing a nearer resemblance to hand-work than has been hitherto achieved, while as a mechanical process chiefly, or entirely, the work is effected at a very trifling cost. Indeed, the cost of an article thus ornamented, very little exceeds the price at which it could be sold plain. As the process is patented, there can be no objection to explain it, and Messrs. Skinner & Branson have supplied us with the following details, abridged probably from their specification:—

"The process is as follows:—Take first a copper-plate, and take from it an impression with an ink made by boiling linseed oil to the consistency of common treacle; the paper used is thin, similar to that in use by the potters in transferring prints to

earthenware. When the impression is taken it is transferred to the article to be decorated, the ink used being of a sticky or glutinous nature. A sponge and warm water is then used to crumble off the paper when the impression of ink will be found on the metal surface; fine resin (powdered) is then applied to the surface through a sieve of fine gauze, the fine particles of resin fix themselves closely to the sticky impression, in fact sink into it. In this state the work is left for a few hours; by this time the impression becomes completely saturated with the resin. A soft brush then dusts off the powdered resin from the surface of the article, and it is perfectly cleansed from the loose resin (which is very important) by a soft rag. By this time you have the resin sunk into and on the design, while the surface is perfectly clean from it. In this state, hot water is poured on the work, which melts the resin and amalgamates it with the printing ink which becomes a varnish sufficiently powerful to resist strong acid. The work is then bitten in in the same manner as engravers bite in

their work. The surface being cleansed, the article is ready for plating."

The acids used are, of course, the secrets of the trade; in fact, the process in its earlier parts resembles that adopted by the potter, and in its latter stages that in use by the engraver, or etcher. As it is, however, the application has produced very satisfactory results, with the important advantage that, as it is easy and rapid, but little extra expense is incurred by the manufacturer, and, consequently, but little by the consumer. The one thing wanted is GOOD DESIGN: this is indeed the "all in all" required by so many of our manufacturers. Hitherto, Messrs. Skinner & Branson have striven for strong effects rather than for a purer order of ornamentation; but they are rapidly advancing in this respect, and we hope to see arise from this valuable patent a marked improvement in all classes and orders of "Sheffield goods."

* Their patent includes other modes of producing this work, with these effects, but the one referred to is that which they chiefly use.

SUGGESTIONS OF SUBJECT TO THE STUDENT IN ART.*

BY AN OLD TRAVELLER.

CHAPTER I.

Introduction—Effect of Themes repeated—Fields open to the Artist—Sources awaiting the Ponder—Pictures lost in Portfolios—Hypatia in the Schools—The Daughter of Theon borne to the Basilica—The Captive's Predilection to Agrippa—The Emperor Charles V. and the Woodman—Hyrcan Ballads—The Heydukes—Love wakes the Dead—St. Mary the Egyptian—Dante—The Angel at the Gate—Monsieur du Corbeau—An Irishman's Version of La Fontaine—A Georgie of the Boy—Immortal Youth of Oxen: Mage to wit—Cocino Concilio—Eleonora Galigai—Death of Gustavus Adolphus—Francis Albert of Saxe-Lauenburg—Duke Bernhard of Saxe-Weimar.

AMONG the many and various merits of Mr. Leighton's truly admirable work, "The Madonna of Cimabue, carried in procession through the Streets of Florence," not the least important is the fact that the painting is a highly suggestive one. Who can stand before this picture without finding incident after incident recur to his memory, each attaching itself in some manner to the story of the well-known personages represented in the painting? Now we have some touching or stirring episode, heard once again in the musical periods of Dante, or there rises before us some noble structure, recalled by the figures of Arnolfo di Lapo, or Niccolò Pisano; then passes some jacketed angel, or other quaint apparition, summoned to the mind's eye by the forms of Gaddo Gaddi or Simone Memmi. Or, it may be, that the more youthful spectator shall be laughing in his heart, as he pictures to himself some wicked prank performed by the mischief-loving Buffalmacco; whether fixing his tiny torches to the backs of great beetles, and setting the creatures to crawl about his chamber, in the hope of curing his master, Andrea Tafi, of the inconvenient practice, adopted by the latter, of rousing him to his work before the dawn; or whether salting the froth of his neighbour, Capodocia, in return for the music of that spinning-wheel, which the gooshead's wife did not fail to set whirring, before Buffalmacco had well laid his head on his pallet—the painter's couch, unluckily, standing in too close proximity to the instrument of her industry.

It will be remarked that we here allude chiefly to the facts and incidents recalled by Mr. Leighton's "Cimabue," making but slight mention of its higher action on the regions of thought and feeling. The obvious effect of the work in these directions we do not now insist on; our business for the present is rather to invite attention to the many pictures existing in and called up by the one painting before us; and we are led to confine ourselves to this consideration by the dearth of subject that would seem to exist among artists, if we are to judge by their very frequent reproduction of the same idea, and by the pertinacity with which they cling to some few hacknied themes.

Certain remarks to this effect, with expressions of regret that a new and good subject was not more frequently treated by our rising artists, were heard to proceed from a group of accom-

plished amateurs, at the private view, on the opening of the Royal Academy's Exhibition, in the present year, and they were such as might have been listened to with advantage by more than one amply-gifted aspirant to the honours of the brush.

For how many a nascent light is extinguished by the deadening chills of that indifference with which the ordinary spectator turns from the oft-repeated tale, but too generally presented by the canvas of our painters! Or if to this it be replied that the true master in Art, the judge, on whose decision the student's hopes are hanging, will detect the merit of the work, however hacknied its theme, may not the lover of Art rejoin by asking, "Why, yet, should the youthful painter do his genius the wrong that results from ever harping on so few strings, when he has the full diapason wherewith to charm the spheres? Wherefore will he submit to endure the cold reluctance of that faint regard which is all we have to the well-known, and often related, when the boundless universe, with mines of yet unappropriated wealth, lies before him? when, not this world only, 'with all that it inherits,' but every other also, with whatever riches they may be endowed withal, is his domain!"

Yes, certainly; for if science have her limits, that she may not overpass, none have yet been laid down for the realms of imagination. Let the learned waste their breath over such questions as whether this or that planet have its dwellers; and for you—Oh, ye of higher destinies! the radiant creatures that make bright your visions, shall richly suffice to people each and all, if such shall be your pleasure! Admitting, then, that you have "conquered worlds," what shall forbid you to "imagine new?"

But is this so? Has the painter, verily, nothing more remaining to him beneath the glimpses of the moon? Has he indeed exhausted all the resources of our own poor planet? Can the history of nations offer no event of interest sufficient to tempt his notice? Is there nothing in poetry that may stir his spirit? Does the drama present no scene still worthy of his pencil? Has exquisite Nature no effect, as yet unmarked by the crowd of her lovers? Nay, has not our daily life full many an incident yet untold of the limner? Enough there is, in each and all of these limitless regions! Do but look for yourselves, ye who aspire to join that band of immortals, amidst whose shining ranks "Cimabue" so worthily holds his place. Follow not, each on the trace of the other, as do sheep that would enter the penfold, but acknowledge, once for all, that Judith, with her ill-won trophy, is not the only treasure to be gathered from the stores of Holy Writ; that his Ophelia, his Beatrice, are not the sole creations of our world-adored Shakspeare; that the Florentine has other pictures beside that of his Francesca; or—to descend at once into such an atmosphere as we have strength for breathing in—that one may at length be supposed to possess a sufficiency of Marians, more especially when we consider how few of those painted before us bear the palest resemblance to that Mariana of the poet, whose delicate presentation is but marred by the many counterfeiters usurping her name.

Should then the painter be a book worm, perpetually hunting through the widely spreading regions of storied old, for the "subject" that, in such case, he would, perhaps, be slow to find? Or should he consume his days in the study of those "modern instances" so much less likely to reward his labour? By no means. There is not indeed any great danger in this our time, that the younger votary of Art should wear his eyes out over black-letter; and if the many among his brethren who have made shipwreck on the rocks of commonplace, do not warn him from putting his trust in the last new poem, or "the novel of the season,"—Heaven save the mark!—no lamp that we have the force to light could avail to serve him for a beacon; nor is he of the number of those for whom we could hopefully sound the note of warning.

But the question of how, and to what extent, the artist should be a reader, is one into which

we are not now about to enter; here, as in all beside, the golden mean is, without doubt, the golden rule; and in no case do we advocate undue devotion to book-lore, whether of the old or the new. Nay, since life is indeed so short, and Art so long, there at once arises the question, has the painter leisure for protracted evenings with the historian and the poet, the dramatist or the mythologist; and we incline to think that he has not. His hours are all too few for the various studies attaching themselves peculiarly to his own most glorious art. The demands of the painting-room, with its numerous dependencies, and often conflicting claims, have the right to supersede those of the library; and therefore are we about to try if we cannot assist the student to economise those precious hours. We propose, that is, to delvo for him, in the fields extending their illimitable space around us, presenting for his selection whatever may be found, that shall seem to offer matter worthy of his notice.

In this attempt to serve as the painter's pioneer, we shall not confine ourselves to order of time, nor seek to establish arrangement as to class of subject. Passing through all ages, and examining each period of the world's progress, we shall levy contributions from all sources, and take our spoil wherever it may be found; our object being to offer suggestions that may suit themselves to all good tendencies, and gratify every pure taste. Thus, times, ancient or modern; lauds, far or near; story, national or personal; incident, grave or gay; each in turn shall be made to render tribute, and take part in that service of the youthful student in Art, whereunto we propose to devote the pages that follow.

Nor, among the sources whence we may probably draw, for his advantage, will the least abundant be found in those stores of undeveloped thought, often much lamented over by the present writer, during a life-long perambulation through all the best-known, and not a few of the more obscure, Galleries of Europe. We allude to the many admirable designs lying incomplete—perhaps never to be completed—and now lost amidst forgotten leaves in the numerous portfolios, over which we have not unfrequently been permitted to pass a delightful hour, when "living glorious days" among the studios of northern or southern cities. In the number of these has been found many a well-selected theme, rarely carried beyond the life-like sketch, dashed off in the first heat of conception, or, if worked out into the series of studies, serving to exhibit the more advanced purposes of the author, yet never matured into the noble and admirable picture of which not a few give ample promise.

"Hypatia in the Schools" and "The daughter of Theon borne to the Basilica" were the titles appended to two of these sketches; and in this instance the world of Art has sustained all the greater loss from the non-completion of a worthy purpose, because the hand of the artist is now cold in death. Nor has this subject been treated, so far as we know, by any other master.

In the first of the works in question, the beautiful daughter of Theon is presented in the midst of her disciples. She has risen to receive the Patriarch Cyril, who is entering on the one hand, while Orestes, Prefect of Alexandria, departing on the other, turns a glance of anger and disdain on the Patriarch. This last circumstance shows the point of time selected to be that when the enmity of these rivals in ambition had reached its climax, and was soon to result in the destruction of the virtuous Hypatia.

These sketches, some parts of which are exquisitely finished, exhibit many high qualities. The artist represents forcefully, because he has felt strongly—one of the first requisites to success. His composition is clear and simple. The principal groups are nobly conceived, while the subordinate figures, which are numerous, give occasion for a rich variety in attitude and expression; nor has the master neglected his opportunity. The face and form of Hypatia, in particular, are remarkable for their intellectual beauty and high refinement: the *pose* of her

* [We have for a very long period desired to obtain a series of papers that might be so constructed and arranged as to supply suggestions of subjects for the artist. The task we know to be one of no ordinary difficulty, demanding a combination of requirements very rare—extensive reading, acquaintance with many languages, the advantage of travelling in several countries, and above all an intimate acquaintance with Art, in the past and in the present, and a power to estimate its wants, its capabilities, and its results. The accomplished lady who has commenced these papers, has already obtained the respect and confidence of the artists by her translation of, and notes to, Vasari; and the grace and vigour of her style have obtained for her a wide popularity. We believe she has visited all the leading capitals of Europe, where her chief objects of attraction and study have been the collections of pictures; her other advantages are of a high order, and we believe few persons could be found so well qualified to execute the task we have had the pleasure to place in her hands. We have no doubt of seeing the results of her labour and research in our future exhibitions, giving to them a variety and a character hitherto unknown to them.—Ed. A. J.]

† Capodocia, i.e., "Gooshead," was the byo-name given by Buffalmacco to the neighbour in question.

figure is simple and elegant; from one hand she is laying a scroll (on which may be read a portion of the word "Diaphantus," in the Greek character, showing that the beautiful sage had been engaged with a work of that rhetorician, when interrupted by the visit of the Prefect), while with the other she has gathered up the ample folds of her flowing drapery, her action exhibiting inexpressible grace and dignity. The mingled sweetness and gravity of her features are in perfect harmony with that high character for purity, diffidence, and every other feminine virtue, accorded to Hypatia by the united voices of history. Her finely-formed head is turned towards the haughty figure of the approaching Patriarch, on whom she has fixed the calm gaze of her thoughtful eyes, and whose form—of truly regal port—comes proudly sweeping towards her, with a movement, the life and animation of which are among the highest merits of the work. The architecture is of correct proportions; and the minor accessories have a propriety and significance which do but increase the regret of the beholder, as he considers that all is but a promise not destined to be fulfilled, unless, indeed, some youthful aspirant, becoming sensible to the attraction of the subject, as here presented to him—but treating it according to the dictates of his own genius—should some day establish his fame by the truthful representation of a woman who so well deserves to be commemorated.*

In the second sketch the calumniated Hypatia is in the hands of her ruthless murderer, the fiend-like Petron, who has dragged her from her chariot as she was returning from the schools. He directs his myrmidons towards the Basilica, within whose desecrated walls her pure spirit was destined to depart, and seek congenial skies, but not until the wholly innocent victim of an implacable hatred had suffered torments such as memory shudders to recall. The head of Hypatia is the only part of this study that is more than faintly indicated; the demon countenance of Petron (or Petrus as he is also called) alone excepted.

The following passage has been more than once discussed by the present writer, with very competent authorities, all of whom have admitted its aptitude for the purposes of the Painter; it is further recommended by the easy accessibility of the author, who is, indeed, in the hands of all.† The words of the writer are these:—

"Now Agrippa stood in his bonds before the royal palace, and leaned on a certain tree for grief, with many others who were in bonds also. And beholding a certain bird on the tree (the Romans call it hūbo, which is an owl), one of those bound, a German by nation, asked who was that man clothed in purple, and having been told, he begged leave of the soldier to whom he was chained, to approach him. Being suffered to do so, the German captive addressed Agrippa in these words:—'O young man, know well that thou shalt soon be delivered from these bonds, and wilt attain to such dignity that he who now pities thy hard fortune shall envy thy greatness. Know also, that when thou shalt see this bird once again, thou wilt then have but five days more to live. I appeal to my own country gods as well as to thine, that these words are true; and I adjure thee by all these gods, that thou forget not my bonds when thou hast obtained thine own freedom, but seek to deliver me; so that I be witness to thy good fortune.'"

The life of the Emperor Charles V. is one that has received due attention from painters, but here is a short anecdote, related by Sandoval, in his history of that monarch, which appears to have escaped their notice, although not incapable of effective delineation, as was proved by a spirited design made, at the suggestion of the present writer, by a student in the gallery of the Academy at Venice:—

"The Emperor was hunting the stag at no great distance from his capital, and chancing to

outstrip his attendants, struck the quarry while thus alone. He had scarcely done so before he espied an old woodman, driving an ass with a load of wood on its back.

"Lend me thine animal to convey my game to the city," said the Emperor, "and thou shalt be paid for his labour and thine own."

"Not so, brother!" returned the woodman; "yon stag is a heavier weight than my beast may bear. You are stronger than he, and might carry both him and the stag together, if need were. Take your game on your own shoulder, then, and God be with you."

The scene of this incident, as given by the young Venetian above alluded to, is a forest-glade of surpassing beauty; the group formed by the colloquists and the animals, is placed partly within the shadow of some noble trees, while a stream of sunlight pouring down a distant ravine, gives to view the retreating figures of a hunting-party, yet without unduly distracting the attention from those in the foreground. Of these, that of the emperor exhibits the form and head rendered familiar by his numerous portraits, but wearing an expression rarely seen on it,—amused surprise, namely,—at so unwonted a circumstance as the refusal of his request, and the puzzled, half-doubting look of one not yet certain that so strange a thing can have occurred. The sturdy determination of the woodman is, nevertheless, sufficiently obvious in his attitude and action, as he turns the head of his ass to lead him thence; nor is there a trace of indecision in his countenance, which is yet not stern or displeasing; on the contrary, it is that of a perfectly good-humoured, and very handsome old man. The face and figure of a stolid-looking peasant boy, who accompanies the woodman, lend additional variety to the expressive depicted.

Inexhaustible is the wealth of picture to be found in the national songs and ballads of the Slavonic tribes, and of all their congeners. Those chaunted by the peasant of Illyria to his single-stringed guitar, called the guza, are more particularly valuable as viewed in this light. Among them is one composed by a performer who enjoyed high reputation in his country, and from this more than one fair canvas might be filled. The composer is Hyacinth Maglanovich, and the ballad, called "The Death of the Heydukes," is as follows:—

"Within the shade of a deep cavern, and stretched on its hard floor, lies a brave Heyduke, the dreaded Cristich Mladin; beside him kneels his faithful wife, and at his feet are their two dauntless sons.

"Three days have they remained without food, nor hath the blessing of water moistened their lips, for each pass of the mountain is held by their foes, the cowardly Pandours; yet none dare suffer a plaint to be heard, for they fear to displease Cristich Mladin.

"On the fourth day spake his wife; 'May the Holy Virgin take pity on us, and deliver you from your enemies,'—then she breathed a sigh and died. With eyes unwet Cristich Mladin regarded the dead form of the wife he had loved, but his two sons wiped away their tears when he saw them not.

"When night fell, the elder became frantic; he drew the broad hanzar* from his belt, and glared on the dead, as doth the wolf on the lamb,—but his brother seized the weapon, and piercing his own arm, he said, 'Drink of my blood, O brother, and commit no crime. When we have all died of this fire of thirst, shall we not return and quaff the blood of our enemies?'

"Then rose Cristich Mladin from his lair. 'Children,' he said, 'it is enough! we will descend to the plain. Better is a true bullet than the grim death of hunger.' These words uttered, all three rushed down with the rage of wolves, each slew ten men of the foe, each

received ten bullets in his heart; but when the dastardly Pandours had cut off their heads, they dared not look in the faces of the slain, so heavy on their souls lay the dread of Cristich Mladin and his children."

Of a different character, yet not without its uses for the painter, is the following fragment of a ballad still sung by the peasantry on the eastern frontier of the Austrian Empire; that joining the Turkish border; namely,—

"The warden of the tower hath the fairest of daughters, but the eyes of a Moslem captain have fallen on the maiden, and her tears have washed the roses from her cheek.

"Doh! not the proud one say, 'Give me to wife that sweetest maid'; but Ilauka beheld her father tear his beard, as he listened to the words of the messenger,—her heart hath, moreover, been wiled from her keeping, so hath given it to a brave Tambourgi, and she bids them prepare her grave, saying, 'Better for my mother's child is the earth of her tomb, than the pearl-bestrewn cushions of a Moslem dwelling.'

"Then the captain of the misbelievers came to demand his bride. He came in his youth and beauty, with the love of his heart beaming forth from his eyes, for he had watched the maid in secret, until his soul had become one with hers,—and well had he taught her to love, though she knew him not, save as the humble Tamhourgi."

"But they had him look on the cold hier where she lay, and told her bridal bed had been prepared beside her mother's grave. 'Not long for me shall wait the angel of the tomb,' were his words, as he bent, with a lip that trembled in the anguish of despair, to press the farewell kiss of a hopeless heart, on those eyes that should have been the light of his own.

"When, lo!—mark ye the wonder, maidens—the lids of those eyes rise softly,—their beams shine forth—the celestial blue!—and the setting sun hath seen the Moslem bear a willing bride to his home."

From that inexhaustible storehouse of painters, the legends of the saints, even the older masters have but very partially drawn; confining themselves to some few constantly repeated subjects, that will at once recur to the memory of all who are familiar with foreign galleries. But among these often related stories, we do not remember to have seen any work commemorating the meeting of St. Mary of Egypt with Zosimus the anchorite, one slight study alone excepted, and this, though subsequently worked out to a certain extent, neither has been, nor will be completed. Yet the subject is one not incapable of rendering pictorial effect. St. Mary has discovered the anchorite on the bank of a wide and rapid river, but she is herself on the opposite shore, and cannot find bridge or boat to cross the stream. Undismayed by what would in most cases prove a formidable obstacle, Maria Egyptiaca, as this saint is called in the Roman church, bids the holy man cast his mantle on the waters; this he accomplishes at her bidding, and, floating over to the bank whereon she stands, that frail-seeming bark receives the saint, and bears her safely to the desired shore.

In the study of the subject just alluded to, the figure of the old man, "black with fasting," as the legends describe him, is placed beneath an overhanging rock,—that of St. Mary, remarkable for grace and beauty, floats prosperously towards him; the landscape is a fine one, and the amazement of two herdsmen, who behold the saint proceeding on her voyage, is extremely well depicted. One of them has fallen on his knees in the act of adoration.

In the eighth canto of Dante's Inferno, and towards the closing lines of that canto, is a grand picture yet unpaired, so far as the knowledge of the present writer extends. The fresco executed in the Villa Massimi, at Rome, by

* See Moreri, "Diet. Hist.," or the English reader may consult Enfield, "History of Philosophy."

† Josephus (Whiston's translation). "Antiquities," Book xviii, chap. vi., sect. vi.

* Hanzar, knife or dagger.

† Belief in the existence of vampires has never been extinct among the Illyrians, and many a man of their vengeful tribes is said to console himself in death with the thought expressed in the text, that of returning as a vampire to drink his enemy's blood.

* Tambourgi, drummer.

Philip Veit, Overbeck, Julius Schnorr, and Cornelius, may possibly comprise this subject, but the writer cannot recall it, and does not believe it to be included. A slightly similar, but much less important theme was ably handled by Moralt of Munich, a pupil of Cornelius, in 1843. This picture, an oil-painting, will be in the recollection of many, and of Flaxman's Outlines to Dante no mention need here be made, since it is familiar to all; the passage in question is, however, not included among those chosen for illustration by the great sculptor. But whether painted, and whether sculptured, or not, nay, even if treated by all who have sought inspiration in the Divine Commedia, from the time of Dante downwards, the subject is one not sufficiently known in the country, and the student who shall choose it will do well.

The Poet is advancing with his guide towards the city of *Dite*, near the vast gates of which are bands of fallen spirits. But their pristine radiance is not wholly lost beneath the shadows of the demon nature fast involving them,—their forms are yet grand, their features retain a mournful beauty, or, at the worst, are but partially marred by a bold defiant haughtiness, which is yet not all demonic; one of the number, only, exhibits the malignant aspect of a being wholly corrupt. They are pouring into the city—after a vain attempt on Virgil's part to procure admittance for Dante, and are closing the ponderous gates.

But a Spirit of light is meanwhile descending, his mighty pinions bear him irresistibly onward, and towards the city—the giant valves of its portal shall be cast wide by his touch, and the Florentine, with his Mantuan guide, shall proceed to explore the marvels within.

Dante declares the approach of the angel to be as that of the mighty rushing wind: the whole passage is too long for quotation here, but a few lines describing the advance of the celestial visitant, may be acceptable. The student who shall desire to read the whole will find it in *Canto ix.*, 56,—or if he prefer a translation, that of Cary will serve his purpose well; it is from him that I borrow the version appended in the note, since a more faithful one could not easily be made. The words of Dante are these:—

"E già veniva su per le torbide onde,
Un fucasso, d'un suon pien di spavento,
Per cui tramovva amandue le sponde,
Non altrimenti fatto che d'un vento,
Impetoso per gli avversi ardori,
Che fier lo solva, e senza alcun rattenuto,
Li rami schiavata abbattè e porta fuori,
Dissolva polverosa va superbo,
E fa fuggir le fiere, o li pastori."^{*}
INF., *Canto ix.*, 66.

That the comic element cannot be safely admitted to form one of the resources of the artist, without much reserve and discretion, is a truth but rarely disputed; the mere buffoon, the coarse caricaturist, are indeed not entitled to the name of artist, and soon find themselves reduced to their true level. Altogether different is the condition of him with whom that element is but one among the many which go to form genuine humour. The place appointed to the possessor of this "subtle quality" in the temple of Art may not be among the highest, but he holds it by imprescriptible right, nor is it one that may be justly disdained.

For the humourist, whether in Art or Literature, is one of the born instructors of his kind, and not the least efficient among them. Shrewd are the blows that he levels against vice, when it dares to come before him in its turpitude; keen the shaft aimed by his hand at the follies of the time, and uttering the touch wherewith he raises the veil of Pretension, whatever form the Protean goddess may assume.

* "And now there came, o'er the perturbed waves,
Loud crashing, terrible, a sound that made
Either shore tremble, as if of a wind
Impetuous, from conflicting vapours spring,
That 'gainst some forest driving all its might,
Plucks off the branches, beats them down, and
hurts
Afar; then, onward passing, proudly sweeps
Its whirlwind rage, while beats and shepherds
fly."—CARY.

If considered principally in reference to certain of his fables, La Fontaine may be justly classed among humourists, and the graces as well as good-humour with which he laughs at follies that do not call for more severe repression, are admitted on all hands. Hear him, as he amuses himself with the dear little foibles of personal vanity, for example:

"Eh! bonjour! Monsieur du Corbeau!
Que vous êtes joli! que vous me semblez beau!
Sans mentir, ai votre plumage,
Se rapporte à votre plumage,
Vous êtes le Phénix des hôtes de ces bois!" &c.

We all know the rest, but how shall we render the charming playfulness of these lines? the "impayable" Monsieur du Corbeau! It is by no means to be done, the attempt is hopeless, but there is a dash-at-all Irishman of our acquaintance who would certainly not hesitate to give his version of the passage, and it would not be much unlike that in the note below; * for we won't admit it into the text. How the poor crow came to grief because of these sweet words, none will have forgotten. We all remember, too, the portraits taken of this Monsieur du Crow; there is room for another, nevertheless, and here is one, which, if it have no other merit, will at least serve us as the pretext for an exquisite morsel of woodland beauty, in the landscape you may him for the habit of your penances.

The fateful words have been spoken; they have produced their effect. Mr. Fox has caught the dainty prize before it has well touched the ground, and is taking his pleasant way along a sweet sun-lighted wood-path, his handsome brush sweeping with a proud complacency over the soft green turf. The figure of our bereaved O'Crow is much less triumphant; his amazement has not yet left him at leisure to close those musical lips that have worked his woe; and the aspect with which he regards his retreating despoiler is not a dignified one. On a high branch, far above the head of the crow, sits a saucy squirrel, eating his breakfast of nuts, with every appearance of satisfaction: he is bestowing the shells full upon the head of poor Sir Patrick; let us hope they are falling by accident, or it might be supposed that he was laughing at the evil plight of his neighbour.

All who love to contemplate beauty of form, and delight in the fervid tones of Italian colour, will ever rejoice in the successful transmission of both to their canvass by so many of our distinguished artists; but let us not the Pesant of the Abruzzi, however picturesque his figure, nor the Contadina of the Campagna, radiant as is her glance, bear off all the honours of their notice. A bright and glowing scene is the Wine harvest, but it does not monopolise the poetry of the fields, and although much of the romance of rural labour in our own fair land has doubtless been destroyed, yet there still remain some lingering relics of old custom in remote districts, and these occasionally offer a spectacle not unworthy of the painter's eye.

In certain parts of Holderness, for example, the last load of the wheat-harvest is still brought home amidst songs of triumph, and with rude garlands of field flowers suspended from various parts of its huge mass. Boys, and the younger labourers, dance merrily beside the gaily decorated load; their exultation ever and anon bursting forth in the following words, which are used with slight variations, in all the villages where this primitive custom still lingers.

"We hev her! we hev her! †
Oor last cart's i' t'ether,
Sae gin us a coo,

* "Now the top o' the morning! Sir Patrick O'Crow, Faith! 'tis handsome you are! sure! the broth o' a bean!"

† If you sing as you look,
We may seek high and low
But we'll not find your equal, Sir Patrick O'Crow! &c., &c.

‡ The attribution of the feminine gender to things inanimate, in these regions, is sufficiently amusing. The clock, the oven, the kettle, and many another of the good wife's household belongings, are thus distinguished, her husband calling his watch "she" in like manner.

Or 'tis nobbut * a lamb,
For ye see we coom seaf
Wi' oor harvest yam, †
At oor loon end, at oor loon end,
We've a saep o' good yal, ‡ and we've mooney §
to spend.
Sae coome big and little,
Sae coome yan and all,
Ye'll get yal and get apples,
Whats'ever befall."

The "coo" is no longer expected, nor is even the lamb forthcoming in these degenerate days; but a gift of apples is made ready for the boys by every cottager before whose dwelling the auspicious procession takes its way. That the cereal and floral games of the ancients have been the origin of these now dying customs, is manifest, but with this question we are not, for the moment, concerned. If the artist will admit that they may present subjects no less worthy of his pencil than the broad-fronted buffalo, and more fragrant load of southern climes, may a charming picture, never yet painted, may rejoice the eyes of the beholders, while it rescues from oblivion the last trace of national customs, now rapidly falling into disuse.

From a Georgic to Bucolics the transition is not violent, and here is a remark of that accomplished gentleman and eminent agrarian authority, the late Thomas Gisborne, which may give our incipient Paul Potters rare occasion for glorifying the never-changing youth which their own chosen walk of Art may truly boast.

Gisborne, in his *Essays on Agriculture*, is descending, with a most engaging gentility, on all that Mago the Carthaginian set forth, some good dozen of centuries since, as to the merits and attractions of a thoroughly handsome ox. These are the words of Mago, which Gisborne, loving his author for the sake of those loving beauties, whose charms the Carthaginian chronicled so long ago, "will not accept," he tells us, "in the German of Heeren, or the English of Dickson," but renders them, and to the letter, for himself. The translation is as follows:—

"The young oxen we buy should be square in their form, large limbed, with strong, lofty, dark-coloured horns, broad early fronts, rough ears, black eyes, lips prominent, and expanded nostrils; long and brawny neck, ample dewlaps, pendant nearly to the knees, a wide chest, large shoulders, roomy bellies, with well-bowed ribs; broad on the loin, with a straight, level, or even slightly depressed back; round buttocks, straight and firm legs, by no means weak in the knee; large hoofs, very long and bushy tails: the body should be covered with thick short hair of a red or tawny colour, and they should be very soft handlers." (*Zuch corporis molissimo.*)

"A very tidy ox!" adds Mr. Gisborne, "whether purchased in Libya, by Mago the Carthaginian, 600 hundred years before Christ, or in our own good county of Northampton during this current year of 1852." He subsequently tells us that *his* Mago—for there were more than one of the name, as all will remember,—discoursed thus eloquently, and to the purpose, on oxen, in the time of Darius Hyaspas, and was the founder of that great Punic family wheeue Hannibal claimed descent.

Let, then, our young Paul Potters,—offering due allegiance also to Paul's worthy contemporary, Cuy,—take a goodly herd of such oxen as the Carthaginian has here depicted; let him give them to rove at will in such pastures as his heart best loveth to paint, and he shall cause the excellent Albert, not less than dear Paul to smile approvingly as they give each other a cordial shake of the hand, in that bright painter's elysium, amidst whose fair broad uplands, fitly browsed by well-shaped flocks, they now expatiate together.

Like Gisborne and the Carthaginian, a dear lover of all that peoples the field, the present writer has just taken counsel with another eminent "judge of fat cattle," to say nothing of lean, or of such as are neither fat nor lean—and this authority likewise upholds the correctness of the Carthaginian, save only in the article

* 'Tis nobbut—if it be but.
† Yam—home.
‡ Yal—sie.
§ Mooney—money.

of horns, which, as he sayeth, should not be black, but white, seeing that the last named colour is now "your only wear." Let the student make his election, but in any case let him give us the cattle and their pasture; the horns he shall make of such colour as may best please him.

"Gli occhi tuoi pagheran, se in vita vesti,
Di quei sanguis ogni stilla un mar di pianto."
Passo.

These words—their vengeful import intended for the king, Louis XIII.—to whose ears they were quickly repeated by the enemies of the unhappy speaker, are declared to have burst from the lips of Eleonora Galigai, when the mangled corpse of her husband, Concino Concini, was laid before her. Whether Louis XIII. were thus menaced by the bereaved woman, in her frenzy, or not, the fate of Eleonora had certainly been decided on when that of Concini was determined; nor can this be doubted when we remember that the crime of which her vengeful judges pronounced her guilty, was that of witchcraft, an accusation manifestly invented, for their purpose, by the destroyers of her husband. For this she was condemned to the bitter death of the stake, and did in fact suffer on the Place de Grève—but by the more merciful process of decapitation—some few weeks after the murder of Concini.

More than one mournful story here awaits the hand of the painter; and if it be true that the grievous tragedies alluded to are already familiar to all readers, yet let the hand of the artist make them known to a yet wider circle of disciples, seeing that the lessons they convey are significant, and have proved useful to more classes than one.

There may indeed be some who are still unacquainted with this deplorable episode of French history, and we therefore add the few words required to give its outline.

When Maria de' Medici entered France as the bride of Henry IV., she was attended, among others, by Concino Concini, whose father, originally an obscure notary, was then high chancellor to the first duke of Tuscany.† At the French court, Concini married Eleonora Galigai, a woman whose origin was yet more humble than his own: she was indeed the daughter of a woodcutter and a washerwoman; but talents and qualities of various kinds had raised her from the condition of a menial to that of first lady of the bedchamber.

After the assassination of Henry IV., and when Maria de' Medici was declared regent of the kingdom, this couple became the virtual rulers of France. But if Concini did not find means to repress the disorders that prevailed, neither was he the origin or promoter of those disorders. The depravity in things public, so justly complained of, was not the cause; it was but the pretext of his downfall. The hatred of that party, at the head of which stood the Prince de Condé, whose instrument De Luynes, the king's favourite, was not less ambitious than Concini himself, was the true source of the Italian's ruin. But we enter into no details: let it suffice to say that Concini—at this time known as the Marshal D'Ancre—was murdered with the consent, nay, under the very eyes of the king, as he was entering the Louvre to wait on that unworthy monarch; and that his wife, awakening from her dream of greatness, was conducted as above described, to a death—not merited very certainly for the crime it was declared to expiate—by the hands of the common executioner.

The few words by which Eleonora Concini repelled the accusation of sorcery, when standing on her mock trial before the Presidents of the Parliament of Paris, are in the recollection of all, and need no repetition. She left a son, not more than sixteen years old, and this boy, having been dragged by an infuriated mob to the windows of his devastated home, was com-

pelled to look on, while the body of his father, first laid hastily in a grave at St. Germain L'Auxerrois, but torn thence by the populace, was suspended on a gallows raised for that purpose. The life of the boy was saved, but not until he had been so roughly treated that every part of his clothing was torn to shreds. A cloak was then cast around the insensible youth by one of the spectators, more compassionate than the rest, who rescued him by declaring that he was already dead, and conveyed him, while yet unconscious, to the Louvre.

What follows will not be credited without difficulty; it is true, nevertheless, and may serve to show of what stuff was made that mistress for whom Concini offered the sacrifice of his life, for it is well known that he might easily have escaped to Italy after his danger had become obvious—had he been willing to abandon the queen to those who were her enemies no less than his own. The son of Eleonora, carefully educated in the luxurious court of France, was remarkable, among other accomplishments, for the grace and beauty of his dancing: this was known to Maria de' Medici, and, with the tears of sorrow for his parents still dimming his eyes, the terror he had so recently endured yet blanching his cheek, the hapless orphan was called on to exhibit his proficiency as a dancer for the amusement of the queen, and, with his breaking heart, was thus compelled to minister to the idle pleasures of her train. He died at Florence, in the year 1631, and with him perished the short-lived greatness of his house.

The death of Gustavus Adolphus, at the Battle of Lützen, has been amply discussed by writers, nor has it been wholly neglected by the painter; but there is still place for a fair delineation of that event, which yields in importance to few that occupy the historian, and has more than sufficient interest for the poet, whether painting or song be the muse of his invocation.

The great defender of the Protestant cause, and "one of the best men that ever wore a crown," Gustavus Adolphus, excelled in bravery, as in every other high and noble quality. At the Battle of Lützen he led the attack, and is indeed affirmed to have been the first who dealt a blow on that inauspicious day. He was heading a second charge, and had borne down all before him, when the laud of treachery effected that to which the force of Austria had proved unequal. Francis Albert, Duke of Saxe-Lauenburg, the cousin of Gustavus, is accused of his murder by the concurrent testimony of his contemporaries. He was close to the king at the moment when a ball, coming from behind the latter, entered his back, and he fell dying from his horse. A German noble, the creature of Francis Albert, is said to have been also near Gustavus, and the traitorous shot has been attributed by some writers to his hand; but the author of that dark offence was, without doubt, the Duke of Saxe-Lauenburg, whose subsequent defection from the Protestant cause and the welcome he received into the Austrian service, which he soon after entered, leave no doubt of his guilt.

That victory, nevertheless, remained with the Swedes, our readers will remember; this was due to the heroic efforts of Bernhard, Duke of Saxe-Weimar. He dashed into the ranks of the enemy, calling on every true man to aid him in the rescue of their monarch, whom he declared to be a prisoner in the hands of the Austrians. The impetuosity of his attack proved irresistible, Austria was defeated with fearful slaughter, but, thanks to her treachery, the grieving Swedes bore only the lifeless remains of their beloved monarch from that dearly-won field.

The painter who shall select this theme will treat it all the more justly as well as effectively if he adorn his canvas with the animated figure of Duke Bernhard. The omission of this would indeed be a violation of historic truth, as well as a mistake, whilst its introduction would supply the artist with a *point* in the composition, which, if successfully carried out, would, as we have just said, tell most effectively in a picture.*

THE ROYAL PICTURES.

THE BAY OF NAPLES.

W. Callow, Painter. R. Wallis, Engraver.
Size of the Picture, 2 ft. 5½ in. by 1 ft. 6 in.

NAPLES is a favourite *point d'appuis* with our travelling landscape-painters who visit Italy; occupying, as it does, one of the most beautiful situations that can be conceived; built in the form of an amphitheatre, surrounded almost entirely by ranges of lofty verdant hills; and washed by the dark blue waters of its noble bay, the city and its environs present just such features of picturesque composition as an artist likes to have before him. From whichever side the view is taken, whether from the east or west, the high ground of Capo di Monte, at the back of the city, or the surface of the bay at its feet, he is certain to find subject-matter for his pencil of the most delightful character, wanting, however, that which, to the eye of an Englishman especially, constitutes one of the greatest charms in nature, the rich and clustering foliage of extensive woodlands: it is the absence of this feature which gives to the scenery of the country round about Naples, particularly in the summer time when the herbage becomes dry and parched, a barren and somewhat naked appearance. Still, with this drawback,—

"not a grove,
Citron, or pine, or cedar; not a grove,
Sea-worm and matted with the gadding vine,
But breathes enchantment. Not a cliff but flings
On the clear wave some image of delight,
Some cabin-roof glowing with crimson flowers,
Some ruin'd temple or fallen monument,
To muse on as the bark is gliding by."

Mr. Callow's picture was purchased from the Gallery of the Water Colour Society, by the Queen, on the occasion of her private visit in 1852. It represents a distant view of the City and Bay of Naples, from the western heights, and onwards over the wide level plain that lies between the city and Vesuvius, distinguished by the column of smoke rising from the peak. The treatment of the picture indicates early morning; the atmosphere is cool and clear, every object is distinctly visible through its transparency; the bay, calm and unruffled, reflects the soft blue of the sky, except when the rising sun throws a long pallid light on its surface. The foreground of the composition is occupied by one of those "cabin-roofs glowing with crimson flowers," to which the rays of the morning sun give increased brilliancy. The lofty tree to the left, though not sufficiently picturesque to satisfy the eye of an Englishman, accustomed to the majestic oak and noble elm of his own country, gives importance to the composition, and assists in throwing back the middle and extreme distances.

There are certain scenes—and this is one of them—which offer ample scope for meditation to those who, looking at a beautiful landscape, find something in it to engage their thoughts beyond the outspreading of the luxuriance of nature. A man of reflective mind, standing on the spot where Mr. Callow must have stood when he sketched the subject, could scarcely fail to place in juxtaposition the living city, almost at his feet, and the "cities of the plain," at no great distance from it, so lately restored to light from the darkness of centuries. "Naples," says Mr. Forsyth, "in its interior has no parallel on earth: it is a city teeming with life of the most complex and varied description; splendour and squalid misery, in appearance, joining almost hand in hand, or at least jostling each other through the thickly crowded streets. Less than an hour's ride by the railroad—for the hoarse screech of the steam-engine is now echoed from the sides of Vesuvius—carries the traveller to the cities of the dead—to Herculaneum, where Cato's sister lived in the villa presented to her by Julius Cæsar; and to Pompeii, where Cicero, and Seneca, and Phædrus had their homes, and whose walls were encompassed by the legions of Sylla. In short, the whole country teems with the memories of past greatness, associated with the grandeur and glory of ancient Rome. The picture is in the Royal Collection at Osborne.

* These lines may be translated—if not quite literally, yet with sufficient closeness—by the following—

"For each dear drop poured from his veins this day,
Thine eyes a sea of bitterest tears shall pay."

† See Litta, "Famiglie celebri Italiane," Roma, 1820.

* To be continued.



Date	Description	Amount
1880	Jan 1	100.00
1880	Feb 1	200.00
1880	Mar 1	300.00
1880	Apr 1	400.00
1880	May 1	500.00
1880	Jun 1	600.00
1880	Jul 1	700.00
1880	Aug 1	800.00
1880	Sep 1	900.00
1880	Oct 1	1000.00
1880	Nov 1	1100.00
1880	Dec 1	1200.00
1881	Jan 1	1300.00
1881	Feb 1	1400.00
1881	Mar 1	1500.00
1881	Apr 1	1600.00
1881	May 1	1700.00
1881	Jun 1	1800.00
1881	Jul 1	1900.00
1881	Aug 1	2000.00
1881	Sep 1	2100.00
1881	Oct 1	2200.00
1881	Nov 1	2300.00
1881	Dec 1	2400.00
1882	Jan 1	2500.00
1882	Feb 1	2600.00
1882	Mar 1	2700.00
1882	Apr 1	2800.00
1882	May 1	2900.00
1882	Jun 1	3000.00
1882	Jul 1	3100.00
1882	Aug 1	3200.00
1882	Sep 1	3300.00
1882	Oct 1	3400.00
1882	Nov 1	3500.00
1882	Dec 1	3600.00



VIEW OF THE TOWN OF MALDEN, MASSACHUSETTS, FROM THE HILLSIDE

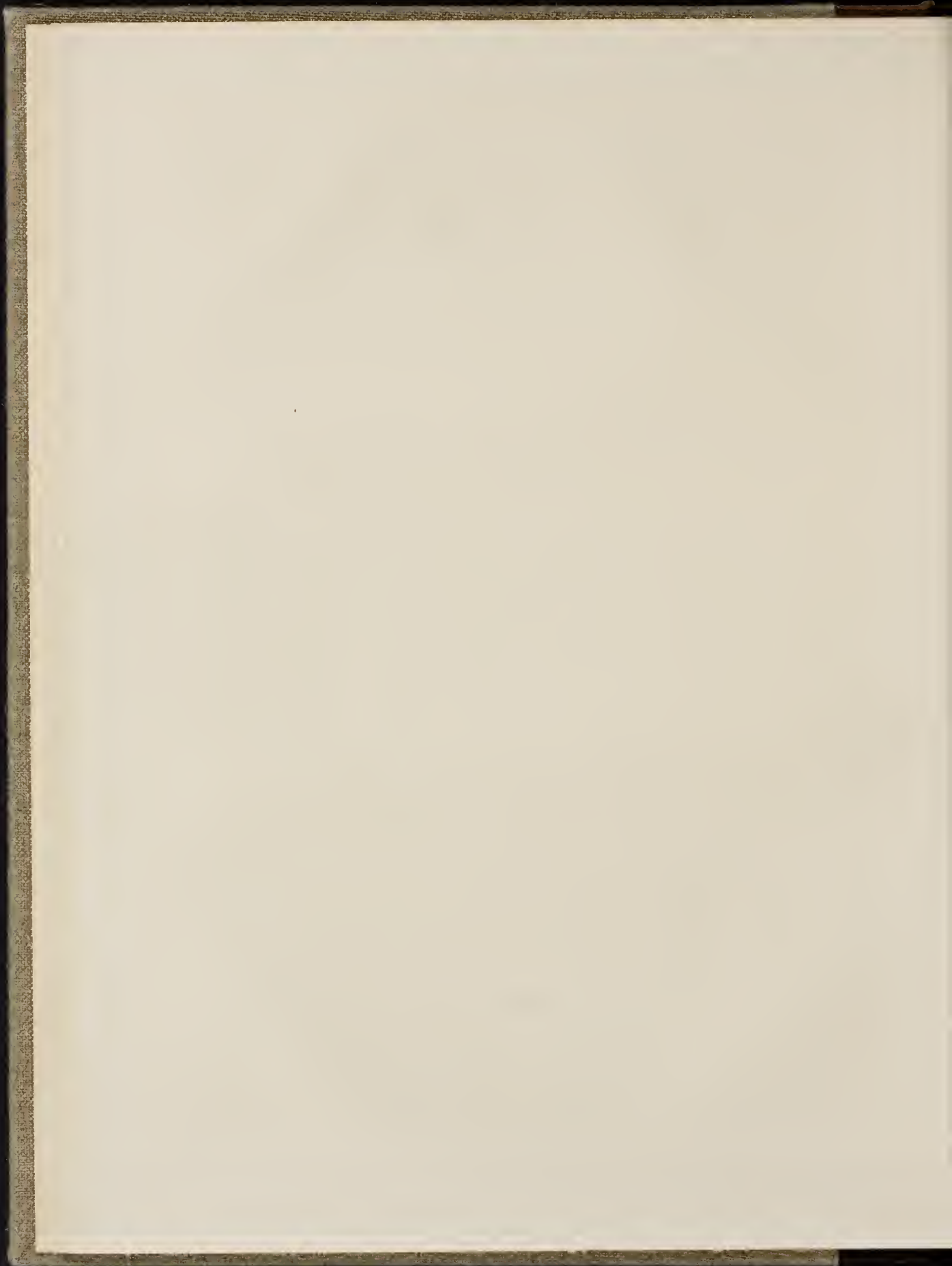

THE EXPOSITION GENERALE
OF 1853,
AND ITS CLOSE.

WHILE, with the old year, we take our leave of its *Exposition Universelle*, in both Fine Arts and Commerce, we do so with one brief final comment upon its closing scene, and the judicial decisions, which may be taken to direct its ultimate

results. In connection with these, as referring more immediately to the Fine Arts, we here offer to our readers a statistical table, formed with some care, in which they will be able to learn, almost at a glance, the names of the different states which contributed to the teeming contents of the *Palais des Beaux Arts*; the number of artists by which each was represented; the number of their works in separate departments and in the aggregate; the honours dis-

pensed in the several classes; and, in addition, the nearest proximate proportion between the gross amount of the latter, and of the works sent in. A moment's considerate inspection will avail more than the most precise description towards enabling those whom it may interest, to estimate the facility thus afforded them of learning at present, or on any future retrospective reference, those various statistical incidents:—

	PAINTING.					SCULPTURE.					ENGRAVING AND LITHOGRAPHY.					ARCHITECTURE.					SUMMARY.							
	Number of Artists Exhibiting.	Number of Works.	Grand Medal of Honour.	First Class Medal.	Honourable Mention.	Number of Artists Exhibiting.	Number of Works.	Grand Medal of Honour.	First Class Medal.	Honourable Mention.	Number of Artists Exhibiting.	Number of Works.	Grand Medal of Honour.	First Class Medal.	Honourable Mention.	Number of Artists Exhibiting.	Number of Works.	Grand Medal of Honour.	First Class Medal.	Honourable Mention.	Total Number of Works.	Total Number of Honours.	Proximate Proportion of Honours to the Works.					
MEXICO.....	1	1																			1	1	1					
JAVA.....	1	1																			1	1	1					
TURKEY.....	1	1																			1	1	1					
HANOVER.....	1	1																			1	1	1					
PERU.....	1	1																			1	1	1					
HESSE.....	1	1																			1	1	1					
THE SICILIES.....	1	1																			1	1	1					
GREECE.....	4	5																			15	15	15					
WURTEMBERG.....	7	11																			18	28	1 1/2					
TUSCANY.....	7	8																			15	15	1 1/4					
SAXONY.....	8	13																			14	29	1 2/3					
BADEN & NASSAU.....	10	16																			13	23	1 3/4					
ROME.....	10	16																			15	30	2 1/2					
AMERICA.....	11	45																			13	50	3 1/2					
SARDINIA.....	14	26																			16	28	1 2/3					
PORTUGAL.....	14	23																			17	28	1 2/3					
HANSEATIC TOWNS.....	19	18																			17	19	1 1/4					
DENMARK.....	29	52																			32	58	1 1/2					
SWEDEN & NORWAY.....	33	52																			40	69	1 1/2					
BAVARIA.....	31	65																			38	74	1 3/4					
SPAIN.....	35	80																			58	128	2 1/4					
SWITZERLAND.....	37	94																			45	111	2 1/2					
PAYS BAS.....	62	99																			74	129	1 1/2					
AUSTRIA.....	61	107																			110	213	1 3/4					
PRUSSIA.....	74	139																			109	227	2 1/4					
BELGIUM.....	116	236																			143	274	1 3/4					
GREAT BRITAIN.....	149	381																			235	759	3 1/2					
FRANCE.....	697	1870	7	29	23	20	69	175	286	3	6	11	16	29	94	286	1	3	13	92	188	1	8	16	23	1068	2730	2 1/2
Totals.....																					2166	5678	2 1/2					

In this review, from the units of Mexico and Java to the thousands of France, will be found an unparalleled artistic congress. France, it will further be found, has, in quantity and variety, had the advance over all, and might be taken, in the result, to have established for herself a pre-eminence as an *officina* of artists and Art. The times for this comparative meeting were not only *not* out of joint for her exhibition of power in this quarter, but in a directly opposite condition, of firmness and strength. Her generation of artists has never, probably, been more prolific than at present; and, as a school of Art, in every class, her tone most assuredly has never been so high.

It will be seen from our table, that while the total number of works of every kind sent in to this Exhibition amounted to 5978, her portion thereof, *i.e.*, 2730, was more than *what came from the other six-and-twenty contributing nations*. Her great rivals in the highest range of Art, the Prussian and Bavarian fresco painters, could not, *ex necessitate*, join the noble tournament. In their paucity they could not invest themselves; they could not enter the field in the imperfect equipment of their cartoons, and so they withheld. Cornelius and Kaullach, who, trusting to their great names, took the other course, can scarcely be said to have done so discreetly. The cartoons of the former, for the fresco illustrations of the Campo Santo at Ercin, were not calculated to enrich the wreath of his well-acquired laurels. They presented, in their sublime and exacting subjects, something too much of an unflattering contrast of weakness and exaggeration—mingled, however, with unequivocal emanations of the great master mind. Our own impressions on this nice point, were confirmed by the deep regrets expressed to us by one who, amongst the first, does honour, as an old pupil, to the studio of Cornelius. It is much to the credit of the Fine Arts Jury of this department, that they did homage to the already

acknowledged creative genius of this first of contemporaneous sons of Art, and awarded him their highest honours. The name of Cornelius, by a happy alphabetical accident, stands first in the *elite* to whom the *Grandes Medailles d'Or* have been assigned.

While France, under the stimulus of the great occasion at hand, which, moreover, involved the interests of her annual exhibition, guided by zealous, active, intelligent, and experienced managers, poured the full tide of her artistic power into what must be considered a confluence of competition, it is to be doubted that an equivalent agency operated in favour of the stranger comers from all quarters. Whether or not it was anticipated that this was to be a field of contest and trial, it is needless to ask—the fact is, that there was not, on any side, amongst the *externes*, that appearance of cumulative effort, which, it must now be felt, was but expedient and for their full credit.

We much apprehend that our own school was not unaffected by this misadventure. At another time, we might have sent a stronger force of men of genius to sustain our honour in the severe *mêlée*. Now, we have not one to spare, while France had scarce reason to feel the absence of her Scheffer and De la Roche. Neither was there the same glorious response to the call that was made upon our body of artists. In painting, something of misapprehension, something of doubt, and something of indifference, may have chilled their emulative efforts. Probably, a still more effective and less untoward cause than these may have been found in the disavowal of owners to part with favourite works, and submit them to possible casualties against which no insurance could be held satisfactory. This, it can be easily felt, must have been especially operative in the case of sculpture. We had, in that department, too few of those masterpieces in marble, upon which time has set its stamp; and it is impossible, even with educated

eyes, for the plaster cast to compete with either bronze, or Parian, or Pentelic. In the distribution of honours, it will be found that in this department we were comparatively least successful.

Looking, nevertheless, at the statistical table, it will be perceived that, upon the whole, the number of honours awarded to the British exhibitors was, although less, not so very much, than that to the French. In the class of painting, we had 381 works and had 34 honours, or about the 11th part. The French, in the same department, had 1870 works and honours 157, or about the 12th part.

In sculpture, we gave a range of 77 works, and had but six honours, or a 13th, as near as may be. The French had 386 works and 62 honours, or a proportion of 1-6th. The adverse proportion in this class was, to use a moderate expression, *aggravated* by our honours being all in the lowest category.

Our engravings, including lithographs and woodcuts, numbered 199, our honours 8, or about a 24th part. The French had 286 works of the same class and 21 honours, or about a 14th.

In architecture, there were 128 British works and 15 honours, about an 8th. The French had 188 works and 48 honours, about the 4th.

Making a total—we had to 785 works of all classes exhibited, 63 honours, or a 12 1/2th part.

The French had 2730 works, and honours 288, or between a 9th and a 10th part.

Belgium, it will be perceived, had a higher proportion of honours, *viz.*, a clear 9th, than either France or England.

Prussia also had some advantage over us—her prizes being in the proportion of an 11th.

In a general point of view, then, there seems but little reason for dissatisfaction at the distribution of honours. Exception, we doubt not, will be taken to many detailed and relative arrangements of merit; and most assuredly, in looking over the long array of the honoured,

some strange and unnatural transpositions and repudiations must startle those familiar with the well-understood precedence of parties here at home in England.

There are, however, some of the awards, and some of what we fancy must be termed the slights, of this jury, against which it is impossible for us not to enter our strongest protest. To pass them *sub silentio* would be a mistake. And first, their understood resolve to withhold the higher honours from Mr. Mulready, which led to the sound and spirited proceeding of our commissioners to withdraw his name from competition. While we reclaim what was due to Mr. Mulready, let us guard ourselves against any supposed or intimated canvas as to his and Mr. Landseer's relative merits. The latter has well won his latest honours; and he too has had a long trial before the tribunal of his country's opinion.

It would be idle for us to enter here into an analysis of the merits of Mulready. They are too familiar to all, on this side of the Channel, to allow such a proceeding to be other than a work of supererogation. We shall, however, call into evidence two out of the many French critics (not members of the first jury in *Les Beaux Arts*), who have put his name through their crucible, and brought it forth with first-stamp of metal. We here repeat that notice, which appeared in the *Moniteur*, and which we have already, in our number for October last, presented to our readers. "Mulready," says the critic, "enjoys, in England, a reputation with which we have been familiarised by engravings. To know him, however, it is necessary to have seen his original works, which reveal rare qualities in both tint and treatment. This master—and he deserves the title—has seven pictures in the Universal Exhibition, which hold a place of honour amongst the best of all countries. It is remarkable that each of these is treated after a different manner—often in strong contrast—so that a forward attention alone could recognise in them the same hand. Many artists, too readily content with their efforts, repeat themselves from the beginning to the end of the chapter. Mulready, ever searching forward, studies, toils, and experimentalises; not impressing his works for ever with the same character. * * * * It would be difficult to associate this artist with any of the old schools; for the character of English painting is modernness. It is obvious that, like Wilkie, he has profoundly studied Terburg, Nestcher, Metz, Mieris, Gerard Dow, Ostade, Teniers, Dreuwier, Bega, Craesbecke, and all those charming painters of Holland, whom the fastidious taste of Louis XIV. repelled. But he has not copied them. He absorbs them, and nourishes his own genius with their essence—without being transformed."

A critic of higher name and authority than Mons. Gautier, Mons. Maxime Du Camp, thus, in his masterly and popular volume, "*Les Beaux Arts à L'Exposition Universelle de 1855*," gives his estimate of Mr. Mulready. We transfer it in its original vividness and force:—

"*L'homme le plus fort que consacre l'exposition britannique, celui qui domine tous ses confrères de la hauteur d'un incontestable talent, est, selon nous, M. Mulready, artiste populaire en Angleterre, et qui, par quelques-uns de ses tableaux, laisse loin derrière lui la plus part des peintres de genre français. Ses personnages, animés et bien en scène, sont tout à leur affaire; ils vivent et ne posent pas; ils sont dans la réalité de leur mouvement et de leur action, et ne ressemblent pas à ceux de M. Meissonnier, qui paraissent toujours avoir mis des habits neufs et prendre des attitudes particulières pour se faire regarder par les amateurs. La peinture de M. Mulready ne rappelle en rien cette peinture enluminée. Elle est vive, sincère et sérieuse, et n'a d'autre préoccupation que de représenter la vérité.*"

A little further on, M. Du Camp, speaking of Mr. Mulready's exquisite picture of "The Bathers," expresses, in his own piquant mode, the opinion, that probably the power of depicting delicate flesh tints was never carried so far. "*Mais disons aussi que jamais, peut-être, on n'a été aussi loin dans l'imitation de la carnation humaine, de ces nuances fraîches et nées, douces et charmantes, que le diable prête à la jeunesse pour en faire sa beauté.*"

We accept these attributes of wondrous variety of style—this genius, nourished with the very essence of the great Flemish school—this leadership, much in advance, of the British exhibitors—this distancing far the great majority of the French painters in *genre*—this matchless flesh-tinting—this life and sincerity of treatment, as contrasted with the posed, *Sunday-evening* mannerism of Meissonnier, and we venture to affirm that a sound and just decision should have placed the name of Mulready, if not before, at the least, beside that of the French master named, in the class of "*Grandes Médailles d'Or*."

If with the most serious mood, we note this error in regard to Mr. Mulready, the same feeling almost lapses into laughter, when we find how the merits of Mr. Danby have been appreciated. He too is one of those artists, whose fame is not of yesterday—is no longer ambiguous. From the days, now long since, when Sir Thomas Lawrence, with a glowing recognition of the young artist's genius, made himself master of one of his first poems on canvas, "The Raft," and gave it a unique place of honour in his painting-room, down at least to the time, when the two works, exhibited here in Paris, "Calypso Landing the Departure of Ulysses," and "The Evening Gun," were sent from his easel, the reputation of Danby has ascended to its culmination without a cloud. On looking back over the series of works, which he has given to the public, and extending our retrospect to the great names that have distinguished landscape Art, we do not feel it too much to hazard the affirmation, that his has been the most thoroughly and purely poetic pencil of the group. His, too, has been not alone the "feeling and the faculty divine" of appreciating and giving to the canvas the loveliest and most striking effects of nature, but he has fully enjoyed the accomplishment of Art which enabled him to do it with the most refined delicacy of touch and firmness of effect. These qualities are all to be found in the "Calypso" and "The Evening Gun." The latter has been the chief favourite with the French critics. Of it, the representative of *La Patrie*, who cannot be accused of the weakness of a leaning towards English arts or artists, says,— "It is impossible better to convey the impression of the undefined vastness of the sea, or a calm summer evening, just when the last rays of the sinking sun fringe with gold the clouds that gird the horizon. A deep shadow already wings its way across the waters, and a ship—the burst of smoke from the porthole of which tells the discharge of the evening gun—shoots up with the clear sky, the regular skeleton of its masts and yards. The ship seems to sleep upon the waters, like the vague silence brooding over it. The 'Evening Gun' is a picture, the poetry of which is perfect from its truth. We are not surprised that it should have been considered a *chef-d'œuvre*."

Again, the *Moniteur* thus harmonised with its contemporary:—"Mr. Danby's 'Evening Gun,' is, in one word, a *chef-d'œuvre*. One could scarcely imagine a picture so poetical. There is in it a tranquillity, a silence, a very solitude, which leaves a deep impression. Never has the solemn grandeur of the liquid element been more touchingly expressed."

Monsieur Maximo Du Camp coincides. In his notice of English art, at large, after having commended in it the over-elaboration of details to which he considers sentiment and general effect to be sacrificed, he thus educes Mr. Danby's "Evening Gun" as a marked exception. We give but the opening and concluding sentences of his critique, the intermediate portion being but an elegant description of the scene depicted.

"*Tous ne sont point ainsi cependant, et quelques-uns ont su marier dans une belle mesure l'exactitude de la facture et la largeur de sentiment; nous citerons comme exemple, Le Canon Du Soir de M. Danby.*"

He thus closes:—"Il y a dans cette composition une poésie réelle, qui réjouit d'autant plus qu'elle est peu commune dans les productions de l'art anglais."

Let us now, before showing how the jury of the department of painting in the *Beaux Arts* have dealt with Danby, make known their judg-

ment on a French artist who pursues the same route, the poetic, *longo intervallo*;—we allude to Monsieur Gudin. Five-and-twenty canvases of this prolific hand stretched many a rood over one quarter of the Palais. They all presented imaginative effects in and on all the elements; but their prevalent treatment was crude and of the scene-painting school. This can be more easily understood when it is stated that when, in Louis Philippe's time, the walls of Versailles were to be covered with epic in a *clin d'œil*—the work of a century, or more, to be improvised in a day—to M. Gudin was entrusted the throwing-off of the historic glories of the French navy.

In reference to his merits Monsieur Du Camp thus writes:—

"At the present day there are but four marine painters in France: M. Courdoun, who has talent; M. Moral Fatio, who has none; M. Zienn, who has still a portion left; and M. Gudin, who is exhausted. Like a child that, changing a *louis d'or* for a lot of copper, thinks itself the richer from the increase in the number of its coins, so M. Gudin, who might have produced some twenty commendable pictures, has preferred associating his name with five hundred that are bad. He is at this moment irremediably lost, and I know not whether some of his earlier works, upon which he has piled up such a mass of mediocrities, will suffice to rescue him from oblivion."

How then have the jury disposed of Gudin and Danby?

M. Gudin has all the honours of the *first class medal*. But, Danby, has he been crowned with those still higher?—By no means. Has he then been made the colleague in *Class I.* with M. Gudin and some forty-eight others?—No. He joins, then, some fifty-one in *Class II.*—No. In *Class III.* with its illustrious fifty-seven? Again,—No. In a word, Mr. Danby, with all his merits on his head, was flung over into the *mêlée* of mediocrities, 157 in number, who are consoled or hest with the word *Mentions Honorables*. Is it not ludicrous! or, as says the classic satirist, *Risum tenentis—amici?*

Strange as this parviding of the poet of our painters may be, it is not more so, than the total omission of Mr. Linnell's name from any one of the five lists of the medallists, or the honourably mentioned. In his works we have been accustomed to recognise a vigour and a freshness allied to, without imitating, some of the best of the old golden times. In one small landscape of his five exhibited on this occasion, these in both colour and handling were finely concentrated. Mr. Creswick's admirably painted picture of "Passing Showers," was a faithful and finely worked-up reflex of nature, from which the French landscape painters, who, as has been fairly avowed by their own writers, owed to the English School a reformation from dry artificial style to something akin to reality, might, even in these, their palmy days, have taken a useful hint, was wholly ignored. We cannot accept the award. Nor, again, its repetition in the cases of Cope, Dyce, and Herbert. The French critics have, in their notice of the *Beaux Arts* on the late occasion, affected a facetious surprise at the abnormal novelty of the British School of Painting, and they would seem to have communicated the spirit of their jest to the gentlemen of the jury. This alone would make us notice the absurd *jeu d'esprit*. Of the idiosyncrasy of the British School we are willing to make Mr. Mulready the test, who brought the vigour of an untrammelled genius into communion with the great spirits of the by-gone times, and while he toiled unweariedly to emulate their excellence, never sacrificed his own originality. If he differs startlingly from Meissonnier, it is no more of a perplexing contrast than that of the delicate effeminacy of the same Meissonnier with the rugged mastery of Rembrandt. It assuredly is not the originality of our artists, with which we shall quarrel—whatever other sins they have upon their heads. Better the freshness of their independence, which gives us at intervals such men as Hilton and Wilkie, Calcott and Turner, Mulready and Danby, than that they should be schooled even in the studios of Paris, to be the tenth transmitters of some great old masters' worn-out style.

Something of the same feeling on the part of French critics and artists in reference to British sculpture may perhaps account for the discretion of judgment which gave the name of MacDowell to the fourth class, or *Mentions Honorables*, in company, to be sure, with the only other five British sculptors, who have the honour of a recognition in the late *concours*. Mens. Maxime Du Camp is one of those bold thinkers in France, who dread the utter decay of sculpture from its over straining after the Greek model, which was no artificial elaboration, but the spontaneous emanation of a peculiar time, a peculiar people, and peculiar, long-abandoned modes of life. He feels that the art should aim more strenuously than it has done at a sympathy with the present period. If any works have come from marble which might be said eloquently to illustrate this theory, they are those of MacDowell. "The Girl reading," and "The Girl preparing for the Bath," which were in the late Exhibition, were fine examples of the new school. They quite exquisite beauty of expression with lovely form, familiar grace, and a most delicate elaboration of drapery. That these should have been dispensed into a fourth class, while in Class I. is placed what is little better than a copy of an antique dancing fawn; and in Class III., a bust by Count Nieuwerkerke, one of the jury, and moreover Director of the *Musées Impériaux*, seems to us, in the full meaning of the well-known emphatic comment "too bad." That the "Ulysses" of Macdonald, the "Boy at the Stream" of Foley, the "Beatrice" of Hancock, to say nothing of Bailey's "Even," and Gibson's works, were not estimated as they merited is much to be regretted. On the other hand, it was gratifying to find a public recognition of the beauty of Lawlor's statue of "The Bathing," which was exhibited in Hyde Park in 1851, without, we fear, being thoroughly appreciated. It is a work that ought to be the forerunner of many fine things. Would that it had been seen here in the marble!

Let us not conclude without expressing our hope of having fairly estimated the vast interest which the late *Exposition Générale des Beaux Arts* was entitled to claim. It was wholly unprecedented, and realised a congress of art of wonderful extent, and unanticipated attractions. It was a revelation, on the whole, most satisfactory, of the state of Art, and the merit of artists throughout Europe, and a trifle beyond. It was well calculated to excite a noble emulation, and give a great general impulse to the progress of the one and the estimation of the other. It was a first experiment, and had defects and defaults, such as might have been expected under the circumstances. Let us hope that, at no very distant period, a repetition may be undertaken with more completeness of organisation, a more even balance of direction, and less ground for the untoward excitement of jealousy. Even at the best, there must be found some alloy to the great sterling ore of which, on such occasions, we become partakers. Still—even still, as in days of Horace, his words are but too true,—

"Nihil est ab omni
Parte verum."

CORRESPONDENCE.

To the Editor of "THE ART-JOURNAL."

THE MEMORIAL OF THE GREAT EXHIBITION OF 1851.

SIR,—Now that we are beginning a new year, and the stores of manufacture and the marvels of industry are moved, or on the move, out of the Great Paris International Exhibition; and the monsters of machinery have been taken piecemeal—bone from bone, and limb from limb in the sun-dryer; and the pictures and the sculptures are packed up and nailed down in their temporary coffins for transit to their homes; and the plaster palace of the *Beaux Arts* is about to subside into its primitive elements and "leave not a wreck behind;" and now that the other exhibitions, also international and universal, have had their day and are past; and the cycle of universal international exhibitions may be said to have performed its orbit and its mission for a time, and a lull has taken place in such matters, which is likely to last at least some

few years—is it the time to forget what the Persian would call "the grandfather of all the great international exhibitions?" I mean, of course, the Great British Exhibition of '51; which, working its way, as it did, wholly without precedent through unexampled and unexpected difficulties, yet has been the only one thoroughly triumphant. Never did an expedition reach port safely through a greater series of dangers than that scheme of '51! Rocks and shoals of all sorts lay in its way, and yet miraculously it escaped all these dangers, manifest or hidden, and came into port with a full cargo and plenty of passengers—to the very day appointed—with the royal flag at the main! Is this, I say, the time to forget the Great Exhibition of '51? or is it not rather the time most particularly to remember it?

That scheme, so successfully carried out, will always remain an historic fact of great interest and of great honour to these Isles. With all the advantage of it as an example, its children in Dublin and America, and lastly, in France, have sought to imitate and surpass it; but in vain; and it may be said to be like what Milton says of our first mother,

"The fairest of her daughters, Eve."

Having now likened the Great Exhibition of '51, firstly, to a grandfather; and secondly, to our first mother, I have certainly gone far enough in lay-bole, and will come precisely to what I mean! and the subject of this is, the *Memorial* of the Great Exhibition of '51, which, after the close and removal of the building was proposed and set afoot, and for which a large number of subscriptions were received,—but of which we have not heard one word for a long time, at least I have not, and I was a subscriber of my mite in aid of what I thought a worthy project. I have just been refreshing my mind with respect to it, by reading an article which appeared in the *Art-Journal* of last year, and find by it that at the time it appeared, viz.: July, 1854, (that is, nearly a year and a half ago) a large sum had been at once subscribed. "7,000*l.*" the article says, "flowed into the hands of the committee of the Memorial without much effort on their part." The article, in addition, contains some remarks in which it combats a diversion, that was suggested, of the funds to another purpose. With those remarks I quite coincide; for if we are to have public memorials at all, what subject can we better choose to celebrate, than the great commercial, historic, artistic, and friendly event in question? "If good deeds" you say, "and great events, having a lasting influence on the condition of large communities, are worthy subjects for public historic memorials, then was the project for erecting in Hyde Park, on the site of its existence, an historic and artistic record of the International Exhibition, an appropriate and worthy thought."

It is a natural question after this lapse of time, what is the fate of the project? To which may be added, and what have become of the subscription? The space formerly occupied by the exhibition is now a broad open green sward in Hyde Park, close to Kensington Gardens. There is no artistic decoration in either of those places besides the Achilles, except perhaps the Coalbrook Dale iron gates that were given to the crown by that firm. Not a specimen of Art besides these is visible within those beautiful pleasure grounds which in any other country would long ago have been enhanced, not only with vases and mere decorations but with artistic works of a high class. Could we begin these with anything of nobler association than a suitable record of the Great Exhibition?—people ask, "Where was the Great Exhibition?" No doubt there should be something to show them where it stood—say, on the spot occupied by the centre of the building. And that something should be instructive as to the nature and history of the event it celebrated, and be worthily adorned with such visible adjuncts as should best convey this to the mind and eye. All classes of people come to Hyde Park and Kensington Gardens for healthful recreation, and therefore in a more fitting state of mind for doing justice to a fine monumental work and the subject it may illustrate, than if it were placed amid the busy hum of business in a crowded thoroughfare where people are rushing by to keep appointments and have no time for other thoughts than those of business.

Thus the occasion and the site, and the fostering to appreciation of art in the country, all point to a fitting memorial in High Park to the Great Exhibition of '51. It was for this that the supporters of the project subscribed, and this they think probably, at least I do, they should live to see carried out. If there has been or now exists any real idea to divert the funds subscribed for this purpose to another object, I should, for one, like to have my mite returned. There are plenty of objects to which one might like to apply it, as the patriotic funds for the poor widows and orphans of our brave

soldiers, or to celebrate virtue and energy, and do good at the same time, by applying it to the Nightingale Fund, without putting it in one's own pocket again; but I confess I should like to have a voice in the matter.

Now, it might be said I might have written all this to Alderman Challis, who so worthily put himself forward in the project in the first instance, and not to the *Art-Journal*. But, in the first place, I presume that I do nothing in thus mentioning a public subject that that gentleman would feel a moment's displeasure at, and, secondly, as I should think other subscribers to the scheme may have similar views with myself, I take the advantage your kindness may afford of thus recurring to the subject through the pages of your widely circulating journal.

I am, Sir, &c.

A SUBSCRIBER TO THE GREAT EXHIBITION OF '51 IN HYDE PARK.

[We have thought it right to insert this letter, with a view to draw attention to the subject; we believe, however, a very large proportion of the subscriptions were "promises;" but certainly those that were paid ought to be returned.—Ed. A.-J.]

GORREGGIO'S "READING MAGDALENE."

SIR.—You would place me under considerable obligation by clearing up some doubts relative to the celebrated composition of Correggio, "The Reading Magdalene." We are aware that Augustus III., King of Poland, Elector of Saxony, became the possessor of an undoubted original picture by Correggio of this subject, at the cost of 6500*l.* Considering the size, this is, up to the present time, the largest sum that has been paid for any painting. After the king's death, this picture was removed to the Gallery at Dresden, from whence it was some time after stolen. It, however, was, we are informed, recovered, and replaced in the gallery, and the picture now at Dresden is said to be identical with the stolen one,—but this is all matter of doubt. And what shall be said relative to the same composition, attributed to Correggio, in Lord Ward's assemblage of pictures? We are told that he paid 1600*l.* for it—surely rather a singular price, for if it be an original by Correggio, it must evidently (bearing in mind the price paid by the King of Poland) be worth four times 1600*l.*; and if it be not an original, it is not value for a sum much above 1600*l.* Truly, the mysteries of picture-dealing and picture-dealers are inscrutable. Perhaps, Mr. Editor, you can illuminate the subject in question—if not with the broad daylight effect of Baboons, at least with the partial gleam of Rembrandt. ARTHUR VINCENT TIDEMAND.

50, UPPER BAGGOT STREET, DUBLIN,
Dec., 1855.

[Perhaps some of our readers can give our correspondent the information he desires, for we confess ourselves unable to assist him.—Ed. A.-J.]

ADOLPHUS TIDEMAND.

SIR,—Your readers may, perhaps, be interested to hear something of the most famous painter in Norway, and I therefore place at your service a few lines concerning him. The first pictures that met one's eye on entering the Exhibition here were those of Tidemand. I had seen something of his in New Bond Street once, a funeral on a Norwegian lake (now in the possession of Lord Lansdowne), and was prepared for great artistic power; but here his sincere and serious religious feeling made one forget Art altogether—that kind of feeling that affects one so in "The Cottar's Saturday Night" of Burns. Tidemand's most touching picture here was a funeral gathering, not on a lake this time, but in a lowly cottage. The resigned and utterly mournful face of the young widow, leaning on the shoulder of her mother—the unconscious peace of her sleeping, fatherless child—the solemn faces of the mourners round the table whereon the coffin stands, with the candles burning on it, and the words of prayer from the lips of the old man floating around it, in the dim light of the darkened cottage—the floor strewn with scattered leaves of fir—give to this picture that rarest quality of true, deep, unaffected poetry, of which I know no parallel example in English Art but "The Shepherd's Chief Mourner" of Landseer. It is well for Tidemand that he can see what lies nearest to him, for with these rusticities he has reached the hearts of princes, and now returns northwards with a Medal of the First Class and the Legion of Honour. I have spent a day with him here; he had never seen any English pictures before, except one or two of Wilkie's, and I felt proud to conduct him through our collection. It would be unfair to repeat his criticisms, but they were thoroughly honest, and

quite unaffected by mere reputation, for he scarcely knew the names of the famous painters. He enjoyed Mulready, Webster, and Leslie most; but "The Order of Release" was more in accordance with the depth and sincerity of his own genius, and we stood a long time before it. He thought Lewis wonderful in his details of still life, and successful in expression, but the fierce, brilliant, white light of the "Harem" affords an opportunity for such powerful chiar-oscuro as his own, and I scarcely think he agreed in my excessive admiration of this drawing. The engravings from Landseer had led him to expect so much, that the pictures disappointed him—a common case. The lonely deer by the lake, and Macle's large baronial interior, I was a little ashamed of; both these pictures will always look best in black and white. Fildemann was greatly interested in our engravings, and in the history of Art in England. I feel quite certain that if his own works were well engraved, they would be extensively purchased by us. I think his works, if studied by our younger painters, would have a very beneficial influence on the feeling of English Art, they are so full of true pathos and tender regard for mankind. The best proof of their excellence is that I have never thought of their technical qualities till just now. I have no room left to discuss them, and it does not matter.

PHILIP GILBERT HAMINGTON.

HOTEL DU LOUVRE, PARIS, Nov. 15.

ART IN CONTINENTAL STATES.

PARIS.—The distribution of prizes has, as might have been expected, caused much dissatisfaction; old tried and talented artists have been totally forgotten, while others of very inferior merit, but well protected, have received large honours. Ingres and his school are outrageous to see him placed on the same rank as De la Croix and Landseer; although many good judges think one little "Doggie" by the last, worth more than all the productions of Ingres. One of his pupils said to the writer, "They ought to have invented a special honour for this great master."—The artists in general are reposing on their laurels, or busy getting home their works; and little is talked of except a project, said to be nearly decided, of abolishing entirely the annual exhibitions, and having a permanent one in the new buildings of the Louvre: the idea is good if carried out in a proper manner. Thus there would be a constant *salon*, continually renewed as the painters finished their paintings, and the hurry occasioned by being obliged to be ready by a fixed day would be obviated.—Great part of the scaffolding has been removed from the Louvre, and disclosed two pavilions of a most magnificent description; it will be a splendid pile of buildings.—A statue of Monseigneur Affre, Archbishop of Paris, has been erected at Rodez; it is by M. A. Barre.—The Exhibition at Vienna, in 1859, is not to be universal.—The season of sales is begun, and they are carried on with spirit; the collection of pictures and bronzes belonging to M. Bertrand, produced 65,000*fr.*—An interesting sale of objects of *vertu*, containing among them many curious and rich Oriental articles, collected by the General Ventura, has taken place; the objects in general sold high. The taste for articles of *vertu*, bronzes, and paintings seems to be on the increase; added to which, the facility of communication with the great collecting country, England, gives a zest to sales unknown only a few years back.

U.M.—At the recent congress of Art-dilettanti held here, many of the questions were lightly interesting. Those relative to works executed in Swabia, before the time of Van Eyk, have remained unanswered. The 23rd question was more interesting to English artists and patrons of Art than any of the others. It was—"What were the last results of the inquiries relative to the family of Holbein and their works before the migration of the younger Holbein to England?" Herr Eigner has the merit of having discovered a number of works, which, according to the signature, have been executed by one Hans Holbein (or Holbein, according to the inscriptions), who could neither be the younger Holbein, nor his father, and who has therefore been designated "Grandfather Holbein." Eigner's view has been adopted, from the unmistakable difference between the works, which distinctly show three different manners. But Herr Herberger, the keeper of the archives, adduces evidence against the suppositions of Eigner, showing that in Augsburg, in 1460, there was one Michael Holbein, a fellmonger and householder. In the same house resided Thomas Burgkunder, in 1493; and in 1494, Hans Holbein, the painter, who, after 1496, became the possessor of the house, in

which lived also his mother, the widow of Michael Holbein. From 1502 till 1504, his brother Sigismund's name appears, and his own is continued until 1517, when he became a citizen of Basle. Before the year 1495, the name of Holbein does not appear in the register of the guild of the painters of Augsburg; but in 1524 his death is mentioned, although absent. It would thus seem that a better foundation than that of Herr Eigner is necessary to maintain the grandfather of Holbein in the position of a painter, as attributed to him. It may therefore be supposed that the Hans Holbein who, in 1499, painted "The Coronation of the Virgin," and the "St. Dorothea," in Augsburg, is not the same as painted "The History of St. Paul" in 1502. In the painters' book no second Holbein is mentioned; nor is there a third, although such a one was very active as a citizen of Augsburg. In pursuing the inquiries relative to the early state of Art, it was elicited that glass-painting in Swabia was by no means in a satisfactory state, even though it was well advanced in other countries.

ERBENHARTSTETIN.—A colossal statue of the late King of Prussia is about to be placed on this celebrated Rhine fortress; the present king having given a commission to Johann Hartung, the sculptor, to execute it in bronze. One of the finest works of Herr Hartung is the group, in marble, emblematical of the "Rhine and Moselle," which stands in the gardens of the royal residence, at Coblenz.

ROSEN.—The *Athenaeum* informs its readers that the Queen of Spain has presented two valuable pictures, by Murillo, to the Pope. The subject of the chief picture is "The Marriage of St. Catherine," which always hung in the queen's bedroom. The other picture represents the "Prodigal Son," the same subject as the picture one belonging to Marshal Soult, and now in the Sutherland Collection. The Pope has had the pictures handsomely framed, with inscriptions commemorative of the donor. They are placed in the Museum of the Vatican.

HANOVER.—On the north-west of the city of Hanover there is an extensive and beautiful park, surrounding the palace of Herrenhausen, and was in a retired spot in this park that King Ernest Augustus in his lifetime caused to be erected for himself a mausoleum after the design of that at Charlottenburg, by Schinkel. Thirteen years ago, one of the noblest of Ranck's works was placed there—the statue of the late Queen Frederika. A cast of this work is to be seen in the atelier of the artist, showing it to be a worthy pendant to that of Queen Louise; and now the artist has completed the marble monument of the king, which is destined for the same place, and is about to be transported thither. The monument has already been briefly described in our columns, but it may not be superfluous to say a few words on the sentiment of the artist's production. In such works he does not treat a representation of death as eternal—there is an allusion to life; nor in the monuments of the living is there a description of activity without an allusion to repose. Such is the spirit of the present work, and it must be confessed that as an evidence of the maturity of artistic power and exalted feeling, it will take a high position among the modern productions of its class. The base of the monument is in the form of a simple sarcophagus, with but little architectural ornament. At the four corners are four angels; those at the head are praying, and the two at the feet are singing—charming figures, relieving the severity of mathematical proportion by an expression of everlasting life. The polished marble of the architectonic parts of the composition contrasts most favourably with the more animated character of the figures. On one side of the sarcophagus are the initials of the king, E. A. R., and on the other the white horse, the heraldis type of the house of Hanover.

VIENNA.—The designs for a new National Bank and Exchange, the competition in which is limited to artists of Vienna, have been exhibited. The building is to be erected in the Herrngasse, the proposed site communicating with two other streets, the Strauchgasse and the Freyung. The building will comprehend an exchange, a bank, a coffee-house, and other departments for the transaction of monetary business. The directors of the bank have done well to limit the competition to the artists of Vienna, one of whom Van der Nüll and Sicardsberg, Ferstel, Hans Forster, Romano, Bergmann, Kornhäusel, Winder, Baumgärtner, and Fellner have responded to the requisition. The designs exhibited speak most favourably for the talent of the architects of Vienna; especially those of the two professors, Van der Nüll and Sicardsberg, who have worked together, and that of Ferstel. These plans, one of which will surely be adopted, are masterpieces in their department of art.

CUPID AND PSYCHE.

FROM THE BAS-RELIEF BY J. GIBSON, R.A., IN THE COLLECTION OF THE QUEEN.

It is a question not hitherto determined whether *basso-relievo*, or sculpture of the round figure, is the more ancient art: in the earliest records of history we read of "graven images," by which is generally understood perfect representations of living things; but, on the other hand, as the sculpture called "*basso-relievo*" formed a component part of the architecture of the oldest nations whose history has come down to us, it seems more than probable that the origin of both is coeval. The art of ornamenting their buildings with bas-reliefs was most extensively practised by the Egyptians, who covered almost the entire front of their edifices with these architectural sculptures, in compartments rising tier above tier, mostly cut in low relief, and some of them also frequently in *intaglio*, that is, cut into the surface of the stone, instead of projecting from it; this sculptured work generally presented a combination of figures and of hieroglyphics.

The Greeks brought this Art to the highest state of perfection; they, it has been remarked, "as a general principle considered the ground of figures in relief to be the real wall, or whatever the solid plane might be, and not to represent air as if it was a picture. The art with them was thus rather the union of sculpture with architecture than a union of sculpture with the conditions of painting. Although we can never expect to see the works of those great artists surpassed, or even equalled by later sculptors, yet it cannot be denied that the moderns have, by the application of the rules of perspective, introduced a wider scope for the representation of the picturesque. It is not supposed by the best authorities that the elder Greeks were ignorant of the principles of perspective, either as applied to painting or sculpture, but rather that the absence of it in the latter art, in their *relievi* works for instance—we have no opportunity of knowing what their painters did—arose from the conviction that perspective would be misapplied to sculpture. The Roman sculptors, or rather the Greeks who practised the art in ancient Rome, very commonly applied perspective to the ornaments of civic architecture, as we find buildings and other objects introduced behind the figures, "thus approaching the spurious style of relief in which the effects of perspective are attempted to be expressed;" various specimens of such works may be seen in the British Museum.

We are chiefly indebted to Flaxman for the revival in this country of a purer taste in the application of *basso-relievo* to architecture: his designs are founded on the best models of the Greeks. Our most distinguished living sculptors rarely execute works of this kind, except for monumental purposes, mainly, we presume, because the demand for it is so limited either for public or private buildings: Mr. Gibson, however, in the group he executed for the Queen, has produced a work of singular grace and beauty.

The fable of Cupid and Psyche, related by Apuleius, has often afforded subjects for our artists and poets; of the latter, the poem by Mrs. Tighe, an Irish lady, who died in 1810, is by far the best that has been written: it is in six cantos, and is characterised by a richness and brilliancy of colouring rarely excelled. This poem is not so widely known as its merits deserve.

Frequently as Cupid and Psyche have separately been represented by sculptors, we do not recollect to have seen them grouped together; Mr. Gibson has, however, produced a composition which inclines us to believe Mrs. Tighe's poem must have fallen into his hand, so luxuriously has he rendered the subject. The arrangement of the two figures is most harmonious in the disposition of the lines; the figure of Psyche is exquisitely graceful in pose, and beautifully modelled; while the foreshortening of the lower limbs and the high relief of the entire group would favour the idea that the sculpture is executed in the round, rather than on a flat surface.







PSYCHE AND CUPID

FROM THE ENGRAVING BY J. G. COOPER, 1801.

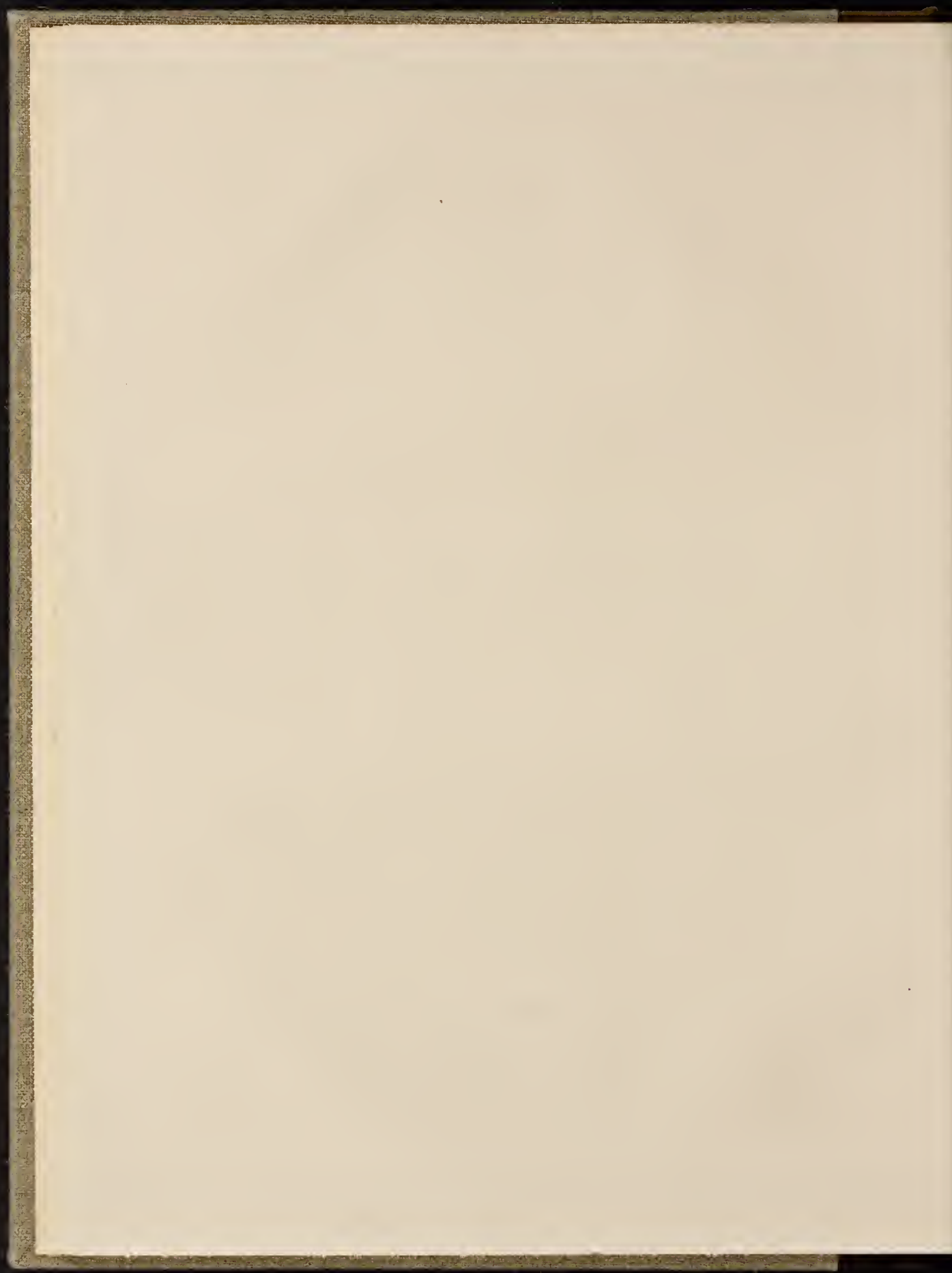

THE COUNTRY OF CUYP.

BY F. W. FAIRHOLT, F.S.A.

WITH ILLUSTRATIONS FROM ORIGINAL SKETCHES
BY THE AUTHOR.*

If the accepted characterisation of a nation's felicity, conveyed in the well-known aphorism, "Happy is the country whose history is a blank," may be equally applied to individuals, then may we safely conclude that the old Dutch painters were among the happiest of the sons of Adam. Their lives were generally so entirely void of what playwrights term "incident," that we know little more of them than is conveyed in the three facts—that they were born in Holland; painted in the land of their birth; and were buried very little distant from the spot on which they were born. Contented with the calm monotony of their native land, they studied its narrowed sphere with so intense an application, and delineated it with so much truthfulness, that they imparted a charm to incidents and scenes the most unpromising, and arrested the attention of connoisseurs absorbed in the grander flights of Italian Art, compelling by the innate merits of their work, a place of honour to be assigned the Dutch School, as a creation, *sui generis*, among the honours of "the world of Art."

It is with national painters as it is with national poets, they suffer by translation. It is not possible fully to appreciate Dutch Art without visiting the Low Countries. It is not possible fully to feel the beauties of a national poet, unless we put ourselves in the position of his countrymen, and learn to understand the similes he brings from familiar objects, and appreciate their force upon the native mind. The *Ranz des Vaches* may be played in our streets without any other notice than its quaint or pleasing melodic clics; but its tones had so many home-associations for the Swiss soldiers of the armies of Napoleon, that after hearing it they deserted in such numbers as to oblige their imperial master to prohibit it in his camp. The golden sunsets of Cuyp, and the rich green meadows of Paul Potter, can be fully appreciated by any admirer of nature; but the quaint peculiarities of Dutch Art—its low, swampy landscapes, sometimes varied by ridges of sand, always abounding in water and sky, with a low horizon, having at times an unnatural look; its cottage roofs scarcely peeping above the raised causeways so laboriously constructed for necessary transit; its stunted willows and avenues of limes; its luxuriant herbage; its thousands of windmills; its well-fed cattle, and equally well fed peasantry, are all so many truths, the more forcibly brought to the mind in travelling over the land whose painters have fixed them on canvas for ever, and made them familiar to the whole world.

One instance of this is as good for the purposes of illustration as a hundred would be. In the skies of Wouvermans particularly, we constantly see the bright blue partially obscured by a group of clouds of a perfectly smoky tint—a deep rich brown, totally unlike cloud tints among ourselves, and bearing a disagreeable similarity to our native horror, a "London fog"—now, this is as true a transcript of a Dutch sky, as Ostade's boors are faithful portraits of his countrymen; and it is impossible to be some hours in Holland without seeing the perfect honesty of many other points in their delineations, which might be considered tasteless or unnatural by the critic who judges at his own home. It, therefore, follows that peculiarly national Art can never be fully appreciated out of its country, or by persons who are not familiar with its features; and it also argues the extraordinary abilities of the native artists of the Dutch school, who could, out of such unattractive and unpromising materials, create a position now universally accorded them, antagonistic as it is to the classic and spiritual schools, which alone were considered to be worthy of attention

* This, and other papers to follow, on the subject of Holland and its artists, are the results of a tour through that remarkable country, recently undertaken by Mr. Fairholt, during which he made many notes and sketches for express publication in this Journal.

in the days when it first came fresh upon the world. It was truth again a victor!

Leslie, in his sound and sensible "Handbook for young Painters," has excellently explained this. He says—"Italy is sometimes called 'the land of poetry';" but Nature impresses the varied sentiments of her varying moods as eloquently on flat meadows and straight canals, as on mountains, valleys, and winding streams; and visits the mill and the cottage with the same splendid phenomena of light and shadow as she does the palace. This was well understood by Cuyp and Ruysdael, and their most impressive pictures

are often made out of the fewest and the simplest materials. There is a small sunset by Cuyp in the Dulwich collection. It has not a tree, except in the extreme distance, nor scarcely a bush; but this has one of the finest skies ever painted, and this is enough, for its glow pervades the whole, giving the greatest value to the exquisitely-arranged colour of a near group of cattle, bathing the still water and distance in a flood of mellow light, and turning into golden ornaments a very few scattered woods and brambles that rise here and there from the broadly-shadowed foreground into the sunshine."



THE GRAND CANAL, NEAR DORT.

Albert Cuyp was born at Dordrecht (or Dort, as it is usually abbreviated) in the year 1696. It was the year that also gave another of its greatest artists to Holland—the profound master of light and shade, the "gloomy Rembrandt." The father of Cuyp was a landscape painter, but Jacob Gerritz Cuyp never raised his works above a quiet delineation of nature, the simple repose which might satisfy his countrymen, but would never lay claim to attention out of Holland; it was reserved for his son to give poetry to this prose, and by patient stages to work upward to greatness, and slowly to fame;—so slowly, indeed,

that death arrested the painter's hand ere he knew the value the world would put upon his labours. In his own time his works can scarcely be said to have been appreciated, and we have no record of even fair prices being given for them; indeed, it is asserted by one of our best authorities,* that down to the year 1750 there is no example of any picture of Cuyp's selling for more than thirty florins, which is about five shillings less than three pounds in English money. How would the worthy painter be astonished if he now saw his works fetching from 500*l* to 1000*l*. each, and sometimes more!



VIEW OF DORT.

It is another proof that the intellectual work for posterity; it is the great gift of genius alone to arrest the oblivion which generally follows in the footsteps of time, and reversing the order of decay, rise triumphant over its common laws.

Cuyp was born in stirring times, when his countrymen were actively engaged in resisting the oppression of Spain. They had not been permitted to enjoy peacefully the unenviable swamps of Holland, or the simple faith of their fathers, without a struggle unequalled in the annals of history. The bloody Alva, that fierce and inhuman protector of the Roman Catholic

church, had murdered its men in cold blood, at Leyden and elsewhere, after guaranteed submission to his arms, and their surviving countrymen had seen that Spanish oaths were as fragile as reeds; so, after losing the best men of their race, and laying their country beneath water, enduring horrors and miseries which might have been thought impossible among civilised men, they established at Dort a synod which opposed further attempts successfully, and ultimately gave independence to the Dutch.

* Smith, "Catalogue Raisonné."

Dort at this time became the important centre of political negotiation, and here the Stadtholder had his residence, and met those men from whose councils were framed the general independence of the country.* Here resided Barneveldt, one of the purest patriots in an impure age; and here was he arrested and carried to the Hague to die on a scaffold, sacrificed by the very people he had served so well, and who were blindly

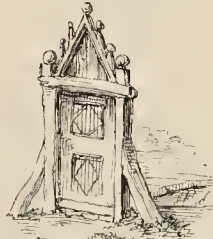

A DUTCH FARM-GATE.

misled by their treacherous Stadtholder, Prince Maurice. At this time Cuypp was thirteen years of age, and must have been in the way of seeing and hearing much of an exciting kind; indeed, excitement of the strongest was at that time abundant in Holland. Home miseries were, however, succeeded by great successes abroad, and the trade and wealth of the country gradu-



HAY-STACKS.

ally grew in spite of savage internal dissensions, until the peace of Munster, in 1648, gave over-taxed Holland free leave to recover itself; but they had again the misfortune of a bad governor in William II., who embroiled the country in party war; his death in 1650 once more seemed to promise peace, but growing dissensions arose between England and Holland, and Blake and



A STORK'S NEST.

Van Tromp fought for each country at sea. The death of Van Tromp in 1652, and the gloomy

* The island on which Dort is situated may be called Holland *proper*, inasmuch as historians inform us it was one of the first settlements made by its earliest ruler on this district, once submerged by the sea, and to which the name *Holt land*, or wooded land, was applied. It thus casually formed a bit of unclaimed land, which gave Count Thierry, who had seized it, a right of independent sovereignty in the eleventh century, which he vigorously upheld, and assisted surrounding districts in doing the same. The water about it is still called *Hollands Diep*.

prospects of their trade, induced the Dutch to again apply for peace to Cromwell, which was obtained from him at so inglorious a rate, that universal discontent and rebellion spread throughout the republic, and increased into a flume during the early part of the reign of our Charles II. The Dutch were aided by Louis XIV., only to meet with his strenuous opposition on the death of Philip IV. of Spain, at a time when the people might have fully expected repose, and a formidable aggression on the part of the French army forced them once more to internecine war; the sluices were again opened, the country sub-

merged to destroy the invaders, and extensive tracts of land, which had occasioned years of persevering labour to protect against the sea, were reduced to barrenness and desolation. The murder of the De Witts in 1672 gave the whole power into the hands of the young Prince of Orange (afterwards our King William III.), who, by his admirable judgment, unflinching courage, and pure patriotism, raised his devoted country from the dust.*

Cuypp lived quietly through all this. The year of his death has not been recorded, but it was certainly after 1672, as his name appears in a



A DUTCH ROAD SCENE.

list of the burghers of Dort made during that year; and one writer, Immerzeel, of Amsterdam, states that he was living in 1680. Man and his wars of policy and religion appear not to have affected his calm course. His Holland was not the Holland of feud and dissension, but the calm home of the peasant living happily among flocks and herds in genial sunshine.

"His soul was like a star, and dwelt apart."

His world was nature, without the baser elements introduced therein by man; repose is his treasure; and his own quiet temperament is

reflected in his portraits, glows upon his canvas with a warmer radiance, and elevates the scenes he depicts with a poetry that scarcely belongs to the country itself. It may be asked, where, amid all this flatness and apparent monotony of scene, did Ruysdael study his romantic waterfalls, or Cuypp his hilly landscapes? The former must have dealt at times in the imaginative, but Cuypp might readily have strolled from his native Dort into the province of Guelderlandt, and been among scenes as far removed from general flatness as he ever depicted. With his dreamy love of nature, he must have gladly escaped the poli-



THE VILLAGE OF ROOSENDAAL.

tical and religious dissensions which agitated that city in his time, returning to it only as to a workshop wherein he might elaborate his sketches made in the peaceful fields, and dispose of them at a moderate rate among his less happy fellow-townsmen. His patrons are not generally known, with the exception of Prince Maurice of Nassau, who was attached to his pictures. It is quite possible that the painter's life was expensive and unambitious; his pictures would appeal directly to his fellow-citizens and their neighbours; and his moderate wants and wishes be amply satisfied by the small amount of

patronage they could offer, yet enough for his small wants and pleasant dreamings as a free man in his native fields.

The visitor to Dort will now see a very different city to that Cuypp inhabited; it has under-

* It is recorded of him, that when the proposal was made to him of constructing Holland into a kingdom, of which he was to be sovereign, provided he gave up to England and France what they required, and his consent were because nothing could save Holland from ruin, he heroically refused, declaring "There is one means which will save me from the sight of my country's ruin—I will die in the last ditch."

gone changes, but many of the old buildings remain. As he approaches it by the steamboat from the Moerdyke, he will be struck by the peculiar aspect of the grand canal. It is walled by dykes, constructed most laboriously of earth or clay, and interwoven with a wicker-work of willow-boughs, which has to be continually renewed as it rots away. This accounts for the great cultivation of willows in Holland. The long lines of trees which edge the road on the



A WOODEN SHOE.

summit of the dykes have also their uses, irrespective of the pleasant shade their bowing foliage affords, for their roots assist in holding the earth together. So careful of these dykes are the inhabitants, that in some places they will not allow a plant to be plucked by the roots from their sides, for there is record of a great inundation, accompanied with much damage, having ensued by such an act, which gave water-way to a banked canal, the small leakage thus occasioned having rapidly increased, and ended



A FARMER'S WIFE.

in a torrent which was fatal to the level land near it. The abundance of windmills that surround Dort plays an important part in ridding the land of superfluous water, which is raised from the low country by their means to the higher embanked canals, and thence carried out to sea when the tide will allow the opening of the great flood-gates. The amazing number of windmills in Holland may be accounted for by the fact that they are destined to do at least three times the work they do in other lands.



A HORSE-SHOE.

They not only grind grain of all kinds, as with us, but they are extensively employed in sawing wood, and still more extensively in drainage, the most important of all employments in Holland. Consequently, wherever there chances to be a rising ground, there a windmill is stationed, and their numbers are sufficient to have quenched the ardour of the knight of La Mancha himself, who must have considered Holland entirely peopled with giants, with whom his single arm could only hopelessly contend.

The traveller who, like Oliver Goldsmith's, would wish to see

"Embosom'd in the deep, where Holland lies,"

would find his quickest course by rail from Antwerp. As soon as he leaves that quaint historic city, he finds the flat land assume a different aspect to the flat lands of Belgium; it is damper and more arid, patches of sand and rushes occasionally appear, and the inroads of the sea in the old times are visible. By the time he reaches the frontier town of Roosendaal he will fairly feel that he is in another land. Here, while the most minute search is made by the government officials on the luggage of the

entire train, he may study the view before him, which we have faithfully recorded in our engraving, and which is as characteristic of the country generally as anything he will meet on his journey. The low sand-ridges in the foreground, with a few stunted bushes on them; the higher sand-hills crowned by a windmill; the housetops appearing from the lowland beyond, looking as Hood happily described them, "as if set like onions to shoot up next season;" the masts of the vessels mixed among all, indicating the presence of a canal in the marsh, too low to be detected, are all strikingly peculiar features of this unique country.

Holland being at a lower level than any land



DUTCH HEAD-DRESSES.

on the continent of Europe, has been reclaimed from the sea by an amount of labour, in the way of artificial ramparts against its continued encroachments, unparalleled in the world. Goldsmith has well described this:—

"Methinks her patient sons before me stand,
Where the broad ocean leans against the land,
And, sedulous to stop the coming tide,
Lift the tall rampire's artificial pride.
Onwards, methinks, and diligently slow,
The firm connected bulwark seems to grow;
Spreads its long arms amidst the wat'ry roar,
Scorns out an empire, and usurps the shore;
While the pent ocean hangs o'er the dyke,
Sees an amphibious world beneath him smile;
The slow canal, the yellow blossom'd vale,
The willow-tufted bank, the gliding sail,
The crowded mart, the cultivated plain,
A new creation rescued from his reign."

The necessary expense of this continued strain on the energies and wealth of the inhabitants, who have constantly to guard against the dangers by which nature has surrounded them, renders Holland a very expensive country for residence. The taxation in every way is immense, and with a national debt exceeding that of England, the people pay local taxes to a large amount, while personal property, even furniture, pictures, and prints, are taxed by yearly rates, increased as every trifle a man acquires in his home is increased; hence we find a sordid love of gain among the middle classes degenerating into downright cheating among the lower. The stranger visiting Holland must expect to be "shorn as a lamb," echoing Goldsmith's not very



THE VILLAGE OF BROECK.

complimentary lines on the Dutch, following those in the poem we have just quoted.

On reaching the Moerdyke and embarking in a boat winding among the large islands known as Overflakke, Beverland, &c., and which seem to have been formed originally by the spreading currents of the Maas (or Meuse) over the once sandy levels of the sea, the stranger will more fully understand the amphibious life of the Dutch:—

"A land that lies at anchor, and is moored,
In which they do not live, but go aboard."*

* Butler's "Hudibras."

With that strange love, born of early associations, a Dutchman seems to dote on the fetid canals of his infancy; and wherever the water is most stagnant, and the stench most oppressive, there he builds his summer-house, and goes in an evening to smoke his pipe and enjoy himself. How happily has Washington Irving depicted this abiding trait in his "Knickerbocker." The Dutchmen of America, true to their home pleasures, repaired to the dykes "just at those hours when the falling tide had left the beach uncovered, that they might snuff up the fragrant effluvia of mud and mire, which, they observed, had a truly wholesome smell, and reminded

them of Holland ;" but all this must have been only an approximation to the real thing, inasmuch as the smell of a genuine Dutch canal, when its fetid waters are only slightly moved by the heavy, slow-going barges, is something which exceeds description. Yet in these localities do we continually find gaily-painted pleasure-houses, rejoicingly inscribed with words over their portals, such as "Wel te vreden" (well-contented), "Gerustelyk en wel te vreden" (tranquil and content), and others all equally indicative of the content and happiness they produce to their owners.*

Nothing can exceed the vivid colours of the country houses we pass. The brightest of greens, the gayest of reds, the richest of blues cover their surfaces. They are generally separated from the road by the ditches which form a sort of net-work over the landscape, and the proper way of reaching them is indicated by a wooden door, regularly built up and standing alone—made, in fact, for making's sake—on the edge of the ditch. These advanced gateways are frequently seen in the pictures of Rembrandt, Teniers, and Ostade† You cross the wooden bridge and enter the farm. The pasturage, upon which so much depends, is stacked close by the house, and is generally built up round a strong pole, to prevent its dispersion in a stormy wind, which sometimes unmercifully sweeps over the flat lands.‡ As they are finished they are surrounded by other poles, supporting a movable roof, which is drawn downward as the stack is consumed, and so it is sheltered while any remains. The farm-house will strike a stranger most forcibly by the solid comforts it exhibits, the rich massive furniture it contains, the looking-glasses in ponderous carved frames, and the heaps of rich old Japanese and other china which abound everywhere; an evidence of the former trade of the country, once so exclusively and prosperously carried on. The kitchens, with their brightly-scoured kettles, bring to mind the kitchens of Gerrard Dow, and the sleek kitchen-maids seem to have sat to Maas for his servaut-wenches. But the wonders of the farm are the dairies: here they revel in cleanliness, sprinkling the stalls of the stables with snow-white sand, stroked into a variety of ornamental geometric figures by the broom, when the cows are away; and when these are present they are as carefully attended to as if they were children, their tails being hung in loose strings to the ceiling, lest they should dabble in the mire! When the cold season sets in, the animals are protected in the fields by a coarse sacking fastened over their backs, much like the coverings here adopted for favourite greyhounds, and the milk-maids are paddled lazily up the stagnant canals that pass round each field in place of our hedges, until she lands on the square patch of swampy grass, achieves her labours, gets into her boat, and is pushed or paddled by a stout swain, pipe in mouth, to the next rectangular plot, until her pails are sufficiently filled, when she is pushed gently toward the farm. There is no use in hurrying a Dutchman; he does all things leisurely; anxiety on your part will only make him more perseveringly stolid, and irritation more obstinately immovable.

Town life differs from country life only in the extra gaiety produced by better dwellings, and a greater concourse of people: its formality is as great. The heavy carriages which traverse the streets of Amsterdam upon sledges instead of wheels, drawn by large black horses, are more indicative to a stranger of a funeral than a friendly call. The provision made upon the gabled houses for the board and lodging of the favourite storks also indicate the quiet character of the youthful Hollander;§—there are no *gamins*

here, such as infest the streets of Paris: those animals could not live many days in this ungenial clime. We can fancy the misery of one of them, seized by proper officials, and put into the heavy charity dress, to learn what was proper of a Dutch pedagogue. The lugubrious little old figures that pass for children in pictures of the old native school, seem to have never differed from their parents but in age or size. Formality runs through everything in this land; the night watchman still

"Breaks your rest to tell you what's o'clock;"

but he does more than this; he announces his approach by a huge clapper of wood, which he rattles loudly, probably to warn thieves of his approach, that they may leisurely pack up and go away, and then the guardian, like Dogberry, may "presently call the rest of the watch together, and thank God they are rid of a knave!" To see the perfection of Dutch cleanliness or village-life run mad, the stranger should visit the renowned Broeck, in Waterland, as the district is properly termed in which it is situated, on the shores of the Zuyder Zee. From Amsterdam the grand ship canal, which extends for nearly fifty miles to the Texel, will be seen *en route*, and a four-mile drive deposits the stranger at the entrance of the village. There he must alight and walk over the village, for all carriages and horses are forbidden to enter this paradise of cleanliness. It is recorded that the Emperor Alexander was obliged to take off his shoes before entering a house. A pile of wooden sabots at the doors testify that usual custom of its inhabitants. The rage for "keeping all tidy" has even carried its inhabitants so far as to tamper with the dearest of a Dutchman's treasures—his pipe; for it is stipulated that he wear over it a wire net-work, to prevent the ashes from falling on the footpaths; these are constructed of small coloured bricks, arranged in fancy patterns, and are sometimes sanded and swept in forms like those we have described in dairies. Nothing can exceed the brightness of the paint, the polished coloured tiles on the roofs, or the perfect freedom from dirt exhibited by the cottages, which look like wooden Noah's arks in a genteel toy-shop. The people who live in this happy valley are mostly well off in the world, and have made fortunes in trade, retiring here to enjoy Dutch felicity. The pavilion and garden of one rich old clergyman, Myndeer Bakker, has long been a theme of admiration. The good man revelled in a caricature of a garden in which he sunk much money; and at his death left a will by which it should be kept up. This is no inexpensive thing in Broeck, for, owing to the hoggish nature of the soil, it continually requires attention and renovation.† In this garden are crowded summer houses and temples of every fanciful style yet "unclassified." Plump Dutch divinities stare at wooden clergymen, who pore over wooden books in sequestered corners; while wooden sportsmen aim at wooden ducks rotting on the stagnant water. The climax of absurdity is reached at a small cottage constructed in the garden, to show, as our guide informed us, how the country folks "make the money." You enter, and your guide disappears as rapidly as a Dutchman can, and leaves you to contemplate a well-furnished room, with abundance of crockery, an immense clock, and a well-stored tea-table, at which sit two wooden puppets, as large as life; the old man smoking his pipe, and preparing the flax, which the old woman spins, after the field labours are over. All the movements of these figures are made by clockwork, worked by the invisible gardener, and concealed under the floor. In former times the good lady hummed a song; but her machinery being now out of order, the stranger is only greeted on his en-

trance by some spasmodic yelps from a grim wooden dog, who always faithfully keeps watch and ward at her feet.

In Broeck no one enters a house by the front door, nor is any one seen at a front window. The front of a house is where the "best parlours" are, which are sacred to cleanliness and solitude. Irving's description of such an apartment is rigidly true; "the mistress and her confidential maid visited it once a week, for the purpose of giving it a thorough cleaning, and putting things to rights; always taking the precaution of leaving their shoes at the door, and entering devoutly on their stocking-feet. After scrubbing the floor, sprinkling it with fine white sand, which was curiously stroked into angles, and curves, and rhomboids; after washing the windows, rubbing and polishing the furniture, and putting a new bunch of evergreens in the fire-place, the widow shutters were again closed to keep out the flies, and the room carefully locked up till the revolution of time brought round the weekly cleaning-day." The people of Broeck always enter their houses by back doors, like so many burglars; and to ensure the front door from unholly approach, the steps leading up to it are removed, never to be placed there but when three great occasions open the mystic gate, and these are births, marriages, and funerals; so that to enter a Dutchman's house by that way is indeed an "event."

The country girls generally wear the plain and ugly caps represented in our cuts; but the richer farmers' daughters, particularly in North Holland, are extremely fond of a display of the precious metals in their head-dress. Pins of gold, to which heavy pendants hang, and elaborated ear-rings frequently appear, and occasionally the hair is overlaid entirely by thin plates of gold covered with lace; the forehead banded with silver richly engraved; bunches of light gold flowers hang at each side of the face, and pins and rosettes are stuck above them. We have engraved a specimen of this oppressive finery, which is sometimes further enriched by a few diamonds on the frontlet of the wealthy ladies of Broeck when they appear on a Sunday at church.

It would seem as if a Dutchman really loved the ponderous, for nowhere else may be seen the weighty wooden carriages in which they delight to drive along the country roads; they are solid constructions of timber, elaborately carved and painted, resting on the axles, and never having springs, which, indeed, are not so essentially necessary as with us, owing to the softness and flatness of the roads. The guide-posts are equally massive, and the outstretched hands with stumpy fingers which point the route to be taken, seem to be made for future generations. The wooden shoes of the peasantry make the foot the most conspicuous part of the body, and ensure slowness; while in some places the horses are provided with a broad patten strapped across the foot, and making their movements as measured and sedate as their masters.* The tenderness with which they look after their beasts, and comb and plait their tails, shows no necessity for a "Society for the Prevention of Cruelty to Animals" in Holland. Their solicitude for their cows and pet storks we have already noted; and the number of their charitable institutions is so great, that poverty or want never meets the eye of a traveller. There is a well-fell comfort pervading all classes, and a scrupulous neatness and order over the whole country, the result of a constant cheerful industry, which scarcely asks for rest.

It is not the custom of the travelling English to visit Holland; it is a *terra incognita* to them, though other parts of Europe are filled by them to repletion. In this and other papers we hope to bring its features strongly before our readers, if they will, by aid of pen and pencil, travel in imagination with us over the land of Cuyp, Rembrandt, and Paul Potter.

* The hoggish nature of the soil of Holland, and the mischief which might be done by the sinking of a horse's feet, have led to these inventions, the low countries of England can also produce examples of broad protectors to prevent a horse from sinking or cutting in the swampy land, somewhat similar to those used in Holland; and which entirely surround the shoe.

* To the left of our view of Broeck there is a good example of one of these erections in a sort of Chinese taste.

† Our first engraving represents one near Leyden, which is completely identical with those depicted two centuries ago by the artists named.

‡ In the second of our little cuts we have shown this useful and simple mode of stacking, which is universal in Holland.

§ These nests are constructed on small beams of wood, placed by the inhabitants on their horse-ridges, as it is considered lucky to induce storks to build. They come regularly to their old nests in their periodical visits, and they are never molested. To kill or injure one would be considered as a sacrilegious act.

* These sabots, once so popularly known by name in England, when it was the custom to talk of William III. as having saved the nation from "popery, slavery, and wooden shoes" are generally formed of willow and elm. They are very cheap, and threepence will purchase a pair of the commonest kind, such as we engrave; but others are ornamented with carved bows and buckles, painted black, and smart-looking; these are much dearer, and worn by the better class of farm-servants, who sometimes protect the foot by a soft inner shoe of list.

† The gardener informed us that the surface sunk at the rate of half a foot in a year.

THE EXPOSITION UNIVERSELLE OF 1855, AND ITS CLOSE.

As we have done, in the case more nearly touching us—the "Beaux Arts"—so do we further purpose, in reference to that weightier manifestation of manufacturing effort, to which it was seemingly attached, to give our readers a condensed table, by means of which they can, without the labour of research, learn the main statistical incidents connected with it—viz. the number of contributors and the number of their works—the number and quality of honours gained in the different classes, upon the award of prizes—and their respective amounts. It will thus be seen how each country has stood, and how it has come off. Our great object in this having been in reference to home, we have only deemed it requisite to embrace in this process nino of the more important states that have joined in the exhibition. From the position of these on the occasion, that of Great Britain will be sufficiently illustrated for

all useful objects. We have ourselves felt a deep interest in the competition and contrasts which here, as in 1851, were salutarly conspicuous. They have confirmed, with an impression too potent to be further trifled withal, the truth that Manufactures and Art must become inoro and more connected each succeeding day, and that heavy must be the responsibility of those who having the power, do not zealously exert it to render that union permanent and all-pervading throughout our whole operative organization.

We profess a thorough trust in the capacity of our working classes to become comparatively refined in matters of artistic taste, if they be indulged in that education which can be without difficulty brought within their reach, and if moreover every one in their familiarity with exhibited Art be heartily encouraged: we fear not future competition with our foreign intellectual antagonists, if we be supplied, as we can be, with equal arms for the encounter. We have no reason to be discouraged from the result of the late grand re-union—and few, we are inclined to believe, are aware of the fact, which will appear below, that upon the whole,

Great Britain has taken off the greater proportionate share of the honours dispensed—we do not include the "mentions honorables"—with the multitude of which we have deemed it quite unnecessary to encounter numeral arrangements already sufficiently complicated. We must here premise that the latest French general catalogue is so defective in its details that they wholly forbid exact precision in the amount of exhibitors. We have in that matter sedulously endeavoured to arrive at a *cy pres*, which may enable our readers to form general results and conclusions upon which they may rely. In the table here subjoined, our readers can refer at once to any class of the 27 included in the organization of the Exhibition, and find the number of exhibitors in it, for any of the nine States included, and what honours they gained in any of the metal dispensations. They will also find comparative tables.

We repeat, the results to England are encouraging rather than discouraging; and that, on the whole, our country is justified in reviewing the awards with a fair degree of natural pride: had our leading manufacturers done more, we should certainly have gained more.

GOLD GRAND MEDALS OF HONOUR, AND GOLD MEDALS OF HONOUR.

Country	Class I. Mining and Metals	Class II. Hunting, &c.	Class III. Agriculture	Class IV. Machinery: Paper Movers	Class V. Machinery for Transport	Class VI. Milling Machinery	Class VII. Weaving Machinery	Class VIII. Philosophical Instruments	Class IX. Heat, Light, and Electricity	Class X. Chemicals: Leather, and Paper	Class XI. Alimentary Substances	Class XII. Pharmacy, &c.	Class XIII. Military Arms	Class XIV. Engineering
U. S. OF AMERICA	1	1	1	1	1	1	1	1	1	1	1	1	1	1
SWITZERLAND	1	1	1	1	1	1	1	1	1	1	1	1	1	1
SWEDEN & NORWAY	1	1	1	1	1	1	1	1	1	1	1	1	1	1
SPAIN	1	1	1	1	1	1	1	1	1	1	1	1	1	1
BELGIUM	1	1	1	1	1	1	1	1	1	1	1	1	1	1
AUSTRIA	1	1	1	1	1	1	1	1	1	1	1	1	1	1
PRUSSIA	1	1	1	1	1	1	1	1	1	1	1	1	1	1
GREAT BRITAIN	1	1	1	1	1	1	1	1	1	1	1	1	1	1
FRANCE	1	1	1	1	1	1	1	1	1	1	1	1	1	1

Country	Class XV. Sheep and its Products	Class XVI. Glass and Metal Work	Class XVII. Goldsmith and Jewellery, &c.	Class XVIII. Glass and Pottery	Class XIX. Cotton, &c.	Class XX. Woollen, &c.	Class XXI. Silk	Class XXII. Flax, &c.	Class XXIII. Hemp, Flax, and Carpers	Class XXIV. Furniture and Decoration	Class XXV. Ornamental Objects	Class XXVI. Glass and Metal Work: Photography	Class XXVII. Musical Instruments	Mixed Commission of Classes X., XI., XII., XXII., XXIII.
U. S. OF AMERICA	1	1	1	1	1	1	1	1	1	1	1	1	1	1
SWITZERLAND	1	1	1	1	1	1	1	1	1	1	1	1	1	1
SWEDEN & NORWAY	1	1	1	1	1	1	1	1	1	1	1	1	1	1
SPAIN	1	1	1	1	1	1	1	1	1	1	1	1	1	1
BELGIUM	1	1	1	1	1	1	1	1	1	1	1	1	1	1
AUSTRIA	1	1	1	1	1	1	1	1	1	1	1	1	1	1
PRUSSIA	1	1	1	1	1	1	1	1	1	1	1	1	1	1
GREAT BRITAIN	1	1	1	1	1	1	1	1	1	1	1	1	1	1
FRANCE	1	1	1	1	1	1	1	1	1	1	1	1	1	1

TOTALS IN FIRST AND SECOND CLASS GOLD MEDALS.

Country	Total of Exhibitors	First Class Medal	Second Class Medal
FRANCE	5790	65	137
GREAT BRITAIN	1568	17	32
PRUSSIA	1135	5	18
AUSTRIA	1362	5	15
BELGIUM	749	7	7
SPAIN	550	7	1
SWEDEN & NORWAY	600	1	1
SWITZERLAND	454	1	1
U. S. OF AMERICA	140	1	1

FIRST CLASS MEDALS OF SILVER, AND SECOND CLASS MEDALS OF BRONZE.

Country	Class I. Mining and Metals.		Class II. Hunting, &c.		Class III. Agriculture.		Class IV. M. M. & Prime Movers.		Class V. Machinery for Transport.		Class VI. Manufacturing Machinery.		Class VII. Machinery.		Class VIII. Philosophical Instruments.		Class IX. Heat, Light, and Electricity.		Class X. Chemicals, Leather, and Paper.		Class XI. Alimentary Substances.		Class XII. Pharmacy, &c.		Class XIII. Naval and Military Arms.		Class XIV. Civil Engineering.				
	Number of Exhibitors.	First Class Medal.	Second Class Medal.	Number of Exhibitors.	First Class Medal.	Second Class Medal.	Number of Exhibitors.	First Class Medal.	Second Class Medal.	Number of Exhibitors.	First Class Medal.	Second Class Medal.	Number of Exhibitors.	First Class Medal.	Second Class Medal.	Number of Exhibitors.	First Class Medal.	Second Class Medal.	Number of Exhibitors.	First Class Medal.	Second Class Medal.	Number of Exhibitors.	First Class Medal.	Second Class Medal.	Number of Exhibitors.	First Class Medal.	Second Class Medal.	Number of Exhibitors.	First Class Medal.	Second Class Medal.	
U. S. OF AMERICA.....	11	0	0	0	0	0	0	0	0	0	0	0	0	0	0	0	0	0	0	0	0	0	0	0	0	0	0	0	0		
SWITZERLAND.....	11	0	0	0	0	0	0	0	0	0	0	0	0	0	0	0	0	0	0	0	0	0	0	0	0	0	0	0	0		
SWEDEN & NORWAY.....	11	0	0	0	0	0	0	0	0	0	0	0	0	0	0	0	0	0	0	0	0	0	0	0	0	0	0	0	0		
FRANCE.....	213	34	37	70	47	135	221	25	52	149	374	42	206	400	41	268	45	929	55	135	70	25	52	149	374	42	206	400	41	268	45

Country	Class XV. Steel and its Products.		Class XVI. General Metal Work.		Class XVII. Goldsmith and Jewellery, &c.		Class XVIII. Glass and Crystals.		Class XIX. Cotton, &c.		Class XX. Woollen, &c.		Class XXI. Silk.		Class XXII. Flax, &c.		Class XXIII. Leather and Carpets.		Class XXIV. Furniture and Decoration.		Class XXV. Ornamental Objects.		Class XXVI. Pottery and Porcelain.		Class XXVII. Musical Instruments.		MIXED COMMISSION OF CLASSES X, XI, XXII, XXIII.		
	Number of Exhibitors.	First Class Medal.	Second Class Medal.	Number of Exhibitors.	First Class Medal.	Second Class Medal.	Number of Exhibitors.	First Class Medal.	Second Class Medal.	Number of Exhibitors.	First Class Medal.	Second Class Medal.	Number of Exhibitors.	First Class Medal.	Second Class Medal.	Number of Exhibitors.	First Class Medal.	Second Class Medal.	Number of Exhibitors.	First Class Medal.	Second Class Medal.	Number of Exhibitors.	First Class Medal.	Second Class Medal.	Number of Exhibitors.	First Class Medal.	Second Class Medal.	Number of Exhibitors.	First Class Medal.
U. S. OF AMERICA.....	0	0	0	0	0	0	0	0	0	0	0	0	0	0	0	0	0	0	0	0	0	0	0	0	0	0	0	0	0
FRANCE.....	32	35	31	308	34	59	37	31	50	309	35	102	168	12	9	32	30	11	113	13	15	15	15	15	15	15	15	15	15

Country	Number of Exhibitors.	First Class Medal.	Second Class Medal.
FRANCE.....	9750	202	309
GREAT BRITAIN.....	1568	108	147
PRUSSIA.....	1163	27	54
AUSTRIA.....	1362	202	309
BELGIUM.....	740	108	147
SPAIN.....	550	27	54
SWEDEN & NORWAY.....	696	31	60
SWITZERLAND.....	455	23	31
U. S. OF AMERICA.....	140	13	24

From the above it will appear that the proximate proportion of the *Grand Medals of Honour* attained, in reference to the number of exhibitors, stands thus:—
 America, $\frac{1}{11}$; Great Britain, $\frac{1}{11}$; Belgium, $\frac{1}{11}$; France, $\frac{1}{11}$; Prussia, $\frac{1}{11}$; Austria, $\frac{1}{11}$; Sweden and Norway, $\frac{1}{11}$. The Second Gold or Medal of Honour: Switzerland, $\frac{1}{11}$; America, $\frac{1}{11}$; Great Britain, $\frac{1}{11}$; Prussia, $\frac{1}{11}$; France, $\frac{1}{11}$; Austria, $\frac{1}{11}$; Belgium, $\frac{1}{11}$; Spain, $\frac{1}{11}$; Sweden and Norway, $\frac{1}{11}$.
 It will be found that in the distribution of the silver and bronze medals, Great Britain held a similar former position, and upon the whole may be considered to have had accorded to her a sufficient testimonial of the comparative deserts of the contributors, by which she was content to support her manufacturing pretensions. We are aware that there have been many complaints respecting the decisions of the juries—we have to doubt that of many not a few had good foundation—but it is a useless and unwise task to overhaul errors of this kind. It is for future times, future organisations for similar vast rival displays, to guard, if it be possible, against the

causes through which they may be supposed to have occurred. It is for us, and all friends of our country's continued prosperity, to draw the moral from the great drama that has been enacted, and that is—that as all over the Continent, but more especially in France and Germany, industrial labour appears to be in an unprecedented state of forward movement, developing itself with all appliances of Science and Art, England,—if she would continue to vindicate her past repute for pre-eminence, must bring amply to the aid of her zealous, manful, and intelligent operatives, those higher refining intellectual agencies to which we have alluded, and through which a sort of heathy is made to pervade and enliven with unimagined charms the rudest produce of their toils.
 If we review the progress of British Art Industry during the past ten or fifteen years, we shall have much reason to congratulate our manufacturers and our artisans: a comparison of the present with the past is anything but discouraging. Many engines have been at work to produce advancement; if the Schools of Design have not achieved all of which they are

capable, they have certainly done much good. In spite of bad management, short-comings, and unseemly squabbles, they have wrought a change in the manufacturing districts which is gradually converting the artisan into the artist, and which will in course of time enable our Art-workmen to compete with the Art-workmen of France—the true source of the superiority of French productions.
 Are we not justified also in claiming for THE ART-JOURNAL a share in this onward movement? France has vainly attempted to produce a similar work. It is notorious that there is not in that country "a public" to sustain it. We have continual evidence that the manufacturer on the one hand, and the artisan on the other, appreciate our labours, because they learn from them; and perhaps there is not a single Art-manufacturer in the kingdom in which the Journal is not the daily adviser of those who labour in "the workshop."
 So much we are free to say, to give heart to those for whom we cater; and to derive stimulus and encouragement for ourselves.

OBITUARY.

THE REV. ROBERT MONTGOMERY.

We have obtained, during the year which has just closed, so many sad reminders that "friend after friend departs," that we have become painfully accustomed, as it were, to the death-bell. But none of these warnings came upon us more suddenly than the loss of the Rev. Robert Montgomery. We had known him from his youth up,—had at intervals enjoyed his brightness and kindness in society—and been still more frequently interested and improved by his pulpit vigour and eloquence. We know that the desire of his heart was to do good, and that one institution (the Hospital for the Cure of Consumption, at Brompton) has had its funds increased more than a thousand pounds by the earnestness and frequency of his sermons only; and we mourned for his "departure" as a public bereavement, even on that ground alone; for this was but one of his many "outlets" of Christian charity and love.

We knew Mr. Robert Montgomery before the world accepted him as a poet, and previous to his being ordained. He had, in the fulness of boyish recklessness, written a satire, which, knowing he would be sorry for it hereafter, we,—somewhat older and more experienced,—entrusted him not to publish; but he was, even then, so brave for what he believed right, that he would not be advised, and so lunched his paper boat upon the "ocean of strife," where it certainly attracted more attention than could have been expected for the work of an unknown author. Yet it did him harm—as satires always do—and made him foes who reluctantly pardoned, if they ever did so.

Gifted by nature with great good temper and unflinching cheerfulness, he endured the rebuffs then heaped upon him without evincing bitterness or disappointment, and determined, nothing daunted, to "try again." In the meantime, his youth, good looks, frankness, natural gaiety, and a perfect guilelessness of heart and manner, were winning their way in society, and those who felt a real interest in the man, more perhaps than in the poet, feared he would be spoiled for anything great. It was almost impossible to believe that the brilliant fluterer had a fixed purpose—from which he never swerved. Scraps of his poetry, full of hearty and feeling, in a different tone and spirit to "The Age Reviewed," enriched the pages of "The Literary Gazette," then edited by Mr. Jerdan, who was more likely to spoil an aspirant for literary distinction by over-praise, than to crush him by disdain or neglect. He "took up" Robert Montgomery with the same enthusiasm with which he had taken up "L. E. L.;" and the result was, that even before the publication of "The Omnipresence of the Deity," the literary coteries of which "The Literary Gazette" was the oracle, caught the new lion; and we have seen his progress watched through crowded salons, by young ladies with albums and old ladies without, but all anxious to obtain a how or a smile from the young poet. There are no young poets now-a-days to "catch," but if there were, we doubt their being so petted and followed and flattered, as the friend who has just passed from this throbbing world. Unlike the generality of literary men, he had large talent for society; his "small change" was ever ready, and his ringing laugh and pleasant voice, told how much he appreciated the wit or cheerfulness of others. His conversation was rather flowing than sparkling, and he was never either "sharp" or dictatorial; never ready to "give it," even to his foes, though ready to "take it," without ill-temper. Indeed his fondness for society, and of late years his duties, occupied so much of his time, that it is a matter of astonishment how he found leisure to issue poem after poem. Had he been entirely devoted to literature, many of his productions would have been more worthy of his reputation, and more fitted to take their stand by "Luther,"—which we consider his finest work. It is well to look back and note how the young man, in the full blaze of his London popularity, devoted the means he gained by his poetry to graduate at Oxford

and enter the Church. He soon became noted as an eloquent preacher, and had his lot been cast in England instead of Scotland (where for some years he filled one of the principal Episcopalian churches in Glasgow), he would not have died minister of Percy Chapel. Some of the best years of his industrious life were embittered by bickerings and disputes at this great City of the North. Perhaps the most charitable judgment to write is, that the people did not understand him, and he did not understand them. On his return to London, after an absence of some years, he created a congregation of admirers and friends, and was himself the friend of all who sought advice or needed assistance; shrieking alike from the very "high" as well as the very "low" church, he continued faithful in what he believed the Christian path he had chosen; but it is possible that his belonging to no "party" retarded his Church preferment. He has frequently been accused of an over-love of popularity, and he was too truthful and sincere to conceal the pleasure that all derive from praise—indeed, wearing "his heart upon his sleeve"—there were abundant "daws" to peck thereat, and no man could have had so large a share of fame without having to contend with herds of disappointed detractors; an edition or two of a bad work may be "got through" by the instrumentality of reviews, or the labours of a publisher, and readers who do not care to think or feel, are often rejoiced at being spared both thought and feeling by the instrumentality of "the Press,"—adopting an opinion in lieu of the endeavour to create one; but the *prestige* in favour of an author's ability will not carry a publication through a score of editions, unless there be vital talent and vigorous power to bear it onward. It is far easier to catch than to keep a reputation.

"The Omnipresence of the Deity" has reached the eight-and-twentieth edition, and the mighty thunder of Printing-house Square long ago declared that, "a purer body of ethics had never been read, and that he who could peruse it without emotion, clothed as it is in the graceful garb of poetry, must have a very cold and insensible heart."

The Rev. Robert Montgomery was born in Bath, in July, 1807, and his boyish days were passed at Dr. Arnot's school, near his birth-place, and in 1843 he made a most happy marriage with Rachel, the youngest daughter of A. McKenzie, Esq., of Bursledon, Hampshire; the only surviving issue of this union is a little daughter of four years old. He died at Brighton, at the end of November, 1855.

Mr. Montgomery never corrected the notes of a sermon, without talking over in the domestic circle, where he was so tenderly beloved, the plan and subject of the next. With even more than usual care he prepared a sermon, which he preached on the 18th of November, in Percy Chapel, on *Jacob's Death Bed*, and his wife observed, that now she hoped he would take some rest, as he had not busied himself with preparations for the following Sunday. Many of his people say that that sermon was the most powerful and eloquent he had ever preached; it was like Mozart's requiem—his own dirge! His physician had often told him that he was wearing out his strength and brain, but he would laugh and reply that he would "die in harness." The poor, in every sense of the word, were "ery near his heart"; by his preaching and collecting for them, he was enabled, (we speak, having authority from one who knew him well) to distribute a *thousand a year* in charity, and this, when the net income of Percy Chapel hardly yielded him five hundred a year. But after that memorable sermon, his wife and physician insisted that he must rest, and the following Sunday he took the first holiday he had had for fifteen months; it is not to be wondered at if the discharge of the duties due to so large a congregation, added to his literary occupations, rendered him fearfully nervous; and it was hoped that perfect rest at Brighton would act as a tonic to his system; he never, during his brief but most trying illness, uttered an impatient word, and his mental wanderings were suggestive of the happiest and most consolatory images.

It was not until within a few hours of his death, that Mrs. Montgomery had an idea of his danger; he regretted that his strength had passed so rapidly away that he could only say little prayers for her and his people, and, after enquiring if some relations he hoped to see had arrived, he asked her whom he loved best in the world to say out the Lord's Prayer.

She did so, and his faltering voice followed hers until about the middle—it ceased! When she had finished, *his* could he heard no more on earth! The world knew him as a poet—his congregation as a faithful, eloquent, Gospel minister—the poor as an unflinching friend—but in his home, no more tender or unselfish husband, father, or relative, ever left a hearth desolate! Restless as was his nature, he could tame it down at any time to watch by the couch of sickness or relieve the pangs of sorrow. A few words in honour of his memory can be considered by no one as words out of place.

A. M. H.

MR. B. PISTRUCCI.

We have as yet delayed our notice of the death of this distinguished medallist, which took place at his residence, at Englefield Green, about three months since, in the expectation of being in a position to place before our readers a history of his life and his works. Hitherto we have not been able to collect the materials necessary for the purpose; we hope, however, to do this eventually; in the meantime we would remark that as chief medallist in the Royal Mint, Mr. Pistrucci executed, with the exception of the shillings and sixpences, all the coins of the reign of George III. since 1815, and the six principal coins of George IV.; the coronation medal of the latter monarch, and the grand medal to commemorate the battle of Waterloo, which has never yet made its appearance, although we believe it was completed long before the death of the artist. This medal is, we understand, one of the finest works of its class ever executed; but whether the public will ever have the opportunity of estimating its merits seems problematical; "for" in the words of a contemporary, "George III. died, still nothing certain was heard about it; George IV. died, and collectors were still impatient. William IV. died, and Mr. Hamilton assured us that it was in hand—would be a glorious work, and well worth waiting for. Then came the Mint Commission of 1845, and it was not forthcoming." The medallist himself is now gone, but yet we hear nothing of his final and chief work.

SAMUEL ROGERS, ESQ.

The death, on the 18th of December, of the venerable poet, Samuel Rogers, Esq., whose poems have so frequently been the themes of British painters, is an event not to be passed over in our columns; though we have but a few lines into which to crowd a notice of one who, for more than half a century, has filled no unimportant niche in the temple of literature, and in the great commercial circles of the metropolis. "It must have been," said a writer in the *Times*, the day after the death of Mr. Rogers, "by an extraordinary combination of position, of intellectual and social qualities, of prudence, and of wisdom, that the same man who was the friendly rival of Byron, Wordsworth, and Scott, talked finance with Huskisson and Peel upon equal terms, exchanged *bon mots* with Talleyrand, and was the friend of all the eminent men, and of many of the indigent and miserable who flourished and suffered during three parts of a century. Such a man was Samuel Rogers."

MR. JAMES CARTER.

We are desirous of supplying an omission in the paragraph which appeared in our last number, relative to the subscription that is being made for the widow and daughters of the late Mr. Carter. Mr. Ackerman, of the Strand, has kindly undertaken to receive any contributions that may be forwarded to him for the purpose set forth in our former notice.

TESTIMONIAL PLATE.

PRESENTED TO SAMUEL COURTAULD, ESQ.

PRODUCED BY MR. S. S. BENSON, OF CORNHILL.

On the opposite page we introduce an engraving of a "piece of plate," which for want of a better name we must call a "centre-piece." It is a work of a more than usually high order; and as such justly claims the distinction we have given it: for, as the production of excellent Art-workmen, executed by an accomplished sculptor, and highly honourable also to the City gold and silversmith from whose establishment it issues, (and who is also the designer), it may be rightly considered and described as a very superior work of Art.

With its history we have little to do, further than to say that it is a testimonial presented to SAMUEL COURTAULD, Esq., whose memorable contest in the famous "Breitree Church Plate Case," effected changes in parish judicature which a large number of persons desired to record to the honour of the gentleman, who by large sacrifices, indomitable energy and perseverance, during a lengthened period of seven years, had fought a battle which terminated in a victory.

This testimonial is the result produced by the combined subscriptions of many sympathising admirers. The commission to execute a piece of plate was, after competition, given to Mr. S. S. Benson, of Cornhill—the style and subject being left entirely to his own taste and judgment. He very properly, and very wisely, sought the co-operation of an artist of high talent, and in Mr. Foley he found a worthy co-adjutor. The production will certainly rank with the very best works of this class which have been executed in this country, and affords satisfactory evidence of our advance beyond the unmeaning and haphazard "things" which in time past wasted precious metal—rendering a testimonial valuable only according to its weight in silver. Some description of this work is necessary to guide those who examine it; and this description we copy from Mr. Benson's printed circular: the design being to exhibit "CIVIL AND RELIGIOUS LIBERTY TRIUMPHANT."

The upper figure (Liberty) holds in her hand the emblem of Victory; under her feet are chains, fetters, and scourges, the symbols of Civil and Religious Tyranny.

Liberty is supported on one side by Christianity, and on the other by Justice; Wisdom being the third figure in the tripod.

On the base, History records the triumphs of Liberty, Civilisation rejoices at the results; at the back is a Figure emblematic of Perseverance and Industry.

It has been thought desirable to make Moral Power the prevailing feature in this work; Justice is therefore divested of the Sword.

The height is about 30 inches; the breadth at the base, 23 inches. Weight of the whole 600 oz.

The engraving—which is highly satisfactory—has been executed by the eminent engravers, Messrs. J. & G. Nicholls.

We cannot doubt that the engraving of this very beautiful and highly meritorious work will be acceptable to the readers of the *Art Journal*. It does credit to all concerned: the design is of the best order; honourable to the fame of the accomplished sculptor; the Art-workman have ably seconded the artist; and its issue cannot fail to enhance the reputation of the goldsmith, who in sending forth so excellent a work of Art, has advanced the character of "the City."

We attach more than ordinary importance to the production of this work; for it is a proof of the general progress of a purer order of Art; and a proof also that producers will not be, as they have so long been, content to send forth a valuable material degraded instead of elevated, by being passed through the hands of parties who can do nothing but follow in the footsteps of ignominious predecessors. Mr. Benson has taken especial care that all his associates should be worthy of trust; and we imagine the subscribers, whose combined contributions have been thus expended, must be more than satisfied with the result. Under such circumstances, the Manufacturer becomes an Artist.

MADAME LIND GOLDSCHMIDT
AT EXETER HALL.

PERHAPS our *Journal*—"The Art Journal"—ought, on the Continental plan, to embrace the Art Music, as well as the sister Arts; but to give the same attention, and render the same justice to music that we endeavour to do to painting, would require an augmented staff and enlarged space; so that only on rare occasions can we venture to touch upon what, we are happy to say, affords a continually increasing enjoyment to the English people. The re-appearance of a lady so distinguished and so respected as Madame Goldschmidt, however, calls for a brief record, even from us. And it certainly was with no slightly moved feelings of memory and expectation, that we once more encountered the crash of a "Jenny Lind night."

We rejoiced at the crowd inside and outside; we knew that Madame Goldschmidt deserved the welcome she was sure to receive; we never did separate, and we never wish to separate the "artiste" from the woman; we care not if we are called "enthusiasts" or "partisans," or any other ugly or foolish name; but we still consider Madame Goldschmidt the perfection of both woman and *artiste*; we cannot divide her talent from her charity; they are inseparably linked; we knew her noble, generous nature was unchanged; that she returned to England a happy wife and mother, with as warm an affection for the country as when she left it to test the reception she might meet in America; and we heard in the morning, from one well qualified to judge, that her voice was finer in power and quality than ever—this was to be expected. Madame Goldschmidt is in the prime of life; her voice has had long rest, with only occasional public exertion; and she is in the full enjoyment of health, and the blessings which she earned and deserved. From time to time we heard of her movements; and the great hearts of Europe beat stronger and quicker when they rehearsed her good deeds and triumphs. It was gratifying to observe how the audience poured in—and nothing but the admirable arrangements in the Hall could have preserved order; there were over a thousand "reserved seats," and had there been twice as many they would, even at this unpropitious season, have been filled. True, it was only here and there we recognised one of the *habitues* of the Opera—the unmistakable head, the genuine opera-glass, and irremovable white gloves natural to "the stalls" in the old Haymarket, wondering how they got to the reserved seats at Exeter Hall. Looking round, we saw that the audience was a good, hearty, intelligent English audience, but it was not the audience which greeted the Prima Donna in "Alice," or lung upon her sweet sounds in the "Sonnenhals;" however, if not as refined, the crowd had hearts and hands, and both hailed her appearance. As town fills, the regular opera-goers will be again recognised; now, the citizens—and that great undefined power, the "middle classes"—have the best of it.

We saw the multitudinous chorus and orchestra stumble up and down, as it might be, to their seats, and thought how much better it would be if they could have been classed or arranged, so as not to look so "spotty;" there a dense mass of black coats, here a patch of scarlet opera cloaks, and there again a flock of white dresses, looking so pitiously cold and chill. We have a theory of our own that the chorus of an oratorio should dress like the choir of a cathedral, it would add greatly to the pictorial effect and expression of the scene. We had leisure too to think how exceedingly low the ceiling was for music, and how flat and ugly the room appeared—so hard, and blocked out without the least pretension to elegance or comfort: it is simply a square common hall fit for mob orators, it seems, but totally unsuited to its present high purpose. We were dreaming over what the walls could tell of the varied scenes which had passed within them, and thinking over what we ourselves had witnessed therein, when the organ issued its great command to the

gathering, and the stragglers swarmed into their places, and there was a low buzzing sound like the hummur of bees, and a rapid turning over of "scores," and the audience rose a little over and fluttered a little, and then settled down. There was a pause, broken by "my seat, 879," and mine, 908," followed immediately by "hush—h—h—," and then, sligher than ever, pale and white as a statue—not a bit of colour about her—her snappy hair parted and folded as in the "Figlia"—large white roses at the hack—no ornament except a diamond star upon her bosom—there came, half hesitating, half confiding, the unspoiled favourite of Europe and America. The orchestra, chorus, audience rose to greet her, every species of bonorable "noise," from the hearty clap to the "bravo" and "hurrah!" gave her welcome—again—and again—until Beuedict waved his wand, and the well-trained orchestra commenced "The Creation."

Perhaps no public singer ever found her way so thoroughly into the hearts of "the people" as Madame Goldschmidt; yet a claque here whose strength lies in a sneer, speak and write as if England was the only country where what they call "the Lind fever" prevailed; if there be such a distemper, it devastated Sweden and Germany, before its arrival in England; we only formed in their wake, and all our ovations are as the blossoms of a hege primrose to the splendour of the *Victoria Regia*, in comparison with the homage rendered the *Cantatrice* in America. A fashion will last a season, but no longer; and many seasons, and, alas! years, have passed since Hans Andersen so eloquently and beautifully described the flutterings of the Swedish Nightingale in her own land. She looks still "the young girl robed in white," and she is still what she was then, as earnest in working on the character of whatever music she sings, as if she were a disciple, not a master, in her Art. Her musical conscientiousness is beyond all praise, she never thinks of self—never of where she can put in (a singer's temptation) "her best notes;" she bends to the composer's feeling as much as to the composer's style, and while she imitates his inspiration, becomes herself inspired.

When Madame Goldschmidt rose to give the first solo lines of that mighty chorus—"The heavens are telling," we knew her voice would tremble, yet they were delivered "as if an angel spoke;"—the sweetness and loveliness of "With verdure clad" thrilled through the room; but Madame Goldschmidt was not her perfect self until she sang "On mighty pens,"—that proved the truth of what we had heard, that her voice was not only greater but *freer* than when she first came to England. After this varied burst of song, so faithful because so eloquent of sentiment and music, the audience paused as if unable to express their delight; but after a moment it burst forth into the most loud and animated applause, in which the chorus (forgetting its official dignity) tumultuously joined. Madame Goldschmidt acknowledged the enthusiasm of both with her old bows and smiles of pleasure. She carried the audience as triumphantly with her throughout the music of "Eve" as she had done while rendering "The archangel's melodies." Madame Goldschmidt's face in repose seems to us more thoughtful and steadfast, more marked than we remember it to have been; but it becomes perfectly radiant when she sings—which she does without an effort. In the more exalted passages her large blue eyes dilate into such darkness and power, that it is almost impossible to believe they are the calm soft orbs that a little before appeared commingling with her own thoughts, heedless of the palpating crowd.

The impression which her first appearance left was, that in sacred song she was firmer and finer than ever; and as it is to be hoped she will remain a few months with us, and visit the provinces, all who love music will have the privilege of hearing and seeing her. Continental "on dit" leads us to anticipate much pleasure from Mr. Goldschmidt's fine taste and excellence as a pianist. He is said to have powers of the highest and rarest order.

A. M. H.



TESTIMONIAL PLATE

TO SAMUEL COUSTAULD, ESQ.

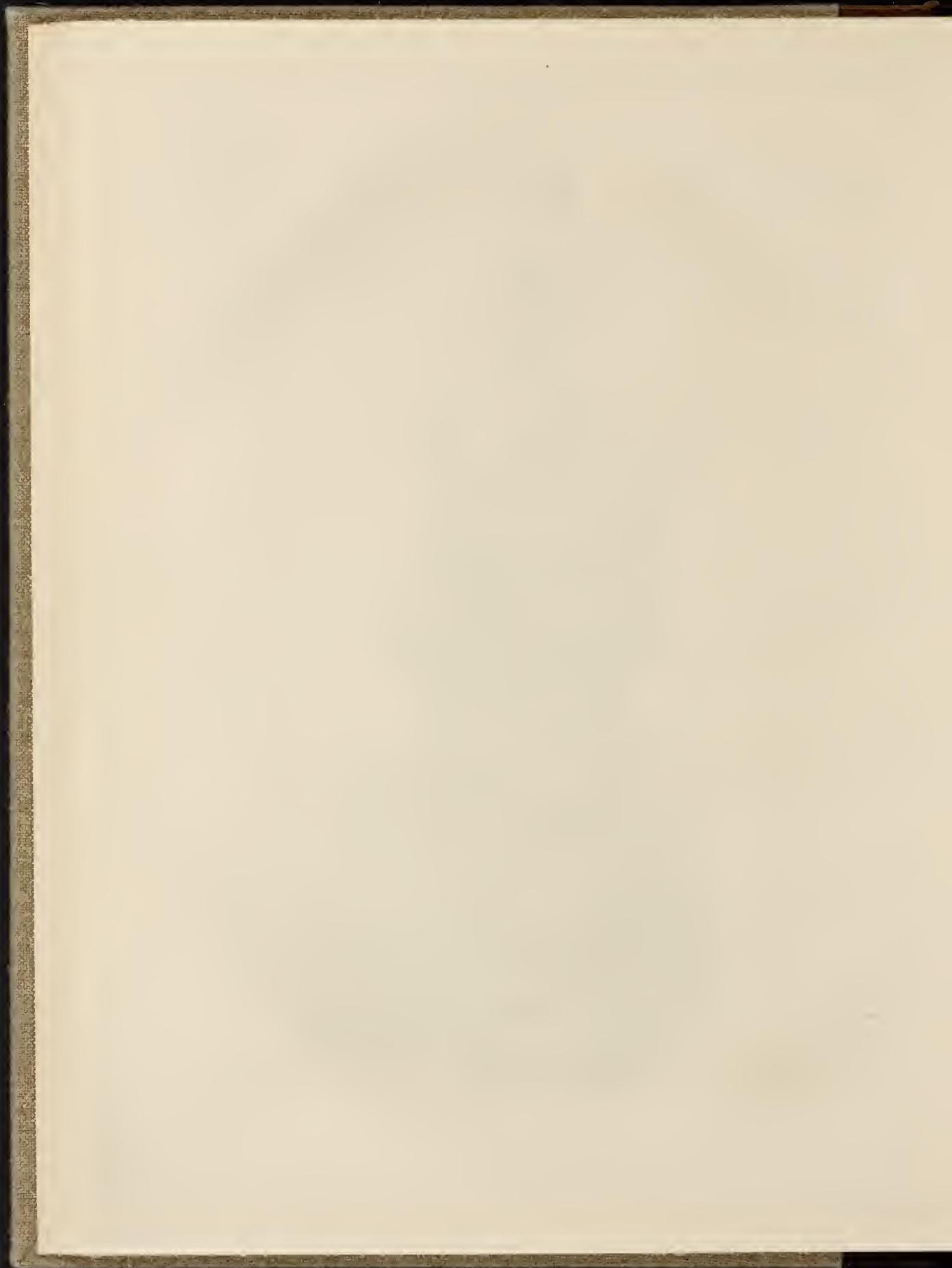

THE
ARCHITECTURAL EXHIBITION.

OUR new year's number goes to press too early in the preceding month, to allow us to do more than mention the opening conversation of the Architectural Exhibition, which took place on the 18th ult., and was attended by a considerable number of ladies and gentlemen. The exhibition, which is now open at the Suffolk Street Galleries, consists of a large number of drawings of buildings recently erected, or in progress, together with designs, some views of old buildings, and a few photographs. There are about 600 works of these classes. Amongst the designs are several for decorative enrichments and furniture. There are also some specimens of executed decorations, and numerous models and specimens of materials, manufactured articles, and new inventions connected with architecture and decorative art. The merits of objects in these latter classes are to be reported upon by the council of the Royal Institute of British Architects, towards the close of the exhibition. Certain evenings are set apart for lectures, namely, "On Ancient Assyrian Architecture," by Mr. Fergusson; "On Early Christian Art, as illustrated in Mosaic Paintings," by Mr. Scharf; "On Ultramarine in Architecture," by the Rev. J. L. Petit; "On the Ancient Architecture of Scotland," by Mr. Billings, and "On the Influence of Light and Shadow on Architectural Composition," by Mr. Thomas Allen.

The interest with which we have watched the progress of this exhibition is known to our readers; and though this year, there are a few leading architects whose recent works should have been represented, the collection approaches more nearly than that of last season to an adequate exemplification of the existing state of architectural taste, and there is every appearance that the assertion on which we ventured—that the rooms were far too small for such exemplification—was made with reason. The subjects to be presented in an exhibition of the kind, are very varied: for these, such classification as now may not be possible, would be desirable; and geometrical and detail drawings are so important to the architect visitor, and are objects so essential for the purpose of familiarising the public eye with their nature, and with the character and amount of labour and thought which go to the production of an architect's design, that we should wish to see the complete sets of many such works,—although without trampling upon space which it may be desirable to give to other subjects. Though, for opinions about the architectural talent of the country, it is still not sufficient to take the *data* solely from this exhibition, the collection gives many gratifying evidences of the progress which is being made. The provincial buildings are but sparingly illustrated: the exceptions—the Manchester warehouses, and recent designs for schools of Art—are, however, of some importance; and the contrast which is presented between some works of the former class, and what has been done in London, is unfavourable to the metropolis,—progress as architecture here also may be. Again, it must be recollected, that the more important works of the day are being carried out by those who in many cases have little time for the necessary representation of them by perspective views. The aspect of the rising talent of the country is however, placed in a very favourable light. Were we to make any exception to such an assertion, we should allude to the somewhat dangerous fondness for crude colour, which in designs is by no means confined to interiors; but is sometimes distracting the attention of otherwise able architects from the higher expressions of beauty that are within the domain of form and proportion. The designs for decorations are, many of them, made without due consideration of principles—happily now more attended to than formerly; but they, nevertheless, display great talent, executive and otherwise; and some of the specimens exhibited are such as should bring honour and profit to those who have prepared them. Next month we may have space to look more particularly at the merits of some of the principal works.

MINOR TOPICS OF THE MONTH.

THE ROYAL ACADEMY.—We presume, although we have no direct knowledge of the fact, that the Members of the Royal Academy met, as usual, on the 9th of December, to elect their officers for the ensuing year. We think we have some right to complain of a want of courtesy on the part of the authorities, for not affording us the information which our subscribers naturally look for, but which we are not in a position to give them.* If the omission has been accidental, it ought to have been guarded against; if intentional, we take the liberty of saying it has not been merited; for though we have thought it our duty occasionally to express opinions adverse to the present constitution of the Academy, and to the pretensions of some admitted into membership, we have invariably acknowledged its services to Art, and employed whatever influence we may possess to uphold its privileges. It has generally been our practice, too, whenever the opportunity was afforded us of making the necessary examination, to comment on the works exhibited by the students for the annual prizes; which prizes are awarded on the same evening as that whereon the election of officers takes place; but this we are also unable to do, as we received no invitation to view them. But unwilling that the successful competitors should, through the carelessness or discourtesy of others lose the benefit of such publicity as our columns might afford them, we have obtained from an artist who was present on the occasion, a correct list of the awards, as follows:—the Gold Medal for the best historical picture, to Joseph Powell; the Gold Medal for the best historical sculpture, to John Adams; the Silver Medal for the best painting from the living draped model, John White Jones; Silver Medal, for the best drawing from the life, Philip R. Morris; Silver Medal for drawing from the life, James Waite; Silver Medal for the best drawing from the antique, Samuel J. Carter; Silver Medal for drawing from the antique, George A. Freezor; Silver Medal for the best model from the antique, Henry Bursill; Silver Medal for a model from the antique, Samuel P. Lynn; Silver Medal for a model from the antique, George Miller; Silver Medal for a perspective drawing in outline, Thomas Sich; Silver Medal for a specimen of geology, Augustus H. Parker; Silver Medal for Medal die, cut in steel, Joseph T. Wyon. If we remember rightly, Mr. Powell had two medals awarded to him in 1853; he has now received the highest honour the Academy can bestow upon a student, and we heartily congratulate him upon his success. We have watched his progress for some time past, and although we have not seen the picture that has procured for him a golden reward, we have no doubt he has worthily won it. But with our congratulations we shall also offer a word of advice; he must remember he has only just entered upon the path which ultimately leads to fame; he has a difficult journey before him, and if he desires to reach the end of it honourably and to secure a lasting reputation, he must be up and doing laboriously, studiously, and perseveringly. There is no other method of accomplishing the task. We have known "gold medalists" who have thought that the receipt of that honour was sufficient to enrol their names among the worthies in Art, and relaxing in their efforts have never been heard of afterwards, except as a unit among the multitude; we trust such will not be Mr. Powell's fate.

THE NATIONAL GALLERY.—In contemplation of the removal of this edifice (according to a

* Since the above was written, we have seen in the advertising columns of a contemporary the following list of officers for the ensuing year:—President, Sir C. L. Eastlake; Council, E. M. Ward, S. Cousins, C. W. Cope, W. Dyce, P. MacDowell, F. R. Lee, J. R. Herbert, Esq., and Sir R. Westmacott; Auditors, Sir R. Westmacott, Sir G. Barry, and W. Mulready, Esq. The new blood infused into the list of the Council will, we hope, impart fresh vigour into the "doings" of the Academy: there is one name especially among the "Council" which marks a new era in its constitution; it is that of Mr. Cousins, the engraver. It is thus seen that at length engravers are presumed to be artists, and able to give advice on matters relating to a School of Art.

recent recommendation of a committee of the House of Commons) a plan and notices have been deposited at the Private Bill Office, as a preliminary step towards applying to Parliament during the ensuing session for an act to enable the promoters to erect a large hotel on the plan of the *Hôtel du Louvre*, Rue de Rivoli, Paris, which is now one of the lions of that city. It is proposed to build the hotel on the site of the National Gallery, and on the ground in the rear now chiefly occupied by the barrack-yard and the workhouse of St. Martin's parish. Such is, at all events, the "rumour;" but her thousand tongues may be all wrong. The Royal Academy is not likely to be dispossessed of that which is their right.

THE SOCIETY OF PAINTERS IN WATER COLOURS have elected John F. Lewis, Esq., President, in the room of the late Copley Fielding, Esq. The choice is a good one, and cannot fail to give general satisfaction. Mr. Lewis was for many years a resident in Egypt; the works of his more recent exhibition are picture scenes and incidents of the East, and they are of the very highest merit. He is the son of the venerable engraver, and the brother of the mezzotint engraver, Mr. Charles Lewis. The only other candidate was Mr. E. Tayler, who lost the election by five votes; eleven members voting for Mr. Lewis, and six for Mr. Tayler. A rumour prevails, that the latter lost his election through the fact of his being one of the Fine Art jurors at the Paris Exhibition, whose decisions have afforded so much dissatisfaction to the artists of our country.

SIR CHARLES EASTLAKE, P.R.A., during his recent visit to the South of Europe in connection with his office as Director of the National Gallery, has purchased for the nation a large picture by Paul Veronese, which was formerly in the church of St. Silvestro in Venice. The subject is the "Adoration of the Magi;" a reduced copy of a portion of it, attributed to Carlo Cagliari, is at Hampton Court. It is not yet hung in the gallery, and we shall therefore postpone any remarks about the acquisition till we are afforded the opportunity of seeing it.

MR. E. M. WARD, R.A., has been honoured with the commands of the Queen to paint a large picture representing the installation of the Emperor of the French as a Knight of the Order of the Garter. The work will of course include portraits of the illustrious and distinguished personages who took part in the ceremony.

HONOURS TO ENGLISH ARTISTS.—Among the British artists to whom the Emperor of the French personally delivered the Cross of the Legion of Honour on the 15th of November was Mr. WILLIAM WYLD, whose works have obtained considerable celebrity, not alone in his own country but in France. Mr. Wyld however, has so long resided in Paris, that he is classed as a member of the French school, and he is, we believe, *décors* accordingly. His name, therefore, does not appear in the English list: nevertheless, we share the distinction he has obtained, and acknowledge the very graceful compliment accorded to him by the Emperor.

ENGRAVINGS AFTER LANDSEER.—The unique collection of engravings from the works of Sir E. Landseer, recently exhibited in Pall Mall, is now, we understand, scattered, through the instrumentality of Messrs. Southgate & Barrett, the auctioneers. It is a great pity such a history of this painter's art should be dispersed. What an acquisition would the collection have been to some public gallery or museum.

BRITISH ART ACADEMY IN ROME.—In the course of a lecture on Antiquarian Art, recently delivered at Birmingham by Earl Stanhope, his lordship took occasion to observe, how much benefit the Fine and Industrial Arts of our country might derive from the establishment of an Art-Academy in Rome, such as is possessed by our neighbour and ally, the French nation. The noble earl stated that he so much felt the improvement which to the manufacturing Arts especially—those, of course, connected with ornament—such an institution might confer, he should be greatly tempted in a period of peace, if his health and leisure would permit, to bring

the question before the House of Peers. His lordship, comparing the state of our manufactures with those of France and Italy, reiterated the general opinion, that our inferiority is the result of the want of proper Art-education, a want that would be supplied by such an institution as he advocates.

THE PARIS EXHIBITION.—Our attention has been called to an error which appeared last month in "The Illustrated Catalogue of the Paris Exhibition;" the piece of lace engraved on one of the pages is manufactured by Mr. TREADSWAY, of EXETER; it was stated to have been the work of Mr. Treadwill, of Honiton. This is an error we very much regret: but Mr. Treadwin has made his name so generally known, that no doubt it has but little prejudiced him: his productions are certainly the best of their class manufactured in England.

MR. EDWARD HALL, F.S.A., whose name frequently appears in our columns as a contributor of papers connected with his profession as an architect, has recently delivered two lectures at Westbourne College, Bayswater, the first on "Architecture, its Purpose and Origin," the second on the "Principles of Practical Art, as applied to House Decoration and Furniture." If the public were better educated in these matters than they are, and Mr. E. Hall is well qualified to be a teacher, we should see fewer absurdities both out of doors and in-doors, than now constantly meet our observation.

THE NIGHTINGALE FUND.—We ask the attention of our readers to the Report printed in our advertising columns, which the Committee have issued as the result of a Meeting that took place at Willis's Rooms at the end of last month. That meeting was in all respects remarkable; but chiefly as representing all classes and parties; the high purpose of the assembly, and of those who called it together and directed the proceedings, being to do honour to the admirable woman whose name has become a household word to indicate affection and respect. The newspapers have been so full of the subject, as to render it unnecessary for us to do more than express a hope that we may be the means of conveying to the Fund the contributions of many of our subscribers.

GLASS PILLARS AND SASH BARS.—A combination of gilt or silvered metal, and glass for light columns or shafts, in buildings, has been at various times suggested as a means of decoration. At the Panopticon Institution, the architect, Mr. T. H. Lewis, introduced silvered plates of coloured glass, as a coating to some of the iron columns, and Professor Cockerell once suggested the use of glass cylinders with an iron column, gilt, as a core. Messrs. Lloyd and Summerfield, of Birmingham, have lately carried out a similar idea, which deserves the attention of architects. They manufacture bars of flint-glass, cut to various patterns and grooved, when necessary, for the insertion of the sheet of glass, or window-pane. The bars are considered to be applicable to skylights and glass-doors, besides show-cases and looking-glass frames. Their chief use, however, is put forth as regards shop-fronts. In that case several lengths are joined together by means of an iron rod, silvered, running through the centre, ornamental collars being fixed at the joints, and a capital and base added. Here the glass becomes the chief support; and the strength would be considerable were it necessary to depend upon it. In shop-windows, it would of course be desirable to apply the pillars, if possible, without adding to the appearance of vacuity and weakness. There are, however, many purposes for which the bars may be brought into use in decoration; and they are manufactured in black and coloured as well as white glass. For instance, they are suitable for balusters, and, indeed, are made for this purpose in various forms. The convenience as to cleaning is of course a recommendation of any contrivance into which glass enters as a material.

MERCHANT TAILORS' SCHOOL.—In the course of the papers which appeared a short time ago in our Journal "On the Halls of the City of London," the writer ventured to urge upon the company the necessity of rendering their important public school more accordant with the age. He showed, that whilst the school was one

from which proceeded those who became men of influence as to educational advancement, no attention was paid to Art, and to subjects of vital importance to the national position. Having in the same paper and others, adverted to the several advantages derivable from greater development of the different branches of Art, the writer adverted to the value in education of knowledge of objects, considered as merely *forms*. It is therefore some satisfaction to us to find that the company has so far acted up to the spirit of our remarks as to arrange for tuition in drawing. The remuneration proposed for the master is not very large; but some men of ability are amongst the candidates. Drawing has become so common a branch of education in schools of far less pretensions, that Merchant Tailors' School could not safely stand longer in its old unimproved condition; and though the instalment for the advancement of Art is small, it is one which will be productive of great worth.

THE STATUE OF CHARLES I., which but a short time ago was cleansed from its surcoat of smoke and blackness, is once more surrounded by a lofty hoarding, preparatory, as we understand, to its being elevated on the site, to give it more importance than it has had since the erection of the Nelson Column and the National Gallery. The *tout ensemble*, as the passenger views it on approaching from the Admiralty, is now most unfortunate for the Statue, which is altogether lost by comparison with the objects in the background.

A NEW PAPER.—We write this notice on paper which we are given to understand is made entirely and exclusively of straw; and we are called upon to give our opinion of it. The process of converting straw into paper is, as our readers know, by no means new. Not long ago we examined a book, which professed to be printed on straw paper, which bore the date of 1800: but various circumstances have prevented its adoption into general, or even partial use; chiefly because of the difficulty of rendering it a good colour—clear and smooth: but also because it could not be produced at a cost less than paper of the ordinary character. These obstacles Messrs. Parkins & Gatto profess to have overcome. Evidence that they have succeeded in one respect is before us, and for the other we must take their word, or rather accept the witness supplied by the price at which it is sold—being about three shillings a ream for note paper, and in proportion for sizes larger. It is unquestionably of a good colour, a milky white; the pen runs over it rapidly, and it may be with entire safety written upon on both sides, being more than usually opaque. Because of its cheapness therefore, and its peculiar fitness for manuscript—indeed as *office paper*—this produce may be strongly recommended.

GLAZED BRICKS have long formed a desideratum in practical architecture. The facility of cleansing such surfaces has pointed them out as particularly suitable to the improved dwellings of the poor, and in 1851 some glazed bricks were exhibited, which would have been adapted to the end in view. The price was, however, an objection. Mr. T. Summerfield, of the firm of Lloyd & Summerfield, of Birmingham, has lately patented what he calls chromatic glass, or glass-faced grooved bricks. These are made in various forms, adapted to ordinary walling, plain and fluted columns and cornices, and as tiles for facing, and are prepared in several colours. By another patent, tiles are made to receive a pattern, with a view to their use for roofing, paving, and general surface decoration—as in the case of the ordinary encaustic tiles. Mr. Layard's discoveries, and the specimens in the British Museum, were hardly required to prove the durability of glazed patterns on clay, the medieval encaustic pavements, after the test of wear, being found with the glazing scarcely injured.

NORWICH SHAWLS.—It was with no surprise we found that honours had been conferred in Paris upon the famous shawl manufactory of Messrs. CLABBURN & Co, of Norwich. Their renown has gone over Europe, and their fabric has very largely contributed to uphold the fame of the city that, for a century at least, has taken and kept the lead in a manufacture which is a

"staple" of Great Britain. It would have been unnecessary for us to allude to this matter but for the fact, that an injustice was committed in awarding to Messrs. CLABBURN "the large silver medal" instead of "the médaille d'or." The circumstances are briefly these. The jury especially appointed to decide on the merits of these fabrics, VOTED A GOLD MEDAL UNANIMOUSLY to Messrs. CLABBURN. The group of juries corroborated the decision of the first jury, also unanimously. The joint decision then came before the Royal Commission for confirmation, and they decided that Messrs. CLABBURN & Co. should only receive the large silver medal, because looking to the character of Norwich as a manufacturing city, its manufacturers—except Messrs. CLABBURN—had contributed nothing, directly, to the Exposition. That such is unquestionably the fact, is proved by the official letter addressed to Messrs. CLABBURN, and written by them; it is as follows:—*M. CLABBURN, Fils, et CRISP, ont obtenu le médaille de première classe pour la perfection et la beauté de leurs produits. Ils exposent de châles en soie d'un joli goût et d'une belle fabrication. Leurs produits sont d'une qualité supérieure, et l'on remarque dans l'Exposition de ces honorables productions des magnifiques étoffes quel on désigné sous le nom de Crêpe de Norwich, Parachuta, &c.* It seems absurd as well as unjust to diminish the recompense to these gentlemen because they were the only manufacturers who upheld Norwich; because the city drew back from competition, and left its honours to the guardianship of a single firm—who, however, did guard them ably, and extended them widely. Surely, in such a case, justice would rather have augmented their recompense than have lessened it. But, in giving publicity to this fact, Messrs. CLABBURN's object is fully answered.

THE ROYAL SCOTTISH ACADEMY.—The Twenty-Eighth Annual Report of the Council of the Royal Scottish Academy of Painting, Sculpture, and Architecture, has just been issued; but the document has not as yet come into our hands. We understand, however, that the Council congratulate their constituents on the continued prosperous condition and still opening prospects of the Society. Next month we may have something more to say on this matter.

INDUSTRIAL PRINTING ON METALLIC PLATES.—Dr. Lohky, a Polish gentleman resident in London, has shown us a specimen of type-printing on metallic plates, concerning which he has written to say, that "Messrs. Adams & Gee, printers of London, have found that metallic plates of the thickness of ordinary sheet tin, may be printed upon with the usual printing type, if the plates be first coated with some peculiar composition. If sheets thus prepared and printed upon be afterwards subjected to a certain japanning process, an even lustrous surface is produced, on which the print may be read as if it were on common paper, and it cannot be erased but by a sharp steel instrument. Considering this invention, on the present occasion, only from its bearing on the culture and advancement of Art, it is evident, in the first instance, that all these lessons of lineal, architectural, or figure-drawing, which are largely used in schools, academies, and private instruction, can now be produced on the printed metallic sheets, effecting thereby a great saving of cost and change of those hitherto paper-printed patterns. In how far it is possible that copper-plate printing and lithography will be once practised on metallic plates—in how far it is probable that Arabesque ornaments on buildings, externally and internally, may be thus produced—an enamelled fresco painting of an imperishable nature,—time and our energy will decide. But recollecting the mosques of the Mohammedan religion, and the golden spans of the Alhambra, a profusion of ethnic and moral precepts, and injunctions written thereon, strikes our eyes. I think that some of the Turkish inscriptions are written on China, or other fine sort of earthenware—a tedious and expensive process. I have some idea of printing on gold and silver plates, for the ornamentation of baptismal, confirmation, or matrimonial keepsakes, and testimonials of a more elevated character—a combination, perhaps, of enamel and flegree work, &c."

REVIEWS.

HANDBOOK OF THE ARTS OF THE MIDDLE AGES AND RENAISSANCE, AS APPLIED TO THE DECORATION OF FURNITURE, ARMS, JEWELS, &c. Translated from the French of M. JULES LABARTE. With Notes, &c. Consistently Illustrated. Published by J. MURRAY, London.

If, half-a-century ago, the same means of acquiring a knowledge of the Industrial Arts had been as much within the reach of our artisans and ornamentists as are now offered to them, what might not have been expected, ay, and accomplished, too, with the constantly increasing facilities that scientific discoveries, and largely accumulating capital, would supply to aid in their labours? But it is impossible to deny the fact that, up to a comparatively very recent date, ignorance has been the incubus sitting on our chariot-wheels, not, indeed, delaying its movements, but mystifying and misdirecting its course, and blinding the eyes of its occupants to a sense of the true and the beautiful, so that instead of moving onwards and upward, we have travelled round and round in almost an unvaried course, completing the journey of half a century not very far from the point from which we started.

Happily this state of things is in process of amendment, and in good earnest, too; evidence of which is supplied by the numerous publications which, during the last three or four years, have been issued to meet the increasing demand for books of an educational purpose: the work of M. Jules Labarte will be found to be one of the most instructive treatises on architectural art that has hitherto appeared, and ought to be consulted and studied by all who are occupied in the ornamental arts. Originally written as an introduction to a descriptive catalogue of the Debruge-Dumoulin Collection, of which the author was co-inheritor; it affords a complete history of the origin and development of the Decorative arts during the period to which it has reference. The contents of the volume are arranged in the following order: Ornamental sculpture, painting and calligraphy, engraving, enamels,—a large and important section,—Damasceen work, the lapidary's art, the goldsmith's art, pottery in its various branches, glass, the armourer's art, the locksmith's art, clockwork, ecclesiastical and domestic furniture, and Oriental art. Here is a range of subjects, ample enough to take in all on which the skill of the ornamentist may be employed, the only omission being that of textile fabrics,—we presume from the fact of these requiring for their production the aid of machinery, while others are the result of handwork alone. The observations of M. Labarte on the different arts show deep research into the works of the great artists of ancient times, and an intimate acquaintance with the principles on which they built up their artistic reputation: the translation is by a lady whose name does not appear, but she has performed her task well; and an abundance of charmingly executed woodcuts assist to make the volume a text-book and an exemplar of the highest value to those engaged in manufactures connected with Art.

THE EVE OF ST. AGNES. By JOHN KEATS. Illustrated by E. J. WEHNERT. Published for J. CUNDALL, by SAMSON LOW & CO., London.

The critic who "does his spitting gently," may lay himself open to the charge of partiality, or of possessing too much of the milk of human kindness, but he has the consolation of feeling that none except himself, perhaps, is injured by what he writes; his error is at least a godlike one when he leans to the side of mercy; and towards the young aspirant for fame in the field of Literature and Art, such feeling should always predominate, unless he be some bold and ignorant intruder to whom the lash would be of infinite advantage as a punishment for trespassing where he has no right to enter. This, however, was not the case with young Keats, on whose first appearance the "Quarterly" put forth so crushing a criticism, that its severity not only embittered his future brief existence, but laid the foundation of the disease which hurried him to an untimely grave. Byron, in his "Don Juan," alludes thus humorously to the death of the young poet:

"Poor fellow! his was an untoward fate;
'Tis strange the mind, that very fiery particle,
Should let itself be snuffed out by an article."

Even Jeffrey's kind, and generous, and appreciating review in the "Edinburgh," on Keats's second volume of poems, failed to atone for the injuries the poet had already received; the bow had been drawn, but not at a venture, and the shaft struck right home. Yet Keats was a true poet, his mind

was richly stored with forms and thoughts of beauty and grandeur drawn from Classic lore; he had a creative fancy united with deep feeling, and an enthusiastic love of nature. He lacked, however, the discipline which time and experience would have brought to soften the crudities of style, and to teach him to arrange his thoughts, and to use, without prodigality, the materials at his command. "His writings," said Jeffrey, "are flushed all over with the rich lights of fancy, and so coloured and bestrewn with the dowers of poetry, that, even while perplexed and bewildered in their labyrinths, it is impossible to resist the intoxication of their sweetness, or to shut our hearts to the enchantments they so lavishly present."

The character of Keats's poetry, like that of Shelley, and of others of a somewhat similar school, is not of a nature to be popular; his admirers will always be few but enthusiastic. The most considerable of his poems are "Endymion," and "Hyperion," both of them containing passages,—and many of them, too—which any poet of any age might not have disdained to acknowledge as his own. This "Eve of St. Agnes," written in Spenserian measure, is lighter and more graceful than those, sparkling with brilliant descriptions and flowing expressions. This edition, very prettily illustrated, and in its external dress of emerald and gold, must be one of the "gift-books" of the season. Mr. Wehnert's designs are of unequal merit, but there are none to which we would positively take exception; they are well engraved by Messrs. Harral, Bolton, and Cooper.

THE PROPORTIONS OF THE HUMAN FIGURE. With Six Illustrative Outlines. By JOSEPH BONOMI, Sculptor. Published by H. KESSAW, London.

Whether the impeachment be right or wrong, the charge brought against our artists of all classes is, their incapability to draw the human figure correctly; and certainly it is a grievous fault where it exists. Drawing is the fundamental principle of all Art; composition, colour, expression, are comparatively valueless without truth of form. Nay, where those qualities are most conspicuous, they only heighten regret at the absence of the latter. Mr. Bonomi's pamphlet—for it is nothing more, yet quite sufficient for its purpose—will, if carefully studied, be of service to the young painter and sculptor, though he professes to give nothing more than what has heretofore appeared in print, but not in such a way as to come within the reach of all. He has taken the text of Vitruvius, as translated by the late Mr. Wilkins, R.A., Professor of Architecture at the Royal Academy, and amended from the Italian of Leonardo da Vinci. Mr. Bonomi is of opinion, that the celebrated Canon of Vitruvius, relative to the proportions of the human form, and which is referred to by Leonardo, is, in fact, the work of Polyctetus. Mr. Bonomi's notes to the treatise of Vitruvius and his diagrams, will be found sufficient aids to the study of the subject.

JUVENILE LITERATURE: THE MARTYR LAND. ANGELO. SIR THOMAS. THE TALKING BIRD. TALES OF MAGIC AND MEANING. Published by GRANT & GRIFFITHS, London.

We have named five of the publications of Messrs. Grant and Griffiths, as types of the class of books which "The Corner of St. Paul's Churchyard" has sent forth for the amusement and instruction of the young this winter. We once heard a publisher say to a lady who had acquired a good reputation as a writer for children, "that it was very easy to 'knock off' a child's book." This is a great mistake; writing for children requires more care and thought than writing for those who can care and think for themselves. Children are more reasoning and observant than they are believed to be. We have only to look back to our own early days to be convinced of this, and recall what we heard that it was not intended we should hear, and all that we remembered of what we never should have heard. It also requires considerable skill to infuse a lesson into a child's "story," without appearing to teach or preach. This danger has been successfully avoided in "THE MARTYR LAND," a well-drawn and simple history of the sufferings of the VAUDOIS during their bitter days, which were drawn to a happy conclusion by the father of the present King of Sardinia, CHARLES ALBERT. The thread upon which these historic scenes are hung is skillfully woven, and adds much to the interest of the charming little volume. We cannot agree with those who say such persecutions should be forgotten. History is the great teacher of the future, and as long as facts are recorded, as they are here, without undue bitterness towards the persecutors, they cannot fail both to warn and to instruct.

"ANGELO, OR THE PINE FOREST IN THE ALPS," is by GERALDINE JEWELRY, and prettily illustrated by JOHN ANSOLON. This will be a favourite story with all young readers; the characters are well drawn and life-like; there is enough of adventure to charm the boy, and sufficient of home-love to please the girl. We have read it ourselves with great enjoyment.

"SIR THOMAS, OR THE ADVENTURES OF A CORNISH BARONET," by Mrs. R. LEE. We almost believed that Mrs. Lee could have found nothing new to say of Africa, and yet "Sir Thomas" is as original in construction as it is interesting in detail. The sketch of the old Cornish gentleman is fresh and vigorous, and his adventures in the swarthy land of his adoption, are full of strange, wild life, fresh and health-giving. "ANGELO" will be most relished by children under twelve; but young ladies and gentlemen who have entered their "teens" will not think "Sir Thomas" "a child's book." Indeed old and young will find more than an hour's interest and amusement in its pages.

"THE TALKING BIRD" is a pretty story for young children, intended to prove the wisdom which conceals the future from our knowledge. MARY and ELIZABETH KIRBY are becoming such household names in juvenile literature, that we would entreat them to bring out the moral of their tales by human rather than by impossible means. An avowed fairy tale is pleasant, and not injurious; but fact and fiction are so mingled in "The Talking Bird," that it is not easy for a child to understand what is to be believed, what disbelieved. These ladies' style of writing is simple and engaging, but one of the first steps towards serving a child, is to engage its belief. All who read much to children have frequently heard the little earnest question, "Is that all true?" We had a hard task to separate the true from the untrue in this well-told tale; and the best criticism was that of the child to whom it was read—"But she should have been taught how wrong it is to want to know things that she ought not to know without a *black dove*, which I don't believe in."

"TALES OF MAGIC AND MEANING," are so called, we presume, for the sake of the aliteration; and here we have Mr. ALFRED CROWQUILL as an author as well as an artist. We have long rendered him all honour as an artist in his own peculiar style, but were not quite prepared to yield him the praise he certainly deserves as an author. We have rarely met with a volume of fairy tales more charmingly disguised, or in better keeping with their object. It is most difficult to invent a new fairy tale,—and translators have ransacked the northern and southern nations for every scrap of fairy lore that it was possible to turn into English. Mr. ALFRED CROWQUILL cannot claim strict originality for all the tales in his delightful little volume; but they are so gracefully arranged and so freshly dressed, that they are all "as good as new," while some we believe to be purely original. Then, they are really "Tales of Meaning." They have all objects—good objects—and their gentle teaching is as skillful as it is pure.* Now and then, in compliance with the *bad taste* of the times, there is a word, or perhaps a sentence, in accordance with the "fast" school, which will make boys laugh and girls wonder—but this does not often occur—we are almost hypercritical to note it; but we are very fastidious in our nursery, and have named the only faults we can discover. "The Little Silver Bell" might be made the groundwork of an "entertainment"—indeed, the tales are all dramatic, and Mr. Planche could weave any of them into a *spectacle*, that would take "the town" by storm.

SABBATH BELLS CHIMED BY THE POETS. Illustrated by BIRKET FOSTER. Published by BELL & DALDY, London.

A book that requires not the help of the reviewer to lift it into notice if once seen. It was a happy thought to bring together what a multitude of poets have sung in harmony with the sound of "the church-going bells," so as to make, as it were, a chorus of sweet and solemn music, floating along streamlet and valley, from "distant towers and antique spires," presented by the pencil of so charming a sketcher of rural scenery as Mr. Foster. It is a book for the six days of toil or the seventh day of rest, adding to the hallowed influences of the one, cheering and softening the labours of the other by the prospect of what is to succeed them. Among all the sights and sounds that are welcome to our

* In "Young King Flexible" we think a mistake has been made in working out the story by means which should never be introduced into nursery or school-room, because they must originate thoughts and questions that are better avoided; the *object* of the story is as good as that of any of the others, it is its *detail* that we object to.

eyes and ears, none are more pleasant to us than to see the humble inhabitants of some rural district wending their way through pasture, and cornfield, and hedgerows, to the house of prayer, when the Sabbath-bell summons them together.

"Six days may rank divide the poor,
O Dykes from thy banquet-hall—
The seventh the Father opens the door,
And holds his feast for all!"
BULWER LYTTON.

It will be a dark hour for England when, whatever the pretence may be, this seventh day is no longer a reprieve from mental and bodily toils, but pressed into the service of the others, as there is danger it may be when the Sunday is made, legally, a day of "independent recreation." We have, however, one fault to find with the artistic portion of this otherwise elegantly "got-up" volume; it is a great pity the illustrations are coloured; the beauty of Mr. Foster's designs is by no means increased by the tintings, while the delicacy of the engraving, by Mr. Evans, is altogether lost; they would have been far more acceptable left plain. It was quite a "mistake" to send them forth in their present garb.

A MANUAL OF ELECTRICITY, INCLUDING GALVANISM, MAGNETISM, DIA-MAGNETISM, ELECTRO-DYNAMICS, MAGNETO-ELECTRICITY, AND THE ELECTRIC TELEGRAPH. By HENRY N. NOAD, Ph.D., F.R.S. Published by G. KNIGHT & Co., London.

Some years since, Dr. Noad published his "Lectures on Electricity." These were very favourably received, and three editions have been exhausted. Dr. Noad has re-arranged—in a great measure re-written—his former work; and his last edition assumes a more complete form as a "Manual of Electricity." There is no department of physical science in which such advances have been made as this. Within a few years the lightning of a thunder-cloud has been shown to be of the same character as the electrical spark of a glass machine. Machine, or frictional electricity, has been proved to be identical with chemical or voltaic electricity. The conversion of these forms of force into magnetism, and the production from magnets again, of these two forms of electrical force, sufficiently determine the relation between them. The physical arrangement of most forms of matter has been shown to be due to some law of magnetic polarity; and, in the operations of vitality, it is evident that there is a development of electrical power. All these facts have been established by a series of inductive experiments of the most perfect character, such as scarcely any other division of experimental science can produce. Beyond this, electro-chemistry has been applied to metallurgical operations of the utmost importance. By the electrolytic process we obtain *fer-sulfides* of the most perfect examples of ancient Art; and by producing, at a comparatively small cost, copies of the highest efforts of the human mind, an improved taste is generated, which would otherwise have remained untaught. We silver and gild the common metals by the electricity which we get by chemical change in the battery, or by merely mechanical power from the permanent magnet. Beyond all this, the electric telegraph now spans Europe with its wires; it unites our island with the Continent; it is stretching its fibres across the Mediterranean Sea; and, as we advance with our wires towards the East, India is rapidly sending electrical threads westwards, so that soon Europe, Africa, and Asia will be chained in this mysterious bond, and we feel safe in saying that eventually, and at no far distant period, the Old World will be united with the New—an electric girdle will indeed encircle the earth, compared to which Puck's girdle was the plaything of an idle boy. Electricity, then, is the science of the age; and such a manual as Dr. Noad has given was required to tell us of the truths of electrical science, and to instruct us in its laws. We have carefully examined this, the first part of the manual, and we are bound to declare that if the work is completed—which we do not doubt but it will be—as ably as this extensive portion of the subject is executed, there will be little left to desire.

POPULAR MUSIC OF THE OLDEN TIME. By W. CHAPPELL, F.S.A. Published by CRANER, BEALE & CHAPPELL, London.

We have devoted very little attention in our journal to "things musical," but the interesting publication upon our table has a claim. Apart from "the language of sweet sounds," not only is it a collection of "Ancient Songs, Ballads, and Dance Tunes," illustrative of the national music (perhaps

it would have been better to call it the national melodies) of England, but Mr. Chappell has rendered the numbers valuable by introductory data of different periods, and notices of the airs of the sixteenth and seventeenth centuries. There is an interesting account of the minstrels, and notes upon various antiquarian matters that are, as it were, bound up with music, so that when our fair friends have tried over the "airs," they take possession of the information. Some fifteen years ago, Mr. William Chappell published a collection of "National Airs," now, we believe, out of print; but of all our writers, the antiquarian is the most persevering; and so Mr. Chappell went on collecting and collating until he was able to send forth this very able and interesting addition not only to our musical, but our antiquarian libraries. A great deal of the information now given, in this pleasing and popular form, was locked up in "Mitson's Dissertation," in "Percy's Reliques," in monastic records, in Dr. Burney's history—in scores of "ungetatable" quarters—from whence Mr. Chappell has drawn and arranged it; and it is no small advantage to find a publication for the music-student as well as for the drawing-room table, combining learning and pleasure in so agreeable a manner. We thank Mr. Chappell as much for judgment as for industry and good taste; the musical world are indebted to him for the preservation of our few fine airs; and his addition to our literature is a matter of congratulation to our book-collectors.

THE KEEPSAKE.—1856. Edited by MISS POWER. THE ENGRAVINGS under the superintendence of MR. F. HEATH.

Were it only for the sake of "lang syne," when the table groaned beneath a load of "splendid annuals," we should rejoice to welcome this "relic" of the past to our drawing-rooms. But taken altogether, even without the "memory," it is a pretty and a pleasant volume, bright in scarlet and gold, and filled with enough of tale and song to charm the lovers of light literature in the twilight, or by the Christmas fireside. Portraits of the Duchess of Argyll and the Marquis of Lorn have called forth a highland song by Mr. Beuoch; and the penicils of Margaret Gillies, Besançon, E. H. Corbould and others, have been "worked up to" with feeling and spirit by those who have "written to the plates." Miss Power has done her spriting gracefully; and her own story, "Percy Leigh's Wooing," reminds us of some of poor Lady Blessington's tales. There is a translation of "Auld Robin Gray" into French by the Chevalier de Chatelain, which is really a literary curiosity, faithful as it certainly is. The actual construction of the language is incapable of conveying the sentiment of the charming original:

"Young Jamie loved me weel,
And asked me for his bride,

is faithfully rendered into

"Jeune Jacques m'aimait, il me vouloit pour femme."

But if we translate that back into English, how strangely it reads. There are several names in the table of contents that belonged to the palmy days of "the annuals;" Barry Cornwall, whose only fault is, that he writes too little; Rev. Henry Thompson, M.A.; Mrs. Abdy, a faithful contributor to "the annuals," and we believe (alas for time!) the only survivor of "the Smiths," whose "Rejected Addresses" were anything but "rejected" by the public; Mrs. S. C. Hall, Mrs. Newton Crossland, always grave and graceful; Mr. Albert Smith, who occasionally descends from Mont Blanc to ascend Parnassus; Major Calder Campbell; Mrs. Ward, who has written so much and so well about "the Cape;" Mrs. Shipton, who, when "Anna Savage," was one of Lady Blessington's favourite contributors. There are others comparatively new to the craft; all have done their best for "The Keepsake;" and there is one delicious little poem towards the end by Mrs. W. P. O'Neil, which no mother could read without tears; it is called "A Child in Heaven," and is in itself worth the price of the volume, which is a pleasant first offering for the New Year.

THE POETICAL WORKS OF GEORGE HERBERT. Illustrated. Published by NISBET & Co., London.

With a distinct recollection of the multitude of elegant books that have been sent out for many years past, we cannot call to remembrance one that can lay claim to superiority over this as a specimen of illustrated typography; it may serve for a model of the printer's art in the nineteenth century, so delicate is the type, and so admirably are the sheets printed by Messrs. Clark, of Edinburgh. The paper

is like vellum in the smoothness of its surface; the woodcuts and designs are in the best style of Messrs. Birkett Foster, J. Clayton, and Noel Humphreys; and engraved by Messrs. Evans, Dabiel, and Woods, with a degree of refinement that cannot be surpassed; and the binding by Messrs. Leighton, Son, & Hodge is rich but very chaste; altogether it is a volume of rare merit. The poems of the ancient Dector of Bemerton are worthy of the skill and taste that have been here exercised upon them; quaint as they all are, and full of fantastic imagery and strange conceits, as many of them are, with here and there expressions and similes he would never have used in such an age as ours, there are also in them many tender thoughts, and much deep religious feeling. Good old Isak Walton was a great admirer of George Herbert, and has left a pleasant and graceful record of the divine in his "Country Parson." We hope, in a future number, to give some specimens of the illustrations which grace this edition of Herbert's Poems, and shall postpone till then a more lengthened criticism on the volume; but in the mean time would commend it as a new year's offering that must yield precedence to none of this season or any other.

WAITING FOR THE DEER TO RISE. Engraved by H. T. RYALL, from the Picture by SIR E. LANDSEER, R.A. Published by GAMBART & Co., London.

This print, intended to form a companion to one published some time since, "There is Life in the old Dog yet," was, we believe, originally engraved for Sir E. G. Moon, but, on the retirement of the latter from business, the plate was purchased by Mr. Gambart, who also holds Landseer's picture from which it was taken. If we have been rightly informed, the publisher intends to have the plate destroyed as soon as the number of impressions he proposes to issue have been struck off; if this be done in all good faith, it will be the first step, on the part of a publishing firm, as regards a new plate, in the more recently made by Mr. Boys, to limit the market, and so far to satisfy the collector that his purchase is not likely to become materially deteriorated in value. We are assured that the number of impressions taken is as follows:—100 artist's proofs; 100 proofs before letters; 100 lettered proofs; and 750 prints. We have mentioned these details, as the purpose of the publisher commences a new era in the history of the "trade." With respect to the print itself, though not so acceptable a subject as many of the works of Landseer, it is an admirable representation of Highland deer-stalkers enthusiastically occupied with their sport; the figures are skilfully grouped behind some rising ground, watching, with their dogs, the appearance of the antlered tribe in some portion of the landscape not seen in the picture. There is a passage in Landseer's large painting of "The Drive" very similar to this work.

WHISPERING IN THE PALMS: HYMNS AND MEDITATIONS. By ANNA SHIPTON. Published by NISBET & Co., London.

The eastern tradition of the palm tree is, that when its leaves quiver in the wind, they whisper the holy name of Jesus. This little manual of sacred thought and song has been prompted by the beatings of a heart "sorrowful yet rejoicing," and earnest in the desire that all should partake of the faith as it is in the Saviour, she has poured forth her whole soul, steeped not only in the reality, but the poetry of Christian love in this volume. Many of the poems are suited to the capacity of childhood; others are eminently spiritual; but we have not lingered over a collection of such truth and sweetness for a long time: truly she resembles the palm tree, whispering evermore "the name of Jesus."

THE ADVENTURES OF THE CALIPH HAROUN AL-RASCHID. Reprinted by the Author of "Mary Powell." Published by A. HALL, VIRTUE, & Co., London.

It is many years since we parted from our old friends with whom the "Arabian Nights" brought us into pleasant company; but we fancy we recognise some of the party in this volume, though habited in new costumes. The moral conveyed by the stories is good, and tending to promote the social virtues. The book, with its old-fashioned type, and antique style of binding, will be an agreeable change from the philosophical and learned treatises which, in the garb of children's books, we are accustomed to put into the hands of the young, in the expectation of making them wiser in their generation than their fathers.

THE ART-JOURNAL.



LONDON, FEBRUARY 1, 1856.

A FEW WORDS

ON EXHIBITIONS.

THE FRENCH AND OUR OWN.

Present—*MAGISTER and AMICIUS.*

AMICIUS.—And what may be the artist's feelings to the great Paris Exhibition, now that it is past and gone, and some time has elapsed to let ruffled spirits subside?

MAGISTER.—It was a great benefit in affording a general view of the present state of

European Art-progress. I believe our artists so appreciate it. At any rate, none who crossed the sea to visit it could have regretted their expedition. One's own practice is directly affected by the opportunities of comparison it yielded between the tastes, aims, means, and results of the various schools.

AMICIUS.—Do you consider it afforded these in perfection?

MAGISTER.—On the whole very well, but not thoroughly, of course, for several great European artists took no part in the show, and others were but indifferently represented; in some cases, also, whole classes of works were wanting: the Fresco Art of Germany, for example, the nature of which debars its removal. But, considering the magnitude of the idea of a Congress of modern Art, I think it was largely realised.

AMICIUS.—It is satisfactory, perhaps, to feel that the subject of modern Art was not wholly exhausted on this one occasion, and that there is something still to see beside what was contained within the plaster walls of the Beaux Arts. It takes the poetry out of a subject to define its boundaries precisely, and it is well to leave something to the imagination. It is very comfortable, in a cherished subject, to have this resource, this consolation to lean on; for the effect on us, I am sorry to say, of the mass of Art work there collected, was not altogether pleasing. My spirits were jaded with so much to admire: our's cup of admiration is but of a certain size, and the receptacle could not expand to so much at once, and thus each image had to content itself within a smaller compass, and so got jostled, and squeezed, and diminished in the crowd. Now, to do justice to a work of genius, it should reign alone, and have sole dominion for the time being; it should have free room to expand and fill the whole mind. I like to be thus carried away, and lifted up, as it were, off my feet, from this prosaic world, by the pennons of a great work, and to feel for the time as if it were part of my own being; but in those great halls I was pulled a thousand ways at once. The battalion—the army of works took away from the impression of each, as, in a martial review, you lose the individual unit in the mass.

MAGISTER.—As a matter of mere amateur pleasure, there is no question that viewing a few selected pictures is the best way, not only to do justice to them, but to gratify yourself. But now and then, as a *tour de force* for a nation, or for comparison, a great exhibition may have

excellent fruits, although a few works of Art you can make friends of, of course are vastly to be preferred to a crowd of such acquaintance.

AMICIUS.—Oh! the same thing holds in our exposition every year at the Royal Academy, as respects the grouping there altogether of such various works. In going round the rooms, the mind is called upon to be always jumping from great to little, and from grave to gay, and back again, and has to go through a series of sudden convulsions and transitions, in seeking to do justice to the labours of each artist. For my part, my powers are not facile enough to prance with ease from broad fare to pathos, or from pet lap-dogs, and dogs and horses, to a great historic or poetic effort; or from the Vale of Tempe, or the Ruins of Carthage, or the representation of some holy act of old, far back in the dim mystery of years, to the broad business city face of Mr. —, with his well-brushed whiskers. The first impression on me of our annual exhibition is that of a great jumble. I have sometimes thought it might be much better to put all the portraits by themselves, and all the historic and poetic works together, and make the still life, and the landscapes, and the dogs and horses, and squirrels and parrots, into separate clubs, and so on. Such a departmental arrangement might be worth trying; at any rate it would avoid the jarring I allude to, and allow one to go more calmly and philosophically through the show, in lieu of the present saltatory and right-about-face evolutions one is obliged to execute in following the pace and direction of each artist. It would afford more harmony in the arrangement, and I am sure the works would be done more justice to, and the whole would leave a pleasanter impression.

MAGISTER.—You speak as one not knowing of the great and various difficulties of a hanging-committee's office: the many interests there are to attend to; the grouping of colours in the pictures that have to form one side of a room—for each side, though made up of a number of pictures, should form one harmonious picture and *ensemble* of itself—and then the size and comparative merits of the works, &c. &c. have to be considered. I assure you the arrangement of the annual pictures, especially within the short three weeks that can be spared for it, from the time of the artists who prepare, or those who arrange them, is an office of great difficulty, anxiety, and pressure, and a thankless one to boot. What you suggest may be very well in theory, but I doubt its bearing practice. In the first place, you speak of these *désagrémens* purely as a "lover of Art," and it is from that point alone that you view the subject; but the Academy yearly exhibition is not addressed solely to the pure and earnest lovers of Art. If the funds of the Academy (which they redistribute so beneficially) depended on the shillings from these alone, they would not be able to keep their doors open! The Royal Academy annual exhibition is a great show and a lounge, as well as a banquet-room for the lovers of Art, and the mass of the visitors go to see the portraits of their friends, or wile away an hour or two, or to say they have been there, and to be amused, but not to think closely of or study the works; and the variety of images and characters in the very quick succession to which you object is part of the amusement and excitement to them. In such exhibitions, Art is in great degree addressed to the multitude, and must be so, like other public matters, to be successful. The general taste must so be catered for, and it is better to do so in the temporary arrangements of the works, than in their individual intention and execution. Besides, the real lover of Art can concentrate himself on one work which delights him, however close it may be placed to some incongruous effect.

AMICIUS.—He must not however indulge himself so at a full time of the day, or he will be a public nuisance to the ever-circulating crowd. To avoid this, I not unfrequently go in late. There is a sort of dreaminess about the late afternoon time at the Royal Academy, when each ten minutes is making the rooms thinner, that I much enjoy; when the softening light adds a deepening faith and illusion to the pictured forms, and one can go on gazing at an Italian scene till the blue sky and clear waves

seem real, and felucnas seem to be moving in the bay, and the thin smoke to curl up from Vesuvius, and the whole vision appears to swim and glimmer in poetry before our eyes. I believe I am recalling one occasion when such a painted reverie kept me so late in the rooms that I narrowly escaped being swept out with the rest of the dust!

MAGISTER.—The early morning time, also, as soon as the doors are open, has its advantages, and the atmosphere is pleasanter.

AMICIUS.—I will try that next summer, but it must be in clear, warm weather, for the morning's rays always seem to me here cold for works of Art. I like to be cooled down to business, and warmed up to Art. But there is another consideration about masses of works in exhibitions. Their numerous conflicting effects are such that I have but little faith in my critical powers in such an assemblage, and I have often heard artists say that a picture painted up to exhibition key, and looking very prominent in the academy rooms, is apt not to bear nearer and more intimate inspection so well as one elaborated with modest views, and that thus the "private virtues" of a work are not unfrequently sacrificed to its "public ambition;" I mean, that it will lose when removed to a private room, and that thus a public exhibition does harm sometimes, and is moreover by no means a sure test of the sterling qualities of Art.

MAGISTER.—That is very true. To go through an exhibition cursorily, and say which is the best picture in it; or, still more, to apportion out with justice the degree of praise due to each remarkable work, were, indeed, an arduous task, especially so unless you have had great opportunities previously of studying the style and excellences of each master. In balancing, however, the advantages of exhibitions or their non-existence, you would find them to be mainly on the side of exhibitions. Public exhibition has, undoubtedly, some disadvantageous effects on Art, but it has far more than countervailing advantages: Art would soon dwindle were without public exhibitions.

AMICIUS.—I asked you a little while ago what was now thought about the Paris Exhibition at the Beaux Arts—I meant to include the awards, &c.—and you replied by a general acknowledgment of its benefit, &c.; you turned to the generalities you could praise, I fancy, to avoid the specialities which you could not; but may not what you have just said afford some excuse for some of the mistakes which have been so widely spoken of, especially as to the awards of the British portion, for I heard one of our best artists say, the other day, that the quantity, and variety, and style of our Art quite took our neighbours by surprise?

MAGISTER.—You mean that their want of converse with the qualities of our masters forms an excuse for their want of appreciation of them? Perhaps that is about the best excuse to be made for the juries.

AMICIUS.—And this were letting them down very easily. A tribunal, however, which was too much startled by the novelty of the case to enter into the evidence cannot be thought an adequate one. I should vote for an appeal and a new trial. The decisions, omissions, &c., have caused considerable ebullition in our artist-world. Is it not so?

MAGISTER.—That is the part of the affair most to be regretted. It were much better had it been passed over by us in silence; there would have been no presumption in our quietly looking on the desperate scramble among our neighbours for distinctions which really were no worth to us, and to which we should attach none of the value as possessors, which now we are apt to do as non-recipients. Every English artist who could go to Paris on occasion of the Exhibition was right to go—professionally—for the sake of study and comparison; he was right to cull from the Exhibition all the good he could obtain; but he was not right to be irritated with decisions that are only calculated to be a nine days' wonder, and which there is not the least chance of the world's endorsing. The acts of the juries of Art were self-destructive, and needed no word of ours for their conviction; for instance, some of the works which were wholly passed over, as

far as medals or mention goes, were already "standard works" throughout the civilised world, before they came under the arbitration of the juries. These, of course, are not in the smallest degree affected by the dicta of these gentlemen, whose judgment, on the other hand, is damaged before the world (their judges in turn) by their attempt to throw a slur on such works. The whole affair of medals, as regards us, too, is an anachronism: such affairs are out of date with us, and are almost worn out even for little boys from the kind hand of that grandfather of our institutions, the Society of Arts. Our artists desire but employment, and present and future appreciation in reward of their efforts; and if they stick to that text, their real and proper motto, they can afford to smile quietly at the little *contretemps* of the hour.

Amicus.—Well, it may be very wise for you in the profession, under the circumstances, to apply to these matters a philosphic diminishing glass, but they present themselves to me as great mistakes.

Magister.—Great or little, they will tend probably to advantage in discouraging medals and such like rewards for some time to come.

Amicus.—Would you include in such rewards to be discouraged, decorations of rank, such as the Legion of Honour?

Magister.—The artist makes his own decorations, and our paintings and sculptures are our true stars and garters. But such decorations of rank are of a different character altogether to medals. What I object to in these last is the direct struggle into which the best artists are forced by them, and of which there is no arbitrium but themselves capable of judging—except that of matured public taste, which is the inevitable and ultimate judge, an all-sufficient one, too. Why, then, thrust us into any other? It does not, I really believe, benefit Art: it kicks up all the dust of the arena, and smacks more of the prize ring than of the quiet emulation by which the higher regions of the Art are to be sought. Let us have great exhibitions now and then, if you like, and I am sure I shall be very happy to take part in my small way, with the one they talk of to be in Vienna, but let there be no prize medals. A new feature for a repetition is a great thing, and Austria will have, at any rate, that opportunity of novelty, the absence of medals. On our part I will answer for it there would be none the less exertions made to be well represented from the absence of medals of merit, but the contrary; for I doubt whether our artists, as a body, would now enter into any scheme that might have similar unengaged results in this respect to those on this last occasion. But you were speaking of decorations of rank: there is not so much to be said against them, for they are not put up to public competition, like a hat at a fair, on a slippery pole, but are presumed to be free and unapplied for honours, conferred by royalty on merit. But they are apt, from their nature, to be abused, and their value lessened, by being given away in numbers.

Amicus.—Yes; you see very queer people, indeed, in France decorated with the Legion of Honour! I hope if the "Order of Merit," the "O. M." attached to the name, be eventually created here, which has been so often spoken of as our forthcoming decoration for *intellect*, in contradistinction to the knighthood so often bestowed, on mere occasion, that it will be given away more charily and carefully than its analogous antecedent has been in the course of years in France.

Magister.—It is evident, however, that this distinction has been given in some cases by the Emperor, at the last moment, to make up some of the lapses of the juries. Our monarch had no such recourse on the occasion of the '51 Exhibition in Hyde Park.

Amicus.—No; the knighthoods and C. B.'s were not conferred for that reason, but perhaps it was not then so much wanted, for we did not err. I believe, in retaining the lion's share of the rewards for our own country; at any rate, I heard it said in many quarters that our juries rather gave the down-scale to foreigners, especially in Art-manufactures, and Art itself, in as far as sculpture could repre-

sent it; and, perhaps, it was much better it was so.

Magister.—Up to a certain point the feeling dictating that is very well, but if acted on to any great extent, it is productive of serious harm, for our competitors are not apt to give us much credit for generosity, or to rank us higher than we place ourselves. As medals were then decided on—although the last act of the lamented Sir Robert Peel was to reduce them all to bronze ones, showing his animus against them—as medals were then unfortunately decided, for their adjudication was the least satisfactory thing about the whole Exhibition—the best thing (as it is in all cases) would have been to have adhered to exact truth and justice, as far as possible, without turning to the right or left, and without any Quixotic generosity.

Amicus.—Yes, there are certain things in which the Briton is apt to be overweening of himself and his country, but certainly estimation of native Art is not one of these. In his own idea he can fight better than any one else, if he is put to it, although he also deems he is very peaceable, which delusion he illustrates by being in almost every war through the world. He thinks, also, that he can produce the staple of manufacture and machinery better than any other nation under the sun; and it is, perhaps, from a secret feeling that he is a little presumptuous in these claims, and from a desire to make up for it, that he is ready to sacrifice all the pretensions of his own country to Art or Music. He fancies he understands his own character, and that he is a strong-minded, sensible, courageous, beef-fed person,

"Broadcloth without, and a warm heart within," who can, as far as substantialities go, take the van of all the world; but, as to the lighter elegancies, he is very magnanimous in trumpeting forth his own inabilities, and sacrificing at the shrine of this apparent liberality the hopes of many of his own sons, who are striving head and hand to make up the deficiencies of which his loud voice seems almost to boast. Is it not so?

Magister.—The real Art-knowledge that is now spreading slowly but surely in this country is tending, I trust, to silence this cry, and induce people to take fairer views. Appropos of what we have been talking of, I see a strong element of hope of this in the way in which the adjudication of awards on this occasion has been taken in this country, not only by the body of artists, but by the press and the public, who have anything but endorsed the decisions. Indeed the bill drawn on our belief has assuredly not been honoured. This evident reaction is an evidence of the growing consciousness of the substantial qualities and truthful unaffected vigour of our own style of art, for, after all, a country must be true to itself, to do great things in any way, and it must be mainly the patron of its own Art if it is to retain and develop fully a national style: at least it was so with the Greeks and Italians, &c.

Amicus.—But excuse my again recurring to these awards. Do you consider the mistakes and omissions that were undoubtedly made on this late occasion arose from carelessness or want of judgment on the part of the juries; or was there any settled plan that gave rise to the result; and were our artists to blame?

Magister.—I will first premise that our artists were, perhaps, rather inclined to hang back on the threshold of the proposition, when first invited to take part in the Paris Exhibition. They were somewhat slow, perhaps, to be imbued with the importance of the great *concoers*, and this had some effect, doubtless, on the eventual show they made. On the other hand, as regards the action of the French juries, doubtless they were not prepared to witness so much individuality and progress in English Art, and there was at first a disposition to smile at us as eccentrics, but the Nature in the British works was not to be suiled down, and so the affair took this turn: they ceded by allowing us merit in the lower branches of Art, and giving us seats on the lower forms, but kept all the high seats of Art for themselves. The British, they were fair to convey, are not great artists in the highest sense of the word: they fall in the poetic, the

historic, and epic; but in the quaint representation of every-day life and of every-day things we allow their excellence. They smiled approvingly—although here and there a strange want of recognition was even here shown—on our landscapes, our portraits, and our dogs and horses, &c., but bristled up in opposition at any approach on our part to the "heights" of Parnassus. We might gambol as much as we liked in the meadows below, but must not presume to ascend the hill. "That is your region, this is ours," was the secret watchword; this was the stamp desired to be impressed on British Art,—and this is, I believe, the clue that will unravel the labyrinth of the awards—The Key of the Mystery, and one that will fit pretty nearly every case throughout the painting decisions, and is especially indicated by the case of the British sculpture as a mass—which, being composed nearly wholly of poetic works, they put out of court altogether. Moreover, I may add that these views were especially emphasised by their signal notice of what has been called the "jockey part" of our contributions, the highest rewards having been bestowed both in oil and water colours, on pictures of animals!

Amicus.—Truly we are a sporting nation, and this is one of the very few points on which the French are ready to look up to us, and so they thought, perhaps, this would give a sort of psychological truth to their decisions.

Magister.—And thus to be greeted at least with "si non o vero e ben trovato." But it is best for us to forget all about it. I am sure we forgive it already, and shall never treat a French picture the worse in any exhibition of ours from a remembrance of the mistakes of '55.

Amicus.—In the kindred branch of Art-manufactures, how do the awards to the British bear reviewing, or give satisfaction?

Magister.—I believe, on the whole, better; I could not, however, but remark that it was those among our Art-manufacturers who employ the most French hands that were selected for reward.

Amicus.—But there may be some just reason for that.

Magister.—We will not enter on that now. One fact, gratifying and flattering to ourselves, I thoroughly believe: our immediate neighbours have a very different appreciation of our Art now than they had before the Exhibition, and they would be prepared to give a very different welcome to it on another occasion.

Amicus.—Do you, then, think our artists would join in another such exhibition?

Magister.—If there were no medals of merit, I believe they would, but not just now; we have had enough of great exhibitions for the present. Suppose, however, such an occasion were to occur again within a few years. A medal of recognition and thanks to each exhibitor would be very well, and also that careful reports should be drawn up of a readable and popular nature, and not in the "blue book" style, of each class of Art and Industry displayed. I would have all the hitherto expense of medals of merit applied to these purposes, and to the affording increased facilities for appreciating all that might be seen and learnt on such an occasion. As it was, my feeling as to the great Paris Exhibition of the year 1855 is cordial thanks for the opportunities it afforded me, and the benefit I derived from it. I am only sorry we did not meet there.

Amicus.—We missed only by a day or two; but there is a pleasure in comparing notes now. I was told during my stay that there is a growing feeling in Paris that France has seen her best days in Art generally, and that she is not improving; that she is too commercial, and works now more *pour la poche* than *pour la gloire*.

Magister.—It may be that other nations are coming more up to her, or that she has more opportunity of seeing what they have done and are doing; but I see no signs of any falling off in the oil-paintings, although it may, perhaps, apply to some other parts of Art, such as small sculpture and ornamental decorative works of the various kinds that Paris makes for the world. The historic oil-paintings of the present day in Paris are quite up to the mark of former times; and various other branches of Art, comparatively

novel, appear to be followed even more successfully than heretofore.

Amicus.—But do you consider French taste healthy in Art?

Magister.—Healthy for us? Ah! that is a large subject, which we will not enter on now, for the daylight is very short this time of the year, especially for us brethren of the brush, with the spring exhibition in the horizon.

Amicus.—

"You see a hand I cannot see,
That beckons you away."

a hand holding one of Messrs. Robertson's best brushes? *Au revoir.*

RECOLLECTIONS OF DANNECKER.

THERE are few things more pleasant to behold than a healthy, happy old age. And when, added to contentment for the experience and the many blessings that a long life has brought, we find a lively sense for the beautiful in nature and in Art—the mind still fresh, though the body be fading—the charm is then quite irresistible: we are drawn towards such a one with reverential affection, and forget in converse with him the wide space that lies between youth and age. And it seems the especial privilege of genius to remain thus ever young. It is the fresh spring imparting everlasting youth.

Our Dannecker had this divine gift been bestowed. At near 80 years of age he possessed the warmth of feeling, the elasticity of mind, the pleasurable sense of the beautiful, which we generally look for but in hopeful manhood. He loved to be with the young, and to see and hear their enthusiasm; for his years pressed not heavily upon him, and at heart he felt as fresh and as buoyant as they; and his undimmed eye would sparkle, and over his countenance a flush of brightness would spread, as he talked of what he had done; and by his manner, his voice, and his words, one might have supposed that he was about to start upon the race, and not that it was already run. There was a fire within that prevented the ice of winter from forming. The genial warmth kept not only the blood in his veins, but his affections and sympathies in a strong and equal flow. The selfishness that comes upon us by age he seemed to have shaken from him. He was keenly alive to the remembrance of past friendship, and when he spoke of Schiller it was with all the intensity and fervour of a first love. His name recalled at once the days when they were together. Schiller was again in his presence, radiant and full of life, and the separation of years and of the grave had dwindled down into a recent yesterday. "He was his dearest friend," he said; "they had studied together—here at Stuttgart—at a school that the king had founded." And all the circumstances attendant on making the bust of his friend flashed at once on his mind. "Schiller said to me, 'You must make my portrait,'" so the happy old man began to relate, "and I answered 'Yes, I will: come to me to-morrow morning early,'" he continued, with an arch look, as if pleased at having managed it so cleverly; "I told him to come early, because I knew that he would then be fresh, and by thus coming to me he would be obliged to go into the open air, for he did not live very near me, and would have some distance to walk. And so he came, and he was excited and pleased, and when he entered my room with a light elastic step—his eye bright, and his whole countenance fresh and cheerful, and his hair off his temples—I determined to make him as he then looked; just as he was when he came in asking for me."

I remarked to Dannecker, that Schiller's brother, who was still living, was very like his bust.

"Yes," he answered, "but much stouter. 'He is a man who rides, and walks, and shoots, and goes about, and is much in the open air, and is out early of a morning, and that makes a man look hardy, doesn't it?' But Schiller," he continued, "studied all day long, and night too, sometimes, and so he was thin," he observed,

putting his hand to his face, and drawing it down over his cheeks. "Have we nothing of Schiller up-stairs," he asked of his wife, in order that he might show it me; but it seemed there was nothing that had belonged to him at hand.

The bust of Schiller was in a small room adjoining that one where the other works of the sculptor were arranged. It was veiled. On removing the covering, you might perhaps be struck by the size of the bust, which was much larger than life. But what a majestic countenance! How full of life,—beaming, too, with expression of the noblest kind! How large the forehead, how high and capacious, extending unthinkingly to the very temples, uncovered by the blown-back hair! The temple is undulating, and you see the full vein creeping underneath. In the month there is great benevolence and sweetness, and his expression is gentle and benign. The face is full of "traits," and you soon understand that it was not possible to make it on a smaller scale.

A strange feeling possessed me when in that lonely room, in presence of the veiled bust, and I trod cautiously, as though moving along a chamber where the remains of one whom I had loved were lying.

Dannecker was of short stature, but hale and hearty, although so old. His face was rather flushed, like that of a man who has lived much in the open air. His eye—what fire and lustre were there! His whole countenance was brightened by it. He had gray hair, which fell back in long, venerable locks. His forehead was broad, and resembled Schiller's, except that it did not extend, like his, to the very temples.

He spoke about Art and of Rome. Putting his face close to mine he said, whispering rather in an earnest manner, "These feet of mine carried me to Paris, and then to Rome. Yes, I was four years at Rome; I should have liked to stay longer, but I could not; the king sent for me to come back." And by his manner it was clear that though he would have preferred to stay at Rome, he felt pride and pleasure in being recalled to his native country by his sovereign. "I was sorry to quit Rome," he added, "but I was very grateful to his Majesty."

Of Schiller's bust he said that he would not part with it, that he should always keep it by him. "It shall not leave the country; it must remain in Germany, in this land of Wurttemberg. It shall remain here in Stuttgart," he exclaimed with the greatest energy, his fine eye sparkling with a look of triumph, as though he felt that his name and Schiller's would hereafter be mentioned together, and be united in the memories of their countrymen. He told me he had been often asked to sell the bust, but he would not; "Nothing in the world should make him do so. No," he said, "I must keep it."

When Lady Murray was at Stuttgart, she went often to visit Dannecker. He said, "She has a work of mine, Psyche. She was a great friend of sculpture. Here," pointing to an engraving of one of Canova's works, "Canova sent me that. Lady Murray brought it from Rome. How beautiful it is! How fine that hand pointing to heaven, and this drapery, too! Oh, Canova was a most lovable man; he was so good and so friendly. And he was merry, too, and full of life. Sometimes he would run into my room on tiptoe to surprise me," and as he told me this, his eyes sparkled with pleasure at the recollection of those happy days. "Oh, yes," he added, "Canova was a kind man!"

On taking leave of Dannecker, I asked permission to come again, a request which he readily granted. "Certainly, come when you like." The man who was at work below told me that during the last six months Dannecker had done nothing; but that no piece of sculpture ever left his house without his own hands having worked at it. There was one most beautiful work there, a recumbent figure of Sappho. He had sold this; but he had caused it to be rebought. How artist-like—how like my own dear friend, John Constable!

Friday, June 18th, 1837.

Went again to Dannecker's. He was at the window in his usual white jacket and white

waistcoat, as I crossed over to his house. After I had been some time in his atelier, he joined me there. I was in the little room where the bust of Schiller was placed, and sitting before it. After he had shaken hands and shut the room door, which he had left open on entering, he seated himself beside me before the bust. After a while he rose, and standing on tiptoe told me to do the same, and so look at the bust from above. Then I was to look up at it, and then into the face, and then at it in profile. It seemed as if, while looking on that countenance, the gulf which was between them was forgotten.

He afterwards spoke of his "Ariadne," and asked if I had seen it. I told him I often went to look at it. "It was quite by chance," he said, "that I came to do it. It was a curious circumstance. At that time I had my atelier in the palace, and there was a young girl there the most beautifully formed of any I knew. So I asked her if she would sit to me. She said 'Yes,' and she did so with drapery. I then asked her if she would sit to me uncovered. She said she would, if I would make something particularly fine. Well, I came home and thought about it, and at last I determined she should be an Ariadne. I made a sketch, and I said," (speaking with much energy and fire), "she shall sit upon a panther. And so I made her."

There was a model of the statue in the room, and we walked round it. "Stoop down," he said, taking hold of me when we came to the feet, "stoop down, and look upwards: look how high it seems to be." And he then led me behind and made me observe the fine flowing line of the back. In the adjoining room was the beautiful figure of "Sappho." He dwelt upon it with a most complacent look. "He had sold it," he said, "but afterwards his wife rebought it. She would have it for herself: it is hers, not mine." There was, too, a group in clay of "The Fates," a mere sketch, but very fine indeed. One figure was spinning the thread; another, who was holding it, looked astonished as she turned and saw the third, who held the fatal shears, calmly sleeping. It is an exquisite group. "She ought to cut the thread," said Dannecker, "but she sleeps." "You might make something wonderfully fine of that," I observed. "Yes," he answered, in a low, significant voice, "but I have no more time!" I knew what he meant, and said nothing.

C. E.

DARTMOUTH.

CORRESPONDENCE.

To the Editor of "THE ART-JOURNAL."

BOOKBINDING.

SIR,—Since symmetry is so commonly allowed to be a main element of beauty, I have often wondered that so little attention should be given to it in the binding of books, and especially in the divisions and lettering of their backs. We have books with backs of sundry numbers of divisions, from four to seven, though they are most frequently five or six, and with lettering-pieces at divers places, from the middle division of the odd numbers, to the uppermost but one of all of them; and we have books in boards and cloth, with lettering-pieces of seemingly accidental widths, if they are at all commensurate with the backs of the book, and placed at heights which bear no intelligible proportion to those of the volumes to which they are attached. I have lately applied harmonic proportion to the back-binding of books, dividing the back into six band-spaces, and placing the lettering-piece on the third from the top. Then, if we call the whole height of the book 1, the space below the lettering-piece will be $\frac{2}{3}$ or $\frac{1}{3}$; the space above the lettering-piece will be $\frac{1}{3}$ or $\frac{2}{3}$; and the width or height of the lettering-piece itself will be $\frac{1}{3}$; and $\frac{1}{3}$, $\frac{1}{3}$, and $\frac{1}{3}$ are the reciprocals of 3, 3, and 3, which are a harmonic series. If it were useful to attach a second lettering-piece, it might be placed on the third division from the bottom, and it would still preserve the harmony of the spaces. I usually choose the respective colours of the binding and lettering-piece upon authorities afforded by nature for the juxtaposition of colours.

W. DAVENES.

DORCHESTER.

THE ROYAL PICTURES.

THE WOLF AND THE LAMB.

W. Mulready, R.A., Painter. C. W. Sharpe, Engraver.
Size of the Picture, 2 ft. by 1 ft. 8 in.

EXCEPT by a comparison of one with the other, the old maxim "Life is short and Art is long" will not apply to Mulready and his works: for more than half a century—an unusually lengthened period in Art-life—he has devoted himself to his profession, with an assiduity and zeal rarely known; and each year of that term has, almost without interval, produced something that will perpetuate his name among the great painters of the world. And the most remarkable feature in his career is that with advancing years he appears to have been imbued with increased powers; his whole life seems to have been one of progress towards perfection, as if he felt that he had always something to learn—that there was some point of excellence to be reached which, as yet, he had not attained to. Half the secret of his success may be traced to the manner in which he embarked on his course; he set out with certain defined principles of action, so to speak, and to these he has constantly adhered, so that the differences which the various epochs of his Art may show are not alterations of style, but progress in that he commenced with. Colour and execution are the results at which he aimed; and if we examine a picture of any single year, we shall find it was the best he was capable of producing at that particular period, his latest works being those wherein these two qualities are the most conspicuous; while even his earliest pictures exhibit a depth and force of colour which are found in the productions of other painters only after a life-time of severe study. We remember seeing at the Royal Academy, a very few years ago, two little pictures—views at Kensington, which were painted in 1813; they are simple scenes, but so extraordinary in execution and feeling, as to place them at once on a level with the very best works of their class of any age or country.

Yet it must not be supposed that Mulready's art is limited to the mere materialism of painting, and that he has had no higher motive than to excite admiration by the brilliancy of his colouring, or surprise at the elaborateness of his manipulation: in these qualities some of the old Dutch masters may equal, though none surpass him. His humour is rich, natural, and delicate; his sentimental narrative, graceful and touching; so that we scarcely know to which class of subject to give the preference. Both are studies not only for the artist, but for those who desire to read the philosophy of human life; the former will find in them the very highest qualities of his Art, and the latter will discover, among the groups that make up his subjects, something beyond the types and shadows of individual character. Mulready is the "Esop" of painters, inasmuch as beneath all his figurative expressions lies the moral of truth, fashioned indeed after the similitude of a fable, but easily discerned and applied.

What a story, for example, is told in the picture of "The Wolf and the Lamb," already well-known from the engraving by Mr. J. H. Robinson, published many years since, the plate of which is, however, destroyed. That wolfish boy—he has outgrown everything he wears—is the terror of all in the village; he is always ready to do battle, save in a righteous cause, and when his opponent is bigger than himself; his hair, his collar, his coat, and his sleeves, are all turned back, expressive of defiance; in his hands to place himself in a fighting attitude, or more properly speaking in a bullying attitude, he has burst the strap of his trousers, while his countenance exhibits the most perfect embodiment of juvenile tyranny. The other, a meek-looking—but, we will venture to assert, a well-disposed lad—is possibly "the only son of his mother, and she a widow;" the little girl is his sister, whose cries for assistance have brought their parent to the door of the cottage to rescue the "Lamb" from the fangs of the "Wolf." The whole picture is full of natural incident expressed in the most felicitous manner.

It is in the collection at Buckingham Palace.

OBITUARY.

JEAN PIERRE DAVID (D'ANGERS).

THE French papers announce the death—on the 6th of January, at Paris—of this eminent sculptor, whose name ranks among the highest of his native school.

In the *Art-Journal* of August, 1847, appeared a long biographical sketch of him and his works. We must extract from this history the principal events of a long and well-spent life, referring our readers who desire acquaintance with its details to the previous account of John Pierre David was born at Angers on the 12th of March, 1793. His father, a wood sculptor, was unwilling to subject his son to a profession from which he himself was able to procure only a comparatively scanty provision for a large family. All opposition, however, to the strong inclination of the lad, who would be a sculptor, proved fruitless—he had attempted to destroy himself because he felt he would not yield to his entreaties—till at last he left home with the blessings of his parents to encourage him, and entered Paris at the age of eighteen, with nine francs in his pocket, the whole capital wherewith to commence his career of art. Soon after his arrival in Paris he attended the ateliers of his namesake, David, the painter, and of Boland, the sculptor, within eighteen months of his quitting home, he had gained a medal at the French Academy, and been favourably noticed by the various professors. In 1809, his native town voted him an annuity of 600 francs to enable him the better to prosecute his studies. In 1810, he bore off the prize for the "Head of Expression," and the second prize for sculpture; and in the year following the great prize, that of Rome, was awarded to him for his relief of the "Death of Epaminondas." During his five years of study at Rome, as pensioner of the Academy, he attracted the attention of Canova, who thought very highly of the talents of the young Frenchman, and whose works were held by David in the greatest veneration. When the latter returned to Paris, in 1816, the sight of the restoration of the Bourbons—for he was an ardent Napoleonist—and of the allied forces at the gates of the city, induced him to come to London, trusting that through Flaxman he might find the opportunity of dedicating his genius to Britain. Flaxman, however, took it into his head that this young sculptor was somewhat or other related to David, the painter, whose ultra-republican principles he detested. Flaxman gave him a cold reception, so there was no hope for him in that quarter; and an offer, as it was said at the time, which was made to him by some individual in high position to erect the Waterloo Column, so disconcerted him that he immediately sold all he had brought over with him, and returned to Paris.

Once more in his native country he set earnestly to work, leaving politics to take care of themselves, notwithstanding he still retained his strong party feelings. We can only enumerate his principal works in the order, or nearly so, in which they were executed. His first great work was a statue of Ganké, placed in the first instance on the bridge of Louis XV., and subsequently transplanted to Versailles; this was followed by a group of "Christ, the Virgin, and St. John," for his native town; the "Twelve Apostles" for the chapel of the palace at Vincennes; four bas-reliefs for Fontainebleau; a frieze, 104 feet in length, for the Place Bastille, since removed to the Arch of Triumph at Marselles; the statue of "Reni, the Good," King of Sicily, at Aix; three bas-reliefs and a statue of Fenelon, at Cambay; a statue of the Vendean hero, Bouchamps, in the church of St. Florent; a monumental statue of General Foy, with four bas-reliefs, at Péro-la-Chaise—a grottoous work of the sculptor's; statues of Carnaille, at Rouen; of Carrier, at Montbeliard, and at the Jardin des Plantes; of Jefferson, at Philadelphia; of Talma, at the Théâtre Français; of Racine, at Laferté-Melon; of St. Cyr, at Péro-la-Chaise; of Carrel, at Rouen; of Philopomen, in the garden of the Tuileries; of "St. Cecilia," in the church of St. Mamet, at Angers; of Bichard, in the Hotel Dieu; of Marshals Lefevre and Suchet, &c.

The busts and medallion portraits by David are too multitudinous to particularise here; they include a large number of the most distinguished characters of Europe, contemporary with the sculptor.

In 1823, the king wished to confer on David the Cross of the Legion of Honour, but he modestly declined the honour, on the ground that he had not yet deserved it; in 1825 it was accepted. In 1826 he was elected member of the Institute, and soon after professor at the *Académie*. In 1827 he again visited England, where he was cordially received,

and where he modelled the heads of many of our distinguished countrymen. In 1829 and in 1831 he travelled into Germany, for a purpose similar to that with which he visited England. To this period of his life belongs his famous statue of Gutenberg, at Strasburg; with its powerful bas-reliefs; of Jean Bart, at Dunkirk; and the group of Xavier Bichat, at Bourg. Perhaps the statue which David most delighted in was that of Barra, a young Republican drummer, who fell in the wars of La Vendée; it was destined for the Pantheon, but was not placed there, nor do we know what has become of it.

On the wall behind the chair on which the writer is penning this brief and imperfect tribute to the memory of a great artist, hangs his portrait; it is that of a man of genius, stern, and somewhat imperious in expression, but earnest and enthusiastic. This earnestness and enthusiasm were the great features of his character, and bore him onwards to success. Sternness was far from his natural disposition, though hasty, and somewhat intolerant towards those who differed from him in politics. But he possessed the attributes of kind and generous feelings, sympathised with the distressed; was liberal towards the young and aspiring artist, and open in the avowal of his sentiments, whether to friend or enemy.

SUGGESTIONS OF SUBJECT
TO THE STUDENT IN ART.*

BY AN OLD TRAVELLER.

CHAPTER II.

The Sculptors in Council—Agesander and his Sons, Athenodoros and Polyarktes—Tucida Lambertazzi—The Brothers' Visit—The Lady's Death—In their death they were not divided—Vienna and her Lovers—Friendly Criticism, of a learned German—Our "Brandy-Maidens"—Prague and its Builders—Sidney's Safe-conduct—The Martyr's Friends—Frederick of the Palatinate—The Winter King's Banquet—Bohemian Critics in Art—Sculpture Galleries of the Vatican—The Xbis and his Children—Books of the Figures—The One Fault of our Mother-land—"Floreat Etona"—Hal has come!—John of England—The King's Justice—Alice will not marry—Sculptor or Painter—Georgina to the Rescue!—Egeria—The Camæna Listening—The Nymph in Sorrow—Hippolytus and the Dryads—Approach of Artemis—Consolation and Deliverance.

MORE frequently should those, who now uphold the empire of Art, be found offering homage to the glories of their Great departed. All honour to the artist—worthy of the name—who devotes pencil or chisel to the memory of the mighty dead, and who gives to these later times the form, the face, the living presence of one who has illumined the past.

Have we then a painter or a sculptor who can do this worthily, as regards him to whom the whole broad world is debtor for one of its richest treasures in Art?—"as regards them" perhaps, we should say, since it is of the creator of the Laocoon, of Agesander, and of his sons Athenodoros and Polyarktes, that we speak.

The sublime master and the sons who have not degenerated from such a sire—contemplating the well-nigh completed work that was to bear their names triumphantly through all time—surely these may form a company well fitted to occupy the nights and days of one whose soul, vowed to Art, can worship only in the presence of her highest manifestations; and we know that we have among us some who feel that they may aspire to treat such themes.

It is to the Sculptor that this grand and glorious Council of Sculptors would seem of right to belong, and even at this moment who shall say that its reproduction is not in the heart of one, who does but wait until he shall find such marble as he can hold to be pure enough for so lofty a work! Let the day come! but, meanwhile, we are content to accept the life-giving canvas. See only that it bear the magnificent forms of those immortal sculptors; let us have their noble heads, with the light of his genius irradiating each brow, and all praise to the painter who shall enrich the coming ages with a gift so valuable.

* Continued from p. 16.
† Called also Polydorus.



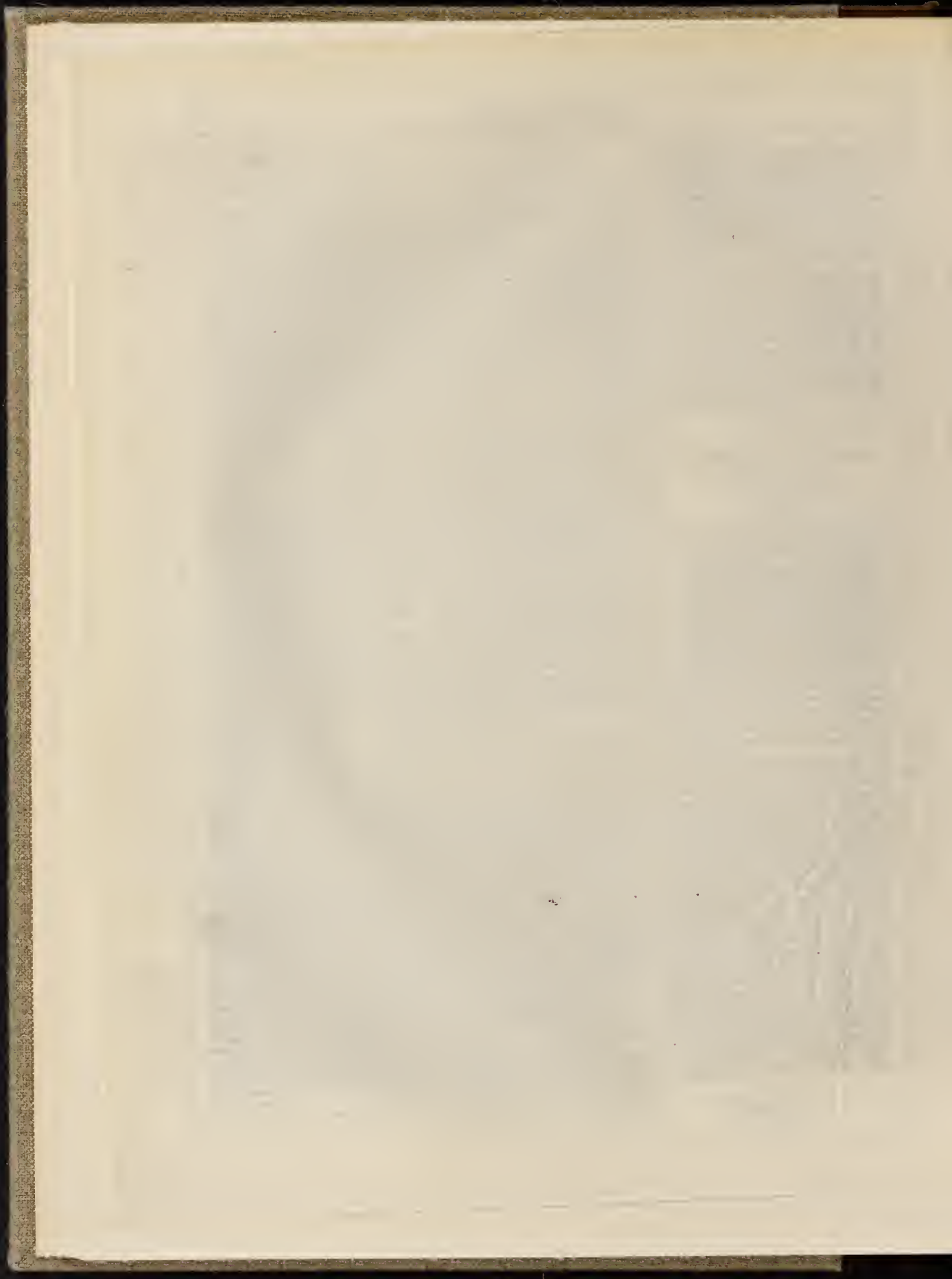



THE FINE OLD FASHIONED
THE FINE OLD FASHIONED

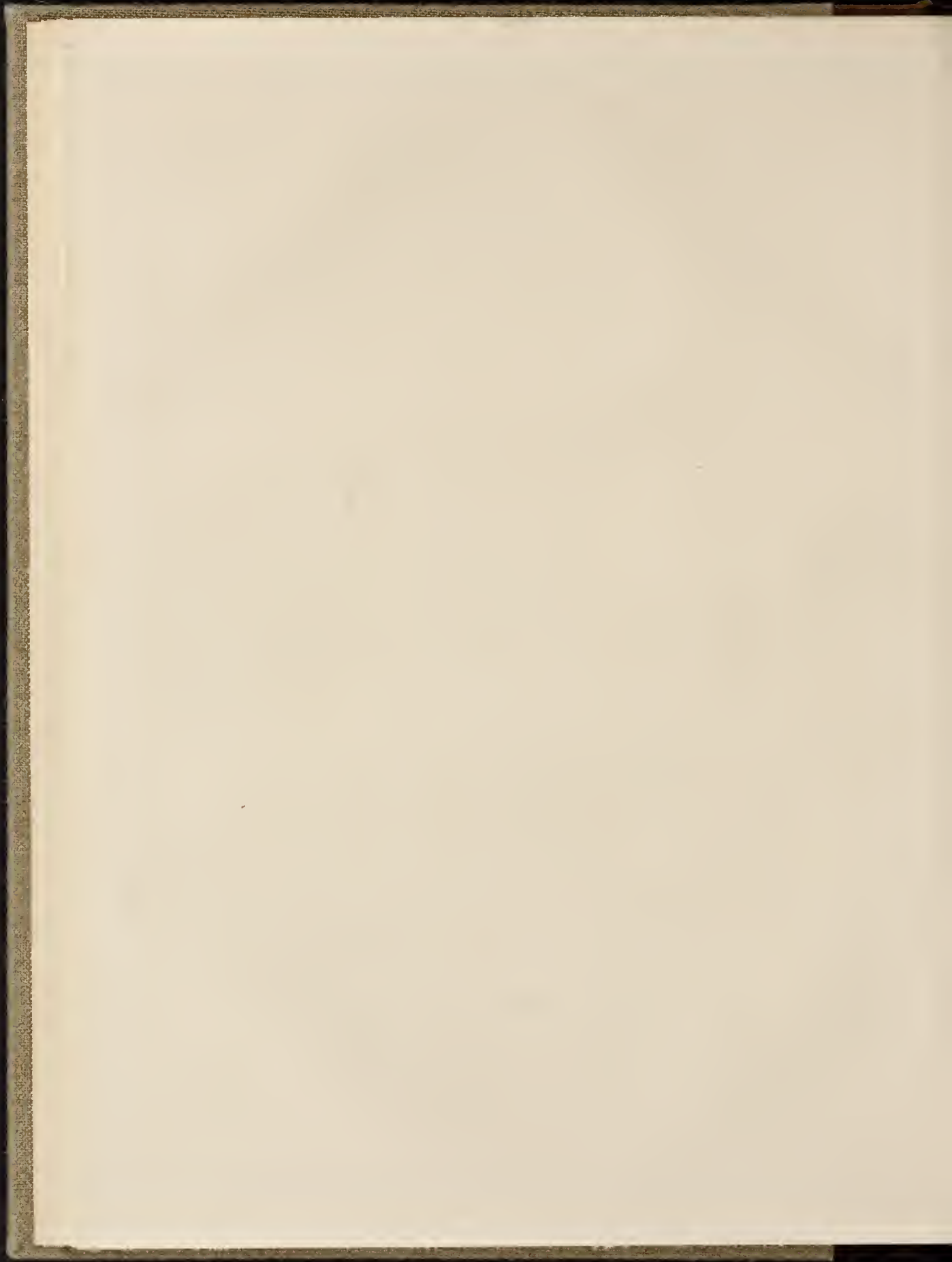

few cities, even of romance-inspiring Italy, present a richer abundance of picturesque memories than does Bologna. And among the well-authenticated story of Inelda Lambertazzi might commend itself to the student of pictorial effect with a force of appeal scarcely inferior to that of her who has made of Verona a shrine for the pilgrim of Art in all ages: but where hath been the bard to chronicle its details? "And Echo answers, where?" The history of Inelda would seem to have lain concealed beneath that dust which ever accumulates over the mere dry annalist; or, if touched on by more attractive authors, it has been so slightly, as to awaken no responsive chord in the great heart of the masses; neither will the simple mention of its unhappy close, to which our present purpose confines us, be more than the driest detail of facts,* yet from these may the painter assuredly derive some matter for his musings.

Inelda Lambertazzi was a daughter of that family whose then chief was the head of the Ghibelline faction in Bologna, yet she had met, and fatally been taught to love by the young Bonifazio Geremei, whose noble horse stood paramount among the most zealous of the Guelphic party. A secret marriage had united the lovers; but their stolen meetings were betrayed to the family of Inelda by the treachery of one she trusted; and her brothers, forcing their way into her apartments, attacked the unarmed Geremei with their daggers. Declaring to their sister that their weapons were poisoned, they thus sought to deter the unhappy lady from placing her own slight form between themselves and their victim. But the warning proved vain. Inelda threw herself before her husband, and is supposed to have received some injury from the poisoned daggers. Be this as it may, Geremei was despatched, and his body was dragged to a distant part of the palace, where the murderers left it in a vaulted chamber, there to await some more convenient season for burial.

They had been followed by a dwarf in the service of Inelda; and this poor creature, returning to his mistress with tidings of the place where her husband's corpse was laid, conducted her to the vault, when the means by which Eleonora of Castille is popularly, but erroneously, said to have saved the life of our own Edward I. in the Holy Land, were eagerly adopted by the unfortunate Inelda. And her happy husband did awake to consciousness; but it was only to acquire the certainty that his wife had sacrificed herself in the vain hope of saving him. The poison she had inhaled, aided, perhaps, by that received from the weapons of her brothers, had already begun to produce its effect; and the priest, who had performed their marriage rite, sought by the faithful dwarf, could but arrive in time to discover the pair so fondly united in their lives, thus dying together. From his hands they received the consolations of religion; and the last sigh of Geremei was exhaled in a blessing on the wife who had so dearly proved her faith. The feeble arms of the expiring Inelda were then twined around her insensible lord,—both happy, at least, in that they were delivered from the pains of separation by the pitying hand of death.

More than one of Inelda's compatriots, with whom these incidents have been discussed, in the city of her abode, have pointed out moments in the same, well calculated to attract the notice of the painter. These have varied as differed the tastes and feelings of the speakers; but all have agreed that many pictures were to be found in the story; their selection and treatment we leave to the artist.

"Rich and rare," without doubt, are the attractions of the Austrian capital; yet they have, for the most part, received their full meed of praise, and in some instances have been lauded much beyond their deserts. Vienna is a brilliant city, nevertheless, and "abstraction faite" of all the

* The writer thinks it possible that some mention of Inelda Lambertazzi may be made in Rogers's "Italy," but has not the book at hand to ascertain the truth of this conjecture.

exaggerated eulogies bestowed on her by the more ardent of her lovers. Fair collections in Art enrich the princely palaces of her great nobles; and the courtesy with which these are offered to the inspection of the foreign guest, is no slight addition to the pleasure they convey.

Revisiting one of the most important of these collections, after the lapse of some years, the present writer listened, with pride and gratification, to the admiration expressed for the Galleries of our own high Magnates, by one whose fat is, in such matters, held to be conclusive. But the remarks of the same speaker, on our periodical exhibitions—those of the Royal Academy and other institutions, that is to say—although pleasing in the main, were, in certain respects, less flattering to the English ears of his auditor, while the impression they made was all the more lasting, from the known disposition of the reluctant censor to see every thing produced by England "en beau." The undeniable justice of these friendly strictures gave them added force. Let us try if we cannot profit by them.

"Why will so many of your really clever painters give themselves to the delineation of fat red boys eating what you call *the darning*, or to that of your 'brandy-maidens' *à la jeunesse omne!*" quoth my colloquist, not exactly familiar with our idiom, but coming, nevertheless, very near the true character of the subjects depicted.

"You would surely not prohibit incidents of ordinary life?" returned his interlocutor, knowing well that he had no such desire, but unprepared at the moment with any better defence.

"Certainly not; but neither will I permit them to push all other incidents from their stools," was the smiling rejoinder. "Here have I been delighting myself with the many great and excellent qualities exhibited by your artists in the —, and the —, and the —," he exclaimed, in continuance, running over the names of some half-dozen among our exhibitions of that year, "but in every one I find more or less cause to regret the predominance of the subjects in question, while you neglect another class of themes, to which no school of painters could do more effectual justice than your own."

"I do not mean the Grand Historical," he continued, referring to an remark he had been previously making, "but rather to what we will, if you please, call the Domestic History of Nations. And I ask you if your annals are not amply rich in events of interest worthy to be commemorated?" They are, without doubt. And the earnest speaker rapidly adduced several more or less familiar incidents from our history, in proof of his assertion. "Is it, then, that your artists do not read, or must we suppose that the brandy-girl appeals with more success to your national tastes? Ah! it is not brandy she wills to give you!—perhaps not; but do not let us split straw (this in reply to a most stupid attempt at explanation on the part of his companion—mine unworthy self, *ridiculous*). I grant you, too, that she is piquante and pretty, that sherry-girl, since you say I must not call her a brandy-maiden, she does veritably offer 'an excuse for the glass;'* as your good comrade has it; but your able artists should more frequently do themselves the justice of handling higher themes. You have seen the exhibition at — this year, I know, and at —, and at —, and I think also at —?" And my interrogator enumerated certain continental cities, not of the first class, whose academies he had recently visited. It was true, I had seen them all, but of the exhibition in the last-mentioned, I insisted that it was not worthy to be named with the least meritorious of our own.

To this my friend agreed; but he added, "It is for that very reason I cite it, since *even there* I ask you if you did not see a class of subjects, whereon the genius of your artists would have produced an effect widely differing from that which justly dissatisfied you at —?"

There was no denying the fact; nor indeed

had the writer failed to remark it, or to draw the inference, as now drawn by our friendly critic, whether before or after his words had been spoken. Being at Prague, for example, some short time subsequently to the conversation here partially repeated, we were reminded of its tenor by many a pleasant example of the tendency to choosing incidents of the domestic history of their nation, evinced by the gifted painters whose works were then exhibiting in that quaint and beautiful old city. Here is one, of which the interest is common to every Protestant people of Europe.

The Bohemian painter, Jawurek, takes for his theme that most sorrowful of episodes, the judicial murder of John Huss, at Constance. He does not harrow the soul of the spectator by permitting the victim to be seen amidst the glare of those fires, kindled to prove the worthlessness of the Emperor Sigismund's safe-conduct; the point of time chosen is somewhat later: the crime has been consummated; the name of the dishonoured potentate has become the by-word of the future (for, with every tale of Imperial treachery that has since appalled the world, this deed of darkness is recalled, to *his* infamy), and we stand on that desecrated spot, where the pile of martyrdom is scarcely yet extinguished. There with us, are two grave and majestic forms, profound grief speaking from every feature of their faces, and ineffably impressing a sorrowful recollection of both on the heart of the spectator. They are but two, and the scene is but a desolate waste, from whose outraged soil they have gathered a poor handful of ashes, the mournful token which is all they can now bear to expectant Prague of that loved and treasured son, whose safety had been solemnly confided to their protection by the reluctant and anxious city. Yet is what we behold of the highest significance; for these are the bereaved friends of the martyred saint. They are the Counts Von Chlum and Von Dubé—those trusted and honoured men to whom Prague committed the guardianship of her valued teacher when she suffered him to leave the safety of her walls for what was known to be a service of danger, but from the perils of which she fondly believed him to be sheltered by the regis of Sigismund's imperial honour.

The picture is an admirable one, and presents a perpetual lesson, whether to princes or people; beautiful it is, too, and full of various merits as a work of Art; but of these we are not now to speak; it is with the subject alone that we are now occupied.

Frederick the Elector Palatine, rising from a banquet to receive intelligence of the defeat of his army at the Battle of the White Hill, is a work presented in the same exhibition. This is by Cernack, of Prague, and is of value, inasmuch as that it commemorates an event of incalculable importance—one which materially affected the destinies of Austria and of Europe; its effects on those of Protestantism many of our readers will remember. The Winter-King, as the Germans call Frederick of Bohemia, from the circumstance of his reign not extending over a longer period, is but one of many figures crowding this picture, the merits or demerits of which we do not discuss; it is the subject only that we here allude to, and that is not ill-chosen.

The compatriots of the painter reproach him for suffering the messenger of that fatal news to be adorned and perfumed before approaching the sovereign's presence; and they ask the artist wherefore the more appropriate figure of a soldier, covered with dust and worn with toil, had not rather been chosen, that so the "heart of the mystery" might at once have been laid open to the now half-doubting inquirer, who may justly demand, therefore, then, are these revelers thus startled from their festivity? This question we leave the painter to settle with his querists; but it is not without a certain pertinence.

Other pictures of similar character were treated by the artists whose works adorned the exhibition in question, and to some of them we may hereafter return; but, for the moment, we refrain from specifying these. Let us rather see if our own history may not furnish us with

* "Let the toast pass,
Drink to the lass,
I'll warrant she'll find an excuse for the glass."

Song of Charles in "The School for Scandal."

something of approximate, or at least of equally available kind. Our researches will assuredly not be vain. More than one occurrence, well-suited for illustration by the pencil, presents itself to the memory, and shall receive the attention due; but, first, there is a subject of somewhat different sort demanding our care.

Among the many superb halls and galleries devoted to sculpture in the palace of the Vatican, is one called the Nuovo Braccio, erected during the pontificate of Pius VII., and under the immediate superintendence of that pontiff's enlightened minister, the Cardinal Ercole Consalvi. Of priceless worth are the treasures of Art that arrest the steps of him who takes his fortunate way through even this one portion of the vast collection of sculptures assembled in the Vatican, although it is not here that the richest gems in that collection are sbrined. But we confine our remarks for the present to one only, which, if not the most exalted in conception, is at least one of the most genial in subject and perfect in execution of all contained in the gallery. This is a recumbent statue of more than colossal dimensions, and of imposing, yet most beneficent aspect; excavated from the site of a temple sacred to Isis and Serapis, when the papal chair was occupied by Leo X., and placed by him in the Vatican. This figure, believed to represent the Nile, is in itself a work of infinite majesty and beauty; but the effect of its massive proportions is enhanced by the presence of exquisite children, all clambering and sporting, with the most life-like truth and animation, over and upon the mighty limbs and enormous trunk of the colossus.

Few lovers of Art give their cordial approval to allegory; its far-fetched conceits too frequently perplex rather than gratify the beholder, and it is but the simplest form of this figure that can ever hope to enlist his true sympathies. But in this work we have the simplest form;—we must needs admit it to be an allegory, since the statue is that of a river-god, and the beautiful boys, toiling in all directions to surround his colossal form, represent the sixteen cubits which are the desired extent of the Nile's annual increase, yet, so slight are the intimations of allegorical allusion, so pure and simply grand is the conception of the work, that you are at liberty to forget the fact that it is allegory, and may resign yourself without interruption to the charming spectacle before you.

The god himself is a figure of rare perfection; the head is crowned with ears of corn, and flowers of the water-lily; a beard of magnificent amplitude flows over the breast, and the face has a most heart-winning expression of benevolence, in the highest sense of that much-abused word.

But the boys! the beautiful children! what a delight are they! you might furnish forth a total gallery by merely copying those life-like groups,—merely copying, did I say—now I would that some half-dozen of our artists would set themselves to do it! we might then hope for a collection such as we are else little likely to obtain.

"The boys," you will say, "the boys! let us see what they are doing;" and you are right, they amply justify your impatience to look more closely at the animated pictures they are making for us. The grace and beauty of their infantile forms and eager faces, you will imagine; words could do nothing towards describing these. As to their object in life, that is to obtain high place on the marble world presented to them by the vast figure of the god. No idle waiters upon fortune are they. It is true that one of them has been led away by the false hope that he may reach the top of the ladder before he has set a prudent foot on the lower rounds, but you see that disappointment awaits him; disdaining to join his companions, who are toiling to get a first step on the mighty foot, this man has laid a covetous grasp on the extreme points of the long flowing beard, and seeks to drag himself up by the massive bandful which his uptoe efforts have enabled him to reach. But, no; it is not thus that the head is to be gained—another moment will see him stranded on his back, and

certain of this, you turn to see how the rest are "shaping." Some—legitimate labourers these—have attained, after due effort, to eminent places on different parts of the limbs, and even of the trunk; one among them is amusing himself with the useless toil of a comrade, who is seeking to mount at the knee. The others are strenuously pursuing their upward path.

At the foot is a wee man who cannot make up his mind to try; the effort is too difficult! he is cogitating the matter, with grave looks that sit comically on the baby face of him, but above,—and already making progress up that long and steep ascent, the right leg,—are good friends of his, who look back with encouraging gestures. Wait awhile; he'll begin presently; their good counsel cannot but prevail.

On the mountain of a shoulder sits one who has made his way to that glorious eminence by many a brave effort oftentimes renewed, he you are sure of that. So there he sits and takes breath awhile. Another, whose head appears below the neck, and who is in a truly perilous position, has his two arms clasped round a cable-like lock of the river-god's hair; but how, even with that solid holdfast, he is to establish those struggling limbs on the point he is aiming for on the powerful neck, does not yet appear. Fast approaching the enviable occupant of the shoulder is another successful aspirant; he holds a lotus in his hand, and is extending it towards a comrade less advanced, with an expression that says "Keep good heart, man! it is to be done."

But the monarch and glory of that gladsome troop, the observed of all observers, is one who has not only reached the broad table-land of the river-god's head, but has actually stepped thence into the Cornucopia which Nilus holds in his large left arm. Yes, he has seated himself there—even there—and the pride of his heart may be well nigh seen to quiver through every beautiful part of his exquisite form. One plump foot pressing firmly on the edge of his well-won eyrie, he sits with head erect, his round arms folded on his baby bosom, while the charming face comes forth from the rich curling locks, thrown back in his triumph, with a frank demand for sympathy in his gladness that no heart of man could resist.

In front of the god is a crocodile, whom one of the children raises his hand to strike, but a second interposing, begs for mercy, and a third tries to urge the creature into motion; two others stand gravely considering what manner of animal the playmate of their comrades may be.

Near the right foot of the statue lies one idle beauty, who does not care to emulate the toils of his brethren, he prefers to sport with the flowers that bloom on the river-god's couch. One might say—"let us hope that he may tak' a thought, an' mend—;" but see! he is doing his best to drag down the good steady man who has won his way to the ankle, which he bestrides with a solemn satisfaction, showing how he hath not accomplished so much without his pains. Surely the fruit of all that labour will not be lost! he cannot suffer himself to be dragged back! let us see what comes of the struggle! No; the sensible plodding fellow has resisted,—he will not hear the voice of the charmer, and another wretch shall free his foot from the tempter's grasp.

And now, to say something respecting the life-like truth and animation of all these groups, would seem due to them, and would be but the barest justice; but nothing short of beholding them for yourselves could give you even a faint idea of their varied perfections;—the joyous alacrity of some, the earnest gravity of others, the perfect life of motion exhibited by all, and the charm of grace and beauty pervading every part, all this could not be worthily described in words, wherefore I will not waste your time in the vain attempt.

The base of the statue is adorned with sculptures appropriate to the subject; among them are Barks manned by Pigmies,—celebrated by Pliny for their boldness in chase of the various creatures inhabiting the Nile,—and figures of the sacred ibis, with a combat between the crocodile and the hippopotamus. The execution of the whole work is admirable, and if one could ever be tempted to feel dissatisfied with the present

Rome, it would be when thinking of what the glorious city must have been, when such were to be seen abounding in all her public ways.

If there be a fault in the sweet mother-land,—and when this question is discussed, we are never able cordially to support the affirmative proposition—but if there be a fault, it must assuredly be found in that coy reluctance, wherewith alone the blessed sun permits us to behold his comely features, through the larger portion of the year. Grim, grey, and wholly inapprecious are the veils heind which he, for the most part, conceals the splendours we would so fain be daily worshipping, and for this it is that we do sometimes cast looks of regret towards certain of those more favoured regions, wherewith his eyes of glory are less unwillingly bent. Nay, are we not sometimes moved to the degree of rushing forth, and of putting between this our well-loved mother, and our shivering selves, that belt of waters wherewith her excellences and her beauties are girdled in from the "broad profane" of the outer world? We are, there is no denying it; but then, it is ever in chase of a gleam of sunshine, nothing less potentially attractive could lure us from her side. No, "by him who sleeps in Phycis," we go for the sun, and the sun alone, nor could we find it in our heart to expatriate ourselves, once for all,—would it be for aught save the love of his "beaux yeux."

Not that even this would avail to produce the effect. We would make visits to other lands—many and often—but for persistent abode, or even for protracted residence, give us the land of our fathers. England, and no other, is emphatically the place for an Englishman; this is his home, though his tendency to wandering be of somewhat frequent recurrence, and granting that his outbreaks do occasionally take him far afield.

For admitting that we becom ourselves, and break our hearts over the unkindness of Dan Phœbus,—or that we scowl at his obduracy with a visage dark as the sky, through precious weeks and months, while those lazy Palermitans, Ischioters, or Calabreses, with many another ragged rogue of our worshipful acquaintance, he basking in his rays, have we not the sunshine of our hearths to dry our tears withal? and where, in all the world, shall be found a consolation—though your grief be of that depth which is justified only by the lack of blue skies—where shall be found a consolation so complete in all its aspects as is the glow of our English fireside!

"The bonny bright blink o' my ain."

We all know the rest, and fair bide the memory of the poet who so cheerily sung and said it. For the love of this, then, let us still hold fast by the land of our birth,—its grim grey skies and all.

And having agreed to do that, why may we not more frequently warm up our galleries by some of those "exquisite reasons" wherewith we are so amply provided as excuse for our determination? Here, for example, is one out of hundreds at this moment presenting themselves in the fair homesteads of England, that must appeal to the hearts of thousands, and if you will but give us their simple history, as you may see it proceeding before your eyes in the goodly halls of a family that need by no means be specified, seeing that its name is Legion in our land, you will merit well of all whose sufferings are worth the asking, and need not go farther from home for your subject this time.

"Florent Etona!" are the words of greeting uttered with beaming countenance, and in the most cheery of tones, by a true Englishman, standing on his own hearthstone, to the right noble-looking heir of his house, to the right room within which his way to the magnificent room within which he remains,—and we with him,—by the two sweet sisters hastening down a splendid staircase, also visible from our "post of vantage."

The bright face of the young Etonian, up-turned to meet their glance, gives us fair opportunity for marking the frankness and truth of his brow: the clear intelligence of his eyes, the

force implied in that well-formed chin, with the mingled firmness and sweetness of the mouth, are alike revealed by this attitude, while there is a beautiful expression of heart-warm affection now lightening over all these features, as he replies to the looks of love showering down upon him from those fair heads bending over the massive balustrade; their silky locks half conceal the faces, which are, besides, turned to him, and not for us.

His lithic elastic figure has meanwhile not ceased its forward movement, even now will he clasp those glad sisters in his embrace, and that before they have well gained the lowermost stair.

"Hal has come! he has come!" cries exultingly a much younger boy, who has rushed before him into their father's arms, with the news. Long emancipated from the inglorious dominion of "my sisters' governess," this fine member of our family gathering is the faithful satellite of his brother. He has inherited Hal's pony, since the latter assumed that most envied of thrones, the "Pigskin" (but not as yet the "Pink") on the clever mare always found in so good a place with the Cottesmore hounds last season; and in his secret soul has that urethru vowed to emulate the honours of his senior, through all the wider fields of youthful ambition.

For Hal is the god of his idolatry, and that no finer fellow than he adorns this whole world's round, is the younger brother's most cherished creed. He, too, will join that radiant band of our "jeunesse dorée" who disport themselves on the banks of Thames, where the conscious river reflects England's one truly royal hold, the Castle of Windsor. He waits impatiently for the time, and thinks how he, too, among other bold deeds, will then sit down in his saddle, and keep "his horse's head straight,"* as enjoined by a competent authority of the day, whose example effectually illustrates his precept.

The still fair mother of these rejoicing children is crossing the floor with steps that have not lost their lightness, and whose eagerness cannot near their grace; a more ancient ancestress is rising from her cushions, to throw off half the oppression of her years, as she takes her part in the greetings to ensue. Other accessories there are, but I cannot pause to describe them. Dogs of various races assert their claim to a share in the gladness. And now, if you are not glad for them yourself, the dear people—Etouin, boy-brother, dogs and all—may, if you cannot see that even the pale governess, stealing down after the two fair girls, and forgetting to restrain the bounding fairy at her side—whose hand she holds but to steady her steps—if you cannot see that even she has a beam of welcome for Hal on her face, it is not you who shall paint their picture. Call your comrade, with a heart in his bosom, for this labour of love; you would spoil my heartsome faces for me, and I want them to be set before us with all the warmth of their feelings, no less than with the intelligence of their brows and the beauty of their race.

And a something like this—the same in its heart-warming happiness, and differing only in the less or greater luxury of the details and accompaniments—may be witnessed, as every such scene comes round, in the dwellings of high and lowly, throughout the length and breadth of our country. Why, then, should we heave the sun's long absence? Say that he does still keep aloof—and Heaven knows that it is but too true—let us wipe the tears from our eyes, nevertheless. We make sunshine of our own, we English; and when you have painted me these my people, with all the genial glow of your own fervid nature, O painter of my heart, transfused into their good-looking forms and faces, we may defy the world to say that they at least have not well understood the process.

* See Mr. Warburton's "Lyrics of the Chase." His words are those that follow, or nearly so, for verses and title are equally quoted from memory.

"If your horse is in blooming condition, Well up to the country, and up to your weight, Oh then give the reins to your youthful ambition, Sit down in your saddle, and keep his head straight."

And now, remembering that flogging we got no long time since from our friendly German critic, what say you to looking at our old chronicles; or, if you better like them, at the annals of a later period? But first, let us glance at a morning's work notified by the good Canon, Walter Hemmingford, a writer born in the reign succeeding that of the monarch whose doings we are about to commemorate.

If not very edifying, the scene Hemmingford describes* has at least the elements of pictorial effect in abundance, and may beside avail to make the fair lady-artist thankful that her lot hath been cast in these later times.

You have, firstly, the third of our Plantagenet kings—even John, of evil memory—employed in what he was pleased to call the distribution of justice, and attended as befits his state. But the business of the morning is peculiar: this is not a criminal court; the prince is merely adjudicating on certain matters between himself and his "wards of the crown;" and it is after this fashion that he settles them:

The lady of rueful countenance whom you see standing immediately before John's seat of justice, is Alice Bertram. She has just been condemned to pay 100 marks—a serious sum in those days—for not coming to be married to one of the king's vassals at the said king's summons.† Unreasonable Alice!

That other dame approaching from the right—a goodly matron, with her children clustered round her—is a certain "Celestia, widow of Richard, the son of Hubert." She hath come to offer those same "marks," and in good number, to the end that "she may have her children in her own ward, and may not be *disstrained* to marry, except to her own good liking."

Advancing up the hall, comes Isabel de Bolebec, an orphan damsel, who hopes for the same immunity; but she knows the humour of her sovereign, and promises "three palfreys," in addition to 300 marks, with this proviso: that he "be good lord to her," and release her from the dread of enforced marriage; she meanwhile making engagement to accept no husband without the king's consent. There is an anxious face of a youth peering from behind a group of older men, and gazing at this very Isabel, which looks as if its owner were not without an interest in the result. Heads of horses appear through the distant doorway; are they those of Isabel's "poffer?"

Nay, 'twere rash to say so, for yonder stands Bartholomew de Muleton, who has bought the guardianship of such lands as Lanherd de Yvetot left, with that of his heir, to say nothing of Lambert's widow, whom he hath leave to marry himself, or give her to any other, as shall best suit him. For this, be sure, Bartholomew must pay well; and the horses may be tribute from his stores. Whereof enough: but methinks we have some pity picturing here, and that not always of the merriest for the Alices and the Isabels concerned; the Bartholomews fared better, as of right: but even for them things did not always remain couched on the rose-leaves so often cited, as we may have future occasion to show.

The life of Henrietta Maria, daughter of Henry IV. of France, and queen of Charles I., was at one period chequered by many a "moving accident," as our readers will all remember. Here is an instance that would furnish a variety of subjects for the painter, and has claim to that distinction which the living canvas bestows, not only as a well-authenticated fact of history, but also as a theme calculated for the exhibition of more than one quality in the artist who shall treat it.

The circumstances are related by Henrietta herself, in a despatch written to her husband, by whom she had been sent to Holland in search of aid against the Parliament. The queen landed in Burlington Bay, after a perilous voyage and narrow escape from Admiral Batten, the Parliamentary leader, who had nearly made her prisoner, despite her Dutch convoy. It is at this moment that the incidents related in the following letter take place.

* See also Madox, "History of the Exchequer."

"BURLINGTON, 25 Feb., 1643.

MY DEAR HEART,—As soon as I lauded, I despatched Progers to you; but hearing to-day that he has been taken by the enemy, I send this bearer to give you an account of my arrival, which has been very successful, thank God; for, as rough as the sea was when I first crossed it, it was now as calm, till I came within a few leagues of Newcastle, when the wind changed to north-west, and compelled us to make for Burlington Bay; where, after two days lying in the road, our cavalry arrived. I immediately landed, and later in the morning the rest of the troops came in. God, who protected me at sea, has also done it on land; for this night, four of the Parliament ships came in without our knowledge. . . . These four ships soon began so furious a cannonading, that they made us get out of our beds, at least us women, for the soldiers behaved very resolutely in protecting the boats of ammunition.

"I must now play the Captain Bessus, and speak a little of myself. One of those ships did me the favour to flank my house, which fronted the pier; before I could get out of bed, the halls whistled over me, and you may imagine I did not like the music. Everybody forced me out, the balls heating down our houses. I went on foot some distance from the village, and got shelter in a ditch, like those we have seen about Newmarket; but before I could reach it, the balls sang merrily over our heads, and a sergeant was killed twenty paces from me. Under this shelter we remained two hours, the balls flying over us, and sometimes covering us with earth. At last the Dutch admiral sent to tell the Parliament ships that he would treat them as enemies if they did not give over. This was rather of the latest, but he excused himself on account of the fog. Upon this the Parliament ships went off; and besides, the tide ebbed, and they would soon have been in shoal water.

"As soon as they had withdrawn, I returned to my house, not being willing that they should boast of having driven me away. . . . All this day we have been landing our ammunition. It is said that one of the Parliament captains came before the cannonading to reconnoitre my lodging; and I assure you he had marked it exactly, for he always fired at it. I can say with truth that by land and sea I have been in some danger, but God has preserved me, and I confide in his goodness, that he will not desert me in other things. I protest to you that in this confidence I would face cannon, but I know we must not tempt God. I must uow go and eat a morsel, for I have taken nothing to-day but three eggs, and slept very little in the night."

A truly characteristic letter, and one not ill calculated to awaken that interest for his subject without which the labours of the artist are but of poor avail. Several points in this narrative are highly susceptible of pictorial illustration, whether sea or land be the object of the painter's predilection. They do not need minute specification; the simple, yet highly effective relation of the queen is sufficiently graphic, and he who does not perceive her page to be sparkling with not one only, but many pictures, may throw his pencil to the dogs. Nor is the scene of this adventure unworthy to be limned. The beauty of Burlington Bay is acknowledged on all hands; the bold promontory called Flamborough Head, around whose rocky base the wild waves fret themselves into clouds of snowy foam, terminates fittingly its graceful curve; sea-birds, in countless numbers, heighten the animation of the scene, as they wheel about on flashing wing, their softly-tinted plumage glistening through the diamond spray; the hoarse cries they send forth are no inappropriate accompaniment to the hollow reverberation of the deeply-caverned cliffs, which are here of imposing altitude, and are crowned by a snow-white and glittering Pharos, remarkable for the pure elegance of its proportions.

The supremacy over her sister Arts, accorded to Sculpture, by Seneca, Lactantius, and other

* Harleian MSS., 7379.

writers of antiquity, was stontly upheld by the old Florentine, Benedetto Varchi, in the sixteenth century, and has furnished abundant matter for dispute among artists, down to a much more recent period.

For we may not affirm that the votaries of painting held their peace when these questions were in agitation. All will remember the fluency—if we are not to say the force—where-with Vasari maintains the excellence of his own beloved Art; and few will forget the picture ingeniously painted by Giorgione, to prove that painting could represent the object on every side at one view, no less effectually than sculpture.* Later still, the lively Frenchman, Danton, retorts on the sculptor Falconet, who was boasting the universal capabilities of his Art, in the following words: "Fais-nous donc un clair-de-lune avec ta sculpture";† but on this the accurate Stirling remarks that Vasari had previously cited "*il laocer delta luna*," as one of those subjects which are beyond the power of the sculptor to imitate.

Don Felipe de Castro, "*primer escultor de Camara de Su Magestad*," the king of Spain, in the middle of the last century, upheld the part of sculpture in that country against Pacheco and the painters, and—as we find in the admirable author cited above—he translated the work of Vasari into his native Castilian, for the benefit of such as could not read it in the original. How much or how little this would contribute to convert Pacheco and his followers, the reader will judge. In a note to this passage, Stirling has the following: "The final problem with which he (Vasari) poses the sculptor is, to represent a clown blowing his porridge, and to represent the breath of the one and the steam of the other."‡ At a word, there has been no lack of disputants on either side; but we are not now disturbed by these profitless discussions. Each resplendent sister has long since taken her glorious place in the world's estimation, well content, and justly so, with that appointed her. No painter now racks his brain for the means of presenting all the sides of his picture at one view, and on the same canvas; nor does any sculptor feel aggrieved by the declaration that he cannot show the steam as it rises to the nose of the man who eats his porridge.

There is no longer any reluctance on the part of the sculptor to admit that his fields of range are less extensive, or, at the least, less varied in their character, than are those of the painter; and this acknowledged, the former is all the more unwilling to leave unappropriated any part of that domain which is more particularly his own. Now then does it happen that we so rarely find him occupied with a subject that, more than all others, might be supposed likely to appeal to his sympathies? We mean that most spiritual of the Canonas, the Nymph Egeria. Even in the mother-city of Art, great and beloved; even in Rome, the guiding genius of Numa hath not yet had "all her praise," nor by the sacred haunts of that Fountain, well-nigh within your ken as you leave the city, though duly honoured by Livy and Plutarch, do you see the temples you so naturally hope to find in a region so highly honoured. Again, by that our Fount of Aricia, beloved of Art for its own fair beauty, no less than for the memory it holds of fervid praise, as breathed from the lips of Silius Italicus, nay, as uttered by Virgil himself, the fane you look for are not yet consecrated to this most legitimate object for the worship of Art.

That no early statue of Egeria has been found, is, without doubt, one cause of the want we deplore; for too frequently has the artist of all ages condescended to reproduce the idea already familiar, when he should rather have enriched his Art with some offering, the result of his own genius. But this circumstance is amply accounted for by that law, promulgated by Numa Pompilius, whereby all representation of the gods by human forms was forbidden; and so rigid was this prohibition, that nearly 200 years

had elapsed from the death of the legislator, before any statue of the gods had been placed in a Roman temple. Those found in Rome at a later period were the work of Etruscan artists. Thus the sculptor has had few models for his imitation, as regards this fertile subject. For the fact that he has not more frequently trusted to his inspiration, we have already expressed our regret, and will not now recur to it. The absence of ancient works on this theme is then not surprising, however much to be lamented; but that so few statues of Egeria have been attempted in modern times is less easily accounted for. That the mutilated figure, lying in the fountain, at that part of the Roman Campagna which Italians now call the Caffarella, but which is perhaps better known to English travellers as the Fountain of Egeria, is no statue of the nymph, none who have seen it will require to be assured—it is, in fact, not the figure of a female at all.

The few statues representing Egeria with regal attributes, and making her the personification of peaceful rule, as opposed to lawless anarchy—that, for example, by René Frémin, a pupil of Girardon's—do but poorly express the many attributes attaching themselves inseparably, and as her undoubted appanage, to that image we all hold in our hearts, of the exquisite Canonas.* Wisdom in its perfection, and therefore Goodness in its highest manifestations, as well as in its most attractive form; these are at once presented to our thoughts, and demand our willing reverence, as we think of Egeria. For what are we to understand by the influence of the Nymph, if it be not that this constituted the whole sum of those virtues whereby Numa was enabled to elevate his people, and thus to render them happy?

By no effort of human genius could all the lofty ideas connected with the image of Egeria be worthily represented in the external sense,—but among her attributes is one by which she is brought well within the limits of human sympathies. This is that sublimated affection, far raised above all taint of earth, which forms a distinctive peculiarity of the Canonas's character, and is perhaps inferior to none in its beneficial action on the destinies of mankind. He, then, who shall exhibit Egeria in this one phase of her ethereal being, will assuredly place the beholder in such a presence, as must be worthy of admission to, and deep worship in, the purest of Art's shrines.

Now would that Thou hadst lived to make this worthiest of themes thine own—ah, too early lost!—but no, let us not bewail the departed; let us rather wait in hope for the advent of that Master whose soul the deep-veiled Future is preparing for this work.

Look to it, then, ye who aspire to the high name of Sculptor, believe not lightly in the whisperings of self-love,—yet let him whose brow is indeed destined for the laurel, not forget that "Be bold! be bold!" was an injunction that preceded the "Be not too bold!" Few among you need reminding of the latter precept, none know better than yourselves that true modesty ever accompanies true merit—that the counterfeit of either is soon detected. But for success in this enterprise, there is more than mere boldness, and more than ordinary merit required—let him who shall undertake it, see that his inspiration be derived from no source unworthy of his theme, let him approach his exalted task, then only when the robe of Art's most solemn priesthood may be assumed without peril of desecration; thus alone can he hope to see breathing from his marble, some faint perception of the true Egeria—perfect Wisdom, that is, and therefore Goodness in its highest manifestation.

On the brow of the nymph there is the inspiration of the Sibyl—as of right—but, even yet more effectually appealing to our sympathies, there is also Love—the deep love of the Seraph†

* It may, perhaps, not be unnecessary to remind the reader that the Canonas are of a higher order than the Nymphs generally, since they add to the attributes of the latter the Sibylline distinction of prophecy, and are endowed with knowledge of all the future.
† The reader will remember that, in the hierarchy of angels, the seraph is the spirit of love, as the cherubim are the spirits of knowledge.

—which beams from every feature of her faultless face—for the divinity of Egeria was in that Love. The sweetness of the perfect mouth has no touch of earth, and to the delicate cheek, the artist—himself inspired—whose soul shall be transfused by this dream of beauty, will feel constrained to impart a refinement, unknown to the mere ideal of physical perfection in form as applied to the grosser Olympian deities; while the softness of the chin shall have a firmness withheld, truly declaring the power of the Canonas for enduring. Yes, Egeria might have borne aught save the departure of the beloved—beneath that fiction her divine spirit sank, and was dissolved.

Many and beautiful are the phases of her exquisite existence, that must at once arise to the mind and memory of the artist—but say that he attempts to render his idea of Egeria listening to the step of the approaching monarch—his footfall has sounded on her ear, and his blessedness of an ineffable content is in her heart; no eagerness disturbs the calm of her more than regal beauty, the finely moulded cheeks slightly raised and thrown back, while the richly rounded yet flexible figure exhibits that grace which is inseparable from our idea of the Nymph Egeria, and is indeed the unfading result of a beauty whose fount is in purity of heart, and elevation of soul.

This, then, is Egeria's moment of happiness; but how sad the contrast that awaits her!

For let us suppose that the artist—sculptor or painter—who shall have given his heart's best love to this pearl of an old mythology—and let none other presume to approach it—let us suppose that he has proceeded to shadow forth the idol of his reveries as advanced into the next mournful period of her life on earth. The gods have reclaimed their own, Pompilius has departed, and the haunts of the Canonas are left desolate. She has sought forgetfulness in the forests of Aricia—once, says Silius Italicus, her favoured abode—but the wood-nymphs seek in vain to assuage her grief; they have gathered mournfully around her, their graceful groups scarcely less worthy of the sculptor's art than is the form of the sorrowing Egeria herself.

Hippolytus has joined his efforts to those of the Dryads; the hero, devoutly worshipped in Arician forests, has forsaken his shrines to offer consolation to the bereaved. But, like the wood-nymphs, he has failed—her suffering has no trace, and "the worship of the great Goddess Diana is interrupted by her plaints, which do not cease."

Hippolytus departs, as do the wood-nymphs, and Egeria is left to her sorrows; left by all save the Art-devoted, who is wholly her own. He returns, as to the lodestar of his life. The Canonas has not found consolation, but even as he gazes there comes a change. From the most retired depths of her sacred groves the compassionate Artemis approaches—he beholds her advancing, and kneels, awe-struck; Egeria, too, has perceived the goddess, the Canonas feels that her deliverance draws near, her drooping head is once more raised; a brightness, as of more than mortal beatitude, succeeds to the superhuman sorrow by which that heauteous head was bowed; the pitying Diana will complete her work, and Egeria shall cease to grieve, as her form dissolves into that Fountain whose purity shall ever remind the beholder of her own.

And now, seeing this, shall not the Artist—painter or sculptor—once again betake him to the pencil or the chisel, insufficient though he find them to the perfect realisation of those high thoughts suggested to him by his immortal Art! Let him not fail therein! and if he bring not forth in all its radiance that divine creation which hath made glorious his dreams, he shall at least produce a presence, far beyond aught that our more earthly perceptions had power to imagine of pure and beautiful.*

[The author is not aware that this subject is now being treated by one of the most accomplished sculptors of the age—Mr. J. H. Foley, A.R.A. He selected it for "the commission" he received from the Corporation of London.—Ed. A.-J.]

* To be continued.

* See Vasari, "Life of Giorgione."
† See "Annals of the Artists of Spain," vol. iii, p. 1237, et seq.
‡ Stirling, *ut supra*, vol. iii., p. 1238.

BRITISH ARTISTS:
THEIR STYLE AND CHARACTER.

WITH ENGRAVED ILLUSTRATIONS.

NO. XII.—JAMES CLARKE HOOK, A.R.A.



VERY artist who has reached a high position becomes, from the very elevation to which he has raised himself, public property, so to speak: that is, the public whose favourable suffrages he has won by his works, feel also an interest in the individual who created them; they desire—and the desire is legitimate and perfectly reasonable—to learn something of his life and history as associated with his works, to know when and how the spirit which has exalted him above the multitude and linked his name with the great ones of the earth first developed itself, and how it was fostered and grew to maturity. Such a man can no more expect to escape observation—and mark, it is not the eye of impertinent curiosity that seeks him out, and that would penetrate even the solitude of his studio, and, to a certain extent, even to the sanctity of his domestic hearth—than a great legislator, or a renowned warrior, or a successful author, or any other who soars above the range of common men. It is the penalty, if it be so considered, each pays for his position and popularity: the man himself may be indifferent to the praises or the censures of his biographer; nay, it may be most distasteful to him to find his history "chronicled in a book," though he cannot be regardless of the fame which attaches to his deeds; but as the history is the inevitable result of the reputation, he must make up his mind that when he has himself achieved the one, sooner or later somebody will effect the other for him.

It is at all times a delicate task to write of the living, but especially of those whose mental constitutions and almost monastic seclusion from the active business of life cause them to be peculiarly sensitive to the remarks of the critic and the biographer. Politicians, and all those numerous

classes of men who voluntarily engage in the din and clamour of public affairs of every kind, expect to have their sayings and doings canvassed in and beyond the sphere of their operations; they lay their account to the misrepresentations and hard blows of their opponents as evils from which it is impossible to escape; and inasmuch as they are self-immolating victims on the altar of public opinion, and the shafts hurled against them by hostile hands are generally only the weapons of party spirit, and are directed against their public actions alone, whatever result follows is one comparatively easy of endurance, and is forgotten in the excitement of new political or speculative movement. But artists, as a body of men, are cast in a different mould; the nature of their occupation, thoughtful, silent, sedentary, tends to promote that peculiarity of feeling which seems to be an inherent portion of their existence; nor does it forsake them even when they have reached a point of distinction where the harsh judgment of the critic is powerless to turn popular favour into other channels. Some, indeed, like Barry and Haydon, are made of sterner stuff, and care little for what foe or friend may say or write, almost as indifferent to the praises of the one—unless in precise accordance with their own views—as to the censures of the other, which are generally ascribed to ignorance, and frequently this is not far from the truth. It becomes then, as we before remarked, a delicate task which we have undertaken to perform: our labour has, however, been greatly lessened by the information as to facts, courteously given us by those of whom we have written; nor have we felt much solicitude when speaking of their works, for these already have passed the ordeal of public criticism and received a favourable verdict. Our subjects have been good, we have endeavoured to do them justice; whatever of failure there is, is our own, and while freely acknowledging the inadequacy of the performance, we must also profess that our aim has been, and is, to extend a knowledge of the British School of Artists—in their lives and their works—wherever the influence of the *Art Journal* prevails; and to do this with a right appreciation of the artist's feelings, so as to invite his co-operation rather than drive him to a distance from us, to cheer him with the kindly accents of a friend, but not to insult him with "the deceitful tongue of the flatterer."

The father of Mr. Hook held an important government post on the coast of Africa, where, we believe, he died: his grandfather on the maternal side was Dr. Adam Clarke, the distinguished biblical commentator. Mr. Hook entered the schools of the Royal Academy at an early age, and gave proofs of his industry and ability by gaining, in 1843, for



Engraved by

MARKET MORNING.

[J. W. Whymper.]

the best copy in the School of Painting, the silver medal, with the Lectures of the Professors Barry, Opie, and Fuseli, and the silver medal for the best drawing from the living model. In 1846 he had awarded to him the gold medal of the Academy, with the Discourses of the Presidents Reynolds and West, for the best historical painting in oil of "The Finding of the Body of Harold:" of this picture we published at the time the following remark;—"We cannot speak too highly of it; it is in

all respects a work of great promise, that will place the artist high in the list of fame." We are accustomed to hear outcries and complaints against the Academy as an institution effecting little or nothing for the good of Art: now, admitting that, in comparison with many of the continental schools, it does not offer such advantages as the country has a right to look for, and also that there is much in it requiring a radical change, it cannot be denied that the majority of our best artists have been educated

in its schools, and stimulated to exertion by the rewards and encouragements it holds out to the young student, while there is not an artist in the kingdom who is not emulous of being associated with its members, not because the privilege necessarily stamps the possessor as one among our greatest artists, but because he is presumed to be, by those who are looked upon as the best judges and whose opinion carries weight with the public, worthy of the distinction; and thus the painter, if a good one, and conscious of his own deserts—for few men are blind to their own merits or demerits—feels that his talents are recognised by his professional brethren; if a bad one, the cabalistic letters "R.A." after his name give him a position he would never attain without them, and are at least a sign of presumptive excellence, and bear a proportionate value.

The first work exhibited by Mr. Hook must have been while he was yet a young student in the schools of the Academy, or prior to his entering, for we find in the Catalogue of the Exhibition for 1839 his name appended to a picture entitled "The Hard Task;" in 1842, the year before he gained the silver medals, he exhibited a portrait of a youth, and in 1844 an incident from Boccaccio, "Pamphilus relating his Story." In the following year he sent to the British Institution "Four Subjects from Rogers's Poem of 'The Wish,'" which elicited laudatory notice in the *Art Journal*; and to the Academy a "Portrait of a Gentleman," of which we spoke as showing "considerable merit," though deficient in colour, a fault which none will lay to his works at the present time; and a picture of higher pretensions than any he had yet produced, "The Song of the Olden Time," which called forth the following observations from us:—"This work is not unworthy of 'the line' in the great room. The portraiture of the aged knight is perhaps objectionable, as too obviously 'a study,' but the young and happy pair whose joy he is contemplating, form a picture of exceeding and touching beauty: it is capably painted, as well as excellently composed." In 1846, the year wherein the gold medal was awarded to him, he exhibited another picture of good promise, "The Controversy between Lady Jane Grey and Father Feckenham, who was sent to her from Queen Mary, two days before her death, to try to convert her to Romanism;" it was unfortunately so ill-placed—in the room usually assigned to architectural subjects—that it was impossible to judge of its real worth.

Stimulated no doubt by his success in the competition for the gold medal, Mr. Hook essayed in 1847 a work of a higher order than any he had yet attempted, for it will scarcely be denied that subjects from sacred history, however much they approximate in character to the ordinary incidents of life, require a more elevated style of treatment than any other class of subject. We can never dissociate from the mind the idea that the commonest event, if such a term may be employed when referring to biblical history, which is therein recorded, is separated by a wide line of demarcation from what may occur among ourselves; and it can only be truly represented by the art of the painter when he feels that he

is illustrating a passage of sacred history; it must be treated religiously no less than artistically. "Rispah watching the dead Sons of Saul," contributed by Mr. Hook to the British Institution, is a difficult subject for a young painter to grapple with; Mr. Hook evidently found it so, but the work displays considerable skill in the disposition and foreshortening of the lifeless figures, and a knowledge of colouring in the distinction between the flesh-tints of the dead and those of the living. His contribution to the Royal Academy this year,—"Bassanio commenting on the Caskets," from the "Merchant of Venice,"—like that of the preceding year, was hung where it could not be examined properly; we saw sufficient, however, to satisfy us it ought not to have been in the position it occupied. His solitary picture of 1848 was a composition of numerous

figures, taken from "The Chronicles of Giovanni Villani," a scene in ancient Florence, when the Emperor Otto IV. visited the city; the work, notwithstanding the care that had evidently been bestowed upon it, did not favourably impress us; there is an air of stiffness about the whole composition that mars its good qualities.

In 1849 Mr. Hook commenced the series of subjects, for we scarcely can include his picture of 1847 among the number, from Venetian history, real and fabled, with which his name is now closely identified: he sent to the British Institution a painting entitled "Venice—1550," illustrating a presumed period in the annals of the republic, when, as the poet says, the nobles

"Did please to play the thieves for wives."

The picture represents an extensive hall which opens on one of the canals intersecting the city; at the farther end of the hall is seated a man in the prime of life, and in the nearer part of the composition is a girl whom a youth, who has just stepped out of a gondola, is addressing in a manner that sufficiently indicates his purpose, which is to elope with him; the picture is painted with very considerable power, both as regards colour and expression. In the Royal Academy exhibition of the same year he had three pictures: "The Chevalier Bayard wounded at Brescia," a graceful composition, in which the knight, "sans peur et sans reproche," is tended on his couch by two ladies; the painting is remarkably rich in colour and refined in character: "Othello's

first Suspicion" is expressively illustrated, particularly in the rendering of the gentle Desdemona: "Bianca Capello," from Rogers's "Italy," is, as a subject, somewhat similar to the picture in the British Institution just referred to; those who have read the poem—and who, having the opportunity, has not read and admired one of the most graceful poems of modern authorship!—must well know the story, which the artist has illustrated in a kindred spirit of warm but saddening feeling.

To the British Institution, in 1850, Mr. Hook sent "The Chevalier Bayard departing from Brescia," a companion picture to that exhibited in the Academy the preceding year: the Chevalier is now restored to health, and is preparing to go forth once more in the pursuit of new honours; his groom is buckling on his spurs, and the ladies to whom he is so



Engraved by]

A DREAM OF ANCIENT VENICE.

[J. W. Whymper.

greatly indebted for their careful nursing, present him at parting with *souvenirs* of their companionship during the days of sickness and suffering; we have always considered this picture one of the most charming works of the artist. The history of Francesco Novello di Carrara afforded Mr. Hook a theme for one of his two pictures exhibited this year at the Academy: Carrara and his wife, the Lady Taddea, have concealed themselves in a thicket to elude the emissaries of their enemy, Galeazzo Visconti: the horror of the fugitives at the proximity of their pursuers is very forcibly expressed. The other picture, "A DREAM OF VENICE," forms one of our illustrations, it needs therefore no description; the original is brilliantly painted. In the autumn of this year Mr. Hook was elected an Associate of the Academy.

"The Rescue of the Brides of Venice," exhibited in the Academy in 1851, was among the chief attractions of the annual collection: the ladies have been captured by pirates, who are surprised at Caorli, while dividing their spoil, by the young nobles of Venice and their retainers: there is a sharp conflict going on in boats; the great object of the rescuers, next to

the liberation of the captives, is to protect them from the dangers of the encounter. The scene is full of excitement; and the grouping of the figures is good, the general design most artistic, and it is carried out in all its details with vigour and great ability. His second picture of this year, "The Defeat of Shylock," is the "pound of flesh" scene from "Othello"; the characters that are here brought into view are presented with a just discrimination of the dramatist's personations.

We extract from the notice of the exhibition of the British Institution, which appeared in the *Art Journal* of 1852, the following remarks upon a small painting exhibited by Mr. Hook, "Olivia and Viola":—"The picture is remarkable for brilliancy of colour and softness of execution. The high intellectual power of the artist may have been better seen in more ambitious works, but there is exquisite feeling in this." His contributions to the Royal Academy this year, "Othello's description of Desdemona," and a subject from Boccaccio, "The Story of Signor Torello," scarcely sustained the well-earned reputation of the painter, and we took the liberty of advising him to forget Italy for awhile, that he might here-



Engraved by]

TIME OF THE PERSECUTION OF THE REFORMERS IN PARIS.

[J. W. Whymper.

after return to her with newer conceptions;—advice, however, which was only accepted in part, for we find him exhibiting the next year in Trafalgar Square another incident in the history of the Chevalier Bayard, representing him conferring the honour of Knighthood on the infant son of the Duke of Bourbon, when visiting this prince, on a journey through Moulins; there are five figures in this picture, the Chevalier—who wears a full suit of plate armour—the Duke and Duchess, the infant and his nurse: the subject of the picture would scarcely declare itself, were it not for the title; not, however, from any defect in the composition, but because the historical incident is singular: the conception of the work is good, and it is carried out in the usual vigorous style of the artist. A story from Spanish history was made the subject of Mr. Hook's second picture this year, "Queen Isabella and her Daughters in the Interior of a Nunnery, engaged in Needlework with the Inmates of the Institution," a practice which Mr. Prescott, the historian of the reign of Ferdinand and Isabella, says the Queen adopted throughout her kingdom: the incident is illustrated very charmingly.

In 1854, however, Mr. Hook entirely lost sight of Venice, her brides,

her cavaliers, her gondolas, the water-gates of her palaces, and her dingy canals, and found something to suit his pencil in the hedgerows and corn-fields of old England. We always like to see a painter of acknowledged ability and genius turning his thoughts into a new channel, especially when, as in this case, the diversion is favourable to the artist: the world is often apt to think—and generally the suspicion is well founded—that his powers cannot reach beyond a certain line of characters, in dramatic phraseology; we believe the chief reason why artists so rarely attempt novelties is that they are content to wear the laurels gained in one service, united with the apprehension that a failure in another would involve the partial loss of those they have already won. Possibly, too, they may entertain feelings similar to those which, we believe, most actors possess, who would greatly prefer to play the same character over and over again, to undergo the labour and study of a new one. Of the three pictures exhibited by Mr. Hook in 1854, the first, entitled "A Rest by the Wayside," represented a group of noble trees, thickly clustering shrubs, and verdant herbage, the former serving to shelter a gipsy woman and her child resting under their shadow: the foliage is pencilled with truth and delicacy;

we scarcely remember to have seen a better piece of landscape-painting by a professed historical painter. The second, with a rather ambiguous title, "A few minutes to wait before Twelve o'clock," represents a cornfield in which reapers are at work; the wife of one of them, with her young child, has brought the labourer his dinner, and is waiting the noontide hour allotted to the repast: it is a pleasing composition, naturally and poetically treated. The third owes its origin to the history of the Huguenots; it is called "TIME OF THE PERSECUTION OF THE CHRISTIAN REFORMERS IN PARIS;" it forms one of our illustrations: this picture is, without doubt, one of the artist's best productions. It represents a Protestant family passing the image of the Virgin in the public

streets without paying it the homage which the Catholics required of the passengers, by uncovering the head: a zealous soldier "unhonnets" the recusant with his lance, as no Catholic would pollute his fingers by contact with anything worn by a heretic: the priest is directing the attention of the chief of the family to the figure which he has passed unnoticed: the earnest look of the wife, and the horror of the young boy, are points in the composition which the painter has rendered very expressively.

It remains for us only briefly to notice Mr. Hook's exhibited pictures of the last year; his contributions to the Academy were more numerous than on any preceding occasion, five in number:—"MARKET MORNING," a bit of genuine English scenery, exquisitely wrought out;—"A Frac-



Engraved by]

THE FIRST WHISPER.

[J. W. Winyper.

ture," a portrait of a little urchin mourning over his broken plaything — "A Landscape," but whether from nature or fancy we know not, yet there is abundance of nature on the canvas;—"The Birthplace of the Streamlet," nature again;—and "The Gratitude of the Mother of Moses for the Safety of her Child." With the exception of the last, it will be seen that all these subjects are of home growth, and they show that Mr. Hook's pencil delineates the scenery of his country as gracefully and as powerfully as it revivifies the romantic histories of "The Bride of the Adriatic." None, we are certain, however much and deservedly they appreciate the artist's Italian subjects, will regret the change that has recently come over him: still we shall welcome an occasional introduction to those scenes which first brought his name into prominence, and

to which he is indebted for the position he has reached. While speaking of subjects for painters, it may not be amiss to draw the attention of our artist-readers to the series of papers on this matter with which we commenced the new year: no one will pretend to say that British Art has drawn so largely upon British history, the drama, poetry, and the writings of the novelist, as entirely to have exhausted them; yet something which the public has not been accustomed to see almost year after year would be most acceptable, and there are some admirable subjects for the artist, described in the articles which the pages of our Journal have furnished, and will continue to furnish from time to time.

The picture of "THE FIRST WHISPER" is from an early picture by the artist; a simple yet elegant composition, rich and harmonious in colour.

ANCIENT ARMOUR.*

ARCHEOLOGY, as a branch of study conducive to the proper knowledge of past history, has received an amount of respectful attention of late years by no means accorded to it in times past; this has resulted chiefly from the labours of a few men, who, instead of confining themselves to the pettiness of collecting curiosities, and descending on topics of small importance, have taken a broader and truer view of their mission, and have assisted us to the fuller comprehension of the habits and customs of our forefathers; giving strength to the narrative of the historian, by bringing forth silent witnesses to his truthfulness, from the grave of the Saxon, or the Norman battle-field. By a careful comparison of written evidence, with actual discoveries of all kinds, and an examination of museums, public and private, an enormous mass of information of the greatest possible value has been obtained from out-of-the-way sources. This has, however, been the result of very many years' patient labour, and the credit of it by no means belongs to the present generation. The slow accumula-



SAXON WARRIORS.

tion of facts, the careful examination of conflicting evidence, the clear elimination of *data* from the whole course of study pursued, have been gradually appearing for the last fifty years; and even now the result is in some instances open to doubts, and wanting in proofs more conclusive. Many of our early authors whose minds were decided on certain points, may now be proved in the wrong; but we must ever remember that we start with the possession of all the knowledge they gathered, and have therefore a vantage-ground given to us by them, which should always be gratefully remembered even when we may feel obliged to note their mistakes.

The study of ancient armour has never been very popular in England, and we doubt whether it ever will be. Many reasons may be given for this, but probably the best one is the entire absence of military experience in the people, as contrasted with that forced military education so common to other nations. The collecting

* ANCIENT ARMOUR AND WEAPONS IN EUROPE. FROM THE IRON PERIOD OF THE NORTHERN NATIONS TO THE END OF THE THIRTEENTH CENTURY. WITH ILLUSTRATIONS FROM CONTEMPORARY MONUMENTS. BY JOHN HEWITT. PARLEY, OXFORD AND LONDON.

of specimens of ancient armour is equally unpopular, but may more readily be accounted for in the difficulty of devoting space and care to its preservation, as well as the heavy expenses of the taste. With the exception of Sir Samuel Meyrick's there was no collection a few years ago but that in the Tower of London.

It is due to the memory of Sir Samuel to acknowledge him as the true originator of what taste and knowledge do exist amongst us: it was to his indefatigable exertions that our national collection was put in proper order; he also amassed a more extraordinary private collection at his seat, Goodrich Court, in Here-



GREAT SEAL OF WILLIAM THE CONQUEROR.

fordshire, while the volumes published by him and Skelton, illustrative of that collection and the history of armour in general, are among the most important contributions of literature to this branch of knowledge. Many errors there may be in these works, and a few conclusions too hastily formed; but to value them fully we must

remember how little there was before that time for guidance, and how much these books have left for posterity to repose more safely upon. The large mass of transactions of antiquarian societies at Somerset House and elsewhere, have greatly helped in elucidating minor facts, and the continued researches all over the kingdom gradually



GREAT SEAL OF RICHARD I.

elicited a large mass of evidence for the patient modern investigator.

Mr. Hewitt appears from his quotations to have industriously waded through all this; and to him the credit is undoubtedly due of bringing together, in one portable volume, an enormous quantity of scattered facts of the greatest utility

to the student of ancient armour. His book is the cheapest and most portable general treatise hitherto published; and it is illustrated by many neatly-executed wood-engravings, of which our present pages furnish examples. The earliest we select is a group of Saxons copied from a MS. of Prudentius, in the Tenison Library, believed to

have been executed in the eleventh century; the spear, sword, shield, and helmet, seem to have been the soldier's chief defence; body armour first appears as a leather coat, and upon that rings of metal were sewn, (as seen in the figures of our warrior sovereigns, in their two great seals,) which, however, appears to have been appropriated to the chiefs of the battle. Thus originated the chain mail of the middle ages, which varied from it in the important point of consisting entirely of linked rings, making it in fact an iron pliable garment. The notices our author gives of the importance attached to these defences are curious: thus it was enacted by Henry II, that "whosoever held a knight's fee should have a coat-of-ferce, a helmet, a shield, and a lance; and every knight as many coats, helmets, shields and lances, as he shall have knight's fees in his domain, and every "free layman having in rent or chattles the value of sixteen marks," is to make provision like the man who may be worth a knight's fee. "But no Jew shall have in his custody any coat of mail," for he



KNIGHT'S EFFIGY, HASELEY, GLOS.

must sell or give it for the king's use. Isaac of York might, therefore, value Ivanhoe for the protection he could afford his house. The miserably restricted policy of feudal times peeps continually forth in the pages of the historian; and its general tyranny nowhere appears greater than in books devoted to the so-called "glorious" art of war. The arbitrary enactments for enforced military service are continual; but the power and endurance of the common soldiery in the middle ages was most remarkable; and we hear of knightly legs, severed through the armour by the strong axe of the foot-soldier, and falling on one side the horse, while its unlucky owner dropped on the other; or of bowmen who "shot a good shaft" so powerfully as to penetrate an oaken gate "four fingers thick." The hardy half-wild character of these sons of Mars, often gave them an advantage over the mail-clad horsemen, who kept adding continually to their cumbersome defences, until the sixteenth century saw them as completely enclosed in solid plate-armour, as is a lobster in his shell. The

researches of our author do not, however, at present carry his history so far; his latest examples belong to the thirteenth century. Of the

character of knightly defence then used, the engravings on this page will furnish specimens; the first selected from one of those valuable



MOUNTED ARCHER OF THE THIRTEENTH CENTURY.

monumental effigies so common in England, and so rare elsewhere; the second from an illuminated manuscript of the close of the thirteenth century (Royal MS. 20. D. 1), which also displays

the housings of the horse decorated with the arms of its master; the third from a glass painting in the window of the north transept of Oxford Cathedral, representing the murder of St



THE MURDER OF BECKET.

Thomas à Becket. The knights are armed in suits of hand mail, with knee-pieces of plate, their shields are richly adorned with disper-

work; the foremost knight, the famed Fitz-Urse, has three bears' heads on his, allusive to his name and family coat.

In going over so large and difficult a field of investigation, we feel that Mr. Howitt has acted diligently and well; we think, however, he has trusted too much occasionally to the opinions of a few foreign antiquaries, such as Worsaae, who would deduce every thing from the original usages of their own countrymen. We also cannot "be at once convinced," that the famed Bayeux tapestry was "not wrought by courtly ladies, but by the ruler hands of the tapestry-workers;" we should, in fact, come to a totally different conclusion, by the same "careful examination" our author speaks of. But these minor points are of small consequence where so much has been done; and we rejoice to find Mr. Hewitt a strenuous advocate, as we have ever been, of the folly and mischief of modern restorations of old monuments, like that of the knightly effigy on the preceding page. He assures us, and truly, that "they have been patched up with Roman cement, eked out with supplementary limbs, plastered over with mock Parthenon marble. The mistakes that have been committed in costume, equipment, and art-treatment, are more fit for the pages of a jest-book, than those of a sober treatise; and it is scarcely necessary to say, that for any purpose of the historian, the archaeologist, or even in the more narrow view of ancestral portraiture, the statue has become, under such a treatment, utterly valueless." With this sensible quotation, we close our notice of a book, which has certainly added much to our knowledge on an abstruse and difficult study.

ART-STUDIO AT BIRMINGHAM.

SOME time ago we informed our readers that an enterprising and liberal gentleman of Birmingham, Mr. Underwood, was about to establish an institution there, with a view to the propagation of Art by lectures, a library, &c. &c.

It is now formed, and during the past month was opened by an inaugural address, delivered by W. C. Aitken, Esq., who has on many previous occasions been eminently useful in the work, with the best interests of which he is closely associated.

The Lecturer commenced by remarking that the Studio had been founded by the liberality and public spirit of a private individual (Mr. Underwood), who, animated by a desire to help forward the cause of Art-education, had provided the numerous casts, pictures, drawings, and other works of Art which adorned the room, together with a selection of very costly books for the use of the students. The proper use of these means would materially aid in elevating public taste and promoting the appreciation of the beautiful, and would tend to civilise, humanise, and refine the community generally, as well as intending artists and Art-workmen, by placing before them the necessary appliances for the attainment of that desirable object, an acquisition of the principles of Art. It was not intended in establishing the Art-Studio to trench upon the province of teachers of drawing, or to interfere with any existing institutions. The object was rather to foster an improved taste, by affording to students the means of perfecting themselves in the higher branches of Art. The love of the beautiful was implanted in our nature for the noblest purposes, and the cultivation of this God-given sentiment was a duty imperative on all. Quoting a passage from Milton's "Paradise Lost" in support of his argument, the Lecturer pointed out that not one of the talents given to man was intended to lie dormant—far less those faculties that stimulated the moral sentiments through the medium of the visual organs. The most perfect mode of education was through the medium of the eye: the nations of old, in attempting to give expression to ideas, instinctively adopted picture-writing, or painting, as the means of doing so. Thus, by the touch of the painter, the sentiments of piety, admiration, and friendship had been beautifully expressed to succeeding ages. The works of the Egyptians and Greeks, for instance, still excited admiration and awe. Glancing at the works of the Greek sculptors and painters, Mr. Aitken remarked on the eagerness manifested in that remote age to possess high-class works of Art, citing as an example the circumstance that one of the sieges of Rhodes was undertaken to obtain a picture by Apelles which was kept in that city. He proceeded to remark that if the relics of these productions even now excited wonder, what must have been their effect when they were unmitigated? With a climate

suitable for the display and preservation of works of Art, the Greeks attained a degree of excellence never surpassed; and although their genius had departed, its ancient influence would be felt to the remotest times; works such as the Medicean Venus and the Apollo Belvedere stood out in bold relief as records of a people great in arms, in art, and in song. The Lecturer then reviewed the development of Italian Art, through the works of Cimabue, Giotto, and their contemporaries and successors, until it arrived at the culminating point in Raphael, Michael Angelo, and Leonardo da Vinci. In the course of his argument, Mr. Aitken carefully pointed out the transition of the Italian Art from the religious to the sensuous phase, and illustrated the change by engravings from pictures produced in either manner. Passing on to modern Art, he observed that the French school, until recently, had not produced any artists who were entitled to be called great masters, notwithstanding royal patronage and munificence had been extended to men of all nations, from the time of Francis I. down to the reign of Louis Philippe and Napoleon III. He referred to the late Paris Fine Art Exhibition in proof of the progress made by France, and alluded also to the modern schools of Continental Art as there developed. The modern German School was distinguished by the great works executed in fresco, in all probability arising out of the state patronage and the adaptability of the public buildings of that country for artistic purposes. Cornelius Kaulbach and Overbeck were the leading masters. He then directed attention to the state of Art in England. Doleful complaints had been made of our inferiority as practical artists or theoretic judges of Art. And this was not to be wondered at, for the artist had not until of late years met with due encouragement; and the mass of the people had not been instructed to appreciate the artist. Our condition in that respect contrasted unfavourably with that of other nations. He showed how men of pre-eminent ability had fallen short in performance for want of opportunity. He pointed to Barry, and Hilton, and David Scott, in illustration. On the other hand, it was most true that we had picture-buyers and collectors amongst us; but they, while they paid high prices for questionable specimens of the old masters, heeded but little what was nearer home. British art and artists had but little sympathy from the dilettanti. It was, however, a pleasing feature of our time, and inspiring to the artist, to know that the demand for the old masters was on the decline. It was true that the buying of spurious copies of the old masters, to the prejudice of the living artist, was brought to an end; * not that he wished to undervalue the real works of the old masters, but that the living and modern artists should be duly encouraged. It was necessary, however, that Art-education should be more general before the more complicated labours of the artist could be universally appreciated. The heaven which the old Puritans introduced into religious matters still showed its effects. In their zeal the stonied pane was shivered, the statue defaced, the picture mutilated. Had the mischief ended there, the consequences would have been less important; but the result had been, that the artist was almost wholly excluded from our churches, and until recently was but charily patronised by the State. If we glanced over the history of Art, we should find that its noblest triumphs had been dedicated to the service of religion. He asked them to have, instead of square yards of stone colour, the works of the painter—the Stable of Bethlehem, the Disputation in the Temple, the Miracles, the Agony, and the final scene on Calvary. By such representations would the words of the preacher be rendered more effective, and the Holy Book better understood. Then would the works of man join in an offering, in worshipping that source from whence all talent, all wisdom, and all power is received;—genius, a gift from on high, speaking through the visible language of the pencil. After alluding to the Government encouragement of Art in the decoration of the Houses of Parliament, Mr. Aitken gave a rapid sketch of the more modern masters of the English School, referring especially to the Pre-Raphaelites, who had done much to stem the tide of conventionality; and if they had accomplished nothing more, had done a good deal by making even their opponents think. In conclusion, he said that the object of his address had been rather to excite the mind of the student to inquire, than to satisfy it; and after giving some practical advice to intending students, he stated that in the library attached to the Art-Studio will be found many works which might be perused with great profit.

* We do not observe that Mr. Aitken made any reference to the leading cause of the change he considers so beneficial. But we are well aware that dilettanti of Birmingham are afraid to "speak out."

As a guide-book in Art, there was nothing better than Leslie's "Hand-book," the Treatises of Burnet on "Light, Shade, Colour, and Composition," "The Education of the Eye and Landscape Painting" contained a vast amount of information which it is essentially necessary that every intending artist should be in possession of. The "Liber Veritatis" of Claude ought to be examined by every landscape-painter; and equally so the treatises of J. D. Harding on "Elementary Art," "Lessons on Art," and the "Practice of Art," John Ruskin's "Modern Painters" (and "Lectures on Painting and Architecture" might be read with much profit. The biography of artists was also instructive reading. They formed incentives to exertion, and were instructive as showing the gradual growth and development of the painter's skill. As an artist should know a little of everything, in addition to a knowledge of anatomy (if he practised the figure), he should make himself somewhat acquainted with the sciences of natural history, geology, and botany. To elevate and store the mind with true poetic feelings the pages of our poets might be perused with great profit. Neither should the pages of our historians be neglected, abounding as they did equally with those of our poets in word-pictures. The artist, to be a true artist, should be educated in every perception and feeling. Doubtless there had been artists uneducated whose works were admirable; but how much more so would they have been had the mind which produced them been educated up to its capabilities? The claims of the Art-Studio, with its collection of paintings, water-colour, and pencil drawings, its books of ornament, its casts, and library, brought together and dedicated by Mr. Underwood to the extension of Art-education, was now before them. The interests of students of fine and ornamental Art had each been duly considered and cared for. In their hands was placed the success and prosperity of the Art-Studio, and shame would it be if, for lack of interest on the part of those for whose benefit it was projected, an institution fraught with so much good, alike to fine Art and Art-industry, should fail for want of that support which it so well merited.

CERAMIC COURT AT THE CRYSTAL PALACE,

UNDER THE DIRECTION OF T. BATTAM, ESQ., F.S.A.

WE have great pleasure in directing the attention of our readers to this project, because of the high degree of interest which must attach to such an exhibition as that proposed, and also from the conviction that its success will lead to the extension of the principle upon which it is founded, to other important branches of manufacture, so as ultimately to realise an Exhibition of Art Industry of high and uniform excellence without the admixture of works of that objectionable character which have hitherto tended to depreciate the value and influence of previous collections. We extract the following paragraphs from a circular published by order of the Directors in reference to the scheme.

"One of the chief objects originally advocated and proposed by the promoters of the Crystal Palace, was that it should include within its range the materials for an educational system unprecedented, both for comprehensiveness and completeness, and that this should be developed in a form so simple and attractive, that its advantages might be generally and readily available for the instruction of the masses who it was reasonably presumed would be eagerly drawn to profit by its examination.

"The progress of a plan so vast in its scope, and so complex in detail, must necessarily be gradual, since its development involves not only a vast financial outlay, but requires the co-operation of men of eminence in the particular studies selected for illustration.

"Reference to those portions of this scheme already completed, viz. Restorations of the Architecture and Decorative Art of the Assyrians, Egyptians, Greeks, Romans, and Moors of Spain; also of the Byzantine, Gothic, Renaissance, and Modern Italian periods, will demonstrate how far and how successfully this principle has been worked out in regard more immediately and exclusively to the Fine Arts.

The Directors of the Crystal Palace are now

about to extend their sphere of operations to the illustration of Art as allied to Manufacture, and with this view have determined upon the foundation of a Ceramic Court as an experiment, which, if attended with the success they confidently expect, will be followed by a series that shall eventually represent, in its fullest and highest capabilities, the productive power of the principal manufactures of England."

This is certainly progress in the right direction; and if carried out in the spirit which is here professed, will do much to extend the utility and increase the attractions of the "Palace," as well as enlist the interest and sympathy of that large and valuable class of the community, the *élite* of our manufacturers, who have hitherto in the great majority of instances held aloof from connection with its exhibitive arrangements. The publicity which its space offered for the exposition of manufactures generally was at once admitted to be of great value; but so large a sum was demanded for its occupation that numbers, otherwise disposed to avail themselves of its influence, withdrew from so costly a venture, and those who acceded to the terms did so in the determination to adopt such means to secure sales as might "somehow or any how" repay them the heavy tax to which they were subjected; and the consequence has been that courses were resorted to which have seriously militated against the institution. At the commencement of the scheme, we repeatedly pointed out the serious evil thus incurred: we did so in vain; however, persons were intrusted with the "arrangements," to whom they ought not to have been confided—who had no single qualification for the important task. We protested without effect:—and finding the inutility of "advice," we have for a long period said nothing on the subject—leaving things to take their own course: and that course was ruinous.

This error has been, at length, made apparent, and the future arrangements in this respect give hope of greater consideration—indeed, we may say liberality—towards exhibitors, by which such a class of "exhibitions" will be secured as must prove a source of remuneration and deserved attraction.

Obviously, the best policy of the Directors is to seek such "deposits" as shall increase the sources of revenue from an additional number of visitors, rather than from the exhibitors.

In making these remarks we refer to the productions in the higher branches of Art-manufacture, the exhibition of which is certain to be attractive, and the illustration of which must necessarily be costly to the manufacturer. We understand that the works admitted to form the collection of the Ceramic Court will be received free of all charge to manufacturers and exhibitors; and, consequently, no work will be included but that which in its kind possesses the claim of positive excellence.

The selection of Ceramic Manufactures as the initiatory step in this movement is, we think, in the highest degree judicious. In respect to this, the circular to which we have referred adds—

"It would be superfluous to enlarge upon the interest which will attach to a collection of rare and valuable objects, illustrating the beauty and variety of a manufacture with which Art formed so early and intimate an alliance, and which presents, through all its details, a combination of science and art without a parallel in the whole range of industrial action. The national importance of our potteries, in a commercial point of view, is not yet thoroughly appreciated. They call into exercise important powers of chemical analysis and mechanical ingenuity, and they develop artistic faculties to an extent and with a fitness certainly unequalled in any other branch of manufacture. It is of especial importance that the English people should have some intimate knowledge of the nature and extent of their own commercial resources, for without such a knowledge they can never properly appreciate their national interests.

"The proposed exhibition will contain a large and valuable collection of Plastic Art, from the earliest dates of its invention down to the present time.

"The collection of modern works will, it is presumed, exemplify the perfection to which the

various branches of this manufacture have attained, and as regards England, entirely by individual enterprise, unaided by state subsidies."

In respect to the productions of the present day, it is now a fact admitted by all who have had opportunities of comparative analysis, that English Ceramics take a high and proud position, and, with the solitary exception of the Royal works at Sèvres, stand unrivalled; by none is this superiority more readily acknowledged than by our continental rivals. The fact was established at the late Exhibition in Paris. The rapid advance in this branch of English manufacture is without a parallel in Industrial Art, and forces the conclusion that judicious patronage alone is requisite to realise a success "at home" equal to the highest foreign achievements. We are sanguine that the result of this exhibition, combining, as it will, the finest works of foreign talent in immediate proximity with those of English produce, will be largely influential not only in stimulating further advance in those improved features in which the Staffordshire potteries, and those of Worcester and Coleport, are so satisfactorily progressing, but also in more fully developing those in which they are already decidedly superior. It will also tend to cause that excellence in the highest field of labour to be permanent and general, which is from want of public appreciation and encouragement but occasional and exceptional,—a want in a considerable degree attributable to *inadequate representation*.

It is true that Exhibitions of Industrial Art have been of late years tolerably frequent; but their exponents have been of too mixed a character to be of that influential value as attesting the high capabilities of English manufacture which a more qualified and restricted admission would have secured. A space having been once assigned to an exhibitor, its occupancy was left solely to his own discretion, and the result has too often been that works of indifference or of inferiority have unfortunately tended to neutralise the influence of those which were really meritorious, and led to the assumption that the latter were more the result of chance or imitation than of purpose and originality.

To select one qualified to exercise such a judgment as the successful working of this plan necessarily involves, was a matter of extreme difficulty, and the Directors in securing the services of Mr. Battam have been singularly fortunate. The high position he has long held in connection with this branch of manufacture, the practical knowledge he possesses of its various stages and manipulation, have at once enlisted the full confidence and hearty co-operation of the leading manufacturers—many of whom are now engaged on special works expressly for this Exhibition, as well as reproductions of those important objects which attracted so much admiration and won such high awards at the recent Paris Exhibition.

We look confidently forward to the complete success of this work, which, we understand, will be ready for public inauguration on the 1st of May.

The subject is one, as our readers know, in which we have ever taken a deep interest: if there be any branch of British manufacture which has derived assistance from the *Art-Journal*, it is that of the English potteries: it will suffice to say that twelve or fourteen years ago, when we began to report their position and progress, and to illustrate their leading productions, they were in a very different state from that in which we find them now. During our earlier attempts to represent Industrial Art, we were cordially and zealously aided by the producers of this class of British manufacture: it was with them, indeed, our movement was first commenced. Other producers followed in due course: but we have not forgotten, and are not likely to forget, that from the potters we received that support which stimulated us to exertions when difficulties were many and encouragements few.

We expect from this very satisfactory effort at their due and proper representation, a very large and very rapid advance: it will be no doubt our duty to co-operate with Mr. Battam, and to aid his movements by engraving from time to time many of the leading objects exhibited.

THE ROYAL PICTURES.

THE WALK AT KEW.

T. Gainsborough, R.A., Painter. C. H. Jeens, Engraver.
Size of the Picture, 5 ft. 3 in. by 3 ft. 11 in.

GATSSBOROUGH was a man singularly endowed with the gifts of Nature; handsome in person, brilliant conversational powers, well skilled in music, of rare and varied talent as a painter, blessed at an early age with a wife in every way suited to him, and with the additional advantage of possessing an income that placed the young couple (neither had seen twenty years when they were united) in comparative independence: seldom, indeed, has an artist entered into the uncertain arena of his profession under such favourable circumstances. But his art was his idol—next to his Margaret—and in spite of clouds, which will occasionally flit across the brightest skies, he threw his entire soul into the work he had chosen and for which he was so fitted, and his success was commensurate with his enthusiastic devotion.

Historical painters are very frequently great in portraiture, but it is most rare to meet with landscape painters who excel in portraying the "form and lineaments" of the human face: Gainsborough was one of the few masters of both styles; so much so, that critics have pronounced a divided judgment as to which to give the palm of superiority. At one time busy amid the green lanes, and verdant fields, and the homely cottage-children of his native county, Suffolk; and at another immortalising on his canvas the features of the great men who thronged the Court of George III.; he seemed equally at home in both. "He is the best English landscape painter," &c., Reynolds is reported to have said of him one day in the hearing of Richard Wilson;—"He is not," replied the latter, "the best landscape painter, but he is the best portrait painter." Although these opinions were doubtless not exactly those which the two speakers, who were so over-friendly towards each other, really entertained, they may be accepted as tolerably correct evidence of the high estimation in which both held Gainsborough.

If we accept the dying words of the artist—words spoken when the shadows of death had more than half obscured the light of an intelligence yet busy with the memories of his Art—as indicating that class in which he most delighted, we may assume it to be portraiture. A short time only before he breathed his last, he exclaimed with unusual rapture,—"We are all going to heaven, and Vandyke is of the company!" But they who associated with him, and best knew his feelings, have recorded that he never desired to rest his reputation on his portraits; they were the "business" part of his profession, not its pleasant pastime; he loved to exchange the lace and ruffles, and satin vests, and well-turned perukes of fashionable life, for the straw-hat and coarse habiliments of some ruddy-cheeked maiden at her cottage-door, or sturdy waggoner "driving his team a-field."

The picture in the Royal Collection here engraved unites the two styles of portrait and landscape, though the latter has an aristocratic character which carries us away from the painter's usual sylvan scenery; the carefully trimmed lawns and graceful foliage of Kew-gardens differ essentially from the homeliness and rusticity of his Suffolk views. It is altogether elegant in composition—in the bearing of the figures and in the forms of the trees—except in the angle caused by the arrangement of the ladies' dresses; this is not agreeable to the eye. The personages introduced are presumed to be—for some doubt has been expressed on the subject—Henry Frederick, Duke of Cumberland, third son of the Prince of Wales, eldest son of George II.; his wife, Anne Horton, daughter of Lord Imham; and the Lady Elizabeth Luttrell: the duke died without issue, September 18th, 1790. It was this marriage, and that of Cumberland's brother, the Duke of Gloucester, who married the dowager Countess of Waldegrave, that led to the passing of the "Royal Marriage Act."

The picture hangs in the corridor at Windsor Castle.



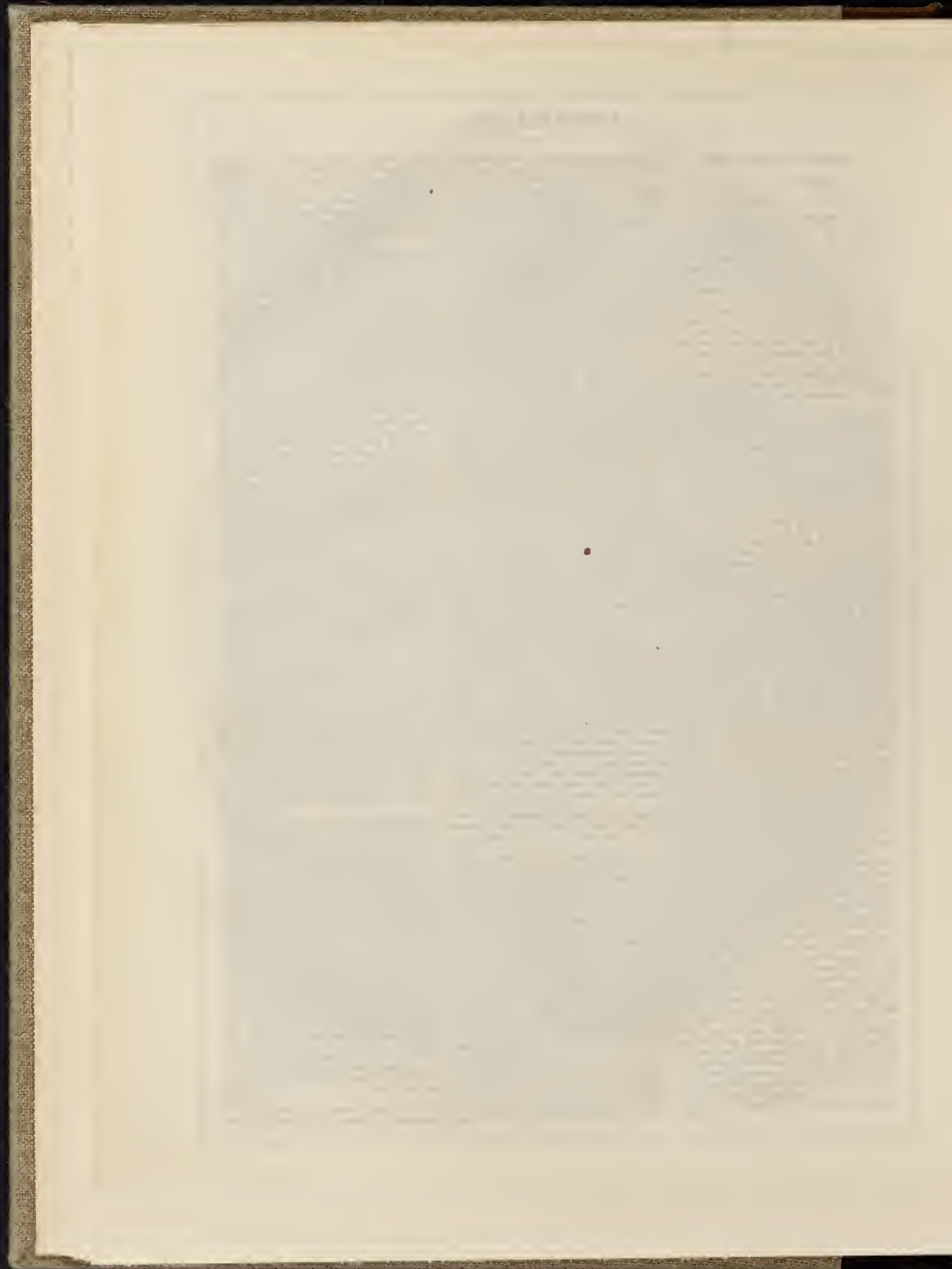



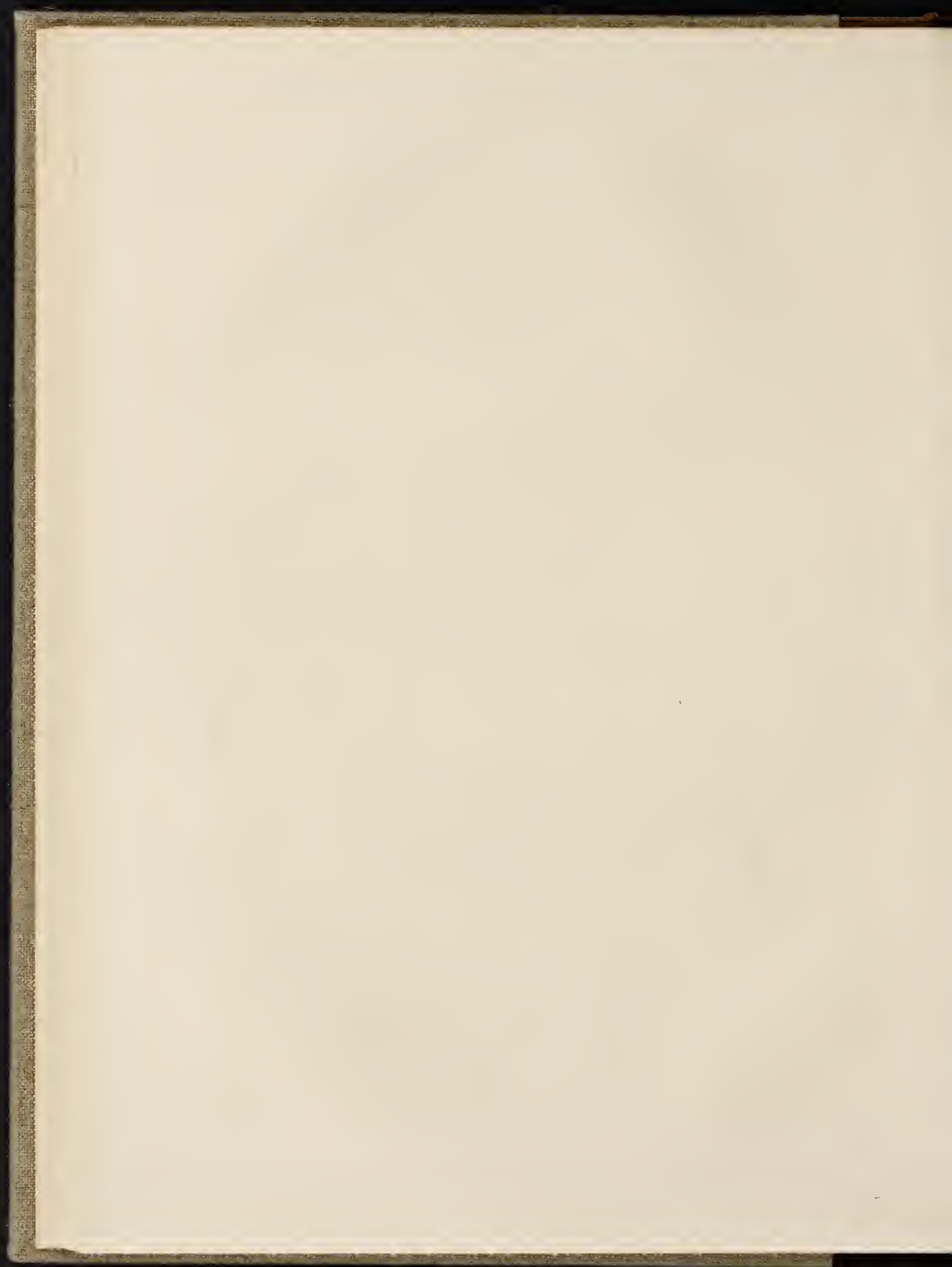

PHOTOGRAPHIC EXHIBITIONS.

THE Photographic Society has during the month opened its third Exhibition. Penton's Crimean photographs (noticed *Art-Journal*, October) are now exhibited in Pall-Mall; and Robertson's photographs, taken after the fall of Sebastopol, are to be seen in Regent Street. The fact, that three exhibitions of sun-drawn pictures are open in the metropolis at the same time, sufficiently proves the growing interest in this beautiful art.

The present appears a favourable opportunity for examining the state and prospects of photography—and, with these public exhibitions to refer to, we shall find no difficulty in directing attention to illustrative examples of each point with which we shall have to deal.

During the last year or two, there have not been any considerable advances in the science of photography, but the art has been greatly improved. When the discoveries of Daguerre and Talbot were first published to the world, several experimental philosophers seized upon the subject, and their industrious researches were soon rewarded by the development of new and unexpected truths. These directed the way to secure improved sensibility in the photographic agents, and pictures were in a little time produced, in a few seconds, superior in all respects to those which formerly required, often, nearly an hour for their development. Herschel, for example, was the first to point attention to the importance of organic bodies in combination with the salts of silver. He showed that the equilibrium was more readily overturned, and the system of chemical decomposition more rapidly carried forward, when the metallic salt was associated with some of those carbon compounds, which especially possess the power of removing oxygen from substances with which it is associated.

A knowledge of this fact led to the use of gallic acid as an accelerating agent, and, although unfortunately the steps are wanting, and we are prevented from tracing the progress of the discovery, we find photographers advancing from the use of paper, to the employment of gelatine and albumen, and eventually to the introduction of that important agent, collodion. Collodion proved so distinguishingly an accelerating power in photography, that almost every other preparation has given way before it.

In proof of this the present Photographic Exhibition numbers 606 frames of photographs of various kinds. Of these there are of pictures by the

Waxed paper process . . .	64
The Calotype	78
The Daguerreotype	3
The Collodion	461
	606

This large majority of collodion pictures is, we believe, mainly referrible to the remarkable facility of the process. The preparations required can be purchased ready for use—and it is almost impossible for the veriest amateur to fail of obtaining a picture. We are rather disposed to think that the discovery of the collodion process has had an injurious tendency in stopping enquiry. The pictures obtained are generally so excellent, that little is desired by the photographer beyond the means of ensuring the permanence of his productions. We have had numerous valuable suggestions for the improvement of the collodion process, many of which have been adopted, but no

one appears to attempt an advance beyond this. There is no reason why other agents possessing all the advantages of collodion, and some which are yet a desideratum, should not be discovered. It is with some regret that we visited the three exhibitions of the Photographic Society, without discovering with one exception, any evidence of the study of photography as a science. Amongst the members of the Photographic Society we see the names of men eminent in their especial departments of science; and there are others who, although young, have given evidence of their powers to carry forward original research. Why is it, then, that the exhibition is almost without examples of experimental enquiry? Why is it that the *Photographic Journal* gives no evidence of the progress of scientific investigation? To produce a picture, the process being given, is excessively easy; any one with industry may succeed in this and even excel; to enquire into the physical and chemical phenomena concerned in the production, is a task demanding much higher powers. There are, however, two frames in the exhibition illustrating—one, the action of the *hydrosulphide of ammonia*, and the other of the *permanganate of potash* on finished photographs, which are excellent examples of one line of enquiry. These are by Mr. F. HARDWICK, who has carefully investigated many points in the chemistry of photography, and he, in these examples, seeks an elucidation of the conditions under which photographs are found to give way; these demand a careful study. We have on a former occasion devoted an article to the subject of the fading of photographs, and we still hold to our opinion, that a sun-drawn picture may be rendered absolutely un fading under any of the ordinary atmospheric influences, proper care being taken in the manipulation. So much for the condition of photographic science. Now let us look at the art.

The third exhibition of the Photographic Society is an exceedingly satisfactory one. We miss the productions of some well-known photographers, but they are replaced by others, differing from the older hands in style, but in no respect inferior to them in general effect. We conceive there is more harmony—more delicacy—throughout the pictures than formerly. The printing processes have been more carefully attended to, and we have less of that hard contrast, of intense shadows with high lights, than formerly. We also see that the art of photography has had the advantage of leading its students to look at nature with a more careful eye than was their wont. The results of the camera obscura have not always been found to be quite agreeable; sometimes the sunshine, or rather the effects, upon the landscape, were offensively brought forward, and violent results not unfrequently marked the photographer's studies.

These defects, however, our more advanced photographic artists have learned to avoid. They now select natural objects under their more favourable aspects; they look at nature with an eye to the impression which her illuminated surface will make on the chemically prepared tablet; and they select those conditions of light and shadow which give a pleasing photographic result.

Some of the landscapes, especially those by J. Knight (497, 502), several by J. D. Llewellyn (504, 511, 411, 443, &c.); T. W. Ransden's scenes in Yorkshire (533, 545); F. Scott Archer's views (61, 62); those by W. Pumphrey (127, &c.); the delightful little bits of nature by G. Shadbolt (34, 57, and

58) will, upon careful examination fully confirm our remarks.

"Inhaling the Breeze" (58)

"breathing from the meadows,
As the west wind bows down the long green grass,
And the light clouds pass as they were wont to pass,
Long time ago!"

by Mr. Shadbolt, possesses to us an inexpressible charm; there is a quiet poetry, and a fulness of light about the picture which is magical; it is like a picture by Turner, we can almost feel the west wind soft and balmy. Pre-Raphaelites might study this and some other photographs, and learn how the sun paints, disclosing every minute line on trunk and leaf—yet blending all into one—light melting by undulations into shadow, and shade brightening into sunny glow, like the illumination on summer seas. For minute and yet distinct detail of a peculiar kind, charming in its general effect, we would name (557) *Ferns and Brambles*, by H. White. In one picture by Mr. Archer, and in Bantrey Bay (14) by T. Cadby Ponting, we have natural clouds, but we think we have seen more delicate and beautiful copies of "Cloudland" than those. How valuable to the artist would a good series of photographic cloud-studies be, since few know how to paint them!

There are many fine examples of "Ruined fanes, relics of hood and cowl devotion," of crumbling castles and tottering mansions, which show the manner in which Time's effacing fingers produce disintegration of the solid stone. The weather-worn fragment is depicted with every scar upon its face, every channel which the rain drops and the wind has worn. *Scenes from Kentworth* (45, 46), Dolamor and Bullock; *Ludlow Castle* (10), Rev. H. Holder; several portions of *Wind-sor Castle*, by A. F. Melluish; *The Choir, Canterbury Cathedral* (183), F. Bedford; and some similar productions by V. A. Prout, are excellent studies. Few men could paint as the sun paints; it is not to be desired that they should do so, since the expenditure of time in producing all this wonderful detail would swallow up too much of a man's life, and it would, we fear, as a final result, produce marvellous mechanism, to the sacrifice of mind. Photography has its uses,—we fear we see its evils, or abuses, in the way in which some of our artists employ the photographic copy of nature, instead of looking at nature with their own eyes, and mentally fixing some of the ever-varying images which are drawn upon the tablets of those wonderful stereoscopic cameras, the human eyes. Yet many are the lessons, if read aright, which are taught by photography.

O. G. Rejlander and Lake Price contribute several artistic studies of a far more ambitious kind than we have hitherto seen. They are all wonderfully clever, but after all they are but the images of actors posed for the occasion; they all want life, expression, passion. Passion they have none, and yet these pictures tell a pleasing tale. *The three Subjects* (4), by Rejlander, are exceedingly well treated. *The Breakfast Table*, by Lake Price, is a pretty comfortable English interior, in which all is happiness and peace; let us hope it is the artist's home. *The Wolsey—Charles Keen*—(135), by the same photographer, is an exquisite portrait and a fine picture. *The Monk* (150), also by Mr. Lake Price, and its accompanying studies, are good in their way, but they are dramatic representations; and this applies yet more forcibly to the *Scene in the Tower* (139), in which the murder of the young princes is the subject. We doubt the propriety of attempting to rival

the historical painter. We believe, indeed, that such pictures as those will have a tendency to lower the appreciation of Art in the eyes of the public, and unfit them for receiving the full impression intended by, or of seeing the beauties of, the artist's production. We do not mean to disparage the works of Mr. Price or of Mr. Rejlander, they are excellent of their kind, but our love of High Art leads us to desire not to see too many of this class of subjects. J. Watson & Co. exhibit an *Academic Study* (227), and the *Broken String* (259), which must also be regarded as an artist's study, and both possess very great merit as such. We have in this Exhibition numerous examples of the applications of the photographic art. *A Frame containing four subjects of Cuneiform Inscriptions* (201), by Roger Fenton, which are copies of the natural size of clay tablets brought from Nineveh, are wonderfully exact. It would be an almost endless labour to draw these relics of Assyrian story by hand—and here we have every character, by one impulse, faithfully depicted in a few seconds. We have *Hindoo Antiquities and Egyptian Bas-relief* (210) as other examples of the same class.

"One of the Engraved pages from the German Edition of the *Ars Moriendi, Black Book, date about 1470*" (198), Mrs. L. Leigh Sotheby, furnishes another example of important applications of the photographic art. There has been some discussion on the question of copying valuable records, manuscript and printed books. We have seen examples sufficiently numerous to convince us that any of those things can, under almost any conditions, be faithfully copied by the collodion process. Dr. Diamond has shown the antiquary how excellently well coins can be copied, in the *Tray of Admiral Smyth's Roman Coins* (434); and C. Thurston Thompson exhibits the application of the art in copying enamels (585, 594), Art-manufactures (597), and furniture (603). Portraits are numerous, and many of them excellent; we hesitate to particularise, but we must mention Mr. Fenton's *Prince Napoleon* (213), and *Sir Colin Campbell* (195), and Mr. Myall's portraits of *Sidney Herbert* (337); *Lord John Russell* (338); the late *Sir William Molesworth* (339); *Sir George Grey* (371); the *Earl of Aberdeen* (372), and *Sir Cornwall Lewis* (373). Thus our heroes and statesmen, as they lived and looked, are preserved to us, and their lineaments handed down to future ages. We think we have said enough to prove that the present exhibition of the Photographic Society is well worthy of close examination.

Of the Crimean photographs of Mr. Roger Fenton we have already spoken (*Art-Journal*, October, 1855). Mr. Robertson, chief engraver to the Imperial Mint, Constantinople, has produced an interesting series of views taken in the Crimea after the fall of Sebastopol, which are exhibiting at Mr. Kilburn's, 223, Regent Street. The sad tale of destruction is here told with strange exactness. The Redan with the breach where the great struggle took place; the Malakoff Tower and Battery, and other celebrated scenes of "bloody strife," are brought home to us, with fascines and gabions, in confusion thrown, in a manner which no artist could realise. We were especially struck with the *Barrack Battery*, showing the mantelettes for protecting the Russian gunners. Here, we see the excellent engineering of the Russians; and we learn to appreciate the value of these rope protections (*mantelettes*) for the gunners from the rifle-balls: these we have heard a

competent authority declare to be the crowning invention of the war.

Sebastopol and Balaklava, with all the strange confusion which distinguishes both, are before the beholder. The curious may find everything here to gratify them. The locality of each heroic or sad event is chronicled. The geologist may study the rocks of the Crimea without crossing the sea; and the architect the buildings which decorated this fine city. The trenches, the tents, the huts, are respectively represented; and—"last scene of all this sad eventful tragedy"—we have the *English Burial Ground on Cathcart Hill*, with the monuments of the brave men who sleep in the embraces of death, but whose memoirs are dear to the country of their birth, where their names will live and kindle heroic life in the souls of those who must preserve the high character of the Briton for courage and honour.

Photography has achieved wonders. Let any one visit each of the three exhibitions which we have named, and we feel conscious they will leave them with a full conviction that the Art which has achieved the end of the enchanter's mirror, and preserved for us, and shown to us, shadows which cannot fade, of persons and of things which are lost us, or at a distance from us, must produce yet greater triumphs with each re-entrering year.

The sun, which gives light and colour, has answered the call of the evocator, and become the painter of the objects which it illuminates. In obedience to the bidding of the philosopher it will give us yet more truthfulness, and show us still nearer approaches to life.

R. H.

DEPARTMENT OF ART EXHIBITION AT GORE HOUSE.

AN Exhibition of productions of the Metropolitan and Provincial Government Schools of Art, has been open to the public during the last month at this branch establishment. The house outside has but little of an official character; and with its high wall in front—lofty trees surmounting it, and carriage entrance with two gates, has more the appearance of a lord of the manor's residence on an old coach road, than an abode of the Muses. It has undergone a curious change of occupancy within the last few years—within which it has been by turns the residence of the accomplished Lady Blessington;—the 1851 *café* of M. Soyer;—and now lastly the country seat of the Metropolitan Department of Art; Marlborough House, St. James's, being the town residence. It has for some time past afforded exhibition rooms for the works of the students contributed for prizes. These are divided into two collections, and exhibited at different times of the year;—the present one being wholly elementary, consisting of outlines and perspective studies, and of drawings and paintings from the flat, chiefly from examples directly applicable to decoration;—the only departure from set copies being some drawings—but not paintings—from natural flowers and from casts.

These studies, like a child's A B C, or the first chords on an instrument, though indispensable are not very amusing, and are judiciously exhibited at a period when few visitors can be expected as far as Kensington. The more advanced, inventive, and popular portion of the prize efforts of the students is reserved for the merry month of May. The present collection presents the usual features. Many of our old friends in decoration reappear for the thousandth time. Two of the examples, however, there repeated in many copies are Moresque,—the department, doubtless, desiring to vary the character of the studies. The general display is creditable—but of less interest than that to be expected in the spring, when of course it is an

object to render the exhibition as attractive to the public as its nature is capable of.

We are very glad that the responsibility of the Sunday opening of public instructive exhibitions to the public rests not with us; but if the movement to this effect, which appears gaining strength, he realised, this is one of the exhibitions perhaps to be inhaled—as affording to those who have not in the week-day the opportunity of wandering so far a-field, the advantage on Sunday of seeing much that is soberly, as well as practically, instructive; and this close to Hyde Park and Kensington Gardens. The gardens also of Gore House, and the adjoining establishment, are far from devoid of beauty, and would add a new feature of instructive recreation, if they afforded a school of Botany. Open air flowers, which would flourish in that situation, would alone yield both popular and special instruction without vying with the elaborate arrangements of the gardens of Kew, which have now, for two years, been open every summer Sunday; and are found, on that day, to occupy no more officials than are daily necessary to water and give air and light to the plants. But without going into the pros and cons of Sunday instructive amusements, it may be well to add, that there appears an evident demarcation between illustrating, in an exhibition, the works of God and those of man on that day; inasmuch as nothing can be drawn from the former by a right mind, but considerations strictly adapted to the seventh day,—while the works of man may lead involuntarily to a thousand other ideas more appropriate to the other six. Viewed in this light, Gardens,—Botany,—Geology,—the study of animals past and present—may be considered more in accordance with the sacred day than the products of Art and industry. A select collection of Sacred Christian Art however, united with a well-ordered display of the various branches of Natural History, might afford a profitable addition to the subjects of thought on the artisan's Sunday,—and not be foreign to the future purposes of this beautiful portion of London's suburbs.

MEMORIAL FROM THE INSTITUTE OF BRITISH SCULPTORS TO THE ROYAL ACADEMY.

We understand that a memorial, emanating from the Sculptors' Institute, and signed by the members of the profession generally and other artists and lovers of Art, is to be submitted shortly to the Royal Academy, to the effect that some of the lighter and more poetic works of sculpture to be contributed next spring to the annual Exhibition of modern Art in Trafalgar Square, he placed in the centre of one or more of the rooms, the sides of which are appropriated to paintings, &c. This proposal is supported by the example of other collections of Art,—by that of ancient works in Florence and elsewhere, and of the arrangement of the "Beaux Arts" in the late Exhibition at Paris. We need hardly say how much such a movement is in accordance with our own feelings, having considered it but a duty of late years to make an annual exposition, "usque ad museum" perhaps, of the inadequacy of the arrangements for sculpture in our national exhibition; and having but lately drawn the attention of our readers, in our general notice of the modern European sculpture at Paris, to the advantages there arising from the juxtaposition and fraternity of the two Arts; and how they mutually and practically gain from a union which is so graceful in theory. We hope the Academy will incline to add this new grace to the reforms which we are glad to see making their way in that Institution, and that the proposition may meet with success. It is perhaps the best that can be carried into effect, short of a thorough arrangement of sculpture in a large hall specially adapted to that art, with all those arrangements of colour that will welcome the white tint of the statues as the one thing

needful for the completion of the composition of colour afforded by the whole apartment. This is the mode in which colour should be associated, in our belief, with statues—not by colouring or tinting the statues themselves—which though lately revived on the somewhat doubtful authority of the ancients, and perhaps prevailing somewhat for the day, will soon be set to rest by our taste for simplicity; but by arranging the colours of the floor, the walls, hangings, and the whole *entourage*, so as to demand the introduction of the local tint of marble, &c., make up the picture. Of such a nature is the best arrangement for sculpture generally, although even then we would have some few works of this Art in companionship with painting, where the architectural arrangements will allow of it. As it is, and for the beginning of reform, the centre space of the large room evidently offers a convenient area for a few of the lighter and more poetic works. Such examples will be chosen, probably, for this situation as present an ornamental mass and outline, and will not be injured by being directly under the light. Much of their effect will depend on their being symmetrically and harmoniously arranged. The subject assuredly justly requires attention; for the accommodation which sculpture has hitherto had in our national exhibition, is of a nature to degrade it in the public appreciation, check the aspirations of its followers, and entail great difficulties on the arrangers, as there are not more than half a dozen tolerably lighted spots within the area of the so-called sculpture-room; all the rest being miserably inadequate in this respect. Moreover the entrance-hall, through which it is approached, is decorated with casts from some of the finest ancient works, and are there *well-lighted*—which emphasizes most unhappily the comparative short-comings that must ever exist in an annual exhibition—affording the injudicious contrast of the selected works of all time *well-lighted*, with the efforts of one year of a little encouraged Art in our own country *very lighted, and equally disadvantageously placed*. It has not unfrequently occurred, doubtless, that the entrance-hall affords a better site for the annual contribution of sculpture, than the room so long misappropriated to it—and on one occasion this view was partly acted upon—but of this the next exhibition witnessed no continuance.

The proposition appropriately emanating from the Institute of British Sculptors, will no doubt bear its fruit in due season. We trust the experiment proposed will be fairly tried, and that hereafter it will lead to still more desirable results.

ACADEMY REFORM.

This is a subject which according to the constitution of our Academy is extremely difficult of approach, though with reference to foreign academies and by continental writers it is very freely treated. The subject does not occur to us as immediately *apropos* of those grievances so extensively complained of by non-privileged contributors to the walls of the Royal Academy; but suggested by the complaints of a certain Don José Galofre against the Spanish Academy of San Fernando, adversely commented by a German critic. What we therefore advance, inasmuch as it bears upon general abuses, is but a brief *hyper* upon the German critic. Our own academy reminds us of the Palace of Eternal Silence in the eastern tale—how vociferous soever may be those who have not yet been admitted to the honours and the privileges of the *penetralia*, their voices are gone as soon as they are within the threshold, and everything is seen of the same tint as that thrown upon Dannecker's Ariadne at Frankfort—it is called by our French neighbours, *couleur de rose*. Don José Galofre insists upon the utility of academies; our German critic (whose name by the way we are sorry not to be able to give) insists upon them as a necessity—so do we. It cannot now be urged against the academy that they do

not educate their own figure painters—or that their figure painters can draw no better than Reynolds or Fuseli. It is only by a regular education in Art that accomplished painters are made. It is only by severe academical study that the essentials of an Art-education can be obtained. The great fault of our school has been, that its members have commenced the study of their art by painting instead of drawing; thus, when the French school was drawing and painting dramatic demi-gods with almost Greek accuracy, our artists had not yet got beyond portrait and rustic figures. But this is more particularly the question between the academy and the public—there is yet another question between the academy and the “outside” members of the profession, more immediately injurious and unjust—that is, the right of a class of men so privileged as to be enabled to pronounce a tacit condemnation of the works of worthy members of the profession, by exhibiting them in places always assigned to inferior productions. This is a question which divides no other school of Art but our own, for in every other there is a greater measure of justice in the exhibition of works of Art. To this all the objections of the Spanish writers—all the protestations of the German commentator are as nothing—neither of these gentlemen has ever known the horrors of an octagon room, nor have they or either of them ever been elevated to the sky-line of their own academy, or had their works placed among architectural drawings. When Peter Cornelius and all young Germany with him, retired from the school (Nap. and König), of Vienna because they declined working from the poetic conceptions of the immortal and God-like Greeks, they had no further complaint against academies, but straightway established their own “esthetics.” Declarations of the want of patronage for “high art” are not peculiar to ourselves. “Of what use,” says the Spanish writer, “are beautiful pictures and classical statues if they are not admired and sold?” This default with all their government patronage is common to every existing school. It might almost be supposed that in other countries, Art was followed as a profession to an extent beyond the means of patrons and governments to find employment for the increasing generation of painters. This progress with respect to ourselves, is ignored by our academy, whose numerical status has been the same since the day of their establishment. Our academy is a *quasi* self-supporting institution. It were to be desired that it were not so, anything were better than its present exclusiveness. The Royal Academy may ask with ourselves, and with the writer who so boldly attacks these institutions, which exist each as a paradise of painters, in comparison with our own close citadel of art—its members, we say, may ask what real advantages governments can show in return for the large sums they annually expend in the support of Schools of Art. It is true that none of the great masters arose from government institutions—there were no public schools in the days of Bellini, Titian, Raffaele, Michael Angelo, Vandyke, Rubens, Velasquez, Murillo, and Riberia, nor did Phidias, Praxiteles, or Apelles rise from public institutions. Genius, like corn, will therefore come to maturity, independent of protection. Yet, for ourselves, we still would not dispense with academies. Had Rubens been educated in an academy, he certainly must have drawn with more accuracy and elegance, but not so characteristically. Had Michael Angelo been bound by academic rules, would his “Last Judgment” be what we now see it? We have alluded to the vulgar outcry against the Royal Academy for not forming their own members. In order to meet this objection they now elect few, save their own pupils—a tacit demonstration, and by no means a wise one, against the talents of the outside strangers, many of whom are men of distinguished merit. To touch upon one, and one example only—it is very certain that Linnell was once desirous of becoming a member of the academy. Is it true, that Linnell having made a reputation in spite of the academy, has been solicited to become at once a free member of the body, and has declined the honour and

its privileges? It is patent to the commonest understanding that the academy is disproportionately short of what Tonson, the bookseller, used to call “able hands,” in the landscape department. The reply of the academy to this assertion is the question, “Who is there fit to be elected?”—we could mention some few, much superior to their present landscape section, but we will mention no names in seeming partisanship. The subject is an extensive one, and we may deal with it *in extenso* on some early occasion. These remarks are only brought forward by a show of reproach against foreign academies—which are not subject to the government of interested authorities, and from which there is no undue exclusion. But notwithstanding these objections academies have greatly advanced the elements of true Art. It matters little to what modern time or school we turn, if there be any great default it is always traceable to the want of academical education. But that the pretensions of pedantry in this are offensive, and unintelligible, we need only instance the unpopularity of the hard German *parist* school, the manner of all those who went with Overbeck, but who have fallen short of the distinction to which he has attained. The larger section of German painters who were first captivated by the novelty of “Christian” art—saw wisely when they saw cause to forsake the thorny path of inexorable outline and to appeal for relief to the light and shade of nature. Those men who merely painted heads could not be said to draw. With all the learned discourse about Rembrandt's Mill and his “dark imaginings,” had he never seen a mill he would have painted just as he did—but had he been educated he would have worked very differently. Reynolds painted heads and was a master of effect, but he could not draw. If Rembrandt and Reynolds could have drawn, would they have been as popular as they are? Certainly not in the same way. We do not say that a knowledge of drawing would have made them worse artists, but they might have practised their art in a manner less calculated to impress the mind. We scarcely know what Don Galofre and others who desire to reconstruct the academies of the continent would propose—but their expositions amount to nothing in comparison with the abuses which exist in the Royal Academy. If the plaintiffs be painters, their works have been fairly set before the public, and their reputation is in the hands of the public, not in those of an interested corporation.

THE ARCHITECTURAL EXHIBITION.

The slight notice we could afford, last month, of the Architectural Exhibition, was not sufficient to give an idea of the interest which on examination will be excited by the works displayed in the Suffolk Street Galleries. Considering the object of architectural drawings, it may not be expected that these should at first captivate the common eye,—like the more seductive beauties of works of the class usually exhibited. An architectural drawing is not assigned, itself, mainly, for the effect on the beholder; but it is rather the *diagram* conveying explanation of the real work of Art intended. Therefore, although all classes of Art-works deserve to be studied, architectural drawings peculiarly require to be viewed in such manner; and this will be better understood by an allusion to that class of drawings most used by architects, and necessarily so,—for these—where the plans, elevations, and sections are looked at, as they should be, in combination—convey what might be supposed to be given by a model of the building; whilst the perspective view can present but an indifferent representation of the structure in a single aspect.

Though these points should be perfectly clear to all artists, there has been so much of isolation in the different branches of Art,—a state peculiar to our time, and unfavourable to Art generally,—that we deem it necessary to dwell

upon them,—that it may be seen how desirable it is that drawings of an apparently technical nature, should be found on the walls at the Architectural Exhibition, even to a greater extent than they are; and that the gratification which the collection can afford, should be sought through intelligent study,—which indeed, it is needless to say, is always the medium most fruitful in intellectual benefit, and the higher and durable kind of pleasurable emotion.

Judging by the number of persons who have taken season tickets, and the large and attentive audiences at the lectures, we think we may say that the interest of the public has been excited; and much benefit will result to Art generally, from this better appreciation of architecture. There are of course, for Arts like painting and sculpture, walks which may be separately followed; and in these, our country holds no low place; but there is, notwithstanding, a particular walk, and that perchance the grandest, in which neither the supposed high Arts of painting, sculpture, and architecture, nor the extensive branch of industrial and ornamental Arts, can be parted from the sphere of one comprehensive scheme and motive. The architect views his Art as embodying all that pertains to the form and structure, and the decoration, and furnishing of buildings; and if he went even further, he would have the history of Art, and examples from its best periods still as evidence on his side. But this view, and that of the necessity of architectural Art to the cultivation of the higher fields of painting and sculpture, has been before dwelt upon in these pages, as in the papers some time back, on the Halls of the City of London.

Although the opposition of opinion which prevails in the profession,—and of which, works in the present Exhibition are evidence—is not wholly favourable to the comprehension of architectural Art by the public; there are yet proofs of an amount of progress in all respects, which is very gratifying to those who, like ourselves, have striven to bring it about. It happens indeed that a great proportion of the drawings represent churches, cemetery buildings, and schools,—these being almost universally in the Gothic style,—in which we are constrained to think that much inventive skill is not just now shown. At the same time, there is ample evidence of general advantage as having accrued to the Art by the study of Mediæval works. Knowledge of perspective, and skill in delineation, of course form the mere means for the creation of Art; still it is not unimportant to note how these have been fostered,—albeit, allowing that the neatness and precision of French drawings may suggest that deficiencies still exist on the English side. But the real cause for congratulation is the steady growth of what has been lately dwelt upon in a leading article in the *Times*,—namely, the principle of truth in structure. During the period which immediately preceded the revival of Gothic architecture, even in works of great pretension, there had been an entire forgetfulness of the necessity for union between the uses of the structure, as well as properties of the materials used in it, on the one side, and the expression of Art on the other. It is clear that, if these uses are not necessarily to be prominently expressed, there should at all events be no effect which is discordant, or inconsistent with them. Each material, for example, having its own physical properties, these are to be made the most of, in place of using one material in the form which had been characteristic of another; or, as it has been said, iron-work should be treated as iron-work, and cement as cement; in neither should we seek to imitate stone. To act otherwise is at once to court the appearance of pretence, and of inferiority, which, as we have often tried to urge, gives the very impression which is repulsive to Art. The only error which we believe is made by the advocates of *constructive truth*, is in the supposition that it alone will make the beautiful; and this is an error from which neither the article in the *Times*, nor the subsequent correspondents of that journal, were free. That article, however, alone, is perhaps one of the greatest services ever rendered by the general press to Art; and had the same interest been taken, as well as enlightened judgment shown, in archi-

tectural Art before, it would not have remained so long in an abject position.

One of the principal evidences which the Exhibition affords, of the gain from the study of Mediæval Art, is to be found under the class of metal work. Of this kind of Art-manufacture, Messrs. Hart exhibit the remarkable collection which they had in the Paris Exhibition, in addition to other works. Though there is a tendency in some of these, towards exact reproduction of natural forms, the whole display is creditable both to the manufacturers, and the designers they employ.—Mr. Truefitt has attended to this branch of his art with much success, as shown by the drawings of doors from his designs, where iron-work tracery is fixed in glazed panels.—Amongst the specimens of decorative work, Mr. Simpson's paper-hangings—of Mediæval character—may be referred to with approbation; and Mr. Leake's leather-hangings, Mr. Stevens's glass mosaic, and the decorated glass panels exhibited by the Ladies' Guild, are inventions capable of being turned to much account. The best of the specimens of decorative painting are those exhibited by Mr. A. Remon. In some of these works, however, and in the whole lot of designs by Messrs. Galli and Cotti, and others by Mr. Kackuck, the structural principle is lost sight of,—allowing that both prolific fancy and executive skill are not wanting. Indeed the Italian artists named, deserve special notice for the excellent specimens of fresco-painting which they exhibit. In their designs, the error has been the following one: that style of degenerate Italian which was precisely what led to the evils we have referred to, as corrected by the revived Gothic. It would be well if the decorative designers who this year exhibit, would devote some study to this latter style,—though without falling into the error of many of those who follow it,—for which, the loss of their inventive skill would be a poor exchange.—Mr. Kershaw exhibits a door, where the panels are painted with fruit and flowers in excellent style; and Mr. E. Morley's specimens of floral-decoration—besides being executed in a vehicle which dries "dead," yet appears likely to be durable,—show him to be a competent hand in his class of subjects.—Messrs. Jackson & Son in specimens of papier-mâché, and carton-pierre; Mr. Pierce in stoves and chimney-pieces; Messrs. Bowden & Co. in ornamental cut glass, and Mr. L. W. Collman, in a curved oak mantel-piece, exhibit some of their best work; but there are in addition many specimens of materials and building contrivances. We must, however, not omit to mention the numerous varied and beautiful designs of Mr. E. Prignot, the artist engaged by Messrs. Jackson & Graham. Several of them comprise designs in different styles, for the sides of apartments; and in one he has introduced, with accessories consistently combined in the Louis XVI. style, the elaborate sideboard made by Messrs. Jackson and Graham, which formed one of our illustrations of the French Exhibition.

¶ We have, however, got drawn away from the general drawings; though indeed amongst so large a collection, if we refer to any, we may omit others as deserving of notice. Amongst the designs for the Oxford Museum (a building now being erected in a somewhat questionable version of Gothic which has grown into favour of late); there are some which received premiums in the competition. Mr. E. M. Barry exhibits several different designs,—one of the chief of them being Gothic, and another Cinque-Cento Italian, whilst Messrs. Travis & Manguall have chosen the style of the early Renaissance. Mr. I. Anson is the exhibitor of one of the designs for the Birmingham and Midland Institute, which is marked by much novelty of detail, and attention paid to grouping. Amongst the other competition designs, are some for the Taunton Assize Courts. Mr. Lamb's design has a portico well planned for effect. In the details great novelty has been attempted. Messrs. Pritchard & Seddon's design, which is shown in a complete set of drawings, is in the Gothic style, and uses the open-timbered roof of the Westminster Hall class with excellent effect. Of the Westminster Hall roof a good outline drawing by Mr. Dollan is exhibited; and we may say that

of other drawings of old works, the Exhibition contains some interesting specimens.—There are several designs sent in competition for the Sheffield College of Art. In those by Messrs. Weichtmann, Hadfield, & Goldie, and that by Mr. G. R. Gosson, a very marked effort is made to open out a new path, and in both cases with considerable success. In one of the designs by the former gentlemen, paintings were proposed for panels on the exterior; and colour generally plays an important part, both in these designs on the exteriors, and in others in the collection. Mr. Gray, this year as last, has made some successful applications of brick, stone, cement, and tiles combined in a general design, and there is much less of the tendency to ride a good idea somewhat hard, perhaps shown in his application of inlaid tiles, than formerly. His cornices exemplify a manner of using brick-work, which is perhaps even better than is to be discovered in the works of Mr. Kerr,—who has paid particular attention to the subject of brick architecture, and one of whose drawings has considerable merit.

However, the class of buildings in which the chief progress in architectural art has been exemplified, is not adequately illustrated; and the omission of such important works, as we could readily mention, of street architecture, both in the metropolis and the provincial towns, tends, we fear, to some misapprehension of the state of architectural taste. We have read some published critiques, which are indeed sad specimens of the incompetence on Art questions, still too often discoverable in ordinary journalism.

The chief exceptions to the deficiency in this department of the collection, are afforded by drawings of a few of the warehouses lately erected. Amongst the illustrations of Manchester warehouses, Mr. E. Walters's beautiful drawing is remarkable. It shows two or more of the works which have done so much to raise the character of the northern town in the scale of Art.—Mr. Godwin's farm-buildings near Bristol, we may say, exhibit many improvements, not only as to conveniences, but in simple decorative design.

The interest with which we lately said we view the Exhibition, must not be judged of from the length of this notice. The collection displays, we repeat, much evidence of the hopeful condition which architecture as a living Art is attaining; it will, we trust, continue to excite a large amount of public interest; and if the opening could be arranged for a period of the year when town is full, and when the light is better for the minute examination which architectural drawings require, we could hardly attach too much importance to it as an educational agent. A large increase of space is however desirable—not merely for drawings, but for those numerous objects of Art which, as it is being perceived, have had no importance given to them under the régime of the Academy. We should also like the catalogue to be a model of arrangement and accuracy, and the "hanging" somewhat better for the purposes of study. The subjects of the lectures, also, should be less antiquarian; that is to say, the opportunity should be chosen for diffusing information as to what architecture is, and what objects it is calculated to effect,—subjects which have long been little comprehended by the public.

It will not, however, be supposed that we do not feel indebted to the committee for exertions under circumstances of no slight difficulty, and to which exertions it is not too much to say that the nation, as well as the profession of architects and other artists, may owe much. Mr. Asplitel, the treasurer; Mr. Fergusson and Mr. Edmeston, the secretaries; and Mr. Wyatt Papworth, an active member of the committee, are especially entitled to thanks; and the duties which individuals have to undertake in these cases, are never easy, nor light. If hitherto we have afforded less space to the consideration of Architecture than the professors and lovers of the Art think we ought to devote, it has not been because we are insensible to its merits or its beauties, but because there are other journals which Architecture may claim exclusively as its own; we shall, however, report, from time to time, what we consider may promote its interests.

THE MILL AND THE STUDIO
OF REMBRANDT.

BY F. W. FAIRHOLT, F.S.A.

WITH ILLUSTRATIONS FROM ORIGINAL SKETCHES
BY THE AUTHOR.

On the banks of the Rhine, between the villages of Layordorp and Koukerger, there stood, at the end of the sixteenth century, a large, old-fashioned mill, on ground slightly elevated, and commanding a less monotonous view than Holland exhibits in general. It must not be understood, however, that the Rhine here exhibits any of those features of romance which give its banks so much attraction higher up the stream; its flat unvaried course partakes of the melancholy of extinction as it divides its water, and, losing itself in the marshy wastes of Holland, flows into the sea. Herman Gerritz van Rhyn was the owner of the mill, and on the 15th of December, 1606, the somewhat gloomy home he inhabited was rendered more joyous by the birth of a son who was destined to make the unknown name of his father immortal. The young Rembrandt van Rhyn appears to have been left to grow up in boyhood with a perfect freedom from all restraints, even of an educational kind. It is reported that he was schooled a little at Leyden, but it is evident that his attainments could never reflect back any honour upon that seat of learning. Application of such a kind was never to Rembrandt's taste, and historic research, even when necessary for the *raisonné* of his designs, he openly and avowedly despised. How soon his taste for Art developed itself we do not now know, but it is very likely to have been exceedingly early, and the gloomy shade or vivid sunshine which alternated in his father's mill, may have impressed his youthful imagination most strongly at a time when the mind is most open to powerful impressions. His early days must have passed somewhat monotonously in his home, which by his own representation had few attractive features.* The mill itself seems to be situated over the favourite ditch of a Hollander, which stagnates close by the house, a square, gloomy building, with heavy dormer windows, the roof partly overgrown with the rank herbage and parasitical plants of a damp climate. It seems the very realisation of Tennyson's "moated grange;" like that,

"The broken sheds look sad and strange,
Weeded and worn the ancient thatch."

You can detect the marshy moss which "thickly crusted all," while the "sluice with blackened waters" is near, and the distant prospect is but

"The level waste, the rounding gray."

A boy born here, to have become an artist, must have been gifted at birth with a genius for Art, and his visible powers for practising it must have been strong to have induced his parents, who appear to have cared little for his mental cultivation, to obtain instruction for their son of its professors. They were not wealthy, and, consequently, could not obtain the best assistance; four mediocre professors of painting are named by Smith in his memoir of Rembrandt as his instructors.† But the very brief period he remained with each, and the small assistance they could have been to him, except as instructors in its simplest rudiments, is evident from an acquaintance with their works and his own. He soon left them all, and practised what he knew in his paternal house; with his taste for *chiar-oscuro* there can be little doubt that the strong opposition of light and shade constantly before him in the gloomy mill, where his father pursued his avocations, gave him the first hint of the hitherto undeveloped power he possessed, and which he "subsequently carried to such high perfection in his works, that he may be said to have created a new era in painting."‡ Through life he seems to have always worked as if he had the effect of a small amount of con-

* The etching of his father's house and mill, which is here copied, is dated 1641, and was consequently done by the painter when he was thirty-five years of age.

† Prefixed to his complete and excellent "Catalogue Raisonné" of his works.

‡ *Ibid.*

centrated light before him, and as if every object he portrayed was more or less subjected to that medium only. Burnet, in his "Lectures on Painting," has admirably dissected this principle, as original as it is inapproachable; "in real truth," says Kugler, § "he struggled to give vent to a rude defiance of all conventional excellence, and in the fulfilment of this task he has, indeed, produced extraordinary effects. He gives no sharply-defined forms, but merely indicates

them with a bold and vigorous brush; the principal points alone are made bright and prominent by striking lights, but at the same time the lights reflected from them penetrate in a wonderful manner the surrounding darkness, to which they thus give life and warmth."

He appears to have reached the age of manhood ere he left his father's roof, and to have had the mill and its neighbourhood for his studio, and the boors who lived near for his

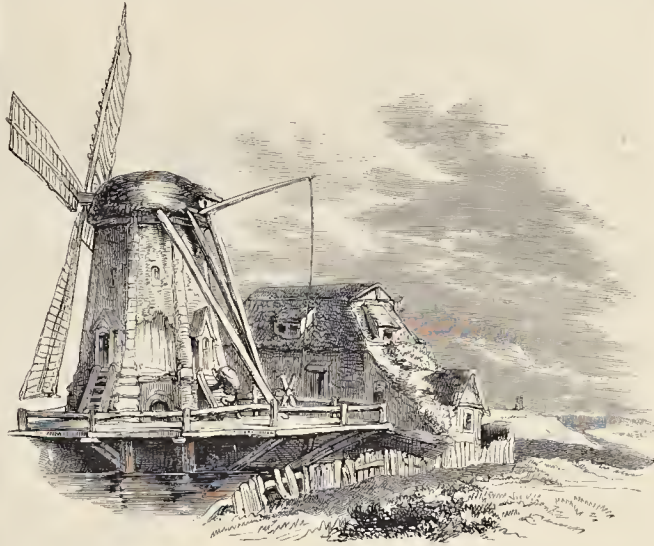

REMBRANDT'S MILL.

companions. He never lost his early tastes, and seems to have loved, in more prosperous days, to revert to the lower companionships of his youth. When rallied on this taste in after-life, he honestly owned the little relief he found in high society, or the envied *entrée* he could command to the houses of the *élite* of Amsterdam, saying, "If I wish to relax from study, it is not honour, but liberty and ease that I prefer." How admirably has a great living artist || vin-

dicated and displayed the true position he occupied. "Men of great and original genius, who, like Rembrandt, have little of what is ordinarily called education, and who seem wayward in their tastes and habits, are sometimes looked upon as inspired idiots. But in the mind of such a man, the immense amount of knowledge accumulated by great and silent observation, knowledge of a kind not to be communicated by words, is something wholly inconceiv-



SIX'S BRIDGE.

able to the learned merely in books; and if their reading has opened to them a world from which he is shut out, he also lives in a world of his own, equally interesting, the wisdom and enjoyment of which his pencil is constantly employed in communicating to all who have eyes for the sublime aspects of nature, and

hearts fitted to receive such impressions through their eyes."

That Rembrandt was thus diligently and usefully studying is evident from the rapidity of hand, and power of expression he possessed in after-life. His vigour was unfading, and his industry unbounded. We possess, in Smith's "Catalogue Raisonné," a detailed account of 614 pictures by him, and he assures us, that "a list of drawings of perhaps triple the number might

§ "Handbook of Painting," Part II.

|| Leslie, in his "Handbook for Young Painters."

be made from the public and private collections in England, France, and Holland;* then add to these his etchings, consisting of 365 pieces, exclusive of the numerous examples of variations in the same plates, and we have an astonishing picture of his powers and industry.

His extraordinary facility of hand is evident in all his works; there is an amusing record of its power in one particular instance, which deserves notice. The painter had gone to pass a day's holiday with his friend Jan Six, the Burgomaster of Amsterdam, at his country house. The time for dinner had arrived; it was served; but when they had sat down to table, the thoughtless servant had forgotten to obtain any mustard; he was despatched in a hurry to the village close by to obtain it, but Rembrandt, fully aware that to hurry is no characteristic of a Dutch servant, at once wagered with his friend that he would etch the view from the window of the dining-room before he returned. The painter had always some plates ready prepared for occasional use at his friend's house, so he took up one, and rapidly sketched upon it the simple view before him, completing it before the domestic returned. Our engraving is a faithful copy of this etching, about one-third of the size of the original; it is dated 1645, and represents the most simple elements of an ordinary Dutch view, a bridge, a canal, a low, level horizon, a village among trees, with a boat half-hidden in the canal beyond. The mark may yet be seen in the original impressions of this rare plate, where Rembrandt tried his etching-point before commencing his work, which is executed with the greatest freedom of hand, so that a few lines only express the trees and boats, and a few decisive shadows give solidity and effect to the scene. There is nothing in the etching to dissipate any faith in the tale of its origin, and it is popularly known as "Six's Bridge," or "The Mustard-pot."†

At this time the artist was located in Amsterdam; his first recognition as a painter was at the Hague, in 1627, where he had journeyed to sell a picture to an amateur, who astonished him with a payment of 100 florins (*St. Gs. 8d. English*) for it. Houbraken, who relates the story, tells of the joy of the young artist, who travelled from his father's house on foot to his patron, a distance of about 10 miles, but was too eager to acquaint his parents with his good fortune to return by the same mode; he therefore mounted the diligence, and when it arrived at Leyden, jumped from the carriage and ran home as quickly as his legs could carry him. In the year following he took up his abode in Amsterdam, and (with the exception of a voyage to Venice, which it is conjectured by some of his biographers he may have taken about 1635‡) never left the important capital of Holland.

Amsterdam has been aptly styled a "Dutch Venice;" it is permeated with canals, and founded in the water. It is, perhaps, the most artificial site in the world for a city; being, in fact, nothing but bog and loose sand, and every inch of foundation for human habitation or use, has to be made by driving wooden piles through this into the firmer sand below; each pile is formed of a large tree, 40 or 50 feet in length, and it is recorded that upwards of 13,000 were used for the foundations of the town-house alone. This may give an idea of the expense of building in the city, and the enormous quantity of timber upon which it is constructed, which led Erasmus to jocularly say of its inhabitants, that they, like

* The *chef-d'œuvre* in our National Gallery, the cabinet picture, "The Woman taken in Adultery," was painted for the Burgomaster Six, and preserved with scrupulous care by the family until the great revolution at the end of the last century, when it was sold to a French dealer, who again sold it to Angerstein for 5000*l.*

† This very rare etching sold in the Versteek sale at Amsterdam, in 1844, for 17*l.* 15*s.*, and would now fetch considerably more, as the value of Rembrandt's etchings has increased yearly.

‡ The conjecture is founded solely on the fact of three etchings of oriental heads, bearing the inscription "Rembrandt fecit." But the *St. Gs.* British observes, "may have been a mere caprice of the master," or a jest in connection with his subjects or their treatment, or else a satire on the taste which would prefer the more ambitious school of Italian Art to his own; a feeling fully in accordance with Rembrandt's expressed opinion on other occasions. There is no other indication than this of foreign travel in his life or works.

crowds, lived on the tops of trees. The distant view of the town from the Y § side is very curious, with its tall houses mixed with shipping, some mansions bending portentously forwards, others sinking sideways or backwards, and all showing the insecure nature of their foundations. ¶ But the most curious feature in the view is the myriad of windmills mounted on the fortifications on the land side of the town. There are thirty bastions now useless, and upon each of these works windmills are erected, the odd effect of the number of their sails rapidly whirl-

ing in the breeze, is a peculiarity as unique as the city itself. These fortifications now make an agreeable promenade for the inhabitants, the city being built in the shape of a crescent from the water's edge. It is nearly seven miles in circumference, and consists of 95 islands, formed by stacks of houses, to which access is gained by 290 bridges. On the quays are many noble houses, the erections of the rich and powerful merchantmen who, in the palmy days of the city, flourished here. The best hear dates of the days of Rembrandt, and testify to the wealth



DISTANT VIEW OF AMSTERDAM.

and taste of their inhabitants. There is a solid dignity and a well-understood comfort about these old houses, very characteristic of that strong domestic attachment which the Dutch so passionately feel. In their love for the substantial they even exceed the English, and the ponderous character of the carved staircases and panelled rooms would more than satisfy the objections of the veriest "John Bull" to flimsiness of construction. Everything seems made as much for posterity as for personal use; and

in walking over the town, you see that two centuries have passed over its buildings, though located in the dampest position, with scarcely a "defeature" from time, and that they may well last two more. There seems no desire for change in a Hollander; that which is substantial and useful is enough for his requirements, and no idea of modern improvement seems to be sufficient inducement for the trouble of alteration. In walking through the best street of Amsterdam (the Kalverstrasse) you see nothing but, the



ST. ANTHONY'S GATE, AMSTERDAM.

quiet red brick houses, with their "crow-step" gables, that we have been familiar with from childhood in the pictures by native artists; or

the heavy wooden shop-fronts, with their ponderous frames, and small squares of glass, much like the old London shops in the prints of the time of William and Mary. One spirited individual has recently built a showy shop here,

§ The Y or *Ji* is an arm of the Zuyder Zee, which forms the port, and this syllable or letter, resembles in sound the word used in Holland for water; *het Y*, the term by which it is usually known, means nothing more than "the water."

¶ In 1827, the enormous corn-warehouses used by the East India Company, loaded with 70,000 cwt. of corn, sank down into the muddy foundation, from the subsidence of the wooden substructure. The old Exchange has also sunk, and been demolished.

‡ Our view is sketched from the borders of the great ship canal, opposite the city, and shows the old church, the quay, and bastions. The boat drawn by a horse is the *treckhuys*, or travelling boat, used by passengers on canals, consisting of a low covered saloon built in a broad barge, with an open railed platform above, to which passengers may ascend in fine weather. It is the most popular mode of conveyance.

light and airy, *à la Paris*; but it seems to be looked upon as a folly, rather than a want, by the inhabitants.

One of the oldest and most picturesque buildings in the city, of a public nature, is the Weighing House, situated near the Museum, and the house where Rembrandt lived. It was originally a gate, before the town had increased to its pre-

sent unwieldy proportions, and was known as the Gate of St. Anthony. It is said to have been erected in the latter part of the fifteenth century, and to have played its part in the wars between the inhabitants and their vindictive Spanish rulers. It is a quaint solid old building, and some few years since was used as a medical school, after its desertion by the merchantmen.

engraving.† It was situated in what was then known as St. Anthony's Bree Street, and which is now called the Jews' quarter. It was a large handsome mansion with garden attached, and was freehold. The artist appears not to have been enabled to purchase it without borrowing the sum of 4180 guilders, which was advanced on mortgage; and being soon after unable to meet his engagements, his entire effects were seized and sold by order of the magistrates, in July, 1656. The homeless painter was obliged to lodge where he could, and make a charge for his necessary maintenance to the bankruptcy court. He was but fifty years of age when this happened, but he did not long outlive his altered position, for he is believed to have died in 1664, as his son Titus received the balance from the same court of 6952 guilders (upwards of 600*l.* English) in the following year, which was paid over to him as a balance of accounts after all claims, including heavy law expenses, had been paid out of his father's property.

From this it appears that Rembrandt, like many other unfortunate persons, was a victim to law and lawyers; and added another to the long list of men of genius who are fed on by the intellectual harpies around them, but who are still ever ready to sneer at the want of business habits displayed by their prey—a sneer too frequently repeated by the wealthier ignorant, always glad to drag genius down to their own low level. The parsimony attributed to Rembrandt is not unusual with his countrymen in general; and the stories of his dining off a herring, or a slice of bread and cheese, need excite no wonder in a land where all practise thrift. The fac-simile of his autograph we engrave is from a letter to the great Huygens, written on a piece of paper which had been previously used to fold round a copper-plate; but with the artist's little love of trouble, we may account for that by other than parsimonious reasons.‡ The tales so readily told of the painter's parsimony, and his unworthy tricks in accumulating money, are almost disproved by the melancholy close of his life. Still, at one period he must have earned much. Smith, his best biographer, is inclined to infer that his difficulties resulted from indiscreet conduct in the management of his affairs. Another easy mode of accounting for much loss of cash, is in the suggestion also thrown out in the same work, that the painter's intimacy with Maussel Den Israel and Ephraim Bonus may have tempted him to part with his money for alchemical pursuits, as both those persons were addicted to cabalistic studies, and the former wrote a book on the subject, for which the artist etched four plates remarkable for mysticism. The etching of Faustus in his study, gazing on the mystic *pentapla*, which irradiates his gloomy chamber, gives us the best realisation extant of the cabalistic belief of the occult philosophers, and proves how far the artist had studied and was familiar with the dreamy science.

Rembrandt's scholars were many; but his power of *chiar-oscuro* did not descend to any of them. Among them were Gerard Dow, Nicholas Maes, and Ferdinand Bol, all excellent in their way, but characterised by few peculiarities like those seen in the works of their early preceptor. Rembrandt cared little for historic properties.

The originality and peculiarity of Rembrandt's genius has left him undisputed master of his own walk in Art. It would be impossible to improve his faults without injuring his productions. By the magic of his hand he has at times elevated low and disgusting forms into covetable marvels of light and shade; the grand management of pictorial effect is always present, while at times the conception of each picture in its totality is unrivalled in Art.



REMBRANDT'S HOUSE.

In the open space in front the scaffold used to be erected for criminals, and others for spectators around it; the burghers at one time firmly believing such spectacles had their uses in deterring evil doing: hence, their families and dependants were compelled to attend these horrible "salutary warnings," as a great moral lesson.

Rembrandt's industry was untiring, as we have shown, and appears to have been so far rewarded with success, that he took a large house in the Blomgracht, and fitted it up for the reception of pupils. He had married the daughter of a farmer, named Uylenburg, living at the village of Ransdorp,† in the swampy district opposite the city, appropriately called

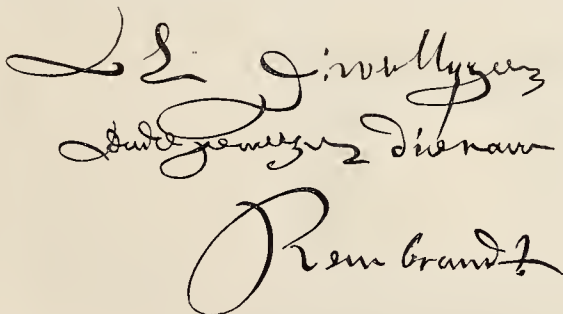

AUTOGRAPH OF REMBRANDT.

Waterland.* His pupils, according to Sandrart, brought him an income of 2,600 florins per year, as he received 100 florins from each for that period. His paintings, drawings, and etchings

must have also realised considerable sums. From 1640 to 1650 appears to be the culminating point of his genius and his fortune.

Rembrandt's misfortunes commenced with the purchase of the house delineated in our

* By this marriage he had a son, Titus van Rhyen, who, educated for Art, never succeeded beyond copying his father's works, and died in obscurity.—Smith.

† The scenery of this village, and the old tower in its centre, were etched by the painter in 1650.

† It is copied from a print published in Smith's "Catalogue Raisonné," from a sketch by Mr. Albertus Brongest, made before the house was destroyed in 1831; the same gentleman caused a black marble tablet, on which the name of Rembrandt is inscribed, to be inserted at his expense in front of the new one erected on the site. It is situated at the back of the museum, the gardens and outbuildings of both joining.

‡ Autographs of Rembrandt are very rare; four letters in Sloepken's collection, and one in London for 3*l.* 1*s.*; the above was in the Donnadieu sale.

THE
PROGRESS OF ART-MANUFACTURES.

NOVELTY seems to be as much the aim of the manufacturers of the present day as any other quality in the objects they produce; we speak



not of novelty in design only, though this is carried to a considerable extent, and often to a point beyond its legitimate principles—but also in the introduction of new materials, or in a combination of those long in use. The taste of the public appears occasionally to require this kind of enticement; and yet it has become so



fastidious, or, rather, it is assuming so right a direction, that novelty alone will not command success.

Though the excitement caused by the great universal exhibitions of 1851 and 1855 has now passed away, there is little fear that the manufacturers of our own country, any more than those of France, will rest upon their oars;



neither we nor they can afford to do this, for each has been stirred up to a rivalry in the art of production which ought to, and we doubt not will, result in good to all. And, inasmuch as we claim to have had some small share in creating these national competitions, it is not our intention to separate ourselves from those whose interests we have advocated to the best of our ability, even although there is now less occasion

for our interference than there was a few years back. We have felt that the Industrial Arts of Great Britain had a claim upon us, and that while endeavouring to promote their progress, and to direct the tastes of the



producer and consumer, we were conferring a mutual benefit on both: we feel this still, and shall therefore continue, at suitable intervals, to report whatever may seem worthy of a place in our columns.

In pursuing this plan, we have engraved on this page several objects selected from the establishment of Messrs. ATKIN, BROTHERS, of Sheffield and London.

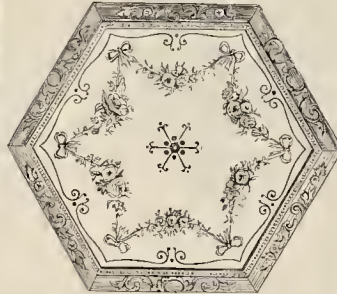

They are examples of that novelty in material of which we have just spoken, the frame-work being composed of electro-plate, and the centres of tiles—manufactured by Messrs. Copeland & Co.—richly ornamented, and highly glazed to prevent their being scratched. The objects themselves consist of baskets for fruit, cakes, or cards; stands for tea-pots,



urns, kettles, or lamps. They are made in a large variety of patterns, sizes, and colours, some of the tiles having a white ground, and others coloured, as seen in the engravings: the best decorative artists are employed on the ornamentation. The novelty and beauty of these metallo-ceramic productions cannot fail to secure them popularity.

THE SLEEPING CHILDREN.

FROM THE GROUP BY W. GEES IN THE COLLECTION OF THE QUEEN.

M. GEES would seem in this work to have taken a leaf out of the book of Chantrey; it is highly probable the Belgian sculptor has never seen the exquisite group by our countryman erected in Lichfield Cathedral to the memory of the young children of the late Reverend W. Robinson; possibly has never even heard of it; there is not, moreover, such a manifest similarity between the two works as to suggest the idea of plagiarism, and yet a glance of the more recent piece of sculpture involuntarily recalls the older group to recollection. The position of the children in both is nearly the same, the arms and heads are disposed alike, both groups are lying on mattresses, but Chantrey's figures are stretched at full length, indicating an entire suspension of animation, while these by Gees are living, though motionless, and are not extended as the others; Chantrey's, moreover, are draped. Death, peaceful, profound, holy, is the attribute which pervades the one group; life, fresh, innocent, lovely, characterises the other.

A work of this nature is a novelty from the hand of a foreign sculptor; it proves that a feeling for subjects of a domestic character, such as have hitherto seemed indigenous to our own soil, are beginning to find a home elsewhere. We believe that this kind of art, though usually, and wrongly, we presume to say, rejected by the learned as high art, has a most beneficial tendency upon the minds of the majority of the public; it elevates and purifies the thoughts by the moral lessons inculcated. The highest state of civilisation, and the greatest excellence to which the arts can attain, are not of themselves sufficient to create a standard of morality and right principles. Greece, when at the pinnacle of her intellectual and artistic greatness, showed how utterly futile were such advantages in themselves to preserve her from moral degradation; the statues of her deities and her courtesans stood side by side at Delphi. Personal beauty, both in their male and female forms, was what the Greek sculptors aimed at,—it was in their estimation the highest merit; as it was a maxim of policy and philosophy among the Greeks, generally, to present to the eyes nothing but models of the beautiful.

Admitting the law of beauty to be a primary condition of all art, but especially of the art of sculpture, that of purity of sentiment and expression has an equal, if not prior claim, on the artist's conceptions. We may, perhaps, incur ridicule for subordinating these qualities to that in which the ancients delighted; but we are not the less certain that their combined existence is essential to the true dignity of art, and that such a combination can alone render it acceptable in our age of the world. Even among those continental nations who have been less lax in their ideas than ourselves, this feeling is now everywhere manifesting itself.

The group of "Sleeping Children," by W. Gees, of Antwerp, the sculptor of the "Lion in Love," engraved in the *Art Journal* last year, is in the Royal Collection at Osborne, and was, we believe, executed in marble, by command of her Majesty, from a plaster model that the Queen had admired. It is one of those subjects that never fail to please, and is executed in a manner which leaves little or nothing to be desired. The attitudes of the figures are perfectly natural, the forms well-modelled, the faces truthful, childlike, and sweet in expression; the heads, especially that of the nearer child, would, perhaps, have been better if rather smaller; we remark that sculptors often fall into the error of exaggeration in the heads of young children.





Vertical text on the right side of the page, likely a title or a list of items. The text is faint and difficult to read, but it appears to be organized into several lines or sections.



THE PUTTI OF MICHELANGELO
The Putti of Michelangelo, from the tomb of Lorenzo de' Medici, Florence.

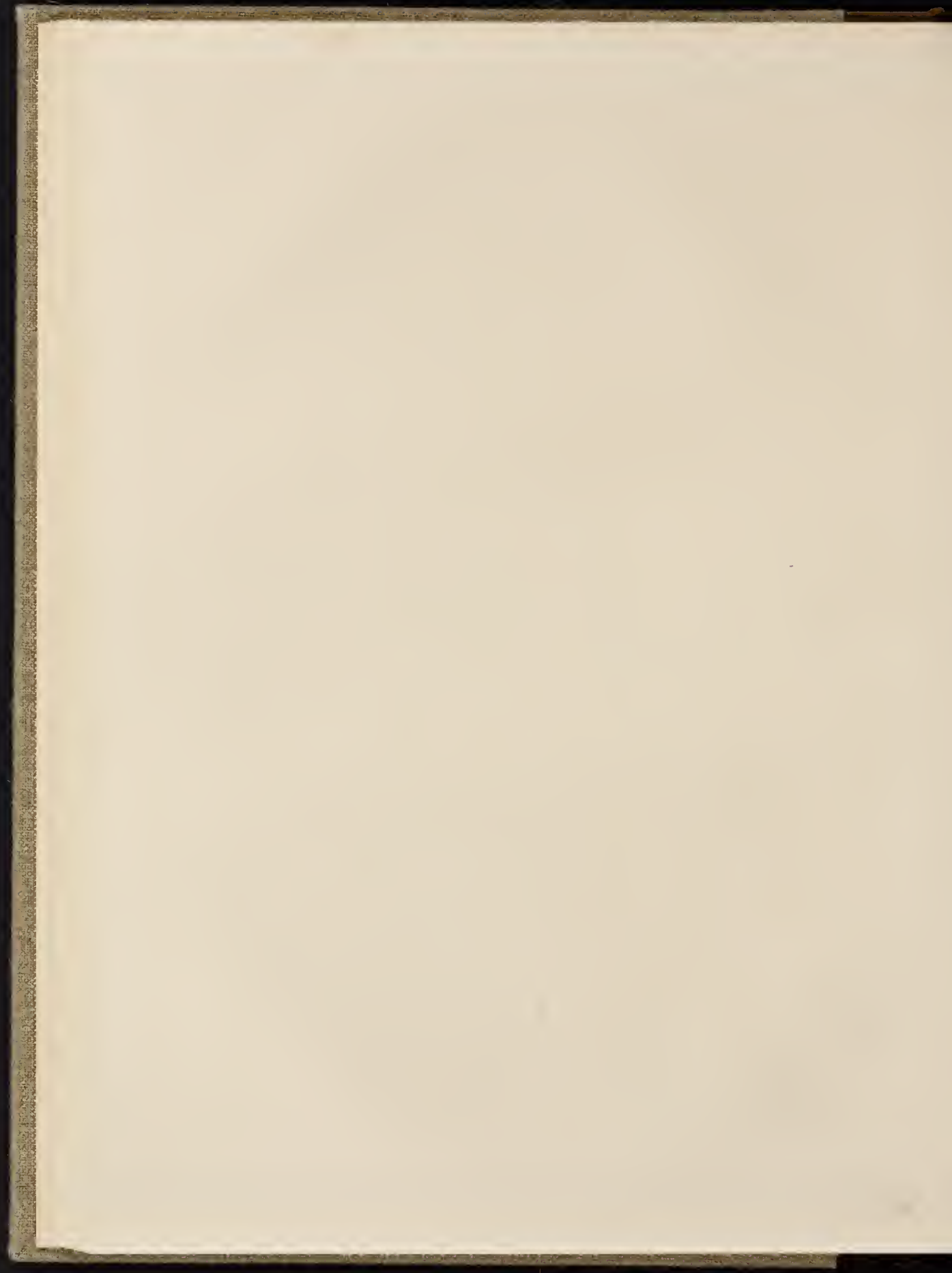

ART IN THE PROVINCES.

BIRMINGHAM.—The Exhibition of the Society of Artists closed on the 12th of January, after a very successful season, as regards both sales and attendance. During the fortnight that the collection was opened to the working classes, it was visited by no fewer than nine thousand persons; and the sales of pictures, according to the catalogue prices, amount to no less a sum than 2,654. 19s. The following is a list of the private sales made during the season:—'Blind Man's Buff,' J. E. WALKER, 120*l.*; 'The Dairymaid,' W. UNDERHILL, 100*l.*; 'Master Walter Scott and his Friend Sandy Orniston,' J. E. LAURIE, R.S.A., 84*l.*; 'Devotion,' A. JOHNSON, 73*l.* 10s.; 'The Charge of the Heavy Cavalry Brigade at Balaklava,' H. SHLOOS, 63*l.*; 'An Old Mill on the River Ouse,' H. J. BODDINGTON, 60*l.*; 'The Gulf of Sorrento,' J. B. PYNE, 60*l.*; 'On the Trent,' J. WARD, 50*l.*; 'Cactus,' Miss MOURLAIN, 42*l.*; 'The Youthful Pioneers,' E. WALTON, 31*l.* 10s.; 'Hollyhocks,' Miss MOTTRE, 26*l.* 5s.; 'Grunners,' G. W. PETER, 25*l.*; 'Brimmy Hours,' F. BRIDGPORT, R.E.A., 21*l.*; 'The Keeper's House,' G. W. HORTON, 21*l.*; 'Mother's Pet,' G. W. HORTON, 21*l.*; 'Secret and Confidential,' R. FAIRBairn, 20*l.*; 'On the Irwell, Bartow Laker,' E. HARGITT, 20*l.*; 'The Little Mischief Maker,' J. COBLEY, 18*l.*; 'The Woodland Spring,' A. BOUVIER, 17*l.*; 'Queen Elizabeth's Room at Combe Abbey,' A. E. EVERT, 15*l.* 15s.; 'Scene near Dovedale,' W. B. HENLEY, 15*l.* 15s.; 'Snow-halls,' J. A. PULLER, 15*l.* 15s.; 'Near Conway,' W. PITT, 15*l.*; 'Rump on the Hay,' J. BOUVIER, 12*l.* 12s.; 'Breach of Pleasants,' G. G. BULLOCK, 12*l.* 12s.; 'A Dispute Arranged,' J. LEVACK, 12*l.* 12s.; 'A Welsh Bridge,' H. MYSTON, 10*l.* 10s.; 'Royal Water,' A. P. COLLIS, 10*l.*; 'Wintermore,' G. W. PETER, 10*l.*; 'Near Farnley,' E. HARGITT, 8*l.*; 'Dittisham on the Dart,' W. PITT, 8*l.*; 'The Farm Yard,' J. STEWART, 7*l.* 7s.; 'Near Hampton,' S. H. BAKER, 5*l.* 5s.; 'At Llanfangel,' S. H. BAKER, 5*l.* 5s.; 'Near Thople Balsall,' S. H. BAKER, 5*l.* 5s.; 'A Shallow Stream,' T. EDWARDS, 5*l.* 5s.; 'A Soldier's Wife,' K. HARTMANN, 5*l.* 5s.; 'Tumbled Bridge,' J. ALLSON, 5*l.* 5s.; 'A Friend in Need,' S. BELMONT, 5*l.* 5s.; 'A Study from Nature,' P. DEAKIN, 5*l.*; 'Wind,' J. J. HUGHES, 5*l.*; 'Banks of the Isis,' A. VICKERS, 4*l.* 4s.; 'Avenue at Bolton Abbey,' A. VICKERS, 4*l.* 4s.; 'Marguerite,' J. BOUVIER, 4*l.* 4s.; 'Still Life,' J. T. HART, 4*l.*; 'Head of a Hindoo,' J. SCARROTHGILL, 3*l.* 10s.; 'Stray Ducks,' C. WRIGHT, 3*l.* 3s. The following is a list of the purchases made for the Glasgow Art-Union:—'Summer Trophies,' J. SAUND, 130*l.* 10s.; 'Capacitization, Plarnigan, and Grouse,' G. W. HORTON, 130*l.*; 'View in North Wales,' J. C. WARD, 80*l.*; 'Lod Tarn, Helvellyn,' G. W. PETER, 70*l.*; 'The Edge of the Wood,' F. H. HENSHAW, 60*l.*; 'Rustic Figures,' J. J. HILL, 56*l.* 15s.; 'A Thought from Bocaccio,' A. J. WOOLMER, 36*l.* 15s.; 'The Margin of Hemeride Water,' G. W. PETER, 50*l.*; 'A Path through the Woods,' H. J. BODDINGTON, 25*l.*; 'Lowestoff Harbour from the Sea,' J. CALLOW, 15*l.* 15s.; 'A Rest on the Road Home,' E. J. CORBETT, 15*l.* 15s.; 'Lanbister Church,' S. H. BAKER, 15*l.* 15s.; 'Old Buildings at Bernadine,' H. HARRIS, 15*l.*; 'A Shady Lane,' P. DEAKIN, 15*l.*; 'A Study on the Rhine,' W. CALLOW, 12*l.* 12s.; 'Venice,' E. PITCHETT, 12*l.* 12s.; 'Lamb's at Play,' J. DEAKIN, 12*l.* 12s.; 'Dewent Water,' G. W. PETER, 10*l.*; 'A Scene at Chilworth,' Surrey, J. DEAKIN, 6*l.* 6s.; 'View in North Wales,' J. C. WARD, 6*l.*; 'An Old Water Mill, North Wales,' J. J. Wilson, 5*l.* 5s.; 'Water Mill, Bettws-y-Coed,' P. DEAKIN, 5*l.*; 'An Old Foot Bridge, near Solihull,' F. W. HENSHAW, 5*l.* The works taken by prizeholders in the Birmingham and Midland Counties Art-Union—those of whom have made no selection, were:—'The School-fellows,' A. RANKLEY, 157*l.* 10s.; 'Gipsy Encampment,' C. T. BURT, 60*l.*; 'A Rustic Cottage,' H. HARRIS, 40*l.*; 'Near Talyllan,' W. HALL, 35*l.*; 'Approaching Rain,' C. T. BURT, 30*l.*; 'The Fisherman's Home,' T. CLATER, 26*l.* 5s.; 'Raglan Castle,' W. PITT, 25*l.*; 'The Farwell,' C. H. IRVING, 21*l.*; 'A Passing Cloud,' T. RAWNDS, 20*l.*; 'The Youthful Artist,' W. T. RODES, 20*l.*; 'Study of a Head,' W. GALE, 20*l.*; 'A Pedlar Boy,' O. OAKLEY, 18*l.* 18s.; 'Instruction,' J. BYLEY, 15*l.* 15s.; 'Cottage Hospitality,' O. OAKLEY, 15*l.* 15s.; 'Banks of the Luggwy,' F. W. HULME, 15*l.*; 'A Fortine Teller,' O. OAKLEY, 12*l.* 12s.; 'Cattle, Milking Time,' J. H. SMITH, 12*l.* 12s.; 'A Child's Prayer,' D. G. BRANSTON, 10*l.* 10s.; 'A Millard, &c.,' G. HICKIN, 10*l.*; 'Gossip in the Plough Field,' J. J. HUGHES, 10*l.*; 'Old Castle on the Rhine,' Mrs. OLIVER, 7*l.* 7s.; 'A Ruined Mill,' F. W. HENSHAW, 5*l.* 5s.; 'Whisper,' A. VICKERS, 5*l.* 5s.; 'Birmingham from Sutton,' W. B. HEN-

LEY, 5*l.* 5s.; 'Mill in Vale Crucis,' W. ELLIS, 5*l.* 5s.; 'The Evening Drink,' J. HAWKES, 5*l.*—The subscribers to the Birmingham and Midland Counties Art-Union met at the commencing of the past month for the purpose of receiving the annual report, and of balloting for the prizes. Notwithstanding the commercial difficulties of the past year, and the increase of national taxation, the subscriptions have increased, though even now they scarcely reach the amount one would expect to see from a locality so populous and wealthy as that of the iron districts; the total being 4997*l.* only. In the ballot for prizes, the two highest, that of 50*l.* fell to the lot of Mr. H. Dawson, of Chertsey; and that of 30*l.* to Mr. W. B. Jenness, of Birmingham. Lord Ward has accepted the office of President of the Society for the ensuing year.

GLASGOW.—The Second Annual General Meeting of the members of the "City of Glasgow Fine Art Association" took place on the 5th of January. The report of the secretary is as follows:—The council have the pleasure of reporting to the association at their second annual meeting that, like "the progress of good taste, which is certain and irresistible," the association this year exhibits the encouraging enlargement which the first annual report anticipated. The subscribers for 1854 numbered 687; for 1855, the list contains about 1490 names. In 1854 thirty-five paintings were acquired by the subscribers; for 1855 the number to be distributed is forty-seven. The paintings to be now drawn for were exhibited in the St. Vincent Street Fine-Art Gallery, and were visited and admired by large numbers of persons. They were considered by well-known connoisseurs of our city to be an extremely well-selected exhibition of modern art. It was intended to have them on the walls of the room in which the annual meeting is held, but the Merchants' Hall being the only available place of meeting, the council have not been able to carry out this intention. The experience of the past two years is evidence that the association has taken root, and in its growth shows features of vigour closely resembling the other Art-Unions of the country, which have, each, slowly perhaps, but surely, attained a magnitude that now exerts a most genial influence upon the Fine Arts in Great Britain. The object of this association is to promote the knowledge and love of the Fine Arts, and their general advancement, by an extensive distribution of the works of living artists—to elevate the standard of Art and its professors, by creating an increased desire and demand for works of Art, and a consequent improved taste on the part of the public. The council think it is not assuming too much, therefore, to say that a position has been attained by the association, which must already have exerted a very important influence; and to express the confident hope that, by its continued rapid growth, the association will ere long exercise an incalculably greater influence on the advancement of the Fine Arts. While they have every reason to be satisfied with the arrangements and progressive improvement of the past year, the council, in order to give the association the advantages enjoyed by the other Art-Unions, have resolved in future to present to each subscriber an engraving, or other specimen of Art in connection with the works exhibited. This resolution is a departure from what was originally intended to be a distinctive feature of this association from other Art-Unions, viz. that the whole funds were to be expended on works for distribution; but the alteration is made in compliance with the general wish of the public; and it is proposed accordingly that each member next year shall receive an engraving or finely-executed lithograph from the picture 'Margaret at her Spinning-Wheel,' by H. O'Neil, one of the present year's prizes. The prize-holder of this admirable cabinet painting will be bound to leave it for a few months with the association. This is the present intention of the council, who wish, however, to reserve the power of selecting a different painting if it seem advisable.

WORCESTER.—The exhibition of the Worcester Society of Arts has proved a prosperous one, considering the infancy of the institution, and the peculiarly unfavourableness of the times for the disposal of luxuries of every kind. Since our last report, in December, pictures to the value of between 400*l.* and 500*l.* have been purchased; the committee of the Glasgow Art-Union having bought liberally, yet with discretion. The entire proceeds of the sale to the time of closing amounted to nearly 700*l.* The following list of pictures sold may be added to that we previously published:—'A Forest Brook,' J. STARK, 50*l.*; 'Fishing-Boats, Dublin Bay,' E. HAYES, A.R.I.A., 17*l.* 17s.; 'A Woodland Pool,' B. WILLIAMS, 26*l.* 5s.; 'Shall I Tell your Fortune?' J. CURSACK, 26*l.* 5s.; 'Neapolitan Pea-

sants,' J. BOUVIER, 8*l.*; 'The Cotti-Flower,' BELL SMITH, 15*l.*; 'Sketch on Hampstead Heath,' C. COMPTON, 5*l.* 5s.; 'The Inattentive Scholar,' J. BOUVIER, 5*l.*; 'Gairloch,' U. BOUVIER, 5*l.* 6s.; 'Germanius,' Miss C. HARRINGTON, 5*l.* 5s.; 'The Game Boy,' J. STARK, 8*l.*; 'Entrance to Canterbury,' J. HENSHALL, 20*l.*; 'Study of Salmon, &c.,' H. L. ROLFE, 21*l.*; 'Borders of Derbyshire and Staffordshire,' J. PHEL, 20*l.*; 'Water-Mill, Mantistile,' A. DEAKIN, 4*l.* 4s.; 'Morning, North Wales,' G. THACKER, 10*l.*; 'Showing,' G. A. WILLIAMS, 20*l.*; 'Scottish Terraces,' T. EXEL, 21*l.*; 'Dead Gang,' J. HARRY, JES., 10*l.*; 'Approach to Market-Place, Lichfield,' J. HENSHALL, 5*l.*; 'Moel Siabod, Denbighshire,' F. H. HENSHAW, 10*l.* 10s.; 'A Nook in a Garden,' H. CHAPLIN, 8*l.* 8s.; 'Meadow Scene, near Leamington,' T. BAKER, 10*l.* 10s.; 'Paul Shripping-boats entering Hedor Haven,' R. STUBBS, 6*l.* 6s.; 'River Thames, near Greenwich,' H. HARRIS, 10*l.* 10s.; 'The Donkey Ride,' N. E. GREEN, 3*l.* 3s.; 'Dewent-water,' N. E. GREEN, 5*l.* 5s.; 'The Rainbow,' J. SIMMONS, 21*l.*; 'Venice,' E. PITCHETT, 8*l.* 8s.; 'Joe G. Rumer,' E. DAVIS, 6*l.* 6s.; 'A Showery Day,' G. A. WILLIAMS, 10*l.*; 'Calin Morning, Coast of Shorclan,' B. WILLIAMS, 8*l.* 8s.

MANCHESTER.—We find that the recent Exhibition of Modern Works of Art opened to the public on Wednesday, September 12th, 1855, and that it closed, after a season of seventeen weeks, on January 5th, 1856. During this time there were 88 Day Exhibitions, at 1s. admittance; 11 ditto, at 6*l.*; 53 ditto, at 2*l.*; the number of evening visitors being as follows:—5685 at 1s.; 1639 at 6*l.*; 31,340 at 2*l.* It will thus be seen that the success of the copper, taking into consideration the relative number of exhibitors, beat the silver tickets, to an extent which even the most sanguine would have scarcely anticipated. The number of pictures sold in the room throughout the season was 71, value 14,65*l.*; of which the Glasgow Art-Union bought 14, value 390*l.*; and the Manchester Art-Union 16, value 310*l.* "The advantage in favour of a liberal system," says a local journal, "is again remarkably manifested on the days when the charge was sixpence, as opposed to the shilling." Taking into consideration the relative number of days on which each were open, it will be found that the sixpence produces as much as the shilling, whilst it gratifies twice as many people. Nor should it be overlooked that the reduced charges were not brought into play until the gallery had been open for several weeks, and consequently when the novelty of the exhibition—at all times an important consideration in any appeal to the public—had passed away. These numbers are exclusive of the governors and the privileged members of their families, who have free admission at all times; also exclusive of free admission given to the drawing-classes of the Mechanics' Institution, the pupils of the School of Art, and a number of Sunday-school children, admitted at a trifling charge."—Manchester proposes to erect a statue of the inventor of the steam-engine, James Watt. A subscription has been started to defray the expenses of having one executed from that in Westminster Abbey by Chantrey; it is to accompany those of Wellington, Peel, and Dalton, which now stand in front of the Infirmary. We should have thought a memorial of Watt would have had precedence in Manchester, of these other worthies, for the steam-engine has proved a mine of wealth in that city; and while the manufacturers should not honour Wellington, Peel, and Dalton less, they ought to honour Watt more.

BELFAST.—The Government School of Art in this town will, it is reported, be re-opened about the beginning of the present month; but there is not, as we understand, any truth in the statements made in the *Times*, a few weeks back, that the government had restored the annual grant of 600*l.*, which was taken away from the School some time ago. The only assistance now rendered to this or other similar institutions is a minimum guaranteed salary to the master for the first year, provided the half fees received in the central school, and all the fees paid to the master for particular tickets, together with the value of his certificates (10*l.* for each), do not reach the sum specified; (in the case of the master of this school, it amounts, we believe, to 150*l.*) in such case, the deficiency will be made up by the Board of Trade. The injustice of this measure is, that while masters on the old foundation still receive a guaranteed salary equal to their former allowance, without being required to pass any examination, or undergo any additional training at Marlborough House, certificated teachers, who are expected to be qualified for the same duties, are only entitled to the value of their certificates, with half the pupils' fees, as before mentioned, and to a guaranteed salary for one year,

which usually is only the amount of 70*l*. It is not therefore to be wondered at, that local committees should distrust the talent and ability of a master who is willing to undertake the responsible duties of his office on such terms; and hence the reason why so few localities avail themselves of the advantages offered by the Department. The government grant to the Belfast School was, as we have observed, 600*l*.—certainly a liberal assistance; but not too liberal for a school in a large and populous locality when first established. But we are of opinion, and we have expressed the same before on more than one occasion, that large and flourishing towns ought mainly to support their own schools, and not rely upon extraneous aid. The place in which the school is opened, alone, or almost alone, is benefited by the institution; and if the inhabitants are not disposed to make the necessary sacrifices for its support, they have no right to expect the public at large, through the government, should help them, except to a certain extent. The principle contended for by the Board of Trade, that of self-support, is just; and we are satisfied it might be carried out if it were met in a liberal spirit, such as should actuate every thriving commercial community seeking its own welfare.

BATH.—The Bath Society for the Promotion of the Fine Arts has held its first meeting this season at the Assembly Rooms. There were numerous works of Art exhibited, including various known works by Turner, Eddy, Roberts, Sant, Herring, and other masters. The display, according to the local *Chronicle*, rivalled that of any of the preceding exhibitions of the society. Complaints of want of room and crowded meetings promise well for the established popularity of these exhibitions.

CARDIFF.—An exhibition of the Fine Arts was opened here in the month of December, under the auspices of the Bishop of Llandaff and Mr. Bruce, M.P., and a large number of the influential inhabitants of the town and its vicinity. A series of lectures will, we understand, be given during the time of the exhibition, on matters connected with Art. Mr. Bruce delivered the first of the series on the day of inauguration.

NORWICH.—The close of the Norfolk and Norwich Fine Arts' Association shows that, during the term of exhibition, pictures to the value of 3000*l*. have been sold, and after defraying all expenses, a balance of 217*l*. 11*s*. remains in the hands of the treasurer: this is a good augury as regards the future. This society is much indebted for the success hitherto attending it to Mr. Claude Nursey, who acts as its honorary secretary. Mr. Nursey is head master of the School of Practical Art in Norwich, whose classes have been attended during the past year by 876 pupils; namely, 148 central school pupils, and 728 in the out-door classes.

WALSALL.—There was a public exhibition, at the end of the year, of the drawings made by the pupils of the Walsall School of Art, and on one of the evenings when the works were on view, Mr. Smith, the head master of the school, delivered a lecture "On the Utility of Practical Art." The prizes awarded to the successful candidates were presented to them after the lecture, by the mayor of the town.

CORK.—We are happy to learn that the Cork School of Design, which has now been closed for twelve months, is about to resume operations. The differences with the Department of Science and Art have been so far arranged as to admit of the school being re-opened, and at a rate under Mr. Ewart's "Museums, Libraries, and Schools of Art Act" has been passed to provide for the local expenses. Mr. R. E. Scaulan, the late head master, having resigned, the appointment has been conferred on Mr. David Rainbach, a gentleman till lately in charge of the School of Art at Limerick.

LIMERICK.—The School of Art school, which has been closed since March last, was recently re-opened in connexion with the Athenaeum in that city.

WARRINGTON.—The inhabitants of this town have set a most laudable example in order to relieve the School of Art of a somewhat heavy debt pressing upon it. A bazaar, accompanied with sundry festivities, was held during the last month, which realised the handsome sum of 180*l*., for the purpose of discharging the obligations. This shows what may be done when much heartiness and a little expenditure of time and talent—especially on the part of the ladies, to whom the Warrington School is greatly indebted—are expended on any matter taken in hand. We can only point attention to the fact we here record, and trust it may prove a stimulus to other towns whose Schools of Art are in a similar position to that in which the school of Warrington was, to imitate the example. Mr. Brewster is the master of this school, and is entitled to praise for his exertions in superintending the bazaar.

INDUSTRIAL ART AND ART EDUCATION.

[We extract from the columns of one of the ablest and best conducted of provincial newspapers—the *Midland Counties' Herald*—always a safe guide and sensible exponent in matters concerning Art,—the following remarks from an article of considerable length, which reviews a pamphlet recently issued by Mr. Potter of Manchester. His views have received some comments and some replies from Mr. George Wallis, but they do not materially touch the main questions at issue. Any observations of his, however, are entitled to consideration and respect; and perhaps there is no master associated with the Government school, so free from prejudice, or so little likely to advocate opinions merely because they are those of the "heads" under whom he acts. We shall therefore take an early opportunity of examining the pamphlet of Mr. Wallis; while at present we content ourselves with adopting the views of our intelligent contemporary concerning that of Mr. Potter.]

A School of Art has existed in Manchester for seventeen years. It is conveniently located in spacious and well-arranged rooms, in which respect it is said to be unequalled by any other provincial establishment of the same kind in the kingdom. We find from the report submitted to its supporters, at their annual meeting in May last, that since the first recognition of the school by the government in 1858, the number of its pupils had never been so large as at that time. The report is very laudatory application to study more encouraging. With these satisfactory results, however, the finances of the institution were not in a prosperous condition, which appears to have been owing in some degree to the diminution of the grant of public money in aid of its funds, under the regulations adopted by the Department of Science and Art. They were very feebly as to the propriety of the change which official wisdom had dictated, and they even went the length of declaring it to be objectionable, inasmuch as its tendency would be to establish an inequitable mode of administering the Parliamentary grant between the metropolises and the other parts of the country. They furthermore denounced the injustice of the Metropolitan Schools being entirely or mainly supported out of the national purse, while the regulations of the government operated to render the provincial institutions more and more dependent upon private resources. Having urged their views upon the Board of Trade without success, they came to the determination of bringing the whole question before Parliament during the last session; but owing to the engrossing interest of the war, and the attention which the French Exhibition required, both from the friends of the school and the officers of the "Department," both sides were willing to accept a temporary compromise, under which the council were induced to promise, in their management of the school, a full and fair trial of the propositions of the Board of Trade, who, on their part, promised them as liberal an amount of pecuniary assistance as existing rules would permit.

This is the present posture of affairs, and a very unsatisfactory one it is; but during the brief cessation of hostilities, the council, with prudent forethought, have been exerting themselves to strengthen their position. One of the steps taken by them in furtherance of this object was the holding, in October, of a *soirée*, at which the points in issue were discussed. On this occasion, Mr. Edmund Potter, the president of the school, delivered an able address, in which he considered, at some length, the character of such institutions, the purposes they are capable of serving, and the best means of rendering them efficient; and which is being extensively circulated in the form of a pamphlet. Regarding as proper and natural the anxiety evinced by the Board of Trade as to our position and prospects in matters of taste connected with trade, of which, as disclosed by the nature and extent of the competition in the French exhibition, he thinks some groundless apprehensions have been entertained, Mr. Potter proceeds to make the very important inquiry—has the Board of Trade taken the best and most efficient measures for the extension of that Art-education which not only they but all intelligent persons admit to be necessary for the promotion of manufactures, whether in fancy ornamental articles, in metal, in pottery, or in textile fabrics? A very temperate examination of the evidence in the case leads him to a conclusion decidedly averse to the authorities at Marlborough House, and that had the funds at their disposal been appropriated to

teaching Art, either elementary or more advanced, on a sound, comprehensive system, trade would have been better supplied with more accomplished workmen, and would have educated and paid for its own technical labour. Mr. Potter comments with force and point upon the injustice of the arrangements by which the central school has rent, materials, examples, library, and the benefit of a most ample supply of superintendents, masters, and lecturers, all paid for at the cost of the state, without one penny of private subscription, or aid from such local rate as it has been suggested might be obtained by means of Mr. Ewart's act.

"We feel then," he remarks, "that whilst we are indirectly admonished for want of power to sanction in 'taste, we are injured; that Art, and the desire for it, are not only repressed by our being treated in some measure as a branch school of inferior grade, but that we are restricted and lessened in our allowance, and thrown on local effort or local taxation, whilst we see a completely different example exhibited of liberality, if not profusion, in the metropolitan establishment. Let me admit, however, that Marlborough House has a staff of gentlemen perfectly able to conduct the Art-education of that establishment; I differ widely with the heads as to their mode of administration, and more particularly as to the position in which they would place the provincial schools of Art, by trying to make them into mere elementary drawing schools. They cannot expect gentlemen composing councils like yours, and in charge of schools established, and of property contributed for other purposes, to devote time and funds to the forwarding such schools, any more than they can expect them to associate together for the purpose of organising haphazard writing schools.

I wish to confine myself in my remarks to the position of schools of Art, quite apart from elementary drawing schools of recent establishment. I would ask, how it is that scarcely one out of the nineteen schools of Art established since our own, chiefly by the aid of local funds and subscriptions, is now in a comfortable position? I have reason to know that the larger majority are in a very uneasy, uncertain state, with lessening funds, apart from the war question; and that from the very nature of their undefined and unstable constitution, the present process may let some of them down to elementary drawing schools, or found such on their ruins. One thing is certain to my mind, that local schools of Art have as yet not been established on a permanent basis. It is because I am anxious that they should be so, that I wish to press upon you the fact. They expire in large towns, or are shut up, because they are at issue with the department of practical Art, or because the country has not appreciated their value. I do think the action of the Marlborough House department upon the provincial schools has been disastrous; it has created no kindly feeling, no sympathy; and the spirit in favour of Art-education has, I believe, suffered amongst us."

Mr. Potter is of opinion that the country does not yet appreciate the schools; that they are held in comparatively slight estimation, and that but a limited use is made of them in comparison with their real value. Most cordially do we concur in the arguments subsequently advanced that Art-education ought to be diffused; and that if manufactures need the development and encouragement of a more elevated taste, here in the provinces—the seat of such pursuits—ought the means of improvement, the examples, and embellishments to be afforded; that in proportion to our numbers and taxation, we have a right to our share of public instruction and ornamental display; and that the wider such agencies are spread, the more likely is good to arise from them. Mr. Potter thinks that the remedy for the evils of which he complains may be found in the transfer of the anomalous powers in reference to them, now exercised by the Board of Trade—the department of the State most overtaxed with the weight of its own proper functions—to some competent branch of the Government, less fluctuating in its constitution, more specially adequate to the discharge of the duties devolving upon it, and directly responsible to Parliamentary control:—

"To effect this, I venture to think the best mode would be to create a board for the advancement of Art-education and public taste, with a minister at its head, not for life, nor yet liable to be turned out of office after a period of a few weeks, or a few months, but with a chance of some years' occupancy or experience. I should like to see a man appointed, competent to undertake the chairmanship of such a board, equal in class to what we have had in a Buller or a Baines at the Poor Law Board, with a similar position and standing, and, if practicable, with a seat in the House of Com-

mons—the representative literally of some art-constituency—why not, if a university for letters have such? I would have him joined at his board by a few, very few provincial representatives of art interests to aid and suggest in the distribution of even the present funds, if no more were granted. As to the expense, if it could not be otherwise met, a few thousands a year could be well saved, for such a purpose, from certain items in the grant now made to the Department at Marlborough House."

But Mr. Potter has yet another objection to the existing system. He is opposed to "technical" or (as he chooses to style it) "trade" teaching, "as out-stopping the province of the Government, encouraging and patronising, as it always does, particular branches of trade in particular localities for the sake of employing a particular class of labour, and from motives of benevolence rather than sound economy." Further on he adds:—

"You will have gathered from my opinions, that I think one great error has been made since their original institution in London, and that with the exception of the Elementary Drawing Schools, the Government, instead of teaching Art, has rather been trying to do what I consider the worst possible thing it could attempt—trying to teach trade. "Their anxiety has been for trade, not for Art. I would now suggest that they try strictly what they can do for Art dissociated from trade, and from the Board of Trade, as the most unsuitable department of the Government to have the direction of matters of education in Art and taste particularly."

THE PUBLICATIONS OF MESSRS. LLOYD BROTHERS & CO. IN 1855.

THESE eminent publishers have been prolific during the past year; notwithstanding that the times have been greatly against luxuries, and that the war has operated grievously to the prejudice of Art. Their list contains between thirty and forty publications, of varied character, ranging from high class works to those of a cheap yet good order, which modern improvements in coloured lithography have brought within reach of the multitude; supplying close imitations of drawings which, except for their intrinsic value, are calculated to give as much enjoyment as the original productions of the artist. Messrs. Lloyd & Co. absorb a considerable portion of what is called the "country trade;" but their establishment, on Ludgate Hill, is well-known as the source from whence the city is to a large extent supplied with prints. We have had frequent occasion to direct attention to their issues, and it is now our duty to speak of those they have sent out during the past year.

The first that may fall under our notice is a large print engraved by Bellin, from a painting by Claxton, representing "The Saviour blessing little Children." In size and form it is designed to companion the beautiful work of Eastlake, "Christ looking down on Jerusalem." It is a fine and vigorous composition, telling the story with force and effect. The groups are skillfully arranged. The mothers and their treasures are gracefully introduced; and if the excellent artist has comparatively failed in depicting the Saviour, he has but followed in the steps of nearly all his modern predecessors.

Of opposite character is another large print, entitled "A Glimpse of an English Homestead," engraved by Paterson, from one of the pictures of Herring; the subject is a covered shed, adjacent to a farm-yard. The prominent objects are two horses—a white and a black; at their feet are the ducks, fowl, chickens, rabbits, and pigeons, in describing which the artist surpasses all his compeers; indeed the painter has contrived to introduce into this work all the peculiarities of art for which he is famous—not forgetting the produce of the kitchen garden, and the young girl who presides over the homestead as the guardian of the pets.

Another large print is "A Sunny Summer's Afternoon;" a lithographed impression from a painting by Sidney Cooper. The scene is thoroughly English—there is no mistaking it—

and it is therefore especially welcome; for, although the world has been of late years searched for subject-matter, the lanes and meadows, the rich low-lands and picturesque hills of England, have been too much neglected—that is to say, as far as the publisher is concerned. Save the charming mezzotint prints, after Constable, we can call to mind few or none of this beautiful and interesting class. The scene here represents a pool in low soil, beside which grows a noble oak, under the branches of which cattle are reposing, while others are drinking of the refreshing water at its foot. The lines illustrated are from Thomson. Here, as in the instance just alluded to, the more prominent excellences of the painter are brought together. To say that the picture is by Sidney Cooper, is almost sufficient to describe the accessories and the manner of their treatment.

The next we notice is a pretty and touching print, engraved by S. Bellin from a picture by T. Brooks, representing three orphan children by their father's grave in the village churchyard. A guardian angel, visible to the spectator, though not to the orphans, is watching over them. The story would have been, perhaps, better told without this introduction; it gives too much the air of melodrama to that "touch of nature" which connects the living with the dead. The sympathy of the rough dog, who looks up to the young mourners, supplies an incident more effective.

The oft-told tale of two young ladies consulting over a love-letter has been treated by Mr. Brooks, and a very pleasant engraving, entitled "Strictly Confidential," is the result, though with but little pretension to originality, either in conception or treatment.

Of an infinitely better order is another print,—"Bed-Time"—a fine engraving of a high order of merit, by Mr. Lauch Stocks, from a painting by Frith, R.A. It represents a young mother hearing the prattled prayer of her child before consigning her to rest. The circumstance appeals to all, and is understood by all; there needs no writing to tell the story. Perhaps there are few, if there be any, recent publications more likely to become popular than this.

Though very opposite in character, as much interest and pleasure will be derived from two prints, named "The Old School" and "The New School," and bearing the dates 1755 and 1855. They are pictures of shipping. In the one is the now aged and worn "Victory," but then in its prime, surrounded by the varied craft of the period, which made the sailors who made "Britannia rule the waves." In the other is the smart steam-frigate, warranted to reach Australia in sixty days. The contrast thus produced is exceedingly agreeable. "The pair" should be hung in the cabin of every ship in the service, and cannot fail to be welcome acquisitions to all mariners, young and old.

A lone maiden sitting by the sea-shore, her thoughts following her heart across the ocean, is charmingly engraved by James Faed, from a picture by Thomas Faed. The subject is somewhat painful, but it is treated with much skill, and bears evidence of considerable power in the painter.

A series of small "Sporting Prints," from paintings by Ansdell, very excellently engraved by Ryall, cannot fail to find favour with all to whom this class of subject is desirable. It is a class that always has been, and ever will be, popular in England, where "field-sports" supply so prominent a pleasure-occupation of the aristocracy. These are small prints, about 10 inches by 7, but they are not the less valuable on that account. They are of marvellous fidelity; each represents a dog occupied according to his nature—whether pointer, lurcher, hound, or water-spaniel, and each has found, or is bringing in, his bird. The engraving is of the best order of merit, and perhaps no series of this kind better deserves the success it is certain to achieve.

There are other issues of Messrs. Lloyd—in line, in mezzotint, in stipple, and in lithography,—the produce of the past year, to which we can do no more than allude, as proofs of their activity as publishers; but some reference to those productions in coloured lithography, for which they seem especially to have "laid them-

selves out," is needful, in order to supply to our readers a reasonably fair report of the progress of this house.

These are chiefly issued in pairs; and are so closely imitations of original drawings, as to startle by the apprehension that they may satisfy so many as materially to abridge the actual labours of the artist, and so act as heavy blows and great discouragements to the profession. We know, however, that such is not the case; since the improvements in coloured lithography, carried out by Messrs. Hanhart, Messrs. Day, and Mr. Brooks, to say nothing of Messrs. Rowney, whose productions we not long ago reviewed—the societies of Painters in Water-colours have not only not retrograded, but their occupations have increased, and at the two great exhibitions of the season there have been very few works of merit left unsold. Yet these very beautiful pictures (for they may be safely so called) will go a long way to content even the connoisseur, and certainly the public, for the absence of more costly productions from their portfolios or their walls.

The first two we examine are copies of slight sketches by John Absolon: "Hay-Harvest" and "Corn-Harvest;" they are free in touch, and bear no pretence to finish; but they have the marks of the master, and are full of sparkle and spirit.

To show, however, how well the art can deal with more elaborate works, we turn to a copy of "Bielsten on the Moselle," by J. D. Harding, and its companion, "Sunset on the Danube," by J. Bright. The former, especially, represents with singular fidelity the work of the accomplished master, in that rare combination of delicacy and force by which his name has been placed among the highest in the records of fame. We have here in contrast with the two we have noticed above, satisfactory evidence that, no matter with how much elaborate care a drawing may be painted, the lithographic artist can imitate it with so much marvellous accuracy, as to substitute the copy for the original with little fear of detection by the ordinary eye.

A set of three pictures after Jenkins, of incidents among the peasantry of Normandy, perhaps—in France, certainly—are among the pleasantest productions of a class always agreeable, and ever welcome. One is of a young mother with her child pick-a-back; in another she guides her child over a plank across a brook; and in the third she watches her child, which is peeping into a well. The picturesque costume, the home-incidents, and the treatment of the subjects, combine to render these imitative drawings among the most popular that have been produced in this style of Art.

Even more pleasing than these, is one that is as yet without a companion; it is a copy from a painting by Alexander Johnston, which represents the "two bonnie lasses," Bessie Bell and Mary Grey, famous in Scottish song and story; they are sitting by the hura-side, full of health, as mountain maidens always are; and with that beauty and grace which Nature gives to her favourites. The print is a charming specimen of the artist's power; and a very valuable example of the Art which does so much to create enjoyment and to bring pleasure at all seasons within doors.

Our notice may be closed by a brief reference to two small lithographic copies of Stanfield—Fort Rouge at High and at Low Water. They are slight in character, but characteristic of the great master, and seeming to bear his touches.

We have written sufficient to show that to the active enterprise of Messrs. Lloyd Brothers & Co. the public is much indebted for a supply of excellent and attractive prints. None of those upon which we report are of the very highest order; but they are all good of their kind, and of a class which is especially needed, inasmuch as they minister to the wants of the many rather than the few, and bring excellence within the reach of those who find the more costly luxuries of Art beyond their grasp.

This great and high purpose has been achieved only within the last few years; twenty years ago it would have required pounds to have procured that which now-a-days a few shillings may obtain. The good hence derived is incalculable; instead of taste being impaired, it is

improved by acquisitions that are offered "cheap." "Cheap Art" is ever a thing to be derided, if not of such an order that the mind is strengthened by enjoyment, when the acquisition is made. "We have done our own part in this matter; and it is and will be the most agreeable of our duties to aid those publishers who, like Messrs. Lloyd, adopt as their motto, "mind not high things, but condescend to men of low estate."

We must not, however, be misunderstood. These publishers by no means confine their issues to works of comparatively humble cost; although to this essential point our present reference is chiefly made. They have produced and are producing works of large expense; we need but now refer to two of them—"The Sands at Ramsgate," from the famous picture by Frith, and "St. Michael's Mount," from one of the most admirable productions of Stanfield.

ART IN CONTINENTAL STATES.

PARIS.—A serious accident has occurred at the Palais des Beaux Arts, by which the "Hémicycle" of P. Delaroche has nearly been destroyed. On Sunday, the 10th December, the annual distribution of prizes was, as usual, to take place before the Minister of State and the Members of the Academy. The wood forming the seats, being very dry, caught fire, the warming-stove having been too much heated. Assistance fortunately was at hand, and the flames were got under before this fine painting was totally destroyed; but as it is, the damage is considerable, the greatest part of which consists in the heat having disintegrated the stones of the building on which the painting is executed; the following method having been adopted. Previously to beginning his laborious task, the walls were thoroughly dried with great care, after which a layer of strong drying oil was laid on; this, when dry, was covered with a coating of white paint, the same as is spread on canvases for painting. At first the whole of the painting appeared destroyed, but on removing the smoke and soot occasioned by the flames, much was found unjured. The damage done is to this extent—out of 75 figures composing the work, only 20 are completely unjured; 39 will have to be thoroughly repainted by Delaroche himself; the rest will be repaired by M. Mercier, restorer of paintings, who was chosen for this task by the Minister of State, and who has begun the cleaning. The intense cold following the fire, the smoke, and the vapours from the water employed in extinguishing the same, caused the injury; it is astonishing so much carelessness can exist in a government establishment, where so many persons are employed. This event ought to make the Directors of the Louvre seriously careful of our great gallery, which is placed in long rooms serving as barracks for cavalry and other troops.—We have recently lost an excellent painter of the French school, M. Stenben; his principal works are, "Napoleon's Return from Elba," "Napoleon at Waterloo," "Death of Napoleon," "Peter the Great saved by his Mother in a Revolt," "Judith and Holofernes," "Sampson and Delilah," "Esmeralda and Quasimodo," "Esmeralda and the Goat Dancing," "Christ on Calvary," "Napoleon on Mount St. Bernard," "The Youth of Milton;" most of them have been cleverly engraved by Jazet and others.—A very splendid equestrian statue has been placed in the centre of the Louvre; it represents Francis I., and is by Clesinger; the execution is fine, and the attitude commanding, but it is too large for the situation; it is probable another place will be chosen for its final destination: the present statue being only a plaster cast, bronzed, it will form a magnificent ornament in a proper situation.—The interior of the Carrousel is now open to the public, and it certainly is most superb.—A medal is being executed at the Paris Mint, in commemoration of the taking of Sebastopol; it is by M. Borel.—Messrs. Morley & Cague have been commissioned to execute a medal of large dimensions, to commemorate the celebrated public subscription of 500 millions, which was more than quadrupled by 180,000 subscribers.—The picture-sales are now in full vigour; that of Canille Roqueplau, deceased, consisting of a few finished works, and the usual miscellaneous mixture of sketches, unfinished works, &c., has sold well; this could not have been otherwise, as his works here are much sought for; I send a few prices:—"Promenade in the Park," and "The Swing," bought by M. Hastings for 9800 f.; "The Rent-Day," 2200 f., to M. Davin; this

amateur has also purchased several other works; the sketch of the 'Lion Amoureux' realised 1065 f.; it was bought by the Marquis of Hertford, who purchased the original for 15,000 f.; "The Prohibited Novel," 1680 f.; "A Daughter of Eve," 1150 f.; Mr. Stevens bought the fine drawing in charcoal of 'France victorious, dictating Laws,' being the sketch for the ceiling of the Luxembourg Palace, 1300 f.; and 'The Garden at Eaux Bonnes,' 910 f. M. Hoquet, a clever landscape-painter, has also made a sale of his works; 21 pictures brought about 10,000 f. M. Tesson was also recently sold 34 paintings, and 24 water-colour drawings, of considerable merit. The French artists have adopted the plan of amassing a quantity of their works, and selling them by auction, no doubt in consequence of the little encouragement given to Art in this country, where a few favourites engross all the patronage; this plan reduces Fine Art to the standard of mere trade.—A discovery has lately been made by Mue. Rouvier-Paillard, of considerable importance; this lady has, it is said, discovered a method of liquifying ivory, and using it instead of plaster, for casts.—Paris is being driven out of town; 6000 fresh notices to quit have been issued, to complete the Boulevard de Sebastopol, and others in project.

KÖNIGSBERG.—The Art-Union, founded here in 1832, has met with extensive encouragement through the exertions of the late minister Degen, inasmuch as now to number fourteen hundred subscribers. This extensive patronage has been procured by all the legitimate means available in furtherance of these institutions, especially by the exertions of a public gallery for the exhibition of modern works of art. In the gallery of the Museum there are a hundred modern productions, many of which have been purchased, and others presented to the collection. There is a proportion of old pictures, to many of which attach names of great celebrity; but the greater space is given to the works of recent and living artists, among which we find productions by Schroeder, Schorn, Stille, Sohn, Christian Kohler, Leopold Robert, Verboeckhoven, Ary Scheffer, Delaroche, Guin, &c., &c.

BERLIN.—Great activity has of late prevailed here in the erection of private residences. It is especially the Western and more wealthy parts of the city that have been enriched by this marked improvement in domestic architecture. In the Friedrich Strasse considerable improvements have been effected; and in the Leipziger Platz, a beautifully decorated house has been substituted for the unseemly brewery, which was a principal feature in that locality; and of the most tasteful and elegant buildings the most striking is that erected by Bellevue Strasse after the design of Halmann. It is intended in the course of next summer to forward an entirely new street to be called Humboldt Strasse, intended to connect Link Strasse and Potsdamer Strasse. This street is to consist of elegant and commodious residences.—The Museum has recently received from Rome the addition of an excellent plaster-cast of the famous sarcophagus of Junius Bassus, who, as prefect of Rome, died soon after his baptism, in the year of our Lord, 359. It is richly ornamented, and compartments formed by pillars contain sculptured subjects from sacred history, besides a series representing the "Seasons." This museum contains, besides, casts of eight other ancient Christian sarcophagi very highly ornamented.—The recent contributions to the permanent exhibition are numerous and valuable, and afford evidence of the industry of artists to support this institution. Macnus exhibits two life-sized portraits, one of the Minister Von Arnim-Boitzenburg, works of a high order of merit, though perhaps the features of the lady are somewhat too material, not treated with that lightness which points rather to Nature than to Art. By H. Kauffmann a genre subject is exhibited, showing the banks of a river, along which a vessel is being towed; the perspective of the picture is extremely delicate, but it is managed with much success. Among the landscapes there is a striking work by R. Krause entitled 'From the Mountains of Albania;' the scene is wooded, and is presented under a sunny aspect, and it is well made out generally, with the exception of the foreground, which requires more careful detail. A 'Landscape with a Stormy Effect,' by E. Rollmann, shows a fine feeling for the poetry of nature; the clouds especially are effectively painted. A 'View of Havre,' by J. Rauch, is not without many beauties in the colour and tones of the sea, land, and sky, but generally the picture is brought forward in a manner cold and dry, and the drawing might be more careful in parts. A picture, by A. Berg, entitled 'Ruins of the Cathedral of Metz, in Lorraine,' is a work of great merit in its particular, and is interesting as a faithful representation of an attractive archaeological relic. There is, by Valentine Ruth,

of Düsseldorf, a wooded landscape of the rarest excellence in its department of Art. This work is worthy of a lengthened description, but we have not the space at our disposal. There are other meritorious works, especially by Jablin, also of Düsseldorf, by Nordgren, Morten Müller, Herrensburger, Ehrke, &c. &c.

DRESDEN.—It will be remembered that we mentioned a proposal, first brought forward in Dresden, for a subscription for a memorial worthy of the name of Friedrich Schiller. The appeal was made to universal Germany, and nobly has it been responded to, a sum of 3000 thalers having been soon subscribed. Branch committees have been formed at Vienna, Munich, Stuttgart, Frankfurt, Hamburg, Leipzig, Breslau, Darmstadt, Offenbach, Nürnberg, and many other places.

MUNICH.—The reception accorded to German works of Art at the Paris Exhibition seems to have given some dissatisfaction. Many of the comments we have seen are much less moderate than the following extract from a German paper:—"It is highly advantageous that the Fine Arts should be sent upon their travel to see the world and to be seen by the world. Many a home-earned reputation is shattered by the judgment of the world; but on the other hand, many a smaller light has given forth a starry radiance raised to a place of eminence. The judgment that has been passed upon our works in Paris is not final, and may be a faulty one. But this much is incontrovertible—that when nations mingle with each other, true greatness becomes manifest; that whatever becomes distinguished in the confusion of such a competition is not a result of accident or particular taste, but of a general conviction of intrinsic worth."

NÜRNBERG.—Some of the mural paintings by Dürer are in progress of being copied for the collection in one of the public museums, especially the admirable group of "Musicians in the Town-hall," which has been recently copied by the hand of the engraver Gabriel Meyer, and the ravages of time, by washing preparatory to the process of copying, parts of the painting have effectually been brought to light, but only a part. In the middle of the wall is a beautiful balcony, which architecturally belongs to the fourteenth century. Above this is a picture which is, in truth, but little suited to it; and on the roof are seated two nude figures of children, who hold flags on which are emblazoned the arms of the city of Nuremberg. The lower part of the balcony is ornamented with paintings, and on each side are figures, or, rather, were figures, for they are only now just discernible. At the extremities there are two emperors, of whom one is determinable as Charlemagne, but there is some uncertainty of ascertaining the name of the other. Besides these, there are many other figures, to which names cannot be assigned.

PROFESSOR COCKERELL'S SECOND LECTURE ON ARCHITECTURE.*

In his second lecture at the Royal Academy, on the 10th of January, the Professor said,—On the annual recurrence of the present season, when he had to prepare himself for the performance of that evening's very agreeable duty—when he was relieved, for a short time, from the turmoil and bustle of this vulgar world, and was enabled leisurely to contemplate the noble and important art which they had in hand; to view its deeply-interesting history and expand the wings of imagination upon its delights, and dwell upon its openings up of the sublime and the beautiful, he felt himself almost overwhelmed by the conviction of his incompetency to represent the dignity of so noble a science. When he looked at the ingenuity of mind required; the mathematical attainments, the natural endowment of sensibility, the taste, the invention, the poetical imagination, the genius which were essential, he was really appalled; and he took courage only in the grand principles asserted by the masters of the art; and in reliance upon the candour of his hearers, and in the admission

* We are indebted to the industry of our valuable contemporary, the Builder, for this report of Mr. Cockerell's Second Lecture at the Royal Academy, and regret we were not in a position to notice the first. These lectures of Professor Cockerell must interest many others besides the professional student.

that all were bound to make, that while desecrating on so glorious a subject, they were by no means required to be masters of all its departments. So entirely did the Academy of France appreciate the extent of the difficulty of the art, that to carry out instruction in all its parts, they had established three special professors of three departments of architecture. The first was a professor of The Theory of Architecture; the second, of The History of Architecture; the third, of the Statics of Architecture; and during the season they had many lectures, as well as direct teaching. Many of the scholars were sent to Rome and Germany for five years, at the expense of the Government, the Government having a claim upon their talents at all times. Thus the French Government never lost its hold upon those who had derived advantage from its patronage.

They ought, in directing their minds to this great art, to approach it with all the respect, humility, and circumspection which a subject so grave required. Proficiency in it was in a great measure to be attained by study and by genius—by disinterested, long, and faithful pursuit of books in the first place. They should study the works of Blondell and many others which would at once occur to their minds. Again, this art was to be cultivated by careful travels; by observations in travels at home as well as abroad; by seeing monuments in their proper sites; by circumspection, as far as possible, from the ordinary business of life; and by that leisure which enabled the mind to expand into those speculations and day-dreams which constituted the delight of the architect. But then, from the art itself, to go to the great practitioners of the art,—to their interesting biography, and the benefits which their genius had conferred upon society; creating, originating, promoting the arts of industry and civilisation, the union of a vast variety of knowledge, and the benevolence which it had brought to bear upon their creations; so that they might feel all the force of the language of an ancient writer who had no higher epithet to apply to the Maker of all things than "The Great Architect." There was indeed, one individual to whom they might apply the title "architect"—as the architect of his own fortune—Sir Christopher Wren. He was a scholar from his childhood; a great mathematician at thirteen; professor of astronomy at Gresham College at twenty-one; at thirty-seven surveyor-general to this country and kingdom; and after the Fire of London, at forty-three, appointed to St. Paul's; the principal founder of the Royal Society, and the largest contributor to it; the founder of the Commission of Sewers; the sustainer of schools of art in the Society of Froemasons,—then acting in their original and proper character as builders; the friend and counsellor of the king, and of the wisest in the State; and the chief benefactor of his country.

It was wonderful to contemplate such a character, and to consider that he had left, for special study, structures which could not fail to delight and instruct those who were familiar with his works. Many of Wren's works were without parallel in foreign parts, and were cited by the French as constituting our best title to the possession of taste in architecture. His works were more or less published, and his friend, Mr. Clayton, whom he had the happiness to assist, had added a great deal to what was before known. There were many works still unpublished, and he would recommend to them as conferring a benefit on the profession, that they should, when opportunity offered, so prepare them as to give them to the public. The age of Sir Christopher Wren was one of peculiar magnanimity in all that affected art and science, while every succeeding age had brought us to that commonplace and plebeian mediocrity with which so many at the present time were content; so that we were now beginning to be considered, in all that belonged to the fine arts, as inferior to other countries. In his (the lecturer's) late visit to Paris, he had had the advantage of a critical view of the architectural monuments of that famous city, in company with one of the first architects of the day. Putting aside the advantages of climate, and of material exemption from smoke, which conferred so great a

lustre on the works of that city; and waiving all that distinctive talent for ornamental design, in which the Italians themselves confess the French to excel, he would challenge their pretensions to the graver merits of architecture, and would discuss deliberately with them the beauties of St. Paul's, Greenwich, and other works of Sir Christopher Wren and Inigo Jones, in comparison with their own, as far superior in harmony, unity, variety, invention, and taste. In his first visit to St. Paul's after returning from Paris, he was especially struck with the dome and towers of that building, which, seen from Fleet Street or Ludgate Hill, at about eleven o'clock on a summer morning, presented one of the most striking views in Europe. St. Paul's was without a rival in its beauty, unity, and variety.

The position of the consistory and morning chapels, the mode in which the aisles were finished with hemispherical domes, and, in particular, the novelty of the contrivance of the windows within the apse, by which the light penetrated into the building after the Gothic mode, was peculiarly striking. There was all the strength of a pier, all the grace which such an apse must give, and a lightness which he believed was unique,—for he had found such a combination nowhere else. It was commonplace to point out to them the absolute novelty of making a dome equal to the width of the whole church, instead of the usual mode of making it equal with the nave. It gave him great pleasure to find in the work of the Rev. Mr. Petit, great commendation of the first model of St. Paul's. When they proceeded farther to consider the economy of the structure, its contrivance throughout for sanitary and meteorological purposes, its grace and ornament, a judicious mind could not but rejoice in so marvellous a building in our country as conferring a lasting renown upon us. The building was remarkable for its adherence to rule and the masonic laws. With regard to character and taste, St. Paul's was a remarkable instance of combination. Sometimes the elements of the sublime and just were handled with a strangeness of proportion and physiognomy, or with some extraordinary audacity, as in Boronini, Michel-Angelo, the chief of the Italians, and a great many among the French. One man surprised and alarmed—created terror and astonishment—by a sort of elusory power; but Wren was an artist following Nature, in whom they found no extravagances or excesses of power: all was correct and harmonious.

In the Gothic an unearthly attitude was frequently attempted, and in much of the French architecture they found an overstepping of all masonic rule. Such extravagances might transport with their novelty, but they violated the correct spirit of masonic architecture. Wren always trusted to the natural character of his contrivances, and the perfection of his equipage.

No architect of Europe in his day understood better, or more highly appreciated, the merits of Gothic structure. Witness his surveys of Westminster and Salisbury churches; his restorations of St. Michael's, Cornhill; and many others. St. Paul's is, in fact, a Gothic structure, clothed in classic garb.

In comparing the quality of taste in Wren's productions with that of other masters of his period, the Professor illustrated the modesty of his character. The sublime displayed itself rather to the understanding than to the eye in his forms and combinations. Inigo Jones exhibited more pomp and passion, he was more of a painter than Wren; but he never dreamt of the structural combinations which the mathematician delighted in. Wren overstepped not the modesty of Nature, while Hawksmoor, his pupil, more striking to the eye, discarded all logic. Hogarth has ridiculed his Lion and Unicorn on the spire of St. George's, Bloomsbury, by placing it in the background of his drunken scene at St. Giles's,—as if Hawksmoor was scarcely sober when he designed it: his squinting columns in the niches of St. Mary Woolnoth, are equally indefensible.

Vanbrugh had much of the same taste, and improvised in stone such works as were admissible for theatrical scenery on canvass only. He affected force and magnitude of parts, but

he stood on the dangerous limits between the sublime and the ridiculous.

He went on to compare Raffaello and Michel-Angelo in the same strain, illustrating his position by the advice of Hamlet to the players; and he recommended that the student should set his mind to distinguish between real greatness and swagger, between daring and halderdash, the massive and the coarse, grace and affectation, intricacy and confusion, elegance and effumacy. These were the essential distinctions which we should well consider in the formation of our taste.

Very few indeed were those who were enabled to carry out works, but they might design them. They might put them on paper, and thus become useful to their country. The Palace at Whitehall was estimated on the continent as one of the finest works of that day.

In the Vitruvian element "*Dispositio*," the architects of that day were conspicuous. Both Inigo Jones in Whitehall, and Wren in the examples cited, reminded us of military disposition and battle array, with all the order and discipline of warfare in the sixteenth and seventeenth centuries, which had reversed the desultory system of the previous centuries under the feudal warriors. The disposition of buildings had participated in the reform, as these arrangements had been always determined by the accidents of site, and generally by ecclesiastical requirements, and had all that picturesque (so contrary to architectural principles of Wren's day) which sketching ladies and gentlemen adored in the present.

Inigo Jones and Wren had earned for us the good opinion of Milizia, amongst other foreign writers, who had said, that architecture, banished by the licence and caprice of other countries of Europe, had taken refuge in England.

He would particularly invite the attention of the younger members of the profession to that magnificent palace projected by his Royal Highness Prince Albert at Kensington Gore, which, at some time or other, he hoped they would see rising, a splendid national monument. The site was equal to the site of any of the great buildings of Europe. That palace would really be a subject of useful study to those before him, in comparing the great monuments of Europe, and so exercising their own genius as to produce something which should do honour to their country. They might, of course, have competition in which one would be successful, and others not thanked for their pains. That was one of the degradations at which their art had arrived, and which it behoved them to try and relieve it from, namely, the discreditable manner in which such efforts were received. He presumed the only way of so doing was to make their efforts really worthy of respect; and to teach, if possible, all supercilious observers and judges that there was something due to those even who were not successful. It was a great gratification for him to find that a late friend of his had left a legacy of 40*l.* a year, to be given to the unsuccessful candidate for the gold medal. The first candidate, the donor said, had his reward; but the second, who had made all possible effort, and who probably might be very near the first, had failed, had lost his time, and his means, perhaps; and now there were 40*l.* to prevent this. Finally, while we were bound to acquaint ourselves with foreign examples, to respect and to borrow from our illustrious neighbours, who were ever intent on the advancement of every noble art and science, we were not to overlook our own, or to depreciate those masters who had conferred such lustre on our country; and he recommended the remark of Pliny, that "we often make expensive journeys to visit objects, which, when under our noses, are neglected. I know not," says he, "whether it is an order of nature that we are incurious about everything we are not obliged to seek, or that the desire languishes when an object is easily obtained, or that we defer always that which we can visit any day."

From whatever cause, certain it is that our own country possesses many objects which, at a distance, in Greece or in Egypt, we should regard as miracles; and we should visit and illustrate them in the most complete manner.

PHOTOGRAPHIC PICTURES OF
SEBASTOPOL.

HAVING seen views of Sebastopol, and everything in connection with the place, both before and during the siege; nothing was wanting to complete our knowledge of the localities, and the great events in connection with them, but a pictorial description, after the siege, of all these places, the names of which have become so familiar to us through the daily press. This exhibition, consisting of a series of Photographs by Mr. James Robertson, chief engraver to the Imperial Mint at Constantinople, is to be seen at No. 222, Regent Street, in the rooms of Mr. Kilburn. It contains views of the Redan, the Malakoff, the English and French approaches; the Little Redan, all the famous batteries, and every site deriving a melancholy celebrity from those names which now distinguish them for ever, through their ample baptism of human blood. We have referred to these works in another page of the present *Journal*; but a somewhat more extended notice is due to them.

"The Panorama of Sebastopol, taken from the Malakoff, showing the City, Dockyard Buildings, Forts Nicholas, Constantine, Paul, and Michael; the Karabelnaia Suburb, and North side of Sebastopol," presents the city as it were desolated by a succession of earthquakes—here and there a building more or less entire in its outline, affording a sad contrast with the universal ruin amid which it stands. Again, the "View of Sebastopol taken before the last bombardment," shows some portion of the city apparently uninjured; the more distant parts look almost as entire as before the siege. But it is not so much in the city itself that indications of the fearful struggle are to be seen, as throughout the immediate scenes of the closer fighting. In "Part of the Barrack Battery, showing the Mantelettes for the protection of the Russian gunners," we find this battery armed with ships' guns; with everywhere manifestations of the exertion of a destructive power, more fearful than might even be conceived of tremendous artillery. A gun is here seen which shows the method of protecting the gunners against the deadly Minié—that is, a coil of rope, forming a high collar round the gun; and here is an indescribable confusion of broken gabions, sand-bags, shot, powder casks, and every species of material, defensive and offensive, inducing the conclusion that long before such destruction could have been effected, the Russians must have been compelled to cease working their guns, for the parapets are so broken in as entirely to prevent the movement of the gun carriage.

"The Interior of the Malakoff Battery" presents a similar spectacle; and it would appear that none of the battery guns which the enemy were said to have withdrawn from the seaward forts, have been employed in arming these works, because all the guns are on ship-carriages. The parapet here, also formed of gabions and sand-bags, is broken in a manner to exemplify the irresistible intensity of the fire; and in another picture an incident occurs, showing the mere accident on which depend great results—it is entitled "The Romans of the Malakoff Tower, with the Telegraph erected by the French: a bomb shell is distinctly visible imbedded in the wall; it fortunately did not explode, had it burst it would have blown up the French Magazine." The last of the Russian General is not an edifice promising a comfortable place of residence, though the interior may be more satisfactory; it would be difficult to determine it, at a very short distance, even as a place of temporary abode.

"The Breach of the Redan, where the great struggle took place," is one of the most interesting pictures of the series, although, of course, the space represented is too circumscribed to assist a written description, beyond the mere spot represented. "Chapman's Left Attack, showing part of the Redan," describes a portion of the difficulties of the approach; and the spectator is assisted by "Gordon's Battery, with the Redan and Sebastopol in the distance." There are also, "The Corner of the 21-gun Bat-

tery, with the Trenches between the Malakoff and the Malakoff;" "The Sailors' Battery;" "View of the Malakoff Battery, taken from the Malakoff Vert, showing the French Approaches;" "View of the English Trenches, with the Malakoff in the distance." "The Interior of the Barrack Battery, with the pivot guns commanding the Ravine," describes the resources of the Russians in mounting these guns; the support of which is the trunk of a tree driven into the ground, and on this the gun pivots. But if in these views we are to estimate the importance of Sebastopol by the evidences of the defence of the place, we cannot regard it otherwise than as the keystone of their intended Oriental dominion.

MINOR TOPICS OF THE MONTH.

THE NATIONAL GALLERY, it is said, will shortly be enriched by the addition of three pictures bequeathed to it by Mr. Samuel Rogers: "Christ appearing to Mary Magdalen," by Titian, formerly in the possession of the Muselli family at Verona, subsequently in the Orleans Gallery, and lastly distinguished as the gem of Mr. Rogers's collection: it is a glorious work, in excellent preservation. A "Head of Christ," by Guido, engraved many years since by Sharpe, is a beautiful specimen of the painter's chaste colouring and tender expression, and the portrait of a "Young Knight," by Giorgione, a small full length, which Dr. Waquer describes as "noble and powerful in face and figure; and the head of masterly treatment, in Giorgione's glowing tone, the armour of great force and clearness in the chiar'oscuro." A note appended to the above remarks states that "this figure is a study for the St. George in the altar-piece at Castel Franco, the only difference being, that in the latter the figure is helmeted." These pictures will be quite an acquisition to our National Collection, whose growth is but tardy, and its strength not always keeping pace with its increasing size. The remaining pictures, drawings, and objects of vertu left by Mr. Rogers, are to be sold by auction.—The picture brought home by the President of the Academy is waiting for its frame. As the work is large, it has been a matter of some consideration where it should hang, and it has at length been determined that it should occupy the place in which the Del Piombo now hangs,—that is, to the right on entering the door of the great room; and that the Del Piombo shall be moved to the place in which the Paul Veronese now is,—that is, the centre of the same room on the right, and here, we think for the first time, will the Piombo be seen in a light really suitable to it. The three pictures bequeathed by Mr. Rogers have not yet been placed; the light in which they were seen in the places they have so long occupied was by no means so favourable as could have been desired: it is probable they will be better shown in the National Gallery, although there all the best places are filled.

THE BRITISH INSTITUTION.—This gallery will be opened, as usual, on the first Monday of February. We have not heard of any new arrangements, and imagine that matters will be conducted much as hitherto; we have, however, hopes that a general advance will be observed in the works of the contributors.

MR. GIBSON'S STATUE OF THE QUEEN has arrived in England; it is of colossal size, and is intended for the Queen's robing-room in the palace of Westminster. We have not yet had an opportunity of seeing it; but report says that although in many respects it is a grand and dignified work, its resemblance to her Majesty is not so happy as her loving liege subjects must desire to see. The apartment in which it is destined to be placed is not, moreover, the most suitable for a work of this character, it is too small for a statue of such proportions.

PRESERVATION OF WOOD CARVINGS.—At the last meeting of the Institute of Architects, Mr. W. Rogers exhibited some specimens of Gibbons' carving from Belton House, Lincolnshire, and gave the following explanation of his method of

strengthening and preserving the parts remaining, after the lime-tree wood of the interior had been reduced by the worm to a mass of honeycomb fibre. Photographs of the carvings were taken before the ornament was removed from its place: the wood was well saturated with a strong solution of corrosive sublimate to destroy the worm (the natural colour was afterwards restored by a further chemical process), and strength was then given by injecting vegetable gum and gelatine: the separate pieces were afterwards put together according to the original design preserved in the photograph, restoration with new work being as much as possible avoided. Mr. Rogers stated that similar carvings at Barleigh, Chatsworth, Petworth, Cashobury, Hampton Court, Windsor, Trinity College Cambridge, and other places, are in the same state of decay, the surface or skin being covered with a deceptive vegetable bloom, which assists in completing the work of destruction. It is desirable that these should be examined forthwith. We shall enter upon this subject at some length in our next number.

THE PANOPTICON.—Several improvements have been made since we last noticed this place of intellectual amusement. The concert is much better conducted, and the singers more artistic. Mr. L. S. Buckingham has added two amusing narratives, for the holiday visitors, in his tales of "Whittington and his Cat," to which he has ingeniously added "Puss in Boots," as the further adventures of the cat after Whittington's marriage, which ends the old story. The tales are redolent of jest and fun, and are illustrated by illuminated pictures, many of which are clever as works of Art; while all have been much improved by a more powerful light than has been hitherto adopted for their details.

THE ARTISTS' AND AMATEURS' CONVERSATION.—The first meeting of this society is advertised to be held at Willis's Rooms on the 24th of January, after our sheets have gone to press; the others are advertised for February 1st, March 13th, and April 17th. The Society is established on principles similar to those of the elder institution, the "Graphic," and is supported by a number of artists and amateurs of celebrity. We shall report in our next what was to be seen on their first night of meeting for the season.

AN IMPERIAL ALBUM.—We stated some time since that the Emperor of the French had commissioned several artists of the country to execute drawings in water-colours, illustrative of the Queen's late Visit to France. These drawings have now been collected, magnificently bound as an album, and forwarded to Her Majesty as a "Christmas-box" from the Emperor. The principal scenes on which the pencils of the respective artists were employed, are the following:—the "Arrival at Boulogne," by M. Morel Patio; the "Departure from Boulogne," by M. Moziu; the "Ball at Versailles," the "Imperial Supper," by M. Guerrard; and the "Arrival at St. Cloud," by M. Eugene Lami. The cost of the present is estimated at 1000 guineas.

THE QUEEN'S PRESENT TO MISS NIGHTINGALE.—The design of the jewel is admirable, and the effect no less brilliant than chaste. It is characteristic and emblematical, being formed of a St. George's Cross in ruby red enamel on a white field, representing England. This is encircled by a black band, typifying the office of Charity, on which is inscribed in a golden legend, "Blessed are the merciful," of course, in allusion to the merit of Miss Florence Nightingale, the recipient. The Royal donor is expressed by the letters "V. R.," surmounted by a crown in diamonds, impressed upon the centre of the St. George's Cross, from which also rays of gold emanating upon the field of white enamel are supposed to represent the glory of England. Wide-spreading branches of palm, in bright green enamel, tipped with gold, form a framework for the shield, their stems at the bottom being banded with a riband of blue enamel (the colour of the riband for the Crimean medal), on which, in golden letters, is inscribed "Crimea." At the top of the shield, between the palm-branches, and connecting the whole, three brilliant stars of diamonds illustrate the idea of the light of Heaven shed upon the labours of Mercy, Peace, and Charity, in connec-

tion with the glory of a nation. On the back of this royal jewel is an inscription on a golden tablet, written by Her Majesty, which stamps upon it a value inappreciable, as recording it to be a gift and testimonial in memory of services rendered to her brave army by Miss Nightingale. The jewel is about three inches in depth by two-and-a-half in width. It is to be worn, not as a brooch or ornament, but rather as the badge of an Order, the most precious in the manner of its conferring—the most singular in the merit of its recipient—the most illustrious in honour that has yet issued from the fountain of all honours—the Crown of England. We believe the credit of the design is due to the illustrious consort of Her Majesty, and we understand that it was manufactured by Messrs. Garrard, the Crown Jewellers. This graceful gift will mark an era not only in the history of the country but in the records of women.

LECTURES ON ARCHITECTURE.—The Gallery of the Society of British Artists, in Suffolk Street, is at present converted into an occasional lecture room. A course of lectures on Architecture was commenced there last month; the syllabus announces them to be "On Ancient Assyrian Architecture," by Mr. James Fergusson. By the way we have two recently published volumes on Architecture, by this gentleman, now lying on our table for review, a task which we hope to accomplish at some length next month. "On Early Christian Art," by Mr. George Scharf, Jun.; and "On the Influence of Light and Shadow on Architectural Exhibition," by Mr. Thomas Allen.

THE LONDON STEREOSCOPIC COMPANY.—At No. 64, Cheapside, we have had an opportunity of inspecting various series of the most beautiful photographs, artistically considered, we have yet seen. The works by which we were most interested were large groups of flowers and fruit, all apparently photographed from Nature, and relieved by a light open background, as if some plain white field had been placed behind the group. Many of the bouquets were beautifully fresh even without colour, as those of roses, dahlias, hollyhocks, convolvuli, and especially those which are distinguished by any picturesque luxuriance; the groups of growing fruits and flowers were not less attractive—apples, grapes, pears, plums, and currants, each mingling with their respective leaves, so as to constitute a picture. The photographer is, we believe, Adolph Braun, many of whose flower-compositions were engraved in this Journal some years since. Most of these pictures would serve most perfectly to paint from; but while considering them as auxiliaries, we cannot help regretting that photography so imperfectly affords the darker gradations and reflected lights in which we still see characteristic detail in Nature. Besides these large photographs there are, moreover, innumerable stereoscopic views from subjects in the Crystal Palace, in the French Exhibition, and in almost every one of the principal cities of Europe. There are also some costumed figure groups arranged with much skill and taste. The exhibition, we believe, is open to visitors.

THE SURREY GARDENS COMPANY AND MUSIC HALL.—A prospectus has been issued of a company under the Limited Liability Act, with a capital of 40,000l., in 100l. shares, to be called the Surrey Gardens Company, for leasing the Surrey Zoological Gardens, and building a music-hall capable of accommodating 10,000 persons, and at a cost of 40,000l.; the usual open air entertainments likewise to be continued, and M. Julien to be engaged. Shareholders are to be offered the privilege of a personal ticket in lieu of participating in the annual profits. It is contemplated that the music-hall shall be available for public meetings, floricultural and horticultural exhibitions, and other general purposes.

THE DUKE OF RUTLAND has, at the request of his tenants, consented to sit to Mr. F. Grant, R.A., for his portrait. The picture, when completed, will be presented to his Grace as a memento of the respect and esteem in which he is held by the donors, who are also desirous of possessing a likeness of the Duke, for which purpose the portrait will be engraved.

REVIEWS.

TAM O'SHANTER. By ROBERT BURNS. Illustrated by JOHN FAIRB, R.S.A. Published by the Royal Association for Promoting the Fine Arts in Scotland.

This edition of Burns's well-known humorous poem is the gift of the "Royal Association for the Promotion of the Fine Arts in Scotland," to their subscribers of the past year, and a gift it is which Southerners as well as Scotchmen must value, although we are not quite sure that this poem has been judiciously selected for the purpose intended; something more refined in character would have been better adapted for the majority of those who usually subscribe to such societies. It contains six highly finished line engravings, the dimensions of each being about six inches by nine, by Mr. Lamb Stocks, A.R.A., and Mr. J. Stephenson, from pictures by John Faed, R.S.A., an artist as well appreciated on this side the Tweed as on the other; and a pretty vignette of Tam's place of residence, the auld town of Ayr, engraved by W. Miller. The first engraving is O'Shanters "sulky, sullen dame," waiting his return, and "nursing her wrath to keep it warm." The gude woman and her cat occupy respectively one side of the fire-place, the tea is still brewing in the chimney corner, but it is quite evident it will not be offered to Tam very graciously when he reaches home; there is a storm brewing inside the cottage as fierce as that which he encounters without. The second plate "The Souter tauld his queerest stories," is a capital composition, full of genuine hearty humour that Wilkie would not have discomfited. In the text, Souter Johnny, whom Tam "loed like a vera brither," is helping him to mount his grey mare Meg, for

"Nae man can tether time or tide,
The hour approaches Tam must ride."

The lightning darts to the blacken'd heavens, but he is too happy to notice it, or be alarmed at its appearance. The fourth plate is very clever, but the subject is not agreeable, the "uncle sight" in Kirk-Alloway, and there is an absence of delicacy in its treatment, which we think might have been avoided. In the fifth plate, illustrating the lines

"And scarcely had he Meggie rallied,
When out the hellish legion sallied,"

warlocks and witches, and the hideous forms that have been skirling in the old church, rush out of the open window to catch the traveller; there is great spirit in this composition, and the light and shade are so managed as to produce a powerful and startling effect. But no one of the subjects evinces more talent than the last, where Meg has just reached the "key-stane of the brig;" the mare, her rider, and their pursuer are admirably drawn; often as this subject has been illustrated, we have never seen it more forcibly represented than here, the conception and the execution are alike entitled to our highest praise.

LONDON IN THE OLDER TIME: a Topographical and Historical Memoir, accompanying a Pictorial Map of the City as it existed in the reign of Henry VIII. By WILLIAM NEWTON. Published by BILL & DALDY, London.

The history of the metropolis of England has been frequently attempted, with more or less success, since the days of John Stow, to whose ill-requited labours we are indebted for all we know of its ancient aspect. Hence, while our topographical literature lasts, his work will be quoted as forming the grand basis upon which other writers build. Fitzstephen's narrative of the doings of the Londoners in the twelfth century, when he lived among them, though very curious, is but the brief record of a period when London was rivalled in size and importance by other of our cities. Pent up within the boundaries of the old Roman wall, its citizens could emerge from the gates to ramble in the fields around them—held so completely unaltered by sanitary commissions, that the undrained mazes of Finsbury and towards Stepney were looked upon in the light of defences to protect the walls; and the men of Essex had to turn out and construct raised causeways on great occasions, when sovereigns had their public receptions at the Tower, or marched into London at the head of their victorious soldiers, as Henry V. did after the battle of Agincourt. The sovereign could readily kill a stag in the dense forests of Epping, or neverve still, at Islington or Marylebone, enjoy his sport. The north of London was, in fact, thickly covered with trees; and here and there were religious establishments planted in proximity to the town, to which the pious could walk to their orisons, or the sick to the healing waters of some holy well, like that

of St. Clement, which still gives its name to a street anything but redolent with health at present. Even so short a time ago, as 1825, when Hone was publishing his "Every-day Book," St. Chad's Well, in Gray's Inn Lane, was in existence as a healing spring; while the anciently-famed St. Agnes-Jell still exists in Moxton, to which citizens often resorted in old times across the pleasant fields of Finsbury, left for ever "for the maidens of London to dry their clothes in," as the old ballad variously informs us; and where the youth of London practised archery, like so many Robin Hoods. Pleasant enough is it, to read in old records the rural attractions once displayed, where now all is dirt and splendor; to be assured that Saffron Hill, that most offensive collection of bone-bollins, horse-slaughtering, and chemical establishments, surrounded by dense masses of undrained alleys, and the resort of poverty, dishonesty, and vice, was once a rising ground overlooking the pure Fleet River, and had its name from the abundance of saffron flowers which covered it, and gave a golden hue to the fresh fields around; so that the lane leading thence to the north side of Holborn was called Gold Lane in consequence. Or that the now equally abominable Petticoat Lane, in Houndsditch, was, a few years before the time of Queen Elizabeth, a rural way, bounded on both sides by hedges of elm-trees, with foot-bridges and convenient stiles to pass over into the pleasant fields "very commodious for citizens to walk, shoot with bow and arrow, and otherwise to recreate and refresh their dull spirits in the sweet and wholesome air."

When Elizabeth and James I. troubled themselves exceedingly at the increase of London, and their parliaments anxiously enacted laws to prevent country gentlemen from coming there, lest the "decay of good housekeeping," as it was termed, should ruin the country, how little did they think they were merely enacting Mrs. Partington, and trying to sweep back the sea from their doors; could they see what London has now become, and how gradually it has swallowed within its bounds the neighbouring villages to which, in their time, it was dangerous to travel after dusk, there is no doubt their nerves would receive an awful shock. They might, however, recover, when they found the country really not ruined thereby. Yet unavailing as was the rapidity with which London enlarged itself, when peace and religion was established by Elizabeth, it is as nothing compared to the steady growth of the last fifty years. We, therefore, owe a debt of gratitude to those who have preserved the ancient features of the past times, whether by pen or pencil, to aid us in the present. Mr. Newton says in his preface, with great truth, that the advantages a good map of the metropolis in the old time would present to the archaeological student is great, and that this suggested to him "the idea of collecting, from the many available fragmentary records of the metropolis, materials for representing the ancient city in a graphic form."

This has been effected by a general bird's eye view pictorial map of the cities of London and Westminster, the borough of Southwark, and such other detached hamlets having immediate connection therewith, as they existed in the reign of Henry VIII. To do this it has been necessary to consult the descriptions of old authors, as well as the maps and plans of previous times. Two of the most important works of this kind are the views by Anthony Van den Wyngaerde, A.D., 1543, in the Bodleian Library, and the large print by Raimundus Aggas, 1560; both being similar views to the present, as if in fact sketched from a balloon. From the latter has been drawn, until recently, our only views of buildings before the time of Hollar, or the days of the Great Fire; but, as Mr. Newton observes, this work "is extremely rude in delineation, and sadly distorted as to proportionate distances, although acknowledged to exhibit with tolerable accuracy the principal places existing in and about London" at the time of its construction. It has, however, been quite possible to restore very accurate representations of old buildings; for, though thus rudely indicated, it is possible to comprehend what they would be if better detailed. Herbert, in his "History of the Livery Companies of London," was one of the first to attempt such restoration, and he succeeded well. The present map has been constructed similarly, aided by various plans made when there were considerable vestiges of early buildings since destroyed; such as that done by order of government after the great fire, and Roome's survey in the beginning of the last century.

There, however, existed many buildings which were not delineated by the pencil, though carefully done by the pen; and it is from the descriptions of ancient writers, aided by cognate examples of

similar foundations, that the designer of the present map has restored them. "It has been a prominent object of this work to point out, as correctly as may be, their true situations; and in most instances, if not all, it is believed that their position, extent, and general appearance, at the period assigned to our map, are rendered with fidelity." Such are the words of Mr. Newton, when speaking of his own labours, which appear to have been honestly and anxiously performed. The task has been one of some difficulty, and required much patient research, but it bears internal evidence of having received it at his hands. It may be objected that fanciful views of places are calculated to injure the *exactness* of the work, but it must be borne in mind that the small scale on which the buildings are necessarily laid down, does not at all effect the general appearance.

The map measures three feet nine inches each way, and has been most elaborately engraved by Thomas Sherratt. It wants, in fact, the aid of a glass to fully comprehend its minutie. Its great value is in the truth of its proportions, in which all the olden maps fail. As a piece of London topography, it is a welcome addition; and the attempt to restore such buildings as belong to its history, and many of which exist only in ancient descriptions, will aid at any rate the clearer understanding of the incidents narrated by early chroniclers.

The map is accompanied by a brief, but clear exposition of the state of the metropolis at the early time chosen for this view; and we consider this as a most valuable adjunct, comprising 117 closely printed folio pages, minutely detailing the various buildings existing in London and the suburbs before the Reformation, as described by old authors. We know of no better digest than this, by which we may, in imagination, walk over the London of the sixteenth century. If Mr. Newton had done no more than this, he would have done good service to topography. Both map and letter-press bind together in a thin folio volume, the map being mounted on linen; and it therefore ranges with such books as Strype's edition of Stow, to which it will be a welcome addition, as it will also be to the library of the English topographer and historian.

AN ADDRESS DELIVERED IN THE CRYSTAL PALACE, ON NOVEMBER 3, 1855. By M. DICKEY WYATT. Published by BELL & DADY, London.

We had the gratification of hearing Mr. Wyatt deliver this lecture, or address, at the opening of the Exhibition of Works of Art belonging to the Arundel Society; and, while listening to him, could not but regret that his audience was comparatively scanty, for the day happened to be miserably wet and cold, and the visitors to the Crystal Palace were few indeed. Our regret is now partially lessened by seeing it in print,—we say "partially" because, in order to estimate rightly its value, the reader should have before his eyes the traces and drawings from paintings by Giotto, and other early Italian artists, which hung on the walls of the court where the audience assembled, and which works of Art the address was intended to explain. Mr. Wyatt's profession of ornamental artist has led him to the study of early Medieval Art, and the knowledge thus acquired enables him to handle the subject learnedly, while he discourses upon it without pedantry or dryness.

WOMAN'S RECORD: SKETCHES OF DISTINGUISHED WOMEN FROM THE CREATION TO 1854. By MRS. S. J. HALE, New York. Published by HARPER, BROTHERS.

A second edition of Mrs. Sarah Hale's monster Biography of Celebrated Women proves the interest which our transatlantic neighbours took in the first—indeed everything pertaining to *women* finds a ready sale in America—and while Mrs. Hale has rendered the homage of her heart and pen to many well-known and right honourable women, she has filled some niches in her temple of fame with names hitherto unheard-of in Europe. In such a vast undertaking the wonder is not that Mrs. Hale has made some mistakes, both in her details and conclusions, but that she has made so few. The labour of such a compilation must have been immense.

The work is printed in double columns, and extends to 812 closely printed pages; this might have been profitably reduced to six hundred. Mrs. Hale has given specimens both in prose and verse from several women she considers the best authors; some of these quotations are not worth the space they occupy, but where an effort was made to include all distinguished women "from the creation," we imagine Mrs. Hale found as much difficulty in leaving out as in putting in. The volume is divided into four "eras;" but it is im-

possible to dispel the mists which envelope individuals of bygone ages, and the interest of the book does not really commence until the "second era."

In these days of cheap and easy literature we are startled by such a levitation of a book as this which Mrs. Hale has waded across the Atlantic as if it were one of the volumes of "light literature;" but in America the thirst for Biography is unquenchable, and gratified at any cost.

The volume is abundantly illustrated by engravings on wood, portraits of those considered most worthy of such a compliment, and in some instances the likenesses are correct. Mrs. Hale has taken great pains to correct former mistakes; but writing as she does at the other side of the Atlantic, she is in a great degree unable to ascertain if the information she receives is really correct. She says for instance that Mrs. S. C. Hall has frequently illustrated the labours of Mr. S. C. Hall's pencil, by her pen—it is pretty well known here, that Mr. Hall is a barrister, not an artist, and that he never wielded a pencil except to "make a note on't." But as we have already said, it is only to be wondered at, that so few mistakes have been made where such a mass of varied materials were to be collected and arranged. The work is really one of great utility, and we consider ourselves fortunate in its possession.

THE ALMANAC OF SCIENCE AND ART, A.D., 1856. Published by CHAPMAN & HALL, London.

A work of this kind has long been wanted; it will fill a vacuum which every one, either directly or indirectly connected with Art, must have experienced. The information it contains is ample and well arranged; besides the usual contents of an almanac, it sets forth all one desires to know respecting the artistic and scientific institutions of the metropolis, the provincial schools of design, public institutions, libraries, and museums, a list of the prizes awarded to English exhibitors in the recent French Exposition, the acts relating to the registration of designs, &c. &c.

NOLAN'S ILLUSTRATED HISTORY OF THE WAR. Published by VIRTUE & Co., London.

We have already noticed the first three parts of Dr. Nolan's history of the contest in which the Western Powers are unhappily engaged with Russia; the seventh part brings down the narrative to about the period when the allied forces had established themselves in Bulgaria. It must not, however, be thought that this history is a mere record of the movements of fleets and armies, and of the actions in which both sides have displayed so much courage, though not resulting with like success to both; the author enters at considerable length into the political and social condition of the various countries which have become the seat of war, and hence a value is attached to the history far beyond that pertaining to the mere historian of battles. Dr. Nolan writes lucidly and graphically, and when the occasion demands it, with energy and eloquence; he will have scope for the display of these latter qualities when he gets into the thick of the war; at present he sees only the gathering clouds, and feels the drops, few and far between, that presage the coming storm. We fear events are not progressing in such a way as to compel the author to bring his narrative to a speedy conclusion, but whether he lays down his pen early or late, his history will certainly furnish the best report of the contest that has appeared since hostilities commenced. We must not omit to mention that each published part contains a portrait of one of the distinguished warriors of the allied forces, and an illustration of a battle, or some place rendered notable by its connection with the war; all exceedingly well engraved.

SALTAIRE. Drawn and engraved by W. WILLIS. Published by A. HOLROYD, Bradford.

If we could topple down the two tall chimneys that rise from the roof and at the side, respectively, of the vast pile of buildings standing in the centre of this engraving, we might, without much stretch of fancy, imagine we had before us some noble stoyal, or duell residence, in which a host of personages of high degree, with their retinues of serving men and serving women might be lodged and entertained. But it is destined for a different purpose; over that elegantly-constructed bridge, and beneath that decorated archway, hundreds of industrious artisans throng, we presume, to their daily avocations; for the vast edifice is neither more nor less than one of those immense factories with which the midland counties are studded. This view of Saltaire, which includes the village of that name contiguous to the "Works," is taken from Shipley

Glou, situated at Airdale, in Yorkshire. The owner of the property is Mr. Titus Salt, who must have expended large sums to make it as it is represented in this well-executed engraving, which recalls associations of another kind—the strong baronial castle of feudal times, round which were clustered the humble abodes of those who found protection and support under the wing of its owner.

THE HISTORY OF SIR THOMAS THUMB. By the Author of "The Heir of Redcliffe," "Heart-castle," &c. Illustrated by J. B. Published by CONSTABLE & Co., Edinburgh; HAMILTON, ADAMS & Co., London.

This is not a biography of General Tom Thumb, whose appearance in England some time since, under the auspices of Mr. Barnum, created so great a sensation throughout the country, but of Tom Thumb whose history has belonged to half the nations of Europe for centuries; for Germany, France, and Denmark each has its Tom Thumb, though not quite the same as the hero of King Arthur's court. The Author of "The Heir of Redcliffe" has concocted a very amusing tale out of the old legend which children love to hear and talk about, and has made it a text for inculcating a lesson of right conduct, how every man should endeavour to choose what is good, and avoid the bad in every transaction of their lives. The illustrations are not quite up to the mark of the present day, even for a child's book; but the volume would still be a pretty gift to little folk.

THE NEW SCHOOL OF SINGING. By ROBERT FRANCIS BLACKBIE. Published by CLARKE, BEALE & CHAPPELL, London.

The very sensible objects of this publication are to prevent the premature cultivation of the voice, and to moderate the excessive practice of difficult exercises. We are not sufficiently skilled in the subject to pronounce if Mr. Blackbie's plan for the *crescendo*, or drawn tones, will be found more useful than the ordinary system of commencing at once with the practice of long *crescendo* notes. It is frequently the case that the pupil in beginning a note very piano, for the purpose of making the *crescendo*, is seized with a nervous shrinking in the chest, and loss of power over the muscles of the throat, and the sound necessarily issues in a stifled and tremulous manner; if Mr. Blackbie has overcome this difficulty he has achieved a great triumph. But whether or not, there is much in his method which is worthy the attention of teachers as well as of pupils.

PUSS IN BOOTS. By OTTO SPECKTER. Published by J. MURRAY, London.

John Murray, of Albemarle Street, publishes "Master Cat and Puss in Boots!" it is even so, but then it is Otto Speckter's "Puss in Boots," and that is very different from any "Puss" hitherto submitted to the "intelligent public." We recommend this special "Puss" to the drawing-room quite as much as to the nursery; the illustrations are so full of character, the drawing of the figures so unexceptionable, that "well-grown," well-educated people will find quite as much delight therein, as the juveniles to whom "Puss in Boots" of right belongs.

PROFESSOR EDWARD FORBES, F.R.S. Engraved by C. COOK, from a Daguerrotype by CLAUDET. Published by A. CLAUDET, London.

An admirable likeness of one whose early death is almost an irreparable loss to the world of science. This engraving, very carefully executed on steel, in the mixed style, is, we presume, copied from the same daguerrotype as was the lithographed portrait prefixed to the published volume of the professor's literary essays: in both, the highly intellectual countenance of the original, and its kindly and benevolent expression, are well preserved.

THE CHESS-PLAYERS' ANNUAL FOR THE YEAR 1856. Edited by CHARLES TOMLINSON. Published by A. HALL, VIRTUE & Co., London.

The "Game of the Chess," as Caxton titled his earliest printed volume, has for ages been a favourite study and pastime with men of all ranks and all degrees of intelligence. To those who interest themselves in this noble game Mr. Tomlinson's Annual will be most welcome; it is filled with pleasant stories, essays, dialogues and poetry, anecdotes and aphorisms, and all sorts of entertaining contributions to excite the attention of the chess-player.

THE ART-JOURNAL.



LONDON, MARCH 1, 1856.

STUDIES FROM THE LIFE,
BY W. MULREADY, R.A.

THE processes of study by which eminent results are effected have a peculiar interest. It is a privilege to become acquainted with them. It is, as it were, being introduced behind the scenes of a drama presented to the public. To be informed of the mode of acquirement of the man of science or literature, to be shown the steps by which a great invention has been reached, or a secret of nature discovered, or to trace in a first sketch the germs of a poem, or a biography, or a history which has afterwards expanded into a standard work, is a grateful boon. In the province of Art it is no less delightful to witness the methods by which analogous successes have been achieved, and to be instructed in the processes by which such results have been arrived at. To the merely intelligent curious, and to the general Art-lover, this is full of interest; but to the student it is also full of instruction. These are the considerations that invest the collections of sketches, drawings, and studies of the Old Masters with their chief worth. The "Liber Veritatis" of Claude; the first thoughts and studies of Raphael, Michael Angelo, and Albert Durer, from these views derive their liveliest interest. To examine such is like a visit to the atelier of the artist himself, where you do not see him in the full array of honour with which time has invested him, but in his morning gown and slippers, palette on finger, brush in hand, the anxious student of the beautiful, the poetical, the eager enthusiast fluctuating between shortcoming and success, and trembling on tiptoe for yet higher flights! He appears himself to point out to you the successive images and phases by turns selected, that have passed over the vision of his thoughts, and how here he has changed a group, and there a figure, and how a drapery, or a limb, or a turn of a head or hand has been readjusted, and how the first sketch from the living model has been prepared for transference to the canvas or fresco by doubled and troubled lines of correction or refinement, until it has been at last gifted with a contour fitting it for the great work itself. Thus may we sometimes trace in the collections of sketches, in the Louvre and elsewhere, a great and cherished work of Art from its cradle to its manhood. Earnest, indefatigable, devoted, is the scene of study thus displayed; no easy road to fame is there illustrated, but one of studious habits and untiring zeal—the path of those

"Who spurn at ease, and live laborious days."

In no class perhaps do the early habits of study cling more affectionately and enduringly than in that of the artist, in which we may so frequently notice the same earnest methods which characterised the young aspirant still practised in matured age. We need not go back to former times—to the days of Lorenzo de' Medici, or Pope Julius, to find subjects for our admiration,

either of these methods or their endurance—nor wander beyond our own familiar names. Wilkie, Flaxman, and Etty were a worthy trio of examples of enthusiastic and enduring study, and of the excellent success it achieves. The crayon and the brush were ever zealously employed by them in preparatory studies for their works and compositions, and the most earnest search after truth is evidenced in the conscientious readings of nature in their sketches. The loss, however, of these great ones from among us, does not leave us bare of present wholesome examples.

The remarkable studies from the living model executed by our well-known academician, William Mulready, in the simple materials of black and red chalk are indeed not to be surpassed by similar productions in ancient or modern times. We are sufficiently conversant not only with ancient studies, but also with those of modern schools, to say this without hesitation; and we add that in perfection and completion they are not equalled by the crayon drawings of Wilkie, and in refinement do not fall behind those of Flaxman. It would indeed be stopping short of the full impression these works make on us, did we not avow that, take them for all in all, as simple black and red crayon drawings from the life, we do not know their equal either in ancient or modern Art. This is a proud boast for us to be able to advance, in a province in which our strength is said not to lie. The faithfulness and delicacy of these drawings, their detail and yet their breadth, their finish and completion of effect, are hardly to be surpassed by a picture in oil. They are executed by the artist however as a délassément from his works of the latter nature, so deservedly high in public estimation. The crayon comes in occasionally as a relief to the brush, and fills up the time probably while some portions of the picture on the easel are drying in readiness for another day's work; and thus are completed every year some three or four studies, which have had their birth in the life-school of the Royal Academy.

Among the benefits afforded by this body to the furtherance of Art, out of the funds arising from their annual exhibition, is a school for drawing, painting, and modelling, from the living model, and it is one of the duties of each Academician in turn to take the direction of this school, which is held in the evenings of a large portion of the year, and to pose the model for the students to copy; and not unfrequently are these and the director seen all drawing together with like attention and earnestness. Studies so complete, however, as those of which we have been speaking, are not to be executed during the short period allotted to each pose—not, we believe, more than the evenings of one week—but in Mr. Mulready's case are taken home and completed by daylight, in his own atelier, but still "by nature;" and thus their character as studies remain intact, although daylight enables them to be enhanced by a juster and more complete gradation of tint and light and shadow, than the gaslights of the Academic School afford.

At the first sight of these works it is hard to believe, not only by the uninitiated, but by those also conversant with Art, that such effects can be produced by such simple agents. The tint of the paper usually chosen for them, is slightly yellow, and the drawings are wholly made in red and black chalk—the paper itself being left for the lights—without any white being used. This is the usual method; in a few cases we believe a slight addition in material has been used; but the most remarkable of these works have been produced solely with red and black chalk, without anything else entering into the process. The results are most satisfactory from the use of this very sober key of colour:—the slight yellow of the paper, the red and the cold shadow of the black chalk supplying a subdued version of the three primary hues of Nature. The variety of the tints on the surface of the drawing produced by the different intermixture and preponderance of the elements of this simple scale, is marvellous; and the success

achieved by them in that most difficult portion of the painter's art—the representation of flesh—must be seen to be credited.

It may be, also, that this illustrates in an interesting manner the subject of Ancient Greek Painting, of which we possess no adequate remains. Excellent as were the architecture, sculpture, and formative decoration of that people, it has been asserted that the standard of these could have been reached by them in the kindred Art of Painting, from the great simplicity and fewness of their pigments, of which we have record. Due consideration would doubtless be unready to allow that those who showed such extreme refinement and fastidiousness in the sister arts would ever have been satisfied with crudities in painting, or valued so greatly productions that were incomplete; and these studies of Mr. Mulready appear to illustrate this, and justify the reputation of the artists of old; for here we now see all the hues of flesh produced by agents still more simple than those possessed by Apelles, Protogenes, &c. And thus does modern Art illustrate the old, and Dayswater throw back a ray of light on Athens!

"Studies" may be divided in two sections; the first comprising those which are direct preparations for pictures, as trials of composition in line or effect in light and shadow for the whole; or sketches for portions, as for individual figures, or for the principal heads or hands, &c.; and the other those that are not direct in their connection with any principal effort of the artist, but rather such as aim to forward his general knowledge, or refresh his memory of nature. The more ingenious and earnest the followers of Art, however far back may be the date at which they entered her service, ever class themselves as still among her students; as indicated by the well-known reply of the ancient Michael Angelo, when discovered by his friends among the ruins of the Coliseum. Other people cling to youth; but to the poet and the artist youth may itself be said to cling, from the enduring freshness of their appreciation for the beautiful. Sparkling are the goblets they dip out from the well of truth. Vivid are the pictures they reflect from their mirrors, and deservedly cherished is an artist's direct transcript from nature; begun, perhaps, without knowing whether he is to make of it a painting, or only a study. We use the word "only" as no depreciation; for there is indeed a charm about an actual "bona fide virgin study" peculiar to itself. Some of the most exquisite of the sensations experienced by the true Art-lovers are those derived from the perusal of sketches, from fact, on the spot, photographed by the artist's own perception and so imbued with himself—nature—but seen through his eyes. There is somewhat sacred in such fresh offerings; we do not like them to be touched. "Paint pictures from them if you like, but do not touch these," we feel inclined to exclaim.

Of either of these classes of "studies," the direct (or shadowing forth of the future picture), or the indirect (the more close transcript of nature's facts), the "pleasant labours" of Mr. Mulready afford eminent and charming examples; but it is to the latter (those "studies from the life," in which are united the zeal of the young student with the most experienced taste and knowledge) that our eyes are now turned.

Charming as these are as works of Art for the connoisseur and collector, they are, as we have said before, still more valuable as works of example and guidance to the student. Every School of Art throughout England should have the opportunity of witnessing and consulting them; and it is not one of the least judicious of the acts of the Board of Trade that they have ensured for their own Art Department, four we believe, of these works. Her Majesty also, we understand, among the possessors of them, but on the whole they are confined but to few collections. Studies though they are, they are national credits, and go far to redeem us from any remarks on the shortcomings of British Art-acquaintance with the human form. They are most pleasing results of the union of truth and knowledge with grace and refinement, and are eminent examples of the gems to be found even on the footway to the heights of Art.

ON THE PERCEPTION OF COLOUR IN PICTURES.*

THE following letter was printed for private circulation only; but the subject is of so much importance, and the remedy for the evil to which it refers is so clearly and simply set forth, that, considering the public should have the benefit of the writer's suggestions, we have obtained permission from Mr. Smirke to give them a place in our columns. It is, however, necessary we should explain that the pamphlet itself contains examples of the coloured papers Mr. Smirke recommends to be used; these we could not, of course, place before our readers, but they are sufficiently described to enable any desirous of trying the experiment to procure them.—Ed. A.-J.]

DEAR SIR CHARLES,

It is with diffidence and hesitation that I address you on a subject which belongs rather to your Art than to mine: but the two domains adjoin, and the boundaries are not clearly defined; I trust, therefore, to your indulgence if I am found trespassing. No one can be more sensible than myself that, in making the few following observations, I am propounding to you no new doctrines, and am conveying to your mind no information. Yet, as the suggestion which forms the subject of these pages affects almost exclusively the interests of your Art, I feel that I am likely to obtain for it a more favourable and intelligent hearing through the medium of a letter addressed to yourself, than by the adoption of any other course.

Every one who has painted a picture, or decorated a room, or even furnished one, must have acquired some knowledge, however vague or defective, of the harmony and discord of colours, —of their affinities and contrast.

They must generally have felt that pink and green, or buff and blue, when placed in juxtaposition, present to the eye an agreeable impression, whilst orange and green, or green and purple, and other such pairs of colours, require some skill in the artist to prevent them from producing an opposite effect.

The fact is equally well known that, owing to this peculiar relation that colours have to each other, there is, in arranging a collection of pictures, an extreme difficulty in preventing their mutually injurious action on each other.

Few artists, I apprehend, have been so fortunate as not to have experienced, at some time, the vexation of finding their labours frustrated by an obnoxious neighbour; the Massacre of Innocents is, indeed, a tragedy annually, and almost unavoidably, acted, to the injury of many a good picture, and to the disturbance of many an even temper.

But the remark is by no means so trite, nor is the fact so generally familiar, that the impression produced by a colour upon the eye does not cease immediately the eye is removed from the colour; and it is to this fact that I would invite particular attention as forming the basis of the following observations, as well as of the suggestion which it is the object of this letter to submit to your judgment.

Do not fear that I am about to venture one step into even the shallows of science in this matter, or to inquire into the physical nature or causes of the impression made by colours on the retina. This fact, namely, that the impression produced by colour on the eye has a certain amount of permanence, and, for a time, affects its powers with reference to its appreciation of other colours, is all that I desire to have established; and this is very easily done by direct experiment.

Let any one fix his eyes, intently, for a short time upon a bright red object, and then let him turn to any ordinary historical or other picture, containing various colours, and it will be sure to appear to him wanting in warmth, whatever its colouring may be; for all the warm hues will

have temporarily lost their due effect upon his sense of sight.

Or let him look fixedly on pure blue, and he will be sure to find that, for a time, until his eyes have regained their normal condition, the complexion of every one around him appears sallow and leathery, not from any unnatural excess of sallow tints in the complexion, but in consequence of the abnormal condition produced upon his eye by the previous impression made on it by the pure blue.

The fact may be verified by a variety of similar experiments.

It is this phenomena, I apprehend, which contributes to render the task of hanging a collection of pictures so hopelessly difficult. We may place widely asunder two conflicting pictures, but we still cannot prevent their injuring each other, should the spectator happen, or choose, to cause his eye to pass from one directly to the other.

Suppose an eye that has been immersed in the flood of rich colouring presented by a Rubens or a Paul Veronese, were to turn, fresh from the dazzling draught, on to some tenderly and soberly painted picture, whose subject, perhaps, demanded the eye of broken and subdued tints, the critic at once pronounces it to be feeble, faded, &c., whereas the verdict may have been far otherwise, had his eye been previously sobered down to its normal or neutral condition.

The greatest skill is often expended on the nice adjustment of hues. To balance, to neutralise, to contrast, to bring out, to keep down; such are the usual and laboured objects of a painter's solicitude. Sometimes an apparently unimportant object in the picture, a mere spot, as a red or a yellow cap, is thrown in to make peace, perhaps, between two rival hues, or for some such special purpose, placed with great caution, exactly in the right position, and exactly in the right quantity, so as to answer its purpose, and do no more.

Now, suppose we came up to this picture after the close examination of some pictorial conflagration, on which whole bladders of vermilion or chrome have been expended, how utterly unfit should we be to do justice to the painter's elaborate adjustments!

I may here be told that it is idle to complain of an evil that seems inevitable in every miscellaneous collection of pictures; but I trust that the suggestion which I am about to make may show that the evil is by no means irremediable; that, in truth, the remedy is simple, easy, and effectual.

Let any one who wishes to receive a full measure of enjoyment in a picture gallery hold in his hand a tablet painted of a neutral tint,* on which to rest his eyes as he passes from one picture to another. Has his eye become inebriated by some florid colourist? A draught of the neutral tint on his tablet will sober it down, and bring it to the full use of its senses. Has he been contemplating a glowing Italian sunset, or "A Masquerade at Naples?" a glance at his tablet will prepare him for the next picture, perhaps "A Mist in the Highlands;" by means of his tablet his eye becomes, on each occasion, a tabula rasa,—a cleansed pallet, prepared to receive a fresh assortment of colours. Its discriminating powers are restored; its bias corrected; and thus each picture will stand on its own merits, unimpaired by the disturbing effects produced by the impression left behind by the subject of the spectator's previous examination.

A late eminent medical writer on cookery recommended that a saline, or other appropriate draught should be administered to the cook on the eve of a banquet, so that his, or her, taste might be purified and rendered so sensitive as to secure to each entrée and condiment the exact flavour that shall best recommend it to the fastidious gastronome.

Very analogous to this would be the operation of the proposed tablet upon the powers of the eye; it would "purge the visual ray," and so fit it to discern and appreciate the niceties of the colourist.

Indeed there seems a curious analogy in this

* [The neutral tint upon which Mr. Smirke has inserted has a greenish hue.—Ed. A.-J.]

respect between our senses of sight and taste. Who has not experienced after indulging in food of luscious sweetness, that for some, not inconsiderable, time the palate is apt to misjudge all other tastes! Their minor sweetness is temporarily lost upon him. I would hardly have ventured to obtrude upon you this plain and somewhat homely truth, were it not, I think, an apt illustration of the analogy above mentioned, and did it not at the same time serve to explain the nature of the evil that the proposed tablet is intended to remedy.*

I would now advert to another application of the principle on which the proposed tablet is founded; and I think that this also is deserving of attention as calculated to enhance the enjoyment we derive from one of the most pleasing branches of the painter's Art. Landscapes almost always form a large proportion of every miscellaneous collection of pictures, and they are peculiarly liable to suffer by the contact of their neighbours. The landscape painter is prone to use many greenish tints so remote from purity as to require an eye of some discernment to detect their greenness. Artists do this, because their mistress, Nature, does the like. In the cold grey of an early morning, or in the serene and yellow leaf of autumn, we have to seek for any green tendencies with a very careful survey—a survey which our visual organs are ill prepared to make with success, when fresh from one of those crashes of colour which one meets with occasionally in every assemblage of pictures.

Now, I would provide the means of obliterating these adverse impressions on the eye before turning to a landscape by painting the reverse of my tablet† with a deep, pure, but not bright, red.

Let the eye absorb a dose from this side before it contemplates a landscape, and it will be at once found to have been brought into a right condition for duly appreciating the artist's labour. Red offers so powerful, and yet so harmonious, a contrast to its complementary colour, green, that not only will the general effect of the picture be heightened, but every green tinge, however latent, however neutralised, will disclose itself with all the force due to it.

I can anticipate but two classes of objectors to my proposal. One would consist of those who think that it would be too troublesome to be required to stare at a blank tablet when the eye is eager to be engaged on some fine picture. But surely if the enjoyment of an intellectual pleasure be our object in looking at pictures, a few moments spent in adapting the eye to the task, and thus greatly enhancing that pleasure, is a sacrifice too trifling to object to. If our sight is imperfect, we do not hesitate to resort to the use of a glass; if our hearing fails us, we are too happy to avail ourselves of acoustic contrivances; and are thankful to science for the aid she affords us in our infirmities.

I need scarcely say, moreover, that the occasions for the use of this harmless medicine for the eye would not be of constant recurrence. There are in every gallery many pictures that are so neutral in their general effect that they are perfectly inoffensive to others, and are not themselves easily offended; and there are many wherein the interest or value of the work is wholly independent on colour.

When once the principle on which this tablet operates on the eye is clearly comprehended, every intelligent spectator would readily acquire the habit of determining for himself at a glance whether the recourse to it be necessary or not.

* The remark of Sir Joshua Reynolds on a peculiar effect on the eye, observed by him after having looked at white paper, is so apposite, that I think it well to transcribe the note referring to it in Malone's Life of Sir Joshua.—"On viewing the pictures of Rubens a second time they appeared much less brilliant than they had done on the former inspection. He (Reynolds) could not for some time account for this circumstance; but when he recollected that when he first saw them he had his note-book in his hand, for the purpose of writing down short remarks, he perceived what had occasioned their now making a less impression in this respect than they had done formerly. By the eye passing immediately from the white paper to the picture, the colours derived uncommon richness and warmth. For want of this foil, they afterwards appeared comparatively cold."
† A blank, tinted page attached into the catalogue, when there is one, would of course answer every purpose.

* "A Letter to Sir Charles Lockhart Eastlake, P.R.A., suggesting a Mode of Assisting the Eye in the Right Perception of Colour in Pictures. By Sydney Smirke, A.R.A. Not Published. 1856."

To the class of objectors who may ignore altogether the existence of the evil which I propose to obviate, and who cannot perceive that one picture can have any material effect upon another, I can only reply that it is not for the use or benefit of such observers that I offer my proposals. I have no doubt whatever that there are those to whom this mutual action is imperceptible; to these certainly my expedient would appear to be of little value. The persons who are acquainted with the broad distinctions between red, blue, and yellow, are numerous; but were we to count up those who have learnt only to appreciate, or even to perceive at all, the delicacies of distinction which exist in the wide range of mixed tints lying between those three extremes, we should probably find the number considerably reduced.

I venture to think that one of the advantages fairly to be derived from the use of such a tablet as I have described, would be, that it would assist in the education of the eye by leading it to acquire the habit of seeking out the niceties of the colourist's art, and might eventually confer upon them the capacity of looking at pictures with a keener relish, and a more just and critical apprehension of them.

Having laid before you my suggestion, I will trespass on you no further than to request your deliberate consideration of it and of its practical merit and application.

Should my opinion of the utility of this mode of rectifying our vision be so fortunate as to meet with the concurrence of yourself and of other high professional authorities, I shall indulge in the hope that the experiment may be tried, first in private collections, and ultimately perhaps in our public galleries.

I am, DEAR SIR CHARLES,
Very faithfully yours,
SYDNEY SMIRKE.

GROSVENOR STREET,
January, 1856.

BRITISH INDUSTRIES.*

NO. VII.—CLAYS, BUILDING STONES, AND MARBLES OF IRELAND.

ONE of the aims, and by no means the least important one, of the *Art-Journal*, is to direct attention to sources from which may be drawn objects for the uses of the manufacturer—and for the applications of Art. Notwithstanding the energy with which all our commercial enterprises are carried out—notwithstanding the zeal with which new mines of wealth are sought after, there still remains in the small group of islands which constitute the United Kingdom many undeveloped treasures of great worth.

The causes producing temporary blindness to advantages which are scattered around us, and which are consequently neglected, it is not easy to define. There appears to be a law by which matters are developed from time to time, but the operations of that law are hidden from us. Certain it is, that natural productions are known to exist at our own doors, for which our ships traverse the seas. The material is valued being "Foreign" which, when seen as a native produce is regarded as valueless. Certain it is that the mineral productions of Great Britain and Ireland, may, for all the purposes of use and ornament, endure a competitive examination with those of any nation of Europe, we may almost say of the whole of Europe itself.

We have already devoted our pages to the consideration of the marbles, serpentine, and other ornamental stones of England—and we purpose now briefly to direct attention to the lithological productions of the sister island.

A brief sketch or outline of the geology of Ireland will not be out of place. *Granite*, as the lowest rock of the series, claims our first attention. The principal localities in which we find granite forming the present surface, are those of Wicklow, of Galway, of Newry, and of Donegal. There are many other localities in which small isolated masses of granite are discovered, but those named are remarkable as exhibiting this formation, widely-spread, and varying much in character. *Mica-slate*, and *clay-slate* occur extensively. The former in Wicklow and Wexford, and the latter in Wexford, Down, Waterford, Cork, and Kerry. If we examine a geological map of the United Kingdom, it will be seen the geological formations of south-western England are all repeated in nearly the same order in southern Ireland. The slates, which are of the most varied character, constitute many of the more extensive mountain-ranges, but with the exception of the works in the Island of Valencia, and at Killaloe, they have not been made of any considerable industrial value. The quartz rocks of Mayo and Donegal, from the great extent of country over which they spread are objects of much geological, though as yet of small commercial interest. The sandstone, and the sandstone conglomerates of Ireland have received great attention; especially have they been studied by that eminent geologist, Mr. Griffith. These sandstone rocks are very widely spread. The Old Red Sandstone,—that storehouse of ancient life, which has been so graphically described by Hugh Miller, forms the greater part of the county of Cork; and in Longford and Roscommon it is also found largely developed. Limestones—the mountain and the carboniferous varieties—continually make their appearance in connection with the several geological formations already named. In the coal-fields, especially the Connaught coal-field—the carboniferous limestones exist, and yield for industrial purposes a great variety of building-stones and marbles. The magnesian limestone is found in the south of Belfast Lough. It is a true dolomite,—that is, a combination of one atom of carbonate of lime, and one atom of carbonate of magnesia—it sometimes occurs in proportions varying slightly from these. The more recent rocks are so unimportant, and occur in such comparatively small patches, that it is scarcely necessary to mention them on the present occasion. The igneous rocks—such as trap, basalt, and greenstone, in several varieties spread over the table-land of Antrim. All rocks of this character are remarkable for their chemical composition; being indeed often formed of fused masses of the adjoining rocks; and imbedded minerals in considerable variety are found in them. These rocks decompose with some rapidity, and form ochres and clays, distinguished from all others, by the beauty and diversity of their colours. Such is a statement in general terms of the rocks which exist in Ireland.

Mr. Griffith, to whom Ireland owes a debt of gratitude for the careful study which he has given to the mineral productions of the country, informs us, that in nearly all the granite districts, beds are found of clays formed from the decomposed felspar, which are in few respects inferior to those discovered and worked so extensively in Cornwall. The coal-fields of Tyrone contain numerous beds of clay of the same general character as those which occur in the Staffordshire coal districts. The clay of Coal Island appears to be of much value; it differs, however, from the Stourbridge

clay, in containing some peroxide of iron, as the following comparative analyses will show:

	Coal Island.	Stourbridge.
Silica	46.2	46.1
Alumina	30.8	28.8
Peroxide of Iron	8.4	—
Potash	0.4	—
Water	14.2	15.1

Mr. Tighe made a statistical survey of Kilkenny, and he has well described the clay found in that coal-field.

The *Coal-seat*—that is, the underclay of the coal-bed—says Mr. Tighe, has properties which appear worthy of attention; it has been long used at Castlecomer for backs of grates, and is known to stand the fire in a remarkable manner. Mr. W. Davis, an architect who employed this clay largely, states that it will not only answer every purpose for earthenware; but "he hopes, also, that of pots for glass-house purposes, and being convinced of the great utility of the *coal-seat* in the fire, he made trials also of its utility as to external incrustations on walls, where it sets firmly, and he has every reason to think it will answer well;" he found, when properly prepared, that it would answer every purpose of *terras*.

This clay, in its natural state, burned in a strong fire, becomes white, and as hard as many siliceous stones. This *coal-seat*, or clay cannot, therefore, contain any iron, and it is stated, indeed, that analysis proves it to be precisely the same composition as the Stourbridge clay. The clay found near Howth is worked into crucibles by Messrs. Mallett, for various operation of their extensive foundry, and its quality is stated to be such as would render it excellent for delft and stone-ware. Little, if any, use has, however, yet been made of it beyond the crucible manufacture. Mr. Wilkinson, of the Poor Law Commission, made a large collection of the building-stones of Ireland, and made experiments on upwards of six hundred of the number. The details of these experiments have not been published, but in the "Industrial Resources of Ireland," the following general statements of the results are given. These are so important that we are glad to give them extended publicity, by publication in our Journal.

The ordinary limestone of Ireland weighs in average per cubic foot 170 lbs. The average weight of water which is absorbed by immersion was one-fourth of a pound, the greatest absorption was one half-pound of water. The chalk of Antrim weighs 160 lbs. per cubic foot, and absorbs three pounds of water. The improved shaly calp weighs 160 lbs., and absorbs from one to four pounds of water per cubic foot. The average weight of sandstone is 145 lbs. per cubic foot; the extremes are 123 and 170 lbs. The absorption varies from nothing to upwards of ten pounds; the average being five-and-a-half pounds. Grauites average per cubic foot 170 lbs.; its extreme weights were 143 and 176 lbs. The granite of Newry and Kingstown absorbs one-fourth of a pound; that of Carlow from one-and-a-half to two pounds; that of Glenties in Donegal four pounds. Basalt weighs from 171 to 181 lbs. per cubic foot, the average 178 lbs. It absorbs less than one-fourth of a pound of water per cubic foot. Clay roofing-slate weighs 174 to 179 lbs. in average 177; the absorption is less than one-fourth of a pound. The soft clay slates from Bantry absorb about two pounds of water.

In resisting fracture it was found that the slate rocks were the strongest, and of these some were stronger when the pressure is applied on the edges of the cleavage planes than on the faces. The basalts were

* Continued from p. 4.

next in strength; then the limestones; then the granite; and the weakest are the sandstones. Considered in relation to a crushing force, the basalts are found to be the strongest stones; next the limestones, and successively the slates and sandstones. In the different varieties of limestone, some of the larger crystalline stones, and the compact hard calp, are the strongest. The light-coloured crystalline stones of Ardbraccan, and those around Cork are the weakest. The Connemara white marble, or primary limestone, is the strongest that has been found.

Slate rocks of considerable value are found in Wicklow, near Rathdown and Glanmore. These are said, indeed, to be equal to the slates of Bangor in North Wales. The Killaloe slate-quarries are, however, the most extensive in Ireland; and from these, slabs of ten feet square are obtained. About 10,000 tons of manufactured slates per annum are produced from these quarries. The Valentia slates have been already mentioned. These do not answer for roofing-slates; but for flags a large quantity is annually sent to the metropolis. Slabs of Valentia slate are easily obtainable thirty feet long, four or five feet wide, and from six to twelve inches thick. The slates of the other districts are not of sufficient importance to require any particular description.

The Irish marbles have been deservedly well spoken of, and, curiously enough, but very sparingly developed. Throughout the length and breadth of the island, these limestone marbles occur to a greater or a less extent, but it is only in a few localities that we find them at all worked.

Near Galway, and at Kilkenny, the black marble is quarried. From Galway large quantities of this marble are sent annually to London and other parts of the kingdom; and much of it finds its way even to New York. Along the beautiful shores of Lough Corrib there exists an unlimited supply of this valuable ornamental stone. The Kilkenny marble is susceptible of receiving a very fine polish, and is, when cut, perfectly black; but the carbonaceous matter to which it owes its colour is acted on by light and air; and ultimately white marks of fossils, such as are peculiar to the limestones of Derbyshire and other places, make their appearance. Black marble is also found at Doneraile and Churchtown in Kerry, near Dunkerron in Down, and in Tipperary. A variegated marble, exhibiting red, yellow, and brown tints, with some beautiful impressions of fishes, is found at Armagh. Although this marble possesses peculiar beauties, except for small ornaments we believe it is little worked. Near Churchtown, in Cork county, a similar marble to this is found in many varieties, of which yellow and purple veins occur.

The Kileera brown marbles are some of them very elegant. The dove-coloured marbles of Carrigaline and Castle Cary, where are also found ash-coloured and grey varieties, are susceptible of being formed into many articles of internal ornamentation; as are also the black and white, and the purple and white marbles of Churchtown in Cork. One of the most beautiful of the Irish marbles is the variety found in the islands of the river Kenmare, of a purple colour veined with a dark green; much of it appearing to resemble the serpentine rocks of the Lizard. The Kilkenny striped white and red marbles have been much admired. The Galway marbles—or, as it is also called, the Irish Serpentine—and the Connemara marble—which are of a finely variegated light green colour, are very much

esteemed.* The white marbles of these districts are sometimes very pure in tint, although much that has been sent into the market has had a greyish hue. If more extensive workings were instituted, and the blocks were obtained at greater depths than those which are now raised, there is every reason for believing that stones of far greater purity would be obtained. The exportation of these marbles from Clifden is large; but the trade is certainly capable of great extension.

The ornamental stones of Ireland are those which we have grouped under the general name of marbles. Many of the basalts, traps, greenstones, and granites, would, however, if properly worked, be found to be no less pleasing in appearance than the variegated limestones.

There is much difficulty in working many of these igneous rocks, owing to the want of any lines of cleavage or of bedding in them. This is one reason why many varieties of these stones, which are very rich in colour, have not been worked. We have, however, seen some very nice vases made out of the basalts of the Giant's Causeway, and small ornaments of great beauty made from the trap and greenstone rocks. The granites of Ireland are as worthy of attention as any which we are working in this country. From Penryn and the Cheese-wring, in Cornwall; from Dartmoor, in Devonshire; from Aberdeen and Peterhead, in Scotland;—granite is sent, not merely to every part of the United Kingdom, but to the Continent, where the British granites are, for large works, highly valued. We know of no reason to prevent many of the fine granites of Ireland from coming into legitimate competition with those.

Some few attempts have been made at Florentine work in Ireland. Some examples which we have seen have been good examples of the art. In the south of Ireland many fine varieties of the malachites have been found, and those cut have furnished the green stones for the Florentine tables and tazzi alluded to. There would certainly be, under proper management, a large development of industry in these directions.

When we consider that Ireland possesses within the limits of her shores almost every geological formation from granite up to alluvium; when we examine and discover the immense variety of useful and ornamental stones which may be obtained from her rocks; when we reflect that nearly all the metalliferous minerals, the most valuable of iron ores, the most argentiferous lead ore, abundant and rich ores of copper, silver, and gold, are all to be found in considerable quantities, we cannot but regret that so small an amount of industry and intelligence has been expended in the development of her natural treasures.

ROBERT HUNT.

* Fine specimens of this material can be seen on the walls of the entrance-hall to the Museum of Practical Geology in Jernyn Street, which is now opened gratuitously every day except Friday. By the way, many of our readers will doubtless thank us for directing their attention to this Museum, which we believe is not so well known as it deserves to be, as a place of intellectual amusement and instruction. In it are exhibited the building-stones of the United Kingdom; and British marble and other ornamental works are shown in plasters, panels, and pedestals. Among other interesting objects from natural materials, are tessellated pavements, casts from statues, tazzi in granite, alabaster, and Irish serpentine; objects showing the useful application of the sciences of geology and mineralogy; maps exhibiting the geological formations of the earth; and, in short, the Museum is full of what will enlighten and interest the intelligent visitor. At one end of the upper story is the laboratory in which all kinds of experimental investigations and practical analyses are carried on, and at the other end the Mining Record office, in which all the documents connected with the mining interests are deposited.—Ed. A. J.

THE ROYAL PICTURES.

THE TROOPERS.

A. Cuypp, Painter. E. Hucker, Engraver.
Size of the Picture, 1 ft. 5½ in. by 1 ft. 3½ in.

ALBERT CUYPP, one of the great luminaries of the Dutch school, owes the popularity which now attaches to his pictures to the discrimination and judgment of English collectors. To the want of discernment in his own countrymen, or to their negligence of him and his works, must be attributed the fact that so little of his history has come down to us. He was born at Dort, in 1606, and was instructed in painting by his father, Jacob Cuypp, a landscape artist of considerable eminence, and the founder of the school of painting in that town: there is, however, but little similarity between the works of the master and the pupil.

That able critic, Dr. Wagen, referring to Cuypp's only picture in our National Gallery, thus estimates the general character of his works:—"His pictures, like those of so many of the great Dutch landscape-painters, afford a sufficient proof that the charm of a work of art lies far more in a profound and pure feeling for nature, and in the knowledge and mastery use of the means of representation which Art supplies, than in the subject. For otherwise, how could it be possible, from such monotonous natural scenery as Holland presents, where the extensive green levels are broken only by single trees and ordinary houses, and intersected by canals, to produce such attractive variety as their pictures offer? How could it happen that so many pictures, even by eminent masters, such as Jan Both and Pynaer, who represent the rich and varied scenery of Italy, in which the finest forms of mountains and waterfalls, with beautifully wooded plains, in the most agreeable variety, charm the eye, have less power to touch our feelings than the pictures of Cuypp, Ruysdael, and Hobbema? In grandeur of conception and knowledge of aerial perspective, combined with the utmost glare and warmth of the misty or serene atmosphere, Cuypp stands unrivalled, and takes the same place for Dutch scenery as Claude Lorraine for the Italian; so that he might justly be called the Dutch Claude. In impasto, breadth, freedom, and execution, he has, on the other hand, much resemblance to Rembrandt." And again, when speaking of Cuypp's pictures in the collection of Sir Robert Peel, the same authority remarks:—"How happy must this excellent artist have been in the production of such works! yet they seem to have been but little esteemed about fifty years ago; for nothing is known of his life, and his pictures were so low in value, that this fine landscape (an old castle with towers, &c.) was originally purchased in the town of Hoorn, in Holland, for about one shilling English. But his pictures gradually so increased in value, especially through the approbation which they met with in England, that Sir R. Peel paid about 350 guineas for this specimen." We cannot, however, take this case as an instance of the value set upon Cuypp's works by his countrymen: Sir Robert's picture was doubtless bought from some one who thought that the piece of panel on which it was painted would only sell for the price of the wood: hundreds of fine pictures have thus been rescued from the hands of ignorant possessors, who knew not the treasures they held till they had lost them.

The majority of the pictures by this master are, as it may be presumed from the foregoing observations, in our own country: Dr. Wagen mentions and describes about ninety in different collections. Buckingham Palace contains nine; among these is "The Troopers," of which he says:—"The execution is careful, and the effect of the warm evening light masterly." Smith, in his "Catalogue," enumerates more than two hundred and seventy: of this, which stands No. 244 in his work, he says, it is "a charming example of art;" the group consists of two soldiers, *bourgeois*, one of whom has dismounted from a grey horse, and stands at the head of his steed conversing with a peasant; the other soldier, riding a brown horse, waits for his companion, and a third is riding off behind the ridge of ground. The picture is painted on panel.

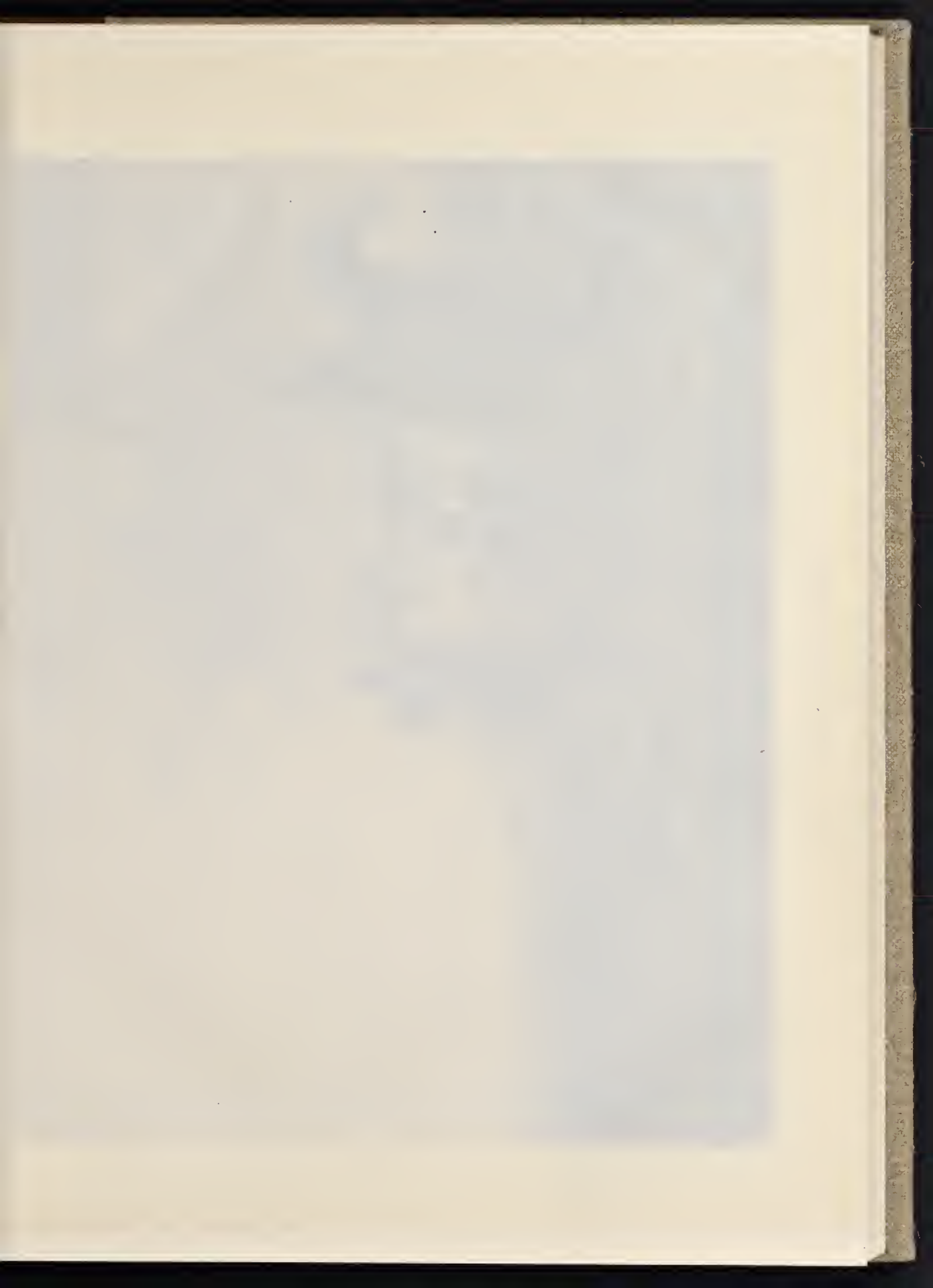

[The text on this page is extremely faint and illegible due to low contrast and blurring. It appears to be a multi-paragraph document.]



THE FARMERS

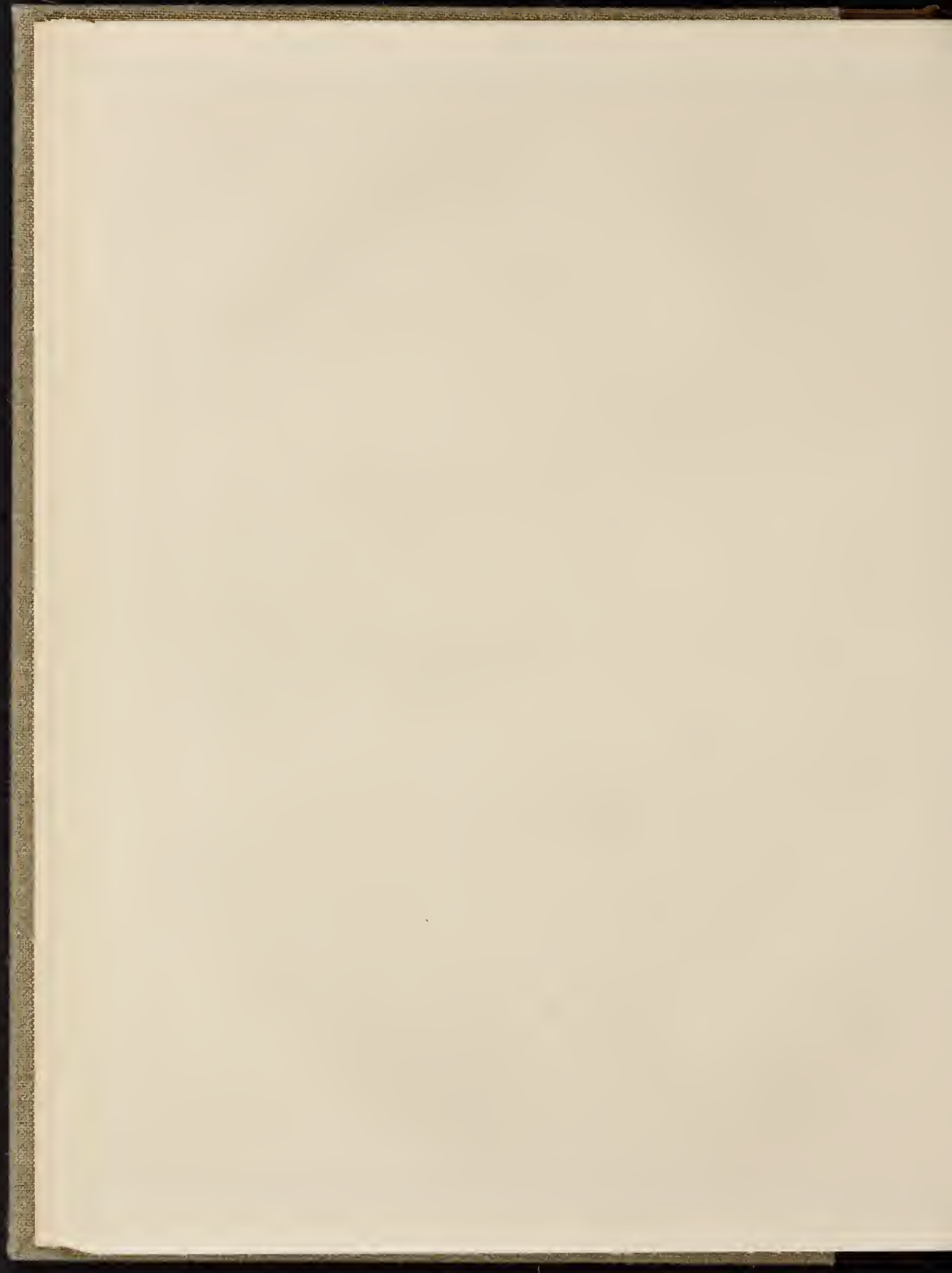

THE ARTISTS AND AMATEURS' CONVERSAZIONE.

The first meeting for the season of the "Artists and Amateurs' Conversazione Society" took place at Willis's Rooms, on the 24th of January; the room was well filled with a large assembly of members and their friends, among whom were a very considerable number of ladies; for this society, unlike its elder brother, "The Graphic," does not close its doors against the entrance of those whose presence graces and dignifies every meeting the object of which is to add to the sum of human happiness, or to ameliorate the condition of our fellow-creatures. A member of the Graphic, with whom we conversed in the room at Willis's, observed that "the ladies had no business here; such meetings as these are for artists to talk together about their Art." "And are there no such beings," was our reply, "as lady-artists, and ladies who can converse upon Art, and write about it, too, learnedly, philosophically, and most agreeably? Do you not know that the Art-literature of this country has not a few of its ablest supporters in our female writers?" and even were it not so, upon what principle would you exclude ladies from such an exposition as is now before us? are they unable to appreciate it? too frivolous to be interested in it? unworthy of holding communion with the intelligent minds that created the works so abundantly scattered on these tables, or placed against these walls?" We paused for a reply, but received none, and left the member of the Graphic to pursue his way through the long levies of tables and portfolio-stands extending the length of the apartment; not solitarily however; for he had brought a lady to the meeting, and thus ignored the principle for which he had contended. It would be well for the Graphic, we presume to say, to be less exclusive in the conduct of its *reunions* than it is: it would seem to have the organ of Secretiveness very largely developed; the doors of the Hatched House are jealously guarded against every intruder, unless introduced by a member, or he is fortunate enough to possess wealth to expend on Art, or to have gained a distinguished name. The fifth law of the Graphic declares;—"That there shall be annually chosen by the Society, and invited to the conversazione, a number not exceeding twenty noblemen and gentlemen, who are known as admirers of the Fine Arts, and encouragers of native talent; and also that there be chosen and invited five gentlemen distinguished in science, and five others eminent in literature; such invitations to be made in the name of the Society for the season, from a list to be proposed by the Committee at the end of each season, and presented to the general meeting for election by show of hands." Surely to this miserably restricted list of thirty noblemen and gentlemen, some ten representatives of the public press might be added, to say nothing of the ladies, without detriment to the interests of the Society. We have long since refrained from noticing the proceedings of this Institution—a fact which is, of course, of little importance to the members—simply because we do not choose to be indebted, to enable us to do so, to the mere courtesy of an individual for introduction to the room. And now, having said our say on this matter, we proceed to notice what the "Artists and Amateurs" had got together for the amusement and instruction of themselves and their friends at their first meeting. The oil-pictures were neither numerous nor of a very good order; the best being one or two studies of female figures, and another, a finished work, by Mr. Frith, R.A., and a large painting, by Mr. Britton Willis, of plough-horses resting, entitled the "Morning Meal;" the animals in this work are very carefully drawn, but the landscape seemed to us deficient in vigour, and the distance wants air. Mr. Willis might give another week's labour to his picture with advantage. The contributions of water-

colour drawings, both framed and in portfolios, by Mr. David Cox, Jun., were extensive and good; like his father, he has a capital eye for colour, and a free style of handling; qualities that tell effectively in his sketches from nature. A portfolio of landscape sketches, by Mr. W. Bennett, who belongs to the "Cox" School, attracted a large crowd during the evening; so also did another by Mr. Soper, who is quietly but surely gaining ground among our landscape-painters: we do not remember ever to have seen before this any of his productions in water-colours; they are vigorously painted, and very truthful. A portfolio contributed by Mr. Dillon, of drawings from the pictures in the Pitti Palace, was much admired; they seemed to be executed in pencil only, or pencil over tints of ink, exquisitely finished, and, as we understood, were made by an Italian artist for the purpose of being engraved. Mr. W. Collingwood Smith, the President of the Society, sent a number of his landscape sketches, very boldly executed, and Mr. J. J. Jenkins a good variety of his figure subjects. From Mr. E. Goodall, was a large supply of Criméan sketches, many of which the public has seen in the columns of the *Illustrated News*. But the contributions of two amateur artists appeared to rivet the attention of the company as much, if not more, than any others: one, by Mr. Roberts, a gentleman resident at Camberwell, of landscapes, English and foreign, wrought out with a fine feeling of the truth of nature, a just conception of what constitutes the really picturesque, and a perfect mastery of his materials; the other, by a lady, Mrs. Robertson Blaine, of views in Syria, Venice, &c., and sketches of figures, slight in execution, yet powerful in effect to a degree, and admirable in colour: so excellent are these drawings, they might have passed as the works of some long-experienced master. The meetings of this Society have opened well, with abundance to interest the visitors during the whole evening.

SUGGESTIONS OF SUBJECT TO THE STUDENT IN ART.*

BY AN OLD TRAVELLER.

CHAPTER III.

The beloved Physician—The House of the High Priest—Who shall paint the Picture?—The Tuscan Masters—Fra Bartolommeo—Il Beato Angelico—The Schools of Umbria—Perugino and his Disciple—Leonardo—Sant' Agnese fuori le mura—Cammeos—The True Servant of his Master—Philippe le Hardi—German Writers and the Artists of Germany—A Picture from Umland—The Invitation—An Interior of Elizabeth's Day—"Monsieur his Physionomie"—The King's Visit—An Impediment—Pictures from Corvantes—A Mexican Inn Yard—The Search—An Arrest—The Rhodian Swallow—Children of the Greek Isles—A worthy Race of Dogges—The Hair of Brankosome—Masters of Homoids in the Olden Time—Gaston-Pluebus—Bernabé Visconti—The Dogges' Tragedy.

THERE is a passage in the writings of the Syrian Evangelist—"the beloved physician"—St. Luke, for whose profoundly touching uses neither Painting nor Sculpture has yet supplied an adequate exponent. Nay, recalling the wido and various import of those words, it may be affirmed that human art could scarcely avail to give them their full effect, whether in marble or on canvas: but honoured should be the artist, and proud the land of his birth, who should come but near to that heart-moving picture which the mind at least has power to call before it, when we read or listen reverently to the words in question. They are these:—

"And the Lord turned and looked upon Peter, and Peter remembered the words of the Lord." †

The extent to which the hall in "the high priest's house," with the various figures known to have been present, and other accessories, shall be brought into the picture, must depend

on the individual feeling of the artist; the moment which, in the writer's mind, has ever absorbed the whole interest, is that of the utterance of those words—never to be repeated but with the lowliest reverence—"And the Lord turned and looked upon Peter, and Peter remembered." Alas, for the agony of that remembrance! a pang deepened by the divine goodness of the pardon, beaming its gentle assurance from the sacred features of the Master, even while his unhappy follower stood self-condemned, as he lifted his tearful eyes to their light. No; we can never hope to have all this set before us but the eyes of the mind and heart; nor for these, save in their best and purest moments: I despair of any worthy result, now or ever.

Do you differ from me? You, young, trusting, faithful; who feel that Art is a religion, and that none is worthy to serve at her altars who has not faith in the supremacy of her power. Be it so; and thrice welcome is your conviction, for who shall set limits to what such trust may accomplish?

You believe then that there are artists in the world—no matter to what country they may belong—so richly endowed that even for this high and holy task, this labour of pure love, they may find heart, and hand, and hand, that shall prove sufficient? But read again, and you will feel that to assert so much would be to declare that all the noblest qualities demanded by Art in her most exalted phase, may be found combined in the person of one artist—for he who is to succeed must possess them all.

Have you ever seen a head of the Saviour that did not fail to give you entire satisfaction? We might even use less genteel terms, and say, that did not disappoint and chill you? It has at least not often been the writer's good fortune to escape these results, when standing, after long-cherished wishes, and with high-raised expectations, before a work wherein the delineation of the sacred form and features have been attempted, whether in painting or sculpture; yet, in speaking of the latter as well as the former, there is present to my recollection more than one work of great celebrity, and by renowned hands.

From the narrow and æsthetic schools of Spain you will not hope much; but there are certain among the Tuscan masters who cannot fail to present themselves to your memory in reference to this subject. Fra Bartolommeo will stand prominent, yet not first, in the group, and there are works of his in Florence and at Lucca,* that might almost justify your thought; but pass through the Pitti Palace, where some of his finest paintings are to be found, and, admirable as most of his pictures are, it does not appear to me that even the "Christ after his Ascension," highly meritorious though it be in very many respects, could wholly satisfy you of his sufficiency for our present purpose.

Of Il Beato Angelico, it may be affirmed that beyond any other master he was worthy to undertake this sacred task; and if pure holiness of purpose, a seraphic devotion, the most lowly reverence, the utmost tenderness, could ensure success, for this—which being eminently a labour of love, and work of the heart, would require all those qualities—in Fra Angelico da Fiesole they were all to be found, and he must have succeeded. Then, you examine his works in Perugia, or you visit the chapel of Pope Nicholas, in the Vatican, † or the Gallery of the Academy in Florence, ‡ or you linger long before the frescoes of Orvieto, § and from each of these places you bring recollections of grace and beauty, holiness and sweetness of expression, which

* Among others, the "Madonna della Misericordia," in the church of San Romano, with another Madonna, having St. Stephen and St. John beside her, in a chapel of San Martino, a church of the same city.

† Where there are ten fresco-paintings, from the lives of St. Lawrence and Stephen, many of them unhappily much injured by restoration.

‡ Scenes from the life of Christ, formerly in the Sanctissima Annunziata, the convent of the Servites, in Florence. A "Deposition from the Cross," with figures in pyramidal compartments, attributed to Il Beato (Don Lorenzini), and many other works by Aureliano, are to be found in the Gallery of the Florentine Academy.

§ The subject of these works is "The Last Judgment"; they are in the chapel of the Madonna of San Brizio. In the Vatican Palace, in Rome, there is also a "Last Judgment" by this painter, with whom the subject was a favourite one.

* We need only mention Mrs. Forster, who so admirably edited "Vassar;" Mrs. Jameson, Mrs. Merrifield, the late Lady Callcott, Lady Jervis, "Florientia," Mrs. Bray, the biographer of St. Bernard.

* Continued from p. 40.

† Gospel of St. Luke, twenty-second chapter, sixty-first verse.

force you to shrine this master in your heart of hearts; inasmuch that when these qualities are in question it is to him that your memory first, nay, almost exclusively recurs: but have you the force and grandeur that you also want? Have you the sublime repose you seek, the dignity and divinity of pardon, the superhuman perfection of all holy attributes that you must equally require? I fear you have not; and wanting these, it is not from Angelico, warmly admired and deeply beloved though he be, that we may hope to obtain the work we look for.

But the prince of painters,—but he of whom it has been truly said, that in him "beauty of form is the expression of elevation of mind, of utmost purity of soul"—even Raphael; surely, you will perhaps say, "from his hand we might have hoped whatever the most devoted disciple of our Lord could either imagine or desire."

To this I will but reply, that if, for the greater glory of Art and the happiness of his contemporaries, Raphael had been permitted to delight and benefit his kind some ten years longer, he might, without doubt, have achieved whatever human power could or can accomplish towards the object we meditate.

You do not name Il Perugino—you omit all mention of him whose light, deservedly brilliant, was yet much dimmed, if not eclipsed by that of his greater disciple, as we find remarked by more than one writer. But if you examine his works, at a period when he was as yet untouched by those injurious influences which did undoubtedly ruin the efficiency of this painter, you will admit that he has not always received full justice; and if not meet for the work we think of, he is at least well entitled to take rank among the first of the Umbrian masters. We have not space for the citation of particular instances among his numerous—too numerous—works, in proof of this assertion, but without going beyond the walls of the Florentine Academy, you will find enough to convince you that the obligations of Raphael to his early master have been frequently underrated.

Loud and long have been the plaudits that have ever followed the name of Leonardo da Vinci, yet has he never had all the praise due to his deserts—has not and cannot have; for if the life of the most enduring patriarch had been doubled in his instance, he could have filled it all with glory. What then was there wanting to Leonardo? He wanted leisure; and that notwithstanding his length of days. Courts and Kings came between him and his genius; and here I do not allude to the universality of his powers and attainments, a quality in which he was never approached, I am content to abide by what he was, as relates to the formative Arts only, and I say that, when left to his own inspirations none could surpass him. To name but one proof, out of many that may be given—for our space has long been overleaped—go to Milan, and in the Gallery of the Brera you shall find a work which, although but a sketch, may serve appropriately to illustrate our present position, since it is a head of Christ, believed to be a study for that now ruined treasure, Leonardo's "Last Supper." Beautiful things by the same master are also to be found in the collection attached to the Ambrosian Library, in the above-named city; but for the moment they must all be left unspecified.

There is a small but in marble, standing on a lonely altar in the subterranean church of Sant' Agnese, beyond the walls of Rome, and popularly attributed, but without sufficient authority, to Michael Angelo. It does not remind you of the great Florentine, and there is much to desire in the work, but the expression has a beauty of holiness too often sought in vain.

"I am ending the course of my life; the world knows, and will one day bear witness to the truth, that I have dearly loved my country; I have returned, not only to die in her bosom, but to die with her."

Such are the words of Camoens, uttered at the close of his varied life. It is still of Portugal

* See Knigler's "Handbook of Painting," with the valuable notes of Sir Charles Eastlake, Part II., p. 326.

he thinks, not of himself: heart-broken for the ruin he saw clearly to be impending over his native land, the patriot-poet forgot, if he did not disdain to mourn over, his own sorrowful condition. Let us see how his country repaid him.

Through one of the most frequented streets of Lisbon a hazy population is pouring its noontide stream: priest and soldier, peer and peasant; the high-born dame and the dark-eyed maiden of lowly birth, her loveliness and sweet goodness her sole dower; the crutch-borne grandsire, bent with age, and the dancing child caring for none of these things; you have here whatever a great city has to offer; but the interest of the whole is concentrated—for you—on the head of an aged beggar, whose whitened beard descends from a face of beautiful expressions, although he may not boast the features of the proud Caucasian races.

For this is the Javanese servant of Luis de Camões: of Camoens, "at once the Homer, and the Virgil of Portugal." He is begging for the morsel that is to sustain the life of his master during the few short days yet to intervene, before the most illustrious bard of Lusitania shall die miserably on the flock bed of the public hospital. Too scanty, alas, is the pittance accorded; and the brave soldier, the enlightened patriot, the inspired poet—for Camoens was all these—sinks untimely, despite the faithful cares of his follower. Do not let the devotion of that true servant to his master be forgotten. Time—the all-restoring, no less than the all-destroying—has offered to the Poet such reparation as Fame may give—the follower yet awaits his guerlon; let the hand of the artist weave the chaplet for his brow, and be certain that it shall not be placed on an unworthy head.

Two causes are assigned for the epithet "Le Hardi," bestowed on Philippe, son of John of France, the incidents are not in either case ill-suited to the purposes of the painter, and you shall have them both.

At the Battle of Poitiers, the Dauphin and his two brothers, the Dukes of Anjou and Berry, were prevailed on to leave the field, even while the conflict was still raging; thus they may be said to have abandoned their father, who was hotly engaged in the midst of the strife; but Philippe, the youngest brother, then but sixteen years old, refused to accompany them, and kept close to his father's side: severely wounded, he yet fought on, and was taken prisoner with the King—a result which at that period, and with his feelings, the young prince must have detested more than wounds or death.

For his brave defence of his father on this occasion it was that, according to some writers, he received the name of Philippe le Hardi; others declare the following incident to have given rise to the appellation.

While at the English Court, Philippe was in the habit of attending, with other young nobles, and as was the custom of the time—on the two kings as they sat together at table, when he remarked that one of his companions, an Englishman, and subject of Edward, presented the viands to his own Sovereign before offering them to the King of France. "Thereupon," as an old writer on the subject hath it, "this prince up with his fist and dealt that youth a wherret on the ear, saying—'How now! hast thou dared to serve the King of England while the Monarch of France sits at the board?'"

The affronted noble drew his dagger, and raised his hand to avenge the blow, but King Edward, hastily extending an arm, drew the French prince within his clasp, and commanded the justly-enraged assailant to forbear. Then, turning to John, who was an anxious spectator of the scene, he exclaimed, with a friendly smile; "We must call this boy Philippe le Hardi; we may be sure that he will know how to justify the title."

Now, the battle or the huff? one or both. There is no lack of interest in either picture, nor any danger, methinks, that you should suffer the salient points of either action to escape you.

The artists of Germany do not let the words of its writers fly unheeded to the ground; least of all could Göthe complain of inattention on their part to such oracles as it pleased him to propound.

Here is half a line, written from Volletri, in a letter, dated 22nd February, 1787, in which the author simply uttereth the following. He is speaking of Prince Chigi's seat at Aricia, and he says:—

"Es gäbe das grösste Bild, wenn es ein rechter Künstler unternähme." "This would furnish the finest of pictures, if a true artist would undertake it."

On this hint it is that Oswald Offenbach, an exhibitor in the German Exhibition held in London last year, has spoken; his landscape—seen by the present writer at Vienna in 1852, but mentioned principally in illustration of the remark made above—is an Italian scene of well-known features, and will rise before you without further description. We will presently show that our own oracles yield responses by no means less significant than those of the great German; nor will we be negligent in the consultation thereof, when the propitious moment shall arrive: but for the present occasion, we too will seek our picture among those painted by the pens of our Teutonic cousins.

And in Ulband we find one, still a landscape, but appealing to a wider range of sympathies than that so faintly intimated above; if not for itself, yet certainly for its figures, and for the universal interest of that feeling which animates the speaker, and is as clearly shared by the listener of the group. It is in "Die Einladung"—"the Invitation," that we find it, the words are these:—

"Ich hab' ein kleines Hütchen nur,
Es steht an einem Wiesenhügel,
Bei einem Bach, der Bach ist klein,
Könnt aber wohl nicht heller seyn."

The following may be accepted as a translation sufficiently close to give the features of the scene, with the relation borne by the actors to each other; a cordial and pleasant one, as ye shall see in a summer day's journey:—

"Mine, dear one, is a poor cot only,
'Tis in a vale, flower-gum'd and lonely,
There's a glad streamlet dancing near,
A rude wild thing, but crystal clear."

Then follow two stanzas concerning a tree and a nightingale; but these, if you be so minded, we can "prätermit." The conclusion is as follows:—

"Du kleine, mit dem blonden Haar,
Die längst schon, meine Freude war,
Ich gehe; ranhe Winde wehn,
Willst du mit mir ins Hütchen gehn?"

"Sweetest! with locks of golden aloe,
Thou who hast long my sole joy been,
Lo! I depart. The chill winds blow,
Wilt with me to my poor cot go?"

And she will go. The earnest-looking supplicant is not doomed to refusal. He may say with the Muscovite lover—

"'Tis not to day that first we tell
How long our hearts have loved—how well."

And the maiden? She is no mere "yellow-haired lassie"—the sweet girl! the "golden sheen" is on locks of a soft clear lovely brown; but they have it, and to perfection, that sheen. Do not believe the lover's partial eyes are seeing what exists only for them; look for yourself;—that is a veritable golden glow on those rich brown tresses; but, much better than this, she lifts trustingly towards the face of the speaker a pair of the most heart-warming eyes—deep dark blue, with a tinge of the violet, and a tempering fringe for their lashes: these give comfortable assurance that the hope of her frank-looking manly suitor will not be rendered vain, now or hereafter. What a firm, yet elastic, steep, too, is that with which she draws yet nearer to her lover's side: the figure is worthy of the face, which gives a thousand pleasant promises in its somewhat serious, yet sweet and cheerful aspect. Nor is the winner of this prize unworthy of his

* Bobrov, from the "Russian Anthology" of Sir John Bowring.

fortune: you see well that he is the proper counterpart of that fair girl: wherefore, let us give them our benison, and leave them to their happiness.

Meanwhile we may bestow a glance on the place of their abode: and you see that in addition to the "Vale"—charmingly framed in by fine heights, where the stream does not close its bounds—there is a delicious "distance,"—and across a glade of this, you may perceive a doe with her fawn, passing slowly. It is then veritably a "lonely" dwelling, that you can but just discern, partially appearing beneath the grand old oaks;—so much the better: and blessed be their lot therein, the winsome pair.

Highly worthy of the painter's attention, and not infrequently chosen by our artists for the varied effects they present, are the rich and quaint Interiors of Elizabeth's time; and here is one of the Palazzo of Theobalds, which combines almost every attribute, whether of form or decoration, whereby these gorgeous rooms attract to themselves so large a share of the artist's regard.

A chamber of ample space it is, and exhibits due harmony of proportion: the prevailing tints are deep and warm; and, for the moment, the place is tenanted by a flitting bevy of fair damsels, eagerly clustering about a table whereon are placed rare caskets of Italian workmanship. One of these stands open and displays the jewels, brought, without doubt, by the dark-looking figure, in southern garb, who is evidently "waiting her Highness' pleasure."

Elizabeth herself, no longer young, is seen walking slowly along the terrace, which is visible from the open windows of the room. She has been interrupted in her examination of the "gauds" by some less agreeable occupation; her head is bent thoughtfully; and she seems to be listening, in some displeasure, to the ancient noble, whose spot follows her own at the distance of less than half a pace: he is, in fact, all but walking beside her.

This group offers a notable contrast to that gathered around the stranger,—a Venetian merchant, perchance, admitted to this high presence in consideration of the rarity and great value of the productions enriching his caskets. Towards one of these, still closed, a fair and curious finger is pointed, as if the owner would entreat that its contents might be given to her view; but the matronly dame, who is extending her protecting hand over the lid, while she turns a warning glance on the stately figure without, seems to recommend discretion, until their royal mistress shall return to set the treasure free.

In the right hand of the merchant is a jewel which fixes general attention, and if not that very "littel fount of gold, with a froggo thereon and therein Mounsier his phisomye,"—the said "phisomye" believed to be a portrait of the Duke D'Alençon, afterwards Duke of Anjou, and one of Elizabeth's most nearly successful suitors—it is yet manifestly worthy of all consideration, in the eyes of the group by which its fortunate exhibitor is surrounded. The left hand of this personage holds a "pomander-box" not unlike to that "cunning flasket of amber, with a foote of golde and on the top thereof a heare, with his ragged staffe"—the device, as our readers will remember, of the Earl of Leicester—which was also among the possessions of Elizabeth in that day when her "three thousand gownes" had all to be resigned for the narrow garments of the tomb.

Fallen from the open casket and lying on the table is "A cawle of gold, with nine true-loves of pearl and seveu buttons of fine gold, with, in each button, a ruby," and beside this desirable decoration lie certain "nutte-crackers" also of gold, having "diamond sparkes to garnish the heade and pointes thereof." Other and equally delectable contrivances there are, "happy woman be her dole," who is privileged to behold, what then to call herself mistress of such!

But some topic scarcely less absorbing is surely in discussion by that youth, half-concealed in the shadows of a distant window, or he could scarcely have induced the bright girl who

listens, to abandon the dear occupation of her companions. She glances towards the terrace, where paces the grim Majesty of England, but Elizabeth is happily intent on other cares, and so the colloquy holding in that deep recess may proceed to its obvious results. Numerous accessories brighten the interest of the picture, as Imagination presents it brightly to the view, but these will vary to infinitude, as the taste and character of him who paints shall vary: wherefore we need not further indicate such as "our own poor fancy" furnishes.

Continuing to stay at home at ease—let us nevertheless vary our ground to some extent, and see whether the romantic annals of the motherland may not furnish us with a subject that shall enable some aspirant to a name in the future to show us how fire should be exhibited on canvas. There is a well-authenticated fact, closely germane to the matter, among the not always praiseworthy *Gestes* of Henry VIII., and as it does not appear in the general history of the period—although conspicuous in its local records, the story is believed to have escaped the notice of our painters.

Among the rich possessions of that lovely Joan Plantagenet, whose poetical appellation the "Fair Maid of Kent," will perhaps be best known to our artist-readers, was the manor-house of her maternal ancestor, Baldwin de Wake, which, having been strongly fortified by Thomas de Wake in the early part of the fourteenth century, was thenceforth known as Baynard Castle.

It was perhaps about the third decade of the sixteenth century, and when the dangerous vices of our eighth Henry's later life had rendered his nobles cautious of their monarch's approach to the sanctuary of their homes, that the then Lord of Baynard Castle—still a De Wake—had taken to himself a beautiful bride, with whom he there lived in close retirement. Rumours of the lady's loveliness had not failed to reach the court, and Henry, visiting his northern cities, resolved to judge for himself as to the justice of the praise bestowed on it,—thus he despatched a messenger to his great feudatory, giving the latter to know that on the day following the one which saw the missive reach him, he might expect the honour of a visit from his sovereign.

But De Wake knew the character of the perilous guest proposed to him; therefore it was that he avoided the court, and he was firmly resolved that no breath of suspicion, such as might well be apprehended from the menaced visit, should pass over the fair fame of his wife.—Yet how decline the proffered distinction? He could invent no pretext, discover no means for doing so—the moments were passing rapidly, an early hour of the following morning had been named for the King's arrival, yet night fell and eleven o'clock—an unusually late period for vigil at that time—found De Wake with the King's letter still in his hand, while he remained wholly undetermined as to the mode whereby he might escape from the danger, which he had nevertheless resolved not to incur.

His fair wife,—to whom he had confessed his apprehension of the King's arrival, but without offending her ear with any intimation of its cause—had long stood beside him, now suggesting some plan—rejected as soon as proposed, then again devising some other method, which had no better fate, and anon doing her best to reconcile her husband to an infliction that seemed inevitable.

"His presence will not disturb us long,"—she urged, when, all her simple wiles declared to be impracticable—she became convinced that the visit must be endured, since better might not be.—"He will not be with thee more than the second day at most, my husband," she softly said, "then we may return to the quietude thou lovest so well, and will forget that ever he came."

But this did not avail to diminish the gloom that had settled on the brow of De Wake, and hopeless of an issue from the dilemma into which they had fallen, the young bride laid her head mournfully on the shoulder of her husband, and hurrying her small hand lovingly amidst the

waving locks on his forehead, she exclaimed, "Now I would that we were but as our good Robert the Forester, and had no kind of dwelling that could lodge this evil king!"

Her words were an inspiration! "Thou hast said it, sweetheart," returned her awakened lord, and rising hastily from his attitude of despondency he aroused his seneschal, an old and trusted servant of his house, commanding him at once to summon that Robert the Forester, to whose lowly abode the lady had so opportunely referred. For a moment she remained in blank astonishment, unable to divine the manner wherein her lamentation over their inconvenient greatness could avail to deliver them from their strait, but the directions given to his seneschal by her husband, soon made her sensible to all the value of her words, and after a few hours spent in the needful preparation, she was led forth by De Wake to a bold elevation at a safe distance from the home whose splendour she had bewailed, and which they presently beheld blazing at all points.

Morning found the high-horn pair without any dwelling wherein they could lodge yon "evil king;" they were reduced to accept shelter from Robert the Forester, and as his hut could not suffice beyond the first moments of necessity, De Wake was constrained to hear his wife to a distant abode, having duly notified to that approaching sovereign that untoward mishap whereby the honour of a royal visit had been for that time lost to his house.*

There is more than one point of time in this narrative, sure to recommend itself to the pencil of the painter. Even to the duller and less imaginative eyes of the writer many pictures arise, as he reproduces the old story, and to the choice of the artist we leave them. Three daughters inherited the beauties and excellencies of this fairest lady—whose maturer life proved her to be wise and good as well as lovely—but she had no son, and each of the three carried a portion of her broad lands into a noble family whose name still remains to such portions in attestation of the fact. The Duke of Richmond, the Earl of Westmoreland, and the Lord of Powis, were the bridegrooms of those maidens respectively, and the lauds received by these nobles with their brides, continue to be called Cottingham Powis, Cottingham Westmoreland, and Cottingham Richmond, accordingly.

Among the shorter stories of Cervantes, less known than his *Don Quixote* and not so much admired, but works of considerable merit nevertheless, is a tale of a gypsy-girl, which having been translated into English, is in the hands of most readers. Within its few pages are many pictures, and here is one that has at least the advantage of animation.

The scene is in the *patio* or court-yard of the Murcia *venta*, or inn, where Juana, the daughter of the *ventero*, or landlord, having fallen in love with the nobly-born *Novio*, or betrothed, of the heroine *Preciosa* (who lives disguised among the gypsies, to be near his promised wife)—is avenging herself for his refusal to accept her own hand, by accusing him of theft, and demands to have the baggage animals of the gypsy-tribe, all loaded for departure and surrounded by their owners equally prepared for travel, unpacked and examined in search of her lost property.

Now Juana had concealed certain of her jewels among the packages of Don Juan, the disguised lover, but, unsuspecting of her treachery, he rebuts the charge with unembarrassed mien. The delicate face of *Preciosa*, calm in her assurance of her lover's integrity, presents a striking contrast to that of the hold Juana, and even to those of her companions, who are of gypsy-race, while she, as the story has already told us, is, like her lover, highly-horn. The old woman who has stolen her, and who stands near, is in consultation with men of the

* The reader will be hereby reminded of a similar sacrifice made at a later period by the then chief of the noble house of Campden, but under circumstances of different character. Lord Campden destroyed his Gloucestershire manor-house, to prevent the troops of the Parliament from availing themselves of its shelter.

tribe, varying in age, but all presenting the picturesque forms and handsome features of their race.

The officers of justice, summoned by Juana, are entering the court, and the *mozo de la cuadra** is contending with a gypsy woman from whose ass he is removing its burthen.

At a later moment in the same incident, there is a second picture of a totally different character, although with the same actors. Don Juan, having received a blow from a soldier, and forgetting all but the dictates of a suddenly awakened rage, has torn the sword of the offender from its scabbard and laid him dead on the spot with his own weapon. "Then do cries for vengeance become frantic yells," exclaims the Spanish author; "then do the kinsmen of the dead fall on the disgraced cavalier: Preciosa sinks down fainting, Don Juan, hastening to assist his betrothed, neglects to provide for his own defence and is seized before he can approach her, while the old hag of a pretended grandmother wrings her brown hands, and the wicked Juana—cause of all the mischief—smiles with the joy of a demon over the ruin she has made."

In all this there is evidently much life and movement; the first of these pictures is perhaps the most attractive, but the second may be preferred by some of our young readers, to whom we leave the choice without further comment.

A custom recorded by that most voracious of readers, and strangely various writer, Athenæus, of Naucratis,† as prevailing in his time, and which probably continues to prevail even to our own day, in the more unfrequented of the Greek isles, must needs present many circumstances well calculated to afford matter for the study of the painter.

When the Swallow returns with the return of spring, bright troops of Rhodian children, securing tenderly the first they can obtain, bear the bird with jubilant songs and dances from dwelling to dwelling. They are crowned with flowers, and rejoicing beneath the blue sunny heavens of their delicious clime, they sing the following strain:—

"He comes, the bird whose wing shall bear
To its soft hours and seasons fair,
The Swallow hither comes to rest
His sable wings and snowy breast.

Then from thy flowing wealth bestow
Rich fagons of the rosy wine,
And whetted cakes of flour most fine.
The ripe fig-cheese within our baskets stow,
And let the Swallow guest partake
The dainties of thine omelet cake.

Now shall we empty-handed go,
Or will you give? Say, 'Yes' or 'No.'
If 'No,' then see you guard your door,
We'll take it, posts and all,—nay, more,
Your dainty wife—'tis mere child's play,
So light she is—we'll bear away.

Give, then, and give with liberal hand,
The Swallow asks, your doors unfold,
No grey beards we, faint, feeble, old,
But Rhodian boys that on thy threshold stand."

The pictures presented by these verses require no further description, they "sautent aux yeux," as our neighbours say, and very pleasant encountering too.

The love of Sir Walter Scott for every "worthie race of dogges," as quaint Gervase Markham hath it, is well-known; and from his honoured hand we have here, what is called by a competent judge, "the best poetical description yet written of one species in action." That

* *Mozo de la Cudra*, hostler or stable-boy.

† He is said, by a German writer, to quote more than fifteen hundred *loci* works, and to cite the names of seven hundred authors, many of whom would have remained unknown but for Athenæus.

‡ This translation is by the Rev. J. Milford, and will be found in the pleasant "Favourite Hounds" of Jesse, p. 295. It is supposed by the present writer—who is acquainted with the original by extract and translation only—to be taken, as are other passages in the same volume, from the "Arenæteses" of Athenæus; that being the only work of the author—a few fragments excepted—that has been preserved to our times.

species is perhaps not the most amiable or most interesting of its kind, but it is at least among the most sagacious. In any case the words of Sir Walter present you with an excellent picture. They describe the heir of Branksome when lost in the forest, and do their "spiriting" so effectively that not another word needs to be added.

"He journey'd on,
And deeper in the wood is gone,
For aye the more he sought his way,
The farther still he went astray,
Until he heard the mountains round
Ring to the baying of a hound.
And hark, and hark, the deep-mouth'd bark,
Comes nigher still and nigher,
Bursts on the path a dark blood-hound,
His tawny muzzle track'd the ground,
And his red eye shot fire.
Soon as the wilder'd child saw he,
He flew at him right furiously.

I wene you would have seen with joy,
The bearing of that gallant boy,
When, worthy of his noble sire,
His wet cheek glow'd with fear and ire;
He faced the blood-hound manfully,
And held his little bat on high;
So fierce he struck, the dog, afraid,
At cautious distance heavily bay'd,
But still in act to spring:
When a shaft an archer through the glade,
And when he saw the bound was stay'd,
He drew his tawny bow-string,
But a rough voice cried, 'Shoot not, hoy!
Ho! shoot not, Edward! 'tis a boy!'

Here follows a prose description of this dog (the blood-hound) by an excellent authority of the day:—

"A true blood-hound—and the pure breed is rare—stands about eight-and-twenty inches in height; he is muscular, compact, and strong; the forehead is broad and the face narrow towards the muzzle; the nostrils are wide and well-developed; the ears are large, pendulous, and broad at the base; the aspect is serene and sagacious; the tail is long, with an upward curve when in pursuit, at which time the bound opens with a voice deep and sonorous, that may be heard down the wind for a very long distance.

"The colour of the pure breed is almost invariably a reddish brown, darkening gradually towards the upper part till it becomes mixed with black on the back; the lower parts, limbs, and tail being of a lighter shade, and the muzzle tawny." Pennant adds—"This dog has a black spot over each eye;" but those in the possession of Mr. Astle, known to be of pure blood, have not these marks.

Speaking of hounds in general, Gervase Markham says—"They runne surely, and with great boldness, *loving the Stagge* more than any other beast, but they make no account of hares."

Now herein these estimable animals differ widely from those fairy beagles about whom so disastrous a tale is told, for these did so *love* the hare, according to Markham's definition of loving—namely, worrying to the death—that they were never known to return from the chase without baying "stuck to and worried her at the last," even though they "could never get near enough to press her very closely in the early part of the run."

What marvel then, since such was their beautiful persistence, that their happy and yet most unhappy owner should die of despair when—But we are beginning our tragedy at its close, and must recommence, to proceed "in the forms."

These exquisite little Beagles, (so delicately diminutive that the whole symmetrical twenty-two of them were taken to the field in a pair of paniers on a horse's back) were one night locked safely in their kennel, with all the care due to their perfections; but lo you, now! what chances! on the following morning was it not found that some thief, or rather, some body of conspirators, had forced the door, and that the whole "cry of beagles" had been carried bodily thence? Alas! they had! and since this is but too true, can it surprise us that the disconsolate owner should break his heart? or if he did not actually effect so much, one is almost inclined to say he ought to have done so, and the rather as a more appropriate manner for the dying—I beg his pardon, the "going to earth" of a master of hounds, "well-bred," could scarcely be imagined.

Talking of masters of hounds would remind one, if his history were not in other respects so

melancholy as almost to darken one's recollections even of Dame Julian's joyous science,—of that brave, wicked, handsome, horrible Gaston-Phebus, Count de Foix, whom one knows not whether most to admire and pity, or most to shudder at and abhor, but whose kennels (to keep to our muttons) held no less than 1600 dogs, "worthie" or not, as the case may be, and who made the wilds of his beautiful territories amidst the glorious Pyrenees daily echo with their music.

Hear this, ye Lambtons, Wardes, Beaumonts, and Assheton Smiths, past, present, or to come: ye of our own merry hunting-grounds; hear it and hide your diminished heads, whenever numbers rather than quality may chance to be the question!

Yet is even this great "M. H." fairly eclipsed by one of the Visconti, whose dogs amounted to full 5000, and who loved them so much better than his peasants—whose lives were chained to the care of the animals, those last being drafted into different villages, since Visconti had not kennels for their lodgment—that if he found one too lean, he would cut off the keeper's ears, and if another proved too fat, the delinquent's members were equally forced to pay for the mistake: the dismal remembrance whereof shall make this suffice for the subject, which is else one that we might be willing still to dilate on together; for I hold that he will prove but a cold kind of artist who doth not love "a wortible race of Dogges."

OBITUARY.

MR. WILLIAM RADCLIFFE.

Mr. Radcliffe, an engraver of considerable practice and distinction, long settled at Birmingham, died there, on the 29th of December last, in his seventy-third year. We have, on more than one occasion, availed ourselves of the talents of Mr. Radcliffe, on the engravings which have appeared in the *Art-Journal*. He executed for us "Rest in the Desert," after the picture by W. Muller, in the volume for 1847; and "Crossing the Sands," after Collins, R.A., in the volume for 1848. We abridge from a local paper, the *Midland Counties Herald*, the following account of his career.

Mr. Radcliffe was a native of this town, and resided in it for more than seventy years. Devoting himself to Art as his profession, he zealously applied himself to line engraving, giving at an early period of his career unmistakable proofs of proficiency by an ably-executed plate of the late Rev. Dr. Almer, after a portrait painted by the late Mr. H. Barber. Another portrait of Lord Nelson, published about the year 1805, was also conducive to his reputation. Afterwards he contributed largely to the gratification of the popular taste for light literature, pictorial illustration, and sumptuous binding, by furnishing a number of the plates by which the annuals, in their best days, gained their popularity. He engraved various pictures by Turner, Reinagle, and other painters, but the "Graphic Illustrations of Warwickshire," issued in 1829, was undoubtedly his *chef-d'œuvre*. This charming volume, which still maintains the reputation of being a standard book, was enriched by thirty-two line engravings, from drawings by David Cox, De Wint, J. D. Harding, J. V. Barber, Westall, Hutchinson, and others. These engravings were all executed by Mr. Radcliffe himself, and have probably never been surpassed, or even equalled, as book plates. Roscoe's "Wanderings in North and South Wales" owes much of its attractions to the productions of Mr. Radcliffe's hand. In 1814 he was associated with Mr. Barber and Mr. Samuel Lines, in establishing the first School of Art, opened in Birmingham. The institution was dissolved in 1821, and in the same year the Society of Arts, in New Street, was founded. With this institution Mr. Radcliffe was associated from the commencement. When the disruption between the artists and the society took place, in 1842, Mr. Radcliffe followed the fortunes of his professional brethren, assisted in forming the present Society of Artists, and continued to discharge the duties of an active member until he was seized with the affliction which terminated in death. Many engravers of established fame were trained in their Art by Mr. Radcliffe, amongst them being Mr. J. T. Willmore, A.R.A.

* To be continued.

BRITISH ARTISTS:
THEIR STYLE AND CHARACTER.

WITH ENGRAVED ILLUSTRATIONS.

No. XIII.—CHARLES ROBERT LESLIE, R.A.



AMERICA claims Mr. Leslie as one of her own offspring, and here, in Art-circles, it was very generally believed that he was born on the other side of the Atlantic, till the appearance of a letter in the *Art-Journal* of January, 1843, set the matter at rest. This letter was from a fellow-student with Mr. Leslie; it ran thus:—"Leslie has no more title to be called an American than you or I: he was born in the parish of Clerkenwell, and was taken early to America by his parents, not so early, however, as to prevent his having a perfect recollection of the voyage out, of which I

have heard him relate many particulars. He was afterwards apprenticed to a book-seller in New York (Philadelphia), during which time it was his delight to open the parcels that came out from England for the sake of the beautiful engravings with which the books were at that time decorated. Stodard, Sniro, Cook, and Uwings were the artists who first inspired Leslie with that love of painting which has been matured by study into excellence. No sooner had

he emancipated himself from his shop apprenticeship, than he returned, yet a youth, to his native country, and entered as a student at the Royal Academy, where he soon distinguished himself," &c. &c. These facts are in all essential particulars borne out in a biographical work* very recently published; we there read that Mr. Leslie, "painter and author, was born in London,—not, as often stated, in America, but — of American parents, in the year 1794. In 1799 his father quitted England, and settled in Philadelphia, where the painter was educated. In 1811, the latter returned to England to study the Art. His first instructors in England were both American-born artists; the venerable President, West—who in all ways showed himself a kind friend to the youth—and Washington Allston, a painter of very refined taste, better and more justly known on the other side of the Atlantic than on this." We believe there is an error in this statement; that Mr. Leslie's parents were not American but English; they migrated to the United States, where the talents of the youth attracted the notice of some gentlemen, who advised his return to this country, and gave him letters of introduction to Messrs. Dnlop & Co, American merchants in London, afterwards his warm friends and earliest patrons.

According to the statement of an American writer,† Mr. Leslie's "first attempt was a likeness of Cooke the tragedian, taken at the theatre while apprenticed to a bookseller at Philadelphia. He soon copied admirably, and became, like most of his fraternity, early occupied with portraits. After teaching drawing a short time at West Point, he resigned the appointment, returned to England, &c. She claims him as her own, but although born there, his parents were Americans, and his first lessons in art received on this side of the water." We have before us another account of Leslie's youthful life, published in Aruold's "Magazine of the Fine Arts," so far back as 1834; the writer there asserts that Leslie "came over to England very early in life, when he was quite a boy, and

received his education at the Charter-House School, along with his brother. It was at this school that he first became instructed in the rudiments and elementary parts of drawing, under the tuition of Burgess, the father of the present talented artist of that name; excellent for his delineation and portraiture of trees. And long previous to his quitting the Charter-House School, the pupil had by many degrees outstripped the master in the character and general beauty of his drawings." We give both these statements without attaching credibility to either of them; for it is scarcely probable that Leslie, himself yet untaught, and employed in a business, would either have the ability or the time to become an instructor, and moreover he was not more than sixteen years of age when he returned to England. Mr. Tuckerman is evidently wrong in his dates; the appointment of Mr. Leslie to the military school at West Point did not take place till several years after he had become a Royal Academician. Neither does it seem likely that he was ever in the Charter-House School, for he could not have been above six years old when his father took him to America, and after he came back he must at once have entered the Royal Academy. After all, it is of comparatively small moment where a man of genius is born, or where educated; still, every country has a right to be proud of her great minds, and England, as we presume to have shown satisfactorily, may claim Mr. Leslie on the score of birth, parentage, and Art-education, while to America belongs the honour—and it is by no means a slight one—of discovering his talent, and putting him in the right road for its full development.

The earliest works of this painter were, as is often the case with tyros, of a rather miscellaneous range of subject. Young artists are apt to test their own powers, as well as the taste of the public, in a variety of ways, that they may ascertain what is likely to succeed, and what it would be policy to avoid. Mr. Leslie attempted history, sacred and profane, and domestic subjects. In the collection of Sir John Leicester, afterwards Lord De Tabley, was a large early painting by Leslie, of "Saul and the Witch of Endor," which showed the young artist to possess very considerable skill in composition, and much poetic imagination; it bore evidence also of great power as a colourist. He soon however had the perception to discover where his strength lay, and at once directed his attention to painting English history from the pages of Shakspeare, and scenes admitting similar dramatic treatment, from Sterne, "Don Quixote," the "Spectator," &c. Among his most successful early pictures, were "SIR ROGER DE COVERLEY GOING TO CHURCH AMID HIS TENANTRY," a work, as Dr. Waagen remarks, of delicate observation of character; in it we recognise "the fine old English gentlemen" whom Steele describes, kind, courtly, and benevolent: it is in the possession of the Marquis of Lansdowne. Others were "ANNE PAGE AND SLENDER," and "MAY-DAY IN THE REIGN OF QUEEN ELIZABETH," all three of which were engraved not very long after their appearance, and are now transferred to our own pages. In 1821 Mr. Leslie was elected associate of the Royal Academy.

In 1824 appeared his first version of "SANCHO PANZA AND THE DUCHESS," painted for the late Lord Egremont; other versions, such as that in the Vernon Gallery, were produced some years afterwards: our readers who will take the trouble to compare the engraving on this page, which is from the former work, with that we gave three or four years since in our "Vernon Series," will see what variations the artist has introduced into his later work. Miss Rogers, sister of the deceased poet, has, according to Dr. Waagen, the assistance of Shallow, conring Anne Page;" "Sir Henry Wotton presenting the Countess Sabrina with a valuable jewel on the eve of his departure from Venice," engraved in "Wotton's Lives;" and six subjects (drawings) from the Waverley Novels, engraved in the illustrated edition of Scott's works. In this year Mr. Leslie was chosen Royal Academician, and signalled his election in the exhibition of the following year by his "Don Quixote having retired to Sierra Morena to do penance, is induced to relinquish his design by a stratagem of the Curate and the Barber, assisted by Dorothea." This work elicited very general admiration, yet perhaps even less than his picture of 1827—



Engraved by]

ANN PAGE AND SLENDER.

[J. & G. F. Nicholls.

repetition of this subject. In 1825 he exhibited "Slender, with the assistance of Shallow, conring Anne Page;" "Sir Henry Wotton presenting the Countess Sabrina with a valuable jewel on the eve of his departure from Venice," engraved in "Wotton's Lives;" and six subjects (drawings) from the Waverley Novels, engraved in the illustrated edition of Scott's works. In this year Mr. Leslie was chosen Royal Academician, and signalled his election in the exhibition of the following year by his "Don Quixote having retired to Sierra Morena to do penance, is induced to relinquish his design by a stratagem of the Curate and the Barber, assisted by Dorothea." This work elicited very general admiration, yet perhaps even less than his picture of 1827—

* "Men of the Time." Published by D. Bogue, London. A most valuable book of reference: it gives a short, yet, for general purposes, sufficiently ample historical sketch of all the eminent living men of our day, whatever the subject may be which has raised them to distinction.

† "Artist's Life," or, Sketches of American Painters." By H. T. Tuckerman. Published by D. Appleton & Co., New York. 1847.

for we do not rank his two clever studies of the heads of Sancho Panza and Don Quixote, exhibited the same year, as anything else but studies—"LADY JANE GREY PREVAILED ON TO ACCEPT THE CROWN," this picture, from the gracefulness of the composition, the truthful and poetical feeling thrown into it, and the purity and sweetness of the colouring, must take its place among the finest works of the artist; it has been engraved on a rather large scale. The following year Mr. Leslie exhibited nothing, but in 1829 appeared another capital scene from the "Spectator," "Sir Roger de Coverley having his fortune told by Gypsies;" it tells the story in a forcible and natural manner. The year 1830 was also a blank. To the exhibition of 1831 he contributed "Uncle Toby and the Widow Wadman," now in the Vernon Gallery. Mr. Sheepshanks has a repetition of this inimitable picture, in which the widow appears somewhat more refined in character than in the Vernon picture; the other contribution of this year was a scene from the "Merry Wives of Windsor," the dinner in Mr. Page's house; the personages of the dramatist are placed on the canvass with singular appreciation of their characters, and are painted with great solidity and firmness of drawing, and with a powerful general effect arising from the skilful management of the two principal colours, black and red. This picture, we believe, is also in the possession of Mr.

Sheepshanks. In 1832 he exhibited two pictures, one of them of a nature to tax the powers of any artist; this was a "Family Picture," containing portraits of about a dozen members, male and female, of the Grosvenor family. Leslie, says a critic of the day, "mastered the difficulties of the subject, and proved how subservient every obstacle can be to one who knows how to study nature in her proper mood, and conceive a proper taste in the selection and arrangement of his objects." It was painted for the Marquess of Westminster, in whose possession it of course remains. The other, a scene in the "Taming of the Shrew" where Petruchio, Catherine, Grumio, and the Tailor are present, and Petruchio vents his rage upon the trembling maker of the lady's cap and gown, represents the incident of the play in a perfectly truthful yet original manner; the attitude and expression of each figure are really dramatic, yet not overstrained; this quality of close adherence to nature is one of the great charms of Mr. Leslie's illustrations to Shakspeare, Don Quixote, &c. Mr. Sheepshanks is also the fortunate owner of this picture.

To the exhibition of 1833 Leslie sent three paintings, "Tristram Shandy recovering his lost Manuscripts," "Mother and Child," and "Martha and Mary before Christ." Of these the first was the most successful; "the earnestness and anxiety of poor Tristram, as he unfolds each crumpled



Engraved by]

MAY-DAY IN THE TIME OF ELIZABETH.

J. & G. P. Nicholls.

scrap of paper, mixed with anger and vexation, was the very acme of excellence and truth; and equally admirable was the expression of the poor confused and perplexed grisette, as, with cheeks reddened with blushes, she untwists her hair out of the precious MSS. The sacred subject clearly manifested that the genius of the artist does not lie in this direction; the "Mother and Child" is a simple bit of nature, pleasing and graceful.

It was, we believe, in the autumn of this year that Mr. Leslie embarked for America, to fill the post of Professor of Drawing, at the Military Academy at West Point, to which he had been appointed by the government of the United States, as we have already intimated. The occupation, however, was not congenial with his tastes, and after a residence there of about five months, he returned to London, which he has ever since made his abode. His absence from England prevented the appearance in the following year of anything from his pencil; but it probably suggested the idea of one of his pictures, "Columbus and the Egg," exhibited in 1835; his other work exhibited at the same time, "Gulliver's Introduction to the Queen of Brobdingnag," is in the collection of General Wyndham, who inherited the Petworth property on the demise of the Earl of Egremont. These two pictures added little to

the reputation of the artist, though they detracted nothing from it. The subjects are devoid of much interest. "Antiochus," from the "Winter's Tale," the only work he contributed to the Academy in 1836, is a small picture, rather slight in treatment; it is the property of Mr. Sheepshanks, as is also "Florizel and Perdita," from the same play, exhibited the following year with a scene from "Old Mortality."—"Charles II. and the Lady Bellenden breakfasting in the Tower of Tilietudlen;" in the latter work the artist once more shines in his purest light; the portrait of the proud and formal old royalist dame being represented to the life. In 1838 appeared the "Principal characters in the 'Merry Wives of Windsor' assembled at the house of Mr. Page;" we must confess our recollection does not enable us to speak with any certainty of this picture; whether or no it is a repetition of that painted in 1831, and of which we have already spoken as belonging to Mr. Sheepshanks, or whether this is actually the work which that liberal patron of British Art possesses; we believe, however, our former statement is the correct one.

"Who can this be?" and "Who can this be from?" exhibited in 1839, are the titles of a pair of pictures either painted for Mr. Sheepshanks or purchased by that gentleman from the walls of the Academy; both are love scenes, happy in conception, but rather low in colour. "Sancho

Panza," another picture of this year is "the embodied iden of the Prince of Barataria, when cheated of his meals by order of the physician." His fourth work of the same period, "Dulcinea del Toboso," a pendant to the former, scarcely realises the character of Don Quixote's *inamorata*, the artist has represented her as a stout rosy country-girl. Mr. Leslie's only work of 1840 was a portrait of the late Lord Chancellor Cottenham, an admirable likeness vigorously painted; in 1841 he exhibited three pictures, "Le Bourgeois Gentilhomme," the scene where M. Jourdain, fencing with the maid, receives a thrust of the foil from her: it is a fine example of character, full of point and humour, but not agreeable in colour; we remarked of this picture at the time,—"Mr. Leslie's views of life are so slow, and his perception and pouring of character so strong, that he is borne safely through peculiarities of colour that would seriously injure a lesser man;" these observations would occasionally not be considered out of place even in the present day. "Fairlop Fair," the next on the catalogue of this year showed much that is excellent, but as a whole is not so satisfactory as many other works from the same hand. "The Library at Holland House," is a skilfully arranged and elaborately finished picture, into which are introduced portraits of the late noble owners of this fine baronial mansion. In a "Scene from Twelfth Night," exhibited in 1842, Sir Andrew, Sir Toby, and his niece's chambermaid are introduced with that fine perception of individual character which the works of this painter pre-eminently manifest: in colour also this

work is unexceptionable. Mr. Sheepshanks possesses the other picture of this year, the "Scene from Henry VIII.," in which Queen Katherine entreats her attendants to divert her troubled thoughts with music; it is a beautiful and touching composition, or, as Dr. Waagen says of it, "the expression of sorrow in the queen is very good, and the gloomy keeping of the whole is congenial."

The contributions of Mr. Leslie to the exhibition of 1843 were more numerous and varied than at any preceding period; the first in the list was a "Portrait of Mr. B. Travers," the late eminent surgeon; the next one of those difficult subjects that test the skill of the greatest artists, "The Queen receiving the Sacrament at her Coronation;" it is too well known to the public by the engraving of Mr. S. Cousins, R.A., to require any comment or description; suffice it to remark that the picture was a triumph. The third was a subject from the "Vicar of Wakefield,"—"Virtue, my dear Lady Blarney, virtue is worth any price, but where is it to be found!" it is a genuine illustration of the characters Goldsmith has drawn with so much truth and power; the fourth was a portrait of Mr. H. Augelo; and the last a "Scene from Molière's 'Le Malade Imaginaire,'" "admirably represented," writes Dr. Waagen; the picture is one entirely of character, and in the spirit in which it is painted has been very rarely equaled and never surpassed; it belongs to Mr. Sheepshanks, who, as our readers will have perceived, is especially "rich in Leslies." A "Scene from 'Comus,'"—"Hence with thy brew'd enchant-



Engraved by]

SIR ROGER DE COVERLEY GOING TO CHURCH.

[Mason Jackson.

ments, foul deceiver," a composition for one of the frescoes executed in Buckingham Palace, was one of Mr. Leslie's exhibition pictures in 1844, but it was evidently a subject whose style is not in harmony with the painter's mind; not so, however, with his other contribution of this year, his old and favourite subject "Sancho Panza in the Apartment of the Duchess," in which appeared several striking improvements upon his former pictures; we presume this is the repetition we have spoken of as the property of Miss Rogers. In 1845, he sent the "Heiress," a composition of three female figures in a richly-furnished apartment, but they scarcely afford a solution of the title; and a "Scene from Molière's 'Les Femmes Savantes,'"—Trissotin reading his sonnet to the ladies; the picture, in the collection of Mr. Sheepshanks, is far more sketchy than is usual with Mr. Leslie, but the characters are successfully maintained.

The most important picture exhibited in 1848 was the "Reading the Will Scene, from 'Roderick Random,'" it is a large work, and treated with great originality, but has a heavy appearance in colour, arising from the predominance of black; this, however, is almost unavoidable, from the subject: the work belongs, we believe, to Mrs. Gibbons, of Hyde Park. His other productions of this year were "Mother and Child," a charming little picture, very similar to one we have already referred to under the same title; and the "Portrait of Mr. C. Dickens, in the character of Captain Bobadil." In 1847 appeared "Martha and Mary,"

—a replica of his picture of 1833—in which the figures are substantially and beautifully painted, yet without reaching the dignity of Sacred Art; the "Pharisee and the Publican," equally successful with the former in execution, and treated altogether in a more congenial spirit; and "Children at Play," a sweet little composition of "genteel comely" by small folk. "Lady Jane Grey," exhibited in 1849, is a graceful personification of her,

"who in her chamber sat,
Musing with Plato:—"

she is thus represented in the picture; and the "Shell," exhibited at the same time, is also remarkable for the refined feeling that pervades the subject—a child, on the knee of its mother, listening to the "echoes of the deep" as they murmur through a shell held to the child's ear by a beautiful girl. "The Masque-scene in 'Henry VIII.," was one of two works exhibited in 1849; the picture throughout displays much valuable artistic performance: the other, a "Scene from 'Don Quixote,' where the Duke's chaplain, after attacking Don Quixote for his devotion to knight-errantry, and Sancho for his belief in his master, reprimands the Duke for encouraging their fancies, and leaves the room in a passion;" this is unquestionably one of the best works Mr. Leslie has created out of the history of the Knight of La Mancha.*

* To be continued.

THE POEMS OF GEORGE HERBERT.*

THE courtesy of Messrs. Nisbet, in lending us some of the blocks engraved to illustrate the very beautiful edition of the poems of George Herbert, recently published by them, enables us to fulfil the expectations held



out to our readers when reviewing the volume in our January part. The poetry of this original thinker and quaint writer requires not the aid of the artist by way of recommendation, but it becomes especially attractive when his thoughts and picturesque descriptions pass before



the eye as we see them here. Herbert's principal poem, entitled "The Temple," includes reflections upon every thing associated with the Church

* THE POETICAL WORKS OF GEORGE HERBERT. Illustrated. Published by JAMES NISBET & Co., London.

as an earthly or a spiritual edifice; the artists have therefore selected from the various subjects contained in the poem such as seem best fitted for illustration; thus the verses entitled "The Church Porch" is adorned with two exquisite designs by Mr. Foster of a small venerable English church and parsonage-house, and a distant view of a similar building, with rustic "tribes going up to worship." To "The Sacrifice," Mr. Clayton contributes "The Betrayal by Judas," and "Christ crowned



with Thorns," both subjects treated with nice feeling and considerable power. The poem entitled "The Agonie," is illustrated in a truly devotional spirit by a representation of "Christ praying in the Garden of Gethsemane," also by Mr. Clayton. The two lower engravings on this page, by the same hand, are respectively prefixed



to the poems "Vanie" and "Faith"; the two upper, by Mr. Foster, to those entitled "Employment" and "Grace": these will afford sufficient evidence of the character of the illustrations, which are lavishly scattered over the pages of this charming book. We regret that the form of Mr. Noel Humphreys's graceful floral "headings" and "side ornaments," prevents our introducing examples of them also.

FRENCH CRITICISM ON
BRITISH ART.

M. MAXIME DU CAMP.

DURING the successive months of the late Universal Exhibition, we took especial care to present to our readers in general, and to our artistic friends, more particularly, copious selections from the ephemeral criticisms of the French daily press upon our works of Art. They were of interest from their freshness—eager for the surprise of which they were the vehicles; but, for the most part, distasteful from an ungenerous levity, by which they were characterised. By the latter, what might have been a useful lesson, was marred: for it must be admitted in the abstract, that it should have been a wholesome occurrence for our painters and sculptors, to have had their works passed through the process of a Continental criticism. Even in literature, such strictness might be of importance in reference to general structure and the general purport of our productions, although valueless in appreciating delicacies of verbal expression: but in Art, where the language is cosmopolitan, where all aim at the same end through precisely the same means, the utility of such foreign review, if fairly carried out, cannot be a subject of doubt. However distinct may be the varieties of style between the artists of the same country, yet, if they are habitually rechecked from foreign competition and its comparisons, habitually mingled together in schools and exhibitions, pervading peculiarities will insensibly creep in amongst them, and gradually establish national mannerisms. It behoves the British artist, in his island seclusion, to accept and welcome with a dispassionate feelings as he may, the notes and comments with which the foreign observer makes up an estimate of his merits. Actuated by this conviction, we present our readers with a chapter on the English portion of the Beaux Arts Exhibition, from the general criticism of Mons. Maxime Du Camp, which was not written with precipitancy, or the flippancy of the newspaper press, but deliberately digested, as deliberately published, and to which, in the Parisian circles, has been given the authoritative position amongst the various brochures on the Exhibition which have appeared. Mons. Du Camp holds an honourable place amongst the literary men of the day in France—in both prose and verse—but more particularly as an Oriental traveller. His present work indicates how deeply and devotedly he has interested himself in Art. It will, moreover, afford cogent evidence that he has no vain predilection for the schools of France. For them, in fact, he has reserved his severest and most searching strictures; so that to the British artist, who would know precisely wherein they sin, we can safely commend the perusal of this large octave. After having given nine out of fifteen chapters to his own countrymen, Mons. Du Camp turns, in his tenth, deals out his impressions of our oil painters in the Exhibition.

"We will not," he says, "reproach English painting, as we have the various schools of France, with the charge of imitation. In truth, our neighbours across the Channel have carried into Art the essential originality which segregates them, and enables one to recognise them at a glance, amongst all other people. There is in their painting, as in themselves, a something original, especial, eccentric, which attracts attention. It has the flavour of their soil. It is neither Flemish, nor Spanish, nor Italian. It is English, Protestant, methodical, and, up to a certain point, is adapted for them alone. If Reynolds, Gainsborough, and Lawrence have held by a tradition of Vandyke portraiture, it must be admitted, on the other hand, that in *genre*, Britain has spurned all foreign influence. Here and there may be felt in that class, reminiscences of Hogarth; but these are national, and owe no debt to the celebrated masters of Rome, Florence, Antwerp, or the Hague.

"So habituated are we in France to see in the works of our best artists, but copies more or less faithful of by-gone masters, that our first

feeling in proceeding down the long gallery containing the English portion of the Exhibition, was that of surprise. It presented to us an originality thoroughly made out, and in effect, subject-matter for prolonged astonishment. This originality has, however, its vice, which we must at once notify. In their excess of Anglicism, they frequently have no outward human sympathy. Accustomed alone to paint the strongly marked features of their peasantry, the visages of their frigid aristocratic men with two formal lines of whisker, and the rose-blossom carnations of their young countrywomen, they see in all mankind but the British type; they stumble into a predicament similar to that of the laureates of the Villa Medici, who in all their productions, gave but an imperceptible repetition of the types they had studied at Rome, and inflict upon all parties in all their works, visages wholly and entirely English. This emphatic defect, which might be easily avoided by a generalisation of study, is especially noticeable in the 'Sancho Panza,' and 'The Duchess' of Mr. Leslie, 'Esther's Emotion' of Mr. O'Neill, and in the 'Vintage in Medoc,' of Mr. Uwins. In these three scenes, in one of which the dramatic personæ are Spanish; in the other, Jewish; and in the third, French, the actors bear, one and all, the type of the English race. This is an overstrong disguise of truth, and mars the interest of each subject.

"Notwithstanding its first-class distinctive qualities, its sincerity and lofty disdain for the old continental schools, British painting has something in it diminutive, which recalls the minute but effeminate elegance of the Keopsake engravings. It is almost always deficient in imagination—we feel that it wants a *libretto* to inspire it—that it is less an original text than a commentary; in a word, that it but too willingly levels itself to the function of illustration. To display itself, it opens Sterne or Goldsmith; it is literary to excess; but, while being so, it lingers ever within the precincts of fact, nor ever dares to risk itself in those of philosophy. So it only presents us with works of *genre*, and with little of historic reference. In this respect, it corresponds well with the wants of its epoch: morally, it moves in harmony with the stories of Dickens; and materially, it has the adroitness to adapt itself to the narrow exigencies of the dwellings it is intended to decorate. It excels in depicting interior scenes, appropriate to a country replete with families, where they have evening prayers in common: it seems made to adorn walls lit up by glowing coal-fires: it is essentially adapted to be a portion of comfortable chamber furniture, and not to shed honour upon extensive galleries. In the matter-of-fact manner in which it is elaborated, there is something of richness and glitter; a furbishing up, which is, as it were, its national stamp. It is of the earth, earthy; always exact; often amusing; never elevated. It makes one smile and talk; but never promotes deep thought, much less imaginative reverie. In a word, it is positive, or precise, like the people amongst whom it has had its being. It comes within the grasp of artists who have talent,—much talent, but nothing of genius. Their literary equivalent may be found in Sheridan, in Dickens, in Fielding, in Walter Scott; but not one amongst them can enter into comparison with Shakspeare or Milton, or even Lord Byron.

"Cold and calm by acclimatised temperament, English artists never allow themselves to be borne along by those exticements of imagination, which frequently but terminate in some violent miscarriage—but which also sometimes attain the sublime—and which, at least, intimate the pursuit of an ideal. They appear only to labour in virtue of certain premonitory rules, the observance of which is sure to lead them to their desired result. With them all is regular, foreseen, directed, and detailed. It is obvious that they paint with colours of incomparable quality—ground between slabs of porphyry, hard and fine-grained as the diamond—with marvellous vehicles, with exquisite varnish, and with pencils plucked from the rarest martins' tails. They should, like Gerard Dow, after having withdrawn the veil which covered their pictures, stand motionless and long, to avoid agitating the dust.

"But devotedness to minute precision of finish frequently narrows the import of their works, for on their canvas each part has for them an equal importance—a shoe and a face are equivalent. This over-wrought minuteness of detail which degenerates into foible, fatigues the scrutiny and dissipates the interest of the spectator. I shall cite as an example of what I assert, Mr. Millais's 'Return of the Dove to the Ark.' I care but little for the picture, overlaid as it is with ill-harmonised rainbow and blue tints, and I should not have at all noticed it had it not presented, in the mode in which the litter, which covers the floor of the ark, an extreme example of the abuse of detail. This is in truth an absolute illusion: it is not art, but coloured photography. Every sprig of hay and stalk of straw, each hair from the hide of ruminant, or feather from wing of bird, is drawn and painted up to reality. Neither is there a particle of exactitude omitted in the erect figures of the two girls, who almost press in their hands the messenger dove. The almost imperceptible reticulated lines which mark their hands, the lashes of their eyes, each individual hair of their heads, are given with astounding precision. But this is all frigid and shallow. The obvious effort which, after all, is in default of its model, is only painful. The same opinion holds good respecting the 'Ophelia,'—a strange, almost ridiculous, and assuredly perilous production, representing a young female gradually sinking in water, which seems wholly undisturbed by the proceeding. All the slender grasses, all the small flowers, all the delicate plants, that grow on the banks of streamlets, are, as it were, gaily accumulated round this wax doll, that drowns itself, as unlike as possible to the Ophelia of the poet. This picture may be compared to an enamelled toy. To the two, I strongly prefer 'The Order of Release,' which, notwithstanding the undue interest given to some of its accessories, such as the falling primroses, the coat of the prisoner, and the dog's tail, represents, nevertheless, a scene vivid, impassioned, and true. If we have spoken at length of Mr. Millais, it is not because we accord him an estimate of great importance, but because he sums up plainly an error common to the majority of his brother artists, the inmoderate and irrational abuse, which leads quickly to puerility, and consequently to ennu.

"All, however, are not of this class, and some have had the genius to unite a high measure of precision in execution with breadth of sentiment. We will cite, as an example, Mr. Dauby and 'The Evening Gaa.' In a solitary roadstead, near the mouth of a river, where the sombre shadowy forms of some lofty constructions are visible, a ship rides at anchor. The sea is calm, no breeze perceptible, the tide scarce ripples by the buoy, the ocean breathes tranquilly like the breast of a living sleeper. A flight of those indomitable birds, whose sailors call 'souls in pain,' skim along brushing the water's surface with their light, silent wings. At the horizon, where the long clouds lie like immense alligators, the sun sinks to his couch, crimsoning the sky with his strong colours. Against this light gradually fading away into a pale green hue, the ship shoots up its black masts, its yards with sails clewed up, its hallions and ropes all motionless. From its sides a gun-shot has issued, rolling forth thick and heavy volumes of smoke, which the wind carries not away, and which seem as though they should lie heavy on the peaceful waters. This is the signal that day has closed, and the night commenced. They are about to set the watches; they, who will, at regular intervals, hail with an 'All's well, starboard,' 'All's well, larboard,' and the sentinel at the mainmast will reply, 'Be awake at the cat-head.' There is, in this composition a true poetry, which gratifies the more, inasmuch as it is rare amongst English works of Art.

"The man who with greatest strength signals the British Exhibition, who towers with unequivocal endowment above his brother artists is, in our opinion, Mr. Mulready, who in England enjoys an established popularity, and here, on this occasion, has in some of his works left far behind him the majority of French painters in the class *genre*. His *dramatis personæ*,

well and vividly before us, are all in appropriate action; they are not posed but in life-like freedom; they are engaged in the unaffected movement of a scene, having as little resemblance as possible to those of Meissonier, who always have the air of having put on new suits of clothes, and place themselves in special attitudes to catch the eye of the amateur. The canvass of Mulready has nothing whatever in common with this *Sunday-sided* style. It is full of life, sincere and serious, arriving ever at the realisation of truth—truth, it must be admitted, in action of narrow interest, without greatness of thought, without elevated aim, but from its simple manifestation affording proof of a remarkable faculty. Of the nine pictures which he has sent to France, we do not hesitate to give the preference to the 'Whistonian Controversy,' a subject taken from the Vicar of Wakefield, and which we have already seen with admiration in the remarkable gallery of Mr. Baring, M.P., in London.

After having vividly described the action of the picture, falling, however, into the singular mistake of making the Vicar young—"Le jeune Vicaire Primrose," the critic proceeds.

"The truthful combination of parts in this very simple scene is given with extraordinary freshness; its accessories, such as the rich fabric of the table-cover and the books, are introduced with perfect skill, and, without intruding, increase the general interest of the composition. The colouring of this picture, although inclining perhaps overmuch to a yellow tint is very harmonious, and combines with the other qualities of the diminutive canvass, in rendering it highly valuable.

"We are much less gratified with 'The Bathers,' a picture painted after the manner of a miniature, and to which the crude contiguity of pink, blue, red, green, and white tints, gives a twinkling effect. Moreover, the anatomic treatment of its chief figure is dry, a little angular and in parts more meagre than agreeable. But let us add that, perhaps no artist has ever attempted so successfully—gone so far—in imitating the human flesh, in giving those fresh and pearly, those tender and fascinating tints, which invest youth with its most dangerous attractions."

We must confess that a note upon this comment of Mons. Maxime would be extremely welcome if it could only reconcile the opinions contained in these two last sentences. They assuredly jostle in utter antagonism.

"In landscape—strictly so called, Mr. Mulready is not fortunate. His 'Blackheath Park' all dry and crude, reminds one of a large agate stone, on which a mockery of vegetable life is traced. There is neither greatness nor reality in it; it is cold, poor, and without scope."

The critic has here unhappily overlooked what seems to have been the aim of the master who, it is pretty obvious was, in this instance, making a bold and difficult experiment, wholly apart from the picturesque, viz., to represent a lonely landscape under the full effect of a meridian sun. He neither brought to his aid the striking aspect of form in natural objects, nor the equally effective impressions of light and shade. A much more difficult, although ungrateful task, could not have been essayed, and Mr. Mulready has, we should venture to affirm, succeeded in it with a true "*curiosa felicitas*." "I admire much more," continues M. Maxime du Camp, "the pretty scene inspired by the precept, 'Train up a child in the way he should go.' There, at all events, the landscape is enlivened by a group, which makes one overlook its shortcomings. A handsome child ('*un beau bébé*') ruddy and blond, with neck uncovered, after the manner of English juvenility, is taking his walk, accompanied by his governess and followed by his dog, &c." Having described the action of the illustration with vivid piquancy, he concludes with the remark, "This is a charming little picture, less delicate in its execution than the 'Whistonian Controversy,' but equally happy in its details and general effect."

Perhaps, let us remark, the general tone of this criticism may prove to Mr. Mulready that, if he is wounded by the fastidiousness of the late Fine Arts Jury, there is yet something of a haln in Guild.

"After Mr. Mulready we shall place Mr. Webster, who has a leaning towards subjects of a delicate comic vein, and who, from the humour in which he takes them, is obviously of the school of Hogarth. He has none of the dry extravagance, none of the epileptic grotesqueness, which characterises the latter, but he has a finer subtlety of perception, and combines therewith a skillfulness of design and a facile lightness of execution altogether remarkable. He excels in painting children, and, notwithstanding a certain weakness, a sickly paleness of tint, he brings them out happily upon his canvass. 'Contrary Winds,' and 'The Cherry Seller,' are pretty examples of *genre*, although inferior in power to the 'Wolf and Lamb' of Mr. Mulready. 'Foot Ball' is his best picture. The crowd of boys who vigorously cuff and jostle each other in pursuit of the ball; the animation of the game, the rough and rapid evolutions of the players, has been studied and rendered with commendable care.

"In the 'Village Choir,' which presents a quiet, almost serious aspect of caricature, we find a variety of physiognomies finely discriminated, skillfully grouped, and painted with a life-like reality, leaving little to be desired. Two heads (portraits) are a miniature *chef-d'œuvre*. The aspect, in which the artist presents his subject involved a serious difficulty in regard to tints, with which he well knew how to cope. An old man and his wife, seen only from the bust, are placed in profile beside each other. The latter is pale, with the heavy, dull, pallidness which belongs to certain unhealthy organizations. She wears an ample white cap, with large plaits of tulle, and is wrapped in a tippet of swansdown, which frames her face in a wreath of spotless, snowy foam. The painter has vigorously worked his way through this accumulation of whites, so difficult to be brought into juxtaposition. The physiognomy is kindly, smiling, and full of life. These portraits are good—very good—but they are far from being equal to those of Mr. Grant."

Never was there a liberal eulogium more gratuitously marred than what has here been set forth, by its conclusion. The common apothegm, "comparisons are odious" was never more completely illustrated. Mr. Webster is not an ambitious portrait-painter, and the minute and very beautiful work which, under some special inspiration, he thus brought into existence, to be universally admired, in no manner provoked this ungenial piece of disparagement.

"Mr. Grant, carrying out the traditional elements of the styles of Gainsborough and Lawrence, has more of breadth and boldness than the majority of British painters. He unhesitatingly sacrifices a detail, coarsely rubs in an accessory—gives a dash of inexplicable red to a sky, for the purpose of securing a more striking importance to his heads. This mode of proceeding is obvious in the portrait of Madame Beauchamp, and in that of Lady Rodney, but his *chef-d'œuvre* and such it is throughout, is 'The Ascott Meet.' Here, on an extensive plain, bordered in the distance with some leafless beech trees, a reunion is presented of huntsmen in their chase costume, red coats, cravats black or blue, buckskins, and top-boots. They are mounted and grouped as accidental impulse prompts. Each individual—each horse, is a portrait. It would be difficult to exemplify more variously attitude, action, and physiognomy. I know of no production from our French painters of the chase and horses equal to this inestimable canvass, to which its firmly handled colour, although a trifle too grey, gives an indelible charm."

It must be suspected that the diminutive "*quoique un peu grisâtre*" is forced in here at the end of an even strain of eulogium to save the critic's credit from a charge of being in an over-melting mood. If there be a prevalent tone in the picture we should rather have named it *brun* than *grisâtre*. However, the note is detected, and criticism vindicated.

"Amongst the British artists who fain would eschew an English pencil and endeavour to attain something of the present overwrought French style, we must name Mr. Knight. His 'Wreckers,'

have great but unsustained pretension to vigour. Exaggerated sky tints, physiognomic distortion, and violent contrast of contiguous light and shade, are not always power, and sometimes feebleness. Artists, who have an ambition for these spurious extravagancies, may be compared to children, who, concealed behind a curtain, speak in rough tones, to make believe they are men. They wholly fail to deceive. Mr. Knight's catastrophic subject, in its triple division of action, would have been better if treated with tact, without doing violence to dramatic fitness, and without its ineffective strairings.

"We must prefer, as a specimen of enlarged treatment, the 'Morra' of Mr. Hurlstone. This is rather a study of Italian boys than a picture. It seems washed in, as it were, after the manner of a water-colour drawing. Whatever may have been the defects of the model, we have here, at all events, physiognomic expression of a good stamp, and a judicious general effect of colour. But are these Italians? I have my doubts—the fact as it may, they have been thoroughly Anglicised by the artist. Mr. Hurlstone would seem to have much studied the works of Reynolds, and to have retained some of their impressions."

More serious misconceptions will be found and thickly scattered throughout French criticism on English works; but probably one more obvious and amusing than that respecting the identity of Mr. Hurlstone's Italian boys could scarcely be culled from the collection. Familiar as we are in London, and far more than they are in Paris, with the pleasant-faced little rambling organ-grinder, or, white-mouse exhibitors, with their waxy-brown complexions, tinged with an occasional rusty ruddiness, and their mouthful of snowy teeth, we could not for an instant question their reflections on Mr. Hurlstone's canvas, or rather his canvasses, for he has made them long since his special property. Moreover, the type is wholly and totally distinct from that of the English. But it would be too much, as in the preceding case, to let the artist off with nothing but commendation, and so pop goes a blank cartridge.

"To return," continues Mons. Decamps, "to the unequivocal English *genre*, a word on 'The Widow's Benefit Ball,' by Mr. Goodall. Notwithstanding the watery complexion of colour of this picture, which, after all, is nearly the universal peculiarity of English painting, it is an agreeable work, and composed with a degree of care which at times becomes too scrupulously minute. In truth, there is no part of the canvass unstudied—a parallelism between the groups is too obviously wrought out, and is even established between the heads of the two old men, one of whom performs the part of fiddler, at the end of the hall, and the other helps himself to potatoes near the door. There is also an abuse in the introduction of children; they are forced in on all sides to fill up intervals; in other words, they are made to *plug up holes*. Nevertheless, there is an animation, an earnestness, an unsophisticated healthy vivid gaiety realised throughout the whole scene, most agreeable to contemplate. The young man with the naked feet, who accompanies his capers with the snapping of his fingers, is a most successful figure, affording proof of a conscientious study of nature."

"The Novice" of Mr. Elmore is very pleasing. Instead of confining himself, like his brother artists, within the bounds of the narrow romance of familiar facts, he has sought to illustrate a philosophical reflection, and he has succeeded. A young girl, lovely, sad, and pensive, a prey to the struggles of her inner self, is seated, in the garb of a nun, on the little bed in her cell. The neighbouring window is half open, and with the full flow of sunshine, admits the sound of song—of life and youth; for on the other side of the street, it would seem that they dance and are mirthful. She seems to hear with anxiety this joyous excitement, and notices not that in the corridor, to which her open door gives access, an old mother of the convent moves wearily along, leaning on her staff, and supported by a sister. In a distant cloister, some stone crosses are perceptible. All the regrets, all the sadnesses—let us add all the *rinorso*

of cloistral life, have been well combined and depicted on this small canvass. Between these nuptial rejoicings which might have been hers, and the future, which is indicated in the ex-banished old woman, the novice, silent, and melancholy, seems to question on which side lies the truth. Oh, young maiden, the Great Master has said, 'Love one another; he has not ordained, 'Crystallise yourselves in egotism and in fear.'

"Mr. Lance has a great reputation at the other side of the channel, and we are surprised at it, when we see by what pictures it has been attained. We have already noted the tendency of English painters to an abuse of detail. Mr. Lance pushes this infatuation to its utmost bounds, and thus voluntarily dissipates the charm which his pictures might otherwise inspire. The 'Village Coquette' is a case in point. A young, pleasant-faced girl is engaged in an apartment of a farmhouse—a simple scene that should have been simply treated. Far from that, the artist, by accumulating round his sole personage, accessories upon accessories, diminishes the interest naturally attaching to her. He has brought into play all the resources of his talent—a talent unquestionable—to paint a petticoat of satin cross-stitched, a silver-praukt gown, high-heeled shoes, and the silken kerchief of his coquette. Let that pass; but why give so much importance to the structure of a sweeping broom, of which each particular hair is presented distinct—to a book, which lies forgotten on a stool, to the milk-bowl, to the image pasted against the wall, to the treen full of water, to the horn suspended by the key, to the stairs which conduct to another chamber, of which all the furniture is perceptible? The eye passing from one detail to another, overlooks the principal object of interest, and ultimately preserves but the reminiscences of incommensurable dexterity of handling, infelicitously misapplied. And then, when I scan this picture with care, I perceive that the comparatively the most carelessly treated. These eye-deceiving efforts are not made to gratify; they want simplicity, and impart and produce no other impression than the spectacle of a *tour de force* painfully elaborated. Much the same comment I must make on Mr. Lance's 'Red Cap,' where I see a cabbage, of which all the fibres are painted minutely, although with over-much of glisten; and a dead drake is made out feather for feather. The title is elucidated by a little monkey bearing a red cap, which is engaged in scrutinising a large vase full of onions and tomatoes."

This cannot be considered a candid reuke, omitting as it does the extenuating fact, that Mr. Lance has but sinned in common with many of the first masters of the Flemish school. In mere minuteness of finish, which allows no object in a domestic scene, however small, to escape an elaboration *ad unguem*, he neither has nor could exceed their microscopic handling. The class of Art, it need not be said, ranks comparatively low, and lower still where it fails to combine artistic general effect with scrupulousness of execution.

"Amongst the English *romance-painters* we must further range Messrs. Frith, Egg, Horsley, Philp, and Solomons, and having done so, we come at length to the favourite artist of the United Kingdom—Sir E. Landseer. His pictures, rendered familiar to the public by engravings, have acquired for him general renown; but, in justice, we should affirm that a considerable portion of his fame should revert to Messrs. Lewis and Thomas Landseer, his accustomed engravers. In a word, the engravings and aquatints copied from his pictures gratify us more than the pictures themselves. These engravings have in them a something of illumined softness and delicacy which is not to be found on the canvasses. Whence this incident? It is owing doubtless to the dry, hard, and over-brilliant palette of the painter. An easy opportunity for comparison has been offered by the Universal Exposition. We can at once see the picture and engraving of 'The Sanctuary,' which every one has remarked in the print-shop windows of the Boulevards. The engraving, which is from the burin of Lewis, is very striking, and executed

with great truth and depth of feeling. The time is evening—that doubtful interval of twilight when nature seems to yield to general repose. A stag comes forth from a lake, where he has been bathing, and utters a gentle sound as he frightens into flight a train of wild ducks, which had sought a resting-place amongst the adjacent rushes. The drops of water fall slowly from his skin. In this solitude—in this sanctuary—all is calm, sad, and as though Nature were moved to pity. Now, if we look at the picture, this impression will be effaced on finding a sky too clearly bright, against which the form of the silhouette of the stag is overdarkly massed—the foreground merged in blue and questionable shadows—the waters motionless, hard and like crystal, the drops falling from the animal seeming like icy stalactites. I do not find in it the life-like expression—the subdued sentiment, which I have admired so much in the engraving."

A critic figures assuredly in a very false position, who, while dispensing a specially severe sentence, falls into an obvious and gross error, in respect to the subject-matter of his comments. He turns the tables on himself with a vengeance. Hence, for instance, can anything be more pitiable than Mons. Du Camp's perfect innocence. It quite escapes his critical eye, that the noble animal, like his fellow in the forest with the melancholy Jaques, has just won his life from the remorseless hound and huntsman; that, from the far-off shore, whose hills loom in the middle distance, he has made his way through the calm lake—leaving his trail upon the face of the waters—to this island Sanctuary, whither he cannot be pursued. A more effective transformation of poetry into prose—of gold into lead—could scarcely be conceived.

The critic proceeds. "So also, of all the E. Landseer works, which this exhibition presents, we prefer the 'Night,' and its pendant 'Morning,' as engraved by Mr. T. Landseer."

Having described the action of these compositions, he thus trenchantly proceeds:—"No picture painted by Sir E. Landseer produces an equally powerful effect with that of these engravings—more particularly that which is entitled 'Night.' From these remarks, it must not, however, be concluded that we wholly condemn the painting of Sir E. Landseer—that would be a wrongful interpretation of our opinion; but we do hold it to be especially successful in ministering to engraving. It proves that the burin can sometimes be superior to the pencil. In a word, Sir E. Landseer seems to us to be a *gentleman*—highly accomplished as an amateur, rather than an artist, in the serious acceptance of that title. At times he imparts a genuine expression to his animals—as, for example, in the picture of 'The Brazilian Monkeys.' On a small canvass, these are represented mounted on a pine-apple, and watching with meanness a wasp humming near them. At times, too, he attains to a striking correctness, both of contour and colours, as in 'The Tethered Run,' which would be perhaps faultless but for the cold and inanimate landscape by which it is surrounded. But at times, too, he is perfectly unmerciful with truth of nature, when it is his object to make, at any cost, his animals give expression to variety of feeling. Then, indeed, he recognises no bounds of possibility. We take, as an instance, 'Jack in Office.' All the dogs, which yearn to move upon that attractive table, of which the terrible and faithful 'Jack' is guardian, have aspects of timidity, gluttony, and mendacity, perfectly studied; but, nevertheless, in most of them the eye, from an over-wrought effort at expression, is no longer that of the animal—it is human. This defect is especially remarkable in the dun spaniel leaning against the wall. This is not vanquishing the difficulty in the subject, but avoiding it: it is a slight of hand, and in Art these juggleries should

be severely proscribed. In one word, Sir E. Landseer was a greater, a more important person, in our eyes, before than since the Universal Exposition. To attain his full value, he has need to be translated: his pictures are themes, to which engraving alone gives their complete development."

But that the book of Mons. Maxime Du Camp made its appearance before the awards of the Beaux Arts Jury had transpired, it might have been suspected that this piece of criticism had been put forth merely in contradiction of their implied opinion, and in the indulgence of a self-sufficient opposition. It stands, however, in unimpeachable priority.

The remark respecting the physiognomical expression of the dogs we take to be wholly incorrect and unfounded. Sir Edwin Landseer has well illustrated what all close observers of the dog must have noticed—viz, the extraordinary variety and subtlety of feeling which is indicated by its eye.

If Mons. Du Camp would see a human eye figuring in the head of a noble brute, we commend his attention to the horses of the "Divine Raphael," or Du Vinck.

The critic proceeds, and falls into the thoroughly ludicrous error disclosed in the following paragraph:—"Sir Edwin Landseer has some imitators, who, as happens ever in such cases, copy by an exaggeration of his defects. Mr. Hunt in his 'Strayed Sheep' has tried to be more subtle, more minutely particular than *his master*, and he succeeds, through the power of false and fantastic tints, in completing a picture, which seems as if beheld through a solar spectrum, and is curious from the singularity of its discordant tones of colour."

Sir Edwin Landseer will probably be not a little surprised to find that, after all, he is the parent of the school of Hunt and Millais, and that Perugino and Van Eyck, to whom the honour has been freely assigned, must vanish back, poor slighted shades, to the shores of the Styx. This will surely console him for the foregone severities of his French critic.

"Exclusively imaginative painters are rare in England, and in truth I see but Mr. Paton who merits this little-to-be-envied denomination. 'The Quarrel of Oberon and Titania' is a canvas whereon the artist has brought together all the reveries which Shakespeare has crowded into 'The Midsummer Night's Dream'—Puck, Robin-goodfellow, Butterfly, Spider's-web, Mustard-seed—the whole tribe of genii and fairies flit forth from the calices of flowers—glide through the grass and swing themselves on the flexible branches of the trees. It is a wide composition, abounding with various little episodes—well painted generally, well designed, and well grouped in detail, notwithstanding the obvious difficulties of the subject—and would have been extremely attractive had not its three chief entities, Titania, Oberon, and Puck, been but indifferent conceptions, over-substantial and disproportionate. A thousand charming minutiae, let us hasten to add, make amends for this defect. We dimly discover marvellous ruminations in the corolla of the convolvulus—sweet salutes are interchanged under the petals of the rose; all is harmony and fragrance—all lightsoo joyousness, notwithstanding the terrible drama which is being enacted in a corner, between an overgrown spider and a gnome pale and distorted by fear. The general tone of colour in the picture is sufficiently agreeable, although here and there it has some sharp notes not quite in harmony.

"These are the English pictures by which we have been most struck. It would be superfluous to speak of others, all of which follow with inferior merit those we have named. If truth in Art is not to be found in the coarse manner—loose beyond bounds, and even incomplete, behind which the French School, under the pretext of breadth of style, hides its feeble decay—neither is it to be met with in the petty precision, cold, detailed to puerility and even to Chinese in finish, of English painting. Where then does it reside? Where is the material—the executive truth of Art? Patience! We shall, perhaps, find it in the Belgian pictures of Leys; and at Dusseldorf; in those of Knauer."

THE WOODMAN.

ENGRAVED BY E. ROFFE, FROM THE GROUP BY SCHWANTHALER, IN THE COLLECTION OF THE DUKE OF DEVONSHIRE.

It is not a little remarkable that the talents of three of the greatest modern artists of Germany were in their youth held in so little estimation by one who was, or ought to have been, a judge of such matters, that they were recommended to seek some other profession than that they desired to follow. Peter V. Langer, when director of the Academy at Dusseldorf, dismissed Cornelius from the schools of that Institute as a young man without ability; and when Langer became subsequently director of the Munich Academy, he discharged Heinrich Hess for the same reason, and advised the mother of Schwantaler to take her son from the Academy because he possessed no genius for sculpture. Schwantaler's appeal from the dictum of the director was to the king, Maximilian of Bavaria: not directly, but it so happened that one of the royal equestrians, having observed the young artist modelling the forms and attitudes of horses, recommended him to his majesty, who engaged him to model designs for a dinner-service to be executed in silver, which service was to be ornamented with *bassi-relievi*, taken from Greek mythology. In this way originated the first work of Schwantaler, the "Entrance of the younger Deities to Olympus."

By this time Cornelius, another of the rejected by the director, had arrived in Munich to undertake the decorations of the Glyptotheca, and no sooner had he seen these works of Schwantaler, than he engaged him to execute several *bassi-relievi* for the same edifice. The young sculptor immediately set out for Rome, that he might, we presume, the better perform the task assigned to him, for sculptors very frequently seem to possess the notion that the atmosphere of the "seven-hilled city" is more favourable to the satisfactory execution of their works than the air of any other place: at all events Rome affords facilities for study which are nowhere else to be found. In a year or so Schwantaler returned with two graceful *bassi-relievi*, the "Birth of Venus," and "Cupid and Psyche," which are now in the Glyptotheca, as well as several others of a later date.

It is unnecessary, even had we space here for such a purpose, to refer to the multitudinous works of this sculptor: the pages of the *Art-Journal* have at various times recorded much that he did, and we shall, doubtless, hereafter find occasion to refer to them. We therefore pass on to notice the work engraved here under the title of the "Woodman," a name which, in the absence of any other, we have given to it. On applying to the Duke of Devonshire, the owner of the group, for its proper title, his Grace favoured us with the following remarks:—"Schwantaler never would give a name to the group which I consider his *chef-d'œuvre*; when he planned it with me he was contented with calling it 'A Nymph caressed by a Huntsman.' When on his deathbed he gave directions that he might be carried to look at his work, which was undergoing the completion of some minor details by his workmen, he made his brother write to me to express his complete satisfaction; adding with a kind of pun upon his name, that I should be in possession of Schwantaler's *Schwann-gerang* (dying strains)."

The group indicates a mere fancy of the sculptor rather than any mythological subject: it is in the hand of the male figure is an attribute of the woodman's occupation—not of the huntsman's: the female figure, with a kind of lozenge-shaped graving-tool in her hand, and the lute at her side, may possibly symbolise the Arts; but it seems impossible to give a correct definition of the work. The composition is fine and shows genius of a high order: we must admit, however, that it loses much of its beauty and gracefulness in the engraving, the peculiar construction of the group, from whatever point of sight it is viewed, presenting some obstacle in the way of efficient translation.

THE BRITISH INSTITUTION.

EXHIBITION—1856.

This exhibition was opened to private view on Saturday, the 9th of February, with a catalogue of 559 works of Art, of which sixteen are sculptural. The strength of the collection lies, as usual, in its landscape and genre productions, of which many of the examples are of a very high degree of excellence. To this institution must be given the credit of having introduced to the public some of the most eminent painters of our time; and now we continually find on its walls early works which promise in their maturity golden fruit. There are, indeed, of these earlier pictures many, infinitely preferable to others of a subsequent period, painted in a mannered and vitiated taste. An essay in Historical Art by Sir George Hayter is, perhaps, the only production of its class in the present collection; the subject is "The Martyrdom of Ridley and Craumer." A very remarkable production is an oil picture by Inghé, the first, we believe, he has ever painted in oil; it is "The Choir of the Church of Santa Maria Novella, at Florence," which we shall notice according to its merits in its proper place. Inapproachable as this painter is in his own department of Art, we cannot help rejoicing to find him exhibiting in oil. We have often regretted that there was not more cabinet sculpture executed by the artists of our school; such works might be seen to the utmost advantage here, without being overpowered by sculptures of magnitude. In works of this class, and cabinet bronzes, we are very far behind our continental neighbours. We know that many pictures are annually rejected from this institution, from want of room; perhaps not more than one-third of those that are offered for exhibition are hung; it cannot, therefore, be well understood wherefore the exhibiting space is not increased, especially as it is known that the funds of the institution are ample. Among the smaller pictures are some gems, such works as are worthy of being painted on a large scale; while, on the contrary, several of those which are large should have been put upon small canvasses; a few of these we shall instance in the course of our notice.

Of the value of this institution there is no doubt; but it is quite as certain that it is not made as serviceable to Art and artists as it might be. Of late years, however, it has undergone some important improvements; not the least of which is the reduced cost of the Catalogue, and the marking on it the prices of the pictures that are there offered for sale.

The institution, indeed, cannot fail to be regarded as a valuable auxiliary to the societies that are more exclusive in character: it is "open to all;" and has been undoubtedly of much value to "the profession" generally; the more especially as it takes place before the commencement of the ordinary Art-season.

No. 1. 'A la Ducasse, Pas de Calais,' F. STONE, A.R.A. A study of two French peasant girls—*très coquettes*—and very ready at repartee with the spectator. Twenty painters might have studied the same figures without being able to make so much of them; the body attire is common to the whole of France, but the head-dress is striking and admirably managed. We observe more of texture in the flesh than this painter has usually shown. Wherefore, by the way, a French title? is there nothing in the vernacular good enough for the nonce?

And surely these "peasant girls" are not of France, but of England, bearing evidence of the high blood of the English aristocracy.

No. 2. 'The Bay of Baie,' G. E. HERING. The beauty of the place as it is, is very different from that of the past, when Baie was studded with the palaces of the luxurious subjects of Augustus. We see Vesuvius in the right distance, and the broken line of coast trends across the picture, closing the horizon with a variety of forms; but the sentiment of the picture resides especially in the nearest section, where is seen a boat, but without any sign of life, with the exception of some sea-birds busily fishing. Their presence is an intrusion; they disturb the intense tranquillity of the scene.

No. 4. 'On the Seine,' A. MONTAGUE. A small sparkling picture, presenting a view of the Seine a little above Rouen, of which the spires, St. Maclou, and the Cathedral, appear on the right bank.

No. 5. 'A Morning's Sport at Slapton Sea, Devonshire,' H. L. ROLFE. The result is a well-conditioned jack, some perch, and chub, all painted with the truth, which ever characterises the piscatorial essays of this painter.

No. 6. 'Luna o'er the Ocean playing,' C. ROLT. The idea is realised by a nymph-like figure, which, together with the drapery, constitutes a crescent form, but the effect is enfeebled by the necessity of communicating to the whole a luminous appearance. The title is affected, but there is much sweetness in the manner of treating the subject.

No. 8. 'Sion, Canton Valais,' G. C. STANFIELD. Nothing can exceed the real substantiality of the foreground objects of this artist. These walls and buildings are of veritable stone, and the ground we tread on is a most satisfactory base; but to a certain degree the same solidity is carried into distance where we want atmosphere. On the right of the composition rises a hill crowned by a monastery, and beyond lies a mountainous distance. The whole is rendered with the utmost care, which is, of course, most observable in the foreground.

No. 9. 'Orchard Intruders,' F. UNDERHILL. Clearly a misnomer, if there be any difference between mere intrusion and absolute robbery. The subject is the robbery of an orchard by a triad of village truant; one of whom, on the wall of the orchard, is the actual thief, while the others receive the tempting spoil. The figures are more carefully made out than any we have hitherto seen in the works of the painter, but the effect is injured by the breadth of chalky wall against which they are relieved.

No. 16. 'Severe Weather,' R. ANSDILL. This is a large work—the subject, we think, is better suited for a small picture. The incident represented is a Highland shepherd rescuing some sheep that are, we presume, almost frozen to death; this, at least, must be the conclusion, because the drift is not sufficiently deep to suppose that they have been overwhelmed by snow. The shepherd's companion is a very handsome black collie, regarding with earnestness and intelligence every movement of her master. Each item of the composition is distinguished by the most scrupulous truth—the man, the dog, the sheep, and the features of the scenery; but the subject, as we have suggested, is not sufficiently important for a large picture.

No. 17. 'A Cool Day in Venice,' painted on the spot, E. W. COOKE, A.R.A. There is for the painter an endless festival in Venice, but it should be remembered that spectators do get tired of the everlasting Ducal Palace, the columns, the Campanile, the library, the Dogana, and the church of



THE WOODMAN

SCULPTED BY G. B. BAKER FROM THE GROUP OF THE WOODMAN

IN THE GALLERY OF THE BRITISH MUSEUM

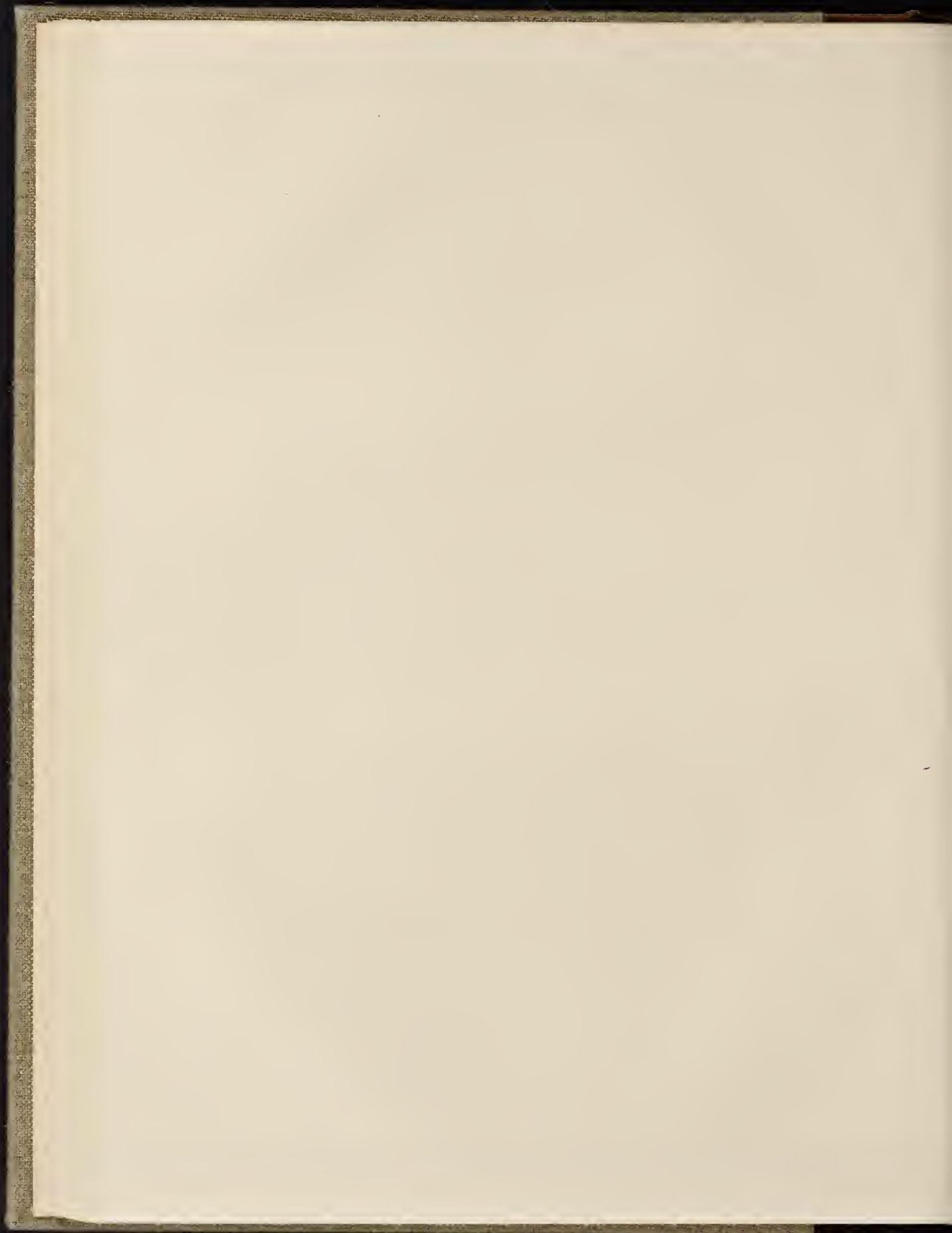

San Giorgio; we have not, like the Doge, married Venice and her sea for ever; *sempre Venezia* is as bad as *toujours perdris*. It is true we know of nothing characterised by the venerable majesty of the City of the Sea, but nevertheless its luxuries pall upon the appetite. To say that the buildings are the same as we have seen them a little short of a thousand times, is true; but it is not true to say that they are always painted thus; we have here an extraordinary finish worked out in part "on the spot," everything being sharp and palpable, because the atmosphere here is like a lens. Farewell ye storied palaces, till we meet again—on the side wall here, and in the next ensuing ten exhibitions of the season, under many a various aspect. This is a cool impression. "Marry! we shall have hot days enow!"

No. 21. 'A Tale of the Crimea,' J. E. HONGSON. A small picture containing many figures, principally an audience listening to the narrative of a wounded soldier; the subject is well sustained.

No. 22. 'Azaleas,' MISS MUTRIE. These flowers are charmingly described; the manner in which they are worked out is as new as it is effective and truthful.

No. 23. 'Sunset in the Meadows,' T. S. COOPER, A.R.A. Every blade of grass on this familiar hummock, every dock, and every sprouting weed, we recognise. As for the cows, they are infinitely long-lived: it is twenty years since those animals were in their calfhood, and they will yet live as long as the artist aspires to shine in the milky way.

No. 24. 'Scene from the Gentle Shepherd,' W. UNDERHILL. The well-known subject—Peggy and Jenny listening to the shepherd's flute. The group is seated under a tree, and the expression of each accords with the sentiments expressed in the bleaching scene. These argumentative rustics may profess to love sweet sounds, but the collier is the best listener; he is the real philharmonic philosopher. Ramsay makes these maidens too well read in the ways of a heartless world, though otherwise genuine enough in pastoral simplicity—here the sentiment is a little too scenic.

No. 31. 'A Study,' J. LUCAS. A very modest title to a work far more worthy of an ambitious name than hundreds for which distinction is sought in by lofty association. It is a life-sized head and bust of the Magdalen class, very successful in depth of expression.

No. 35. 'On the River Mole, Surrey,' G. SAINT. We have not before observed any production by this painter, who has attained to a certain amount of experience without being publicly known. The subject is a good example of the character of the "reluctant Mole"—a deep pool shut in by a screen of park-like timber. The artist seems to have endeavoured with great earnestness to define the botany of his subject, the leafage and colour of each tree is described, and much of the work seems to have been carefully studied on the spot.

No. 36. 'A Natural Reflection,' J. D. WINGFIELD. The scene is an artist's studio, which we recognise at once as the coffee-room of the old Clifton Street school. There are two figures—a young lady seated and inspecting photographs, which are held before her by an artist—personally more like Charles the Fifth than Francis the First. The plaster properties of the place are classic, dusty, and little used; the medieval "fixings" are precisely of that kind which tell well in pictures.

No. 37. 'An old Sloop on the Sands of the Dee,' W. LINTON. A large picture painted in the feeling of the gone-by school

of English Art. The disposition of material presents on the left the old wrecked and decaying craft, with an accompaniment of a stern-boat equally ragged. On the right the view opens over the sands, the ridges of which rise to the horizon. We recognise in the work a principle founded upon very honest convictions. In these days of colour and *ad captandum* effect it is refreshing to encounter anything like simplicity. The composition may be resolved into few parts, in conformity with a very limited range of colour; and from what we see of the determination of the painter, he does not care to enlarge it.

No. 42. 'Fruit,' G. LANCE. This is the dessert of a Sybarite, not so much in the rarity of the fruits as in their exquisite arrangement—so chastely assisted by the disposition of these variously-coloured leaves. Beautiful as may be a well-painted heap of fresh fruit, that beauty and freshness derive an additional charm from elegant composition.

No. 43. 'A River Bit, North Wales,' J. DEARLE. A small and simple production, painted, it would seem, in a great measure, on the spot. There is much more of natural colour in this work than in other preceding productions of the artist, although it appears to us that his foliage is more woolly than it used to be. The freshness and telling effect of the picture will sustain it under any comparison.

No. 48. 'A part of the Lake of the Four Cantons, Switzerland,' T. DANBY. The peculiar charm and sweetness of this picture are not the distinctive qualities of Swiss scenery. The filmy atmosphere which partially veils the distance here, is one of the peculiarities of the landscape scenery of our own islands. It is easy to understand that in Art, under one absorbing impression of the beautiful, which is truth, it is difficult to avoid attributing the same charming truism in other instances which affect us agreeably; what is true of Scotland is not also true of Switzerland. Much of the picture seems to have been treated ideally. We have said the worst of it; in some of the main essentials of painting it is beyond all praise.*

No. 55. 'Frances Jennings,' J. INSKIP. May we call this a historical subject—it is selected from the second volume of Macaulay? Frances Jennings, the sister of the celebrated royal favourite Sarah Jennings, on one occasion dressed herself as a fruit-girl and sold oranges in the streets. The picture presents therefore an orange-girl, whom we at once recognise as only masquerading by the delicacy of the hands and features. The paleness of the face is intended to signify a dissipated course of life, but the artist has left the complexion crude and unfinished. Many a time and oft have we admired the *leger-de-main*—the flowing facility of this artist's brush; but this example is in a style which may be described by one vulgar term of the vulgar tongue—it is so "fast" in execution that much has been forgotten, and the varnish (if it has been varnished) has chilled upon it. A very slight glaze would have subdued the rawness without affecting the paleness.

No. 60. 'The Martyrdom of Ridley and Latimer,' SIR G. HAYTER, M.A.S.L. This

* There are several pictures by this artist in the collection, but none of them have any prices: in other words, they were all sold before they were sent in. It is said that they are all the property of one collector, at Birmingham; and rumour prophesies that at no very distant period they will all make their appearance "in the market," preceded by one or two sales, at which one or two of these pictures will be made to sell for very large sums, which very large sums will become "precedents," and hence buyers will be tempted to "speculate."

subject is one involving the greatest difficulties of historical Art, and demanding for a successful issue the highest qualifications in an artist. The composition is made out according to a passage in 'Fox's Book of Martyrs.' "The scene took place on the 16th of October, 1553, close to the city ditch, outside the north gate and Bocardo in front of Balliol College, Oxford * * *. Lord Williams of Tame arrived from London with the commission for the execution; he was accompanied by the mayor and sheriffs of Oxford * * *. The sister of Bishop Ridley, and his brother-in-law, the humane keeper of his prison, and his wife with Sir Henry Lea, Sir George Barnes, Sir — Dobs, knight and alderman of London, the officers of the guard, and many friends followed them." The picture is small in comparison with the size of those usually called historical, but had it been of such dimensions, the number of figures must have been curtailed. The form of the arrangement is circular as to the agroupment; an entire enclosure being effected by the city wall and Balliol College. The particular moment represented is that of the meeting of the martyrs at the stake, which is being surrounded by faggots. On the right are seen the authorities reading the commission for the execution, and supported by all the officials whose presence was necessary in discharge of their duties. We cannot help feeling that the principal figures are small and wanting in importance in comparison with those of a group nearer the eye and in the shade; but a close examination of the work shows that it has throughout been very conscientiously painted, the object of the artist having been rather historical accuracy than pictorial effect.

No. 66. 'The Soldier's Return,' G. CRUKSHANK. The story is that of a soldier who in returning to his village home, is recognised at a distance by his wife and children. Surely no artist was ever less ambitious than the author of this picture. The tale is pointedly told, and the work is admirable from its entire absence of an affectation of drawing, colour, and execution.

No. 67. 'An Italian girl at her devotions,' H. PICKERSGILL, Jun. The head is an agreeable passage of the study, but the hands are out of all proportion in their exaggerated size.

No. 68. 'An Old Bridge near Pella in Piedmont,' G. E. HERRING. The subject has been selected with a taste for a happy disposition of form; the old bridge, especially, in the foreground is a most picturesque object, and the scenery constituting the middle and remote distances is grand. The right is closed by lofty cliffs and rocks crowned by a monastery, the left opens on a lake shut in by lofty mountains, which close the distance. The retiring masses are graduated with the nicest art, until the most remote tell faintly against the horizon.

No. 73. 'Le Vendemmie,' R. BUCKNER. A group of Italian children, supposed to be engaged in the vintage. The head of the principal figure is too pretty for that of a boy; the others are rather national and characteristic; the hands, especially those of the female figures, are too large.

No. 74. 'The Cradle,' D. W. DEANE. The scene is a cottage interior, the window of which occurs in the centre of the picture,—and opposed to the light of this, is the mother who looks down on the cradle. The opposition of the figure to the light of the window produces a powerful effect, that is well supported by the reflections.

No. 78. 'L'Allegro,' ALEX. JOHNSTON.

"Come, thou goddess, fair and free,
In heaven yclep'd Euphrosyne."

A single figure, three-quarter length, in the attitude of dancing. A most charming study, light and transparent in colour, and beyond measure hilarious in expression. Nothing can exceed the grace and sweetness of the head, it is a most brilliant conception; the features, perhaps, are rather pastoral than classic—a more elevated character had been more appropriate to the subject—but nevertheless as it is, it is one of the most exquisite figures we have of late seen.

No. 83. 'Guy's Cliff, Warwick,' E. J. NIEMANN. The subject is constituted of a portion of the castle, and a dense screen of trees extending on the right along the bank of the river; the time is evening, and the whole of the lower part of the scene lies in shaded opposition to the clear evening sky. The sentiment of the treatment is characterised by much refinement and elegance.

No. 91. 'Magnolia,' MISS MUTRIE. A small but brilliant picture of a very inconsiderable subject, to which importance is given by very skillful painting.

No. 93. 'A Moorland Farm, Devon,' J. H. DELL. The drawing and painting of these farm buildings, the edges and surfaces of these bricks and slates, are described in a manner painfully minute; nothing but a photograph could have suggested this scrupulous manipulation, which in many parts is so hard and sharp.

No. 94. 'Passing the Lock—Winter Evening,' G. A. WILLIAMS. A very agreeable version of a simple subject.

No. 97. 'Calf and Sheep,' G. HORLOR. These animals are successfully painted, but the calf is especially so.

No. 99. 'From our Own Correspondent,' W. HEMSLEY. There are two figures in this picture, one a boy reading the *Times* aloud, and an old Greenwich pensioner listening. It is a small work remarkable for finish and expression; and fully sustains the very high reputation of the excellent painter.

No. 100. 'The Sketch Book,' G. WELLS. This is a life-size study—the head and bust of a girl intent upon "the Sketch Book." The drawing is accurate, and the subject is judiciously painted, but it is felt that the head is deficient in importance.

No. 107. 'Tithe Farm,' J. STARK. From the title we might expect here an agricultural theme, or at least an essay more or less pastoral; but like the best works of the painter, it is a study of a passage of sylvan nature, rendered with infinite simplicity, freshness, and vigour; and remarkable for a feature extremely difficult in tree painting, the definition of the groups and individual trees respectively.

No. 109. 'The Brother's Lesson,' G. SMITH. A music lesson—the instrument being a very primitive pipe, and the master and pupil two youthful rustic figures, with much refinement and execution. The musicians are unexceptionable, but the background does not look natural.

No. 110. 'Portal of the Cathedral at Chartres,' L. J. WOOD. We do not frequently find these subjects interesting in oil painting, but in the small pictures of this artist they are brought forward with a taste and judicious execution that give them an unusual importance.

No. 122. 'Clovelly, North Devon,' J. WEBB. This is an attractive subject, but like every other similarly interesting, it is too frequently painted. We know every stone of the old tower-like jetty; we recognise in each house an ancient and familiar habitation: artists do themselves an unwarrantable injustice in compelling comparisons which perhaps spectators would

willingly avoid. The want of novelty in subject is, however, in this case perhaps compensated by the merits of the work: they are certainly of a high order: the picture challenges comparison with the best productions of its class.

No. 127. 'A Rainy Day on the Lagoon of Venice, a Sketch on the spot,' E. W. COOKE, A. R. A. Under every phase, hot and cold, wet and dry, have these buildings been served up; and there is, perhaps, nothing impresses the mind of an observer so sensibly with the bewildering variety of appearance that excellence in art may assume, as to see a hundred different versions of the same subject, all more or less distinguished by valuable quality. The aspect of the scene is according to the description of the title. We have long been weary of speaking of the weather-worn bricks of Venice; we turn therefore with some relief to the sky, of which nothing otherwise than respectful can be said.

No. 132. 'Sunset in the Highlands,' A. GILBERT. The simple and always striking effect of the opposition of breadths—here there are the sky and the shaded landscape—the latter a wild, mountainous, and rocky tract. With a sprinkling of the antlered denizens of these wildernesses, the principal parts being managed in this facile method a very agreeable picture is produced.

No. 140. 'Near Buceione, on the Lago d'Orta, looking towards Monte Rosa,' HARRY JOHNSON. The manner and feeling of this work are materially different from those of anterior productions. The picture is larger than any we remember to have seen under this name, and we are impressed with its substantive interpretation of nature rather than by flashes from an enchanted brush. We are placed opposite to a block of Italian buildings, with all the variety of parts useful only to be painted; and thence the eye is invited to ascend and scan the mountain sides and crests which sweep round the basin of the lake. The whole is most substantial and earnest, and a most successful and striking passage of the picture is the description of the rapidity of the current as it flows by us; and it is to be observed as a local truth, that the distances do not wear the atmospheric veil which envelops remote objects in our own land.

No. 143. 'Choir of the Church of Santa Maria Novella, Florence,' LOUIS HAGHE. The subject and the painter are worthy of each other. This is a part of the famous church occupying one side of the Square of Santa Maria Novella, and which the lips of Michael Angelo were never weary of praising. Here are works of Cimabue, of Ghirlandaio, once the master of Michael Angelo, of Bronzino and Allori, Orgagna, and early productions of Giotto. But with these we have now nothing to do; turn we therefore to this famous choir as we see it before us—the centre of which is occupied by a large lectern, somewhat exaggerated here, we think, as to size. Having been for many years accustomed to see the most admirable sacred and secular interiors painted in water colour by this artist, we cannot help comparing him with himself. Haghe's most formidable competitor is Haghe. These water-colour works have every charm of light and colour, and perfect illusions of depth and transparency; but in this picture the shaded passages are opaque. If the artist understands glazing in oil colour, he does not practise it successfully. But we forgot to mention that this is his first essay in oil painting, at least that we have seen. The shades are heavy and dull, and there is a thinness and sharpness in the execution that reminds us of water-colour;

but there is, withal, a unique equality in the picture which would distinguish it amongst works of the highest pretension. The interior derives animation from groups and single figures of the Dominican brotherhood, some in movement and others at devotional exercise. In a word it is a production of considerable power.

No. 158. 'Timber clearing on the hill-side, Sussex,' H. JURSTUM. Rather a large picture, and full of the most conscientious elaboration. On the left rises a screen of noble trees, with an accompaniment of the graceful garniture of dwarf and gigantic grasses and wild flowers, which constitute the wealth of a weedy foreground. From the immediate section the eye is invited to the near and remote gradations, and whether this work represents or not a veritable locality, we feel proud of our land in contemplating such passages of Art, because we know, to use a very common proverb, *se non e vero e ben trovato*. The sky teeming with clouds, and the lazy atmosphere are our own. The description of distance and expanse is most successful, and this is much assisted by the sunlight, here and there escaping the envious clouds, and dropping on the summer foliage of the magnificent trees, which extend even to the mysterious veil that hides the horizon from the eye.

No. 161. 'An English Landscape,' J. DEARLE. A subject as simple as could well be selected; but an eloquent evidence, if any further were wanted, that the greatest charm in Art is fidelity to Nature. The subject is composed of a corn-field recently reaped, all the sheaves being stacked—on the right a road, a few straggling trees, and a distance. We like this picture better than any of the river-side subjects we have seen by the same hand, as the colour which should be natural, is so, and not chalky.

No. 162. '***' H. W. PICKERSOILL, R.A.
"The young village maid, when with flowers she dresses
Her dark flowing hair for some festal day,
Will think of thy fate fill, neglecting her tresses,
She mournfully turns from the mirror away."

These lines from Moore's "Fire Worshipers" stand in the place of a title to one of those life-sized studies illustrative of Oriental female character, of which this artist has painted so many, and many of much excellence. There are beautiful parts in the work; and if not so agreeable as a whole as others he has even recently exhibited, the work sustains the high reputation of the accomplished painter.

No. 169. 'Stray Sheep,' R. ANSDALL. It is difficult in this composition to say whether the animals before us have strayed from another flock, or are errant members of the flock confided to the herd who is approaching. This may be immaterial, as to the general merits of the picture; but if any narrative be intended in the spirit of the title, the description appears imperfect; but we cannot help admiring the character of the animals, which it appears are taken in a rocky nook. They are alarmed, and, although they are standing still, it is sufficiently clear that they are rapid in movement and even headlong in flight, almost as wild as *ferae naturae*.

No. 172. 'View near Rothsay on the Clyde, Scotland,' J. DANNY. According to the principle of this artist, the parts of this picture are few—water and mountains. His composition is frequently identical—water shut in by mountains; and his effect is generally the same, that derived from the evening sun. The effect is warm and glowing; but the water is deficient of the same breadth which prevails in the upper parts of the picture.

No. 176. 'Sunset,' W. A. KNELL. This is evidently the work of one who has looked very closely at Nature—we know this to be true;—but were it not so, the work would strike the spectator in the same way. The colour of the sea tells us we are in some large estuary. The sunset is pointedly described; there is wind in the sky, and movement in the water; but we feel the latter to be spotted with lights which, although they in some degree support the proposition of the title, yet destroy the breadth of the lower part of the picture.

No. 177. 'Roman Piper,' R. BUCKNER. A life-sized study of a rustic of the Campagna. The head is looking up with an expression full of thought and intelligence. It is one of the best of this painter's works; and may rank among the best in the collection.

MIDDLE ROOM.

No. 184. 'A Scene suggested by the Death of Pompey,' T. DANBY. Here, then, we are on the shore of the Bay of Alexandria, unseen witnesses of the absorbing grief of the freed-man Phillip as he laments the fate of Pompey, near whose body he sits. We see very distinctly the weeping Phillip, but his dead master is very indistinctly shown, and this is more judicious than to show a revolting object. The effect of the picture is somewhat like that of moonlight, and the whole has a very misty appearance, which is not generally true with respect to Egypt, for there the atmosphere is so clear that even distant objects come forward with much decision and sharpness. But whatever objections may be made to the work, it is one of the best of the landscape (?) quasi historical pictures we have of late seen: the drawing is good and firm, and the proposed effect successfully worked out. A heron is flying away across the sea, and a lizard has just come forth from its hiding-place; the presence of the one indicates tranquillity, but the departure of the other betokens disturbance; but we submit that neither should appear in such a picture. The heron is not a sea-fowl, and although the lizard may be found near the sea, it is no amateur of salt water. The body by the way should be headless; it is not so.

No. 204. 'Winter, Evening—a Black Frost,' C. BRANWHITE. It may be very cold within the freezing region of this canvass, but the spectator is not so rapidly iceed as in contemplating one of the combined frost and snow pieces of this painter. The effective point of the picture is the sky, which is intensely red, broken by dark streaky clouds, which are too material and opaque. The composition is successful, as are all those of the painter, though looking as if gathered piecemeal from Nature and skilfully fitted together. The principal object is on the left, an old lime-kiln, or what you will, by a river's side, and moored near this is a barge being loaded. The river with rows of trees on its banks runs into the composition, an arrangement which is managed with a result perfectly successful.

No. 205. 'The Egyptian Ivory Merchants,' FRANK DILLON. This is, in all respects, a remarkable work, novel and interesting in subject, and, though elaborately wrought, exhibiting much freedom of touch and masterly skill in treatment. It is, perhaps, too abundant of materials, yet all the accessories are evidently painted from nature, and some of them are so highly finished as to vie with the best examples of still life. The artist has obviously travelled for study; his knowledge is not derived from books, but from personal acquaintance with the

character and objects he depicts. Hence the true value of this painting, which combines ability with observation, and thought with industry.

No. 206. 'A Water Nymph,' J. COLBY. A small, all but nude figure, relieved by a white drapery thrown behind. A well-drawn and graceful study.

No. 210. 'Minding the Cradle,' G. SMITH. This is altogether the most perfectly finished little work that the artist has yet exhibited. The subject is of the simplest kind, but in drawing, colour, and transparent depth it is a charming production.

No. 212. 'Cupid tending a Butterfly, Emblem of the Soul,' J. G. NAISH. A conception worthy of the best of the Greek poets. Cupid is flying, and threatening a butterfly with his arrow. The dark colour of the butterfly is a spot in the picture, the insect had been better white for more reasons than one; besides it is that member of our common entomology called "the devil's butterfly." The little figure is charming in colour.

No. 218. 'Northland, Sussex,' J. STARK. A section of wooded scenery, with a road passing through it. Each tree is so well painted as to be individually defined without in any wise destroying the breadth of the whole. These latter works are infinitely better than all that have for years past gone before them.

No. 219. 'The Warrener's Boy,' W. HEMSLEY. A single figure carrying a rabbit—a miniature brought forward with the most scrupulous care.

No. 222. 'Fishing Craft, &c. in a Calm,' W. A. KNELL. As to finish, colour, the character of his craft, and other qualities, this artist desires to break a lance with some of the best of the Dutch painters; but his water is not liquid, and his surface generally harsh.

No. 225. 'Cut Melon and other Fruits,' W. DUFFIELD. The fruits individually are well painted, but the arrangement is deficient of grace.

No. 230. 'The Monte Rosa, Early Morning,' G. E. HERING. The time is sunrise, but nothing is yet lighted save the snowy peaks of the distant mountain—all else is in the gloom and the grey of the morning. A market-boat is on the lake near us; we hear the plash of the oars, but all beyond are silence and tranquillity, presided over by the young crescent of the moon, and one solitary arid forsaken star. The sweetness of this poetic effusion is far before everything which the artist has hitherto achieved in pictorial verse.

No. 231. 'Nymph and Cupid,' W. E. FROST, A. R. A. One of those miniatures which this artist endows with such classic feeling. The Nymph may have been wounded by one of those envenomed arrows; she has therefore seized the bow, and refuses, with bitter reproaches, to return it. The incident is common, but it has seldom been more beautifully rendered than we see it here.

No. 245. 'Danish Fishing Craft on the Elbe at Blankenese,' E. W. COOKE, A. R. A. The boats, as usual, are very conscientiously made out, but every thing about them is as hard as Pharaoh's heart, and nothing is natural in colour—hence the commendable qualities are obtained at a great sacrifice.

No. 246. 'Little Gretchen,' H. LE JEUNE. A study of the head of a little girl sitting with a book on her knee. The face is Dutch, and the feeling of the picture is entirely Rembrandtesque. There is no straining after poetic beauty, it is a purely natural essay; the flesh is soft, warm, and yielding, and the expression life-like and intelligent. It is such a study as Rembrandt might have

made in his youth, for he did work then very minutely, as instance that marvellous example in the second or third room of the Pitti Palace.

No. 250. 'Cruising amongst the Water Lilies,' a Sketch, F. M. MILLER. A Cupid in a shell skiff, sailing in a flowery pool. A pretty conception, agreeably realised; we remember some sculptural productions of this artist of much classic chastity of feeling.

No. 252. 'Rabbit Ferreting,' HARRY HALL. The figures in this work have been very earnestly studied, but it is a mistake to relieve them by a pale background, leaving them as it were cut out of the composition.

No. 260. 'The Raft,' T. M. JOY and J. WEBB.

"O source of life, our refuge and our stay,
Whose voice the warring elements obey,
On thy supreme assistance we rely,
Thy mercy supplicate if doomed to die,
Perhaps this storm is sent with healing breath,
From neighbouring shores to scourge disease and death," &c.

The subject is from Falconer's Shipwreck, but from the time of the first exhibition of the dying survivors of the Medusa, every marine painter has produced at least one "raft." The scene is always distressing—the circumstances, with little variation, are identical—but certainly this is one of the best versions we have seen of the subject. It is sunset, and if we read the story aright there is hope, the distant ship bears up. For Mr. Joy this is an entirely new department of Art; the work is perfectly successful in exciting the emotions which it is intended to reach: is painted with much care; and is indeed a production which closely approximates to, if it does not absolutely reach, the higher qualities of genius.

No. 261. 'The Eagle's Craig,' J. DEARLE. In all the works of this artist we feel first the positive opposition of the sky and the lower section of the composition. The "Eagle's Craig" is a cliff on the other side of a stream which bisects the scene horizontally. The base of the cliff is lost amid the trees which grow on the hill side; the trunks of the trees are definite and sharp, but the masses of foliage are woolly and confused, conditions which cannot coincide in Nature; if the trunks are truly represented, the masses of foliage are wrong; if these are right, the representation of the boles of the trees is false.

No. 262. 'Il Penseroso,' ALEX. JOHNSTON. What Milton could mean by re-baptising, by these sidelong masculine Italian epithets, his nymphs Joy and Melancholy, does not very clearly appear. The marriage of masculine and feminine is natural enough in every way, save in outrage of the second grammatical concord. The position in which Milton has left these ladies before the world is at least equivocal. The figure so entitled is a worthy pendant to "L'Allegro," already noticed.

No. 266. 'Beauvais,' A. MONTAGUE. These dear, dirty, picturesque old houses of Normandy and Brittany help a picture so much! But we think the wooden-framed palaces of Beauvais are scarcely so ragged as we see them here.

No. 273. 'The Morning Lesson,' W. H. KNIGHT. Consisting of two figures—the grandmother mending stockings while the grandchild stands by occupied with the "lesson"—a small picture leaving nothing to be desired.

No. 274. 'A Shepherd Boy,' J. INSKIPP. In our experience of the last fifty years we have never known an artist so ambitiously true to himself as this painter. Whether he recruit himself from Aristides or the

Vicar of Bray matters little. We have for the last twenty years had a nodding acquaintance with the young gentleman in the smock-frock. We wish he were a little more carefully adjusted. We should be sorry to leave him worse than we found him.

No. 275. 'Glaunorfa, Carnarvoshire,' J. W. OAKES. A landscape of much merit, closely imitated from nature.

No. 276. 'The Hypæthral Temple, Philoe, Nubia,' FRANK DILLON. A very famous and beautiful remnant of Egyptian architecture. It is a large and earnestly wrought picture, presenting the temple in the best point of view we have ever seen it. This and the work already noticed (No. 205) will very considerably raise the reputation of the artist: there are indeed few living painters who could have treated this subject better: broad in style, yet industriously wrought as well as carefully considered, there are not many better pictures among the productions of the past year.

No. 277. 'The Emperor Charles the Fifth at the Monastery of Yuste, August 31, 1558,' W. MAW EBLEY. We have seen and written of this, or a smaller sketch for the picture, before.

No. 286. 'Maryport, Cumberland,' W. LIXTON. Presenting a view of a portion of the harbour at low water. The effect introduced is that of uncompromising daylight unassisted by any accidental shades, in which proposition the artist has succeeded admirably.

No. 290. 'Jephthah's Daughter,' E. HUGHES. A charming miniature, but the title is a misnomer,—there is no attempt to idealise the character proposed.

No. 306. 'Midsummer Fairies,' J. G. NAISH. The time is midnight, and the elves are sporting among the leaves of flowers,—a geranium being their favourite resort. The flowers and minute figures admit of the closest examination.

No. 310. 'The Alhambra, Granada,' as seen from San Christoval, from a Sketch by Richard Ford, Esq., W. TELBIN. We have not seen in any work of Art so much of the magnificent scenery around Granada as is represented in this picture, all the details of which are most scrupulously rendered. The grand line of the Sierra Nevada closes the view.

No. 326. 'British Bulwarks,' H. DAWSON. A large picture, which takes us to Spithead, or the Medway it may be. The effect is that of sunset painted with all the power which this artist exercises in his morning and evening essays; the evening gun is just booming from one of the lower ports of a three-decker—the principal object in the picture—which by a little *rise* of perspective is brought forward as of immense proportions. Turner has done this before. It is a production of distinguished merit.

No. 338. 'Dunstaffnage Castle, Loch Etive, Scotland,' J. MOGFORD. A glowing sunny version of a most interesting passage of scenery.

No. 339. 'The Ptarmigan's Haunt,' J. WOLF. A large picture of a section of wild Highland scenery. The birds are admirably drawn, but the rocks are so much like them in colour as very materially to injure the effect of the composition.

No. 340. 'Morning on the Welsh Hills,' A. W. WILLIAMS. In this work, the subject of which is a passage of wild mountain scenery, there are some cattle, apparently well drawn. It is essentially different in feeling from the usual works of this painter—broad and substantial, and yet very minutely detailed.

No. 352. 'Rosalind,' H. O'NEIL.

"From the East to Western Ind,
No jewel is like Rosalind,
Her worth being mounted on the wind,
Through all the world bears Rosalind."

This study, that of a single figure (perhaps too dramatic), is brought forward with all the tenacious elaboration which distinguishes the works of the artist. The lower limbs are out of drawing; the length of the thigh looks altogether disproportionate.

SOUTH ROOM.

No. 358. 'Interior, Ditton House,' C. H. STANLEY. Rather a large picture, presenting a spacious apartment, sumptuously furnished, and enriched with objects of Art. It is rich in colour and well lighted.

No. 361. 'Imogen and Iachimo,' W. GALE. The passage of 'Cymbeline' supplying the subject is found in the seventh scene of the first act—

Imo. Away! I do condemn mine ears that have so long attended thee. If thou wert honourable, Then wouldst thou have told this tale for virtue, not For such an end thou seek'st, as base as strange."

The action of the two figures in this picture is unnecessarily exaggerated; there is a violence in the movement of both altogether inconsistent with dignity of expression. The work does not possess the merit of antecedent productions.

No. 386. 'The Guards relieving the Trenches before Sebastopol, from a sketch taken on the spot,' Hon. C. S. HARDINGE, M.P. We see here the long line of troops winding down into a ravine formed by lofty and towering cliffs. The city and line of attack appear in the distance. The picture presents, we presume, a faithful description of the locale, and possesses much interest, not only with reference to the subject, but as a work of Art.

No. 394. 'Enamel of the Infant Saviour,' W. ESSEX. After Murillo, we think; charmingly wrought, and undoubtedly like the picture.

Nos. 396 and 397 are two enamel groups of 'Flowers,' by Miss H. ESSEX. The bouquets are relieved by a dark background, and each flower is painted with the utmost delicacy of touch.

No. 398. 'Evening,' E. J. COBBETT. A small study of a country girl at a well, brought forward with all the best qualities of miniature Art.

No. 432. 'Dunolly Castle, near Oban, Scotland,' J. DANBY. This is a repetition of the same phase which this artist always paints: an expanse of water and mountains, presented under a sunny evening effect.

No. 433. 'Feeding-Time,' C. HANCOCK. A number of farm-yard animals are here agrouped in a stable; the principal of these is a cow, which is well painted.

No. 436. 'Cupid and Psyche,' CLEMENT BURLISON. In these two figures there is good colour, but in each the classic character is wanting. There is too much of the individuality of the model; the composition also is too much broken up into detail.

No. 445. 'Ronen,' J. HOLLAND. The view is taken from below the line of the quays, and on the opposite bank of the Seine, showing the imposing façade which has comparatively recently taken the place of the wooden-framed houses that still numerously exist in other quarters of the town. The subject is at once recognisable by the spires of St. Ouen and the Cathedral, which rise above the houses. The proposed effect is that of bright day-light, which is admirably sustained.

No. 449. 'The Guard-room,' R. CLOTHIER. A small interior, in which is a solitary cavalier of the seventeenth century, with a quantity of armour of the same period, all very accurately described.

No. 458. 'A Fairy Ring,' G. CRUIKSHANK. The subject is suggested by the popular supposition that the moonlight fairies have danced in those small circles which are common in all pasturages. But here we are amid a jovial company of midnight elves, dancing round Oberon and Titania enthroned on a toadstool. The tumultuous tread of this frantic gallop reaches our ears; and music! was there ever such a troop of earnest musicians,—at least a thousand minute spiritualities labouring on all kinds of instruments. Some of the company are late; they arrive on bats from the moon and stars. We have not really space to do justice in description to these revels; the artist must have assisted at these festivities. He may himself have been born again under Aquarius, but some of his little impalpable friends here have, most shamefully broken the pledge.

No. 472. 'Amiens,' A. MONTAGUE. A very picturesque subject, at once recognisable by the striking features of the composition.

No. 488. 'A Welsh Spring,' E. J. COBBETT. Two Welsh girls gossiping at a spring, while the thin and tardy thread of water fills their cans. The heads are painted with all the artist's usual sweetness, and the rest of the picture is worked up to equal value, especially the herbage and the local portions of the composition.

No. 502. 'Fresh Breeze, Dublin Bay, from East Pier of Kingstown Harbour,' E. HAYES, A.R.H.A. The breeze is rendered with great spirit, and the whole of the points of the composition are well brought together.

No. 503. 'Noontide on the Thames, near Henley,' W. J. FERGUSON. A subject extremely difficult to paint, but treated in this picture in a manner very gratifying to the eye from the natural truth prevalent throughout the picture.

No. 520. 'Squally Weather off Dover,' J. J. WILSON. The subject of this work has often been painted. It is the view from near the entrance to the harbour, looking towards the Castle. The character and principal features of the scene are so striking, that it is at once determinable as a view of Dover.

No. 537. 'Finding the Lessons,' J. COLLINSON. We have more than once commended the extreme earnestness of this artist. This work is throughout not less conscientiously executed than those productions which have earned for him his well-merited reputation.

535. 'An Autumnal Day, a scene on the Bovey Heath Fields, with Dartmoor Hills in the distance,' W. WILLIAMS. We feel the foliage here rather more crisp than in nature, but other passages of the work are very creditably executed.

The sculpture of the exhibition, as we have already observed, is limited as to the number of works; of those that strike us there are, a 'Marble Statue of a Young Girl,' T. THORNYCROFT; 'Undine,' a marble statue, ALEX. MUNRO; 'Model of a group executed in stone and now fixed upon the portico of the New School House for Female Orphans,' E. G. 'PHYSICK'; 'Zephyr and Aurora,' T. EARLE; 'The Queen of the Waters,' J. GEFFS; 'We frolic while 'tis May,' FELIX M. MILLER; 'The Good Shepherd,' P. VANLINDEN; 'Venus and Cupid,' S. A. MALEMPRE, Sc. We have looked carefully through the collection and find every department of Art represented; but we find a lamentable deficiency of impressive subjects, a want that must rest with the artists themselves, many of whom, in the enjoyment of reputation, are by no means equal to themselves as we have known them.

THE
CARVINGS OF GRINLING GIBBONS.

In calling the attention of our readers last month



Mr. Rogers having been professionally employed to direct the preservation of the carvings by Gibbons, at Belton House, has very properly stated the result of his investigations and experience before the Royal Institute of British

to the preservation of carvings by Grinling Gibbons at Belton House, Lincolnshire, under the direction of Mr. W. G. Rogers, we mentioned that in all cases photographic views of these high works of decorative Art were first taken to serve as a memorial of them in their original state, and as a guide to their re-position. Of these photographic representations we have selected one for engraving from the gallery of the chapel at Belton House, but which evidently was designed for the decoration of a dining-room. It is one of the perplexing disarrangements frequently to be met with in old houses, that time has produced innovations so inconsistently, that sacred subjects have been removed to private rooms, and emblems of festivity transferred to the walls of an ecclesiastical edifice. In the composition before us, the intention of the artist is carried out with the most scrupulous attention to propriety, everything being avoided which does not strictly belong to the subject. The upper part is composed of two cornucopias, the horns tied at the top with bunches of flowers crossed with palm branches, and bound together with wreaths of bntercrops which unite the top to the sides.

The sides hang from ribbon ties, and consist of a profusion of finely formed fruit, corn, hops, and wild flowers; some of the most disregarded of the latter class being turned to the best account and introduced with the happiest effect. The poppies and poppy-seeds with the elegant foliage of this class of plants are sculptured with the nicest appreciation of arrangement, while flowers of lesser note are pressed into the service in a way unappreciable by those who, studying in the drawing-room, rather than in the meadows, content themselves with conventionalities instead of nature, and attach a vulgarity of their own to all except roses and lilies.

Grinling Gibbons, as a great artist studied nature deeply and unceasingly, but whenever her works claimed the labour of his chisel, they were not slavishly or unmeaningly copied irrespectively of use or position, but were employed rather as the materials for composition than as composition itself. They were introduced and grouped with the most devoted attention to the architectural effect of the buildings destined to receive at his hands their choicest embellishments, and the appropriate nature of his classifications must long furnish a theme for the admiration of students. He broke through the rules of conventionality in a manner almost unprecedented, and it is probably on these grounds that he has received the meed of so much popular, although richly deserved approbation; but we are not aware that any attempt has ever been made (only possible by the assistance of photography), to form a critical examination of the works of this great master, and to compare his rich and varied compositions with those of other schools, and especially with those represented by Giovanni da Udine and Raffaele.

It cannot be doubted that all possible opportunities should be seized upon for the preservation of the works of a man who has given to the Art of wood-carving in this country a fame more than European, and who as an artist especially appointed by the state, and working under its immediate patronage, left behind him for the admiration and guidance of succeeding generations, works in royal and palatial edifices, which are pointed out as proud specimens of British decorative Art, although they exhibit the bloom of a fallacious youth, and are positively falling into irreparable decay.

Architects, and has accompanied his remarks with a startling revelation as to the state of nearly all the carvings of the period of Charles II., James II., and Queen Anne in this country. These magnificent remains are so rapidly perishing, that if immediate means be not taken for their preservation they must soon cease to exist. From one end of the kingdom to the other an insidious disease is preying upon the vitals of the noblest works of sculpture in wood this land ever produced. The fabled fruit of the Dead Sea was not more fragile or more filled with putrid dust than the fruit, the work of the chisel of Gibbons, which hangs on the walls of Bntleigh, Potworth, Chatsworth, Wollaton, Belton, Oxford, Cambridge, Windsor Castle, Hampton Court, Gosford House, Lowther Castle, Witley Court, and other public and corporate buildings, but also on the very many choice objects of his art in private collections, such as portraits of royal and noble persons, set in panels surrounded by a glorious profusion of emblematical decorations, thrown about them with a freedom and daring truly marvellous, and with a delicacy equalling the famous point-lace tie from Strawberry Hill, now in the possession of Miss Burdett Coutts, or the string of family portraits dispersed among the carved flowers in Lord Ilchester's borders. Mr. Rogers has, no doubt, ascertained, from his long familiarity with these works, that many historical records are preserved in them, and if they could be brought together, they would fill a gallery, and form an exhibition of great interest.

In many of our city churches there are the seeds of the same approaching decomposition. The white superficial bloom (so agreeable to the eye of the uninitiated), which appears in nearly all the specimens Mr. Rogers has seen and handled is assisting to complete the work of destruction. This mildew, covering the surface of the fruit flowers, and dead game, is a vegetable thrown off from the decaying interior, and must ultimately, if left to accumulate, destroy the skin or rind which holds together the outward form only, the interior being nothing but skeleton fibre powdered with dust and unable to resist the slightest pressure.

Specimens of carvings by Gibbons taken from various sources were recently exhibited at the Royal Institution; some presenting the deceptive bloom alluded to, some in which it had been removed by the touch, and some in which Mr. Rogers had sawn the fruit in two so as to show the interior honeycombed by worm, suggesting to the observer that the carvings have been so far neglected as to reach the extreme period at which preservation is possible.

Surely it is high time that works of Art of such national importance as those which we have named as existing in the various palaces and mansions of this country, should receive the small amount of skilful attention indispensable for keeping them from actual annihilation. To preserve is not necessarily to restore. Restoration is sometimes worse than neglect; but we maintain that wherever a festoon or frieze or drop or truss by Gibbons exists, it demands, as public heir-loom, that chemical science and practical experience should be exerted and employed upon it to arrest the progress of the animal and vegetable foes, whose devastations have been so opportunely pointed out by Mr. Rogers.

We trust the means resorted to for restoration will be employed without delay to rescue these fine works from destruction.



THE ILLUSTRATED
HANDBOOK OF ARCHITECTURE.*

Few things have been so industriously cultivated among us of late years as architecture—both the study of its ancient monuments as a branch of archaeology, and the pursuit of it as a fine art: and it is well worthy of the pains which have been bestowed upon it. Its ancient monuments, bearing as they do the impress of the national traditions, and of the actual civilisation of the peoples who built them, are among the most important evidences of history; less durable only than written literature, and inferior only to it in value. As an art, architecture is the most popular of the fine arts; for its *chef-d'œuvres* are not secluded in galleries and locked up in cabinets, but are set before the eyes of all men in the streets and public places of the great centres of population. And though the popular favour for it may have been a little disproportioned to the popular cultivation of other elements of history, or other branches of art, yet this is not at all to be regretted; for the circumstances of the times made it desirable that the thoughts of all sorts of people should for a time be concentrated upon this one subject. We are in the throes of the birth of a new architecture; and we need that antiquaries should hunt out and arrange all the old schools of the art; that practical people should consider what additional conveniences and comforts they require; engineers should tell how to apply all the contrivances of modern science; architects should take orders from the practical people, apply engineering science, with minds imbued with the principles of their art, gained by a study of its ancient monuments; and that the whole educated people should look on and criticise.

Both for the historian, the artist, and the *dilettanti* patrons and critics, it was in the first place important to have a correct general knowledge of all preceding schools of architecture. Much has been done to furnish them with the materials;—for the last twenty or thirty years a continuous series of grand architectural works have issued from the press, from elephant folio in size downwards, full of the finest illustrations which pictorial art, from line-engraving to chromo-lithography, can furnish; so that now there is hardly a school of architecture, ancient or modern, upon which we do not possess some important works. But alas! the cost of such a collection of books as this amounts to a sum such as not many artists can afford—such as few amateurs can afford to spend upon the study of only one subject. And then the careful study of all these monographs—the digesting from them of a clear comprehension of the history, and principles, and characteristics of each school of the art—and the connecting of this knowledge of all the different schools into one comprehensive view of the whole subject; this demanded an expenditure of time and labour which very few men, artists or amateurs, would or could devote to it.

It was necessary to premise these observations in order to give a fair idea of the importance and value of such a Handbook of Architecture as this, for which we are indebted to Mr. Fergusson. The plan of Mr. Fergusson's work embraces the great styles of architecture of the whole world;—the Buddhist and Hindoo; the Egyptian, Assyrian, Persian, Greek, and Roman; the Saracenic of Syria, Egypt, Persia, India, Spain, and Turkey; the Romanesque, and the styles which sprang from it in Lombardy, and on the banks of the Rhine, in France, Belgium, Germany, Italy, Spain, Great Britain, and Scandinavia; the Byzantine of the East and of Russia; and the styles of China and Central and South America.

One might perhaps anticipate that in so wide a range, some parts at least would be executed

superficially, or would be mere compilation; but this is not the case: every separate article bears internal evidence that extensive research

has been made into all the available data, and that the material so collected has been carefully and thoroughly studied: the author has made

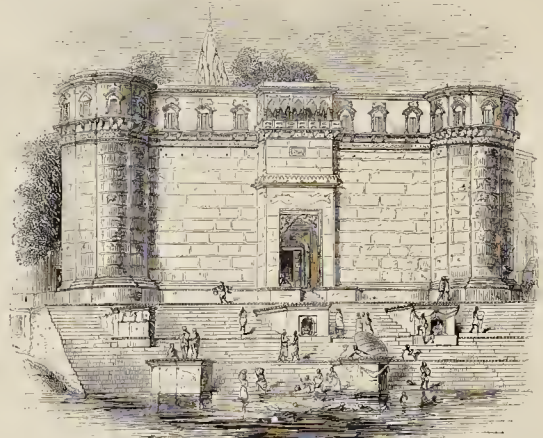

GOPURAM GHAT, BENARES. (FROM TRINSEP'S VIEWS.)

himself master of each style before he has begun to write upon it. And the book is not a mere analysis of ancient buildings—it is really what

it professes to be—a History of Architecture: it gives such historical notes and sketches as enable the reader to connect the buildings



VIEW OF PORCH AT CHILLUMBRUN. (FROM DRAWINGS BY THE AUTHOR.)

with the history of the people whose monuments they are; and we have throughout the book valuable comparisons and criticisms of the

various styles of the Art, and of the different great buildings which are most instructive as examples of the true principles of the Art. The

* THE ILLUSTRATED HANDBOOK OF ARCHITECTURE; BEING A CONCISE AND POPULAR ACCOUNT OF THE DIFFERENT STYLES OF ARCHITECTURE PREVAILING IN ALL AGES AND COUNTRIES. By JAMES FERGUSSON, M.R.I.B.A., &c. Two vols. 8vo. pp. 1004, woodcuts 550. London: JOHN MURRAY, Albemarle Street.

work is illustrated with no less than 850 very excellent wood-cuts of plans, sections, elevations, and perspective views of the most important and most typical buildings of every style of architecture.

On the whole, then, this is a valuable addition to our historical and fine-art literature,—valuable to the general reader, who will find that the masterly sketch of the whole subject which is here placed in his hands, will make other architectural works unnecessary, except for the thorough prosecution of some especial branch of the subject; and no one, we feel sure, will more readily recognise its value than the professional reader; unless he have a first-rate architectural library, and have bestowed years of diligent and judicious study upon it, he will find very much in this little work which is new and important to him: every architect will find it a valuable hand-book and guide to his more extensive studies; and after all his study, will still find it a useful compendium, and index, and book of reference. In these days of superficial books, we were not prepared to find so much learning, and thought, and judicious labour, within the small compass of two octavo volumes.

We are enabled by Mr. Murray's courtesy to present our readers with several examples of the illustrations of the work, which we have selected so as to give some idea to the eye of the wide field which the work embraces. But in endeavouring to give some further notion of the value of Mr. Fergusson's history, we shall confine ourselves principally to a digest of some of his suggestions upon our own English Art.

In the first place we may notice that Mr. Fergusson finds fault with the received nomenclature of the subject, and suggests some modifications. Some of the terms which are commonly used involve the assumption of incorrect theories, and thus unnecessarily introduce error and confusion at the outset into the mind of the student and of the general reader, who naturally assume that the theories implied in the very terminology of the sciences are the received and correct theories of the sciences. It has become the fashion, for instance, to apply the term "Byzantine" to styles as unlike anything Byzantium ever saw as any style can be to another, and where it is impossible to trace any influence direct or indirect that capital ever had on the buildings in question. "Romanesque" in like manner is applied to styles as essentially barbarian as the most pointed and most florid Gothic. It has been attempted to apply the name "Lombard" to all the round arched styles of Europe, and German and Teutonic to all the pointed styles, all involving the assumption of theories, which, so far from being granted, are generally without the least foundation in fact. The term "Gothic" which is usually applied to the pointed styles only, Mr. Fergusson proposes to extend also to the earlier styles which were engrafted on the Roman by the barbarians who overthrew the Roman Empire and founded upon its ruins the kingdoms of modern Europe. This he would subdivide into round-arched and pointed-arched Gothic. If it were desirable to introduce a new term in the place of Gothic, Mr. Fergusson would adopt that of Feudal as the most characteristic, since the style of which we are speaking arose, culminated, and fell with the Feudal system.

For the subdivisions of English Gothic he would abjure technical and descriptive terms, and use dynastic terms only, such as Saxon, Norman, Plantagenet, Edwardian, Lancastrian, Tudor, Elizabethan, Jacobean, and Stuart. From his resumé of the history of English architecture we call the following notes.

Of the Saxon architecture hardly enough is left to teach us the characteristics of the style; it was probably a rude style of Art; but a considerable interest attaches to it, because probably it is to its influence that we must attribute some of the peculiarities which distinguish all the English styles of Gothic from the contemporary Continental styles.

The Normans brought over their own artists and introduced their own style of building: their early buildings in England consequently exactly resemble the contemporary works of the Continent. But as the Saxon and Norman races

gradually coalesced into the English, so the Norman art was gradually influenced by the old

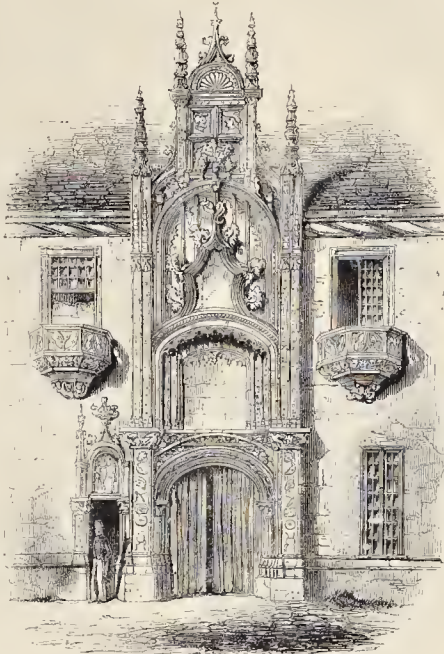

PORTAL OF THE DUCAL PALACE AT NANCY. (FROM DU SOMMERARD.)

Saxon; until by the beginning of the twelfth century the English style of architecture had



CHOIR-SCREEN FROM THE MADLAINE AT TROYES. (FROM ARNAUD, "VOYAGE DANS L'AUBE.")

become very different from the contemporary Continental style; we may call it Norman

Saxonised, or Saxon Normanised, but certainly it is not Norman. Indeed the buildings of the latter half

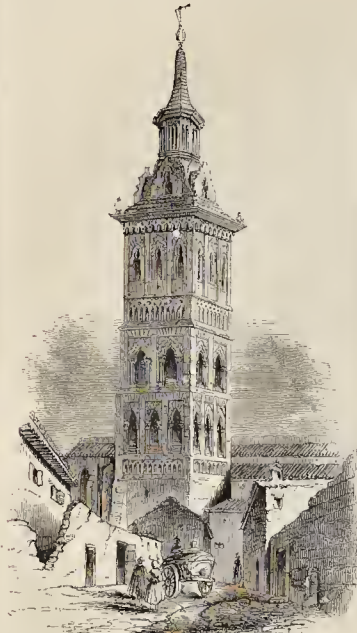

TOWER AT ILES-CAS. (FROM VILLA AMIL.)

of the twelfth century show that the English were making considerable progress in the elaboration of a perfect round-arched Gothic style; but at the end of this period they fell under the spell of the new French art, which had then for some time been using the pointed arch, and had already brought to some perfection the new style to which that new constructive feature gave rise. For Mr. Fergusson lays it down as beyond question that we did not evolve a pointed style contemporarily with the French; but that the style arose first in France, and after some thirty to fifty years was adopted in England, and not till half a century later still by the Germans, and was never adopted by the Italians.

The thirteenth century was the great building era; not even the Pharonic era in Egypt, the age of Pericles in Greece, nor the great period of the Roman Empire will bear comparison with the thirteenth century in Europe, whether we look to the extent of the buildings executed, their wonderful variety and constructive elegance, the daring imagination which conceived them, or to the power of poetry and of lofty religious feeling that is expressed in every feature and in every part of them. Mr. Fergusson goes into interesting critical descriptions of some of the great works in this and the other Gothic styles, which we recommend to the attention of our readers, but into which want of space will not allow us to follow him.

The geometric tracery of the

succeeding style was first introduced at Westminster Abbey; and we note that Mr. Fergusson does not appear to entertain so high an opinion of its merits as is generally held; it is difficult, he says, to make the circles of which it is principally composed fit pleasingly into the pointed arch; and though the English architects are sometimes singularly successful in overcoming the difficulty, yet it was this difficulty, he thinks, which led to the adoption of flowing tracery both in France and England. Of the perpendicular window tracery, on the contrary, Mr. Fergusson entertains a higher opinion than the popular one: it has the merit not only of fitting any form, but of being mechanically correct in all its bearings and joints; consequently it gave the architects the power of erecting windows of any size without difficulty or fear of the result; and even to the latest period of Gothic it retained its propriety and elegance of design. Like all tracery it was merely a frame-work subordinate to the painted glass which filled the windows, and in judging it, it is always necessary to bear this in mind; used as it was at first it was nearly the perfection of tracery, but it fell in evil days, and it possessed a fatal facility, which had a tendency to bring it down to a prosaic level.

Towards the end of the second volume (p. 279) is a very interesting chapter on the peculiarities of English Gothic as distinguished from that of the Continent. The first peculiarity is in the roofs; during the round-Gothic style, or Norman, style in England, there was no attempt made to vault the central aisle of a large church; they were all roofed with wood; sometimes the aesthetic blunder was committed of imitating the French stone-vaults in wood; probably because it had come to be thought indispensable that a first-class church should be vaulted.

poor; the ridge-rib, the bold projections of the ribs generally, and their greater number, and the profuse use of sculptured bosses, give a



ST. PAUL, SARAGOZA. (FROM VILLA AMIL.)

peculiar richness to English vaulting. But, says Mr. Fergusson, beautiful though the stone vaults of early English architects undoubtedly are, it is perhaps after all to be regretted that they did not work out their own system in their own manner. It is more than questionable whether, if the same money had been spent upon timber-roofed cathedrals that was spent on those with vaults, the result would not have been more satisfactory. For instance,—the roof of Westminster Hall is as noble a thing as any vault in the kingdom, and if raised 50 or 60 feet higher, and properly lighted, would have made a nobler nave than any which we possess. Other peculiarities are in the general proportions of the ground-plan and elevation; the Continental cathedrals are lofty and comparatively short, the English are very long and comparatively low; the length of the English cathedrals enabled the architect to project their transepts so as to give the utmost possible variety to their outline, the shortness of the Continental cathedrals made it necessary to keep the transepts down, usually in French examples actually within the line of the aisles. Again the towers of English churches have a much nobler and finer effect than those of the Continental cathedrals; not so much because they are really loftier, as because from the smaller height of the churches they dominate much more nobly over the roof-lines.



AISLE IN TRINITY CHURCH, EDINBURGH.

But when the English architects did, in the thirteenth century, begin to vault their great buildings with stone, they excelled the French in the

The erection of the principal tower over the intersection of the roofs of the church is also an arrangement peculiarly English, and gives a picturesque grouping to our exteriors, which is wanting in the Continental cathedrals. The east ends of English cathedrals are square, with a great east window; the French east ends are composed of a corona of circular chapels; in German cathedrals both east and west ends are commonly apsidal. Another characteristic in English cathedrals is the repose and dignity of their exterior, as compared with the confusion and flutter of the pinnacles, flying buttresses, and other expedients to prevent the building from falling, which characterise the exterior of French cathedrals. And again there is a characteristic difference in the sites selected for the cathedrals of the two nations; ours are placed outside the city with an eye to a commanding or a picturesque situation; and are surrounded by a clear space occupied with green lawn and trees; and encircled at a duo distance by the venerable residences of the cathedral officials. The French cathedrals always stand in the market-place, in the very centre of the town; often surrounded by hovels and shops, built even against their walls, and which are not always modern excrescences, but frequently as old as the churches themselves. This difference of situation may have had an effect in producing some of those differences which we have previously noted in the general design; the ample precincts of the English cathedral, and its site outside the town, gave space to exhibit its picturesque and grand exterior effects; the French cathedrals can hardly ever be seen at one view, and their height, and the general sacrifice of exterior to interior effect, are perhaps necessary consequences of their standing in the midst of the tall houses of a town.

Mr. Ferguson's Hand-book supplies a general desideratum in so very excellent a manner that it is quite sure to be very popular; and we shall be disappointed if his popularisation of a comprehensive knowledge of the whole Art, and of true principles of criticism of it, do not produce a favourable effect upon the development of the Art in our modern practice.

A FEW WORDS

ON OUR NEAR NEIGHBOURS' TASTE
AND OUR OWN.

POPULAR PAINT—WAR PICTURES.

Present—MAGISTER and AMICUS.

Amicus.—Some one has said, "if a Quaker had been consulted at the creation, what a drab-coloured world it would have been!" No roses or carnations—nor buttercups in the meadows, nor harebells in the woods, but all nature like his costume, brown or gray, like a drawing in sepia or Indian ink!

Magister.—You do the "Friends" injustice; they love flowers as well as other people. Their peculiarity of dress puts them at undue disadvantage with the world; besides, even as to that, it is of excellent texture, scrupulously clean; and the Quakeress lace, for example, ever a marvel for fineness and for neat getting-up, as the ladies say.

Amicus.—Ah! Nature must out somewhere; and if stopped in fine colours, she must out in fine texture. I own I admire a Quakeress; she has a fresh, dairy-maid—new-milk air—neatness and demureness itself. One can fancy her prancing herself in the sunny morning like a bird! I confess I do not admire the gentlemen so much. By the bye, I wonder whether there are any French Quakers? Dear me! a French Quaker would be a phenomenon—a chimera—a union of opposites indeed—composite to be classed with a centaur or a hippogriff!

Magister.—I don't know whether we can laugh at the "Friends" with a very good grace, as they are only the superlative of what a very great many of us are the positive or comparative; for we have a deal of the early

Puritan about us!—The old commonwealth still clings to us, and sets up plainness as the badge of respectability.—Really as far as house and costume are concerned, these are synonymous terms with a large class.—And this is one stop, mind you, to the freer introduction of ornament and artistic decoration generally about us.

Amicus.—But simplicity is a good wholesome quality; and I think we can have this without being followers of the followers of Fox.

Magister.—I am not one to undervalue it; but simplicity is not plainness, but harmony; and there may be quite as much of this in ornamentation as in baldness of parts and colours, and in a decorated entourage, as in one as sober-tinted as a gray north-country village.

Amicus.—Do not say anything against our north-country villages—I have seen a great many of them quite charming!

Magister.—But more from situation and Nature's hand than from man and his ingenuity.

Amicus.—That is regulated so much by the materials the spot affords. You cannot expect a poor cotter to go far afield for bright-coloured stones, while the gray ones lie ready to his hand at the threshold.

Magister.—I have seen Scotch villages that, at a little distance, but for the thin reek from a chimney here and there, and a plaid or two out to dry, had nothing to distinguish them from the houlders around. To be sure, when you came near, you were soon convinced by the rush of the "callants" that you were amid human dwellings! The inhabitants, however, have, as you say, their excuse in poverty or want of means. But it is not so in richer places, with large resources, and where the materials of pleasant decoration are at the easy call of the purse. The want of selection, more than the want of means or of expenditure, is there to be deprecated; nor have we the excuse of the Quakers, who make the matter one of conscience!

Amicus.—Ah! we may learn something in this from our near neighbours. How pretty the French towns are—some of them are gay enough, if you like!

Magister.—Yes, the first step into a French town is enough to convince the Englishman, without the recollection of his passage, that he is in a new land; the aspect of everything is different—gayer—brisker—unaccustomed. The houses have windows and doors, but they are not like ours—their very mouldings and fittings are dissimilar, and their roofs and chimneys are not our roofs and chimneys. The very colours used by the house-painter are of a different family from those he uses here. Indeed, the whole expression of a French room is on a lighter gayer key than an English one, and our countryman, without having time, or being able perhaps, to enter into the details of the causes, is impressed with the amusing novelty of his sensations.

Amicus.—Olfactory and otherwise!

Magister.—I speak only of his eye—which assuredly dilates at what he sees—wonderment becomes admiration, which again perhaps slides into approbation.

Amicus.—But if novelty merely were the cause of this, I suppose it would soon slide back again!

Magister.—I would not father such pleasure and enjoyment derived from French objects solely on their novelty; indeed I am quite prepared to uphold a very different view. It is, however, but fair to premise that novelty itself does form one of their strong points of interest with us. This "novelty" appears an essential part of the French character, and is manifest in almost every phase of life, sometimes for good and sometimes for evil. To the historian it presents a series of changes since the breaking out of the first revolution, that could not have occurred in any other country in five times the time—and in all other subservient and collateral matters, the same mercurial never-resting spirit is evidenced. Love of novelty is a constant living moving principle in Paris, where the very establishment of a thing may be said to be against its continuance! The commencement, the first step towards the

end! The Parisian desires to keep the kaleidoscope continually turning so as to present ever a new set of images. He acknowledges it himself. Nothing is so distasteful to him as "*toujours la même chose!*" and this makes his restless metropolis the head quarters of new things.

Amicus.—And Paris the *merchandise des nouveautés* for all the world! and what wonder, when she receives such encouragement—from our race especially. The Anglo-Saxons, as a body, go to the French for their fashions: it is not only England and Scotland that come "boozing" to her for her new thoughts, but even across the wide deep purveyors come from far lands "hooning" too. In all our Colonial towns that have worked at all up to a metropolitan pitch, the same reverence is paid to French examples and patterns. The lucky digger's wife at the Antipodes, pours out her husband's "dust" for a French bonnet, and he bears her company in a French watch-chain. But of all our race, no portion go further than our brothers of the United States in their detestation to French dicta in all such matters—costume especially.

Magister.—The great branch of novelty-making in Paris is of course encouraged to the utmost by her thus having the first market, throughout the world for her efforts and goods of this class, from a cap to a clock case, and thus it is justly founded on a truly peaceable and commercial footing; but the mine must have been there before it was worked, and very precious ore it has produced. I am armed against novelty for pure novelty's sake when unaccompanied with sterling qualities to support it; but I perceive and acknowledge a vast deal of substantial worth in many of those things in France whose first chief impression on us, as strangers, is that of novelty.

Amicus.—Yes, that has occurred to me as you have been speaking, that there is a wide distinction to be drawn between what are novelties to us as strangers, and which may rather be fixed habits to the people themselves, and those which are novelties and matters of change to themselves as well as ourselves.

Magister.—For instance, as to the key of colour presented by the more frequented towns of France. That, perhaps, in its details, may be a matter in some degree affected by change and fashion, but taken altogether broadly, it may be considered, as you say, among its fixed habits, and from among these fixed habits especially may be culled some things thoroughly worthy of our attention and imitation. On this very point of colour, for instance, in our watering and sea-bathing places, where people congregate, not only for health of body, but for relaxation of mind and amusement, to which every kind of cheerful gay tones are conducive, if the houses had somewhat more of the costume of a Continental town, there would be much gain and no loss. At Brighton, for example, when I have been on the pier and have looked back on the range of terraces that line the cliffs, I have regretted their want of colour, and have felt their appearance would have been vastly improved by a gayer key. Even letting the forms alone, by a better, less puritanic application of paint, a vast improvement might be effected. It would cheer up the frontispices of the place from the sea, and he a sign, rightly hung out, of its character; not that of a business town, but an offset of the metropolis—a sucker from the main plant taken root by the sea at the end of a long stem of railway! a place of recreation, with which the tones of festivity would be as much in accordance in colour as in sound.

Amicus.—A sort of Herculeaneum to the modern Rome.

Magister.—Nay, rather a Baie by its size. Herculeaneum and Pompeii were decorated enough, and so, no doubt, was Baie on a grand scale, although no vestige now remains of it.

Amicus.—There was no Vesuvius to preserve it in lava like its coteremporaries—like a naturalist putting live creatures in spirits to retain their gay tints!

Magister.—In France one of the remarks that arise on observing the popular use of colours and paints that give a certain air of gaiety even to the otherwise forlorn and dilapidated portions of the suburbs and "allées" of Paris,

is, that with all their variety they are seldom gaudy, and that their lightness, contrast, and effect more depend on the harmony and knowledge of effect with which they are arranged than on their individual brightness and force. The first thought of the Englishman is whether the colour will stand, with the Frenchman whether it will be pleasing and admired. If the Englishman depart from some very sober "respectable" colour, such as invisible green (which looks black) and so forth—he is likely to indulge in some positive primary colour in full force—and some sudden contrast probably close to it! But not so our near neighbour. If he select one strong pure colour, he will put "no rival near its throne," but will soothe it down to placidity by associating with it subservient secondary or tertiary colours. Assuredly in their use of the broken tints the French workmen are more *au fait* than ours. I am speaking now of the general effect of the towns, and contrasting them with ours to our disadvantage. Doubtless with us a very just knowledge is increasing of colour in appliance to dwellings inside and out, but the circle of information is not so wide. The knowledge of these matters has a much more extensive and popular orbit there than here, and the artist and the workman step more together in France than in England, as has been often said.

Amicus.—The results forming part of national taste?

Magister.—Yes.—Painting, sculpture, architecture, decoration, even the character of dress, being connected with each other as higher or lower branches of the same subject, national tastes are evidenced and illustrated by each and all of these.

Amicus.—In talking of national taste, it is very natural to turn to painting and its national characteristics and peculiarities. Is it not a strange thing that a people (I still mean our neighbours) whose dramatic propensities will not allow of a death on the stage, can yet witness without reprobation and I suppose with some degree of satisfaction deaths and death-pangs represented in another Art, enhanced too with every ingenuity of horror. I am thinking and speaking somewhat abruptly I know—but it has just struck me apropos of taste—and I want to know whether it is to be considered good taste?—of a picture I saw among the modern French pictures at the Beaux Arts Exposition. I forget the exact name of it, but it represented a decollation, and not a frightful detail was omitted that could inhere it with its utmost effect. It was a thing to make you stop and shudder! The gore from the victim is caught in a dish by a black female, who gloats fiendishly on the sight of the agony, involuntarily gapes her mouth with a sympathetic gasp! And the gazer for the moment could hardly be doing the same thing.

Magister.—It cannot be denied that as regards horrors as subjects for art, the tastes of our neighbours and ourselves are widely apart; and I avoid them—they seem to welcome them; and I certainly think we have the best of it. I recollect the picture, for such scenes have a fatal attraction, and are not so easily wiped out of the recollection. They seem to possess, among other evil qualities, the fascination of the serpent; for there is unfortunately in most minds a morbid weakness, on which such harrowing subjects eagerly clutch. Our neighbours, however seem to cherish the "morgue" like sensation. "Grind plenty of the red" has been repeated as the exclamation of David, the historic painter, during the first revolution, and the French palette seems never to have forgotten the injunction. French galleries are art team with battles, executions, and death-struggles.

Amicus.—Our neighbours' military tastes, and the delights they take in the pomp and circumstance of glorious war, familiarise them, no doubt, with such crimson results.

Magister.—And, in consequence, a larger portion of such subjects are to be seen in French galleries than in those of other nations. The Versailles collection alone contains enough battles and onslaughts to supply the whole world—unredeemed, too, as many of them are, by the excellencies visible in some of the later

contributions; such as Vernet's scenes from the late wars in Algeria; of which the vigour, variety, truth, movement, and character half excuse the terrors they pourtray.

Amicus.—But how the French people like them! What holiday attractions they are. I have seen the room which is appropriated to them at Versailles thronged with gay Parisians, taking evidently the extreme delight in those scenes of rapine and bloodshed, and hanging with the eye of connoisseurship over struggles so faithfully represented that you may fancy you hear the cry of despair and the death-shriek of agony. The gestures and gesticulations of admiration among the visitors, from even the women and children, show how unaffected is the delight they derive from these presentations.

Magister.—It certainly is enough to make an artist apply himself to such subjects, and to spur him on the path, when such is the appreciation that follows. But the feeling for such here would be very different; and what would please across the water, would shock us on this side: and this is not one of our characteristics that I would wish changed. Admirable, however, as these works are, you will agree with me, no doubt, that they did not gain by their removal from the place for which they were painted, at Versailles,—where it appears we have both seen them—to the apartment in the Beaux Arts. They appeared to me to lose much by being placed too near the eye: their slapdash and scenic style of workmanship became too evident, and emphasized still more strongly the rank I have always given them as works of execution, that is—but the tiptop of panorama painting. In this respect they are not up to the mark of "standard works," although they display vast powers, unparalleled resources, and magical facility. As regards these, indeed, the artist is a marvel. I was told by a friend, who was well acquainted with him, and had the "entrée" while he was at work, that when he was engaged on this very scene, he called on him one morning, and being asked his opinion of the work in hand, he freely objected to a principal figure which Vernet had just put in. Having occasion to leave the artist and to return after two hours, he was surprised to see a wholly new figure completed in its place! Within this short space of time, the artist, accepting the criticism with the true frankness of genius, had wiped out the noxious figure, and completed another in lieu of it!

Amicus.—And what makes it the more extraordinary is what I have heard, that he rarely makes use of models, so that he must do it, as boys say—"all out of his own head."

Magister.—Nay the close copying of models were inconsistent with such facility. An artist even of equal powers, who worked close by nature, would not have been capable of the foregoing marvel, although the style of his work might be more sterling; for facility is often its own bane, producing the very slapdash which makes the shortcomings of these works; and it often produces a conventionalism lacking of Nature's essence.

Amicus.—That latter observation you would not apply to Vernet's works. We have just said they were only too natural.

Magister.—In one respect, but as works of execution—in detail and completion—not quite complete. Even Vernet's memory of Nature will not reach to the minutest refinements.—But what a recollection he has! I suppose he never forgot a group or an action.—There on his memory it is dagger-retyped for ever! For the details of battles his resources appear endless!

Amicus.—No wonder!—for the story goes that on occasion of his visit to the East, at the commencement of the Crimean hostilities; on his giving his opinion on some point of the War, before the late Marshal St. Arnaud, the latter alluded to its being at any rate not a professional opinion—when the veteran artist retorted—it is said with truth—"Marshal, I have been in more battles than you!"

Magister.—Dramatic enough—the sword in one hand and the brush in the other, and either proud of the other. I saw him once at St.

Cloud on a fête day: ancient, upright, "svelte," active, with every ounce of superfluity evaporated by the beat and motion of the restless spirit within. His whole chest, from shoulder to shoulder across, and from waist to gorge, was blazoned with decorations! I thought him a General at least!—till I was undeceived—but he was no less—

"A king can make a belted knight,
A royal duke—and a' that."

A monarch may make many generals, but not a Horace Vernet!

Amicus.—He is a true son of France, and a vast favourite with his countrymen.

Magister.—His works have deservedly a large public in France, for they are exactly in accordance with the national taste. They are moreover state engines—fostering the love of the people for military distinction. To be enshrined in a *tableau* of Vernet's, were the height of ambition to the young aspirants of the *École Militaire*. His works send many a recruit to the army.*

ART IN THE PROVINCES.

BIRMINGHAM.—The exhibition of the works of the pupils of the school of Art, which has been open here, is now closed: the local papers speak in very favourable terms of the contributions of many of the students, and of their general progress.—On the whole, this exhibition proves that the local administration of this district, and the instruction imparted therein, are of a very satisfactory and gratifying character; and apart from the head master (Mr. George Wallis), the thanks of the public of Birmingham are due to Mr. Daniel Wood, the deputy head master; Mr. William Wallis, the elementary master of the central school; and to Mr. Walker, to whom is confided chiefly the practical working of the classes in parochial schools, and of the class at the Worcester Diocesan College, Saltley, where, according to Mr. H. Cole's statement at the meeting, referred to elsewhere, the students have been pre-eminently successful at the last examination in drawing. It is quite clear that an earnest spirit is at work in this district; and it is equally clear that the fault of any lack of progress in future will lie at other doors than those of the head master, and those acting with him, in the work for which he is responsible.—Prior to the close of the exhibition, Mr. Wallis delivered a lecture, explanatory of the course of instruction, as illustrated by the works of the students, to a large audience, composed chiefly of artisans.

NORWICH.—The committee of the Norwich School of Art recently invited the friends and patrons of the institution to a *conversazione* at the school-room in St. Andrew's Street, an invitation that was accepted by a large number of the most influential inhabitants of the city and its immediate neighbourhood, as the chief object of the meeting was to promote a taste for Art among the citizens; and for this purpose there was a very considerable collection got together of pictures, drawings, engravings, photographs, and illustrated books. The large class-room contained a variety of artistic productions by the students, including the drawings which lately obtained medals from the Department of Science and Art in London. During the evening Mr. J. H. Gurney, M.P., addressed the company on the present and future prospects of the school; in the course of his remarks he said, "In the public schools there are 79 pupils, and in the special and intermediate 41, making a total of 120, which, I am informed, shows an increase in the second class during the past year. There are 850 pupils belonging to the public schools, making a total of 977, who are reaping the advantages of this institution." It seems that the number of medals—ten—recently awarded to the pupils of the Norwich school was much larger than those awarded to any otherschool, in proportion to the population of the places, respectively, which came into competition. This speaks most favourably for the judicious system of training pursued by Mr. Claude L. Nourse, the head master. Sir H. Stracey, Bart., M.P., Sir S. Bignold, M.P., and the Mayor of Norwich, Mr. J. G. Johnson, also delivered their sentiments on matters connected with this institution before the assembly broke up. The arrangements.—The Exhibition in aid of the Patriotic Fund, which has been for some time in preparation, under the patronage of H.R.H. Prince Albert, Chancellor of the University, and

* To be continued.

of many of the most distinguished members of that seat of learning, opened on the 11th of February, and gave an agreeable surprise to the visitors. Not only have valuable pictures been collected from the neighbourhood, but Canada, by their influence and exertions among friends, have discovered and drawn out considerable amateur talent from all parts of the country. The exhibition contains pictures by Claude, Both, Watteau, Berghem, Holbein, Rembrandt, Van dyck, among the ancient masters; and by Turner, Frost, Gainsborough, Lee, Clint, Herring, Copley Fielding, Dallas, Richmond, among modern painters. The works of Mr. and Miss Colclott, of Cambridge, attracted much notice. C. Joyns, Esq., Dr. Phelps, W. Hopkins, Esq., and Miss Hopkins, contributed liberally from their excellent collections. We believe the origin of this exhibition, and no small part of its ultimate success, are due to three or four young "gownsmen," lovers of Art, who worked hard during the last long vacation to promote the object: they deserve all credit for the highly satisfactory result of their labours. It is to be regretted that the committee talk of closing in a month's time: we trust the energy displayed will be so earnestly responded to by the town and its visitors, as to justify them in keeping the exhibition open for some time longer.

OXFORD.—"The collection of objects of Art," says the *Athenæum*, "which Mr. Chambers Hall presented to the University Galleries at Oxford, has been arranged in a room leading from the staircase to the long gallery, which contains the original drawings by Raphael and Michael Angelo. Mr. Hall's collection affords specimens of great variety, but of unequal merit. Some might have been well spared. Among the antiquities are a few exquisite bronzes with the blue Pompeian patina upon them,—a graceful *Præfericulum* and several vase handles deserving especial attention,—also some terra-cotta griffins, gilded figures, gem rings, and a small vase of whitish clay, picked out with a greenish tint, which affords another proof in its figures and ornaments of the connection between Assyrian and Etruscan Art. A small mounted drawing of the head of the Madonna in red chalk, by Leonardo da Vinci, is very questionable. Not so a beautiful drawing by the same master, with silver points on prepared reddish ground, representing two sitting figures and some mechanical devices. These, and a drawing by Raphael of 'The Nativity,' which has been engraved in fac-simile in Ottley's 'School of Design,' belonged to the Lawrence collection. These precious drawings are fortunately re-united as nearly as possible to the large mass happily detained in our own country at the time of the first sale of Sir Thomas's treasures. Two other fine drawings by Raphael, 'The Presentation' and the 'Child in La Belle Jardinière,' hang on the same wall; and near the door is a magnificent cartoon of a 'Holy Family' by Razzi, II Sodoma. A small model in wax by Michael Angelo of the female figure of 'Morning,' for the monument of Lorenzo de' Medici, is evidently a first thought. The modern pictures include a fine portrait of Mrs. Brady, by Sir Joshua Reynolds, two sketches of Garrick as Abel Druggier, by Zoffany,—a portrait of Thornhill, by Hogarth, and his sketches for the 'Country Inn Yard,' 'A conversation of Connoisseurs,' and 'The Enraged Musician.' Pictures with greater names are less satisfactory. An exaggerated portrait of the donor, by Linnell, fails to convey the benevolence of expression which all who knew him must remember. He left also an ancient painting from Heracleum of a seated female, attended by Cupid holding a toilet-box. It is inserted in the wall of the staircase, near the Nisroch sculpture presented by Mr. Lyward."

LEEDS.—Mr. J. C. Swallow, principal master of the Leeds Government School of Art, has recently delivered some lectures on ancient ornamental art as practised by the Egyptians, Greeks, and Romans, illustrated by diagrams. In his introduction he remarked, that to a manufacturing nation like England, a knowledge of ornamental art must be a subject of vital importance. It had for its object the improvement and adornment of manufactures; and as a superior and improved article will always be preferred, a knowledge of ornamental art must tend to extend and increase the demand. This knowledge, therefore, becomes a question of the consideration of all classes. Ornamental art could not be confined to a class. It operated with the patron or purchaser, with the producer or manufacturer, and with the workman. The first inquires, according to his knowledge, for the most beautiful thing for his money. The second finds that he meets with a reader sale, and can obtain a higher value for extra beauty. The architect, as a producer, finds ornamental beauty a great addition and recommendation in his profession. In fact, whatever may be the thing produced or manufactured,

ornamental art adds greatly to its value. The workman, too, could obtain higher wages and better employment by his knowledge of the ornamental. The claim of nations to high civilisation is based upon their knowledge of, and progress in, ornamental art. We must judge of them by their buildings, their decorations, and the improvement and beauty of their manufactures. Mr. Swallow, in his third lecture, said the Saracens did not build mosques, but they left several palaces, and one in particular at Palermo, which takes its name from the last word of an inscription, *à la ziza*, and was called by the Italians, *La Zisa*, or the Zig-zag. And there we get, he said, the origin of the word "zig-zag;" and the importation of the peculiar zig-zag form is a characteristic of Norman in this country and in France.

BATH.—The second conversation of the Bath Society for the Promotion of the Fine Arts took place on the evening of February 12th, and was very fully attended. The large assembly room was used for the display of oil pictures, while the settee room was appropriated to the drawings, sketches, photographs, &c. The most important works contributed on this occasion were Turner's 'Burning of the Houses of Parliament,' and Landseer's 'Waiting for the Deer to Rise,' both the property of Mr. Wallis; 'The Light of the World,' and 'The Strayed Sheep,' by H. Hunt, belonging to Mr. Hoad; 'The First Step,' by T. Fagot; 'Diogenes in Search of an Honest Man,' by T. Barker; 'Too Hot for the Fish to Bite,' by J. Burnet; there was also a large collection of pictures and drawings framed, and drawings in portfolios, by H. Johnson, Woolmer, J. Philip, Blacklock, H. B. Willis, Bright, A. Fripp, Jutsum, Jackson, Syer, Luny, Mr. and Mrs. Duffell, Warren, Robins, Branwhite, Shayer, Rankley, F. Goodall, A. R. A. Lance, David Cox, J. Hargrove Smith, Toplam, Miller, Payne, J. Danby, Rastbury, Havell, Gosling, Harlow, &c. &c.; and the gathering, as a whole, was of a right good order.

LIVERPOOL.—The committee of the fund raised as a testimonial to the late Mr. H. L. Elmes, the architect of St. George's Hall, in Liverpool, have decided to allow to the widow the interest on the sum now collected, about 1400*l.*, and at her decease to the surviving son. At his death, two scholarships, to be called the "Elmes Scholarships," for Architectural students, or students of the Fine Arts, are to be founded, and to be made available for two years each to pupils of the Royal, the Collegiate, or the Mechanics Institution, as the trustees for the time being may decide, on the merits of a specific examination for the purpose.—The following pictures were purchased by collectors from the gallery of the Liverpool Academy of Arts, at the exhibition recently closed:—A Watercourse in July, A. FRASER; 'The First Thought of Murder,' W. DOUGLAS, R.S.A.; 'The Lesson,' J. STIRLING; 'The Idlers,' G. PAGES; 'Haymaking,' C. DAVIDSON; 'Falkland Palace,' A. FRASER; 'Carnarvon Castle,' W. J. J. BOND; 'The Twentieth of August,' J. HADBY; 'Mechanical Science adding Speed to the Wheel,' F. M. MILLER; 'Antiquarian,' DR. BROCK; 'Mill near Ashford,' A. FRASER; 'Ireland's Mansion,' T. N. HENSLIAH; 'Peace,' F. M. MILLER; 'War,' F. M. MILLER; 'A Snug Retreat,' R. P. BURCHAM; 'Fish Girl,' MISS S. BRIGHT; 'The Source of Nantle River,' J. W. OAKES; 'Relics of Bygone Days,' A. PENLEY; 'Ariel,' F. M. MILLER; 'Bonchurch, Isle of Wight,' W. COLLINGWOOD; 'Liverpool from Seacombe,' W. J. J. BOND; 'Near Kenilworth,' MRS. W. OLIVER; 'Carnarvon Castle,' MRS. HAY; 'Fast Bind, Fast Find,' J. PELHAM; 'Covenantor Listening to a Preacher,' E. H. HARRDEN; 'On the Banks of Loch Ness,' W. S. ROSE; 'Welsh Seascenery,' B. SHIPHAM; 'Falls on the Isla, Forfar,' G. L. BEETHOLME; 'A Nubian, Upper Egypt,' J. F. LEWIS; 'Early Morning on the Rhine,' MRS. W. OLIVER; 'Venice,' E. PRITCHETT; 'Tobacco of St. Peter,' J. DOBBIN; 'Loch Scene,' F. WATTS; 'Villagers Going Home,' J. PERI; 'Flower Girl,' F. M. MILLER; 'The Poet's Haunt,' W. HAVELL; 'Fowls and Pigeons,' W. HUGGINS; 'Waterside Vegetation,' E. HARGITT; 'Coron Mill, Anglesey,'—Evening, J. W. OAKES; 'Enamel of a Fox's Head,' W. ESSEX; 'View on the River Maas,' G. CHAMBERS; 'Clean your Boots, Sir,' J. E. MANTON; 'Harvest Girl,' O. ORLEY; 'The Totaller and Tippler,' J. HAYLLAR; Marble statuette,—'The Good Shepherd,' P. VANLINDEN; 'The Devil's Bridge,' W. C. SMITH; 'The Archbishops' Tombs,' L. J. RAYNER; 'Riviere de Levante,' C. VACHER; 'A Summer's Morning,' H. J. BONDINGTON; 'Birds' Nests,' J. H. BIRCH; 'Loch Katrine,' S. B. PERCY; 'Interior,' a Sketch, T. ROBERT; 'An Orange Girl,' W. CHAMBER; 'Gracie,' J. BOUVIER; 'Scenery,' 'The Village Common,' A. PERRY; 'Rue du Caudet,' L. J. WOOD; 'The Navvies' Dog in the Crimea,' J. ZETTER; 'Welsh

Pensant,' G. YOUNG; 'Graystock Castle,' W. HAVELL; 'The London Orange Girl,' J. STIRLING; 'Scene at the Entrance of Newhaven Harbor,' the late C. FIELDING; 'Incident in the Desert,' J. A. HOBSON, R.S.A.; 'Scene near the Hardest,' H. SHERIDAN; 'Beach View,' New Brighton, J. WAKE; 'Old House, near Chester,' R. CLOTHIER; 'Sundawn,' E. HARGITT; 'Ben Nevis,' J. S. RAVEN; 'Lato at School,' W. BROMLEY; 'The Milkmaid,' B. CALLOW; 'View in Tilgate Forest,' the late C. FIELDING; 'Dysart, coast of Fife,' S. BOUGH; 'Smiler,' a Study, N. BRANOWIN; 'Evening on the Ouse,' E. STEUBEN; 'Harbour and Town of Galais,' A. BREDANT; 'A Cloudy Day in August,' H. B. WILLIS; 'Fishermen of Portland,' U. BOUVIER; 'Little Nelly,' C. COMPTON; 'A Corner in the Hayfield,' J. BOUVIER; 'View on the Trent,' B. SHIPHAM; 'Castle of Ehrenberg,' MRS. W. OLIVER; 'Pomerne on the Moselle,' MRS. W. OLIVER; 'The Miller's Daughter,' E. HAVELL; 'The Best by the Wayside,' T. P. HALL; 'Richmond Park, Surrey,' G. C. MAUND; 'A Partridge,' Miss J. BOUVIER; 'Distant View of Osborne,' E. DUNCAN; 'The Truant's Return,' J. SMITHAM; 'Venice, from the Church of San Giorgio,' W. CALLOW; 'Venice, from the Foscarei Palace,' W. CALLOW; 'Spring,' E. HAVELL; 'Early Spring Evening,' W. DAVIS; 'Nature and Art,' G. LANCE; 'A Sketch,' J. CALLOW, JUNR.; 'Adam and Eve,' H. G. WHATTE; 'Scene in Edinburgh,' W. G. HERDMAN; 'A Brown Study,' W. HUGGINS; 'In the Vale of Neath,' A. YICKERS; 'Eton College, Bucks,' W. PARROTT; 'An Embroiderer,' E. J. CORBETT; 'Free Trade and Protection,' J. BUCHANAN; 'Fishing Boats on the Coast of Sussex,' W. WILLIAMS; 'Port Glasgow, Evening,' S. BOUGH; 'Remains of Stokesay Castle,' MRS. HAY; 'In South Wales,' T. FROD; 'Nestwood Kilns,' C. DAVISON; 'A Mallard,' G. HICKIN. Pictures selected by the Liverpool Art-Union Prizeholders:—'Shallows on the Lugwy,' F. W. HULME; 'Flowers, &c.,' R. CLOTHIER; 'Morning on the Mersey,' R. CLOTHIER; 'The Mountain Stream,' J. HILL; 'Staircase at St. Maclou,' J. NASH; 'Digging for Lobsters,' C. DAVIDSON; 'On the Shore, Forby,' W. J. J. BOND; 'Interior, Haddon Hall,' S. D. SWARBRICK; 'Blarney Castle, Ireland,' J. DOBBIN; 'Interior of Crypt at Kingfield Manor House,' W. G. HERDMAN; 'The Keep, Carisbrook Castle,' W. GRAY; 'Easby Abbey, Yorkshire,' S. D. SWARBRICK; 'The Royal Fugitive,' W. COLLINGWOOD; 'A View on the River Erne,' E. H. HURBLE; 'Mills at Montreux,' W. COLLINGWOOD; 'A Welsh Trout Stream,' A. F. ROBERT; 'Rustic Cottage,' J. CALLOW; 'The Penitent,' F. P. HALL; 'The Stable Door, Haddon Hall,' A. PENLEY; 'Interior of the Hall, Magdalen College,' J. NASH; 'Autumnal View in Richmond Park,' H. C. PIDGON; 'Entrance to the Keep, Richmond Castle,' S. D. SWARBRICK; 'Pool on the Llugwy,' A. HUNT; 'Bidston Marsh,' A. W. HUNT; 'The Highlander's Departure,' R. ROBERTS; 'A Chimney Nook,' J. CAMPBELL; 'Experimental Philosophy,' J. BUCHANAN; 'At Jersey,' A. MONTAGUE; 'Nant Mill, N.W., G. D. CALLOW; 'Snowdon,' F. M. HORLOR; 'Barn Castle,' MRS. W. OLIVER; 'Pheasant,' J. D. WATSON; 'A Sketch from Nature,' J. WAKE; 'Homestead, Watering Cattle,' A. R. C. CORBOULD; 'A Salmon Pool,' A. F. ROBE; 'Lauze Scene,' J. CALLOW; 'The Mountain Spring,' J. BOUVIER, sen.; 'The Paper, Please,' W. ROMER; 'Antwerp Cathedral,' J. DOBBIN; 'The Cheshire Coast,' B. CALLOW; 'Landscape,' F. WATTS; 'An Avenue in Hatfield Park,' H. J. JODDINGTON; 'A Weedy Bank on the Thames,' H. J. BODDINGTON; 'The Timber Wagon,' J. HORLOR; 'Moel Siabod,' S. BUCH; 'The Church at Harfleur,' A. MONTAGUE. Pictures purchased by the Glasgow Art-Union:—'Birk Craig,' G. C. STANFIELD; 'Adeline,' W. COLLINGWOOD; 'Preparing Dinner,' J. F. PASMORE; 'An Interior at Kerland,' A. PROVIS; 'The Lesson,' W. WEIR; 'View from the Top of Llanberis Lake,' W. PITT; 'Departing Day,' W. FREEMAN, JUNR.; 'Ducks,' C. H. WEIGALL. The total sales amount to 2956*l.*, of which the private sales amount to 2957*l.*; and the Liverpool Art-Union Prizeholders took 667*l.* 7*s.*, and the Glasgow Art-Union 231*l.* 13*s.*

GLASGOW.—The Art-Union of Glasgow has issued its first list of pictures purchased for the prizeholders of the current year. It contains, among others of smaller pecuniary value, the following:—'Ben Blayou, Isle of Skye,' H. McCULLOCK, R.S.A., 150*l.*; 'Cottage Window,' R. GAVIN, A.R.S.A., 200*l.*; 'Caught Again,' E. NICOL, 130*l.*; 'Summer Topple,' J. SANDY, 126*l.*; 'Grouse, &c.,' G. W. HORLOR, 120*l.*; 'The Dancing Lesson,' R. T. ROSS, A.R.S.A., 115*l.*; 'The Villa Fountain,' W. L. LEITCH, 100*l.*; 'The Household Gods in Danger,' J. FAED, R.S.A., 84*l.*; 'View in North

Wales, J. C. WARD, 70.; 'Red Tarn, Helvellyn,' G. W. PETTIT, 60.; 'A Pleasant Way through the Welsh Woods,' H. J. BODDINGTON, 60.; 'The Lynn Spout, near Dalry,' H. McCULLOCH, R.S.A., 60.; 'The Stepping Stones,' E. J. COBBETT, 55.; 'The Edge of the Wood,' F. H. HENSHAW, 50.; 'Birk Craig, near Harrogate, Yorkshire,' GEORGE G. STANFIELD, 50.; 'Adeline,' W. COLLINGWOOD, 50.; 'Stiff Breeze,' E. T. CRAWFORD, R.S.A., 45.; 'In the Island of Arran,' E. HARGITT, 45.; 'A Forest Brook,' JAMES STARR, 40.; 'An Interior at Kerlindi, near St. Paul de Leon, in Brittany,' A. PROVIS, 40.; 'Early Morning on the Thames,' H. J. BODDINGTON, 40.; 'A Thought from Boccaccio,' A. J. WOOLMER, 30.; 'Rustic Figures,' J. J. HILL, 30.; 'Poetry, Music, and Painting,' K. HARTMANN, 30.; 'A Woodland Pool,' B. WILLIAMS, 25.; 'The Margin of Emmerdale Water,' G. W. PETTIT, 25.; 'Chalk Pit, Ganton, Surrey,' C. DAVIDSON, 25.; 'Catherine of Aragon (a Study),' H. O. NEIL, 25.; 'Lewis Castle, Sussex,' C. DAVIDSON, 25.; 'Roslin Glen, WINTOUR, 25.; 'Cupid in a Shell,' JOHN GEO. NAISH, 25.; 'Haddon Hall,' E. HARGITT, 25.; 'On the Berwick Coast,' R. T. ROSS, 25.; 'The Rainbow,' J. S. WILSON, 21.; 'Shalott,' J. T. FORTUNE, JAS. CURNGOCK, 21.; 'May,' K. HERDMAN, 20.; 'Study of Salmon and Trout,' H. L. ROLFE, 20.; 'The Borders of Derbyshire and Staffordshire, near Stapenhill,' J. PEEL, 20.; 'Scotch Terriers,' T. EARL, 20.; 'A Path through the Woods, N. Wales,' H. J. BODDINGTON, 20.; 'Preparing for Dinner,' A. J. PASMORE, 20.; 'Floral Emblems,' J. COLLY, 20.; 'Snowing,' G. A. WILLIAMS, 18.; 'The Terrace Avenue, Haddon,' R. H. LINES, 18.; 'Study from Nature,' WINTOUR, 18.; 'Entrance to Canterbury by West Gate,' J. HENSHALL, 18.; 'The Blind Father,' K. HARTMANN, 17.; 'The Old Library,' B. WILLIAMS, 15.; 'Fishing Boats in a Fresh Breeze, off the Bayley Lighthouse, Dublin,' E. HAYES, 15.

WARINGTON.—We are desirous of correcting an error in our notice last month of the fancy fair recently held in this town: the master of the school is Mr. Thompson, and not Mr. Brewtnall, as we stated: the latter gentleman is secretary, and to his exertions the success of the bazaar is mainly owing.

ART IN CONTINENTAL STATES.

PARIS.—The author of the panoramas lately exhibited in the Champs Elysées, Colonel Langlois, is now at Sebastopol, by orders of the French government, to execute a panorama of the town and forts.—A new "Salle" is opened in the Louvre, containing sculptures and bas-reliefs of the middle ages.—A museum has been opened at Napoleon Vendôme, for painting, sculpture, and local antiquities.—Delacroix is hard at work repairing the "Hémicycle."—The scaffolding of the Caroussel has been taken down, and the public is admitted to see the splendid buildings; if there is any fault to be found in them, it is in the superabundance of ornament.—It is reported that Clesinger, our excellent sculptor, is about to emigrate to England, in consequence of his fine equestrian statue of Francis I. having been rejected by the government, and from disgust with the intrigue and partially displayed here in every department of Art, &c.—Yvon, author of the "Retreat from Moscow" exhibited last year, is in the Crimea, studying the sites, in order to execute several of the great battles.—An immense number of churches have been given into the hands of artists for decoration; Sigol, Gonlier, Marquis, Glaise, &c., have received commissions; generally the churches are being overcharged with all sorts of ornaments, Byzantine, &c., by which all simplicity will be lost, until time takes down the glare of colour: the church of St. Elizabeth, Rue du Temple, ornamented with rich wood carvings, mural paintings, and stained glass, is one of those which has been most favoured by municipal liberality.—The sixth exhibition of Bordeaux has been opened with great success; most of our great artists have contributed works. Several gifts have been made by the Minister of State for the lottery which follows the close of the exhibition.—Sebastian Cornu has executed many excellent paintings at St. Severin.—Two statues in bronze, half life size, have been placed in the Champs Elysées, representing respectively Buffon and Olivier de Serres; also one of Marshal Gerard.—The Minister of State has ordered of M. Elias Robert two groups for the Avenue de l'Impératrice, Bois de Boulogne.

* This statement of our correspondent is denied in other communications from Paris which we have seen.

THE ROYAL PICTURES.

MIRIAM.

W. Hensel, Painter. H. Bourne, Engraver.
Size of the Picture, 5 ft. 2 in. diameter.

HENSEL, one of the most distinguished living painters of the school of Berlin, is the son of a clergyman, and was born at Trebbin, in 1794. He evinced at an early age a taste for the Fine Arts, but his parents, having another object in view, sent him, when sixteen years old, to Berlin, to qualify him for a post under the Government. The death of his father very shortly after he had gone to Berlin, removed the chief obstacle in the way of his entering upon the life of an artist; and encouraged by the director of the Academy, Frisch, Hensel commenced his studies in right earnest. In the Berlin Art-Exhibition of 1812 appeared his first oil-pictures—a portrait of himself and "Christ on the Mount of Olives" the latter showing considerable feeling and devotional character. During the three following years the pencil was passed for the sword, and the time was exchanged amid camps and battles, in rolling back upon France the tide of war which she had thrown upon the nations of the continent. On the restoration of peace in 1815, Hensel resumed his occupation at the easel; but his success at first was not commensurate with his zeal; he therefore abandoned historical painting for a time, principally because he had a mother and a brother dependent on him for support. Money it was essential he should earn; and to accomplish this purpose, he made drawings and engraved etchings for almanacs and other similar publications, and also painted portraits. He at length received a commission to paint, in one of the saloons of the new theatre, a series of subjects taken from the most celebrated tragic authors: several of these have been engraved in outline. To this period also may be traced the most eventful epoch of his life—a journey to Italy, for which the King of Prussia furnished him with the necessary means. Prior to his starting, however, he was charged to execute the portraits of a number of distinguished persons who had taken part in a grand fête at court in a sort of *tableau vivant* of "Lallah Rookh;" these portraits are all in costume.

Hensel set out for Rome in 1823; he there made a copy, the size of the original, of "The Transfiguration," by Raffaele; this copy is in the chapel of Charlottenburg. At Rome, too, he painted a large picture of "The Good Samaritan," which is in one of the country palaces of the King of Prussia, placed most disadvantageously among many other pictures of different kinds; had it formed an altar-piece in some church, it would be seen with far better effect. Returning to Berlin in 1823, Hensel became a member of the Academy, and was appointed painter to the King. He married the sister of Mendelssohn, the renowned composer.

The most important picture painted by Hensel is the property of the King of Prussia; the subject is "Christ before Pilate," a large work, with a vast number of life-size figures. It is in the church of the garrison of Berlin, and, having a good light, is seen to great advantage. Another fine work of this master is "Christ in the Desert," of colossal dimensions.

His "Miriam" was painted in 1836; it represents the Israelitish maiden at the head of her countrywomen, chaunting her song of gladness at the destruction of the hosts of Pharaoh: "Sing to the Lord, for he hath triumphed gloriously; the horse and his rider hath he thrown into the sea;" or, as Moore has beautifully paraphrased the song,—

"Sound the loud timbrel o'er Egypt's dark sea;
Jehovah has triumph'd, and Israel is free."

The composition is rich in poetical sentiment, and is characterised by exceeding grace in the principal figures, especially in the female with the harp; it is powerfully coloured; the figures are life-sized.

The picture is in the collection at Osborne.

COPYRIGHT IN ENGRAVINGS.

AN interesting case has been heard before the Vice-Chancellor, Sir William Page Wood, application was made on the part of Mr. Cassell (the well-known publisher of cheap illustrated publications), to restrain Messrs. George Stiff and George Vickers (also publishers), from selling, or exposing for sale, or hire, or otherwise disposing of, or causing, procuring, or permitting to be sold or exposed for sale or hire, any copies or copy of any of the parts or numbers of the *London Journal*, already published, containing any prints, drawings, woodcuts, engravings, names, designations, letter-press, copied or colourably altered from the periodical French work, *L'Illustration*; and also from printing, or publishing, or selling, or exposing for sale or hire, or otherwise disposing of, or causing, or procuring, or permitting to be printed, published, sold, or exposed for sale or hire, or otherwise disposed of, in any future parts or numbers, or in any future part or number of the *London Journal*, or in any other publication, any print, drawing, wood-cut, engraving, illustration, passage, article, paper, matter, or thing taken or copied, or colourably altered from any print, drawing, wood-cut, &c., contained in any of the numbers of the periodical *L'Illustration*, already published, in which Mr. Cassell has copyright, or which shall or may at any time or times hereafter be copied, printed, and published in any of the future numbers of *L'Illustration*. The plaintiff's bill asked an account of profits made by partial copies of prints from *L'Illustration*, and a decree for payment of such profits when ascertained. The plaintiff, Mr. Cassell, stated that prior to June, 1855, Armand Le Chevalier had been the proprietor of No. 60, Rue Richelieu, Paris, were the editors and proprietors of *L'Illustration Journal Universel*, a periodical published every Saturday in Paris. It was alleged that Messrs. Armand Le Chevalier and Paulin had made such agreements with the authors and designers of articles and papers, and of prints, drawings, and engravings which appeared in *L'Illustration*, as to confer on them a perfect right to the exclusive benefit derivable from that work, under the international convention between England and France relating to copyright, concluded between her Majesty Queen Victoria and the French Republic in 1852, and under the 7th and 8th Viet. of the act to amend the law relating to international copyright; and under the 15th and 16th Viet., c. 12, which was passed to enable the Queen to carry into effect the convention with France in respect to copyright, to extend and explain the international Copyright Acts, and to explain the laws relating to copyright engravings. Messrs. Armand Le Chevalier and Paulin had, pursuant to the requisitions of the 15th and 16th Viet., c. 12, signified their intention of preserving their copyright and the right of translation here, by a notice printed on the title-page of their periodical. The plaintiff stated that in June last he negotiated for the purchase of the English copyright of *L'Illustration*, and on the 18th of that month entered into an agreement with Le Chevalier and Paulin, that they should, in consideration of his taking of them and paying for, at rates specified, the copyright of the engravings, woodcuts, or drawings to be contained in *L'Illustration*, the aggregate amount to be paid being stipulated to amount annually to 12,500*l.*, sell and assign to Mr. Cassell their copyright in this country in the periodical work *L'Illustration*; and Messrs. Le Chevalier and Paulin, on the 21st of June last, caused the work *L'Illustration* to be registered at Stationers' Hall, as prescribed by the statutes, and deposited a copy of the work, and caused an entry to be made in the registry book there, of the assignment to Mr. Cassell, as prescribed by the 5th and 6th Viet., cap. 45, sec. 13. Mr. Cassell stated that he inserted in his works, *Cassell's Illustrated Family Paper* and the *Picture Times*, articles, papers, prints, drawings, woodcuts and engravings selected from the work *L'Illustration*, and he alleged that Mr. Stiff and Mr. Vickers, publishers of the *London Journal*, had inserted in that work prints, drawings, woodcuts, and engravings from *L'Illustration*, and that they had done this without permission, and to the injury and damage of the plaintiff. Counsel having been heard for plaintiff and defendant, the Vice-Chancellor said the questions of construction on these Copyright Acts, in connection with the facts, were much too doubtful to be decided upon a motion for an injunction, until the plaintiff had established his legal right in an action. He had grave doubts upon the 15th and 16th Viet., c. 12, sec. 7. Some questions might arise upon the order in council on the subject. There must be liberty to bring an action, and liberty to apply.







1857

1857

THE MUSE

Published by the Author, No. 1, Pall Mall East, London.

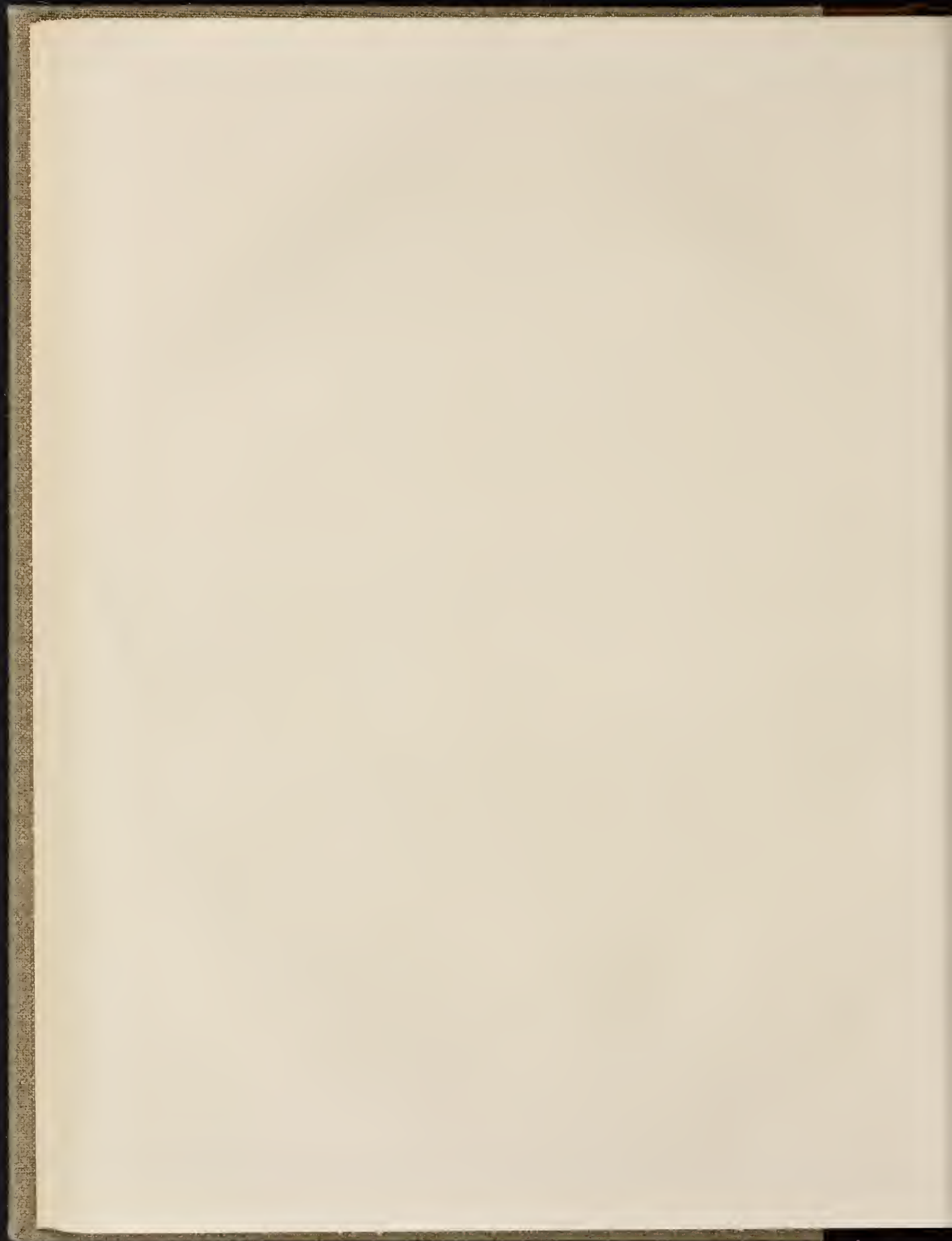

THE
BIRMINGHAM SCHOOL OF ART.

THE Earl of Hardwicke, as President of the school, has presided at the annual meeting in Birmingham; and is succeeded in the Presidency by Lord Ward. Mr. Cole and Mr. Rodgrave attended, and both gentlemen delivered addresses: from that of Mr. Cole we extract the following passages:—

It was generally supposed that the French government did everything for the people in the matter of Art education, while our own did little or nothing; but this was far from being the case. He ventured to say there was nothing like the assistance rendered to any provincial school in France which this institution received from the government of this country and from the public of Birmingham. The French schools of Art in the provinces were entirely worked out by the persons resident in the localities, the funds being derived from the *octroi* dues levied in every town. The government, in fact, did nothing whatever for the provincial schools of France, with the exception of sending them bad pictures purchased from the exhibitions of Paris. He had not found a single instance in which a French school derived aid to the same extent as was received from government by the Birmingham school. It had been said, too, that although the government did meddle a little in the question of Art education, it did a great deal more in London than anywhere else. Now, that he conceived to be entirely a mistake. Whatever might have been the state of things at the outset, the whole tendency of the present system was to extend aid to schools throughout the provinces, as was proved by the rapid increase of schools of design. Not much more than five years ago, the number of schools did not exceed eighteen, while at present there were upwards of sixty such institutions, and there was reason for believing that this increase had mainly arisen from the course government had pursued. It had been said that the expenditure of public money for the promotion of Art was in greater proportion in the metropolis than elsewhere. The object, however, of the institution in London was to train up masters for the provincial towns, and at the present time they had the advantage of the services of three or four of these gentlemen in Birmingham.

We give Mr. Cole the full benefit of his views upon this topic: for there can be no doubt they will be much canvassed in the provinces, where it is known so much discontent prevails. They received indeed partial comment and consideration from Mr. W. C. Aitken, who spoke at the meeting to the following effect:—

He admitted that the same amount of care was not given to some departments of Art in France as in this country, but he must express his opinion, that if the money spent in the Art-museums of France was taken into consideration, it would be found that the assistance rendered by government in that country, was on a more liberal scale than in our own. He would ask Mr. Cole how it was, that with so little Art education in France, they still stood in the van of all that regarded Art; for even though much of French ornament might be redundant, yet take away the excess, and the French ornaments would still be far in advance of our own. When Mr. Cole spoke of the small amount of state assistance afforded to Art in France, he would ask why he did not take into consideration the support given to the Louvre, to the Hotel Clugny, to the Gobelins, and to the manufactory of Sevres? Reverting to the support of Art in England, he would remind Mr. Cole, that while the sum of 7960*l.* 9*s.* 11*d.* was expended on the Marlborough House school, the direct payments to the whole of the provincial schools, did not amount to more than 634*l.* 13*s.* 0*d.*, of which only 47*l.* were allotted to the Birmingham school. He contended that a larger measure of assistance ought to be extended by the government to the Birmingham and the other provincial schools.

The Hon. and Rev. G. M. Yorke supported this view of the subject:—

He believed that the self-supporting system, if applied to the school at Birmingham, must be a failure. In order to meet the expenses, the fees would have to be raised, and many students would consequently be compelled to give up attending. To be self-supporting the school must be maintained entirely by the fees paid by students, and, he asked, was it possible so to increase the number of students as to raise the sum now derived from government and from voluntary contributions?

CORRESPONDENCE.

To the Editor of "THE ART-JOURNAL."

COPIES OF THE "OLD MASTERS" IN THE NATIONAL GALLERY.

SIR,—I think that the large number of copies (chiefly after the great Italian masters) in the National Gallery, must occasion regret to every true lover of Art. The following list of pictures does not include all the examples which might be enumerated:—

1. CORREGGIO (after), "Agony of our Lord in the Garden." Purchased by Mr. Angerstein, from an Italian, for 2000*l.*, upon the opinion of Sir Thomas Lawrence and Mr. West, who pronounced it to be a genuine work of the master; the original forms part of the collection at Apsley House.

2. After the same, the "Ecce Homo." This copy of the picture by Correggio, in the National Gallery, is attributed to Ludovico Carracci.

3. After the same, "Study of Heads," copied from the frescoes in the Duomo at Parma.

4. After the same, the companion to the preceding picture.

5. CLAUDE LORRAINE (after), landscape marked "Marriage d'Isaac avec Rebecca. Claudio Gel. inv., Roma, 1648," evidently placed upon the picture to suggest the idea that this work differs in composition from the very celebrated landscape by the master, entitled "La Molina," in the Doria Palace, Rome; it is, however, only a copy of that picture.

6. After the same, landscape, with three female figures, carrying weapons proper to the chase, intended probably for Diana and her attendants; this is a copy of a fine composition of the master.

7. TITIAN (after), "Venus endeavouring to detain Adonis from the Chase." This is a copy of a favourite subject with the master; the best original repetition that I have seen is that in the Royal Museum at Madrid.

8. JOHN BELLINI (after), "Virgin, Infant Saviour, and St. Joseph;" the group is completed by a figure in armour (evidently a person of distinction), who kneels in adoration before the divine infant; a little behind, at the other side of a low wall, an attendant is seen holding the nobleman's horse. This composition is erroneously called a Giorgione; it is a copy from a picture by John Bellini. I understand that it was purchased from the family of the late Mr. Woodburne, for about 600*l.*

9. GIORGIONE (after), "The Death of St. Peter the Martyr." This is a school picture, in imitation of the style of the master, by whom there was only one example in the Gallery the last time I visited it, viz., "The Concert," erroneously attributed to his pupil, Titian.

10. MICHAEL ANGELO BUONAROTTI (after), "A Dream of Human Life." This great artist never made use of an oil vehicle in colouring his designs, the only authenticated easel picture by the master, "The Holy Family" (upon a circular panel), in the Tribune of the Uffizzi Palace, Florence, being painted in tempera.

11. ANDREA DEL SARTO (after), "The Holy Family." This is one of the numerous copies of the master; no style is more easy to imitate than that of Del Sarto, and, consequently, copies of his works, called originals, may be seen in hundreds in various European galleries. Florence is almost the only place where this great artist can really be seen, most of his best works being here.

12. RAPHAEL SANZIO (after), "Portrait of Pope Julius II." An old copy from the Borghese Palace; the deficiency in "the keeping" is very apparent, and betrays its want of originality.

13. SEBASTIAN DEL POMBIO (after), portraits, said to be those of the Cardinal Hippolyto de' Medici, and the painter himself. The singularly unequal execution of this work indicates that it is a copy of the master. The head of the Cardinal is weak in expression and painting; on the other hand, the so-called head of the artist is considerably better, both in tone and force.

14. LUDOVICO CARRACCI (after), "Susannah with the Elders." A school picture, feeble in the expression, and the colouring too heavy for the master; it was formerly in the Orleans Gallery.

15. DOMENICHIÑO (after), "St. Jerome with an Angel." This copy of the master was formerly in the Aldobrandini collection; the outlines are hard, and the colouring dark and heavy. Upon my last visit to the gallery, I was surprised to find the picture entitled "Erminia and the aged Shepherd," by Domenichino (erroneously attributed to Annibale Carracci), still hung near the ceiling; this is one of the very finest works in the gallery, for which the country is indebted to the consummate taste and judgment of Mr. Buchanan, who imported it from Italy, with many other important pictures.

16. GUIDO RENI (after), "Susannah with the Elders." A school picture, and a work eminently calculated to injure the student of Art; criticism would be quite thrown away upon such a production. The composition entitled "Lot and his Daughters," which was hung upon the line, near to the "Susannah," is a work of Guido Reni, of his earlier time, when he imitated the dark powerful forms of the Naturalist; this example of the master should have been hung over the line, as it was painted for effect, and not for the purpose of being closely examined.

17. RUBENS (after), "The Holy Family." This is a production of the school, and probably painted after a design by the master; the colour is heavy, and the execution very coarse. The picture was formerly in the possession of the widow of Rubens.

Now, I think that the wall-space occupied by these inferior works would be infinitely better appropriated to genuine examples of the "old masters," more especially as the accommodation for pictures is so limited in the National Gallery.

ARTHUR VINCENT TURNER.

50, UPPER BAGGOT STREET, DUBLIN.

[We perfectly agree with our correspondent that a National Gallery ought consistently to contain only original pictures, and these the best that can by any possibility be procured; but if such cannot be obtained, then it is desirable to have the next best—good copies, painted in many instances, under the immediate eye of the master. Besides, authorities do, and will, differ upon the merits and authenticity of pictures; for example, the late Mr. Ottley considered the heads, after Correggio, to differ so much from those in the cupolas at Parma, as to suppose them to be fragments of some large work, now lost. Michael Angelo's "Dream," Dr. Waagen thinks is of the later time of Sebastian del Pombio; the Claude is generally considered to be a copy of the Doria Palace picture by one of his pupils. Ottley and Hazlitt call the "Head of Pope Julius," by Raffaele, a true picture; Mrs. Jameson attributes it to the hand of Giulio Romano, under Raffaele. Ottley and Mrs. Jameson are of opinion that the "Venus" of Titian is by that master, one of several copies he made of the picture at Naples. Mrs. Jameson is very doubtful about the "Peter the Martyr," ascribed to Giorgione. The Correggio "Agony of our Lord" is unquestionably a copy of the Apsley House picture; the "Holy Family," by Andrea del Sarto, is a bad picture, even if painted by him, which is extremely doubtful. We merely bring forward these examples to show how "doctors will differ" not only as to the merits of a picture but also as to its authenticity.

Both here and on the Continent are numerous paintings in various galleries, the owners of which claim originality for their respective possessions; at the distance of time from which these pictures were painted, scarcely any of the highest authorities will presume to offer a decided opinion upon their originality, and in some instances, even as to the painters of them.—Ed. A. J.]

MARKS OF GOLD AND SILVERSMITHS.

On perusing your number for October last, which I have just taken out of the library, I find there is an excellent and valuable article by Mr. F. W. Fairholt, on duty and hall-marks, as used at the different assay offices in the kingdom. Had I been acquainted with the writer's address, I would have written to him, pointing out one or two trifling mistakes he has made in his description of standard marks. He observes, "the standard mark for silver being a Lion's head *grased*, the figure of Britannia." I have to observe that the standard mark to denote silver of the quality of 11 oz. 2 dwt. fine is a lion *passant*. The figure of Britannia, as the Act directs, is only struck on silver of superior quality to standard, namely, silver holding 11 oz. 10 dwt. of fine in lb. Troy, and it is very seldom indeed that goods are ordered to be made of *Britannia* silver. Having held the situation of Assay Master in Sheffield for a period of 23 years, I have had the best opportunity of knowing that the figure of Britannia has not often been called for; I do not think during the above-named period I was called upon more than some six or eight times to test what is known to the trade as Britannia silver. The intrinsic value of Britannia silver is, of course, greater than that of standard, but as it is somewhat softer metal, it is not so useful when made into goods that are in constant wear, although it retains its polish or brightness longer than standard silver does.

LEWIS CHARLES SAYLES.

SHEFFIELD.

MINOR TOPICS OF THE MONTH.

THE NATIONAL GALLERY.—The additional pictures are now in their places: the Paul Veronese (brought from the continent by Sir C. L. Eastlake) occupies the place of the Sebastian del Piombo, at the end of the great room. As to size, in comparison with that picture, the Paul Veronese is fourteen inches wider, but ten inches shorter. The subject is "The Adoration of the Magi," to which, by the addition of palatial architecture, the artist has communicated a great degree of dignity. The indications of the painter, independently of his well-known tastes in composition, are sufficiently manifest in the heads, which resemble those of his "Marriage at Cana," "Martyrdom of St. Catherine," "St. John Preaching in the Wilderness," &c., and also in the singular crispness of his draperies. The Virgin is seated on the right, holding the Child in her lap, behind her is Joseph, and near her the ass, and one or two figures in costume, too modern (always an error of Paul Veronese). One of the kings, attended by two pages, kneels before her, and the two others with attendants are behind the first, almost on the same plane. From the top of the composition a beam of light descends upon the Virgin, and a choir of cherubim is seen above. The picture is in fine condition, and must be regarded as a valuable acquisition to the collection. The bequest of Mr. Rogers consists of three pictures. The well-known "Ecce Homo," said to have been painted by Guido in six hours, but the picture looks as if the glazes had been put on after the substantial work was dry; be that as it may, it is an admirable work, already well known to the public through Strange's fine engraving. A second from the collection of Mr. Rogers is a Titian, also well known, "Christ appearing to Mary Magdalen in the Garden;" and the third is a small study of a knight in armour, by Giorgione, reminding us of the portrait of Gaston de Foix, and an extraordinary advance on the art of the time in which it was painted, when we remember its general character. The Titian and the Guido are protected by glass, and the whole of these fine works are of unquestionable value and excellence.

THE ROYAL ACADEMY.—In a recent number of the *Athenæum*, our contemporary refers to a communication from a member of the Royal Academy, complaining that "certain ancient gentlemen—who have long ceased to exhibit, and who are never seen at the board of the Academy—will hold their place on the list of the Forty; and he asks us whether it is impossible to provide a remedy for this serious evil." This is a subject on which we have frequently spoken; and we have on more than one occasion suggested the remedy which the *Athenæum* proposes; namely, that "the Academy should create a class into which it would be honourable to retire." This is the only way to get rid of a just ground of complaint on the part of men shut out from what may be considered a legitimate claim, and of a determinate adherence to a principle which tends, more than anything else, to bring disrepute on the Academy.

SOCIETY OF PAINTERS IN WATER-COLOURS.—At a general meeting of the Water-Colour Society, held February 11, for the election of candidates, Mr. James Holland was unanimously elected an associate. Mr. Holland has established for himself a high reputation by his beautiful Venetian subjects, and must be looked upon as an important acquisition to the list of water-colour painters at this institution. A second candidate was elected in the person of Mr. George Andrews, a painter of marine subjects, whose works we shall look for in the collection of the forthcoming exhibition with interest.

HIS ROYAL HIGHNESS PRINCE ALBERT commissioned the sculptor Lawlor to execute for him, in marble, the statue of "The Bather," a work that attracted much attention at the Great Exhibition of 1851, and was much admired in Paris in 1855. The work has been completed, and is now at Osborne. This commission may act as an example; it is one of a hundred cases of encouragement to "artists without

patrons," who have long suffered under "hope deferred."

PICTURE BY MURILLO.—The "Revue des Beaux Arts" and the "L'Europe Artiste" speak in very glowing terms of a picture, ascribed to Murillo, which is at present located at No. 7, Rue d'Amsterdam, Paris; the subject is the "Repentance of St. Peter." The saint is represented as an old man kneeling, his head soft and silvery, his hands clasped in the attitude of supplication, and his eyes lifted up to heaven: he is in a sort of cavern or grotto, the darkness of which is illumined by a solitary gleam from the sky. It is said to be painted in the most brilliant manner of the great Spanish artist; but how the picture got into Paris nor where it came from we do not learn; nor have we Mr. Stirling's volumes at hand to give us any information about it, if it ever came under the notice of the historian of the Spanish School.

ARTISTS' GENERAL BENEVOLENT INSTITUTION.—We have been requested to give publicity to the following abstract from the laws of this Society relative to applications for relief, in order that correct information may be easily obtained with regard to the form in which such applications must be made, and the times at which they should be presented.—There are two classes of cases in which relief may be given to "Distressed meritorious artists, their widows, and orphans." 1st. Those which arise from ordinary circumstances of distress. 2nd. Those which are caused by sudden and unavoidable calamities. Cases of the 1st class are relieved half-yearly, in January and July. In order to enable the applicant to receive the relief then afforded, it is necessary that a statement of the circumstances of the case should be made in a letter addressed to the council; and transmitted to the Assistant-Secretary on or before the 1st of June, or the 1st of December, that they may be properly investigated. This statement must be certified by the signatures of two Subscribers, one of whom must, in addition, state by letter his personal knowledge of the truth of the facts; this testimony to the correctness of the applicant's statement being relied on without personal appearance before the council being required. Relief cannot be granted to the same person twice within twelve months, unless in a case of extreme urgent distress, when special circumstances occur after the case has been considered and relieved at the half-yearly meeting.

URGENT CASES.—To meet them, enlarged powers have been given by the laws; but the most stringent rules with regard to their application have been enacted:—"only such cases can be relieved as arise from sudden illness, the death of a near relative, distress of household goods, imprisonment, fire, or other sudden and unavoidable calamities." Urgent cases must be signed by four subscribers; one of whom, as before, must certify by letter his knowledge of the truth and merits of the case, and may be brought before the council at any time in the year when properly signed and transmitted to the assistant-secretary. Those whose cases have been relieved as urgent cannot apply again within twelve months. No subscriber is entitled to sign more than six cases within the year. The following extracts show the regulations respecting the certificates which must be produced by widows and orphans:—"Every widow must transmit the certificate of her marriage and that of the burial of her husband. Orphans must produce certificates of the marriage and death of their parents, and of their own baptisms; or other satisfactory proofs of their identity. Orphans are not admissible, as such, when the age of the male exceeds 21 years, and that of the female exceeds 30 years; married females are not considered as orphans." When cases have been forwarded and received by the assistant-secretary, Mr. W. J. Roper, No. 19, Great Coram Street, Russell Square, to whom all communications must be addressed, a paper of printed questions will be sent by him to the applicants; it is indispensable that these should be fully answered. Further, it is required that in all new cases some specimen of the talent of the artist who himself, or whose widow, or orphan shall apply, must be submitted to the council, as no person can be relieved on account of distress,

unless his "WORKS HAVE BEEN GENERALLY KNOWN AND ESTEEMED BY THE PUBLIC." In conclusion, it is necessary to state that the laws are very strict in affirming—"That no artist who has embarked in speculation in trade, in bills of exchange, or transactions inconsistent with his profession, can be admitted as an applicant."

ENAMELS BY THE LATE H. P. BONE.—Among the works of Fine Art advertised for sale during the present month by Messrs. Christie & Manson, we notice a collection of more than one hundred and seventy of the beautiful enamel portraits executed by the late Mr. H. P. Bone. A large portion of these enamels consists of portraits of kings, queens, statesmen, warriors, poets, painters, and personages distinguished in history, all copied from pictures by the greatest artists or from other authentic sources: the series embraces the period from the reign of Richard II. to that of our gracious Queen. Added to these are several large enamels of fancy subjects after various painters. The collection as a whole merits the attention of the amateur, and there is little doubt of the sale being well attended, as it appears to be the last opportunity collectors will have of acquiring specimens direct from the family of the artist. Messrs. Christie & Manson also announce for sale the pictures collected by Mr. Wethered, referred to elsewhere; the pictures and objects of *virtu*, the property of the late Col. Sibthorp and Samuel Rogers respectively; and before our Journal is in the hands of our readers Messrs. Forster & Sons will have dispersed the gallery of modern pictures collected by Mr. Birch, of Birmingham.

"THE SANDS AT RAMSGATE."—This charming picture, purchased by her Majesty, and which is unquestionably the *chef d'œuvre* of the accomplished painter, W. P. Frith, R.A., is under process of engraving by C. W. Sharpe, and will be a plate of large size. The plate has, we understand, been purchased (it is said for the sum of 4000*l.*) by the London Art-Union Society, for presentation to its subscribers at some future year.

A STATUE OF THE LATE EDWARD BAINES, of Leeds, is to be erected in his native town—a town to which his intelligence and enterprise brought so much prosperity. The commission to execute it has been given to Mr. William Behnes. There were but three competitors for the commission—Messrs. Behnes, Noble, and Milnes. The amount to be paid for the statue is 800*l.*—not a large sum.

THE SCRIPTURAL MUSEUM.—A circular has reached us of a proposal to establish a Gallery of Scriptural Illustrations with the view of awakening and stimulating an interest in the study of the Scriptures. To carry out this object it is proposed to collect materials of every kind mentioned in the Bible: pictures of the scenery of Palestine, natural and mechanical productions, costumes, manuscripts, &c. The committee include many distinguished names, both lay and clerical. The "Palestine Archaeological Association" has offered its rooms at 22, Short Street, Bloomsbury, as a temporary museum, where the Rev. D. Edwards will be glad to receive any communication on the subject, as well as to receive contributions of specimens to aid in forming the museum.

THE GLASGOW ART-UNION is preparing to issue to its subscribers of the present year two very charming engravings—"The First-Born," after C. W. Cope, R.A., and "The Villa Fountain," after W. L. Leitch. We received impressions of these prints just as we were going to press, and must therefore postpone any notice of them till our next number, except to say they will effectually uphold the credit of this society for taste and discrimination in the choice of subjects to be presented to its patrons.

THE CRYSTAL PALACE COMPANY have appointed as its "general manager" James Fergusson, Esq., the author of "Palaces of Nineveh and Persopolis Restored," and of "The Illustrated Handbook of Architecture," recently published by Murray, and reviewed in the present number of the *Art-Journal*. A more useful appointment could not have been made; it is one upon which we may safely congratulate the company and the public. We feel assured that now this dying Phoenix will arise from its ashes, and be really the valuable *appanage* to Art it was expected to

be, may be, and ought to be. We trust, however, that Mr. Fergusson will begin his task by getting rid of certain encumbrances, worse than useless, by which Art-manufacturers have been discouraged and impeded; shallow and arrogant pretenders, who thought they were accomplishing marvels when they extracted the golden eggs, and left the nest empty for ever. We believe that British manufactures, under judicious management, may even now be made serviceable allies; they have been hitherto disgusted—the word is not too strong—by employments of the company, who will, we hope, be at once removed. We need not point out to Mr. Fergusson how powerful an auxiliary to British Art-industry the Crystal Palace may be made, nor how much its best interests may be promoted, by the zealous co-operation of the manufacturers generally throughout the kingdom. For our own parts, we shall cordially aid him in the improvements he will, no doubt, very soon introduce into this establishment—which at present stands as one of the wonders of the world, out of which very little that is good has been obtained.

THE PHOTOGRAPHIC SOCIETY finding that the duties of the Secretary were greatly increased, and seeing the importance of rendering its journal yet more useful, resolved on appointing a paid secretary and editor. There were forty-four applications for the office, all of unusual excellence. The council, after several meetings, elected the Rev. Mr. Major, of King's College, and into the hands of that gentleman the business of the society and the editorship of the journal is now committed.

HOSPITAL FOR CONSUMPTION.—The Committee of Management of the Hospital for Consumption purpose holding a Bazaar in the month of June next, to increase the fund for carrying on this national and now extensive charity—the usefulness of which has been recently increased by accommodation for 130 additional patients, and the opening of the Sanatorium at Bourne-mouth for the reception of convalescents, a branch of the Institution which cannot fail to prove a most valuable auxiliary to the charity. Desirous as we have always been to lend our aid to forward the success of this well-conducted hospital, we gladly direct the attention of our readers to the proposed bazaar, and solicit, on behalf of the Committee, contributions of such articles as are suited to the object: all contributions should be sent to the Hospital at Brompton, where they will be most thankfully received.

CHROMOLITHOGRAPHY.—At Messrs. Rowney's in Rathbone Place are exhibited some of the most successful imitations of water-colour drawings we have yet seen. They approach more nearly to the spirit of the brush than anything we have observed in this description of Art, the texture of the stone being almost superseded by the successful imposition of the colour; for the less the impress of the stone is observed the more nearly will the imitation approach the freshness of the original. One of the remarkable features of the success of these fac-similes is a representation of the texture of the paper and the unequal manner in which the colour sometimes settles on the paper. Since our last notice many additions have been made to the exhibition, and it must be observed that these additions exhibit marked improvement. "The Bridge at Tours," a chromolithograph after Turner, from a drawing in the possession of R. C. Vivian, Esq., is an admirable example of minute imitation—the subject itself is original and striking in its form—the left section being occupied by the picturesque and broken arches of the bridge, beyond which the eye is led to distant architecture. The original drawing has been very highly finished, and this careful manipulation has been very happily met by a succession of stones which have communicated a variety of tint very like what we are accustomed to see in Turner. We have noticed in a former article the beautifully spirited imitations of Cattermole's two subjects from Maebeth; Callow's "Frankfort," and "Cologne;" works after Prout, &c., &c. A "Street in Verona," by Bentley, a drawing made shortly before the death of the artist, is a work of much excellence; clear and sparkling in the lights, but somewhat less felicitous in the shaded passages, because perhaps chromolithography does

not realise the depth and transparency obtained by washing. The series is numerous and interesting, and some of the original drawings may be compared with the fac-similes in attestation of the truth of the latter. "Windsor Castle" after Pyne, "Fowey Castle" after Jackson, "Donne Castle," J. D. Harding, and others after Copley Fielding, T. Rowthorn, T. M. Richardson, &c., &c., are all brilliant examples of this art, which we really think is carried to a degree of perfection inasmuch as almost to rival original drawings in all their best features.

MADAME GOLDSCHMIDT has announced her intention to give a concert at Exeter Hall on Tuesday, the 11th of March, the proceeds of which are to be contributed to the NIGHTINGALE FUND. It will be remembered that some four months ago we announced such intention on the part of this accomplished and most estimable lady. There are matters connected with this graceful act which, if we were permitted to explain them, would augment its interest and value. The public will receive the announcement with peculiar pleasure: it is the homage of one great and good woman to another: the contribution will be, no doubt, very large: and, hereafter, Madam Goldschmidt will look upon "The Institute for Nurses" as she must often look upon "The Hospital for Consumption," as in a great degree her work, for by her generous efforts immense benefits will be conferred upon thousands.

MESSRS. CHRISTIE & MANSON have commenced their season of picture-sales; a reference to our advertising columns will show that several are in progress. We have always borne, and shall rejoice to bear, testimony to the high character which this establishment has so long sustained: no one has ever questioned their fair dealing: they cautiously and scrupulously avoid lending their name to aught that will not bear a close inspection: and where wrongs have been committed under their sanction, they have been the first to cause inquiry, and to make amends. The natural result has been to secure for them an amount of confidence which certainly no other auctioneers enjoy. One of the "approaching sales" to which at this moment we would direct attention is that of the collection of Mr. Wethered, which consists of about fifty pictures, the productions of modern British artists, together with several bronzes and objects of vertu. The pictures are all well known, and of unquestionably high value. Mr. Wethered is one of those persons in trade who, having had capital at his command, some taste, and abundant opportunities, have availed themselves of these advantages to obtain the best works of the best painters. Generally, as in this instance, they are afterwards distributed, being, indeed, often collected with an express view to distribution. But the amateur is thus supplied with valuable chances: he can see "aforehand" that which he inclines to possess; and if he is called upon (as, no doubt, he always is) to pay a large premium upon the original purchase, he has at all events "a choice," and can secure that which he covets. The pictures of Mr. Wethered will, we imagine, be objects of warm competition: there are no fewer than twenty-three paintings by Etty, some of them being his more remarkable productions. Of the remainder, there are works by Lee, Stanfield, Collins, E. M. Ward, Miller, T. S. Cooper, Linnell, Holland, and D. Roberts.

SHIP-BUILDING.—A novelty enormously in advance of anything seen before in the Art of Ship-Building is now in course of construction at Scott Russell's Wharf, Blackwall. A vessel is here building of the enormous length of 683 feet, its depth being 69 feet, and capable of carrying 38,000 tons. It is entirely constructed of iron, and carries eight boilers, each as large as a single-room cottage. In looking at this erection, we seem to be inspecting some great barrack or public building on the banks of the Thames, rather than a ship, which is destined to outstrip in speed all hitherto constructed: it is a wonderful work; and one which seems to realise the ancient tales of ship-building in classic days when gardens and palaces were stationed on deck; in this instance there would be no difficulty in getting up a race, the course encircling the deck.

REVIEWS.

THE ELEMENTS OF PICTURESQUE SCENERY; OR, STUDIES OF NATURE MADE IN TRAVEL, WITH A VIEW TO IMPROVEMENT IN LANDSCAPE PAINTING. By H. R. TWIVING. Vol. II. Published by CHAPMAN & HALL, LONDON.

It is about three years since the first volume of Mr. Twiving's "Elements of Picturesque Scenery" passed under our notice: in it the author's remarks referred to all those solid objects in nature which attract vision—rocks, hills, trees, and what ever belongs to, or is implanted on, the surface of the earth; his second volume relates to those objects, or rather effects, which are connected with the atmosphere, and with its abundantly pervading influence, light; or, in other words, it is a treatise on aerial perspective, that peculiar characteristic of good landscape-painting which so few artists comparatively know how to reach, and the absence of which, as a consequence, spoils many a picture in every other respect highly meritorious. The failure arises from ignorance of, or inattention to, the phenomena of nature; the solid objects which the painter sees are in their forms and picturesque appearance too often of far more importance to him than the effect produced on them by atmospheric colouring, and hence one of the most beautiful qualities of the landscape becomes only a matter of secondary consideration. Mr. Twiving is of opinion that the "old masters generally, when representing distant scenery, have shown themselves not only incapable of rendering those more subtle effects which are due to accidental and transient changes, but they are even very deficient in simply accounting for the due and progressive influence of the atmosphere on the tints of retiring objects. You may sometimes observe in the Dutch masters, especially Breughel, transitions from green or brown, to blue, so sudden and abrupt, that in nature they could not occur under the circumstances which are implied in the picture. Even Claude, whose aerial gradation is so beautifully maintained in his pictures of sea-ports, when the subject is near and the atmosphere hazy, fails in giving the true aerial distance to his mountains in an extensive prospect during clear weather. Some of his distant hills appear crude and heavy, and occasionally may be seen a grey, which approaches too near to white to be natural under the particular circumstances of the scene—unless it were intended for snow, which does not at all appear to be the case. Cuyp is almost the only painter of that period who appears generally consistent; but then his evening glow is nearly the same in all his pictures: there is no attempt at diversity of effect."

The treatise is divided into four parts respectively, entitled—The Atmosphere, Phases of the Day, Clouds, Winds and Storms; and each of these is subdivided into descriptive subjects, systematically arranged; thus the whole phenomena of aerial nature in their relation to the earth and those things which are of it are brought under discussion. It will be evident that a subject so treated can only, in the restricted space to which our "Review" columns are limited, be spoken of generally; we have no room for extracts, nor do we find any statements in the book that are open to argument; on the contrary, Mr. Twiving seems to have studied his subject closely and truthfully; his observations and experiences are embodied in language as free from dryness and technicalities as their nature admits of, so that his pages will be found as interesting to the general reader as they are valuable to the landscape-painter, to whom the investigation of the science of nature is of the highest importance when he desires to apply it to this Art; and, as the author rightly observes—"Modern painters have a theme much more difficult before them than that concerning which the old masters have left them practical examples; since, in order to satisfy the prevailing demand for diversity, they are frequently compelled to broach those effects of nature which formerly would have been set aside as being placed almost without the limits to which Art might be expected to attain." This is no less true than it is complimentary to modern Art, for where among the greatest of the old painters shall we find any attempt to represent on canvas such natural appearances as Turner, Danby, and Martin have given us? men who saw more in the heavens than masses of rolling clouds or the quiet glow of a summer's sunset. We would never advocate a style of painting that chooses the extraordinary phenomena of nature, but we do like to have our thoughts attracted to something which indicates that the painter can see with a poet's eye, and trace with a poet's hand, some of the beauty and grandeur which nature, in her fantastic moods, so to speak, spreads over the

landscape,—that, while there is but One whose prerogative it is to

"Ride on the whirlwind and direct the storm,"

yet He has endowed his creatures with the intelligence to admire and wonder at his creating powers, and with genius that enables them to imitate—even at a distance—what He permits us to behold, and find pleasure in.

HARVEST IN THE HIGHLANDS. Engraved by J. T. WILLMORE, A.R.A., from the Picture by SIR EDWIN LANDSEER, R.A., and SIR A. W. CALCOOT, R.A. Published by the Art-Union of London.

Whatever be the cause, whether the success of a rival institution, or a more enterprising and intelligent spirit than we have been accustomed to see influencing the Council of the Art-Union, it is quite certain that within the last four or five years, with one exception, the engravings it has issued have been of a very superior class to those received by the subscribers on preceding occasions. The "Harvest in the Highlands" is for the subscribers of the current year, and we shall be much mistaken if it does not tend to augment considerably the annual subscriptions. The original picture, the joint production of two great names—among the greatest in their respective departments, of any age or country—we are well acquainted with, though it has long been hidden from the public eye, in the country residence of Mr. S. Cartwright, F.R.S., near Tunbridge, Kent, where we had the pleasure of seeing it a few years since. We know that more than one eminent publishing firm had desired to engrave the picture, and we have heard that no less than 1000*l.* or 1200*l.* had been offered by its owner for permission to use the picture for such a purpose. That, however, which was refused to private speculation has been granted to a society whose object is to create a love of Art among the thousands. For many reasons, then, we rejoice to see this beautiful composition in the hands of the public by the aid of Mr. Willmore's *burin*. The picture is one of those long narrow canvases which Calcott frequently used, and Landseer now does occasionally. From the left of the composition a lofty range of mountains stretches away into the extreme distance; a considerable portion of these is concealed by clouds and vapours, for a shower has just passed over the distant landscape, which is in deep shadow, except where a rainbow appears to spring from its surface; the long level plain between this and the foreground is more or less lighted up with gleams of sunshine. In the foreground on the left, and leading into the centre of the picture, is the corn, partly standing, partly gathered into sheaves; nor does it seem that the owner of the produce is very anxious to have it garnered, for the labourers are few, one elderly woman with a kind of rake in her hand, and a young girl holding a sickle, and with a small sheaf under her arm: the latter is conversing with a group of boys, one of whom is keeping back a collie dog whose attention is directed to a number of deerstalkers coming up in the distance laden with their spoil. Between the old woman and the group of children is a cart, laden with corn; it is drawn by a rough-looking animal with a foal by its side, and to the right of the group, among a mass of granite blocks, and a calf tethered, a goat and its kids; all these figures are, of course, by Landseer. We have entered thus minutely into the composition of the picture because it is a work very little known. The engraving will bear comparison with the best issued by any Art-Union Society; there are parts of it which would be benefited by a little more of that refinement which Mr. Willmore knows so well how to employ; but the general character of the print is delicate yet effective. The clouds, the mountains, and the distances are charmingly rendered, both with regard to texture and to atmospheric effect, and the foreground exhibits much free and masterly handling of the graver.

THE VOYAGE OF LIFE. Engraved by J. SMILLIE, from pictures of T. COLE. Proprietor and publisher, the REV. GORHAM D. ABBOTT, Spingale Institute, New York.

Were we called upon to produce evidence of the progress of Art in America—good Art, too, though of a peculiar class—we should point to three engravings recently received from New York; another is to follow, which, at present, is not quite ready: the series, when complete, illustrates the "Voyage of Life" as sung by a hundred poets, great and small. The prints before us represent respectively "Childhood," "Youth," and "Manhood," from pictures by T. Cole, whom the Americans regard—and not without sufficient

reason—as one of their best landscape-painters. Mr. Cole is English by birth, parentage, and, to a great extent, by Art-education; we believe: he was taken to the States when very young, and, except his visits to Europe for improvement, has always resided there, and, of course, is regarded as an American citizen. These compositions afford evidence of a most poetic mind, of one whose inspirations have been nursed on the banks of the mighty Ohio, and amid the giant forests of the artist's adopted country; the rocks, trees, plants, and flowers belong to that New World, though many appear of primeval growth,—all is essentially American in its vastness and in its grandeur. In the first picture of the series, "Childhood," a boat has just emerged from a dark cavern in the midst of a mass of rocks, through which runs a stream; the little vessel is richly sculptured; the figures aboard is a young female with wings, and bearing an hour-glass in her hand: in the boat is the Child playing with wreaths of flowers; a radiated figure is at the helm, as its directing angel; the banks of the stream are covered with gorgeous flowers and magnificent plants, which glitter in the morning sun, before whose brightness masses of heavy clouds are rolling away: there is a fine feeling for the beautiful nature in this composition. In the second, "Youth," the landscape is an open scene; the river has widened its banks, the boat is hurrying onwards, now steered by the youth, but the guardian angel is by the river-side, pointing the voyager towards a magnificent palace faintly outlined in the sky; noble groups of trees appear in the foreground of the picture; the craggy forms of the hills in the middle distance are not agreeable; they mar the repose of the scene, as suggesting the idea of some great convulsion of nature. "Manhood" comes next, reminding us of John Martin in the unearthly grandeur of the scene: it is wild and black; the rocks and trees are riven, and "a horrible and terrible scene is round about;" hideous diabolical forms are half concealed among the clouds—tempters with the dagger, the cup of poison, for the man has let go the rudder-bands, and is drifting rapidly towards a whirlpool, that threatens to swallow him up: but his good angel has not totally deserted him; through a small bright opening in the clouds she still watches him; and there is no doubt, when the fourth plate makes its appearance, we shall find she has conducted him safely through the perils of his journey.

These works certainly merit much commendation; they evidence, as we have already remarked, a highly poetical conception, and, generally, it is carried out most successfully; there is nothing commonplace in them, nor is Mr. Cole guilty of plagiarisms; his ideas are his own; and their originality, gathered from the natural sources by which he is surrounded, invest them with a freshness and a charm which cannot but be attractive to an eye accustomed to European landscapes. The engravings are of large size, and for vigour, freedom, and clearness, the work of Mr. Smillie will bear a favourable comparison with some of the best examples done on this side the Atlantic: they are, we understand, his own work entirely, the assistance of which in England engravers so frequently avail themselves, Mr. Smillie was either unwilling or unable to procure. The series of plates is, we should consider, the most important publication ever attempted in America: the character of the work, no less than the way in which it is produced, must do a great deal towards improving the tastes and elevating the minds of the people for whom it is more especially intended. We are truly glad to see American Art in so advanced a state; and must congratulate the reverend gentleman whose name appears on the prints as publisher and proprietor on the successful completion of his costly undertaking thus far. The pictures are in his possession, and he has caused them to be engraved, far less from any desire to derive pecuniary benefit from the work, than in the hope the engravings will conduce to the intellectual benefit of his fellow-countrymen.

SPECIMENS OF TILE PAVEMENT IN CHERTSEY ABBEY. By HENRY SHAW, F.S.A. Published by Subscription.

From the site of the once famous Benedictine Abbey of Chertsey, in Surrey, have been dug up within the last few years, large quantities of richly decorated encaustic tiles, on which in ages long ago "the sandal'd monk," and the bare-footed brother doing penance, trod softly; many of these tiles are now preserved in the local museum and elsewhere, and from them Mr. Shaw, the archaeologist, has copied and published. They are of the date of the thirteenth century, and are more or less elaborate in design, the colours used invariably, so far as Mr. Shaw's examples show us, being yellow orna-

ments on a red or brown ground. Three of the specimens have curious devices in their centre; one a figure, whom we presume to be St. Peter from his holding an enormous key in his hand—The Abbey of Chertsey was dedicated by King Edgar to this Apostle—stands in a gateway of a castle; in the centre of another is a figure in a boat, into which another figure is attempting to enter by means of a ladder raised against the prow; we should imagine this device is intended for a representation of Peter walking on the sea; the figure in the boat lifts up his hand as if to chide the Apostle for his unbelief. In the third a youth is playing the harp to a crowned head, possibly meant for David and Saul: both figures are seated together on a kind of couch. Modern manufacturers of encaustic tiles will do well to refer to Mr. Shaw's work for designs.

ZAHMES GEELUGEL. Gezeichnet von E. HASSE, in Holzschnitt ausgeführt von HUGO BURKNER. Dresden, bei ERNST ARNOLD.

DOMESTIC FOWL. Drawn by E. HASSE, the Woodcuts by HUGO BURKNER.

We had, some time ago, in a biography of H. Bürkner, occasion to notice his proficiency in the art of wood-engraving, and the specimens of his skill which we gave, must, we think, have fully justified our praise. The four large plates before us display a mastery of execution which must delight every admirer of legitimate Art. The first plate shows the common "Cock" in all his strutting pride and glory, a perfect representation of the Dryden's chanticleer; the bird is full fourteen inches high; it will be seen, therefore, that scope is afforded for the boldest handling. The "Hen" follows with her chickens. Then come "Ducks" and "Geese." Nothing that Herring ever painted has, in its way, more character and expression than will be found in these studies from the life. The drawings may be used for copies, and as specimens of what wood-cutting is capable, they deserve attention. They cannot fail to add to Mr. Bürkner's reputation.

MACHINERY OF THE "ARABIA" AND "LA PLATA." Engraved by J. PETTICOLIN and G. B. SMITH, from Drawings by D. KIRKCALDY. Published by W. MACKENZIE, Edinburgh, Glasgow, and London.

It is rarely we are called upon to notice such a work as this; and we presume it is almost as rare for any large manufacturing firm to incur the cost of producing such a work; but then Messrs. R. Napier & Sons are not ordinary engineers, and the machinery of the noble steamships which traverse the Atlantic are not ordinary manufactures; and therefore we can easily see reasons for such a publication. We cannot enter into the mechanical merits of these plates, but we can wonder at the magnitude of the machinery, its complicated parts, so beautifully fitted and adapted to each other, and at the science which contrives the whole, and puts it into working order: the merit of this is due to the constructor, Mr. Robert Napier. The engravings are admirably executed from Mr. Kirkcaldy's drawings, who had a medal awarded to him at the Paris Exposition for them and others exhibited by his employers. It is only when the eye takes in, as it does here, the whole compass of these gigantic steam-engines, that one can form a correct estimate of the mind that creates, and the ingenuity that executes: surely, to borrow an Hibernianism, this is the "golden age of iron-work," in its adaptation to machinery.

HERE AND THERE IN PORTUGAL. NOTES OF THE PRESENT AND THE PAST. By HUGH OWEN. With Illustrations after Photographs. Published by BELL & DALDY, London.

A more pleasant, gossiping volume of travels than this it has rarely been our fortune to fall in with: the talk, too, is of a country little visited by tourists; this adds to its interest, for one gets terribly tired with the multitude of books written about places where Englishmen "most do congregate." Mr. Owen does not pretend to tell of more than he saw, but he seems to have seen a great deal of the people, their habits, manners, customs, and condition at the present time; these are the chief topics of the notes he has jotted down, in considerable variety and with much intelligent observation. His is a record of facts, not of theories, or fancies, or statistics, or pictorial descriptions, the usual materials of travel-writers; and it is the absence of these which imparts a freshness and an interest to his narrative about Portugal.

THE ART-JOURNAL.



LONDON, APRIL 1, 1856.

NOMENCLATURE
OF PICTORIAL ART.*

BY J. B. FYNE

THE BEAU-IDEAL.



F this subject be approached through the web of contradictory opinion, which entangles rather than illustrates it, or through those more subtle complicated disquisitions which attempt to obliterate all primary and common-sense appreciation of things in the gloom of a logical negation, it were hopeless, in any limited space, to attempt a disentanglement.

For the Art-loving world it is unfortunate, and for the Art-student more so, that the beau-ideal should remain a vexed question. The world, in general, is the more fortunate of the two, for throwing aside doubt and disquisition, and refusing to complicate a subject of apparently the utmost simplicity, it at once saves its time, avoids trouble, and enjoys its beauty; lives in happiness and dies under the full persuasion that though deformity may occasionally obtrude itself on the attention, beauty may always be had for the searching, and whose beau-ideal is a reality exactly commensurate with its experience.

With the student it is quite otherwise. His aspirations push him continually onwards. His experience should extend to the ultimate experience, and his productions be transcendental.

If the world is perfectly agreed as to the existence of beauty, and its climax in the beau-ideal, readily assenting to it when discoverable in works, and only disputing as to its degree, it is sufficient. Less knowledge would not decrease its happiness, and more might not augment it. The enthusiastic student however may not in commencing his artistic career be satisfied with this state of things. They are not sufficient for his purpose, which is ever onward, deriving sustenance on his route from all sources; at first indiscriminately and wildly, and followed by many arrangements of his mental digestion.

There is then much unassimilable reading matter to be waded through on the subject in hand; sufficient, indeed, to try the strength of the finest mental digestion, to swerve a taste of originally pure and correct bias, and warp a judgment from its first fresh healthy and vigorous conclusions.

One theory contends for the actual separate existence in the eternal order of things of such qualities as beauty and deformity.

Another denies altogether the actual

existence of beauty and deformity as distinct and separate qualities, and would attribute the perception of them to association alone.

A third theory—a kind of "juste milieu" between the irreconcilable antagonism of the first two—admitting the actual separate existence of beauty, would account for its presence by an universally accompanying fitness: a fitness of parts with a whole, and a whole with external conditions.

There may possibly be other links or grades of opinion serving to bring more closely together these three great salient points, but as they may not be able to extend the subject on either one side or the other, so they could not open up new ground for reflection; but as they are, must be considered to embrace the whole field of opinion upon which the war about beauty has been and will have to be contested.

Nor should a man be vain enough to imagine that with a dash of the pen or the best arranged discourse he might be able to settle the question. If it were an affair of numbers, weight, or measurement, of colour, of force, of solidity or liquidity, it had been settled long ago. If it were a matter of commercial or productive import, the want of which should be felt by the million, with a profit of twopence-halfpenny a yard or a penny a pound, obscurity had vanished almost before it were felt to be obscure. But as it is a matter wide a-field of these things, felt only as a want by the few instead of the millions, in an age far in advance of the age of animal wants and the actual necessities, it must still wait its solution. We have arrived at the age of luxury, it must perhaps wait its final solution in an age of refinement.

It may be questioned, then, "why write," "why discourse," and it can only be answered that to do both one and the other are instances of the purest natural egotism, in which the speaker or writer would register himself in his opinions; addressing himself virtually to his peers though ostensibly to the whole world. He does so by way of advertisement for the discovery of a mental relative with whom he may well sift a subject in which both may be equally interested. And these stray lines are thrown together as much to arrive at self-assurance as to the soundness of his own views as with any idea of being able to seriously influence any preconceived theory of his fellows.

There are many considerations which involve the improbability that the principles connected with beauty and the beau-ideal will yet be solved, or if solved be generally acknowledged.

Some works possessing the beau-ideal to a great extent have however been produced, and many more still which have an undisputed title to the beautiful, both intensely appreciated; the one attributed to fine taste and knowledge, and the other to a divine inspiration: and the latter flattering though vague and unsubstantial reception will continue to be given to all works of rare elevation of thought, though they may be—like all the present known instances of the beau-ideal—derivable entirely from a high type of Nature itself.

The position of this beau-ideal, standing isolated at the very head of human form, and illustrating what may be considered to be the Creator's first design as to its highest possibilities, throws it far in advance of the wants that agitate the mind of a people, and hence the obscurity that involves the subject, the wonder at its occasional production, and the flattering inapplicability of the language resorted to in its description.

But before losing sight of the subject in

premature digression, though without entering into a full disquisition, for which there is no space, it were well to canvas slightly those opinions, already stated as dividing the attention of the student regarding the material separate existence of beauty and deformity. As without this material existence the fight is comparatively for a shadow, but with it, for a glorious reality, worthy alike the consideration of the Art-lover, the statesman, and the philosopher.

To clear the ground of all rubbish and impediments that obscure a fair view of the object in question, and to render it open to the gradual advance of common sense and simple reason, it will be necessary at once to discard from the mind every notion of those sublime logical absurdities, those curiosities in the perversion of language that would deny existence to those things of whose presence every sense vouchsafed to man attests the actual identity; to receive at once those things as real, to whose reality the senses testify.

Thus, then, I think it necessary at once to accept the first proposition mentioned, which asserts "the actual separate existence in the eternal order of things, of the qualities of beauty and deformity," taking deformity in the sense of the ugly, and in which sense it will always be used in this paper. If there be allowed any point of dispute on such a subject, let it merely be the "why such beauty," and the "wherefore such deformity," and not as to the actuality of either one or the other. Without this fair starting-post the race is for nothing, the runners fools, A No. 1. The umpires hunbugs, with themselves only for a course, and a sham triumph of emptiness. Asserting broadly what is beauty, under the shelter of a definition of the character of the extinct school, it is that which is furthest removed from what is universally allowed to be deformity; and *vice versa* with deformity. But there is no need of such a definition except by way of general summary, its constituents being tolerably well determined in the general mind.

In form it would be defined to be the greatest possible amount of variety dominated by harmony, which again would be defined as relationship and opposition with subordination. As regards its variety, not that sudden hectic and wild dissimilarity of parts that would contain the longest with the shortest, the roundest with the flattest, the most pointed with the most indented, but a variety founded on affinities, the culminating illustration of which may nowhere be found in an equal degree with the form of Man himself, who displays, both in structure and movement, a category of all the varieties of form distributed, in a less degree, through all other objects in nature.

The best collateral evidence of this constituency of beauty may be had in the comparison of some of these other less beautifully developed objects in nature, objects of a less complicated structure with a less number of parts; as constituting, by their greater simplicity, a more easily to be determined character.

The second theory, which "denies altogether the actual separate existence of beauty and deformity as distinct and separate qualities, and would attribute their perception to association alone," can hardly be disposed of in so summary a manner as the first. An artist cannot do so; his business is with life and reality, and it is as much as may be expected of him if, in the liberality of his temperament, he may be able to attribute to fair and just motives the attempt to disintegrate from the actualities of nature,

* Continued from p. 199, vol. for 1855.

some of its noblest and most beautiful identities. It is as much as may be required of him if, in due consideration for the egotism of a professional obliquity, he excuse a man whose business may be writing alone (and which business of writing allows for an impalpable subject for illustration), for a proneness to make most things impalpable, ideal and associative, but he cannot be expected to go further, nor pin his faith to so slender a tissue. Neither need he throw down his familiar instruments, whether they be pencil or chisel, and assume the stranger pen to confute theories which would assume to weaken the appeals of his pursuit to the human mind. He may cut down such theories with the chisel, or paint them out with the brush. He may perhaps do either one or the other more easily than write them down. An artist would, by way of argument, most readily allow of the infancy of Art altogether, from its noblest achievements to its humblest. And if logical precision or cunning be capable in the present state of the science of ignoring an universally acknowledged identity, it is rather a proof of the possible infancy also of logic itself, or of language, than of the destruction of such an identity, which must still remain an identity intact in the mind, from a more than faith superinduced by the senses. In the present instance such a more than faith does not in any way necessitate the entire absence of association, which may have its full play in augmenting a secondary class of beauty to the same level with one of a first class. But it is submitted that association alone can no more create a first class of beauty, any more than the smell of a kitchen may be able to realise a first-class dinner, or the effects of one.

But throwing aside this mischievous misuse of logic, the science by itself may be allowed to be perfect; and if limited in its application to subjects of utility, one of the utmost importance to be preserved in its utmost integrity. Logic however has its limits as clearly marked as any other science; for instance, it is not strictly of an initiatory character, and follows rather than leads. It cannot go far enough to grasp with first causes, but must wait for previously acquired knowledge upon which to work out its searching precision; its province is in secondary causes, and is powerless when attempted to be carried further. Its only further power is one of a more curious and negative class than otherwise. It is capable of curbing the too arrogant and speculative mind, and defying it to prove to a demonstration that of which it has not previously acquired the true knowledge, and in this regard has its uses.

The human mind, however, being of an essentially initiatory character, will no more be content to rest satisfied under the knowledge only of secondary causes, than a colony may be content to rest satisfied with anything less than the possession of the whole of a continent.

Under the far-strained and perverted powers of logic, one is denied the right of proving the existence of man. Man's existence a negation, beauty resolves itself into a nonentity, and there remains you may say—in an equally fair mode of reasoning—nothing but the logician himself accompanied by his perversity. But the logician himself thus remaining is by the process identified, and becomes a nucleus around which other existences may establish themselves, and amongst them perhaps even beauty.

Logic is the arithmetic of language, and a very complete one; the accounts in which it is used are kept by double entry, and

bear a balance on their face of *all we know*; but at the same time it does not represent the *all we have*, for which we are indebted to a more comprehensive and liberal process. The more purely initiatory intellect of the world, in the use of this more comprehensive process, is at work far away beyond the trodden paths, labouring with untired courage and daring on the very verge of that darkened abyss which separates the known from the unknown. One ventures into space and brings back a star, another acquires a continent, a third an art, the last of which importations, in its present form, that of photography, is enriching and entertaining the world with pictures which produced in a single instant, require the strongest microscopic powers to thoroughly develop, and any amount of time to thoroughly examine.

Form itself appreciated under the terms of the second theory denying "the actual separate existence of beauty and deformity," would be an instance of the reproduction of that dark abyss which separates the known from the unknown, the dispersal of which is grandly shadowed forth as the first act of Omnipotent creation; and a mind incapable of seeing throughout the whole universe of form, anything of sufficient intelligence to rank itself at once at the head of all such antagonistic qualities, as grandeur, simplicity; beauty, deformity; strength, weakness; harmony and discord; must be in itself a stagnant well of darkness, of doubt, and of deformity: one constituted on the experience of four senses, with the crowning glory of vision in abeyance.

In the face of that high and universal presence of intelligent form, rounding as it does the infinite separate existences in nature; as distinct in its minute as in its most colossal modes; it is impossible to force the mind by any act of reason to ignore its intentionality, or to doubt that amongst it—accompanied by proportion—a true beauty exists without the aid of association or egotism, which may—by way of admission only—render an object more beautiful to one individual than another; and even more beautiful at one time than another: the last case entirely depending on the varying degrees of activity or supineness of the same reflective mind at different times.

It should not be a difficult matter in answer to this beauty-denouncing theory, to prove the intelligent character of form by a slight survey of its universality.

The first act of creation was in the substitution of form for chaos; and all its subsequent acts are the additions of so many new forms; proportion itself being nothing more than subdivisional separations of form by other forms, components of the first matter of form.

For as far as the mind is able to possess itself of the knowledge of things as they are, does it become the more impossible to imagine that the Creator—in commencing with form—did not begin with the most essential quality of things, and that bad creation—as regards the external world—gone no further, man would not have had to complain of any essential wants. This has been so frequently and so distinctly felt that we frequently hear the opinion, that the unessential colour is in effect a proof that the great aim of creation was that of producing the greatest possible amount of variety. This, if to any extent true, appears to be a merely putting the cart before the horse. The self-evident intent of creation would perhaps be more truly given, by stating that creation, in adjusting an infinite number of things to an infinite number of

ends and uses, has projected an infinite number of forms admirably adapted to them, and that hence has occurred the infinite variety; so full in itself, that more than satisfying man's wants and expectations, leaves him at a loss to discover the motive for such an apparent waste of form and colour, and leads him on a wrong scent in accounting for them.

We find, also, an admirable harmony and genial agreement between the Mosaic account of creation, and what may be called the revelation of geology in the order of that creation. We first find the acts of creation first merging into light and intelligence on the grandest scale, such as in the great globe itself indicated as a mass of waters. "And the earth was without form and void; and darkness was upon the face of the deep. And the spirit of God moved upon the face of the waters."

After the rising of the land above the surface of this profound solitude of water, we find creation occupied in calling into existence the simplest and less complicated forms of animal life: proceeding gradually through the more complicated winged tribes, the vegetable, the terrestrial animal, and only, as an ultimate act, producing Man with a completeness and variety such as to offer in itself alone a fair constructive balance to all the rest of creation besides.

The gift of the whole of this previous creation to man is more than an indication of the perfect equilibrium existing between the two. And as fair an indication that, being presented with an even balance-sheet on entering life in the world, he may be required to produce as fair a balance upon leaving it.

If it be still possible to doubt that amongst this infinity of varying form there is included an ultimate beauty, and that such beauty has always, amongst other qualities, been present in the scheme of the Creator, it is only necessary to contemplate the added infinite variety of colour to turn the mind from its doubt, and permanently fasten upon it the more healthy conviction that beauty reigns in different degrees at, and as the head of every definite class of things; and that by comparing classes, and placing that which includes Man at the head of all others, the highest possibilities of the human form realise in its ultimate fulness an instance of the *beau-ideal*.

While feeling that every class is capable of maintaining beauty at the head, it is easy to allow that it permits deformity at the base. It would appear that the very nature of things insists on this conclusion. The infinite variety includes infinite difference and separation. This difference and separation may not be utility and inutility, as universal fitness and utility are more conspicuously clear and defined in the works of nature than any other quality; that is, they are *universal*, as they never vary, but attach equally to things beautiful as to things deformed. We say a thing must either be more or less useful, or more or less ornamental. As this infinite variety and difference does not affect the useful things are all useful, but more or less ornamental, and hence *beauty and deformity*.

It is inadmissible to speak of the works of Nature upon the same terms as of the works of Man. Of the latter, it may be said that some are neither useful nor ornamental; and I should therefore say of that theory which would devalue beauty in the world and place her at arms under the varying caprice of a well-informed or ill-informed associativeness, that it is neither useful nor ornamental; but most gratuitously mischievous, as calculated to retain a base

mind in its original coldness, and as offering some plausibly philosophic grounds for lowering the generous and grateful warmth of a great one. Though not coming under the strict definition of beautiful, as being imperceptible to vision, there are other qualities applicable by other senses not entirely irrelevant, as thus belonging to the beneficent side of the nature, and have consequently a certain amount of affinity with the beautiful. Textural smoothness, elasticity, softness, and warmth, have all their value in heightening the impression of an appreciated beauty.

Reasoning on the constitution of the mind, and the several causes contributing more immediately to the development of its various sentiments, feelings, and passion, we find that it would never ascend to so high a one as love without the presence of beauty. And by analogy, on the general scheme of creation, in which nothing is left undone which tends to high purpose, we must admit at once that the world is wondrously full of beauty. Some will say that certain minds are so full of love that they include the whole world as the object of this passion. But it would, perhaps, be safer, in this instance, to call this passion feeling, and pronounce this feeling benevolence, as, if tested severely, it would be found to fall far short of that passion which absorbs all others in its glow, as the sun absorbs all other modes of light in its effulgence. It will be therefore safe to conclude that, as creation had so universally elaborated the susceptibility to this passion, it has been no less liberal in the distribution of its most essential aliment—under the numerous forms of beauty—for its eternal sustenance.

Thus the mind, while instinctively but unconsciously weighing the different gifts of creation, will be found as unresistingly possessed by the following feelings: gradually ascending with the gradually extending benefits; commencing with the simplest contentment in return for the mere privilege of life and wherewithal to live, and grandly terminating in veneration of the Creator for that extension of the boon in which the mind finds itself still better provided for than the body.

Thus, uncivilised man in the possession of the merely necessary, remains contented,—with the useful, he becomes grateful; the arts, science, and luxury excite his admiration; beauty and refinement, his love; and under a true appreciation of the essence of Deity, in which his own mind expands with his gradually expanding knowledge, his soul fuses in veneration.*

NATIONAL PORTRAIT GALLERY.

On the evening of March 4th, the Earl of Stanhope introduced into the House of Lords a measure for the formation of a National Portrait Gallery. From no one, either in the House of Peers or out of it, could such a proposition have emanated with better grace, or with a greater chance of the arguments in its favour receiving that attention which they deserve. His lordship, as the historian Lord Mahon, has a high name in the literary world; and his pursuits naturally incline him to feel a warm interest in the project he has undertaken to advocate—an interest, however, which ought to be, and doubtless is, shared by every intellectual member of the community at large. There are difficulties, as the Earl of Ellenborough and other noble lords remarked in the course of the debate which followed Lord Stan-

hope's proposal, in creating such a gallery of portraits as England ought to possess: but let us once have a suitable building for its reception, and ways and means will, we are confident, not be wanting to decorate it with the "forms and lineaments" of those who are worthy of being found there: the greatest difficulty will be in making such a selection. The motion was agreed to without a dissentient voice; and we are sure our readers, who may not have found opportunity to read Lord Stanhope's speech, introductory of the motion, as reported in the daily papers, will thank us for enabling them to do so in our own columns: we print it as reported in the *Times*, and it will well repay perusal for the truth of the arguments, and the eloquence with which they were supported. We should also have been well pleased to have followed it by Lord Ellenborough's sensible speech, but our space will not permit us to do so.

"Earl Stanhope said that, in rising to bring forward the motion of which he had given notice for the gradual formation of a gallery of portraits, he begged to explain that this question was not altogether new to Parliament. Four years since, just before the last general election, and while he was a member of the House of Commons, he introduced this project in a conversation on the miscellaneous estimates. A right hon. gentleman who represented the Government at that time—it was the Government of the noble earl (Derby)—expressed himself in approving terms of that proposal. Other members expressed the same approbation, and he was so far encouraged as to give notice that, if he had the honour of a seat in the next House of Commons, he would bring the matter forward as a substantive motion. He was not able to fulfil that pledge, because, as it chanced, he had not the good fortune to obtain a seat; but now, although in another place, he would endeavour to redeem his pledge. He thought he could not better introduce this question to their lordships than by asking the greater number of them to recall to mind what they had seen in the galleries of foreign countries. Many among their lordships must have felt no small degree of weariness and disgust on passing through an almost interminable line of tawdry battle scenes of the largest dimensions at Versailles. Many of these battle scenes would no doubt recall the words of a modern author, who had described them as 'acres of spoilt canvass.' Many such acres of spoiled canvass presented themselves upon the walls of Versailles; but their lordships would also recollect the great pleasure, and as it were refreshment, with which they had passed from all these tawdry battle pieces and pageants into a smaller gallery, less gorgeously decorated, and containing excellent contemporary portraits of French celebrities. Few Englishmen could have been at Versailles without wishing that in our own country the errors of the larger gallery should be avoided, and the small gallery not only adopted but further extended. In this country the portraits of our great historical characters were very numerous. He doubted, indeed, whether in any country this class of portraits so much abounded, but they were scattered far and wide—many of them in country houses and in private collections; and it was only now and then that a single portrait or a whole collection was exposed for sale. There were many advantages to be derived from forming such a gallery. The main recommendation was, that it would afford great pleasure and instruction to the industrious classes. It would also be a boon to men of letters."

After quoting the opinion of Mr. T. Carlyle on the importance of the subject, his lordship proceeded:—

"He thought the testimony of so gifted a man as Mr. Carlyle should be allowed to stand alone, though he could easily accumulate other authorities. It might be shown also that the formation of such a gallery would be of very great importance in the promotion of Art. It would be of immense advantage to portrait painters to be able to see in a collected form a series of portraits of men famed in British

history, from the first rude attempts of panel painting, in the thirteenth or fourteenth century, down to the finished works of Reynolds and Lawrence. It would enable them to soar above the mere attempt at reproducing a likeness, and to give that higher tone which was essential to maintain the true dignity of portrait painting. But to historical painters such a collection would be of still greater value. Their lordships would no doubt recollect two great pictures—'The Execution of Montrose' and 'The Last Sleep of Argyll'—for which a friend of his, Mr. Ward, had received commissions. Mr. Ward had told him that it was scarcely possible to conceive how much difficulty he had met with in ascertaining the correct likeness, and the dress, and the decorations of the time, in preparing those two pictures. In a letter to Mr. Sydney Herbert, in January last, upon a proposal to purchase a picture of Sir Walter Raleigh for the National Gallery, Sir Charles Eastlake, the President of the Royal Academy, said:—

"I thank you for your information about the portrait of Sir Walter Raleigh. . . . For the National Gallery it is not, I think, adapted. But whenever I hear of portraits of historical interest, I cannot help wishing that a gallery could be formed exclusively for authentic likenesses of celebrated individuals, not necessarily with reference to the merits of the works of Art. I believe that an extensive gallery of portraits, with catalogues containing good and short biographical notices, would be useful in many ways, and especially as a not unimportant element of education."

After such testimony it was not necessary to say more in proof of the advantages which would accrue to Art from the establishment of such a gallery as he had suggested. But there was another mode in which, he thought, it would be valuable. It would be useful as an incitement to honourable exertion. They all remembered the exclamation ascribed to Nelson, just before the battle of the Nile—'A coronet, or Westminster Abbey.' Of a coronet he would say nothing, lest he should be supposed to desire to revive recent debates; and, with respect to a place in Westminster Abbey, it was as difficult to attain as a seat in their lordships' house. If the thought of a tomb in Westminster Abbey was so inspiring to such a mind as Nelson's, at so great a moment, would not the same effect have been produced by the thought of one day occupying a place in the collection of portraits of his country's worthies? The hope of honourable distinction served at all times as an incentive to exertion. In the emphatic words of one of the wisest and most sagacious men that ever lived, *contemptu fama coluntur virtutes*. He had spoken of the advantages from such a scheme. Their lordships had a right to require, and it was his duty to show, by what particular means those advantages were to be secured. He should be sorry if the execution of the project were postponed until a new National Gallery was erected. To plan, and still more to construct, a National Gallery must be a work of time, and if the gallery were ready now, to place there the few pictures which at first could be obtained would give an appearance almost unsightly. He hoped her Majesty's Government would assign some temporary apartments, either in Marlborough House or in the Palace of Westminster for the purpose, and then the scheme could at an early period be commenced. The supply of portraits would depend on two sources—purchases and presents. It would, of course, be necessary to establish some authority which should direct purchasers and consider offers of presents. It would be of the greatest importance that anybody exercising that authority should possess sufficient discernment to make proper purchases and also a power of refusal in cases of offers of portraits, the reception of which in a national collection would not be warranted by the importance of the persons represented. Such a body actually existed in the Fine Arts Commission which was established by Sir R. Peel in the first year of his Administration, under whose direction and supervision most of the decorations of the palace in which their lordships were assembled had been executed. The marble statues which ornamented one of the halls of that house had been placed there

* To be continued.

under the authority of that commission, of which Prince Albert, distinguished for his love and patronage of Art, was chairman, and Sir C. Eastlake was secretary. The commission had first to consider upon historical grounds who should be the persons selected; next to consider upon artistic grounds what sculptors should be entrusted with the execution of the statues; and they had also generally to superintend and direct the progress of the work. He thought that its functions, and even to extend them in the direction which he proposed. Adverting to the question of expense, it would, of course, be a matter for the House of Commons to consider what should be the annual vote for such a purpose; but he was inclined to believe that a building once obtained, a very moderate sum would suffice to provide the portraits worthy of being placed in it. He thought a yearly sum of 500*l.* would be adequate, although, perhaps, for the first year, a sum of 1000*l.* might be necessary; but it must be clearly understood that, in the event of the purchases made in any one year not requiring the whole sum voted by Parliament, the balance should remain as a fund for future purchases, as opportunities might occur, works of Art not being always in constant supply. It might be necessary for him to give some grounds for his belief that much might be done, even with the very moderate sum he had mentioned; and therefore he would state a few cases of remarkable portraits sold for small sums during the last few years. He had been present when a full-length portrait of Mr. Pitt by Gainsborough, an undoubted original, was sold by auction for 100 guineas. He might also mention a portrait of Chatham, of whom only three portraits were known to exist, which was sold to Sir R. Peel for 80 guineas. About eleven years ago the portrait of Blackstone, an engraving of which appeared in all editions of the learned judge's "Commentaries," was sold for 80 guineas; and an original portrait of Mr. Perceval was purchased by the late Sir R. Inglis for 40*l.* Those instances justified him in believing that with a very moderate sum of money a valuable collection of national portraits could be formed, but undoubtedly the body to whom the duty of expending that money should be intrusted ought to exercise its power with care and discernment. Another part of its duties would consist in deciding upon offers of presents which might be made. He believed from that source many valuable portraits might be expected, for since he had given notice of his motion several noble peers had told him they were willing to make presents to a national collection. When it was remembered how many of their lordships were descended from men famous in the history of this country, it was not unreasonable to expect valuable contributions from those who possessed, as many did, four or five portraits of their eminent ancestors, and the honour of having a place assigned to such portraits in a national collection would be great incentive to such liberality. There might be other cases, too, where persons possessing valuable portraits had no convenient place for them in their own houses, and who would willingly bestow them on a national collection such as he suggested. The most careful supervision, however, would be required in deciding upon the acceptance or refusal of the offers of presents which would be made to the body exercising the supreme control. He attached the greatest importance to the power of refusal, and believed the whole success of the undertaking would depend upon the proper exercise of that power, for if they admitted into a national collection portraits of those who possessed no adequate claim to such honour the inevitable consequence would be that the gallery would be deprived of all the distinction which he wished to see attached to it. The power of refusal must therefore be necessarily exercised in many cases, and should be facilitated by a rule that in no case should the portrait of any living individual be admitted into the gallery which he wished to see founded. He proposed that three-fourths of the votes of the committee of selection should be necessary for the acceptance and detention of a portrait,

so as to have it hung upon the walls of the gallery. There was another question—namely, whether the superintending body ought not to be allowed the power of parting with duplicates? Suppose a present of a portrait sent to the gallery, and that there was in the gallery at that time a portrait of the same person at the same time of life, and, in fact, a kind of counter-part, it might be then in the power of the committee to receive the present, and to dispose of the portrait which they already possessed. But these were points of detail with which it was not necessary to detain their lordships. He proposed to give a general power to the superintending body to receive presents. He felt sure that a beginning would soon be made. If only a temporary apartment were erected, and only a grant of 1000*l.* were made on the estimates of this year, he ventured to say the whole thing would be done; his opinion being, that such would be the popular favour with which this gallery would be regarded, that there would be no want of portraits, but that donations would come in in such considerable numbers, that there would be no fear of the failure of the scheme. He only desired to see the project commenced. There were two collections of portraits in this country, about which it might be expected he should say something. It was some time ago that they might form the foundation of a portrait gallery, such as he had described, out of the collections at Hampton Court and the British Museum, but there were obstacles to both. With regard to Hampton Court, he should be sorry to diminish the inducement to make a summer's holiday excursion to see the pictures there, especially as regarded those who were confined within the walls of London during the greater part of the year. With respect to the British Museum, there were some portraits there, some of which were curious and some valuable, but many of them were ill-placed. Some persons proposed to transfer the whole of this collection to a national gallery of portraits, but he did not think the whole of them would be worthy of a place there. It would be necessary to make a selection, and take the best and leave the worst. * * * He supposed it was unnecessary for him to state that in the proposed collection it should be a fundamental condition that none but authentic portraits should be admitted, and that there should be no such imaginary characters as they saw on the walls of Holywood House, where there was a long line of Scottish kings, all assumed to be painted before the art of oil-painting was known in this country. All such imaginary portraits, he repeated, ought to find no place in the proposed gallery. He thought he had now gone through all the principal considerations which he had wished to suggest to their lordships, and it only remained for him to apologise for having so long detained their lordships. But he thought that these questions were interesting to a great body of persons. When they considered the great number of their countrymen who were struggling in the various walks of Art, and intent on that rugged path that led to fame, he thought that some mark of sympathy and some encouragement should be given to their exertions. Dependent upon the time was past when, considering the education of the people of this country, they could disregard the refining influence of Art. This truth was every day becoming more widely understood and acknowledged—that the Fine Arts, under true rules and guidance, were to be ranked, not merely among the ornaments of human life, but among the appointed means for the elevation and improvement of the human mind. Believing this to be a step in the right direction, and a movement in advance, he begged to move—

"That a humble address be presented to her Majesty, that her Majesty would be graciously pleased to take into her royal consideration, in connexion with the site of the present National Gallery, the practicability and expediency of forming by degrees a gallery of original portraits, such portraits to consist as far as possible of those persons who are most honourably commemorated in British history as warriors or as statesmen, or in arts, in literature, or in science."

THE ROYAL PICTURES.

FOUNTAIN AT MADRID.

D. Roberts, R. S., Painter. J. Cousen, Engraver.
Size of the Picture, 1 ft. 2 in. by 30 in.

THIS picture, like that of the "Bridge of Toledo," by the same painter, which was engraved in an early part of this publication, is the result of a commission received from the Queen; her Majesty having selected the subject from a number of Mr. Roberts's Spanish sketches, and directed a painting to be executed from it, in oil, to be presented to the Prince Consort on his birthday. The picture has never been publicly exhibited.

Madrid has fewer attractions for such a pencil as Mr. Roberts's than most of the cities of Spain, from the fact of its being of later origin, and therefore possessing none of those remarkable architectural features introduced by the Saracens, such as are seen in Grenada, Seville, Cordova, Burgos, Toledo, and others—relics of the period which Byron laments over:

"Oh lovely Spain! renowned romantic land!
Where is that standard which Pelagius bore,
When Carra's traitor sire first called the band
That dyed thy mountain streams with Gothic gore?
Where are those bloody banners which of yore
Waved o'er thy sons, victorious to the gate,
And drove at last the spoilers to their shore?
Hed gleaned the cross, and waved the crescent pale,
While Africa's echoes thrilled with Moorish matron's wail."

Till the reign of Philip II., son of the Emperor Charles V., Madrid was little more than a hunting residence for the Spanish monarch: Philip fixed his court there, and henceforth it became the capital of his dominions. Yet the city is not without much that is interesting to an artist, though all partakes of a comparatively modern character; the two noble bridges thrown over the insignificant river of the Manzanares—so scanty a stream as to have given rise to the witty remark, "that the Kings of Spain ought to sell the bridges, and purchase water with the money;" the wide and well-planted promenades in and about the city, the magnificent churches, and imposing public buildings, are not without a certain value in the estimation of the painter. The squares add greatly to the splendour of Madrid, especially that known as Plaza Mayor, where the bull-fights are exhibited; its form is quadrilateral, and it is enclosed by three hundred houses, uniform in height, of six stories, each story having a handsome balcony, supported by columns of grey granite, which constitute a fine piazza all round. The churches and convents are numerous, but scarcely one can be pointed out as an example of a pure style of architecture. The palace is considered one of the finest royal residences in Europe: it is a large square building, which stands upon an eminence commanding a fine view of the adjacent country; the interior is decorated in a style of costly magnificence, is richly furnished, and adorned with valuable pictures. The celebrated palace of the Escorial is some few miles distant from the city.

Public promenades abound in Madrid. The most resorted to is the *Prado*, a portion of which is seen in Mr. Roberts's picture; it contains a variety of alleys lined with double rows of trees, and ornamented with beautiful fountains, of which that in the picture stands at the entrance to the *Prado*. Adjoining the promenade is the *Retiro*, a large and beautiful garden. On the east side of the *Prado* is the National Gallery, a splendid building with a noble Tuscan portico and Doric colonnades; the collection of paintings hanging here is, perhaps, unsurpassed by any in Europe for their general excellence.

The fountain at the entrance of the *Prado* forms a picturesque and striking foreground object in the picture here engraved; the edifice seen in the background is the Observatory: the groups of figures in their various characteristic costumes enliven and enrich the scene. The picture is painted almost throughout in the low, warm yellowish tints, which this artist used to employ some years back much oftener than he does now. The figures have also little positive colour, but they are brought forward with sufficient power.

The picture is in the collection at Osborne.

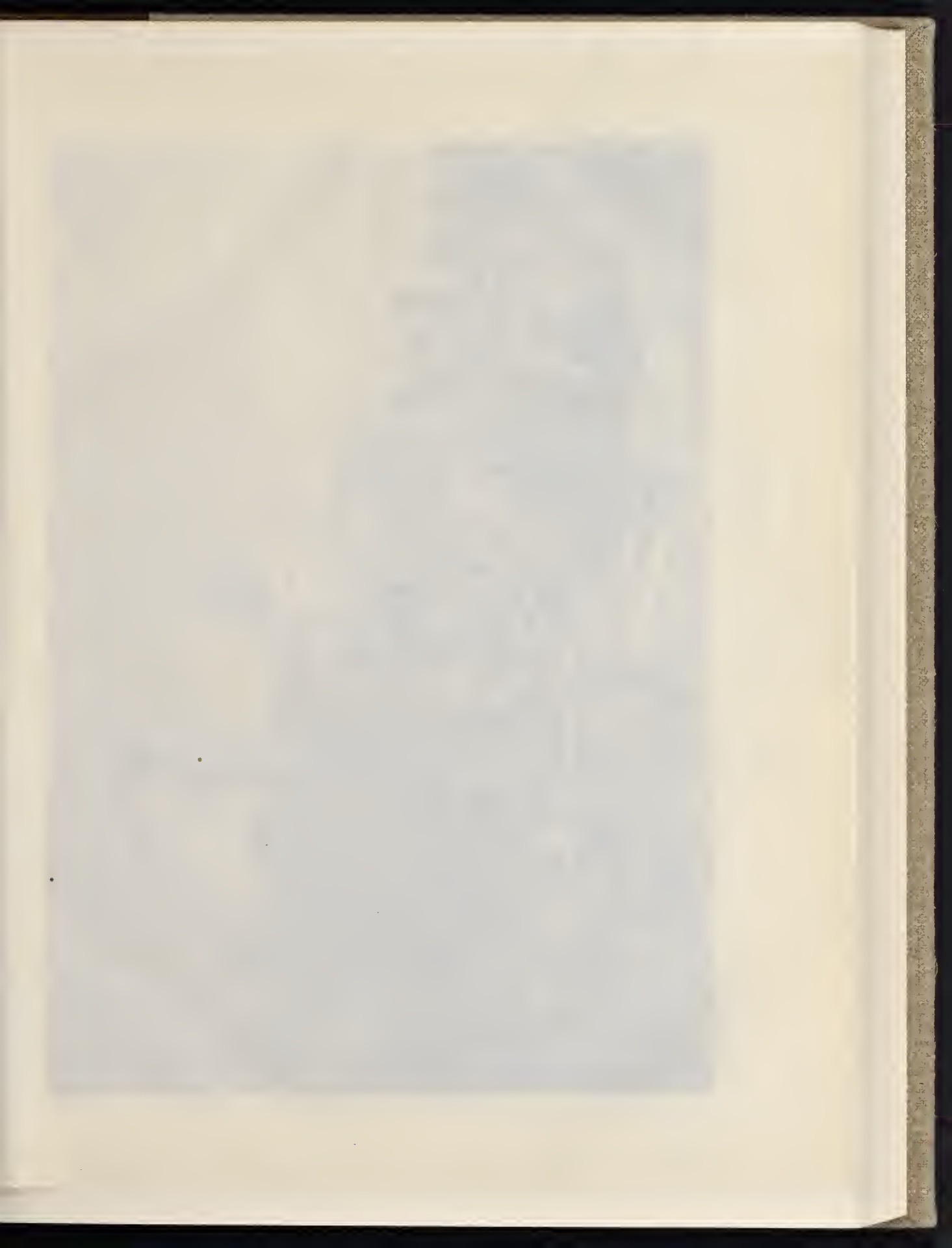





THE FOUNTAIN AT MYSORE
INDIA

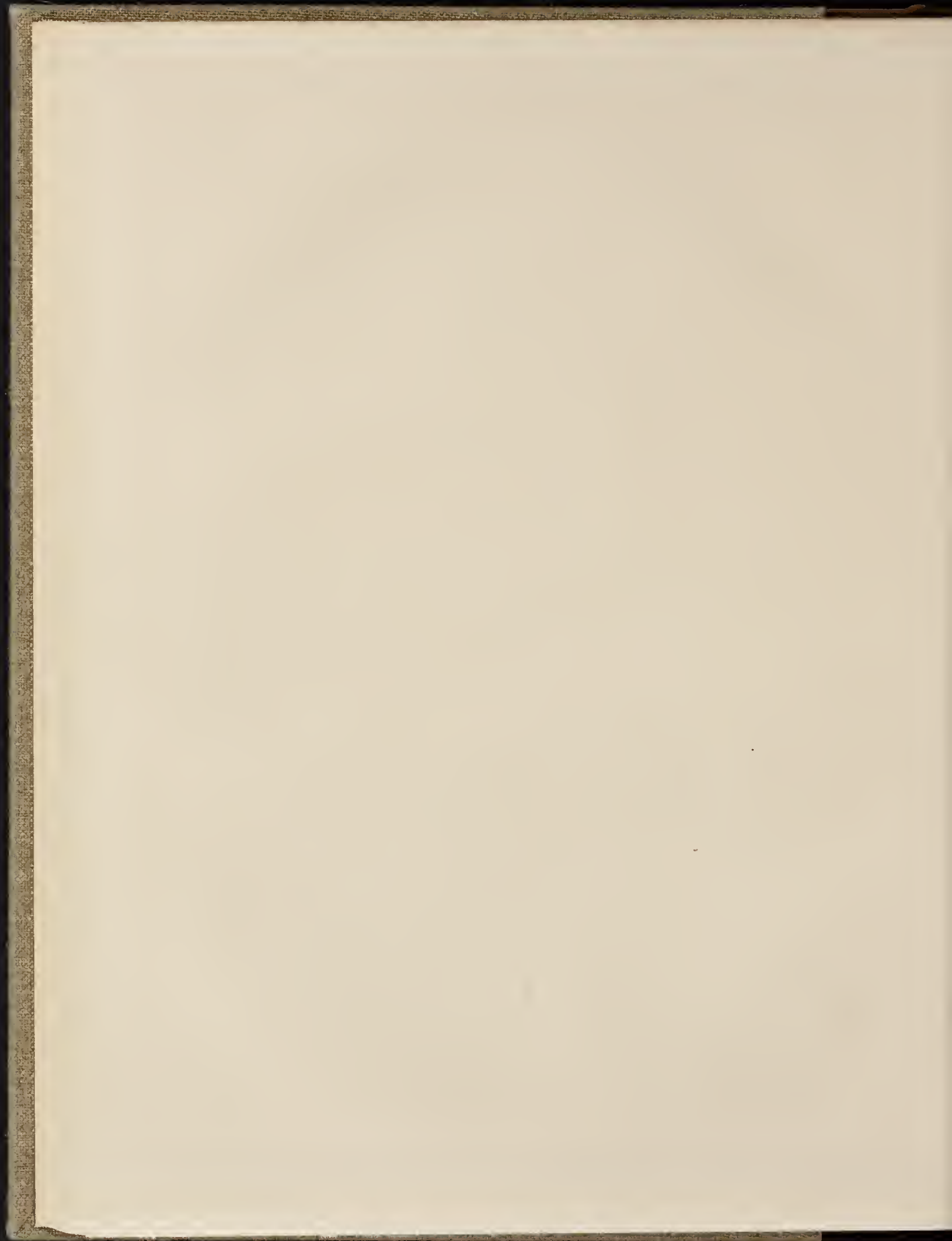

SUGGESTIONS OF SUBJECT

TO THE STUDENT IN ART.*

BY AN OLD TRAVELLER.

CHAPTER IV.

The Duties of the Gifted—Poets of the Pen and Pencil—Let her Die!—A last Appeal—The Cathedral of Catania—Fresco of the Sacrifice—The Truce of Etna—Groans of the Dying—Effect on Survivors—A Legend of San Giacomo—A Team of old time—The Magician of Antioch—Cyprian, Bishop and Martyr—Santa Christina—A Studio in the New Forest—Go but deep enough!—An Amstron of l'on no dine pas—The disappointed one!—A Teacher—Grief in the Forest—Woe for our Chums and Gossips—Imperial appreciation of English Art—Street Life in Rome—The Morris—The Cripple of the Scalinata—Roman Children at their Studies—The Battle of Scarston—The Traitor Duke—Gratitude of King Canuto—Inkermann—“Spring hath come!”—Song of the Turkish Poet—Lament of a Captive—Queen—Dante, “Il Purgatorio”—Buonconte of Montefeltro—Spirits of Light and Darkness—The Price of a Tear.

THERE are duties imposed on you by your heaven-sent dower of genius, oh ye, the true-born sons of Art; and one of the most imperative among them is this. That ye fail not in that binding clause of your mission which constitutes you the teachers of all whose pilgrimage of life is appointed to them in a less exalted region of thought and feeling than that reserved for yourselves. It is for you to aid us in our efforts after a better understanding of things, and look well to it, lest we, whose hearts are ever open to the profit of such lessons as ye prepare for us, and whose eyes wait trustingly on the work of your hands, should be left still wandering in the gloom of our darkness, because ye have not so cast around us the bright radiance of that light, which the artist, no less than the poet of the pen, has been seen on this lower earth to dispense for our behoof.

Below is a commencement already made by one of the last named missionaries—made with head fully given to the work, and with heart well attuned to the service. Let us hope that no word of it has been lost, but do you cause that which has, as yet, but amended the reader, to become the effectual monitor of the thousands who do not read. And not of those alone who lack the ability to do so, but of the crowds whose butterfly days present so fair a sunshine that they cannot choose but pass the whole sum of them in flittingly amidst the beams. For even these are accessible to the monition of the painter: their idle glances is not refused to the canvas whatever may become of the printed page. A picture! oh, by all means! it is a pleasure the more, and stand aside to let them take a fair look at it, for there may be one among them that shall profit thereby.

To them succeeds a larger, if not so bright a train of spectators; these are they who have not light enough in their dreary experience of that which—for lack of another term—they too call life, to let them see the beneficent words of the poet, but to you, oh painter, their eyes and hearts are still accessible: see that you do not leave them longer without appeal. Here are the pictures: they are not joyous ones, but they show truth; and what is—alas that it should be so! But shall these things continue to be thus? Let your part of protestation against them be done, and when you have spoken to the great heart of the public; when the voice of approval has decreed that your work is of Art's contributions to the well-being of humanity; when, by the beneficent power of the graver, your teachings have been reproduced, till brought to the knowledge of all; then, if you shall hear but of one whose downward step has been arrested by the warning they hold forth, will not your reward be a rich one, and shall not your fellow-labourer, the poet, declare you both to be largely repaid!

It is within the walls of a prison that you find your subject: that hapless girl! The moving words that follow tell you sufficiently what your part in the work must be.

* Continued from p. 72.

“Name her not, the guilty one!
Virtue turns aside for shame
At the mention of her name:
Very evilly hath she done!
Pity is on her mis-spent;
She was born of guilty kin,
Her life's course hath guilty been;
Unto school she never went,
And whatever she learnt was sin:
Let her die!”

“She was nurtured for her fate,
Beautiful she was and vain,
Like a child of shafted Cain,
She was born a reprobate!
Lives like hers the world defile,
Plead not for her, let her die,
As the child of infamy!
Ignorant, and poor, and vile,
Flogue-spot to the public eye,
Let her die.”

“Let her die!” But at least let us hear her last appeal—the teacher of the pen has not shrunk from giving it; do not you spare to send it, trumpet-tongued, where the illest must at least be made to know of its utterance, and cannot plead that “if such things were, they wist it not.” Listen to her, that poor wailing outcast; the mandate has gone forth; those early rays of morning—alas, that the sweet sunshine should ever seen out of place—are the last that her eyes shall behold; pass some few short hours, and the narrow cell she kneels in shall be exchanged for a yet narrower abode. But we know whether it is that her last words are ascending, and shall they not prevail!

“Let my cry of anguish reach thee,
God of love!”

Amen! and amen!
Hear beside some portion of the lesson to ourselves, which the writer has conveyed in other parts of these sad heart-moanings—thus they commence:

“I am young, alas! so young,
And the world has been my foe,
And by hardship, wrong, and woe
Hath my bleeding heart been stung.
There was none, O God! to teach me
What was wrong and what was right,
I have sinned before thy sight,
Let my cry of anguish reach thee,
Piercing through the glooms of night,
God of love!”

“I must perish in my youth,
But, had I been better taught,
And old virtue at I ought,
I should not have fallen so low.
’Tis the wretch's dire mischance,
To be born in sin and woe,
Pity Thou my ignorance,
God of love!” †

In the serenity of the cathedral of Catania is a fresco, preserved with scrupulous care, although by no means remarkable for its merit as a work of Art: the interest attached to the picture consists principally in the startling fidelity with which the artist has rendered the awful event depicted; this is the eruption of Etna in the year 1669, and in the fresco that fearful catastrophe is set before the spectator with a vivid reality, truly surprising.

A Sicilian artist, profoundly impressed by the terrors delineated in this work, assured the present writer that nothing short of the actual eruption could be more awfully true than the picture before us—“so far as the eye alone is concerned,” he added; “but there were sounds,” continued the speaker with a deep shudder, “there were sounds of which the pencil can of course tell you nothing, yet these gave an addition of horror such as never can be effaced from the memory of any who heard them. Nay, they are in my ears now!” exclaimed the excited Italian, and he lifted his hands to his head, as one who would shut out some fearful sound.

These words were uttered some few months after the last great eruption of Etna, to which our colloquist had been witness; he was thus a competent judge, and, among other peculiarities of the dreadful scene, he described the effect on the trees, as the resistless flood of molten lava

neared them. But this was not until the frequent intercourse of a long journey, taken in his company, had produced a sort of intimacy, the subject being one that was evidently not to be lightly approached.

His home, to which he was then returning from the study of his Art in Rome, was at the distance of some twenty miles from Catania, and he had mounted his horse, as he subsequently related, at the first rumour of an eruption, but long before he reached the foot of the mountain, the terror of the animal compelled him to dismount, and the horse was left to the care of a vine-dresser. Proceeding on foot, our informant found his progress much impeded by smoke and sulphurous fumes; the sun glared fiercely through the lurid air; dark clouds, edged with a glittering, hard, marble-like whiteness, such as he had never seen before, lent a further strangeness to the aspect of things, and the whole atmosphere was full of a sobbing, moaning sound, now rising into a sort of menace, and anon becoming little more than a fluttering sigh, as it were the last breath of a creature expiring in the agonies of torture.

Nor did this wailing seem to proceed from the mountain alone, all things appeared to sympathise with the Titan sufferer: earth, air, and sea alike sent forth the expression of grief and pain; all space was pervaded by that vast anguish, and the peasantry, familiar as they are with these phenomena, wore looks of anxiety and fear that became ever deeper as our informant drew nearer to the mountain. He had ultimately approached the rivers of lava so closely as to have his eyebrows singed off and his whole face much scorched; on our expressing surprise that he should endure so needless an infliction, he replied—“Nay, rather ask me by what influence I was restrained from standing, fixed and rooted as I was, until devoured altogether by that sea of fire; for the sights and sounds of that horrible night had exercised so strange a fascination over me that during the greater part of it I sometimes think I must have been mad.”

Then it was that our Sicilian acquaintance described the effect of the eruption on the trees: he spoke “with hated breath,” and declared that, as the lava approached them, they seemed to quiver, with the dread of creatures senseless to their fate. The groans of these inanimate objects, as the glowing destruction neared them, had made it impossible to him to remember that they were not sentient beings, and had caused him to suffer a sense of pain and grief, the effects of which he had been long in throwing off. At the last moment, and when he no longer dared to look at them but from a great distance, all their leaves turned of a livid white; they were blanched by the fervour of the heat, and this before the lava had touched them; may while it was yet at considerable distance. Once touched, they burst into raging flame in every part; and before that fatal river of death could fully roll its annihilating waves around them, each hapless creature had fallen on the flood, a heap of ashes.

“Each hapless creature,” the speaker's own words: the idea of conscious suffering had manifested not even yet departed from his mind; nor could he recall the scene he had witnessed without shuddering.

That there was no exaggeration in this description was obvious; and we were ourselves in a condition to vouch for a portion of its truth, from certain facts presented to our notice on Mount Vesuvius, some years earlier. By an act of culpable imprudence, partly our own, but chiefly attributable to our guide, who should have used his authority to prevent it, we were for some time in imminent danger—a circumstance that never need occur on Vesuvius, as many of our readers will know. Into the details of that day's history we do not propose to enter; but it was then that we did ourselves behold the instant destruction described by our Sicilian acquaintance. The effect, however, is so extraordinary, that one requires the testimony of one's eyes to believe it possible: at one moment, the object is there, in its entirety; before the succeeding second has passed, it has become a heap of white ashes; and even these—disappearing beneath the next heavily rolling

* Mary Howitt, “Lyrics of Life.”

† Ibid, “The Heart of the Outcast.”

wave of that low hissing flood, which seems to mutter anathemas on its victims,—do not leave the faintest trace to show that they have been.

A Franciscan monk, pleasing in manner, and much more highly cultivated than is usual with men of that brotherhood,* was the companion of the artist, whom he called Don Ippolito, and the colour of whose life had apparently been changed by the spectacle he had witnessed. Other circumstances of the emblem, in addition to those related above, were subsequently described by both; but for these we have not space: our business is henceforward with the portfolio of the artist, which was freely offered to our inspection during the sort of intimacy that occasionally results from the fortuitous meeting of travellers.

Legends of the saints, and subjects of similar character, predominated; they may, at some future time, be revered as altar-pieces in many a village church, among the more remote districts of the island. Here are some few of those best remembered.

The first is a legend of San Giacomo, and the saint is represented in the act of guiding a plough, to which he has harnessed a bear: beside him lie the oxen, by whom the office of drawing the plough had previously been performed; but they are dead—the bear has killed them; and it is in token of the repentance awakened in him by the exhortations of San Giacomo, that Drin permits himself to be harnessed in their stead.

And very earnestly does he bend himself to the work: a bear can look ironically enough when he pleases, as we all know, and is at no loss to mark his sense of a joke: but no thought of jesting is in the head of this good fellow; he wears a face of the gravest, and the most compunctious solemnity, and lifts no eye to that of the spectator, as who should say, "Is not this rare sport?" The Saint is equally intent, and the state of the ground gives evidence that their husbandry is making good progress.

A second study gives the conversion of St. Cyprian by Santa Justina. Still wearing the robes of the Pagan magician, he stands before the beautiful Christian with a face from which the last shades of doubt have departed; his hooks of magic art lie neglected at his feet—soon to be given to the flames; and behind the Saint, who has converted the magician, is seen the figure of a handsome youth, departing with the action and expression of one reduced to despair. In this picture the artist has fully related the legend, which is simply as follows.

A noble of Antioch, long the sutor of Justina, has recourse to the magic art of a renowned sorcerer; but the latter, having exhausted his powers in vain, is at length reduced to inquire of Santa Justina by what means she has foiled his efforts, and ultimately caused the most powerful of his demons—whom, in his rage, he had finally cast loose on her—to declare himself worsted, and decline all further attack. The Saint informs him that she does all in the power of the Cross, and the conversion of the sorcerer is the result. Receiving the rite of baptism, he is henceforward called Cyprian, and subsequently became Bishop of Antioch: he suffered martyrdom, together with Santa Justina herself, under the Emperor Diocletian, in the year 304.

Full of movement and spirit is the sketch that next succeeds; the legend is that of St. Egidius, who is standing before the cave which forms his hermitage. Within its shadow is the hind, which he has rescued; an arrow from the hunters, who have driven her to that refuge, still quivers in her side, whence the Saint has not had time to extract it: for the hunt is all upon him; but the dogs are restrained from entering the

* Taking the four great divisions of the monastic orders, the Benedictines are still the most learned, as of old; but among the Dominicans, men of solid attainments are frequently met with, and the Augustinians are not without instances of learning; yet neither they nor the Franciscans are considered to maintain so much of the distinction of older times as do the sons of St. Benedict.

† Not to be confounded with Cyprian, Bishop of Carthage, whose martyrdom—also by decapitation, for which cause he has the sword as one of his attributes—took place half a century before that of Santa Justina's convert, the Bishop of Antioch.

cave by the power of his sanctity, and certain of the hunters are already kneeling, although others yet remain contending with the saint, whose hand is extended between them and the rescued animal. The scene of this prettily told story is eminently beautiful, and will be remembered with pleasure by more than one of our readers—heing a faithful reproduction of one of the wildest and yet most lovely defiles to be found in that exquisite region, of which Vico is held to be the queen and capital.

The last of these subjects that we shall now mention, represents the preparation for one among the many torments suffered by Santa Christina, who is discovered in her dungeon filled with reptiles, which have, however, no power to harm her. The rays of light, falling into her prison from narrow clefts in the rock-like walls, serve to exhibit the flexile forms and brilliant colours of these reptiles, which do but awaken new feelings of devotion to their Creator in the heart of the saint. These it was her wont to pour forth in hymns that troubled the repose of her enemies, and to repress them, an executioner is now entering the partially opened door; he holds in his hand the instruments with which he is about to tear out her tongue, but the Saint regards him calmly, and without fear.

All these legends were evidently depicted in good faith, and as events that had veritably occurred; that men of education, one of them a person of some learning, could so accept them, is, without doubt, extraordinary; yet, thus it was; the grave simplicity with which all the details of these incidents, sought by the writer, were afforded, whether by the monk or his young friend, spoke clearly of earnest conviction. The snail of incredulity would have been deep offence; and the writer enjoyed all the more content in the examination of these studies, from the fact that no one likely to inflict such pain on their author, or his clerical guide, was partaker of the pleasure.

Among the many fair shrines where Art is most fitly worshipped, and which still reserve their almost untouched wealth for him whose genius shall supply the divining rod to their gushing fountains, is that wherein the character and habits of the "ferre nature," the masterless denizens of the wild, may be "taken in the manner," and are shown—not as man has fashioned them to artificial life, in the haunts of luxury, but as boon Nature has made them in her solitudes, and as they revel and riot amidst the joyous abodes appointed to them by that Supreme Beneficence which has created them for happiness no less than ourselves.

Not that we would seek to undervalue the home-bred favourite—by no means; he, too, is heartily welcome, whether dog or horse, and whatever his rank, so only that he be perfect in his kind: the "cleverest" of hunters and the shooting pony "worth his weight in gold;" the wolfhound and "my lady's brack"—none shall come amiss; but let not any, or all of them, exclude the frank inhabitants of moor and forest: give us the pride of our fields, and the pet of our hearths, but let us also have the gladsome dwellers by moor and stream.

It is true that we possess those glorious amuls of deer-stalking, to which the world of Art owes so many a bright inspiring theme, but we want more, and in more varied sort. Not to every man is it given to range brown moor and heathery fell at will, nor can the haunt of the boar or buffalo—so well beloved of the vigorous Fleming, so devoutly worshipped by the zealous and right-worthy Roman follower of Snuyders in our own day—be as readily attained by their English brethren; but neither are the narrower limits of lone vale and shadowy woodland niggard of their inspiration for such as seek aright. Let the votary bring but a spirit attuned to the delicious harmonies ever breathing around those unsullied shrines of Nature, which are equally the true fairs of Art, and for him shall the Genius Loci, writing to be propitious by every altar, pour forth his fairest gifts.

Nor does any need to make a long pilgrimage;

he has but to lift his eyes, and—provided always he be not "pent" within the noisome limits of some great town—there shall ever be wealth of objects for his worship. Great beauty or striking peculiarities of character, however attractive, are not indispensable: the least promising of localities will scarcely fail to present some portion of that life and movement which are among the first demands of the painter: treasures are to be found in each devious path of nature's own free tracing, and blossoms of loveliness hang on the lowliest humbly for him who has power to perceive them.

But say that you have the privilege of selection, and, taking of the best, have plunged into the recesses of our Hampshire woods. Go but deep enough, and you will not complain of your studio; neither shall there be any lack of company to sit for their portraits, supposing the delineation of character to be one of your objects. There are wilds, or there were such, in the happier ancient days of some ten years back, in certain parts of the New Forest (misnamed assuredly, seeing how venerable is its age), where your highest aspirations after beauty in nature shall be satisfied, while the "ferre" of the place will approve themselves to be in all respects of the purest water.

To secure these, you must, however, not content yourself with hovering on the verge of things, you must plunge boldly into the depths; press through entangling underwood, and never trouble yourself to be seeking a path, for where you go there is none. Count rather on the long thorny bramble the sarcastic point of the glittering holly, and bold Sir Blackthorn aiding them with such might as he hath; for all these shall oppose your access to that region of delights. Yea, your sweet friend the woodbine, will do her utmost to har you thence with her delicate toils; nor shall the grave and solemn ivy spare his potent frown, to say nothing of those tendrils wherewith he has tied together a mated harrier of impervious broom and tough, though pliant fern.

Yet keep on; hold stout heart, and when you have beaten all down knightly, you shall—

"We shall get through, ridiculous prate-ape, and have done with it!"

Not at all! You shall do nothing of the sort: these are the mere outlying works; the more potent defences have yet to be stormed; but all mention of their names shall be spared you. Do I not know your "genus irritabile"? There is only some few hundred of good stout furze-bushes, fifteen to eighteen feet high, at this moment impeding our passage, but as these are wholly impervious, we must e'en turn fairly back, and make our way as best we can to the point whence we got into this *Imbroglia*.

Take patience, nevertheless, and by no means be discouraged: at our next attempt we shall be more successful in hitting the weak point, and that accomplished, great is your reward! Keep good heart only, for at length we stand in face of the portals to be forced. Dark strong-armed bats are crossing on sullen wing, for just now we are in the region of perpetual twilight, and the horned owl is adding his harsh remonstrance, as he sits, marvelling at our intrusion, among the branches of that stunted oak.

A more open space succeeds, and sailing across it come the dusky raven, the kite, on his wide powerful wing, and the sharp-beaked hawk, with his pitiless cruelty of gaze.

Or, less imposing, but more cheerful of aspect, there steals from the copsewood an elegant-looking congener of the weazle tribe. He darts, lightning-like, across the sweet sunny glade,—which has at last repaid our toil,—amazed in haste his delicious home invaded, and to find to make the unwonted advent known.

The burley grey badger may, perchance, succeed our last hurried visitant, but for his arrival you may have to wait patiently, seeing that he does not care to enlarge the circle of his acquaintance. The fox is more accessible, or rather, being a gentleman of rambling propensities, you shall stumble on him now and then when neither of you has expected the presence of the other; and should you chance to beat up his quarters while his children are sporting

around him, or when his lady, the vixen, has gathered the youth of their family for educational duties, you need scarcely ask a more animated group for your sketch-book than that household shall present.

And while now we seat us beside the deep dark water-course, adown whose precipitous, but happily not very high bank, we have just tumbled with so little ceremony, to scramble up on the opposite shore, and have gained this fair sweet oasis of sunbright green, you shall hear an extract from the foxito annals.

The event commemorated is of the strictest truth—when they write history they keep wholly apart from fable, those well-judging foxes—their consequences plunged two respectable families of the ancient tribe of fox, into much grief, but though trying to your sensibilities, the story must needs be related, because there is at least a little dozen of pictures therein.*

The facts are as follow, and the scene to be depicted is on this wise. A flock of wild-geese have alighted on a broad estuary, rapidly narrowing into a sedgy river; the banks on one side are high and more richly wooded than is usual within the near neighbourhood of the sea, but the opposite shore is lower, and in the distance are the grey rocks of a bold wave-beaten promontory. From the underwood steals forth a well-grown fox, and perceiving the rich argosy on the water he at once proceeds to secure what he considers in his conscience to be his own portion in its wealth. Having drawn together a sufficient mass of tangled grasses, he suffers himself to float gently down beneath the veil thus formed towards the new arrivals, and under cover of the mask he has provided, succeeds in securing a beardless bird, whom he brings to land in good sportsman-like fashion. But there are certain considerations which prevent his beginning instantly to feast on the booty obtained, and he hurries it amidst the low hanging branches of an old twisted thorn: that done he departs; but soon returns with a second fox, whom he leads directly to the tree, manifestly "on hospitable cares intent."

But, "What are the hopes of man!" sings the poet—"What those of foxes?" be might have asked; for, during our poor friend's absence, a lurking, poacherly fellow—see that you give him no free-forester look, but a veritable hang-dog aspect, won from many a jail—has crept from his hiding-place, and, carrying off the deposit from its rightful owner, has caused the consternation you are here to depict.

For a moment, our first acquaintance stands howlered and confounded; his gossip, who arrived with that modest and disclaiming, yet well-pleased and above all respectful expression, with which men and foxes alike follow "L'Amphitruon on l'on dine," has at length begun to suspect an intentional affront! He turns fiercely on his late revered inviter, whom he now confronts with reproachful eyes; but the honour of our despoiled Reinecke is not to be questioned with impunity, a mortal combat ensues—or rather not mortal, it would hardly have come to that—they were foxes, and without doubt the reasonable creatures on the four legs would have presently thrashed each other into a better comprehension of the matter, nor suffered any grievous injury on either side: but now—and I grieve to say it—must the two-legged brute come into the picture; he holds his deadly tube—a disguised and contraband thing, without name or decent kindred, we may be sure—in the villainous left hand, which hath so manifest a tendency to hide behind his back; this he brings to bear upon the champions who contend but for their honour, and slooting the intended host through his hospitable heart, he knocks over the wonder-struck guest before he has recovered from his amazement, when he too, poor disabled innocent, becomes that postilent jail-hird's prey.

After that, I can do nothing for the rest of our halt but bewail the unmerited fate of my hapless chums. Had they perished in fair chase, and

with the music of the pack as their appropriate dirge!—But it skills not talking, nor can weeping avail, and I dry my tears. Admirable society in the woods is your fox, and good merry companions were these two, but with them we shall hold parley no more. "Woe is me, Allama!"

His Imperial Majesty of France does but confirm the verdict of the French critics, when expressing his admiration for the works of our countryman, M'Innes; and it is to be regretted that his majesty's wish to become the possessor of the "Love and Piety," exhibited in Paris by that artist could not be gratified. There would have been a decided gratification to the English *amour propre* in meeting that pleasant acquaintance among the gems of Louis Napoleon's private collection in our subsequent visits to his capital; but "the present proprietor was not to be prevailed on to resign it," say the Parisian *Littérateurs* in Art, and there is nothing more to be done. The "Scene from the Life of Luther," an earlier work of the same artist, has been equally appreciated by the German critics, these last considering him to be one of those among our countrymen "who are most successfully working for the future." Very high praise this from our thoughtful cousins, by the way, since they do not always give us credit for that upward tendency, and even reproach us occasionally with loving the gold that glitters to-day better than the Fame that heans from the future; nay, better than Art itself, which, in the bosom of the true votary, should be placed above even Fame.

Few things gratify the "national vanity" of the present writer more than expressions of approval from the great German authorities; their knowledge of the subject is unquestionable; they are invariably just; thinking of the work only, never of the artist, with whom they have rarely personal acquaintance; and this is not without its value, when the productions of the day are in discussion, as many of our readers doubtless know.

We hear so much of the discouraging influences by which our artists are oppressed, that methinks it may not be amiss to record some few of the "per contra," to borrow a phrase from the "Ships, Colonies, and Commerce" school. The artist we have named above, for example, is well known to have been long estimated highly in the Roman world of Art, wherein much expectation was some years since awakened by reports of a work perfectly new as to subject, and certain to arrest universal attention, once it should leave the studio of the master. It has not yet appeared, and having no authority for the allusion, we refrain from describing its theme, but having deeply shared the interest excited by the rumour, one of our first inquiries on returning home, some time after, was for the painting in question, nor have we yet abandoned all hope of its appearance. The subject, as before remarked, we do not feel authorised to describe; but there are certain desigus made by a different hand at the same period, respecting which we are under no such restraint; the artist, a very youthful student, but one of much promise, being no longer in existence, and the sketches, the subjects of which were in fact suggested by the writer, being entirely at our disposal.

The first presents a scene of out-door life in Italy: it is but too familiar to the quiet-loving traveller, for who is there so fortunate as never to have had his repose interrupted by the clamours of the *Morra*? This game, said to have been invented by Germanicus, to preserve his Legionaries from the perils of inaction, is still the delight of the populace; they have its implements ever at hand, since it is played with the fingers only.

The object to be obtained is an accurate guess at the number of fingers thrown out by your adversary from the closed hand. Thus, loud cries of "Uno! Quattro! Due! Tre! Quattro! Due! Quattro! Uno!" yelled forth at the topmost strength of their triple-brass lungs, resound from many an eager pair, wherever idlers "most do congregate;" and in Italy where are they not?

Look at this group—would not a stranger believe those two men, there standing, in fierce

opposition, were preparing to tear each other's eyes out? How menacing are their gestures! how eagerly do they stretch forth their discoloured fingers, each thrusting his claw-like hand into most offensive proximity with the visage of his neighbour. But they fare only playing the *Morra*, or *Mora*, as it is elsewhere called; and such are the fascinations of what we should call that wearisome exercise, that few of their own class, passing within the wide-spreading limits of the echoing sounds uttered by the players, can resist the temptation to pull up and watch the result.

Two specimens of half the vagabondage of Rome have accordingly gathered around the group depicted by our artist; but the place of honour is accorded to one whom you all know well—"The Sturdy Beggar" of the *Scalinata* namely, no less a personage; ho, who, without any legs at all, will prove himself more than a match for both yours, if at any time you seek to distance him across the broad platforms of that winding way, the uppermost of which has long been his undisputed domain. Get ready your *bajocchi*, 'tis a poor return for his joyous "Bnon giorno Eccellenza!" but as none resist that appeal, so the dowry, carried to their carefully-selected *Spesi* by the daughters of this well-known mendicant, are said to be of no contemptible quality. Here we have him, returning to his dinner as do other men of business, when the toils of the morning have ended: he is mounted on a good serviceable ass, and his attendants bumbly wait his pleasure, which, at this moment, is to watch the *Morra*. The head of our crippled acquaintance is a good portrait—the features are not those most frequently found in Italy, though the man is a Roman—they are rude, irregular, and somewhat harsh, the hair is verging towards grey; the eyes, also grey, are shrewd and keen; the general expression is bold, yet severely frank, and the whole face, though clever, is something short of prepossessing; nether limbs, our friend has none, and to this fact does he owe the prosperity of his fortunes.

The scene of our picture is the northern bank of the Tiber, near which that distinguished *Habitué* of the Piazza di Spagna makes his abode; the Ponte Rotto is within view; the church appearing on the far left is that of Santa Maria Egiziaca, and the Temple of Vesta may be discerned in the distance. Two Jewish ancients are holding consultation before the squalid entrance of what was once a palace, and beneath that broad portal are beautiful children, shaking their rugs in a sort of frenzy, as they imitate the game performed by their seniors.

We have other incidents of life in Italy, depicted by the same hand; but, for the present, we prefer to select from sketches of a different character; these we take from the early times of our own history. And first we have the "Battle of Saratoga."

Edmund Ironside, a noble figure, whose fine features and candid expression instantly bespeak our sympathies, is fighting hand to hand with the less graceful and more crafty-looking Canute. Already is the Dane slightly wounded, Edmund presses him closely, and manifestly holds the victory within his grasp. This is your first picture.

But there is unhappily a second, the warrior has treason beside him—alas for that old, old story, doomed ever to be repeated and scarcely stranger even to our own *spitless* times. Exalted from a low station to be Duke of Murcia by the injudicious partiality of Ethelred, significantly named the Unready, the father and predecessor of Edmund Ironside, Edrie Stracen had resolved to slay his sovereign in the confusion of the strife; but, failing in this, and now perceiving that the battle was about to be decided by the fall of Canute, the traitorous wretch struck the head from the body of Osmeor, an attendant of Edmund, and bearing a strong resemblance to his master; then, holding the head aloft on his sword, he cried aloud, "Fly, ye men of Dorset and Devon! fly and save yourselves, for here is the head of your king!"

Compelled instantly to forego his advantage over Canute, Edmund eagerly bares his brow and exposes his heated features to the gaze of all around him, exhorting them to take

* The relation that follows is true to the letter; the incident was described in its minutest details by a sportsman, who witnessed all that took place, and has distorted no feature of the occurrence.

encourage, but the effort is vain, a panic has seized his warriors, they fall into disorder, and all their prince's bravery and skill can but avail to maintain the combat until night once more closes on this, the second day of the conflict.

For the artist whose "joy is in the" battle, there is here motive for at least two pictures—perhaps for more. Let us now see what becomes of the traitor.

Many changes have taken place since the battle of Scarston: other combats have been sustained by Edmund Ironside, but the hiring of Canute has found means to render even victory fruitless: what, in fact, cannot treason in high places accomplish? More; he has contrived the murder of his sovereign, while that of Edwig, brother to Edmund, is also ultimately accomplished by his agency. But this last has not been done to the satisfaction of Canute, whose part in the crime is rendered too obvious by Straou's mismanagement. The crafty usurper has secretly vowed revenge, and Edric of Murcia is doomed. Rapacious as he is faithless, the traitor has entered that rude building on the Thames, which serves as the palace of Canute, whom you perceive to occupy the chair of state; with intent to complain of broken promises, and to seek rewards too long withheld. Around the king are fierce-looking chieftains of his own land, and beside his chair is Eric of Norway; before them stands the Duke of Murcia, dark passion deforms his else handsome face, and he angrily bids Canute remember that for him he had imperilled the welfare of his soul.

"Not for me," retorts the offended monarch, interrupting the stream of revelations fast pouring from the lips of the excited Edric; "not for me, but for thine own ambitious ends, hast thou defiled thy hands with murder. How traitor! thou didst compass the death of thy sovereign? Thou!—Be thine own words thy condemnation."

Canute turned towards Eric of Norway, who struck the Duke to the floor with his battle-axe. Others then fell upon him, he was strangled by their fierce hands before the eyes of the man who had bought him for his evil purposes; and the last sob had scarcely been gasped forth from his hackened throat, before the voice of Canute rose high above the tumult. "This traitor, self convicted, came to seek the reward of his treason," he exclaimed, "and yet have bestowed it fully." "Throw the carrion to the river," added the scornful monarch, and a moment later the dark waves rolled over the betrayer of his master.

History does not give us warrant for the introduction of any other figure that might relieve the gloomy effect produced by those iron visaged warriors who alone took part in the well-authenticated event here proposed for your study: hoy-attendants might nevertheless be permitted to give the relief of their grace and beauty to the darksome group; dogs of appropriate breed would not be out of place, and even female figures might be suffered to cross the entrance of the rude hall, or be seen in the ante-room beyond it; but the persons truly belonging to our picture, are those here mentioned only.

Talking of battles, might it not be supposed that Byron had the fearfully glorious day of Inkermann in prophetic vision before him when he wrote the lines that follow. Could any one, writing from the field, have depicted more faithfully the dark opening of that terrible drama! Its anniversary is closing as the stanza is here transcribed.* May the lives then so freely offered up, avail to save the world from the frequent recurrence of these terrible holocausts! But does not many a name, whether of the survivors or the dead, appeal to the sympathies of the artist as he recalls that day, demanding from him the wreath of immortality which his hand—no less than that of the poet—holds the proud privilege of twining for the brow of the

* The commemorative bonfires were blazing on the distant hills when these lines were written. Future anniversaries will happily bring us less vindictive memories than those still permitted to mingle with the proud thought of our glorious "battle for the right" at Inkermann; wherefore let us hope that the November last bygone will prove to be also the last of the "Guy Fawkes" exhibitions.

victor? They do, and he will admit the claim: let us now turn to the words of the author we have cited:—

"Hark! through the silence of the dull cold night,
The hum of armies gathering rank on rank.
Lo! dusky masses steal in dubious sight
Along the leaguerd wall and bristling bank.

No star peers through the vapours dim and dank,
Which curl in curious wreath. How soon the smoke
Of hell shall pall them in a deeper cloak!"

"Listen to the story of the nightingale! that the vernal season has come; the Spring has formed a bower of joy in every grove, where the almond-tree sheds its silver blossoms. Be joyous therefore, be full of mirth, for the spring season passes away—it will not last.

"Again the dew glitters on the leaves of the lily, like the sparkling of a bright scimitar; the edge of the bower is filled with the light of Ahmed among the plants, the fortunate tulips represent his companions. Come, oh people of Mahomet, this is the season of enjoyment. Listen to me—listen to me! Be joyful, he full of mirth; for the fair season passes away, it will not last.

"Roses, anemones are in the garden, the time is past when the plants were sick, and the rose-hud hung her thoughtful head. Be joyful, he full of mirth—the fair season passes away, it will not last.

"The groves and hills are again adorned with all their beauties, bright and beaming are the flowers, rich and pure is the breath of their lips. Be joyful therefore, be full of mirth; the fair season passes away, it will not last."

In remarkable contrast to this glad some exhortation of the Turkish poet, is the "lament" of Scotland's Mary, as she too beheld the "dew glittering on the leaf of the lily," but for her the appropriate resemblance would scarcely be that of the bright scimitar: the many who would gladly have bared their weapons in her cause she knew to be powerless, and "the fair season" was far from "joyous" to her.

The "Lament" is familiarly known, yet there are few, if any memorials on canvas of the moment, one that but too often recurred in her sad history, commemorated by the verses in question.

That the lines are from her own pen adds greatly to their interest, but this circumstance is not their sole recommendation; they have a pathos, a simple beauty, not derived from any extraneous consideration, and which is due to the thought and its expression only. They were written, as most of our readers will remember, when the return of Spring had caused the royal sufferer more than ever to deplore the misfortune of her captivity. The verses are as follow:—

"Now Nature hangs her mantle green
On every blooming tree,
And spreads her sheets o' daisies white,
Out o'er the grassy lea,
Now Phoebus cheers the crystal streams,
And glads the azure skies,
But nought can glad the weary wight
That fast in durance lies.

"Now larks wake the merry morn,
Alot on dewy wing;
The merle in his noon-tide bower
Makes woodland echoes ring;
The mavis mild, w' many a note,
Sings drowsy day to rest,
In love and freedom they rejoice,
W' care nor thral oppress.

"Now blooms the lily by the bank,
The primrose down the brae,
The bawthorn's budding in the glen,
And milk-white is the slae,
The meaneest hind in fair Scotland
May rove their sweets among,
But I, the Queen of a' Scotland,
Maun pine in prison strang."

Touching and beautiful, these lines bring us an exquisite picture of Spring, no less than a moving tale of sorrow. The young artist who shall make them his theme can scarcely fail to produce a valuable addition to our moments

* The joyous song of the spring time, given above, will be found in the Turkish of Mesihî; the translation is by Sir William Jones, but the stanzas are taken by the present writer from "The Boatman of the Bosphorus," vol. i., pp. 206 and 236.

of the much-wronged queen: he will give imposing dignity to the fine figure; the delicate face, whose beauty is so familiar to us, shall wear an expression of sadness, yet redeemed from any suspicion of weakness, by the brightly intellectual cast of the lovely countenance. The landscape Mary looks on from her deep oriel window, with such other accessories as he will admit to a place in his picture, will all serve, in their various degrees, to heighten the interest of the work, but this is, of course, chiefly centered on the person of the Queen, at whose feet there is a hound sleeping; otherwise she is alone.

In the fifth canto of the "Purgatorio," and while the Florentine poet, with his Mantuan guide has not yet proceeded beyond the approaches to that place of trial, the former describes the ascent of a mountain, on whose declivities Virgil and himself are surrounded by the souls of the departed; all are advancing, like themselves, towards the "girore" where their appointed probation is to begin.

At a fair height on the mountain are the shades of those who had lived to the end of their days in a state of sin, and were finally dismissed to their account by a violent death. But "having repented at the last moment, and then forgiven their murderers, they were reconciled to God in their death," says the poet.

Among these spirits is that of Buonconte of Montefeltro, of whom Dante inquires wherefore the place of his burial had never been discovered? In reply to this question, Buonconte bids him know that "having expired on the banks of the Archiano, his body was carried into the stream by a flood, on whose waters it was borne to the Arno," where the corpse was lost amidst the depths of that river.

In the course of this relation occur some fine lines, presenting a fair study for the painter. Of the peril that may be mingled with the hope conveyed in the passage, we are not now to speak. The lines are these:—

"Arrivò io forato nella gola,
Fuggendo a piede, e sanguinando l' piano
Quivi perdè la vista e la parola:
Nel nome di Maria fui, e quivi
Caddi e rimase la mia carne sola—
Io dirò l' vero, o tu l' ridi tra i vivi:
L' Angel di Dio mi prese, e quel d' inferno
Gridava: 'O tu dal ciel, perchè mi privi
Tu te no parti di costui letare.
Ter una lagrimetta, che l' mi togli.'"

The lone wild bank of the rushing and foaming river, with the fallen yet still darkly beautiful Spirit of Evil, vainly demanding his hoped-for prey from the radiant "Son of Heaven," within the shadow of whose glittering pinions may be dimly discerned the vaporous presentment of what once was Buonconte. All these may serve to awaken the imagination of the painter, to whom we leave them. A passage from the nineteenth canto has also very tempting elements, and I defer the transcription of the stanzas with regret, but they must, for this time, be resisted, as must likewise an eloquent description—but of somewhat different character—involving us by the voice of Ariosto. "Not all that is deferred, proves to be lost," however, says the French proverb, and these, and these we now reluctantly postpone, may find place some other day.†

* The writer would have been glad to give the translation of this passage by Cary, holding it better to take the maturely-considered work of an approved author than his own crude and hasty rendering, *pro re nata*; but failing Cary—not to be obtained at the moment—the following may suffice to give the mere sense to such of our readers as shall prefer to see it in English:—

"Flying on foot, with pain I reached the shore
Of Archiano. In my throat I bore
The deadly gash, pouring a crimson rain.
That, where my faint foot passed, bedewed the plain.
Here speech and sight forsook me, but I cried,
Hopeful, to Mary mother ere I died.
Thou lay my corpse, all prone and lonely there.
True are my words, do thou their truth declare
To all of mortal race—God's Angel took
My soul, but o'er me bill's dark spirit shook
His dusky pinions. Wherefore, Son of Heaven,
Hast thou, he cried, 'from me my conquest riven?
That soul was mine; yet to the brighter sphere
Now shall he rise, and all for one poor tear.'"

† To be continued. Purgatorio, Canto Sesto.

BRITISH ARTISTS:
THEIR STYLE AND CHARACTER.

WITH ENGRAVED ILLUSTRATIONS.

No. XIII.—CHARLES ROBERT LESLIE, R.A.*



RESUMING our catalogue *raisonnée* of the works of Mr. Leslie, at the date where we were compelled to leave off in our last publication, we find that in 1850 he exhibited three pictures;—"Beatrice," a lovely young girl looking over a balustrade into a garden; an incident from the "History of a Foundling," "Tom Jones showing Sophia Western herself in a glass, as a security for his good behaviour;" and "Queen Katherine of Arragon giving her dying charge to Capucius," from "Henry VIII.," a composition evidencing much profound thought and tender feeling.

Of two pictures exhibited in 1851, one was a small half-length figure of a lady, entitled a "Study;" the other, "Falstaff personating the King;" the interest of this work is exclusively maintained by the figures, and in these the artist's genius in the impersonation of character has nowhere failed; the whole *dramatis personæ* in the scene are admirably put on the stage; Falstaff especially is inimitable; the picture has few accessories to distract the attention of the spectator from the "players."

Mr. Leslie's solitary contribution to the Academy in 1852 was a small half-length of "Juliet," examining the draught given her by the friar; the face, on which the light falls brilliantly, is highly expressive of misgivings and anxious thought. The year 1853 brought nothing from the painter; but in 1854 we had "The Present," another half-length of a young lady (possibly intended as a *pendent* to the "Juliet") examining a locket; a portrait of a lady; and a scene from the "Rape of the Lock," Sir Plume demanding the restoration of the Lock. The remarks we made on this picture are of so recent a date, that we find it unnecessary to do more than just quote the concluding paragraph of our criticism:—"The forms and faces are graceful and beautiful; the story is admirably told;

and if we object to the picture as *weaker* than his earlier works, our objection is merely to the execution; the pure and high feeling of the artist is here as fresh as it was in the vigour of his youth. We doubt, indeed, if he ever produced a picture better than this in all the loftier essentials of Art."

Sancho Panza is one of the first names with which the pictures of this artist are identified; so is it also the last of which we have now to speak—"Sancho and Dr. Pedro Rezia," being the subject of the only painting exhibited by Mr. Leslie last year; though, as was remarked of his "Sir Plume," it is somewhat "slight in manner, it has otherwise all the clearness and precision of the best of the painter's works." There is, however, one picture by him too important to be omitted, the "Christening of the Princess Royal;" it was never exhibited; but as it must be well known from the large engraving published from it, it may be passed over without comment, though deserving of high praise.

Such is a summary—and nothing more—of the principal labours of forty years devoted to Art: they show but little in our narrative; yet who, save the artist himself, or those similarly circumstanced, would attempt to measure the study, the toil, the deep and anxious thought such labours must have cost? Mr. Leslie seems never to have considered *how many* pictures he could get ready for the "opening-day."—at no time, if we recollect rightly, has he exhibited more than four, and rarely above three—but what those should be which he was preparing; and hence there is scarcely a single work he has produced that does not present indubitable evidence of the intelligent *mind* that wrought it. As a painter of dramatic subjects he is unrivalled; his characters all stand out with an individuality and a truth which cannot be surpassed; they are living portraits of the men as the poet or the novelist drew them, not mere artist's faucies, while at the same time he invests them with the poetry of his art. His pictures are to be read and studied; they are not meant for gewgaw ornaments on the walls of a richly-furnished drawing-room—the gold and the crimson would out-dazzle those unobtrusive canvasses that speak so quietly, yet eloquently, the language of the painter's art. "The most poetic of the painters of domestic; one of those who have attained the highest excellence without (to this day) having paid a visit to Italy—though an intelligent and catholic appreciator of the works of his predecessors in the art—his style is individual and English, and has been one of progressive excellence. . . . Competent judges pronounce him to have succeeded—in a 'modest' manner of his own—in whatever he has undertaken. His art is as refined as it is unconventional."* The highest qualities of Mr. Leslie's style are

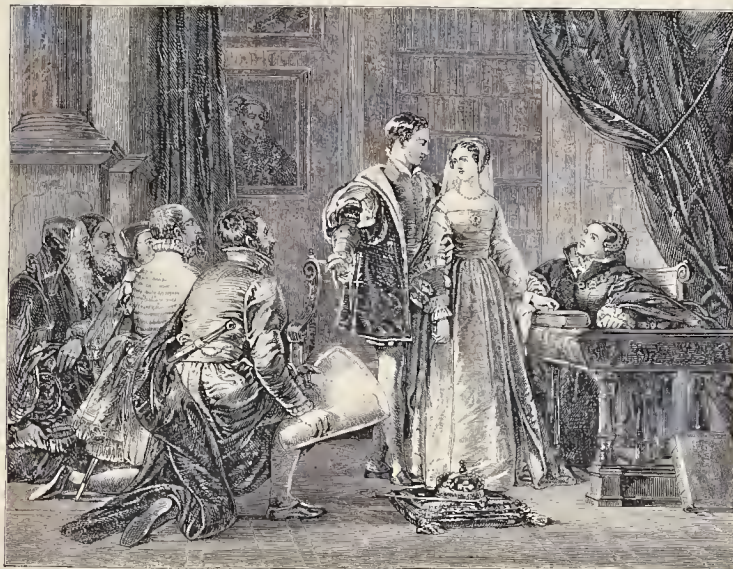

Engraved by]

LADY JANE GREY ENTREATED TO ACCEPT THE CROWN.

[J. & G. P. Nicholls.

character and expression; these are always appropriate to the subject: his drawing is good, correct, graceful, and unmechanical; the execution, in general, very careful, and not deficient in power; as a colourist he is unequal, often rich and harmonious, occasionally cold, crude, and heavy: he seems to us to work on different principles at different times, as if he had no definite theory of his own; but this must be an impossibility to one who has so long and so successfully practised.

As we are always gratified to find our own opinions expressed or confirmed by other critics, we reprint what another writer said many years

since about the works of this painter, the truth of which all Mr. Leslie's subsequent productions amply bear out:—"In his general perception of females, Leslie always invests them with more of the mental than mere physical beauty, and gives them an air of noble and dignified deportment." This is perhaps especially conspicuous in the females introduced into his pictures of "The Duchess and Saucbo." "Nor are his men deficient in all the elevated qualities of their sex; and for real humour and quaintness we have shown that in his Sancho Panza, Uncle Toby, and Tristram Shandy, he is perfectly original in their delineation; and one of Leslie's

* Continued from p. 75.

* *Men of the Time*. D. Bogue, 1856.

most admirable characteristics is, that he can most truly and graphically develop the plot and meaning of his compositions with comparatively few figures. He never has recourse for the mere sake of effect to overcrowding his compositions with a multiplicity of figures. In sentiment Leslie is truly poetical; there is no affectation of it, as if it came second-hand, but appears the pure effusion of a highly gifted mind. The graces of his females are not borrowed from the stiffened artifices of drawing-rooms, nor the dignity of his men from the skill of a tailor; they are derived from nature alone, where is to be seen the true aristocracy of mind.*

Several of Mr. Leslie's pictures have, as we have already stated, been engraved on a scale of considerable magnitude; and when the "Annuals" were in full bloom, many of the best prints which ornamented them were from the productions of his pencil.

Having thus considered, however imperfectly, Mr. Leslie in his character as an artist, it remains for us to add a few words about him as a writer upon Art. It has often struck us as something remarkable in the annals of Art-literature, how very few of those whose pencils prove them

to be men of superior intelligences ever give their thoughts to the world through the medium of the pen; they either cannot, or will not, write: a large number cannot, nor is it to be expected; but very many can, and yet do not. Who ought to be so well able to enlighten others in these matters as they who have made them the study of their lives? Not to go beyond the painters of our own school, how limited is the number of authors which it includes: Reynolds, Barry, Opie, Fuseli, Phillips, published their lectures delivered in the Royal Academy, but these can scarcely be regarded as voluntary contributions to the literature of Art; while of the many living painters, we can call to mind only Sir C. Eastlake, Leslie, J. Burnet, J. D. Harding, and Pyne in the columns of the *Art-Journal*, who have taken up the pen to become teachers. In no other profession is such a dearth of writers to be found: in the church, in the army and navy, in law, in medicine, authors are numerous enough, affording abundant information to their professional brethren as well as to the public generally; so too has architecture. Painting and sculpture alone have to depend, generally, for their exposition, upon the amateur: it is a pity it should be so, but we fear there is little chance of its being otherwise,



Engraved by]

THE RIVALS.

[J. & G. P. Nicholls.

In 1815, Mr. Leslie published a "Life of Constable," a genuine and unaffected piece of biography, and a worthy tribute to the memory of that great landscape painter: we quoted at some length from it in our notice of Constable's works last year. In 1848 he accepted the office of Professor of Painting at the Academy, which he retained till 1851, resigning his post, chiefly, we believe, on account of the delicate state of his health, to its present occupier, Mr. S. A. Hart, R.A. The lectures delivered by Mr. Leslie to the students were published last year under the title of "A Handbook for Young Painters"†; we noticed the work when it appeared last year, but the present opportunity enables us to refer to it again.

While reading over these lectures a second time, we thought it not improbable there would be found in them something affording information on his principles of colouring, but we discover none; and it is somewhat singular that a painter who entertains so high an opinion, as Mr.

Leslie does, of the importance of colour, and who is so ardent an admirer of the school of great colourists—the Venetian, should so frequently have adopted almost the very opposite: he acknowledges the deficiency, if we may employ the term, and also the difficulty that lies in the way of any painter excelling in this quality. "It was, perhaps, very much from modesty that Reynolds placed the things he so greatly excelled in lower than I think they should be placed among the attributes of Art. It was natural that he should not think the most highly of what he found so easy; but as I have not the same reason for undervaluing colour and chiar-oscuro, I will endeavour to show why I venture to dissent on those points from so high an authority. * * *

It is a fatal error to believe that Colour is a matter of more easy acquirement than Form; I conceive it to be far more difficult. Form may be measured; its anatomical structure may be investigated, its lines are not changed; its tints perpetually are, by the shifting light of day or the accidents of reflexes. If the beauties of form are subtle, those of colour are evanescent; and, combined with chiar-oscuro, from which, in nature, they are inseparable, they become the last refinements of the Art, as it addresses itself to the eye.

"It must be remembered that, at the present day, there are greater

* Arnold's "Magazine of the Fine Arts." 1834.

† "A Handbook for Young Painters." By C. R. Leslie, R.A. J. Murray, London, 1856.

obstacles in the way of becoming colourists than existed in the infancy of Painting. The discovery of chiar-oscuro has much increased the difficulties of colouring; and unfortunately, ever since the time of Raphael, indolence in a study so difficult has been able to shelter itself under the example of him who was indolent in nothing that belonged to the Art.*

The following truthful remarks ought not to be lost on some of our young artists, whose great fault is that they are always looking at one or another of the leading men, whose style they are desirous of imitating because it has become popular.

"The minds of students are much more impressed, in the commencement of their studies, by the productions of their contemporaries, than by the works of the old masters, and these early impressions are not always wholly eradicated through the longest life. There may be seeming exceptions to this, but I believe there are very few real ones. That contemporary Art is the first to impress us may be advantageous, or otherwise, according to circumstances. Its advantages need not be dwelt upon, as such influence stands in no need of recommendation; but it may be useful to point out some of the dangers of what is an unavoidable, because an unconscious, habit of our students, the habit of resorting to our annual exhibitions as to so many schools.

"In an assemblage of the incidental productions of a year, and with which it is necessary to cover every inch of wall,* there must of necessity

be a great preponderance of the indifferent, and very much of what is positively bad; and inexperienced eyes cannot dwell often and long on this without injury. The student is apt to thank his stars that he can do better than much that he sees, and contents himself with respectable mediocrity; and the more so as it is found that mediocrity, unaided by ordinary talent, may secure patronage and even fortune, while unworshipful genius is often neglected. There are no topics more frequently dwelt on by writers and talkers than the faults of the age—and yet nothing so difficult to understand. But to the young artist it is of the last importance that he should see clearly what are the besetting sins of the school to which he belongs. These, it is very true, are to be seen in their fullest luxuriance in our exhibitions; but there is danger if the student resort frequently to them for instruction, that he may become hopelessly blind to the mannerism of the day; and indeed this error in self-education is the chief cause of the decline of Art in every school."

Mr. Leslie's opinions upon High Art harmonise with those we have frequently expressed:—"Englishmen," he says, "are constantly told by foreigners, and are constantly telling themselves, that High Art has never existed in England. True it is, there has been no British Michael Angelo, or Raphael, any more than there have been painters approaching to them in the modern schools of Italy, France, Germany, or Holland. But the Art of Hogarth, of Reynolds, of Gainsborough, of Wilson, of Fuseli, of

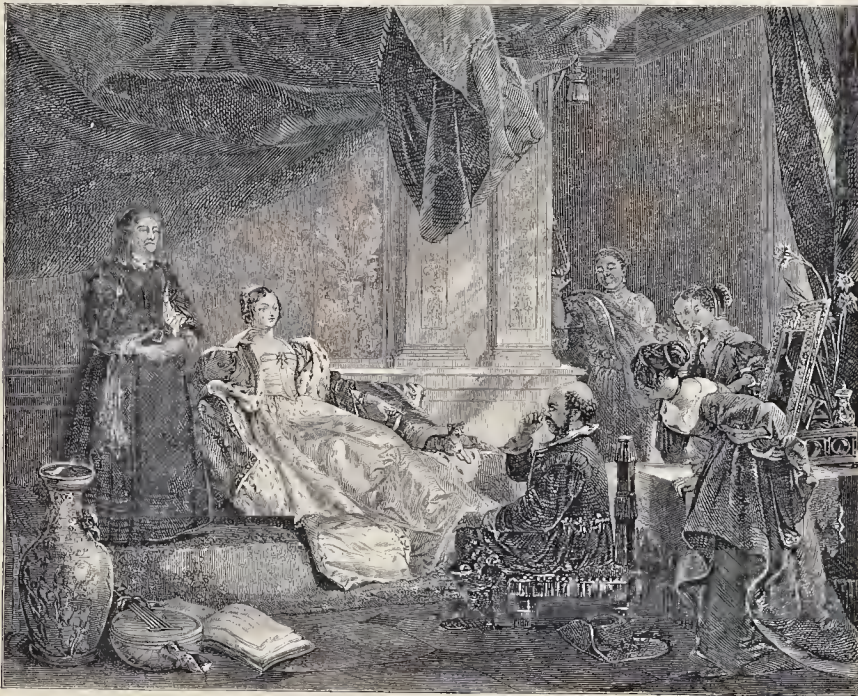

Engraved by]

SANCHO PANZA AND THE DUCHESS.

[J. & G. P. Nichols.

Opie, Stobard, Turner, Constable, Wilkie, and of Etty, and the Art displayed in Haydon's 'Judgment of Solomon,'—what are we to call it!—I care not what, but I will say that, out of Great Britain, nothing so high has been produced since the death of Watteau; whose Art, distinct from its subject, is of the highest order.

"Latterly, the term 'High' has generally been exchanged for 'Religious,' which means Art of which the subjects are from the Bible or the Legends of the Church. I should make no objection to the definition as a matter of convenience, and if understood no otherwise than of Art of which the theme is religious. But, I fear, it is too much received and intended as defining a style necessarily differing from other styles.

"It is clear to me, that had any of the early Christian painters descended to subjects of familiar life, their treatment would not, in principle or in execution, have differed from that in their religious pictures, for in that of their portraits it did not. I think, therefore, that the

attaching of more importance than they deserve to such definitions as *religious Art* and *religious painters* is calculated to blind us to many of the beauties of nature, and to lead us to suppose that because, by the early masters, some of her grandest and most charming qualities were unperceived, they are inconsistent with religious feeling; and that there must be a marked difference between religious men, women, and children, and the rest of the world; and that even skies, trees, fields, rivers, and mountains may become religious, and therefore sublime, by their unlikeness to Nature. *Severe* is a word sometimes used, and I have also heard of *heroic* landscape. Such classifications are calculated to mislead the young, while they may be easily taken advantage of by the indolent and cunning, who, with little study or thought, may at once put themselves forward as religious painters, by some mannered deviations from Nature."

Mr. Ruskin, and the pre-Raphaelite school, will scarcely share in this opinion, nor in others of a similar nature contained in the volume.

It would be a very easy matter to cull from Mr. Leslie's "Handbook" many passages similar to those extracted, either as examples of his theories of Art, or of his critical remarks upon the works of other painters: we have, however, shown enough for our purpose, and as much as our space will allow, and must therefore take our leave of him with the expression of an opinion, that both as an artist and a writer upon Art, he is one of whom the British School has full reason to be proud.

* We must take the liberty of differing from Mr. Leslie on this point; we think no such necessity really exists, and that it would in every way be far better to exclude many pictures that are hung than to admit them. In the first place they are useless where they are often hung, except, as Mr. Leslie says, to "cover the walls"; and secondly, the placing these pictures out of sight creates endless heart-burnings, which often terminate in indifference or disgust. It is our conviction that such admissions are neither profitable to the artist nor welcome to the public.

WINCHESTER COLLEGE.*

The lives of the great and the good, of the men who made their brief sojourn in the world useful in "their day and generation," are always studied with pleasure and advantage; but how much greater and nobler is the record when devoted to the life and acts of one whose benevolence has very long outlived his age, but which still flourishes after five centuries have nearly elapsed, surviving all changes of time, creed, and manners, and blessing the present age as it has blessed the past? Such a man was William of Wykeham, and thus lasting has been his enlarged views and pious benevolence. More enduring than thrones and kingdoms, his collegiate foundations still bless our land; and while the record of conquerors becomes a schoolboy's task, he seems to live among us still, dispensing learning and charity as in his own day.

"Only the actions of the just,
Smell sweet, and blossom in the dust."

Irrespective of the gratitude which all Englishmen owe to this prelate as a national benefactor, his life presents other claims to their attention. He is a glorious example, added to the numerous others it is our boast to show, of men who by intelligence, truthfulness, and perseverance, have raised themselves from the lowest grade to the highest in the land. William of Wykeham was the son of a simple yeoman, and born in the early part of the fourteenth century, a period when the rights of the commonalty were little understood, and still less cared for; when the old feudal laws were in full operation, and the



ARMS OF WYKEHAM.

difficulties which beset the upward path of the son of poor parents infinitely greater than we can now understand. Young William doubtless soon showed the bent of his mind, and a tendency to the books of the priest rather than the barn of the labourer. His assiduity in study attracted attention in an age when it was rare, and rarer still among his own class, so that the lord of the manor of Wykeham, Sir Nicholas Uvedale, desired his services as clerk. Sir Nicholas held the offices of Lieutenant of Southampton, and Governor of Winchester Castle, and when the young man grew to be his secretary, his tact and ability in writing to the nobles and the king promoted him to the same office in the household of Bishop Edyugdon, of Winchester.

At this time Wykeham was in good reputation as an architect, and certain repairs and alterations made in Winchester Castle, then a royal residence, introduced him to the notice of King Edward III., who on his return from the taking of Calais, made a sojourn there. At this time William was but twenty-three years of age, but the king saw in him the man he needed, and henceforth his rise in the state was sure though gradual. He directed his attention still more to clerical studies, and the king conferred, two years afterwards, his first benefice upon him. In those days, when the church was all-powerful, and numbered amongst its sons all the professors of the liberal arts, the ability of Wykeham as an architect added greatly to his chances of position

* WILLIAM OF WYKEHAM AND HIS COLLEGES. By MACKENZIE E. C. WALCOTT, M.A. Published by D. NUTT, London and Winchester.

among his fellows. To record his steady rise in temporal and ecclesiastical power would occupy too much of our present space. Suffice it to say, that he became one of the greatest men of his age, the chancellor of the king, and the benefactor of the poor, dying, full of years and honours, September 27, 1404, at the age of eighty years; he was buried in the cathedral of Winchester

which he had loved so well, and decorated so liberally.

It is no small privilege to be the historian of such a man; to feel called upon, after five centuries have experienced the benefit of his wisdom and charity, to narrate the rise and power he possessed, and how well he used it. With Mr. Walcott this has evidently been a labour of love,



WATER MEADS, WINCHESTER.

yet done with discriminating taste. He speaks of the great churchman justly when he says:— "With a lofty genius, capable of planning and achieving mighty things, set in high places the most seductive to the enterprising mind, the wise head and sound heart of Wykeham neither grew confused, nor yielded to temptation;"

hence he has won this due eulogium, and, our author observes, "his greatest praise is that he will be remembered as one of the best known of Christian bishops in any age, the mild benefactor of his country."

With the innate nobility of a truly great mind, Wykeham never forgot his early days and their



LIBRARY DOOR, WINCHESTER COLLEGE.

associations, and the experience gained in his passage through life, he treasured up as hints for doing good, where good was needed to be done. With him Christianity was an active principle, not bounded by ecclesiastical routine, but spreading forth in general benevolence. His corn was not only garnered, but sent forth as

seed for abundant future crops, and the present age is now gathering the harvest he sowed. "He believed himself God's almoner," says Mr. Walcott; "he gathered only to spend for the benefit of his fellows. Selfish motives and temporary ends he cast from him; he is one whom England should look upon with a sacred love, and whose

memory she may take home to her heart without reproach or fear."

Well might Wykeham take for his motto the expressive words, "Manners makyth Man;" without patrimony or inheritance, his own pains, fidelity, and unwearied industry, had been his only recommendation to the favour of princes; nor did he falsely feel shame to remember it. "As appears from his seals, upon his accession to the episcopate, he still used two chevrons between three roses (the chevron, or carpenter's couple, as Nicholas Upton, the herald, wrote, being 'signum per carpentarios, et domorum factores portatum'), in allusion to his knowledge of architecture, to which he owed his rise and fortune." To his unceasing efforts in designing and rebuilding his cathedral at Winchester, the architectural student owes a debt of gratitude,



WYKEHAM'S ARCHIDIACONAL SEAL.

but his great educational foundations, the colleges at Winchester and Oxford, demand here a few words.

Oxford, in the time of Wykeham, had sunk low; poverty, neglect, and pestilence had done their work; silly disputes between the academicians and friars abounded. The prelate brought an enlarged mind to bear on the reform of education. He founded New College in that city, and in such a manner that his rules show a degree of enlightenment much in advance of his age. In Winchester he founded the College of St. Mary, to act as the nursing mother of the Oxford institution, and which still subsists as flourishing as if the good bishop was yet bestowing upon it his fatherly care.

Winchester College occupies the spot where stood, in his days, a small decayed grammar-



WYKEHAM'S PRIVATE SEAL.

school, built upon the ruins of a Roman Temple to Apollo, and here, they say, our great King Alfred studied. The early associations of Wykeham were connected with the building, and he determined to found a new and more useful school there. How he did this must be told by Mr. Walcott, and to his pages would we refer for much pleasant reading thereupon. What he did still remains, and it is well worth the trouble of a journey from busy London to view

"the calm sequestered shade"

of the cloistered walks, the noble chapel, and the peaceful home good Bishop William has left for scholars. The pleasant meadows near the heights of St. Catherine, the old Hospital of St. Cross, are all happy spots in close vicinage, and the heart must be cold indeed that can stroll

around Winchester, the courtly home of our Saxon kings, without grateful feelings toward the illustrious departed!

Beneath the spot where the school-boy prayed, the honored prelate sleeps. His effigy lies, says Mr. Walcott, "upon a raised tomb of alabaster, beneath the lofty vaulting of a chapel rich in carved work; it is the figure of a peaceful

slumberer, in his holy robes, the mitre on his head, the staff by his side, his face turned heavenward, and his hands joined in prayer across the bosom, concealed by purple folds. The lines of thought, the lineaments of high resolve and noblest courage, are imprinted on the pale countenance; good angels watch around the head; at the feet are seated children, in the



THE CLOISTERS OF WINCHESTER SCHOOL.

dress of his students, with loving faces, praising their benefactor."

One poetic custom—a tradition of old times—still exists among the scholars; it is the singing of the noble old chant *Dulce Domum* a few weeks before holidays. The old tradition asserts it to be the remembrance of the fate of a scholar

in the olden time, who was kept fastened to a pillar at school during the vacation, while his happier school-fellows were at their homes. Before they had returned, their unfortunate school-mate had sickened and died.

We have already said that Mr. Walcott brings due enthusiasm to his task, and the result has



VIEW FROM THE WARDEN'S GARDEN, WINCHESTER.

been a work elevated above the ordinary dry reading such books almost invariably present. The volume is elegant, also, in its "getting up," and is enriched by many excellent architectural engravings on steel, and several tasteful woodcuts, of which our present pages exhibit specimens. To Wykehamists—as our author delights

to call the students of his colleges—it must be a very acceptable volume; but it has claims on all who take interest in our educational foundations, as the true source of the intellectual greatness of the country; or who desire that noblest of instruction which all may gather from the life of a good and truly noble man.

THE HOME OF PAUL POTTER.

BY F. W. FAIRHOLT, F.S.A.

WITH ILLUSTRATIONS FROM ORIGINAL SKETCHES
BY THE AUTHOR.

The Hague has always been considered the most aristocratic and pleasant of Dutch towns. Its old name, Gravenhage, indicates its position as the boundary of the principality of the ancient Counts of Holland. Its pleasant and healthy position gave it an advantage over most other towns when Holland became a kingdom, and it was chosen as the residence of the court. Its close proximity to the sea, the healthy character of its location, and the fresh beauty of the wood which for ages was allowed to grow as nature pleased in its close vicinage, were all charms uncombined elsewhere, and "*les delices de la Haye*" were spoken of even at the court of Versailles. The palace of the Stadtholder was here, and the picturesque pile of building used as the town-hall was the scene of many an event and discussion vital to the interests of Holland, in an age fruitful of great events to that country, whose annals possess an interest second to those of no other modern European state. It would almost be expected in the nature of things that the marshy tract of unproductive sand which forms this country, would be left to the quiet possession of the industrious people who had with such unwearied assiduity reclaimed it from the sea. Scarcely would it be possible to mark out a place in the old maps of Europe less attractive for the foundation of a settlement, presenting greater difficulties to be overcome, and demanding more constant care to preserve when these difficulties had been conquered. It was rescued from the sea only to be reclaimed by it upon the slightest relaxation of vigilant watchfulness,—but the fear of encroachments from their natural enemy was as nothing to those which had menaced for many centuries their civil and religious liberties; and the records of no country present more noble instances of unflinching patriotism and bold love of liberty than theirs do, when its sons were vindicating for its unwholesome swamps the only attractiveness they could ever possess, the consciousness that it was the country of free men.

We have already noted, in the lives of Cuyper and Rembrandt, the quietude with which their days passed amidst the din and bustle of an age of political and religious warfare. In Paul Potter we have another instance of this mental abstraction, which could allow the mind to be withdrawn from the ordinary doings of the world, to pursue a calm course of its own, achieving its own greatness by a placid energy which could not be turned aside from its goal. His life was a short one, but he employed his brief sojourn most earnestly in the study of Art through Nature. He won, and will ever hold, an undying name as its true exponent, while his works increase in value as time adds to their years, and true criticism advances our knowledge. Thus the painting which delighted at first as a simple transcript of nature, becomes, as we study it more, like nature itself—a hidden mine of poetry, awaiting the research of the earnest student who will seek to discover it.

The Hague may be considered as the "home" of Paul Potter, in the best sense of the word—that sense which makes the word convey to the mind all that is genial and lovable, and that marks the happy residence where intellect expands itself freely, and attaches itself fondly to the place of its growth. Though Amsterdam was the city of his early days, the Hague was the home of his choice, and his happiest years were passed within its boundaries; or in wandering beneath the shade of its neighbouring wood; or seeking subjects in the fertile fields of its vicinity. His desires and wants were bounded by this simple practice, and his native genius could elevate all he saw so readily and well, as to insure a place of honour on the walls of a palace to the simplest rural scene Holland might offer to his inspired pencil.

Potter was born, in the year 1625, in the town of Enkuisen, where his father practised Art, but

ranked low as a painter. His ancestors had held honourable posts in that city, and were descended from the noble house of Egmont. Soon after his birth his father went to Amsterdam as a permanent residence, and here he taught his son all that he knew of the rudiments of Art. He never had another master, nor did he seem to want one, for his own genius did for him what no master alone could effect; and at fourteen years of age his great ability as an artist was

acknowledged; but he felt the trammels of home life, and left it soon afterwards for the Hague.

Holland at this time had declared itself free from foreign yoke; the tyranny, falsehood, and cruelty of Spanish rule had been effectually opposed, even to the partial destruction of the country, and a brighter day dawned on its brave people.* Spain had become weakened in its resources, Germany was torn by religious wars,



A DUTCH SEA-PORT. 1633.

France was the ally of Holland, while England was busied with its own great civil war, in determined opposition to the encroachments on its liberties made by Charles I. Holland at last held a proud and independent position under its Stadtholder, Prince Frederick Henry. By land its arms had been successful, but at sea they were glorious; and the brilliant victory of

Van Tromp, known by the name of the battle of the Downs, from having been fought off the coast of England on the 21st of October, 1639, raised the naval reputation of Holland to the highest point. The trade of the country had steadily increased, and the distant settlements of Brazil and Batavia, as well as the enormous trade with the East and West Indies, enriched



AMSTERDAM IN 1630.

the merchantmen of the land immensely. Although taxation was enormous, and its national debt excessive, the country enjoyed great wealth and power, and the taste for pictures and the luxuries of life increased greatly.

The prospects of Potter were therefore good; and the objection made by the rich architect, Balkenende, when he asked his daughter in marriage, that he was "only an animal-painter," and ineligible for such an honour, was soon removed by the patronage so profitably enjoyed by the young artist; at the age of twenty-five,

Potter therefore married his daughter Adrienne,

* The great dykes, upon which the very existence of the country depends, were cut in many places to submerge invading armies; and at Leyden, during the memorable siege in 1574, the sea flowed up to the walls of the town, destroying above one thousand Spanish soldiers, the inhabitants sallying out in boats, and continuing an amphibious combat with others who had ascended trees. The whole country for 20 leagues around was ruined for agricultural pursuits for many years. Indeed, during these wars, it became almost reduced to its original state—a tract of waste mud, sand, and stagnant water.

a somewhat gay and flighty young lady for a Dutchwoman, and settled himself in one of the best houses of the town, which was soon frequented by the principal men of Holland, who deluged the painter with commissions, which he executed with untiring energy and comparative ease, because he had in the close vicinity of his home an abundant field of study, and his favourite flocks and birds were ever near him in infinite variety.

The rich character of the vegetation in Holland is due to the irrigation the soil so continually receives. The whole country is a network of canals, but it is in "the Polders" that the greatest fertility is seen; this is a technical term for a tract of ground which has been once a morass or lake, below the level of the sea, but which has been reclaimed by clearing away the water. The great lake of Haarlem has recently been converted into most profitable garden and pasture-land in this way. This is done by the simple process of forming a raised bank all round the lake, to prevent water from flowing into it. A series of windmills, each working water-wheels, is then erected on this dyke to pump the water upward into a canal on their own level, from whence it is drained off into the sea, or lifted into a series of higher canals by the same wind-agency. Thus we find sometimes three or four stages of canals used to lift the water to a proper level for drainage. The fertile soil which forms the bed of the Polder is laid out into a series of fields in the form of parallelograms, each separated on all sides by a deep ditch, the waters in which form the only means of communication with the fields, and render other guard over cattle unnecessary, as they cannot roam from the confined space allotted to them. The small ditches are continually kept to a proper level by the industrious water-mills, and the canals thus filled communicate with the others which intersect the country, and give water-way* for commerce of all kinds, and the supply of the markets. Thus a very large pastoral portion of Holland is artificial, and requires constant watching; the least neglect or inattention might prejudice much property, and ruin an agricultural district.† It has been well observed that "the inhabitant of the provinces bordering on the sea, or the Rhine, constantly threatened with the danger of submersion, is not more secure than he who dwells on the side of Etna, or at the foot of Vesuvius, with a volcano heaving beneath him. A stranger can have a full impression of this only when he walks at the foot of one of these vast dykes, and hears the roar of the waves on the outside, sixteen or twenty feet higher than his head."‡ In the days of Potter the system of perfect drainage now seen in Holland had not been introduced; the small streams were allowed to flow and spread lazily over the land, and the engraving we copy of a Dutch seaport, from the curious "Book of Emblems," by I. Cats, published at Dort in 1635, gives an excellent idea of this. The sluggish stream which flows from the village inundates the fields irregularly, and men are employed in marking its boggy boundaries by warning-posts. The sea-wall for the protection of the port, formed by the stems of trees, stretches far away, and makes an agreeable promenade. These ramparts are generally formed of clay, their surface sometimes being protected by wicker-work of willow-twigs, which, as they perish in the course of three or four years, require to be

* This simple and convenient mode of transit is abundantly adopted in Holland. It suits the quiet habits of the people best, to glide idly over the canals from town to town in the *treckschuyt*, or passenger-boat; it is also a communication which improves in winter; for at that season the wide population den their skates, and travel with great rapidity over the ice, which gives continued connection all over the country. Market-women will carry their wares an incredible distance in this way.

† So short a time ago as the year 1825, the whole of Holland was in great danger from the quantity of water which rushed from the mouths of the Rhine and Meuse, and the extraordinary height of the tides. It is declared, that had the sea continued to rise but *one quarter of an hour* more, the great dykes which protect Amsterdam would have overflowed, and that city might have been ruined. As it was, it occupied more than two years of incessant labour to repair the damage done.

‡ The coat of arms of the province of Zeeland fancifully alludes to the geographical position it holds, and consists of a lion half submerged in the waves, with the motto, "Luctor, et emergo," I struggle to keep above water.

constantly watched and renewed. The base, if not protected by piles, is generally faced with stones, or walled with bard-baked bricks, called *clinkers*, while rows of piles form breakwaters as a further protection to their solidity. Thus continuously has the Hollander to labour in the preservation of his country, and nowhere is in-

dustry so strikingly visible as among the Dutch; for it meets the eye continually, and challenges observation everywhere. The ground beneath the feet is "made earth," to use a gardener's term; sometimes brought from considerable distances, and only preserved from being washed away by the embankments just alluded to. This



TOWN HALL, THE HAGUE.

necessary attention to the state of the land produces an extremely artificial look over its entire surface. It seems as if the whole country had been constructed by human labour; more particularly as the Hollander scarcely allows a blade of grass to grow freely—all is trimmed and tended with care; while bushes and shrubs

are subjected to the gardener's shears, and cut into those wonderful figures of birds and beasts occasionally to be seen in quiet English villages, where Dutch taste has penetrated. Even large trees occasionally assume the form of square masses of foliage supported on naked upright stems, or else are tortured on iron frameworks



A DUTCH POLDER.

till they look as little like trees as a Chinese lady's foot resembles that of the Venus de Medicis.

In Holland the laws of nature seem to be reversed; the sea is higher than the land—the lowest ground in the country is 24 feet below high-water mark, and when the tide is driven high by the wind, 30 feet! In no other country do the keels of the ships float above the eim-

neys of the houses, and, nowhere else does the frog, croaking from among the bulrushes, look down upon the swallow on the house-top. Where rivers take their course it is not in beds of their own choosing; they are compelled to pass through canals, and are confined within fixed bounds by the stupendous mounds imposed on them by human Art, which has also

succeeded in overcoming the "everywhere-else" resistless impetuosity of the ocean. In a very extensive range of the country there is not a stone or pebble to be found in the alluvial or sandy soil; and there are no hills, save such as are raised by the winds; unless, indeed, we take into consideration those vast artificial mountains of granite which have been brought at enormous expense from Norway and Sweden, and sunk under water to serve as barriers to the sea. Excepting the eastern provinces, the parks of Haarlem and the Hague, and the avenues leading from one city to another, the land does not produce much wood; but the entire Norwegian forests have been buried beneath the mud in the shape of piles.*

It is in some degree surprising that so pure and good a school of natural Art should have been formed by its native-born painters, and still more remarkable that men thus compelled to see only conventional views of her beauties, should look upon the goddess dressed in Dutch taste, but delineate her in all the freedom of the purest innocence and simplicity. We might have expected a sort of Chinese landscape painting to have predominated, and cattle to have rivalled in pictures the productions of their own pottery at Delft; but the painters of Holland never committed this error, they seem

to have avoided with scrupulous care any other than the purest features she presented to them. To them she denied her grander traits—the rocky beauties of Switzerland, or the verdant graces of Italy. With them the all-glorious Rhine became a flat heavy stream, pouring its many mouths to the sea in a swamp of mud; yet limited as the field of native Art thus necessarily became, the Dutch artists, by their unwearied study of nature, and profound and patient delineation of its most minute characteristics, founded a school at once original and excellent.

Among all their national painters, none held higher rank than Paul Potter, whose finest work, "The Young Bull," still decorates the public gallery of the Hague, the favourite residence of the painter, the scene of his studies and his triumphs, but wanting, alas! in the greatest joy of all—domestic felicity. His wife was fond of flirtations which gave the peaceful painter constant uneasiness, and to such an extreme was this at last carried, that the artist one day caught his wife listening to one of her admirers; when enraged beyond measure, he cast over them the net-work he carried on his arm; and which he had taken from his horse, who wore it to keep off the flies; then tying them together with it, he exposed them both to the laughter of

the habit of painting, and he was anxious that size should be no bar to his success. The life-sized pictures of animals he now painted, although characterised by vigour and truth of touch, lose greatly in interest and beauty by their gigantic proportions, and the celebrated bull at the Hague disappoints at first sight, while few would wish to possess it in preference to his less obtrusive works. But to whatever scale the artist worked, he was always the captivating exponent of simple nature, and gave a truth, and a life, and a poetry to his scenes, which elevate the commonplace to the classic.

An early death awaited the artist; he had not completed his twenty-ninth year when he expired of a decline; leaving behind him the wife he fondly loved, in spite of her humble levities; and a little daughter three years old. In the great chapel at Amsterdam lie the remains of this one of the greatest artists of Holland;—the painter reposes in the very reverse of the quiet scenes he loved so well to depict. All around it is the bustle of life, the throng of commerce, the din of busy feet. The quaint and characteristic steeple peeps over tall warehouses, surrounding busy docks where produce is unladen from all quarters of the world. You cannot rest on the bridges which span the canal to reflect on the mausoleum of the painter, for the heavily laden cart is constantly moving with merchandise, or the quaint old coach almost noiselessly sliding on its sledge in place of wheels, might too dangerously disturb your reverie. There is something incongruous in seeking the grave of the pastoral painter in such ungenial scenes; and in the very midst of "life's fitful fever," to find the grave of one who revelled in "fresh fields and pastures new"; who studied them with a poet's love, and delineated them with the highest artistic power; whose whole soul was imbued with a love of nature, and whose head should have slept where trees shadow and flowers garnish the sod; pastoral life smiling around the resting-place of its truest worshipper.

An artist like Potter is a creator of a style; his genius enables him not only to delineate what he sees, but to express the hidden sentiment which gives the charm to nature itself. He has gone below the surface. He has been thus contrasted with painters of his school by a modern critic: "Others have painted cows, oxen, well-drawn sheep, all well-coloured and painted. He alone has seized their expression, the physiognomy of their inner existence, of their instinct. We admire the flocks and herds of Berghem, of Van der Velde, of Karel Dujardin; we are touched by those of Paul Potter."

It should ever be remembered that it is to the artists of Holland we owe a relief from the trammels of the mere "academic" school. It is to their love of nature, and persevering study of her beauties that we are indebted for a purely natural series of pictures, which rely alone for immortality on their true reflection of her varied beauties. The world as it lay around us was long a book unstudied in the flights of fancy after the ideal. To them was given the power of discovering the gold that is hidden amid the dross; the poetry that is in humble nature; the sentiment that lurks beneath the simplest form. They created therefore a new School of Art, and a school which might successfully appeal to all, by the simplicity of its sphere of action. The minute traits of nature in their pictures resemble the charming traits of her features which delight us in the poetry of Shakespeare or of Burns. As the "lush woodbine" or the "mountain daisy" could gladden the hearts of these noble poets into song, so the changing aspects of the sky could elevate into grandeur the simplest elements of Rembrandt's pictures, and the level meads and happy cattle of Paul Potter give a sentiment of happiness to the spectator, like that felt by Goethe's "Faust," when, tired of all the artificial glories of life, he feels his loftiest emotions arise from the contemplation of the fertile fields and happy peasantry around him. Truly has the bard of Avon declared

"One touch of Nature makes the whole world kin,"

and while this cosmopolitan relationship exists the Dutch painters will find admirers.



THE GREAT CHAPEL, AMSTERDAM.

the friends in his house. So ridiculous and disgraceful an affair soon became the talk of the town, and at last grew to be so disagreeable as to oblige the painter to remove to Amsterdam.

It was in 1652 that the painter settled in that city. The Burgomaster Tulp was his great patron, and enriched his fine gallery with the principal works of the artist. Amsterdam was at this period one of the wealthiest of European cities, and its rich traders delighted in embellishing their houses with pictures, carvings, and the rarest and most costly works of India, China, and Japan—a taste which has survived to the present day; and nowhere is so much of the finest work of this kind to be seen as in Holland, while rare old china is in the dealers' shops as common as Staffordshire ware among ourselves. The noble old houses of Antwerp, constructed by the De Ruyters, the Van Tulps, and the rich burghers of old days, still stand to attest their wealth and magnificence; but if we would see the city as in the days of its greatest glory, we must turn over the pages of the chroniclers of its great public events. There is a magnificent volume devoted to a detail of the reception given by the city to Catherine de' Medici, embellished by the most minute and beautiful engravings by Savery, and we have selected a view on the grand canal from this rare volume, to illustrate

the Amsterdam of Potter's era.* The view comprises a group of imposing houses, intersected by smaller canals, over which miniature bridges are carried, and it gives an excellent idea of the characteristics of one of the most extraordinary cities of Europe. Some few of these noble mansions still remain in Amsterdam in all their pristine integrity, giving a stately look to its old quays as their time-honoured fronts surmount the trees which line the borders of the canals. Their architectural characteristics might be considered as "delated" in the judgment of a severe student of the Art of building; but they have an imposing effect with their rich arcades, floriated pilasters, and fanciful gabled fronts, surmounted by statues, or vases of flowers.

After the removal of Potter to Amsterdam, he enlarged the proportions of his pictures, forgetful of the important fact, that size does not constitute greatness—for the ancient artists of Greece developed their genius as grandly upon an intaglio or a coin, as they did upon the Elgin marbles. He was, in fact, betrayed into this by emulation rather than design, for he saw there, in the possession of wealthy amateurs, pictures of far larger proportions than he had been in

* It is entitled "Byde Inkomst der Allerdorringh-tigste Koninginne Maria de' Medicee t'Amsterdam," and was published in that city in 1639; her majesty having paid the visit on her way to England, to visit her daughter, Henrietta-Marie, wife of our Charles I.

* Murray's "Handbook for Holland."

MODERN PAINTERS.*

The conclusion of a given term of years leaves few of us morally the same as we were at its commencement. It is we think about ten years since the first volume of "Modern Painters" awakened the Art-circles to a consciousness of their utter ignorance of Turner. It might have been hoped that the mellowing influence of such a period had dealt with the impulsive emotions of Mr. Ruskin as it operates upon the crude sensibilities of others. But in the way of improvement, ten years have been a blank to him—he has learnt nothing. The book before us, it is true, is characterised by a selfish prudence in the abstinence of its author from that reckless dealing with names and reputations which blots the pages of former volumes—but Mr. Ruskin is not chastened; this is sufficiently evidenced by his notice of the Exhibition of the Royal Academy of last year, and yet more distinctly shown by a letter addressed by him to an artist of eminence in reference to Roberts' picture—"Home." In the pages under notice the author has abstained almost entirely from abusive reference to British artists; but this negative atonement for the past will avail but little—it will not avert the finger of scorn, or silence the laugh of contempt; he learns too late that it is as easy to sneer in disparage as it is to vociferate in clamorous and senseless laudation: the former injures himself—he feels it, and has omitted it in this book; the latter only injures his victim—this he will never feel. All that he has written in favour of Turner will not add one shilling to the real value of the works of that artist—were it so, surdy even Mr. Ruskin would be ashamed of the cause he has taken up. Nor will anything that he has set forth against those men whose works he has so ignorantly and coarsely attacked, ever depreciate their productions to the consideration of one sixpence. Had Mr. Ruskin known really anything of the principles of Art, he might in his criticisms have been in some degree dangerous—as it is he is only ridiculous. Is this to be his last volume on the subject of "Modern Painters" ("Tandem aliquando Quiritos—?"); the worst of it is, that having taken him by the hand from the first, we feel bound to read and report upon all he writes; in which, while seeking reputation, he has attained only to notoriety. Years ago we sought for something about Art in his first volume, but finding nothing we dismissed it in a few lines; his third, we cannot part with on such terms, because he has now been so long before the world in particular, and is now attempting the famous stage trick known in pantomimic circles as "swallowing himself." In any three volumes upon a given subject it is impossible to find less matter relative to the subject proposed. It is doubtful whether the series could ever be made of any utility, but it might be at least less offensive if, with the assistance of some competent person, he were to cut the whole down to a volume of three hundred or three hundred and fifty pages. Mr. Ruskin's criticism consists of two extremities—violent and unreasonable censure—extravagant and groundless eulogy. Such is the character of the book before us, we find its author continually in the suburbs, but never within the province, of Art; the book professes something about everything but painting. We have poetry, music, botany, geology, anything; but as soon as he feels himself warming into Art, he adverts to the leaf of the flower in his button-hole, or we may go and gather limpets on the sea-shore. The work is an overdone and excessively ill-designed frame with a blank canvas. In his chapter on "High Art," we thought at least he would have turned to Michael Angelo, and have turned his "Fall of the Damned" inside out; he might in hardihood have attempted it. But to turn at once to this book and its contents there is some significance in the quotation on the title page, from Wordsworth:

".....accuse me not
Of arrogance....."

* MODERN PAINTERS. Volume III. Containing Part IV. OF MANY THINGS. BY JOHN RUSKIN, M.A., &c. &c. LONDON: SMITH, ELDER, & CO., 65, CORNHILL.

If having walked with Nature,
And offered, far as frailty would allow,
My heart a daily sacrifice to truth,
I now affirm of Nature and of truth," &c.

This is a confession that the author feels in some degree the truth of the strictures he has drawn down on himself; but it cannot be expected that it will be accepted as an apology by those whom he has so deeply outraged. The writer states in his preface that the delay in the appearance of this volume was occasioned by the death of Turner. "The first and second volumes were written to check, as far as I could, the attacks upon Turner, which prevented the public from honouring his genius at the time when his power was greatest. The check was partially given (?), but too late: Turner was seized by painful illness not long after the second volume appeared: his works towards the close of the year 1845 showed a conclusive failure of power; and I saw that nothing remained for me but to write his epitaph. The critics had done their proper and appointed work—they had ambittered, more than those who did not know Turner intimately could have believed possible, the closing years of his life; and had blinded the world in general (as it appears ordained by Fate that the world always shall be blinded) to the presence of a great spirit among them, till the hour of its departure. With them, and their successful work, I had nothing more to do; the account of gain and loss, of gifts and gratitude, between Turner and his countrymen, was for ever closed." This is an entirely new feature in Turner's biography—he died a martyr to the insensibility of the public and the strictures of critics, to which he was exposed during a lengthened and prosperous period of perhaps sixty-five years! Who will believe this mandible absurdity! Turner died full of honour, and with a fortune very much larger, perhaps, than has ever been amassed by any member of the profession. Turner as a painter was idolised by the profession, and the public rushed in crowds to see his works, and purchased them at what prices soever he chose to appreciate them.

The expiring flicker of that vivid power which had made his reputation, was seen in two Venetian subjects, exhibited in the Royal Academy about fifteen or sixteen years ago. After these, all was uncertain; perhaps the "Temeraire" was his greatest work in the interval between that period and his death. The only hope for an artist late in life is to paint with even more care than he has been accustomed to employ in his youth. But Turner abandoned himself to a course of levity and eccentricity which his warmest friends could not defend. He himself did not understand his own extravagances. Mr. Ruskin professed to expound them, but he never could assist any one else to a knowledge of them. He does not add the reputation of his friend in making him die of a broken heart, after a career of unexampled success. The first chapter, "Touching the Grand Style," is a fine field for one who has travelled and seen so much of Art as the author of this book; but it turns rather upon a paper by Reynolds contributed to the "Rambler," without venturing independently to touch at all upon any of the many examples of the "Grand Style" which we possess in this country—a subject which alone might have filled a volume. In treating of "Greatness of Style," it is said:—"For nearly every word that Reynolds wrote was contrary to his own practice: he seems to have been born to teach all error by his precept, and all excellence by his example: he enforced with his lips generalisation and idealism, while with his pencil he was tracing the patterns of the dresses of the belles of the day: he exhorted his pupils to attend only to the invariable, while he himself was occupied in distinguishing every variation of womanly temper; and he denied the existence of the beautiful, at the same instant that he arrested it as it passed, and perpetuated it for ever."

It does not surprise us, who know precisely Mr. Ruskin's qualifications, that he should write thus; but it will much surprise every artist who may read this, and a multitude of similar passages, that he should propose himself as an authority

in matters of painting, without being acquainted with the principles of the art. Mr. Ruskin does not seem to understand that, although Reynolds was a portrait painter, he was also President of the Academy, and in that character delivered lectures upon, not portrait but historical painting. It had been well if some friend of the author of "Modern Painters" had looked over his manuscript before he gave it forth with such glaring errors to the world. He does not know that the same principles which assist the adjustment of the most complicated works are also applicable to a single figure. Yet in his considerations on "Greatness of Style," notwithstanding his patent deficiencies, he presumes to set forth the elements of "greatness," saying that "the habitual choice of sacred subjects—such as the Nativity, Transfiguration, Crucifixion—if the choice be sincere" implies that the painter has a natural disposition to dwell on the highest thoughts of which humanity is capable; it constitutes him so far forth a painter of the highest order." &c. In this strain we are told that Leonardo is a painter of the highest order; Raphael, in reference to his School of Athens, is an artist of the second order. Again: in ordinary life, Hunt holds the highest rank, and Leslie is classed in the second, and Webster and Teniers are classed together. The book extends to 330 pages; and, little as there is, either new or in anywise available about Art, the author sometimes stumbles upon a wholesome truth. If the histories of the Bible are not still all waiting to be painted, not a very large proportion of those that have been accepted have received that justice which will satisfy a severe critic. The monstrous anachronisms in medieval, and even in modern Art, are most offensive to every enquiring intelligence. We are told that Moses has never been painted; Elijah never; David never; Deborah never; Gideon never; Isaiah never. We perhaps go farther than Mr. Ruskin in this: if these, however, are the few sacred characters who have not been painted, there remains, perhaps, a considerably extensive list that have. What had Turner ever to do with Religious Art? We know not: yet we are told (p. 69) that Turner's Art and the Pre-Raphaelite movement, are to form the foundation of a new and a true method of religious painting. Turner—who ever revelled in the festive sunshine—devoted to the pleasures, luxuries, and utilities of his life—pronounced a painter of sacred history! Mr. Ruskin tells us that Religious painting is the highest class of Art, and places those artists who paint ordinary subjects in the second, third, and fourth ranks; and yet Turner, who painted only Venice and a thousand less interesting localities, is a painter of the first class—a religious artist! It took something to make Turner smile, but he would have laughed outright at this, had such an observation been made to him in his lifetime. He was much astonished at reading the qualities attributed by Ruskin to his works—he never knew what it meant; but it would have been still more unintelligible to him to be ranked among the religious painters.

We are glad to squeeze our author by the hand from time to time: we must agree with him upon a second point which seems entirely new to him. He takes three pages to tell us by precept and anecdote that in all Art the beautiful may be allowed to supersede rule or principle. In this long discussion he never hits upon the word genius. Great men, we are told, never know why they do this or that; they never speak of principles. The moment a man recognises a principle, Mr. Ruskin writes him down as a person of the lowest capacity. It is perfectly true that in all Art there are accidental flats and sharps, for which the author of a passage of painting or of music will account, not according to a principle, but because they tell well in the places into which they have fallen.

As an example of the complacent egotism of the book, we need only say that at the opening of the chapter on the Grotesque we find in the first seven lines the first personal pronoun "I" occurring no less than six times. Hence it will not seem surprising that Mr. Ruskin should continually fall back upon himself, referring to

"what I have said" in "The Stones of Venice," or in some antecedent volume. He adopts, accordingly, from "The Stones of Venice," the three kinds of grotesque there propounded. (A.) Art arising from beautiful but irrational play of the imagination in times of rest. (B.) Art arising from irregular and accidental contemplation of terrible things; or evil in general. (C.) Art arising from the confusion of the imagination by the presence of truths which it cannot wholly grasp. Although we continually find that the earliest acceptation of words is worn out, and other significations insensibly arise, yet the word "grotesque" is one which must ever remain the same, because it describes that definite character which distinguished the ancient ornamental compositions that were discovered during the brilliant period of Italian Art. The qualities of grotesqueness will always be associated with the ludicrous and no effort upon the part of this writer will ever raise the meaning to heroic sense. From these distinctive periods we look up from time to time with a doubt that we can be reading the convictions of one who professes to have dwelt so long in the courts of Art—the whole series of essays looks so like one continued satirical experiment on public credulity. This essay on the "Grotesque" absorbs the whole cycle of the Muses—Ariel is a grotesque, as is also Titania! There is the "noble" grotesque, and the "sublime" grotesque; and the writer does not hesitate to address himself to Scripture for varieties of example, of which the following is quoted as one:—"Jeremiah, what seest thou? I see a setting sun, and the face thereof is toward the north. Out of the north an evil shall break forth upon all the inhabitants of the land." The word *ἀλαζονεία* is utterly ignored, but it nevertheless retain its significance until some better term be found. If the grotesque be allowed to be thus comprehensive, wherefore are not the sublimest effusions of Milton—the most touching utterances of Shakespeare—the deepest emotions of the heart, and the most soaring imagery of the head, all grotesque? The chapter closes with seven pages about griffins—a disquisition on true and false griffins. Who in this wide world cares one feather about the best griffin that ever went before a tail? Faces, hands, feet, personal expression, are the most pointed illustrations of the grotesque; but Mr. Ruskin shrinks from addressing himself to these. From the chapter on "Finish" we make the following extract:—"And it will become us to consider seriously why (if, indeed, it be so) we dislike this kind of finish—dislike an accumulation of truth. For assuredly all authority is against us, and no truly great man can be named in the Arts—but it is that of me who finished to his utmost. [The italics are in the text.] Take Leonardo, Michael Angelo, and Raphael, for a triad to begin with. They all completed their detail with such subtlety of touch and gradation, that in a careful drawing by any of the three, you cannot see where the pencil ceased to touch the paper; the stroke of it is so tender, that when you look close to the drawing you can see nothing; you only see the effect of it a little way back! Thus tender in execution—and so complete in detail, that Leonardo must needs draw every several vein in the little agates and pebbles of the gravel under the feet of the 'St. Anne' in the Louvre. Take a quartette after the triad—Titian, Tintoret, Bellini, and Veronese. Examine the vine-leaves of the 'Bacchus and Ariadne' (Titian's) in the National Gallery; examine the borage blossoms, painted petal by petal, though lying loose upon the table, in Titian's 'Supper at Emmaus' in the Louvre; or the snail-shells on the ground in his 'Entombment'; examine the separately-designed patterns on every drapery of Veronese, in his 'Marriage in Cana'; go to Venice, and see how Tintoret paints the strips of black bark on the birch trunk that sustains the platform in his 'Adoration of the Magi'; how Bellini fills the rents of his ruined walls with the most exquisite clusters of the Erba della Madonna. You will find them all in a tale. Take a quintett after the quartett—Francis, Angelico, Durer, Hemling, Perugino—and still the witness is one, still the same striving in all to such utmost perfection as their

knowledge and hand could reach." All this is mere trifling; not one of these is more finished than it ought to be; and the finish thus extolled by this writer is nothing in comparison with the finish put into pictures in the present day. Millais professes to paint fifteen hundred grasses in an inch square. Fifteen hundred! we really know little of the varieties of these *gramina*, but we believe the microscope has revealed this number, in Millais's picture. According to our author we may even look for the lymph circulating in the ivy in Hunt's "Light of the World;" and after this is it not absurd to speak of the works of Raffaele and Leonardo. We may perhaps have examined more extensively than even Mr. Ruskin, the collection of drawings by Michael Angelo, and Raffaele, and Correggio and Leonardo, and of a long list of other celebrities—those relics which are most carefully kept in heavy chests in the little rooms near the Venetian Room in the Palazzo Vecchio at Florence. But the whole of these are only preparatory sketches—that quality which Mr. Ruskin lauds as finish is only a certain neatness in hatching a reticulated surface, but for which the whole would be ragged and broken. If no man be great who does not finish to the extent mentioned above, how can Turner be great who never finished at all, and whose execution of late years was so exuberant—whose drawing generally was so faulty that in many cases where his figures were to be made out by the engraver, the latter was compelled to put them into form before he could send forth a plate to the world with his name to it. The "Old Téméraire" is an admirable picture, but when it was engraved the artist was obliged to correct the drawing of the towing steamboat, in order that it might look like a steamboat. We could quote innumerable instances of this kind, but in the face of all this Turner is quoted as an instance of high finish. The addition of such instances as those above is most absurd, because no picture in the present day would be admitted into any exhibition without a higher qualification than that described. And this is all that is said about finish: its value, its effects in opposition to shaded breadths where it is lost, are not thought of. Mr. Ruskin says nothing about the loss sustained by this quality in connection with hardness—nor of what it gains in connection with softness. He might have quoted Reynolds here once more with advantage—Sir Joshua's opinion of the nice balance of the sharp and the lost lines in Teniers, the only painter who understood this valuable nicety. Is there no finish in the Dutch school worth notice? and is mere imitative surface the sole end and object of finish? These and many others which we could propose, are questions that our author has not considered, in the chapter "Of the Use of Pictures." Mr. Ruskin notices some observations of our own, on the impossibility of his reconciling his taste for Turner with his "Pre-Raphaelite" enthusiasm. Silent contempt of empiricism on the part of those who could really determine between "a true" and "a false griffin," he arrogates to himself as so much admiration. "People of any sense, however, confined themselves to wonder." "I think it was only in the *Art Journal* of Sept. 1, 1854, that any writer had the meanness to charge me with insincerity." "The pictures of Turner and the works of the Pre-Raphaelites are the very antipodes of each other; it is, therefore, impossible, that one and the same individual can, with any show of sincerity, [Note, by the way, the *Art Union* has no idea that *real* sincerity is a thing existent or possible at all. All that it expects or hopes of human nature is, that it should have a *show* of sincerity,] stand forth as the thick and thin [I perceive the writer intends to teach me English as well as hom-sty] eulogist of both. With a certain knowledge of Art, such as may be possessed by the author of 'English Painters,' [Note, further, that the eminent critic does not so much as know the title of the book he is criticising] it is not difficult to praise any bad or mediocre that may be qualified with extravagance or mysticism. This author owes the public a heavy debt of explanation, which a lifetime spent in ingenious reconciliations would not suffice to discharge. A fervent admiration of certain pictures by Turner, and at the same

time, of some of the severest productions of the Pre-Raphaelites, presents an insuperable problem to persons whose taste in Art is regulated by definite principles." We extract the foregoing passage to show the kind of defence Mr. Ruskin sets up. What we have said with respect to sincerity we still say,—the sincerity of every man who lavishes the most exaggerated expressions of admiration on two things diametrically opposite, will always be suspected. With respect to teaching Mr. Ruskin English, we should have said nothing about his eccentricities in the vulgar, had he himself not alluded to this; but since it is so we do not even decline the task, and commence by counselling him to avoid the monstrous affectation of coining useless words, when there are better at hand to express the meaning he would convey.

And with respect to the title of his work it is very likely, not having the work at hand, that we might misquote the title, but there could be no doubt about the book to which we alluded. Mr. Ruskin is equally wrong in speaking of the "Art Union," which is not the title of this Journal. [This eminent critic does not so much as know the title of the book he is criticising.]—but these are trifles about which we should not think a second time. To the subject of "classical landscape," on which really there is nothing to be said, because there was no "classical landscape," a rather lengthy chapter is devoted, the result of which is that because Homer always associated some utilitarian view with his rural descriptions—the Greeks had no taste for the picturesque. We cannot believe that a people so deeply imbued with an admiration of nature in one form could be wanting in feeling for it in another. The friends of this writer have again and again deprecated his at all retouching the very painful subject of Turner—but he insists in this volume on saying something in justification of his having proclaimed an equal admiration of Turner and his own Pre-Raphaelite friends, on the assumption that the same principles of feeling and execution are common to both. Having taken Mr. Ruskin by the hand in the best sense of the phrase, we feel most anxious that he should set himself right with the world of Art. But to this end the beginning must be made by himself, he must commence his amendment by acknowledging himself a little wrong. Having thus far succeeded we shall not despair of inducing him to acknowledge that he has been very much wrong. But this is hopeless so long as we find him quoting from himself, underpropping his baseless fabric of bygone years. Why will he thus continue to restow his "tediousness" on those of his patient friends and well-wishers who really are desirous of hearing, even after the eleventh hour, if he have anything reasonable to offer in self-defence. We wish he would quote somebody else whose works are read, it is irksome to be continually referred to these books to learn "what I have said" on this or that really unimportant matter. So original is this writer that nothing in the entire range of Art literature is found in support of his own surpassing views. He quotes Reynolds to prove him wrong, and poor Fuseli disappears overwhelmed with contempt. It is quite unnecessary to say a word in defence of Reynolds, but we will say of Fuseli, notwithstanding all his pedantry and affectation, that on any page he ever wrote, we will point out truths, practical truths, which Mr. Ruskin has never been able to understand. There are few of us who turning for a little time our backs upon the future and looking down the array of years through which we may have passed, would not wish to recall something we may have said, done, or written. When Mr. Ruskin is in this way of thinking we shall slay the fatted calf—none more than ourselves would rejoice in his regeneration—we await his *veni—vidi—peccavi*. No one wince under correction more than he, but he endures the chastening with clenched teeth. He pronounces against the works of living painters in a manner the next thing to personal invective. Wherefore is he the Pariah of all Art Societies? Neither he nor no one need ask this. There is scarcely a brilliant reputation of our school that he has not done his best to sully—scarcely a meritorious name whose bearer he has not wantonly

humiliated by an offensive and revolting show of patronage. We will not detail the long list of distinguished painters of whom he has degradingly and scurrilously written—it would be painful to such persons to see their names brought forward in reference to this; indeed, we feel it were almost an impertinence to defend them. If he be a wanderer in the outskirts of Art-society with a mark on his forehead, it is but a hearty expression of repentance from himself that can in any wise serve him. The manner in which he essays to confirm and reconcile his views of Turner and the Pre-Raphaelites is not ingenious. His position is not so good as to be called even unsafe; we cannot even say of him that he has "not a leg to stand upon;" he is not even down, we do not find him in the condition of a man that might be picked up, but we find him falling with his pedestal, which he himself has cut from beneath him. "There are," he says, "some truths easily obtained, which give a descriptive resemblance to nature; others only to be obtained with difficulty, which give inner and deep resemblance. These two classes of truths cannot be obtained together; choice must be made between them. The bad painter gives the cheap deceptive resemblance. The good painter gives the precious non-deceptive resemblance. Constable perceives in a landscape that the grass is wet, the meadow flat, and the boughs shady; that is to say about as much as I can suppose, might in general be apprehended, between them, by an intelligent fawn and a skylark. Turner perceives at a glance the whole sum of visible truth open to human intelligence. So Berghem perceives nothing in a figure, beyond the flashes of light on the folds of his dress; but Michael Angelo perceives every flash of thought that is passing through its spirit; and Constable and Berghem may imitate windows, but Turner and Michael Angelo are nevertheless the best." Again: "Thus far, then, though the subject is one requiring somewhat lengthy explanation, it involves no real difficulty. There is not the slightest inconsistency in the mode in which throughout this work I have desired the relative merits of painters to be judged. I have always said he who is closest to nature is best. All rules are useless, all genius is useless, all labour is useless, if you do not give facts; the more facts you give the greater you are; and there is no fact so unimportant as to be prudently despised, if it be possible to represent it. Nor, but that I have long known the truth of Herbert's lines,

"some men are
Full of themselves, and answer their own notion."

would it have been without intense surprise that I heard querulous readers asking, "How it was possible" that I could praise Pre-Raphaelitism and Turner also? For from the beginning of this book to this page off, I have never praised Turner highly for any other cause than that he gave facts more delicately, more Pre-Raphaelitically, than other men. Careless readers, who dashed at the descriptions and mixed the arguments, took up their own conceptions of the cause of my liking Turner, and said to themselves—'Turner cannot draw, Turner is generalising, vague, visionary; and the Pre-Raphaelites are hard and distinct. How can any one like both?' But I never said that he was vague or visionary. What I said was, that nobody had ever drawn so well; that nobody was so certain, so visionary; that nobody had ever given so many hard and downright facts." Now the preceding effort at justification involves the usual fallacies, absurdities, and contradictions which characterize all Mr. Ruskin's writings. We are neither at a fair nor at a horse-race, and yet this writer proposes to us a game—the name of which shall not sully our pages—wherein the only novelty in his method of play is that he employs only two thimbles instead of three—these he calls "the cheap deceptive resemblance," and "the precious non-deceptive resemblance." But Mr. Ruskin is a novice at this game, for we very often find Turner under the wrong thimble. It will at once be understood what is meant by these terms—a picture affording "the cheap deceptive resemblance" is a passage of Art representing nature as we usually see it,—a work

proposing the "precious non-deceptive resemblance" is a picture open to any interpretation which a playful imagination may put upon it. Nothing is easier than rhetorical criticism. Constable is bitterly ridiculed because he succeeded in representing wet grass, the meadows flat as they were, and the boughs shady. Turner is extravagantly praised for succeeding (according to Mr. Ruskin) in representing a piece of the trunk of a tree so minutely as to require a microscope to discern its elaboration—an infinitely less difficult thing to do than that in which Constable succeeded. Again and again must we ask, how any one can express a taste for work of this kind, and in the same breath praise, as meriting equal encomiums, such a work as Turner's "Napoleon?" and yet Mr. Ruskin does this. Constable painted what he saw, as also do the Pre-Raphaelites, yet Constable is coarsely censured.*

PICTURE SALES.

THE picture sales of the season commenced on the 27th of February; Messrs. Foster & Son having on that and the following day offered a portion of the collection of Mr. Birch of Birmingham to public competition; it consisted of forty-six drawings and twelve oil-paintings. Mr. Birch's pictures were well known to amateurs, and the prices they realised are not only evidence of their excellence, but show likewise that the state of the money-market as regards Art is in a healthy and flourishing condition. The dealers mustered numerous in the rooms of the auctioneers and hid so freely there was no chance of any mere amateur securing a bargain; the principal lots fell to the bidding of these gentlemen; whether they bought on their own account, or on commission for others we know not; but, any how, we have an idea that some "paid dearly for their whistles," however meritorious the works of the artists are in reality. One thing is evident from this sale; our painters need not at present begin to despair, nor fear to be driven out of the field by the progress of photography, or any other of the many *graphies* which our age has produced; the painter's star is yet in the ascendant.

The first day's sale included the drawings; of these there were thirteen little gems by our old favourite DAVID COX, most of them of his best time; they all sold well, one, 'Figures with Cattle at a Watering place,' from the Bernal Collection, realised 23*l.* 12*s.* 6*d.*; and another, 'The Hop Gatherers,' 28*l.* 7*s.*; two by S. AUSTIN, an artist who has been dead several years, and whose works we used much to admire in the gallery of the Old Water Colour Society, sold for 9*l.* 19*s.* 6*d.*, and eight guineas respectively; 'Maboth and the Murderers,' and another by G. CATTERMOLE, sold for 37*l.* 16*s.* and 28*l.* 7*s.* respectively; 'Venice,' by the same artist, and the 'Dance,' also by him, 50 guineas and 43 guineas; 'Ullswater,' by DEWINT, 20 guineas; 'Richmond Bridge,' DEWINT, 29 guineas; 'Spring Garland,' WALTER GOODALL, 33 guineas; the 'Lacemaker,' by the same, 17 guineas. The drawings of W. HUNT sustained the popularity of this inimitable artist, as the following prices indicate. 'Pinks,' 24 guineas; 'Hyacinth, and other Flowers, on a bed of Moss, 29 guineas; 'Pine-apple and Grapes,' 31 guineas; 'Grapes and a Pear,' 26½ guineas; the 'Fortune-teller,' 53 guineas; the 'Cricketer,' from the Bernal Collection, 81 guineas; the 'Cold Morning,' also from the Bernal Collection, 49 guineas. 'French Peasants,' a small drawing by J. J. JENKINS, was knocked down for 10½ guineas; and a larger, and very charming work by the same artist, 'Scene on the Danube, 48 guineas; 'Cow and Sheep,' a very small work, by T. S. COOPER, A.R.A., 18½ guineas; 'A Spanish Lady,' J. LEWIS, 12½ guineas; 'Pandy,' by the late W. MULLER, 11 guineas; 'La Fille mal gardée,' a small highly finished drawing, by MACLISE, dated 1853, sold for 41 guineas; a beautiful specimen of the

water-colour painting of F. P. POOLE, A.R.A., 'Village Girls and Child at a Spring,' was purchased by Mr. Wallis for 60 guineas; 'A Naval Engagement,' by C. STANFIELD, R.A., 9 in. by 6 in., 21 guineas; 'Highland Drovers ascending the Mountain,' by F. TAYLOR and BARRETT, 27½ guineas; 'On the Nile,' by J. M. W. TURNER, 11 in. by 9 in., 60 guineas, bought by Mr. Holmes; and 'Calais Lighthouse,' also by TURNER, and of the same size as the other, was bought by Lord St. Leonards for 55 guineas. The twelve oil-paintings from Mr. Birch's collection reached the following prices—'River Scene,' BOXINGTON, 40 guineas; 'Whitchurch, Haymaking,' W. MULLER, 140 guineas, bought by Mr. Holmes; 'Welch Mountain Road,' J. LINNELL, 241*l.* 10*s.*, knocked down to Mr. Wallis; 'A Nursery Scene,' by PLASSAN, a modern French painter, 88*l.* 4*s.*; 'The Advent of Spring,' F. DANBY, A.R.A., bought by Mr. Holmes for 273*l.*; 'Gillingham, Kent,' by LINNELL, by Messrs. Colnaghi, for 54*l.*; 'Canterbury on the Stour,' T. S. COOPER, A.R.A., by Messrs. Graves, for 194*l.* 5*s.*; the 'Golden Age,' ETTY, bought in at 850*l.* 10*s.*; 'Sir Thomas More and his Daughter,' J. R. HENBERT, R.A., a repetition of the same subject in the Vernon Gallery, and engraved in the *Art-Journal*, bought by Messrs. Lloyd, Brothers, for 150 guineas; 'the Windmill,' J. LINNELL, by Mr. Wallis for 540*l.*; 'The Approach to Venice,' TURNER, by Mr. Wallis for 882*l.*; 'The Baron's Hall,' by MACLISE, bought in at 1650*l.*

Immediately after the conclusion of the sale of Mr. Birch's pictures, Messrs. Foster proceeded to dispose of about thirty-three paintings, the owner of which was not announced. The principal among them were 'The Smuggler's Cottage,' T. WEBSTER, R.A., 210*l.*; 'The Entrance to the Zuyder Zee,' C. STANFIELD, R.A., bought by Mr. Agnew for 498*l.* 15*s.*; 'The Barge,' J. CONSTABLE, by Mr. Holmes for 367*l.* 10*s.*; 'The Contest for the Golden Girdle of Florimel,' F. R. PICKERSGILL, A.R.A., 100 guineas; 'Furs and Furze,' J. T. LINNELL, 110 guineas; 'Scene from the Bourgeois Gentilhomme,' W. P. FITCH, R.A., 498*l.* 10*s.*, knocked down to Mr. Agnew; 'The Bashful Lover and Maiden Coy,' F. STONE, A.R.A., 131*l.* 5*s.*; 'The Homestead,' the engraved picture, J. F. HERRING, 231*l.*; 'Scene in Wales,' J. B. PYNE, 70 guineas; 'Lake Como,' C. STANFIELD, R.A., bought by Mr. Pemberton Leigh for 252*l.*; 'Timber in a Landscape,' F. R. LEE, R.A., 70 guineas; 'Venus and Cupid,' 8 in. by 6 in. only, W. E. FROST, A.R.A., 42 guineas; 'Cow and Sheep,' T. S. COOPER, A.R.A., 100 guineas; 'Ruins near Athens,' 20 in. by 16 in., D. ROBERTS, R.A., 64 guineas; 'A Grotto,' 17 in. by 14 in., J. PHILLIPS, 75 guineas; 'The East,' F. STONE, A.R.A., 32 guineas; 'Scene in Sherwood Forest,' T. CRESSWICK, R.A., and R. ANSDLEY, 123*l.* 18*s.*; 'Master Heriot and Margaret Ramsay,' 16 in. by 12 in., A. L. EGG, 62 guineas; 'The Smithy,' 14 in. by 12 in., F. GOODALL, A.R.A., 45 guineas; 'The Rose of Seville,' C. BAXTER, 130 guineas, bought by Mr. Rought; 'Dark Eyes,' J. SANT, 102 guineas, bought by Mr. Wheen; 'The Rival's Marriage,' W. ANTHONY, 100 guineas; 'Robinson Crusoe reading his Bible,' 19 in. by 15 in., C. B. LESLIE, R.A., 120 guineas; 'Arming the Knight,' J. CATTERMOLE, 27 guineas; 'Andromeda,' 29 in. by 13 in., W. E. FROST, A.R.A., 98 guineas; 'Christ Walking on the Water,' R. S. LAUDER, R.S.A., 50 guineas; 'On the Scheldt,' E. W. COOKE, A.R.A., 125 guineas; 'Cologne,' C. STANFIELD, 420*l.*, bought by Messrs. Graves; 'The Flight into Egypt,' attributed to J. DANBY, A.R.A., 40 guineas; 'View near Sydenham,' P. NASMYTH, 155 guineas, bought by Mr. Ravenshill; 'The Vicar of Wakefield,' 162*l.* 15*s.*, bought by Mr. Agnew; 'Cordova,' E. A. GOODALL, 26 guineas.

On the 7th of March, Messrs. Christie & Manson offered for sale a portion of the pictures and articles of *virtu* collected by Mr. W. Wethered, of Regent's Park. Of the paintings, this collection was richest in the works of ETTY, but if our recollection serves us aright, several of the best examples of this master were not included in the sale, and of those which were disposed of, many were only studies and sketches. We subjoin a list of those which realised the highest prices:—'Eurydice,' 64*l.* 1*s.*; 'Three

* To be continued.

Nymphs in a Landscape, a fine specimen of the painter, 169*l.* 1*s.*; 'A Pheasant and a Group of Fruit and Flowers,' small and very rich in colour, 7*s.* 15*s.*; 'An Israelite indeed,' 57*l.* 15*s.*; 'The Forest Family,' 201*l.* 12*s.*; 'Norman Peasants at a Fountain,' 96*l.* 12*s.*; 'The Three Sisters,' 63*l.*; 'A Bacchante lying on a Panther's Skin,' 109*l.* 4*s.*; 'The Syrens, from "Comus," with Cupids in the lunettes, a fresco, 117*l.* 12*s.*; 'The Young Scribe,' 136*l.* 10*s.*; 'A Nymph reclining,' 154*l.* 7*s.*; 'The Green Wood Slade,' painted expressly for Mr. Wethered, a work of the highest quality as an example of Ety, 201*l.* 12*s.*; 'The Daughters of Hesperus dancing round the Golden Tree, from "Comus," a fresco designed for Buckingham Palace, the merits of which we certainly failed to discover, 105*l.*; another fresco of the same subject, 94*l.* 10*s.*; 'Zephyr and Aurora,' truly designated in the catalogue as "one of the artist's most beautiful poetical compositions," 745*l.* 10*s.* The large picture of 'Joan of Arc finding the Sword' was bought in.

The other pictures belonging to Mr. Wethered sold at the same time were, generally, small in dimensions, but they sold well:—'Three Cows in a Landscape,' T. S. COOPER, A.R.A., 89*l.* 5*s.*; 'An Italian Coast Scene,' C. STANFIELD, R.A., 126*l.* 10*s.*; 'Interior, with Cattle,' T. S. COOPER, A.R.A., 126*l.*; 'Leith Hill, Surrey,' very small, J. LINNELL, 127*l.* 1*s.*; 'A Roman Mother and Child,' C. R. LESLIE, R.A., 68*l.* 5*s.*; 'A Fresh Breeze,' C. R. STANFIELD, R.A., 143*l.* 17*s.*; 'A Boar Hunt,' J. LINNELL, 91*l.* 7*s.*; 'Brigands in the Apennines,' C. STANFIELD, R.A., 68*l.* 5*s.*; 'Turkish Merchants fording the River Mangerchii, in Asia Minor, by Torchlight,' W. MULLER, 99*l.* 16*s.*; a pair of small landscapes, by F. R. LEY, R.A., with cattle by T. S. COOPER, A.R.A., 193*l.*; 'The Siege of San Sebastian,' C. STANFIELD, R.A., the sketch for the larger picture, we think, 109*l.*; 'Interior of St. Stephen's, Vienna,' a small duplicate of the large painting exhibited two or three years since, 281*l.* 11*s.*

The priced catalogues of two sales of pictures that have recently taken place in Edinburgh have been forwarded to us by a correspondent there. The one purports to be that of "the cabinets of the late Earl of Cathness, and of a gentleman of taste, recently deceased, together with the select collection of a gentleman removed in the country." The other collection was announced as "the property of Signor Galli, who, in consequence of declining health, has resolved upon retiring from business, comprising choice examples selected from Continental and British galleries during a period of forty years."

We annex the prices which a few of the pictures of Signor Galli realised, as examples of the two collections:—'The Death of Lucretia,' GUIDO, 11 guineas; 'Christ carrying the Cross,' OLD FRANKS, 10*l.*; 'A powerfully painted Head,' CORREGGIO, 14*l.*; 'Head of Saint,' SEBASTIAN DEL PIONNO, 10*l.*; 'View in Venice, with Gondolas and Figures,' J. M. W. TURNER, one of the best finished pictures of this great landscape painter, 4*l.* 10*s.*; 'A Music Party of Six Cavaliers and Ladies, under the porch of a palace in Italy,' a gallery picture of great importance, by PAUL VERONESE, 6*l.* guineas; 'A Grand Gallery Picture, representing Diana and her Nymphs Bathing,' splendid in colour, and in the finest state of preservation, from the collection of Lord de Tabley, by PAUL BRILL and A. CARRACCI, 14 guineas; 'The Magdalen,' GUIDO, 3*l.* 5*s.*; 'The Angel appearing to Mary,' GIULIO ROMANO, a fine cabinet example of this master, 4*l.* 15*s.*; 'Christ bearing the Cross,' MURILLO, 2*l.* 2*s.*; 'Italian Landscape, with Figures,' REMBRANDT, 45 guineas; 'Portrait of Albert Cayp,' REMBRANDT, 45 guineas. We have no doubt the purchasers of the whole of the pictures are satisfied with their bargains, and as little that they have ample reason for being so; the paintings seem to have realised their full value, including the frames, and nothing more, and we dare say will make very good "furniture pictures." This is as it should be, and we have no further comment to make on the sales. But would such results have happened ten years ago, before the *Art Journal* had taken these matters under its notice? We guess not.

HAGAR AND ISHMAEL.

ENGRAVED BY J. H. BAKER, FROM THE BAS-RELIEF BY E. S. BARTHOLOMEW.

In a very recent number of the *Art Journal* we remarked, as, indeed, we have done on several previous occasions when writing of Sculpture, how wide a field lies open in the pages of Scripture for the operation of the sculptor's art, and how little absolute necessity there is for an everlasting occurrence to heathen fable or heathen history for subjects. Nay, we will venture to hazard an opinion, that were the works of the sculptor more in accordance with the tastes and habits of the age—prejudices, some would, perhaps, call them, whether rightly or wrongly we do not now care to enquire—he would have less occasion to complain of want of patronage than he has good reason for doing. People will not purchase what is repugnant to their feelings, or opposed to their tastes, however excellent it may be as a work of Art.

The Bible absolutely teems with passages—we could point out a hundred—eminently suggestive of subjects for sculpture: many have already been adopted, others are waiting the selection of the artist, and he will not, we are sure, search long without finding what he wants, whether it be of the poetical, the dramatic, the heroic, or of any other kind. We have no recollection of seeing any previous representation in sculpture of the subject of which Mr. Bartholomew has made so very pleasing a group. Mr. Bartholomew is an American, a native of Colchester, in the state of Connecticut, and although that comparative remote locality be far removed from everything pertaining to the fine arts, he very early exhibited a decided taste for sculpture. His parents removed to Hartford, the capital of Connecticut, when he was fifteen years of age, when he at once commenced the study of the art, in the face of the many difficulties existing in a new country where but little art exists, and amid the opposition of his parents and the discouragement of friends. He persevered, nevertheless, till he had reached his twenty-eighth year, when he determined to realise his long bright dream of Italy, and, accordingly set sail for that country, and arrived in Rome in January 1851. After passing a year there, studying the antique, and especially bas-relief sculpture, he undertook a trip to Athens, for the express purpose of seeing the friezes of the Parthenon, returning, after an absence of four months, with many proofs of his knowledge and appreciation of the beauties of the Greek sculptures.

In one of the papers entitled "A Walk through the Studios of Rome," published in the *Art Journal* last year, reference was made to a statue by this sculptor, who still resides in Rome; the subject is "Eve repentant," the figure is considered by competent judges, we are given to understand, as the best female statue ever executed by an American, it has only just now been finished in marble. A correspondent writing to us from Rome, speaks thus of Mr. Bartholomew. "I know of no one who has encountered so many discouragements, or overcome more obstacles. His only care and desire seem to be to arrive at great excellence in his profession."

The two figures in this bas-relief are not circumstanced according to the description recorded by Moses, but the treatment of the narrative is sufficiently expressed. Hagar is "lifting up her voice" for her child, whom famine and thirst threaten to destroy in the wilderness of Beer sheba. The attitude of the mother is one of earnest supplication, that of Ishmael one of helpless dependence; the heads of both are remarkably expressive, and the figures group well in the composition, all the lines seeming to flow naturally yet picturesquely; we should, however, have preferred to see greater breadth given to the drapery below the loins on the right, by less redundancy of folds. The bas-relief is three feet eight inches in height, by two feet two inches in width: it still remains unsold in the atelier of the sculptor, though many of his inferior works have found purchasers.

CREATION OF A MUSEUM OF MANUFACTURED STUFFS AT LYONS.

THOSE of our readers, who feel an interest in that most important subject, the development and practical success of our Industrial Schools of Design, will, we doubt it not, be struck with the following communication, which we find contributed to the *Revue des Beaux Arts* by a member of the French Legislative Assembly.

"In this fair land of France, where artistic aspirations are all pervading—where, as it was emphatically affirmed, a few years since, *they love Art for Art's sake*—every one has a theory respecting painting, drawing, sculpture, &c., while but few carry those theories into practical application. Many seem to fancy that artistic composition has no other aim or object than to represent eyes, noses, ears, and historic incidents. That is surely an obvious error. Design is, and ever should be, intimately connected with works of industry. It is indispensable in furniture, in drapery, in the whole range of upholstery.

"Nevertheless, let us now ask, where amongst us are the schools of Industrial Art? What is their number? Is the necessity for their existence truly appreciated?"

"England, that *Alma Patens* of modern industry, has learned to feel, since the occurrence of her Great Universal Exhibition, the error which, in this regard, she, like us, had committed, and she has hastened to repair it, in organising three hundred schools of design—a great number of connected museums, three hundred professorships, and an inspector for each of her counties. The very detailed Report recently prepared by her official department of the Fine Arts, as to the result of this operation, has returned 55,000 as the number of young students, who, in the year 1853, availed themselves of the new schools. We know further, that this number has in 1854 been advanced to 62,000, and to 70,000 in 1855." The movement so begun cannot but be accelerated. Where will it stop?

"The erection of these schools, and the foundation of these museums in England should awaken the attention of our industrial classes, and of our Government. The enlightened efforts of our rivals—the sacrifices to which they subject themselves, in order to perfect the tastes of their workmen and industrial artists are, we may feel assured, but the prelude to persevering efforts, which British prelativity will carry out to its extreme conclusion, to diminish gradually our superiority, and bring the productions of the United Kingdom to a level with the excellence of those of France.

"Hence it is that, with all our heart, we applaud the good and great project, which has, for so long a period, been entertained by Monsieur the Senator Vaissé, the administrator of the Department of the Rhone, and which he has succeeded in realising through the vote of the Chamber of Commerce of Lyons, to create in this city a Museum for Woven Fabrics, where the students in Industrial Design may, by studied comparison of texture and pattern, recognise the beauties and the errors by which they may be illustrated or injured.

"At present how happens it with the young man who, leaving the school of St. Pierre at Lyons, or even the Industrial School directed by M. Chautre, enters into a great establishment or manufactory of stuff? The designs which he produces and offers may be linearly irreproachable as representing either foliage or vegetable form; but he knows not what result may be arrived at when his work has been subjected to the operation of the loom. He hesitates, he proceeds with uncertainty, and he fails.

"If, on the contrary, he has previously studied the various structure of woven fabrics, and can clearly account, in his own mind, for the effects of harmonic contrasts which they exhibit, he then not only produces a good design, but one which the weaving operations will easily realise, and which will redound to his honour.

* The writer, it will be observed, has greatly exaggerated.



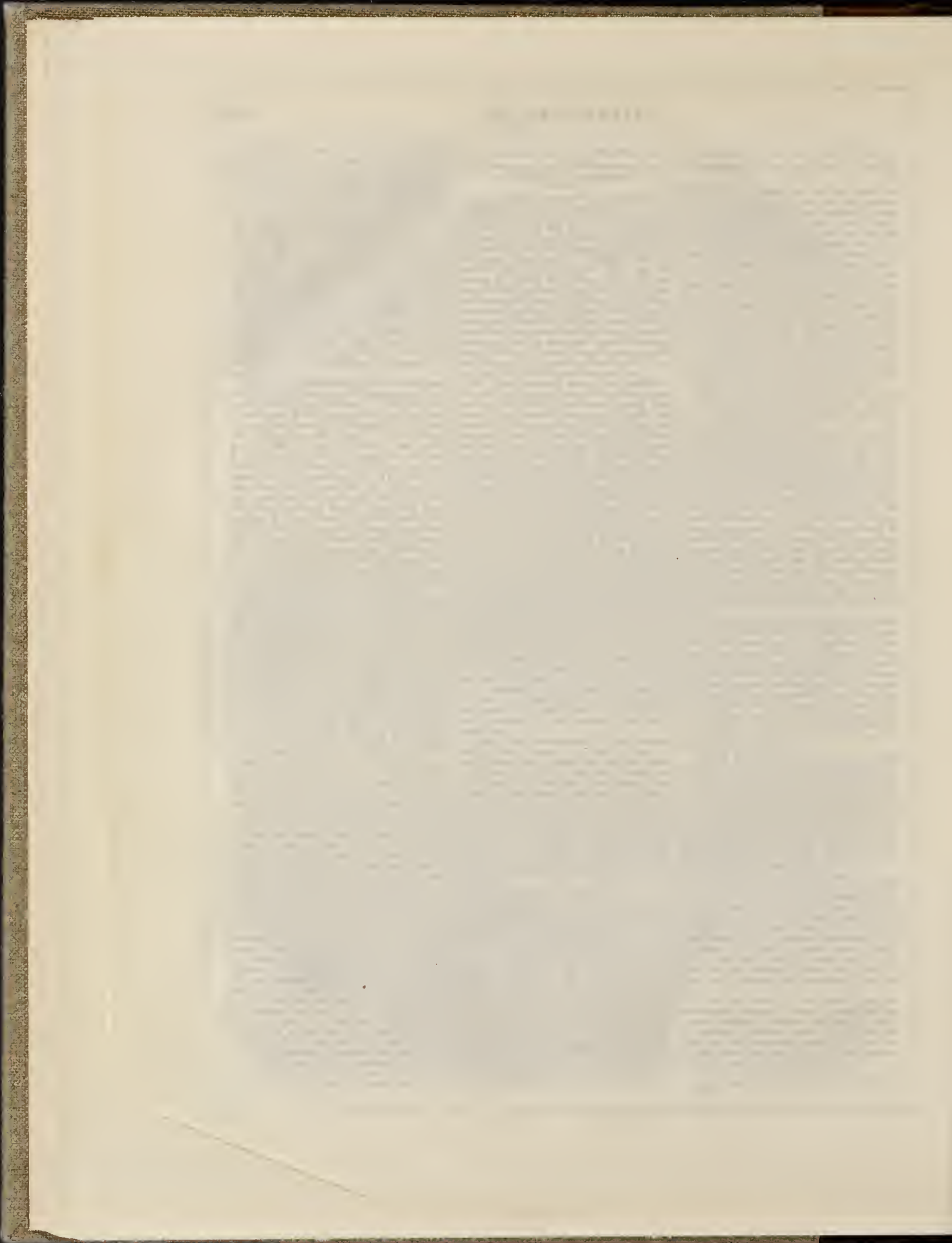



SCULPTURE BY M. J. B. ...

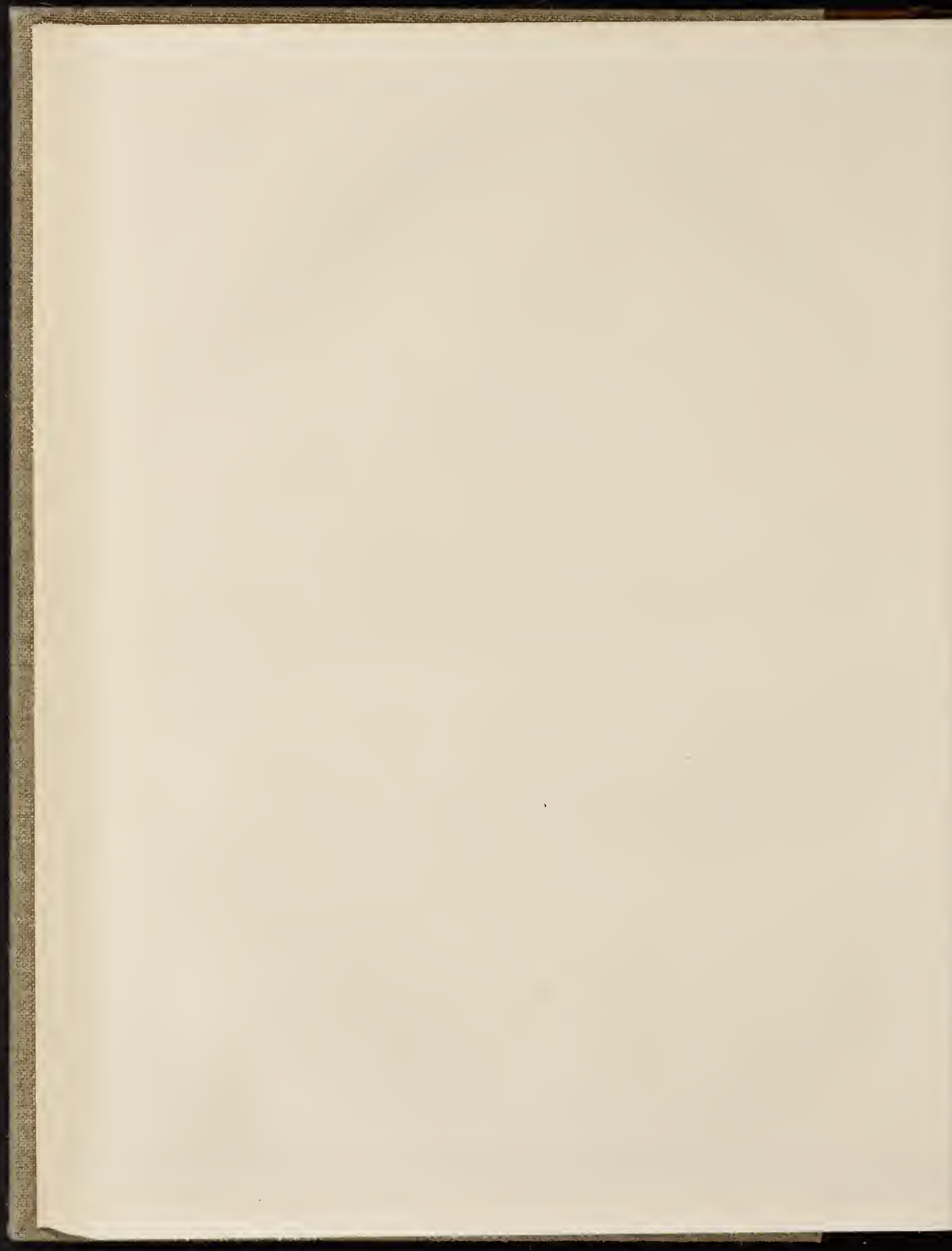

"Here in Lyons he will now find those means of practical investigation of which he has hitherto felt the want. The Museum of Woven Fabrics will not only furnish him with examples of effects for his compositions, but will present him with a history of his Art. The great houses of Meynier, Mathévon, Bouvard, Yemeniz, Cinier, Soidelquerck and Lénire, those leading agents of the industry of Lyons, will hasten to open, for the use of the the new museum, their archives of manufacture with examples carried back even to the sixteenth century. The amateurs of antiquities will present to it ecclesiastical stuffs old as the middle ages—as the ninth century—some covers of immemorial manuscripts will yield up needlework of the old world. In a word, in a few years from the present time Lyons will have enriched herself, and at a very little expense, with a collection of the kind in question, which we doubt not will be unequalled in the world.

"What is requisite to effect this? But a little good-will and energy on the part of a philanthropic administrator.

"The question is now before the Municipal Court of Lyons, where Monsieur Vaïsse has carried a vote approving of the principle of the Museum. The Chamber of Commerce has done as much. Monsieur Rouler, the minister of public works, is its warm partisan, and only waits for the practical movement to lend it all his aid. We trust that the Municipality of Lyons will thoroughly associate itself with the zeal and hopes now indulged on all sides, and that this chosen body of citizens will endow its native city with a new, and most useful element of study and progressive improvement.—ACHILLE JOURNAL, Member of the Legislative Council."

ANOTHER CONVERSAZIONE AT THE PAVILION AT BRIGHTON.

We have had another pleasant soirée at the Pavilion. The number of guests was about eleven hundred, and it is but doing justice to the honorary secretaries of the Brighton Literary and Scientific Institution to say that the arrangements for the evening's entertainment appeared to give general satisfaction.

The whole suite of state-rooms, five in number, and also the old picture gallery, were thrown open upon the occasion, and the different objects of Art and entertainment were so equally divided and arranged in the different apartments, that, with the exception of the music room, and the picture gallery, which are always crowded, no inconvenience was experienced by the pressure of the large assemblage in any of the apartments.

Commencing our examination with the Banqueting Room, we observed a beautiful and numerous collection of birds of the most brilliant plumage, and many cases of foreign butterflies and moths, among the latter of which were some of enormous size. These were exhibited by Mr. Swaysland, whose skill in preserving natural history specimens is well known.

At the end of the room were several models of vessels and steamers. The railway company also contributed, among other articles, a series of models, on a small scale, of the carriages in actual use on the line. Less useful, but more curious, was a model of a locomotive engine seven inches in length, and complete in all its parts, made by Mr. D. Dixon, an engine-driver on the Brighton line, who had employed in constructing this diminutive model the leisure hours of four years and a half. It was pleasant to see the air of gratified pride which beamed on the countenance of the happy and skilful mechanic as he listened to the expressions of admiration elicited from the spectators while examining the diminutive object which had occupied his thoughts and his hands for so long a period. He seemed to look upon his engine with the same affection that a sailor entertains for his ship.

Turning from the machinists, the next object

which claimed our attention was a new invention of Mr. Wildnau Whitehouse, the same gentleman to whom the sum of 5000*l.* was recently awarded for improvements in the electric telegraph. The new invention is an instrument called the Electric Harmoniograph. It is designed to afford facilities for composition to those who possess a musical ear and taste, but who, not having made music their profession, have neither the time, nor probably the aptitude required, for attempting written composition. It will also be found useful to professors for recording their fugitive thoughts for future reference. A galvanic battery is conducted by wires with the keys of the instrument upon which the performer is playing; and, as each note is struck, the electric apparatus records it with proper emphasis on lines produced by the same agency, upon a strip of paper prepared to receive the impression. The notes are indicated by dark-blue lines instead of dots—the length of the lines marking the relative value of the notes. The naturals record themselves on the lines and in the centre of the spaces; the semi-tones occupy a position midway between them—the sharp above, the flat below its corresponding natural. The division into bars can be effected at the time, if necessary, by the mere beat of the foot; it is, however, thought better to calculate the bars afterwards by reference to the notes in accordance with their known value. An improvement is, we are told, contemplated, by which the division into bars will be produced by the same action as the notes. The system may be termed a stenographic or short-hand system of musical notation, the correctness of which, when fully understood, is unavoidable, and a copyist would be able to transcribe any composition with perfect ease, after ascertaining the key and the time intended to be used. The Harmoniograph was, we are informed, exhibited to her Majesty the Queen and Prince Albert by Mr. Whitehouse, the inventor, assisted by Mr. F. Wright, on the occasion of the royal visit to the Polytechnic Institution. At the conversation Mr. F. Wright again kindly gave his assistance, and afforded explanations to the numbers who crowded round the apparatus. We had the pleasure of receiving, as a specimen of the work, the air of "God Save the Queen."

A Russian swivel gun, capable of carrying two miles, and which was taken at Balaklava, occupied the centre of the room, and was an object of interest to many persons; while some of the younger guests found amusement in watching the activity of the shrimps, as they darted rapidly through the water and among the seaweeds of the aquarium, or the awkward movements of the hermit crab which was restlessly thrusting forth its claws from its new lodging in a whole shell.

Near the door, a collection of phenological casts attracted some attention, and some of the guests suffered their heads to be manipulated by the gentleman who presided over this department. At a later period of the evening, Mr. Collier exhibited the electric light, which astonished by its brilliancy, while it dazzled the eye by its fitful flashes.

The yellow drawing-room was devoted to the exhibition of works of Art. A few paintings lent by different gentlemen were placed on easels around the room. Groups of French paper flowers, made by Miss Crowhurst, of East-street, and collections of shells and sea-weeds, exhibited by Mr. Pike, occupied the end of the room.

One of the most interesting tables was that at which Mr. M. Penley presided. Here we noticed a pair of Cellini cups, a pair of Sèvres Tazze, and several shell cups lent by Mr. Bright; a silver cup of Indian workmanship, exquisitely chased, and of elaborate and elegant pattern, especially the stem and foot, which displayed that happy adaptation of the design to the form of the object for which Indian artists are so remarkable. The effect of the design on the body of the vase, extremely graceful in itself, would have been more striking had it been less elaborate. This beautiful cup was lent for exhibition by Mrs. Graham. In a glass case near the cup were some Indian ornaments in

filigree silver, and some exquisite embroidery in gold from Benares. A case of miniature portraits of the Sikh princes by native artists, were more interesting as studies of Sikh physiognomy than as works of Art, and the beauty of Dhuleep Singh was no less conspicuous than the coarse brutality visible in the countenances of some of the other chiefs. A Sikh knife, without ornament, and of remarkably neat workmanship, lay, with its sheath, by the side of the case containing the miniatures of the Sikh princes and warriors, while an Indian shield of stout leather, ornamented with enamelled horses, was placed on a chair near the other Indian articles.

On the same table was a book containing very interesting illuminations from a MS. missal, attributed to Albert Dürer. The subjects are executed on vellum with body colours; and the hair, and many other parts of the figures, are gilded. The subjects are treated with the quaint elaborateness of the period, but some of the figures, especially one of the Saviour, are full of grace and dignity. It would occupy too much space were we to mention all the objects of Art-manufacture and the curiosities which attracted our attention. We noticed a small equestrian statuette of Napoleon in silver, from the Great Exhibition; and in a glass case near it, an "assignat" of the French republic.

We must not omit to notice an ingenious model belonging to Mr. Penley, of Carisbrook Castle, or the smallest lever watch in the world, made by Mr. G. Fennell of this town.

The photographs were good, but not numerous; some views of Hampstead Heath, and trees under their wintry aspect, pleased us exceedingly. Two views of the sea from the shore would have been admirable studies of the waves, had not the motion of the water rendered them slightly indistinct.

One of the tables was occupied by botanical specimens; among those we remarked an interesting collection of flowering plants from the stoves of the Rev. Mr. Roper, and many varieties of graceful ferns, as well plants as fronds.

In the centre drawing-room, stereoscopes and microscopes divided the attention of the visitor, while, in the farther drawing-room, were displayed the collection of minerals belonging to Mr. Turrell, and the fine and valuable fossils of the chalk, lent by Mr. Henry Catt. The collection of sponges was particularly interesting, and many of them very beautiful. Some vertebrae of a whale, and the molar teeth of a fossil elephant, both found in the neighbourhood of Brighton, excited astonishment from their enormous bulk.

During the evening, the company were entertained with music. A concert, in two parts, with an interval of an hour and a half between them, took place in the music room. Herr Kühn played two solos, while between the parts Mr. Thomas Wright played a grand fantasia on the harp in the banquetting room, and Mr. Sleight afterwards explained and illustrated his mode of educating the deaf and dumb.

A great addition to the pleasures of the evening was the view of the beautiful water-colour drawings from pictures in the private galleries of her Majesty the Queen and Prince Albert. These were the copies made for the purpose of being engraved in the Royal Gallery of Art, and *Art-Journal*; many of the subjects are, therefore, familiar to the readers of this Journal. By the kindness of Mr. S. C. Hall, these pictures were lent for exhibition to the Brighton Society of Arts, and this society liberally threw open the exhibition to the guests assembled on this occasion at the Pavilion. We regret, however, to remark, that while musical talent commands almost any price in Brighton, the number of those who will pay a shilling for the pleasure of seeing pictures is extremely limited. It is saying but little for the taste of a wealthy town, containing nearly 70,000 inhabitants, to express a doubt as to the success of an annual exhibition of paintings; we will therefore hope that our fears are without foundation, and that one of the most luxurious towns of the empire will show at least as much encouragement to the imitative arts as the commercial towns of equal size and equal wealth.

M. M.

THE STEREOSCOPE.

THE Stereoscope is now seen in every street; it is found in almost every drawing-room;

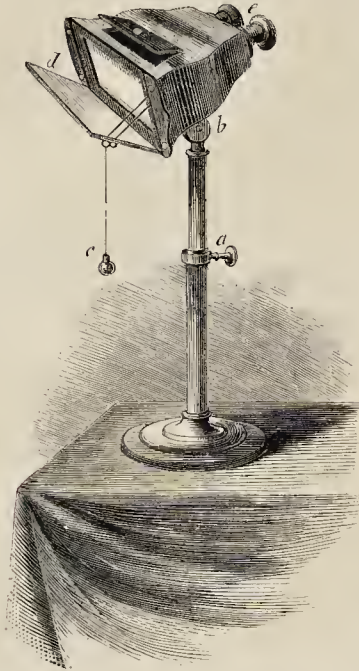

which this instrument is constructed, and still greater want of knowledge of the philosophy which it involves.

philosophers talk learnedly upon it, ladies are delighted with its magic representations, and children play with it. Notwithstanding this, we find a very general ignorance prevailing of the principles upon

We are so little in the habit of asking ourselves questions about *common things*—to employ a very hacknied phrase—that

there are not many men or women who have paused a moment to consider—Why, having two eyes, they do not always see all things double? The stereoscope, to a certain extent, answers the question; it is, therefore, important—and it cannot be without interest—that we should endeavour to explain, as popularly as possible, this instrument, which enables us to see things as they are in nature.

We derive the term stereoscope from two Greek words—*στερεος*, *solid*, which we commonly employ in *stereotype*, signifying *solid type*; and *σκοπεω*, *to see*, used also in *telescope* and *microscope*. The word therefore means, *solid to see*, the instrument converting images drawn upon a plane surface into apparent solids, or images possessing three dimensions—*length*, *breadth*, and *thickness*. If we first describe the construction of the stereoscope, the subsequent explanation of its principles and its phenomena will be rendered more intelligible. The accompanying figure represents one of these instruments, mounted in the manner now adopted by the *London Stereoscopic Company*.

The refracting or lenticular stereoscope—as this form of the instrument is called, to distinguish it from the reflecting stereoscope, which we have already described (*Art-Journal*, 1852)—consists of two eye-pieces at *e*, adjusted as in an opera-glass; an oblong box, with a door on one side, to allow the light to fall in upon pictures on opaque tablets; and a flap, *d*, which can be adjusted at any angle by the adjusting pulley, *c*, the object of this opening being to render visible pictures upon transparent surfaces. This stereoscope is mounted upon brass pillars, which can be fixed to any height convenient to the observer by the screw, *a*, while the instrument can be placed at any angle by means of the joint at *b*. By these simple methods the stereoscope is rendered perfectly convenient for all kinds of pictures, and under all circumstances for observation. The brass eye-pieces, *e*, in which the optical arrangements are placed, are capable of adjustment to meet the differences in the width between the two eyes which are found occasionally, and the varia-



THE GLEN OF MEIRINGEN, SWITZERLAND.

tions in focal distance to meet the conditions of sight.

Such is the external structure of the instrument. The pictures which we place in

it for observation may be geometric drawings made according to a fixed rule, photo-

graphic pictures upon daguerreotype plates, or positive copies on paper or glass from collodion negatives or collodion positives. Two pictures of the same object, or set of objects, are mounted side by side on the slide, as in the accompanying landscape, "The Glen of Meiringen, Switzerland," and this being placed at the base of the



stereoscope, and looked at through the eye-pieces, resolves itself into one image of perfect solidity—a miniature realisation of the picturesque scene itself.

The lenses of this instrument are but parts of lenses; this we must explain. The above figure, *a*, is a secture of a double

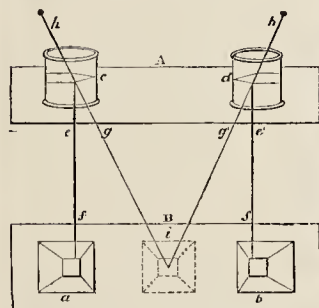

convex lens, the inner lines being intended to indicate the fact that such a lens is virtually two prisms placed together at their bases. Such a lens is cut into halves or quarters, and these are placed in the instrument with their edges opposite each other, as *b b*.

The rays of light passing through the air

and then traversing a denser medium are bent from their straight path, or refracted, and the degree of refraction depends upon the density and thickness of the medium



the edges of two prisms, we observe two images, properly constructed, and continue onward the lines of sight, we shall find the two pictures will resolve themselves into one image.

To explain this, let us suppose a skeleton stereoscope—engraved on the former column. Two geometrical figures, *a, b*, the lines forming a square pyramid, are on the tablet, and these are viewed through the prismatic

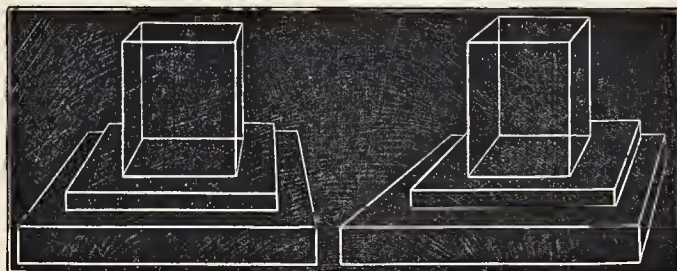

lenses, *c, d*, the rays proceed from the objects along the straight lines *e f* and *e' f'*, but those rays entering the lenses are bent, and enter the eye along the lines *g h* and *g' h'*. Now, if those lines are continued to *i*, it will be seen that the two images will be superposed, and form one; so that, under those circumstances, one image only

would be visible, namely, the image at *i*, and by throwing the pictures in the stereoscope slightly out of adjustment, this may be rendered very evident by the appearance in the instrument of parts of three pictures. The reader will necessarily now inquire how it is that a solid image, a figure having three dimensions, results from combining

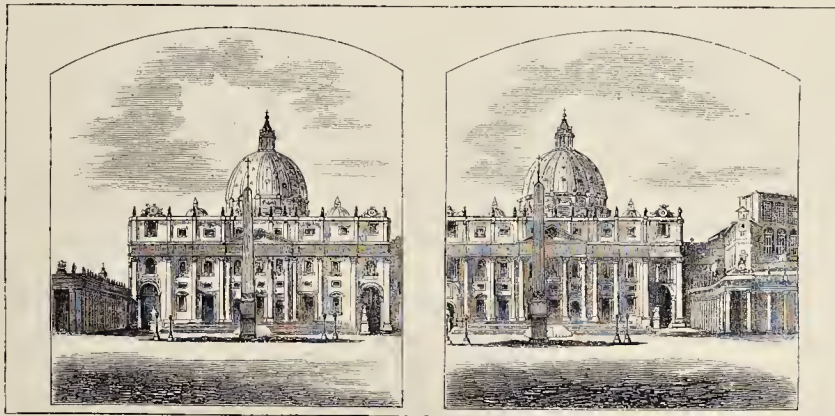

ST. PETER'S, ROME.

two dissimilar pictures. We must endeavour to explain this.

Draw a circle upon paper, and a line as its diameter; place a thin straight object

upright exactly in the centre, and so that the line and the rod are both in a vertical plane passing between the two eyes. Bring the eyes near this arrangement, close the

right eye; you will see the line to the left hand of the upright; open the right and close the left eye, the line will now appear on the right hand of the rod. The image seen by

each eye is proceeding in an opposite direction, as the arrow in the woodcut on the preceding page. With a very little practice these two images may be *squinted* into one. The result will then be the same as that produced in the stereoscope, a solid arrow proceeding directly towards the eye.

Again, place a cube upon some books arranged as a flight of steps. Place the hand as a screen a short distance in front of the nose, and, shutting first one and then the other eye, make a drawing of the arrangement under each condition. The result will be what we have represented, but these will resolve themselves into a system of solids when observed in the stereoscope.

Stereoscopic pictures are, indeed, the pictures of objects as viewed with the right and the left eye respectively. We are not—until reminded of the fact—aware that we must (seeing that the pupils of our eyes are about three inches apart) view every object under a slightly different angle. Without going into the question of vision, or examining with minute accuracy the structure of the eye, it will be sufficient for our present purpose to mention the main facts.* We see, because the rays of light which fall upon any body are radiated from the surface of that body with differing degrees of intensity, these varying with the colour, condition, and contour of the surface. These surface radiations passing through the pupil of the eye, suffer refraction by the crystalline lens, and a picture is formed on the retina of each eye. By taking the eye of a recently killed animal, and cutting an opening in the upper part, through which we may look in upon the reticulated membrane, we can see the picture as in a camera-obscura. The retina is an extension of the optic nerve, consisting of an infinite number of the most delicate fibres, piercing through a peculiar dark-coloured pigment at the bottom of the eye. The arm and its great nerves, divide in the hand into the fingers and smaller and more delicate nerves, and with these we feel objects. Now the optic nerve, when it reaches the eye, is divided into a thousand optical fingers, which feel the slightest variation in the quantities or the intensities of the light-rays falling upon their extremities, and the sensation felt by the delicate members of the eye is communicated to the brain, and this constitutes vision, the sense of sight, the effect of a luminous cause. The pictures drawn upon the eye vary as much as is the difference of the angle due to the two passages through which the rays pass—the pupil of each eye—to the optical arrangement within, which is so exquisitely delicate and refined. Each two corresponding points of the two pictures are seen at the converging of the optic axes, the eyes uniting each pair of points in succession, and conveying to the mind the impression of a solid.

It is difficult, if not impossible, with the knowledge which we have of solid bodies, to ascertain the effect upon a single eye, without the interference of the mind. We immediately adjust according to our preconceived knowledge; and hence, even with one eye, men see, under nearly all circumstances, objects of three dimensions. Yet we

may prove some of the advantages of two eyes, in giving us a correct notion of solidity.

My moderator lamp is burning on the table before me. I rest my head on my right hand, and closing my right eye, mark carefully how much of the circular form I can make out, and the arrangement of light and shadow on its ornaments; without moving my head. I open the right eye and close the left. When the left eye is open I see further round on the left hand of the lamp than when it is closed; and so of the right hand side when the right eye is opened. Now, if I open both eyes, I see round on either side better than I did with one eye; I have a more distinct perception that the cistern of the lamp is round.

Now the stereoscopic pictures are the pictures of the same building, statue, landscape, or of any group of objects, as seen respectively with the right and the left eye. We have these pictures on a plane surface—mere lines and light and shadow, as we see in the woodcut, representing the Church of St. Peter's, Rome, on the preceding page.

These pictures, as previously described, are by the prismatic lenses resolved into one. Our space forbids us from entering more into detail than we have done; we feel that our descriptions are necessarily imperfect from the consciousness to which we have been compelled; we would refer those who desire to know more of the stereoscope to the prize essay on this instrument recently published by the London Stereoscopic Company,† and we would recommend the student or the amateur to visit their establishments, and examine their collection of stereoscopic views from almost every quarter of the globe.‡ It would be almost impossible for the most accomplished artist to draw two such pictures with sufficient correctness to produce the solid image in the stereoscope. The photographic camera, and the sensitive photographic processes which we now employ comes to our aid. A single camera obscura may be employed to take the pictures from slightly different points of view; or two cameras with lenses of the same focal length may be adjusted at the required angle.

If the object is 100 feet from the cameras, their lenses should be placed 4 feet apart; if 150 feet distant, 6 feet apart; and so on, varying the distance of the cameras, or of the points at which we place our single camera, with the nearness or remoteness of the object. By carefully examining the views of Meiringen, in Switzerland, and of St. Peter's, at Rome, which have been engraved with much precision from the immense stock of the London Stereoscopic Company, it will be seen that, as we have stated, the pictures are not identical in either case. They are, in fact, in this, as in all other examples, a pair of pictures of the same scene, and the same temple, as seen with either eye. There are various mollifications of Sir David Brewster's instrument,

one of which, that by Mr. Knight, we desire specially to notice; we shall do so probably in our next.

By the extreme sensibility of the photographic processes, we are now enabled to obtain pictures of objects in remarkably short spaces of time. The moving clouds and the restless sea can equally be fixed upon our sensitive tablets, and these, viewed in the stereoscope, become so real as to cheat the senses. Under every aspect of light and shadow we can copy nature in her wildest as in tranquil moods. The limpid valley, with the sinuous river, reflecting back the sun's rays more lovely than he sent them; the forest with its mazy windings, and the fitful strugglings of light to pierce its leafy recesses, are brought out in the stereoscope with a magical reality. The gigantic vegetation of tropical climes, the stunted growth of arctic regions, are realised here in a way which defies the most skilful painter, and thus the stereoscope may be made the medium of conveying the best possible lessons in natural history, and by calling into play the powers of observation, greatly advance the education of the people.

By means of the stereoscope and photography, the Bible student may examine the rocks of Ararat and the plains of Mamre; the desolation which marks the submerged Cities of the Plain, and the endurance of man's work in the pyramids of the desert; the homes of the idolatrous Assyrian, and the temples of Darius the Persian. The student of profane history may wander over Marathon, and grow patriotic at the view of Thermopylae. The works of the intellectual Grecian, who breathed the breath of poetry into marble, and the efforts of the sterner Romans, who had more of the genius of war than of love in all their efforts after the beautiful, may be studied in a modern drawing-room and in the labourer's cottage.

We have heard the stereoscope called a toy; to some it may appear to be so; but, even if its charming productions are viewed in sport, there must still be drawn from it an earnest philosophy, for it must teach man to love the beautiful in nature, and to appreciate the efforts of mind in the productions of Art.

ROBERT HUNT.

[The establishment to which in this article we have directed especial attention is at 54, Cheap-side, with a branch establishment at 313, Oxford Street. Both have been studiously and very judiciously fitted up, with a view to the proper appreciation of effects, and in order that selections of subjects may be made under the best circumstances. As we have intimated, the purchaser has an enormous collection from which his choice is to be made, and varying in prices from those of a highly finished order to the plain and cheap photographs; and, as we have explained, they consist of almost every conceivable variety. To convey an idea of the immense extent of subjects would require large space; but this is not needed, as the Company have printed a somewhat extensive list. Upon the enjoyment to be derived from this new source of happiness it is needless to dilate. It is pure Art teaching all classes and orders; gratifying the best informed, and delighting the least instructed. By this means nothing is learned that must afterwards be unlearned; taste is never impaired, because nature is never misrepresented; there are a hundred ways in which we can hence derive instruction, but not one by which we can sustain injury; in short, the Stereoscope is a silent Teacher, from which only good can be obtained. In a word, the loveliest scenes of nature, and the grandest monuments of human genius, are, by the magical power of this little instrument, brought in all their reality and beauty, to our own homes and firesides. Its sources of gratification are inexhaustible, and administer equally to our delight in society and solitude.—Ed. A.-J.]

* Those who are desirous of examining the best authorities on the phenomena of vision, may consult the following authors:—Young's "Lectures on the Mechanism of the Eye," *Philosophical Transactions*, vol. xcl.; Brewster, *Edinburgh Philosophical Journal*, vol. 1.; Wollaston, "On the Semi-Decussation of the Optic Nerve," *Philosophical Transactions*, 1834; Wardrop, "On Blindness," *Philosophical Transactions*, 1836; Dr. George Wilson, "On the Extent to which the received Theory of Vision requires us to regard the Eye as a Camera Obscura," *Transactions of the Royal Society of Edinburgh*, vol. xxi.; Ditto, "Researches on Colour Blindness," *Sutherland and Knox, Edinburgh*, 1855.

† The prize offered by the London Stereoscopic Company for the best essay on the stereoscope was awarded, by Sir David Brewster (to whom the duty was confided by the Company), to W. O. Lewis, Esq., Professor of Mathematics at Madras College, St. Andrew's—one of the candidates for the chair of Natural Philosophy at the Marschal College, Aberdeen. This essay we shall bring under review in our next.

‡ These views, of all classes and orders, are many thousand in number; they comprise several hundred views of the Crystal Palace at Sydenham, and of the late French Exhibition; scenery in great abundance, English and foreign; historic buildings, &c. &c.; passages of great interest taken at Herulanum and Pompeii; and views in Africa, Portugal, France, Rome, the Rhine, Venice, Florence, Padua, Pisa, Milan, Verona, Genoa, Nice, Heidelberg, Como, &c., consisting of cathedrals, statues, monuments, &c., collected with taste and care. In these are comprised the ruins of the great buildings of Rome, its forum, temples, triumphal arches, castles, &c. &c.

THE NATIONAL INSTITUTION.
EXHIBITION, 1856.

AMONG the five hundred and eighty works of Art constituting this exhibition, there is a remarkable lack of figure-subjects. What we mean by figure-subjects is, historical, poetic, didactic, or romantic narrative, carefully elaborated, but without the pedantry of Art. Who is not weary of simpering rusticity? What foreigner, on seeing our eminently rustic bias, does not at once pronounce us descended of a race purely pastoral and bucolical? Scarcely can we call rustic impersonation figure-narrative; they are brought forward without narrative past or prospective, positive or allusive. Surely the world of human incident is wide enough; it is a current that would flow on for ever with features that might be made over new in Art. The very seductions of hand-carp Art lead to perfection in it; but book-lore seems repugnant to painters, hence so little advance in figure-narrative. A visitor, seeing many of the landscapes on this occasion for the first time must pronounce them of very high class; but he would hesitate to do so if he knew that the subjects and the treatment had been identical in others, which for a series of years had preceded them. They are still of high class, but the monotony is not creditable to the genius of the painters. There is in the very best of exhibitions always, necessarily, a proportion of indifferent productions, and here, of course, we find a considerable alloy. It is much to be regretted that there is so little variety with such an amount of labour; were it otherwise, this exhibition in its landscape section would be attractive beyond all the other oil-picture collections.

No. 3. 'Breton Cardplayers,' A. PROVIS. The picture presents the interior of a French cottage, which is rendered, as to detail, with a minute truthfulness fatal to good effect; that is, too much is made of passages which had been better subdued. We need not say that the work evinces power and knowledge.

No. 11. 'Caernarvon Castle, North Wales,' JAMES DANBY. This is the well-known view, presenting the magnificent ruin laterally, and occupying the right section of the composition. It is brought forward under an evening aspect, with a flood of red and amber light, such as is often repeated by this artist. The general treatment is touchingly elegiac—but the sentiment is materially injured by the introduction of an episode of every-day life.

No. 13. 'Outskirts of a Forest,' J. STARK. There is a powerfully natural charm in the manner in which this artist defines his groups of trees—the masses of foliage are palpably distinct, and this is seconded by the chiaro-scuro alternations beneath and beyond the trees. The foliage is less fresh than that of other recent pictures. Girth, the swineherd, might still find here ample food for his squeaking porkers.

No. 31. 'Feeding Time,' A. WYLLIE. Two children feeding chickens in a cottage. The subject is of a very ordinary kind, but it evinces independence of feeling, and is treated with a Dutch earnestness as to effect and realisation.

No. 32. 'At Rotterdam,' A. MONTAGUE. Groups of venerable and decrepit houses, all that can be desired pictorially, but, save us from the experiment of living in them. The Dutch are a clean people, but the neglected exterior of these dwellings suggests a conviction which we have been compelled, how reluctantly soever, to admit, viz., that dirtiness is more picturesque than cleanliness.

No. 35. 'Night, Moonrise—Hastings,' E. C. WILLIAMS. With respect to identity of locale, this might be anywhere on the coast. It is simply an effect according to the title—early in a summer or autumn evening; the coast material, boats, sails, figures, &c., opposed to the light sky. The picture is well cared for in every part, and as to refinement and allusive narrative, it is the best work we have ever seen under this name.

No. 38. 'A Storm Gathering on Cader Idris, North Wales,' S. R. PERCY. In this work the solemn menace of the heavens is rendered in

most impressive terms. The mountain is already mantled in the blackest draperies of the sky, the yet unveiled portion of which will soon be shrouded by the careering clouds, the movement of which is forcibly felt. Below, the landscape is sullenly awaiting the deluge and the whirlwind. The description had been entirely sublime but for the hay-cart and its accompaniments below.

No. 44. 'Sunset—Winter,' G. A. WILLIAMS. A class of subject to which this artist generally does ample justice. We feel the intense and piercing truth of this example.

No. 47. 'The Housekeeper's Daughter,' W. DEPPFIELD. The scene is the larder, the figure is therefore consistently surrounded with varieties of game, fish, and vegetables—the whole brought forward in a favourite Dutch form; that is, as it were, at a window. The tapestry is a most successful study.

No. 48. 'Nuts Gathering,' F. POWELL. Two little figures, backed by a hazel brake, the leafage of which has been very studiously worked out.

No. 64. 'Cimon and Iphigenia,' F. UNDERHILL. Burlesque titles are very rarely happy. The Iphigenia of this composition is a girl sleeping at a stile, overcome by the fatigue of her day's labours in the gleaming field. The Cimon is an unweath'ered peasant boy, whose broad features expand into a smile. The work is firm, vigorous, and well coloured; but we submit it had been better were Cimon absent.

No. 67. ' * * * * * C. ROSSITER. The subject is from a popular song,—'Dame Margery sitting "in her own still room," ruffled like the wife of a Dutch Burgomaster of the time of "that Antonio Vandyke," so famous for ruffs and ruffles. The effect of the picture is injured by the overpowering quantity of white in it.

No. 69. 'Sawdale,' J. PEELE. There is much less of manner in this than in antecedent productions of the same artist; and it is throughout distinguished by an unflinching assertion of local colour, very skillfully modified by an almost palpable atmospheric medium. It is the best picture the artist has as yet produced.

No. 73. 'Evening Thoughts,' J. A. HOUSTON. Like a miniature—if it be so, it is a fair example of miniature in oil.

No. 76. 'The Burnie Side,' BELL SMITH. A study of a girl standing by the brink of a rivulet. The figure is relieved by a wild and rocky background, with the very best results.

No. 81. 'Left in Charge,' W. HEMSLEY. Two cottage children "left in charge" of an infant sleeping in its cradle. The figures and the whole of the incidents are made out with the nicest finish.

No. 85. 'Medora,' J. G. MIDDLETON. She is presented in profile; and circumscribed as if mourning the absence of Conrad. The sentiment is appropriate, and successfully worked out.

No. 88. 'The Morning Rest, in Ploughing Time—A Scene in Sussex, near Newhaven,' H. B. WILLIS. The subject is a team of oxen brought forward in a landscape, flat and unbroken; thus giving principal importance to the animals, which are really equal to anything we have ever seen in this department of Art. It is impossible that the heads of oxen could be more faithfully drawn; and the successive tones of their coats are so skillfully managed with respect to perspective gradation, that each remoter animal clearly holds a position farther from the eye. It is a work of the highest excellence of its class.

No. 90. 'Salmon with Otter,' H. L. ROLFE. 'Otter with Salmon,' we think should have been the title here; inasmuch as the unfortunate fish plays only a secondary and a most reluctant part. Of the salmon we need not speak: the sinister look and the predatory character of the amphibious felon are described with much truth.

No. 92. 'A Portrait,' BELL SMITH. A well-coloured and most faithful resemblance of the painter.

No. 93. 'A Derbyshire Mill—Showery Weather,' J. WRIGHT OAKES. The sky and other parts of this work are unexceptionable; the principal components lose, perhaps, importance, by the precedence given to the near foliage.

No. 97. 'Going Out,' S. E. HODGSON. A small study of a young lady tying on her bonnet at a glass. It is very carefully painted.

No. 101. 'The Falconer,' MOSES E. WAGREZ. An example of a foreign school; showing in feeling and manner the result of the study of pictures rather than of nature.

No. 112. 'A Welsh Valley,' F. W. HOLME. The haunt of the dainty kingfisher: a stream reduced to its summer limits, forcing its way over a stony bed shaded by trees; such is the nearest section of the composition; the more remote being rocky and well-wooded acclivities. The serious and earnest tone of the picture presents that simple and every-day phase of nature, which is most difficult to paint.

No. 116. 'A Bright Day on the Thames,' J. DEARLE. A section of river scenery, in which the trees and meadows are brought forward with a feeling of indisputable truth. The pale sky is reflected perhaps too vividly in the water, and there is a wooliness in the clouds which is not natural. The simplicity of the picture is its highest commendation.

No. 120. 'An English Farm-Yard,' A. F. ROLFE and J. FREDERICKS. All the material of this composition is admirably painted, especially the horses; but the manner and feeling prevalent throughout the whole are so like that of a well-known animal painter, that we had some doubt of the accuracy of the catalogue with respect to the names of the painters.

No. 124. 'Fluellen compelling Pistol to eat the Leek,' C. ROSSITER. The Pistol of this composition is similar to that of a small picture exhibited last year. Two more figures are now added. There is a difference between this work and those previously executed by this artist; it is harder, and consequently less agreeable.

No. 127. 'An Antinatal Evening, North Wales,' J. DEARLE. We feel here that the artist has painted exactly what he saw, and no more. Composition would have supplied what composition feels to be deficient. If the wooliness of the near stones be intended to reduce their importance, the artist will find such a principle of working to be erroneous.

No. 135. 'The Heavy Burden,' J. SURTEES. A girl resting with a creel full of peat: the head is a highly successful performance.

No. 141. 'Thames Tow Barge, Shiplake, Berks,' W. S. ROSE. This picture contains much that is highly creditable; but wherefore should that which is immediately under the eye be less definite than that which is remote from it? The near masses representing herbage are almost destitute of significance for want of a few sharp touches.

No. 143. 'A Tributary of the Clyde,' W. PARNOTT. An extremely picturesque subject, brought forward with such confidence of manipulation as could only be acquired by very close study on the spot.

In this room there are three screens, containing numerous small works, of which the greater proportion are in water-colour. We find among those worthy of mention—'Going to Market,' A. H. TAYLOR; 'The Crypt, Wells Cathedral,' S. RAYNER; 'Scene from the Legend of Lady Griseld Baillie,' KARL HARTMANN; 'The Principal Street in Toledo,' T. R. MACQUOID; 'The Oatery,' S. RAYNER; 'Entrance to the Fore Walk, Wotton, Surrey,' G. BARNARD; 'Flowers,' Mrs. W. DUFFIELD; 'Viola,' A. H. TAYLOR; 'Group of Wild Flowers,' Mrs. WITHERS; 'Hop Pickers,' (a very graceful composition, well considered and charmingly painted), Miss S. F. HEWITT; 'Spring Shower, Vale of Arden, Warwickshire,' CHARLES MARSHALL; 'Scene in Caernarvonshire,' A. O. DEACON; 'Strong Breeze—Scene on the Scheldt,' T. S. ROBINS; 'A Peep into a Cottage Garden,' J. D. WATSON; 'Ariel, a Sketch,' F. M. MILLER; 'Lark near Weald, Essex,' J. E. MEADOWS; 'The Coming Storm,' FRED. S. BRIDELL.

MIDDLE ROOM.

No. 299. 'In the Marshes—Morning,' G. A. WILLIAMS. A broad and effective picture, showing the whole of the lower section with all its material in shaded opposition to the sky.

No. 308. 'One of the Ancient Rows still

remaining in Chester,' S. D. SWARBECK. A curious and unique subject, made out with the nicest attention to drawing and perspective.

No. 317. 'In the Highlands,' A. GILBERT. A large and broad composition, descriptive of the rising of the moon over lake and mountain. An expanse of water occupies the nearer headths of the view, which is closed by high mountain ridges cutting the light sky. It is a production of much solemn grandeur.

No. 324. 'Bell Smith,' BELL SMITH. The story is the consultation of the flower, in order to learn the state of a beloved object's affections. It is, of course, a girl who appeals to the oracle by plucking the flower to pieces leaf by leaf. It is, we think, the most graceful picture the artist has ever produced.

No. 332. 'In the New Forest,' SIDNEY R. PERCY. In this picture the painter has withstood the temptations of *ad captandum* effect. The composition consists of a small patch of herbage cleared of timber, immediately closed in by a dense screen of ancient trees, which again are supported by remoter groups. This mere simplicity of statement is, after all, the most difficult to deal with.

No. 334. 'A Portrait,' R. S. LAUDER, R.S.A. This, like the few portraits which this artist exhibits, is endowed with that kind of intelligence which should always be, but is so rarely, a qualification of portraiture.

No. 335. 'J. Watt and the Steam Engine—the Dawn of the Nineteenth Century,' J. E. LAUDER, R.S.A. The subject is undoubtedly of much interest; the artist has felt this, and has presented Watt a life-sized figure. He is occupied with the construction of working drawings, and leans back from the table at which he sits to watch the progress of a small steam-apparatus that is in operation near him. The picture pronounces at once its own title.

No. 341. 'Approaching Storm,' ALFRED W. WILLIAMS. A lightly meritorious production, so accurately balanced both in material and chiaroscuro, that no item of the one or passage of the other could be withdrawn without the loss being felt. It is characterised by an elevated conception beyond what we have seen in this painter's series. The cows are really worthy of a professed cattle painter.

No. 347. 'Aberdour Castle,' R. S. LAUDER, R.S.A. The subject of this picture may be simply described as a portion of a rocky acclivity overhanging the stream below. It has the appearance of having been painted on the spot, and has been realised with such surprising truth that no pebble, no blade of grass, has been overlooked. The gradual retirement of the upper portions of the ascent is most successfully represented. It is sufficiently minute to have been wrought from a photograph, but there is a mellowness about the execution that indicates rather a careful transcript from the veritable.

No. 353. 'View of the Lover's Leap, Duxton, Derbyshire,' J. A. HAMMERSLEY. An attractive subject, very conscientiously elaborated.

No. 356. 'The Swale, above Richmond, Yorkshire, looking across the Vale of Mowbray,' JAMES PEEL. The expression of graduated distance here is at once felt as an impressive truth. The subject, it is true, is of the most captivating kind, and thus contemplated under a summer sky could inspire only poetic sentiment. The gradual melting of colour into air is most happily realised. The subject, we repeat, is really a fine one, and it has received ample justice at the hands of the painter.

No. 359. 'The Attendant at the Old Hall,' DANIEL PASMORE. An agreeable piece of composition, worked out with more care than we have before observed in the works exhibited under this name.

No. 360. 'The Sea Nymph's Repose,' J. G. NAISH. A miniature in oil, containing three nude figures: it is charming in colour; but in composition it might have been brought better together.

No. 364. 'Summer-time, and the Last Magazine,' W. M. HAY. We discover here a young lady reclining within the shade of trees, intent upon a book. The feeling of the little picture and its amount of success had been better supported by a higher degree of finish.

No. 366. 'Psyche steering the Bark of Love,' J. G. NAISH. This same barque is a shell, evidently a very bad sea-boat, in tow of the sign Pisces—two fish very like grey mullet. It is very clear that Psyche has never been accustomed to handle the tiller. It is a pleasant phantasy; but why is the tempestuous sea only indicated? "The course of true love," &c.

No. 350. 'A Breeze down the River,' E. C. WILLIAMS. There is much more dash about this work than in any other we have ever seen by the same hand. It is broad and firm: the water and the sky leave nothing to be desired.

THE THIRD ROOM.

No. 404. 'Waterfall on the Long Strath, Stuteshwaite, Dorset, Cumberland.—Painted on the Spot,' HENRY MOORE. This is an example of the severest method of truth-telling. We see from time to time works executed closely from nature, with all the parts charmingly brought together, and as much as is desirable of the *suaviter in modo*. The picture is timidly painted; but study of this kind must bear fruit.

No. 408. 'Rouen,' A. MONTAGUE. We are here looking down the river, and see at some distance the two well-known towers. The picture is slight and sketchy.

No. 412. 'Castle of Lourdes, Pyrenees, France,' A. F. ROLFE. The castle is a fortress of some historical importance, having been ceded to the English as part of the ransom of the French King John. The site, surrounded as it is by lofty mountains, is one of the most picturesque imaginable: these reasons are sufficient to render the picture interesting.

No. 428. 'Hotel de Ville and Petite Place, Arras,' L. J. WOOD. The Hotel de Ville, which is partially in shade, is really most conscientiously detailed. The gable *alignement* of gables on the opposite side is described with great truth.

No. 429. 'Evening,' H. BRITTON WILLIS. We are here introduced to a *ripost*, an evening picnic of milky mothers that have settled for the night on a small peninsula of herbage, past which flows a wide and deep river. We could scarcely have believed that a small society of cows could interest us so much. It is the best cow picture we have of late seen. Many of our best friends will go to grass for many a summer before they will paint in this way.

No. 430. 'Homestead,' A. R. ROLFE and J. FREDERICK. The subject is a farm-yard and buildings, over which rises a screen of stately elms. The life of the composition is constituted of horses, fawn, and pigs, all of which are carefully drawn.

No. 432. 'Mael Siabod from near Bryntyrch, North Wales,' F. W. HULME. The whole of the near section of this composition is a water surface—a broad current flowing down to the frame. This is closed by rocks and trees, which retire in various forms, until the eye is led to the peak of the mountain, which is passing an array of dark and yet darker clouds. So masterly is every passage of this work, that we cannot commend it too highly.

No. 444. 'On the Coast near Edinburgh,' EDWARD HARGITT. A study of a small section of sea-side scenery, very pleasing in colour, but in a desire to express breadth definition of parts has been lost sight of.

No. 446. 'Fruit,' W. DUFFIELD. A composition containing the usual varieties. The white grapes, especially, are deliciously painted.

No. 448. 'View of the Undercliff, near Bonchurch, Isle of Wight—Sandown Bay and Culver Cliffs in Distance,' painted from nature, J. E. MEADOWS. This is a faithful description of the character of the Undercliff, and a great merit of the picture is the successful expression of distance, with the maintenance of local colour.

No. 461. 'Dutch Vessels entering the Port of Lillo, on the Scheldt,' T. S. ROBINS. We are at once sensible of the breeze which here sweeps the sky and the surface of the water. It has been the desire of the painter to sustain this throughout, and the result is most successful.

No. 466. 'Place Cordelier, Dinant, Brittany,' L. J. WOOD. This artist really makes a great deal of these studies of ancient architecture.

They are admirably drawn, and although every stone is individualised, the most perfect breadth is preserved.

No. 472. 'The Angler's Haunt,' H. B. GRAY. The trees in this composition are less open to exception than the other principal parts. The bridge is unduly hard and sharp, and the water is opaque.

No. 475. 'Abbeville,' A. MONTAGUE. The cathedral of Abbeville can never be mistaken; the groups of houses want definition.

No. 478. 'An Orange Girl,' JAMES COLLINSON. This picture is marked "unfinished," but certainly it cannot be the brick wall in front of which the girl stands, for every brick has received ample justice. The figure is very earnestly painted, but it ought to have been brought out from the wall.

No. 484. 'The Beches, Winter Morning,' H. H. H. HORSLEY. Twin beches are the principal feature of this wintry landscape; they have been worked with the most exemplary patience.

No. 490. 'The Evening Walk, Malvern,' CHARLES COUZENS. A small, full-length figure, evidently a portrait; it is severe in taste, but distinguished by much graceful simplicity.

No. 495. 'The Dell, Derbyshire,' J. A. HAMMERSLEY. A study closely imitative of nature; the weedy foreground is the most striking passage of the composition.

No. 499. 'Coming Events cast their Shadows before,' H. L. ROLFE. The coming event here is a stealthy cat, which we know to be approaching the latter, because the animal's shadow is on the wall. Grimalkin will have two courses—enough to satisfy any moderate cat. The salmon and the birds—especially the former—are painted with the truth which characterises all the artist's works.

No. 502. 'The Grave-digger's Riddle—Hamlet, act v. scene 1,' H. STACY MARKS. These two figures are extremely hard in execution—a disqualification which deprives finish of all its value. The church is rendered exactly, with all its mortar and minute flints—a passage of the picture which entirely supercedes the figures.

No. 509. 'Evangeline,' H. BARNARD. The figure is erect, in a contemplative pose; the drapery wants breadth, but there is in the work the feeling of a good picture.

No. 512. 'The Barmouth Valley, North Wales,' SIDNEY R. PERCY. A large canvas, showing a romantic section of lake and mountain scenery. The rough and broken foreground, with its rank grass, repeats a feature which in the series of this painter has always been remarkable.

No. 516. 'Interior of a Welsh Cottage,' C. OAKES. Somewhat more freely painted than others that have preceded it. The life of the composition is the cottager's wife contemplating her child on the ground as she sits at her wheel.

No. 521. 'Avenue from Nature,' EDWARD HARGITT. As to careful manipulation, the work is unobjectionable; but the hue of the foliage is too crude and metallic for the young green of trees; the masses also require separation and variety of disposition. The artist succeeds better in landscape breadths.

No. 523. 'The Terrace, Old Manor House—Warlaxton, Lincolnshire,' DANIEL PASMORE. A very pleasing composition, much in the feeling of the French school. It is what it professes to be—a representation of an ancient mansion, on the terrace and in the gardens before which, are strolling numerous groups of figures, attired in the costume of a period in which the mansion may be supposed to have been in its palmy state.

No. 541. 'Grassmere, Westmoreland,' Mrs. W. OLIVER. A small round picture, gracefully composed, having a mass of near trees and underwood, which very effectively assists the distances.

No. 543. 'The Bullfinch's Throne,' BENJAMIN WILLIAMS. The bullfinch is perched on a spray of apple blossom, of which every leaf has been scrupulously studied from nature. The bird is well drawn, and the idea is pretty and original.

No. 551. 'Commoners,' W. H. HOPKINS. These are two donkeys, the property of a neighbouring

encampment of gipsies. The animals look too well-conditioned to be the property of this vagrant race.

No. 552. 'River Scene, North Wales,' P. WEST ELEN. The water-course winds downward, occupying the nearest breadth of the canvas. The work presents the distinctive character of the best passages of Welsh scenery. The view is closed by mountainous ridges, to which the eye is skilfully led by intermediate gradation.

No. 562. 'Near Goatfell, Arran,' EDWARD HARTER. In this picture the proposed distances are painted so substantially, that they do not retire sufficiently. It is a wild and very attractive subject, rendered with appropriate feeling, and in a manner original and independent; but the distances almost vie for precedence with the foreground.

No. 563. 'Eel Bucks on the Loddor,' R. BRANDARD. This has very strongly the impress of nature—but it is rather cold in colour.

No. 567. 'Autolyens as the Pedlar,' H. STACY MARKS. It is much to be regretted that the result of a determination to finish should so frequently end in mere hardness. The whole of the picture is very minutely manipulated; but the lines are unusually severe.

No. 573. 'The Nest,' ELLIAH WATLOW. It is that of a hedge-sparrow, surrounded by flowers of white and pink May; but the flowers are too large—they rival the eggs in size, whereas they should be much smaller; but the whole is worked out with the most conscientious exactitude as to detail.

The sculptural productions are only five in number. 'Paolo e Francesca di Rimini,' a group in plaster by ALFRED MUNRO, two small figures in the act of interchanging those emeralds which consigned them to that circle of the Inferno in which they were found by Virgil and Dante. 'The Spirit of Nature,' a small female figure in plaster, broad, and essentially modern in taste, also by ALFRED MUNRO. 'The Sea-Nymphs discovering the body of Lycidas,' 'The Brothers in Conus,' and 'The contest between Good and Evil,' three bas-reliefs by F. M. MILLER, characterised by infinite elegance and refined feeling.

As we have already said, the prevailing feature of this exhibition is its landscape, in which, notwithstanding the identity of which we have complained, there is a great amount of excellence: the number of exhibitors works is increased, but the proportion of striking figure-compositions is not proportionably augmented.

THE CRIMEAN EXHIBITION.

Such is the name given to a collection of pictures and drawings, exhibited at 121 Pall Mall, having especial reference to the late campaign in the Crimea. The drawings by Mr. SIMPSON amount to ninety-one; affording views of every point of interest connected with the recent operations. The pictures are only three in number; a full-length portrait of the Queen, painted by Mr. CATTERSON SMITH for the Corporation of Dublin; and two large pictures, 'The Battle of Inkermann,' and 'The Battle of Balaklava,' by Mr. E. ARMITAGE. For the portrait by Mr. SMITH, the Queen condescended to give fourteen sittings. The composition is extremely simple, as the accessories are few and unobtrusive. Her Majesty is standing on a dais, with the head turned slightly to the right, and wears a dress of plain white satin. We think it one of the best portraits of the Sovereign we have yet seen. 'The Battle of Inkermann' is represented as at near the close of that dire and sanguinary conflict, the time being about ten o'clock, when the Zouaves are just coming into the action, which had been sustained already for hours by our troops. We are placed near the sand-bag battery; and the immediate ground is occupied by the Grenadier Guards, who seem to be engaged with the enemy while yet in column. If this be not the disposition, it should not seem so: we are certainly not at the

head of the column, because the columns which are before us are with the centre companies. It is true that in this, the "soldiers' victory," there was nothing of the military pedantry of a Hyde Park Review; and, in the fearful pressure of these few awful hours, it is impossible to say into what anomalies of formation a battalion may have fallen. We think the artist conveys an imperfect conception of the battle, in one of the main principles on which he has worked. It is historically true that our troops were opposed to, and beat an overwhelming force of the enemy; but the vast disproportion does not appear in the pictures. We can perfectly understand the predilection of the painter for large figures; but, perhaps, with all the facilities which he has enjoyed, it might have been better to have shown more of the field, and more of the dispositions of the enemy: this would by no means have enfeebled his description of any one of the incidents he has introduced. On the high ground, which, from this view of the field, closes the composition at a little distance from the foreground, is seen the Duke of Cambridge with Major Macdonald; and in the *mêlée* before us, is Colonel Lindsay cheering on his men; also Captain Peel of the navy, followed by a middy—volunteers on this occasion. A great many of the men, Russians as well as English, are portraits; and, if the representatives here be according to natural truth, which we believe must be the case, from the opportunities which the artist has had of arriving at facts—the Russians in anything like equality of force can have no chance in front of our stalwart grenadiers, or even of our line regiments, of which so many are essentially grenadiers. The morning of that memorable fifth of November was rainy and dark, the aspect of the sky is therefore clouded, and the general appearance of the field excessively dreary. The men on both sides are fighting in their great coats: the Russians wearing flat-topped cloth caps, and our own people, of course, their bearskins. Throughout the picture there is an entire suppression of colour—this, consistently with truth, could not be otherwise; but where colour might with propriety have occurred, as, for instance, in the standard, it is even then reduced, in order that there may be no relief to the impression which, it is at once felt, is intended to be conveyed. In the Cavalry charge at Balaklava, the troops immediately engaged are the Scots Greys, and the 6th Dragoons, led by General Scarlett, who is himself penetrating the enemy's lines. Major Clarke, of the Scots Greys, is also a prominent figure. The troops with whom these regiments are engaged are Russian Light Cavalry, in grey or light blue uniforms, who, neither men nor horses, can make any stand against such force of hone and muscle as our troops bring against them. As in the other picture, the figures are large, only a very small section, therefore, of the battle can be shown. The figures are many of them portraits, and the ground is most accurately painted. Mr. Simpson's sketches are very interesting; there is not a spot associated in anywise with the history of the Crimean campaign that is not commemorated. A few of the sketches describing certain of the most remarkable localities may be mentioned, as—'The Interior of the Malakoff,' 'Interior of Fort Nicholas,' 'Ditch of the Bastion du Mât,' 'The Interior of the Redan,' 'Attack on the Malakoff,' 'The Battle of the Tchernaya,' 'The Interior of the Mamelou Vert,' 'Charge of the Light Cavalry Brigade,' 'Charge of the Heavy Cavalry Brigade,' 'The Docks, &c.,' 'Entrance to Excavation, at Inkermann,' 'Admiral Lyons and Staff,' 'The Valley of the Tchernaya,' 'Camp of the Light Division,' 'The Town Batteries, or Interior fortifications of Sebastopol,' 'Funeral Cortege of Lord Raglan leaving Head Quarters,' 'Prince Woronzoff's Palace,' 'Sebastopol from the Sea,' and a large and highly-finished drawing showing the retreat of the Russians to the North-side, with Sebastopol blazing like one vast furnace in their rear. These engravings are executed on tinted paper, the lights being put in with white; they are unexceptionable in execution, and of their truthfulness there can be no question.

ART IN CONTINENTAL STATES.

PARIS.—The splendid stained glass windows, formerly removed from the church of Notre Dame, because they obstructed the light, are to be replaced; this is a proof of good taste, as they are magnificent specimens of a former age.—The Tour St. Jacques de la Boucherie is nearly completed; stained glass windows are being placed, and the square round the tower planted with trees; the whole has a fine effect.—A splendid cradle is being constructed for the imperial infant; the body is in the form of a ship (the arms of Paris) richly ornamented with sculpture and enamel. The artists employed on this unique "domestic" object are Messrs. Baltard, Simart, Jaquemart, Gallois, Grohé, and Froment-Meurice.—An Art-exhibition is projected at Vienna; the paintings, by Winterhalter, of the Empress Eugenie, exhibited in Paris last year, are to be, by special request, forwarded to that town.—Lottories are quite the fashion here; the various articles presented to the nation by artists and manufacturers after the close of the Grand Exhibition, will be put up as prizes in a lottery; the proceeds are for the widows and orphans of the army of the Crimea.—A shield in bronze has been presented to the Baron C. Dupin (chief commissioner at the London Exhibition, 1851); it is executed by Liennard, Froment-Meurice, and H. Flon.—M. Prévost has just finished a statue of Le Notre for the government.—The bust of Leopold Robert has been placed in the Louvre; it is by Adam Salomon.—The "Death of Patroclus," by Gérard, has been sent to the Museum at Tarbes.—The cross taken at Sebastopol by the French, in the church of St. Vladimir, has been placed in the Musée de Cluny.—Horace Vernet is busy painting the "Battle of Alma."—The whole ornamental part of the Louvre has been reproduced in photography, by order of M. A. Fonléd.—It is said that the Emperor has demanded from the civic authorities of the Hotel de Ville all the ancient plans for the embellishment of Paris; if this be true, the whole of old Paris is to be pulled down, and a new city built. The works are to be undertaken by three companies, and the estimate of the cost is at least 800 millions of francs.—At a sale of pictures belonging to M. Barfollet, the opera singer, Paris, a few days ago, some Watteaus were disposed of at high prices—namely, one, representing "The Alliance of Music and Comedy," at 160*l.*; another a portrait of "M^{me}. Julien" in mythological costume, at 158*l.*; a third, "Clytie Adoring the Sun," at 158*l.*; and "Le Glorieux," at 36*l.*—On the same sale a "Triumph of Venus," by Boucher, fetched 120*l.*; "The Mountebanks," by Callot, 138*l.*; "The Silver Goblet," by Chardin, 30*l.*; a portrait of "Louis XVI.," by Greuze, 94*l.*; "The Pied de Bouff," by Lancret, 158*l.*; "The Unfortunate Author," by Prudhon, 118*l.*; "A Charge of Cuirassiers," by Charlet, 38*l.*; "Maternal Care," by Frayonard, 29*l.*; and "The Caravan," by Martthal, 55*l.*—At another recent sale in Paris, twenty-eight small landscapes, by Buechel, were sold for 450*l.*; "An Interior of a Church," by Peter Neuss, 18*l.*; "An Interior of a Cathedral," by the same, 19*l.*; "Politicians in the Garden of the Tuileries," by Bailly, 19*l.*; "Flowers on Porcelain," by Pricte, 30*l.*; "The Chamber of Jesus," by C. Dolez, 16*l.*; "A Holy Family," by Maratti, 25*l.*; "The Marriage of St. Catherine," by Beschev, 16*l.* 10*s.*; and "The Adoration of the Magi," by Tiepolo, 17*l.*—At the same sale some works in ivory were disposed of, and amongst them were an "Ascension of Christ," 38*l.*; an "Adoration of the Shepherds," 19*l.* 10*s.*; "Birth of Christ," 35*l.* 10*s.*; a small "Christ," 34*l.*; and a "Calvary," 27*l.* 10*s.*

CARLSRUHE.—We hear, says the *Literary Gazette*, that a work of Art, just arrived from Rome, is creating much attention there. It is a statue of a young violin player, executed in Carrara marble by Herr Steinhauser. The subject would seem most insuited to sculpture; but it would appear that the artist has completely conquered the difficulties in his work. The statue, placed on a pedestal of red marble, represents a youth of the size of life, draped in a cloak cast over the left shoulder, which envelops the body, and descends to the knee. The attitude of the head, and expression of the face, denote the moment of rapt inspiration as he is about to sound his instrument. The bow and strings of the violin are of bronze. The statue is the property of the Prince Regent, who does everything in his limited power to further Art in his states.

COLOGNE.—The provincial government of Cologne, we learn from the *Builder*, have ordered M. Hôhe, professor of drawing, to copy and trace the old mural paintings of St. Gereon's Church. They

belong to the thirteenth century, and are conspicuous for correct design and brilliant colouring, and represent figures of saints, above life size; containing also the apocalyptic signs of the evangelists; who stand in the niches of the chapel. The surrounding ornaments are in the Romanic character, passing somewhat into the Gothic.

ART IN THE PROVINCES.

WARRINGTON.—The council of the Warrington School of Art report that the prospects of the school at the close of the first year of its perfectly independent existence are most gratifying in every respect. The school has now fully overcome the difficulties that beset such an institution at its outset, has won general confidence, has enlarged the sphere of its labours, and now really promises a future of stability and permanent usefulness. The year has been an eventful one; and though sometimes difficulties have gathered, the very efforts that have been necessary to overcome them have done much to spread a knowledge of the advantages of the institution, and to enlist public sympathy in its behalf. The attendance of students at the central school during the year has been as follows:—Special Class, males, 16; females, 26. Public Day Class, males, 25; females, 11. Public Evening Class, males, 45; females, 2. The entire number of students who have attended the school during the year is—Males, 86; Females, 39. Total 125. The relative merit of the works of the pupils has been impartially tested by examiners appointed by the Board of Trade in the three public exhibitions of students' works which have been held in London since the date of the last report of the school. Medals were awarded in those exhibitions to thirty-four works of the Warrington students, a number greater than that awarded to any school of the same age, even in large towns, and exceeding in some cases the number granted to the old-established schools.

PLYMOUTH.—The school of Art in this town progresses so satisfactorily that the accommodation at present provided does not meet its necessities, so that the committee have been compelled to refuse a considerable number of applicants for admission.

BATH.—The committee who manage the agreeable *réunions* at Bath exert themselves most laudably for the advantage of their visitors. The third conversation of the season, which took place on the 11th of March, attracted much interest from the large number of excellent paintings and drawings lent for exhibition; the most valuable of these were contributed by Mr. Wallis, who sent Maclise's "Veiled Prophet" and "Spirit of Chivalry," Ary Scheffer's "Francesca di Rimini," Rankler's "Dream of Hope," Goodall's "Raising the Maypole," a small *replica*, with some slight variations, of the larger work; Lunell's "Windmill," Wilkie's "Alfred in the Neather's Cottage;" drawings by Austin, Turner, Stanfield, Müller, Chambers, W. Goodall, Hall, Hunt, Rayner, D. Cox, sen., T. S. Cooper, Bright, Salmon, Lewis. Among other works deserving of especial notice were "The Halt of a Party after a Day's Sport in the Highlands," by J. F. Herring; "Sunset at Sea" and "Isola del Pescatori," by G. E. Hering; "Sea Coast" and "Stepping Stones," by T. Dauby; "Roses," by Miss A. Mutrie; "The Gardener's Store-room," G. Lance; "The Mill" and a "Landscape," by Bright; two "Views in North Devon," W. Muller; "The Mill-tail," G. Frigg; "Coast Scene," T. B. Aylmer; "Child mourning over a dead Bird," Sant; "The Deer-Leap," and others, by H. B. Willis; some interiors by Helmsley and J. and D. Hardy respectively; water-colour drawings in frames by Collingwood Smith; and in portfolios by Bennett, McKewan, Soper, Jutsum, Stephano, &c.

TRURO.—The ladies of the morning class of the School of Art have presented to the master, Mr. G. R. Gill, a silver-mounted dressing-case, as a mark of their esteem for his manner of conducting their studies. The progress of the class it refers to affords much satisfaction, we are told, to the promoters of the school.

CLIFTON.—The first conversation for the season of the Bristol and Clifton Graphic Society took place on Tuesday evening, the 4th of March, at the Victoria Rooms, Clifton, and was well attended.

WORCESTER.—The Society of Arts of this city gave a *soirée* on the 26th of February. The great feature of attraction were the pictures selected by the Art-Union of Glasgow. M. De Peix Durtoux during the evening read a paper on Art, which was listened to with much attention.

THE ROYAL PICTURES,

GENEVÈVE OF BRABANT.

G. Wappers, Painter. J. C. Arncliffe, Engraver.
Size of the Picture, 24. by 16. 5/8 in.

BARON GUSTAVUS WAPPERS, an artist whose merits have procured him from his sovereign an honourable title, was, till recently, President of the Academy of Arts of Antwerp, in which city he was born in 1803. He was a pupil in the school of which he afterwards became the head. In 1821 and 1823, he contended, but on both occasions unsuccessfully, for the prize which would have sent him to study at Rome: being frustrated in his desire to become acquainted with the great masters of Italy, as they are seen in their own country, he applied himself assiduously, under the direction of M. Herreyens, to the study of those works which were within his immediate reach—the pictures of the Flemish painters, especially those by Rubens and Vandyke. Subsequently he went into Holland to look at Rembrandt, and to Paris for the purpose of seeing the Italian pictures in the Louvre. But the style of this artist inclines far more to the Dutch and Italian schools than to that of Italy.

In 1833 he exhibited at Antwerp a large picture, painted for the church of St. Michael at Louvain. The subject is "The Entombment." The composition of this work is fine, but the colouring is somewhat overdone, a fault pardonable in a young artist whose enthusiasm was not yet tempered by judgment. An incident in the last Belgian Revolution, "The Populace tearing down the Proclamation of Prince Frederick in the grand square of Brussels," gave him, in 1835, a subject of another large work, which, in all the essentials of good painting, showed a marked superiority over the preceding picture: while his exhibited production of the following year, "Charles I. taking leave of his Family," manifested a striking advance in the powers of the artist. "M. Wappers," wrote a foreign critic some years back, "has in this picture really shown himself a great poet: it is impossible to be more poetical, more profound, more noble, and more truthful at the same time. The canvas is a complete poem,—it is full of thoughts finely rendered."

We may mention among his other historical pictures, as especially entitled to honourable mention, his "Anne Boleyn;" "Charles IX. on the Eve of St. Bartholomew;" "The Massacre of the Protestants;" "Charles VII. and Agnes Sorel;" "Heloise and Abelard;" "Peter the Great at Saardam;" "Louis XI. witnessing a Fête-Champêtre;" "The Temptation of St. Anthony;" "The Defence of Rhodes against the Saracens by the Chevalier Fauleques de Villaret," painted in 1848, by order of Louis Philippe, for the Palace of Versailles; &c. &c. The portraits by Baron Wappers are not unworthy of the great master whom he has most studied to follow in this branch of Art—namely, Vandyke.

This picture of "Genevève of Brabant," painted in 1845, was, we have heard, a gift from the painter to Prince Albert, as a birth-day present to her Majesty. The subject is taken from an old Flemish legend, as popular in that country as the "Babes in the Wood," or any other, is in our own. Genevève, driven from her home, through a false accusation, while her husband, the Count of Brabant, is engaged in the Crusades, is forced to take refuge, with her infant, in a cavern, where a hind daily ministers to their sustenance. She is represented in the picture at the entrance of the grotto, which opens towards a forest; the child is resting in her lap, the hind at her feet. The cavern is illumined by the brightness of day, and the painter, in a happy mood, has concentrated the rays of light chiefly upon the child's face. By this his idea is sufficiently illustrated. Though Genevève's head is shaded, she does not look up painfully, nor does she appear as suffering from mental disquietude; her thoughts are with her child, who, blessed with health and infantine beauty, is her comfort and joy in these dark hours of her history.

The picture is in the collection at Windsor.

EXETER HALL

ON THE ELEVENTH OF MARCH.

THE great London world knows that, on the evening of the eleventh of March, Mr. and Madame Goldschmidt gave a concert at Exeter Hall, devoting the whole of the *receipts* to the NIGHTINGALE FUND. Some months have elapsed since this was determined on, and the manner of the "doing" has been worthy of the doers, and of the cause: the public saw the effect; but only those who were so fortunate as to be "behind the scenes" can thoroughly appreciate the sacrifice, the earnestness of purpose, the care and pains bestowed in "getting up" the concert. Indeed, the rehearsals were as well worth hearing as the concert itself—in some instances better: for Madame Goldschmidt did not hesitate to sing over and over again, not only passages but pages, when the accompaniments wanted perfecting; these repetitions were given with as much strength and expression as if the "public" were present; hour after hour passed away, but Mr. and Madame Goldschmidt remained with Mr. Benedict, labouring for the completeness of the whole.

The evening concert was also distinguished by another mark of this desire for perfection: not only did it present the mingled attractions of Beethoven, Mozart, Mendelssohn, Rossini, Weber, and Meyerbeer, but Mr. Goldschmidt had reserved the first performance of what may be called a miniature Oratorio of his own composition for the occasion; thus adding a decided novelty to the attractions of "the world's favourites."

Mr. Goldschmidt's reputation as a *pianist* has increased with every performance; the selection of his subjects is evidence of his school, and of his taste: but to thoroughly appreciate the tenderness and delicacy of this *artist's* pianoforte playing, he should be heard in a less spacious concert-room; for though his finger is sufficiently eloquent and powerful to fill Exeter Hall in the stronger parts, yet the ball is ill adapted for the conveyance of those delicate phrases—those soft and exquisite passages—which Otto Goldschmidt renders with such perfect sentiment—such marvellous depth and tenderness of feeling and expression.

Taking the 130th Psalm as his text, Mr. Goldschmidt's introduction was prayerful and fervent: the preface to a pleading and pathetic melody, "From the deep I cry unto thee, O Lord," which was exquisitely and truthfully rendered by Madame Goldschmidt; this was followed by a chorus, founded on Martin Luther's *Chorale*; then came a short interlude, preceding a delicious chorus of female voices:—

"See all the lilies clad in glory,
They labour not;
See all the birds that fly before thee,
They gather not;
Yet the Lord maintaineth them,
His mighty hand sustained them;
Say, art thou not more than the flowers he unfoldeth,
And more than the birds he upholdeth?"

The effect of this chorus was all that could be desired; and the applause was only partially subdued, despite the "time-honoured" custom of not applauding sacred music.

The duet between Madame Goldschmidt and Mr. Swift, which immediately followed, sustained the character of the composition; while the chorus for male voices that burst forth at its conclusion, freely expressed the hope and mercy which the words conveyed.

The *Arioso*, sung by Madame Goldschmidt, with obligato accompaniment on the clarinet by Mr. Lazarus, relieved the chorus, and was exquisitely given; we could have wished it prolonged; but the composer revels in multitudes of voices and instruments, perfectly acquainted with the power and extent of those he calls into action: all is commanded by a master's skill; each plays its own part towards the perfecting of the whole; and, if we felt the first chorus drag a little before its conclusion, the last left us positively nothing to desire but its repetition.

Without being professedly critical in things musical, we can bear ample testimony to the poetic conception and fulfilment of this varied



Faint, illegible text, possibly bleed-through from the reverse side of the page. The text is arranged in several columns and appears to be a formal document or letter.



J. C. ARMYTAGH

G. WAPPEL - ENGRAVER

GENEVIEVE OF BRABANT

FROM THE PICTURE IN THE MUSEUM OF THE UNIVERSITY OF BRUXELLES

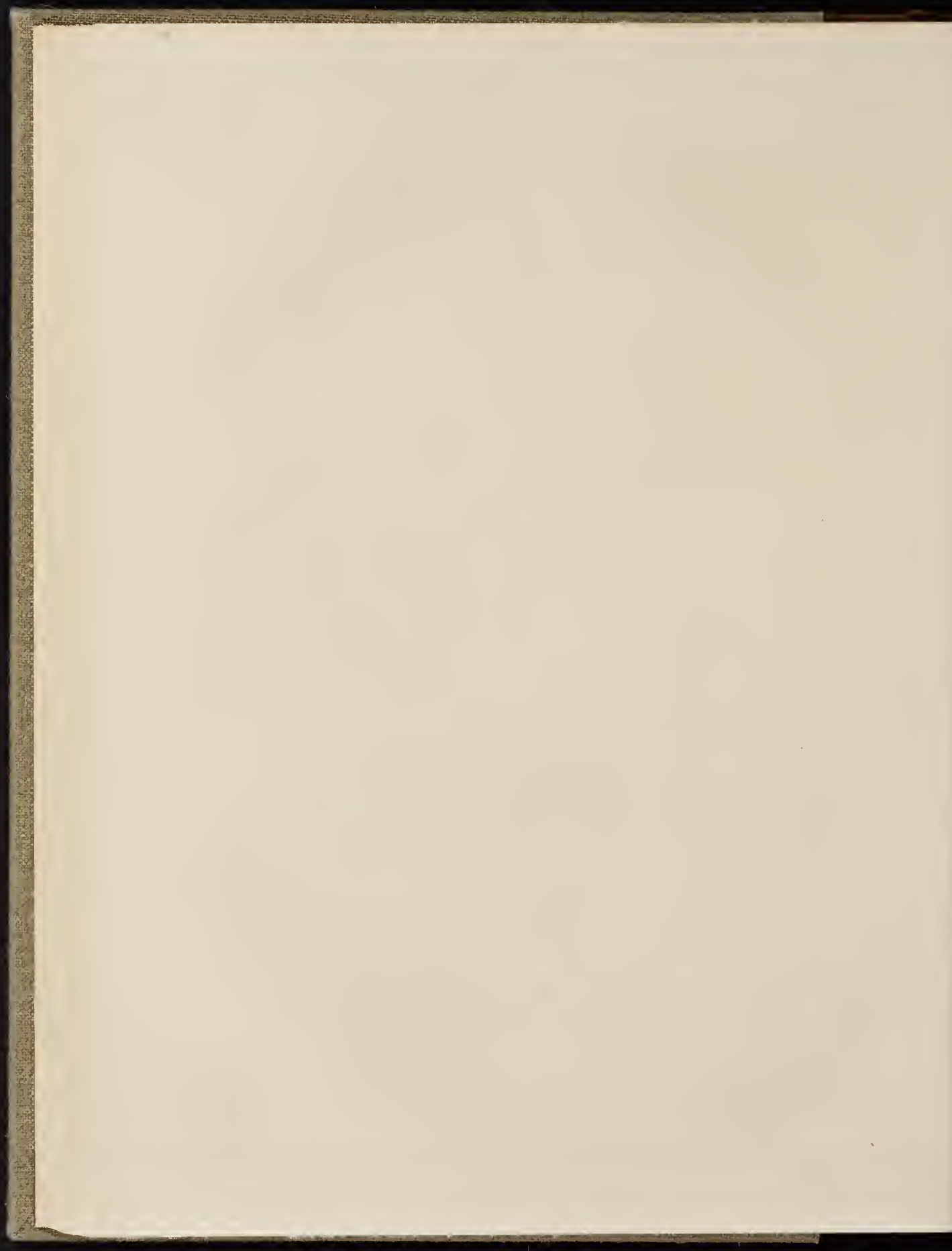

and beautiful composition; giving sound and voice first to the earnest prayer, then to the evidences of Almighty goodness; and, lastly, to the exulting triumph, springing from faith, in the "Great Shepherd." We have reason to rejoice that Mr. Goldschmidt has contributed so effectively to our store of sacred music; and to thank him for the graceful homage rendered to Miss Nightingale, by producing what was in itself so pure and holy for such an occasion.

Nothing could be more rich and varied than the first part of this unrivalled performance. The test of the musical standing of an audience is in their appreciation of instrumental music; "a song" hushes even the least initiated into silence; but it is only an educated and comprehending audience that are "hushed as the grave," when Beethoven and his compeers speak; England is still in its novitiate as a musical nation. Plying for a thing and appreciating it are two distinct matters; but the more we advance, the more thoroughly shall we comprehend the rendering of the compositions of the old masters, by the hands of such conscientious and faithful musicians as Mr. Otto Goldschmidt.

The second part of this deeply interesting concert was hailed by the most vigorous applause—the audience, freed from the restraint of custom, indulged their enthusiasm; all could wonder at and admire the miraculous vocalisation of Madame Goldschmidt in "Squallida veste e bruna;" it was a concert in itself, giving ample proof that while her voice has not lost a shadow of its eloquence and beauty, it has gained in strength, and even in extent. Her singing in the trio for a soprano and two flutes, has achieved popularity throughout Europe and America; and the concert wound up gloriously by the world-famous solo quartette and chorus "Alziam gli evviva," from Weber's "Euryantle."

Charming as was all—perfect of its kind—a leader of rare and varied accomplishments, unsurpassed artists and orchestra, a well-trained chorus, and a brilliant audience—there was a purpose about this concert more grand in its simplicity than anything that has hitherto been felt or known in England. A country gentlewoman, moved by the spirit of Samaritan Christianity to devote herself, while in the bloom of womanhood, to the alleviation of suffering and the amelioration of the necessities of the poor, trains her accomplished mind to the duties of a nurse. She seeks abroad the information which, to our shame be it spoken, she could not find at home, by the power of a mind which, seeing that its attributes are purely feminine, it would be an offence to call "masculine." She saw, combined, considered—and, freighted with her slowly but surely developed purpose, she returned, not to the ease and luxury of her beautiful home, to visit the sick in "silken shew," and talk over her "experience" in "county families," but to alleviate the sufferings of the "poor gentlewoman," in an asylum which she undertook to superintend, reorganise, and assist to support. This was all done without sound or parade—none had then heard the name which has since been hailed as the one unsullied glory of our war: there she watched and waited, not as a lady, but as a woman; never perhaps thinking of the gifts which were working out a destiny, the most glorious that ever fell to woman's lot. When the time of her country's struggle arrived, the path she considered duty wide and broad before her. Many devoted women desired to combine with her, and others followed in their wake. Mr. Sidney Herbert saw the bane and antidote,—to him we are indebted for appreciating Florence Nightingale when her name was hardly known in her new calling, beyond the refuge where she succoured and saved—he knew her purpose, knew her strength, knew that England could trust her. And she went with one or two friends, and a band of women—all prepared to devote themselves for the honour of their country and the good of mankind!

But all words concerning this admirable woman are now needless; the world feels, appreciates, and acknowledges the debt the world owes her; to the thousands who have derived health and life from her labours may be added

—in the prospect—the hundreds of thousands of the hereafter. It is a glory to have aided the future of such a woman, while recording homage and gratitude for the past.

But in the matter to which we now more immediately refer, there is something inexpressibly gratifying; Mr. and Madame Goldschmidt are foreigners; they cannot, either indirectly or directly, derive comfort or advantage from the Institution Miss Nightingale is to form—except in their large love of humanity, and their abounding desire to do good. Yet see what they have done for the Nightingale Fund! The concert realised a sum of no less than 1,872. 6s., that is to say, such was the sum paid by the attendance for Mr. and Madame Goldschmidt would permit no deduction on account of the necessary expenses; these expenses they paid themselves, and they exceeded in amount 560l. Had they contributed only this 560l., it would have been a noble contribution! As it is, it is without parallel: so grand and graceful a gift of homage from one woman to another has never been recorded.* Surely this great example must spread; surely there will not be a woman in the British dominions who will not—as far as her means permit her—"do likewise!"

A. M. H.

THE ARTISTS' GENERAL BENEVOLENT FUND.

This very valuable society had its anniversary festival on March 15. We have so often directed attention to its claims and merits, that our duty may now be discharged by simply recording its progress. Since its institution—so far back as the year 1814—it has relieved a large amount of suffering; and although it is, very properly, a principle not to publish the names of those who are relieved or assisted, we speak within our own knowledge when we say that among the "cases" are many of a deeply touching and highly interesting character. Our readers are aware that this society differs from "The Artists' Benevolent Fund," inasmuch as it is open to all applicants—artists, their widows and orphans, who are in difficulties or distress; while "The Artists' Fund"—an admirable institution—does not, and cannot, afford relief to any who are not of its subscribers. The dinner on the 11th was well attended; the President and eight or ten members of the Royal Academy being among the guests. Lord Stanley discharged the duties of chairman with remarkable felicity, and with considerable eloquence; he was ably supported by the Earl Stanhope, who made the very gratifying announcement that the sum acquired by the forthcoming "Life of Sir Robert Peel"—the production of which from the great and good statesman's papers had been entrusted to him and Mr. Cardwell—was by his directions to

* We print with much pleasure the following "acknowledgment," which has been circulated by the Committee:—

"THE NIGHTINGALE FUND.—5, Parliament Street, March 17, 1856.—The Committee of the Nightingale Fund have the gratification to announce, that they have received from Mr. and Madame Goldschmidt the magnificent contribution of 1,872. 6s., being the proceeds of the concert given by them at Exeter Hall, on Tuesday, the 14th of March.

"This amount is free of all deduction on account of the expenses of the concert, which have been entirely defrayed by Mr. and Madame Goldschmidt.

"The contribution is presented by Mr. and Madame Goldschmidt as a testimony of their warm interest in the purposes to which the fund is destined, and of their sympathy and admiration towards the lady whose name it bears."

"The Committee feel that any observations would be superfluous, but they cannot issue this announcement without expressing their belief that this act of Christian sympathy on the part of an accomplished foreign lady, marking her appreciation of the services of one of her own sex, and of the benevolent and useful purposes to which the fund is appropriated, cannot fail to call forth new and increased exertions on the part of all the countrywomen of Florence Nightingale.

"MONTAGUE, Chairman.
"SIDNEY HERBERT, } Secs.,
"S. C. HALL, }

be divided among several charitable institutions—of which the first hundred pounds was then and there presented to "The Artists' General Benevolent Fund." A scarcely less gratifying announcement was made in the Hall: two very beautiful engravings have been given to the society by Lord Yarborough; one of these, the far-famed "Wreck of the Minotaur," was exhibited in the room. This most liberal and valuable aid to the society was communicated by his lordship in a letter to the President of the Royal Academy, of which we are permitted to print a copy:—

MANSY HALL,
BRIDGE, Nov. 3, 1855.

DEAR SIR CHARLES,—

Some three years ago I presented to Mr. Charles Agar, of Manchester, the copyright of "The Wreck of the Minotaur," which he undertook to have engraved for general distribution.

Since then, circumstances have occurred which have induced me to make arrangements with him for the purchase of the engraved plate. In consideration of the benevolent object for which it is my intention to apply it, he kindly resigned any pecuniary advantage to be derived therefrom.

The position you occupy as President of the Artists' General Benevolent Institution, induces me to address you, to ask your assistance in enabling me to carry out to the fullest extent a scheme I have in view—viz., to assist deserving but distinguished artists, their widows and orphans.

With this object I propose to present to the Artists' General Benevolent Institution the copyright and two engraved steel plates from pictures in my own possession. The one, "The Wreck of the Minotaur," on the point of completion by Mr. T. O. Barlow; the other, "The Opening of the Vintage of Mâcon," which engraving the same gentleman has engaged to complete by the 10th of September, 1857. Both these pictures, as you are doubtless aware, were painted by the late J. M. W. Turner, R.A., and under the following circumstances.

My grandfather, with two other noblemen, subscribed a sum of money to enable Mr. Turner to travel, and take advantage of the opportunities then offered to artists to study the works of old masters. Whilst so travelling—I think about the beginning of this century—he painted the latter picture, styled "The Opening of the Vintage of Mâcon," of which a relative of mine wrote to me in 1851:—"Turner's own description, some thirty or forty years ago, was 'Between Chalons and Mâcon,' at that time it caused a great sensation." I believe that picture was painted about 1807, and then purchased by my grandfather. The other picture, "The Wreck of the Minotaur," was painted for my father, I believe, about the year 1811.

In the *Naval Chronicle*, at vol. xxv., page 56, a description of the wreck is given.

I therefore present to the above-named Institution the copyright and engraved steel-plates of these valued works of Art, to induce other proprietors of valuable pictures to follow my example, by which I am inclined to hope substantial means of affording relief to distressed artists may be forthcoming, and at the same time an encouragement given to artists to produce works of sufficient importance to secure their being handed down to posterity; and, let me observe, that whilst the proprietors of such pictures may be supplying themselves with another work of Art in the shape of an engraving, those prized pictures may at the same time encourage a charity in every way deserving of support.

I must ask you to be so good as to frame, with the assistance of the council, the most desirable mode of securing to the Institution the largest amount of money, which the possession of these plates may enable them to add to its funds.

You will, perhaps, allow me to observe, when I consider the circumstance of the late Mr. Turner having been a zealous and anxious supporter of your Institution, the possession of these plates by it is rendered very appropriate.

Believe me,
Dear Sir Charles Eastlake,
Yours faithfully,
YARBOROUGH.

MINOR TOPICS OF THE MONTH.

THE MODELS FOR SIX NEW STATUES to illustrate the creations of the poets of Great Britain, have been selected by the London City authorities, and the six commissions finally given. Mr. Baily undertakes another Miltonic figure, "The Spirit of the Woods;" Mr. Wyon a statue of "Britomart," from Spenser's "Faery Queen;" Mr. Theed, a figure of Gray's "Bard;" Mr. Durham, a statue of Hermione, in the "Winter's Tale;" Mr. Weekes, a figure of Sardanapalus, from Byron's tragedy; and Mr. Foley, a statue of Caractacus. These works are to be executed in marble; and for each the City is to pay the sum of 700*l.* The height of each is to be six feet. We have repeatedly expressed the exceeding satisfaction the public will feel at this encouragement of Art, on the part of the magnates of "Great London." We are not quite sure that wisdom has been exercised in permitting to the sculptors the choice of subject: they are, as will be seen, so varied in style and character, that all harmony is sacrificed. This may not be a disadvantage if they are to be placed in separate and distinct apartments; but it will be a serious evil if they are all to occupy the Egyptian Hall.

THE NATIONAL GALLERY.—Mr. Coningham, we fear, will never rest satisfied with any acquisition the National Gallery receives till he is consulted previously to its purchase: it is a great pity the trustees do not remove Sir Charles Eastlake, and substitute Mr. Coningham in his room; they will then, probably, be permitted to hold office in quietude. This gentleman has recently addressed a letter to the *Times*, asserting that the new purchase, "The Adoration of the Magi," by Paul Veronese, is absolutely worth nothing! We dare say if it fell into the hands of one of the itinerant picture-dealers who traverse the country, something would be made of it; at least, a few years ago this would have certainly been done. We are not prepared to say the picture is worth 20,000*l.*, about the sum which, it is stated, was paid for it; but surely the President of the Royal Academy, who is also Director of the National Gallery, and Mr. Wornum, the Secretary, who also, we presume, had a voice in the purchase, are as capable of forming an opinion on the originality and the value of a picture by an old master as Mr. Coningham: for ourselves, we have far less confidence in his judgment, even were he of less querulous disposition, than in that of the Director and the Secretary.

COPYRIGHT IN PICTURES.—The Royal Academy, it would seem, is about to stir itself in the long vexed question of Copyright in Pictures, a meeting of the Council having been held on the evening of March 14th, to consider the best method of procedure. Such a movement it is right should emanate from such a body, and if properly managed, as there is every reason to believe it will be, must result in a manner satisfactory to the artists and the public. At present neither the one nor the other know what are their rightful claims.

COVENT GARDEN THEATRE.—The destruction by fire of this fine edifice on the morning of the 4th of March must be a matter of sincere regret to every lover of dramatic and lyric art, and scarcely less to the admirers of what more strictly belongs to the Fine Arts. In the almost universal conflagration, the magnificent scenery painted by Messrs. Grieco & Telbin during a course of many years for the various operas, pantomimes, and dramatic representations which were performed within its walls, is involved: of this description of Art-work it is not too much to say that they have never been surpassed in this or any other country, the talents of these artists having brought scene-painting to the highest point of excellence. The four pictures by Hogarth, representing the "Seasons," which hung upon the walls in the private room of the lessee, are also destroyed, besides an immense quantity of fine ancient armour, costumes of infinite variety, and "properties" of every kind, all of which served to make up the living pictures that have proved sources of rational enjoyment to thousands. But the ruins make a pic-

torial "subject" which would be worth looking at by some of our architectural painters; standing among them, one may, without any vast stretch of imagination, fancy himself among the relics of some old Roman edifice. The building itself was not without considerable attractions as an architectural work: it was erected, in 1809, from the design of Sir Robert Smirke, R.A., and the portico, which formed the principal feature externally, was always greatly admired; the sculptured bas-reliefs, and the statues of "Tragedy" and "Comedy" which also decorated the front, were executed by Flaxman. The theatre had frequently been used for purposes unworthy of its original object, and of the names—the Siddons and the Kembles—so long associated with its glories; and we cannot help lamenting it has fallen a victim to one of the most senseless and demoralising exhibitions that was ever contrived to pass away hours devoted to relaxation: we have often wondered that a sober-minded people, like the English, could tolerate the absurdities—to add nothing more—of a *bat masque*.

THE ROYAL INSTITUTE OF ARCHITECTS.—The *Builder* announces that at a special general meeting of the Institute, held on Monday evening, February 18th, the Royal Gold Medal was unanimously awarded, subject to her Majesty's gracious approval, to Wm. Tite, Fellow, F.R.S., M.P. The Soane Medallion was awarded to Mr. Leonard R. Roberts, of Sackville Street, Piccadilly, for his design for a town mansion. A Medal of Merit was awarded to Mr. Thomas C. Sorby, of Guildford Street, Russell Square, for his design for Law Courts. A Medal of Merit to Mr. James Blake, of Handsworth, Birmingham, for his design for a town mansion. And the Silver Medal of the Institute to Mr. T. A. Britton, of Camden Town, for an essay on "The Timber-Growing Countries of Europe and America."

THE PROPOSED NEW NATIONAL GALLERY.—There seems to be some movement afoot relative to a new National Gallery, for Prince Albert, attended by Sir W. Cubitt and Mr. Edgar Bowring, recently paid a visit to the ground at Kensington Gore, purchased some time since by the Royal Commission: we shall wait anxiously to know what is contemplated.

TURNER'S BEQUEST.—TRIMMER v. DANBY.—This case, which has been adjourned from time to time, to settle the terms of compromise between the Crown and the next of kin and heir-at-law of the testator, has at last been brought to a termination by the sanction of the Vice-Chancellor. The result, so far as the public is concerned, is that all pictures, finished and unfinished, sketches and drawings (except engravings), are to go to the Trustees of the National Gallery—that is, all works by the hand of Mr. Turner, the selection to be committed to Sir C. L. Eastlake, President of the Academy, and Mr. Knight, R.A., the Secretary. The engravings and other drawings (we do not quite understand what these "other drawings" can be) to be delivered to the next of kin: the trustees of the Royal Academy to be entitled to 20,000*l.* free of legacy duty. There thus seems to be no chance of the "Artists' Almshouse."

MADMOISELLE ROSA BONHEUR's fine picture of "The Horse Fair," engraving for Mr. Gambart, is at present being exhibited at the Royal Institution, Manchester, under the care of Messrs. Agnew & Sons. Mr. Thomas Landseer is working most assiduously on the plate, which he hopes to have completed by the end of the year; it is of large dimensions. We have had an opportunity of examining an etching proof; it is, certainly, the work of a master; Mr. Landseer has caught the true spirit of the artist in the drawing and character of the animals, and if the plate is finished as it has been commenced, of which there is no doubt, it will, we expect, be the *chef d'œuvre* of the engraver.

GREENWICH HOSPITAL.—A stained glass window of large dimensions, about twenty-five feet in height, has recently been placed in the eastern end of the Painted Hall of Greenwich Hospital. It was executed from the designs, and under the superintendence, of Mr. Burchett, headmaster of the School of the Department of Science and Art, at Marlborough House. The principal decorations consist of our national

armorial bearings, surrounded by naval emblems and other ornaments: the whole has a rich effect, adding materially to the beauty of this noble apartment.

PICTURES AT THE CRYSTAL PALACE.—It is announced that a collection of paintings will be exhibited at the Crystal Palace during the summer, such pictures to be gathered not only from England, but from the various countries of the continent. Such a scheme might possibly have succeeded a year or two ago, but it cannot be concealed that the palace at Sydenham has lost its *prestige*, and it is not likely that artists of rank and merit will be disposed to place their pictures there—even if they have them to place, which is improbable. The project is to exhibit them "for sale," and this may tempt dealers to consider the Crystal Palace a convenient store-house; further than this we do not expect it to be; but while we view the affair with doubt approaching suspicion, it will be our duty to aid if we find the performance better than the promise.

THE PEACE CONFERENCE.—Mr. Gambart, the publisher, of Berners Street, has, it is said, given a commission to M. Dufaye, to paint a picture of the plenipotentiaries assembled in Paris to settle the question of peace: how the artist is to make his sketch "from the life" we know not, if the apartment in which the conferences are held is so hermetically sealed up against spectators and hearers as it is reported to be. M. Dufaye is a pupil of Paul Delarocche, and is to have 1200*l.* for his picture, which will be brought to England to be engraved.

THE OLD CHURCH under the Guildhall of London is, we hear, about to be converted into a *kitchen*, where turtle and venison will be dished up for future civic entertainments: Mr. Banning has been requested to procure estimates for the necessary cooking apparatus. Is there so little reverence for antiquities among the civic authorities that this crypt, one of the finest specimens of early English architecture that the city can boast, must be sacrificed at the shrines of Mrs. Glass, Mrs. Dalgarin, and M. Soyer?

THE HAMPSHIRE CONVERSAZIONE held a meeting on the 11th of March; the members and their friends assembling in considerable force. The principal Art-contributions were a large number of landscape sketches in oil, by Mr. J. W. Oakes, and in water-colour by Mr. W. L. Leitch; of churches by Mr. H. J. Johnson; Mr. E. Armitage's original sketches of the "Battle of Inkermann," and the "Charge at Balaklava," for the two large pictures now exhibiting in Pall Mall; sketches in the Crimea, by Mr. M. Halliday, an amateur artist; Mr. Cockerell, R.A., sent his ingenious and clever drawing of the "Professor's Dream," a comparative view of all the great buildings of the world; and his son, Mr. F. P. Cockerell, contributed several architectural drawings, chiefly of churches in Paris, Rome, &c. Other objects were collected in the apartment to aid in the evening's amusement; china, majolica ware, and weapons of war taken in the Crimean campaign.

PANORAMA OF SEBASTOPOL.—From the time of the elder Barker to the present, the wars in which England has been engaged have formed many of the most interesting and popular exhibitions in the building so long devoted to panoramic representations in Leicester Square; this is not to be wondered at if we recollect how wide an interest is created by the stern realities of war, even though we know them only through the aid of the artist's pencil. Mr. Burford, the worthy successor of the younger Barker, has recently opened to the public a "View of the City of Sebastopol, the Assaults on the Malakhoff and the Redan, the Retreat of the Russians to the North Side of the Harbour," &c., the whole constituting a most perfect and truthful representation of the final terrible struggle for this stronghold of Russian power in the Crimea. The panorama is painted from sketches taken by Captain Verschoyle, of the *Greaudier* Guards, aided by photographic views, which give to the work a truthfulness it would have been quite impossible to reach by any other means. The whole scene lies stretched out before the eye of the spectator—who is presumed to be standing on one of the outworks of the Malakhoff—in all its terrible vividness: we see the brilliant and

successful attacks of the French on this almost impregnable position, our own not less gallant but unfortunate attempt to storm the Redan, the long lines of trenches intersecting the surrounding country like a net-work, the town of Sebastopol riven and shattered by the long-continued and heavy fire of the besiegers, the suburb of the Karabelnaia, a perfect scene of ruin and desolation—everything, in fact, not only painted with the skill of a true artist, but, as was remarked by a visitor who had been present throughout the whole campaign, with "marvellous fidelity." We trust the day is very far distant when such another subject—one in its vastness, its terrific and awful grandeur, can scarcely, however, occur again—will engage the pencil of Mr. Burford and his able assistant, Mr. Selous. We scarcely need to recommend a visit to it, but we can heartily do so. By the way, would it not be possible to open the exhibition in the evening? There are thousands who would gladly avail themselves of such an opportunity, whose occupations afford them no other; we throw out the hint for Mr. Burford's consideration.

STUMPS FOR CRAYON DRAWING.—We have received from Messrs. Houghton & Co. specimens of stumps applicable to crayon drawings of every kind; they seem to possess qualities as good as the stumps which are supplied to this country by manufacturers of France, who have hitherto enjoyed almost a monopoly in England of this useful article. The leather stamp of Messrs. Houghton is very solid, and shows none of the interstices which so much annoy artists by producing double lines in ridges, and it possesses that great desideratum, a firm and solid point. The paper stump manufactured by them is made of the best white blotting-paper, which, by the aid of machinery, is rolled into a solid and correct form, pleasant to work with. The pulpy nature of the material gives to it a beautiful softness of surface unattainable by the hard paper in general use. There is also a stump which the makers call the "Cartoon Stump," it will be found very useful from the peculiarity of its shape; the flat end being adapted for rubbing in foregrounds, and for model-drawing. These stumps may be procured from any of the principal artists' colourmen in London.

EVANS'S HOTEL.—Artistic improvements in our places of public resort are of so uncommon a kind, that we feel bound to devote a few words to a supper-room recently constructed at the back of Evans's Hotel, Covent Garden, and which may be considered one of the most elegant rooms in London; its proportions are magnificent, and its style of decoration sufficiently classic, without that sombre look too frequently assumes. Its architect is Mr. Finch Hill, and he has judiciously availed himself of hidden lights above the architrave to give lightness to his ceiling; while it aids the uses to which the room is devoted. A very few years ago it would have been impossible to have alluded to this improvement at all; but to the present proprietor, Mr. Green, is due the honour of having elevated the moral tone of its amusements, and made them unobjectionable. This is no small honour, whose profit was gained by the reverse nightly; and it required some moral courage to abandon the course altogether, as well as courage of another kind to hazard so much in the construction of this really beautiful room. It is a wholesome proof, however, of improved public taste, to find increased patronage rewarding him.

THE PORTRAIT OF THE DUKE OF RUTLAND, painted by Mr. F. Grant, R.A., has just been presented to his Grace, by a donation of his tenantry, at whose cost it was executed. The Duke is represented in a sitting position; the likeness is pronounced excellent.

THE BRITISH MUSEUM.—Mr. Panizzi has been appointed Principal Librarian to the British Museum, in the place of Sir Henry Ellis, who has recently resigned the post, after occupying it for more than half a century.

THE GRAPHIC SOCIETY had another meeting on the 12th of last month: what was to be seen on the occasion we know only from hearsay, and do not choose to report on second-hand authority.

REVIEWS.

THE FIRST-BORN. Engraved by T. VERNON, from the picture by C. W. COPE, R.A. **THE VILLA FOUNTAIN.** Engraved by W. FORREST, from the picture by W. L. LEITCH. Published by the Art-Union of Glasgow.

These two charming prints are intended for the subscribers of the present year, to the Art-Union of Glasgow, and a more acceptable presentation they could scarcely desire to receive. In lieu of giving an engraving of very large dimensions, such as the "Return from Deer Stalking," and "Coming of Age," of former years, the committee have this year determined upon issuing two of a smaller size, yet of sufficient importance to hang on a wall: in this we think they have acted most judiciously, as in many instances the cost of framing large prints is a matter of consideration, and where it is not it is always convenient and agreeable to have variety, both of size and subject. But, we believe the principal reason of this departure from the usual course is, to avoid any unnecessary delay in the delivery of the prints—a delay that the working of a large plate would unavoidably have entailed. Mr. Cope's picture is one of his works exhibited at the Royal Academy within the last two or three years; it represents a young wife and her husband, most picturesquely grouped and attired, bending over the couch of their "first-born," who lies sleeping, and in a state of half nudity, its round fleshy limbs giving strong evidence of health and vigour: the boy will make a stalwart man if his life is preserved, and a handsome one, too. This, the lower part of the picture, as Mr. Vernon has translated it, deserves especial commendation: the whole is very good, but there is a delicacy and softness in the flesh of the child, and in the coverlet of the couch, we have rarely or never seen excelled; the lines show a masterly power of cutting, united with great tenderness. Mr. Vernon, whose engravings must be well known to our readers, will certainly add greatly to his reputation by this work. The upper half of the composition, which takes in the parents and the heavy foldings of a curtain, contrasts somewhat unfavourably with the lightness and elegance of the lower part; it is almost entirely in shadow, the weight of which well-nigh overpowers the rest; we think this might have been obviated by throwing a little more reflected light on the face of the mother, and on the right arm and shoulder of the male figure; although the light in the picture falls the other way, such a liberty, with the artist's treatment, might have been taken without injury to his composition, while it would certainly have much improved the engraving, by leading the eye gradually from the highest lights to the deepest shadows, and preserving a more equitable balance between the two. Yet as the work now stands it is a print to be coveted.

The "Villa Fountain" is from a very beautiful landscape composition by Mr. Leitch, whose imaginary Italian scenes are most poetically conceived and artistically painted: this picture shows pre-eminently his skill in designing and arranging Roman architecture in the midst of the most delicious landscape. We have in the picture before us, temple and palace, gateway, and bridges on lofty arches, not quite as they might be supposed to have been left by the original builders, but more or less spoiled by the hand of time; shrubs partially hide, and noble trees overshadow, the beautiful remains of Roman grandeur. In the foreground is a terrace, on which are numerous female figures engaged in fetching water from the "fountain" flowing through a kind of gateway below: the middle distance is occupied by a pile of buildings leading from a bridge that spans a narrow stream, which is seen winding its way through a long tract of country interspersed with villas and half-ruined edifices. It is paying Mr. Leitch no higher compliment than he deserves, to say his picture forcibly reminds us of some of Turner's best compositions of similar materials. The engraver, Mr. Forrest, has ably done his part to make the print popular; he appears to have caught the painter's feeling throughout, and to have translated the work with great ability: there is a richness and a fulness in his style that tell most effectively, while at the same time he has not lost sight of the delicacy of handling which marks the highly-finished engraving. There is, however, one passage in the work to which we should have drawn his attention had we seen a proof before printing. The aqueduct in the middle distance, and the masses of trees immediately below should have been a little lighter—as they now stand they come too forward, and give an appearance of heaviness to that portion of the engraving: the printer might have obviated this by careful "wiping out."

WHAT IS PRE-RAPHAELITISM? By JOHN BALLANTYNE, A.R.S.A. Published by W. BLACKWOOD & SONS, Edinburgh and London.

After reading this pamphlet through very attentively, we do not seem to have arrived at any satisfactory solution of the question indicated in the title: Mr. Ballantyne writes sensibly upon certain characteristics of Art, but he has not answered his own query; we object only to the title given to his work, for he rather explains what Pre-Raphaelitism is not, than what it is. Assuming Mr. Ruskin's definition to be correct, that it is "the close study and imitation of nature," Mr. Ballantyne would class Wilkie, Mulready, and others with the Pre-Raphaelites, except for the absence of those peculiarities in which the latter indulge; and he is perfectly right in doing so. There is no doubt that the painters anterior to Raphael studied nature closely, but their ignorance of the other essentials of a true and graceful representation of what is natural, renders their pictures the very reverse of agreeable, and far more of what is beautiful: they wanted, in fact, the science of Art to aid them to interpret aright what nature revealed to them. We may well doubt whether Cimabue, Giotto, Masaccio, Francia, Perugino, and other predecessors of Raphael would have painted as they did, if they had been born after the great master instead of before him; they would have been the first to recognise and imitate his truth, elegance, and beauty. Mr. Ballantyne has a thrust, a very gentle one, however, at Mr. Ruskin, for his advocacy of the claims of their modern followers, who, we are glad to find, are fast turning from the errors of their ways into a more rational and living style. Mr. Ballantyne's pamphlet is worth perusal, as a dissertation upon true and false styles.

THE LANGUAGE OF THE EYE: THE IMPORTANCE AND DIGNITY OF THE EYE AS INDICATIVE OF GENERAL CHARACTER, FEMALE BEAUTY, AND MAJESTY. By JOSEPH TURNLEY. With Illustrations by GILBERT ANSLAY, &c. Published by PARTRIDGE & Co., London.

We have always regarded the loss of sight the greatest calamity that can befall an individual, next to the loss of reason; not only because the deprivation of this sense shuts out from him the enjoyment of all that is beautiful to the eye, and to the mind through that organ, but because he himself appears to all the world as one whose lamp of intelligence is extinguished, and he walks among his fellows a man on whom a very heavy portion of the primeval curse has fallen, in that he has lost the light of life. How often, when regarding such an object, have we desired the godlike power—

"From the thick film to purge the visual ray,
And on the sightless eyeball pour the day."

True is it that the loss of sight has mercifully been supplied, in some degree, by extraordinary acuteness of perception in the use of other faculties; and the face of the blind is often expressive of the highest mental qualities belonging to our nature; yet, in every such case, there is still wanting that radiance which is necessary to illumine outwardly the understanding, just as we require the beams of the sun to light up, in all their beauty and infinite variety, the tints and colours of the landscape and the flower.

The language of the eye! what poet has not sung, who among all living creatures has not felt, its power, and its eloquence—more stirring than any words uttered by the lips of man? The eye, says Mr. Turnley, speaking of it as the inlet of thought to the brain, "is, of all the senses, the most reflective and powerful: by its rapid agencies man principally acts and thinks; and through its channels pass influences more numerous than the sands of the sea-shore,—influences which are as sparks of eternal light amidst kindred glories. By the aid of this acute sense, man is enabled to act amidst the social throng with order and excellence; through its agencies, his imagination is captivated, his affections secured, and an irresistible and seductive influence consummated over his will, his judgment, and every attribute of his nature." And while the eye acts so as to assist materially in forming the character of the man, it is also a medium of developing that character to his associates, as well as the feelings by which he is at all times influenced: love, anger, joy, grief, pity, contempt, all the good and all the evil passions of his heart, shine through that mysterious organ, and proclaim what is passing within him as clearly as if the words were written on his forehead with a pen of fire.

Mr. Turnley is happy in the subject he has selected for a book, and he has treated it happily, handling it scientifically and philosophically, as

well as poetically. He has divided it into chapters, the first half of which speaks of the subject generally, the last half of particular characteristics—Genius, Hope, Innocence, &c. &c. His style of writing is good, except where now and then it becomes a little inflated—an offence that one may readily pardon, considering the topics to which his subject necessarily leads him at times. We have read his volume with much pleasure, but wish the whole of the illustrations, from the frontispiece to the last, were away; the former evidences had taste in a living author, the rest are neither ornamental to the book, nor aids to the understanding of its contents.

CHOICE FRUIT, after the Picture by G. LANCE: PARIS FROM THE POST OFFICE, after the Picture by T. S. BOYS. Printed in colours, and published by M. & N. HANHAUT, London.

A noble melon, grapes of prodigious size and quality, as it would seem, bunches of red currants, plums, &c., a lot of interesting—Mr. Lance's matting is imperishable, it never wears out—are the materials of this chromo-lithographic picture: it is a large print, all the fruit being of its natural size, and it comes as near to the original as we think, any colour-printing of such a subject can approach: the tints are rich and glowing, and the painter's touches are well copied; but we miss the transparency Mr. Lance gives to his fruit; this, in the grapes and currants, is especially lacking, nor do we think the art of Mr. Hanhart, or any other printer, can produce it; and, therefore, pictures of this nature are not so well adapted to exhibit the merits of chromo-lithography as are landscapes and figures.

The view of Paris is almost all that can be desired. The picture has evidently been painted in a low tone, but it is very life-like: we object, however, to the strong shadow thrown over the terminating end of the Louvre; it is far too heavy, and looks a blot on the print. In nature, a shadow so cast could only be accidental, and, therefore, would not be so intense, particularly at such a distance from the point of sight; had it fallen from any object in close proximity to the building, it would still be too dark: we presume the fault here rests with the painter rather than the copyist.

PHOTOGRAPHS TAKEN, UNDER THE PATRONAGE OF HER MAJESTY, BY ROGER FENTON, ESQ. Published by AGNEW & SOXES, Manchester.

The large number of photographic pictures taken by Mr. Fenton in the Crimea last year, formed for some months one of the most attractive exhibitions in the metropolis; these photographs were taken expressly for publication, and the first part has now appeared, containing two subjects from each of the several divisions, portraits, incidents, and landscapes. A work of this character is almost beyond the criticism of the reviewer; he has not to comment upon the art of the painter nor the skill of the engraver; nature, aided by the scientific talents of the photographer, does the work of both, and in this case the work has been done well. It seems almost unnecessary to recommend a publication to which so universal an interest is attached, for there is little doubt of its finding the patronage to which it is entitled, both as regards the nature of the subject and the beauty of the sun-pictures.

THE DISTURBER DETECTED. Engraved by W. T. DAVEY, from the Picture by G. CRUIKSHANK. Published by T. MACLEAN, London.

From Mr. Cruikshank's pencil we always expect to see something diverting, or some lesson of sound morality, and we are rarely disappointed. The "Disturber Detected" is of the former class, and, if we are not mistaken, is the first engraving from any oil-picture by this artist. The scene is the interior of a country church: seated in the front of the pews is the beadle—of the veritable Bumble species—at whose right hand is a group of village children, one of whom, an ill-favoured looking boy in a round frock, has let fall on the stone flooring a peg-top, to the disturbance of the whole congregation: the beadle is horrified, the squire casts a side-glance over the corner of his eye at the offender, the squire's family are all on the *qui vive*, the quaint nose-pener, whose head appears above the back of the pew, is shocked; the culprit is looking at the beadle as if anticipating the application of his official stick, while the companions of the boy regard him with various expressions, according to the ideas they entertain of the farce or fun of the disturbance. There is one lad quite a study; a "good" boy, whose eyes are

fixed on the preacher, and who would have him believe that he never brought a top to church in his life. The engraving makes little pretensions to a work of Art, strictly so called, but it has in it an abundance of amusing character, and, as a cheap print, will find many desirous of possessing it.

THE ART OF PAINTING AND DRAWING IN COLOURED CRAYONS. By HENRY MURRAY. Published by WINSOR & NEWTON, London.

Messrs. Winsor & Newton have published a number of Handbooks, including almost every subject that comes within the domain of the Fine Arts, but the series would not be completed had they omitted to furnish a guide to the art of crayon painting, or pastel-painting, as it is now more generally called. This very pleasing method of producing pictures has been brought to great perfection by Mr. Bright, the landscape-painter; in figures, however, it has been but little practised in this country, though to a considerable extent in France. Mr. Murray's little treatise explains the best method of working the crayons, and preparing the various materials necessary for practising the art; the directions are concise but intelligible, and we should think, amply sufficient for the purpose of the learner. An art so comparatively easy of execution, and producing such pleasing results in the hands of a moderate proficient, ought to find many desirous of practising it: to such we would strongly recommend Mr. Murray's little book.

THE ART OF FLOWER-PAINTING. By MRS. WILLIAM DUFFIELD. With twelve Illustrations on Wood, engraved by DALZIEL. Published by WINSOR & NEWTON.

Another of Messrs. Winsor & Newton's Handbooks, Mrs. Duffield takes rank among our most accomplished flower-painters, and therefore may be regarded as an authority when she inculcates precepts having reference to an art which she practises so successfully. Her book professes to be nothing more than an elementary treatise in which instructions are submitted to the learner for painting a few flowers singly, with some general remarks as to grouping. So far as teaching without the aid of a master can be made effectual, the remarks of Mrs. Duffield will answer their proposed end.

PHOTOGRAPHIC VIEWS OF SEBASTOPOL, TAKEN IMMEDIATELY AFTER THE RETREAT OF THE RUSSIANS, SEPT. 8, 1855. By G. SHAW LEFEVRE. Published by J. HOGARTH, London.

Mr. Shaw Lefevre is an amateur photographer, who paid a visit to the Crimea in the autumn of last year, and has now published, at his own expense, a series of twelve photographic views; the profits arising from the sale of the work he purposes most appropriately to devote to the "Nightingale Fund." The series of pictures includes many of the most interesting points in Sebastopol and its immediate vicinity:—"The Glacis of the Redan from the Curtain of the Malakoff," "View of the Redan, looking towards the Great Ravine," "Cannonade Battery—Sappers looking for Electric Wires," "View of the Russian Batteries behind the Redan," "The General's Bunk in the Redan," "Street in the Karabelnaia," "Luterior of the White Tower in the Malakoff," "The 'Leander' at the entrance of Balaklava Harbour," &c. &c. The whole of these views are given with much clearness, and must afford a very faithful idea of the devastation and the bustle entailed by war. The name of the artist is deservedly honoured—near and far; and the younger branch of a renowned family upholds its high repute: there is something peculiarly gratifying in his thus giving to the world the results of his adventurous travel; and dedicating the fruits to the most interesting and important purpose that modern times have developed for the benefit of the age.

"I'M A-THINKING." Engraved by F. BAÇON from Drawing by F. W. TOPKAM. Published by ACKERMANN & Co., London.

The subject of this pretty little print is, we should think, a study from nature: a child, with a remarkably intelligent and pleasing face, has let the book she is reading drop on her lap, and, with her finger to her lip, seems meditating on something she has found in the volume she cannot quite understand. It is just one of those subjects which will enforce popularity through its simplicity, truth, and agreeable expression. The engraving, in a mixed style of line and mezzotint, is carefully executed by Mr. Bacon.

MISCELLANEA GRAPHICA: A COLLECTION OF ANCIENT MEDIEVAL AND RENAISSANCE ILLUSTRATIONS, IN THE POSSESSION OF THE LORD LONDONDOROUGH. Illustrated by F. W. FAIRHOLT, F.S.A. Part VIII. Published by CHAPMAN & HALL, London.

This very beautiful—and, to certain classes of Art-manufacturers, very useful—work, continues to make its appearance at intervals consistent with the careful execution of the plates. The first sheet in Part VIII. contains coloured fac-similes of Merovingian brooches, all of them of gold, or silver-gilt, inlaid with precious stones, and, in one or two instances, enriched with filigree ornaments. The second plate contains an engraving, very highly finished, of the miraculous bell of St. Muran, which, according to the Irish legend, is said to have descended from heaven, ringing loudly; "but as it approached the concourse of persons who had assembled at the miraculous warning, the tongue detached itself, and returned towards the skies; hence it was concluded that the bell was never to be profaned by sounding on earth, but was to be kept for purposes more holy and beneficial. This is said to have happened on the spot where once stood the famous Abbey of Fohan, near Innishowen, County Donegal, founded in the seventh century by St. Muran, or Muranus, during the reign of Abobh Slaine." The bell was for several centuries in the Abbey, and was used as a depository of various objects, held in especial veneration by the people: it ultimately fell into the possession of a poor peasant, residing in Innishowen, who sold it to Mr. Brown, of Ballyvaughan, from whom it was purchased by Lord Londondorough in 1855, for 80*l.* Its form is quadrangular, standing about six inches high. It is of bronze, ornamented with a tracery of Runic knots; over the surface plates of silver had been laid, at a subsequent period, as Mr. Fairholt thinks: these plates are embossed "in the style known to have prevailed in the eleventh century." The centre is adorned with a large crystal, and smaller gems have once been set in other vacant sockets round it; only one of amber now remains." The entire ornamentation of this antique relic is very similar to that which is found on the old Irish crosses.

The next plate contains five representations of ancient iron-locks, all of them richly chased and carved; one of these weapons, a "wheel-lock gun," was originally the property of Charles IX. of France; "it is traditionally reported to have been the gun he used in firing on his Huguenot subjects during the Massacre of St. Bartholomew." The last plate introduces some Roman bronzes, one of which, an archer, was found by Mr. Charles Smith, in Queen's Street, Cheapside, in July, 1842, while some excavations were being carried on there. The Roman plough is a singular example of Art-manufacture, and the Lamp is very elegant; the latter bears the Christian monogram on its side.

ECCLESIASTES, OR THE PREACHER. By the Rev. A. A. MORGAN, M.A. Published by T. BOWORTH, London.

We can best describe the nature of this handsomely "got up" volume, by quoting its lengthy title:—"The Book of Solomon, called Ecclesiastes, or the Preacher, metrically paraphrased, and accompanied with an Analysis of the Argument: being a Translation of the Original Hebrew, according to the Interpretation of the Rabbinic Commentary of Mendelssohn, the Criticisms of Preston, and other Annotators. The subject newly arranged, with analytical headings to the sections." As an illustrated book, embellished with large woodcuts from some charming drawings by Mr. George Thomas, it calls for our notice rather than as an attempt to verify the "sayings of the Wise Man." As we hope, however, to introduce specimens of these illustrations into a future number, we reserve what we have to say, both as to text and the engravings.

A DICTIONARY OF GREEK AND ROMAN GEOGRAPHY. Edited by WM. SMITH, LL.D. Part XIII. Published by WALTON & MABELLY, London.

Dr. Smith's unwearying labours for many years in the cause of classical science are too well known and too highly appreciated to need any enforcement here. The dictionaries he has already completed are among the few books produced in our own day of fine literature that take rank with those which have received the award of scholars in past time. Sound as authorities, and scrupulously laborious as compilations, embracing the fruits of the latest researches in scholarship, this new addition will be welcomed beside its fellows. It is intended to be completed this year, and will be an indispensable guide to the student of classical topography.

THE ART-JOURNAL.



LONDON, MAY 1, 1856.

THE MINSTRELS OF THE MIDDLE AGES.

BY THE REV. EDWARD L. CUTTS, B.A.



It would be exceedingly interesting, but it would carry us too far afield, to give a sketch of the early music of the principal nations of antiquity, such as might easily be deduced from the monuments of Egypt and Nineveh and Greece. We may, however, briefly glance at the most ancient minstrelsy of the Israelites; partly for the sake of the peculiar interest of the subject itself; partly because the early history of music is nearly the same in all nations, and this earliest history will illustrate and receive illustration from a comparison with the history of music in medieval England.

Musical instruments, we are told by the highest of all authorities, were invented in the eighth generation of the world—that is in the third generation before the flood—by Tubal “the Father of all such as handle the harp and organ.” The ancient Israelites used musical instruments on the same occasions as the medieval Europeans; in battle; in their feasts and dances; in processions, whether of religious or civil ceremony; and in the solemnising of divine worship. The trumpet and the horn were, then as always, the instruments of warlike music.—“If ye go to war then shall ye blow an alarm with the silver trumpets.”* The trumpet regulated the march of the hosts of Israel through the wilderness. When Joshua compassed Jericho, the seven priests blew trumpets of rams’ horns. Gideon and his three hundred discomfited the host of the Midianites with the sound of their trumpets.

The Tabret was the common accompaniment of the troops of female dancers, whether the occasion were religious or festive. Miriam the prophetess took a timbrel in her hand and all the women went out after her with timbrels and with dances, singing a solemn chorus to the triumphant song of Moses and of the Children of Israel over the destruction of Pharaoh in the Red Sea, —

“Sing ye to the Lord, for he hath triumphed gloriously: The horse and his rider hath he thrown into the sea.” †

Jephthah’s daughter went to meet her victorious father with timbrels and with dances:—
“The daughter of the warrior Gileadite,
From Mizpeh’s tower’d gate with welcome light,
With timbrel and with song.”

And so, when King Saul returned from the slaughter of the Philistines, after the shepherd David had killed their giant champion in the valley of Elah; the women came out of all the cities to meet the returning warriors “singing and dancing to meet King Saul, with tabrets, with joy and with instruments of music;” and

* Numb. x. 9.
† Exod. xv. 21.

the women answered one another in dramatic chorus—
“Saul hath slain his thousands: And David his ten thousands.”*

Laban says that he would have sent away Jacob and his wives and children “with mirth and with songs, with tabret and with harp.” And Jeremiah prophesying that times of ease and prosperity shall come again for Israel, says: “O Virgin of Israel, thou shalt again be adorned with thy tabrets, and shalt go forth in the dances of them that make merry.” †

In their feasts these and many other instruments were used. Isaiah tells us ‡ that they had “the tabret and pipe and wine,” and again § “the harp, and viol, and wine in their feasts;” and Amos tells us of the luxurious people who lie upon beds of ivory, and “chant to the sound of the viol, and invent to themselves instruments of music like David,” and drink wine in howls, and anoint themselves with the costliest perfumes.

Instruments of music were used in the colleges of Prophets, which Samuel established in the land, to accompany and to inspire the delivery of their prophetic utterances. As Saul, newly anointed, went up the hill of God towards the city, he met a company of prophets coming down, with a psaltery, and a tabret, and a pipe, and a harp before them, prophesying; and the spirit of the Lord came upon Saul when he heard, and he also prophesied. || When Elisha was requested by Jehoram to prophesy the fate of the battle with the Moabites, he said: “Bring me a minstrel; and when the minstrel played, the hand of the Lord came upon him, and he prophesied.”

When David brought up the ark from Gilead, he and all the house of Israel played before the Lord on all manner of instruments made of fir-wood, even on harps, psalteries, timbrels, cornets and cymbals. ¶ And in the song which he himself composed to be sung on that occasion, ** he thus describes the musical part of the procession:—

“It is well seen how thou goest,
How thou, my God and King, goest to the sanctuary;
The singers go before, the minstrels follow after,
In the midst are the dancers playing with the timbrels.”

The instruments appointed for the regular daily service of the Temple “by David, and Gad the king’s seer, and Nathan the prophet, for so was the commandment of the Lord by his prophets” were cymbals, psalteries, and harps, which David made for the purpose, and which were played by four thousand Levites.

Besides the instruments already mentioned, —the harp, tabret, timbrel, psaltery, trumpet, cornet, cymbal, pipe, and viol,—they had also the lyre, hag pipes, and bells; and probably they carried back with them from Babylon further additions, from the instruments of all peoples, nations and languages with which they would become familiarised in that capital of the world. But from the time of Tubal down to the time when the royal minstrel of Israel sang those glorious songs which are still the daily solace of thousands of mankind; and further down to the time when the captive Israelites hanged their mourning harps upon the willows of Babylon, and could not sing the songs of Zion in a strange land,—the harp continued still the fitting accompaniment of the voice in all poetical utterance of a dignified and solemn character: the recitation of the poetical portions of historical and prophetic Scripture, for instance, would be sustained by it, and the songs of the psalmists of Zion were accompanied by its strains. And thus this sketch of the history of the earliest music closes, with the minstrel harp still in the foreground; while in the distance we hear the faint sound of the faufare of cornet, flute, harp, sackbut, psaltery, dulcimer, and all kinds of music, which were concerted on great occasions; such as that on which they resounded

* 1 Sam. xviii. 7.
† Jer. xxxi. 4.
‡ Is. xxiv. 8.
§ Is. v. 12.
|| 1 Sam. x. 5.
¶ 2 Sam. vi. 5.
** Psalm lxviii.

over the plain of Dura, to bow that waving sea of heads to the great Image of Gold:—an idolatry, alas! which the peoples, nations, and languages still perform almost as fervently as of old.

The northern Bard, or Scald, was the father of the minstrels of medieval Europe. Our own early traditions afford some picturesque anecdotes, proving the high estimation in which the character was held by the Saxons and their kindred Danes; and showing that they were accustomed to wander about to court, and camp, and hall, and were hospitably received, even though the Bard were of a race against which his hosts were at that very time encamped in hostile array. We will only remind the reader of the Royal Alfred’s assumption of the character of a minstrel, and his visit in that disguise to the Danish camp (A.D. 878); and of the similar visit, ten years after, of Aulaff the Danish king, to the camp of Saxon Athelstane. But the earliest anecdote of the series we shall have hereafter to refer to, and may therefore here detail at length. It is told us by Geoffrey of Monmouth, that Colgrin, the son of Ella, who succeeded Hengist in the leadership of the invading Saxons, was shut up in York, and closely besieged by King Arthur and his Britons. Eadulph, the brother of Colgrin, wanted to gain access to him, to apprise him of a reinforcement which was coming from Germany. In order to accomplish this design, he assumed the character of a minstrel. He shaved his head and beard; and, dressing himself in the habit of that profession, took his harp in his hand. In this disguise he walked up and down the trenches without suspicion, playing all the while upon his instrument as a harper. By little and little he approached the walls of the city; and, making himself known to the sentinels, was in the night drawn up by a rope.

In Saxon times, before the date of the Norman Conquest, we find the various features of minstrelsy as they continued through the middle ages, already established. In the illustration



which we here give from a late Saxon MS. in the British Museum, (Cotton, Tiberius, C. vi.) the royal harper is surrounded by a band of minstrels, while the mime of the band is playing the common feat of tossing three knives and three halls.

The harper always continued throughout the middle ages to be the most dignified of the minstrel craft, the reciter, and often the composer, of heroic legend and historical tale, of wild romance and amorous song. Frequently,

and perhaps especially in the ease of the higher class of harpers, he travelled alone, as in the cases which we have already seen of Baldolph, and Alfred, and Aulaff. But he also often associated himself with a band of minstrels, who filled up the intervals of his recitations and songs with their music, much as vocal and instrumental pieces are alternated in our modern concerts. With a band of minstrels there was also very usually associated a mime, who amused the audience with his feats of agility and leger-de-main. The association appears at first sight somewhat undignified—the heroic harper and the tumbler—but the incongruity was not peculiar to the middle ages; and the author of the "Iliad" wrote the "Battle of the Frogs,"—the Greeks were not satisfied without a satiric drama after their grand heroic tragedy; and in these days we have a farce or a pantomime after Shakspeare: we are not all Heracituses, to see only the tragic side of life, or Democrituses, to laugh at everything; the majority of men have facilities to appreciate both classes of emotion, and it would seem, from universal experience, that, as the Russian finds a physical delight in leaping from a vapour-bath into the frozen Neva, so there is some mental delight in the sudden alternate excitation of the opposite emotions of tragedy and farce. If we had time to philosophise, we might find the source of the delight deeply seated in our nature: alternate tears and laughter—it is an epitome of human life.

The other Saxon instruments, besides those already mentioned, are the flute, cymbal, viol, tabor, hand bells, lyre struck by a plectrum, and the organ: the latter was already the favourite church instrument: William of Malinesbury says, that Archbishop Dunstan gave many to churches, which had pipes of brass, and were inflated with bellows.

We give here an illustration of the organ, of much later date indeed, for it is from a MS. in the British Museum of early fourteenth century date (Royal MS. 14 E iii.), but it gives a good idea of the large organ in use throughout the middle ages.



The Northmen who invaded and gave their name to Normandy, took their minstrels with them; and the learned assert that it was from them that the troubadours of Provence learned their art, which ripened in their sunny clime into *la joyeuse science*, and thence was carried into Italy, France, and Spain. It is quite certain that minstrelsy was in high repute among the Normans at the period of the Conquest. Everyone will remember how Taillefer the minstrel-knight commenced the great battle of Hastings. Advancing at the head of the Norman host, he animated himself and them to a chivalric daring by chanting the heroic tale of Charlemagne and his Paladins; and then rushed into the Saxon ranks, like a divinely-mad hero of old, giving in his own self-sacrifice an augury of victory to his people.

From the period of the Conquest, authorities on the subject of which we are treating, though still not so numerous as could be desired, be-

come too numerous to be all included within the limits to which our space restricts us. The reader may refer to Wharton's "History of English Poetry," to Bishop Percy's introductory essay to the "Reliques of Early English Poetry," and to the introductory essay to Ellis's "Early English Metrical Romances," for the principal published authorities. We propose only from these and other published and unpublished materials, to give a popular sketch of the subject.

Throughout this period minstrelsy received the patronage, and was in high estimation with, all classes of society. The king himself, like his Saxon predecessors, had a king's minstrel, or king of the minstrels, who probably from the first was at the head of a band of royal minstrels.†

This fashion of the Royal court, doubtless, like all its other fashions, obtained also in the courts of the great nobility (several instances will be observed in the sequel), and in their



fine representation of a similar scene occurs at the foot of the large Flemish brass of Robert Branche and his two wives at St. Margaret's Church, Lynn; the scene is intended as a delineation of a feast given by the corporation of Lynn to King Edward III. Servants from both sides of the picture are bringing in that famous dish of chivalry, the peacock with his tail displayed; and two hands of minstrels are ushering in the banquet with their strains: the date of

measure in the households of the lesser nobility. Every gentleman of estate had probably his one, two, or more minstrels as a regular part of his household. It is not difficult to discover their duties. In the representations of dinners, which occur plentifully in the mediæval MSS., we constantly find musicians introduced; sometimes we see them preceding the servants, who are hearing the dishes to table; a custom of classic usage; and which still lingers at Christ Church, Oxon, in the song with which the choristers usher in the boar's head on Christmas-Day; and at our modern public dinners, when the band strikes up "Oh, the Roast Beef of Old England," as that national dish is brought to table.

We give here an illustration of such a scene from a very fine MS. of the early part of the fourteenth century, in the British Museum (marked Royal 2 B vii. f. 134^b and 135). A very

fine representation of a similar scene occurs at the foot of the large Flemish brass of Robert Branche and his two wives at St. Margaret's Church, Lynn; the scene is intended as a delineation of a feast given by the corporation of Lynn to King Edward III. Servants from both sides of the picture are bringing in that famous dish of chivalry, the peacock with his tail displayed; and two hands of minstrels are ushering in the banquet with their strains: the date of the brass is about 1364 A.D. In the fourteenth century romance of Richard Cœur de Lion, we read of some knights who have arrived at the presence of the romance king whom they are in quest of; dinner is immediately prepared for them; "trestles," says Ellis in his abstract of it, "were immediately set; a table covered with a silken cloth was laid; a rich repast, ushered in by the sound of trumpets and shalms, was served up."*



Having introduced the feast, the minstrels

continued to play during its progress; we find

* The King's minstrel of the last Saxon king is mentioned in Domesday Book as holding lands in Gloucestershire.

† In the reign of Henry I., Roger was the King's Minstrel. Temp. Henry II., it was Galfrid, or Jeffrey. Temp. Richard I., Blondel, of romantic memory. Temp. Henry III., Master Ricard. It was the Harpist of Prince Edward (afterwards King Edward I.) who brained the assassin who attempted the Prince's life, when his noble wife Eleanor risked hers to extract the poison from the wound. In Edward I.'s reign we have mention of a King Robert, who may be the impetuous minstrel of the Prince. Temp. Edward II., there occur two: a grant of houses was made to William de Morley, the King's Minstrel, which had been held by his predecessor, John le Boteler. At St. Bride's, Glamorganshire, is the insculpt effigy of a knightly figure, of the date of Edward I., with an inscription to John le Boteler; but there is nothing to identify him with the king of the minstrels. Temp. Richard II., John Camuz was the king of his minstrels. When

Henry V. went to France, he took his fifteen minstrels, and Walter Hallday, their marshal, with him. After this time, the chief of the royal minstrels, seems to have been styled *Marshal* instead of King; and in the next reign but one we find a *Sergeant* of the Minstrels. Temp. Henry VI., Walter Hallday was still Marshal of the Minstrels; and this king issued a commission for impressing boys to supply vacancies in their number. King Edward IV. granted to the said long-lived Walter Hallday, Marshal, and to seven others, a charter for the restoration of a Fraternity or Gild, to be governed by a marshal and two wardens, to regulate the minstrels throughout the realm (except those of Chester). The minstrels of the royal-chapel establishment of this king were thirteen in number; some trumpets, some shalms, some small pipes, and others singers. The charter of Edward IV. was renewed by Henry VIII. In 1520, to John Gilman, his then marshal; on whose death Hugh Woodhouse was promoted to the office.

Ellis's "Early English Metrical Romances," Bohn's edition, p. 287.

numerous representations of dinners in the illuminations, in which one or two minstrels are standing beside the table, playing their instruments during the progress of the meal. In a MS. volume of romances of the early part of the fourteenth century in the British Museum (Royal 14 E iii.), the title-page of the romance of the "Quête du St. Graal" (at folio 89 of the MS.) is adorned with an illumination of a royal banquet; a squire on his knee (as in the illustration given above) is carving, and a minstrel stands beside the table playing the fiddle; he is dressed in a parti-coloured tunic of red and blue, and wears his hat. In the royal MS. 2 B vii., at folio 168, is a similar representation of a dinner,

in which a minstrel stands playing the fiddle; he is habited in a red tunic, and is bareheaded. At folio 203 of the same MS. (Royal 2 B vii.), is another representation of a dinner, in which two minstrels are introduced; one (wearing his hood) is playing a cittern, the other (bareheaded) is playing a fiddle; and these references might be multiplied.

We reproduce here, in illustration of our subject, two engravings which have already appeared in the *Art-Journal*, in illustration of Mr. Wright's "Domestic Manners of the English." The first is a representation of a royal dinner of about the time of our Edward IV., "taken from an illumination of the romance of the Compté d'Artois,

time of Henry and Elizabeth, were so fond, and of which Mr. C. Kean has lately given the play-going world of London so accurate a representation in his *mise en scene* of Henry VIII. at the Princess's Theatre. The band of minstrels who have been performing during the banquet, are seen in the left corner of the picture.

So in "The Squire's Tale" of Chaucer, where Cambusean is "holding his feste so solempne and so riche."

"It so befel, that after the thridde cofers,
While that this king sit thus in his nobley,"
Harking his ministralls her + stringes play,
Before him at his bord deliciously, &c.

The custom of having instrumental music as an accompaniment of dinner is still retained by her Majesty and by some of the greater nobility, by military messes, and at great public dinners. But the musical accompaniment of a medieval dinner was not confined to instrumental performances. We frequently find a harper introduced, who is doubtless reciting some romance or history, or singing chansons of a lighter character. He is often represented as sitting upon the floor, as in the accompanying illustration, from the Royal MS., 2 B vii., folio 71 b. Another similar representation occurs at folio 203 b of the same MS. In the following very charming picture, from a MS. volume of romances of early fourteenth century date in the British Museum (Additional MS., 10,292, folio 200), the harper is sitting upon the table.

Gower, in his "Confessio Amantis," gives us a description of a scene of the kind. Appolinus is dining in the hall of King Pentapolin, with the king and queen and their fair daughter, and all his "lordes in estate." Appolinus was reminded by the scene of the royal estate from which he is fallen, and sorrowed and took no meat; therefore the king bade his daughter take her harp and do all that she can to enliven that "sorry man."

"And she to dou her fader's best,
Her harpe sette, and in the feste
Upon a chaire which thel sette,
Her selve next to this man she sette."

Appolinus in turn takes the harp, and proves himself a wonderful proficient, and

"When he hath harped all his file,
The king's best to fulfillle,
A wale goth dishe, a wale goth enp,
Down goth the borde, the cloth was up,
Thel risen and gone out of the hallis."

In the sequel, the interesting stranger was made tutor to the princess, and among other teachings,

"He taught hir till she was certeyne
Of harpe, cithole, and of riote,
With many a trevis and many a note,
Upon musike, upon measure,
And of her harpe the temprure
He taught her eke, as he well couth."



in the possession of M. Barrois, a distinguished and well-known collector in Paris."* The other is an exceedingly interesting representation of a grand imperial banquet, from one of the plates of Hans Burgmaier, in the volume dedicated to the exploits of the Emperor Maximilian, contemporary with our Henry VIII. It represents the

entrance of a masque,* one of those strange entertainments, of which our ancestors, in the



Another occasion, on which their services would be required would be for the dance. Thus we read in the sequel of "The Squire's Tale," how the king and his "nobley," when dinner was ended, rose from table, and preceded by the minstrels, went to the great chamber for the dance:—

"Wan that this Tartar king, this Cambusean,
Rose from his bord ther as he sat ful hie;
Before him goth the loudé ministralle,
Til he come to his chambre of paraments,†
Theris they sounde divers instrumens,
That it is like an Heaven for to here,
Now dauncen lusty Venus children dere," &c.

* *Art-Journal* for 1854, p. 275.
† Great chamber, answering to our modern drawing-room.

In the tale of Dido and Æneas, in the legend of "Good Women," he calls it especially the dancing chamber:—

"To dauncing chambers full of paraments,
Of riché bedes; and of pavements,
This Æneas is ledde after the meat."

[To be continued.]

* Among his nobles. † Their. ‡ Conches.

* *Art-Journal* for 1853, p. 246.

PROGRESS OF
BRITISH ART-MANUFACTURE
THE PORCELAIN OF WORCESTER.

Messrs. KERR & BINNS—the present proprietors and conductors of the long-famous Porcelain Works at Worcester—have recently produced some examples of the Art, of which it is not too much to say they surpass all the productions of their class that have been hitherto manufactured in this country. We allude chiefly to their attempts (in which they have eminently succeeded) to imitate the artistic character of the works of Limoges on a porcelain body; hitherto

they have taken as their models those in one colour, of Jean Courtois (1540) and in various colours those of Noel Landin (1695).

In the works of Limoges, all the shades are laid in with dark colour on white; but it is the peculiarity of the Worcester cummels that the shades are produced by the reflection of the blue ground through the white. A very delicate tone is hence given to the pictured subject,

which is still more advantageously "set off" by the intense colour of the cobalt, which forms the ground. It will be understood that the whole of the material of this imitation enamel is porcelain; differing therefore from the ancient produce as well as the Sèvres imitations, in which the porcelain is laid over thin sheets of copper.

We believe this attempt is the first that has succeeded to obtain such effects by such means,



and we cannot doubt that large difficulties have been overcome by patient and careful study to obtain a peculiarly delicate glaze, a very sensitive medium, and especially accomplished workmen for the perfecting of the task.

Our attention was first directed to these singularly beautiful works at the Exhibition in

Paris, where we found them very much admired, but where certainly they were not considered to be composed entirely of porcelain body—on which so valuable an effect had been produced by the apparently simple process of layers of white on a deep blue ground, the shading being produced by the thinner or thicker gradations of

the white, through which the blue was suffered to make its way to the eye. The engravings here given convey but a limited idea of the beauty of these works; yet, the reader will hence be able to understand that the subjects have been selected with much judgment and taste, and we give him the assurance that the



execution of the pictures, so to speak, is of a rare degree of excellence, drawn with severe accuracy; for upon this particular quality the value of the article mainly depends.

The subjects speak for themselves. Our selections are confined to the EVER and STAND, a VASE, a PASTILE BURNER, a PLATE and a TAZZA; but, if we understand rightly, various other articles are

produced by these manufacturers in this style—some of a very elaborate character, and some of a less costly description.

The designs are, we believe, for the most part from the pencil of Mr. R. W. Binns and the painting is by Mr. T. Bott. Our engravings are copied from photographs, but we imagine we are correct in stating that, although several of our

specimens are in the one tint—the white upon blue—others are in colours. Our acquaintance with these works, when we carefully examined them at Paris, justifies the high praise we bestow upon them in describing them as foremost among the most successful efforts in porcelain that have been produced in Great Britain, or probably in any other country.

We rejoice at these results, not only as upholding and extending the character of British Art manufacture, but as restoring the ancient renown of Worcester, which has, for a long period, lain comparatively dormant. The porcelain productions of that city, executed some forty years ago, are held in the highest repute, and are sought for by collectors with great avidity. Unlike the manufactory at "Chelsea"—of which almost as little is known as of that of Etruria, except by its "remains"—the establishment at Worcester has never been abandoned; its history may be traced back to its founder, and it is a great satisfaction to report its progress in 1855, as in no way behind that of the best periods of its existence during the century it has lived and flourished.

The Royal Porcelain Works of Worcester were founded by Dr. Wall, who, in conjunction with some other eminent chemists, made assiduous researches to discover materials proper for the imitation of China ware, and, in 1751, established a manufactory under the title of the Worcester Porcelain Company. "Printing upon porcelain," is said to have originated with Dr. Wall. To him is "generally assigned the ingenious method of transferring printed patterns to biscuit ware, which is now universally practised." A guide book to the Porcelain Works, Worcester, contains some prints from copper-plates, which are believed to be from the earliest plates used in printing on porcelain, and these are excellent examples of design and drawing. In 1783 the manufactory was purchased by Mr. Thomas Flight, by whom it was transferred to Messrs. Flight & Barr; under their judicious management, and by their employment of competent artists, it obtained a renown which it kept for a long period undisputed. In 1790, a manufactory at Worcester was formed by Messrs. Chamberlain. With this manufactory that of Messrs. Flight & Barr was subsequently incorporated, and in due course it passed into the hands of its present proprietors—Messrs. Kerr & Binns—Mr. Binns having been for a long time previously the director of the Falcon Glass Works, the well-known establishment of Messrs. Apsley Pellatt in London.

Judging from the works they have already produced—from those of the highest and most costly character down to articles for ordinary and daily use—we but discharge our duty in expressing a confident belief that this manufactory will be restored to the palmy state it occupied at the close of the past and beginning of the present century.

The Exhibition of 1851—as far as porcelain is concerned—did much to convince the world that England was not behind any country of Europe in ceramic art. Until that event, we obtained comparatively little credit for our home productions. When aught that was especially graceful and beautiful was seen in "shop windows," it was usually looked upon as foreign. There was no gaining the facts supplied by the stalls of Messrs. Minton, Mr. Alderman Copeland, Messrs. Rose, &c.; and this branch of British Art-manufacture unquestionably derived immense advantages from "the Exhibition." Its fame was entirely upheld at Paris in 1855: our manufacturers were surpassed by none—if we except the government establishment at Sèvres. The issues hence are, it is known, produced without regard to cost; and there can be no fair comparison between those of "the Empire" and the private fabricant, either of England, Germany, or France.

We rejoice to know that the impetus thus given to a manufacture, only second in importance to that of Manchester, has produced its natural results. Few more satisfactory or encouraging proofs of this can be laid before the public than these works of the manufactory at Worcester.

It may not be improper to add that it has always had a large share of "Royal Patronage" from the early time of George III. to the present auspicious reign: and that a very considerable portion of the more famous visitors to Europe from all parts of the world have inspected the Porcelain Manufactory at Worcester.

THE SOCIETY OF BRITISH ARTISTS. THE THIRTY-THIRD EXHIBITION.

This exhibition was opened to the public on the 24th of March, with a catalogue of upwards of eight hundred works. Although there are no really ambitious pictures in the collection, there is an absence of those experimental essays wrought on vague principles which are always inglorious failures, or, at least, painful eccentricities. There are some figure studies not of exalted character, but highly meritorious, and there are landscapes of a high degree of excellence. When we stand in the middle of the great room, and glance round the line and above the line, we feel at once that the general quality of the collection is superior to that of recent years; yet we cannot help feeling also that but few of these works are executed for reputation: they are kept down to the common market standard. This is always to be regretted, because Art cannot stand still. We may choose for half a century the same class of subject, but if we realise our works always in the same manner, this is virtually retrogression. We have observed that this society is more slow than others to adopt that prevalent taste for high and minute finish, which is daily gaining ground—since this is purely mechanical, and we cannot help thinking that more elaboration would add a tenfold value to many of these works, which seem but the repetition of others, that we remember in series during many past years on these walls. It might seem invidious to individualise prejudicially in these few prefatory remarks; the exhibition is better than those of many years past. We proceed, therefore, to select a proportion for brief observation.*

No. 7. 'Arcangelo,' R. BUCKNER. Such is the title given to one of those studies of Italian life which the artist has of late painted with much felicity. It is true that any undue coarseness or vulgarity would be highly objectionable, but the features are, perhaps, carried to an opposite extreme, they are refined overmuch.

No. 11. 'Streatley Mill, on the Thames—a Summer's Morn,' H. J. BODDINGTON. A large picture presenting a passage of scenery essentially English. The effect is that frequently introduced by this painter,—a sunny day, the sun being kept just out of the picture. The water, trees, weedy foreground, and other passages of the composition, are brought forward with the masterly feeling which characterises all the works of this artist.

No. 16. 'My Boyhood's Home,' J. O'CONNOR. A small work, the subject of which is principally a shady avenue of garden-trees, leading to a neat residence. The study is by no means easy, but it is brought forward with much spirit.

No. 18. 'Off the Hermitage Rocks, Elizabeth Castle, Jersey Coast,' J. J. WILSON. We are almost too near these rocks to be said to be "off" them; it is, however, the most pleasing work we have of late seen under this name. Of the manner in which the water is painted, it must, however, be observed that the forms want solidity.

No. 25. 'The Hay-Field,' J. J. HILL. The subject is a group of two rustic figures, a youth and a maid, the former whispering and the latter listening to that most ancient of all communications, a declaration. The figures are freely and substantially wrought,

* It is to be regretted that this society continues to charge a shilling for the catalogue; sixpence would be sufficient, and we believe at that cost the remuneration to the society would be better than it is. In this age a large quantity of printing is expected for a shilling.

they come palpably forward, and the work is altogether brilliant and effective.

No. 29. 'The Castle Rock, Linton, Devon,' J. TENNANT. A charming copy of a wild yet grandly beautiful scene, highly finished, yet full of force and character.

No. 37. 'Early Morning,' J. DEARLE. The time is accurately told by the dull grey aspect of the composition. We find here an absence of that wooliness of which we have spoken elsewhere.

No. 38. 'Bathing Buffaloes in the Pontine Marshes,' J. B. PYNE. An extraordinary subject, but pointedly characteristic of the source whence it is derived. The animals are driven into the water, and not permitted to come out until they have in some degree cleared the pool of the rank herbage with which it abounds. Such is the fidelity of interpretation, that the spectator sees at once that the Campagna is the theme.

No. 39. 'Summer Evening—Bantry,' ALFRED CLINE. The sunny lustre of the ripple as it rolls in upon the shore is a feature that instantly attracts the eye from its extraordinary truth—but the other parts of the picture are not less veracious.

No. 45. 'The Beauty Spot,' T. ROBERTS. A very pleasing fancy portrait, painted with delicacy and skill; a little too broken, perhaps, but exhibiting much power.

No. 46. 'The Lily,' C. BAXTER. A production equal to the most finished of this painter's works; a study of a lady wearing a Spanish hat, and holding flowers in her hand. The great charm of these captivating studies is their exquisite colour, the beauty of the faces, and the enchanting delicacy of manipulation with which they are worked out.

No. 48. 'Music,' W. UNDERHILL. A pyramidal composition, presenting three figures, the centre one touching the strings of a harp. The personages are grouped, perhaps, too methodically; they are, however, firmly painted, though faulty in the drawing of the extremities, and deficient in refinement of character.

No. 44. 'Cup and Ball,' and No. 63. 'Gleaners,' W. GELL. Two very clever and highly-finished rustic groups of children.

No. 65. 'Castel d'Ostia,' J. B. PYNE. This is the well-known fortress near the mouth of the Tiber. We do not, however, see the sea, and the castle itself is removed to a little distance from the eye. Figures and a team of bullocks are seen in the foreground. The picture sets forth the utmost wealth of the palette, but there is no passage of colour here that could be subdued without its loss being felt.

No. 66. 'Going to the Ferry on the Danube,' J. ZETTER. A principal in this composition is a ruined tower, past which numerous figures are hastening to, we presume, the water's edge. As in all this artist's works, the showy manipulation is unique.

No. 83. 'Venice from the Lido,' J. B. PYNE. We are glad to see Venice without the Palace, the Library, the Rialto, the Columns, St. Mark's, in short, without the hundred and one historical edifices which every artist who visits Venice thinks he must paint. Something new—Venice in the distance—refreshing sight! We have been counting the bricks and stones of Venice for the last thirty years, and have, of course, established a nodding acquaintance with every one of them. But this is a charming picture, a gorgeous sunset over the sea, surpassingly beautiful in colour and touching in sentiment.

No. 84. 'Portraits of Daughters of Captain Hopwood, of Hopwood,' F. Y. HURLE-

STONE. In the heads of these two children there is much of that graceful animation which eminently distinguishes the youthful features of the studies of this painter. The composition is pictorially treated; they are busied in gathering blackberries.

No. 88. 'Portrait of Sir John McNeill, G.C.B.,' J. R. SWINTON. We were much disposed to doubt the accuracy of the catalogue in this instance. If the portrait resemble the subject, he is the most youthful G.C.B. that ever wrote these frequently hard-earned letters after his name. The character of the head is that of a student—a poet—an enthusiastic minister of the Muses.

No. 89. 'Un Dicitore della Buona Fortuna,' W. SALTER. A rustic seer beguiling a couple of maidens too willing to be deceived. The figures wear the ordinary dress of the Italian peasantry, and in character they represent very perfectly the class to which they may be supposed to belong.

No. 90. 'The Farmer's Nag,' H. J. PIDDINO. A small composition, of which the principal is a small grey pony, likely to be an able supporter of any moderately-fed yeoman.

No. 97. 'Cottage Pets,' J. INSKIP. These pets are rabbits that are contained in a hutch, on which is resting a girl in the act of feeding them, whose head only comes into the picture. The head is, perhaps, more detailed than others recently exhibited by the artist, but the other objects of the picture are alluded to rather by colour than form. The day for this conventional freedom is gone by; nothing now in art can be accepted save that which is drawn and painted.

No. 107. 'Ursula of Veletri,' R. BUCKNER. A carefully-drawn and well-painted study of an Italian rustic maiden, very strong in individuality.

No. 110. 'Eavesdroppers—the Asking,' J. CAMPBELL. This is a very remarkable work; the artist has contrived to make a disagreeable picture of an agreeable subject; it is, however, full of merit, manifesting great power, abundant in character, and, altogether, a production of great promise. We look to this painter as to one who will be "great hereafter."

No. 120. 'My Servant-Girl,' J. INSKIP. We doubt not the truth of the title; she is engaged in shelling peas. We have often wished that this painter would not colour the necks and features of his figures with the same glaze or tint; this identity is never seen in healthy nature.

No. 130. 'The Druid's Temple, Cumberland,' J. P. PERRIN. A large picture, showing in one of its nearer sites the masses of stone whence the title is derived. If this be like the locality, we cannot help very highly commending the taste of the Druids for the picturesque.

No. 131. 'Portrait of Edward Mackenzie, Esq.,' W. SALTER. A full-length figure of the size of life, presenting the subject in an erect attitude, easy and natural. It is forcible and unaffected.

No. 134. 'A Pifferaro,' T. GOODERSON. A very successful study, that of a rustic playing on the Italian bagpipe. There is in the treatment of the conception a striking originality, with an agreeable dash of romance.

No. 140. 'Gone to the Crimea,' H. H. MARTIN. This is a creditable production—a profile portrait of a lady absorbed in the contemplation of her husband, who is, as the title tells us, far away.

No. 141. 'Master Frank,' T. F. DICKSEE. This young gentleman is playing with a

drum and bells; it will, therefore, be understood that he is not yet in the second half of his first lustre. The infantine portraiture of this painter is always marked by excellent quality.

No. 149. 'Neglected Flowers,' T. M. JOR. These flowers may be either the children that pluck them, or the flowers themselves. To place the children in shade is an independent perhaps daring method of treating them, but it is, notwithstanding, successful.

No. 150. 'Mrs. Jas. H. Hulme, Cliff House, Barlow, Derbyshire,' P. WESTCOTT. A portrait of an elderly lady, attired in black. The reality of the impersonation, and the effective simplicity shown in this work, are among the most desiderated qualities of portraiture.

No. 151. 'The Wild Wood,' W. W. GOSLING. A large picture, wherein the manner in which the trees are drawn is most masterly. The divergence of the branches, showing them as retiring into the picture or coming out of it, is amply and truly realised. We see our way well into the thicket, and, had we time, would take a stroll through the forest, although the foliage looks so uninviting. We have never seen foliage so repulsively cold; any kind of warmth would be nearer truth.

No. 154. 'The Orphans,' S. S. MORRISH. Two little figures very pleasantly wrought, and in sentiment fully sustaining the title.

No. 155. 'Henry VII.'s Chapel, Westminster, painted on the spot,' H. WILLIAMS. A subject so unique could never be mistaken for anything else; the complicated details are very elaborately worked out.

No. 159. 'On the Welch Coast,' J. HENZELL. The principals here are two fish-girls, unquestionably like what they are proposed to represent, but from their reality deduction is amply made by the newness of everything around them. The picture is a study of textures, to which everything is sacrificed. The rocks look new, the dresses are rubbed threadbare for the nonce, the rocks and stones are theatrically new, and even the atmosphere is new without being fresh. Very little is wanted to bring the whole into every-day harmony—a glaze were enough.

No. 164. 'A Line-of-Battle Ship firing a Gun at a Waterspout in a Storm,' C. A. MORNEWICK, JUNIOR. A production of considerable power: an original subject treated with masterly skill.

No. 166. 'Bantry Bay, South of Ireland,' ALFRED CLINT. A very romantic subject, brought forward with such an expression of space, that everything maintains its relative site, and nothing is lost. The eye is very artfully led from distance to distance till the entire ample space is closed by remote mountains, the interval being broken, and here and there forced into light by the flitting shadows of the driving clouds. We read here of the most common phenomena of nature, and these, after all, are the most difficult of description in painting.

No. 178. 'Welsh Children Woolpicking,' E. J. COBBETT. From the treatment of the subject it seems probable that the artist has seen this incident and has represented it as it appeared to him. A cottage is the scene of the labours of the group, on which the light is broken in a manner to bring the figures substantially forward. The children are painted with the utmost nicety, the transparent shades being realised with perfect truth.

No. 179. 'Narrative of an Engagement,' T. CLATER. The narrative is read from a newspaper to an attentive audience in a shoemaker's shop, the shoemaker himself being the principal figure of the group. It

is among the best of the artist's productions, all the still life in the composition has been most conscientiously worked out.

No. 186. 'Loch Long,' G. COLE. A well-chosen subject, the composition is charmingly diversified with the most romantic features of lake and mountain. The sky and the distant hills are passages distinguished by much fine feeling.

No. 190. 'Portrait of the Lady De Mauley,' J. R. SWINTON. We cannot help thinking that in the portraiture of which this is a most favourable example, the best points of identity are sacrificed to sentimentality. We see continually in such works the nose lengthened, the upper lip shortened, the eyes enlarged, and the cheeks almost colourless. In this portrait we see much of this kind of affectation, which after all is very much less difficult to paint than any of the thousand and one diversities of natural expression.

No. 199. 'Tenants of the Forum Romanum in the Nineteenth Century,' F. G. HURLSTONE. The title suggests a comparison, but it is rather of the present and the past of the locality, than between the impersonations before us and those who might have basked there in the sun of two thousand years ago. The faces of those who vowed by Hercules and the Temple of Apollo, were quite as handsome as those who now swallow miles of macaroni, and supplicate you for a *bajocco*. This is the class of subject which this artist painted years—long years ago—and he has never been more successful in anything else.

No. 201. 'The Golden Age,' F. UNDERHILL. The artist is right in substantive effect but he is poetical in prose. The golden age is something to dream of; but we find ourselves here invited to join the dance by nymphs with the most common-place faces. We cannot therefore raise ourselves beyond our every-day age of iron. These same ladies we have seen as late as last summer haymaking in Essex and hopping in Kent; the Arcadian delusion is at once dispelled. There is very much to praise in the picture, but were it a little more classic it would be very much nearer the spirit of the proposed subject.

No. 217. 'Landscape with Cattle crossing a Stream—Kenilworth Castle in the distance,' H. HAWKINS. A very interesting subject full of material, the ruin pronounces itself at once to be Kenilworth.

No. 218. 'A quiet Morning on the Coast of Arran,' J. W. OAKES. This is striking and forcible in its treatment. It is generally low in tone, and the aspect of the sky threatens rain, an effect which we feel at once to have been closely imitated from nature.

No. 223. 'River Scene and Cattle,' T. F. WAINWRIGHT. This picture reminds the spectator of Cuyp. Imitations like comparisons may be odious, but it is better to succeed in some degree in following a good master than a bad precept. The light and warmth of the work are at once felt, and there is otherwise much to commend.

No. 226. 'Scene near Great Marlow, Bucks,' A. F. ROLEE. A small picture, firmly painted and generally agreeable in composition. No. 237, also by this artist, and entitled 'View of Windsor Castle from Romney Island,' is not less creditable.

No. 238. 'Good News,' J. NOBLE. A small life-sized head—that of a lady intent on reading a newspaper. It is agreeable in expression and life-like in colour.

No. 244. 'Caves in the Lias—South Wales,' W. WEST. When we look at this work we are surprised how little of subject-matter with judicious painting will make a picture.

The material is only a passage of sea-cliff running into the picture; but the perspective is most accurate, and every cleft and fissure is carefully drawn and painted; the whole presenting an infinity of elaboration. It is truly a geological study, but it has perhaps too much pretension to give it a geological title.

No. 248. 'Prophecy of the Destiny,' S. ANDERSON. This title is too obscure to assist in anywise the picture, or to elucidate the point of the subject. There are two figures—one of a child sleeping, clasping what seems to be a doll; and standing in contemplation of the sleeping child is a female figure, perhaps the sister. The light is well managed, but the multitudinous folds of the drapery confuse the composition. It is, notwithstanding, a very touching and impressive picture, and cannot fail to give pleasure.

No. 250. 'Pilate's Wife saying to him—"Have thou nothing to do with that just man; for I have suffered many things this day in a dream because of him," Matthew xxvii, 19,' J. Z. BELL. The figures in this composition are well executed, but they are deficient in character and nationality. There is also a want of state and presence in the principals. It happens too frequently that artists paint nothing but the models they see before them, without reference to what might have been the impersonations of the characters presented.

SOUTH-EAST ROOM.

No. 263. 'Sunshine and Showers—a Fishing Weir on the Thames,' H. J. BODDINGTON. A large upright picture with a menacing sky; in execution the picture is perhaps less fortunate than are usually the productions of the painter.

No. 267. 'Pastoral Scene at Maxfield, near Hastings,' J. J. WILSON. The composition shows a small farm-house, with trees and other appropriate incidents; and were it not that the foliage is unnaturally cold and metallic, there is more truth in this and the other like subjects painted by the artist than in his marine subjects. By the way, the title is a misnomer—the subject may be rural, but it is not pastoral.

No. 273. 'Lady Godiva,' A. J. WOOLMER.

"The woman of a thousand summers back,
Godiva, wife of that grim earl who ruled
in Coventry."

Almost any semi-nude female study may be turned into a Godiva. We find her here undressing for her penal promenade. There is a shadowy allusion to a caparisoned horse under a distant portico; but for a subject so popularly understood, it is not enough that the figure be painted with much sweetness as to character and colour. If a story be proposed, it should be told in conscientious drawing and painting—a sketch is not enough for perspicuity of narrative.

No. 275. 'A Scene near Dolgelly,' J. SYER. This composition is got up with breadth and force; the properties of the theme are developed with good taste, and all the insignificant and unimpressive incident which might be brought forward in such a picture is with good feeling omitted. The principals of the composition are a torrent foaming as it rolls over its rocky bed, a screen of trees, and a glimpse of distance,—harmonious in colour and decided in manipulation. The treatment is somewhat loose, yet, on the whole, there are few better landscapes of our school.

No. 280. 'Portrait of Lieutenant-Colonel Cowell,' R. BUCKNER. A full-length portrait, presenting the subject in the act (we presume) of leading troops to an attack;

but this idea is by no means supported by the dark background. The hands strike the spectator at once as being altogether too small.

No. 281. 'The Shepherdess,' J. J. HILL. She is asleep, but not in a very easy posture, with her dog lying by her. The treatment is that generally followed by this painter—the group or figure being presented in a broad and open field of view.

No. 283. 'The Merry Thought,' H. J. PIDDING. This title is given to a study of a country girl, who is laughing at some quaint conceit. The features are in a high degree expressive of hilarity.

No. 286. 'Abd-el-Kader,' R. BUCKNER. It is not like those portraits of the Emir that are usually considered authentic. Whether Abd-el-Kader sat for this head or not, we cannot say: if he did not, it is at least bad taste to exhibit the work with a title which may lead to a supposition that it is an authentic portrait.

No. 295. 'The Broken Bridge in the Hartz Mountains,' J. ZETTER. The subject is brought forward in a manner to convey an impressive idea of the difficulties of travelling in such a region; it is wild and dismal enough for the abode of all the demons of the tempest.

No. 303. 'A Mountain Shepherd's Home,' J. P. PETTIT. This home is a cottage, immediately behind which is a rocky perpendicular eminence, a striking feature of the mountainous character of the region whence the subject may be derived. It is very carefully painted, but it will be felt to be too grey in colour.

No. 313. 'A Neapolitan Peasant Boy,' F. Y. HURLSTONE. For the class of subject, there is perhaps too much refined sentiment. The head, like all similar youthful essays of this painter, is a charming study.

No. 316. 'Preparing for a Bal Masque,' J. NOBLE. A pendant to this work is numbered 318, and entitled, 'The Return from a Bal Masque.' In each is seen a trio of ladies; but in the composition showing the preparation the subject is most conspicuous.

No. 317. 'Autumn,' C. BAXTER. A small picture, containing one figure, that of a girl carrying a small basket of fruit. Like all the heads painted by the artist, the special characteristics of this are sweetness and simplicity. It is everywhere highly finished, and most captivating in colour.

No. 330. 'Going to Market—Road-scene near Llangattoch, Breconshire,' J. TENNANT. A large picture, presenting an expansive diversity of Welsh scenery, and leading, as is customary with this painter, the eye to remote distance, till the objects are veiled by the filmy atmosphere.

No. 335. 'Storm—Fishing Boats running into Harbour,' ALFRED CLINT. We are placed here close in shore, at high water, with a gale blowing off the sea. The water is still deep, and immense volumes of water are thrown in upon the rocks; a large ship, already a wreck, is driving rapidly in among the breakers; and the small craft are running in shore for shelter. The description is impressive, and the heavy surging sea is painted with a daring sharpness which can only be ventured on from close study of the forms assumed by water under violent agitation.

No. 336. 'Virgin and Child,' W. SALTER. This is a subject rarely treated in modern art: it is a small picture, showing skilful grouping, and much brilliancy of colour.

No. 337. 'On the Coast, near the Valley of Rocks, Linton, Devon,' W. WEST. Altogether in the good feeling of the works already noticed by this painter, who renders these stratified rocks with great truth.

No. 338. 'On the Barmouth Waters, North Wales—Mid-day,' H. J. BODDINGTON. An effect frequently treated by this painter: it is here realised with the success which usually attends him in these essays.

No. 345. 'Running into Port,' G. COLE. From the title alone we learn that there is a storm coming off the sea: it is sunset, and the aspect of the heavens warns the scared small craft to their places of safety. The story is told in simple but forcible terms.

No. 349. 'Nature's Toilet,' T. R. POWELL. A small composition, presenting a semi-nude female figure dressing by aid of the reflection in a garden basin. It is very attractive in colour, and otherwise skilfully executed.

No. 360. 'The Embroidress,' E. J. CORBETT. A most pleasant fancy portrait, very ably treated.

SOUTH-WEST ROOM.

No. 385. 'Ehrenbreitstein, and Bridge of the Moselle,' V. DE FLEURY. This view is taken on the Moselle, a little above the bridge, and looking over towards the "Gibraltar" of the Rhine. Although the importance of the fortress is diminished by the bridge and near objects, it presents an imposing view, which is enhanced by judicious treatment.

No. 391. " " " " G. WOLFE. This is a sea-coast scene, very earnestly painted, but deficient of breadth.

No. 392. 'Drying the Nets,' J. HENZELL. The dispositions here are creditable, but the work partakes of the disqualifications we have already noticed in the works of this painter: there is a marked crudity of colour which is not natural.

No. 403. 'The Weald of Sussex, Chantombury Downs in the distance,' G. COLE. There is some excellent subject-matter in this district: we are surprised that it is so little visited. This is one of the best works we have seen exhibited under this name.

No. 419. 'The Rheinfels, looking towards Thurnberg,' E. J. NIEMANN. A subject that very few painters would select. The objects in the foreground are fallen ruins, and the aspect near and far is wild to a degree.

No. 434. 'Portrait of Lady Eden,' F. Y. HURLSTONE. A very graceful impersonation: it is among the best of the painter's works.

No. 435. 'Return from the Ball—Sunrise,' A. J. WOOLMER. These preparations for, and returns from, the ball, constitute a present a very favourite class of subject-matter; and they are principally ladies who, in the latter case, are represented as returning home at all hours of the twinkling stars, even till the sun is well up in the sky. We find here accordingly a lady, as usual, charming in colour; but, whether she is in boudoir or bed-chamber, cannot be determined by the upholstery of her whereabouts. With the exception of the figure, the composition is beautifully indefinite.

No. 436. 'A Fall in the Snow, near Presburg, Hungary,' J. ZETTER. A small picture; the best we think exhibited by its author.

No. 438. 'The Rendezvous,' J. NOBLE. A small picture, presenting a gentleman wearing the cavalier costume of the seventeenth century. It is agreeably coloured.

No. 449. 'Laying Monster Tubes from the New River,' J. B. PYNE. This subject transcends even the utilitarian; it has scarcely as much of the picturesque as we sometimes see in an engineering draught; but even to this subject is communicated a surpassing charm: it is the effect of sunshine under which these huge tubes, and all about them, are brought forward. This is an essay truly masterly.

No. 452. 'Flowers,' MISS RIMER. This study is much in the taste of a foreign school: it is, however, painted with firmness and truth.

No. 453. 'Study of Trout,' H. S. ROLFE. A couple of fish, in which every natural characteristic is most perfectly realised.

No. 459. 'A Country Boy—from Nature,' W. HEMSLEY. This little picture sustains the reputation of the accomplished artist—and that is saying much.

No. 462. 'A Welsh Ford,' G. SHALDERS. The subject is brought forward under a subdued light, with the moon rising. The sky, distance, and the general breadth of the composition, are highly commendable.

No. 465. 'Lock Katrine, Looking towards Ellen's Isle,' J. DANBY. Really a brilliant and powerful production. We look up the lake at a late hour of the day, when the sun casts a profusion of golden and mellow light on the entire scene. This series of works will remind the spectator of Richard Wilson, whom, perhaps, they sometimes suggest too positively.

No. 466. 'The Old Avenue,' A. J. WOOLMER. Well and substantially treated, though not without manner. There is more of reality here than of that playfully obscure allusion of which we have elsewhere spoken in these works.

No. 472. 'The Rest,' C. BAXTER. A new class of subject for the painter; and one in which, he ever so successful, he will never surpass those charming essays upon which his reputation is so firmly based. The figures here are a rustic mother with her two children.

No. 479. 'Home through the Heather,' E. J. COBBETT. Those who are thus moving homeward, are a group of cottage children laden with fern. The figures are distinguished by much sweetness and simplicity.

No. 504. 'Near the Head of Loch Katrine,' G. COLE. This recalls at once the locality. The light and atmosphere are very felicitously managed.

No. 506. 'The Bridge of Sighs,' E. BARNES. This composition seems to have been suggested by Hood's Poem: it contains a group of figures removing from the water, by torchlight, the body of a woman who has drowned herself. We are surprised that the subject has not been treated more frequently. There is much to praise in the picture: it is worthy of being painted larger, being characterised by all the earnestness of good Art.

No. 536. 'A Portrait,' J. R. SWINTON. A study of a female head; very loose in execution. Such works in exhibition do not assist a reputation.

No. 537. 'Une Soirée,' J. HAYLLAR. The title is not intelligible as applicable to the picture, of which the subject is a small society of men, whom the most unprejudiced person would at once pronounce to be *garrotteurs*. They are engaged in a rubber. The French title does not suggest any fruitful idea. The future fate of these gentlemen is evident; they are even beneath the respectability of the ticket-of-leave.

No. 551. 'Near Barmouth, North Wales,' ALFRED CLINT. This work is very successful in its description of space; it presents to the eye a vast expanse of country, comprehending all the elements of the beautiful.

No. 568. 'The Exercise of the Fan,' T. ROBERTS. The subject has already been treated in a large composition; and here it is interpreted by a single figure, that of a young lady, with that number of the "Spectator" before her which suggests the flirtation of the fan as a science. The head is very delicately painted; indeed, it is, throughout, a careful study.

No. 571. 'A Garden Scene,' J. FRANKLIN. A small composition, freely touched, containing an agroupment attired in the taste of the seventeenth century.

No. 574. 'Ferry-boats at Gean on the Danube,' J. ZETTER. The spirit of these sketches is equalled by very few that we ever see in this dissipated but sometimes pleasant manner.

No. 584. 'Toinette,' J. E. COLLINS. A study of the head of a girl in green drapery. It is fresh in colour and otherwise creditable.

No. 589. 'The Youthful Days of Mary Queen of Scots,' F. COWIE. So rarely do we see anything new in the way of subject-matter, that we cannot pass it without remark. We find Mary here with her uncle, Francis, Duke of Guise, and his wife, Anne d'Este. She is kneeling before him, and he is amusing her with tales of his wars. It is a happy subject, and bespeaks reading and thought.

No. 603. 'Job and his Friends,' C. ROLT. The force and substance which the artist has given to the patient man diminishes the reality of the other figures. The artist has had recourse to the Nineveh marbles for his costume.

No. 619. 'A Sketch,' P. WESTCOTT. A profile of a man's head, natural in colour and firm in manner.

No. 625. 'The Ballad,' A. BOUVIER. A small composition, agreeable in colour, but very faulty in drawing.

The Water-Colour Room contains a great variety of essays, among which the most prominent are—No. 637, 'The Green Market, Amiens,' J. DOBBIN; No. 645, 'Flowers,' V. BARTHOLOMEW; No. 655, 'Big lying to for a Pilot,' C. P. KNIGHT; No. 661, 'Summer Fruit,' MISS ADAMSON; No. 662, 'Interior of St. Paul's, Antwerp,' S. READ, a production of great merit; No. 668, 'Valley of the Medway,' R. P. NOBLE; No. 673, 'Flowers—Hollyhock,' MISS ASHBY; No. 674, "What! shall we have incision! shall we imbrue?" R. W. CHAPMAN; No. 692, 'Grapes and Quince,' MISS STEEDMAN; No. 697, and following numbers, 'Souvenirs de l'Opera,' J. R. POWELL; No. 711, 'Portrait in Crayons,' T. SENTES; No. 712, 'Portrait of Mrs. Frances Hammond,' MISS ROBERTS; No. 713, 'Roses,' MISS F. JOLLY; No. 724, 'The Rev. H. H. Beamish,' S. B. GODBOLD; No. 728, 'Miss Pickard,' CLARA E. F. KETTLE; No. 731, 'Portrait of Miss Burdaby,' J. HAYTER; No. 738, 'Robin,' MRS. WITHERS; No. 739, 'Moor Hen,' P. HOLLAND; No. 752, 'The Path through the Glen,' A. STANLEY; No. 762, 'Rydal Lake, Westmoreland,' C. PEARSON; No. 769, 'Enamel on Porcelain, after Etty, in the Vernon Gallery,' A. ROGERS; No. 777, 'Ravine near the Summit of Carnedd, Carnarvonshire,' W. EVANS; No. 785, 'Abbeville,' S. READ; No. 792, 'Richmond Park,' R. P. NOBLE; No. 799, 'Wickham Church, Kent,' R. NOTTINGHAM; No. 806, 'Little Red Riding Hood,' W. BOWNESS; No. 809, 'Fern Island, Coast of Northumberland,' T. HARRER; No. 813, 'Grapes and Pomegranates,' MISS STEEDMAN; No. 817, 'Study from Nature,' W. BOWNESS, &c. There are only three sculptural works—'The Industrious Girl,' and 'David playing the Harp whilst a Shepherd,' G. FONTANA; 'Bust of Marshal Pelissier,' F. B. TUSSAUD.

The catalogue, as we have observed, is more lengthy than usual, and the best works are those of the members; but it must be observed that, inasmuch as they themselves occupy all the best places, there is still little temptation for non-members to contribute pictures which they may have carefully elaborated.

THE ROYAL PICTURES.

THE CHILDREN IN THE WOOD.

J. T. PEELE, Painter. H. BONNE, Engraver.
Size of the Picture, 3 ft. 7 in. by 2 ft. 3 in.

A LOVE of Art, no less than the desire to cultivate any taste or faculty which nature has implanted in us, will develop itself in whatever circumstances an individual may be placed, although the rapid growth of such taste and faculty can only be expected when it is under the influence of an atmosphere most favourable to it. The records of many artists bear evidence to the truth of this assertion; and we find another instance in the history of Mr. J. T. Peele, the painter of "The Children in the Wood." He was born at Peterborough, Northamptonshire, in 1822, but migrated with his family, at the age of twelve, to America. After wandering for a considerable time from one State in the New World to another, in the hope of finding a locality that presented some prospect of success in business, the family at length settled down at the town of Buffalo, on the borders of Lake Erie. In this remote place the artist, for the first time in his life, saw an oil-picture by gaining access to the studio of an itinerant portrait-painter, whose works, whatever their merit or demerit may have been, awakened the Art-spirit within him, and made him ambitious of becoming a painter. But his father discouraged all such pursuits: he entertained the idea that Art was a "low occupation," and that idleness had prompted his son to select it, and he threatened to eject the boy from his home if he did not relinquish his purpose. In spite, however, of opposition and all kinds of difficulties he persevered; and as his father would not furnish him with money to buy materials, he begged a few dry colours and a little oil from a house-painter, manufactured a palette out of the lid of a cigar-box, and set earnestly to work on the portraits of his brothers and sister, whom he caused to sit to him day after day as models.

After some considerable lapse of time the father yielded to the inclinations of the youth, and supplied him with small sums of money to purchase materials, and at the end of a year or two he ventured to receive sitters for a trifling remuneration, and made so much progress that his father began to take a more liberal view of the profession, and furnished him with the means to study in New York, where he remained a year and a half—not greatly to his advantage, however; for while in Buffalo he studied nature alone, though without any definite knowledge of principles to guide him, in New York he was exposed to the danger of imitating the works—and these too, it may be assumed, not of the best order—of others.

On leaving New York, Mr. Peele came over to England, at the request of his friends here, who promised him patronage, which it was subsequently found could not be realised. After remaining in this country for three years, without profit in any way—for his means would not admit of studying in London—he returned to New York, partly abandoned portraiture, and commenced ideal pictures, in which children form the principal feature. His success was commensurate with the industry and talent displayed; he was elected a member of the National Academy of Design, and enjoyed the friendship of the most distinguished American artists. At the end of seven years he once more visited England, where he seems now to have finally settled down.

Mr. Peele, since his residence among us, has been a constant, though not a large, contributor to our exhibitions. In his pictures he aims at, and generally succeeds in, embodying the principles of high Art into the portraiture of children; and thus to remove the objection against the insipid and conventional style in which these charming little models are generally represented.

His picture of "The Children in the Wood" is skilfully treated, but the "hubs" are of a more humble position in the social scale than those which the old ballad speaks of. It was purchased by His Royal Highness Prince Albert, from the Society of British Artists, and is now in the collection at Osborne.







ALEX. COOPER IN THE FOREST

BY W. G. BROWN, OF LONDON.

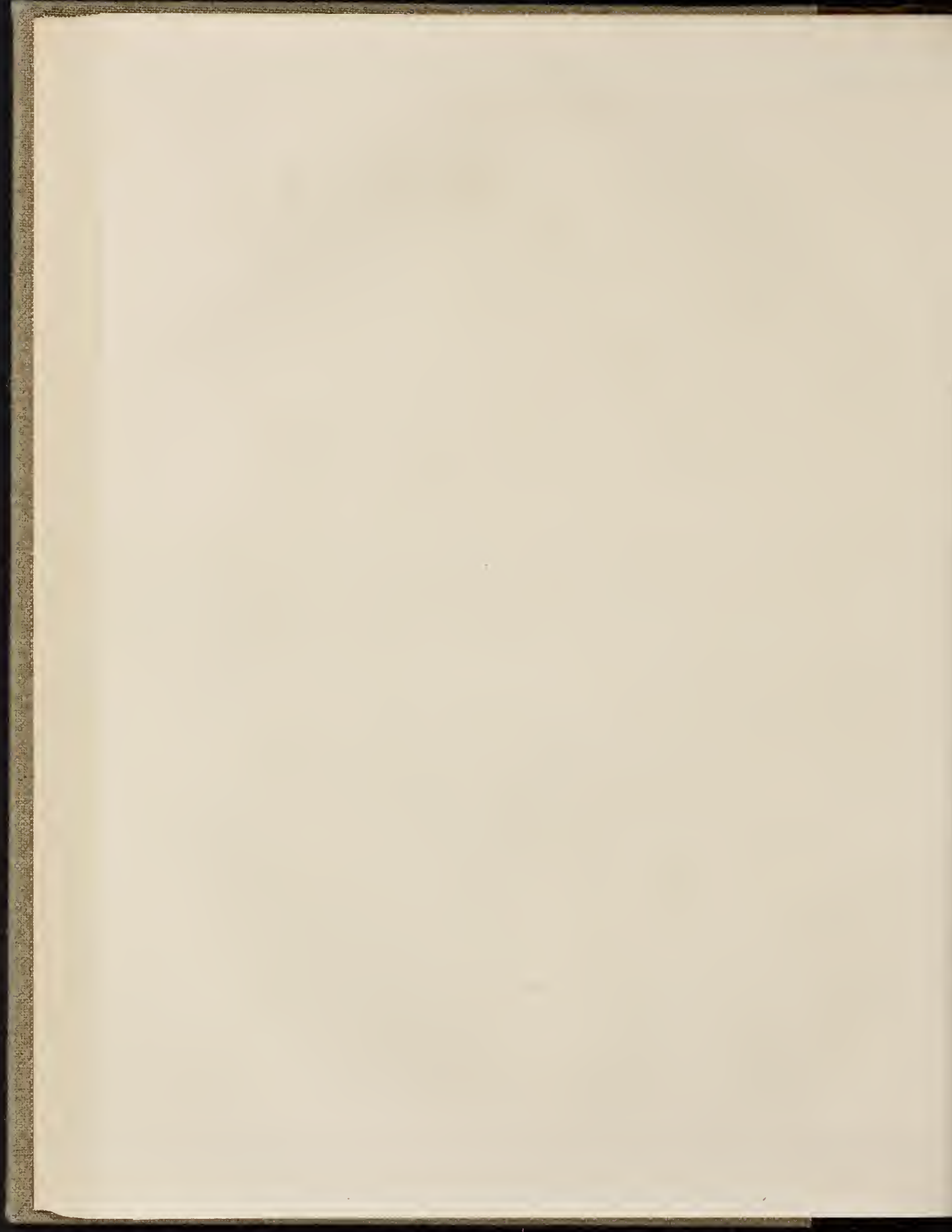

A FEW WORDS

ON OUR NEAR NEIGHBOURS' TASTE
AND OUR OWN.*

BATTLE PICTURES—"PUNCH" AND THE "ILLUSTRATED LONDON NEWS"—AMY SCHEFFER—CONCENTRATION IN ART—PAUL DE LA ROCHE—CHOICE OF SUBJECT—COUTURE'S PICTURE OF "THE DECADENCE OF THE ROMAN EMPIRE"—PAINTING, SCULPTURE, AND DECORATION.

Present.—MAGISTER and AMICUS.

Amicus.—I dare say they do send many a fine young fellow to the wars, for there is a deal in those battles of Vernet's to stimulate martial adventure and stir the mind. They certainly do this. They stir the mind; and I, for one, would not give a fig for a picture that does not do this in some way or other. Mere workmanship does not satisfy me, however good it may be; and, although I confess I should not like a battle-piece in my room, if battles *must* be painted, they should be thorough no doubt, and not sham-fights.

Magister.—They cannot be left wholly out of Historic Art, any more than out of History; and maybe are as indispensable in the one as in the other. But no,—they have not quite this excuse, inasmuch as a history—such as Napier's of the Peninsular War, which describes a series of battles and military manoeuvres—gives an actual account of what took place in each engagement, as far as records and recollection and documents go, without indulging in imagination or being forced upon it. While, on the other hand, the painter can only excite his work by means of his fancy. All he can do is to take a principal fact, and present it by the most likely groups, &c., that he can select from his ideas. These must be drawn from himself and cannot be actual, except by a chance so remote that it can hardly be taken into account. The life and death interest of a battle is so absorbing, that the coolest head cannot carry out of the field any dependable recollection that would serve faithfully the painter's art—the strangest contradictions as to details proceeding even from those who have been close actors. At such a time near combatants and dear friends are in total ignorance of what each other is doing; such is the dust, smoke, turmoil, thunderstorm, whirlwind, and hurricane of a mortal struggle! And the General guiding all is so occupied with his dreadful game of chess and its stake, that of course he does not notice the groups of his men or the incidents of the contest, except from a military point of view. So much is all this the fact, that there appears to be next to no chance, out of all the battle-scenes that have ever been painted, that any one representing a near point of view should be a truth.

Amicus.—Vandevelt used, I think it is said, to follow the fleets of his country in his own yacht, and make sketches of conflicts at a distance.

Magister.—At a distance; but those were naval conflicts, in which the ships, sky, and sea-scapes formed the subject, and not land to land struggles. Thus such may be more easily faithful to fact than land conflicts, the higher class of which, as works of Art, cannot be depicted except from near points, which nothing but an instantaneous photograph could give data for, and which it would require a bold artist to manipulate, even if he could get more allowance from the general to be "in the way" than even the *Times*' reporter.

Amicus.—But other historic works of Art, even of the most peaceful kind, cannot pretend to be actual facts in their details.

Magister.—Not wholly so, but there is more opportunity to obtain these, as the actors are not absorbed to the same degree, and there may have been spectators to leave records affording precise information, &c. &c.; but the more peaceful scenes do not, I suppose, require the same excuse for representation as we were thinking that battles do. In this view battle-

scenes are introduced into Art only as forming an indispensable part of History, while other historical subjects are chosen for their moral or pleasing nature, requiring no excuse for representation. You said you would not like a battle-scene in your room as a constant subject of contemplation. But there are other subjects of history that would be always acceptable.

Amicus.—Historical incidents, however, rather than historical events. For my own room incident, for a neighbouring gallery event; but *apropos* of photographs, what a photograph that would have been—to have been painted by the sun when it broke out after three days rain on the evening of Waterloo—just as the last French charge was made and over!

Magister.—It often occurs now, in reading history, what invaluable things photographs would be of such-and-such events, and such-and-such characters! Photographs are already part of history, and will become still more as the art advances. But *apropos* of the 18th. of June, 1815, I think if I had a photograph of that day, I would keep it to myself for the present. To speak in parliamentary phrase, it would be a curious return to get—the number of representations of that action that have been made and sold in Great Britain during the forty years that have elapsed since it took place—sufficient, I should think, for the present century.

Amicus.—We can't ignore Waterloo!

Magister.—But we need not emphasize it.

Amicus.—Or we should have to rechristen Waterloo Bridge and no longer foot it in Wallington!

Magister.—Bluchers were as *mal à propos*. I would not rechristen Waterloo Bridge; but were we to build a bridge now I certainly would not call it by that name. That battle—if once our strength—is now one of our national weaknesses. I have a theory that about eleven at night—unless there be some other special subject of interest—a party of Englishmen always begin to talk about Waterloo!

Amicus.—It comes in about the third cigar?—perhaps so. Well, we have other battles to "fight o'er again" now, and to paint—the Alma, and Inkermann, and Sebastopol. And so we may hang these over the other for the time being—as they do the modern pictures over the old ones in the Louvre.

Magister.—One quality of the great Duke's was his being to time—and his retirement from this mortal scene, be it spoken in reverence, accorded with this. Let us learn by him: and now that he has left us, and there is no annual banquet to celebrate the great day, leave the record of Waterloo to the page of history.

Amicus.—In Art we can well afford this, especially as we are agreed that we do not admire gory scenes. Still, however, we must not, I fear, flatter ourselves that we are really so very peaceful in our tastes. We may, it is true, turn away in disgust from the presentation of the more horrible actualities of war; yet it may not be denied, that if you see a shop-window with an engraving or picture of a battle in it, there are sure to be plenty of people looking at it. And see that ingenious caterer for us all, the *Illustrated London News*, who so well knows how beats the pulse of the public. There is never an action takes place, but a picture of it soon, marvellously soon, appears in that publication.

Magister.—Yes, marvellously soon, especially if you take into consideration the drawing and woodcutting. But this promptness and information must be little short of miraculous to the good country people, who doubtless religiously believe, as an article of faith, in the authenticity of all the details and pictured episodes, and of the actions and expressions of the people who are slaying and being slain!

Amicus.—What happy unsophistication; what would I not give to be in such a primitive state!

Magister.—Really, without hyperbole, however, some of the battle sketches produced in that periodical are among the most remarkable efforts of the time. They are done sometimes with great rapidity, by one of the artists especially, who thinks nothing of designing and dashing off a battle-piece *improvisata* on the wood

block, ready for cutting, while the printer's devil waits for it!

Amicus.—The marvel of that depends upon how long the printer's devil has to kick his heels in the hall before he gets it. Those sable gentry have often to wait a good while—waiting is one of the "institutions of their existence."

Magister.—I mean but an hour or so. These works, indeed, are looked at merely as sops for the public thirst for "true and particular representations of a late interesting and exciting event," and are apt not to be viewed enough as works of Art, although they satisfy so many requirements of it. There may be also some "pride of position" and Art birth-right about some of your regular built artists, which would seek to draw a line between the talent requisite for a regularly constructed picture, or statue, or aquarelle, and that manifested in these sketches. Assuredly all clever sketches might not "finish" equally well, but I have seen many sketches of the nature of which we have been speaking in the *Illustrated News* which would finish, to the best of my belief, admirably well, and which for spirit, action, variety, and expression, were not to be surpassed.

Amicus.—And how wonderfully some of them give the idea of distant multitudes with but a few hasty but artful strokes, on examining which you can hardly conceive how the effect is produced!

Magister.—Many of the inopportune pictures in that journal are true works of genius. They are, to be sure, in some degree epicurean, but so are leaders in the *Times*—the more the pity for both—but they are none the less excellent for that.

Amicus.—Certainly I have seen nothing in France equal in their way to our illustrations in *Punch* and the *Illustrated News*. Is not that rather strange? One would have expected just the reverse.

Magister.—It is hopeful for our Art-strength here, showing its real resources when called upon. There has been of late years a substantial demand for pictorial illustrations of the characters, events, and humours of the day, also for comic sketches of them, and it is well responded to. I quite agree with you that one would have anticipated that these were just the points in which the readiness of invention and execution, and the laughter-lovingness of our near neighbours would have given them advantage over us, and yet it is not so, for undoubtedly these two periodicals are superior to anything of the kind they produce. The demand for "periodical" Art is one of real commercial character, and behold how excellent is the supply. Long may these publications strive to keep their Art-work up to the highest level that the people demand. In this way they do vast good to the people and to Art; teaching the people through their eyes, that short road to the brain, and spreading among them a love of graphic pictorial and formative representation. I look indeed upon the class of publications which the *Illustrated News* and *Punch* represent, to be most valuable adjuncts to our progress. Their advantages are not confined to us, or even to those who speak our tongue,—as the language of the eye is universal—but spread their benefits through the world. What a public they have! They are true circumnavigators! Here—in this country—they have become integral portions of our Art. Taking their rank moreover as sketches, the light craft of the Art, they do a deal of good by whipping up your regular seventy-fours and three deekers to greater exertion. It would not do for the men of heavy metal to fall astern of these sloops and gun-boats! I believe that one influence of the excellence of our present periodic graphic illustrations is to raise the general standard of composition. Their excellence would never permit illustration in this country to sink again to the level of many of the plates in Boydell's illustrations of Shakspeare,—of which—I mean the bad ones—and other tame pedantic representations of that ilk, the last century bore no small crop. The wood-drawing and engraving of the present day is for Art what printing is for Literature. We can never again have a "dark age" in it.

* Continued from p. 91.

Amicus.—Then long life to them! I hope, however, that the "events of the day" may soon direct their pencil to softer scenes. We were talking of battle-pieces and Vernet's power in them, and the general vigour displayed by the French artists in their treatment of these subjects; but there is a style which is the direct reverse of this, in which France is also great. Are not Ary Schaffer's productions the perfection of taste and abstract refinement? A frankness of sentiment appears to hover about them! The beings of his pictures appear to live in a cloud region of essential existence. An angel element of pure air!

Magister.—There is indeed a peculiar delicate spirit in his creations that charms us, in spite, not unfrequently we must allow, of defective proportions and eccentric arrangements, just as we are smitten by the sweet expression of a female face of which the features are not regular. I know no works in which the magic of taste is more fascinating than in his.

Amicus.—And yet he seldom in them, in extent, goes beyond an ode or a sonnet.

Magister.—That is a chief cause of their quality, and he is led to it by his love of concentration, which he possesses in perfection. Everything superfluous is shed away. Nothing is left that does not tell its story compactly. In this, combined with refinement, lies his strength. I wish our artists would keep this a little more in mind; as the orator emphasised *action*, so would I, had I the powers, emphasise *concentration* as the essence of true force in Art. *Three figures are enough for the highest effort in Art.* Those in general are the best subjects that require no more. At any rate they supply the best mode of an artist's laying out his time. For in a picture treated in the *multitudinous* manner, and in which the *crowd* is relied on for effect—and I hate a crowd of all kinds,—a quantity of work that might be *so*, or might be *thus*, or might be *here*, or might be *there*—and is not essentially and vitally compacted with the main group and thought takes a long while to do, and is not of adequate effect, and only dilutes the work. While, on the other hand, how forcible is "everything in its place"—nothing but what is wanted—which must be *so* as it is done—and not anyhow else. As a high work of Art is not from any chance point in nature or history—but from a selected point, so should the details be selected. And the more the grosser particles are boiled away, the purer is the essence, the stronger the spirit, and the truer the result as a work. Just as with the poet, whose mission is, not to lead you over heavy acres where you have to make a long excursion and traverse many a weary step to collect spare flowers, but so to conduct you at once to the springy turf of a fresh meadow, rich with perfumed plants, or to a garden, where every step affords a fresh floweret. As in the drama the highest effects are produced by a few characters, and in music the most exquisite and affecting airs by a few simple chords, so is Art most forcible when she is closest to her theme, as comets are swiftest when nearest the sun.

Amicus.—At the same time it is evident that some of the most remarkable works of Art contain a multiplicity of figures, as the School of Athens, of Raphael, or the "Last Judgment" of Michael Angelo.

Magister.—Rather, perhaps, many groups than one multiplicity. Several pictures in one, each with their separate interest—but no crowd, and no superfluity—and thus neither of these works produce their full effect until the mind separates them into groups and separate interests. To these subjects many figures were *essential*. They could not be represented *otherwise*, but this is on a very different principle from that—not, by the bye, to be called a principle—which introduces a quantity of make-up figures to fill up the canvas, while the interest is confined to one small portion. Also in the case of both these great masters, I doubt whether their many-figured works would have excited so great admiration, had not their reputation been supported and their power exercised by works of lesser extent, and more concentrated sentiment. For my part, in the Sistine Chapel

itself, I am more impressed by the simple and individual figures of the Prophets and Sibyls than even by the great wonder and triumph of powers that occupies the end, simply because they are each a *concentration*, while the "Last Judgment," taken as a whole, and not in groups, is a *diffusion*; and the class of works produced by Raphael, on which his fame most firmly reposes, is surely that to which belongs the "Madonna del Sesto," with its wonderful divine infant; the "Madonna della Seggiola," &c. The great master, however, should of course be equal to the various requisitions of his art, among which are, doubtless, the filling of large architectural spaces, and the record of historic events comprising numerous personages, and in either case a large number of figures may be essential. As a general axiom, however, the stories best worth telling, are those which can be told with fewest figures.

Amicus.—The "School of Athens" reminds me of the great picture of De la Roche's in the Henricie, at the Ecole des Beaux Arts, that has just been injured by fire. It was evidently suggested by Raphael's work.

Magister.—It is fortunate the injury has occurred during the artist's life, so that it may be repaired by his hand, and still be De la Roche's instead of Mr. Somebody else's, the picture repairer. As you say, its plan is in some respects that of the School of Athens. It is a child worthy of the parent, and especially in the harmony of its plot—a collection of pictures in one—not a crowd, but a series of groups, each to be regarded in turn; and this is favoured by the horse-shoe form of the wall on which it is executed, which, bending round the spectator, prevents the whole work being presented at once. Its treatment is strictly in accordance with the architectural arrangement. It is a noble, thoughtful, philosophic composition, or series of compositions, full of dignified repose, and of the hiographic-historic class, but not of the dramatic and thrilling interest on which this great artist so often loves to found his works.

Amicus.—Not like the "Death of Elizabeth," or "Cromwell regarding in its coffin the body of Charles," or of the "Murder of the Duke of Guise?"

Magister.—All of which are full of vigour and reality, both in conception and execution. They may savour, especially the last, somewhat of the ruthlessness of French art, but that acknowledged, his themes are selected with a keen perception of dramatic point, and of the capabilities of the painter's art. They are, after their kind, excellent subjects. It is evident that De la Roche not only paints but thinks.

Amicus.—And I must say, the French artists as a body seem to be more alive to the importance of *subject* than we are here. The stories they choose are assuredly not always those that we should select, but they are stories—they tell something—whereas it is more common with our artists, than with theirs (I think), to be satisfied with a something that will make only a picture, superficially—which stops at the eye—at the portal—and claims no admission to the master of the house—the mind.

Magister.—And any one acquainted with exhibitions for the last twenty years, must have noticed how apt our artists are, as to subjects, to run in flocks. One person finds a mine, and more rush to it than it can accommodate. As at the diggings, when some keen explorer has found a precious nugget, crowds fly off to participate in his gains.

Amicus.—And when all the nuggets are gone, and but siftings remain, the earth is washed over and over, till the grains get very small indeed!

Magister.—And hardly worth picking up. A notable instance of this was the number of paintings we had at one time from the "Vicar of Wakefield." A remarkable picture or two was produced from this exquisite tale of English domestic life; and forthwith every one rushed to good Dr. Priuore's parish, as to a new spa! and we had Moses, and Olivias, and Sophias, and Mr. Burchells, till one was quite weary of them! The Wakefield fever continued in great force for many years, and even now is hardly extinct. However, by this, I do not mean, by any means, to cast any slur upon any of the

really charming pictures that have been suggested by Goldsmith's work—but only to regret that, while so many precious fields of subject and suggestion lie around unexplored, that our artists should choose to follow each other as closely as on a sheep track, and risk giving a first impression of satiety to the Art-lover, by being so gregarious in their search for pasture.

Amicus.—There seems to me more to be said in the way of excuse for this, as respects the "Vicar of Wakefield," than in most cases; inasmuch as the amount of good instruction, kindly feeling, unaffected piety, moral, and variety of scenes of English country life, as fresh as the mams of the family itself presented by that novel, is without rival in any work of fiction. However, if the painters are bad enough in this respect, what are the sculptors;—for ever a nymph preparing for the bath, or a nymph coming out of a bath! as if these bandsome young ladies had nothing to do but to wash themselves!

Magister.—And this while such a wealth of female characters is offered on every side by the historian and poet. This is a point that illustrates how few people really think for themselves, or how much people are obliged to others for thinking for them, whichever way you put it. Our old subjects are, however, I suppose, new to the French; so, perhaps, there may be a good many among their subjects which appear new to us, which are hackneyed to them; so we must not emphasise the discrepancy of the two nations too strongly; and, after all, it is more important to have a subject good than new: for an old subject may be made a new one by original treatment; but a bad subject cannot be made as good as a good one by any excellence of execution;—at best, then, it is a struggle of elements; while with a good subject you have wind and tide with you.

Amicus.—What a noble field for the display of the highest qualities of Art is taken by Couture in his great picture which was in the centre saloon of the Beaux Arts Exhibition.—The "Decadence of the Roman Empire" I think it was called. On the whole no picture in the French portion struck me so much, or so fully came up to my idea of a grand work. A theme for all time! The moral essence of Gibbon's "Decline and Fall of the Roman Empire" presented at a glance! Resting on no individual historic fact—although a fact—but its interest bound up in man's good and evil nature; poetic, philosophic, epic in its highest sense—presenting, in awful warning, the causes that sapped the mighty Roman strength, the fungus of evil and luxury that eat away its pith and core.—The scene rises up before me.—Stretched on couches round the board in a gorgeous hall, are grouped the imperial Romans with the most exquisite forms of woman-kind. Steeped in orgies they conduct their carnival, and mingle love, wine, feast, music and thoughtlessness in one unholy wreath. Here the gay reveller clasps at his fair companion, nothing loth. There she fills for him his overflowing cup, and binds his brow with scented flowers. There the thoughtless laugh, the gay, the impious jest, wreaths the young lip, crimsoned with the blood of the grape, and welcomed by long eyes floating in indolence and love. Wine—more wine is brought, with fruit, by the laden attendants, while the voluptuary lolls overcharged with feast, and the faded flowers droop from the brow of the satiated reveller, across whose racked brain the scene seems to swim and totter.—While from above—the marble statues of the ancient Romans that surround the hall appear to frown in sorrow down from their stone brows on the sybaritic scene of weakness and luxury that points with prophetic hand to the extinction of their country!—There—that is pretty well for one breath, is it not? but words will not describe a picture—at least mine can't. I think old Fuseli was about as good a hand at describing pictures as I know, especially when he was on his own ground—Michael Angelo. His words sometimes make the great Florentine's works glow before one, but it is given to very few to do this. I should think Eugene Sue could if he were to try—

perhaps he has done so, only I have not seen it—describe a picture as well as any one. For really he has the wonderful power to make us feel more by his description than if we were actually witness of what he describes. I recollect reading an account, I think it is in his "Julf Errant," of a black panther killing a white horse in a caravan;—He gives it with such extraordinary power, that I am sure I felt more horror in reading his description than I should had I really been present at the death of the poor brute.

Magister.—It is often a grief that the tendency of his works is what it is, for his powers of description are magical, and of dialogue, too. The French, who would not object to him on the score we do, hardly appear aware of the genius they possess in him, and even prefer to him those inferior spirits who possess only, in degree, those powers which make him so Samson-like in power. And as regards this picture of Conture's, the same thing may be said. Our neighbors do not seem to me to appreciate it high enough, nor to be aware of the treasure they possess in it. I agree with you, it is an admirable example of the power of subject, and that its moral renders it a work for all times. Its subject is thus the foundation of its excellence. The largeness of its theme inspired the artist throughout—gave wings to his power, and held him aloft above the usual level of Art; for it is excellent at all points. Its conception and composition are large, clear, well presented, and perfect in their adaptation to the painter's art. Had it not these qualities, it still would be admirable for the grace and drawing of the individual figures; and had it not the grace nor drawing, it would still remain a marvel of excellence of colour, and effect of light and shade.

Amicus.—I have heard it remarked that its general effect and colour reminds one of Paul Veronese's "Marriage at Cana."

Magister.—Perhaps:—and they are both feasts. That only shows, however, that its colouring is good.

Amicus.—I noticed bits in it wonderfully like Eddy.

Magister.—Praise again! For there have been few masters of colour equal to our countryman. His "Evo before the Flood" is a bouquet of the most exquisite and well-arranged gorgeous flowers, and yet as true as Nature's self.

Amicus.—There was one figure especially like Eddy; a female in the background with her hands up, behind a recumbent figure on the left-hand side representing Vicellus, dashed in and left half finished, as it were, yet giving the impression of finish, exactly after the fashion of some of the secondary figures in Eddy's pictures.

Magister.—I recollect. With an ivory-like complexion. Eddy's best flesh—was like flesh so beautiful that it was just like ivory.

Amicus.—Like Pelops' shoulder?

Magister.—The poetry of flesh, so firm, so pure, so polished, so delicate, and yet so vital!

Amicus.—I heard, while in Paris, that Conture had a pendant to this great picture—one representing the decadence of France—then in his studio.

Magister.—And how represented?

Amicus.—Oh, a gorgeous masquerade of French life and character—very severe and very sybaritic! but I only say what I heard. There was a quality in the picture that we have been speaking of that struck me as unusual—at least in degree—and yet not in the least stiff, and that was its ornamental arrangement and balance of parts. In the exact centre of the picture there was a group of forms made by, I think, the statue of Cato, and a male arm holding a cup, and a female's pressing grape-juice into it, which being, as it were, the text of the whole tableau, was at the same time its centre boss.

Magister.—And that is praise again; for a picture or a statue is none the worse, as a work of high Art, but the better for being essentially a work of decoration too. In many of the finest works this decorative element is evident; and a consequent degree of uniformity and balance, not, however, obtusive. The works of Raphael, Angelo, and Fra Bartolomeo, and fine Italian art in general afford many instances of

this. And in the sister-art the Venus de Medici has acquired much of her fame by being, as regards general arrangement, a piece of ornament. This renders it decorative on its pedestal wherever it is placed. The same with the group of the Cupid and Psyche, which presents a perfect vase form. The view of Painting and Sculpture that does not comprise ornament, or take it into consideration, is assuredly not complete. Paintings and sculptures are the highest kind of decorations, as men and women are the highest kind of animals—gifted with reason, if you like, instead of instinct—and with moral and intellectual attributes, in place of those of mere sensation; but still their structure in their material parts are on the same principles; and it is the small view of Art, and not the large one, that overlooks this. In this respect our European neighbours—French, German, and Italian—have all the advantage of us. With them pictures and sculptures are not looked at in so isolated a manner as they are here. There appears rather an unwillingness here among the followers of the two most intellectual branches to a claim of kindred being made by decoration, decoration being somewhat regarded by our painting and sculpture in the light of a poor relation, and hardly to be owned.

Amicus.—Like what Charles Lamb said of the monkeys!

Magister.—And the general public, and even Art-lovers, have much the same ideas; for although the number of collections of paintings are on the increase here, you often find them in the plainest possible houses, where you would not expect such treasures. While, on the other hand, with the French, you find all the kindred of Art more associated, and the higher branches relied on but in part for the attraction of their apartments. It is astonishing what the Parisians lavish on these occasionally.

Amicus.—Yes, I forget what Madame told me she had spent upon her boudoir, but something enormous.

A NOVELTY IN FANCY-WORK.

A YEAR has now elapsed since the publication in the *Art Journal* of a series of articles "ON DESIGN AS APPLIED TO LADIES' WORK."* On resuming the subject the following questions naturally suggest themselves, namely: Have the papers been productive of good? To what extent have the designs furnished by the shops improved in their ornamental character? and, Has the taste of those for whose benefit the designs are made been equally progressive? The answer to all these questions will, it is believed, be satisfactory; and it must be gratifying to the Editor of this Journal to reflect that not a little of the improvement in the public taste may be attributed to his increasing exertions, which now extend over a period of nearly eighteen years.

Although Fancy-work can never aspire to the dignity of a fine art, yet, the beauty and variety of which it is susceptible, the universality of its application, and its adaptability as an employment for the leisure hours of the affluent and easy classes, will always render it one of the most important of the Industrial Arts. Between the fine Arts and those of industry, there appears to be the following grand distinction. The former depend for their effect and value chiefly upon design, to which the technical execution is entirely subservient, hence the estimation in which each individual work is held as the single production of genius. The latter, on the contrary, are valued for the mechanical dexterity with which they are executed, and the frequent repetition of a favourite design is considered no deterioration of its value. In the one, the artist is identified with the *originality* of the design, and on this ground rests his claim to distinction; in the latter the workmanship is too frequently admired, while the very name of the designer is forgotten, even if any person were curious enough to inquire it. With needle-work, espe-

cially such as is practised by ladies, it is to be feared this will ever be the case; the pleasure of executing the work is the object they have in view; few will take the trouble to make designs which they can purchase for a trifle. Some few may acquire such a knowledge of the principles of design as may enable them to select good patterns, and in this we have endeavoured to assist them; but by far the greater part of the lady-workers will be content to take what is offered them at the shops, or make their selection independently of any governing principles of taste. They seek pleasure, not toil, in their fancy-work, and are content to follow it with as little labour as possible.

Under these circumstances it is gratifying to remark a general improvement in the character of the ornamental designs exhibited in the shops, and also in some contemporary publications. This progressive improvement is especially perceptible in the designs for fancy-work published weekly in the *Lady's Newspaper*. This paper is the only one which has adopted, and with apparent success, the plan of expressing colour by a variation in the strokes produced by the graver. It were much to be desired that this practice should become general in ornamental designs. Were it always adopted for designs intended to be coloured, it would not only obviate the expense of coloured engravings, but it would be scarcely possible for the copies in needle-work to exhibit inharmonious arrangements of colour, unless the copies themselves should be defective in this respect.



The greatest improvement, however, which has yet taken place in designs intended for ladies' work, is that which has been patented by Mr. George Curling Hope, of Hastings, for braid-work. But, before entering into a description of his "Patent Impérial Appliqué," it will be necessary, in order to appreciate his improvement, to make some preliminary observations on the description of fancy-work to which it is adapted.

Braid-work, as usually executed, consists, as our lady-readers are aware, in tracing the outline of a design with narrow braid, which thus constitutes the only ornament. Running patterns are usually selected for this work in order to avoid the inconvenience of frequently cutting and joining the braid. The design of the border as represented in the lighter part of the scroll wood-cut, answers this requisition; but, it may be asked, is the design satisfactory, and in what respects could it be amended? The grand defect is, that the design is not sufficiently apparent to the eye, for it is not otherwise distinguished from the ground than by the narrow edging of braid, which although only the *outline* of the pattern, really appears to constitute the *whole* of it. Designs, as I have before remarked,* should be varied from their grounds either by texture, by colour, or by light and shade. Now, in the above cut the ground and the pattern are exactly alike, and the eye cannot follow out the design without considerable effort, and even then the effect is unsatisfactory. Nor is this an extreme case; I have examined many patterns for braid-work, and found them deficient in this respect, and not unfrequently imperfect in their outline from the endeavour to avoid cutting the braid.

The only designs adapted for braid-work on a

* Inserted in vol. vii. of New Series, for the year 1851.

* See remarks on this subject in vol. vii. of New Series, pp. 74, 75, 136, 137.

plain ground of one colour are "strap-work," or geometrical tracery, or scrolls, which require no filling up, and in which the requisite continuity of outline is obtained, without departing from the braid-like character, which ought to be a continuous design of unvarying width.

Referring onco more to the wood-cut, let the reader try the simple experiment of filling either the ground or the pattern with a darker tint; the design will immediately become distinct, and a more satisfactory result will be obtained. If a white outline be preserved, the effect will be still better. But, it may be asked, how is this effect to be produced on the actual work; it looks well on paper, but how is it to be carried out in practice? It would be easy to vary a lace ground

by a pattern in muslin, the outline being over-cast or sewn, like that old point-lace; or to make the pattern in open stitch, on a muslin ground; but, although a design in satin on a merinos ground, or of velvet on a cloth ground, would look extremely well edged with braid, it would not be easy to execute such a design, so as to preserve the sharpness of the contour, and avoid rugged clumsy edges. I have, however, seen a very rich effect produced by forming a design of coloured flowers and green leaves of coloured satin, on a ground of claret-coloured merinos. The difficulty of the work would, however, prevent its becoming general.

By the invention of Mr. G. C. Hope, the difficulties and defects above alluded to are obviated. Instead of applying the braid upon cloth or other textile fabric of an unvaried colour, in the "Patent Impérial Appliqué"—for this is the name given to it by Mr. Hope—the design round which the braid is to run is produced in a different colour from the cloth forming the ground; thus producing the same effect as has hitherto been attainable only by cutting out figures from another coloured cloth, and laying them on the ground, a process which necessitates the consumption of a double quantity of cloth. This, as I have before observed, is also very inconvenient to work, from the edge of the figure rising above the ground.

The darker part of the border pattern is intended to show the effect of the same design when produced in a colour or shade different from the ground, and edged with coloured silk braid, or gold or silver twist.

The invention is a very happy one, and will not only be a great improvement upon braid work generally, but will, if I am not mistaken, induce towards establishing a better taste in design, and a more harmonious arrangement of colours. The colours being applied to the cloth by the patentee, are more likely to be harmonious when selected by a person who has studied design than when chosen according to the fancy of the person working it. As the variation in the colour is obtained by printing one colour upon another, there are some few difficulties of a chemical nature to be overcome. Time will probably remove these. Among some of the combinations of colour which are at present ready are scarlet

on black or claret; green, on dark green, black, or claret; blue on black; white on scarlet, blue, or marine; white grounds with two or three coloured figures.

The braid should generally be of a neutral colour, gold, silver, black, white, maize, &c. Every one who has studied the beautiful effect of Indian embroidery and decoration, must have perceived how much of the richness of the



No. 1.—BRAIDING AS USUALLY DONE.



No. 2.—PATENT IMPÉRIAL APPLIQUÉ.

design is produced by the decided outline which always surrounds the figures when the ground is of a contrasting colour.* The English embroiderers of the middle ages, who were very celebrated for their skill, always surrounded the flowers which were embroidered for the decoration of rich ecclesiastical vestments, with a raised edge of gold twist. The moderns cannot

do better than follow such good examples. It is only necessary to see some specimens of Mr. Hope's "Patent Impérial Appliqué," to be convinced not only that it is infinitely preferable to the common kind of braid-work, but that it is capable of producing very rich effects.

The circular wood cut underneath is intended



as another illustration of the superiority of Mr. Hope's process over that now in use; we submit the matter to the judgment of our lady-readers especially.

* The reader is referred for some remarks on this subject to the before-mentioned articles in the *Art-Journal* for the year 1855, pp. 136, 137.

THE ROYAL PICTURES.

AMALFI: GULF OF SALERNO.

G. E. Hering, Painter. E. Goodall, Engraver.
Size of the Picture, 2 ft. 10 in. diameter.

THE painter of this picture, like many other men, began life in a far different course from that which nature evidently intended him to pursue. He was engaged in a banking-house, where he busied himself more with sketching in blotting-books, than in attending to balance-sheets and ledgers. His family, seeing the inutility of keeping him to an employment so little suited to his tastes, allowed him to follow his own inclination, and sent him to study painting at Munich; subsequently Mr. Hering visited Italy, Hungary, and the East, returning to England after an absence of seven years.

Italy is the land with which the pictures of this artist are, without a single exception, identified; the first work he sent to the Royal Academy was in 1836, when he exhibited the "Ruins of the Palace of the Cæsars at Rome," and from that year to the present, the annual exhibitions of the Academy and the British Institution have seldom, if ever, opened without one or more specimens of his classic and elegant pencil; for these terms, perhaps, express his style better than any other. It was, however, some time ere his pictures got so placed on the walls of the exhibition rooms as to afford a fair opportunity of judging of their merits; he was indebted to the poet Rogers for first bringing him into notice, and it was with reference to this picture of "Amalfi." The work was painted in 1841, and sent to the British Institution, of which Mr. Rogers was then a director. Going to the Gallery one day, prior to the pictures being hung, he made inquiry after the painting sent in by Hering, who had a short time previously been introduced to him, and, finding it worthy of a good position, caused it to be well placed. The result of the poet's judgment and kindness was the purchase of the picture by his Royal Highness Prince Albert. Mr. Hering always speaks in terms of grateful acknowledgment of Mr. Rogers's act, as the first step towards his future success; he had never before sold a picture out of an exhibition-room. His works are now among the best illustrations of Italian landscape-scenery that grace our public galleries.

Amalfi is a small town in the kingdom of Naples, and is built on the steep declivity of a mountain, which overlooks the Gulf of Salerno. The artist's poet-friend thus refers to it:—

"He who sets sail from Naples, when the wind
Blossoms fragrance from Pustlips, may soon,
Crossing from side to side that beautiful lake,
Land underneath the cliff where once, among
The children gathering shells along the shore,
One laughed and played, unconscious of his fate;*

There would I linger—then go forth again;
And he who steers due east, doubling the cape,
Discovers in a covelet of the rock
The fishing town AMALFI. Haply there
A heaving bark, an anchor on the strand,
May tell him what it is; but what it was
Cannot be told so soon."

This little fishing town—for it is nothing more now—was once a large commercial port, renowned for its trade with Egypt and the East. The whole region round about the bay of Salerno is one of great interest, not alone for its picturesque beauty, but because it was the favourite haunt of some of the great painters of past years—Guido and Domenichino, Spagnoletto, Caravaggio, and Lanfranc; and since their time few artists visit Italy without including it in their travels.

Mr. Hering's picture shows but little of the town. He has taken his sketch from an elevated point overlooking the bay, while an exceedingly picturesque arch of red brick offers a striking fore-ground feature; the effect is that of a tranquil mid-day, somewhat cool. The artist has caught the true spirit of the Italian landscape—that air of listless luxuriance that pervades both the scenery and the people of Italy.

This picture, which is painted with great tenderness and transparency of colour, is in the collection at Osborne.

* Tasso.







1841

BRITISH ARTISTS:
THEIR STYLE AND CHARACTER.

WITH ENGRAVED ILLUSTRATIONS.

NO. XIV.—THOMAS CRESWICK, R.A.



ENGLAND is, of all countries, that in which landscape-painting has reached the highest point of excellence, and where it meets with the most liberal encouragement; and, perhaps, in the latter fact, we may find the cause of the former, inasmuch as a demand usually produces a supply. Nor would it be difficult to assign a reason why this class of Art is so generally esteemed among us: the English are proverbially lovers of the country—of its scenery, its occupations, its amusements, its retirement and quietude. The nobleman or the unfettered landed proprietor, whose estates have been handed down through successive generations, exults in his broad

acres as his eye surveys park and pasture, woods and bounding corn-fields; and, while he feels they are the sources whence his wealth is procured, and his position in society maintained, he admires the beauty of the landscape—he plants and cuts down, he opens out views and closes up spaces, to aid Nature in forming the picturesque. The merchant and the prosperous tradesman, unlike those of most continental cities, leave the mart, the counting-house, and the shop, when the labours of the day are over, for their suburban villa, with its neatly-trimmed lawn and well-stocked garden, and half-a-dozen acres of grass, perhaps, for the cow and the poultry; and these become aids to the enjoyment of real rural life. And, descending to a yet lower scale of society, the mechanic, whose mind has not become vitiated, and his senses dulled by the gin-shop—the great curse of England—finds relief from his ceaseless toil, on the few holidays that fall to his lot during the year, in wandering with his wife and little ones into some remote outskirts of the city or town wherein he dwells, that they may breathe the air of scented flowers, and refresh their eyes with the verdure of the green fields. "The architecture of castles and palaces," says an American

writer, "the statues of local divinities, the designs of esentcheons and sepulchral monuments, address the feelings both of love and pride which bind generations of men together," but there is something which addresses the feelings, and invites the admiration of every human being—though its voice speaks more eloquently and persuasively to some than to others—and that is Nature, in her grandeur and her simplicity, in her tempests and her calm. In such contemplation the peer and the peasant, the lettered and the ignorant, stand on equal ground; science, philosophy, education, a cultivated taste, are needless, as they are unoperative, to create a love of the beautiful, or for its appreciation. A man can no more shut his heart against its influences than he can effectually seal up his eyes to the brightness of the meridian sun; and though he may be unable to explain how he is affected by the light of the one and the magnificence of the other, he feels his sensibilities awakened, and is glad.

We are not among the number of those who regard landscape-painting as an Art requiring little mental capacity, nor even as one of a comparatively inferior character. The eye that is ever resting on the amplitude and the glory of the works of a Divine Maker—the imagination that is filled with their beauty and their power, receives what must expand and elevate the mind. Can that be an inferior Art which portrays the thunderstorm as it echoes from peak to peak of Alpine mountain, till every living creature is awed by its terrible majesty—that paints the sun as he wakes up a world from its slumbers, or decks it with a "robe of molten gold" as he sinks in the western horizon—that brings before our eyes the rushing of the cataract, or the murmur of the rivulet, so that we fancy our ears catch the rippling of the one and the roar of the other—that leads us beside pastures of living green, or into the cool recesses of the shady woods—that shows us the husbandman binding his sheaves, or dotting the meadow with tiny mounds of newly-mown grass? Is that an Art of inferior degree which compels the closest studies of the subtilties and the delicacies of Nature in her ever-changing woods, her infinite varieties of material, and her operations; which requires a certain amount of botanical knowledge to delineate the forms and the anatomy of trees and plants; of the science of geology, with reference to the shape and colour of rocks and other irregular masses; of so much of meteorology as to understand the laws that regulate the action of the sun with reference to light and shade, the motion of the clouds, and atmospheric appearances; and of chemistry, with regard to the uses and properties of colours? We do not say that every good landscape-painter has all this knowledge in himself, so as to be able to give a rule for whatever he does; but he must possess a practical knowledge—though he may be partially ignorant of theories—or he will never become a faithful



Engraved by

THE ENTRANCE TO THE COVER.

[J. & G. P. Nicholls.

copyist of Nature; and if landscape-painting requires so many varied attainments, each being in itself of a high character, such an Art must not be lightly spoken of, as one of secondary degree. We doubt much whether any class of Art offers to those who practice it so much real enjoyment, for, whether sketching in the fields, or working in the solitude of the studio, they are always surrounded by the beautiful; like the children of Israel, when thick darkness overspread the land of Egypt, they have ever "light in their dwellings."

The name of the artist to whose works we now propose to introduce our readers is closely identified with our school of landscape-painters. His biography may be written in a few lines: the story of his life is on his canvases. Mr. Creswick was born at Sheffield, in 1811; of his lineage and his first essays in Art we know little; but we believe that he acquired some knowledge of painting in Birmingham. However this may be, he soon found his way to London; for in 1828 he had taken up his abode in the neighbourhood of St. Pancras, and

exhibited two pictures in the Royal Academy, one of which attracted our attention especially, for on turning to our Catalogue of that year, we find a mark of approval against "No. 37. Llyn Gwynant, North Wales—Morning, T. Creswick." As the works of a young artist, especially if he be a landscape-painter, admit of little else than a kind of general criticism, we briefly pass over the first few years of Mr. Creswick's appearance before the public, with the remark that he became a regular contributor both to the British Institution and the Royal Academy, each successive year bearing witness to his industry, his progress, and his popularity. Looking over our piles of catalogues of this period we see a commendatory note against many of his pictures, the scenes of which are laid chiefly in North Wales, Yorkshire, Lancashire, and the adjacent counties.

In 1836, Mr. Creswick removed to Bayswater, where he still resides, and where he had as a neighbour another of our distinguished landscape-painters, the late Sir A. W. Callcott, R.A. He must have visited Ireland about this time; for some of his exhibited pictures were

views taken in that country, such as "Blackrock Castle, Cove of Cork;" "Gleazariff, County Cork." We have, however, rather an indistinct recollection of a picture painted in 1838, of a very different character from these; it was called "The Wayside Inn—Market-day," a cleverly-painted composition, representing one of those picturesque incidents of rural life which this age of iron horses has almost driven off the road.

Callcott and Collins were at this period the two artists whose delineations of English scenery were held in the highest respect; yet it was quite evident there was another rapidly advancing, not to push them from their thrones, but to share in the honours they had acquired. Creswick, however, was no copyist of either; he followed Nature alone, and so closely, that in many of his early pictures there is such an undue preponderance of the vivid green peculiar to our trees and herbage, as to be painful to the eye on canvas, however welcome it is in the real landscape. There was also some apprehension in the minds of those who were watching



THE HAWKING PARTY.

his progress, that the delicacy of touch and attention to detail which his works showed would degenerate into prettiness—an error that a painter finds difficulty in amending if it once becomes a practice. But the pictures he exhibited in 1841—five at the British Institution, and three at the Royal Academy—entirely removed whatever apprehension existed: he seems all at once to have struck into a new path, one uniting vigour and boldness of handling with debecacy, and greater variety and harmony of tints with the fresh verdure of Nature. Two of the pictures of this year may be singled out as decided examples of improvement. "A Road Scene" (British Institution), into which a blacksmith's shop is introduced; and "A Rocky Stream" (Royal Academy): these are both most vigorously touched. The former is an evening scene; the dim light of closing day is very skillfully managed, and the reflection of the blacksmith's fire on the adjacent trees is perfectly illusive. The "Rocky Stream" is a small picture, but—our readers must pardon an unintentional pun—it is a gem of the purest water, boldly and vigorously painted, the strength bappily mixed with debecacy.

The "reign" of Mr. Creswick may be dated from 1842, when he exhibited two pictures at the British Institution—"Afternoon" and "June"—which surpassed all previous efforts. These were followed, at the Royal Academy, the same year, by three others, concerning one of which, "The Course of the Greta through Brignall Wood," we expressed the following opinion:—"The subject of the picture is a bower of greenwood, woven by Nature over the course of the Greta, amid the rocks and stones of which struggles a shrunken thread of water. The foliage is painted with the accustomed excellence of this artist, and a portion of it conveys perfectly the effect of the light of the sun breaking without the screen of leaves. It would be difficult to exaggerate in praising the works of this accomplished artist. He paints facts; at least, he always seems to do so, for his works are full of what appears strict truth; and, at the same time, he always contrives to make a poem of a picture, no matter how insignificant may be the scene: a solitary tree, a lichen-covered rock, a bubbling rivulet, become most graceful when touched by his almost magic

pencil." In the autumn of this year he was elected an Associate of the Royal Academy.

It would be vain to attempt—and, indeed, it is altogether unnecessary—to give a *catalogue raisonné*, in our limited space, of the works of so productive a painter as Mr. Creswick, we shall, therefore, only just note down a few of his pictures, the recollection of which has not yet left our memory. Where an artist, as he has done, adheres so closely to one range of subject-matter, and with very little alteration of treatment, it is difficult to avoid sameness of description. Welsh glens and mountain-streams, skirts of forests and avenues of lofty clms, luxuriant valleys and winding rivers, however variedly disposed in Nature or in Art, are not the materials on which to comment without hazard of

repetition and monotony; hence the landscape-painter taxes the ingenuity of his critic or biographer far more than the painter of historical or *genre* subjects.

A "Welsh Glen" (Royal Academy, 1843) is a picture that those who have once seen it will not soon forget. It is a bright summer's-day, but the stream, flowing down between lofty perpendicular rocks, crowned with thick foliage, is in deep shadow, presenting to the eye a solitude of exceeding beauty and solemnity, *nullo penetrabitis astro*, for the only ray of sunshine that lights it up falls on the crest of the rocks and on the trees. The "Mountain Torrent" (Royal Academy, 1844) is a highly poetical treatment of a similar kind of subject. The scene lies, we should think, in Scotland, the rocks being bolder and more ragged than those generally found in Wales, and the torrent broader



Engraved by

THE PLEASANT WAY HOME.

[J. & C. P. Nicholls.]

and wilder in its impetuous rushings: the tumultuous dashing of the water is finely expressed in this work.

In the British Institution, in 1845, was a picture, not very large in dimensions, which was rather a novelty from the hand of this painter; the subject was an Old Water-mill; so venerable it seemed, that the oldest inhabitant of the parish in which it then stood could scarcely remember to have heard the cliking of the wheel, decayed and worn out. Every item in this work is painted with exceeding fidelity, yet it leaves an unpleasant impression on the mind by its truth; it suggests a thought of bankruptcy, ruin, and distress. In the same room, and at the same time, hung another work, totally different from all previous—and, so far as we recollect, from all subsequent—pictures by Mr.

Creswick, a passage of Alpine Scenery, painted, we presume, from a sketch by some other hand, for we do not remember to have heard that he has ever travelled into the country of the Alps; at all events he has never, we believe, made it the subject of his pencil except in this instance. The picture is painted with great power and feeling, but we prefer the artist in England. Of five pictures exhibited at the Royal Academy this year, two especially deserve to be pointed out for their picturesque composition and freshness of colour—"The River in the Glen," and "Rain on the Hills;" it is impossible to imagine any landscape scenery more beautifully painted than are these subjects.

Have any of our readers ever journeyed into the Weald of Kent in the autumn of the year? if so, they must have witnessed such a sight as no other country

in the world—and we may add, if we consider the general aspect of the landscape, no other county in England—can furnish: a vast range of hop-gardens, over which the eye traverses till it meets the horizon, or rests upon the thick masses of foliage of some distant wood; the tract itself relieved from monotony by noble oaks and elms, that frequently serve to shelter the plants from unfavourable breezes. The vineyards of southern Europe can show no scenery more picturesque and luxuriant than these gardens, which Mr. Creswick made the subject of a charming painting, exhibited at the British Institution in 1846. The peculiarity of the subject required, on the part of the artist, much patient labour, united with taste and skill, in the management of materials possessing great uniformity of character; these qualities are quite apparent in his picture. "Haddon Hall" has been a favourite spot with this artist; he has frequently painted it from different points of sight; one of his most interesting views to us, was that exhibited in the Academy in 1846, representing the well-known flight of steps leading from the garden to the terrace, with the ancient yew-trees and spreading elms: the subject is treated with great originality, but with unaffected truth. "The Valley," exhibited at the same time, is a well-remembered picture: a large open landscape, taking in an extensive and varied range of country, the whole lit up—except the immediate foreground, which is in shadow—with the most glorious sunshine. Another contribution of this year, "THE PLEASANT WAY HOME," engraved on the previous page, is a scene to cause envy in those who, like ourselves, are compelled to trace their way

home through lines of bricks and mortar, instead of such a noble avenue of green leaves, dancing to the music of the summer's breeze, as we see here.

There was a picture exhibited by this artist at the Academy, in 1847, which bore the simple, yet comprehensive, title of "England;" and certainly our rich and verdant landscape was never more exquisitely represented than in this work, the largest we recollect from his pencil; it is, we imagine, a composition, not a sketch from Nature; but England boasts many such scenes,—a wide expanse of country, corn-fields, and pastures well watered, homesteads, and distant spires that mark the spots where

"The rude forefathers of the hamlet sleep."

This picture ought, on every account, to have found a place in our National Gallery. Indeed, this painter never at any former period came out in such power and general excellence; while we are quite sure he has never surpassed his productions of 1847, an *annus mirabilis* with him: let those who can, recall to mind his "Doubtful Weather," and "The London Road a Hundred Years ago," to prove the truth of our assertion. How magically the light plays over the barren heath in the former picture, and how charmingly it alternates with the broad transparent shadows!—in the latter, the landscape is not only rendered with the most poetical feeling, but there is in the composition a group of figures introduced such as we have never seen from his hand: whoever owns one of these three works, possesses a treasure of Art he cannot value too highly.



Engraved by

SPRING-TIME.

J. & G. P. Nicholls.

Among the five pictures contributed to the Academy Exhibition the following year, we remember one that, had Colburn been living at the time, we should have ascribed to him, both on account of the subject and the treatment. A coast-scene was a perfect novelty from the pencil of Creswick, yet in his "Home by the Sands" we have a work as truthfully and skilfully painted as if he had all his lifetime been accustomed to study by the sea-shore, in place of glens, woodlands, and

"Rivers by whose falls,
Melodious birds sing madrigals."

The sands are traversed by groups of country-people returning from market with their purchases, in carts, in baskets, &c.; the tide has ebbed out, leaving here and there pools of shallow water which reflect the evening sun; the whole shows most careful and accurate study of Nature. There was also another sea-side scene exhibited at the same time, called "A Squally Day;" it pleased us far less than the other, though the intent of the artist is carried out with unquestionable ability.

In 1850 the name of Mr. Ansell appeared, in conjunction with that of Mr. Creswick, against a picture exhibited at the British Institution, under the title of "Southdowns;" the "Downs" or landscape being, of course, painted by the latter, and the "Southdowns," or sheep, by the former. Each did his part marvellously well; so well, indeed, as to induce them to work together again at various subsequent times,—just as Mr. F. R. Lee and Mr. T. S. Cooper are accustomed to do. The "Wind on Shore," an Academy picture of the same year, gave another proof of the talent of Mr. Creswick in depicting coast-

scenery; it would be hard to say whether in such subjects, or in those with which his name is more frequently connected, he shows greater excellence. He was elected Academician at the end of this year; and here we must conclude our reference to particular pictures, which we have selected almost at random from those that are most vivid in our "mind's eye."

We have spoken of the year 1847 as Mr. Creswick's great year; a few, perhaps, of his subsequent pictures will bear comparison with it, but certainly not those which have appeared during the last three or four years. If he has not fallen into the "sear and yellow leaf," he has adopted a low and dingy scale of colouring, which, in a very short period comparatively, must place them on a level with the smoke-dried old masters that are now rarely to be found but in the shop of the broker. This practice is not new to him; it was tried once before for a season or two, but he had the wisdom to perceive his error and to amend it; let us hope he will do so again. Humbly speaking, many years of active labour are before him; the pastures of Old England are as green as ever; her forests and her dingles have lost none of their bright verdure; her mountain-streams and rivulets still flow joyously and sparklingly: the eye of the painter cannot surely be blind to this; why then should he try to tempt us into the belief that Ichabod is written on the forehead of our land, or that he himself cannot see as he once saw? Though we have many other excellent landscape-painters, whose works always afford us exceeding pleasure to contemplate, we are most unwilling to have our admiration of Mr. Creswick lessened—we do not mean by comparison with others, but with himself: of late, such comparison is certainly unfavourable to him.

A NEW PLEASURE. THE MARINE AQUARIUM.

BY MRS. S. C. HALL.

"'Tis said that Xerxes offered a reward
To those who could invent him a new pleasure."
BYRON.

HAPPY are they who to admiration of the beauties of nature—inseparable from a feeling and reflective mind—add a knowledge of the causes and effects of what the Giver of all Good has so abundantly scattered, not only over the face of earth, but underneath the waters. Yet so universal are the wonders of creation that those who go "abroad in ships" do not encounter greater marvels than are to be met with in standing pools, or mingling with the murmurs of tiny rivulets "at home." To the lover and observer of Nature nothing is barren, nothing "common or unclean;" the blade of grass, the drop of water, the sparkling pebble, the stiff clay, the teeming mould, the rocky fragment, the glittering sand, the whispering shell, the bursting bud of the wayside flower, the penetrating subcan, the pale ray of the quenchy moon, the crystal salt in the chasm to which the wave seldom returns—all are suggestive of thought, and all may be sources of enjoyment—while all, insignificant as they seem, are essential parts of a mighty whole.

In the bright summer or cooler months of autumn, who reside in London think it as much a duty as a pleasure to inhale the freshness of the country, and return from our rambles to our city homes laden with "specimens" of the material world, or flowers and ferns that will keep "green memories" amid the snows of winter; we enrich our "fern-houses" with tributes from our Glens or Highlands, and few things cheer us more than the remembrance of how the little plant was obtained, and who assisted in the gathering. Dried leaves have too much of death about them to convey unalloyed pleasure to the living, and we consider "Ward's cases" to be acquisitions for which all town dwellers are bound to hold the inventor in high esteem—the living memory of many a mountain marble is enshrined in a "Ward's case," or even beneath a simple bell-glass. But we Islanders are too fond of the element to which we owe our safety as well as our restraint, not to seek its shores, if we cannot cross its waves; and until lately the only moments we could bring away of the storm or quiet of the deep were dried "flowers of the sea," or beautiful shells, the least perishable of all the forms that enclose life: our own, alas, soon mingle with the dust to which they are doomed to return, while the dwelling of the periwinkle and the limpet seem to endure "for ever."

The "new pleasure" to which we invite our readers, has to do, not so much with the homes of the limpet and the periwinkle, as with the manners and customs of their inhabitants. We have become in some degree familiarised with the small family, and understand their value in keeping the plants that flourish in our glass-bowl from being coated with "fnn" or slime. We have advanced a good many steps in our treatment of gold fish; we no longer doom the little animal to an eternal swimming mill, without the relief of shade; we permit him to meander through groves of the delicate *Valisneria*, and in the centre of his crystal palace we build him a miniature Stonehenge, wherein he can play at hide-and-seek, and enjoy a cozy nap without disturbance, or even observation; we introduce to his habitation a tiny shoal of minnows—most frolic-loving things—which, when we tap the glass, flock to the surface and greedily devour the fragments of "pastry cook wafer" which, though they never did banquet thereupon in their natural state, they much enjoy in their captivity. We have learned from Mr. Warrington to treat the tiny stickleback with as much respect as we were taught in childhood to bestow upon the beaver, and recommend our

young friends to purchase a miniature aquarium especially for them, and so have the pleasure of observing the care bestowed by father stickleback in the formation of his family mansion, and the parental attention he pays to the protection and education of his young masters and misses, whom he keeps from the jaws of devouring minnows. We understand all such creatures better than we did, and it may be they return the compliment.

Our own special "new pleasure," however, is the MARINE AQUARIUM. Concerning this drawing-room "romance of nature," we borrow a pen better qualified than ours to deal with the object to be attained, i. e. the arrangement of a collection of animals and plants in salt water, in such a manner that, by the working out of natural laws, the whole may be permanently self-sustaining and self-purifying, without frequent change of the water being necessary.

The circumstances which brought about the growing taste for such an agreeable adjunct to our homes as the Aquarium, were mainly some experiments on the domestication of marine life, commenced—almost simultaneously—about five or six years ago, by Mr. R. Warrington and Mr. P. H. Gosse.* Then came some popular, accurately written, and beautifully illustrated books on the subject, by Mr. Gosse, followed by the opening to the public, in the spring of 1853, of the large and magnificently appointed aquatic collection of the Zoological Society, in Regent's Park, London, which produced as important effects on the branches of natural history to which it relates, as did the previous great event of 1851, in Hyde Park, on the sciences at large.

"No sooner was it found possible thus to make daily acquaintance with the 'manners and customs' of a great variety of curious organisms previously hidden from all except professed naturalists, than many old notions on their natural history became exploded, and indeed it would be easy to name more than one accepted text-book, dozens of pages of which must be cancelled by the aquarium-experiences of the last few years. Of course the desire to have Aquaria at home became obvious. In fresh-water, it was an easy matter to plant aquatic vegetation among gravel at the bottom of a vase, and to put in fish and other animals; but the attempt to set up a marine collection and to maintain it in a healthy state, involved many difficulties. The supply of sea-water was uncertain and costly, and even when obtained, its purity, and that of the vessel in which it was brought from the coast, could not always be depended upon. In cases of accident, too, the whole of the livestock might perish before a fresh importation of water could be made. At length Mr. Gosse stepped in with a formula for the manufacture of an artificial sea-water from its constituent salts, which, after adequate trials, has been found nearly to answer every purpose of actual sea-water.†

"It then became necessary to obtain the animals and sea-weeds from the coast. This, to residents inland, was a matter of difficulty. Amateurs could not always find the time and means to visit the sea-side and collect for themselves. Nor was it always practicable to employ an agency for the purpose; to hire a man to procure and transmit so small a quantity of specimens as would merely suffice for a vase or tank, would obviously be working at a disadvantage both to collector and purchaser. In short, it became essential that some one in the metropolis should be found willing to 'set-up shop' in this kind of 'marine stores'; to establish a regular communication with the coast; to receive consignments at stated intervals; and to be willing to retail them in any quantities according to the variation of the tastes and means of purchasers."

This important object has been attained: and although we furnish in a note some information

* Mr. Gosse, writing in the "Magazine of Natural History," in Oct. 1852, states that "priority of publication is universally acknowledged to give a title to whatever honour attaches to a new discovery, and this I shall not dispute with Mr. Warrington."

† Previously, however, (in 1839) Dr. Schmitzer had made marine salts, for the formation of artificial sea-water, after his own analysis of the Channel water off Brighton.

for the guidance of our readers, we have no doubt there either are—or will be—in London as well as at the sea-side, many other ministers to the wants of purchasers.*

We commenced our salt-water "Aquarium" under the most favorable auspices. The accomplished secretary of the Zoological Society was so good as to order for us a tank of "suitable" dimensions, and permit one of his intelligent keepers of "marine stores" to arrange the interior of our mimic ocean; he also gave us the necessary quantity of sea water, "dipped up" from the Atlantic, and some excellent advice; but we furnished our tank as young house-keepers are apt to furnish a house—with much more than was necessary. Every specimen we could collect was floated into "the tank." We should not, during the days of our young experience, have hesitated to have introduced a juvenile shark or cod fish into our marine menagerie. It was in vain that the Hermit crabs gathered in their claws, that swimming crabs and other crabs crowded from the bottom, and endeavoured to reach the summit of the rocks to escape with life from the noxious gases generated by dying and sickly fish without a sufficient counteracting influence of marine plants; it was in vain that the pined *Crassostrea* bloomed and died within a day, that the *Actinia bellis* (the hardy daisy), refused to implant itself among our pebbles—that the *Salicella* crept out of their cases, and the delicate *Actinia dianthus*, and even the hardy *Mesembryanthemum* let their tentacles droop in unhealthy inertness; still we continued adding instead of withdrawing, pouring in half-pints of innocent periwinkles, and half-dozen of springing shrimps, until in a few days the water became offensive, and the whole contents of "the tank" was obliged to be thrown away! We were "all in the wrong,"—and in addition to the information derived from the secretary of the Zoological Gardens, from the kind counsel of Mr. Gosse, as well as from his books, varied and beautiful as they are; from that also of Doctor Farre, who wrote concerning the interest of those sea-creatures some twenty years ago; in addition to our sea-side experience during the autumn, and our daily access to Mr. Heale's picturesque cottage at Ilfracombe, where, beneath a bow of roses and woodbine, his bright and pretty daughter has become as familiar with "*Madrepores*" and "*Salicella*" and "*Actinia*" of all kinds, as the generality of village maidens are with "*primroses* and "*buttercups*," in addition to the inspirations of "*Glaucois*" and the concentrated wisdom of the pretty square books published by Mr. Reeve; though we waded ankle-deep at least in Watermouth Bay, and explored "tide-pools" and wide-spreading sands in the bewitching localities of Ilfracombe and Torquay; in addition to the advice of friends, the information of books, the frequent inspection of the Vivarium at the Zoological Gardens, the "peeps" graciously afforded into the "tanks" of Mr. Gosse, Mr. Warrington, and others learned in Zoophytes—and, moreover, acquaintance with the varied creatures to be seen in Mr. Lloyd's sale-room, in the towers of Capstone Cottage, Ilfracombe, or in the pretty "Shellery" of Mr. Pike, at Brighton—we had to learn the lessons that are taught only by EXPERIENCE.

Atmosphere and light, and the least difference in position have such an effect both upon

* This commercial link has been satisfactorily supplied by Mr. Lloyd, of 164, St. John Street Road, Islington. Mr. Lloyd, from whom we have derived much information, not only sells one, two, three, or five, as may be wished, of these charming creatures the Sea-Anemones, and Madrepores, and curious fun-shaped Tube-worms, together with sea-weeds in proportion, but he also keeps on hand numbers of glass jars and vases neatly stocked, and with all the contents in a flourishing and domesticated condition, of such sizes as can be conveniently carried away in the hand, thus saving to the non-seasonal all trouble and anxiety on the score of the accurate adjustment of the "balance of life." Here then we have an entirely new trade established in a locality where originality would seem to be most difficult—even in London, where it is proverbial that "anything may be had for money;" and, as if to make the proverb more universally true, we have just shown that it is now possible to buy a mimic ocean, fully equipped. Mr. Lloyd also sells the marine salt we have alluded to together with Aquarium vessels empty, of all sizes and shapes, both rectangular and curvilinear, specific gravity tests, and all other appliances, not only for marine, but for fluvial collections.

weeds and waters, that nothing but *observation*, in fact—will enable you to maintain a marine Aquarium in health and respectability. If you give too much light the water resists the intrusion, and becomes opaque; if too little, the animals pine away. You must have practice and patience: in truth there is as much pleasure in both these virtues as in the peace and prosperity of your "Aquarium." We tried the sea-water three several times, and with the same result; we ceased to overstock our sea farm, yet still the creatures died! The water was thrown away and the shingle washed over and over again; and an Irishwoman, a "help," who assists all our experiments, declared, "No wonder people got say-sick crossing the sea, if the water was all like that!" At last, by Mr. Gosse's advice, we put our Aquarium under Mr. Lloyd's care; he nearly filled it with the composed water, replaced our weeds and shingle, and arranged the flagging *Actinia* in what he considered the best situations. The next day the water looked nearly clear, a delicate *Dianthus* had adhered to the glass, several *Bellis* had fixed themselves in the shingle, and those hardy fearless *Mesembryanthemums* were in their full bloom of activity. We felt singularly elated—we should have been so glad to have shown our minnie caverns, over which floated banners of the green *Ulva*, to Mr. Mitchell or Mr. Gosse, or even to the triumphant Mr. Warrington, who has kept his sea-water unchanged for upwards of five years, and whose venerable prawns prowl about perpetually, seeking what they may devour.

But soon after, another kind friend sent us a bountiful supply of animals and most beautiful sea-weed from Falmouth: we did not—however tempted by the swelling beauty of the *Gemmaeae*, or the graceful bend of the *Dianthus*—overstock our tank with animal life; but we had a weakness for the picturesque, and we loaded it with seaweed; child like, "because it looked so pretty!" Though we knew that the *Ulva latissima* is all sufficient for the purpose of keeping the water pure—still we were tempted, and the water soon became discoloured and turbid. Mr. Gosse says water under these circumstances can be brought back to purity by being placed in a dark closet, but we had not a "dark closet," and so were obliged to get another supply of Mr. Lloyd's prepared salt, and replenish our ocean; since then, we have been greatly successful, the water is "clear as crystal" now, and it has continued so for more than ten weeks.

The desire to know something about, and to possess some specimens of, those "living flowers," is becoming so general, that "agents" can be met with at most of our sea-side resorts, who will procure a sufficient number of "zoophytes" to effect a commencement; but, we repeat, without patience you cannot prosper.* Your tank may be on the plan of those at the Zoological Gardens, oblong, formed of plate-glass and slate, and bound with iron (mine contains about 18 gallons, the cost 4l. 10s.); you can have smaller vessels, from a finger glass upwards; but all require patient observation, care, and cleanliness: whatever you put in must be first cleansed—of course, in salt-water.

Very recently, however, improvements have been made in tanks; and such improvements should be made extensively known; for in many ways they greatly augment the "new pleasure";

* Among the most intelligent agents we have met with is Mr. M. C. Pike, of Pool Valley, Brighton; he is a naturalist who has earned joy in his vocation; and although Brighton is not the best place for variety of marine productions, he has established relations with other places, and can be useful in supplying the wants of collectors at very reasonable charges, and the information he gives with what he sells cannot fail to be instructive. He is a "dealer in shells, sea-weeds, and minerals;" he supplies a small globe furnished with "sea things" for a few shillings; and may certainly be a valuable auxiliary to all who desire the new pleasure to be had from the "Marine Warrington." Of Mr. Heal and his daughter at Ilfracombe we have already spoken; they were among the earliest practical assistants of the naturalist, and have been, in a measure, taught their business by Mr. Gosse. We believe there is also a valuable agent at Weymouth, Ilfracombe and Weymouth, we understand, yield the best specimens. No doubt in many others of our sea-coast towns there are persons able as well as ready, and willing to assist the collector, and it will give us pleasure to make them known.

first, as avoiding all danger to the inmates; and next, as supplying articles of furniture so elegant as to be accessories to the drawing room. I allude chiefly to the tanks manufactured by Messrs. Lloyd & Summerfield, of Birmingham. By a patented process, these gentlemen have substituted glass for wood and iron, in many cases where, heretofore, wood and iron were indispensable. In several of the large shop-windows of London, the whole is of glass—pillars, supports, and sashes. Thus, in the tank, the plates of glass are brought together by glass pipes, neither wood nor metal being used anywhere. The advantages are so obvious, that hereafter, we imagine, this principle will be

adopted universally, as at once more elegant, and more healthful to the inhabitants of tanks, either of fresh or salt-water, but especially the latter. We engrave one of these tanks; and it will be understood that it is entirely of glass.

But Messrs. Lloyd & Summerfield, we believe, designed these articles not so much to serve as tanks as for Fern-houses; although it is apparent that they are quite as well suited for the one as for the other. They are produced in very great varieties: some being larger and more shallow; others being without legs, to stand on tables; others are made to serve as fountains, standing on a graceful glass pillar, through which runs a metal pipe connected with a supply of water.



These gentlemen also manufacture a variety of globes, large cups, vases, and basins; so that all the wants and wishes of those who cultivate Aquaria may be hence supplied—taste as well as convenience having been studied. Examples may be seen at the Crystal Palace; and, if our impression be correct, those entirely of glass very little exceed in price those of mingled glass and iron.

A fresh water Aquarium is much more easily managed than a salt one, and the active movements of the fish increase its interest; but fish are by no means as varied and curious as the zoophytes. Wherever Nature is, there is interest and beauty, so you can choose one or the other—or you may have both. In addition to your tank you will require a syphon, a syringe (of either glass or zinc), and a long-handled wooden spoon, with a sponge tied on the handle end; you must also have a little glass "test," to regulate the density of the water.* If a town-dweller, we suppose you will obtain the prepared salt from Mr. Lloyd; although Mr. Gosse and Mr. Warrington prefer the sea-water, and it continues pure and healthy in their tanks; I have no doubt that when it can be procured pure, and not near the sea-beach—where it is necessarily injured by extraneous matter—it is far better than the artificial water. But whether you use the sea or the composed water, you must, first having washed and seasoned your tank for a few days (and all vessels, large or small, require a little salt water to stand in them for a day or two), put in a thin layer of sand, then a layer of shingle, then arrange a few carefully-washed rocky stones according to your own fancy, let them be rugged, because the *Actinia* can the better grasp them, and you can place your sea-weed to greater advantage; an arch, which you can easily build or have cut at a stone-mason's, is always pretty, and the sea-weeds hang well from the top; then put in your sea-weed, taking care that it is growing, and has its roots fixed to bits of rock or stone; the *Ulva latissima* (the delicate sea lettuce), and the corallines, are quite enough as a commencement;

the "copper beech" of the ocean adds much to the beauty of your marine garden, the only difficulty being in the arrangement of light; it loves deep waters, and will fade beneath the rays of a strong sun. Having arranged your plants, leave them alone for two or three days, and then introduce the hardiest of your *Actinia*.

Mr. Warrington told us of a worm that conceals itself in the sand, beneath the shingle, and, in gratitude for its seltzer devours all impure and dead substances; the prawns do this also, but we would not put prawns into new water, nor until the lower organisms of animal life had been fully established in their several localities: the *Bellis* (daisy) hanging from some rough stone; the *Dianthus* wandering imperceptibly along the glass, now looking like a knob of jelly, then extending like a telescope with a number of the most delicately cut fibres at the end—a living white carnation; the *Gemmaeae*—so worthy of its name; and every class and colour of the *Mesembryanthemums* from the scarlet strawberry to the delicate olive green, are all safe tenants, and may be introduced at the same time. The *Crassicornis* we have not been able to keep alive more than a week—with one exception; a very small one fixed itself upon a fragment of rock, and we placed it near "high-water mark"; there it lived and bloomed seven weeks, at last dropped off and died. A very intelligent correspondent at Falmouth tells us that he takes his *Crassicornis* out of the water every day for a couple of hours, shakes a little gravel over them and returns them to the water, and that "they live months;" he does this "because," he says, "they are in their natural state frequently left exposed by the receding tide." I regret that I have not time to air them, as ladies air their lap-dogs—but the practice has reason in it.

It may be that the daisies (*Bellis*) will not fix, but "blot" themselves out and roll about in the water; this is a bad sign, yet they may change their minds, and root well for all that; if, after three or four days, they are not fixed, they will lose their firmness and colour, become spongy, and not withdraw their tentacles when touched; then lift them to the surface of the water in your fishing-spoon, and you will soon perceive by the aroma that they are dead. Nothing dead must on any account be suffered to remain in the water, so throw them away, and put in

* The syphon is necessary to draw off the water without disturbing your arrangements; the syringe to throw in, (if used for five minutes once a day), a supply of fresh air; the "spoon" to remove the dead animals; and the sponge to clean the glass.

others. Ascertain that your "test" globule floats upright, and when you force it down, if it rises slowly, very slowly to the surface, the water is fit; there is always, even when you cover your tank (which I strongly recommend you to do), an evaporation which renders your water too salt; you must prevent this by occasionally pouring in from a teacupfull to half a pint of fresh-filtered water, watching the movement of your "test;" you may also introduce the active and beautiful *Anthea cecus*, but I find it wiser to introduce the small not the large specimens. My large *Anthea cecus* all died after two or three weeks, but I have two small ones which are growing; one fixed itself at what may be called "high-water mark" on the glass, the other floats on a leaf of *Ulva*, and never changes its quarters, while its sister moves an inch or so every day, but always near the surface; half-a-dozen periwinkles must be thrown into the water (taking care they do not remain on their backs), they will prevent the accumulation of decayed vegetation, and mow from off the glass the mossy growth which would soon obstruct your view of your favourites, if permitted to accumulate. Avoid disturbing the bottom of your tank; and note down the number you put in: a certain quantity of water can only afford nourishment to a certain quantity of animal or vegetable life, so I would entreat you not to overstock. You will require some (say for a tank of 13 gallons three or four) prawns (not shrimps, who must burrow in sand, and do not float about like the beautiful prawns); they are the most gentlemanly scavengers you can imagine. All *Actinia* throw off a sort of cobweb, which in the absence of prawns I frequently sweep off with my sponge or a feather. I can see to a hair's breadth if my *Actinia* move during the night, or during my absence; they suffer from cold, and I lost several that I had just received from Mr. Dunstan, of Falmouth, simply because the water which warms the corridor where the tank stands, grew cold in the night, and the thermometer fell below freezing point; several *dianthus*, *bellis*, and *gemma* were flat and dead in the morning. Crabs of all kinds are very active and interesting, but they are so restless and revolutionary in their movements, that I would not recommend them as inmates of an Aquarium; they scratch, and dodge, and tear everything; the hermit crabs—in fact, the whole crab family are the same: in mischief they are the very monkeys of the sea. I have still some beautiful madrepores which I brought from Ilfracombe in September; I know nothing more beautiful than the madrepores, when they bloom from out their caves; but do not let the large *Actinia* creep too near them; if once their tentacles embrace a madreporic, a prawn, a crab, a periwinkle, the next day they will disgorge the shell, but the substance will have been extracted. Sometimes, if my *Actinia* do not bloom freely in deep water, I remove them to the more shallow, and vice versa, which a young friend calls "giving them change of air;" though sometimes when I have removed a green, or a grey, or a scarlet *Actinia*, for the purpose of getting a nice bit of colour at a particular point, so as to add to the beauty of my tank, the obstinate thing has either slid away or died, as if in sheer perversity. I have, therefore, learned, if they seem healthy and happy in one situation, not to attempt to remove them to another.

I pray it may be understood that my notes upon this "new pleasure" are simply intended for the instruction of tyros, who will be saved much disappointment by going to the A, B, C of the "Aquarium," and then learning from learned hooks and experience, what I—myself a learner—could not presume to teach. During the past winter, those "blossoms of the sea" have afforded me a great deal of enjoyment. Every bit of weed and rock—every zoophyte—has its little history. I have beguiled some lonely midnight moments by placing my candle, so as to produce different effects of light and shade on my mimic ocean; and those dim links between vegetable and animal life have carried me back, without an effort, to the delicious scenes from whence they came.

How patiently have we watched the receding tide, to enable us to explore the mysteries of

some tide-pool, difficult of access, but richly repaying our exertions by the abundance and variety of its inhabitants! How have we deplored the loss of a "specimen," and, like all bad workmen, quarrelled with our tools—"the hammer was too heavy," the "chisel too light!"—and, when we made sure of "such a magnificent *Bellis*," how foolish we have felt when it disappeared from our grasp, sinking into its rocky crevice, scarcely leaving a trace of its retreat! We triumph to this day in a *dianthus*, remembering how nearly our boat was upset beside a group of rocks off Torquay, while endeavouring to obtain the prize. What a delicious day that was! The overpowering heat of the southern sun, tempered by a breeze cool only by contrast, yet still refreshing! The sky, bright as in Italy! The distant splash of oars, as boat after boat passed to and from the delicious bays which indent the Devonshire coast with their mysterious beauty: there, a bold headland, purple and green amid its dark-browed rocks and golden veins, stands sentinel of sea and shore, shading without obscuring the low-roofed cottages, whose trellised roses and verdant lawns, hanging midway on yonder hills, realise an English Arcadia!

We frequently sought amongst the weeds which the lavish waves had heaped upon the strand for *Actinia*; and if we moved a stone, it seemed as if the bay produced nothing but crabs, such scrambling multitudes rushed forth and disappeared. We found one or two marvellously large "strawberries" there—one, who still hangs at the corner of our tank, like a pendant of "Love lies bleeding" always in active bloom, seeking what he may devour—a fragment of beef, a bit of chicken, a dead "*Bellis*" or a minnow—a most gluttonous creature! and this reminds me that he is the only *Actinia* I have ever fed, though Mr. Warrington indulges his captives, at long intervals, with little scraps of mutton; and the blue old lobster, at the Zoological Gardens, has his food as regularly as the lions and tigers. But if you feed the zoophytes with palpable food, I doubt the possibility of keeping the water pure, and the water produces sufficient for their existence; though I dare say their growth would be increased by a more liberal supply.

It is quite amusing to observe how the little children, both at Torquay and Ilfracombe, have caught the taste of the times, and come to the sea-side visitor with a bunch of "zoophytes," as they used to do with a young bird or a bouquet of wild flowers. They patter along the shore with their bare feet, turning up the sea-shag, and astonishing the crabs and sand-hoppers; or splash boldly into the pools. One little fellow brought me a worm in great triumph, calling it a sea-serpent; while his sister—brown, though blue-eyed—produced a green *Actinia*, which survived until Christmas: it is pleasant to remember the children toiling up Capstone Hill, attracted as much by the music of the brass band as by the hope of selling "zoophytes."

We need only recal our own hours of most wearisome do-nothingness at watering-places, in days long since, to properly estimate what this "new pleasure" was to us during our rambles along the coasts of North and South Devon—the lane-walks affording us such specimens of ferns and wild flowers as we never gathered before, and the shore rambles sending us to our lodgings with our living sea-flowers, to be turned into every available glass and basin, with the cheering and inexpensive speculation of how they would look "at home."

* While at Ilfracombe last year, it was our happy fortune to meet there Mr. Gosse, with his "class;" it cannot be inappropriate here to say that this amiable and excellent gentleman, and accomplished naturalist, usually forms "classes," who accompany him to the sea-side, partly to obtain health, partly recreation, and partly knowledge, under the certainty that, in his valuable society, and that of his excellent lady, they will acquire much of all. We cannot do better—in gratitude for the pleasure and instruction he has given us—than print the "card" he has this year issued; for, although it is intended only for private circulation, he will not, we think, object to its being given to the public, inasmuch as it may be the means of enabling some of our readers to enjoy this "new pleasure" under the best possible auspices and circumstances:—

"MARINE NATURAL HISTORY CLASS.—In the summer of 1855, I met, at Ilfracombe, on the coast of North Devon, a small party of ladies and gentlemen, who formed themselves into a Class for the study of Marine

It is impossible to admire these beautiful creatures, and the simple labours by which they exist, without thinking of HIM who, insignificant as they appear, works for them and in them. Surely, if HE cares for them—which cannot except by the contentment they exhibit, acknowledge HIS bounty—how much more will HE care for us!

The amiable and enlightened Doctor Landborough claims a remote antiquity for these wonders of the shore. In one of his charming books,* he says, "the *Scutidaria* that wave their plumes in the sea in the present day, are not in the least more skilful than those that lived immediately after the Deluge. But they can boast of kindred who were great before the flood—which have for ever passed away—though their existence is proved by their wonderful remains, buried in the rocks in every place of our land, and they can more proudly boast of kindred yet alive in foreign climes—numerous almost as the sand of the sea-shore, which have achieved what human power could never have accomplished, and with unwearied assiduity, are still carrying on works which the united efforts of myriads of millions of mankind would in vain attempt to effect. We speak of the coral-forming zoophytes of foreign seas."

Surely there is both simplicity and dignity in a pursuit which leads us to a more intimate knowledge of these dwellers in the sea, and when I perceive the birth of an *Actinia* and observe the little creature—hardly bigger than a pin's head—working its oars and seeking its own food, I cannot but feel that by "studying the nature and habits of these little denizens of the deep we see the kind hand of God, whose our forefathers never thought of looking for it, and where we should not, in all probability, have seen it, but for the invention of the microscope. In the very lowest department of Zoology we deal with things that have life. Who, of earthly mould, can give life and voluntary motion to the smallest creature? This is God's doing; and it is not only marvellous, but pleasant to our eyes!

I have thus endeavoured to add my mite to a treasury, the wealth of which is open to all, earnestly desiring that many may share with me the enjoyment to be derived from this NEW PLEASURE. The longer we live the more we are impressed with the conviction that there can be no happiness that is not participated: it is a solemn yet a pleasant truth that we become happy by making others happy.

The "season" is now approaching when thousands will quit for a time the "busy hum" of cities for the breezy melody of the sea-shore: under such circumstances it becomes almost a duty to be idle; but surely "idle time" will not be "idly spent" by those whose daily strolls are ministers to a "new pleasure!"

Natural History. There was much to be done in the way of collecting, much to be learned in the way of study. Not a few species of interest, and some rarities, fell under our notice, scattered as we were over the rocks, and peeping into the pools, almost every day for a month. Then the prizes were to be brought home, and kept in little Aquariums for the study of their habits; their beauties to be investigated by the pocket lens, and the minutest kinds to be examined under the microscope. An hour or two was spent on the shore every day on which the tide and the weather were suitable; and, when otherwise, the occupation was varied by an indoor's lesson, on the identification of the animals obtained, the specimens themselves affording illustrations. Thus the two great desiderata of young naturalists were attained simultaneously; they learned at the same time *how to collect*, and *how to determine the names and the zoological relations of the specimens* when found.

A trial also was effected in the way of dredging the sea-bottom and in surface-fishing for Medusæ, &c.; but our chief attention was directed to shore-collecting. Altogether, the experiment was found so agreeable, that I propose to repeat it by forming a similar party every year, if spared, at some suitable part of the coast. Such ladies or gentlemen as may wish to join the Class should give in their names to me, early in the summer; and any preliminary inquiries about plans, terms, &c., shall meet the requisite attention.

"P. H. Gosse."

"58, HORTONSDON STREET,
"BRISTOL, LONDON.
"March, 1856."

* "Popular History of British Zoophytes." Reeve & Co.

ART IN CONTINENTAL STATES.

PARIS.—The splendid old building, the Hôtel de Cluny, is about to be isolated; the surrounding houses are now being pulled down for that purpose. This museum is daily increasing its stores of Art.—The celebrated manufactory of porcelain at Sèvres is to be converted into barracks; the porcelain works will be carried on in a new edifice to be built in the park at St. Cloud.—The Exhibitions of Lyons and Bordeaux have been very brilliant this year; in that of Bordeaux, 49,717*l.* have been expended in purchases by the society of the *Louis des Arts*.—The Gallery in Luxembourg is about to receive several of the late purchases made at the Grand Exhibition, and will be augmented by about twenty paintings of high merit. Among them are "Hay-making," Rosa Bonheur; "Christ Mocked," by Gosse; "Burning of the Kent Indianman," Guéin; "Funeral of St. Cecilia," by Bonguereau; "Tepidarium," by Chusserau; "Christ in the Garden," by Jalabert; "E. Lesueur at the Chartreuse;" landscapes by Troyon, François, and Lecomte.—The restoration of the "Hémicycle" of P. Delaroché goes on well; the damage it received will scarcely be apparent when the repainting is finished.—The picture by M. Gosse, subject "St. Vincent de Paul converting his Master," and which has been for twenty years in the Luxembourg Gallery, has been given to the church of the Seminary of St. Pé.—The Emperor has bought the fine painting of "The Lake of the Four Cantons," by Calamé; the Empress that of "The Virgin and Child," by Deschwandner.—M. Sauvageot has been named conservator (honorary) of the museums; this gentleman had collected a valuable museum of articles of *art*, and has presented them to the nation, on condition that he has the care of them, with suitable apartments. We find in this collection an immense quantity of the Palissy ware, Italian majolica, sculptured ivory and box-wood coffrets, statuettes, diptychs, mirrors, &c., Limoges enamels, Venice glass, portraits of the sixteenth century. It is said that an English *million* offered him 500,000*l.* for the collection, but he preferred the enjoyment of the same in the Louvre, in a room named the "Musée Sauvageot."—The fine weather has given an impulse to the improvements of Paris; houses are being pulled down on all sides; the town will soon deserve the title of the "Ville des Boulevards;" indeed, little that is old will shortly be left in Paris. Three of those beautiful little *tourtelles* of the medieval times will soon be destroyed in one street, the Rue Hautefeuille.

OBITUARY.

MR. W. F. VARLEY.

We have received from a correspondent the following biographical notice.

On the 2nd of February, died, at Ramsgate, aged 71, William Fleetwood Varley, artist, youngest brother of the celebrated landscape painter. He was a man condemned to know the severest changes of fortune, having entered the profession under the tuition of his brother with the fairest prospects before him, when a needle shot from an arrow in the playground of an academy entered his eye and nearly blinded him for some years; he in a measure regained his sight, but his eyes were ever afterwards too weak to admit of his pursuing the profession with an arduous sufficient to obtain emolument.

As a teacher he was highly patronised in Cornwall, Bath, and Oxford; at Bath he broke his right arm, which, not having been properly set, frequently gave him great pain, especially in cold weather. He married, had a large family of daughters, seven of whom, with one son, survive him; he now pursued his profession with great respectability, and to the advantage of himself and family.

When at Oxford, by the reckless frolics of a party of students, some of whom were his own pupils, he was nearly burnt to death. From the agonies he then endured, he was never wholly himself again, but gradually sunk in health and in circumstances, and, though assisted by his brother, he, with his numerous family, experienced every species of distress, even to the bitterness of want, and became a nervous, ruined man.

His death took place under happier circumstances than he had known for years, he having enjoyed the calm comforts of a domestic home for many months, under the roof of his excellent son-in-law, Mr. Joseph Conder, tended by a kind and affectionate daughter.

SPRING.

FROM THE STATUE BY B. E. SPENCE.

This statue has been recently executed in Rome, where the sculptor resides: Mr. Spence is also the author of two other figures, "Lavinia" and "Highland Mary," which have been engraved in our series at different periods. He has here treated the subject as it is usually represented in Iconology, where the pleasant season of Spring is always symbolised as a beautiful young female in a dancing attitude, crowned with a chaplet of flowers, and with a wreath of flowers in her hand; oftentimes flowers are seen shooting up beneath her feet, and young animals are playing at her side. The association of these objects with the impersonation are sufficiently obvious: poets and painters have in all ages thus represented her.

Joy to the teeming earth!

Once more from sleep awaking;

Blossom and bud are everywhere

In dell and forest breaking:

Fresh from the sunny south,

Dancing o'er hill and plain,

Come the light footsteps of young Spring;

—Joy to the world again!

O'er verdure-covered realms

She holds supreme dominion,

The fairest things that nature hath

Attend her bright pavilion;

Proclaiming Winter past,

The storm-fiend fled and dumb,

And that the time of singing-birds

Full pleasantly is come.

Hail to thee, haughty Queen!

Of love a heavenly token.

In that the covenant with man

Shall not be void nor broken:

Immutable and sure

He sees the promised stand,

"Seed-time and harvest shall not cease"

"For ever through the land."

Yes, every thought of thee

Should be undimmed by sadness,

Though they are gone whose song of yore

Welcomed thy look of gladness.

Do not immortal flowers

Around their pathway cling!

Are not all seasons of their world

A never-ending Spring!

There is, to our mind, a peculiar gracefulness in Mr. Spence's conception of this figure: it conveys the idea of easy, elegant movement; the step is light and buoyant, yet well poised; the head, a little inclined, is indicative of motion; and the drapery, adhering closely to the front of the person, and slightly flowing behind, aids the idea which should be conveyed, that of progress. The outline of the whole figure may be so clearly made out—in some parts, as in the exterior lines of the lower limbs, it is perhaps rather too much defined, when the arrangement of the dress is considered—that it is easy to discern how carefully and correctly it is modelled; the sculptor evidently being unwilling that a suspicion should arise in the mind of any critic of his work of a desire to conceal defective modelling by covering it with drapery; just as we have known some painters who, unable to draw the hoofs of animals—not so easy a task, by the way as might be supposed—often hide them in long grass or other herbage as a veil to incorrect drawing.

We should like to see the works of Mr. Spence more frequently in England than we do: he is a sculptor of great taste and ability; and although we cannot but be perfectly aware there is, comparatively, only small encouragement of his Art here, yet we are quite sure he would be appreciated in the way to which he is justly entitled. It is not meant to be implied by these remarks that Mr. Spence receives no commissions from this country, for we know he has executed several; but he rarely exhibits them, and therefore his name is not so familiar with the public as it deserves to be.

MODERN PAINTERS.*

Is it decent that Mr. Ruskin should assert Turner to have been killed by criticism? We have heard Turner within the walls of the Academy profess the most profound contempt for all and any criticism, and we know that he felt what he said. He has done kind things, but who will mock his memory with the mandarin assertion that he was a man of what is called "fine feeling"? He had a large and a solid reputation, which never could be injured by any of the absurd comparisons of his latter works to "salad oil and mustard." He has enjoyed a more extensive popularity of that kind most valuable to a painter than perhaps any artist that ever lived, and if he were content with the result, that was one of the best proofs of his good sense. It has been seriously asserted by painters of high position, men never given to facitiae, that Turner's later works were experiments on the intelligence of the public. This we cannot believe. What he did, he did earnestly, whether it were a picture painted on the walls of the Academy in twenty minutes, or one of the tree-stems, described by Mr. Ruskin, elaborated under a microscope during twenty days. He might have been sored from time to time by senseless observations on his works: but Turner sensitive!—commend us to a rhinoceros for a thin-skinned animal. Some proportion of what has been said of Turner is true, but it is the severest visitation that could rest on his memory to say that he possessed the inflection of criticism. We would vindicate him from that. But really he was never thoroughly himself after the publication of the first volumes of "Modern Painters." Were not his worst works painted after the appearance of these volumes? This painter's fondest friends may have placed "Modern Painters" above even him, and they may have assumed to discover in those productions that Turner was working up to the spirit of these essays, while, alas! he was only working down to them. Mr. Ruskin knows that even to a good cause apologies and recantations on the part of an advocate are most prejudicial: he is bound to defend Turner, for in doing so he defends himself, and, like a good pleader, he is little scrupulous. Perhaps Mr. Ruskin believes that the empiric toxicology of his volumes was too much for a man, whom certainly all who knew him would pronounce to be the last to be affected by such a treatise—a man who had lived so entirely with nature as to be altogether unimpressionable by all the charlatanism of his time—a sorerer in his Art—but (we would not be uncharitable) one whom everybody knows to have been one of the *ferre natura* of society. But Mr. Ruskin seems now to have done with Turner; we trust it may be so, for his interpretation of the examples he instances from his works are such as to place in a very ridiculous light that which, according to the simple rendering intended by the artist, may be really beautiful. But to return to the book: we had expected in the chapter entitled "The Fields," to have seen something about that kind of nature for which artists usually look in the fields—something in reference to those who have painted the fields; but there is no allusion of this kind: the chapter is made up of excursive speculations on the favorite colors of ancient poets and mediæval painters. There are dissertations on the "pictures" of Milton, Dante, Shakspeare, Homer, and other poetic painters of less note. After having considered, as usual, a multitude of things altogether beside Art, the author proceeds to deductions. "There are, it seems to me, several important deductions to be made from these facts. The Greek, we have seen, delighted in the grass for its usefulness; the mediæval, as also we moderns, for its colour and beauty. But both dwell on it as the first element of the lovely landscape; we saw its use in Homer, we see also that Dante thinks the righteous spirits of the heathen enough comforted in Hades by having even the *image* of green grass pent beneath their feet; the happy place in Purgatory has no other delight than its grass and flowers; and finally, in the terrestrial

* Concluded from p. 115.



SPRING

DESIGNED BY M. KNIGHT FROM THE STATUE OF THE SEASONS

paradise, the feet of Matilda pause where the Lethe stream first bends the blades of grass. Consider a little what a depth there is in this great instinct of the human race. Gather a single blade of grass, and examine for a minute its narrow, sword-shaped strip of fluted green. Nothing, as it seems, there of notable goodness or beauty. A very little strength, and a very little tallness, and a few delicate long lines meeting in a point—not a perfect point neither, but blunt and unfinished, by no means a creditable or apparently much cared-for example of Nature's workmanship, &c. * * * * The fields! Follow but forth for a little time the thoughts of all that we ought to recognise in these words. All spring and summer is in them, the walks by silent scented paths, &c. Such is the material of which this chapter is composed; there is nothing of practical Art. Let the author write as many books as he pleases, but let him not assume that they are useful to the artist—at all auxiliary to the practice of Art. Another example of elaborate trifling is found in Mr. Ruskin's interpretation of the Italian word "bruno." "I was for some time embarrassed by Dante's use of it with respect to skies and water. Thus, in describing a simple twilight—not a Hades twilight, but an ordinarily fair evening—(Inf., ii., 1), he says, the 'brown' air took the materials of earth away from their fatigues; the waves under Charon's boat are 'brown' (Inf., iii., 117); and Lethe, which is perfectly clear, and yet dark as with oblivion, is 'bruno-bruno,' brown, exceedingly brown." There is yet much more about this word, which, indeed, the author might have spared himself the trouble of writing, for it is well understood as simply meaning dark, and is a common word for twilight. All these dull diversions—and there are many of them—are analogous to what we have observed in the writer's notices of pictures: he fixes on a ripple or a wrinkle, and writes a page or a chapter on it, as the case may be. Hunt, the painter of "The Light of the World," has succeeded Turner in Mr. Ruskin's estimation, and many opportunities are found of mentioning him. In speaking of "affectation," it is said, "I know no painters without it, except one or two Pre-Raphaelites (chiefly Holman Hunt), and some simple water-colour painters, as William Hunt, William Turner, of Oxford, and the late George Robson; but these last have no invention, and, therefore, by our fourth canon, chap. iii., sec. 21, are excluded from the first rank of artists; and of the Pre-Raphaelites there is here no question, as they in nowise represent the modern school." It might be very fairly asked of Mr. Ruskin what he means by "affectation." He does not mention the names of any painters who are signalled by "affectation," but we hear of some of those who are without it; they are chiefly artists who paint elaborately what they see; conversely, therefore, all who do not work on this principle are "affected." In the chapter entitled "Of Modern Landscape," really a fine subject, there is scarcely a page about painting; it turns entirely upon a consideration of certain of the modern poets. We are told that nothing is more notable or sorrowful in Scott's mind than his incapacity of steady belief in anything. He is educated a Presbyterian, and remains one, because it is the most sensible thing he can do if he is to remain in Edinburgh. He cared for neither painting nor sculpture, and was incapable of forming a judgment upon them. Byron is rather sulky and despondent than melancholy; Keats is sad because he is sickly; Shelley because he is impious; Scott's heartfelt and sincere love of nature is summed up in a few words by himself—"I, Scott, am nothing, and less than nothing; but these crags, and heaths, and clouds, how great they are, how lovely, how for ever to be beloved, only for their own silt, thoughtless sake." We may not, perhaps, agree entirely with Scott for the reasons he gives wherefore the rocks should be beloved; but we cannot help admiring Scott's humility of spirit as a contrast to the insufferable egotism of Ruskin. Scott is not allowed to be so subtle a colourist as Dante, which, under the circumstances of the age he could not be, but he depends quite as much upon colour for his power or pleasure. He does not say much about things, but the one character

which he gives is colour. If he has a sea-storm to paint in a single line, he does not, as a feebler poet would have done, employ some term descriptive of the temper or form of the waves; he does not call them angry or mountainous. He is content to strike them out with two dashes of Tintoret's favourite colours—

"The blackening wave is edged with white,
To lurch and rock the sea-mews fly."

"There is no form in this; nay, the main virtue of it is, that it gets rid of all form. The dark raging of the sea, what form has that? But out of the cloud of its darkness those lightning flashes of the foam, coming at their terrible intervals,—you need no more." What are meant here as Tintoret's favourite colours? If black and white are Tintoret's favourite colours, how has he employed them? He was a great flesh colourist, finishing sometimes with glazes, at others with the carnation impasto: as a curious example of the latter, we refer Mr. Ruskin to the well-known head in the third or fourth saloon of the Pitti, painted, as it were, with a trowel. He may have used black and white as dead colouring; but where do black and white occur in Tintoret's works as a presumption of colour? They are employed generally for effect, either as principals or auxiliaries; and, where the one or the other prevails to any extent, there is a proportionate denegation of colour. Are we to believe that Mr. Ruskin is praising Scott for the simplicity of his tint? If so, how are we to reconcile what he says in an antecedent chapter, when he asserts that the colouring of nature cannot be too brilliant and luxuriant? Wherefore is it necessary to go so far away as Tintoretto in a question of painting, what perhaps Tintoretto never attempted? Had we desired a comparison, and especially in a question of painting water, we should have instanced at once Vandeveldt, who, in his latter years, painted the sea in little else than black and white. But he did not paint the sea without form. If a sea without form be here commended, how is this to be reconciled with what is said in a former volume of the forms of the sea, in a description of Turner's picture of the slave ship! In that work (we speak only from memory) much of the force of the picture depends on the forms of the sea. Of this kind are the arguments under the heading "Of Modern Landscape;" a chapter which does not contain a sentence on the subject of modern landscape. Instead of treating of painters the entire essay is of poetics; we have no objection to this; but, if there be any difference between versification and the practice of painting, this chapter should not have been called an essay on landscape. Mr. Ruskin concludes his volume with a chapter on the teachers of Turner; and concludes finally with a disquisition on the recent war. It is asserted that Turner, having suffered under the instruction of the Royal Academy, had to pass nearly thirty years of his life in recovering from its consequences. We have never seen anything in Turner's works that the Academy could have taught him: he drew figures excellently—worse than Claude; and the Academy does not teach clouds and sunshine. If he learnt anything of figure-drawing there, he must have been extremely well taught; that thirty years were necessary to his teaching. We know living engravers who have continually improved his drawing in their plates from his works. In youth he is said to have wasted his time in painting subjects of no interest, as parks, villas, and ugly architecture in general; and, in late years, to have devoted his strength to meaningless classical compositions, such as the "Fall and Rise of Carthage," "Bay of Baie," "Daphne and Leucippas," and such others; which, with infinite accumulation of material, are yet utterly heartless and motionless; dead to the very roots of thought; and incapable of producing wholesome or useful effects on any human mind, except only as exhibitions of technical skill and graceful arrangements. The very qualities which are disparaged in the production of these works, are abundantly praised in the antecedent volumes.

Our notice of this volume has been what we ourselves consider slight; although, to a certain

class of readers, it may be already too long, and would have been tedious had we followed the author analytically through all his propositions. We have from time to time counselled him for his good; but he is slow to acknowledge a benefit. We press his hand once more with this advice;—if he wish to gain credit for knowing something of Art, he must cease to sneer at the works of men of undoubted talent; men whose power is acknowledged in the face of the world; artists from whose reputation he could not detract one iota, were he to continue his so called artistic diversions for a hundred years. Farewell, John Ruskin; if you are true to your word, we meet again in a brief space in the great room of the Royal Academy. Oh! that our friend would paint a picture!

ART IN THE PROVINCES.

MANCHESTER.—The men of Manchester are talking of erecting a Crystal Palace of their own for an exhibition, on a grand scale, of works of art of every kind. The *Manchester Guardian* says—"The plan is to have a vast exhibition in Manchester, to embrace and be limited to everything that can be fairly comprised within the title of 'Art-treasures,' which will not only include pictures, engravings, sculpture, and statuary, but every variety of works of Art—as distinguished from works of industry, manufactures, machinery, and mechanism)—that can be collected, of all ages and countries, especially articles of taste and *virtu*, bronzes, marbles, medals and coins, gems in cameo and intaglio, works of art in every metal and in many other substances, glass and china, ivory, wood, and stone,—in short, everything that is not mere workmanship, but may fairly be classed as Art. It is intended to have this Exhibition on a scale commensurate with the importance and dignity of this great metropolis of the manufacturing district; and the means proposed are a large guarantee fund, and the erection of an edifice of the magnificent character, if not the full dimensions, of the Crystal Palace of Hyde Park and Sydenham. We may express a confident opinion that the grandeur of the scheme, the vastness of the scale on which it is proposed to be accomplished, will give to it an attraction so universal and absorbing, as to secure its being, as a whole, self-supporting and remunerative. The Art-contributions from the private collections of Lancashire alone would cover acres of space. Everything augurs well for the success of an undertaking, conceived in a large and liberal spirit, and the plan of which is of proportions so colossal." We cannot at present understand whether the building is to be of a permanent kind or not; we can scarcely suppose that, with the example of the Sydenham Palace before them, gentlemen so shrewd and calculating as we know those of Manchester to be, can contemplate the erection of such another edifice, with a similar object, except for temporary purposes.

ST. ALBANS.—It is intended to attempt the restoration of the fine old Abbey Church of St. Albans, one of the noblest examples of Saxon architecture in the kingdom. A meeting, at which a large number of the county gentlemen, and of those interested in the preservation of our ancient architectural monuments, attended, has recently been held, when a liberal subscription was entered into for the purpose. It is supposed that St. Albans will be the seat of one of the new bishoprics which rumour states the government is about to create.

TAMTON.—Mr. Cole, C.B., Inspector-General of the Department of Science and Art, lately visited Tamton, to aid a movement now making in the town for establishing a school of Art, which appears likely to be successfully carried out.

DUNDEE.—The travelling picture-dealers, driven out of the highways of the country, are seeking a market for the disposal of their merchandise in nooks and corners. We have before us a catalogue of pictures recently offered for sale at Dundee, from the gallery of "the late Captain Rennard, of Southampton, a well-known collector." The names which figure pre-eminently in the list are, among others, those of Van Stry, N. Pousin, Sassoferrato, Tintoretto, Vandeveldt, Panini, Paul Veronese, Brughel, Guercino, Cuvp, Jordans, Bionnet, Spagnoletti, Murillo, Callott, Danby, Cooper, Hogarth, Reynolds, Duncan, P. Nasmyth, Morland, Etty, &c. &c. The specimens realised from 2*l.* to 10*l.* each; not an unprofitable speculation, we should imagine, with nearly one hundred lots at the disposal of the auctioneer.

SUGGESTIONS OF SUBJECT

TO THE STUDENT IN ART.*

BY AN OLD TRAVELLER.

CHAPTER V.

The midnight Sun—Repose in the Wilderness—The World has sleeping—Benefic influence of a beaming—Inertia to witness—Good fortune of the Painter—He enters protest—Woe is not for the *semper cadens*—Treasure trove!—A Dog that's new—A better Time coming—Penitence—Results—The Princess at Tewkesbury—Edward the King—The Son of Henry—Richard of Gloucester—A Leave-taking—Elizabeth Woodville and Elizabeth "Porphyrion's" —Her Brothers, also born in the Purple—An old Tale of Wood-craft—Where are the Sheriff's eyes?—The Liege-man's Resolve—Doings of little Fiction—The Birds are coming!—Felicity Hannus—Wordsworth—Aristophanes—Division of Labour—Commissariat of the Magpie family—The Counsel of Antipas—The Ethnarch before the Sanhedrim—Simeon, whose name was Simeon—The Tetrarch beside the Fountain—Escapade of the Assonean Princess—The Feast of Tabernacles—The Death of Aristobulus—Arraignment of Mariamne—Defection and Death of Alexandria—The Sons of Mariamne—Cestoborus the Kilmee—Gadiah and Dositheus—Lapidation of Tero—Last Hours of Pheroas—Antipater the Son of Doris—The Close of all.

The interest attaching itself to the Exhibition of works by German Artists, last year holding its third anniversary in London, was much increased by the many beautiful landscapes adorning its walls: those of Norwegian Forest and Fjord were more particularly remarkable, but among them was not one of those life-like reproductions of the MIDNIGHT SUN, for which Becker of Darmstadt, Saal of Heidelberg, and other German artists, have obtained a merited reputation.†

Among the works of the last-named painter is one,—much admired in the Austrian capital, and subsequently at Prague,—representing the Alps that rise above the Guldenbrands valley, as they lie under the deep crimson and rich rose tints of the midnight sun, in the months of June and July. The picture is one of unusually vast dimensions, a circumstance which I mention here, because, in a painting of this kind, size—if not, as in architectural effects, an element of beauty, is at least an advantage to be appreciated.

The scene chosen by the artist is a wild valley strewn with rocks, between which there grow painfully and reluctantly a few coarse herbs and stunted shrubs; in the back-ground is a range of high peaked mountains covered with snow—although we know that the season is midsummer, and the day that of St. John's festival—their grand and silent forms are reflected in the dark waters of a wide extended Fjord, now still and silent as themselves: over this waste of mountain, rock, and water, there shines the strange, weird, mysterious light of the midnight sun.

In the farthest distance the higher Alps are tinged with a delicate rose-hue, while the shadows of the lower range are blue and cool; but the bare gigantic rocks of the fore-ground are glowing like molten steel beneath the fervid beams, for they are still fervid, midnight though it be. Towards the far left of the picture, which exhibits a vast space, as we have said, the light is varied: a less glowing, yet still brilliant tinge of red is shining over all, and in the pale blue sky of this portion of the work are scattered, at wide intervals, great piles of clouds in strange fantastic forms, yet such as we have all seen at times in our own beautifully varying heavens.

But perhaps the most peculiar characteristic of this truly wondrous scene, and that which most effectually distinguishes it from every other, familiar to the dwellers in more southern climes, is the clear perception forced upon you that, despite the glowing sunshine, it is midnight; profound solitude, dead silence, inviolate stillness, all betoken the hour of universal repose: the painter has not permitted any human form to appear; silently, and with very

* Continued from p. 104.

† Since writing the above, it has occurred to me, that the two previous exhibitions of the German artists may have made our youngest student acquainted with these works, but the writer was not in England on either of these occasions, and cannot at the moment refer to the obvious sources of information.

slow movement, a rein-deer is crossing a low hillock, but, beside him, not a living mortal is seen. Yes, you are made to feel that it is midnight, and if you could venture to speak in that solemn presence, it would be in the lowest of murmurs only. But can you speak?—by no means, it is not the time for converse, nor yet for movement, and being here, in the midst of this great pause of life, you sink down quietly into the couch of soft mosses and beside the stilly waters, and you take part in that calm and trusting repose in which the beautiful creation is all lying, child-like and helpless, yet softly breathing and in blest security, beneath the beneficent guardianship of the Father Supreme.

The rein-deer mentioned as passing across this strangely solemn "place of rest,"—for to this, notwithstanding the rudeness of the features, is the scene here depicted consecrated by the potency of the hour—the reindeer, I say, contributes greatly to the force of the general effect, by its singularly unrestrained and leisurely demeanour: this is not the moment for haste, there is nothing waking but himself, the beautiful world around him is all his own; his step—may, he scarcely makes a step, he is only about to do so in good time—gives clear intimation of his perfect ease, and this attitude of the animal has been judiciously adopted by the painter, being, as it is, in perfect harmony with the profoundly touching scene he has depicted.

There is a picture of similar character and also of great merit, but with different treatment, by Len of Dusseldorf, to which I would fain call your attention; but uncertain whether both may not have been exhibited in our country last year, I refrain from doing so, since, in that case, they will most probably have been discussed by the Critic in Art, who takes possession of the whole subject, and does not confine himself as is the case with the present writer, to the mere choice of the theme.

"Blessed is he who hath got himself well beaten, for he shall mend his manners,"—such is the purport, or nearly so, of an adage not infrequently heard in Inertia, and if we cannot subscribe cordially to the truth of its avowment, neither is this a convenient opportunity for proving the fallacy thereof. Let us even assume it true for the moment, and that accorded, how fortunate is your case, oh ye painters, and how effectually shall your manners be mended!

For such an amount of "stick-meat" as they are making you eat! *Ye Bogle!* as the Muscovite says,—and a learned man is your Russ, when the *batogs* are in question—they have provided you with rods of every growth and thickness; you have but to choose and must by this time have decided which tree you like best, unless you are very difficult indeed: at all events you will have acquired a critical judgment in the discrimination of *varieties*.

Right and left you are getting it—blows are raining from every point of the compass and all at once, so that, beneath which side of the hedge you were best take shelter must be a question just now puzzling you mightily, the rather as you do not all seem to be largely gifted in the bump of find-which-way-the-wind-blows-advices, if we are to judge by the fashion in which you place some of your poor creatures *à tabri*, when you have first exposed them to pitiless storms. For proof of this, I refer you to *qui de droit*.

"They are being very uncivil persons, these Critics!—and why should we care for them? We won't! for say they have some show of right on their side, when they abuse Blank Blank, of Blank, and demolish What's-his-name, and tear in pieces no end of other fellows, yet my picture of—never mind its title—is a good one, and if they have not the wit to discern its merit, so much the worse for them."

Well, that is all very true perhaps, and, argumentative beside,—“if we had but the wit to discern its force,” and clever too perhaps, and above all useful, for criticism will be doubtless put down by its eloquence, or if not, it ought to be, but in despite of your oratory, the critics are *non grumbling*, and they *will* grumble. Why,

they maintain—But no, we won't repeat their talk of "this not right" and the other "all wrong"—why should we, since you don't intend to profit by it? Let us rather confine ourselves to what concerns our own especial matters, and hear what they say of that ceaseless iteration whereof they make their plaint. One deprecates what he is pleased to call "the yearly increasing tendency of artists to repeat themselves," and adds, "this perpetual repetition would be bad enough if the pictures were good, but as things are!"

"Enough of him!"
Hear the next then—"This never-ending recurrence of poor and meaningless subjects has been long matter of universal complaint. This year we are more than ever oppressed by—"

You don't like that neither? Let us try a third—"Weak and shallow! what has become of the rich invention once—"

You waver your hand impatiently, you will not have that *non plus!* but there is then no hope of pleasing you, for all is in the same tone! One declares that "even of the good pictures, people are disposed to speak reproachfully, after counting the number of times each subject is repeated in every essential point, all over the galleries." He further asks, "Why must we have the same Italian boys in all sorts of disguises and in half a hundred exhibitions?"

Complainant then proceeds to specify cases wherein the same figures are presented perpetually with only the slightest difference, but we do not give place to the instances—our remarks are general—not particular: he adds piteously, "These children we have seen *ever so many times!*" And hath he so! the poor good man! But are you not ashamed so to heebat him of his reasonable expectations? and have not things come to an evil pass when a good friend and warm lover of yourselves and your works is reduced to self-gratulation over "this dog, because he is *new* to us?"

For observe; what the writers I now cite are complaining of, is, not things had—but things old—"iteration"—omitting the malediction—"iteration is the burthen of their Jeremiads,—“Who shall deliver us from these wearisome self-repeatingings!" they exclaim; and they are right. One remarks, and certainly not without cause—"There is an utter absence throughout, of pictures from Scripture, from English history, from English poetry, and even from English fiction."

And they are your friends who speak thus, they are those who wish you well, and who wish well to Art. Yet these it is whom you compel to ask you—Is there no such thing as a Goldsmith in the land! has no tradition of a Lemprière, ever penetrated your haunts? or could you not at least contrive an introduction to some penny story-book, (in this our day, when the supply of intellectual needs is not particularly meagre,) with, it may be, an apology for a picture upon its front, by way of rousing up your imagination a little!

Nay, but wherefore will you suffer these discourtesies to be addressed to you? and how long shall the regrets of your friendly monitors be rendered yearly more profound? "No scriptural subject—no history—not even fiction."—You will surely not let further cause be given for these too justly merited accusations, since it is certain that the power of preventing them is in your own hands.

Of the scriptural subjects we will not now speak, we are not in fitting mood for the discussion; but what prevents you from turning to history? that of every nation lies open to you, not one shall refuse its stores,—or to poetry, and in that bright region you shall find equal riches; meet as cordial a welcome. For the realms of fiction, I do make mine avowal that they are somewhat of the widest; they demand a peculiar kind of courage from him who shall enter on quest therein, but at worst you shall find a very plethora of provender, and if it be not of the daintiest, let us have it nevertheless, since better may not be; food of any kind is better than famine. Give us something. Let it no longer be said, as of late it hath been and with too much truth, "Our English artists are neglecting books and men, they shun galleries and whatever tends to promote the love of Art

in its highest phases, as if some pestilence were in the air of all that elevates. Many have even severed all connection with the realms of fancy and seem to have abandoned themselves to the rule of common-place.

It is true that the critics have as yet but the light skirmishes before them, and when the great guns of the Academy are brought to bear, they may see cause to change their tone. And you will perhaps say "Neither is this the heaviest artillery of criticism that comes rattling about our ears." Perhaps not, but if the *mirabile* be effective, one gets pretty well peppered even by that, and methinks the shower falling on this occasion is none of the lightest. Then the weapon of your assailant is ever the more sharply penetrative when he has pointed it with a truth, and I ask you if these that are now flying about you do not "hit in the white" every one!

Still, it is not I who will consent to despair of a good time coming, had we not the dawn of it in the very last year's works? were there not the — of — but no — there shall be no names or titles specified, we know what we know, and by and bye we shall have better still. Even now you do not all wear those defiant looks of "Harry, who didn't care!" with which you began to listen, as we repeated to you what your friendly critics are saying. There are some of you indeed who seem to be getting your penitent faces on. Good boys! One has even crept into a corner, slate and pencil in hand; he has determined on some grave exposition of History! you divine it by the importance of his preparations. A second rubs his eyes—he has heard of the "fine frozzy rolling," you shall see now if he will not give us poetry! As to you third! I think he must have horrified the milkman's chalk: what has made him so short of tools, and bow does he mean to employ the loan he has secured? perhaps he will regale us with some preparation from the *cuisine* of fiction, we shall see.

Suppose we look over the shiny shoulder of each toiling urchin—and I would that some one might paint me this studio bodily, every tiny man depicted as he is bending him to his task,—what may History be doing to begin with?

None so bad upon my word! He has made us a tent—a regal pavilion rather—ample of dimensions and richly appointed; the period he has chosen considered, for you see that the warrior figures who occupy the interior are Edward IV., with his brothers, Richard of Gloucester and George of Clarence. Other leaders are also there, Lord Hastings among them; but who is the handsome youth so boldly confronting the king?

Alas, it must needs be the unhappy son of Henry VI., and our student has given us the tragedy that closed the battle of Tewkesbury.

King Edward is asking—as we know he did—"How darest thou so presuming, with hamper displayed, to enter this my realm?" And the youth—according to Speed—is replying: "It is not thy realm, but that of thy sovereign and mine, King Henry VI. and I come to recover my father's most rightful inheritance."

"Then," says the same historian, "did King Edward, with his gauntlet, dash the prince on the mouth, whom Gloucester, Clarence, Hastings, and the rest did then most shamefully murder, even before the face of the king."*

Another moment and these acts of violence shall be in course of their unhappy progress; but our limner has pleased to give us the point of time as above stated—and the wiser man he:—not badly done either. King Edward, handsome, but of hard and doubtful expression, with as much cruelty of aspect as a face still youthful might well express; Richard, also very young,—not twenty in fact—no vulgar hunchback, a somewhat ungraceful person, but with more of intellect on his brow than belongs to any other in the assembly; George of Clarence is weak and treacherous looking—and rightly so, for a

notable traitor he was, as the unhappy Warwick, his father-in-law, had already learned to his cost. All are good and characteristic figures; therefore, homely words of encouragement from that kindly personage, Dame Juliana Berners, I cannot but say—"Loke ye do ever see, my dere child, and ye shall come good speede."

But he turns his slate! The good fellow! he has done us another; who said there should be no more history! Edward IV. again, but this time with his Queen, Elizabeth Woodville and her three fair children: Edward V., a two-months' king; Richard of York, now turning his sweet bright face of six years old, towards the uncle, who was afterwards to incur the infamy of being his murderer—whether justly or not has never yet been made clear; and Elizabeth, doomed subsequently to become the detested wife of Gloucester's mean successor—Henry of Richmond.

Not so rigidly matter of pure and authentic history as the last picture, this, which is apparently a leave taking for some short absence, is yet correct as regards the personages depicted. The two princes—Edward the King and his brother, Richard of Gloucester, are much older than in our previous study; the period is indeed that immediately preceding Edward's last and fatal illness, as is manifest from the age of the children, nor have the excesses of his life failed to produce effects that are even now visible; Richard is urging his brother to hasten, but Elizabeth—her beautiful face much careworn—has still some words to say, and the king pauses to listen. Her eldest son is standing close beside her; he eyes his uncle Richard doubtfully, but the younger boy, a child of little more than six years old, is clearly preferring some childish suit to Gloucester, whom he holds fast by the hand. It is an effective picture; said we not well—"there's a good time coming."

Now for my little Poetry: he comes tossing his bright curls well from his brow, and there is a right saucy look in the merry bright eye of him; it is not in melting mood, and that he has been working, and so may be seen. He is holding his picture on a fat round rosy knee;—such have I seen in a certain chamber of the Vatican,—who will fail to remember the instance? An old-world tale of archery perfai! The "proud sheriff of Nottingham,"—no less a personage—hiring Little John "to be his manne," as he did to his sore repentance and heavy discomfiture; a fact that none of us can have forgotten. But what possesses the sheriff to trust him!—might he not see the roguish purpose of the tall archer in those hold laughing eyes? No wonder my Poetry's two good-looking blue orbs should themselves laugh as he recalls his work. The sheriff too, a very comfortable sort of personage, not too obese,—my "dere child," Poesie, has too much good taste to fall into caricature;—beside that, so keen a lover of wood-craft as was the sheriff, must needs have kept some measure in the matter of girdle. The scene is a sort of chase, at no great distance from the town, since we have the towers of a cathedral in the extreme left, with some portion of a rich and stately abbey appearing beneath the magnificent oaks of the middle distance. Well done! and very well done too, my Poetry, also. The words that served to inspire him, after he had well rubbed his eyes, would seem to have been these that follow:—

"Lithe and liston, gentle-men,
All that now be here,
Of little John, that was the knightis man,
Good mirthe ye shall hear.

"Three times little John shot about,
And alwey cleft the wand,
The proud sheriffs of Nottingham,
By the marks 'gan stand.

"The sheriff swore a full great oathe,
By him that died on tree,
This manne he is the best archere
That ever yet saw I me.

"Say me now, wight young man,
What is now thy name?
In what country wert thou born
When-as thou wast at home?"

"In Holderness I was born,
I wis that from my dame,
Mon call me Reynold Greenleaf,
When-as I am at home."

"Say me, Reynold Greenleaf,
Wilt thou dwell with me,
And every year I will give thee
Twenty mark to thy fee?"

"Now so God me help," said little Johan,
And by my true lewtee,*
I shall be the worst servaunte to him,
That ever yet had he!"

Without doubt he will; and this is clearly the thought which it has seemed good to our painter to reproduce on his face. How is it that the sheriff does not see it there? Of the "mirthe" that ensued from the fact that he had not the faculty for doing so, another good picture might be made, and perhaps will be; but of this at some future time. We have now to look after little Fiction.

He has given us a solitary figure only, but full of promise; let us look at it somewhat closely. A subject taken from the very prince of his class—even Defoe; and the moment is one abounding in the deepest interest. It is that when the hero of the book—everybody's hero, for it is Robinson Crusoe—describes his terrible discovery of the foot-prints on the shore.

"One day it happened that, going to my boat, I saw the print of a man's naked foot on the shore, very evident on the sand, as the toes, heel, and every part of it. Had I seen an apparition in the most frightful shape, I could not have been more confounded. My willing ears gave the strictest attention. I cast my eyes around, but could satisfy neither the one nor the other. * * * * * Struck with confusion and horror, I returned to my habitation. That night my eyes were never closed."[†]

Manifestly they have no chance for doing so: dread and anguish have murdered sleep. You have but to look on the lone figure before you to be sure of it, and if, in their effective simplicity, the words of our author are eloquent, so also is this rendering of them by the painter. The utter loneliness of the solitary man is impressed on you with a force there is no resisting; you do not look in the distance for any other figure—you feel that there is none. Solitude has no partner in her reign, save only Silence, and she too is absolute: the stillness is unbroken, the water laving the boat can make no sound, for it lies altogether without motion, and it is the slight and almost imperceptible movement of the boat itself that alone breaks the level of the waveless shore.

Well done to Fiction also, then, and there shall be no more talk of slate-pencils or the milkman's chalk; 'tis a pleasant thing to be able to shake hands cordially with one's "dere children" all, and to say with the genial abhess of St. Alban's, "ye shall speede welie."

For the last six weeks has one of Nature's gladdest and most entrancing voices been calling us forth, that proceeding from the rejoicing birds, namely: nay, the woodlark has sent out her invitations even longer than that, and despite the acrimony of the weather, she found courage to make her sweet notes heard even in the doubtful days of February. March brought us the blackbird and thrush, nor were there wanting snow-drop and brilliant violet to give them welcome; these greeted even your wearied eyes, oh, unhappy ones, who do not escape from the far-reaching breath of the toiling town, but for ye—beloved of the kinder gods—who may take your way deep into the unspoiled wilds, there is less sophisticated company, and whither-soever your path may lead you, there shall rise the music of a gladsome brotherhood to greet your advent withal.

Is your way across the fields, you find the joyous hunting crossing your path in his merriest mood; keep forward to the bright streams, and you shall have the reed-sparrow to hear you com-

* Loyalty.

† "Life and most surprising Adventures of Robinson Crusoe, of York, Mariner," edit. London, 1719, p. 65.

* So Speed and other chroniclers; but we are not to forget that Bernard Andreas, a well-accredited author, writing within less than forty years after the event, declares Prince Edward, son of Henry VI., to have been killed in the battle of Tewkesbury, and the story here related is by many affirmed to have been invented by the enemies of the House of York.

pany; pursue the breezy upland, and lose yourselves among the sheep-walks,—there you need have no fear of oppression from too profound a solitude—pleasant is the society awaiting you there, were it only in the person of the stonemason; or if you more affect the woodlands, there will come the willow-wren to cheer you with her note. On the downs are the wheat-ear and the lap-wing, to say nothing of their agreeable neighbour the whinchat, snugly nesting amidst the furze. Bithesome now is the ring-ousel on a thousand hills; or should none of these delicious haunts be within your reach, and you have but the beach of the coast for all appanage, even there shall the sea-mew be found hastening to exhibit for you the most graceful measure that he can dance with his gay red legs, as who should say "not even amidst unpromising sands shall you fail to meet some creature rejoicing in the happiness provided by Nature's bounty for all."

To the glad arrival of the passage-birds, there will be none so cold as to profess indifference. Who is there that does not think long of her coming, if the nightingale delay to follow her mate? beyond the last days of the showery April? Hear, also, the truth and the wisdom that come to us with these beloved wayfarers, when adjured to declare their mission by such as know how to enquire aright. It is Felicia Hemans that questions them; these are her words,—

"Birds! joyous birds of the wandering wing,
Whence is it ye come with the flowers of spring?"

And they answer promptly—

"We come from the shores of the green old Nile,
From the land where the Roses of Sharon smile,
From the palms that wave through the Indian sky,
From the myrtle-trees of glowing Araby."

"And what have ye found on the monarch's dome,
Since last ye traversed the blue sea's foam?"

"We have found a change, we have found a pall,
And a gloom o'ershadowing the banquet hall,
And a mark on the earth, as of life-drops spilt,—
Nought looks the same save the nest that we built."

"Oh, joyous birds, it hath still been so,
Through the halls of kings doth the tempest go,
But the huts of the hamlet lie still and decay,
And the hills o'er their quiet a vigil keep.
Say, what have ye found in the peasant's eot,
Since last ye parted from that sweet spot?"

"A change we have found there, and many a change,
Faces and footsteps and all things strange.
Gone are the beads of the silvery hair,
And the young that were hove a brow of care,
And the place is busied where the children played,
Nought looks the same save the nest that we made."

"Sad is your tale of the beautiful earth,
Birds that o'erstep it in power and mirth!
Yet, through the wastes of the trackless air,
Ye have a guide, and shall ne desert?
Ye o'er desert and deep have passed,
So may ye reach our bright home at last."

Hear, too, what Wordsworth finds to say to your oldest of old acquaintance, the heart-gladdening skylark—

"Ethereal minstrel! pilgrim of the sky;
Dost thou despise the earth where cares abound?
Or, while thy wings aspire, are heart and eye
Both with thy nest upon the dewy ground?
Thy nest, which thou canst drop into at will,
Those quivering wings composed, and music still!"

"To the last point of vision and beyond,
Mount, darling warbler! that love prompted strain
(Twixt thee and thine a never-fading bond,
Thrills not the less the bosom of the plain.
Yet mightst thou seem, proud privilege! to sing
All independent of the leafy spring."

"Leave to the nightingale the shady wood,
A privacy of glorious light is thine,
Whence thou dost pour upon the world a flood
Of harmony, with rapture more divine
Type of the wise, who soar, but never roam,
True to the kindred points of heaven and home."

Of the ability exhibited by birds, when it pleases them to become artificers, let us hear what Aristophanes declares:—

"Birds, with their own good hands, have wrought these works.

* The male bird is known to arrive invariably some fifteen days or so before the female.

Bricklayer, nor stone-mason, nor carpenter.
But birds with their own hands—tis marvellous!
From Lybia came about three million cranes,
Who had swallowed stones for the foundation; then
The cornrills, with their beaks, did chip and hew;
The storks, another myriad, hove the bricks,
While water, to the air from underneath,
Was brought by sea-larks and the river birds.
Ptolemaeus. And who with mortar served them?
Messenger. Herons, with hods.
Fish. And how did they the mortar throw therein?
Mes. That, too, was managed, sir, most dexterously,
For by their feet the geese, with understroke,
As 'twere with trowels, cast it in the hole.
Fish. Oh, what may not by help of feet be done!
Mes. Aye, and the drakes, by Jove! with apovits
tucked up,
Rare bricks, and after them, like serving-hods,
Flew up, with cement in their mouths, the swallows.
Fish. Who now would pay hired labourers for his work?
Dat, let me see, the timber-work o' th' wall,
Who wrought at that?
Mes. Those carpenter-fowls, the hickwalls,*
Who with their beaks did hack the gates out workmanly,
And of their hacking the like sound arose
As in a dock-yard."

Now we do not bid you paint the good drakes with their aprons tucked up, nor insist on a picture of herons stiling along under hods of mortar as aforesaid; yet has the artist occasionally made him merry with "metal" infinitely less "attractive;" and if you do nothing worse than reproduce the old Greek dramatist, all the easier shall be your shrift. Meanwhile there is a story told by an observant traveller in our own country, wherein the power of combination, not unrequently refused to animals by writers who treat of their instinct, is singularly exemplified. More than one good name, well honoured in Art, might be cited, whereof the owners would indubitably have called pencil to aid had they witnessed the little incident thus described by the traveller in question.

"On the road between Huntley and Portsoy, I observed two magpies hopping round a great hush within the garden of a poor-looking house, and remarking something peculiar in their proceedings, I stopped to see what they were doing. The countryman then told me, that these magpies had built there during several successive years, and had brought up their young in that hush; he added that they had not only harricaded their nest, but had so strongly encircled the bush itself with briars and thorns, that no cat or hawk could penetrate to the young; nay, so formidable were their defences that it would cost even a fox, cunning as he is, some days of painful labour before he could get into the nest. I found that the whole length of my arm did not suffice to reach from the outside of the bush to the centre, so that man himself could not break through without the use of a bodge-knife, hatch-bill, or something of the kind. The parent-birds fed their young with frogs, mice, worms, or any thing living within their power to subdue."

So far our traveller loquiter. One day it chanced that the mother magpie had ventured to attack a rat in the absence of her mate, but after a long battle the quadruped was on the point of getting the best of it, and was fast making off, when one of the young ones came from the nest and joined the fight; a conflict of great animation then ensued, but their antagonist was too many for both mother and son, and the rat would still have escaped had not the father happily arrived with a dead mouse in his bill; this he deposited safely, then adding his forces to those of his wife and het, poor Ratibolan was eventually killed, when that handsome piece of venison, which had previously formed his personal identity, went to swell the stores of the magpie larder.

After that, do not say that birds are incapable of combining; above all, admit their talents for performing the duties of the commissariat.

"Stand not before the Sanhedrim as stands the guilt-stained, or the suppliant, but appear thou in thy might and thy splendour; be the purple of thy sovereignty the robe of thy wear; and let the most approved and faithful of thy guard keep watch around thee."

Such were the counsels of Antipater, or as, in

* Hickwall, the woodpecker.

† "Birds of Aristophanes," Cary's translation, p. 109.

the Hebrew form, he is called, of Antipas, the father of Herod, when the latter, summoned to answer for the death of Hezekias, had finally determined to appear before the great tribunal of the Jewish nation in awful conclave assembled. For their president the Sanhedrim had the high-priest Hyrcanus, grandson of that renowned pontiff,—one of the most distinguished among the Amonnean rulers of his people,—the great John Hyrcanus, and inheritor of his name no less than of his office. Well had it been for the Hebrew nation had he likewise inherited his grandson's indomitable force of will; but this boon had been withheld, and in the countenance of the high-priest you detect the weak irresolution of his character.

The respect of Herod for his father was unbounded, it was equalled only by his love; had the wise and able Antipater enjoyed length of days, his son might have developed only those finer qualities which he certainly possessed, but the father died untimely, and from that misfortune dates the downward tendency of Herod.

Conforming to the counsels of that beloved father, it is in his "pride of place" that the young Ethnarch—be was then sole governor of Galilee—advances to confront his judges; martial forms precede, and open to him a broad free path up the hall of justice. Herod is in the first summer of his youth, and of faultless beauty. Thus it is that you shall paint him: he comes arrayed in robes of flowing amplitude, and of the richest texture; jewels of mighty cost lend all their lustre to heighten the gorgeous effect of his imposing presence. Nor are those who should repress that insolence of demeanour wholly uninduced by his boldness: the awful patriarchs wear looks of doubt and anxiety; some are gathering their robes around them as do men who are meditating flight; but there is one who rises superior to that unworthy weakness, and even more beautiful than the brilliant youth of Herod, is the reverend age of him who bends on the glittering Ethnarch the full majesty of his reproving gaze, after he has exhorted his brethren to remember their duty.

These are some few of his words, as recorded by Josephus—read them; and there cannot fail to rise before you that high nobility of aspect, which it is for you to render permanent on your honoured canvas, in the person of the grave and reverend speaker.

"Oh, you that are assessors with me, and thou, Hyrcanus, who art our chief, I neither have ever myself known such a case, nor do I suppose that any one of you can name its parallel, that one called to take his trial at our bands, ever stood in such a manner before us. For every man, whoever he be, coming to be tried by this Sanhedrim, presents himself submissively, as in a fear, and who would move us to compassion: all come hither with hair dishevelled, and in the garments of mourning; but this man Herod, accused of murder, and called to answer an accusation so heavy, stands clothed in purple, his hair finely trimmed, and his men of war around him. Now if we condemn this man, he may slay us, and shall himself escape; neither do I now complain of Herod himself in this matter; he is more concerned for his own safety than for your laws. But know ye, my brethren, that God is great, and by this very man, whom ye, for the sake of Hyrcanus, will now absolve, shall be punish both yourselves and your chief."*

Thus spoke Simcon, whose name was Sameas,† and the effect was immediate; some anxious faces still remained in the assembly, and so must you depict these men of feeble heart; but, turning their eyes on the noble Sameas, are others worthy to be his peers; let the dignity and distinction of their majestic persons not be lost in your bands. These men are

* "Nor did Sameas fail to prove a true prophet," says Josephus; Herod, when king, slew all the members of that Sanhedrim, Hyrcanus included; Sameas alone, "whom he honoured for his righteousness," was permitted to escape, although he still persisted in maintaining that evil would befall the Jews at the hands of Herod. See Antiq., h. xiv., c. 9, sect. 4.

† Reland observes, that the Talmudists confirm this account; they call Sameas, Simcon the son of Shetach. Ibid., note.

prepare to affirm his decision, and will uphold the sanctity of their law to the death. But the high-priest extends his hand, he defers the discussion to some future day, the Sanhedrim is adjourned, and the Edmarch is saved.

Look closely at Hyrcanus, for this is your moment, and it is now that you must paint the picture. No worthy successor of the Asmonean princes, there is yet a certain dignity in his bearing as he utters the few words whereby the assembly is dissolved; notwithstanding his deplorable irresolution of character, you have still the descendant of a noble race for your study. Nor is Hyrcanus actuated solely by unworthy motives, in thus shielding Herod from the ire of the Sanhedrim; it is not for dread of Sextus Cæsar that he labours to save the Edmarch, but the letters of the Syrian general may have had their effect, but "Hyrcanus loved the youth as his own son," says Josephus; and at this time Herod was not unworthy of his affection.

Neither was the act of which he was accused a murder. Hezekias, a noted robber and assassin, had been justly punished—the whole fault of Herod was that he had put him to death without first obtaining the sanction of the Sanhedrim—an illegal act, but not a crime. Thus there is a conviction of his own rectitude on the proud brow of the accused, and this lends valuable aid to the fine effect you will produce by the mere portraiture of his magnificent beauty.

Your next picture of him is wholly different, and must show him under a less favourable aspect. His first great crime has been committed, he has caused the secret murder of Malchus, and if his provocation has been great—for by Malchus, his beloved father, even Antipater has been foully poisoned—* so also is the guilt now resting heavily on his soul, and you have no longer the consciousness of an upright intention to depict. Oh! "*Facilis descensus Avernî*;" let us never forget it!

"*Facilis descensus Avernî:*

*Sol revocare gradum, superisque eadere ad auras,
Hoc opus, hic labor est.*"

His first youth has passed; Herod, now Tetrarch, is in the force of his manhood; thus it is a figure of imposing stateliness rather than of youthful grace, that you have here to set before us. He is standing beside a fountain within the great court of his palace; pain and grief are in every feature, for the brother of his dearest love—the brave and sincere Phasaelus, has fallen into the toils of the wily Parthian, from which he shall escape only by a painful death.† Herod feels that the power to save that beloved brother is not with him, although he would give his heart's blood to secure it, and the iron hath entered into his soul.

Bitter is the expression with which he follows the retreating figures of the Parthian messengers, who have come to entrap him also, if that he possible; but he distrusts their purpose, and they are departing foiled. Soldiers of his guard recline beneath the shade of the portico surrounding the court; they mark his displeasure, and some are placing a ready hand on their weapons, but their commander gives no sign and they retain their place. Crossing from the colonnade to the fountain, is a woman of regal beauty, though no longer young, this is Alexandra, the daughter of Hyrcanus, and another of Mariamne, Herod's betrothed but not yet wedded wife. She comes to implore that he will not go forth of the city, as the treacherous Parthians would fain have him do; he does not yet perceive her approach, but the position of each figure is favourable for your purpose; let us have them as they now appear.

Your third picture shall be one of glad

triumph—alas, that it must be the only one of that character. Woe, woe for Herod! Few and fleeting were the moments of happiness permitted to brighten that storm-tossed life. This is the last.

The scene is Samaria, the event to be delineated is the marriage of the Tetrarch with his long-loved Mariamne. How radiant was her beauty you well know, and the joy of the hour has restored a portion of their early splendour to the looks of Herod. The gorgeous accompaniments of these espousals do not need description; you are familiar with their details, they are such as befit the regal state of the affianced, and all is brilliant festival. One face alone has turned a look of menace on the bride, but there is a world of evil in that glance; half concealing its malignant fire beneath the sheltering veil, it yet glares balefully from the glowing eyes of her who was soon to become the evil genius of the wedded pair. This is Salome, the sister of Herod; even now is she preparing a heavy future for the hapless Mariamne, and of one among the earlier results of that fiend-like woman's influence shall be the fourth picture in your series.

Evening is falling over the shadowy palmetrees of the Royal Gardens; the fervid evening of an eastern clime. It is the feast of Tabernacles, and after a day of high revelry the brilliant guests are gathered about the fountains. A youthful hand surrounds the sparkling waters in that ample basin, and Aristobulus, the young brother of Mariamne, not then eighteen, and described as a very miracle of beauty, has been persuaded to join them, as they plunge beneath the crystal lymph: together have the young men entered that unwonted bath, luxuriously are they disporting themselves in the delicious coolness—all is joy and exultation.

Now you will remember that the criminal ambition of Alexandra has imposed the burden of the high priesthood on those young shoulders; but Aristobulus reckes little of his unbecoming dignities; gaily has the princely boy borne his part in the festival, and joyously have the peals of his laughter rung forth on the well-pleased ear of his mother and sister, as they recline at a distance beneath the sheltering trees.

But there is treachery in that seeming sport. Salome has taken part with those who have led Herod to believe the youth dangerous to his power: perhaps he was so, in the hands of the designing Alexandra, but he will menace no more. The young companions are full of playful gladness; each labours to plunge the other beneath the waters; loud are the cries of ecstasy as the revels go on, but all who gather round Aristobulus are not his friends; surely, they keep him too long immersed! Alarm succeeds to merriment, there is a rushing and tumult; they have laid on the dark soft bordering turf a white inanimate form; you cannot see wherefore that marble stillness, for you are distant, but the agony of Herod, not all feigned, tells too clearly what has chanced. Doth not the Tetrarch rend his garments?—then Aristobulus is dead! and the unhappy son of Antipas has made a further descent adown the precipitous path to that gulf of crime which now yawns inevitably before him. Alas for Herod!

Years of fearful violence succeed, each marked by the searing effects of frequent crime and varied suffering. Deeply has King Herod dyed his hands in kindred blood; Hyrcanus, the grandsire of his bride, and Joseph, his father's brother, have followed Aristobulus. The latter had revealed to Mariamne the command of her husband, that in the event of his death she should not be permitted to survive, and when that became known to Herod he "was like one distracted, his anger made him stark mad; leaping from his couch he ran about the palace wildly, resolved on the destruction of Joseph, at which time his sister Salome took the opportunity and so moved him against Mariamne that he commanded to slay her also, but evoking that orler out of his exceeding love for his wife, he caused Joseph to be put to death alone."^{*}

But her escape was not to be for long; proud and resentful, the unfortunate Mariamne took no measures to conciliate her enemy; other charges succeeded, and she was at length brought to trial; the accusations against her were adultery and attempted murder, of both which it was known certainly, that she was innocent.

Here, then, is the melancholy scene you have next to depict. His councillors have assembled by command of the king, and before them is arraigned the wife he still so dearly loves. She is condemned, for so do those unworthy judges believe to be the will of their master. "A woman," says Josephus, "of excellent character both for chastity and greatness of soul; if she wanted moderation and had too much contention in her nature, yet was she endowed with many great and fair gifts; her beauty and majestic appearance surpassed whatever can be said to describe them, and the charms of her conversation were even more powerful than her beauty in the influence they gave her over Herod."

You behold then the kind of woman whom you have now to present to the future ages; no longer the brilliant bride, she is something infinitely more touching, more sublime—she is a faithful wife, a good mother, and a deeply wronged woman; so will you depict her. Her sentence she hears with calmness, for life has long been a weary load, but the serenity of her aspect is for one moment troubled; it is when her worthless mother, Alexandra, whom you perceive to be addressing her with flashing looks, affects to overwhelm her with reproaches, and is daring to express a belief in the truth of those who accuse her daughter, although one can be more firmly assured of Mariamne's innocence than is Alexandra.

By this act the wretched woman, tempted thereto by a mean terror for her own life, ensures the contempt of all who witness it. Even Cyrenus, the mother of Herod, and no friend to Mariamne, yet regards the raving Alexandra with abhorrence; she might even be led to plead for the condemned, although she, too, as well as Salome, has but too frequently felt the scorn of the proud Hebrew princess, to whom her Idumean birth was an offence and a stumbling-block; but her daughter is at hand; no ruth is in the heart of the vile Salome; she marks the anguish of her brother, she beholds him on the point of relenting, but the name of Sohemus escapes her lips, that sound has rekindled all his fury, and Mariamne is led to death. Fearful is now the misery endured by Herod: not this the splendid Edmarch of the Sanhedrim; the rejoicing bridegroom of Samaria; nay, the figure of the king, as you must now delineate him, shows clearly that much has been performed and suffered, much of wrong-doing and its retributive sorrow, since last we met him at the Feast of Tabernacles, although the brightness of his pristine glory had even then departed.

The unworthy Alexandra is his next victim; her base abandonment of her child did but serve slightly to prolong her miserable existence, and she dies unpitied; all remembering how the murdered Mariamne "gave her not a word, nor was discomposed at her peevishness, save that out of her greatness of soul she could not but feel concern for her mother's offence, and was grieved to see her expose herself by that unbecoming violence."^{**} Thus Alexandra knew herself to be the object of universal scorn.

The Idumean Costobarus followed Alexandra, with Gadias, Dositheus, Lysimachus, and others, until the sword of the tyrant had at length left him no friends to share his woes.

Next there conspires with Salome the first-born of Herod, even Antipater, the son of his Idumean wife Doris; their object is to ruin the two sons of Mariamne, Alexander and Aristobulus, and by their machinations these young men are brought to a deplorable end. But as if it had been decreed that no evil thing should chance without the agency of the doomed king, it is by himself that his sons are arraigned before Cæsar, and even after they have been acquitted by the tribunal of the Emperor, it is by his own

* See "Wars of the Jews," b. 1, c. 11, sect. 8.

† "The manner of that death is related on this wise: refusing to abandon Hyrcanus, who, as well as himself, had been hired into the power of the Parthians by false pretences, Phasaelus, who might else have escaped, was straightway bound. He then tried to dash his head against the walls of his prison, but his bonds prevented him from striking an effectual blow, and a physician, subsequently sent to tend him, put poison into the wound. Of this it was that Phasaelus died, but, being aided by a certain woman, he found means to send an account of the whole to Herod, saying, 'Now shall I die content, since my brother will avenge my fall.'"—Antiq., b. xiv., c. 13, sect. 10.

* Wars, b. 1, c. 23, sect. 5.

** Antiq., b. xv., c. 7, sect. 5.

voice that they are condemned. They receive the pretence of a trial, at Berytus, and this concluded, those ill-fated descendants of the noble Maccabees are taken to Sehaste,* where both are strangled.

Then it was that the old soldier Tero, Herod's last remaining friend, broke into his presence, declaring that "Truth had perished from the earth, and justice been taken from among men." "I am not able to endure these evils, O king!" exclaimed the veteran warrior, "and have resolved to devote this day, which thou wilt assuredly make my last, to one more and final attempt at causing thee to hear of things as they are." The old man then proceeded to describe the evils that must result from the course pursued by the king, who seemed for some moments disposed to listen: but Tero was ultimately cast into prison, and being subsequently accused of conspiring against his master, he was stoned to death at Berytus, as was his son, who had been involved in the accusation. †

And now why continue this melancholy series of pictures? why further dwell on the vast amount of wasted blessings and misapplied endowments that might have rendered the life of this lost king so glorious?—nay, but even to these our days, some lessons may be taught by the story: here however is its end. His days draw to their close, and thus does he approach it. Pheroras, the last beside himself now remaining, of Antipater's four sons, and Herod's well-beloved brother, is accused of designs against his life, the women of his household are tortured into admissions of guilt which is not believed to have had existence, but Pheroras finds means to clear himself: he is nevertheless commanded to leave the capital and retires in bitter resentment to his Tetrarchy, where he subsequently falls sick unto death. Then revives all the old affections of Herod, whose love for his brethren was among the most powerful impulses of his nature, and he hastens to the couch of the dying Pheroras.

Here then will we meet him for the last time. The mere wreck of his former self, he heeds sorrowfully over the couch of the sick man, who had registered a solemn vow to see his face no more, and had refused to return to the presence of the king when Herod had himself been at the point of death. Yet has Herod come hither unweaned and unwished for—nay, the pale face of Pheroras wears an expression of reproach, heart-breaking to the wretched brother, who is at this moment repentant. A woman is kneeling beside the bed, it is the wife of Pheroras, grief and terror are in her looks, she is conscious to a guilty knowledge that poison had been prepared for the king, but it is by the wicked Antipater, who has caused it to be brought from Rome by his freed man Bathylus, nor has there ever existed any intention on the part of Pheroras to use the drug against his brother. He has indeed supplied her unhappy self with a portion thereof, as a means of escape from the anticipated cruelties of the king, when he shall himself be laid in the grave. These things are made known after the death of Pheroras, and when the fears of his wife have caused her to attempt self-destruction. But we pursue the grievous theme no further, already has that "fire which glowed in him slowly," as says Josephus, commenced its ravages, and his remaining days are to pass in maddening torture. Even now, you have small trace of the stately monarch we formerly knew: that ruined form bent over the couch of Pheroras gives evidence of suffering more terrible than that of the dying.

In his last paroxysms, Herod commanded the death of the wicked son of Doris, even Antipater, whom he already held in bonds. Presuming to indulge in rejoicing anticipations of his father's approaching death, the words of his first-born are repeated to Herod, and the result we have related. Five days after the execution of Antipater, Herod himself departed. ‡

* Our readers will remember that when Herod had strongly fortified Samaria, the name of the city was changed, and it was thenceforth called Sebaste.

† Antiq. b. xvii, c. 14, sects. 4 & 5.

‡ To be continued.

BRITISH INDUSTRIES.*

No. VIII.—THE WHITBY JET AND AMMONITE ORNAMENTS.

THERE are not many branches of Art-manufacture which are of more interest than the working of Jet. The material itself—which is a comparatively rare production—being confined in this country to the neighbourhood of Whitby, is curious in its general character, and peculiarly interesting in its mode of occurrence.

Jet was certainly known to the Romans, and used by them for ornamental purposes. A few fragments of jet ornaments which have from time to time been discovered in this country, prove that it was worked at an early period in these islands. The jet of our coast was known to the ancients by the name of *gayates*. In the history of Whitby, by Lionel Charlton, we find this passage—“I myself have lately viewed the earring of a lady, who had most certainly been buried in one of the *houses* (tunnels or barrows) long before the time of the Danes in England. It is of jet, more than two inches over, and about a quarter of an inch thick; made in the form of a heart, with a hole towards its upper end, by which it has been suspended to the ear: it lay when found in contact with the jaw-bone.” Ornamental articles have probably been manufactured from the jet of Yorkshire from the earliest historic times; and during the period of monastic rule, especially when the Abbey of Whitby was a seat of learning, and the resort of pious pilgrims, there cannot be much doubt but that jet-crosses and rosaries were common. A good specimen of a jet crucifix of ancient manufacture is in the possession of Mr. John Robinson, of Gros-mont. In the time of Elizabeth it is certain that this manufacture was carried on, since affixed to a deed dating April, 1598, we find the name, “John Carlile, of Whitby, *jet worker*.” This manufacture appears, however, to have declined, if it did not, indeed, entirely cease, and it was not until 1800 that we have any further information of this branch of industry. The rise and progress of the jet trade from this period is interesting, and from a local journal we extract the following particulars: “About the year 1800 a painter named Robert Jefferson, who is still living (1854), and one John Carter, who kept a public-house in Haggsgate, a native of Bedale, and who is often spoken of by the name of Katterfelto, in consequence of having married the widow of Gustavus Katterfelto (a Prussian who delivered lectures on science in the Town-hall, Whitby), began to make beads and crosses of jet with files and knives. A neck-guard, made in this barbarous manner, was sold for 1*l.* 1*s.* A short time afterwards Captain Fremlett, a naval pensioner, came to reside at Whitby, who, stopping in Carter's house, observed Jefferson and Carter pursuing the art in its rude state. He showed them some amber beads, which he had turned with a lathe, and said he would ask some turner if jet could not be turned in the same way. The trio went to one Matthew Hill, who had the workshop lately occupied by Mr. Thomas Horsman. Hill succeeded in making beads, but had no confidence that the art could be pursued to profit. Fremlett, however, agreed to pay him his wages as a turner if he would work for him in the making of jet ornaments. Subsequently Mr. Thomas Yeoman, silversmith and druggist, in Bridge Street, employed Hill's whole time in the manu-

facture; and, business increasing, one Frederick Ward, who had been taken by the abovementioned Carter, out of Leeds poorhouse, to assist him in his inn, went to work with Hill. Mr. Yeoman afterwards employed Foster, another turner. Others then entered the ranks—the next being George Harrison, a cartwright of Sneaton, who was taught by Jefferson. One Charles Brown, of Scalby Mill, near Scarborough, then commenced, and a lad named Wormald served his apprenticeship to him; since which the trade has gradually increased, and by the exertions of Mr. Thomas Andrew, now jet-ornament manufacturer to her Majesty, Mr. Isaac Greenbury (who has had the honour of an order for bracelets for the Empress of the French), with others who have adopted the jet-manufacture as their vocation, the art has arrived at its present excellence, and the trade to its present extent.” Learning that this homely account of the rise of the jet-manufacture was strictly reliable, we have thought it advisable to transfer the paragraph entire to our pages. A very important industry has been created from very small beginnings, it has been steadily extending itself, and, notwithstanding the manufacture of cheap imitations of jet in glass, papier-mâché, shell-lac, and Cannel coal, the real material still keeps its position, and from the beautiful polish of which it is susceptible, and the intensity of its blackness, it is not likely to be superseded.

The origin of jet must still be regarded as a matter of doubt. In many respects jet has the characteristics of amber so closely, as to warrant us, from the analogies, in supposing them to have a similar origin. But this idea will not satisfactorily hold, when all the conditions under which the jet is found, are considered. Most of the local authorities who have carefully examined the subject, ascribe to jet a vegetable origin. Young, in his “Geology of the Yorkshire Coasts,” says—“The principal repository of jet is the main bed of alum shale, but it is not limited to the aluminous beds. We found some of it in the *second shale*, near Torrington, and it has been often found in the same bed at Malton. Even the sandstone sometimes contains it, though in that matrix it is rather in the form of anthracite, holding a kind of intermediate station between the best jet and coal. Much of this anthracite coal is found in the sandstone cliffs near Whitby, and along the coasts.” This writer, in his “History of Whitby,” writes—

“Jet, which occurs here in considerable quantities in the aluminous bed, may be properly classed with fossil wood, as it appears to be wood in a high state of bituminisation. Pieces of wood, impregnated with siliceous matter, are often found completely encased with a coat of jet about an inch thick. But the most common form in which the jet occurs is in compact masses of from half an inch to two inches thick, from three to eighteen inches broad, and often ten or twelve feet long. The outer surface is always marked with longitudinal striae, like the grain of wood, and the transverse fracture which is conchoidal, and has a resinous lustre, displays the annual growth in compressed elliptical zones. * * * Many have supposed this substance to be indurated petroleum, or animal pitch, but the facts now quoted are sufficient to prove its ligneous origin.”

It does not appear to us that the “ligneous origin” of jet is by any means established—indeed we think the bulk of evidence is against it. There is no evidence, as far as we can learn, of any discovery of

* Continued from p. 68.

trne jet having a strictly ligneous structure, or showing anything like the conversion of wood into this coal-like substance. There appears, however, to be some confusion in the observations of those who have written on the subject. Mr. Simpson, the intelligent curator of the Whitby Museum, who has paid much attention to the subject, says, "Jet is generally considered to have been wood, and, in many cases, it undoubtedly has been so; for the woody structure often remains, and it is not unlikely that committed vegetable matter may have been changed into jet. But it is evident that vegetable matter is not an essential part of jet, for we frequently find that bone, and the scales of fishes has also been changed into jet. In the Whitby Museum there is a large mass of bone, which has the exterior converted into jet for about a quarter of an inch in thickness. The jetty matter appears to have entered first into the pores of the bone, and there to have hardened; and, during the mineralising process, the whole bony matter has been gradually displaced, and its place occupied by jet, so as to preserve its original form." After an attentive examination of this specimen, we are not disposed to agree entirely with Mr. Simpson. Jet certainly encrusts a mass of matter, which has something of the structure of bone, but, without a chemical examination of its constituents, we should hesitate to say it was bone. Wood without doubt has been found encrusted with jet, as fragments of animal matter may also have been. But it is quite inconsistent with our knowledge of physical and chemical changes, to suppose that both animal and vegetable matter would undergo this change. By the process of substitution, we know that silica will take the place occupied by carbon, or woody matter; as, for example, in the fossil palms of Trinidad, and the silicified forests of Egypt; but we have no example, within the entire range of the coal formations of the world, of carbon taking the place of any of the earths.

Jet is found in plates, which are sometimes penetrated by belemnites. Mr. Ripley, of Whitby, has several curious examples,—two plates of jet, in one case, enclose water-worn quartz pebbles; and in another, jet partially invests an angular fragment of quartz rock. "This is the more remarkable," says Mr. Simpson, "as quartz rock, or, indeed, any other sort of rocky fragment, is very rarely found in the upper lias."

The very fact that we find jet surrounding belemnites, casing adventitious masses of stone, and investing wood, seems to show that a liquid, or, at all events, a plastic condition, must at one time have prevailed. We have existing evidence of this. Dr. Young, in the work already quoted, says:—"In the cavities of nodules containing petrifications, we sometimes meet with *petroleum*, or *mineral oil*. When first exposed, it is generally quite fluid, and of a dark green colour; but it soon becomes viscid and black, and at last hardens into a kind of pitch, which readily melts with heat, and, when ignited, burns with a crackling noise, and emits a strong bituminous smell." One more sample of evidence in favour of the view that jet has been formed from wood. It is stated ("Reed's Illustrated Guide to Whitby") that in front of the cliff-work of Haiburne Wyke existed a petrified stump of a tree, in an erect posture, three feet high, and fifteen inches across, having the roots of coaly jet in a bed of shale; whilst the trunk in the sandstone was partly petrified, and partly of decayed sooty wood. Even in this example it would appear, that after all, a coating of jet was

all that really existed upon this example of the Equisetum, which probably stands where it grew. Mr. Simpson, in a valuable little publication, "The Fossils of the Yorkshire Lias described from Nature; with a Short Outline of the Geology of the Yorkshire Coast," says:—"From all we know respecting this beautiful mineral, it appears exceedingly probable that it has its origin in a certain bituminous matter, or petroleum, which abundantly impregnates the jet-rock; giving out a strong odour when it is exposed to the air. It is frequently found in a liquid state in the chambers of ammonites, and belemnites, and other cavities; and, whilst the unsuspecting operator is breaking a lias nodule, it flies out and stains his garment. * * * * * This petroleum, or mineral oil, also occurs in nodules which contain no organic remains; and I have been informed by an experienced jet-miner, that such nodules are often associated with a good seam of jet, and are therefore regarded as an omen of success." The readers of the *Art-Journal* will now form some idea of the difficulties which beset those who would account for the formation of jet.

Having in the most obliging manner been allowed by Mr. Simpson to examine all the specimens in the Whitby Museum, especially those to which he himself refers in his work, we are quite disposed to think that bituminous matter, separating from the alum shale during the process of consolidation, has distributed itself between the laminations of the shale, and insinuated itself into all the cavities, formed by pieces of wood or stone which had been involved in the alum mud. The layers of jet are often not thicker than the edge of a knife; and they seldom exceed, indeed, rarely, are found of two inches in thickness. These are not, therefore, the conditions belonging to any vegetable formation; but, just such as would prevail, if bituminous matter had gradually filtered through mud, slowly consolidating, and assuming a state of lamination.

The process of mining for jet is rather one of quarrying; although some judgment is required, in order to determine the direction in which the search should be prosecuted. The best jet is obtained from a lower bed of the upper lias formations at Whitby. This bed has an average thickness of about twenty feet, and is known as the jet rock. An inferior kind, known as soft jet, is obtained from the upper part of the upper lias, and forms the sandstone and shale above it. The production of jet seems to be limited along the coast of Yorkshire, from about nine miles south of Whitby, to Boulby about the same distance to the north, the estates of Lord Mulgrave being especially productive. There is a curious allusion to this in the *Poly-Olbiion* of Drayton:—

"The rocks by Moulgrave, too, my glories forth to set,
Out of their crannied rocks can give you perfect jet."

Jet is also obtained in the district extending from Rosedale, near Pickering, to Bilsdale. There is, indeed, every reason for believing the jet-deposits will accompany the peculiar rock in which it is found at Whitby, wherever that formation may extend.

Collecting jet is attended with some danger; since working upon the edge of the cliff, the men are obliged to expose themselves in very perilous places. In a paper now lying before us, we see recorded the death of a labourer in the jet-works at Kettlewell, who was killed by a fall from the top of the cliff. He fell upon a piece of broken rock, and was killed on the spot.

The number of people employed in the several branches of industry connected with jet at Whitby, or dependent upon it for their support, has been estimated at a thousand. The population of Whitby does not greatly exceed ten thousand; so that nearly one in ten of the population rely on this special manufacture. Raw jet varies in price according to its quality; soft jet being sold for two shillings the pound, whereas the best varieties of the hard jet will fetch twelve shillings the pound. There are about twelve manufacturers of jet in Whitby; the principal ones being Mr. Isaac Greenbury, Mr. Thomas Andrew, and Mr. Wright. The value of the manufactured jet was, last year, somewhere about twenty thousand pounds. All the best examples of the manufacture find their way to the metropolis; while a very large trade, especially in the less valuable varieties, is carried on with the United States of America.

Since jet manufacture has been almost entirely confined to the purposes of ornament, and those ornaments such usually as can be worn only in seasons of sorrow, there are no very extended limits for the art of the designer. Necklaces, ear-pendants, brooches, and articles of a similar description, have a somewhat stereotyped character; but still we cannot but think that a considerable value might be given to this manufacture, if some skilled designers, acquainted with the peculiarities of the material with which the maker has to deal, turned their attention to the material. It appears that the more spirited of the manufacturers of jet have offered prizes for, and have endeavoured to adopt many new designs. But owing to the fact that the artist has not been a manufacturer, the designs furnished have not been generally applicable. In this, as in other departments of Art industry, it is necessary that the power of the artist, and the skill of the manufacturer, should be united. It would be of the utmost advantage to the town of Whitby in which, what may be regarded as a new manufacture, is developing itself, if means were taken for the establishment of a school of design, in which there should exist a class, whose sole study should be the construction of forms, which should combine all that is elegant in design, with adaptability to the beautiful material in which it was to be worked. An intelligent jet manufacturer informed us that very few of the designs which he obtained by purchase from the metropolis could be worked; that they were far more successful in their attempts to copy from natural objects, than from any artificial combination. In the large collection of jet ornaments manufactured by Mr. Greenbury, we saw many examples of copies from nature, which were very perfect as copies, and exceedingly beautiful as ornaments. We were much pleased also with some examples in jet from ancient brooches, and copies in jet from works of superior excellence in gold. Notwithstanding many satisfactory examples of this kind to be found in the collection of Mr. Greenbury, we know he is fully impressed with the advantages to be derived from the introduction of some Art-education. It appears that he frequently avails himself of the designs published from time to time in the *Art-Journal*, but still the necessity for a good designer in jet was freely admitted.

Jet manufacture must be regarded as in some measure the staple of Whitby. Long celebrated for its ships, ship-building still takes precedence of every other industry; but next to it comes the jet, so peculiarly associated with this locality in nature.

The Ammonites—of which fossil no less than one hundred varieties have been found around Whithby, and described by Mr. Simpson—are characteristic of the lias rocks of this neighbourhood. These are the well-known "snake stones" of popular tradition, rendered familiar by the verses of Scott in "Marmion":—

"They told how in their convent cell,
A Saxon princess once did dwell,
The lovely Editha,
And how, of thousand snakes, each one
Was changed into a coil of stone,
When holy Hilda prayed."

These Ammonites are found in the greatest abundance, of all sizes, and, as we have said, of numerous varieties. These are mounted in gold and silver as brooches and pins, and are eagerly sought after by the curious; forming, at the same time, most elegant ornaments, and instructive examples of one of the forms of life which had existence upon this world ere yet man had being.

Such are a few of the peculiarities of the natural productions, found within a limited area, from which have grown an important industry, still capable of considerable extension.

ROBERT HUNT.

THE NATIONAL GALLERY AND ITS DEFAMERS.

"He defied any one to point out any artist who could have been appointed to the situation, who would not have been immediately a butt for the anonymous attacks of every disappointed competitor." These are the words of Lord Palmerston in the House of Commons, during a debate on a motion moved by Mr. Otway, and seconded by Mr. Harcourt Vernon; which motion was intended to show that Sir Charles Eastlake is entirely unfitted for the position he occupies, as Director of the National Gallery; a motion that was rejected by 152 against 72. Mr. Otway in reply said, that "the House was not dealing with anonymous slanders, but rather with the criticisms of the most eminent journals in the empire; every magazine of character; every newspaper worth anything; nay, more; the very gentlemen who had been appointed by the government to high office—Mr. Hurlstone, President of the Society of British Artists, and Mr. A. Stevens, the Gold Medalist—had commented with severity on the proceedings and purchases of Sir C. Eastlake."

The two passages we have quoted contain pretty nearly all that is to be said—for and against—concerning the recent attacks upon Sir Charles Eastlake, and those with whom he is allied in the executive of the National Gallery; and Lord Palmerston very well knows, that if it were possible to collect the knowledge of all who have ever lived, and condense it into "one small head," that head would as surely be "a butt for disappointed competitors," as Sir Charles Eastlake has been.

But, with respect to Mr. Otway's statement; it is as fair a specimen as could be had of the nature and style of this discussion—a bold assertion unsupported by fact. We deny in toto that every magazine of character, every newspaper worth anything, has commented with severity on the proceedings and purchases of Sir Charles Eastlake.* We are fully aware that in several periodical works, attacks of this kind have been made; but they all, or very nearly all, issue from the same source; and may be traced to one of four persons—Mr. William Coningham, Mr. N. T. Walter, Mr. F. Y. Hurlstone, and Mr. A. Stevens. With regard to the two latter, whom Mr. Otway describes as "the very gentlemen who had been appointed by government to high office," and who in so describing them exhibits the accuracy of his information, the public know the one as President of the Society of British Artists—that is his "high office" to

which he has been "appointed by the government;" but, of the Society and the office it can only be said, that neither the one nor the other is calculated to give weight to any testimony concerning Art; nor has Mr. Hurlstone ever supplied a solitary proof of his fitness to judge of pictures, or of the capabilities requisite in a Director of the National Gallery. The "high office" to which "government has appointed" Mr. Stevens, we imagine to mean one of the junior masterships of the Government School of Design; but as to what are his qualifications as a public guide in this matter, we are as ignorant as we believe Mr. Otway to be. He boasts, indeed, of his long residence in Italy; it appears he spent his youth in Florence, whither he was carried as a boy. "Mr. N. T. Walter" is a pawnbroker living in Goswell Road; we may judge of the value of his cool and considerate testimony, who asserts that "the Eastlake-Wormnn-Mündler Paolo Veronese, an extremely damaged, vamped-up, and originally bad picture, is not worth *teopence*." If we know but little of Mr. Walter, we know too much of Mr. Coningham: for many years past this gentleman has perpetually assailed the management and condemned the purchases of the National Gallery, and will continue to do so until Mr. William Coningham is made Director thereof. This is as simple a truth as that two and two make four. If the Trustees would but effect this easy change, they would save themselves much vexation and annoyance: all things would then go right; there would be no confusion; no ruinous picture-cleaning; no jobbing of any kind; and the nation would be at once convinced that—"the right man being in the right place"—Parliament would be only troubled to make annual grants; and that Mr. William Coningham, assisted, perhaps, by Mr. Hurlstone, Mr. Stevens, and Mr. Walter, would "do all the rest."

In treating this case—which Mr. N. T. Walter has so gracefully described as the Eastlake-Wormnn-Mündler job—and the judgment of the public concerning which depends so mainly on his "opinion"—regard must be had to the "previous character" of the accused as well as the accusers.

Of Herr Mündler we know little: he is a German of high repute as a judge of pictures; of large experience; a good linguist; and, perhaps, on the whole, as valuable an ally as could be found as "travelling agent;" whose information as to when and where pictures are for sale, and whose services in the negotiation of such sales, are to be made available by the Director. We believe his duty does not extend beyond this; and for such a post, a familiarity with foreign languages is indispensable.

Mr. Wormnn, the Keeper and Secretary, is, beyond doubt, a gentleman of extensive knowledge concerning Art; to say nothing of the "high office" to which he was "appointed by the government" in the School of Design, he may be judged by evidence far less fallible—his published writings. These are *authorities*; and prove beyond controversy, that few men living have seen more of, or thought more about, the works of the ancient masters: he is a scholar, a gentleman, a critic, and a man of letters, and singularly well fitted for the post he occupies—that of *Secretary* to the National Gallery. He, too, has resided many years abroad.

With regard to Sir Charles Eastlake very little need be said: no one disputes his capabilities as a scholar; no one doubts that he has derived large experience from a lengthened residence in Italy, and frequent visits to the Continent; all admit his merits as a painter; and none question, even for a moment, his high integrity,

* "He had seen Mr. Mündler in some of the towns of Italy, and that gentleman appeared to be an extremely painstaking and laborious person, and he had heard his opinion with reference to pictures very favourably spoken of by connoisseurs. He also—though his opinion might be worth very little—was favourably impressed with what he saw of Mr. Mündler."—Mr. Harcourt Vernon, seconded by Mr. Otway's motion, in the House of Commons. Mr. Stirling, in the House of Commons:—"Two or three years before Mr. Mündler received his present appointment, he heard him mentioned by several artists in Paris as a person remarkable for his honesty and integrity."

his unblemished honour, or his earnest aim to do in all things right. If Sir Charles Eastlake stood in need of "testimonials," he might obtain them upon all these points, not only from the purest of all sources at home, but from every man of learning in Art and letters abroad: we would undertake to back his claim to the Directorship of the National Gallery by a thousand "opinions," every one of which should have more weight than that of Mr. William Coningham.

For the present we shall content ourselves with quoting some three or four passages from the Report of the Debate in the House of Commons, which forms the ground of this article.

The Lords of the Treasury in their minutes of March 27, 1855:—"My lords propose to appoint a director of the National Gallery, with a salary of 1,000*l.* per annum, such appointment to be for a term of five years, but the director to be eligible for re-appointment, which appointment, however, may be at any time revoked by the Treasury. My lords consider it a fortunate circumstance that they are able to select for the first appointment to this important office a gentleman of such high attainments as Sir C. Eastlake, who is president of the Royal Academy, and has shown qualifications of the highest order for the office."

Mr. Harcourt Vernon, who seconded the resolution of Mr. Otway, and who did not wish to see Sir Charles Eastlake Director to the National Gallery, said—"In Sir C. Eastlake the government had found a gentleman, and a man above all sordid considerations. He was a person of great refinement, and of considerable pictorial knowledge."

Mr. T. Baring:—"The trustees were unanimous in thinking that the management of Sir C. Eastlake had been most satisfactory up to the present time; and they were happy to see in the National Gallery a director of knowledge, taste, and discretion, and upon whom perfect reliance might be placed."

Mr. Otway "knew Sir Charles Eastlake to be an honourable man, and an excellent artist." Lord Palmerston—"With regard to Sir Charles Eastlake, he had no hesitation in concurring in the previous determination that he should be the director; because his high character, his great knowledge of Art, and his professional ability as an artist, pointed him out as undoubtedly fit to hold the office intrusted to him."

With such "testimonials" as these, Sir Charles Eastlake may safely leave unnoticed the sneers, sarcasms, calumnies, and insults, he receives from "disappointed competitors." It would be, indeed, a public calamity, an outrage on common sense, and an irreparable injury to Art, if this gentleman "above all sordid considerations," on whom "perfect reliance can be placed," who has "shown qualifications of the highest order for the office," and who is pointed out as undoubtedly fit to hold the office entrusted to him, because of "his high character, his great knowledge of Art, and his professional ability as an artist," should be displaced by a person who has no solitary claim to the appointment, except that he "talks big"—

"Makes gallant show and promise of his mettle;"

whose sole merit is derived from the simple process of abuse; and towards whom no party or person has, as far as we know, ever expressed a particle of confidence, for any one of the qualities so universally attributed to the President of the Royal Academy.

In this article we have to do only with vague assertions, or with "opinions" entirely unsupported by the semblance of facts. Nay, there is one fact undoubtedly;—Sir Charles Eastlake admits that he was deceived in the case of the spurious Holbein; and in a speech, to say the least of it, most ungenerous, Mr. Otway is reported to have said, *therefore* Sir Charles Eastlake has himself admitted his unfitness for the office of Director of the National Gallery. We should like to know which of the connoisseurs, in or out of Parliament, will "cast the first stone?" what buyer of "old masters," no matter how large may be his knowledge or experience,

has never been taken in; and that, when his own money was to pay the price of a deception. If Mr. Otway wishes for cases in point, we can ourselves supply him with a score or two, of dealers, collectors, connoisseurs, and amateurs, who have been occasionally the victims of clever rogues, who buy, and sell, and manufacture pictures.*

This is the only "fact" upon which are based the arguments of Mr. Otway, and those by whom the honourable gentleman has been instructed. Mr. William Coningham has indeed printed in a Morning Newspaper a letter—of which he has extensively circulated copies—extending to three columns; in which we cannot find a single other fact, or the semblance of a fact.† We find indeed, some thirty or forty assertions—such as these: "a disgrace to the National Gallery, and spurious;" "a commonplace work of a degenerate school and of doubtful origin;" "ignoble in character, and spurious;" "a scandalous purchase," "utterly unfit for study," "useful only as a beacon what to avoid," "a libel on the painter to whom it is ascribed," &c. &c.

If we are to believe Mr. Coningham—which assuredly we do not—Sir Charles Eastlake, either because of his ignorance or of his dishonesty, or both, has been invariably taken in; he has been either the victim or the ally of all the chief picture-swindlers of the age; he has betrayed his trust, degraded his country, and ruined Art. Consequently, inasmuch as, by a Treasury minute, the appointment of the Director may at any time be revoked by the Treasury—"if the Treasury deal honourably by their trust, they will at once revoke that appointment."

So thinks, or so says, Mr. William Coningham; but the Treasury is supplied with no proofs except the said Mr. William Coningham's opinion. The writer well knows that, with no better evidence, no jury would convict a ticket-leave man accused of attempt at burglary on entry. Will the public find it difficult to believe that if Mr. Coningham had a single proof, he would have hesitated to adduce it? Is it not quite certain that he has sought for proofs—in books from buyers and sellers, from dealers at home and abroad—in short, that he has ransacked every possible source by which to sustain his assertions—and now, as ever, without procuring one? This consideration alone gives to Sir Charles Eastlake a triumph on which he may be congratulated; he has been, to our thinking, over and not under cautious; it is, we believe (and we regret it) his nature to be so; if he had been more venturesome, he might have been more fortunate in his acquisitions; but he has hitherto passed unscathed through an ordeal—where he was watched at every movement and dogged at every step, and where a woman's departure from the straight path of rectitude would have been ruin.

Concerning the other three newspaper letter-writers, a very few remarks only are necessary. Mr. Walter—from his "picture gallery in Goswell Road"—writes in admirable keeping with his calling. He describes the picture, which those ignorant pretenders, Sir Charles Eastlake, Mr. Wornum, and Herr Müdler have bought,

as "damaged, vamped up, and originally bad," and he values it at "two pence;" he does not say how much he would advance upon it if pledged at his shop, but we take it that the utmost sum he would lend on such security is one penny—without the frame.

Mr. Hurlstone, indeed, tells us "there is strong evidence that 'The Adoration of the Magi' is not by Paolo Veronese." What that strong evidence is he does not inform us—merely because he cannot. If it be "the absence of the best characteristics of the artist," that is opinion—his opinion—and not evidence; it may be taken at its full value, and not be worth much, although Mr. Hurlstone has been appointed to "high office"—that of President of the Society in Suffolk Street—by "the government."

The letter of Mr. Alfred Stevens is simply an impertinence; a bare opinion—that "The Adoration of the Magi" is a work of the lowest type of the Venetian school"—is followed by a coarse assertion—that the purchase "is the natural consequence of placing the National Gallery under the control of three such notoriously incapable men as Sir Charles Eastlake, Mr. Wornum, and their 'travelling' adviser, Herr Müdler." Only think! Mr. Alfred Stevens talking to the world of the "incapacity" of Sir Charles Eastlake: a Golnith of Gath slaying little David, and borrowing Samson's weapon for the death-blow. Truly, these four apples swim very prettily.

The world is not now to be told that there is a pretty large class of persons who mistake notoriety for fame, and think they are elevating their own characters by decrying those of others. Some of them go further, and, believing, with Sir Fretful Plagiary, that "the malice in a good thing is the herb that makes it stick," take especial care never to be without a supply of the article—always ready for use.

These four "letter-writers" have had for some time possession of the public ear: the voice of Sir Charles Eastlake will not be heard in answer. Such adversaries are not to be encountered by such a man; he does wisely in treating them with silent contempt. As little right has he to answer Mr. Otway, Mr. Gladstone, or Lord Elcho, so long as they insinuate, and do not attempt proof. In fact, where there is no charge there can be no defence.

But we all know that to create a prejudice is easy; calumny takes rapid root: and it is by no means unlikely that a portion of the public are believing the Director of the National Gallery to be either so ignorant or so dishonest as to have bought all the trash Mr. Coningham says he has bought, and to have let the fine pictures he might have secured pass into other hands.

And this upon such "authorities" as the four persons we have been describing!

We have left ourselves but little space for comment upon the picture—the "Adoration of the Magi," by Paul Veronese, by which has been raised this storm in this puddle. Mr. Walter, as we have said, values it at two-pence; Mr. Bowyer says it is worth 50*l.*, and was offered, "he has been told," for sale some time ago, at that sum; Mr. Otway opines that it would not be appraised by an auctioneer at more than 100*l.*; on the other hand, Mr. Wilson affirms he had seen a letter from Paris in which 2400*l.* had been offered for it. These statements may be taken at what they are worth.

The picture is now placed in the National Gallery, and any one who pleases may see and judge for himself. It is, to our thinking, a fine and valuable work of the master. But, good or bad, useful or useless, of its authenticity no honest man has a doubt. Its history is this—we extract from the blue book.

"Paul Veronese. — 'The Adoration of the Magi.' In the foreground the Virgin and Child, Joseph, and the three Magi; on the right and above, some peasants. Behind is the retinue of the Magi, some bearing presents, others attending to their horses and camel. A ray of light, with winged cherubs hovering along its course, falls upon the Infant; above is a group of infant angels. Painted on canvas; measure, 11 feet 7 inches high, 10 feet 7 inches wide. Purchased in London, in November 1855, from Signor Angelo Toffoli, of Venice, for 1,977*l.* Engraved by Carlo Sacchi, 1849. On the whole, well

preserved. When the picture was removed from the church in which it had been originally placed, it was folded twice, horizontally. The foldings, which may still be traced in certain lights, occurred, however, in unimportant parts, and have been skilfully repaired.

"This picture, which bears the date 1573, was, about that time, placed in the church of S. Silvestro in Venice. It is mentioned as being there by Sansovino, Bassini, Ridolfi, Barri, Zanetti, and others. The church having required repairs, the numerous works of art which it contained were, in 1837, together with this picture, removed from the walls to a room within the precincts of the building. In the course of the architectural repairs, the internal form of the church had undergone alteration, so that when the pictures were to be replaced, as originally proposed, not one of the larger works could be fitted to the new altars and compartments. After much delay, a papal decree, together with an order from the local authorities, was obtained for the sale of those pictures. In August 1855 they became the property of Signor Toffoli, from whom, as above stated, the Paul Veronese was purchased for the national collection."

Now, these statements are not impugned in the slightest degree by any one of the polite letter-writers by whom the picture has been assailed. Mr. Coningham calls it "a daub." Mr. Walter describes it as "damaged, vamped up, and originally bad;" what is said in the *Lancet*, the *Dispatch*, the *Civil Service Gazette*, the *Empire*, the *Church of England Quarterly*, (papers quoted as authorities by Mr. Otway) we cannot tell. The *Examiner*, also quoted by him, has observed—"We should really like Mr. Otway to favour us with a reference to the page of the *Examiner* in which that journal has been found joining in an unprovoked and ungenerous cry against an able artist, and a competent critic of Art." Probably, if we had the means of reference to "every magazine of character, and every newspaper worth anything," which Mr. Otway says has commented with severity on the proceedings and purchases of Sir Charles Eastlake, we should find their comments represented with about the same amount of accuracy as were those of the *Examiner*.

Of this the public may be perfectly sure—notwithstanding the testimony of these four gentlemen—that a high-class work, of one of the greatest of the Italian masters, of unquestionable originality, its history being perfect, has been purchased for the National Gallery at a price not beyond its value.

We ask therefore, with the *Literary Gazette*—at least as safe an authority as the *Lancet*, or the *Dispatch*—if the public "are willing to abandon the guidance of accomplished artists, who have made the practical and literary study of Art the object of their lives, for the opinions of jealous professional men, or of interested jobbers and dealers, whose violent and partial statements are guided by the experience of shops and auction-rooms; and whose critical faculties, always on the stretch to preserve them against fraud, suspect nothing but trickery in every straightforward statement!"

Such insolent and scandalous attacks on public men are public grievances, and it is the duty of the public to protest against them. Where shall it find trustworthy and intelligent servants, if they are to be exposed to such outrages without protection? Neither of the gentlemen thus insulted are dependent on the offices they hold: and the probabilities are that, but for the opinions expressed in Parliament by Lord Palmerston and Mr. T. Baring—may, by the mover and seconder of the motion to degrade them—they would have resigned in disgust and indignation. Men who do their duty, and have the consciousness of integrity, can bear much; but there is a point at which endurance becomes dishonour. Under present circumstances, retirement from their posts would be discredit to Sir Charles Eastlake, Mr. Wornum, and Herr Müdler: but it might have been otherwise.

We should find it very difficult—if it were possible—to name three gentlemen better qualified to fill the important offices these gentlemen fill in our National Gallery.

* One may for the present suffice:—No one would doubt the judgment, knowledge, and experience of the late Mr. Hope, more especially as connected with the works of the Flemish school. He purchased a "Rembrandt" for 2000 guineas: upon hanging it up, he found there was some difficulty in getting it easily into the frame, and sent for a common carpenter to ease the panel a little with his plane. Mr. Hope had been telling the carpenter how large a sum he had given for the picture, and how good was its state of preservation, considering it had been painted nearly two hundred years. The simple workman saw at once the error, and observed that was impossible, for the picture was painted on mahogany, and mahogany was not introduced into Europe until some time afterwards. Mr. Hope examined the panel, and saw at once he had been taken in; he burnt the picture immediately: he could afford to lose 2000*l.*, but he could not afford to show the world he had been cheated to the Hollar. Mr. Coningham was a genuine production of the master. We could also tell a story of a well known gentleman, of undoubted skill and knowledge, who, having bought a fine example of an early school—painted on copper—discovered, not long afterwards, the names of "Thompson & Smith," stamped on a corner; the painting had sunk into the indented letters, and the fraud was obvious.

† In alluding to the Hollar, Mr. Coningham says, "the notoriety of this production exempts it from comment," and forthwith proceeds to comment upon it to the extent of half a column of the newspaper.

MINOR TOPICS OF THE MONTH.

THE ROYAL ACADEMY.—The exhibition will be opened, as usual, on the first Monday of May. Report speaks of it highly: we have no doubt of its being such as to uphold the reputation of our school. Its principal strength will be derived from the labours of the younger members: members, however, who are not now young. We confess it would give us greater pleasure to learn that among the hitherto "unknown" there was found rich promise of the hereafter. The sculpture-room will be over-full, a considerable number of large works having been sent in: the memorial of the Sculptors' Institute will thus have a practical illustration. The evil might be easily removed by the simple erection of a temporary building for the exhibition of works in sculpture.

THE HANGERS this year at the Royal Academy are Messrs. E. M. Ward, Cope, and Cousins, all of whom, we believe, discharge this onerous duty for the first time. They are gentlemen in whom the public and the profession will confide: but if they were archangels, they would fail to give "entire satisfaction." At all events, let them do the worst they can, they cannot do worse than was done last year in this important matter.

THE LIBRARIAN OF THE ROYAL ACADEMY.—Mr. Uwins has resigned this office, in consequence of declining health, which, we rejoice to know, however, has been much restored of late, although he deems his strength insufficient to enable him to discharge the duties incident to the appointment. The council has selected in his stead Mr. H. W. Pickersgill, and the nomination has been approved by the Queen.

THE NEW SOCIETY OF PAINTERS IN WATER-COLOURS—being the twenty-second annual exhibition—opened their rooms to the public on Monday, the 21st April,—too late in the month for us to do more than place the fact on record. We shall, of course, review the collection in our next.

THE NATIONAL COLLECTION OF BRITISH PICTURES will be deposited in the gallery now erecting at Kensington, probably about the end of the autumn of the present year: the museum of the School of Art will occupy the ground floor; and the pictures the floor above. It will contain the Vernon Gallery; all the works of British masters the property of the nation; and the pictures become national property under the will of J. M. W. Turner, R.A. These latter will amount in number to between thirty and forty; and among them will be the two grand works at Trafalgar Square. These two pictures were bequeathed by Turner under the express condition that they should occupy places beside the Claudes: they stand so at present in the National Gallery; but this condition has been ignored by the Court of Chancery, and they will be removed to Kensington. The drawings—"all that came from Mr. Turner's hand"—are now at the National Gallery; but it is probable they will go to the British Museum. The Exhibition cannot fail to be deeply interesting as well as instructive; it will be a monument to the great painter even more worthy than that which is to be erected to his memory in the Cathedral of St. Paul.

A MR. BOWYER, who is a member of Parliament for somewhere, has informed the country, speaking from his place in the house, that it "has a sculptor;" the sculptor to whom he refers is the Barou Marochetti. It is truly lamentable to find such utter ignorance existing in the House of Commons whenever Art is considered or discussed; there was no one to rise and set this honourable gentleman right. He is not aware of the existence in England of such men as Baily, Foley, MacDowell, Marshall, Bell, and others—who are in comparison with the one sculptor "now in England" the great masters whom he cannot approach: and if Mr. Bowyer would seek opinions better than his own, he would find that such is the testimony of every school of Europe, wherever the works of British sculptors have been seen. If the honourable gentleman would but examine the statues of Hampden, Clarendon, and Falkland—the works of Foley, Marshall, and Bell—and con-

trast them with the Peel of Marochetti—which he may see at the Crystal Palace, we imagine he will be enlightened as regards this particular class of sculpture, and that his "one sculptor" will dwindle much: we trust he may also have an opportunity of examining the "Bacchus and Ivo" of Foley, the "Sabrina" of Marshall, the "Day Dream" of MacDowell, to say nothing of the "Eve" of Baily; and if his eyes be open, we can scarcely doubt his conviction that England has more sculptors than "one." It is an outrage on sense, justice, and patriotism, perpetrated in the House of Commons,—many apathetic witnesses standing by—against which we enter our protest.

TO BRITISH SCULPTORS.—We heartily and cordially rejoice to record the following statement made by Sir Benjamin Hall, in the House of Commons, in reference to the monument which the country is to erect in St. Paul's, in memory of the Duke of Wellington:—"It was his (Sir B. Hall's) intention, if the conduct of this business should be placed under his control, to call in the aid, not only of four, but of several artists of the greatest eminence in this country, in order that we might see what the talent of England could produce, and that we might have something worthy of the memory of the great man whom we all desired to honour." This is most encouraging—full of hope! It was stated also that a sum of nearly 25,000*l.* would be appropriated to this high purpose: such sum being the balance remaining out of the amount voted by parliament to pay the expenses of the great Duke's funeral. It will be remembered that the sum fixed was no more than 5000*l.*, and when four sculptors were called upon for models—i. e. Baily, Foley, Gibson, and Marochetti; and the two latter refused to compete: the designs of the two former were rejected by Sir William Molesworth: but we may well ask what could have been done for such a sum? and we may add, what may not be done by a sum four times larger! We earnestly hope—may, we devoutly pray—that in this case there may be no diversity covertly at work to prejudice this lofty branch of Art in Great Britain. No event of our time is so pregnant with good—or evil—to the British sculptor: there has been none upon the issue of which so much depends for the honour, glory, and permanent benefit of the country.

THE REPORT OF THE DIRECTORS OF THE TRUSTEES OF THE NATIONAL GALLERY extends to twenty-two pages: it consists of remarks under the several heads—"Report on the purchase of pictures; arrangement of the pictures; description of the pictures; conservation of the pictures; general arrangements; and bequests and donations;" and the information conveyed is remarkably clear and distinct. The Appendix contains a variety of interesting documents with regard to the general plans, the duties of officers, the recent purchases, and so forth. This Report may be purchased by any person for a sum of about one shilling. We do not, therefore, occupy our pages by printing it; but, from time to time, we shall refer to the various matters upon which it comments. Meanwhile, we entirely agree with a contemporary—the *Literary Gazette*—in considering that, "So far as this Report is concerned, we think, there is nothing that the most captious critic can condemn. On the contrary, its clearness, fulness, and simplicity, appear to be the very model of this sort of compilation, where every point connected with the subject is prominently set out, and illustrated with just the sufficient amount of correspondence and precise information in the Appendix."

AN ADDITION TO THE NATIONAL GALLERY has been hung during the past month. It is a Mantegna, of which the following particulars are stated in the Report:—"The subject is the 'Madonna and Child Enthroned;' on the right of the spectator, the Magdalene; on the left, St. John the Baptist, both standing. It is inscribed, 'Andreas Mantinea, C.P.F.' It is painted on cloth, and fastened but not glued to a panel; the medium being tempera, or something 'differing in its results' from oil. The picture is from Milan: it has been engraved by Allprandi, and is described by Selvatico, in a commentary upon Vasari's 'Life of Mantegna.'"

ART-MANUFACTURES.—Scotland, we believe, has the credit of introducing into Britain those societies which, under the name of "Art-Unions," have been the means of circulating through the country, for many years, so large a number of Fine-Art productions, and of extending a love of Art through the empire: from a printed circular which has recently come into our hands, we see she is desirous of promoting a similar movement in favour of Art-manufactures. The prospectus we have received is headed "Association for Encouraging the Application of Fine Art to the Manufacture of Articles of Utility and Ornament." This object, it is thought, may be attained by an extension of the system of Art-Unions, which have already been successful in the encouragement of Painting and Sculpture. It is proposed to have periodical exhibitions of manufactured works, remarkable for beauty of design and execution, and to distribute among the subscribers such of the articles exhibited for sale as may be deemed worthy of being purchased, under the superintendence of a committee annually appointed. These exhibitions it is proposed to hold in Edinburgh, Glasgow, or elsewhere, where encouragement may be given. The objects to be acquired for distribution are intended to be exclusively such as may be properly described as works of Art, and will embrace articles executed in metal, stone, and marble, porcelain, glass, stoneware, papier-mâché, tapestry, &c. &c.: and in order to secure manufactures of the highest class, it is intended that the committee shall have the power to purchase examples both at home and abroad, and to give commissions for original works, or for copies of existing works of superior excellence. The funds of the Association will be raised by annual subscription, in shares of one guinea each, and by donations. Such is a general outline of the plans of the Association, the object of which has our hearty approval, and there is little doubt it will have the cordial support of every manufacturer of any importance throughout the kingdom. It is, indeed, the manufacturer who will derive the greatest advantage from the operations of such a society, by the encouragement it will give to the production of works of a high class, which, as is now too often the case, are made only to show what he can do, and then are left unsold in his ware-rooms for years. We have frequently heard manufacturers complain that it is of little use to execute articles of a high standard of excellence, as the cost of production almost places them beyond the hope of sale. Another benefit accruing from the society is, that it must materially assist in elevating the public taste with reference to such matters, and so, indirectly, be the means of calling into existence a description of articles, even of an ordinary kind, far superior to those now commonly sent out. The artisan, also, will find a stimulus to his skill and talent by the demand which will thus be created for objects requiring both: and thus all classes will be benefited by the success of this Association, which, we understand, has received the approbation of the Privy Council, and has already a goodly list of subscribers, including many of the leading artists and manufacturers of Scotland, and of persons eminent by their position in society. Earnestly, and—it may be added, we trust, without presumption—not unsuccessfully have we laboured to advance the progress of the Industrial Arts of the country: we rejoice to see such a movement as the present, which ten years ago would never have been contemplated, but which now requires only to be extensively known to be liberally supported.

PUBLIC WORKS AND BUILDINGS.—The estimates recently published include 195,141*l.* for public buildings and royal palaces; 7,868*l.* for additional works in the south portion of Buckingham Palace, for external enclosures, lighting, and warming; 91,684*l.* for royal parks and pleasure gardens; and 99,383*l.* for the New Houses of Parliament. As regards the parks, it is found that to St. James's, the Green, and Hyde Parks is appropriated 25,631*l.*; to Kensington Gardens, 2,716*l.*; to Chelsea Hospital grounds, 750*l.*; the Regent's Park, 6,601*l.*; to Victoria Park, 4,800*l.*; to Greenwich Park, 2,287*l.*; and to the Royal Botanical and Pleasure

Gardens at Kew, 19,078*l.* Under the head of the New Houses of Parliament, Sir C. Barry demands 9,500*l.* for the completion of the Victoria Tower, 7,600*l.* for the clock-tower, and other items, amounting altogether to 52,540*l.*; exclusive of the works not under his direction: 4,000*l.* is to be applied this year to the decoration of the new Palace at Westminster, under the direction of the Fine Arts Commission. The works include Mr. J. Gibson's statue of the Queen and its bas-reliefs, Mr. J. R. Herbert's frescoes in the Peers' robing-room, illustrative of "Justice on earth and its development in law and judgment," and the marble statues of men of eminence (as members of Parliament) in St. Stephen's Hall. The work of Mr. Gibson is nearly completed. Mr. Herbert is about to commence his fresco paintings, and, as regards the statues, commissions for ten, at the cost of 1,200*l.* each for three, and 1,000*l.* each for the others; even, have already been given. The sum of 25,643*l.* has been voted for the British Museum, exclusive of the estimate for General Building Purposes: this sum is apportioned as follows—painting the walls and vaulting of the basement under the Egyptian Gallery, 90*l.*; alteration in the form of the windows of the New Reading Room, and in glazing of the external sashes, 1,413*l.*; area between the main building and the New Greek Gallery, proposed to be roofed over and converted into a place for the public exhibition of Assyrian and other sculptures, total estimate, 4,500*l.*; on account, 30,000*l.* For works, fittings, and furniture—in the department of printed books, 12,507*l.* 10*s.*; manuscripts, 15,500*l.*; antiquities, 2,788*l.*; natural history, zoological branch, 844*l.*; mineralogical and geological branch, 991*l.* 10*s.*; botanical branch, 124*l.*; prints, 218*l.* 10*s.* Miscellaneous works, 1,284*l.* For professional remuneration to Sir Charles Barry, 390*l.* 12*s.*

A MARBLE STATUE OF "OMPHALE MOCKING HERCULES," the work of JOHN BELL, life-size, is now being exhibited at Dickenson's, 114, New Bond Street. It is emblematic of the triumph of Beauty over Strength. She has taken the club and lion's-skin, and the apples of the Hesperides, held by the Farnese Hercules, which statue she travesties somewhat in her attitude; in fact, she is jesting at her great lover. The statue was in the Paris Exhibition in an unfinished state, but it attracted much attention there. It is now completed, and will be justly ranked among the most meritorious examples of British Art. It will undoubtedly raise the reputation of the accomplished sculptor, whose position is already so high.

THE ARCHITECTURAL MUSEUM.—The two prizes offered by the committee and Mr. Ruskin have been awarded "for the best carvings in wood and stone." On the occasion of their presentation, several distinguished gentlemen were present, Professor Cockerell, R.A., in the chair. Other prizes were offered, and several speakers addressed the assembled workmen, explaining that one of the chief objects of the museum was the encouragement and "individualisation" of the Art-workman of the present day, by offering to him a prize for the produce of his own invention and skill.

THE BRITISH INSTITUTION.—We rejoice to find a very large number of pictures have found purchasers. We had prepared a list for publication, but are compelled, from want of space, to postpone it till next month, when, there is little doubt, we shall be compelled to make considerable additions to it.

INSTITUTE OF BRITISH ARCHITECTS.—The Council of this Society has awarded the "Queen's Gold Medal" for the present year to Mr. Tite, A.P., the architect of the Royal Exchange.

FRIEND OF THE CLERGY CORPORATION.—Among the numerous benevolent institutions which, at this season of the year particularly, are brought before the notice of the public through the annual festivals, there is not one more worthy of whatever aid we can render it than the "Friend of the Clergy Corporation." At the present time especially, it demands the increased exertion of every one interested in its existence and progress, owing to the serious defalcations of its late secretary, Mr. Aldrich, amounting to 4500*l.*, and the loss of 500*l.* by the failure of

Messrs. Strahan, Paul, & Co., the bankers. Such heavy losses to the funds of a young society must have jeopardised its existence, had not its friends, as we were pleased to hear Lord Feversham say, at the sixth anniversary dinner, on the 16th of April, rallied round the committee, and, by their liberality, partially extricated it from the difficulties in which it had been placed. The object of this corporation is to allow "permanent pensions, not exceeding 40*l.* per annum," to the widows and orphan unmarried daughters of clergymen of the Established Church, and to afford temporary assistance to necessitous clergymen and their families. It would be perfectly useless to expatiate on the merits of such an institution as this; nor need we stay to remark how many and urgent are the claimants on its resources.

A NEW CRYSTAL PALACE, on a small scale, is now in course of erection near Brompton Church. It is intended partly for the articles presented to the Royal Commission by various exhibitors of 1851; partly for the Museum of Animal Produce formed at the Society of Arts, in conjunction with the Royal Commission; for the Patent Museum; and for the important collection illustrative of Industrial Art in Marlborough House; and here these various collections are to remain until a more commodious and permanent gallery is provided for them. It will thus be seen that the government is preparing in earnest to make Kensington Gore the home of our Art-museums. Already 80 acres of ground have been purchased, and still farther acquisitions are contemplated. The present building is being constructed by Sir William Cubitt entirely of iron and glass; it is about 40 feet in height, 266 feet in length, and 125 feet in breadth; the roof is circular, and the arrangement of the interior is much like the world-renowned building which graced Hyde Park in 1851. It will speedily be completed.

AN ORIGINAL PORTRAIT OF SIR WALTER SCOTT, painted by no less an artist than DANIEL MACLISE, R.A., will, we understand, be sold by Messrs. Christie during the month of May. It was, we believe, painted by MacLise somewhere about the year 1825 or 1826, at Cork, during the visit of the great author to the south of Ireland. It is said to be—and we do not doubt it is—an admirable and striking likeness of the man. From the same collection there will be also sold a fine Romney, a portrait of the beautiful Mrs. Croneb: she is represented sitting on the coast at Brighton, the head being highly finished and very lovely. Also there will be disposed of, at the same time, the original of the well-known engraving of Miss M. A. Tree (Mrs. Bradshaw), the sister of Mrs. Charles Keane.

THE BRITISH MUSEUM.—The *Literary Gazette* says there is a rumour abroad that an Art-Director is to be appointed at the British Museum, in the person of Mr. Owen Jones.

BRITISH ARCHITECTS.—Whatever unfavourable opinion foreigners, and, indeed, too many of our own countrymen, may entertain of the British Schools of Painting and Sculpture, it is quite clear that our architects must not be included among the incapables. The architects of all countries were recently invited to compete for the rebuilding of the Cathedral at Lille: forty-one designs, from England, France, Germany, Switzerland, &c., were sent in answer to the appeal, and of this number twenty-two were put aside by the jury, either for want of merit, or excess of cost over the estimate. Of the remainder, the first prize has been awarded to Messrs. Clutton & Burgess, of Westminster; the second to Mr. Street, of Oxford; and the third to M. Lassus, of Paris. Of the ten prizes awarded by the jury, *five were carried away by Englishmen*; silver medals having been given to Messrs. J. Olden & Son, Manchester; Mr. C. Brodrick, Leeds; and Messrs. Evans & Poplarel, London: "honourable mention" is also made of the designs of Mr. J. L. Pealey, Birmingham, and Mr. J. Robinson, London. Nor must we forget that a few years since, Messrs. G. Scott & Moffatt received, under similar circumstances, the first prize for their designs for a new cathedral at Hamburg, now, we believe, completed, under the direction of Mr. Scott, who was recently elected Associate of the Royal Academy.

THE LIVERPOOL WELLINGTON TESTIMONIAL.—At a meeting of subscribers, Mr. Moss stated that the amount subscribed was 5893*l.* 16*s.* 6*d.*, all of which, except 161*l.* 1*s.*, had been collected. The interest amounted to 551*l.* 2*s.* 8*d.*, and the balance is 6275*l.* 10*s.* A column, as first intended, would cost 10,000*l.* or 12,000*l.*; and the question was, what was to be done.—Mr. Charles Turner thought a column could be erected for 7000*l.*; and if the money was left at interest for a time a sufficient sum would be realised. He made a motion to that effect.—Mr. Wm. Rathbone and Mr. James Aikin preferred an equestrian statue, and Mr. Aikin made a motion to that effect.—Mr. George Arkle observed that there was no site in Liverpool for a column.—Mr. Torr objected to an equestrian statue, as there was no English artist could model a horse. Ultimately, Mr. Aikin withdrew his motion, and that of Mr. Turner was adopted. We extract the above from a Liverpool paper; and extract Mr. Torr and the other members of the Committee, to see the equestrian statue of Lord Hardinge, by Mr. Foley: the result will be a change of opinion as to whether an English artist can, or cannot, "model a horse." We earnestly hope a column will not be adopted: but that the Committee will take steps to expend the large sum at their disposal, for the advantage of Art and the honour of their city.

MR. LEWIS GRUNER is about to leave this country for his own, having been appointed Keeper of the Royal and National Collections at Berlin. Mr. Gruner is here favourably known as an engraver and a decorative artist; in the latter capacity his services have been frequently called into requisition by the highest personages in the realm, who, we believe, have also often taken counsel with him on Art-matters generally, of which his knowledge, experience, and taste render him a safe adviser. He has been for some time at work on engravings from the Cartoons of Raffaele; how these will be completed when he is removed from them we know not. His absence will certainly be a loss to this country, and we are selfish enough to regret the preference which deprives England of his services.

THE ROYAL NAVAL FEMALE SCHOOL.—We see, by reference to our advertising columns, that a Bazaar will be held during the current month to aid the funds of this excellent Institution, whose object it is to provide the daughters of "necessitous Naval and Marine officers, of and above war-room rank, at the lowest reduction of cost practicable, a good, virtuous, and religious education, in conformity with the principles and doctrines of the Church of England." The cost, to the parents and guardians, of one pupil of the school, is about 12*l.* per annum; but it is clear that this sum would go but a small way towards the end proposed, and that the Institution must therefore appeal to the support of the public for a large portion of its income. We believe it is only necessary for us to direct attention to the proposed Bazaar, to obtain for it such contributions as will be of essential service to its promoters.

THE SIBTHORP COLLECTION.—A sale of nine days has dispersed a large miscellaneous collection of objects of all ages, kinds, and qualities, formed by the late Colonel Sibthorp. A more heterogeneous gathering has seldom passed under the hammer, and, considering the quantity, the quality was far below the average. The sale, however, attracted considerable attention, and realised good prices. An ivory tankard, that cost the Colonel 50*l.*, realised 250*l.*; but, as some few good things went cheap, while others of inferior merit fetched three times their value, caprice rather than judgment seems to have influenced buyers. As at the Bernal sale, some most absurd prices have been given, which would never have been offered in the ordinary way of business.

ASSYRIAN SCULPTURES.—Another shipload of antiquities from the East has arrived in London, and been deposited in the British Museum; they consist chiefly of architectural and other sculptured ornaments, and of animals, some of which are reported to be admirably represented. These works are of a somewhat later date than those we have hitherto received from Assyria, and many are, we regret to hear, much injured.

REVIEWS.

CRANIA BRITANNICA: DELINEATIONS AND DESCRIPTIONS OF THE SKULLS OF THE EARLY INHABITANTS OF THE BRITISH ISLANDS, TOGETHER WITH NOTICES OF THEIR OTHER REMAINS. By J. B. DAVIS, M.R.C.S., F.S.A., &c., and JOHN THURNHAM, M.D., F.S.A., &c. Decade I. Printed for J. B. DAVIS by TAYLOR & FRANCIS, Red Lion Court, London.

Although a work of such a nature as this scarcely comes within the limits of subjects to which our notices are usually confined, it is yet one that can hardly be considered out of place. The cranial peculiarities of any of the great races of men are worthy the study of every intelligent mind, for, "as the guardian of that ray divine, which is essentially 'the image' of his Creator, the receptacle of the grand yet delicate centre of his nervous system, the skull has for some time been recognised as the best epitome of Man." From the examination of these relics of the dead may be derived knowledge of the utmost interest to the inquirer after the principles of physiology, so that those who have made them their study do not hesitate to determine the character of the living man from the osseous formation which the spade of the excavator has once again brought to the light after centuries, perhaps, of interment. The motives for the publication of this work will be found in the following remarks by Mr Davis:—"As these islands have become the dwelling-place of a people, whose in future ages of the world will inevitably excite many curious inquiries, their origin and extraction, and ethnological histories and characters, must be regarded to be surrounded with great interest, and every valid contribution to knowledge on these matters as deserving of attention. It is in the spirit of this impression we propose to conduct our labours, remembering the importance of our subject, the obscurity in which it is almost necessarily involved, and the fallibility which may attend the best efforts to give it that illumination it deserves."

Until we had gone through the pages of this work we had no conception the subject would have yielded so large an amount of matter interesting to others than those whose business it is to investigate such a branch of natural science. True, those ghastly-looking skulls, with holes

"which eyes did once inhabit,"

are pictures humiliating enough to bring down all man's loftiness of look, and his aspiring imaginations; but they are no less reminders of his divine origin, his ennobling capacity, and his intellectual and moral powers, than they are of the ultimate destiny that awaits the most exalted of human intelligences.

There are some curious antiquarian remains engraved in the book, and representations of tumuli, from which they and the skulls were taken: altogether, the "Crania Britannica," as illustrating the origin of the English people, should find a place in every well-selected library.

THE HISTORY OF FRANCE, FROM THE EARLIEST PERIOD TO THE PRESENT TIME. By THOMAS WRIGHT, M.A., F.S.A., &c., Corresponding Member of the Imperial Institute of France. Part I. Printed and Published by the London Printing and Publishing Company, St. John Street.

Had such a work as this been commenced a year or two back, the announcement of its appearance would have fallen listlessly on the ears of the public; now the intimate alliance that has been formed, and cemented by mutual daring and suffering, between the two countries of England and France, must, it will be supposed, naturally incline each to know something of the history of the other. It is not a little remarkable how ignorant even many educated Englishmen are of the history of a country only separated from our own shores by a few miles of ocean, except it be of those periods of her annals which are interwoven with our own; and of these the points most familiar to the mind—and very often they are all that are known—are the battles we have fought, and the victories we have won: we believe that five-sixths of our countrymen who talk about Cressy and Agincourt, are ignorant of their information from no other source than the dramas of Shakespeare. But this ignorance, presuming it to exist, is not altogether excusable; we have hitherto had no history of France in such a form as to become popular: histories of particular periods have appeared occasionally, chiefly in connection with the biographies of distinguished characters, and translations from French writers, but such works can never supply the information we

would desire to have respecting a country which for many centuries has exercised so powerful an influence on the destinies of Europe. Such a desideratum Mr. Wright's book professes to supply, and no doubt will supply, so far, at least, as the chronicle of events that have taken place in that kingdom during the eighteenth and nineteenth centuries, for it is notified that, "although the history of France previous to the year 1700 will be sufficiently detailed to satisfy all the wants of general readers, it shall be so far condensed as to give more ample room for a minute history of the many important revolutions which have succeeded each other since that period. Of the three sections, therefore, into which the history will be divided, the first will include that portion which preceded the death of Louis XIV., while the two others will be devoted to the events of the last century and a half." It is to be regretted that such an arrangement should have been determined upon: it is the earlier periods of French history of which we here are most ignorant, from the commencement of the fourteenth century, when our Edward III. went over to Guienne, to pay homage to Philip VI. for the territory of Guienne, to the end of the sixteenth century, or a little later, when the hopes of Protestant France were crushed by the murder of Henry IV.; what a catalogue of great and remarkable events affecting the future destinies of the nations of Europe does this epoch open up to the historian! we think, therefore, it is a pity the narrative should be here compressed within narrow limits, for of the subsequent periods—the long reign of Louis XIV., and the era of the great Revolution, almost a natural consequence of the state into which France had been brought by the acts of that monarch, the licentiousness of his nobles, and the neglect of the clergy—our literature furnishes ample records.

Mr. Wright, whose name has often appeared as a contributor to our columns, is well qualified by his intimate acquaintance with French history, antiquities, and language, for the task he has undertaken; all the resources which the literature of the country affords for the prosecution of his work are at his command, and his mind is of an order that leads us to anticipate in his writings the truthfulness of facts—which should be the chief aim of every historian—rather than the vivid and often false colouring, bordering on romance, in which we frequently find history presented to us. He has a wide and rich field of investigation before him, and we have little doubt his labours will have the effect of contributing to eradicate many of the prejudices existing on this side the Channel against our ancient foes, when we are made as well acquainted with the bright side of their nature as we have hitherto been with their faults and weaknesses.

HER MAJESTY THE QUEEN, HIS ROYAL HIGHNESS THE PRINCE ALBERT, HER ROYAL HIGHNESS VICTORIA, PRINCESS ROYAL. Lithographed by R. J. LANE, A.R.A., from the Portraits by WINTERHALTER. Published by J. MITCHELL, London.

Of these three portraits we greatly prefer that of the Queen, and that of the Princess Royal: they are elegant yet unpretending pictures, broad and artistic in treatment; the likenesses of both the royal ladies are excellent, and very pleasing in expression: her Majesty, we presume, is represented as she is accustomed to appear at the meeting or prorogation of Parliament, reading the speech to the assembled members. Mr. Winterhalter has been less successful in his portrait of the Prince Consort; the face lacks far too much of the intelligent expression which is so characteristic of his Royal Highness, and the attitude is stiff and constrained: but we have always noticed in the various pictures which this artist has made of his royal patrons, that he has been less happy in the male portraits than in the female. The drawings from which these lithographs are copied, were made, in 1855, by the Queen's command.

LITHOZOOGRAPHIA. By JOSEPH ARESTI. Published by the Author, 61, Greek Street, Soho Square.

The word Lithozoo-graphia is explained on the title-page of the book by "A series of stippled Gra-tions produced upon Drawings washed or painted on Stone;" the object of the brief treatise is to afford directions for the execution of such drawings with "ease and celerity." All who are practically acquainted with the art of drawing on stone, are fully—we may add painfully—aware how much time is expended in producing with the chalk highly-finished flat tones or tints, as in skies and in buildings. Attempts have been made, at various

times, by different artists and lithographers, to overcome this difficulty by using a solution of the chalk with the brush; to this method was given the name of "litho-futing;" it was adopted by Mr. J. D. Harding in some of the drawings made for the "Baronial Halls and Mansions of England," as well as by Mr. F. W. Hulme in several landscapes he executed; but from some cause or another, it was found, in the printing, not always to answer its intended purpose, and, in consequence, has fallen into disuse. It is obvious that if the sketch of the artist could be reproduced by this method, it would have many advantages over the ordinary process of working with the dry chalk, even if accompanied with the use of the stump. The object of Mr. Aresti is to effect more than this; he would "enfranchise the sombre or photographic cast so opposite to the stippled effects of aqua-tinta on copper, to which beautiful, but difficult, Art it so closely approximates, and which, perhaps, it is eventually destined to supersede, as much by the greatest variety of tones, as the manifest rapidity and ease in producing them." The method of effecting this is explained in a few brief paragraphs, to which we must refer those who may care to make the experiment. We must confess, however, that the finest examples introduced into the work do not much dispose us in its favour: the mechanical and architectural examples are better; but we believe Mr. Aresti is preparing a second edition of his work, which will exhibit vast improvement in the plates.

GOLDEN A B C. Etched from the German by J. F. HOPPER. Published by J. H. PARKER, Oxford and London.

A volume of scripture texts, each beginning with a letter of the alphabet in consecutive order, and containing precepts, aspirations, and exhortations, selected with much good taste. The initials are filled with minute delineations of scriptural events, and each text is enclosed in an ornamental framework. The title-page by Luke Linnier is very graceful, but the smaller etched title is more quaint and characteristic. The volume is calculated for all ages in life, and its simple texts may be daily conned with advantage. Such a volume will grace a drawing-room table more than many of greater pretension; it gratifies the eye while it elevates the mind.

ELEGANT ARTS FOR LADIES. Published by WARD & LOCK, London.

Should any of our young female friends be unfortunate enough to suffer an attack of ennui, or find cause to complain they "have nothing to do"—either of which is no uncommon malady affecting young ladies—by all means we recommend them to look into this book, where they will assuredly find enough

"For idle hands to do."

A score of "elegant arts," many of them branching into a diversity of ramifications, are here taught, both by letter and illustrated examples—feather-flowers, weaving or plaiting hair-ornaments, imitation carvings in ivory, shell-work, painting on velvet and glass, illuminating on vellum, gilt leather-work, bead-work, potichomanie, wax flowers and fruit, and many more "arts" beside. And it ought not to be forgotten that in becoming well acquainted with some of these subjects, the mind is at the same time acquiring a knowledge of higher matters, is gaining such an insight into certain portions of the natural sciences as must elevate it above the comparative trifles upon which it is employed, and produce in it nobler aspirations.

BECHSTEIN'S HANDBOOK OF CHAMBER AND CAGE-BIRDS. Edited by H. G. ADAMS, Esq. Published by WARD & LOCK, London.

Bechstein has so long been an authority on the treatment and management of "birds in captivity," that his work has become as much of a "household book" with those who keep birds, as Buchau's "Domestic Medicine" used to be with matrons and housewives in the days of our boyhood, when, in all well-conducted households, it ranked only second in estimation to the family Bible. But Bechstein's volume is rather an expensive one for a large class of those who own feathered pets, and therefore Mr. Adams has extracted from it all the most really useful information, adding thereto instructions derived from his own experience and from reliable sources, which, neatly printed, prettily illustrated, and tastefully bound, will be heartily welcomed by many lovers of chamber and cage birds.

THE ART-JOURNAL.



LONDON, JUNE 1, 1856.

THE ROYAL ACADEMY.

EXHIBITION THE EIGHTY-EIGHTH: 1856.

LOOKING round these walls from year to year, we observe the spirit of the old school disappear—the spirit which held that drawing was not necessary to painting—that free and facile execution was the essence of Art. The works of men of that "persuasion" are now regarded as curious instances of senile infatuation. Who will say that in painting there is not a fashion independent of nature? In any given exhibition we may show all the decrees of nature pleasantly reversed, yet in the extraordinary progress of our school there is one thing for the accomplishment of which we still wait—that is, to see the microscopic labour of some of these small works applied to what is called the "grand style," with life-sized figures—then may we expect to count the threads in draperies painted with a touch that shall make the labours of even Maclise look coarse and sketchy. But the stipple that is becoming so universal, and as it is used in working out heads, is destructive of good colour—this is instanced in all Millais' works—it evidences labour, but vitiates the tints of natural shade. The time is not long gone by when foreign critics declared English works to be not only faulty in drawing but altogether wanting in finish; yet many of the works lately exhibited in Paris were there noticed as marvellous instances of assiduity. We regarded not long ago the works of the German school as dry and hard in their impertinent elaboration; but there may be instanced works in this exhibition which far out-distance the most careful productions of modern German Art. Our school of landscape is superior to any other in Europe, but curiously enough there is this year no landscape by any member of the Academy, and those landscapes which have recently been exhibited by members have been much inferior to those in other exhibitions regarded as very subordinate in comparison with the Academy. We have frequently of late years remarked this—this year our assertion is forcibly illustrated—*there is no landscape, essentially so-called, by an academician.* Our landscape is taking a curious divergence towards intense green, a fact more striking now than in preceding years; the colour has reached its ultimatum—it may be yet more abused. We look at many of these works—seriously marvelling what Sir George Beaumont

would do with his brown tree (we believe it is in Leslie's Life of Constable that the anecdote is revived). The Academy may look round inquiringly as to whom they could honour by electing as landscape painters; they need not hesitate long, there are many by whose election they would do honour to themselves. Long did we think that the walls of the Academy were alone without ears—it is not so; there are to be no more executions in the Octagon-room—at the door is written "Price Office," instead of what might have been formerly the inscription—

"Per me si va nella città dolente,
Per me si va nell'eterno dolore."

The President, Mulready, Danby, Maclise, Herbert, and Dyce exhibit nothing—with one work from each of those the exhibition would have been the best that has ever been seen in these rooms; as it is, with so many valuable contributions from non-members, and even without any landscape strength, the collection is one of very superior merit.

It is probable—nay, perhaps, it is certain—that those of our painters who may have seen the great exhibition of Art in Paris, have been benefited by their visit. They could, at least, compare French and English pictures in juxtaposition, and so learn from such comparison what qualities may be safely adopted from the French school. In the exhibited works of this year, there is a greater degree of earnestness than we have ever seen before; our sketching school, to which we have already alluded, is all but extinct; and the French, who knew our school only from prejudiced tradition, were immeasurably astonished at seeing the very opposite of that which they expected to see—that is, a degree of finish far surpassing that of their own school. Unfortunately, in their criticism of all modern Art, the maxims of the mass—"Ce qui n'est pas Français, n'est rien;" the surpassing colour of our school was not understood; but there are intelligent men who, while they justly uphold the merits of their own school, do justice to ours, and, among other things, admit the pre-eminence of our colour: in this we have nothing to learn from the French. It occurs very opportunely that there is now a portrait of Mr. Dickens by M. Ary Scheffer (according to the Catalogue), in the Academy. We regard at all times the productions of M. Scheffer with the highest admiration; he is one of the most accomplished of living artists, and stands alone in the exaltation of his sentiment; he is a school of poetic Art;—but we cannot receive this work as an example in aught to be followed: the features want relief and roundness, and the colour of the flesh is entirely false. M. Scheffer is one of the magnates of the French school, but there are fifty portraits more natural, on these walls. It is not, therefore, colour that we have to learn from French artists, but more of serious narrative in our subject-matter, be it historical, poetic, or didactic. Any observation, how rapid and superficial soever, will show the great amount of frivolous and uninteresting subjects on which the most patient and valuable labour is exhausted. When we look round the walls of the Academy, we feel some degree of shame that the objects of our school should be so little dignified, for even caricature is not without its place there. The spirit of "Pre-Raffaellism" survives, but in a modified form; the manner of execution, so called, is so easy of attainment, that many young artists, dazzled with the notoriety which has attended the efforts of the first professors of this taste,

will be continually publishing themselves as followers of the heresy, though gradually subsiding into something more reasonable, as with those who have gone before them. There is, we think, more good masculine portraiture on the walls than we have ever seen before. The heads are admirable; all full of thought and argument, most penetrating in expression, and at once engaging the spectator in speculation on the character of the individual. We are not prejudiced: we are cosmopolites in Art, and have studied every European school, but in none can we find such examples of portraiture as we find in this exhibition.

The "opening day" was, as usual, the first Monday of May (May 5),* and, as usual, the rooms were crowded with artists, eager to know their fate. Of the hanging this year we have little to complain; but it is understood that the number of pictures "rejected" is immense. This melancholy fact is easily accounted for; naturally, artists increase: all professions are, so to speak, over-crowded; and the Arts afford peculiar temptations now-a-days; for mediocrity has its chances, and will have, so long as Art-Union societies flourish, and provincial exhibitions are eager to exhibit all works "unsold." While applicants for space greatly augment, the space they are to occupy is diminished. It is, we think, a boon, that the "Octagon Room" is converted from an exhibition-room into an office, where a clerk sits at the receipt of custom; but the consequence is, necessarily to reduce by about fifty, the number of works placed on the walls of the Royal Academy in 1856. Surely, then, it is high time to remove a grievance which presses heavily on the profession; and this can be done only, by appropriating to the Academy the whole of the building in Trafalgar Square. The members are sufficiently rich to purchase it; or, at all events, arrangements might be made by which they could become its purchasers at a "fair valuation," deducting the estimated worth of their vested rights,—rights which must be considered as unquestionable. The

* THE DINNER AT THE ROYAL ACADEMY was reported fully in the *Times*; the party was large; several of her Majesty's ministers were there, and others whom, for obvious reasons, the members "delight to honour." Mr. Dyce, it appears, is a composer of music as well as a painter; the event of the evening was some new music by him to the old words, "Non nobis." The President spoke much and well; the only passage in his speeches, however, which calls for special comment is the following: he said, or is made to say—"the office of the professed critic is, almost necessarily, to detect imperfections." From this doctrine we utterly dissent: it is unsound in principle and untrue in fact; and coming, as it does, from high authority, is pregnant with danger. That criticism is not only unwholesome, but thoroughly evil, which labours to discover blemishes, and takes little or no note of beauties or perfections. There is no way in which genius could be so effectually crushed, or talent rendered so entirely useless, as by a system so ungenerous and unjust. We emphatically deny that any such office necessarily or immediately belongs to "the critic." On the contrary, the duty of the critic, and surely his pleasure, is to do good: to create happiness where it may be done faithfully; and to avoid giving pain where it can be avoided honestly. The man who looks upon any work—the result of toil, the produce of anxiety, and the seed of hope—or, indeed, upon any work of any kind—merely, or principally, to "detect imperfections," is not a man whose head and heart are to be envied. The only happy man is he who disseminates happiness: this is a solemn, an impressive, and glorious duty. Genius is proverbially sensitive; and genius is rarely without fault. Accused he who would depress rather than sustain; and doubly accused he who would inflict a pang where he might heal a wound.

We have felt no common indignation at the perusal of the passage we have quoted—delivered in the presence of many artists and a few men of letters. It is adding largely to the want of sympathy we have long deplored as separating the two professions: we humbly think the duty of the President is rather to combine them for mutual aid than to divide them by mutual distrust.

money thus acquired by the country might be added to a parliamentary grant; and would considerably increase the sum, which the nation will soon be called upon to expend, in the creation of a National Gallery, either at Kensington, or on the site of Burlington House.

Among the "rejected" this year are the productions of many artists who have been regular exhibitors at the Royal Academy for a quarter of a century, and who have not yet passed their zenith; while many of the most meritorious among our younger painters have also been doomed to disappointment. No one will consider this as unjust but a serious evil; it is an evil that must not be tolerated. We trust that steps will be taken by the many who have thus been placed at a disadvantage; and that any appeal they make to the Government, or to the House of Commons, will receive the earnest and cordial support of the Royal Academy.

The long existing misery to which Sculptors have been subjected, is this year greater than ever. It is impossible to enter the dark den on the ground-floor, without feeling how terribly it acts against the progress of this branch of Art,—an art which advances in spite of so many positive discouragements. The subject is one that involves so many considerations—and is of such deep importance to Art,—that we have resolved to postpone for a month our comments on the Sculpture Room of the Royal Academy—merely remarking now that a large number of very valuable and highly meritorious works are therein "huddled together."

No. 6. 'The Lady Claude Hamilton,' J. R. SWINTON. A full-length portrait of the size of life, in which the lady is introduced standing, and in full dress. The taste of the present day tends to plainness of attire in portraiture, and with the best reason,—it is less liable to be vulgarised than full dress: this observation is prompted by the treatment of this portrait.

No. 7. 'A Dream of the Future,' the landscape by T. CRESWICK, R.A., W. P. FRITH, R.A. This might be an incident from some of our elder novelists or poets—Richardson, Fielding, or Crabb. Although called "a dream," there is nothing somnolent, either in substance or allusion. It is a story of a country girl leaving her native village, and about to seek employment in London which appears in the distance, St. Paul's being always the notable sign of the great city. The features are charmingly painted; we see the head in profile, as she turns to take a last look at her home. The trees are pencilled very much more carefully than Mr. Creswick has worked of late, and the foliage is more natural in tint.

No. 9. 'An Arab Sheikh and Tents in the Egyptian Deserts,' T. B. SEDDON. A small picture, in which the sheikh is seen standing, and in the background, at a little distance, appears the camp. The impersonation, we doubt not, is very characteristic, and the whole is most elaborately worked out; but there is yet something insipid in these sunny shadeless breadths of desert, which no skillful painting can qualify.

No. 10. 'Christmas Day in St. Peter's at Rome, 1854,' D. ROBERTS, R.A. We have seen very few pictures in which the vastness of the interior of St. Peter's is satisfactorily given; the subject here, however, receives ample justice,—and, compared with 'Rome,' the large picture of last year, it is more scrupulously worked out. The area is filled by a gorgeous procession, in which

Pio Nino appears enthroned, surrounded by all the state of the Catholic church, and the course of the procession is lined on each side by French troops. The near figures are accurately drawn, and the more distant ones very spiritedly sketched and indicated. There is much more colour in this work than we have seen in later productions of the painter, while less than there is would not have been consistent with truth. The passages of light, half light, and shade, are most effectively distributed; in short, it is a picture of the very highest excellence—one of the best of the catalogue of important productions at which this accomplished artist has, of late, been long and earnestly labouring.

No. 11. 'A Roman Balcony during the Carnival,' R. LEHMANN. A subject frequently painted, and, we think, not of sufficient interest for figures of the size of life. In the features there is much of the Italian character, and the heads are altogether worked out with the utmost precision. The picture claims, and deserves marked attention: it is a work of high order both in composition and execution.

No. 16. 'Mrs. Coningham,' R. BUCKNER. The features tell with a certain degree of brilliancy, but they are also somewhat hard in execution. The lady is standing; she is dressed in black, and relieved by a background treated for depth. In all the portraits by this painter the persons are represented as taller than in life: this appearance is effected here by carrying the drapery below the extremities of the person.

No. 17. 'Love's Labour Lost,' F. R. PICKERSGILL, A. The composition is according to the second act of the play.

"Biron. Lady, I will commend you to my own heart.
Rosaline. Pray you do my commendations; I would be glad to see it.

* * * * *
Longaville. I beseech you a word; What is she in the white?
Boyet. A woman sometimes, an you saw her in the light.

* * * * *
Shot, by heaven; proceed, sweet Cupid."

The theme, it will be seen, is not a continuous and perfect subject from the play, but is rather comprehensive; the incidents being culled from separate passages,—but all the *personae* are present—the Princess, Rosaline, Maria, Katharine; the King, Longaville, Dumain, Biron, and others. It is much the most natural and least ethical composition that we ever remember to have seen exhibited under this name. It is more eloquent in the language of the human heart than any antecedent production, either imaginative or from Spenser, although here there is still a tendency to allegory which sorts but ill with an everyday expression of human passion. In looking at the picture, we are at once struck with its strong relation rather to schools than to nature. The female figures remind us at once of Titian; the male figures recall Giorgione. Titian, in the vigour of his life, painted principally from one person; we see her everywhere where Titian's works are preserved; but she is especially found as 'Flora' in the Venetian Room of the Palazzo Vecchio at Florence—a picture still as bright as when it left the easel. There is the prototype of all who follow Titian, and there is the ever-surviving idea of the picture before us. We see continually a recurrence of identity in the works of most painters; but no artist would paint a series of such identities could he divest himself of the paramount idea by which he is exclusively possessed. All the figures are well drawn and painted, and the whole is brought most fittingly together; but in the upper part of the work there is a group of Cupids, which cannot be present

with real impersonations; and the objection may be even more strongly urged against the Cupid with sun-bright wings in the immediate foreground.

No. 18. 'A Group of Fowl,' W. HINGENS. Very well drawn and painted, but not sufficiently relieved.

No. 19. 'Bedroom of Mary, Queen of Scots, Holyrood Palace,—showing the ante-room whence Rizzio was dragged and murdered, and the secret staircase by which the conspirators entered,' S. D. SWARBRECK. Rather a long title for such a subject, but an instructive picture to those who have not been to Holyrood. The historical mark on the floor is now so indistinct that we really think the story of the commercial traveller and his scolding drops, so pleasantly told by Scott, was no joke. The "damned spot" has been recently in greater danger from an enthusiastic student of chemistry, who is most anxious to scrape away the surface, and, by chemical test, set at rest for ever the question as to its being a stain of human blood. The picture is very like the place.

No. 23. 'Eunni,' the property of the Right Hon. Lord Lonsborough, A. COOPER, R.A. This is really a beautiful work as a portrait of a horse; it is the kind of subject to which this artist should exclusively adhere.

No. 24. 'Haymaking,' N. LUPTON. The subject is a section of a meadow with near trees and a glimpse of inland distance; it looks as if painted on the spot and has been very diligently worked out. The trees are painted with less decision than the lower parts, and there is an unpleasant greenness in the foliage tints.

No. 25. 'A Portrait,' T. GOODERSON. A head of a child very simply and delicately painted.

No. 33. 'Sea Weeds,' H. TIDEY. We notice this to instance the silly inapplicability of the title to a party of fish girls dancing. If we are wrong in our description, the hangers are in fault, though it is one of the works that we would not have one inch lower.

No. 34. 'Sea Campbell of Monzie Castle, Perthshire,' SIR J. W. GORDON, R.A. The lady is standing, attired in black, and relieved by a plain background. The treatment is entirely free from affectation,—the features are fresh and clear.

No. 35. 'Home,' J. N. PATON. Here is a domestic tale recited with the most penetrating power of moving eloquence. A corporal, apparently of the Fusilier Guards, has returned from the Crimea with the loss of his left arm; he has just entered his cottage home, his clothes rent and travel-stained, for he has been long on the march. He has just sat down and is held in the embrace of his wife who kneels at his feet, and round her he has thrown his remaining arm, while behind him is his mother who hides her face and weeps upon his shoulder in that tumultuous grief which has no utterance. Even beyond the high artistic merit of the picture is its simplicity and truth—so difficult of attainment is simplicity. The group is such as we see them in this condition of life. We can discover no attempt at refinement which would at once vitiate the entire narrative—even the washing or whitening of the hearth pronounces as favourably for the observation of the painter as for the household care of the wife—that incident is a long chapter of the history. The broken boots and trowsers bespeak a toilsome journey; it is many a day since that part of his kit was on parade—and then the helmet of the Russian guardsman on the floor is a

trophy that speaks of victory won by personal prowess as dear to him even as the medal on his breast with its three clasps—poor fellow, he deserves the best pension the board can give him. Adieu, mon caporal. You will have to be honoured in old age, and fight your battles over again with your children's children: although the wife and mother look so hopeless now: and herein is the fault of this truly admirable picture—a "gem" of its class and one that honours our British School. The artist should certainly have given a more distinct impression that he meant his hero to live: and not have made the wife and mother so utterly abandoned to despair.

No. 39. 'The Stream from Llyn Idwal, Carnarvonshire,' A. W. HUNT. Really a charming production, exemplifying in a great measure the deficiencies of what is called "Pre-Raphaelite" art; these are harmony of colour with harmony of parts, combined with the utmost finish that can be accomplished in painting. The view is selected with good taste and a feeling for composition, a circumstance which we are always glad to notice, for it is not merely anything that will make an agreeable picture. The work is worthy of all praise as the best we have yet seen in the manner of its execution.

No. 40. 'The Wear at Durham,' J. PEEL. Not at Durham, but somewhere in the meadows above the city; the picture is fresh and natural in colour. The artist maliciously introduces a piscator on the banks—we wish him success: for ourselves we could never touch a fin in the Wear—commend us to the Whitadder, Till, and Tweed.

No. 50. 'Sir Anthony de Rothschild, Bart,' S. A. HARR, R.A. A portrait of the size of life, treated in the simplest manner, with a perfectly plain background; the head is successfully painted. The portrait is intended to be placed in the Jews' hospital at Mile End.

No. 52. 'Spring Flowers,' J. H. S. MANN. A little girl with her apron full of flowers; the head is an interesting study.

No. 53. 'Dutch Pinks arriving and preparing to put to sea on the return of the tide,' E. W. COOKE, A. These are the same boats that the artist has celebrated for the last two or three years; he seems as determined to make Dutch pinks as famous as Dutch tulips, but it were desirable that he should paint some other sea-flower. The skipper of the "Van Kook" (that we see is the name of the craft) is we hope too wise a man to venture to sea in such a gale. The sea is painted with a greater liberality of touch than usual, the water is not so thready as we have seen it; and this contrast gives a degree of hardness to the boats and their rigging.

No. 54. 'The Administration of the Lord's Supper,' J. C. HORSLEY, A. The cup is held by an old man and his son who kneel together at the altar, and before them stands the officiating clergyman. The figures are well drawn and painted, and to the composition is communicated a solemnity becoming to the subject.

No. 61. 'The First Buttons,' D. H. FRISTON. A small picture very minutely executed, the subject of which is a little boy trying on his first jacket and trousers.

No. 62. 'Charles Dickens, Esq.' A. SCHEFFER. This is scarcely such a portrait of Dickens as we should have supposed that Ary Scheffer would have painted. It is extremely unassuming, but we think too highly glazed, which toning will become deeper with age. It is not, we think, a very striking resemblance: it is something, however, to be painted by so great a master.

No. 63. 'His Grace the Duke of Rutland,' F. GRANT, R.A. The Duke is presented as a man of business, being in the midst of papers and accounts, a very much better arrangement than any introduction of state. The identity is at once pronounced, but it should have been the purpose of the painter to have reduced the angularity of his study.

No. 67. 'The Lady Edith Campbell and the Lord George Campbell, children of his Grace the Duke of Argyll,' J. SANT. The two children are grouped as at prayers and wearing their night-dresses, with an expression of feeling eloquently devotional. The treatment is very simple, the light group tells against the dark background. The picture is absolutely delicious: the children are exceedingly beautiful: they belong to Nature as much as to the Duke.

No. 68. 'Little Red Riding Hood,' R. REDGRAVE, R.A. This is a large study of sylvan scenery very conscientiously rendered from the selected subject. The near section of the picture with all its grass and weeds, and the minute drawing and painting of the stems of the trees, is a most veracious transcript from nature, but the colour generally strikes the eye as too green. We have looked for leafage of this colour, but could never find it; we have never seen it either in the lights or shades, without light warmth or dark warmth—nothing is more difficult than to paint foliage under penetrating light so as to give relief respectively to the different masses; the artist has felt that difficulty here—anything that would relieve the flatness of the upper part of the picture would be an advantage.

No. 69. 'A Welsh Interior,' E. J. CORBETT. A very careful study of a portion of a cottage, in which the light, in all its effects and gradations, is admirably described. A more successful picture of the kind is rarely met with.

No. 75. 'The Last Parting of Marie Antoinette and her Son,' E. M. WARD, R.A. Scene, the Prison of the Temple; persons present, the Queen, her son and daughter, the sister of Louis XVI, and the members of the Revolutionary Committee. The subject is derived from Beauchêne's "Life of Louis XVI," in which it is stated that the Queen, having collected all her energies, seated herself, drew her son near to her, and placed both her hands on his little shoulders; calm, motionless, so absorbed in grief that she neither wept nor sighed. She said to him in a grave and solemn voice:—"My child, you are going to leave us; remember your duties when I am no longer near to remind you of them. Never forget the merciful God who has appointed you this trial, or your mother who loves you: be modest, patient, and good, and your Father in Heaven will bless you." It is a large picture, with more freshness, less of the yellowness of the French school than we have seen in antecedent works. The composition is divided into two groupments, that of the Queen, her children, and sister-in-law; and on the left the revolutionary committee; the former light, the latter in shade. The character and the accessories of the picture—the poignant distress on the one side, and the coarse insolence on the other, with the peculiar personalities, declare the subject as unmistakably an incident in the history of the royal family of France after the first revolution. The group on the right is of itself a picture; the darker group on the left does not approach it in the success of its chiar-oscuro, although the description of the men is co-incident with the treatment to which the unfortunate prisoners were subjected.

We cannot too highly praise the dispositions; the composition is not thronged with useless material; every object has its voice in the story. Upon the whole, we think, it cannot fail to be pronounced the best of the pictures which the artist has executed from the history of these "unfortunates." It will establish a reputation already among the highest: and may be safely considered the most admirable work of the exhibition.

No. 76. 'Mrs. Hambury Leigh and Children,' W. BOXALL, A. This work is not so successful as others which the artist has exhibited; the figures are deficient in roundness and substance.

No. 82. 'Miss de Rothschild,' J. SANT. A portrait of a young lady in a gauze dress; she is represented standing, and the features are seen as a three-quarter face; the head is a masterly study; and the whole picture is beautiful: but the artist has been fortunate in his model.

No. 83. 'The Brook, Chudleigh, Devon,' W. F. WITHERINGTON, R.A.

"Falling fast, from gradual slope to slope,
With wild intricate course and lessened roar
It gains a safer bed, and stuns at last
Along the mazes of the quiet vale."

The stones, broken bank, near herbage, water, and all the foreground material, are very successfully rendered; and not less so is the upper foliage, with the stems and branches. It is most difficult to paint sunshine on leaves, and because there is no such occurrence here, the picture is more like the reality of nature than any other production by the same hand, in which this condition of light is seen. It is altogether the most agreeable essay in this genre that has appeared under this name.

No. 85. 'Hark!' W. H. KNIGHT. An agroupment of small figures in a cottage. The incident which points the title is the father of the family holding his watch to the ear of his youngest child, seated on its mother's knee. The group is not effective, as well in relief as in colour; the head of the father, and the wondering features of the infant, are a triumph of miniature in oil.

No. 86. 'Brook Ford, Devon,' J. M. CARRICK. The arrangement consists principally of a streamlet crossed by a wooden bridge. The water flows over a shallow with weeds and stones, and is shut in and shaded by trees; the subject has undoubtedly been painted on the spot, and every passage of the work has been wrought out with the nicest manipulation.

No. 87. 'The Persian Maid,' H. W. PICKERSGILL, R.A. This picture is painted after the lines in "Lalla Rookh"—

"The young village maid when with flowers she dresses
Her dark flowing hair for some festive day,
Will think of thy fate till, neglecting her tresses,
She mournfully turns from the mirror away."

It is one of those oriental costumed figures of which the artist has painted many, and has based a reputation on them.

No. 88. 'The Countess of Ducie,' F. GRANT, R.A. The lady is attired in black velvet, and is seated, holding a book on her knee, but looking out of the picture. The features are characterised by too much severity.

No. 92. 'Crossing the Sands to Swansea Market,' E. F. D. FRITCHARD. There is a bright daylight breadth about this work which is very agreeable in effect, but it is too high for inspection: this is to be lamented, for the artist has established a prominent reputation for pictures of the class, and this is apparently one of his best.

No. 93. 'Richard Owen, F.R.S., Hunterian Professor of Anatomy and Physiology, &c.,' H. W. PICKERSGILL, R.A. The Professor, who wears his academic gown, is presented

standing as if in the act of lecturing. It is a striking likeness of a great and good man.

No. 94. 'The Abandoned,' C. STANFIELD, R.A. This is a shipwreck story, a tale of interest profoundly pathetic, painted from a passage in "The Voyage," one of the narratives in Washington Irving's "Sketch-book." A portion of the extract runs thus—"There was no trace by which the name of the ship could be ascertained. The wreck had evidently drifted about for many months; clusters of shell-fish had fastened about it, and long sea-weeds fluted at its sides. But where, thought I, is the crew? Their struggle has long been over; they have gone down amidst the roar of the tempest; their bones lie whitening among the caverns of the deep. Silence—oblivion—like the waves, have closed over them, and no one can tell the story of their end. What sighs have been wafted after that ship! What prayers at the deserted fire-side of home!" The pathos of the writer is fully realised by the artist; with respect to the ship itself, the sad story is continued even farther. Since the abandonment of the once brave vessel, the furious sea must have sunk many times into repose; but we see it now as if in sport tossing to and fro the helpless hulk, with her broken cordage hanging over her sides, and her riven copper showing as she heels to port. To give importance to the wreck, she is lifted on to the crest of a sea, while the spectator sees her from the trough. Neither on board nor around is there any sign of life; the gallant craft survives many tempests, and is yet the plaything of the mocking waves, a history even more sad than if she had gone down with all her crew—the ship, their home, still struggles to live upon the waters, but where are they? Without them she moves no more; without her they perish. The picture more than realises the sentiment of the written description. It cannot fail to be classed among the most valuable works of one of the greatest artists of our age and country.

No. 98. 'Shade,' H. JUTSUM. A small picture, a miniature in oil, showing a shaded nook of woodland scenery, of which the foreground especially is a highly meritorious passage of art.

No. 99. 'On the River Brent,' C. SIMMS. The river winds into the picture between wooded banks, and crossed by a bridge at a little distance. The view is well selected and creditably painted.

No. 100. 'West Australian, the property of the Right Hon. Lord Londesborough,' A. COOPER, R.A. This is a portrait of a horse beautifully painted and well drawn; perhaps too much refined upon.

No. 101. 'The Greeting in the Desert—Egypt,' J. F. LEWIS. Here is illustrated the ceremony of the meeting of friends in the desert. Two men, perhaps in the condition of merchants, address each other in friendly terms, grasping each other at the same time by the hand; there are also camels and a slave introduced. The men do not wear the same costume; there is a difference in their dress which may define respectively the Arab of the city and the Arab of the desert, or some other distinction of condition or country. In the execution of this picture there is a greater degree of breadth than in the water-colour works by this painter; but everything here must be accepted as of the most unquestionable accuracy.

No. 102. 'Lady Fitz-Wigram,' MRS. CARPENTER. The lady is seated, resting her head on her left hand; there is a natural ease and relief in the pose of the figure, which is one of the best qualities of portrait-painting.

No. 110. 'Winter,' W. F. WITHERINGTON, R.A. The season is typified by a group of two figures, circumstanced in the open and bare fields, consisting principally of a field-labourer busied in cutting down the superfluous growth of wood, and secondly of a child who has brought him his breakfast or dinner. The incident is realised in a feeling which raises it beyond any of the other figure pictures of the painter—for instance, "Autumn," No. 124, is described by two children returning from gleanings, a production by no means equal to the other.

No. 114. 'Hide and Seek,' T. WEBSTER, R.A. This is a work of great self-possession. It is not like a composition, consisting of a long catalogue of household items, very embarrassing to the inmates; there is a wholesome economy, and an earnest sobriety about the scene of these gambols, which look infinitely more real than a confusion of chattels. The *materfamilias* is sitting nursing her infant, and all the elder children have hidden themselves in various parts of the room, yet to be discovered by the boy who eagerly enters the door. But all are partially visible to the spectator—here a hand, there a head, elsewhere a pair of legs—a notable distribution of heads and limbs. Were we invited to join in the game, the place of our selection would be under that hamper. The whole is rendered with that truth and sincerity which distinguish these works; the children especially are represented not as children without youth, but as children with the buoyancy and freshness of childhood.

No. 116. 'Field-Marshal Lord Raglan,' F. GRANT, R.A. The figure is presented standing in an open landscape composition, and wearing a plain military address. The work is not vulgarised by any extravagant allusion to actual warfare. The head is well painted, and is very like what Lord Raglan was a few years ago.

No. 122. 'Burd Helen; Helen, fearing her Lover's desertion, runs by the side of his Horse as his Foot Page,' W. L. WINDUS. The subject is from an old Scottish ballad—

"Lord John he rode, Burd Helen ran,
A live-long simmer's day,
Until they cam' to Clyde Water,
Was filled free bank to brae."

We instance this as an example of the worst taste in the selection of subject. The lady appears as a page running by the side of her mounted lover, who was a dastard; not to say anything of the discredit attending such a course on the part of the lady. The greater the success in the treatment of such a subject, the more painful it becomes.

No. 123. 'The Lady Clementina Villiers,' F. WINTERHALTER. Simply a life-sized head, elegant in character, and pointed in life-like expression; but the shaded portions are indifferently coloured; the low tints are extremely impure; they are deficient in natural transparency.

No. 125. 'A Sister of Mercy,' Miss A. E. BLUNDEX. She is visiting the bedside of a poor woman, whose days seem numbered. The principal figure is a successful study.

No. 131. 'Many happy Returns of the Day,' W. P. FRITH, R.A. A family party is here assembled in celebration of the birthday of a little girl, who is crowned with, and embowered in, flowers. She looks very much frightened; we presume she has not yet made her speech. If this work be a portrait composition, we must say of it that it is painted as well and as brilliantly as the subject can be; but if proposed as a pictorial production, it must be observed that it is an ungrateful subject. The accomplished artist might easily have selected from a thousand better.

No. 132. 'Cologne—Vegetable Market,' G. JONES, R.A. This does not look like the Altmarkt, and if it be not the Nemmarkt, near the church of S. Aposteln, we give it up: we know not the *locale*. We instance this picture as an example of what we have spoken of in the introduction—our elder school of Art. It is not unprofitable to meet with something to look back upon; we see this picture down the shadowy array of the last fifty years; it is now what it might have been fifty years ago. We cannot even in old age stand still; the years then pass more rapidly, and the greater exertion is necessary to catch "the Cynthia of the minute."

No. 137. 'In Arundel Park,' P. W. ELLEN. In this view we look over the trees behind the castle, the upper turrets of which catch the eye. It is an interesting view, more attractive than park scenery generally.

No. 138. 'Mr. David Cox,' SIR J. W. GORDON, R.A. There is some significance in that name; we wish it had been catalogued without the "Mister;" but let us copy the rest of the text—"Painted by subscription, and presented to him by a number of his friends and admirers of his professional eminence and private worth; to be ultimately placed in some public building in Birmingham, his native town." An ungrateful addition that, from "ultimately,"—the father of the Water-Colour ought to have been spared that *memento mori*. What, we ask, are the people of Betws to do?—they ought, at least, to have a statue, for David Cox's constancy to Betws has seen two generations laid in that primitive churchyard. What is not due in these days to the man whose patriotism sternly refuses to paint anything but English scenery? We might well expect such a resolution from a head like that; farewell, "Mister" Cox; may we yet meet, for years to come, under your own weeping skies, in Pall Mall East.

No. 139. 'Napoleon III., Emperor of the French,' the picture the property of the Queen, E. BOUTBONNE. This is a small equestrian portrait of the emperor, who wears a military uniform. The resemblance is most perfect. The figure and horse are relieved by an open and plain background.

No. 140. 'Hero and Leander,' J. COLBY. A small picture; apparently is the discovery of the body of Leander by Hero. The agronomy and circumstance point directly to the subject.

No. 144. 'Hermione,' C. R. LESLIE, R.A. She is here presented upon the pedestal, and we may suppose her contemplated by Leantes and those with him. The features are modelled to a most appropriate expression—that of tender supplication—she wears the courtly ermine and a regal robe. The head, with the exception of being somewhat too large, is sufficiently successful to suggest the wish that the figure had been made more statuesque.

Nos. 145 and 146. 'Geraniums and Roses,' by Miss MUTRIE and Miss A. F. MUTRIE, exquisitely painted; and with an accuracy that rivals nature.

No. 147. 'Saved!—Dedicated to the Humane Society,' SIR E. LANDSEER, R.A. This is a large picture, showing the rescue of a child from drowning by a large Newfoundland dog. The little boy has been playing on a jetty or breakwater and has fallen into the sea, whence he has just been dragged by the dog. He lies motionless across the fore legs of the animal, the head of which is raised and looking for further assistance. Beyond the fragment of the jetty all is open sea—the attention by the way paid to the individualisation of these stones reduces the importance of the group.

The head of the dog is of course a most masterly study, but the paws have the appearance of being too large. The picture is careless of finish: it is, indeed, a work of genius without labour. Especially it is to be noted that the dress of the child has certainly never been in the water at all.

No. 153. 'Thomas Carlyle, Esq.,' R. TAIT. The subject is presented in profile, in a pose of profound thought. The head is a careful and characteristic study.

No. 154. 'After Sunset,' T. S. COOPER. A group of cows on the bank of a river, seen as in deepening twilight. The work evinces much of the feeling of a foreign school.

No. 155. 'H. M. the Empress Eugénie,' the picture the property of the Queen, E. BOURBONNE. The Empress is mounted and wears a lilac silk riding-dress, and is circumstanced as if in the gardens of Versailles, it may be. The resemblance is at once recognisable, and throughout, the composition is brought forward with the most scrupulous nicety.

No. 157. 'The First Scrape,' R. PARRIER. A small picture, in which a boy is seen attempting to play the violin. His success is indicated by his sister, who holds her ears, and the howling of the dog. The figures are very studiously finished.

No. 160. 'The Letter,' E. DELFOSSE. A small work painted in the taste of the French school; it is agreeable in colour.

No. 161. 'The Old Church on the cliff, Bonchurch, Isle of Wight,' J. E. MEADOWS. This has been studied very accurately from the place; there is nothing very tempting in the subject, the merit of the picture consisting entirely in the natural reality of the representation.

No. 162. 'The Graces,' W. E. FROST, A. To this every-hymning triad the artist adds a small company of Loves, we think with injurious effect. In these figures the flesh tones seldom rise above a middle tint, but the surface texture is delicate to a degree. The movement of the figures looks constrained and measured, a circumstance likely to arise from an expression of fatigue in the model. The back of the figure, turned towards the spectator, looks near the waist as if it had been compressed by the stay. It is however a work of very high merit—elegant and refined in every idea; and sustains the reputation of an artist who deservedly stands at the head of "his order" in this particular line.

No. 166. 'Hugh Heber Percy,' C. COUZENS. Study of the head of a child, a fair-haired hoy—executed evidently with infinite nicety of execution, though too high to be examined.

No. 171. 'The Brambles in the Way,' J. C. HOOK. As to careful execution and reality of representation this work is of a high character, but it is deteriorated by one default not uncommon in these times—that is, the greens are greener and colder than those of nature. With reference to the title—the allusion is to the passage of a country girl over a stile, her progress being impeded by the brambles.

No. 174. 'Part of the city of Morocco (containing the Sultan's palace and gardens), and the Atlas range of mountains as seen from the roof of the Mahmonia palace, the residence assigned to her Britannic Majesty's mission during the months of March and April, 1855,' W. H. PRINSEP. Morocco is a place we know little about, therefore in as far as such pictures are correct, they are instructive. The edifices are low and unpicturesque, we see something however of the country, which is hot enough—without vegetation sufficient to afford one meal to a grasshopper; even the snow on the peaks of the Atlas looks hot.

No. 175. 'The Emperor Charles V. at Yuste,' A. ELMORE, A. This picture is painted from Sterling's Cloister life of Charles V., and the immediate incident—that of contemplating the portrait of the Empress—is one which has been already several times studied. "The sunshine again tempted him into his open gallery. As he sat there, he sent for a portrait of the Empress, and hung for some time lost in thought over the gentle face, which with its blue eyes, auburn hair, and pensive heavily somewhat resembled the noble countenance of that other Isabella, the great queen of Castille. He next called for a picture of our Lord praying in the garden, and then for a sketch of the Last Judgment, by Titian, &c., &c." The Emperor wears a suit of black, and is seated in a black chair, a repetition which we never remember to have seen before practised with such force of effect—such force as to nearly annihilate the remaining groupings. The Emperor is seated on the left of the composition, and near him stands Philip II, who looks older than Philip was at this time, and handsomer. The pictures are brought and placed before the Emperor by monks and servants; and on the extreme right is a group the removal of which would improve the picture, as it detracts from the concentration which should be the feeling in respect of the Emperor. The work is however a composition of great power; the subject is the best the artist has ever entertained, and he has done it ample justice.

No. 176. 'Sir John Watson Gordon, R.A., President of the R.S.A.' Painted for the Academy by JOHN GRAHAM GILBERT. The great portrait-painter is here introduced in court-dress, we had rather seen him in tweed, and on the Tweed with a salmon-rod in his hand. The head is very like that of the subject and is satisfactorily painted, but the extremities should be re-constructed.

No. 177. 'Scene in North Wales,' W. S. BACON. The lines here tell with good effect, and the quantities compose well, with the exception of the principal mountain being brought into the centre of the view, beyond this we can see nothing—the picture occupying a distinguished place near the ceiling.

No. 179. 'Shells of the Ocean,' G. E. HOOKS.

"I stooped upon the pebbly strand,
To cull the toys that round me lay,
But as I took them in my hand,
I throw them one by one away."

It is a young lady who thus gathers and throws away the shells. It is apparent that the head of the figure is too small, but also that there is knowledge and judgment in the picture, but beyond this nothing is discernible.

No. 181. 'Children,' Mrs. W. CARPENTER. A group of two life-sized heads—a boy and girl; the features of the former are engaging.

No. 182. 'Handy Janie,' R. REDGRAVE, R.A. This young lady is presented to the spectator in a small section of pastoral landscape; she is flanked on each side by a water-pail, and stands near the well; we cannot speak too highly of the diligent manipulation of the work.

No. 184. 'Near Moreton, Cheshire,' E. HARRITT. A small sketch of a piece of flat scenery remarkable for sweet and harmonious colour.

No. 186. 'Trukkee, February 28th, 1845,' G. JONES, R.A. A large picture showing a rock-fastness in India, the stronghold of a daring and powerful robber-force, which is here represented as being attacked by troops under Sir Charles Napier. If the sketches from which the picture has

been painted be true, the picture is useful in so far as it describes the nature of the pass.

No. 188. 'Daniel Wilson, D.D., Lord Bishop of Calcutta,' M. CLAXTON. This portrait has been executed for the congregation of St. Paul's Cathedral. The head is remarkable; the features are thoughtful and benevolent.

No. 189. 'Sunset in the Atlantic,' H. J. JOHNSON.

"Far up the wavo,
The clouds that lay piled in the golden heat
Were turned into types of the ancient mountains,
In an ancient laud."

The subject is not shown as at sea, but the spectator is placed in shore, whence he contemplates the sky, and the red draperies which the departing sun has so richly hung over the horizon. The sea opens on the left, on the right the view is closed by a cliff. This picture merits a better place than that in which it has been hung.

No. 190. 'Lieut.-General the Earl of Lucan, Lord-Lieutenant of Mayo,' presented by his friends in the county on his return from the command of the English Cavalry in the Crimea, P. GRANT, R.A. This is not among the most successful of the artist's works.

No. 191. 'A Guarda Costa riding out a Gale, off Fuentarabia, at the month of the Bidassoa, Basque Provinces,' C. STANFIELD, R.A. The landscape portion of this picture is more beautiful in colour, and more satisfactory in its various description, than any of the recent works which its author in the same class of material has dealt with. But the guarda costa—there is the pith of the story—she is jumping over these avalanche-like rollers, holding on by only a painter, not even a hawser—a cunning device of the artist to move the sympathies of the bystanders towards these poor fellows whose lives are thus wantonly jeopardized; for a few yards behind her are rocks, on which they must instantly be cast. The boat and all her gear are admirably painted.

No. 193. 'On the Rosslyn-park Estate, Hampstead,' H. TIFFIN. Small but solidly painted—spotty with busy lights, inasmuch that the eye has no resting-place; it must be a very circumstantial imitation of the place.

No. 194. 'Scene in the Highlands,' R. H. ROE. A small picture, showing lake and mountain; the essence of Highland scenery; too highly coloured perhaps, but very effective and deeply interesting in subject and treatment.

No. 198. * * * * R. HANNAH. A small picture, which in the catalogue is described by a couplet from a song instead of a title.

"When I showed her the ring, and implored her to marry,
She blushed like the dawning of morn."

The fair one is a cook maid who is occupied in scouring her pans at the window of her pantry, wherein is introduced the hand of a policeman holding the ring; but the painter has not worked up to the sentiment of the verse, for the lady is neither coy nor blushing. The figure, with all the household gear by which it is surrounded, is accurately drawn, and very firmly painted.

No. 200. 'Peace Concluded, 1856,' J. E. MILLAIS. One of the happiest results of peace—one which as dealing directly with our affections, not with our interest, and so coming home to our hearts and hearths—is proposed for illustration here. An officer—it is not shown whether he has returned to his home sick or wounded or on leave—reclines on a sofa, holding in his hand that number of the *Times* which announces the conclusion of peace. On the same sofa sits his wife,

with one arm thrown round his neck and the other joined in his; behind them is a very large and wide-spreading myrtle, and before them are their two children, playing with the box of toys known as Noah's Ark. The agroupment of the two principal figures, although a probable incident, is not easy. We lose first the extremities of the husband and have to look for them beyond the wife, and then the question arises as to what she is seated on—being upheld only by a supposition that she occupies some mysterious space at the edge of the sofa. The proposed sentiment upon the part of the wife is an inward tumultuous gratitude, too large and impetuous for mere words, for it has filled the citadel of her heart, and for a time overpowered the tongue to silence; the feeling may be shared by the husband, but it must be in a mixed form. The children in their play make a pointed allusion to the political phase of the time (whether they be both girls, or boy and girl), we cannot tell, so fantastically antique is their dress, one offering a dove with an olive branch to the father, and on the mother's knee the other typifies the four belligerent powers by a lion, a bear, a cock, and a turkey. These allusions could not be understood by children of such tender years—hence this passage of the composition becomes caricature—an infelicitous counterpoint to the emotions of the parents. The colouring and shading of all the faces is the same: the shade tints are brown, opaque, and unnatural; in the children these shades exist in the same strength and in the same tints as in the parents. The drawing and painting of the lady remind us at once of the drawing and painting of the mother in the 'Rescue' (we mean the fire picture); that is, beneath the draperies there is no substance, and the drawing in other respects is glaringly faulty. For instance, the shoulder has no breadth or roundness, the line of the shoulder and that of the arm coincide in an obtuse angle. Whether the arm and shoulder did or did not fall into such lines, they should not have been so drawn. The head-dress of the lady is vulgarised by a towering plait of hair, and the children are stiffened by antique dresses in which they cannot move. If we further consider the drawing of the mother we find her ten heads high, and the hands of the children are coarse and heavy; that holding the dove is the rough red band of an adult. The scene does not appear to be a balcony, or gallery, or greenhouse—it is not apparent that it is either, whence then the myrtle that flourishes at the back of the principal group? Originality is the offspring of genius, but originality must be supported by probability in the absence of patent truth. There can be no substitute in a proposition of originality; the fallacy shows at once as affectation—eccentricity—or absurdity. The myrtle here seems at least an inpropriety. If this be another example of what is called pre-Raphaelite Art, we should be glad of an explanation of the term. Every one of the works of this artist differs from the other, and yet all are called pre-Raphaelite. We can understand those differences in the works of an artist which declare improvement, but we cannot understand that works differing only in their degree of declension should represent excellence worthy of imitation. The 'Ophelia' differed from antecedent works (we forget the precise order of these works, and their exact titles), the 'Huguenot' from the 'Ophelia,' the 'Soldier's Return' from the 'Huguenot,' the 'Rescue' from the 'Soldier's Return,' and 'Peace' from the 'Rescue'—and these differences are not of an ordinary kind—yet all is "pre-Raphaelite."

"Aut prodesse volunt, aut delectare poetæ;
Aut simul et jucunda et idonea dicere vitæ."

and such should be the desire of painters, but productions conceived and executed in such spirit are neither profitable nor pleasurable; but our hope is in Ruskin,—he will dare to praise this picture and others of which we have yet to speak.

No. 201. 'General Sir Colin Campbell, K.C.B.,' H. W. PHILLIPS. This is a portrait of some interest to those who have not seen the brigadier, who with his Highland honnets received the Russian Cavalry in line. There is an immensity of character even in the figure, and the face is one not easily to be forgotten.

No. 207. 'The Right Hon. David Salomons, Lord Mayor of London, in the costume worn at his reception of the King of Sardinia, at Guildhall, on the 4th of December, 1855,' S. A. HART, R.A. The Lord Mayor is really a fine subject for a portrait, and the painter has certainly availed himself of the advantages presented to him; the head is a good study,—his lordship wears a scarlet mantle of State.

No. 208. 'Highland Nurses—Dedicated to Miss Nightingale,' SIR E. LANDSEER, R.A. These nurses are two does that lick the fatal wound of a poor stag that has been shot, and is dying on the highest point of one of the Highland mountains. If it be true that these animals mutually make an effort to relieve the sufferings of each other, it is a most interesting illustration of the fact, but it loses value if only a conception of the painter. The poor stag seems to be beyond appreciating the attentions of his nurses. It is unnecessary to speak of the impressive truth in the drawing and painting of the animals.

No. 209. 'A Passing Cloud,' J. C. HOOK, A. The title alludes to a quarrel between two rustic lovers, but the force of the picture is its landscape material, the whole of which, comprehending a portion of a farmhouse and yard, with adjoining pastures, trees, and hedges, seems to have been most patiently worked out from some veritable locality. The entire composition is kept down to a very low tone, for the sake of breadth. The vegetation and foliage impress us as being too green.

No. 215. 'The Assassination of Alhoïn, King of the Lombards,' C. LANDSEER, R.A. He was murdered at the instance of his wife, who, having removed the guards and all arms, caused the assassins to be introduced into his sleeping-chamber, where he was slain. His sword was tied to its scabbard by his faithless queen, therefore, having nothing wherewith to defend himself, he has stricken down one of his assailants with a stool, and is making a blow at another, but the spear of the assassin is already at his breast. The action of the murderer is by no means so energetic as it would naturally be in such a situation; the figures, indeed, generally are less creditable than the draperies and accessories of the composition.

No. 216. 'Dr. Sandwith, late Chief of the Medical Staff, Author of "The Siege of Kars,"' H. W. PHILLIPS. The portrait looks younger than the subject, but it is firmly painted, with features earnest and intelligent.

No. 219. 'Morning—Dunolly Castle, near Oban,' J. MOFFORD. One of the most picturesque views in that romantic region.

No. 221. 'The Breakwater at Plymouth,' F. R. LEE, R.A. This view shows the stupendous work prospectively running into the picture. The time of tide is high water, with the wind off the sea, and the surf beating violently over the extremity of the

breakwater. On each side the view is open, a few figures, therefore, complete the arrangement—scarcely subject enough for a picture so large; it is, however, unmistakably like the place.

No. 224. 'Evening—a sketch in the Isle of Arran,' MRS. G. E. HERING. A succession of mountains seen in the subdued light of evening; it is a most attractive subject painted with infinite taste and sweetness.

No. 226. 'The Friendly Covert—a Sketch,' T. H. MAQUIRE. A group of persons are here seen concealed beneath the shade of the trees of a dense forest, while their pursuers are passing below; the costume, as far as we can see it, seems that of the days of mail and surcoats. It is an effect satisfactorily managed.

No. 230. 'Master Isaac Newton in his Garden at Woolsthorpe, in the Autumn of 1665,' R. HANNAH. The point of the picture is the fall of the apple, which lies on the ground before the philosopher, who is seated in the shade of the tree. It would scarcely be possible to paint this subject so that it should not be at once recognised, but many degrees of effectiveness might be given to it. This is a dark picture, and the artist has thought it necessary to distinguish Newton by an accompaniment of books and mathematical instruments; in the treatment of such an incident this is superfluous. But what is more powerful than all else in the composition is the importunate greenward just beyond the immediate base. This inexorable *greu saute aux yeux*, before all else, superseding even the figure, and every secondary object. It is an excellent subject, but has now been too frequently painted.

No. 242. 'Sunny Moments,' F. W. HOLMES. A very graceful landscape, affording a view of remote Welsh mountains lighted by the sun. The distance is only a glimpse, for the nearest ground of the picture is almost closed by trees, elegant in form and masterly in execution.

No. 243. 'The Brook,' W. GRAY. A small composition, agreeable in colour and forcible in effect.

No. 245. 'Two Old Campaigners—Portraits of Marengo and Copenhagen, the favourite Chargers of the Emperor Napoleon and the Duke of Wellington,' A. COOPER, R.A. The horses were contemporaries, but they never met; it is a quaint conceit to bring them together, but they are well painted, and the picture would have been destroyed by the introduction of any ill-drawn figures.

No. 246. 'A Peep from the Wood,' C. R. STANLEY. The trees here keep their places, a result attainable only by the closest observation of nature, and in painting this class of subject often too little considered. The picture has in it much of the illusion of substantive reality.

No. 248. 'Agua Fresca—on one of the Bridle Roads of Spain,' J. PHILIP. The figures in this agroupment are rendered as picturesque as anything in extant costume can be. A muleteer has halted a moment at a roadside well, where a woman is drawing water, one of whose earthen vessels he raises to a distance from his head, and suffers the stream to flow uninterrupted into his mouth. The muleteer is a grand figure, just such a fellow as would have interested Velasquez, and the artist has made the most of him. That *olla*, with its garlick and bacon, makes a man thirsty in a hot day. Both he and the girl look as if in their holiday gear: for the sake of a *variorum*, it had been better that one had been a trifle theadry. It is a very successful picture, though the materiality of the textures

almost supersedes the importance of the heads. The artist has made a great display of the costume, and of national personality; there is a confidence in every assertion which places his authority beyond question. It is to be regretted that undue prominence is given to the bright green flask—which first catches the eye of the observer.

No. 249. 'Portrait of the late Joseph Hume, Esq,' J. LUCAS. There is an inscription on the frame, by which we learn that this portrait has been commissioned by a large subscription of members of the legislature, in respectful acknowledgment of his lengthened and distinguished career of public usefulness. The figure is presented standing, and so striking is the likeness in person and feature, that those who see the portrait see the man.

No. 253. 'Viola with the Ring,' G. WELLS. There is little point in the subject; she is represented by a full-length figure standing contemplating the ring. The drawing and painting of the picture are unobjectionable; more of the work cannot be seen.

No. 255. 'The Lollard discovered,' R. W. CHAPMAN. It is unfortunate that the varnish has chilled on this picture; such an accident is more inconvenient in the case of a dark picture than a light one, as it veils the depths and glazes. The subject is suggested by the introduction to D'Oyley and Man's Bible, in which it is set forth that, by a decree passed in 1408, by a convocation held at Oxford under Archbishop Arundel, the translation into English, or the reading in English, of the Holy Scriptures, was forbidden under the severest penalty. A follower of Wicliffe is here discovered reading the Bible; but, although the picture is a creditable performance, the danger of the reader is not apparent in the mere act of discovery. It seems to be powerful in effect, and decidedly touched.

No. 256. 'Marietta,' MISS M. E. DEAR. A small study of a child; the head is nicely drawn.

No. 259. 'On the Look-out,' H. LE JEUNE. Two children, a boy and girl, seated on a gun—a 24-pounder it may be, but to the dimensions of which a critical eye from Woolwich would demur—being too long for a howitzer, too short for field or fort service. The boy has a small glass to his eye, and may therefore be said to be "on the look-out." These two figures, which look like portraits, are qualified with that sweetness which distinguishes the youthful impersonations of the author.

No. 260. 'A Nereid,' W. E. FROST, A. One of those miniatures in oil which are among the sweetest of the productions exhibited under this name—a nude figure, standing in the sea, the water reaching nearly up to the waist.

No. 261. 'A Fisherman's Wife—Gulf of Salerno,' T. UWINS, R.A. A system of beautiful and harmonious colour prevails in this small work, which seems but an experimental essay with a view to a larger work.

No. 262. 'The Village Postman,' J. M. CARNICK. The lilac, especially the leaves—the honsetop, with its garnish of house-leek, and the other portions of this village dwelling—these, and other passages of this work, are rendered with consummate truth. The postman and his pony are outdone by the finish of the houses and their accessories.

MIDDLE ROOM.

No. 270. 'Miss Forester,' G. WELLS. The lady is introduced in a standing pose, a half-length figure. The head is firmly painted, and clear in colour, and the work altogether creditable for the simplicity of the taste in which it is carried out.

No. 272. 'Welcome, bonnie Boat,' J. C. HOOK, A. The subject of the picture is the return of a fisherman to his cottage on the beach. He is received by his wife and child. The composition presents a limited view of the coast and its green cliffs. The work is executed with a view to breadth and substance, the tone, therefore, is kept low; indeed, the nearer and more distant parts coincide almost in a monotone, and the representation of substance is so earnestly sought, that atmospheric effect is superseded. We have already spoken of the overpowering greens employed by this painter; the same force of cold metallic tint recurs here on the cliffs.

No. 273. 'Home and the Homeless,' T. FAER. These two histories—that of domestic happiness, and that of abject misery—are gathered from Burns and Wordsworth. List the former—

"His wee bit ingle, blinkin bonny,
His clean hearth-stane, his thriftie wife's smile,
The lapin infant prattling on his knee,
Does a' his carking weary cares beguile,
And makes him quite forget his labour and his toil."

Now hear Wordsworth—

—"but for her girl,
And for her little orphan boy, she said,
She had no wish to live; that she must die
Of sorrow."

Thus sing the poets, and thus says the painter—The cloth is spread, and the "wife" places on the table a pan of broth—we presume it to be, and the cotter is seated, playing with his youngest child on his knee. The contrast to this is a poor and wretched woman shrinking in a farther corner of the cottage, with two children, one of whom ventures to approach the table, looking wistfully at the broth. But for a close inspection of the touch and manner, the picture would not be recognised as a production of the painter of works that have already appeared under this name; it wants the depth and power of these productions. The effect would be improved by painting the woman's drapery in a lighter key. The outcasts, having been sheltered, should be recognised by some more positive charitable allusion.

No. 275. 'A Berkshire Lane,' N. BRANWIN. The perspective of the road is unexceptionable, and the trees and hedges compose very happily; but the stems are too dark, they look as if painted without nature. A little more crispness in the foreground would have placed it firmly under our feet.

No. 277. * * * * F. R. PICKERSGILL, A. The subject of this beautiful work is—Christ blessing little children—"And he took them up in his arms, put his hands upon them, and blessed them." The Saviour is seated, and holds two of the children on his knees; before him is one of the mothers with her child, teaching it to kneel to Christ; and at his side another checks the impertinuity of hers—another of the women is behind, but her action is not very clear. As spectators, two of the disciples appear on the left, but they both wear gaberines of the same colour; indeed, the presence of those persons vitiates, in some degree, that which should be the prevailing sentiment of the subject: we feel them an interruption of the relation between Jesus and the children: we believe, moreover, that their absence would improve the effect; yet the qualities of the work are of the most signal kind: it is a production of a high order.

No. 279. 'Mountain Mist,' R. S. BOND. Showing a very sullen aspect both of earth and sky, but as a hazy cloudy day to a certain extent successful.

No. 284. 'Happy Days,' J. COLBY. A small study of a female figure—very agree-

able in colour, but apparently faulty in drawing.

No. 286. 'Philip IV. of Spain, knightling Velasquez,' A. J. HERBERT, jun. "When Velasquez had finished the picture called 'Las Meninas,' in which he had introduced himself painting the Infanta, the King came to see it; and in reply to Velasquez's inquiry of his approval of it, said that one thing was wanting, and taking a brush he painted on the portrait of the artist the red cross of the order of Santiago." There are accordingly two figures, the King and Velasquez, the former painting on the picture which the spectator sees in the glass behind the King, placed there by the painter to assist him in correcting his drawing. It is a striking incident, an effective subject, and judiciously managed.

No. 287. 'Nymph and Wood-pigeon,' G. PATTEN, A. A semi-nude figure—too heavy and material for the ideal of a nymph—and rendered yet more heavy by a dark drapery which severs the figure. The flesh-colour is natural.

No. 288. 'On the Coast of Sussex,' F. W. KEYL. A paradise of happy sleep, distributed over a portion of pasture-land on cliffs overhanging the sea. It is an extremely agreeable picture, produced from a very slender subject. It is harmonious in colour and piquant in effect.

No. 289. 'Climping Church,' J. W. OAKES. A small picture worked as if from a photograph; it presents a church, graveyard; and an aged yew. It is astonishing how interesting good execution renders ordinary subject-matter.

No. 292. 'The Evening Prayer,' G. HARDY. The eye is repelled by the blackness of the shades in this picture, which in time will become quite opaque. The point is a mother hearing her child repeat its prayers at bedtime.

No. 293. 'Portrait of a Gentleman,' J. E. MILLAIS, A. This gentleman is a little boy busy in the inspection of a book of woodcuts, but looking each spectator in the face, and complaining querulously of frequent interruption. There is more of nature here than in most of the other works of the painter.

No. 294. 'A Study in the National Gallery,' C. COMPTON. A group of wondering children looking at "The Entombment;" the objects of their interest and their whereabouts are at once understood.

No. 295. 'And the prayer of Faith shall save the Sick,' J. PHILIP. The substance and distinctive surfaces shown here resemble those of the muleteer picture. The scene is the interior of a church in Spain during public worship. A poor woman, bearing her infant with her, has brought her sick boy to the church in the faith of cure; behind her stands a tall aged man of the labouring class, and on her right two damsels, one holding a missal and the other the everlasting fan—a procession is passing by. There is no vulgar prominence given to the particular passage of the composition conferring the title; but the purpose of the mother is sufficiently perspicuous, which at once concentrates the interest on this group. It is a work of great power.

No. 299. 'A Lancashire Witch residing at Bolton-le-Sands,' J. C. HORSLEY, A. A study of a country girl going to school; very simple in treatment.

No. 300. 'An Interior,' F. D. HARDY. We have observed of other studies by this artist that the shades are black and opaque; in this there is more light and relief, but what there is of shade is extremely heavy.

No. 302. 'Winter,' MISS M. H. STANNARD. The point of the subject turns on a poor

bullfinch that has perished of cold and hunger; near the dead bird are some sprays of holly very closely imitated from nature.

No. 303. 'Ronald Stuart-Menzies, Esq., of Culldares,' J. M. BARCLAY. A portrait of a gentleman in Highland costume; the figure is standing, circumstanced in an open hack-ground, with a mountainous distance; in the *aplomb* and presence of the figure are very striking.

No. 306. 'A. H. Layard, Esq., M.P.,' W. M. TWEEDIE. The figure is seated as if in a library; the head is successfully painted, but too much is made of the background, there is a superabundance of red, and it supersedes the person in importance.

No. 309. 'Three portraits of a Lady,' F. W. MOODY. She must have had extraordinary patience to sit for these three heads: one is a full face, one three-quarters, and the third shows only the cheek; it is not a pleasing kind of portraiture.

No. 310. 'The Parable of the Children in the Market-place,' W. C. T. DONSON. This subject occurs in St. Luke, chap. vii.—"Wherunto then shall I liken the men of this generation? and to what are they like? They are like unto children sitting in the market-place, and calling one to another and saying, 'We have piped unto you, and ye have not danced; we have mourned to you, and ye have not wept.'" In this composition is forcibly illustrated the heedlessness of mankind to the preaching of Christ. The picture presents a company of young children; the Saviour himself is represented as a child, and also St. John, who is with him. Christ is preaching to them, but they do not listen; one closes his ears, another treads under foot the lily, and plants a poppy in her bosom; two others are active in pursuit of butterflies—the action of every one betokens utter neglect of the divine precepts. All the figures are drawn and painted with accuracy, and each is endowed with an expression animated, and, in a great measure, contemptuous of the teaching of Christ. There is not in the text an authority for the introduction of the Saviour, yet without his presence the Pharisaical unbelief of the children could not have been so obviously indicated. There has been, however, no undue licence, and the picture is unquestionably among the very best of this year's exhibition.

No. 311. 'The Novice,' J. C. HORSLEY. We find her seated in the cloister of the nunnery to which she is about to attach herself by vow; she has been employed in forming garlands for some festal ceremony of the church, but instead of prosecuting her task she is amusing herself by caressing a dove; and, being observed by two of the elder sisters of the house, is perhaps subject to some penance. The incident is sufficiently legible, but the severer sisters are too prominent to be unobserved by the novice.

No. 312. 'Mid-Spring,' J. W. ISCHBOLD. All the shaded herbage in this work is so abundantly mingled with blue flowers as to give to the grass a cold frosty appearance, but upon close inspection the wondrous and patient manipulation by which all this is realised excites vastly the admiration of the spectator. Each blade of grass and each minute "forget-me-not" has its place in the vegetable throng, and the trees and foliage are microscopically reproduced. The flowers certainly faded, the grass withered, and the leaves fell before this picture could have been painted.

No. 313. 'Dancing Dolls,' G. SMITH. We become here one of a company who are mightily entertained by an Italian hoy with

his itinerant theatre, consisting of a deal board and a couple of dolls. Infant wonder and youthful admiration of the graceful movements of these two puppets, are very literally depicted in the features of the village throng, every member of whom is most scrupulously made out. The weakness of the picture is its colour, good effect is overlooked; the trees and distant objects, for instance, are forced upon the nearest plane of the composition. We have very highly commended the smaller works of this artist, but the infatuation of colour renders his larger productions incomparably more feeble than these.

No. 317. 'Changing Pasture,' J. STARK. Principally a screen of trees telling against the sky, and a clear distance. In the sylvan fragments usually painted by this artist there is a substantive truth which sustains itself well even in comparison with the marvellous finish of the present day. The title refers to a flock of sheep which are being driven from one field into another.

No. 319. 'Doubt,' F. STONE, A. The group presented in this picture is costumed and circumstanced like the fishing population of some part of the French coast. They are at the door of their cottage; the most prominent members of the group being a youth and a maiden—the latter seated, the former standing by her, and showing her a pair of ear-rings, which he has purchased for her. She looks at the trinkets with a smile of levity and carelessness, by which he is pained, and don'tingly turns his head away to another sister who is tenderly helping her aged grandmother to totter out of the cottage to join the circle. The picture is larger than any we remember to have seen before, under this name. In the female figures especially there is a personal refinement which gives to these impersonations rather the appearance of enacted than real characters.

No. 320. 'The Glen, Chudleigh, Devon,' W. F. WITHERINGTON, R.A. A close shady scene, with a little stream flowing out of the picture, and looking much like a section of cove in the home-grounds of some mansion. We observe again that the works of this artist are much broader and more effective than antecedent productions.

No. 321. 'The Deluge,' S. B. HALLE. This is a very large work, executed in the feeling of a foreign school. The narrative sets forth the agony and despair of a remnant of human beings, among the last of their race who have retired before the rising waters, till they find themselves diminished in number, and famished to death on the last summit of the rock to which they have fled for refuge. There is a king, whose sword now lies at his feet, powerless to defend and avenge, who yet grasps his crown, now a mockery of state; he endeavours to support one of his family, who dies even before he sinks in the inevitable waters. At his feet is a mother abandoned to despair, yet still clasping her child. Behind him is one widely vociferating imprecations on the Deity; and near him a woman, become a giddy-headed maniac from the shock of overwhelming terror, pronouncing her dwelling rebuke to the inexorable tide. From another group men and women drop from the rock—being claimed by the insatiate deluge: they float awhile, and then disappear. In this description the artist has taken high ground: he is a natural expressionist of great power, for there is a definite passion in each figure. The principal superior form of the composition is semicircular, traversing the picture diagonally from the upper left corner towards the lower right corner—and he knows what to do with his

limbs, the extremities being made to contribute to the details of the awful episode. The drawing is that of an accomplished student; the execution is simple and unmannered; and the colour is better than we generally see in the essays of foreign schools.

No. 322. 'Loch Lomond, Scotland,' J. DANBY. This is apparently a proposition of morning effect. There is much sweetness in the lighter parts of the picture, but the shaded passages are heavy and opaque.

No. 326. 'The Earl of Ellesmere,' K.G., E. LONG. A simple and unaffected portrait, presenting the subject at half-length, seated. In the features there is resemblance, but not, we think, personally.

No. 327. 'The Children in the Wood,' J. SAINT. They are lying on the ground in a glade of the forest; asleep, it may be presumed, as there is colour in their cheeks. The pose is not favourable, the heads being towards the spectator. The picture is agreeable in colour, but it will not be considered one of the best of its author's works.

No. 328. 'Un Corrillo Andaluz,' D. C. GRASON. The intense vulgarity of a foreign title comes effectively out among such others as "A Kitchen Corner," "A Group of Sheep," "A Bird's Nest," &c.: these unelodious vowels and liquid consonants are music amid our hard and hissing vernacular. But the picture is really praiseworthy: it shows a group of Spanish water-carriers, waiting their turn at a fountain which adjoins a blacksmith's shop. A boy and girl with other figures at the fountain constitute the strength of the picture. The whole of the work is most conscientiously finished, and is, doubtless, circumstantial in description of character and national characteristic.

No. 329. 'Dona Pepita,' J. PRINR. This is a study of a Spanish lady who has sat to the painter. She is seated as if at the theatre, shading her face with the inseparable fan, and looking with a piercing glance at the confused spectator.

No. 330. 'The Intruders,' MRS. E. M. WARD. These intruders are children who have made their way into a pompously furnished drawing-room: they will certainly demolish something before they quit the room. It is an extremely difficult subject to paint, but it is treated very successfully. It is, indeed, among the most successful works in the exhibition, broadly and effectively painted, while the several details are carefully and minutely finished.

No. 332. 'A Group of Sheep,' D. A. WILLIAMSON. It is difficult to understand how they are grouped; we lose entirely the head of one of the animals; yet the work has some meritorious points.

No. 334. 'A Slight Touch of Heart-Complaint,' G. B. O'NEILL. The patient is a young lady, introduced to the physician by her grandmother (!). The nature of the heart-affection is, of course, understood fully by the physician; but, perhaps, not by the old lady. It may be suggested that if Sharp's (is it?) engraving of the portrait of John Hunter were removed to the dining-room, and the heavy glazing behind the doctor lightened into transparency, the picture would be improved. It has been most assiduously worked out in all its details.

No. 335. 'Orchids,' MISS A. F. MURPHY, and No. 342. 'Primulas,' by the same lady, are flower-pictures of infinite delicacy and brilliancy of colour.

No. 336. 'Street Scene in Cairo, near the Bahel Lnk,' J. F. LEWIS. A curious subject—no don't true—every brick: we make this observation with some faith, because there does not seem to be any attempt at aggrandisement, either of space or object.

We find ourselves in a close street, in the company of men, camels, and pigeons. The men are generally seated; the movement of the camels is dreamy and listless; the pigeons are the only active people of business we meet with in this land of luxurious drowsiness, wherein every person, animal, and object, is realised by that microscopic stipple in which this artist stands unique.

No. 337. 'St. Peter's—Looking back on Rome,' D. ROBERTS, R.A. From this point St. Peter's is almost the only object we see. It seems as if Rome had vanished, and St. Peter's stood alone; it is a production of much excellence.

No. 341. 'Garden Flowers,' W. P. FRITH, R.A. A young lady appears here, busied in arranging a bouquet of fresh flowers. She is seated on a garden-seat, almost entirely in shade. The garden background is a well-painted probability, but the face is charming in softness of surface and colour.

No. 344. 'Farm Yard in Hampshire,' T. BARRAT. Everything here seems to be sacrificed to the horse that is placed as if it were the subject to which all else is subservient. A farm yard is a very unassuming subject.

No. 349. 'The Trumpeter,' —, VANDENBOECK. He is mounted on a grey charger, and equipped too slowly for a trumpeter—becoming rather the *cinque* than the field of battle, and this is the more striking as there is a battle raging in the front.

No. 350. 'A Weary Journey,' C. DUKES. A group of wayfarers, a mother carrying one child and leading another; an agreeably coloured picture.

No. 351. 'The Cornish Coast,' F. R. LEE, R.A. The picture proposes to afford an example of the heavy seas that roll in upon this coast; both sea and sky betoken wind.

No. 352. 'Chatterton,' H. WALLIS.
"Cut is the branch that might have grown full straight,
And burn'd is Apollo's laurel bough."

Such is the motto that is inscribed on the frame of this picture; the same accompanies the title in the catalogue. We find the unhappy Chatterton extended on a narrow couch under the window of his garret. We know that he destroyed himself by arsenic, after having applied as a last resource for the appointment of surgeon's mate to proceed to Africa; that his landlady, with the conviction that he was starving, offered him a dinner on the day before his death; and knowing these things, we are surprised to find him dressed as if he had returned from a late revel and was yet under the effects of wine. But the mortal pallor of the features on a closer examination declares death, the blood has been recalled to the citadel of the heart in its last extremity. He wears bright purple or lilac small-clothes, and a velvet coat is cast on the floor. The dress of Chatterton must have been plainer than this at the time of his death; even were it not so, it is not consistent with the spirit of the story that it should be otherwise. His abode is a garret: every friend of humanity will wish his dwelling-place had been more worthy of his powers; and this garret is in keeping with the story, but not the bright purple small-clothes and red velvet coat. It may be said that Chatterton was proud and kept up appearances; it might be so; but still the story had been more consistently moving, rather by a declaration of truth in poverty than by ostentation. Chatterton was buried, we believe, in the City, somewhere between Fleet Street and Holborn, and lived and perished in that neighbourhood. From the window of his garret there is a distant view of St. Paul's with an evening effect, which would place

his residence far east of St. Paul's, at least at Whitechapel, which is not true; if it be proposed as a morning effect, that places his residence as far east as St. James's, an assertion equally untrue. We make these observations with the feeling that in a subject of this kind, when the whole of the circumstances are patent, and the imagination has no play but in the improvement of facts, an artist cannot be too accurate in his statements. The picture, however, exhibits marvellous power, and may be accepted as a safe augury of the artist's fame.

No. 355. 'The First Letter from Home,' A. FARMER. The story is legible enough; a boy at school has received the little hamper of cakes and apples, and is reading the letter by which it is accompanied.

No. 356. 'Evening,' J. RICHARDSON. This might have been made an effective and agreeable picture, but the shaded portions are glazed into intense blackness; it contains one figure, that of a young lady seated at a window just after sunset.

No. 357. 'A Sheep "Lew," East Kent,' T. S. COOPER. What the Cantii mean by "lew," is shown here—a covered fold for sheep; if it be not the French word, it is a Kent-Saxon term we know nothing about. This artist has painted a few of those rough interiors before; we look upon them as a relief in respect of the sunny knoll and that everlasting lowing group of milky mothers.

No. 358. 'Professor Ferguson,' SIR J. W. GORDON, R.A. A head and bust, an excellent study, the best points of which the painter shows that he has felt.

No. 359. 'Cranmer at the Traitors' Gate,' F. GOODALL, A.

"On through that gate misnamed, through which
before,
Went Sidney, Russell, Raleigh, Cranmer, More."

This is a more solemn subject than any that has yet appeared under this name; and as a first essay in this class of subject-matter, it must be observed that the grave importance of the passage has been fully felt; for in the entire composition there is not the slightest incident inconsistent with this propriety of tone. The composition is admirably managed: the rude boat in which Cranmer has been conveyed to the Tower is drawn up to the stairs within the Water-gate, and we see him passing from the boat by a plank to the stairs—he looks up as uttering a pious ejaculation. Behind him is a group of boatmen and guards; the plank is held by a yeoman of the guard assisted by others, and he is received by the governor of the Tower, who reads the warrant received from the officer who commits Cranmer to his custody. As a background the Water-gate is treated with great breadth; there is in it no marking to interfere with the figures, in the principal of which there is dignity and commanding presence. A strong feeling of interest and compassion is expressed in the features of the guards and attendants; but there is a monk whose malignant scowl represents the spirit of persecution under which Cranmer and others suffered. It is a work of high merit, different in everything from the buoyant tone of antecedent works, but such a conception could be treated in no other feeling.

No. 360. 'Graziella,' R. LERMANN. Lamartine's work of the same name has suggested this picture.—"One evening I began to read to them Paul and Virginia. Graziella insensibly approached me as if fascinated by some sudden power of attraction." It is a large picture with life-sized figures grouped on the shore of the Bay of Naples, which opens beyond the figures, so that they are relieved by sky and distance. The impersonations are happily conceived, and

executed with a tenderness and earnestness becoming the proposed sentiment; but we are forcibly struck by the formality of the composition, which is almost mathematically pyramidal—the principal group being in the centre, and the two extreme figures at equal distances on each side from the frame. Yet there is much in the work to commend; there is more of sacredness in it than in many works professing the purest tone of sacred history.

No. 365. 'Sir William C. Ross, R.A.,' MISS ROGERS. The portrait is not flattering to the eminent miniature-painter; the hangers also seem to have thought so.

No. 366. 'The Music of the Reeds—Portrait of Eloise d'Herbal, the celebrated Spanish Pianist,' J. T. PEELE. The former part of the title is unintelligible; the impersonation is that of a young girl, who is seated on the ground. The head is well wrought, and the figure comes well forward.

No. 368. 'Holy Loch, Argyllshire,' R. H. ROE. The shores of the lake traverse the picture as distance softened by atmosphere and mist. The principal subject is a boat aground on an islet shore in the middle of the view. The effect is that of evening, very attractively described. The Highland scenery of this artist has been rarely, if ever, surpassed.

No. 371. 'Henry the Third's tomb, North Aisle, Westminster Abbey,' H. WILLIAMS. In this large picture the extent of the aisle seems to be exaggerated. The representation is immediately recognisable, but the shaded portions are unduly black and opaque.

No. 372. 'Near Rome,' J. LESLIE.

"Beati i poveri, il regno dei
Cieli e loro."

Such may be the text read by the monk to these assembled groups. The figures are numerous, and of the size of life—Italian peasants listening to their confessor reading from a Missal. It is not a subject for a large composition, the incident is not sufficiently important in its relations. The head of the reader is forcible in character, so much so as to reduce the others to a certain degree of insignificance, but the figures seem correct in their representation of nationality of feature and costume.

No. 373. 'The Conspirators—the Midnight Meeting,' P. F. POOLE, A. This is an incident from the history of Switzerland. "Arnold, Werner, and Walter (the last the father-in-law of Tell), of the three forest cantons, are described as having met by appointment at a solitary spot on the lake of Waldstätten, called Rutli, and there to have matured plans for liberating their country from the tyranny of Gessler." Such is the epitome given in the catalogue, though a much more pithy and appropriate accompaniment to the title might be found in Schiller's drama, "William Tell." We must confess some surprise at this work after those we have for some time past seen exhibited by this painter. We find the three patriots conferring secretly in a cave by torch-light, but the figures and all the circumstances are so loosely put in, that if the work were not so large, it would be difficult to suppose it anything beyond a trial sketch, containing in the lights the usual toning of yellow (cadmium?) which we find in all the works of this artist.

No. 374. 'The late Mrs. Crellin,' H. W. PICKERSGILL, R.A. In colour, expression, and execution, this is the best female portrait we have ever seen by the painter.

No. 375. 'The Deer Park,' H. JUTSUM. A composition pointedly descriptive of a passage of park scenery; the foreground is a small tract of rough bottom, with a stream

flowing out of the picture; it is also well timbered, and at a little distance closed by trees; the trees are drawn and painted with a fine feeling for form.

No. 378. 'Wallasey Mill, Cheshire,' W. GRAY. There is a valuable quality of work in this picture, but the materials are curiously brought forward in a succession of straight lines.

No. 379. 'Solitude,' W. GRAY. The principal quantity in this composition is a pretty and effective group of trees telling against a richly-tinted evening sky; it is broad and effective.

No. 380. 'Bridge over the Rhone—at Leak Cauton, Valais,' G. C. STANFIELD. The bridge is covered in, like others in Switzerland, leading to a tract of country mountainous and picturesque, and constituting the principal feature of the picture.

No. 381. 'Primroses,' Mrs. HARRISON. Not an elegant agroupment, but the flowers and leaves are accurately rendered from nature.

No. 383. 'Venice—Approach to the Grand Canal,' D. ROBERTS, R.A. This view is given from a point whence the parallel cuts just within the two columns; the composition, therefore, includes the library on one side, the Dogana on the other, and all the buildings on each side of the gorge of the canal. The buildings are painted with great sobriety of tint (raw umber, qualified here and there, is, perhaps, the only colour), and the architecture is more detailed than has been the case of late in these works, although the touching is rapid and slight—for instance, the railing in some columns on the right goes not only through the columns, but also through the intervals.

No. 387. 'A Summer's Afternoon in the Woodlands of Kent,' J. S. RAVEN. The picture is hung high, but it is, nevertheless, apparent that there are good colour and composition. There is a flock of sheep in an upper section of the view; they should have been nearer the foreground.

No. 392. '***,' E. HUGHES. This is a group of a mother and child, circumscribed in a richly-furnished boudoir, every item of the upholstery of which is most minutely worked; the figures, also, are very careful.

No. 393. 'The Right Hon. Edward Ellice, M.P.—Painted for his constituents at Coventry,' F. GRANT, R.A. One of the best male portraits this artist has ever produced. The expression is agreeable and animated, and the general treatment simple and unaffected.

No. 396. 'A River Nymph,' W. E. FROST, A. A small, semi-nude figure, reclining on a bank, with her left arm resting on an urn. It is brought forward with a very fine touch, though, perhaps, not so highly manipulated as other similar studies by the same hand.

No. 398. 'The Scape-Goat,' W. H. HUNT. This work has been placed prominently before the public on the line, and the painter, as one of the "pre-Raphaelite" brethren, has attracted some share of public interest. It will be necessary to inquire into the merits of the work. The scene, we are told, was painted at Oosdoom, on the margin of the salt-encrusted shallows of the Dead Sea, and the mountains closing the horizon are those of Edom. The subject of the picture is simply a white goat wandering exhausted and thirsty amid the salt deposit on the shore; beyond the animal appears the Dead Sea, and on the other side the mountains, both forming parallels that traverse the picture. The animal is intended to represent the scape-goat of Scripture (Leviticus, chap. xvi.), one of the

two goats that figured in the ceremonies of the day of atonement. One was sacrificed, and the other was driven into the wilderness, with a fillet of scarlet wool bound about its horns, in the belief that if the propitiation was accepted, the scarlet would become white, according to Isaiah—"Though your sins be as scarlet, they shall be as white as snow; though they be red like crimson, they shall be as wool." The animal is an extremely forbidding specimen of the caprineous races, and does not seem formed to save its life by a flight of a hundred yards. If narrative and perspicuity be of any value in Art, these qualities are entirely ignored here; there is nothing allusive to the ceremonies of the atonement, save the fillet of wool on the animal's horns, and this is not sufficiently important to reveal the story of the scape-goat. There is nothing to connect the picture with sacred history; there is no statement—no version of any given fact; a goat is here, and that is all; the ceremonies to which it is intended to refer, but does not, must be read in the Talmud. Had the picture been exhibited as affording a specimen of a certain kind of goat, from the hair of which the Edomites manufactured a very superb shawl fabric, there is nothing in the work to gainsay this. It might be hung in the museum of the Zoological Society as a portrait of an animal that lived happily, and died lamented: there is nothing in the work to contradict it. The artist went to the Dead Sea to paint the scene: but there is nothing there so red and blue as these mountains of Edom. The only point in the picture that has any interest at all is the deposit of salt; this is interesting, if the representation be true: for ourselves, we have often read of this, but never have seen anything like a truthful picture of it. The picture demands no more elaborate criticism than this: notwithstanding, it attracts scores of gazers. It is useless for any good purpose—meaning nothing, and therefore teaching nothing; although it exhibits large capabilities idly or perniciously wasted.

No. 402. 'The Lady Dorothy Nevill,' Hon. H. GRAVES. A miniature in oil, of singularly minute finish. The lady is seated taking tea in a richly-furnished boudoir, being costumed according to the taste of the middle of the last century. The figure is well painted, and it would add to its reality to tone down the background, and bring the figure more forward.

No. 403. 'Bacchanalians,' W. E. FROST, A. They are dancing under the shade of the vine: it is small—a charming sketch that might be executed with the best effect as a large picture; but it would be necessary slightly to alter the arrangement, the figures being too distinctly grouped in couples.

No. 406. 'The Chapel of the Strozzi Family in the Church of Santa Maria Novella, Florence,' W. D. WEST. It is the ninth or tenth of the many chapels in this famous church that contains the Strozzi mausoleum, on which are angels in white marble—and here we are amid great and sacred names. On the floor of this church we are surrounded by the immortal works and the mortal remains of some of the most famous men that have ever practised Art. But in this picture little is seen of the chapel—everything has been sacrificed in order to bring out the painted glass.

No. 411. 'Miss Spearman,' L. W. DESANGES. A portrait of a young lady in white; the features are coloured with much natural freshness.

No. 412. 'Alexander Abercrombie, Esq.,' D. MACNEE. This is a work of first-rate

merit: the head and features are most successful in the manner in which they are lighted.

No. 413. 'The Wounded Cavalier,' — BURTON. To this number in the catalogue there is neither title nor name of the painter, the artist's letter having been mislaid during the printing of the catalogue. The story as proposed is of a duel having taken place between two gentlemen of the time of Charles I., and one is left on the ground desperately wounded. In striking a blow at his adversary he has cut deep into a tree, when his sword was broken, and it is yet sticking there. This blow has been struck from the right of the tree, but we find him lying on the left. He is discovered by two persons—a puritan and his wife or sister (either will do for the story)—the former of whom stands indifferently looking on, caring nothing whether the unfortunate man lives or dies; but the woman supports him, and endeavours to staunch the blood from his hurt. There is perhaps some difficulty about the interpretation of these circumstances, because the cavalier lies on the side of the tree opposite to that from which he struck the blow, as indicated by the sword point being towards him. The scene is the skirt of dense and dark wood, the trees of which, with a boundary wall, and the foreground herbage and stones, are all realised with singular care. We may regret that the story is somewhat unintelligible: that the artist has introduced a cobweb and a butterfly upon the broken blade—where the one was not likely to have been, and the other could not have been. But the picture is a production of great power and originality. The painter has been hitherto unknown, but this picture at once establishes his reputation; he is secure of fame hereafter.

No. 416. 'A Mountain Stream,' H. B. WILLIS. The character of the landscape is like Welch scenery, and the stream, which flows transversely through the composition, resembles the Conway. The material is very effectively distributed—trees, water, meadow, and mountain—and the feeling of the execution is such as to keep the objects in their respective places. It is a production of refined taste.

No. 421. 'A Favourite Retreat, North Wales,' F. W. HULME. A captivating subject, the beauties of which are fully felt. A stream flows down to the base of the picture, and its course is lost in the shade of a screen of trees that traverses the composition, beyond which rises a distant mountain. The foliage and herbage are expressed with infinite truth, and the colour is green—the green of nature, without any approach to that intense metallic verdure which has of late been adopted by the younger school of landscape Art.

No. 423. 'Winter,' W. HEMSLEY. A small picture containing three figures—children travelling over the snow, charged with a pail, which they have placed temporarily on the ground, to rest and blow their freezing fingers. The figures are drawn with the observance of truth usual in the works of the painter, and we feel sensibly his expression of cold.

No. 424. 'Samuel Warren, Esq., Q.C., D.C.L., M.P. for Midhurst,' Sir J. WATSON GORDON. We are always glad to meet with portraiture in which all allusion to any celebrity the subjects may enjoy is entirely eschewed. The head has all the argumentative force with which the painter usually qualifies his works.

No. 426. 'The Hon. Lady Abercromby,' L. W. DESANGES. The lady is standing enveloped in a snowy shawl. The head looks

small, and the expression is not, perhaps, sufficiently dignified.

No. 427. 'Study of Trees, near Highgate,' A. COLLINS. In the manner of these trees there is much natural truth.

No. 429. 'View in North Wales,' G. SHALDERS. A section of mountain scenery highly attractive as a subject for even a larger work.

No. 433. 'The Fort of Delzijl, on the Dollart, an inland sea of Holland,' E. W. COOKE, A. In one or two of the recent works of this painter, his seas are not so well painted as they were wont. The waves here are hard, and their crests sharp and cutting. They are thin, and want volume and fluidity. A dogger is sailing into the harbour with a full and flowing mainsail, and another is sailing out, and in a very short time there must be collision; for there is no sign of the near vessel easing off. There can be no truth in the position of those two boats, if we see them aright. The Dutch are better seamen than to sail into harbour without reducing their canvas, and to place their vessels in serious danger.

No. 434. 'Blossoms in May,' M. ROBINSON. This picture will strike the spectator as being singularly like the work of Macleise. There are two figures, girls, grouped together in sisterly affection. The effect is injured by the prominence of a branch of May-blossom near their heads. The drawing is unexceptionable, and although there is a degree of hardness in the outlines, the work is one of good promise.

No. 435. 'A Mill Stream, near Chudleigh, Devonshire,' N. O. LUTROX. A profitable study of weeds and herbage, with an effective group of trees; the whole constituting an attractive picture.

No. 438. 'A Labour of Love,' J. W. HAYNES. The prominence given to these two figures attracts our notice. They are those of an old man and a boy; the former busy in making a boat for the latter. The execution wants softness, but the group comes well forward.

No. 439. 'Clearing Up—Evening Effect,' T. S. COOPER, A. This is a repetition of what we have seen so often exhibited under this name: a group of cattle in a Cuy-like landscape.

No. 440. 'Lady Gooch,' J. LUCAS. There is an individuality in this impersonation which must be that of the subject.

No. 442. 'Portrait,' W. GUSH. That of a lady, presented at three-quarter length. The head is a very successful study, and is endowed with much feminine sweetness of expression.

No. 448. 'Autumn Leaves,' J. E. MELLAIS. This composition will, perhaps, be interpreted by the admirers of "pre-Raphaelite" Art as an essential sign of the divine afflatus. It contains three figures,—girls with a heap of leaves before them, to which they have just set fire, as indicated by the ascending smoke. Is it that here the painting will be as nothing—that these withered leaves shall be read as a natural consummation, a type of death—that the human forms in their youth shall signify life, or will it be discovered that the twilight of the day shall describe the twilight of the year? The three figures represent, perhaps, priestesses of the seasons offering up on the great altar of the earth a burnt sacrifice in propitiation of winter. In what vein of mystic poetry will the picture be read? The artist awaits the assignment of the usual lofty attributes. The work is got up for the new transcendentalism, its essences are intensity and simplicity, and those who yield not to the penetration are insensible to fine Art. Simply, there is a small society of young

ladies huddled in gathering and burning withered leaves, a heap of which is piled up before them. There is no colour in the picture, it is painted entirely for sentiment. Two of the figures are dressed precisely alike, and all in a taste remarkably plain. The hair of each hangs most unbecomingly about their ears and faces, and their features are devoid of all beauty, and coloured into very had complexion. Such is the picture as we see it. The leaves are very minutely drawn. We had almost forgotten a significant vulgarism; it is, that the principal figure looks out of the picture at the spectator. The look of the lady in "Peace" is also fixed on the spectator. We are curious to learn the mystic interpretation that will be put upon this composition.

No. 449. 'The Letter,' J. W. H. MANN. A small picture in which appears a young lady reading an epistle. The head and hands of this figure are beautiful in colour and most judicious in manner and execution.

No. 453. 'Servoz, near Chamounix,—Collecting Pine Timber,' H. MOORE. The locality presented here is strikingly foreign, all the material—houses, water, trees—are true and effective, and the mountains are true and harmonious in colour.

No. 454. 'Gleaners Leaving the Stubble-field,' T. UWINS, R.A. A large picture, rich with the glow of autumn; and containing numerous figures bearing on their heads the fruits of their day's labour.

No. 456. 'Aeneas Machean, Esq.,' C. SMITH. This is a portrait of extraordinary excellence; it represents the gentleman seated, and everything is subdued but the head, which is lighted so judiciously as to bring it out full and round. It were only to be desired that the background had been the merest trifle lighter round the head.

No. 460. 'W. Newenham, Esq.,' J. ANDREWS. A work of much merit, forcible and characteristic.

No. 461. 'Mrs. Willott,' W. S. HERRICK. This is one of the most elegant feminine portraits we have for some time seen. The lady wears a white robe very effectively disposed, and the figure is all simplicity and grace. We cannot too highly commend this work.

No. 463. 'W. C. Marshall, Esq., R. A.,' E. B. MORRIS. A small portrait, painted with firmness and good effect.

WEST ROOM.

No. 468. 'The Marchioness of Blandford,' J. G. MIDDLETON. The painter has succeeded in communicating to this figure—which is presented standing—a marked air of distinction.

No. 469. 'Ball at the Camp, Boulogne,' J. H. THOMAS. Nothing can be more felicitous than the description of French character here open to perusal. We are introduced into a tent, and although somewhat spacious, it is yet full of the votaries of Terpsichore; quadrilles are the order of the evening, and—

"Order and sobriety are *dot-a-dotes*."

The limbs, encased in the military *garance* have it all their own way here. There are gens-d'arms, douaniers, and police, but Mars in the ascendant. There is a difference between a *pirouette* and a *vol-au-vent*. The *pirouette* of one of these foregoing figures is most perfect, and the *pas-de-zephyr* of others as graceful as the spread eagle. The ladies are of the fairest Boulognaises, grisettes, and the beauty of the along-shore population. The picture is extremely well lighted, and the throng mixes most sociably together, but the force of the

version is its movement—its perfect nationality.

No. 470. 'Grandmama Caught,' A. S. STANLEY. An old lady is here seen sleeping in her chair, and she is discovered by her grandchild. The head comes out well.

No. 471. 'The Birthday Beau,' a Portrait, F. W. KEEL. A singular conceit as a portrait. It is that of a little boy wearing a cocked hat, and the costume of the middle of the last century. He is mounted on a grey pony, which is drawn with knowledge of the anatomy of the horse.

No. 473. 'Uncle Tom, a Study from the Life,' T. UWINS, R.A. A portrait of a negro, very characteristic.

No. 474. 'Dromedary and Arabs at the City of the Dead, Cairo, with the Tomb of the Sultan El Barkook, in the background,' T. B. SEDDON. With respect to effect, this is one of the best of these desert pictures which are now becoming so numerous.

No. 475. 'The Lake of Lucerne, from the mouth of the Brunnen, Switzerland,' T. DANBY. A warm, sunny picture, showing principally the expanse of the lake with a group of boats, the whole shut in by surrounding mountains. For a work so large there is perhaps not subject enough.

No. 492. 'A Weedy Pool,' S. R. PERCY. This is placed high, and being painted in a breadth of shade, the different parts are not sufficiently distinguishable.

No. 483. 'His Excellency Mazhar Pasha (Sir Stephen Lakeman), Governor of Bucharest,' S. HODGES. The Pasha wears a plain undress English military uniform—the features are strikingly intelligent, and full of energetic expression.

No. 485. 'On the Upper Part of the Teign, near Chagford, Devon,' T. J. SOPER. The subject is well chosen, as consisting of but few and simple parts—a bridge, a large group of trees, and a near mass with herbage; the picture is lung high, inasmuch that the details cannot be seen, but it is in composition and effect the best we have ever seen by the painter.

No. 486. 'The Bride,' A. SOLOMON. Besides herself there are two other persons present, her mother and her maid. It is the bridal morning, and she is just finishing dressing; but of the heads of the two standing figures we prefer that of the maid. It is a large composition, rich in showy draperies—the subject declares itself at once.

No. 487. 'Hampstead Heath,' G. C. STANFIELD. Nothing better than this in the way of subject-matter can be found at any distance from London. We do not know the precise point from which the view is taken, but it comes together in excellent relief. The manner of the painter seems to increase in crispness of touch.

No. 489. 'San Giorgio Maggiore, Venice, View looking East, effect immediately after Sunset,' E. W. COOKE, A. We need not describe this church, everybody knows it as well as St. Paul's; but it becomes more and more apparent that buildings are the least successful portions of the works of this painter.

No. 499. 'Mrs. Pender of Bredbury Hall,' P. WESTCOTE. There are many valuable points in this work, but the person is too much elongated.

No. 501. 'Isola di Sau Giulio—Lago d'Orta,' G. E. HERRING. One of those Italian lake subjects which this artist paints with so much success. The buildings that cover the little island are in the nearest site, and contrast forcibly with the surrounding distant mountains, which are represented with much sweetness.

No. 503. 'Summer Crops,' W. LINNELL. The tone and feeling of this admirable picture partake of course of those of the

parent and master, J. LINNELL, who exhibits No. 526. 'A Harvest Sunset,' but a comparison of the two works will award the preference to the production of the junior. It is a common passage of cultivated country which may be found in any part of England—the foreground may have been broken up. It is full of descriptive parts, but broad withal and charming in colour. There is however a field, a division, by the way, in some degree inharmonious as to colour with the rest—a square green patch on the left, but whether it is a field of turnips or a nursery of young trees it is difficult to determine, notwithstanding the difference between a turnip and a tree.

No. 504. 'Lient-Col. Hamley, Capt. R.A. Author of the "Story of a Campaign of Sebastopol, written from the Camp,"' SIR J. W. GORDON, R.A. We are weary of the monotony of praise exacted from us by this eminent painter; no terms can do justice to the living expression of these features.

No. 506. 'Going to be Fed,' R. ANSELL and J. PHILLIP. The materials of this composition are common-place; but the life of the figure and the eagerness of the dogs are full of natural truth. The scene is a section of Highland landscape, and the figure is that of a buxom Highland maiden, attended by three setters in expectation of their dinner. The point of the subject is instantly apparent.

No. 508. 'The Triumph of Music,' F. LEIGHTON. This is a large picture painted by the artist who exhibited the Cimabue procession last year; but we cannot describe the difference of these two works more distinctly than by saying that the last year's work, as is well known, was full of exquisite quality, while the present picture is so entirely a failure as to be utterly deficient in the brilliant and striking excellence of the other. Pluto and Proserpine, two very repulsive figures, are seated on the left, an Orpheus—an extremely ill-conceived mythological Egeanini playing the violin—is the prominent character; but enough; never was disappointment greater. We need scarcely say the subject is the visit of Orpheus to Hades to recover Eurydice.

No. 513. 'The Sisters,' L. W. DESANGES. These figures are portraits of the size of life. The heads are natural in colour and agreeable in expression.

No. 515. 'View on the Banks of the Thames at Maidenhead,' J. D. HARDING. This passage of river scenery has been selected with a fine feeling for composition. All that is seen of the river looks almost like a pool shut in by banks and trees; the character of the view is peculiarly English. In mellow and harmonious colour, and facile execution, the work everywhere indicates the hand and taste of a master.

No. 516. 'Andrew Marvell returning the Bribe,' H. WALLIS. Here is embodied the well-known anecdote of Andrew Marvell, on the occasion of the visit of the Lord Treasurer Danby to Marvell's humble home with a draft for one thousand pounds, in the hope of attaching Marvell to the side of the Ministry. In declining the offer of the Lord Treasurer, Marvell summoned his *chef-de-cuisine*—butler, housemaid, valet, housekeeper, his *omnia in uno*—a gruff and awkward lad, from whose replies to an inquisitorial examination by Marvell for the edification of the Treasurer, it was elicited that the provision of the two for many days was a shoulder of mutton, first roast, then cold, then hashed, then the blade-bone grilled, then cold again—*bis terque coctum*. Marvell returned the bribe with an assurance that his dinner was provided. It is a good

subject; the incorruptible member of the opposition returns the draft, and the Lord Treasurer is preparing to depart. In the drawing, painting, and lighting of these two figures there are shown knowledge and profitable study. The work is of very high merit—sufficient, indeed, to establish a reputation; although we cannot help regretting that the artist has made the patriot so "trimly dressed" as to convey an idea of wealth rather than penury.

No. 518. 'The Tiber, with the Church of St. Andrew the Apostle (and the Vatican),' W. LANTON. The cold severity of tone which has characterised the works of this artist is here relaxed in favour of a more agreeable play of colour and suavity of manner. It is a view from a particular point on the banks of the river near Rome which gives the stream dividing the composition from the horizon to the base of the picture, and showing St. Peter's at the distant extremity. It is the most agreeable of the works that have appeared of late years under this name.

No. 525. 'A. Gillow, Esq. of Wallhouse, Linlithgowshire,' S. PEARCE. The figure is erect, carrying a fowling-piece on the right shoulder; the head and features at once challenge observation.

No. 526. 'A Harvest Sunset,' J. LINNELL. We have alluded to this composition in speaking of an antecedent work. It is a view similar to those which may be obtained in some parts of the banks of the Thames below Gravesend, looking across the river at the distant opposite shore—the foreground being a harvest field, with a road going into the picture, and other auxiliaries of composition. The proposed point of the work is the sunset, the sun being a little above the horizon; but it will be felt that the force of this effect is much injured by the nearer sites of the picture being broken up; there is no repose, no rest for the eye. It is a work of great power, but not so successful as recent productions by the same hand.

No. 528. 'The Church of St. Pierre, Caen,' L. J. WOOD. A subject very often painted, but never more jealously imitated in all details than we see it here.

No. 531. 'On the Mole,' J. STARK. The idle sedgy Mole has afforded of late many landscapes: this is really one of the sweetest of the productions of this veteran tree-painter, whose enthusiasm for oaks amounts to a Druidical veneration.

No. 532. 'The Prosperous Days of Job,' C. T. DOBSON. We are grateful to the author of this production for showing us Job other than a ruined and heart-broken old man. The composition is suggested by the 19th chapter—"Oh that I were as in months past, as in the days when God preserved me; as I was in the days of my youth . . . I was a father to the poor; and the cause which I knew not I searched out." We find him here in his youth visiting the sick and administering consolation to the afflicted. The appeal of the poor is addressed to him in confidence of relief. The work is beautiful in colour; but we have one strong feeling with respect to it; which is, that the object of the artist being brilliancy of effect, all the draperies are painted up to a newness and perfection of condition which is inconsistent with poverty and distress.

No. 533. 'Doubtful Fortune,' A. SOLOMON. Rather a large composition, containing impersonations of three young ladies: one of whom augurs, by means of cards, of the destinies of the other two. The figures are graceful and natural, not characterised by that mistaken refinement which paints angels instead of women.

No. 535. 'A Gipsy Water-Carrier of

Seville,' J. PHILLIP. A life-sized study—that of a woman with her water jars, apparently about to fill them—she is as dark as a Moor, but we presume there is authority for such a complexion.

No. 541. ' * * *,' D. ROBERTS, R.A.
"And basking on each sunny promontory,
Sleeps some old temple in its silent glory."

A long, upright picture, composed from fragments of architectural remains in Greece. It is a solitude of grand and poetic character—typifying by its ruins that wondrous magnificence which is now only historical.

No. 542. 'Market Day,' G. B. O'NEILL. Rather a large picture, representing the bustle of a market day in a country town; the subject and the qualities of the execution scarcely fit for the line.

No. 543. 'Toothache in the Middle Ages,' H. S. MARKS. A small picture containing one figure, that of a man halibited in the fashion of the time of Richard II. The title and the pose of the figure savour too much of caricature.

No. 551. 'Highland Shepherd,' R. ANSELL. He is out on the lull, which is covered with snow, having been looking after the kubs, one of which, half frozen, he is carrying home, its mother following; an incident in pastoral life which is narrated with truthful simplicity.

No. 552. 'Monument to Batteone—S. S. Giovanni e Paolo, Venice,' D. ROBERTS, R.A. In this picture the water is lustrous and much more agreeably painted than in the Grand Canal picture. The buildings look perhaps more important than in the reality, but no other painter could have dealt so successfully with such a subject.

No. 553. 'L'Enfant du Regiment,' J. E. MILLAIS, A. This is most pleasing work this painter exhibits; it is simple of interpretation, being entirely devoid of all mystic and maudlin signification. This child of the regiment is a little boy who has been wounded in the hand in some street skirmish, perhaps in Paris; his wound has been dressed, and, having been laid in the tomb of an ancient warrior, has fallen asleep covered with the coat of a grenadier.

No. 556. 'The May Queen,' an episode from Tennyson's Poem, Mrs. E. M. WARD. A very sparkling picture, in which the effect of light is extremely difficult to paint. The May Queen is dressing near the window, while her mother is preparing some part of her attire. We cannot praise too highly the breadth of light, and the manner of its introduction into the picture. It is, indeed, a very charming work.

No. 559. 'The Pet's Pet,' J. SANT. A portrait, that of the "Pet" and also of her dog, a child accompanied by her dog circumstanced in a piece of sylvan composition. Not so brilliant a performance as other examples of youthful portraiture by this painter.

No. 562. ' * * *,' H. C. SELOUS. The subject of this picture is the scene between Othello and Emilia in the bedchamber of Desdemona—

"Emil. O, who hath done this deed
Des. Nobody. I myself. Farewell: commend me
to my kind lord. O! Farewell," &c.

Desdemona is seen lying on the bed, Othello stands near, and Emilia kneels by the bedside of Desdemona. The pose and expression of Othello are admirably conceived, but Emilia is, in comparison, feeble.

No. 563. 'Landscape and Cattle,' F. R. LEE, R.A., and T. S. COOPER, A. In this picture both artists excel their individual works. It is a large composition, like others that they have painted in conjunction, consisting of cattle, water, trees, and glimpses of distance.

No. 565. 'Denizens of the Tweed,' H. L. ROLFE. Two grise and a trout rendered in the closest imitation of nature.

No. 568. 'The Measure for the Wedding Ring,' M. F. HALLIDAY. This is a so-called pre-Raffaellite work containing two figures, those of lovers seated on a garden-bench within the ruins of an ancient abbey. The lady has been working, and the gentleman reading poetry, but he is now measuring her finger for the ring. It appears to be one of the first errors of pre-Raffaellite Art to reject the beautiful in feature and expression. The lady appears to have an obliquity of vision, and the contour of her face is anything but agreeable. The dress of both figures is severely accurate, but the ruins by no means resemble such a reality.

No. 575. 'After a Day's Sport in the Highlands,' G. W. HORLOR. An animal composition, presenting a rough pony, some dogs, and dead game. Very satisfactory in execution and arrangement.

No. 576. 'Bianca,' F. S. CARY. This is proposed as the Bianca of 'The Taming of the Shrew.' She is seated with her back turned towards the spectator, a daring experiment, but the model has been most profitably studied.

No. 579. '***,' G. LANCE.

"—Fruit of all kinds, in coat
Rough or smooth rind, or bearded husk or shell."

The fruit here is not set forth in that gorgeous display which gives to these compositions the air of a regal banquet; it is a less formal arrangement, but all painted with equal freshness and beauty.

No. 580. 'The Infant School in a Country Church during Morning Service,' R. M'INNES. Many of these children, especially the heads, are imitatively painted; but the linear disposition of the heads and feet is objectionable.

No. 583. 'Chioggian Fishing Vessels, &c., running into the Lagoon of Venice on the approach of a borasoe or violent squall on the Adriatic,' E. W. COOKE, A. A large picture, showing principally a fishing boat making for Venice. We have observed lately that the seas of this painter have become very sketchy; this is markedly exemplified here; the waves want roundness—volume.

No. 585. 'The Birth of Edward VI. and the Death of his Mother, Jane Seymour,' E. DEVEREA. This is an example of the French school, remarkable for many excellent qualities, but especially for the judicious manner in which the light is managed. The principal light falls where it ought, that is on the dying queen, but it is not felt to be at all forced. We must also remark the skilful and abundant use made of draperies.

No. 586. 'The Blind Girl,' J. E. MILLAIS, A. She is seated at the roadside with her sister who leads her. The background is a field rising in gentle acclivity, but the colour is most unnatural.

No. 587. 'Byron's Early Love,' E. M. WARD, R.A. Here we observe Byron looking in at a window at Annesley Hall, where he sees Mary Chaworth dancing with her betrothed. The two lights, that of the moon outside and the blaze of candles within, are expressed with much felicity. But the head is not sufficiently an identity; the features of Byron are so well known.

No. 591. 'The Village School,' A. RANKLEY. Very unmassingly rendered, and containing nothing beyond the probability.

No. 592. 'Highland Mary,' T. FAED. This is Burns' Highland Mary, who is to be supposed as resting by the roadside on her way to visit her parents in the West Highlands. The head is an exquisite study, the

features being made out with the utmost tenderness of touch.

No. 593. 'The Browzer's Holla,' R. ANSDALL. The incident described here is perhaps common where large herds of tame deer are kept. The park keeper calls the herd up to be fed, and they answer to the call in troops. The deer, their keeper, and especially a huge mastiff, are brought forward with the usual spirit of the painter.

No. 594. 'The Viscountess Lifford,' C. SMITH. The lady stands in a garden, her right hand resting on a chair. The economy of the picture is of the simplest kind; but in the figure there is a graceful simplicity highly attractive.

No. 597. 'The Arrest of John Brown of Ashford, a Lollard, and one of the first Martyrs in the early part of Henry VIII's reign,' A. JOHNSTON. A passage in D'Aubigné's "History of the Reformation" has suggested this subject. The Lollard, his wife, and their friends are surprised at table by the entrance of the constable with armed attendants, who seize Brown. His family and friends are in the utmost consternation; some prepare for resistance, but others counsel peace. The mild astonishment of the Lollard contrasted with the savage bearing of the constable is deeply impressive, and the action and expression of all present assist materially in the development of the story.

No. 600. 'The Soldier's Wife,' W. S. HENATEK. The subject of this work is found in Darwin's *Eliza*—

"Now stood Eliza on the wood-crown'd height,
O'er Munden's plain, spectatress of the fight," &c.

And it is interpreted by a female figure carrying an infant and holding by the hand a little boy as anxiously gazing at the combat which is raging in the plain beneath her. It is sufficiently clear that she is watching the fate of her husband. In the manner of this work there is something of the tone of a by-gone school.

No. 604. 'Leap Frog,' F. UNDERHILL. An assemblage of rustic youth at the outskirts of their village. In their gambols there is more of truth than grace.

No. 610. 'The Heir cast out of the Vineyard,' W. C. THOMAS. "But when the husbandmen saw the son they said among themselves, This is the heir, come, let us kill him, and let us seize on his inheritance. And they caught him, and cast him out of the vineyard, and slew him." We see accordingly the Saviour driven forth, followed by a crowd who scourge and insult him. The spirit of parable is sustained in an allusion to the crucifixion by the appearance of the cross in the tumultuous procession. One remarkable figure, on the right, stoops to cut a thorn wherewith to beat Christ. The mediæval costume of this figure is discordant with that simplicity which should characterise the more loosely draped attire of impersonations in religious composition.

No. 611. 'The Fern Cutter,' J. A. STAUNTON. A small study of a girl resting by the way side with a basket of fern at her back. The landscape portion of the picture is perhaps more meritorious than the figure.

No. 613. 'The Watchers,' T. EARL. These are a dog and a little girl in a cottage watching the cradle of a sleeping child. The gradations of light—the depth and repose of this very common-place subject, are worthy of all praise.

No. 614. 'William P. Barrow, naval cadet, H.M. steam frigate "Odin," the youngest son of Sir George Barrow, Bart.,' S. PEARCE. A small portrait, in which the young gentleman appears leaning over a rail barrier. The figure tells effectively in opposition to the clear sky and sea background.

No. 615. 'Mary Magdalene at the Sepulchre,' H. LE JEUNE. The principal figure here is that of the Saviour standing behind Mary Magdalene as she looks into the sepulchre. There is a spirituality in the work which accords with the text, but the figure of Christ is gigantic, and for such a figure the head is too small.

No. 617. 'Mrs. Landseer,' G. LANDSEER. The lady is seated, the head being presented in profile. She holds before her a Skye terrier, and a greyhound and King Charles assist the agroupment. The portrait is executed with taste and judgment.

No. 618. 'Richard and Kate,' F. D. HARRY. The subject is from Bloomfield:—

"Come, Goody, stop your humdrum wheel,
Sweep up your axis, and get your hat,
Old joys reviv'd once more I feel,
'Tis fair day:—aye, and more than that."

It is, although a subject of the humblest pretension, rendered interesting by the exquisite painting by which the figures and all the items of the interior are realised.

In the NORTH ROOM, and hung with the architecture, are some works to which a better place might have been accorded, the more especially as we see inferior productions exhibited in better places; we have space only for the titles and names of the painters. No. 1051. 'The Kiosk,' F. WYBURD; No. 1097. 'The Madness of Ghaucus,' A. F. PATTEN; No. 1100. 'Frederick Soames, Esq., Mrs. Soames and child looking out for the homeward-bound East Indian,' J. THOMPSON; No. 1130. 'The Mill Pool,' J. DEARLE; No. 1185. 'The Haunt of the Moor-hen,' H. J. BODDINGTON; No. 1186. 'The Sunny Hours of Childhood,' J. THOMPSON; No. 1188. 'A Morning Call,' A. B. CLAY; No. 1191. 'Sweet Summer-time,' T. F. MARSHALL; No. 1193. 'Elijah running before the chariot of Ahab, at the time of the rain after the three years' drought,' J. T. LINNELL; No. 1194. 'Frank, son of Richard Hemming, Esq.,' C. BAXTER; No. 1195. 'At Ghent,' A. MONTAGUE; No. 1198. 'Llyn Dinas, North Wales; early morning,' A. W. WILLIAMS; No. 1201. 'Sunshine and Showers,' H. JUTSUM; No. 1204. 'On the Dart, near Backfast Abbey, Devon,' H. MOORE; No. 1205. 'The Frozen Brook, evening,' G. A. WILLIAMS; No. 1207. 'Sunday Morning,' J. DEARLE; No. 1208. 'Gny Fawkes' Day,' T. BROOKS; No. 1209. 'The Lesson of Mercy,' W. J. GRANT; No. 1211. 'J. T. Willmore, Esq., A. E.,' T. J. HUGHES; No. 1214. 'Summer's Eve,' M. ANTHONY; No. 1216. 'The Woods in Summer, Sussex,' A. J. LEWIS; No. 1218. 'A Monastery Garden at Pella, in Piedmont,' G. E. HERING. We cannot quit this room without especially noticing the injustice done to the picture in three compartments, No. 1190. 'The Eve of St. Agnes,' by A. HUGHES; it is exaggerated in colour, but a production of much greater merit than a hundred others that have good positions in the three best rooms.

MINIATURES AND DRAWINGS.

The miniatures and drawings are, as usual, very numerous, but among the former, there are not this year any works of transcendent power and beauty, although many productions of very great excellence. We have already noted the gradual advance of chalk and crayon drawing; we think the taste for chalk portraiture is increasing, as we observe so many remarkable examples in this genre. Of the miniatures, SIR W. ROSS, R.A., exhibits No. 763, a head and bust miniature of the 'Princess Mary of Cambridge'; this portrait is painted for the Queen, and presents an unmistakable resemblance of the princess; also, No. 765, 'H.R.H. the Duchess

d'Aumale, the Prince de Condé, and the Duke de Guise, a family group, showing the Duchess holding the Duke de Guise, an infant, on her knee, and the Prince de Condé by her side; the Duke de Guise is a most successful study, but perhaps the best miniature exhibited by Sir W. Ross is No. 779, 'Mrs. Thomas Miller and Child'; the background is tranquil, and composed in a manner to assist the group and force the brilliancy of the colour; by this artist there are, also, No. 764, 'Miss Grant,' and No. 785, the 'Rev. Charles Plumer,' &c. By R. THORBURN, A., we have No. 782, 'The Viscountess Elcho,' a full-length figure in an elaborately painted Highland Landscape; it is graceful, but the eyes are certainly too large; No. 744, 'Mrs. Dunn Gardiner,' shows the lady grouped with her infant; she is seated beneath an orange tree in an Italian landscape; the feeling of this miniature will remind the spectator of one of Raffaele's Madonnas, the imitation of which, in portraiture, is an instance of singularly bad taste; No. 775, 'Portrait of a Lady,' is a full-length figure in a moiré antique dress, a brilliant and most agreeable performance. No. 751, 'Miss Cushman,' by T. CARRICK, is distinguished by that remarkable identity which this artist always secures in his works; No. 778, 'John Clayton, Esq.,' is perhaps the best of his masculine portraits; the features are animated and full of agreeable expression; No. 826, 'William Pulford, Esq.,' is also a most successful example of masculine portraiture; No. 673, 'Major Hepburn,' by Sir W. J. NEWTON, although a portrait on paper, is one of the most satisfactory we have ever seen by its author, who exhibits also Nos. 851 and 852, 'Colonel Wilson' and 'Mrs. Wilson,' and others of great merit; No. 707, 'Portrait,' J. FISHER, that of a gentleman, is a charming work; No. 712, 'Arthur, youngest son of Charles Baring Young, Esq.,' Mrs. J. H. CARTER, is a most attractive example of youthful portraiture; No. 663, 'The late Earl of Belfast,' Miss LA MONTE, is a pleasing and effective miniature; No. 607, 'Mrs. George H. Virtue,' Miss E. WEIGALL, is brilliant in tint and most conscientiously worked out, and also Nos. 664 and 666, 'Miss Mortimer,' and 'Mrs. Talbot Baker,' Miss C. G. F. KETTLE, are distinguished by excellent quality; No. 723, 'The Right Hon. Lord Suffield,' E. MOIRA, is a full-length figure, of which the head and features are very effectively drawn and worked out; No. 747, 'Mrs. John Watson,' H. T. WELLS, is remarkable for masterly drawing and purity of colour; but the background in some degree distracts the eye; No. 761, 'Gordon, son of William J. H. Money, Esq.,' is a gem of extraordinary brilliancy, and No. 795, 'The Hon. George Bennett, and the Hon. Frederick Bennett, sons of Viscount and Lady Olivia Ossulston, are also admirable examples of youthful portraiture; No. 793, 'Bobby,' R. CLOTHER, is defective in drawing, but harmonious in colour; No. 784, 'Miss Grover,' Mrs. DALTON, a head and bust, very delicate in manipulation; No. 728, 'Mrs. Heber Percy, C. COUZENS, is a production of exquisite taste and masterly power; No. 820, 'Col. H. G. Wilkinson, Scotch Fusilier Guards,' H. WEIGALL, JUN., is extremely beautiful in execution and life-like in expression. There are also distinguished by varieties of valuable quality, No. 801, 'E. Court Haynes, Esq.,' E. D. SMITH; No. 796, 'The Lady Hermione Graham,' C. COUZENS; Nos. 839 and 840, 'Lady Adine Cowper,' and the 'Right Hon. Lord Auckland,' Miss WEIGALL; No. 732, 'Mrs. Dunbar,' W. EGBLEY; No. 740, 'Lady Jane Levett,' H. WEIGALL, JUN.; No. 720, 'Lieut.-General Mansfield,' is a

drawing by R. CHOLMONDELEY, of much merit; No. 743, 'Miss Beamish, daughter of J. C. Beamish, Esq., Plymouth,' F. TALFOURD, is a head of a young lady extremely effective; No. 766, 'Miss Blanche Heber Percy,' R. CHOLMONDELEY, is a profile head of a child, exquisitely sweet in expression; No. 774, 'Fluffy,' daughter of W. Eastlake, Esq., Plymouth, a very characteristic and effective head of a child; No. 773, 'Dr. Neil Arnott, M.D., F.R.S.' Mrs. W. CARPENTER, a head admirably lighted for study and extremely well drawn. Of high merit are also No. 822, 'Lady Troubridge,' J. HARRISON, and No. 823, 'The Lady Mary Yorke,' J. HAYTER; No. 918, 'Mrs. Lunley,' by J. C. MOORE, is a water-colour portrait on paper, a charming figure, simply attired in white, beautiful in colour, but the line under the cheek is too severely dark; No. 962, 'Miss C. Dumaresque,' by the same artist, is a most agreeable portrait; No. 971 is also a highly interesting production. In this room is a variety of remarkable pictures in different departments of Art, of which is it our duty to speak, even at length, had we space, but the extent to which we have felt it necessary to carry our notice of the works in the principal rooms of the exhibition, compels us to limit ourselves to a selection of the titles of some of these, and the names of the artists. No. 623, 'S. T. Partridge, Esq., M.D.,' Miss E. PARTRIDGE; No. 625, 'The Island of Philæ, above the first cataract of the Nile, from the south, afternoon,' E. LEAR; No. 629, 'Enamel of the Holy Family, painted from the original picture by Raffaele, in the Earl of Ellesmere's collection,' W. ESSEX; No. 630, 'Model for the reverse of a medal now being executed for the Madras Exhibition,' B. WYON; No. 633, 'Mrs. James Brotherton, enamel from life,' J. HASLEM; No. 639, 'Study from Life, enamelled on porcelain,' W. FORD; No. 652, 'Isabella Ker Gordon, after Sir Joshua Reynolds, enamelled on porcelain,' W. FORD; No. 690, 'Miss Spelling,' J. HARRISON; No. 616, 'The Hon. Theodosia Vyner,' J. HAYTER; No. 717, 'Portrait of Mrs. E. A.,' E. ARMITAGE; No. 755, 'Interior of a Kentish Cottage,' D. W. DEANE; No. 818, 'The Old Hostelry Yard, Fair Day,' W. J. P. HENDERSON; No. 856, 'The Avenue to the Mill on the Avon, Brent, Devonshire,' J. GENDALL; No. 863, 'Grand Canal, Venice,' after J. M. W. TURNER, R. A.; J. T. WILLMORE, A.E.; No. 866, 'Her Highness the Duchess of Hamilton, after Buckner,' (not published), R. J. LANE, A. E.; No. 867, 'Viscountess Goderich, after Millais,' (not published), R. J. LANE, A. E.; No. 869, 'St. Luke painting the Virgin, from the original painting by Steuble, in Her Majesty's collection,' L. STOCKS, A. E.; No. 873, 'View from the Mount of Offence, looking towards the Dead Sea and the Mountains of Moab, morning,' W. H. HUNT; No. 880, 'The Bottom of the Ravine at Inkermann, from a sketch taken on the spot four months after the battle,' E. ARMITAGE; No. 881, 'The Good Shepherd,' W. DYCE; No. 883, 'Portrait of a Lady,' T. SENTIES; No. 895, 'Interior of a Deewan, painted on the spot,' T. B. SEDDON; No. 914, 'Off the Calif, Isle of Man,' W. E. BATES; No. 917, 'Daughters of the Hon. Gerald Talbot,' J. GLEBERT; No. 943, 'Welsh Peasants,' E. J. COBBETT; No. 948, 'Judith,' W. F. WOODINGTON; No. 951, 'A Triton,' T. DALZIEL; No. 944, 'Evening on the Nile,' F. DILLON; No. 989, 'The Shepherd's Sabbath Evening,' A. W. WILLIAMS; No. 1001, 'Autumn Fruit,' Mrs. V. BARTHOLOMEW; No. 1002, 'The Sphinx, Gizeh, looking towards the Pyramids of Sakhara,' W. H. HUNT, &c., &c.

THE ROYAL PICTURES.

THE VISIT TO THE NUN.

Sir C. L. Eastlake, P.R.A., Painter. S. Smith, Engraver.
Size of the Picture, 2 ft. 3½ in. by 1 ft. 5½ in.

Mrs. JAMESON in the introduction to her volume, "Legends of the Madonna," has truly and beautifully remarked:—"A picture or any other work of Art is worth nothing except in so far as it has emanated from mind, and is addressed to mind. It should, indeed, be read like a book. Pictures, as it has been well said, are the books of the unlettered, but then we must at least understand the language in which they are written. And further,—if in the old times it was a species of idolatry to regard these beautiful representations as endued with a specific sanctity and power; so, in these days, it is a sort of atheism to look upon them reckless of their significance, regardless of the influences through which they were produced, without acknowledgment of the mind which called them into being, without reference to the intention of the artist in his own creation."

Now, whatever the purpose of Sir Charles Eastlake may have been in this touching and most beautiful composition, we have no idea he had any intention of putting it forth as an argument in favour of monastic life—a life, we are so heterodox as to believe, altogether opposed to the doctrines of the Divine Founder of the Christian faith and his immediate followers, who taught us "to see the world without abusing it," and to "let our light so shine before all men, that they may see our good works." But we are not about to preach a homily on the conventional system, and perhaps should not have referred to it at all if the picture did not seem to invite the observation. We read it, however, in a way far from favourable to monasticism. The visitors to the Nun, we presume to be a married sister and her two children—there is also, it may be inferred, another visitor not introduced into the picture, but who has some interest in the visit. The married sister is evidently urging upon the attention of the recluse some topic to which she listens with emotion, though her head half-turned away, and her downcast eyes, show but little inclination to yield to the argument, whatever that may be. The elder of the children is, in the expression of her look, a silent pleader in the same cause, while the younger child holds up a small vase of wild flowers, as if to indicate how much there is in a world beyond the dreary walls of the convent from the enjoyment of which, we less than from the sacred lessons all the works of nature teach us, the Nun has voluntarily excluded herself. These are the principal characters in the story; but there are others bearing a part in it. The old nun to the right is closing the door against some unseen individual—certainly not the father confessor; possibly—though not with much probability, considering that such a visitor could scarcely have penetrated so far into the convent, unless by the influence of bribery—one who feels special interest in the young recluse who has "put lover, friend, and acquaintance out of her sight." Another nun perambulates the cloisters in the distance, engaged in the perusal of some devout book; and above her head is a pair of birds in joyous liberty, suggesting the idea of that liberty which is denied to the inmates of the institution. The fresco picture on the wall represents the scriptural story of Mary and Martha; and on the table is an hour-glass with its sands almost run out, indicating that the time of separation is at hand.

This picture, which was exhibited at the Royal Academy in 1846, is rich in feeling and sentiment exquisitely expressed—a "subject lighted up with that sacred effulgence for which the old masters devoutly prayed, and with which they were endowed, according to their adoration of their art."

The colouring and execution of the painting are in harmony with the deep purpose of the narrative it describes; the picture is undoubtedly one of the President's most charming works. It is in the collection at Osborne.



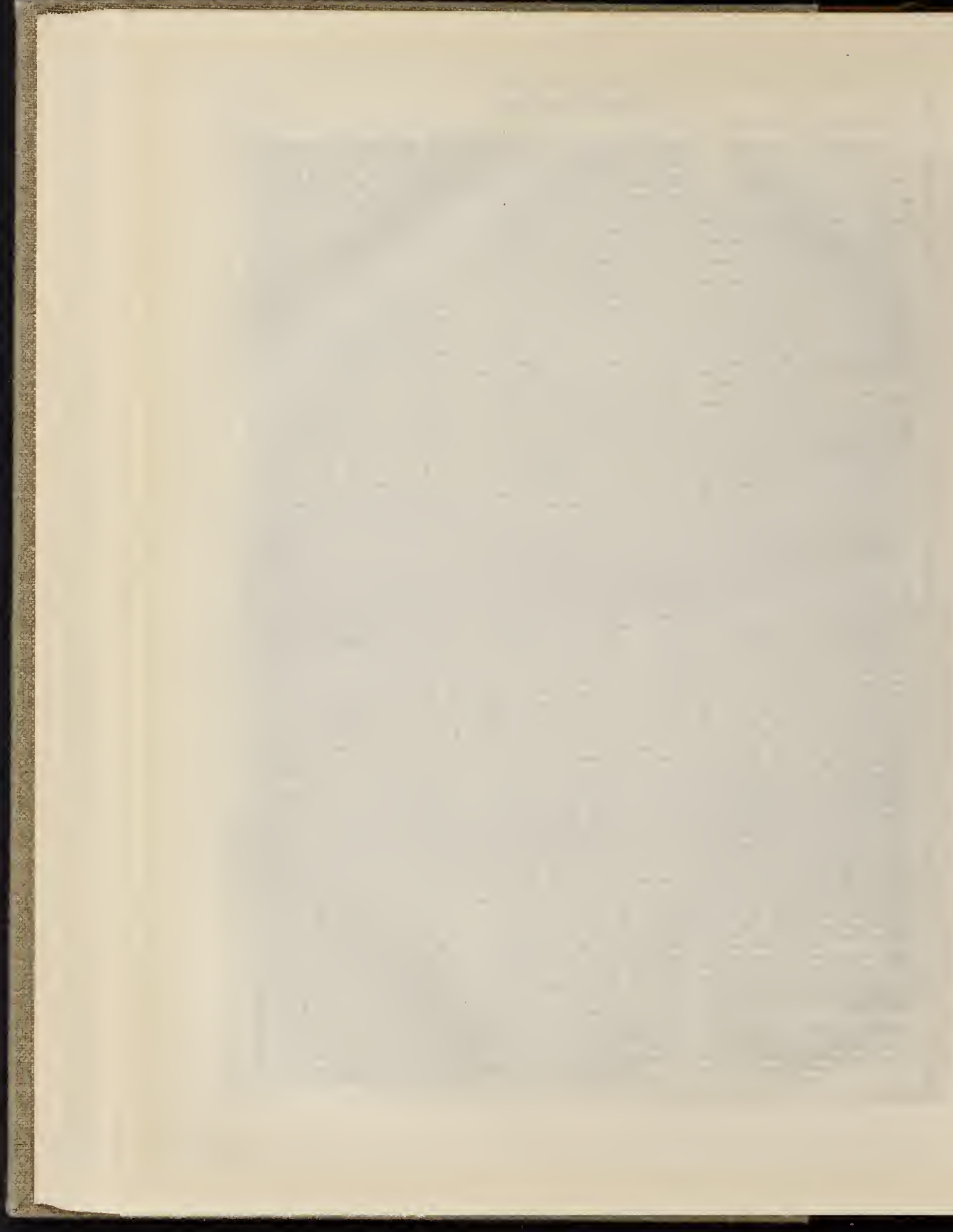



THE VIEW TO THE NUT

FROM THE HOUSE IN THE ROAD COLLECTION

314 - 1847 - 1848 - 1849

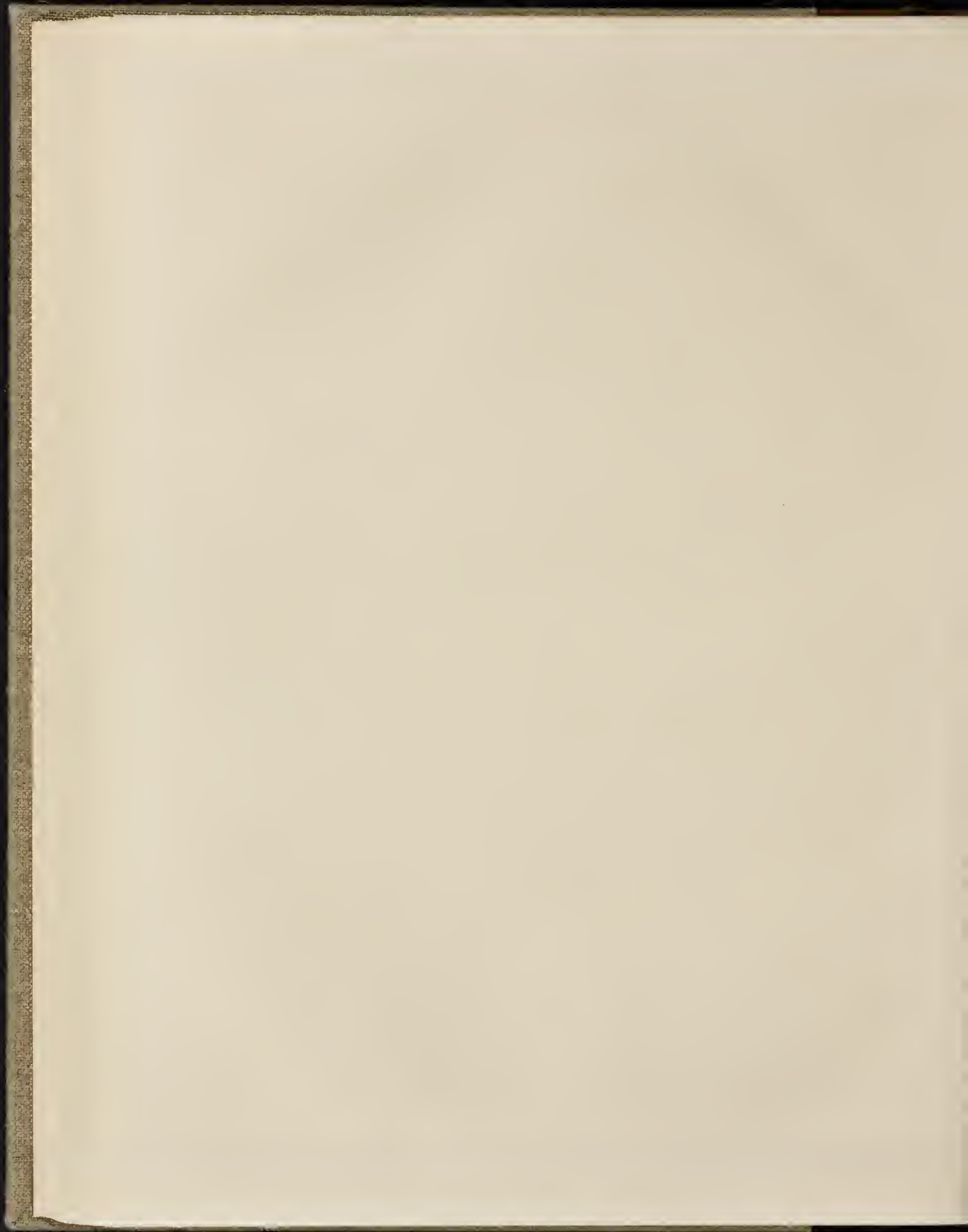

THE EXHIBITION OF
THE SOCIETY OF PAINTERS IN
WATER-COLOURS.

THE present exhibition presents a higher degree of uniform excellence than we have seen on these walls for some years past. The society is fortunate in numbering among its members figure-painters of power, originality, and great diversity of talent. We find resuscitated into effective activity men who seemed to be forgotten, because of late years they have made no sign; we are most happy to assist at the celebration of their revival. Of the landscape and genre art we need not speak; the former, especially, has always been of the rarest excellence. Perhaps the most substantial proof that can be offered of the public estimation of the collection is, that it was soon after the opening of the exhibition nearly all sold. Many of the smaller figure-pictures are of such excellence as to induce the wish that they were large instead of small. There are but few works now to remind us of the older school of water-colour; yet there are some; and among these the works of David Cox are the most notable: he is the father of this section of the profession: he has resolutely passed the last half century of his sketching seasons at Bottes-y-Coed, eschewing all innovations of colour and the meretricious scenery of sunny Italy. But we hold a catalogue of three hundred works;—turn we, therefore, to No. 3, 'The Vale of Dolwyddelan, North Wales,' by D. COX, Jun., in which we observe that in carrying out the principle of materiality—in communicating substance to the objects of the composition—all atmosphere is lost; so that the more distant hills look on the same plane as the nearer ones: it is a wild and romantic subject, with much of the impress of reality. No. 4, 'Before Sunrise, Loch Torridon, Ross-shire,' W. TURNER, is a drawing that reminds us of the works of the late G. Robson; the ferns and herbage in the foreground are worked up with the greatest nicety; the sky, distant mountains, and lakes, are painted in cool tones appropriate to the hour of the day. No. 9 is a life-sized head, that of a 'Sabbath Peasant Woman' by CARL HAAO, very rich in colour, rustic and natural, without any of the attributed refinement which is erroneously communicated to studies of Italian peasantry. This artist introduces the novelty of painting life-sized heads in water-colour. No. 10, 'Composition—Sicily,' T. M. RICHARDSON. A large drawing and although entitled a "Composition," it has all the reality of a veritable locality. A village, from which a group of peasants is passing out, is on the right; a rapid stream running down the centre of the picture, a range of lofty broken hills to the left, and an elevated eminence crowned with a castle, in the rear, are the materials of the subject: all are characterised by great richness and truth of colour. No. 13 is the solitary 'Capri,' W. EVANS, which, seen from any point, can never be mistaken: it seems here, however, to be represented too near the mainland. 'Oyster Dredging off the Mumbles Head, South Wales,' by E. DUNCAN, is a work of great merit; the movement of the water, and the swing of the boats, are strikingly true, and equally faithful are the sky and the aerial medium; in short, the picture throughout leaves nothing to be desired. No. 20 is a very elaborate study of stones within high-water mark; the drawing, by J. P. NAFFEL, is catalogued as 'Collecting Vraic on one of the natural Breakwaters thrown up by the heavy seas from the Atlantic, Guernsey.' It is extremely successful—but, after all, this kind of thing is very mechanical. FREDERICK PAXLER exhibits No. 23, a striking composition, 'Huntsman's Boy and Bloodhounds.' There are two couples of these animals, and nothing can be more naturally true than the points of the species as here prominently shown: the heavy stupid head, awkward limbs, and ill-proportioned body are identical with the reality. It is a fine drawing, devoid of all vulgarity of treatment. No. 24, 'Italian Peasant Woman,' A. FRIPP. A charming little story, elegantly drawn, and in a low tone of colour. No. 27,

'A Dutch East-Indiaman hove down,' by G. H. ANDREWS, shows the large hull of the vessel in shallow water in the middle of the composition: it is an ordinary and simple manner of bringing forward any large object, but the composition is very elaborately carried out; the right hand section is full of appropriate material, which, we think, in some degree detracts from the importance of the ship. 'Flowers,' V. BARTHOLOMEW, numbered 30, is a charming bouquet of azaleas, tulips, and roses. No. 33, 'Richmond Castle, Yorkshire—Sunset,' G. FRIPP, is a production of a high degree of merit. No. 34, 'Land's End, Cornwall,' G. FRIPP. The sketch is taken from a ledge of rock to the right of the promontory: the water is coldly painted, but we have rarely seen the long "sweep" of the wave as it rushes on the rocks more effectively represented. No. 37, 'The Standard Bearer,' JOHN GILBERT, is a figure that would have graced the royal cause at Marston Moor or Worcester; it is masterly in character and colour, and enfeebled by no *petitese* or quaint conceit: the figure reminds us strongly of one Diego Velasquez—that figure more cavalier than painter, groning with Vandyke, Rubens, Rembrandt, and Jordaens in the portrait collection at Florence. No. 38, 'Hay-making—Priory Park, Reigate,' E. DAVIDSON, is extremely agreeable, as having much of the spirit and freshness of nature, and being entirely free from affectation. No. 42, 'SUN FISH, Lynton, North Devon,' W. C. SMITH, is one of the picturesque pools on the Lynton, closed in by rocks and trees: the subject is well chosen, and receives justice in its treatment; the water especially is well painted, being much more transparent than we usually see it in this department of art. No. 46, 'The Hotel de Ville, Brussels,' W. CALLOW, is an oblique view of the facade, to which the artist gives the appearance of great length by introducing some of the adjoining houses: the details of the architecture are very scrupulously made out. No. 47, 'A Mountain Stream, Glen Nevis, Invernesshire,' T. M. RICHARDSON. This, like the other work by the artist, which we have just noticed, is also a large drawing; it contains an abundance of the material peculiar to the Highlands, brought forward with a due appreciation of its characteristics. No. 51, 'Feeding the Chickens,' WALTER GOODALL. This, and two other drawings by the same hand, No. 63, 'The Grandfather's Visit,' and No. 118, 'The Shrimpers,' show that Mr. Goodall is on the high road to excellence: he studies nature closely, is careful in execution, and judicious in the use of his pigments: we should be better satisfied, however, with a little more transparency: he has at present too great a tendency to heaviness. No. 52, 'The Evening Gun at Castle Cornet, Guernsey,' J. P. NAFFEL, is, we think, the best drawing that has been exhibited under this name. Instead of a title to No. 60—a large drawing by W. C. SMITH—the catalogue supplies a quotation from Byron:—

"Clear, placid Leman I thy contrasted lake,
With the wide world I dwellt in, is a thing
Which warns me with its stillness to forsake
Earth's troubled waters for a purer spring," &c.

The view is that which comprehends with the castle of Chillon a large extent of the shores of the lake, closed by the snowy peaks of the Alps. Chillon is too much insisted on as a point—it were better that the eye should seek Chillon than that Chillon should importune the eye, because, as a prominent spot in the composition, it becomes but a speck in comparison with the mountainous masses by which it is dominated; the general treatment however of the subject communicates to it a considerable degree of grandeur. No. 67, 'Porta Nigra, at Treves,' by J. BURGESS, Junr., represents an architectural relic of great interest, to which is communicated, from the manner of the drawing, a palpability of substance and reality. No. 68, E. DUNCAN, is a broad, bright, daylight drawing, showing Spithead, with part of the Fleet, from Ryde Sands, with, curiously enough, a sheep episode in the foreground. The floating castles are lying in perfect tranquillity between the spectator and the mainland—but *revocons à nos moutons*, the poor animals are landed from boats, and look scared at the novelty of their position. No. 69,

'Close Gate and Widows' College, Salisbury,' W. CALLOW. A picturesque bit of architecture, rich in colour, and painted under a powerful daylight effect. No. 72, 'The Old Knight's Blessing,' W. COLLINGWOOD, is an ancient chamber, appropriately furnished, as of the seventeenth century. In No. 73, 'The Pass of Glencoe,' G. FRIPP, the middle and nearer passages of the subject are successfully made out, and the general dispositions constitute a truthful picture of the locality. No. 74, 'The Mole, near Dorking, Surrey,' J. P. NAFFEL. The character of the gentle Mole is readily recognised here, but the foliage is exorbitantly green, the colour has a metallic rather than a vegetable hue. No. 78, 'Autumn Flowers,' V. BARTHOLOMEW, is a vase of China asters, most skilfully drawn, and charmingly grouped as to colour. No. 83, JOHN GILBERT, is a subject semi-historical. 'Her Majesty the Queen inspecting the wounded Coldstream Guards in the Hall of Buckingham Palace.' This subject would of course be seized upon for a picture—a faithful record of this incident on canvass would be a fitting subject for the walls of the Houses of Parliament. The Court occupies the right section of the composition, and the members of the Royal Family that are present with the Queen and the Prince, are the princes and princesses, and the Duchess of Cambridge, with equerries and ladies in waiting on her Majesty and his Royal Highness. We presume that the artist has given value to his picture by having drawn from the men themselves. He has very judiciously introduced red very sparingly into the mass of soldiers occupying the left of the composition; the mass is consolidated by the use made of the grey coats of the men, but these are generally too dark, even when new they are not so dark, and when old are comparatively a light grey; some of the men who have been most severely wounded are seated, but the mass is standing, and her Majesty addresses a stalwart figure of the Grenadier company, if the right-hand company of the Coldstream battalions is still so called. There is a marked anomaly in the picture we cannot pass by without observation, which is, that a soldier never removes his tschako or helmet in the presence of his superior officer or even of his sovereign; the officers very properly wear their bearskins, but all the men are uncovered, and it is somewhat absurd to see the man addressed by Her Majesty saluting without either a forago cap or bearskin on his head. We know not how these men approached their sovereign upon this occasion, they may have been ordered to remove their forago-caps or bearskins, but they never could have been ordered to salute while uncovered—a soldier under such circumstances stands to "attention." We know not whether the artist was present; if he were, and he saw the ceremony as he has painted it, he is quite right thus to illustrate it. In the dark and solid group before us there is much of earnest reality, and the greater truth because is in these various heads no attempt at undue refinement, no essayed expression of sentimental heroism. As a whole, the composition is admirably brought together; but we must press on with our already impatient numbers, and proceed accordingly to No. 85, Naples from the Strada Nuova, T. M. RICHARDSON, in which the lines run very effectively, but the everlasting saussine and idle blue sea of Italy eventually induce a soporific tendency, which neither human nor Neapolitan nature can resist. No. 89, 'Market-day, Genoa,' J. HOLLAND, is a spirited sketch, made upon the spot. Nos. 93 and 94 are two drawings by the same hand, D. COX, Junr., but very different as to their success respectively. The former is 'A Ferry on the Ty at Logerati,' a little place above Dunkeld where you may live, upon eggs, chickens, porridge, oatcake, whiskey-punch, and occasionally get a contraband salmon. The other is 'On Wimbledon Common,' somewhere near London, in Surrey, perhaps, but this is infinitely superior to the other—it is a health scene, forcible and effective. No. 100 is a subject that every figure-painter that visits Rome commemorates in his sketch book; 'The Piffareri,' by CARL HAAO; they are, as usual, playing before the figure of the Virgin. No. 106 is 'The Dochart River in its most impetuous state after

rain—Ben Lawers in the distance,' H. GASTINEAU. There is, we doubt not, much truth in this representation of the swollen river; it is a large drawing, and the rest of the composition is very conscientiously rendered. No. 107, 'The Pope's Mint and Part of the Pope's Palace at Avignon,' No. 108, 'Chateau at Dieppe,' J. BURGESS, JUN. A pair of drawings, rather large in size, painted with a free pencil, and sober in colour, yet true to nature. No. 111, 'The United Service—A Council of War,' H. P. RIVIERE, shows two pensioners, one representing Greenwich and the other Chelsea, following on a map the operations of the allied armies. No. 112 is a drawing of much interest, by G. FRERE, entitled 'Part of the Ruins of Corfe Castle—The Artisan's Tower.' It is a small drawing of a broad daylight effect, all but weak from the want of sensible shade, but most carefully worked out—there is no stone in the crumbling wall that has not had its share of attention at the hands of the painter. No. 114, 'A Winter's Sunset on the Banks of the Avon,' C. BRANWHITE. It had been better to have omitted the Avon from the title of this drawing, for nowhere is the Avon so wide as represented here. With respect to the drawing, it is a charming production. No. 115, 'A Fête Champêtre,' G. DODGSON. This is a misnomer, because the festivities are not *champêtres* but held in the garden of a superb chateau—the title, however, has little to do with the high excellence of this picture, with respect to which one fact impresses us somewhat deeply; that is, that right and left there are—here mediocre, there, inferior, there again positively bad—drawings marked as disposed of while this charming work is still in the market; it is sterling in manner and effect, most graceful in every passage of its composition, and elegant in every form of expression. The artist does himself an injustice if he does not continue to paint compositions of this class. No. 119, 'Morning—a French Lugger shortening sail,' by E. DUNCAN, is a drawing of much merit. The reason is obvious why she takes in her foresail—the sea is rising and we feel the freshening breeze: this description of morning is admirably painted; we cannot wait to see how these fellows handle their mainsail—that breadth of canvas is difficult to deal with in a gale of wind. No. 121 is a close river scene by C. BRANWHITE, entituled as 'On the River Teivi, near Newcastle-in-Emlyn, South Wales; it is painted generally with breadth and well coloured, but it must be admitted that there would be more of nature in it if the masses of foliage were less flat, for faithful representation, enough has not been done. 'The Tyrolean Bride,' No. 122, CARL HAAG, is a single figure, that of a Tyrolean peasant woman kneeling at prayer; it is impossible to speak too highly of the minute finish in this drawing, especially of the head. No. 123, 'The Market Stalls and Bath house, Hanover,' W. CALLOW. In Hanover there is but little of the picturesque—the buildings shown in this drawing are perhaps the most eligible; the oldest houses have precepts from the Bible inscribed on them, and may be as old as Knox's house in Edinburgh, which, if we remember, has also an inscription. 'The Homestead,' No. 124, C. DAVIDSON, is a picture of an English Farm Yard and buildings, apparently very faithfully drawn from the locality it is presumed to represent. In No. 125, 'The Return—in sight of Home,' JOS. J. JENKINS, is a ferry boat, among the most prominent of the passengers in which is a small party of French soldiers, Zouaves, who express their joy at the sight of their native place; the figures are small, but the incident is impressive: by the same artist, No. 129, 'Asleep,' is a small domestic agroupment, a mother watching the cradle of her sleeping child; and in a pendant to this, No. 131, 'Awake,' we recognise the same mother and child, but the latter is now removed from the cradle to the knee of the parent. Both of these compositions are distinguished by that graceful sentiment which this artist always imparts to his illustrations of the natural affections. No. 127, by S. P. JACKSON, is an 'Old Hulk at Plymouth—Sunset,' a work of great excellence, in which the sunset effect is sustained by much sweetness of colour. No. 128, 'Driving the

Flock,' by D. COX, is a heath subject, in which appears a flock of sheep driven by a man: when we look at some of the drawings of this artist containing figures, we marvel how an engraver of the present day would set about committing these works to copper. This drawing is very low in tone, and, with the exception of a little blue entirely without colour, no artist has painted so much of effect and so little of object as we see in these works. No. 133, 'The Vale of Clwyd from St. Asaph,' by D. COX, JUN., presents the view under the aspect of a cloudy summer day; it is a subject of much interest. This is followed by perhaps the most extraordinary work that has yet been painted by JOHN F. LEWIS; it is catalogued 'A Frank Encampment in the desert of Mount Sinai, 1842—the Convent of St. Catherine in the distance.' The picture comprises portraits of an English nobleman and his suite, Mahmoud the Dragoman, &c., &c. Hussein Sheikh of Gehei Tor, &c., &c. In contemplating a work like this it is difficult to understand the physiology that can dwell on a work of this size without being utterly exhausted by the enormous amount of monotonous stipple necessary to the completion of such a work up to a degree of such exquisite *finesse*. The simple statement is, that an Englishman, encamped in the desert, is visited by a Sheikh, who comes in state with camels and attendants; the Englishman remains reclining on his carpet and cushions, while the Sheikh stands respectfully at the edge of the carpet. A conversation is carried on between them, which is interpreted by the Dragoman, with some auxiliary action. Almost any section of the composition would form a picture. The material strewed round the reclining figure is of the most varied description; the left hand rests upon an English terrier, and a Skye hehuid him sits up holding a small stick or whip; the little factory boys of Paisley and Manchester would scream at the imitation, when tired of imitative textures, may pick up and read the *Gaiquand* which his Lordship has just thrown down. The head of the principal figure we recognise as a portrait sketch exhibited some time ago. The Arab personal characteristic seems to be most faithfully portrayed—especially in a ucar figure seated on the ground; the staid and respectful dignity of the visitor is also remarkable, but the volubility and action of the Dragoman have something of occidental manner in them. We cannot help thinking that reflected light is too extensively used in this composition; there is no effective shade, dark, or gradation of tone, and for want of atmosphere the details of the mountain vie in proximity with the draperies of the tent. It is marvellous in minute manipulation; the principle of execution being to describe each object individually as it is presented to the eye, without recourse to the usual licenses which give prominence to certain objects in preference to others, and serve to retain all the objects in their respective places. No. 135 is an elegant fragment from 'Thormia, in Sicily,' by T. M. RICHARDSON. No. 136, entitled 'Il Penseroso,' is a composition of much classic feeling, by F. O. FINCH; the *Penseroso* of the scene is a man reclining on the grass. Near this, Nos. 136 and 137 are two interesting works by T. M. RICHARDSON, 'Beach at Hastings, Sussex,' and 'The Rest, Highland Moors.' No. 140, 'Peat Gatherers, North Wales,' D. COX, is another of those clouded, storm-threatening effects, which being so often repeated would almost induce the belief that this artist has never seen the sun. No. 144, 'The New Song,' is a figure-subject, the best we think that its author, O. OAKLEY, has ever exhibited: certainly the most aspiring, as we remember under this name scarcely anything but gipsies and mendicant organ-boys. A council of three young ladies is held upon "The New Song;" one sings, while the others listen. The figures are very well drawn, and the features life like and expressive; had the costume been a little less of what we see every day, it would have added to the interest of the picture. The composition is very full; the multiplicity of objects diminishes the importance of the impersonations. No. 147 is a theme, by S. PALMER, from "Comus;"—

"Attendant Spirit, Immured in cypress shades the sorcerer dwells.

You may
Boldly assault the necromancer's hall,
Where if he be, with dauntless hardihood,
And brandished blade rush on him, break his glass,
And shed the luscious liquor on the ground," &c.

This is a dark composition, reminding us in colour and effect of those much-quoted people called "old masters." We see the hand of Comus through the trees, and near are the brothers conducted by the spirit. There is a pendant to this drawing by the same painter, No. 153, 'The Brothers, in Comus, Lingered under the Vine;'

"Two such I saw what time the labour'd ox
In his loose traces from the furrow came,
And the swink'd hedger at his upper sat;
I saw them under a green mantling vine,
That crawls along the side of yon green hill."

The composition in this is better brought together than in the other; the only objectionable passage consists of the palpable sunbeams, which shoot over the neighbouring bank. No. 150 is a life-sized study of the head of a child by CARL HAAG; it is entitled 'Roman Flower-Girl.' The features are admirably coloured, but the eyes are large enough for a head twice the size. No. 151, 'Lake of Lucerne—Sunrise,' W. C. SMITH, is a drawing displaying mastery skill, but we feel the lake less in water than as mere colour; the sky, distant mountains, and atmosphere, are fully successful. No. 152, 'East Cliff, Hastings—Sunrise,' by S. P. JACKSON, is a charming example of simplicity and facility. No. 154, by H. P. RIVIERE, is an Irish subject, 'Don't say Nay, charming Judy Callaghan'—(we cannot compliment the artist on his determination of title), of which the point is the proposition of a glass of whiskey by a youth to a damsel. We instance the drawing simply to mention the extreme brilliancy of the colouring of the girl's features. No. 156, 'The West Front and Spire of the Cathedral of Dijon,' by J. BURGESS, JUN., is a drawing extremely spirited and accurate in architectural detail. No. 157, S. P. JACKSON, is a drawing of the utmost excellence; it is 'Cader Idris from the Sands at Barmouth.' The mountains rise on the left section of the composition, a brig is lying on the sands towards the centre of the picture, and the nearest passages are studded with rocks, the substance and tone of which materially assist the distances. This is one of the best coast-pictures we have of late seen; the mellowness and harmony of the colour are most captivating. No. 163, by MARGARET GILLIES, is a single figure, that of a woman contemplating the fragment of architecture, erect and looking up. It is catalogued as 'From Marcello's Anthem'—

"I celi firmamento narrano,
Del grande Iddio la gloria."

It were scarcely necessary to have recourse to the Italian text for the subject, for the English, "The heavens declare the glory of God," is more impressive. The figure is somewhat heavy; were it less material, it would better support the poetry of the extract. No. 175, 'View in the Forum at Rome, from the School of Xanthus—'done on the spot,' by A. GLENNE, is one of the best drawings we have for some time seen from the ruins of Rome; it is highly finished and very effective. No. 166, 'On the River Dee, North Wales,' by C. BRANWHITE, is very deficient in the breadth which we usually see in the works of this painter—the spectator feels on looking at it that there remains yet much to be done in order to reconcile the parts. In No. 168, 'Sunrise on the Jungfrau, from the Wengern Alps,' W. COLLINGWOOD, the whole of the lower part of the drawing is in shade, in order to strengthen the sunlight which strikes the lofty peaks that pierce the morning sky—hence by this contrast of concentration is produced depth and force. No. 176, 'A View in Nuremberg,' H. BRANDLING, is sufficiently characteristic to remind the spectator of the quaint and lofty houses of the Cisalpine Venice. No. 177, 'The Students,' is a composition of two figures by Miss GILLIES, suggested by the verse of Tounyoun—

"Those that eye to eye shall look
On knowledge."

In their hand
Is nature like an open book."

The conception presents apparently a father and daughter, occupied in philosophical inquiry. In the daughter there is much sweetness of expression. No. 182, is a 'Scene on Loch Katrine, Perthshire.'

"High on the south bays Ben Venue
Down the lake in masses three
Crags, knolls, and mounds, confusedly hurli'd,
The fragments of an earlier world."

This subject is brought forward as a very large drawing of extremely picturesque character, showing combinations which cannot be surpassed by any effort of the imagination. No. 184, 'Buck Baskets on the Thames,' C. BRANWHITE, is a very sparkling production, containing an agreeable sequence of gradations, with harmonious colour. No. 187 is a 'Gypsy Girl,' by O. OAKLEY, a drawing of much merit, but the figure is too slowly dressed; the broad-brimmed heaver is under any circumstances not a characteristic property of the tribes; the features would be much improved if the whites of the eyes were reduced. No. 190, 'Beeches at Windsor,' W. SMITH, has much of the reality of nature; and No. 192, 'Richmond Castle, Yorkshire,' C. DAVIDSON, is felicitous as an essay in local colour. The screens contain many beautiful works, but we must be content to record only the titles of some of the most striking of these: as No. 204, 'Going to the Chase,' G. DODGSON; No. 207, 'Keep of Raglan Castle,' H. GASTINEAU; No. 208, 'The Stranger,' F. W. TOPHAM, a study of a negro boy—a drawing of great merit; No. 210, 'Hard Boy—Brace of Loch-Aber, Invernesshire,' T. M. RICHARDSON; No. 212, 'Fruit,' W. HUNT; No. 213, 'Capuchin Monks relieving Pilgrims,' ALFRED FRIPP; No. 214, 'The Thames at Twickenham,' GEORGE FRIPP; No. 215, 'Como Along,' JOS. J. JENKINS—a drawing of great brilliancy, showing a French peasant woman crossing a stream by stepping-stones, followed by her child; No. 219, 'Fruit,' W. HUNT, the grapes painted with extraordinary truth; No. 222, 'A Tale—Beggars of Oher Franken,' F. W. BURTON, an exquisite drawing; No. 227, 'North Entrance of the Palace of Andrea Doria, Genoa,' J. HOLLAND; No. 230, 'Arundel Castle, Sussex,' WILLIAM CULLOW; No. 231, 'A Diffarato,' ALFRED FRIPP; No. 235, 'Landscape—Morning,' F. O. FINCH; No. 238, 'The Ministering Spirit,' MARGARET GILLIES; No. 238, 'The Gaugers are Coming,' F. W. TOPHAM; No. 240, 'Wind and Rain,' D. COX; No. 243, 'Fresh from the Garden,' O. OAKLEY; No. 245, 'Confluence of the Trent and Ouse with the Humber, from an eminence near Brantingham, Yorkshire,' H. GASTINEAU; No. 246, 'Neapolitan Peasant Girl,' ALFRED FRIPP; No. 248, 'The Contarini Palace, Venice,' W. CULLOW; No. 253, 'A Bit of Mont Blanc,' W. HUNT; No. 255, 'Moonlight,' J. HOLLAND; No. 256, 'An Itinerant,' W. HUNT; No. 259, 'The Water Party,' J. DODGSON; No. 263, 'The Return from Hawking,' FRED. TAYLOR; No. 264, 'L'Allegro,' J. M. WRIGHT; No. 267, 'Horses Drinking,' D. COX; No. 268, 'The Ante-Room,' W. COLLINGWOOD; No. 269, 'Roses and Convolvulus,' V. BARTHOLOMEW; No. 270, 'Dead Game,' G. ROSENBERG; No. 274, 'Fruit,' W. HUNT; No. 280, 'A Winter's Afternoon in the New Forest,' E. DUNCAN; No. 281, 'Ill-Nature, Highlands of Scotland,' FRED. TAYLOR; No. 284, 'The Garden Terrace,' G. DODGSON; No. 288, 'Youth and Age,' F. W. TOPHAM; No. 290, 'A Mountain Torrent,' G. DODGSON; No. 291, 'The Madrigal,' by the same painter; No. 296, 'Titian Visiting the Studio of one of his Pupils,' &c. We think this will be admitted to be the most sparkling series that has been seen here for years past. It is true we miss some of those who, until recently, have contributed so much to the interest of the exhibition—none perhaps so much as Cattormole; but, in respect of figure-painters, those who are members of this society are men of the highest distinction. Time was when this was essentially a society of landscape-painters—when figure-drawing was regarded an inexcusable impertinence; but in looking round these walls we are compelled to admit that the education of the water-colour artist must now be as careful as that of the painter of history.

THE EXHIBITION OF THE NEW SOCIETY OF PAINTERS IN WATER COLOURS.

The catalogue of this season gives a list of three hundred and forty-nine drawings, among which, although the most eminent of the landscape painters show in various works the quality whereby they are distinguished, there is no great effort in this department, the subjects being generally common-place and unambitiously treated. The figure painters of the society, although the remarkable works in this walk are not numerous, evince more spirit and speculation; indeed when we consider the amount of labour and the length of time necessary to perfect some of these compositions, it were not reasonable to expect each year more than two or three such productions, supposing that the artist did nothing but work upon these drawings. In looking round a collection like this it is not difficult to see that the majority of the works are brought forward in the best marketable form; and that such should be the case is not so much to be charged to the fault of the painter as to the tastes of his patrons. In many of the minor works are to be found the finest qualities in water-colour Art—the deficiency, therefore, is not in executive power, but in the selection of subjects and in imaginative resource. Among the following examples which we select for notice is continually signalled the excellence of which we speak. No. 3, 'Entrance to the Grand Canal, Venice,' W. WILD. There is a dreamy character about this drawing which gives it the feeling rather of a poetic composition than an essay proposing a reality. It is sunny, and the buildings are in as good condition as in the days of the historic doges. We have St. Mark's upon the right, but the famous temple is too large, according to one of those luxurious licenses of painters and poets. The markings and divisions of the principal masses are too absolute. No. 7, 'The Fisherman's Daughter,' J. H. MOLE. She is on the coast, with the open sea behind her, bearing a basket on her head. It is a characteristic study. No. 16, 'A Kiss,' JOHN ABSOLON. This is suggested by a French print; it presents a group at a stile—a guardsman of the days of the earlier Georges, wearing an 'Egham Staines-and-Windsor,' that is, the three cocked-hat of those days, in the act of kissing a not unwilling country damsel; he should have taken off his uncoth hat, being a most inconvenient headgear for a *tête-à-tête* so close. The title is not happy, and the maiden, "simple tho' she stands there," looks very much as if she had asked for the salute. No. 17, 'The Upper Lake of Killarney,' W. BENNETT. There is little colour in this drawing, but the greys and greens are so judiciously dealt with, that the warm tints acquire a double force. These works remind us continually of the early English school of water-colour drawing. In No. 23, 'The Rugged Bed of the Lynn,' D. H. MCKEAN, the masses of rock in the drawing constitute the subject; the trees are secondary but yet treated too much as a mere base—had the tone of the rocks been reduced, they had been more a part of the composition than they are. No. 26, 'Nutting,' EDMUND G. WARREN. The subject is a section of a woodland path skirted by trees, which are carefully drawn. The title is realised by two children plucking nuts. No. 27, 'Griselda,' E. H. CORBOULD. A single figure, successful as a study, but not as Griselda; she bears a cruse of water, but there is no colouring of the poetry of the Chaucer. The features are distinguished by the utmost delicacy of character, and the extremities are drawn with the nicest accuracy. The refined hues of the drapery are faced by the cold breadth of the background. 'Black Gang—Isle of Wight,' JAMES FAHEY. It is high-water, and the rocks forming the subject are made out in all the wealth of their summer herbage. The drawing is a close imitation of the locality, and the stratified rocks have been very assiduously worked out. No. 33, * * * W. LEE. The place of a title to this drawing is supplied by a verso from "The Christian Life" of Montgomery. There are two figures in the picture—a French peasant woman

and her child, as if at public worship. The figures are most agreeably treated, and the natural simplicity of the incident is the great charm of the work. No. 43, 'Old Eastbourne and Pevensey Bay,' J. W. WHYMPER. We are placed on the ascent towards Beechy Head at the back of Eastbourne church. The subject is at once recognisable, but the distance might have been a little more definite. No. 44, 'The Seaside,' S. COOK. A small drawing, charming in colour. No. 50, 'Ante-chamber of the Tribunal of the Inquisition in the Ducal Palace, Venice,' L. HACHE. The subject is from Daru's "History of Venice," being the capture by the officers of the Inquisition of the head of some noble family, one of whose members has offended against the laws of the State. The story is clearly that of an arrest, but the details are not so perspicuous as are generally those in the productions of the artist—otherwise, the picture is distinguished by the rarest qualities of Art: accurate drawing, powerful and appropriate expression, beautiful colour, with breadth and substance. The head of the house is arrested; his wife and child plead in vain for his release, and the other members of the household are overwhelmed with grief; this is all very clear, but if the subject assumes the cause of the arrest, this does not appear. The same artist exhibits—for him an unusual kind of place—the Ducal Palace on the right of the spectator, looking towards the library. It must have been the novelty of the subject which attracted the artist from his other topics, that are really original. 'Addio, Venezia,' charming as thou art we willingly forsake thee for 'The Town Hall of Oudenarde—Meeting of the Corporations,' a third large drawing by Mr. HACHE, in which we find ourselves among a company of sleek and well-fed hurgers, in the costume of the seventeenth century, that which this artist describes so well. This is the class of subject which he has made his own; in action, expression, and diverse character, these figures are equal to any which he has ever conceived. No. 69, 'Forest Scene—Autumn,' W. BENNETT. The firm and substantial manner of this artist is admirably adapted for the representation of the old and gnarled oaks which he so frequently paints. The substance of his manipulation is amply shown here. No. 77, 'Rebekah first sees Isaac,' HENRY WARREN. The subject is from the twenty-fourth of Genesis, sixty-fifth verse: "For she had said unto the servant, What man is this," &c. The subject is treated in a feeling in which this painter is eminently successful—Rebekah is mounted on a camel, as are also her attendants, and the group is relieved against a sunny sky, the light from which is broken with a fine effect on the figures and animals. It is the best production which the artist has of late years exhibited. No. 83, 'Polperro, Cornwall—Sunset after a Gale,' S. COOK. A drawing of great power, presenting only a section of sea cliff at high-water, as seen under an evening effect. Nothing can be more successful than the colouring of the drawing, with respect to the evening effect; it is managed so skillfully that we are conscious of the light without feeling colour, a preference of which the spectator is never sensible when the picture he contemplates is vulgarised by powerful tints. No. 84, 'Gleaners—Aveley,' JOHN ABSOLON. A very sparkling composition, of which the subject is one extensive corn-field, wherein are numerous figures. No. 93, 'Rochester—Wind against Tide,' T. S. ROBINS. Such may be the conditions of the effect, yet, the river at Rochester is not sufficiently wide to admit of an agitation equal to that of an extensive estuary under a strong breeze; it is, however, very like the locality. No. 95, 'The Weaver's Song—Midsummer Night's Dream,' Ed. H. CORBOULD. This is Bottom with the ass's head; a daring theme as open to criticism on comparative anatomy. He is singing—

"The cussel cock so black of hue
With orange tawny bill," &c.

and dancing to his own music—the treatment is extremely simple, the figure being relieved against a breadth of dark background. The person, especially the limbs, are extremely well

drawn—but for Bottom the weaver the hands are much too refined. No. 99, 'The Mother's Lesson,' J. H. MOLE. The scene is a cottage in which a mother and child are simply circumstanced, according to the title; the lights are, perhaps, too much distributed for good effect. No. 105, 'The Baptism,' JOHN ASSOLO. The party are assembled round the font in church; the ladies are especially piquantes in dresses and character. No. 113, 'A Morning Breeze,' on the hills at the entrance to Looe Harbour, looking over Whitesand Bay, Cornwall. S. COOK. For its independence and originality of manner, we cannot praise this work too highly; the water particularly, although so minutely detailed, is by no means hard or broken up. There is throughout the drawing a charming sentiment; we might see the subject treated twenty times without any approach to the power which characterises this drawing. No. 117, 'Entrance Tower, Hurstmonceaux, Sussex,' J. W. WHEMPER. This is an oblique view of the gate towers, as seen from the brink of the ditch, but presenting the structures as much more massive than they really are, and the colour of the brick is richer than it is given here. It was one of the first brick mansions of its class erected in England. No. 121, 'The Fulfilment,' W. H. KEARNEY. "Why seek ye the living among the dead? He is not here, but is risen." The angel at the tomb of the Saviour is addressing these words to the women who visit the place and find the sepulchre vacant; the figures and their arrangement declare at once the subject. No. 127, 'Roselle Bay,' Jersey, THOS. S. BOYS. A production of much merit—agreeably managed as to colour and chiaro-scuro. No. 130, 'The Ugly Duckling,' (Andersen), C. H. WEIGALL. This is the well-known story from the German, in which the poor cygnet is abused by the entire circle of fowl domestic birds, under the supposition that he is an awkward ugly duck; we find him here shrinking under the abuse of a proud turkey-cock, to the malicious satisfaction of the whole farm-yard. These fowls are drawn and painted in a manner truly masterly. No. 135, 'Aldbury Vale, near Guildford,' H. MAPLESTONE. This district and the neighbouring parts of Sussex are remarkable for the abundance and luxuriance of their oak timber; the character of the scenery is successfully described in this drawing. The spectator is placed upon an upland cornfield, below which extends an expanse of densely wooded country. No. 136, 'Haddou Hall and Bridge,' D. H. MCKEWAN. Much credit is due to this painter for affording us a new view of Haddou. We have seen enough of the terrace and the interior—here we see the exterior of the edifice from the grounds. No. 142, 'View of Monte Rosa, Canton Valais, Switzerland,' T. S. ROWBOTHAM. A very large drawing, showing the objects from a pass overhanging the ravine. The large drawings of this artist are not at all so well composed as to chiaro-scuro as his smaller works; from the desire of bringing forward too much, the effect is enfeebled; the work is deficient in breadth and force, for which no prettiness of colour or manipulation will compensate. No. 143, 'The Back of Skiddaw, with Dassenthwaite Lake in the distance,' AARON PENLEY. The subject is divided as it were into two parts, one light, the foreground, and the other, the background, in shade. This looks artificial, and it is the more unfavourably impressive because the shade and atmospheric tones are so cold. The colour of the heath is too positive—it does not harmonise with the foreground tints. No. 152, 'Market Place, Unterseen—The Jungfrau, &c., Switzerland,' W. N. HARDWICK. The houses in this composition are admirably drawn; so careful are they, that the mountains beyond look unfinished, yet it is the best work we have lately seen exhibited under this name. No. 159, 'At Mullion, Coast of Cornwall,' JAMES G. PHILIP. A drawing of great merit, extremely forcible and effective, showing simply an opening between two walls of rock, with a glimpse of light distance; in colour and breadth, the shaded portions of the subject are highly meritorious. No. 169, 'Kynance Cove at Sunrise, Cornwall—The meeting of the Tide,' S. COOK. The tide meets round a portion of the rock that has been separated from the

cliff, and this occasions the agitation shown in the drawing. The composition is characterised by much sweetness of colour. No. 175, 'Tintern Abbey,' JOHN CHASE. As a representation of this beautiful remnant of monastic architecture the drawing is most faithful; it is everywhere elaborated with the nicest care, and does ample justice to the proportions of the ruin. No. 179, 'Waiting for the Ferry,' J. H. MOLE. Is perhaps the most agreeable production that has of late been exhibited under this name. It is rather a landscape than a figure subject, as presenting an extensive view of mountain scenery, deriving life from two figures—a woman and a boy waiting for the boat from the other side of the loch. No. 182, 'Pallanza, Lago Maggiore,' T. L. ROWBOTHAM. This subject has of late become a *cheval de bataille* and appears now every season from various points of view. It is accurate, sunny, and very square, wanting a proportion of shade to make it felt. No. 185, 'Ben Crnachan, Loch Awe,' is another well-studied theme by D. H. MCKEWAN; the hen is seen beneath the gloom of a stormy sky, whence the clouds have descended so as to conceal the face of the mountain. It is a large drawing brought forward with much spirit. No. 191 is a figure picture, by HENRY WARREN, 'Hagar the Egyptian and her Son' put forth to wander in the wilderness. The mother carries the cruse of water on her shoulder, as Abraham placed it, and leads with her left hand Ishmael, who is looking back towards his late home. The head of Hagar has been modelled from the Egyptian monuments, and in every other respect the theme is sufficiently pronounced—but it might be objected that Hagar is too young and Ishmael too old. 'Summer Shade,' No. 198, by EDMUND G. WARREN, is a very agreeable study of trees. The holes and branches, with the masses of foliage, seem to have been carefully made out from the reality; the leafage is fresh and free in colour and manipulation. No. 211 is an eccentric production by EDWARD H. CORNOLLY, entitled 'Ye Lynncere his Dreame.' The point of the subject, as set forth in the catalogue, is perhaps described better than we can detail it. "Falling into a fitful and uneasy sleep, after a long protracted reading of varied and antagonistic character, he dreams of patrons of art departed for the Crimea, of himself as not having a leg left—of falling into 'the waters of oblivion,' and vainly struggling to call for the drugs of the Humane Society, whose men are gone to Greenwich Fair." In brief, as far as we can understand the composition, it is a painted epitome of the artist's professional career, with an allusion to the substance and the spirit of his works. Under an unaffected title and modest description, the work should be by speculators patiently considered, for there is really much merit in it. The composition is full of fantastic device, pictorial, poetical, allegorical, and even political. No. 223, by E. H. WERNERT, is the scene from Don Giovanni in which the Don gives the white knight his hand as a pledge of accepting his invitation to supper.

"*Commed. Tu m'invitasti a cena,
Verrai tu cenar meco?
Don Gio. Verrò!
Commed. Dammi la mano in pegna.
Don Gio. Eccola! Ohime!
Commed. Cos' hai?
Don Gio. Che celo è questo mal?
Da qual tremore insolito sento assahr gli spiriti."*

Don Giovanni writes in the grasp of the white figure, the statuesque bearing of which is very impressive. No. 228, 'The Baronial Hall, Goodrich Castle, on the Wye,' by EDMUND G. WARREN, is a very successful essay. The subject is a remnant of one of the few castellated edifices that were constructed of brick. We are on the shaded side of the ruin, to which importance is communicated by extending it to such dimensions as to cover the paper. It is well coloured, and detailed in a very masterly manner. We have seen much of the Tilt and its romantic Glen, but we have never seen any passage of the famous stream described with a more charming sentiment than in No. 237, by W. BENNETT, though the stream looks somewhat wider than in the reality. We stood here some time watching the heron, the hermit of the lonely streams, whose staid and contemplative mood bespeaks the security he

feels in the solitude of the place. The foliage is abundant, but they are not all oaks that shade the fitful Tilt. Does this artist feel himself feeble in painting any other but oaks? No. 244, 'The Old Gate at Rotterdam,' by G. HOWSE, is a subject that has frequently been entertained by Dutch painters; but the passage here is made extremely busy by a multitude of boats and figures. The buildings especially are represented with great skill. To instance the repeated recurrence of a certain round of subject-matter, we extract a few of the titles on the page before us:—'Moat House, Ightham, near Tonbridge, Kent'; 'St. Maclou, Rouen'; 'Cookham on the Thames'; 'The Bridge at Betws, N. Wales'; 'Calais Harbour'; and others scarcely less notorious. Our frequent observations on this subject may perhaps prompt the question—"Because certain subjects have been already painted, are they not to be reproduced?" It is not the repetition of subject-matter that is so irksome, but that the majority of the profession should think so little for themselves—a circumstance exemplified by the fact that when new ground is broken by an individual, it is at once exhausted by the crowd, who nevertheless continue to dwell upon the threadbare resource until something new is suggested.—But to proceed. No. 249, 'Murillo's Early School,' W. H. KEARNEY, presents the Spanish painter in his youth, drawing from such figures as he could induce to sit to him in the streets. It is an agreeable incident, which might have been wrought into a picture of great power, character, and effect, but not with its present composition. No. 258, 'Bacchanalian Cup and Fruit,' is a brilliant arrangement of the productions of nature and art, by Mrs. MARGRETS; the grapes are extremely well painted. No. 227, 'Near Bracemar, Aherdenshire,' T. S. ROWBOTHAM, is a small drawing—forcible in its chiaro-scuro, and one of the class of subjects which the artist paints best. On the screens are frequently hung some of the best drawings in the exhibition, for it is very common to find an artist very powerful in sketches, but altogether incapable of attaining to anything like the same force in larger works. No. 285, 'The Challenge,' C. H. WEIGALL, is a poultry picture of much excellence: the birds are drawn with exquisite symmetry and high finish. No. 289, 'Fruit and Flowers,' by Mrs. HARRIS, is a composition of red and white roses, beautiful in colour and accurate in drawing. In the same department of Art is No. 299, by Mrs. MARGRETS, 'Lilac and Hedge-Sparrow's Nest'; the lilac is a very felicitous study. No. 310, 'On the Arno, near Florence,' T. L. ROWBOTHAM, is a subject higher up the river, rather near the distant mountains, than the city; but in the drawing, as in many by this painter, too much is made of the buildings; their inexorable squareness sorts but ill with the romantic features of the locale. No. 318, 'Boys Fishing,' by RONNIE CARRICK, is a composition; the scene a tract of mountainous scenery, with two boys angling for littlebats: it is a simple and forcible sketch. No. 319, 'Farewell! but whenever you welcome the hour,' by G. HOWSE, is one of those small sketches by this artist which we have highly commended in antecedent exhibitions. No. 320, 'Brook Farm,' by FANNY STEENS, is a sketch characterised by good effect and natural colour; and the following number, 321, by SARAH SERRCHEZ, entitled 'Sketch for a picture of an English Cottage Home,' has much of the force which we have seen in larger works by this lady; the subject is interesting, but not so sentimental as others she has exhibited, and perhaps the same qualities could not be realised in a larger picture. No. 322 is another small composition by G. HOWSE, from "Twelfth Night." In the place of a title, stands the well-quoted objection of Sir Toby Belch—"Sir, ye lie: art thou any more than a steward? Dost thou think, because thou art virtuous, there shall be no more cakes and ale?" It is broad and spirited, and, as a large work, would be highly meritorious, could the same qualities be preserved in larger compositions. No. 331, 'A Boy at Prayer,' R. CARRICK, is a very effective sketch—earnest and natural. No. 336 is an admirable drawing by L. HAGHE, catalogued as 'The Scrivener'; it is such a picture as a devotee to the Dutch school

would paint: the author of the work must have intended to break a lance with some of the most eminent of the painters of what dealers call "conversation pieces." The scrivener is seated at his table, and his wife by his side, both curiously presented sitting square, and facing the spectator; the man of business wears his hat, and his wife is attired as becomes the helpmate of one at the head of a thriving concern. Both figures are unexceptionable, and the economy of the room, and the distribution of its furniture, are pointedly descriptive. No. 344, by AARON PENLEY, described as 'Serenity,' is a much larger work than is usually hung on a screen. It is a warm, sunny, mellow drawing, showing Windermere, the Langdale Pikes, Lingmoor Bow Fell, Crinckle Cranckle, &c., in the distance. The foreground is occupied by a herd of kine that are come from their pastures for their evening draught. The sentiment of the title is sustained throughout the drawing. At the conclusion of our examination of the exhibition, we are confirmed in the opinion we expressed on our entering upon it—which is, that the works executed for reputation are not so numerous as they might be, and that those painted merely for the market are more abundant than they ought to be.

THE ROYAL SCOTTISH ACADEMY. THE THIRTIETH EXHIBITION.

THE exhibition of the Scottish Academy is open for the second season in the new rooms, which, *quoad* interior, are elegant and effective, having more the appearance of a picture-gallery than the rooms of our Royal Academy, that have always appeared to us rather designed with a view to the dinners, than to any other festivities which the academy has to offer. Yet the Royal Scottish Academy is not the only mistake as an edifice for the exhibition of works of Art. We have viewed the two buildings (in Edinburgh) from every available point, in order to endeavour to understand wherefore they were built on the site they occupy. Greek architecture less than any other can afford to be looked down upon; these structures are overtopped by every house in Princes Street; and from any of the wynds which pierce the amphitheatre of the old town they appear really less significant than some of the buildings which have been erected for their dogs by certain of the Nimrods or Ramrods of our time. But turn we to the interior and its contents; there is something business-like and even commercial in the way in which the pictures are marked. The recurrence of the *affiche* "Sold to the Art-Union of Glasgow," leads a contemplative visitor to the conclusion that the said excellent institution is the only purchaser; because, if not so, why are not the names of the Smiths and Johnsons attached to the works which they have purchased? With respect to the pictures themselves, they are seven hundred and thirteen in number, with a proportion of water-colour works, and thirty-eight sculptural works, making a total of seven hundred and fifty-one. The portraits are very numerous, more so than in any exhibition we have ever seen; and of that class which represents figure-subjects examples also are abundant, though very few distinguished by original thought; yet, limited as the exhibition is, it shows a great diversity of manner and feeling, we may say freshness. It contains many productions with which we were before familiar; this, with certain other circumstances, suggests the idea that there is some difficulty in forming a correct exhibition of what may be deemed eligible works of Art. In looking round these saloons we see much ambition in small things, but there is little sound didactic narrative; the Scottish school, it may be said, is young, but of its members there are men who have studied all the elder and younger schools of Europe, and the province of these is rather to correct than to pander to the vitiations of public taste. We have one observation to offer on the mottoes

and quotations that preface exhibition catalogues. The extract on the title-page of the catalogue of this exhibition is from "The Language and Literature of Italy," by, we believe, Count Carlo Pepoli, in which are cited the names of Dante, Michael Angelo, Alfieri, and Leonardo da Vinci; but, inasmuch as it is extremely difficult for a person, even well-read and learned in the works of those poets and painters, to discover any relation between the quotation and the works exhibited, it were better to select some quotation or maxim that would not disappoint the critical and enquiring visitor, for it is very clear that whatever Dante and Michael Angelo might have imagined—and the imaginations of both were rather exursive, they never contemplated anything in poetry or painting like English and Scottish rustic subject-matter. Such quotations on the title-pages of catalogues are grandiloquent and sounding, but they become only sorry prologues to domestic and rustic incident. But to the pictures:—we pass on to No. 74, 'The Death of Arthur, Duke of Bretagne,' R. S. LAUDER, R.S.A., from the 3rd Scene of the 4th Act of "King John,"—

"Bastard. Knew you of this fair work?
Beyond the infinite and boundless reach
Of mercy, if thou didst this deed of death,
Art thou damned, Hubert, &c."

Before the two figures lies the body of Arthur, as it had fallen from the cliff; the Bastard stands sternly pointing to it, while the deprecatory action of Hubert expresses well the sentiment of the text. But an artist who sympathises so perfectly with the poet ought not to condescend to a vulgar effect,—that of bringing the head and figure of the Bastard, the darkest points, in opposition to the strongest lights. The damning scowl of the Bastard, and the apologetic embarrassment of Hubert, are unobjectionable. The nail of the former is according to the period,—but wherefore does he rest upon a two-handed sword, a weapon which was not used generally until centuries after King John was forgotten? And wherefore the regal blazon on the surcoat worn by the Bastard? For neither of these incidents, we believe, can any authority be given, and anachronisms detract from the value of what is presumed to be historical painting. No. 191, entitled 'The Tempter,' W. DOUGLAS, R.S.A., is a subject in some degree allegorical. It contains two figures; that of a man seated at a table, and tempted, according to a superstition of the middle ages, to sign away in blood his hopes of salvation. The "Tempter," a shadowy fiend behind him, offers him the pen, and charms his ear with the music of the sound of gold. There is much elaborate painting in the work; it is everywhere carried out with infinite nicety, but perhaps there is too great a contrast between the two figures. No. 203, 'Wat Tielinn,' by JAMES DRUMMOND, R.S.A., is the story from the "Lay of the Last Minstrel,"—

"They crossed the Liddel at Carlew houn,
And burned my little lonely tower,
The fiends receive their souls therefore," &c.

The composition shows the flight of the herder, accompanied by his wife; the whole forming an effective agroupment, though perhaps wanting breadth. A composition entitled 'Burns in Edinburgh,—1786,' painted by W. B. JOHNSTONE, R.S.A., and suggested by an "autobiographical fragment," in which it is stated by Scott that, when fifteen years of age, he saw Burns in the shop of Sibbald the bookseller, in Parliament Square. The poet is here represented as a man of very tall stature; he is accompanied by Adam Smith, Lord Monboddo, Dr. Hugh Blair, Henry Mackenzie, and others. The figures do not seem to be conscious of the presence of each other; but there are many estimable qualities in the work. CHARLES LEES, R.S.A., exhibits a very earnestly painted work, No. 327, 'The Martyrdom of George Wishart,' in which are introduced many of the most zealous of the persecutors of the reformers of that time. The purpose of the artist has been rather to bring forward many impersonations than give force and character to a few; there is also too much attention given to locality. Mr. ARCHER'S 'Last Supper' is a prominent feature

in the large room, but we have already spoken of it and others in this room. 'The Lollard,' E. W. DALLAS, No. 261, is an excellent subject, as showing the tyrannies of the Inquisition. A meek and studious old man, diligent in the search of truth, is served with the fatal summons by two men in masks, one of whom had been sufficient, invested with more of authority and personal dignity; there is, however, much credit due to the original thought. No. 91, 'The Dancing Lesson,' R. T. ROSS, A., is a cottage scene; a child lolling to the screaming music of a tin whistle, blown by an elder brother. The work is full of good colour, and distinguished by appropriate expression. No. 223, by R. GAVIN, A., called 'The Weary Gleaners,' presents a couple of children returning from the harvest field. The figures are painted with breadth and taste, unexceptionable in colour and effect, but these qualities are enfeebled by the deficiency of equal quality in the foliage. No. 238 is a small but interesting work by JOHN FAEB, R.S.A., 'The Household Gods in Danger,' the point of which is a child curiously examining some valuable china, which is painted with the nicest exactitude. No. 297 is a work by JAMES DRUMMOND, R.S.A., in which the elder architecture of Edinburgh divides the field with the figures. We have some remembrance of having seen the picture before; the title of the work is 'A Scene in Edinburgh,—The Morning after the Battle of Preston Pans.' We instance No. 309, 'Claudio and Isabel' (a good subject by the way), to observe the disproportion between the heads and figures of the impersonations; the picture has other errors, but it has not that of being septic, a disqualification which most painters of dramatic subjects think it necessary to communicate to their works. No. 333, 'Harvest,' by ROBERT GAVIN, R.S.A., is a production supported by many valuable points, but the extreme care with which every grain of oats has been individualised gives the corn-sheaf the precedence of the sleeping figure. No. 342 is another meritorious work of that prolific artist JOHN FAEB, R.S.A.; the objects and textures in the work are most successful. No. 376 is a picture of the same class, by the same painter; it is called 'Interior, with Fisherman Reading,' and is equally commendable with the preceding. No. 357, 'A Romp in the Hay Field,' is a small picture by P. F. POOLE, A.R.A., extremely sweet in colour, but presenting the principal figure, that of a girl, in a most ungracefully foreshortened pose. There are by the same painter three other open-air subjects, which we shall presently particularise, and of these we may say that they are much more agreeable than the large works which their author has of late years exhibited. No. 395 is a work by ERSKINE NICOL, A., which we find designated 'Whew! Caught Again!' The scene is a cottage interior, with a woman apparently rushing from the arms of a man, unfortunately plain, and too old to be either her lover or her husband; they have been surprised by an old woman, who stands at the door. The point of the story is by no means perspicuous,—if it be caricature it is a failure; there is a feeling for substance in the picture which might be improved into value in any intelligible subject-matter. 'The Minstrels,' No. 411, by W. CRAWFORD, are two life-sized heads, in the features of which there is agreeable character, but they are not young ladies who live by their minstrelsy. 'Sir Tristan teaching La Belle Isoude to Play the Harp,' by J. E. LAUDER, R.S.A., is a work we have already seen. 'History,' by SANDY, we have also seen before. 'The three small pictures by POOLE, to which we have already alluded, are Nos. 426, 427, and 428, and entitled 'The Young Gleaner,' 'The Path over the Hills,' and 'Youth and Innocence,' they are miniature gems. No. 434, 'Caught,' by ALEXANDER CHRISTIE, A., is a production of little felicity of conception. The subject is a youth and maid, surprised by the father of the latter in a secluded walk, amid their mutual confessions; the pair look exceedingly silly under the rebuke of the young lady's father. Although there is no finish in the work, there is some expression. No. 243, 'An Irish Merrymaking,' ERSKINE NICOL, shows, like

a work by the same painter already noticed, a valuable apprehension of the use of lights and darks in composition; and the artist has also caught much of the instinct of Irish character, but there is the same tendency to caricature that we have observed in a picture already noticed. No. 253, 'The Stolen Ride,' is a horse composition, by JOHN GLASS, A., in which the animals are well drawn. By J. BALLANTYNE, A., is exhibited No. 270, 'The Return of the Sword,' an officer returned from the Crimea brings back to the widow of his friend the sword of her late husband, slain in battle. The narrative is clear enough, but the subject, and the manner of detailing it, are commonplace. The manner of No. 108, 'The Bible,' by R. T. ROSS, is hard, but the general effect and colour are unobjectionable. In 'Lucy Cray,' by JOHN A. HOBSON, R.S.A., there is a striking instance of the immobility of the model, and the inadvantage of the painter. A poor child is represented as in a snowstorm, and we find her, as it were, standing still, instead, as any intelligent being would, of hastening onward; there is much care, but a want of natural truth in the picture. 'The Ridd of Ruthven' is another picture by JOHN FAED, R.S.A., the subject of which is an outrage offered to James II. by the Master of Glamis; the figures are admirably painted, and careful in costume; but the scene of the incident is much too modern in its fittings and carpentry; the group in the recess is admirable; were the picture ours we should cut out James and the Master of Glamis and retain the secondary group. No. 141, 'Scuille in a Gnarled Room,' by MEISSONIER, is a production of great merit, the property of H. R. H. Prince Albert, of which we have already spoken. 'Imagine at the Cave,' No. 147, by R. S. LAUDER, is a remarkable picture, as in it the cave and not Imagine is the picture; it is rather a geological essay than a work of Art. No. 164, 'Watching the Pass—Daybreak,' by J. NOEL PATON, R.S.A., is a production of a high order of merit—there is only one figure, that of a musketeer of the seventeenth century seated at daybreak near a wild and mountainous gorge with a blood-hound for his companion; every passage of the work is endowed with eloquent description. Upon No. 25, 'The Rosicrucians,' a great amount of labour has been bestowed, but perhaps not with all the success that could be desired. The picture is by W. DOUGLAS, R.S.A., who must be complimented on the industry evidenced in every passage of the picture. The figures are too small for so large a canvas; the Rosicrucians were mystic adventurers who seldom were fortunate enough to have a saloon so well furnished to pursue their researches in. The curtain before which they are standing is too rigid, indeed it is a mistake to paint figures so small *à propos* of such a subject on a canvas so large. In many of the landscapes we find a degree of force and originality which we shall instance as these qualities occur in the works which we notice: one of the first of this class that struck us was No. 59, 'Storm on a Highland Coast,' by HORATIO MACCULLOCH, R.S.A., a large picture, the subject being a passage of wild scenery under the effect of a storm in which the drifting of the rain is most forcibly described. No. 63, 'A Woodland Sketch, near Comrie,' by ARTHUR PERIGAL, exemplifies very careful drawing in the boles and branches of the trees, but the definition and separation of the foliage masses, the most difficult thing to accomplish in tree-painting, is not so successful. The fragment of rock in No. 68, by EDWARD HARRITT, called 'In Aran—Ayrshire Coast in the distance,' is among the most perfect passages of this department of Art we have ever seen; it is natural and unmanipulated, exhibiting the essence of nature rather than the pride of the brush; but this is not the only commendable portion of the work, it is sparkling and attractive throughout. There is in No. 78, 'On the Welvin,' by J. MILNE DONALD, a most perfect imitation of the deep and lustrous reflection of water, which has been most patiently imitated from nature, with the forms of near objects subdued to the tone of natural reflection, the glassy surface of the water never being forgotten. Any particularly successful part of a picture such as this

places nature so palpably before the spectator that, unless the other parts of the work are equally sustained by eminent quality, we can never see in them anything beyond the paint and the brush. As an instance of what is meant by the foregoing remark, in No. 92, 'English Road Scene,' ALEX. FRASER, we feel the paint too sensibly, the manipulation is hard although portions are creditably executed. No. 188, by the same artist, 'On the Avon, Warwickshire,' is more agreeable; the materials of the composition are a cottage, trees, barges, boats, &c. No. 195, 'Cattle on the banks of a River,' the cattle by T. SIDNEY COOPER, R.A., and the landscape by F. R. LEE, R.A., is a work of which we have already spoken, but the re-exhibition of old pictures is much to be regretted in a collection like this, save in cases of works of paramount excellence. It is difficult to understand why a work should be again brought before the public with so little to recommend it. No. 207, 'Highland Deer Forest—Isle of Skye,' by HORATIO MACCULLOCH, embodies the essential features of that kind of landscape which it professes to show; it is a highly picturesque passage of nature, with an appearance so rude as to seem yet unprepared as an abiding place for man; the picture is better in effect than colour. In No. 220, 'A Fresh Breeze off the coast of Holland,' by E. T. CRANFORD, R.S.A., the water is too grey to be so near the Dutch shore; the picture shows a strong leaning to the Dutch school of marine painting. No. 233, 'A Village on the Moors,' by HENRY BRIGH, strongly exemplifies that very masterly handling which prevails throughout all the pictures of this artist. This is the only work we have seen by him on the walls of an exhibition for years; it is perhaps too foxy in colour, with a predominance of that kind of inexorable conventionality which must arise from very rapid painting, without enough of the counsel of nature. No. 296, 'A Study of Beeches, near Lavers, Perthshire,' A. PERIGAL, A. These trees have been very closely studied from the reality, the composition throughout is most carefully wrought. No. 311, 'Lucy Ashton—finished sketch,' ROBERT GAVIN, A., is a very charming study—simply as a study—but it had been better to have given it no name than to have called it 'Lucy Ashton,' the impersonation being altogether too childish; it might with equal propriety be called either the 'Maid of Orleans' or the 'Witch of Endor.' No. 312, 'Moonlight Effect—Herring-boats going out,' GEORGE SIMSON, R.S.A., as an effect is very successful, and reminds the spectator of a favourite theme of the Dutch painters. No. 308, 'An Old Shuice,' by JOHN C. WINTOUR, a study throughout very satisfactory. No. 319, 'The Clansman's Curse,' JOHN C. BROWN, A.R.S.A., is a production of much merit, as also are—No. 365, 'An Old English Farmstead,' ALEX. FRASER; No. 370, 'An English Village Winter Afternoon,' SAM. BOUGH; No. 378, 'The Linn Sport, Dalry, Ayrshire,' J. H. CRANSTOWN; No. 450, 'A Woodland Burn,' JOHN C. WINTOUR, and by the same painter 'The Miller's Cottage,' No. 32, 'Outposts,' JAMES DRUMMOND, R.S.A., a work of much depth and careful finish. We cannot, however, omit to notice the works of MR. WALLER H. PATON: they are landscapes of the very highest order of merit; and place the name of the excellent artist not only foremost among the painters of his own school, but among those of the world, in the beautiful art of which he is a professor. They combine vigour with delicacy, and are remarkable for truths poetically rendered, the offspring of a powerful yet refined intelligence. There are many portraits of a high degree of excellence—but some of the best of these we have already noted elsewhere—there are also some masterly water-colour drawings which we have not space to particularise. The sculptural productions amount in number to thirty-eight, among which there are works by W. Calder Marshall, R.A., the late Patrie Park, W. Brodie, and other artists of reputation. As a whole, the exhibition contains many works of admirable quality, but not many strikingly ambitious. The rooms are imposing in effect, but that which is most objectionable is the re-exhibition of known pictures; it bespeaks weakness in the Scottish Academy.

THE ART-UNION OF LONDON.

The annual meeting of the subscribers to this institution met at the Haymarket Theatre on the 29th of April, to receive the report of the committee, and to witness the drawing of the prizes; Lord Montague, the President of the Society, took the chair. Mr. George Godwin, F.R.S., one of the honorary secretaries, to whose indefatigable exertions the Art-Union of London has so long been indebted, read the report, which stated that the total subscriptions for the past year amounted to 13,960*l.* 10*s.*, which sum has been thus expended:—Pictures and other prizes, 6,031*l.*; cost of engraving, 4,694*l.* 7*s.* 5*d.*; printing and other expenses, with a reserve of 2½ per cent. required by charter, 3,235*l.* 8*s.* 7*d.*; total, 13,960*l.* 10*s.* The sum set apart for prizes, to be selected by the prizeholders themselves, was allotted—27 works at 10*l.* each; 30 works at 15*l.* each; 24 works at 20*l.* each; 30 works at 25*l.* each; 20 works at 35*l.* each; 16 works at 50*l.* each; 10 works at 60*l.* each; 4 works at 75*l.* each; 3 works at 100*l.* each; 1 work at 150*l.*; 1 work at 200*l.* To these were added—11 bronzes of 'Her Majesty on Horseback,' 5 bronzes in relief of 'The Duke of Wellington entering Madrid,' 30 vases in iron; 20 porcelain statuettes, 'The Stepping-Stones,' 50 porcelain statuettes, 'The Dancing Girl reposing,' 34 porcelain busts of Clytie; 40 silver Medals of Flaxman; and 30 silver Medals of the late Sir J. Vanbrugh; 500 impressions of the lithograph, 'The Supper Scene,' and 250 of the mezzotint of 'Tyndale translating the Bible,' making in all 1130 prizes.

The engravings in preparation for the subscribers of the year 1856 are 'The Piper,' engraved by E. Goodall from the picture by his son, F. Goodall, A.R.A.; and 'The Clemency of Cœur de Lion,' engraved by H. C. Shenton, from the picture by Cross. For a future year a series of wood engravings, from the best works of deceased British artists, under the superintendence of Mr. W. J. Linton, is in the course of production, and promises to form a work of much beauty. The council have concluded an arrangement with the members of the Etching Club, including Messrs. Redgrave, Creswick, Horsley, Coppe, Taylor, &c., for a volume of etchings, to be appropriated hereafter; and they have further to announce, that some very important works have been put into the hands of engravers for ensuing years. Mr. Ward's engraving, 'Tyndale translating the Bible,' after Mr. A. Johnstone, is completed.

The prizeholders of last year purchased from the various exhibitions of the season 187 works of Art, to the following amounts, irrespective of the sums added by the prizeholders themselves:—From the Royal Academy, 1,975*l.*; the National Institution of Fine Arts, 1,771*l.* 10*s.*; Society of British Artists, 1,340*l.*; British Institution, 430*l.*; Water-Colour Society, 415*l.*; and New Water-Colour Society, 338*l.* 10*s.*

The retiring members of council are the Rev. Mr. Coleridge, Mr. Macdonald, Sir Wm. Herries, and Mr. Sydney Muirke; and in their place Mr. W. G. Taunton, Mr. Fras. Bannock, Mr. J. R. Soden, and Mr. Herbert Minton, have been elected.

The reserved fund now amounts to the sum of 6,955*l.*

The 200*l.* prize fell to the lot of Mr. James Scott, Wath, near Rotherham; that of 150*l.* to Mr. R. Keesly, of Grimsby; and the three of 100*l.* respectively to Mr. J. Bradshaw, Jun., of Leeds; Mr. J. Bontoft, Boston; and Mr. R. Robinson, St. Helen's, Liverpool. We may also observe that, as a remarkable instance of good fortune, five prizes fell to the share of Mrs. H. Graves, of Pall Mall—one of 25*l.*, a bronze statuette of Her Majesty on horseback, and a medal of Flaxman; and her son, we believe, gained another, a bronze of the Duke of Wellington's entry into Madrid.

Considering how the events of the past year have affected all matters of luxury, the Art-Union of London, as the above statement must show, seems not to have lost its hold on public favour. We hope with returning peace to find its next list of subscribers abundantly enlarged.

BRITISH ARTISTS:
THEIR STYLE AND CHARACTER.

WITH ENGRAVED ILLUSTRATIONS.

No. XV.—BENJAMIN ROBERT HAYDON.

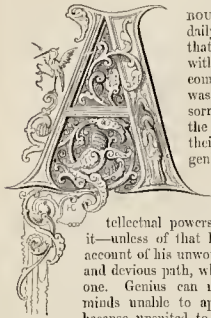

ABOUT the end of the month of June, 1846, the daily papers reported the melancholy intelligence that one long known to the public in connexion with Art had, in an hour of temporary insanity, committed self-destruction. The announcement was received by his personal friends with far more sorrow than surprise; and "Poor Haydon!" was the exclamation which escaped, not only from their lips, but from the lips of all to whom his genius and his conduct through life had made his name perfectly familiar. His is a sad history; yet on that very account is it fruitful of instruction to every man of great intellectual powers striving after fame, and who fails to reach it—unless of that kind which becomes mere notoriety—not on account of his unworthiness, but because he seeks it by a crooked and devious path, which the world will not recognise as the true one. Genius can never extort the "imble reputation" from minds unable to appreciate talent, or unwilling to recognise it because unsuited to their tastes, or rendered unpalatable by the

very attempts to force it into notice. There is, perhaps, scarcely a darker page presented in the whole annals of Art than that afforded by the history of this great painter—for such he undoubtedly was—from its commencement to its unhappy close, and his own pen has written it in the biography he left behind him.

A life so full of sad and strange incident, of turmoil and conflict, of labour and disappointment, would necessarily furnish ample materials for a lengthened

notice: our space forbids this; and, moreover, the subject is of so painful a nature that we feel no desire to say more than is just sufficient for the purpose we have in view.

Benjamin Robert Haydon was born at Plymouth in 1786; he displayed at an early age a taste for the Art to which he subsequently attached himself with so much devoted but ill-directed enthusiasm. His father, a bookseller in the town, cared little to encourage the inclination of his son, but at length yielded to his wishes, and sent him in 1804 to London, not, however, without the hope of soon seeing him return to the family roof. In this he was to be disappointed; nor was it very probable that a young man who possessed the spirit which the following passage from Haydon's autobiography expresses, would be easily turned aside from his path:—"The Sunday after my arrival," he says, "I went to the new church in the Strand, and in humbleness begged for the protection of the Great Spirit to guide, assist, and bless my endeavours; to open my mind, and enlighten my understanding. I prayed for health of body and mind; and on my rising from my knees felt a breathing assurance of spiritual aid which nothing can describe. I was calm, cool, illuminated, as if crystal circulated through my veins. I returned home, and spent the day in mute seclusion."

Very shortly after his arrival in the metropolis he entered the schools of the Royal Academy—this was in 1804; Fuseli, to whom he had received an introduction, took great interest in him. In 1807, he exhibited his first picture, "The Repose in Egypt," which was purchased by Mr. Hope, known as *Anastolus Hope*. In 1809, he exhibited his picture of "DENTATUS," which forms one of our engravings; through the intervention of Fuseli it was well placed in the rooms of the Royal Academy; but in consequence of the "hanging committee" removing it from the great room, where it had been first hung, to another, though the work was equally well seen, Haydon bitterly complained of the injustice done to him. This was the event that cast its shadow over all his after life, and involved him in an endless contest with the Academy, whom he openly accused of fearing his success as the founder of a new school of Historical Art. The "Dentatus," which was exhibited the following winter at the British Institution, where it gained the first prize of one hundred guineas, is a bold and vigorous composition, which would be honourable to any artist, whatever his standing; Haydon, when he painted it, had not reached his twenty-third year.



Engraved by J. J. [unclear]

RAISING OF LAZARUS.

[J. and O. P. Nicholls.]

From the outset of his career Haydon had his own ideas of the grand style of Historical Art, and he persevered in maintaining them whatever his patrons thought or desired to the contrary: is it a wonder, therefore, that he was comparatively neglected, or, at least, that he failed to satisfy many who would have befriended him? Sir George Beaumont, for example, gave him a commission to paint a subject from "Macheth" of a certain size, as he required it to occupy

a particular place in a room; Haydon produced a picture three times as large as the limits assigned him, and then was angry with his patron for expressing dissatisfaction with what he had done.

The painting of this picture, his quarrels with the Academy, and his literary disputations—his pen ever did himself more injury than his pencil benefited him—it seemed a pity he had ever been taught to write—appear to have occupied

Haydon till the spring of 1812, when he commenced his "Judgment of Solomon;" it was finished in the spring of 1814, and exhibited in the gallery of the Water-Colour Society, then in Spring Gardens. "The success of 'Solomon,'" he says in his diary, "was so great, and my triumph so complete, that had I died then my name must have stood on record as a youth who had made a stand against the prejudices of a country, the oppressions of rank, and the cruelty and injustice of two public bodies." It was purchased by two Devonshire gentlemen, Sir W. Eford and Mr. Tingeombe, for six hundred guineas, though what became of it for many years, till it was purchased by its present possessor, Sir E. Landseer, we know not; but when, in 1827, a public subscription was made to relieve the painter from his pecuniary difficulties, he gave the following

account of the disposition of his great pictures:—"My 'Judgment of Solomon' is rolled up in a warehouse in the Borough; my 'Entry into Jerusalem,' once graced by the enthusiasm of the rank and beauty of the three kingdoms, is doubled up in a back room in Holborn; my 'Lazarus' is in an upholsterer's shop in Moimt Street; and my 'Crucifixion' in a hayloft at Lisson Grove." This, it must be acknowledged, is a melancholy statement for a painter of genius to be compelled to make, and is anything but creditable to the country that allowed such neglect.

In the month of May, 1814, Haydon, accompanied by Wilkie, set out for Paris, at that time occupied by the allied armies of England, Russia, &c. Previous to starting, however, Haydon sketched in his "Christ's Entry into Jerusalem;" it was not completed till 1820; was then exhibited at the Egyptian Hall, Piccadilly, where it attracted such attention as to realise to the artist the sum of £1300. He then took it to Edinburgh and Glasgow; the proceeds of the exhibition at these two places realised about £900 more, exclusive of his expenses, so that it may fairly be stated the artist received little less than £2000 for the exhibition of

this single picture—by no means a small sum even for its purchase, though if it be considered that it took him nearly six years to complete, the annual income derived from it would be most inadequate for a painter of Haydon's talents and requirements.

His next work was the "Agony in the Garden," painted for Sir George Phillips, a liberal patron of Haydon, who had advanced him the price of it—five hundred guineas—to complete the "Solomon." "I exhibited it," writes the artist, "with my other works. I took a great deal of money at this exhibition, but not enough; and it was wrong so to strain public enthusiasm. This particular picture was severely handled. Sir George was disappointed

(though he was as much to blame as myself); and when the picture was sent home, he so objected to a sacred subject in a drawing-room, that he put it out of view altogether. It was wrong in me to paint it so large; it was wrong to choose such a subject to be hung where quadrilles were danced. It was wrong in every way." This picture was a short time since, and we believe is now, in the hands of Mr. Barrett, the picture-dealer, in the Strand.

But though Haydon could see his errors, he took no pains to amend them; obstinate and self-willed, he disregarded public opinion, vexed his patrons, and then foolishly complained of the injustice he had received. "I have been eight years," he says, "without a commission from the nobility; and of the thirty-nine years I have been an historical painter, thirty-two without an order of

any kind." And yet, notwithstanding his disappointments, he continued to paint pictures which, from their vast dimensions, no private individuals could hang up; and we have not yet learned to decorate our churches with such works of art. In 1820, he began his "Lazarus." We get an insight into the disposition of the painter from what he has left upon record, and therefore offer no apologies for our extracts. "I always filled my pointing-room to its full extent; and had I possessed a room 400 feet long, 200 feet high, and 400 feet wide, I would have ordered a canvas 199.6 long by 199.6 high, &c. My room was thirty feet long, twenty wide, fifteen high. So I ordered a canvas nineteen long by fifteen high, and dashed in my conception, the Christ being nine feet high. This was a subject and a size which I loved to my very marrow." Can such an act be called by any other name than a mental delusion?

But we have no space for comment, and can only briefly refer to the other pictures of this highly-gifted but infatuated painter. In 1827, he was incarcerated in the King's Bench Prison for debt. Here he painted the "Mock Election" held there for which George IV. paid him five hundred guineas; and the "Charing the Member," bought by Mr. Francis of Exeter, for three hundred guineas. Another work, painted about the same period, "Pharaoh Dismissing Moses," was purchased by a Mr. Hunter for five hundred guineas. His subsequent works were—the "Reform Banquet," the meeting of the "Anti-slavery Society;" the "Banishment of Aristides;" "Nero playing on the Lyre while Rome is burning;" "Curius;" and "Alexander the Great encountering a Lion." At the time of his death he was employed on another large work—"Alfred the Great and the First English Jury;" but mind and body were worn out—he succumbed before disappointed hopes and enfeebled physical powers.

The contemporaries of Haydon, both artists and art-critics, are scarcely in a



Engraved by]

QUINTUS CURTIUS.

[J. and G. P. Nicholls.

position to offer an unbiassed opinion on his pictures; party-feeling or prejudice has been too busily at work to allow us to exercise a calm judgment in estimating them. In his "Lectures on Art"—a work full of sound and valuable instruction—he says, "From the oppression of the authorities in Art, *without any cause* (?), and my subsequent resistance and opposition to them, I had brought on myself the enmity of all those who hoped to advance in life by their patron-

age; loss of employment from their continual calumny brought loss of income; the rich advanced loans to finish great works they were persuaded not to purchase," &c. This, there is little question, was but too true; we stop not to inquire how much his own conduct contributed to such a result; but it may safely be averred that in no country but our own would a painter of his genius, whatever his mental temperament may have been, have met with treatment similar to



engraved by

DENTATUS.

[J. and G. F. Neill.]

that experienced by Haydon during a large portion of his career. Can that be called a groundless charge of neglect which he brought against the public, when 12,000 people flocked to see General Tom Thumb in one week, and only 133 visited the pictures of "Aristides" and the "Burning of Rome," exhibited under the same roof at the same time? Was there not enough in this to excite the anger of a far less sensitive and excitable mind than Haydon's? and was it not sufficient

to urge him to the commission of the awful deed which deprived his country a month or two afterwards of a great and original painter? Pardon to his memory his excellence, no less than his failings, will hereafter receive its due reward.

Haydon, in his earlier time, had numerous pupils, several of whom have risen to eminence, though in a far different style from his own: among them were—Sir C. L. Eastlake, the Landseers, Lance, Prentice, and Harvey.

THE PROGRESS OF ART-MANUFACTURES.

GEM-ENAMELLED VASES BY MESSRS. JENNENS & BETTRIDGE.

We have on several occasions directed the attention of our readers to the manufactures in papier maché of Messrs. Jennens and Bettridge, of London and Birmingham; on this page are introduced engravings from works by the same firm of a totally different nature, but not the less

worthy of notice as beautiful objects of Art-manufacture: these are glass vases, produced by a patented process of gem-enamelling. The largest engraving is from one of a pair executed for Prince Albert, from designs by Mr. Lewis Gruner: they stand about seventeen inches in



height. The groundwork is of a rich deep purple colour. The surface of each vase is divided by floral festoons of gold and diamonds into four equal compartments, one of which is occupied by laurel wreaths of emeralds, with ruby scrolls, surrounding the initials "V" and "A" on a

maroon ground in topaz and gold. In the centre of each of the remaining divisions are the rose, shamrock, and thistle, in their natural colours: the mottoes, "*Dieu et mon droit*" and "*Treu und Fest*," in gold and diamonds, encircle the upper part of the vase, and above this are scrolls of

diamonds, enriched with wreaths of flowers in jewels of appropriate colours. The lower part is set in pierced mountings of electro-gilt metal, by Messrs. Elkington and



Mason, of Birmingham: between these mountings are devices of gold and jewels. The others it is unnecessary



to describe, as our object is principally to show the character of a novel and very beautiful branch of Art-manufactures, which will doubtless be much "inquired after."

THE MINSTRELS OF THE MIDDLE AGES.

BY THE REV. EDWARD L. CUTTS, B.A.*



VERY nobleman and gentleman of estate had one or more minstrels as a part of his regular household, and we have shown that their duties at dinner, in their lord's hall; to play during the progress of dinner; and to precede the gallant and fair company into the great chamber, there to make music to their dancing.

But the dance was not always in the great chamber. Very commonly it took place in the hall. The tables were only moveable hoards laid upon trestles, and at the signal from the master of the house, "A hall! a hall!" they were quickly put aside; while the minstrels tuned their instruments anew, and the merry folly at once commenced. In the illustration, of early fourteenth century date, which we here give from folio 174 of the Royal MS.,

2 B. vii, the scene of the dance is not indicated; the minstrels themselves appear to be joining in the saltation which they inspire. In the next illustration, reproduced from Mr. Wright's



"Domestic Manners of the English," † we have a curious picture of a dance, probably in the great chamber; it is from M. Barrois's MS. of the "Compte D'Artois," of fifteenth century date.



In these instances the minstrels are on the floor with the dancers, but in the latter part of the middle ages they were probably—especially on festal occasions—placed in the music gallery the screens, or entrance-passage of the hall.

Very probably the services of the minstrels of a gentleman's household were also required to assist at the celebration of divine worship. Allusions occur perpetually in the old romances, showing that it was the universal custom to hear mass before dinner, and even song before supper, *e. g.*: "And so they went home and unarmed them, and so to even-song and supper. * * * And on the morrow they heard mass, and after went to dinner, and to their counsel, and made many arguments what were best to do." ‡ Generally, it is probable, the service was performed by the chaplain in the private chapel of the hall or castle, and it seems probable that the Lord's minstrels assisted in the musical part

of the service. The organ doubtless continued to be, as we have seen it in Saxon times, the



most usual church instrument. Thus the King of Iluagary in "The Squire of Low Degree," tells his daughter:

"Thou shalt ye go to your oven song,
With tenours and trebles among;

Your quere nor organ song shal want
With countre note and dyscant;
The other half on organs playing,
With young children ful layu synging."

And in inventories of church furniture in the middle ages we find organs enumerated: * But not only the organ, but all instruments in common use, were probably also used in the celebration of divine worship. The men of those days were in some respects much more real and practical, less sentimental and transcendental than we in religious matters: we must have everything relating to divine worship of different form and fashion from ordinary domestic appliances, and think it irreverent to use things of ordinary domestic fashion for religious uses, or to have domestic things in the shapes of what we call religious art. They had only one art, the best they knew, for all purposes; and they were content to apply the best of that to the service of God. Thus to their minds it would not appear at all unseemly that the minstrels who had just enlivened with their strains their master's afternoon meal, should walk straight from the hall to the chapel, and attune more solemn strings of the self-same instruments to the divine praise. Moreover, they who deduced religious ceremonial from that of the Temple worship would not forget the cymbals, psalteries, and harps of the Levitical service. The only direct proof we can produce is that already mentioned, that the chapel royal establishment of Edward IV. consisted of trumpets, shalms, and pipes as well as voices; and we may be quite sure that the custom of the Royal chapel was imitated by nobleman and gentlemen of estate. It is remarkable that although representations of church interiors frequently occur among the illuminations of MSS., we have not been able to meet with one in which musicians, either playing organs or any other instrument, are introduced. Perhaps they were placed in the roof-loft which occupied the same relative position in the choir which the music gallery did in the hall. But we do derive from the MS. illuminations abundant proof that the ordinary musical instruments were not considered improper to be introduced into divine worship, for we meet with repeated instances in which David singing the psalms is accompanied by a band of musicians, as in the instance which forms the initial letter of this paper, which is taken from a psalter of early thirteenth century date in the British Museum (Harl. 5102). In the MSS. we not infrequently find the ordinary musical instruments placed in the hands of the angels; *e. g.* in the early fourteenth century MS. Royal 2 B vii, in a representation of the creation with the morning stars singing together, and all the sons of God shouting for joy, an angelic choir are making melody on the trumpet, fiddle, cittern, shalm and harp. There is another choir of angels at p. 168 of the same MS., two citterns and two shalms, a fiddle and trumpet. Similar representations occur very significantly in the choirs of churches. In the bosses of the ceiling of Tewkesbury Abbey Church we find angels playing the cittern (with a plectrum), the harp (with its cover seen enveloping the lower half of the instrument) and the cymbals. In the choir of Lincoln Cathedral,

* Edward VI.'s commissioners return a pair of organs in the church of St. Peter Mancroft, Norwich, which they value at 40*l.*, and in the church of St. Peter, Parmentergate, in the same city, a pair of organs which they value at 10*l.* (which would be equal to about 70*l.* or 80*l.* in these days), and soon after we find that the 184*l.* were "paid to a carpenter for making of a planche (a platform of planks) to sette the organs on."

* Continued from page 18.
† *Art-Journal*, vol. vi, p. 19.
‡ Mallory's "History of Prince Arthur," vol. i, p. 44.

some of the noble series of angels* which fill the spandrels of its arcades, and which have given to it the name of the angel choir, are playing instruments, viz., the trumpet, double pipe, pipe and tabret, dulcimer, viol and harp, as if to represent the heavenly choir attuning their praises in harmony with the human choir below:—“therefore with angels and archangels, and with all the company of heaven, we laud and magnify thy glorious name.” We cannot resist the temptation to introduce here another charming little drawing of an angelic minstrel, playing a shalm, from the Royal MS. 14 E iii.; others occur at folio 1 of the same MS. The band of village musicians with flute, violin, clarinet, and bass-viol, whom most of us have seen occupying the singing-gallery of some country church, are probably not inaccurate representatives of the band of minstrels who occupied the rood-lofts in medieval times.

Again, in those more private passages of arms, between a country knight and his neighbour,



who wished to keep their spears in practice against the next tournament; or between a couple of errant knights, who happened to meet at a manor-house; the lists were rudely staked out in the base-court of the castle, or in the meadow under the castle-walls; and, while the ladies looked on and waved their scarfs from the windows or the battlements, and the vassals flocked round the ropes, the minstrels gave animation to the scene. In the accompanying illustration from the title-page of the Royal MS., 14 E iii., a fine volume of romances of early fourteenth century date, we are made spectators of the principal actors in a scene of the kind; the herald is arranging the preliminaries between the two knights who are about to joust, while a band of minstrels inspire them with their strains.

In actual war only the trumpet and horn and tabret seem to have been used. In “The Romance of Merlin” we read of

“Trumps beting, tambours classing,”

in the midst of a battle; and, again on another occasion—

“The trumping and the tabouring,
Did together the knights fling.”

There are several instances in the Royal MS., 2 B, vii., in which trumpeters are sounding their instruments in the rear of a company of charging chevaliers.

The earliest instance which we meet with of the modern-shaped drum is in the Coronation-Book of Richard II., preserved in the Chapter-

house, Westminster. It may be necessary to assure those who are not accustomed to the medieval perspective, that the instrument in the accompanying illustration is really intended for a small drum of the ordinary modern shape.



Not only at these stated periods, but at all times, the minstrels were liable to be called upon to enliven the tedium of their lord or lady with music and song; the King of Hungary (in “The Squire of Low Degree”), trying to comfort his daughter for the loss of her lowly lover, by the promise of all kinds of pleasures, says that in the morning,

“Ye shall have harpe, santry, and songs,
And other myrthes you among.”

And again a little further on, after dinner,

“When you come home your mounie among,
Ye shall have revel, dances, and songs;
Lytte children, great and smalle,
Shall syng as doth the nightingale.”

And yet again, when she is gone to bed,

“And if ye no rest can take,
All night mynstrels for you shall wake.”

Doubtless many of the long winter evenings, when the whole household was assembled round the blazing wood fire in the middle of the hall, would be passed in listening to those interminable tales of chivalry which my lord's chief harper would chant to his harp, while his fellows



would play a symphony between the “fyttes.” Of other occasions on which the minstrels would have appropriate services to render, an entry in the Household Book of the Percy family in A.D. 1512, gives us an indication: There were three of them at their castle in the north, a tabret, a lute, and a rebec; and we find that they had a new-year's gift, “xxx. for playing at my lordes chamber dour on new yeares day in the morning; and for playing at my lordes sone and heire's chamber dour, the lord Percy, iis.; and for playing at the chamber dours of my lord's younger sones, my yonge masters, after viii. the piece for every of them.”

Clerical censors of manners during the middle ages frequently denounce the dissoluteness of minstrels, and the minstrels take their revenge by lampooning the vices of the clergy: like all sweeping censures of whole classes of men, the accusations on both sides must be received cautiously. However, it is certain that the minstrels were patronised by the clergy. We shall presently find a record of the minstrels of the Bishop of Winchester in the fourteenth century; and the ordonnance of Edward II. tells us that minstrels flocked to the houses of prelates as well as of nobles and gentlemen. In the thirteenth century, that fine sample of an English Bishop, Grosstete of Lincoln, was a great patron of minstrel science: he himself composed an allegorical romance, the Casteau d'Amour. Robert de Brunne in his English paraphrase of Grosstete's Manuel de Peches (begun in 1303), gives us a charming anecdote of the Bishop's love of minstrelsy.

“Y shal yow telle as y have herde,
Of the bysshope seynt Roberte,

* There are casts of these in the Medieval Court of the Crystal Palace.

Hys to-name ys Grosstet,
Of Lynkolve, so seyth the gest.
He loved moche to here the harpe,
For manyis write byt makyth sharpe.
Next hys chaumber, besyde hys stode,
Hys harpers chaumber was fast therby.
Many tynes be nyght and dayys,
He had solace of notes and layys.
One askede hym onys resin why
He hadde delyte in mynstrelay?
He answered hym on thys manere
Why he hadde the harper so dere,
The vertu of the harpe, thurgho skylle
and ryght,
Wyl destroye the fandes nyght;
And to the crewe by gode skylle
Ys the harpe lykened weyle.
Tharfor gods men, ye shul lere
Whan ye any gleman here,
To wureschap gode al yowre powere,
As Dauidy seyth yn the sature.”

Minstrels appear to have been retained in monasteries also.* We know that the abbots lived in many respects as other great people did; they exercised hospitality to guests of gentle birth in their own hall; treated them to the diversions of hunting and hawking over their manors, and in their forests; and did not scruple themselves to partake in those amusements; and it is not unlikely that they should also have minstrels wherewith to solace their guests and themselves. It is quite certain at least that the wandering minstrels were welcome guests at the religious houses; and Warton records many instances of the rewards given to them on those occasions. We may record two or three examples.

The monasteries had great annual festivals, on the ecclesiastical feasts, and often also in commemoration of some saint or founder; there was a grand service in church, and a grand

dinner afterwards in the refectory. The convent of St. Swithin, in Winchester, used thus to keep the anniversary of Alwyno the Bishop; and in the year 1374 we find that six minstrels, accompanied by four harpers, performed their minstrelies at dinner, in the hall of the convent; and during supper sang the same gest in the great arched chamber of the prior, on which occasion the chamber was adorned, according to custom on great occasions, with the prior's great dorsal (a hanging for the wall behind the table), having on it a picture of the three kings of Cologne. These minstrels and harpers belonged partly to the Royal household in Winchester Castle, partly to the Bishop of Winchester. Similarly at the priory of Becester, in Oxfordshire, in the year 1432, the treasurer of the monastery gave four shillings to six minstrels from Buckingham, for singing, in the refectory on the Feast of the Epiphany, a legend of the Seven Sleepers. In 1430 the brethren of the Holy Crosse at Abingdon celebrated their annual feast; twelve priests were hired for the occasion to help to sing the songs with becoming solemnity, for which they received four pence each; and twelve minstrels, some of whom came from the neighbouring town of Maidenhead, were rewarded with two shillings and four pence each, besides their share of the feast and food for their horses. At Mantoke Priory, near Coventry, there was a yearly obit, and in the year 1441, we find that eight priests were hired from Coventry to assist in the service, and the six minstrels of their neighbor, Lord Clinton, of Mantoke Castle, were engaged to sing harp and play in the hall of the monastery at the grand refectory allowed to the monks on the occasion of that anniversary. The minstrels amused the monks and their guests during dinner, and then dined themselves in the

* In the reign of King Henry II., Jeffrey, a harper, received an annuity from Hyde Abbey, near Winchester.

painted chamber (*camera picta*) of the monastery with the sub-prior, on which occasion the chamberlain furnished eight massy tapers of wax to light their table.

These are instances of minstrels formally invited to take part in certain great festivities; but there are proofs that the wandering minstrel, who, like all other classes of society would find hospitality in the guest-house of the monastery, was also welcomed for his minstrel skill, and rewarded for it with guerdon of money besides his food and lodging. Warton gives instances of entries in monastic accounts for disbursements on such occasions; and there is an anecdote quoted by Percy, of some dissolute monks who one evening admitted two poor priests whom they took to be minstrels, and ill-treated and turned them out again when they were disappointed of their anticipated gratification.

Here is a curious illumination from the Royal MS. 2 B vii., representing a monk and a nun themselves making minstrelsy.



The corporations of corporate towns probably also from early times had their band of minstrels, of whom the town waits are the modern representatives. The rules of the Beverly Guild of Minstrels order that "no new brother shall be admitted except he be minstrel to some man of honour or worship, or waite of some town corporate or other ancient town, or elac," &c.

But besides the official minstrels of kings, nobles, and gentlemen, bishops and abbots, and corporate towns, there were a great number of "minstrels unattached," and of various grades of society, who roamed abroad singly or in company, from town to town, from court to camp, from castle to monastery, flocking in great numbers to tournaments and festivals and fairs, and welcome everywhere.

The summer-time was especially the season for the wanderings of these children of song,* as it was of the knight-errant † and the pilgrim; ‡ also. No wonder that the works of the minstrels abound as they do with charming outbursts of song on the return of the spring and summer, and the delights which they bring. All winter long the minstrel had lain in some town, chafing at its miry and unsavoury streets, and its churlish money-getting citizens; or in some hospitable country-house, perhaps, listening to the wind roaring through the broad forests, and howling among the turrets overhead, until he pined for freedom and green fields; his host perchance grew tired of his ditties, and his only occupation to con new ones; this sounds like a verse composed at such a time:—

"In time of winter alange § it is!
The foulles lesen ¶ her bliss!
The leves fallen off the tree;
Rain alange ¶ the countree."

No wonder they welcomed the return of the bright warm days, when they could resume their gay, adventurous, open air life, in the fresh flowery meadows, and the wide green forest

* In the account of the minstrel at Kenilworth, subsequently given, he is described as "a squere minstrel of Middlesex, that travelled the country this summer time."

† "Miri it is in somer's tide,
Swaines gin on justing rido."

‡ "Whanne that April with his shour's soke," &c.
§ Than longen folk to gon on pilgrimages."

¶ Tedium, irksome.

¶ Lose their.

¶ Rendours tedious.

glades; roaming to town and village, castle and monastery, feast and tournament; alone, or in company with a band of brother minstrels; meeting by the way with gay knights adventurous, or pilgrims not less gay, if they were like those of Chaucer's company; welcomed everywhere by priest and abbot, lord and loon. These are the sort of strains which they crooned as they roamed under the white hawthorn, and carelessly tinkled their harps in harmony:—

"Merry is th' entis of May;
The fowles maketh merry play;
The time is hot, and long the day.
The joyful nightingale singeth,
In the grene meade flowres sprugeth."

"Merry it is in somer's tide;
Fowles sing in forest wide;
Swaines gin on justing rido,
Maidens liften hem in pride."

The minstrels were often men of position and wealth: Rayer or Raheus, the first of the king's minstrels, whom we meet with after the conquest,* founded the Priory and Hospital of St. Bartholomew, in Smithfield, London, in the third year of Henry I., A.D. 1102, and became the first prior of his own foundation. He was not the only minstrel who turned Religions. Fouquet de Marselle, first a merchant, then a minstrel of note—some of his songs have descended to these days—at length turned monk, and was made abbot of Tournet, and at length archbishop of Toulouse, and is known in history as the persecutor of the Albigeuses: he died in 1231. It seems to have been no unusual thing for men of family to take up the wandering adventurous life of the minstrel, such as others of the same class took up the part of knight adventurous; they frequently travelled on horseback, with a servant to carry their harp; flocking to courts and tournaments, where the graceful and accomplished singer of chivalrous deeds was perhaps more cressed than the large limbed warrior who achieved them, and obtained large rewards, instead of huge blows, for his guerdon.

There are some curious anecdotes showing the kind of people who became minstrels, their wandering habits, their facility of access to all companies and places, and the uses which were sometimes made of their privileges. All our readers will remember how Blondel de Nesle, a minstrel of Richard's court, wandered over Europe in search of his master. A less known instance of a similar kind, and of the same period, is that of Ela, the heiress of D'Evereux, Earl of Salisbury, who had been carried abroad and secreted by her French relations in Normandy. To discover the place of her concealment, a knight of the Talbot family spent two years in exploring that province; at first under the disguise of a pilgrim, till having found where she was confined, in order to gain admittance, he assumed the dress and character of a harper; and being a jocosso person, exceedingly skilled in the Gestes of the ancients, was gladly received into the family. He succeeded in carrying off the lady, whom he restored to her liege lord the king who bestowed her in marriage—not upon the adventurous knight-minstrel, as ought to have been the ending of so pretty a novellet—but upon his natural brother William Longespée, to whom she brought her earldom of Salisbury in dowry.

Many similar instances, not less valuable evidences of the manners of the times because they are fiction, might be selected from the romances of the middle ages; proving that it was not unusual for men of birth and station † to assume, for a longer or shorter time, the character and life of the wandering minstrel.

But besides these gentle minstrels, there were a multitude of others of lower classes of society, professors of the joyous science, descending through all grades of musical skill, and of re-

* The king's minstrel, who is recorded in Domesday book as possessing lands in Gloucestershire, was the minstrel of the last of the Saxon kings.

† Fontenelle ("Histoire du Theatre," quoted by Percy) tells us that in France, men, who by the division of the family property, had only the half or the fourth part of an old seigniorial castle, sometimes went rhyming about the world, and returned to acquire the remainder of their ancestral castle.

spectability of character. We find regulations from time to time intended to check their irregularities. In 1315 King Edward II. issued an ordinance addressed to Sheriffs, &c. as follows: "Forasmuch as . . . many idle persons under colour of mynstrelsie, and going in messes* and other faigned busines, have been and yet be received in other men's houses to meate and drynke, and he not therewith contented yf they be not largely considered with gyftes of the Lordes of the Houses, &c. . . . We wylling to restrayne such outrageous entreprizes and idleues, &c. have ordeyned . . . that to the houses of Prelates, Earls, and Barons, none resort to meate and drynke unless he be a mynstrell, and of these mynstrels that there come none except it be three or four mynstrels of honour at most in one day unless he be desired of the Lorde of the House. And to the houses of meener men, that none come unless he be desired; and that such as shall come so, holde themselves contented with meate and drynke, and with such curtesie as the Master of the House wyl shewe unto them of his owne good wyll, without their asking of any thyng. And yf any one do against this ordinance at the first tyme he do lose his mynstrelsie, and at the second tyme to forswear his craft, and never to be received for a mynstrell in any house." This curious ordinance gives additional proof of several facts which we have before noted, viz, that minstrels were well received everywhere, and had often become exacting in their expectations; that they used to wander about in bands; and the penalties seem to indicate that the minstrels were already incorporated in a guild. The first positive evidence of such a universal guild is in the charter (already alluded to) of 6th King Edward IV., A.D. 1469, in which he grants to Walter Hilday, *Marshal*, and seven others, his own minstrel, a charter by which he restores a Fraternity or perpetual Guild (such as he understands the brothers and sisters of the Fraternity of Minstrels had in times past) to be governed by a marshal, appointed for life, and by two wardens, to be chosen annually, who are empowered to admit brothers and sisters into the guild, and are authorised to examine the pretensions of all such as affect to exercise the minstrel profession; and to regulate, govern, and punish them, throughout the realm—those of Chester excepted. It seems probable that the King's minstrel, or the King of the Minstrels, had long previously possessed an authority of this kind over all the members of the profession; and that the organisation very much resembled that of the heralds. The two are mentioned together in the Statute of Arms for Tournaments, passed in the reign of Edward I. A.D. 1295. "E que nul Roy de Harraunz no Menestrals* portent privez armez: no that King of the Heraldz or of the Minstrels shall carry secret weapons. That the minstrels attended all tournaments we have already mentioned. The heralds and minstrels are often coupled in the same sentence; † thus Froissart tells us that at a Christmas entertainment given by the Earl of Foix, there were many minstrels as well his own as strangers, "and the Earl gave to Heraldz and Minstrelles the sum of fyve hundred frankes; and gave to the Duke of Tourayne's mynstrelles gowns of cloth of gold furred with ermine, valued at 200 frankes." ‡

[To be continued.]

* In the MS. Illustrations of the thirteenth and fourteenth centuries, the messenger is denoted by peculiarities of equipment. He generally bears a spear, and has a very small round target (or, perhaps, a badge of his lord's arms) at his girdle. In the fifteenth century we see messengers carrying letters openly, fastened in the cleft of a split wand.

† It is right to state that one MS. of this statute gives *Menestrals* instead of *Menestrals*; but the reading in the text is that preferred by the Record Commission, who have published the whole of the interesting document.

‡ In the romance of *Richard Cour de Lion* we read that, after the capture of Acre, he distributed among the heralds, disours, tabourers, and trompeurs, who accompanied him, the greater part of the money, jewels, horses, and fine robes, which had fallen to his share. We have many accounts of the lavish generosity with which chivalrous lords propitiated the favourable report of the heralds and minstrels, whose good report was fame.

RELIGION CONSOLING JUSTICE.
FROM THE MONUMENT BY J. EDWARDS

THIS very beautiful example of monumental sculpture, from the chisel of Mr. J. Edwards, is erected, in memory of the late Right Hon. Sir J. B. Bosanquet, one of the Judges of the Court of Common Pleas, in the church of Dingestow, Monmouthshire.

Mr. Edwards is a young sculptor, whose works in the Royal Academy have in more than one instance called forth our special approbation; he possesses talents of no common order, which only require a prominent field of labour, and to be more widely known, to be fully appreciated. His mind appears amply stored with such qualifications as are essential to make a great artist, and there is little doubt of his becoming one, with suitable opportunities for developing what is in him.

We cannot do better, by way of describing this monumental group, than give the sculptor's own ideas of his composition: these will show what he has desired to represent, and they will also prove him to be a man of deep and earnest thought, purposing to make his Art elevated and intellectual. Mr. Edwards has furnished us with the following remarks on the subject:—"My first and chief object was to aim—so far as I could by sculptural treatment—at representing 'Religion and Justice' as the twin daughters, so to speak, of Wisdom and of High Feeling; these latter being, of course, ultimately traceable to the Eternal. This view of the subject was necessary to accord, so far as practicable by me, with the profound and refined mental characteristics of the distinguished judge to be commemorated, in whom religion and justice, in their highest form, shone as salient qualities of the mind. My next object was to take care, in order to continue in keeping with the mental characteristics just named, that the twin sisters in the group should be free from all affectation and display, and that 'Religion' should have nothing prominently apparent but humble and earnest trust in God. In the figure of 'Justice'—from her being, in my view of the subject, less imbued, perhaps, by faith than her sister, it was necessary to have a deep but subdued grief indicated, such as great natures can alone feel at the heavy amount of human woe directly and indirectly connected with the stern necessity that Equity should ever drive Iniquity away, even by the unheeding terrors of the law, where holy love, religion, and morality fail; this deep grief of 'Justice' being subdued by the consoling influence of her sacred sister, 'Religion,' who, in the moment chosen for illustration in the design, looks up in earnest trust to God."

We apprehend that few of our readers will be disposed to consider that Mr. Edwards has failed to carry out the spirit of his conception, for the work exhibits a profoundly religious sentiment, expressed with much poetic feeling, while the whole is treated in a truly skillful and artistic manner. All the accessories of the work are in complete harmony with its leading ideas, and evidence the study which the sculptor gave to the subject to render it perfectly. The monument is executed in the finest Italian marble.

In such sculptured works as these there is a large and important field for the labours of the artist, where due encouragement is afforded him: Mr. Edwards has already done good service therein: he has executed monuments to the sixth and seventh Dukes of Beaufort, and is at present, we believe, engaged upon a similar memorial of the late Duchess of Beaufort. In St. Botolph's Church, Colchester, is also an elegant monument from his chisel to the memory of W. Hawkins, Esq., and two of his children; another at Berechurch, Essex, to Mrs. White, besides others we have not space to point out. Among the ideal subjects for reliefs and statues which he has exhibited at the Royal Academy and the Industrial Exhibition of 1851, we may name "The Last Dream," "The Daughter of the Dawn," "The Spirit ascending," "The Weary reassured," "A Philosopher instructing a Youth," and "The High Priest-Priest of Science." Most of these works have been favourably spoken of by us at various times.

THE COLLECTION OF THE LATE
SAMUEL ROGERS.

THE gatherings of a long life, selected with the refined taste of a poetic mind, and long renowned in private circles, have invested with an unusual interest the sale of works of Art and *verts* which adorned the house of Samuel Rogers the poet. It is seldom that so important a series of pictures appears for sale, numbering among them works which are of European renown, with others belonging to a few prominent names in the English school, which have risen to greatness during the life of the collector, and are curiously instructive to those who watch the steady progress of true genius even in its "money value" merely. We allude to such pictures as LESLIE'S small original of 'Sancho and the Duchess,' for which the artist obtained 100*l.*, and Rogers paid 70*l.*, but which has now realised 1120 guineas, although the artist has painted *replicas*, one of which adorns the Vernon Gallery. The same artist's curious picture of 'The Lady Teaching a Child to Read,' and which was painted for Mr. Rogers from MARC ANTONIO'S engraving of RAPHAEL'S design, realised 320 guineas: it cost Rogers about one-sixth of that sum. Such lessons should not be lost on men who have taste and power to patronise Art by direct communication with artists, thus profiting giver and receiver.

The 236 pictures forming this collection have realised 30,000*l.*: they were sold by Messrs. Christie and Manson on the 2nd and 3rd of May. The most important of the British school were those by RETNAULD'S; it is seldom that we see such fine and pure works of the master as Rogers possessed. 'The Strawberry Girl,' and 'Puck,' have both become types of certain qualifications appertaining to English growth in Art. It is to be regretted that Rogers did not bequeath these pictures to our nation, for they belong so peculiarly to the National Gallery that we shall ever regret their absence from its walls. The first fetched 2100 guineas, the second 980 guineas. Sir Joshua's own criticism on the first was "no man can produce more than half-a-dozen really original works, and that is one of mine." It is a charming impersonation of the arch diffidence of childhood, and perhaps there can be no stronger instance of the strange sort of descriptive criticism that may come from the highest authorities in Art than that appended to this picture in the sale catalogue.—Sir Thomas Lawrence speaks of it as "that magnificent display of impudent knowledge that kicks modesty out of doors," and which can call up no other idea than that of a Nell Gwynne offering fruit at a theatre door, whose beauty can alone excuse her impudence; and yet the picture is that of a simple child of some four years of age, whose natural shyness is only dispelled by a twinkle of frank pleasure, as a playmate or protector is recognised. The 'Puck' is the well-known picture painted for Boydell's Shakespeare Gallery. 'Puck' is a mischievous baby seated on a toadstool, having the ears of a fawn to disassociate him from the human world, but having no more resemblance to the poet's great creation than 'Hamlet to Hecuba.' As a picture, or as an invention, it is an extraordinary work, but no such "realisation" of our national poet could be received from a modern artist in these days of Shaksperian criticism, and nothing can show its advance since the time of Boydell more than this work of Reynolds. The collection was particularly rich in the first President's works, and they exhibited his beauties and his faults most thoroughly, as well as the fatal decay to which he condemned them by his unfortunate taste for speculating in "vehicles." 'The Girl Sketching' is covered with cracks, and 'The Cupid and Psyche' positively unpleasant to look at from the tones which the glazings and tints have assumed. The first fetched 350 guineas, the second 400. A beautiful small copy, by Sir Joshua, of Vandyke's 'Marquis of Huntley,' in the best and purest style, only realised 55 guineas. 'The Mob Cap,' forming the principal figure in his famous picture of 'The Infant Academy,' was bought for 780 guineas, though exceedingly slight in style,

and looking little better than a mass of dirty paint."

A small 'Sea-piece,' by J. M. W. TURNER, painted in early life, but displaying none of the peculiarities which made him great, was purchased for 182*l.* 14*s.*; WILKIE'S 'Death of the Red Deer,' also a small picture, brought 375 guineas. HAYDON'S small *replica* of 'Napoleon on the Shore of St. Helena,' 65 guineas. Sir CHARLES EASTLAKE'S 'Sisters,' realised 380 guineas, and LESLIE'S 'Princes in the Tower,' 22*l.* 15*s.*

Of the Italian School, the most important picture was RAFFAELLE'S 'Madonna and Child' for purity of composition and sweetness of expression; it realised only 504*l.*, less than was paid for it by Mr. Hibbert at the sale of the Orleans Gallery. The finest Flemish picture went also cheaply, a TENIERS, representing a 'Witch quitting Inferno'; this picture was so much admired by Sir Joshua Reynolds that to obtain it from Dr. Cbauncey, who then possessed it, he gave three of his own productions, and two others by celebrated masters. This really extraordinary work was in the purest and finest condition, as brilliant as the day it was painted, admirably displaying the clearness of touch and quaint fancy of the master. It was secured by Dr. Seymour for 315*l.*; it should have been in the National Gallery. RUBENS' copy of the fresco by ANDREA MANTEGNA of the 'Triumph of Julius Cæsar' was purchased for that institution at the price of 1102*l.* 10*s.* Rubens seems to have set much value on this early study, and would never part with it; it is named in the inventory of his effects made after his death, and was sent by Sir Balthazar Gerbier to our Charles I., pending the possible purchase of the collection by that monarch.

The most remarkable early work of Art was the miniature oil-painting by VAN EYCK representing 'The Virgin with the Infant Saviour in her lap,' seated beneath an elaborate Gothic niche. It covers but a few inches of surface, but they are characterised, as Waagen remarked, by "the *ne plus ultra* of delicacy and precision." In the convolutions of the Gothic tracery are represented 'The Seven Joys of the Virgin,' so minutely pencilled as to require a magnifier to comprehend them, and yet all is done with a vigour of touch and power of effect the most surprising. It was purchased by Mr. Rogers from Mr. Aders for 150*l.*, and was now sold for 255 guineas. Next in interest was the portrait of 'Himmelinck, by himself,' dated 1462, and which Rogers obtained also from Mr. Aders; it represents the artist in the dress of the hospital of St. John at Bruges, where he died, and where is still preserved his *chef d'œuvre*, the reliquary of St. Ursula, covered by him with the most minute and beautiful paintings. This curious picture is engraved by Passavant for his notice of the artist and his works; it was sold for 86 guineas. The figures of St. John and St. Mark, by LUCAS VAN LEYDEN, are curious for the engraver-like character of their handling, a peculiarity which is also distinctive in the works of Albert Dürer, of whose powers Mr. Rogers possessed some fine examples in drawings, but the paintings called his we should greatly doubt as the work of his hand. The drawings were all striking specimens of Dürer's precision and truth; the portrait of the Duke of Saxony, most carefully executed with the pen, realised 7*l.* Lucas Van Leyden's equally elaborate pen drawing of the Emperor Maximilian brought 20*l.* But the highest price realised by any of the drawings was 440 guineas for RAFFAELLE'S study for 'The Entombment of Christ.' It was formerly in the Crozat collection, and cost Rogers 120*l.*

The two works by Cimabue, consisted of a small picture of 'The Virgin enthroned amid Saints,' on a characteristic gold ground. It fetched 52*l.* The other represented 'an Evangelist writing,' and formerly belonged to Otley. The band of Giotto was said to be seen in a beautiful small work representing 'The Virgin and Child with Angels.' Dr. Waagen, however, attributes this work to Benozzo Gozzoli. It fetched 310 guineas. A genuine work of this rare master, however, appeared in a small fragment of fresco from the church of the Carmelites at



Faint, illegible text centered below the illustration.

Faint, illegible text centered at the bottom of the page.

No.	Name	Age
1	John Smith	25
2	Mary Jones	30
3	James Brown	18
4	Elizabeth White	45
5	Robert Black	22
6	Sarah Green	35
7	William Grey	15
8	Anna King	40
9	Thomas Lee	20
10	Jane Scott	28
11	George Adams	12
12	Patricia Baker	38
13	Richard Clark	17
14	Laura Evans	42
15	Henry Hill	23
16	Grace Young	32
17	Frank Miller	14
18	Elizabeth Taylor	48
19	Charles Wilson	19
20	Anna Moore	27
21	Joseph Taylor	11
22	Margaret White	37
23	Samuel King	16
24	Rebecca Green	41
25	David Black	21
26	Ann Brown	31
27	John White	13
28	Elizabeth King	46
29	George Taylor	18
30	Jane Adams	26
31	William Baker	10
32	Mary Clark	36
33	Robert Evans	15
34	Sarah Hill	43
35	Thomas Young	24
36	Anna Miller	33
37	James Taylor	14
38	Elizabeth King	49
39	Charles Adams	19
40	Anna Moore	28
41	Joseph Taylor	11
42	Margaret White	37
43	Samuel King	16
44	Rebecca Green	41
45	David Black	21
46	Ann Brown	31
47	John White	13
48	Elizabeth King	46
49	George Taylor	18
50	Jane Adams	26



RELIGION CONSOLING JUSTICE

FROM A DESIGN BY J. ETIARD.

SCULPTED BY M. BONNARDON, AND ENGRAVED BY M. BOSANQUET, UNDER THE SUPERVISION OF M. DE LAUNAY.

PARIS, AT THE PRESS OF M. DE LAUNAY, 1824.

PRINTED BY M. DE LAUNAY, 1824.

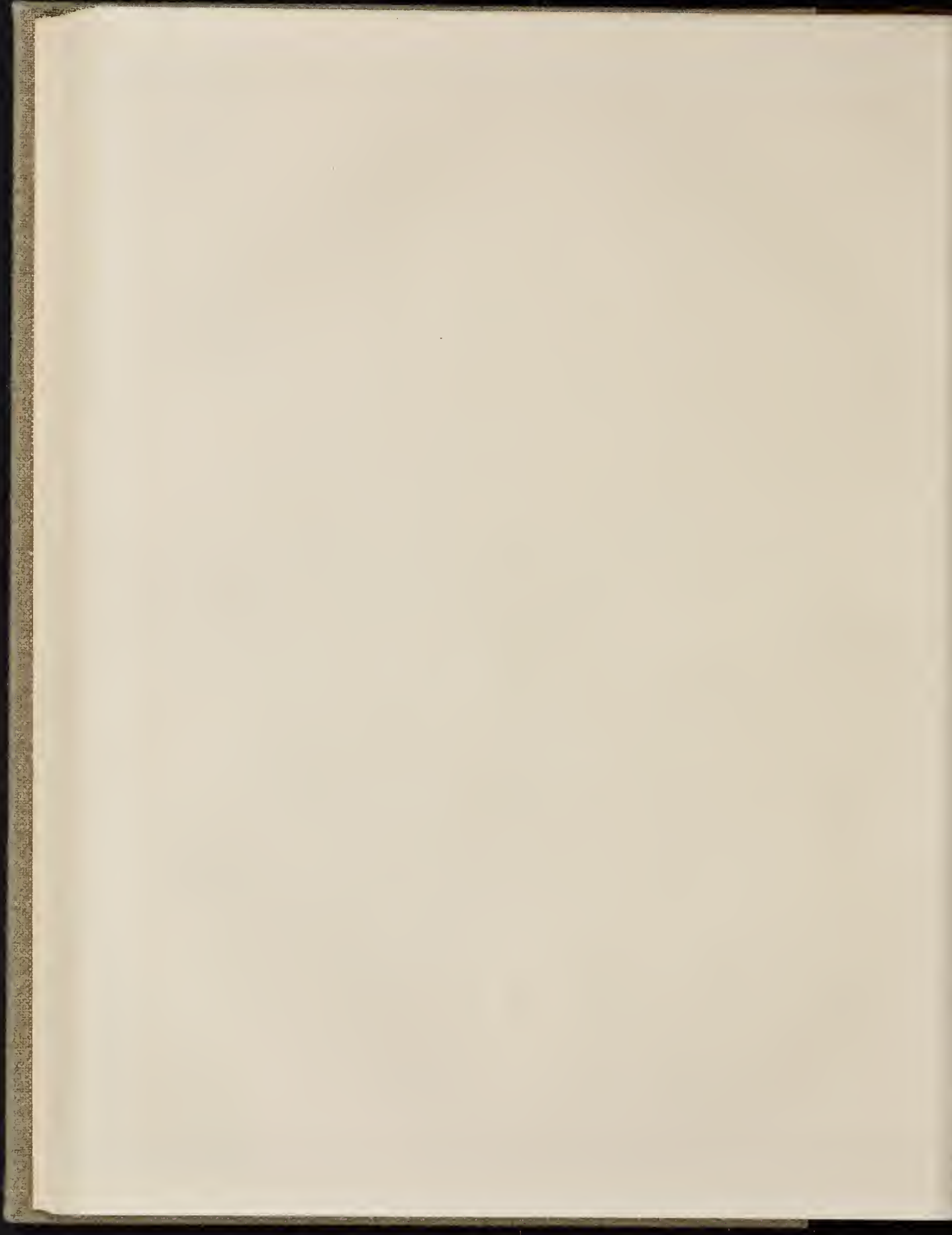

Florence, saved from the fire which destroyed it about 100 years since; it represents the heads only of St. Peter and St. John, bowed with deprecating sorrow, as their clasped hands are raised upwards. It has the grotesque character of earlier Art, combined with a power of thought and intensity of expression for which the Florentine was famous, and which again raised Art into vitality. A LORENZO DI CREDI, the "Coronation of the Virgin," almost equal to RAFFAELLE, and displaying this rare master to great advantage, fetched 380 guineas; GAIOPALDO'S "Riposo" sold for 588*l.*; GORGIONE'S "Knight and Lady," 88 guineas. The celebrated BAROCCIO, "La Madonna del Gatto," from the Salviati Palace, Rome, and which was used in retouching the same subject in our National Gallery, realised 200 guineas. TINTORETTO'S "Miracle of St. Mark" brought 430*l.* 10*s.*; it is a powerful sketch for the great work now in the Venetian Academy.

Mr. Rogers selected three pictures to be over before his eye. They were placed over his writing-table, near the bow-window of a room on the first floor, overlooking the Green Park. One was by RAFFAELLE, and was originally part of a *predella* to the altar of the Nuns of St. Anthony, at Perugia; its subject was "Christ in the Garden of Gethsemane." Another was "The Mill," by CLAUDE; and the third "The Virgin and Saints," by L. CARRACCI. The RAFFAELLE realised 450 guineas; the CLAUDE, 660 guineas; and the CARRACCI, 160 guineas. It has seldom fallen to the lot of authors, particularly of the poetic tribe, to refresh their eyes by decorating their walls with works of art, whose money-value nearly reaches thirteen hundred pounds!

In portraiture we may note the finished study by TITIAN for his grand picture of "Charles V. of Spain, riding in a suit of tilting armour," which sold for 195 guineas; and the more finished and rarer VELASQUEZ, the boy Don Balthazar, son of Charles IV. of Spain, on a black horse, with the Tennis Court at Madrid in the background; this striking picture realised 1270*l.* 10*s.* HOLBEIN'S "Cesar Borghia," a very fine picture, fetched 81 guineas.

The landscapes included some fine studies by CLAUDE, POUSSIN, REMBRANDT, RUBENS, and VAN DER NEER, as well as one by WILSON and GAINSBOROUGH. The highest price was paid for NICHOLAS POUSSIN'S "Campagna of Rome," bought by Lord Fitzwilliam for 1929*l.*; RUBENS'S "Wagon Landscape" fetched 640*l.* 10*s.*; and his "Solitude" 310 guineas; they are both characterised by grandeur of design and power of execution.

Of the pictures not hitherto noticed, we may point out:—"A Group of five Peasants, seated round a table, smoking," TENIENS, 101 guineas; "A Knight on a white horse trampling on a Moorish Prince," B. VAN ORLEY, or BERNARD of Brussels, 100*l.*; "A Masquerade," WATTEAU, 155 guineas; "A Concert," the companion picture, 175 guineas; "A Roman Villa," CLAUDE, from the Orleans gallery, 135 guineas; "Portrait of an Italian Lady," A. VEROCCHIO, 185 guineas; "A Lady and Cavalier," WATTEAU, 140 guineas; "The Horrors of War," a small *replica* of the large picture by RUBENS in the Pitti Palace, 200 guineas; "A Woman with a Bird on her hand, at which a Child is looking intently," from the Borghese Palace, GUERCINO, 300 guineas; "The Virgin, with an Infant in her lap, presenting the Cross to St. Francis," PALMA, 315 guineas; "A Forest Scene, with Figures," REMBRANDT, 250 guineas; "The Dead Christ watched by two Angels," a *replica* of the picture by GUERCINO, in the National Gallery, 155 guineas; "The Adoration of the Shepherds," N. POUSSIN, 110 guineas; "Woody Landscape," GASTON POUSSIN, 166 guineas; "A Classical Landscape," by the same, from the Colonna Palace, 151 guineas; "A Party of Ladies and Cavaliers," WATTEAU, 140 guineas; "The Birdcatchers," DOMENICINO, from the Borghese Palace, 120 guineas; "The Infant Christ," DOMENICINO, 145 guineas; "Philip IV. of Spain," VELASQUEZ, 205 guineas; "The Adoration of the Magi," G. BASSANO, 130 guineas; "The Good Samaritan," G. BASSANO, 230 guineas; "The Infant and St. Francis," MERILLO, 230 guineas; "Mary Magdalen anointing the

Feet of Christ," P. VERONESE, 380 guineas; "Portrait of Rembrandt," by himself, 310 guineas; "St. Joseph embracing the Infant Christ," MERILLO, 380 guineas; "Christ discovered by his Parents disputing in the Temple," MAZZOLINO DI FERRARA, 500 guineas; "La Gloria di Titiaro," TITIAN, 270 guineas; "The Battle between Constantino and Maxentius," RUBENS, 260 guineas; "The Virgin, Infant, and St. Joseph," CORREGGIO, 240 guineas. These prices will serve to show that genuine pictures by the old masters yet find favour with collectors; and the majority of these works, moreover, are of cabinet size, perhaps a reason why they are so much coveted.

But the sums paid for English paintings, as already instanced, must leave our artists nothing to complain of; the competition for these was as great as that for the ancient works. Stothard's "Canterbury Pilgrims," and its companion, "The Principal Characters of Shakespeare," sold respectively for 103 guineas, and 102 guineas. The other principal pictures were—"Italian Landscape," R. WILSON, 130 guineas; "Girl with a Bird," REYNOLDS, 230 guineas; "Woody Landscape," REYNOLDS, 105 guineas; "Landscape, with Peasants in a Cart, crossing a Stream," GAINSBOROUGH, 250 guineas; "The Sleeping Girl," REYNOLDS, 150 guineas; "Landscape, with a Cottage near a Stream," GAINSBOROUGH, 120 guineas; "View from Richmond Hill," REYNOLDS, 430 guineas; "Adrian's Villa," R. WILSON, 135 guineas; "Mecenas's Villa," R. WILSON, 130 guineas; "Italian Landscape, with Cattle and Peasants on the Banks of a River," R. WILSON, 195 guineas.

We have still a few additions to make to the sales of Mr. Rogers's collection: FLAXMAN'S statuette of "Cupid," executed for its late owner as a companion to his "Psyche," sold for 115 guineas; the "Psyche," for 185 guineas; ROUBILLAC'S bust of Pope, in terra-cotta, 137 guineas; a pair of plaster statuettes, never executed in marble, of Michael Angelo and Raffaello, modelled for Sir T. Lawrence, 34 guineas. Of framed drawings, RAFFAELLE'S "Virgin, Infant Christ, and St. John," in red chalk, pen and ink, sold for 140 guineas; "The Entombment," another by RAFFAELLE, purchased by Mr. Rogers from the Crozat collection for 120 guineas, now realised 440 guineas.

The drawings collected by Mr. Rogers were equally indicative of his varied and correct taste. Specimens by our own STOTHARD enormously preponderated, and exhibited the great versatility and purity of his fancy; but the finest examples of the British School were the sketches by FLAXMAN, for his immortal illustrations to "Eschylus," "Homer," and "Dante," works which have done most to raise the English School of Design in the estimation of Europe, but which are not yet fully comprehended in England.

The sale began with antiquities, and ended with hooks and coins. It will thus be perceived that the poet was a general collector, and valued all that a true connoisseur should cherish, restricting himself to no particular style or age in Art. The bent of his taste led him to the Classic, and he was richest in Greek works. It is seldom that so fine a collection of vases and antique Greek gold is brought to public sale, and it speaks better for public taste than has lately been exhibited, when we find they have realised good prices. It has lately been the case, that noble vases of Greek work, of the best period of Art, have sold for one-half the price realised by some painted abortion of the Renaissance, or comparatively modern work of Dresden, Sevres, or even Chelsea. This is termed "fluctuation of taste," but it should rather be called its "decadence." We are, therefore, glad that the predictions uttered before the sale, have not been realised. The "Cyxix" which the poet kept under a glass, on a small table in his drawing-room, and which was painted with figures of "Athletes preparing for the Stadium," all delineated with a perfection of beauty and truth, in simple outlines on its surface, fetched 51 guineas. An "Amphora," with a representation of "Theseus slaying the Minotaur," sold for 90 guineas; and the large vase, with the "Marriage of Bacchus and Ariadne," which once decorated the ante-

room of Rogers's House, realised 40 guineas. The bronze candelabrum, at the foot of which was seated a Roman lady in a chair, which is said to have suggested the form of those used by Rogers in his dining-room, was sold for 51 guineas; it was, however, but the wreck of a fine work. It was recovered from the sea at Puzzuoli, and was blistered and corroded so much, that in some places it looked only like a mass of metal. A more curious work was the Roman *Bulla* in gold, inscribed with the name of the young patrician, Hostus Hostilius, for whom it was fabricated. It was found in 1794, and secured by Bellotti, from whom Rogers purchased it, he having before refused 100 louis-d'or for it; it is now sold for the very moderate sum of 56*l.* 14*s.*

The sale has exhibited the usual fluctuations and caprices which characterise the auction-room; and our notes exhibit in some degree this usual accident in such localities; but not so marvellously as an instance which occurred on the second day, when Michael Angelo's terracotta study for the figure of "Lorenzo di Medici" upon his tomb at Florence, was bought for 23 guineas, while two modern French bronze copies of the figures upon the same tomb, sold for 90 guineas each. Such caprices are not reducible to reason, and show that good things and bad run equal chances beneath the auctioneer's hammer. The gross receipts of the sale are, however, satisfactory; and so is the opinion it helps us to form of the state of public taste, as exhibited at this the most important sale of the present season.

PICTURE SALES.

On the 5th and 6th of May, Messrs. Foster & Son sold, at their rooms in Pall-Mall, a very interesting collection of English pictures and drawings, "selected with much judgment and great knowledge of art by an amateur resident in the north;" the majority of the works, 188 in number, were certainly of a good class, and from the pencils of a large number of our best painters. Among the highest priced oil paintings were "The Golden Age," F. DANBY, A.R.A., bought by Mr. H. Graves, for 241*l.* 10*s.*; "Queen Blanche, ordering her son, Louis IX., from the presence of his Wife," A. ELMORE, A.R.A., 231*l.*, also by Mr. Graves; "Dolly Varden," by W. O. FRITH, R.A., 190*l.* 10*s.*, by Mr. Wallis; "Patriotic and the Ladies at Breakfast," A. EGG, A.R.A., 141*l.* 15*s.*, by Mr. Meers; "The Master is come, and calleth for thee," F. STONE, A.R.A.; "Early Morn'g," J. SAMP, 178*l.* 10*s.*; "English Homestead," T. CRESWICK, R.A., 103*l.* 19*s.*, purchased by Mr. Parnell; "Fruit and a Cinquecento jewelled Canto," G. LANCE, 99*l.* 15*s.* Of the drawings we may point out WEBBET'S "Caxton's Printing Press," sold for 110*l.* 5*s.* to Mr. Copp; "Hunt the Slipper," the sketch, we believe, for the larger oil-painting by F. GOODALL, A.R.A., bought by Mr. Lambart; "The First of September," F. TAYLER, 59*l.* 17*s.*, by Mr. Vokins; "The Watering Place," D. COX, 44*l.* 2*s.*; "The Forest," J. LINNELL, 38*l.* 17*s.*, by Mr. Wallis; "Rough Water," C. STANFIELD, R.A., 33*l.* 1*s.* 6*d.*; "Flowers and Holly," W. HUNT, 26 guineas.

The collection of English pictures belonging to Mr. Fairlie was sold by Mr. Phillips on the 22d and 23d of April; among them was TURNER'S poetical landscape, "The Temple of Jupiter," painted in 1818, and well-known from the engraving; it was knocked down to Mr. Gambart for 1,365*l.*; a small picture by Sir E. LANDSEER, "Puppy and Frog," sold for 394*l.* 10*s.*; "Fidelity," REYNOLDS, 210*l.*; "A Border Raid," T. S. COOPER, 378*l.*; "View above the Slate Quarries, on the River Aguen," the joint production of F. R. LEE and T. S. COOPER, 409*l.* 10*s.*; "A River Scene," F. R. LEE, 178*l.* 10*s.*; "The Choice of Hercules," D. MACLISE, 320*l.*; "Doubtful Weather," T. CRESWICK, 252*l.*; "The Terrace, Haddon Hall," T. CRESWICK, 140*l.* 14*s.*; "Made Wildfire and Jeannie Deans," W. P. FRITH, 115*l.* 10*s.*; "The Woodman's Return," F. GOODALL, 246*l.* 15*s.*; "Return from Deer-Stalking," R. ASSDILL, 120*l.* 15*s.*;

'Youth at the Helm and Pleasure at the Prow,' ETRY, the sketch for the larger picture bequeathed to the nation by Mr. Vernon, 168*l.*; 'The Nursery,' WILKIE, 115*l.* 10*s.*; 'Coast-Scene after a Storm,' MORLAND, 115*l.* 10*s.*; 'View in Switzerland,' P. NASMYTH, 152*l.* 5*s.*; 'Peasants Returning from the Fiesta del Monte Virgine,' T. UWINS, 125*l.* 15*s.*; 'Shrimpers,' W. COLLINS, 147*l.*; 'The Young Anglers,' T. WEBSTER, 117*l.* 2*s.*; 'The Fortune Hunter,' R. REDGRAVE, 102*l.* 28*s.*

THE BRITISH INSTITUTION.

The following is, so far as we could collect, a list of the pictures sold at the British Institution up to the day of its closing.

'Timber Clearing on the Hill-side, Sussex,' H. JUTSUM, 120*l.*; 'The Egyptian Ivory Merchant,' F. DILLON, 105*l.*; 'The Monte Rosa—Early Morning,' G. E. HERLING, 105*l.*; 'The Alhambra, Granada,' W. TELBIN, 100*l.*; 'A Study,' J. LUCAS, 100*l.*; 'A Shift Breeze, Plymouth Sound,' P. E. BRICHAUD, 77*l.*; 'Traces of Past Winters,' H. JUTSUM, 70*l.*; 'Dunally Castle, near Olan, Scotland,' J. W. DANBY, 63*l.*; 'Glenmorfa, Caernarvonshire,' J. W. OAKES, 75*l.*; 'A Natural Reflection,' J. D. WINGFIELD, 84*l.*; 'Don and Sancho,' T. EARL, 63*l.*; 'Cupid and Psyche,' C. BYERLON, 60*l.*; 'On the Thames—the close of a Summer's Day,' H. J. BODDINGTON, 70*l.*; 'Maternal Love,' G. E. HICKS, 42*l.*; 'Wool Picking,' D. W. DRANE, 40*l.*; 'San Clemente, on the Lagoon of Venice, Sunset,' E. W. COOKE, A.R.A., 36*l.* 15*s.*; 'Roman Piper,' R. BUCKNER, 42*l.*; 'Sunset,' W. A. KNEEL, 35*l.*; 'Lockloust Hatch Farm, Surrey,' J. DEARMAN, 36*l.* 15*s.*; 'Sunny Hours,' J. D. WINGFIELD, 25*l.*; 'Fishing Craft, &c., in a Cahn,' W. A. KNEEL, 25*l.*; 'Vessel Ashore, Ryde Pier,' E. HAYES, 25*l.*; 'Noddy Mill, Shire, Surrey,' J. DEARMAN, 26*l.* 5*s.*; 'The Passing Thought,' E. HUGHES, 21*l.*; 'Sun-rise on the Western Coast of Scotland,' J. DANBY, 30*l.*; 'Cattle by a River Side,' J. DEARMAN, 21*l.*; 'Abbeville, France,' L. J. WOOD, 21*l.*; 'Age and Innocence—An Interior at Kellin,' W. LUKER, 21*l.*; 'Interior, Dogs,' &c., G. ARMFIELD, 20*l.*; 'Gleaners,' J. BOUVIER, 18*l.*; 'Happy Hours,' Miss K. SWIFT, 18*l.* 18*s.*; 'Summer-Time,' J. SURTEES, 26*l.* 5*s.*; 'A Dead Moss Trooper,' T. MORTON, 15*l.* 15*s.*; 'A Son of the Soil,' J. COLLINSON, 15*l.* 15*s.*; 'Cupid Teasing a Butterfly,' J. C. NAISH, 15*l.*; 'Portal of the Cathedral at Chartres,' L. J. WOOD, 15*l.* 15*s.*; 'High Street, Tewkesbury,' W. CALLOW, 15*l.* 15*s.*; 'Azuleos,' Miss MURIE, 15*l.* 15*s.*; 'The Surprise,' H. B. GRAY, 15*l.*; 'Cathedral at Lille, France,' L. J. WOOD, 14*l.* 14*s.*; 'Market Group,' J. PELL, 14*l.*; 'The Swing,' H. SHIRLEY, 12*l.* 12*s.*; 'A la Duesse, Pas de Calais,' F. STONE, A.R.A.; 'June,' J. COLBY; 'Severe Weather,' R. ANSELL; 'A Tale of the Crimea,' J. E. HODGSON; 'Sunset on the Meadows,' T. S. COOPER, A.R.A.; 'The Favourite,' G. EARL; 'Fruit,' G. LANCE; 'A Part of the Four Cantons, Switzerland,' T. DANBY; 'Evening—Ringsend, River Liffey, Dublin,' E. HAYES; 'The Cradle,' D. W. DEANE; 'An Old Sussex Cottage,' C. R. STANLEY; 'L'Allegro,' A. JOHNSTON; 'Grey's Cliff, Warwick,' E. J. NIEMANN; 'Magnolia,' Miss MURIE; 'Falcade of San Giorgio, &c., Venice,' E. W. COOKE, A.R.A.; 'The Brother's Lesson,' G. SMITH; 'Cottage Child,' J. P. DREW; 'See the Chariot at hand here of Love,' J. COLBY; 'A Rainy Day on the Lagoon of Venice,' E. W. COOKE, A.R.A.; 'Near Buccione, on the Lago d'Orta, looking towards Monte Rosa,' H. JOHNSON; 'The Pet Rabbit,' W. S. P. HENDERSON; 'Round Tower and Entrance to the Harbour, Havre,' R. H. NYRIS; 'View near Rothay on the Clyde,' J. DANBY; 'Llyn Crafnant, near Trefriw, Carnarvon,' H. W. STEATER; 'In the Rue de la Trinité, Angers,' J. D. BARNETT; 'A Scene suggested by the Death of Pompey,' T. DANBY; 'Mirth,' J. COLBY; 'Study of Fruit,' H. CHAPLIN; 'A Water Nymph,' J. COLBY; 'Twilight on the Exe, Countess Weir,' W. WILLIAMS; 'Country Boy,' J. P. DREW; 'The War-rior's Boy,' W. HEMSELEY; 'The Empty Cradle,' Miss J. MACLEOD; 'Nymph and Cupid,' W. E. FROST, A.R.A.; 'The Dying Soldier,' J. MORGAN; 'Marion,' A. BOUVIER; 'Little Gretchen,' H. LE JEUNE; 'Il Penseroso,' A. JOHNSTON; 'The Way to the Village,' C. R. STANLEY; 'A Country Girl,' J. P. DREW; 'Jephtha's Daughter,' E. HUGHES; 'Protection,' D. COOPER; 'Gipsy Girl,' J. P. DREW; 'View near Hastings,' J. GARDY; 'Morning—Tal-y-Llyn, North Wales,' J. HORLOR; 'Arcan-

gelo,' R. BUCKNER; 'Carminele,' R. BUCKNER; 'The Parmigian's Haunt,' J. WOLF; 'Rosilind,' H. O'NEIL; 'Interior, Ditton House,' C. H. STANLEY; 'The Sister's Lesson,' G. SMITH; 'Going to Market,' C. RICHARDS; 'Forest Scene, with Cattle,' E. GILL; 'Evening,' E. J. COBBETT; 'Paper,' H. S. MARKS; 'Dinner-Time,' J. D. HARDY; 'Musing,' E. HUGHES; 'Little Red Riding-Hood,' J. P. HALL; 'La Maschera,' U. BOUVIER; 'Sunset after a Storm,' G. CLAY; 'The Guard-Room,' R. CLOTHIER; 'The Stricken Mallard,' G. LANCE; 'Comforts for the Crimea,' S. HODGES; 'Sand Assez,' W. WYRKES, JUN.; 'An Interior,' J. D. HARDY; 'Scene near Muswell Hill, Highgate,' E. GILL; 'Landscape and Figures,' L. HUSKISSON; 'Writing Home,' J. MORGAN; 'Girl with Fern,' J. P. DREW.

PICTURE-DEALING IN GLASGOW.

We copy the following statement from the *Dristol Times*:—"A good deal of gossip amongst the lovers of the Fine Arts has been going on during the last day or two, with reference to the following circumstance, which, though at first sight it may appear somewhat equivocal, is capable of the fullest explanation, so far as some of the parties are concerned. Mr. Flateau, the eminent London picture-dealer, has (as our readers are aware) been for the last fortnight in Bristol, with a large collection of pictures; a few days since, he sold to Mr. Sampson, picture-framer, &c., of this city, a little painting, called 'The Black Frost,' by Branwhite. The next day, Mr. Branwhite happening to be in Mr. Sampson's shop, the latter mentioned the circumstance to him, when Mr. B. stated that he had sold to Mr. Flateau two little pictures, one of which bore that name, and expressed a wish to see it; but, on his first glance at the painting, he pronounced it a bad copy of his picture, though in the identical frame in which the original was, when he sold it to Mr. Flateau, from whom, however, Mr. Sampson had got a warranty for the genuineness of the work. Mr. Flateau was immediately applied to by both Mr. Sampson and Mr. Branwhite, and appeared no less surprised than they were at the circumstance. He at once, upon reflection, was able to account in some measure, for the substitution of the forgery for the original; he said he hoped he need not say much—leaving his reputation out of the question—to convince them, or any one, of the impossibility of his being so infatuated as wittingly to bring a forgery for sale, with a warranty, to the place where the artist lived, and where any such attempt must be at once detected. Between the time of his purchasing the picture from Mr. Branwhite, however, and his selling a picture to Mr. Sampson, it was clear a bad copy had been changed for the original in its own frame, and he accounted for it in this way.—When in Glasgow, on a business visit, he sold, for 12*l.*, Mr. Branwhite's picture, which was a very small one, to a frame-maker and dealer there, with whom he had other transactions; when leaving Glasgow, however, the man said to Mr. Flateau, 'the gentleman for whom I purchased that little frost piece, does not like it, and I wish you would take it back.' Mr. Flateau having had many transactions with the man, did so, never pausing to look particularly into the one he got back, and which was the same that he sold in Bristol to Mr. Sampson. Mr. Flateau (and Mr. Branwhite, too), have no doubt that the picture was copied during the month it was out of his possession at Glasgow, and Mr. Flateau, who is naturally much annoyed at the imposition practised on him, has prevailed on Mr. Branwhite to accompany him to Glasgow, in order to take instant steps for the discovery of the fraud, and punishment of the offender. Mr. Flateau's object in having Mr. Branwhite's company (he, Mr. F., hearing all the expenses of the journey, &c.), is that Mr. Branwhite may be able to swear to the identity of the true picture, when they have traced it to its present possessor, which, we trust, they will be able to do. We hardly need add that Mr. Flateau returned the money to Mr. Sampson, on his bringing back the picture."

A correspondent has furnished us with the following additional particulars respecting this transaction:—"Mr. Sampson started for Glasgow and arrived there the same night. The next morning he called at the shop of Messrs. Rankin and Gray, carvers and gilders of Union Street, the parties to whom Mr. Flateau had sold the original picture—it being early (about 8 A.M.) he found nobody at the shop but a woman of whom he asked some questions respecting a frame of a complicated and difficult pattern. The woman not understanding the kind of frame he had described, he took the opportunity of waiting and looking over the pictures, and after a search of some time he was gratified by a sight of the picture he was looking for—he discovered it behind the counter with its face turned to the wall and covered with a sheet of plate-glass. Upon seeing the picture he said nothing to the woman about it, but immediately proceeded to Mr. Crichton, a solicitor, to whom he had brought a letter of introduction. Mr. Crichton at once took means for having the picture restored to Mr. Flateau, and the following letter will show with what success.

UNION STREET, GLASGOW,
22nd April, 1856.

SIR.—We regret to find that in a sale by us to you, you were led to form the idea that you were purchasing the original of the picture "Black Frost," by Charles Branwhite, in place of a copy which we had got made and framed, and on the circumstances which attended the transaction being reviewed, we are bound to admit that we were to blame in causing the mistake, and we therefore feel it incumbent upon us to make some sacrifice to compensate you for the expense you have incurred. It appears we were not, strictly speaking, entitled to make a copy, and we therefore allow it to be destroyed; we also hand you the original that you may have equal value for your money, and as agreed upon, we pay you twenty pounds towards your expenses.

We are, Sir, your obedient Servants,

Signed—RANKIN & GRAY.

ALEXANDER W. CRICHTON, of Glasgow,
Solicitor;

JAMES SAMPSON, No. 10, Park Street,
Bristol;

Witnesses to the signature of Messrs.
Rankin & Gray.

To L. V. FLATEAU, Esq.,
Of London and Bristol."

This contribution to the history of a picture will amuse more than it will astonish: it is the latest but not the most remarkable incident of its class. All we now desire to know is, what has become of "the copy?" If it be true, as we are told it is, that it has not been destroyed (as it ought to have been), Mr. Flateau has made a good thing of "the business,"—having the picture, the copy, and twenty pounds "towards his expenses."

THE WINTER'S TALE, AT THE PRINCESS' THEATRE.

If Shakespeare—who threw off his wonderful dramas for the use of a stage unable to give them the advantages of scenery and dresses—could, after the lapse of two centuries and a-half, revisit a modern theatre, and find all the critical knowledge, antiquarian lore, and scenic appliances, which have been growing to perfection during that long period, devoted to his works; and those works still as attractive as they were upon the first night, when he produced them at the Globe Theatre, on the Bank-side; it would be the greatest ovation that ever awaited man,—a triumph over the usual oblivion which follows in the wake of time, accorded to very few of the "Muse's darlings." When works cast off with the ease of a powerful genius, working out its own end untrammelled by conventionalities, and entirely careless of

anachronisms, are restored with archaeological exactitude to the stage, which thus resuscitates the living pictures of bygone ages for the gratification and instruction of the present; and the theatre reflects a new charm upon a great work, asserts its true position as the vivid exponent of life in all phases; and takes due rank among the fine arts, aided by poetry, painting, and music.

No one of the works of our great dramatist abounds with more anachronisms than the "Winter's Tale." The scene is Bohemia, yet is that country supposed to be bordered by the sea. The decision of the great Delphic oracle is the chief moving agent of the action of the play; yet we hear of "Christian burial," of "an Emperor of Russia," "that rare Bulgar master, Julio Romano," and a "chapel" for the statue of Hermione; while Autolyous and the country-people are so essentially English of the time of Elizabeth, in thought, word, and deed, that they, more than any other characters in the play, fix it in the poet's era. It is impossible to appreciate Mr. Kean's difficult labour in reducing all this to something like congruity, unless we reflect on these facts. To ensure success he has adopted the suggestion of Hammer to substitute Bithynia for Bohemia, preserve the classic era throughout as the period of the action of the drama, "when Syracuse was in no way inferior to Athens in magnificence, and place before the eyes of the spectator *tableaux vivants* of the private and public life of the ancient Greeks and Phrygians." Such portions of dialogue, or passing allusions to more modern events or things have consequently been omitted, and our business will now be to speak of the artistic resuscitation of a past age afforded by Mr. Kean's stage.

The opening scene presents little more than the usual classic background; the second scene ambitiously commences the picture of early Greek manners, so carefully and conscientiously given throughout the drama. The guests in the banquet-hall of the palace of Leontes are reclining on their gilded couches, attended by youths who wreath them with flowers, while attendants bring forth wine in amphora, to mix in the capacious vase over which the symposiarch, or chief butler, presides, and re-serves it by a *simpulum* into the cups of the guests. The girls, bearing the painted wine-vessels on their heads, come forth with all the grandeur of antique statuary; and the careful manner in which the whole scene has been studied, is displayed in every minute trait. The vessels are borne upon the head horizontally when emptied, and the staid of antique marbles, at once recognises the figures his gazes on as studies from the friezes of the Parthenon. The Pyrrhic dance in this scene is also a wonderful realisation of the old Greek warrior, in which no feature of his picturesque or martial attire is omitted; nor are the groups into which these soldiers are thrown without direct authority in antique sculpture.

The court of the Gynæceitis, where Hermione is seated among her women, employed like Penelope and her maids—is another charming realisation of the domestic life of Greece. The queen seated between her baskets of coloured wools, and her ladies busied with distaff and spindle, while the young Mamilius plays with his toy chariot in the open corridor, looking upon the quiet garden, with its richly flowering shrubs, is a charming picture of classical repose. Equally beautiful is the tapestried room looking out on the city and bay; and the effect of the atmosphere is here happily rendered—the deep blue of the sky, the warm tint of the hills, and the transparency of the shadows, realise the climate of the "happy south," with a truth that can only be fully appreciated by those who have travelled there.

The third act is devoted entirely to the trial of Hermione, which takes place in the theatre of Syracuse; and here we feel called upon to admire the art which has surmounted the difficulties presented by so small a stage. To obviate this, and give the apparent size of the interior, a side view of the Syracusean theatre is taken, and the floor of the stage is entirely covered with an imitation pavement in sharp

perspective, which completes the illusion, and deceives the eye completely as to its true extent. The vast area filled with people is only partially developed; and the spectator is insensibly led to carry out mentally the entire conception. We think this one of the highest points of this art-play.

It is, however, in the fourth act that the strength of scenic appliances as regards machinery and masses of performers, are brought most prominently forwards; and certainly the stage has never presented a more exquisite realisation of a poetic conception than the ascent of Phebus in his quadriga,—the light breaking forth from the god as he dispels the fogs of night, and bursts forward, hardly reining his dashing steeds in a blaze of glory; and this is a noble realisation of Flaxman's design in the centre of his Shield of Achilles, which that artist embodied from the antique. The palace of Polixenes, which follows this scene, is remarkable for its barbaric splendour, and the contrast it affords to the purer Greek taste. The shepherd's farm is an exquisite realisation of a picture from Pompeii; but the crowning beauty of this act is the pastoral scene in Bithynia, overlooking the Lake Ascania, with the range of mountains known as the Mysian Olympus beyond. A sweeter picture of pastoral happiness was never placed upon the stage than this, with its umbrageous trees, from which Bacchic masks are suspended; its cool fountain gushing from the rocks; the terminal figure of Dionysus in the centre, and the peasantry with their lambs and goats in the foreground. The wild orgies of the Festival of Dionysus which succeeds, gives us a new phase of antique life; and never was "the riot of the tipsy Bacchanals," more wild and noisy than here represented. At one moment the whirl of the thyrsus and wine-cup over the head of each mad reveller produces an effect of reckless jollity; anon all join hands, and with half-shrieking shouts, rush toward the figure of the god in exuberant recognition amid the clangor of cymbals and burst of pastoral music. It is a realisation of scenes such as antique gems or the pictures of Poussin only give.

The opening scene of the fifth act represents the garden of the palace of Leontes, and has been adapted from a drawing found at Herulanum. In the last scene "the peristyle of Paulina's house," Mr. Charles Kean has shown much originality and taste. The unveiling of the statue takes place at night, and the darkness is but partially dispelled by the flickering torches of the attendants. Nothing can be more poetic than the figure of Hermione, lighted by a ray of pale light. It is life reduced to statuary, and we can appreciate the feeling of the sorrowing Leontes, and share his astonishment when the marble "moves." The repose which reigns throughout this scene, and is not dispelled till the curtain falls, is beautifully in character with the close of the drama, and the poet's conception.

In this, as in other of his revivals, Mr. Charles Kean has called in the assistance of able artists not usually connected with the theatre. Mr. George Godwin has superintended the architectural portion of the scenery, and Mr. George Scharf the landscape and costume; Mr. Davies and Mr. Hutton have endeavoured to realise the old Greek music. It is this travelling from the beaten track which gives pre-eminence to Mr. Kean's scenic accessories. The scene-painter, property-man, and stage dressmaker, some years ago reigned supreme within the walls of a theatre, "their right there was none to dispute," and no scholar, however well versed, might interfere with their conventional notions. What they made of Greece and Rome may be seen in our old dramatic prints, which are extraordinarily curious in consequence; but what may be done with the stage, when the resources of taste and scholarship are brought to bear upon it, may be seen in the Princess Theatre under Mr. Kean's more judicious rule.

The gratitude—not only of "playgoers," but of all lovers of Art, and, indeed, of the public generally, is largely due to Mr. Kean: he has made the drama to answer its high and legitimate purpose—to teach while it gives pleasure.

ART IN THE PROVINCES.

MANCHESTER.—The Exhibition of the "Manchester Institute for the Promotion of the Fine Arts," will open early in the autumn. It would seem almost superfluous to call the attention of artists to this announcement; the manufacturing districts generally, and Manchester in particular, have become the chief depositories of modern Art, and there pictures of any merit are sure to find purchasers. But the committee of the institution not only desire to have unsold works, but they ask from collectors the loan of those which are in their possession, so as to enable them to form an extensive and interesting exhibition. Surely there are many of such patrons who would be pleased to part with their treasures for a few weeks to assist in this object, for after all the "strength" of the exhibition must depend on the assistance which may be afforded in this way, for we apprehend few painters of any standing in popular favour have pictures at their disposal. Mr. Edward Salomons, architect, of Manchester, is the honorary secretary of the institution, and has been in London during the past month arranging for the transmission of contributions, and has we believe, met with very considerable success; but there will yet be a large space in the gallery to fill up.

We noticed in our last number a project for opening at Manchester a grand Exhibition of Industrial Art; a deputation consisting of the High Sheriff of Lancashire and several influential gentlemen of the county had an interview, on May 8th, with his Royal Highness Prince Albert, to submit the project for the approval of her Majesty and the Prince. A sum of 60,000*l.* was understood, subscribed within a few days, in Manchester and its vicinity, as a guarantee fund for carrying out the exhibition on a scale commensurate with its importance.

The annual meeting of the Manchester School of Art was held at the Royal Institution on April 25th; Mr. Edmund Potter, president, in the chair. "The chairman," writes the *Baldur*, "regretted the want of support under which the school languished, its existence being supported chiefly by a few friends instead of the public at large; and he should be glad to see the Royal Institution take the school by the hand, and relieve it from its heavy rent of 200*l.* At present 1000*l.* a year were spent in educating 200 or 300 pupils, which was too much, though the education was of a high quality. The receipts were nearly equal to the expenditure: the subscriptions were about 300*l.* a year. About 100 pupil teachers paid 3*s.* a quarter. The secretary read the report. Efforts were being made to extend the benefits of the school by establishing a class for artisans, and by giving instructions in public schools at a low charge. Mr. Hammersley, the head master, reported that the school had maintained a steady course of improvement, the studies of the pupils being more numerous, and of a higher quality than before. In the first quarter the pupils numbered 458, in the proportion of 363 males and 95 females; second quarter, 194; third, 181; fourth, 204; total, 1037, or an average of about 250 per quarter. The school fees amounted to about 200*l.* The Government grant was 280*l.*; annual subscriptions, 295*l.*; making, with private donations, school fees, &c., about 1000*l.*; and there was a balance owing of 374*l.* Mr. Bazley regretted the withdrawal of a portion of the Government grant, which was last year 220*l.* less than it used to be. It would be disgraceful if such a useful institution lacked support."

BURSTOL.—The annual meeting of the members and friends of the Fine Art Academy was held on the 1st of May. The attention of the assembly was chiefly directed to the new building now erecting, which the President of the Academy, Mr. W. S. Miles, stated was proceeding satisfactorily. The committee hoped that in the course of the present year, about September or October, the roof would be put on, and that at this period next year the annual meeting, not only of this institution, but of the School of Art and the Society of Architects, would be held within its walls. The architectural portion of the work had been done entirely by the Society of Architects gratuitously. In the original design, the building was intended to be erected in a much plainer form than had since been thought desirable. This alteration was made at the suggestion of Mr. Thomas, of London, the sculptor. The five windows will be filled up with different groups of sculpture. Mr. Tucker read the report, which alluded to the services of Mr. Underhill and Mr. Hunt, the two architects who planned and designed the building. The elevation of the edifice is in the Italian style, from four designs by Mr. Hunt. It is approached by a double flight of steps, leading into the vestibule. The building will contain

spacious exhibition-rooms, and a room appropriated for the requirements of the Fine Arts Institution. Accommodation will also be provided for the School of Practical Art. The principal front will be ornamented with emblematical groups, designed and executed by Mr. Thomas, provided the necessary sum can be raised by independent subscription.

BATH.—The fourth and last conversazione for the season of the Bath Society for the Promotion of the Fine Arts, took place on Tuesday the 15th of April; the principal pictures exhibited on the occasion were 'The Brave Old Hound,' by ANSELL; 'Ewe and Lamb,' by VERRORCHLOVES; 'The Child Timothy' and 'Saxon Woman,' by SANT; 'Coast Scene,' STANFIELD; 'Coast Scene,' W. COLLINS; 'View on the Eastern Coast,' BAICHT; 'Death of Robert, King of Naples,' ELMORE; 'In the Forest,' CRESWICK; 'Jedburgh Abbey,' D. ROBERTS; an 'Interior,' F. GOODALL. In the rooms were also paintings and drawings by BRANWHITE, H. B. WILLIAMS, ETTA, SOLOMON, HERRING, J. GILBERT, COX, WARRIN, HAIDING, F. TAYLER, and portfolios of sketches by BENNETT, JENKINS, AYLNER, W. MULLER; and some beautiful flower subjects by Mrs. DUFFIELD; these pleasant and instructive *réunions* owe much of the success which has attended them to the exertions of the husband of this lady, Mr. W. DUFFIELD, himself an excellent flower-painter.

CLIFTON.—*Clifton and Bristol Graphic Society.*—The last meeting for the season of the Clifton and Bristol Graphic Society took place on Tuesday, April 22nd, at the Victoria Rooms, Clifton. It was very numerously attended, there being about four hundred and sixty persons present. Mr. Miles sent a magnificent picture of the 'Adoration of the Virgin,' by Velasquez; Mr. Jacob Bell contributed Sir E. Landseer's 'Horse Shoeing'; Mr. Munroe, a fine picture by Turner, called the 'Rainbow,' &c.

WORCESTER.—Preparations are being made by the Worcester Society of Arts to hold its third annual exhibition; and artists willing to contribute are invited to send in their pictures before the 6th of August. We may remark that the sales effected by this society last year were nearly double those made by it in the first year of its establishment; a fact which entitles it to the consideration of artists.

EDINBURGH.—A society, entitled 'The Photographic Society of Scotland,' has recently been established in Edinburgh, with Sir David Brewster as its president. It already numbers eighty members, with every prospect of a large addition.

THE ROYAL PICTURES.

THE QUEEN'S HORSES.

J. F. Herring, Painter. C. Cousen, Engraver.
Size of the Picture, 2 ft. 1½ in. by 2 ft. 3 in.

A PECULIAR feature of our national character is a strong attachment to domestic animals, especially to horses and dogs. This feeling pervades, in a greater or less degree, every class, from the nobleman or country gentleman, who possesses his stud of racers, or of bunters, or his pack of deep-baying hounds, to the poor mountain shepherd whose colley keeps solitary watch with him day by day on the hills, or the wandering gipsy, whose donkey carries on his back the whole household wealth of the family, and asks no other shelter from the night-dews of heaven than the canopy of the thick-leaved oak, under which his master's tent has been pitched till the rising of the new day's sun. This national feeling has had its effect on our school of art, by calling into existence a few painters who have made it almost a special business to become portrait-painters of animals, because there are few owners of a favourite horse or dog, who are not desirous of seeing him represented on the canvass of the artist; hence have arisen Landseer, J. Ward, A. Cooper, Ansell, Herring, Barraud, and others.

Mr. Herring is among that class of artists who, by the strength of their own innate genius alone, have raised themselves from comparative obscurity into fame and distinction; and in his case this result has been realised without any of those early indications of talent which "cast their shadows before." It is, we believe, about forty years back that he left the metropolis for Yorkshire, without any especial object in view; but a fondness for animals in general, and for horses in particular, and a strong desire to "handle a team" of the latter, induced him to occupy the driving-box of a stage coach; an ambition which, at that period when the glories

of the turpikeroad were at their zenith, was exhibited by not a few of our aristocracy and wealthy commoners. How it was he imbibed a taste for painting we do not know, but it is certain that he filled up his spare hours at this time by making portraits of the favourite horses which came under his guiding rein; and that he painted them and drove them with equal skill, his constant association with the animals making him a perfect master of their forms, habits, and character. His position on the box,—it was the famous York "Highflier," we believe, which he drove—and his success in the department of art he practised, introduced Mr. Herring to the notice of many individuals noted on the turf and in the chase, by whom he was frequently engaged to paint portraits of their horses.

This artist very rarely exhibits at the Royal Academy: he was one of the earliest supporters of the Society of British Artists, in whose gallery and in that of the British Institution his works may annually be seen. The picture here engraved was a commission from the Duchess of Kent, to be presented to her Majesty on her birthday. Her Royal Highness was so pleased with it, that she appointed Mr. Herring her animal painter. The Queen also testified her approbation of the work, by commanding the artist to paint a portrait of a favourite black horse, the picture being a present from Her Majesty to Prince Albert on his birthday.

Of the two horses which appear in the engraving, the darker is a beautiful chestnut, named "Hammon;" he was bred in the stud of the King of Prussia at Trakehn, and was presented to her Majesty by the King in 1844. Though the animal is now nearly twenty-two years old, we are assured by the Queen's riding-master, M. Meyer, that he is as fresh as a "four-year-old." The grey horse is called "Tajar;" he was bought by M. Meyer in 1844 of Count Hatzfeld, having been reared at Twerark in Mecklenburg, by Count Hahu: his age is about a year beyond that of "Hammon;" but, like the latter, he is as fresh as ever. Both horses are of pure Arab sires. "Tajar" is still used by her Majesty when she takes horse exercise in the riding-school. They are represented as standing at one of the private entrances to Windsor Castle.

The Picture is in the Collection at Osborne.

THE NEW STATE ROOMS AT BUCKINGHAM PALACE.

THE additions recently made on the southern side of the palace consist chiefly of such apartments as are devoted to the elegant relaxations of life, and comprise a ball and concert-room, with its necessary refreshment-rooms and corridors. These have been constructed by Mr. Pennethorne, and the decorations carried out under the general superintendence of Mr. L. Gruner. We should naturally expect the home of our sovereign to exhibit the refinement which characterises modern taste, and that adaptation of sculpture and painting to in-door life which is now recognised as an addition to its *agremens*. It is therefore found in these new rooms, and we gladly hail its recognition where it can be so well appreciated, and aid in spreading such taste elsewhere; the court naturally giving the tone to fashionable life.

The rooms are reached by the grand staircase; this is lighted by lamps elegantly designed by Osler, and we especially admired the taste which grouped with them branches and leaves in the same fragile materials, giving the lamps the effect of bouquets of glass flowers. A gallery at the summit of the staircase leads to the music-room; this gallery is decorated in the Italian manner of the cinque-cento, the walls being painted to imitate an open arcade, looking out upon the sky, birds hovering over the flower-vases which occupy the centre of each opening. The panels above them are decorated with pictures *en grisaille* of groups of children. In front of each pilaster a series of variegated marble pedestals support busts of classic form, by Mr. W. Theed. The banquetting-room to the left is

a domed apartment, the walls panelled as if with variegated marbles, alternating with panels filled with copies of Raffaele's arabesques in the Loggia of the Vatican. The same great artists' "Cupid and Psyche" has contributed the subjects for Mr. Theed's *bass-reliefs* on the two sides of the apartment, forming a frieze over all. Gas lustres of very elegant but exceedingly unobtrusive form, and looking rather like pendant ornaments, occupy the corners and centre of the ceiling, and diffuse a warm glow over the harmonious walls. The large buff on both sides of the room, and the busy scene on the floor, make an effective picture on ball nights. A small gallery from the dining-room affords a private entrance for the Queen and court, and its walls are also Raffaelesque in character; the semicircular curves above each door are filled by two charming designs by Theed, representing "The Birth of Venus," and "Venus bringing Armour to Achilles," both executed in high relief, and having a powerful effect by the purity of their colour and form, and the depth of shadow they afford, relieved as it is by the brightness of tint surrounding them.

The ball and concert-room is the crowning point of the new additions; and this, as it should be, is the most important scene of the labours of the Art-decorator. The floor is laid in *parquetage*, the walls are hung with rich silk, the pattern on which combines the national flowers of the United Kingdoms. Above are paintings of the hours from sketches by Raffaele, and Cupidons from his *rescues* in the Farnesina Palace. The top and bottom of the room have arched recesses; that at the top is fashioned to contain the royal seats, and is decorated with columns and figures in the richest taste, emblematic of the era. The opposite recess is devoted to the vocalists and the organ. The case of the instrument is designed in the best taste of Italian renaissance, with seated figures on its summit, ornament of music. The ceiling of the room is highly enriched by ornament, coloured and gilt, and from each of the sunken panels descends a gas-lustre. Standard groups of wax-lights on enriched pedestals occupy the corners and sides of the room, all deep and positive colours being reserved for the seats which surround it. In the entire direction of the whole, Mr. Gruner has reigned supreme, and his taste has secured the general harmony where so many have been employed. Mr. Theed, and Canzoni, of Rome, have been the artists principally employed. Mr. Moxon has executed the marbles and gilding. The candelabra have been designed by Mr. Gruner, and perfected by Barbodienne. The silk on the walls is produced by Jackson & Graham, the furniture by Johnstone & Jeanes, and the carpets by Lapworth. The lustres by Osler, of Birmingham.

It will thus be seen that English Art-manufactures decorate the new rooms of England's Queen, and it is with no small degree of satisfaction that we can point to so successful a result. The decorations of a royal palace are too frequently the exposition of an exploded fashion, and it is not often that modern experiences are brought to bear on its arrangements. The great beauty of the present suite of rooms is its successful display of modern educated tastes—tastes which result from the study of various styles, and the happy adaptation of the best parts of all. The air of repose, as well as richness of fancy, which reigns over all, is the great charm of the *ensemble*, but we think its general elevation in no small degree results from the bappy character of Mr. Theed's stately and *bass-reliefs*; these, by their purity of form and graceful contour, give boldness and vigour to the general design of the apartments, which no flat painting could effect. We should rejoice greatly if our sovereign be enabled to aid the somewhat neglected art of the sculptor, by thus exhibiting its applicability as a tasteful adjunct to the noble homes of England. So far from its being "cold" and "monumental," it is here proved to be the reverse, and we hope to see the Queen and her august consort has never been more fully displayed than in these additions to their home—so bappy a guide to every other home in her dominions.







FRANKLIN & CO. ENGRAVERS

THE GARDEN OF EDEN.

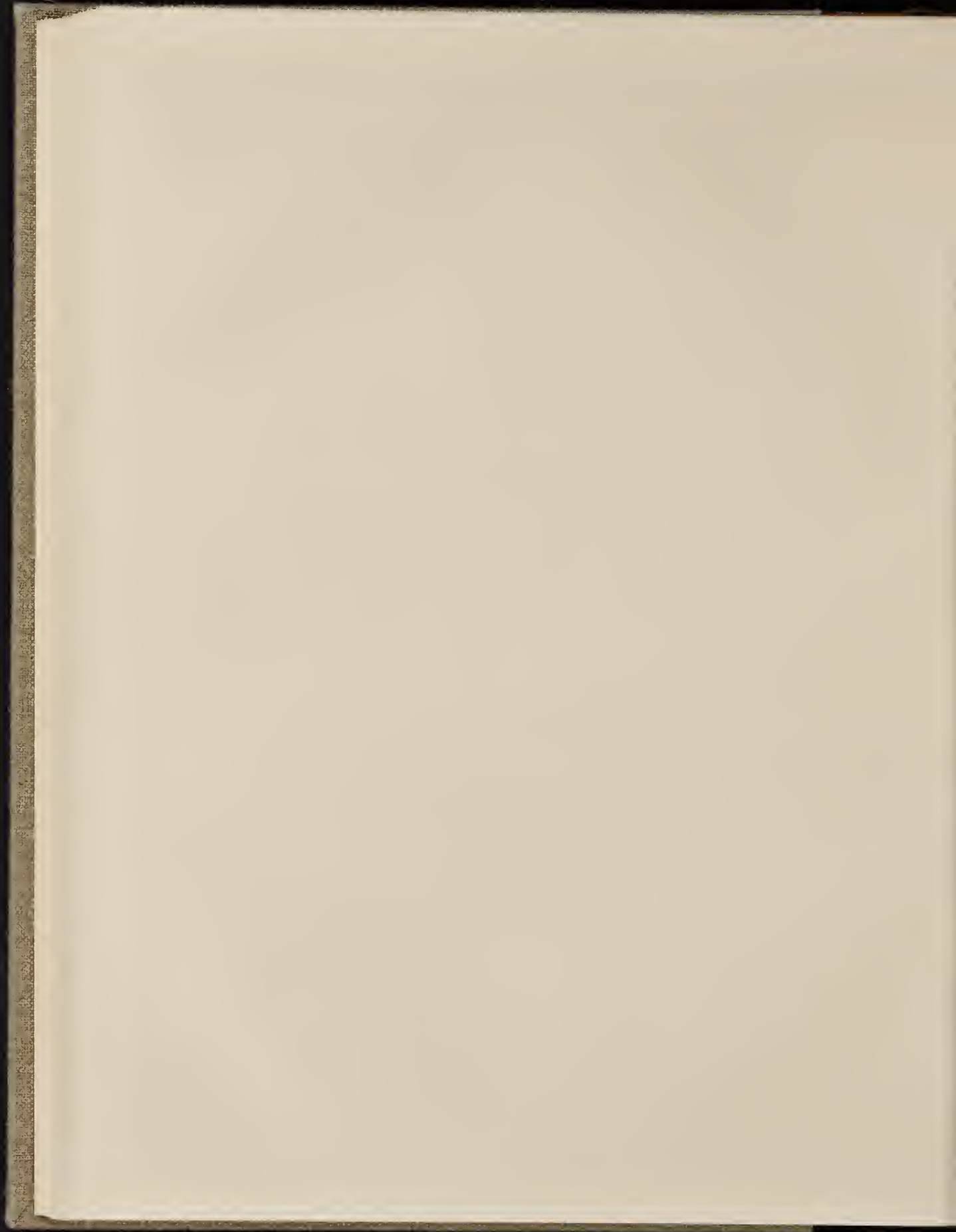

THE EXHIBITION OF FRENCH PICTURES.

THE third annual exhibition of works of the French School contains, as last year, a considerable proportion of small figure pictures, elegant in their tone of subject, and exquisite in execution. These constitute the strength of the collection. Their quality far surpasses that of the landscapes or of the more ambitious classes of composition. The artists who excel in this kind of subject are the Mollières, the Cornelilles, of their school: there is a grace in their conceptions which renders them always agreeable objects of contemplation—we mix with pleasure in their *causeries* and *coleries*, because their reunions are in the best taste of the dramatic masters whom they follow. These little pictures are very highly elaborated; but all finish in them is effected with softness, while among ourselves hardness seems an inevitable result of elaboration. Compared with these *pièces de société*, all the other figure compositions are unattractive. French landscape is undoubtedly mannered—low tone is the prevalent taste, and there is a single-mindedness in the execution which gives the French productions generally of this department the appearance of having emanated from one studio. This may be only the usual resemblance between relatives descended from one stock, but there is more of identity in the family likeness than we see elsewhere. The trees do not display masterly knowledge, and the foliage is generally very loosely painted. We have seen here examples of Lagras and Vernat; but there is in the present collection no work by either of these distinguished men. By DELAROCHE there is the well-known picture 'Napoleon Crossing the Alps,' and by ARY SCHEFFER, an equally well-known composition, 'The Three Marys.' It is gratifying to see these works which have been so long familiar to us through engravings. MADLIE ROSA BONIFER exhibits three small works—No. 45, 'Landscape, with Cattle,' a small picture, low in tone, representing a breadth of pasturage with a group of cattle. No. 46, 'An Auvergne Peasant, a study of a man holding an ox by the horn, as if to be painted; this seems to have been studied for another picture. No. 47 is a sketch of a horse, made perhaps with the same intention. Over the fire-place is a row of these small gem-like works, of which we have spoken. No. 60, 'The Casket,' VICTOR CHAVEL, shows a group of two female figures, one standing and the other seated, the former holding the casket; they are in a bed-room. No. 263, 'A Young Girl selecting Fruit,' by PLASSAN. The figure is erect, and extending her hand to a sideboard, whence she is about to take a pear: remarkable for softness of execution. Plassan exhibits two other works. No. 237, 'A Lover of the Wood,' by MEISSONIER, is a charmingly wrought miniature in oil; it represents a man seated smoking, with a small can of beer by him; the finish of this work cannot be surpassed. We remember a similar figure some years ago by the same painter, but the man then wore his hat. No. 88, 'The Honey-moon,' by CHAVEL, is fine in quality, but he has produced better works. No. 35, 'The Breakfast,' by BILLOTTE, consists of one figure, that of a lady, seated at her breakfast-table, conversing with her parrot; an agreeable composition, but somewhat harder than others above mentioned. No. 58, 'Haystacks on Fire at Midday,' is a large picture by BRETON—the fact of the fire is clearly stated; but in the numerous figures there is a want of energy and spirit—many are very skillfully drawn and lighted, but they will never subdue the fire. No. 162, 'Fishing Boats on the Dutch Coast,' by GUBIN, presents a certain effect of light which this artist often paints. M. Guin enjoys a high reputation as a marine painter in France, but his water wants volume and breadth, and his skies descriptive power. No. 201, 'A Cottage in Normandy,' by LAMBINET, is a small picture; an earnest study from the locality it professes to describe; the cottage, trees, and herbage we feel at once to be true, but the water and the sky are unlike nature. No. 200, 'Before the

Rain,' is a large landscape by the same painter; the subject is by no means an attractive one; but it, like the other, is a truthful description of a locality; this should have been the small picture, the other should have been the large one. No. 195, 'Erasmus composing his Enlogium of Folly at Sir Thomas More's,' by LABOUCHERE, shows but little play of chiaroscuro. We recognise at once Erasmus, and his friend. There are by the same painter two other works. No. 194, 'Luther burning the Pope's Bull at Wittenberg, Dec. 10th, 1520,' and 'Charles V., accompanied by his brother, Ferdinand, and the Duke of Alba, crossing the Elho at the Battle of Muhlberg, 1547.' No. 301, 'Landscape near Nemours,' TOURNEMINE, is a small view, a section of a meadow so like nature that it may have been painted on the spot. By the same artist we observe No. 298, 'Coffee-House on the Banks of the Danube,' and No. 299, 'Bourg de Ratz, on the Coast of Brittany.' No. 179, 'A Church Porch in Paris on Palm Sunday,' HILLEMACHER, contains a crowd of figures numerous and various, the poorer offering to sell palm-branches to the richer; the buyers are principally ladies, foreground figures, well-drawn and well-dressed; it is a work of much merit in the definition of character. No. 181, 'The Kitchen,' by HOUEY, is a most successful representation of a kitchen; there is much movement among the kitchen furniture and utensils, and the place is further enlivened by the presence of the cook; it is an excellent work. The same artist exhibits also, No. 182, 'The Boat Carpenter.' By HILLEMACHER there is a more interesting subject than the 'Palm Sunday,' that of 'Rubens Painting his Wife,' but although the composition has many good points, it is deficient of refined conception and clear execution. We know Peter Paul Rubens very well, everybody knows him, but we never should recognise him in the slovenly fellow presented to us here; there is no lack of portraits of Rubens. No. 322, 'Coffee-House in the Faubourg Bab-a-zou, at Algiers,' is a good, and, we doubt not, very accurate picture: No. 323, 'Fountain in the Faubourg Bab-a-zou, at Algiers,' is a worthy pendant by the same hand. No. 307, 'On the Banks of the Seine, Landscape and Cattle,' by TRIVON, is a large picture, the best landscape in the collection, deriving life from a herd of cows driven apparently down to the river to drink; the animals are judiciously varied in pose and colour, and the light is broken on them with masterly skill—a result of long and profitable experience. The foreground is amply detailed as to grass and weeds, but all sharpness of touch is most studiously avoided, and throughout the whole there is as little as possible of linear demarkation. The animals are sketchy, and not quite perfectly drawn, but upon the whole it is a production of rare excellence. No. 292, 'Cattle Watering,' LAMBINET, is a small landscape closely studied from nature. No. 39, 'The Hunt,' scene in the Forest of Fontainebleau, by AUGUSTE BONHEUR, is a work of much merit, but there are degrees of excellence in the parts; the rough foreground, with its whins, wild shrubs, and grass, is the forcible part of the picture; the trees are mannered, and not painted with that touch which defines masses of foliage, yet generally the work is of much interest. The same painter exhibits another excellent work. No. 142, 'The Toilet,' FICHEL, is a graceful figure composition; other works are exhibited by the same painter; as No. 143, 'The Card Party,' No. 146, 'The Proposal,' &c. No. 105, by DAUZATS, is 'The Interior of the Church of St. Cecile, at Alhy,' full of architectural detail. No. 167, 'The Invitation to Dinner,' by GUILLEMIN, is 'The Interior of the Residence of a French Ecclesiastic,' who receives a friend, and, with a great display of good things, invites him to dine. Other remarkable works are 'The Cold Morning,' by FRERE; 'The Last Supper,' by LEPELLE; and, by the same, 'The Adoration'; 'The Goatherd,' PALIZZI; 'The Lecture, Madame Brune,' 'The Wood,' DIAZ; 'Explaining a Dream,' COMTE, &c.; many of which merit detailed description, but want of space compels us to give only the titles.

BRITISH SCULPTURE.

THE following communication has been addressed to Sir Benjamin Hall by the members of the Sculptors' Institute:—

SCULPTORS' INSTITUTE,
32, SACKVILLE STREET.

TO THE RIGHT HON. SIR BENJAMIN HALL, BART.

"We, the undersigned British Sculptors, feel assured that we shall not be deemed intrusive or officious in addressing the following statements to a minister of the crown charged with the supervision of the public monuments of the country.

"We have observed with regret, that frequent attempts have been lately made by the most influential organ of the daily press to disparage the ability of British sculptors, and to defend as an inevitable necessity a recourse to foreign artists. It is moreover reported, that a large sum of money is about to be devoted to a monument to the Duke of Wellington, and another sum to a memorial at Soutari to the brave men who have fallen in the late war; and in the present temper of the public mind, and in the disposition of some who exercise the patronage of the country, we are not without apprehension that due justice will fail to be done to the English sculptors.

"We desire to guard ourselves against the imputation of an illiberal jealousy of the foreigner. Art is a universal language, and the artist should find himself a native of every great city of the world. There has never been a time, when the English courts and the English people have not received with ready welcome the foreign painter, architect, and sculptor;—may it be thus always. But we claim for native talent, that it also should be sought for and appreciated. It is not true that there is a dearth of genius amongst the sculptors of England. There are works of indisputable excellence from the hands of living artists, that attest the contrary. What is lamentably true is this—that means have rarely been adopted for committing public works to the men of greatest merit amongst us. We would humbly suggest, that, if the patronage of the nation were exercised with more care and discrimination, and with a genuine desire to discover the worthiest on whom to bestow it, the public monuments of England would no longer be appealed to as displaying in so many instances a painful mediocrity.

"None can feel more deeply than ourselves, the degradation which the sculpture of England has suffered during the last fifty years, from the erection in our Metropolitan Cathedral, the Abbey, and Guildhall, of the purilities and distressing allegories which deface the walls of those buildings; but let it be borne in mind, that while large sums were being lavished upon such productions as these, Flaxman and Banks were alive, needy, and seeking employment; men who were neglected year after year by the government and the municipal authorities of that time, are now the boast of every Englishman, and are acknowledged to have earned an European reputation.

"To approach somewhat nearer to our own times, we would point to a fact of no little significance. A sculptor of the name of Watson recently died; he was an industrious artist, and a competitor for most of the public monuments erected in his day; he never obtained a commission, but the rejected models which he exhibited on such occasions are now sought for with avidity, and studied by living artists.

"Whether the same unfortunate method of selection still attends upon us, we must leave others to decide. We must observe, however, that there is an increasing indisposition amongst artists of acknowledged merit to enter into any public competition. It is felt, that a proposal for a general competition is no security against an incompetent or partial judge.

"To combat this indisposition, to foster the genius of the country, to secure for our greatest monuments the artists of the greatest power, we would finally submit,—1st, That in every competition a public exhibition of the models of all competitors should precede the selection of any one of them; and 2nd, That such selection should be made by a committee so constituted, that the body of artists, as well as the public in general, may confide in them.

"To a public competition so conducted we cheerfully invite every artist resident in the United Kingdom, and we rest confident that, patronage very liberally and wisely exercised, there will no longer be an impression abroad in this country, that the English sculptor is unequal to the celebration of English heroism.

"We have the honour, with great respect, to subscribe ourselves,

"E. H. BAILY, R.A.,
P. MACDONELL, R.A.,
W. C. MARSHALL, R.A.,
J. H. FOLLY, A.R.A.,
HENRY WEEKES,
J. E. THOMAS,
F. M. MILLER,
THOS. THORNYCROFT,
ALFRED HONE,
T. BUTLER,
W. BEHNES,

M. NOBLE,
J. HANCOCK,
A. MUNRO,
E. B. STEPHENS,
J. N. WESTMACOTT,
JOSEPH DUBHAM,
J. EDWARDS,
T. THURPP,
E. DAVIS,
S. EARLE,
W. F. WOODINGTON."

[To this memorial Sir Benjamin Hall has returned for answer, that the money for the Wellington monument has not been voted; therefore, no arrangements can be made. Sir Benjamin Hall refrains from saying one word relating to the Scutari monument; he ignores that altogether in his answer; but if "the money not being voted prevents arrangement" being made with regard to the Wellington monument, it applies with equal force to the one for Scutari; and we sincerely hope, for the credit of all, that such may be, and is, the fact, whatever our fears may be.—Ed. A.-J.]

THE PEACE TROPHY AT THE CRYSTAL PALACE.

It is understood that "the Peace Trophy" was a commission to the Baron Marochetti, from the Directors of the Crystal Palace; if so, the Directors have made a mistake; for beyond question it will do them much more harm than good—although it is probable that the actual cost was paid for by the receipts incident to its "inauguration" in the presence of Her Most Gracious Majesty, H.R.H. Prince Albert, the Court, and "the wounded of the Crimea." But loss of character is always ultimately pecuniary loss: and the trophy is a blot, from the reproach of which the Directors will not easily relieve themselves.

We can readily imagine the astonishment, amounting to indignation, of Her Majesty and the Prince, when the canvas covering was withdrawn from this "golden image" which Marochetti had "set up." Their good taste, and knowledge of art, its capabilities and its requirements, are sufficiently well known to induce universal belief that they found themselves grievously out of place in the Crystal Palace, to render honour, amounting almost to homage, to a work which, for any merit of design or execution, would have been rejected by Gunter as the ornament of a trophy plum-cake. It has been so extensively described by the daily and weekly newspapers, that it is quite needless to enter into any description of it here; we observe, however, with no ordinary satisfaction, that we have not seen a single notice that gives to it a less condemnatory adjective than that of "execrable." It is, indeed, impossible to find in it a single particle of merit; a production claiming to be "art," so utterly worthless, was never placed before the British public.

We had some thoughts of selecting, from about twenty newspapers, passages of criticism on this work; and may yet do so—unless it be consigned speedily to the oblivion it deserves.

The monument for Scutari is of a better order, although that also is a poor affair. Who will for a moment believe there are not a score of sculptors in England who could have done more justice to so nobly suggestive a theme?

We earnestly hope our patrons of Art will learn a lesson from these failures. No one denies that Baron Marochetti can produce an equestrian statue; perhaps in a work of that class he surpasses the majority of his competers; but we have never yet seen a production of any other order by him that at all approaches the productions of several of our leading British sculptors. Let any one who doubts this examine his "Peel" at the Crystal Palace, and the miserable has relief at St. Paul's. If this assertion be fact, how deplorable it is that so large a share of public patronage has been accorded to this gentleman, while, of all the arts, sculpture is the most difficult of sustenance in England!

CORRESPONDENCE.

To the Editor of "THE ART-JOURNAL."
THE MONUMENT FOR SCUTARI.

DEAR SIR,—You have so often defended right against wrong, and written so earnestly for the advancement of sculpture in this country, that I am induced to forward to you a few words respecting the exhibition, at the Crystal Palace, of Baron Marochetti's model for the monument to be erected at Scutari.

For full twelve months the *Times* has been feeling the "public pulse" with regard to this same monument and its author, and following, as you know I do, the profession of a sculptor, I am necessarily deeply interested in all matters relating to the Art I practise. It is, therefore, with great pain I have observed the ceaseless efforts of the *Times* to disparage British Art. In sculpture it seems to see nothing,—to know nothing,—to care for nothing,—to notice nothing—except the productions of Baron Marochetti.

Well, sir, at length we see the Baron's monument for Scutari at the Crystal Palace ("the grand and bold monotony," as the newspaper phrases it), and also "the Baron's celebrated peace trophy," of which some laugh and others grieve; but there they are,—and, though it would be unbecoming of me to express an opinion of the merits or demerits of the Scutari model, yet its exhibition decides one very grave and important fact, namely, the question of the sum that it should cost: Parliament, from all accounts, is to be asked for 17,500*l.* for a monument for Scutari. Is it to be the one at the Crystal Palace? If so—and I write with facts before me—all the sculptors I have communicated with (and they are many) would be well content with 6,000*l.* for such a production. I may tell you an estimate has been made, and it could be completed for a sum under 5,000*l.*; then why should there be a grant of more than 17,000*l.* when 6,000*l.* would be ample payment? Again, the character of the design is of that description which, of all others, demands the least amount of artistic work; it is required only to roughly model one figure, and I am sure there are plenty of sculptors in this realm who would be glad to model such a statue for 150*l.*

I have the honour to be,

Yours truly,

A.

MINOR TOPICS OF THE MONTH.

THE NATIONAL GALLERY.—Four pictures from the "Rogers' Collection" have been secured for the National Gallery;—the copy, by Rubens, of Mantegna's "Triumphal Procession of Julius Cæsar," for 1,102*l.* 10*s.*; Rubens's sketch for his picture of "War," in the Pitti Palace, 210*l.*; Giotto's fresco from the Calmine church at Florence, 210*l.*; and Bassano's "Good Samaritan," 241*l.* 10*s.* These are all valuable additions to our picture museum.—Another addition has been made to the national collection during the past month, a picture painted in distemper by Alessandro Botticelli, a Florentine artist of the fifteenth century. The work is one of those purchased in Italy by the director during the past year; it is circular in form, and represents the Virgin with the infant Saviour, and two youthful figures in the act of worshipping him: one of these two is an angel, and the other appears to be St. John the Baptist: the expression of the Virgin's face is very beautiful, but there seems a remarkable family likeness in the three large figures, as if all had been studied from the same model. As an example of this old Florentine master this picture is not without value: it is in good condition, and the colouring brilliant for its age; yet there is little in it that the student will find profitable; the drawing of the limbs is altogether bad. The National Gallery contains no other work by this hand.

PROVINCIAL SCHOOLS OF ART.—It is understood that once in each year an inspector from the head department in London shall visit each provincial school of art, and shall hold an examination in certain of the early stages of the course; and at the same time in conjunction with the head master of the school, and assisted, if necessary, by a head master from one of the

nearest schools of art, adjudge local medals and rewards. The principal and advanced works rewarded with a medal will be sent to form a general or national collective exhibition, either in some one of the great provincial towns or the metropolis.

PANORAMA OF ST. PETERSBURGH.—Often as we have had occasion to speak in favourable terms of the panoramic pictures painted by Mr. Burford, we do not remember to have seen a more successful effort of his skill than the view of St. Petersburg, recently opened in Leicester Square; it is the perfection of scenic painting,—indeed, may almost take rank as a picture with the best class of landscape-painting. The view is taken from the summit of the observatory, near the imperial palace, which commands the whole extent of the city and the surrounding country, seawards as far as Cronstadt. Every part of the picture is painted in a most masterly manner; nothing appears slighted or left for the imagination to fill up, even to the minutest details of the architecture, and the colouring is everywhere as truthful as Art can render it. The painting of the water demands especial notice for its reality: there is a small steam-ship at anchor in front of the dockyard, which is brought forward with such extraordinary power that one can scarcely believe it to be represented on the same surface as the objects in its rear. The ripple on the surface of the river as it flows past the vessel is positively in motion.

THE STATUE OF SIR ROBERT PEEL in Cheap-side is now provided with its lamps, &c., completing the entire design. The tempting chance for the lovers of "uniformity" of placing four lamps at each corner has been modified by better taste, and the general effect improved, by placing two only behind, and two posts in front. So far the change is agreeable, but the pedestal and its accessories are still little removed from the common-place, and are eclipsed by the city-statue of William the Fourth, opposite London Bridge.

MR. T. SEDDOX has arranged, for private exhibition, an interesting series of sketches, by himself, in Jerusalem and Egypt. They are pictures of remarkable places, most truthfully rendered, and an additional interest is given to them by the fact of their being all painted on the spot, and not at home from slight sketches, as is frequently the case. Hence, there is much truth and vigour about them. The large pictures of the Valley of Jehoshaphat and the Pyramids are excellently rendered; the undying interest of most of the scenes depicted, need, however, not be insisted on. They may be seen at 52, Conduit Street, throughout June.

THE BUILDING erecting near Brompton Church, for the use of the Commissioners of the Great Exhibition of 1851, and intended for a Museum, is rapidly completing its features of ugliness. As a new frame-work of iron and glass, its inartistic appearance has been denounced, but it is now closed in with sheet metal, and looks like an immense steam boiler. It is perfectly marvellous how anything so hideous could emanate from such a quarter; the gas-meters of Lambeth are elegancies by comparison.

THE WOOD CARVINGS OF MR. W. G. ROGERS, and especially some of his restorations of the works of Gibbons, are now deposited at the establishment of Messrs. Boose and Roe (successors to Forrest), at No. 54, Strand. A visit to this collection may afford pleasure to all who appreciate excellence in Art, and who can rightly estimate the high abilities of the accomplished artist. Mr. Rogers deservedly stands at the head of his profession; he has been surpassed only by his great predecessor, whose works after the lapse of more than a century it is his pleasant task to rescue from the grasp of the destroyer.

INDUSTRIAL EXHIBITION AT MANCHESTER.—The year 1857 is, it appears, to have its commemoration by another Exhibition of Industrial Art, to be held in Manchester, where a structure is to be erected for the purpose. It will be, of course, our duty to render it all the assistance in our power. If an exhibition could be successful anywhere out of London, it must surely be in this—the great city of Art Manufacture, not only of cotton but of a hundred other articles

which create the wealth of the empire. The projectors do not, probably, calculate upon its "paying" in the ordinary sense of the term, but there are many ways in which it will be remunerative. A very large sum has been already subscribed, so as to render failure an impossibility. We shall, no doubt, have more to say on this subject ere long; meanwhile, we have only to observe that the result will entirely depend on "the management,"—if that be good, there can be no danger; if it be incompetent, disappointment is certain.

DRAWINGS OF THE CRIMEA.—Messrs Dickenson of Bond Street have added very largely to their collection of drawings of the seat of war, comprehending views, battles, marches, buildings, fortifications; in short, all matters which serve to throw light on this ever-interesting subject. The exhibition is free.

A SOCIETY—to which has been given the name of the NATIONAL GALLERY REFORM ASSOCIATION—has, it appears, been formed; of how many "Members" it consists we are not told, but we may easily guess; it would be, we imagine, no difficult matter to name the half-dozen; meanwhile, all we positively know is that "William Coningham" is the Treasurer, and that he addresses from "the Oxford and Cambridge Club."

THE CRYSTAL PALACE.—Some immediate reference to the various improvements that are in progress here seem to be required; although it is our intention next month to notice them at length and in detail. An active and intelligent manager, Mr. Fergusson, has been for some time at work, not only to renovate but to remove; he has had not alone to avoid the evils into which his predecessors had fallen, but to go back many steps in order to give to the scheme the character to establish which it was originally devised. It is notorious that as a nursery of industrial Art—such as it was expected to be—it is entirely a failure; but a remedy is by no means impossible, and arrangements are now making which may yet render the Palace a very valuable auxiliary to the manufacturer. It is to this special branch of the subject we shall direct attention in our next, and in succeeding parts, for our purpose is to illustrate some of the Courts in which the productions of Art industry are deposited.

HOSPITAL FOR CONSUMPTION.—The bazaar to which we referred two or three months since, in aid of the funds of this valuable institution, will take place on the third and two following days of this month, in the grounds of the Toxophylite Society in the Regent's Park, wind and weather permitting—for while we write the elements are terribly adverse to fêtes of this description—there is little doubt of the Hospital receiving substantial benefit from the proposed bazaar, as it always has done on previous similar occasions.

MEMORIAL OF THE GREAT EXHIBITION.—Something, it appears, is to be done in reference to the subscription that was entered into in 1852, to preserve "a memorial of the Great Exhibition, in connection with a testimonial of admiration and esteem to H.R.H. Prince Albert," Alderman Challis (who, as Lord Mayor in 1852, set the subscription on foot) has summoned a meeting of the subscribers; but it was held at too late a period of the month to enable us to comment on the proceedings.

HER MAJESTY'S THEATRE.—The great pleasure of the season is the re-opening of the noble temple of the Musical Drama, "HER MAJESTY'S THEATRE," where for so many years Mr. Lumley delighted the public, while improving their taste, in a manner that should never be forgotten. It was quite refreshing to find ourselves once more in the "Old House at Home,"—to see it as unadorned and fresh as when the "Swedish Nightingale" poured forth her wealth of song within its walls, and the dome echoed back the thunders of Lullabe.

DR. WAAGEN, we hear, is about to visit this country again, during the summer, to complete his work on "The Art-Treasures of England."

CARL WERNER'S DRAWINGS.—We noticed last year the collection of water-colour drawings exhibited by this artist at 49, Pall Mall, and we have much pleasure in inviting attention to a new collection, the result of more recent labours.

They are not numerous—the subjects are principally Venetian interiors, saloons, and halls of state, well-known to many past generations, and now sought by the artist and traveller attracted by their history and tradition. There is among these works one large composition, full of figures, of which the subject is "The Departure of Caberia Cornaro, Queen of Cyprus, from Venice." "The Great Hall in the Doge's Palace" at once recalls the reality to the memory of all who have seen the room; its famous pictures are all recognizable. Other remarkable subjects are "The Library in the Doge's Palace," "The Doorway of the Convent of St. George," "Interior of St. Mark's," "Entrance of the Church of St. Zeno, from the Cloister, Verona," "Tomb of Ronco and Ghilietta, Verona," "Interior of St. Antonio, Padua," with many other subjects of much interest. Carl Werner is undoubtedly an artist of the very highest talent; and as a master there are few in England under whom pupils may so advantageously study.

COPYRIGHTS IN ART.—The following notice of motion was made in the House of Commons, on the 19th of May, by Thomas Chambers, Esq., the member for Hertford: to move for a

"Select Committee to inquire into the present state of the Law of Artistic Copyright; the operation of the Engraving and Sculpture Copyright, and International Copyright Acts; together with the Conventions entered into by Her Majesty with various Foreign States, and the Orders in Council founded thereon, so far as the same relate to Artistic Copyright, with a view to the amendment and consolidation of the Engraving and Sculpture Copyright Acts."

It is high time this subject should be considered by the Legislature; and we shall look for the discussion with no ordinary anxiety.

FLAXMAN'S BASS-RELIEF at Covent Garden Theatre have remained uninjured by the late fire, and will, of course, be carefully preserved. They typify, in two compartments, the ancient and modern drama. In one we see Aristophanes and Menander with the Greek Chorus; and Æschylus contemplating the pursuit of Orestes by the Furies. In the other, Shakspeare is calling up his principal creations in Tragedy and Comedy; while Milton is thoughtfully gazing on a scene from his own "Comus." The very graceful statue of "Comedy," bearing the characteristic mask and crook, emblematic of her pastoral origin, is also by Flaxman, and bears his name on the pedestal.

PRIVATE MUSEUMS.—Two private museums have become public property in the course of the last month; the one by gift, the other by purchase. The gift is to the city of Liverpool, and consists of the large collection formed by Joseph Mayer, F.S.A., and which has long been exhibited in Colquitt Street, in that city. It embraces objects of all ages and countries, and is particularly rich in Egyptian specimens; there is, however, scarcely any department of antiquities unrepresented, and the recent additions of the celebrated Fausset collection of Anglo-Saxon antiquities, and the Pejerary collection of Roman ivories, have given it a great renown. Mr. Mayer has spent more than 30,000*l.* in its acquisition, and has munificently presented it to the Liverpool people for their new Museum and Hall of Science, about to be erected near the Town Hall. The Museum, which has become public property by purchase, is that formed by C. Roach Smith, F.S.A., and which will now be located in the British Museum. It is especially curious as illustrative of Roman and mediæval London; indeed, it almost entirely consists of relics obtained within the boundaries of our metropolitan city, during the excavations made within the last thirty years.

THE ALLIED GENERALS AT SEBASTOPOL.—A painting of very great merit, and of the highest possible interest, at this moment, has been painted by Mr. T. Jones Barker, and will be exhibited, during the month of June, at Messrs. Colnaghi's, Pall Mall. We cannot, at present, do more than refer to it as containing the portraits of seventy or eighty generals, &c., who had "leading parts" in the war, and who are assembled before the ever-famous fortress.

REVIEWS.

THE SCENERY OF GREECE AND ITS ISLANDS. Illustrated by Fifty Views, sketched from Nature, etched on Steel, and described *en route*, with a Map of the Country. By WILLIAM LINTON. Published by the Artist, London.

The sight of any place which has been the theatre of remarkable historical events naturally brings before the imagination whatever has occurred there: it is not necessarily the scene itself, how beautiful soever it may appear to the eye, that renders it attractive, so much as the associations which are connected with it. We rebuild, in our mind, the ruined towers of some ancient fortress, and we seem to see the armed hosts encamped against it; we gaze on some old battle-field, now, perhaps, covered with golden corn ripe for the sickle of the husbandman, and once more it is glittering with helmet and cuirass; we walk amid the silence of cloister and colonnade now mouldering into dust, and remember that the smoke of holy incense once ascended up from its altars, and hooded monks sang in chorus to the loud-pealing organ; we visit the lonely chamber from which the martyr or the patriot was led forth to the scaffold, and the ear still catches the "groaning of the prisoner appointed to die." At times like these we hold communion with the past; thought is too busy with the dead to have much intercourse with the living.

Such feelings as those we have attempted to describe took strong possession of us while slowly turning over the pages of Mr. Linton's delightful volume: we say "slowly," for each picture summons up a train of shadowy thoughts concerning a people whose history seems, at this distance of time, and with the change that has passed over the spirit of our world's mind, to belong rather to fiction than reality. The first plate, for instance, introduces us to the wide level plain of Megalopolis, and the mind instantly reverted to its founder, Epaminondas, the victor at Leuctra, where four thousand Spartans, with their king, were left dead on the field. Next we have Athens in three or four plates, in one of which the ruined columns of the Temple of Jupiter Olympius stand out in bold relief against a background of dark thunder-clouds that appear more in harmony with the noble wrecks of Athenian grandeur, than if these were presented amid the blaze of sunshine. As the traveller leaves Athens for the town of Northern Greece, he passes through the wild and rocky gorge of Phyle (Plate 6), from which Thrasylus descended with seven hundred men against the Thirty Tyrants: the scene is most artistically represented by Mr. Linton's pencil. Boeotian Thebes comes next, conjuring up visions of Pindar, Epaminondas, and a host of other great names that added lustre to old Greece: the modern town, with its aqueduct, and the mountains of Kabaon in the distance, make a picturesque composition. Mount Parnassus, sacred to meditation; the cliffs of Trophonius, amid which were the Haron, or sacred grove, and Temple of Heresyn; the Acropolis and Plain of Chironom; the Athenians were defeated by the Boeotians in the fifth century before Christ; and, with their allies, the Spartans, were also vanquished by Philip of Macedon about a century after, and where the Greek historian, Plutarch, was born; Delphi, "whose oracles are dumb;" the Fount of Castalia, the waters of which inspired all who drank of them with the genius of poetry, severally appear in successive plates.

Salona, to which Diocletian retired after he had abdicated the Roman diadem, forms a beautiful picture, surrounded as the town is by objects of deep interest to the classical student; "a more spirit-stirring scene," as Mr. Linton observes, "is scarcely to be found in all Greece." Eleusis, where was held that mysterious festival, to which many of the Grecian tribes went up, as did the Jews to the feast at Jerusalem, to take part in the most solemn religious ceremony observed by the ancient Greeks, is now a mean village, whose scattered houses, however, form the foreground of an interesting picture. The Acropolis, and Mars' Hill (Plate 17), bring to mind St. Paul denouncing the superstition of the Athenians, no less than all the other events connected with the history of the people, whose great council was held here. "The hill of Areopagus offers," says the writer, "one of the best positions at Athens for contemplating 'the flood of fire' with which the marble columns, the mountains, and the sea, are all heated and penetrated by the illumination of an Athenian sunset."

We have no space to follow Mr. Linton in his tour through the Morea and the islands of Greece, which form the subjects of his remaining plates; there is not one that does not invite our remarks, but we are constrained to forbear. A more captivating book has rarely passed into our hands;

and it is one which must have cost the author some years of arduous labour. We have long thought Mr. Linton an artist whose genius has not been sufficiently appreciated by the public; his pictures of Greek scenery, and his compositions from classic history, such as "The Embarkation of the Greeks from Troy," and "Caius Marius among the Ruins of Carthage," have never been excelled by any works of similar character; they are full of the most expressive poetry of classic Art. He comes before us in this volume as an engraver, for the plates are all from his own etching-needle, aided, we presume, by the ruling-machine; the majority of them have the finish, delicacy, and force of the most elaborated line engravings, so much as to render it difficult to say they are not. He is, moreover, a scholar, of which there is ample proof in the text that accompanies his views, and to the scholar who loves to "tread on haunted ground," this work will be as welcome as it cannot fail to be to the admirer of Art.

NOTES ON SOME OF THE PRINCIPAL PICTURES ENRIPIED IN THE ROOMS OF THE ROYAL ACADEMY AND SOCIETY OF PAINTERS IN WATER-COLOURS. By JOHN RUSKIN, M.A. Published by SMITH & ELDER, London.

We are agreeably disappointed by this notice of the pictures in the Academy. Mr. Ruskin finds it inconvenient to be consistent in his antipathies. In his preface to these "Notes" he deprecates what he calls anonymous criticism, and congratulates himself that he is ready to answer for everything that he has written. What is Mr. Ruskin's response worth? He has, among a certain class of persons unacquainted in art, wielded some influence through a speciousness of language and a professed enthusiasm for painting; and within this circle he has occasionally endeavoured to damage the reputation of the best men of our school, until on all hands there is an unanimous effort to suppress, or at least neutralise, the nuisance. Can we not lay our finger, in Mr. Ruskin's works, on passages the most insolent that were ever aimed at the reputation of distinguished men? Will these men now thank him for his capricious patronage? He claims for himself the purest spirit of impartiality, but he praises inordinately Mr. Millais, and he surely tells us that Millais is his friend; he praises in like manner Mr. Hunt, and claims him also as his friend; he praises also Lewis, and there generally most deservedly, though frequently in the wrong passages. If Mr. Lewis is not already his friend, does he wish to make him so also? How has he written of Maclean, Stanfield, Roberts—now, of all whom he chooses to distinguish from the "new school?" What he wrote publicly of Roberts last year in his "Notes" is publicly known, but not what he communicated to him privately, which it is said amounted to a declared determination to write *down everything that he should in future point*. Now for the remarks which come in the "Notes" before us. Speaking of the St. Peter's picture, he says: "It is both careful and brilliant. . . . I can answer for the careful delineation of what must be to most people a striking scene. . . . Note, for instance, the pretty and true change in the colour of the red cross in the dome, where it is half in shade and half in sun." This of course rescues Mr. Roberts from the ban put upon him last year; he must be most grateful, and will again appear happy to his friends. Mr. Ruskin alludes to a change in Mr. Roberts's manner. There is no change; as he paints this year, so he painted last. Mr. Stanfield is also fortunate in eliciting eulogiums in these "Notes" on "The Abandoned." The sea is "quite Function, in the mystery of the farther waves, and the sentiment of the picture very grand." But Ward's picture is "excepted from the progressive list"—at least Mr. Ruskin "fears" it must be so—and "marked as one of the representatives of the old school;" but the notice terminates with the redeeming clause, "it is not a bad one." This final putting on the back must have saved the artist much pain. Upwards of five pages are devoted to "The Seapeeper," but the pith of the notice is that the picture, "regarded as a landscape or as a composition, is a total failure;" that, in painting such a picture, Mr. Hunt had "forgotten to ask himself first whether he could paint a goat at all." The critic has committed himself to other works, but feels from former experience that it would not be safe to praise his work. In speaking of "Autumn Leaves" (J. E. Millais, A.), it is said to be "the most poetical work the painter has ever conceived, and also, as far as I know, the first instance existing of a perfectly painted twilight." On the whole, the tone of these "Notes" is apologetic; we must say, that they do not present so much of that sneering arrogance which has characterised Mr. Ruskin's former notices.

NAPOLEON REBUKING HIS OFFICERS ON THE BATTLE-FIELD OF BASSANO. Engraved by C. G. LEWIS, from the Picture by T. J. BARBER. Published by J. G. BROWN, Leicester.

The print-publishers in the country seem of late to be keeping pace with those of the metropolis, in the number and importance of the works they bring out: Mr. Browne, of Leicester, is a name rather new to us, and if this print be his first speculation, as we believe it to be, it is a bold effort, but, we expect, it will prove far from an unsuccessful one. The war-fever is not quite over with us yet, and just now we seem to take especial interest in all that refers to the terrible adventures of national conflicts. The engraving before us recalls to our recollection many of the large battle-pieces from the pictures of Horace Vermet, of whom, by the way, Mr. Barber was a pupil, if we mistake not; and certainly his compositions show much of the spirit and daring energy which characterise those of the French military artist. The historians of the wars in which Napoleon was engaged tell us that when he was riding over the field of Bassano, in Italy, one of the places identified with his earliest military achievements, he came upon a dead trooper and his horse, at the side of the former was a large dog piously howling over his prostrate master. Whether or not the French officers had been guilty of unnecessary cruelty, so as to justify the remark addressed to them by their general, we do not at present remember; but Napoleon is said to have directed their attention to the animal with the remark,—"There, gentlemen, that dog teaches us a lesson of humanity." The print is a very large one, the subject divided into three distinct groups: to the right are Napoleon and a portion of his staff, consisting of Generals Augereau, Berthier, Massena, and Murat, each of whom acted a distinguished part in the subsequent wars of the Consulate and the Empire. The centre group is composed of the dead trooper and his companions; the left group, of some wounded republican soldiers, for one of whom a pretty *vivandière* is pouring out a cordial. The background shows the town and fortress of Bassano, and the plain in which they stand is filled with the victorious troops of France. The story is very graphically represented, and carries the sympathies of the spectator with it; the strife of the battle is over, the "hurly-burly is done," leaving, however, its sad and sickening results spread out before the eye; but there is a quietude and repose over the scene contrasting, not unpleasantly, with what has been, for it is in harmony with what now is. Napoleon and his officers have been copied from well-authenticated portraits, that of the general-in-chief from the celebrated bust by Canova; it, of course, represents him as a young man, widely different from the portraits which we are most familiar: this is a very spirited group, both it and the central figures are very effectively engraved; and, indeed, the general character of the execution is vigorous and brilliant. It is certainly one of the best of the "war-prints" which have been issued in this country.

THINGS NOT GENERALLY KNOWN. By JOHN TIMBS, F.S.A. Published by DAVID BOGUE.

Authors, it is well-known, frequently damage themselves when they write long prefaces, or (some say) prefaces of any kind—but that which Mr. Timbs has gracefully prefixed to this volume, is a golden key to his interesting and very useful book. "You may, perhaps say, 'Your volume contains but a small portion of things not generally known.' Granted, but here are no fewer than FIVE HUNDRED groups of instances, from the Heavens and the Earth; the sea and the air; light and sound; life and death; the animal and vegetable kingdoms; the origins of house and home; the festivals of our calendar; historical glances at laws and customs; dignitaries of church and state; national characteristics; wonders of our inventive age; and a few curiosities of art and literature of early times."

The volume is divided into subjects—"Marvels of the Heavens," of "The Sea," of "The Atmosphere," of "Life and Death," of "The Animal Kingdom," of "Domestic Manners;" and so on:—and all are so well selected, as to be capable not only of conveying much information, but suggesting much more; it is impossible to place in the hands of the young, a work of higher interest, of greater value; it bequeaths the reader into knowledge without force or effort; while those who have passed through many years of life, and think, as they may do without presumption, they are well-versed in literature, and have acquired much and varied learning, cannot fail to enjoy a compendium of what they devoted so much time to

acquire: indeed this volume is invaluable to young and old, and we congratulate the public on the result of Mr. Timbs' researches, which may be called "Universal."

THE FERNS OF GREAT BRITAIN. THE FERNS ALLIES. A Supplement to the "FERNS OF GREAT BRITAIN." Illustrated by J. E. SOWERBY, Proprietor of "Sowerby's Botany." The Descriptions, Synonyms, &c., by CHARLES JOHNSON, Esq., Botanical Lecturer at Guy's Hospital. Published by the Proprietor, Mead Place, Lambeth.

The botanical works to which the name of Sowerby is attached have been so long before the public, and so appreciated by that portion of it who are interested in the vegetable kingdom, as to place him among the most popular of our writers on the subject. The importance which the Fern tribe has lately assumed in the conservatory, boudoir, and even in the drawing-room—and how varied and elegant is the foliage of these simple, wild children of the soil—demands such a book as Mr. Sowerby's publication to aid the amateur in its cultivation; for it contains all that is necessary for the amateur grower to know. It seems that the author has not been fairly treated, in reference to this work, by one of the societies that publish books on moral and religious subjects, at a comparatively low price, for the benefit of the large masses of the community; the society in question having, within a few months after the completion of his volume, issued one of a similar character, in which a large number of Mr. Sowerby's drawings were copied without his permission, or the least acknowledgment of the source whence they were taken. This is not honest, and we can scarcely believe that those who have the management of the publishing department of this institution were aware of the offence which had been committed. We do not at all consider that such a society is travelling out of its legitimate path in issuing works of this character; but it ought at least to take care that in so doing, the rights of private authors and publishers are not infringed upon.

The FERNS ALLIES, a term recently applied to certain small families of the Fern tribe, are spoken of in a supplementary volume, which must take its place beside the other on the table of the botanist.

ANALYSIS OF ORNAMENT.—THE CHARACTERISTICS OF STYLES: AN INTRODUCTION TO THE STUDY OF THE HISTORY OF ORNAMENTAL ART. By R. N. WORNUM. Published by CHAPMAN & HALL, London.

We hold it as an axiom that no one can thoroughly enjoy the beautiful in Art, to whatever class the object he contemplates belongs, who has not some knowledge of the principles, or rather of the character, of that which constitutes its beauty. There must be, so to speak, some analogy between the mind and the matter to constitute real pleasure—the faculty of seeing aright must be combined with that of understanding aright. Hence we would strenuously advocate the propriety of making at least the fundamental principles of Art of every kind a part of general education in every school, private or public, throughout the kingdom. Were this done, there would be a generation after us far wiser than their fathers, and better able to appreciate all that is good and to shun whatever is bad; and for such a purpose Mr. Wornum's "Analysis of Ornament" would be a very suitable book of study in that particular branch. Although only an abstract of a course of lectures originally prepared for, and delivered at, the government Schools of Design, there is in the book sufficient information afforded on the characteristic elements of the various styles to be exceedingly profitable. In all Mr. Wornum writes he is eminently lucid and practical, and these qualities, added to the numerous examples of ornament with which his work is illustrated, render it instructive and comprehensible to the mind even of a child.

TASSO AND LEONORA, THE COMMENTARIES OF SIR PASTALEONE. By the Author of Mary Powell. Published by AUSTIN HALL & Co., London.

The Author of "Mary Powell" has acquired a well-earned celebrity by the ease and grace with which she recounts the real and fictitious events of past times. Her descriptions are strictly artistic, and her purity of sentiment, and perfect taste, render her writings most fascinating. If not her best, TASSO AND LEONORA is certainly among her best books, and she has not, as yet, written one too many.

THE ART-JOURNAL.



LONDON, JULY 1, 1856.

THE PORCELAIN MANUFACTORY OF CHINA.



HE making of Pottery has ever been one of the first Industrial Arts practised by mankind. Before they have learned the use of metals, or the mode of working them, the rude inhabitant of civilised countries shapes with his hands the vessel of unburnt clay which serves either to hold water, or to receive the ashes of the dead. Accident, probably, led to the discovery that this primitive ware might be improved by baking. Another step in progress produced the potter's wheel, which gave symmetry to the irregular forms fashioned by the hands. The Panathenaic vases of Greece; the terra-cotta statues of Etruria; the Samian ware of ancient Rome; the elegantly turned pottery of Magna Græcia; the lustrous ware of Moorish Spain; the iridescent majolica of the Mediterranean shores; the rustic pieces of Bernard Palissy; the terra-cotta groups of Luca della Robbia; the Raphael ware of Pesaro; and the perfect porcelain of China and Japan, had no other beginning than the bowl of clay shaped by the untutored hand of the savage.

All these different productions of the Ceramic Art have, in their turn, been the admiration of our race; but Athens, Etruria, Rome, Magna Græcia, and Moorish Spain, have ceased to exist as nations; the processes of the Palissy and of the Della Robbia family have been lost; and the few relics of their Ceramic Art which have been preserved to the present time are amongst the most valued Art-treasures of archaeologists. China alone, which began ere they began; which was a great nation when they were each and all most powerful; is still a great nation when they each and all have passed away, and are no longer reckoned amongst the nations.

The first making of pottery in China is lost in the obscurity which hangs over the mythological Emperor Hoang-ti, the Potter; the invention of terra-cotta in China belongs to the Emperor Chin, also a potter, whose reign verges on the confines of mythology and true history. When the Roman Empire was in its zenith, and the Christian era had not yet begun, China alone had achieved a triumph in the Ceramic Art by the invention of the true hard porcelain. While the great empires of the West were trodden under foot by the northern barbarians, China, safe in her isolated position from all hut Tartars, went on from century to century perfecting her Art, guiding, as it were, by the unity of one mind, the uniting industry of her vast population. All the emperors—as well those of the Barrier as of the Chinese dynasties—fostered and encouraged the porcelain manufacture as the brightest jewel of their crown. While Europe was passing through the troubled times known in history as “the dark ages,” the Chinese porcelain manufactory was in full activity, producing in succession “white jars brilliant as jade,” vases “blue as the sky after rain,” or “of the colour of rice,” or “red as the sun after rain.” Then flourished the Chinese artists Pehang and Chin, and others famous in the history of Chinese porcelain, whose untranslatable names convey no meaning

to an English ear. And the Art-manufacture continued to prosper while distant Europe scarcely knew of its existence, save from the incidental account of some early traveller. Although some specimens had been brought to the Moorish states of Northern Africa during the middle ages, none were seen in Europe until the return of the Portuguese from their long voyage round the Cape of Good Hope, introduced this beautiful product of the Ceramic Art to the West. Europe saw and admired; many untiringly tried to imitate that which for nearly two hundred years proved unimitable. The soft porcelain of France, which was first made in 1695, and the soft porcelain of Bow and of Chelsea, of Derby and Worcester, though beautiful in their kind, were greatly inferior to the hard porcelain of China. It was not until 1706, that is to say, one thousand seven hundred years and more after its invention in China, that Böttcher, then in the employment of Frederick Augustus, Elector of Saxony and King of Poland, succeeded, after many trials, in making hard porcelain. He kept his secret so well that hard porcelain was not made in France until 1768 or 1770. England, however, did not acquire the Art until a much later period.

The Chinese porcelain manufactory has now existed for upwards of eighteen hundred years, and still shows no signs of decay—a circumstance unprecedented in the history of nations.

Shortly before the commencement of our era, some Chinese emigrants carried the Art to Japan; there it prospered among that exclusive people, and there it still prospers. Some connoisseurs prefer the porcelain of Japan to that of China.

From the beginning of the 16th century almost to the Chinese war in our own times, China was looked upon by Europeans as a land of wonders and mystery, from which foreigners were excluded with jealous pertinacity; a land rich in tea and silkworms; whose industrious population produced porcelain and lacquer-work by unknown processes, and with unknown materials; whose sovereign was the “brother of the sun and moon,” and “son of heaven,” whose men wore tails of hair on their heads; who suffered their nails to grow like claws; who used cats for limpiers; who tied stones to their donkey's tails to prevent their lraying; and who eat birds'-nests, rats, and puppies; and whose women had small feet, which were, it was said, cramped and crippled in infancy in order that they might not roam far from home.

The issue of the war, which was successful as far as we are concerned in opening the ports of China, increased our knowledge of the country; our intercourse with the Chinese has now more of reality, less of the marvellous.

The Chinese are a decidedly literary people. Education is so generally diffused that almost every man can read and write. They had stereotyped books in the 8th century of our era, and movable types of baked clay a hundred years before Gutenberg's discovery. Their published works have found a place in the public libraries of Europe, and European professors have begun to study the language. A new field of literature is thus opened to us, and translations from the Chinese are among the most recent literary productions. The most valuable of these to our country is decidedly one on the History and Manufacture of Chinese Porcelain—a French translation of which we feel much pleasure in introducing to our readers. We are indebted for this translation to M. Stanislas Julien, Conservateur-adjoint of the Imperial Library at Paris, a member of the Institut Français, and Professor of the Chinese and Manchou-Tartar languages. M. Julien is already known in this country by his work, entitled, “*Recueil des Principaux Traités Chinois sur l'Éducation des Vers à Soie et la Culture des Mûriers*,” which has been translated into Italian, German, English, Russian, and modern Greek, and which Mehmet Ali ordered to be translated into Arabic for the use of the Syrians. A translation from the Chinese, by an author whose previous work had been so well received, would have deserved our attention, even if the subject had been much less interesting than we find it.

Independently of the passion for old china, which, although not so general as it was some years ago, is still prevalent in this country, the fact that the manufacture of porcelain constitutes one of our Art-industries—and a very successful one too—invests the work with a social value which otherwise

it might not possess. It is no slight recommendation of M. Julien's translation* to say that his rendering of the passages descriptive of the technical processes of the porcelain manufacture in China has obtained the approbation of M. Salvétat, Professor of Chemistry at the Manufactory of Sèvres.† But the interest taken by M. Salvétat in the book is not limited to a simple expression of approbation; he has imparted to it additional value by an introductory preface relating to the manufacture of porcelain, and by the useful practical notes on almost every part of the process by which he has illustrated the technical part of the Chinese work. In order to render the account of the porcelain manufacture as complete as possible, Dr. Hoffmann, of Leyden, has added a memoir, translated from the Japanese language, on the porcelain of Japan.

The first of these oriental works thus happily introduced to European readers by this learned trio is divided into seven books, some of which are historical and descriptive, the remainder technical. The whole are copiously illustrated with woodcuts of the various marks and characters by which the different kinds of porcelain are distinguished, and the fifth part by a series of plates to which we shall again allude.

Beginning with the historical part, and assisted by M. Julien's excellent preface, we shall endeavour to give a brief abstract of the rise and progress of the porcelain manufactory in China. The Chinese, as M. Julien observes, are the only people who possess an exact chronology which extends from the most remote antiquity to the present time. Whether their early history is more trustworthy than that of other nations is perhaps doubtful. Their official annals ascribe the invention of pottery to one of their emperors, Hoang-ti, who, they say, ascended the throne in the year B.C. 2698. In early times, nations selected their monarchs for their personal prowess or qualifications; it was reserved for the Chinese to elect for their sovereigns men skilled in the art of the potter. The Emperor Chin, also, before he was raised to the throne, B.C. 2255, made pottery in the province of Chang-tong. All the Chinese authors are agreed that the manufacture of terra-cotta vases began in this reign, and no other kind of ware was made until the Tsin and Han dynasties, B.C. 249—202.

The invention of porcelain proper, which took place in the district of Sin-p'ing, ranges, according to M. Julien, between the years 185 B.C. and 88 A.D.—no less than one thousand six hundred years before the discovery of the process in France; but if the Japanese account of the porcelain manufacture in that country, in the year B.C. 27, be correct, the invention must be placed between 185 and 27 B.C.

For a long time the process of the manufacture in China was slow and uncertain. During the Wei dynasty (220—264 A.D.) the manufacture extended itself in various localities. The only peculiarity recorded of the porcelain made under the dynasty Tsin (265—419 A.D.) is that it was of a blue colour, and much valued. In the year 583, the manufacturers inhabiting the district of King-te-chen were ordered to make porcelain for the use of the emperor, and to send it to his capital Kien-Kang (now King-ning-fou), the capital of the province of Kiang-nan.

As early as the time of the Soui dynasty (581—618), we find that some of the ancient processes had been lost, and that the green porcelain made by Ho-tcheou to replace it was much praised. In 621, the manufacture of porcelain was generally diffused over the country, and the names of many artists have been preserved as the inventors or improvers of peculiar descriptions of porcelain. About this time were produced the vases which acquired the name of *artificial jade*, and the porcelain of Ho, on a white ground, “brilliant as jade.”

In 954 was made the porcelain of Teh'ai, which was “blue like the sky after rain,” whence its name. It was, says a Chinese writer, “blue as the sky, brilliant as a mirror, thin as paper, sonorous as a k'ing (a musical instrument), polished and lustrous, and as remarkable for the fineness of its veins, or

* “*Histoire et Fabrication de la Porcelaine Chinoise, ouvrage traduit du Chinois par M. Stanislas Julien, accompagné de notes et d'additions par M. Alphonse Salvétat, et augmenté d'un Mémoire sur la Porcelaine du Japon, traduit du Japonais par M. le Docteur Hoffmann.* Paris, Mallet-Bachelier, Quai des Augustins, 55. 1856.”

† See M. Salvétat's Preface, p. lxxviii.

crackles, as for the beauty of the colour." The secret of making this much admired ware was lost after a few centuries; when, such was the estimation in which it was held, that those who were fortunate enough to possess fragments of it wore them in their caps of ceremony, or fastening them to pieces of silk, used them as necklaces. We can only notice briefly the beautiful crackle porcelain ware of "the elder brother" of the Tehang family; the delicate pale blue ware of "the younger brother," A.D. 960; the works of the venerable Chu, who excelled in modelling in porcelain different kinds of animals, birds, and similar objects. The daughter of this artist, called "the fair Chu," was even more skilful than himself in this line of Art, and her vases for flowers were each worth several ounces of silver. The famous "porcelain of the palace" (A.D. 1127) was so called from the manufactory having been established in the house of the director of the palace of the capital of the dynasty of Song, after their removal into the south.

Passing over the Mongol princes of the dynasty of Youen (1260—1349), we come to the great dynasty of Ming (1368—1640), under whom the porcelain manufactories became much more numerous, although their productions still preserved the delicacy and beauty for which they were remarkable. Even now the Chinese antiquaries set a great value upon some of the porcelain of the Siouen-te and Teh'ing-hoa periods of this dynasty. Among the most valued may be mentioned the cups of Lo, ornamented with crickets fighting; especially those made by two young girls, sisters, called Ta-sieou, the ornaments of which—also crickets fighting—were engraved in the paste with a pointed tool. Between 1463 and 1487 flourished an artist in porcelain named Kao-than-jit, who ornamented the top of his jars with the flower of a *Peonia moutan*, and the foot with a hen and chickens full of life and movement.

The commencement of the 15th century was an era in the history of the manufacture of porcelain in China; for the pigment known as cobalt blue, which had been manufactured in Germany in the latter part of the preceding century, was then introduced into China. The Chinese called it *Hoei-tsing*, and were so pleased with the new colour that for an equal weight they willingly paid double the price of gold. "When," says our author, "it was generally known that it would bear the fire without changing, the emperor ordered it to be used on porcelain, to which it gave an antique grace. For this reason the porcelain of this period (1506—1521) with blue flowers is exquisitely beautiful."* Previous to this time the Chinese had used for their blues the impure ores of cobalt found in China.

Between the years 1522 and 1572, we read of the coarse and common jars, basins, bowls, and other ware made at Houg-pou, of the skilful imitations, by the venerable Tsou, of the beautiful porcelain before-mentioned of Lo and the sisters Ta-sieou. From these meagre annals we gladly turn to an interesting account of an artist who flourished in the next period, 1567—1619, and who rejoiced in the long name of *Tcheou-tan-tsiouen*, which we have M. Julien's authority for contracting into Tcheou. This Tcheou was one of the most skilful artists of his time; and, possessing in perfection the imitative powers for which his countrymen have always been remarkable, he exercised his talents in making counterfeits of old porcelain; his tripods, pipkins, sacred vases, ornamented with animals and with lanceiform handles, so closely resembled the originals, that it was impossible for those not in the secret to distinguish the one from the other. They were eagerly sought after by collectors, who valued them as they would gold; in fact, as much as one thousand ounces of silver (7500 francs) have been paid for a single specimen. Tcheou was quite an original in his way, and delighted in carrying his beautiful vases in his own hands to the houses of those antiquaries whom he knew to be passionately fond of old china. M. Julien relates the following anecdote, which is equally illustrative of the character and wonderful skill of this artist:—

"Tcheou one day embarked in a merchant-vessel of Kin-Tehong, and repaired to the right bank of the river Kiang. As he passed Pi-ling, he landed to pay a visit to Thang, the president of the sacrifices,

and asked his permission to examine *at his leisure* an antique tripod of the porcelain of Ting, one of the ornaments of the president's cabinet. With his hand only he took an exact measurement of the tripod, then he took an impression of the veins or crackles with a piece of paper which he concealed in his sleeve. After which he returned to his abode at King-te-tein. Six months after this occurrence, he paid another visit to Thang; drawing the tripod from his sleeve, he said, 'Your excellency possessed a tripod and pipkin in the white porcelain of Ting, I also have one which you now see exactly like it.' Thang, full of astonishment, compared the new with the old, which he had preserved with the greatest care, and could not detect the least difference; he fitted the tripod and cover of the new one to his own pipkin, and found that they suited with the greatest accuracy. He inquired whence Tcheou had obtained this curious antique. 'Sometime ago,' replied the artist, 'I asked your permission to examine *at leisure* your tripod. I took its dimensions in every part with my hands. I assure you that this is an imitation of yours; I have no wish to impose upon you.' The president, satisfied of the truth of these words, purchased Tcheou's tripod for forty ounces of silver (300 francs), and placed it in his cabinet by the side of the other, as if the two had originally formed a pair. The tripod of Tcheou was afterwards seen by one Thoa-kheou, who was seized with a passionate desire to possess it. By day he could think of nothing else, by night he dreamed of it. At last, overcome by his entreaties, Thang yielded the tripod to him for the sum of one thousand ounces of silver (7500 francs, or, according to M. Natalis Boudot, equivalent to 25,000 francs at the present time) (£1000 sterling), and the delighted collector carried away his treasure to enrich his own cabinet."

Among other artists of this period was Ngeou-koung, who distinguished himself by his imitations of the crackle porcelain of "the elder brother," of "the Mandarin china," and the porcelain of Kium. The most esteemed specimens of his works were the veined china with the red and blue enamel. A more original artist was he who called himself, "Ou, the old man who lives in solitude." He withdrew from the world, but produced in his retreat vases of the finest quality, and most elegant form. His most celebrated productions were the saucers ornamented with clouded diapering, and the cups of *egg-shell china*, which were eagerly purchased at any price. The ware called "the vases of Ou" were elegant and in good taste, generally of pale blue, but without crackles; in imitation of certain old china, some were coloured with purple and *feuille morte*. Thang-in-Siouen, who flourished between 1662 and 1722, was the maker of the porcelain known to collectors by the following names:—1st, green of the snake's skin; 2nd, yellow of the cel; 3rd, fine blue; 4th, yellow spotted. Nien, the director of the imperial manufactory at King-te-tein, between 1723 and 1735, was no less remarkable for the care with which he selected his materials than for his skill in the fabrication of porcelain.

We conclude our notice of the Chinese artists with a short account of *Thang-ling* (1736—1795), the co-director with Nien of the imperial manufactory, and who is said to have surpassed all his predecessors in his successful imitation of old china, and the ingenuity of his own inventions. "He recommended," say the Chinese writers, "the fabrication, long discontinued, of the jars ornamented with dragons and the porcelain of Kium, and restored many of the old processes. Thanks to him, the grounds of dark blue and of brilliant red were again produced, and were much admired. Thang was indebted to his own genius only for the greater part of the wonderful processes which he adopted. The emperor, admiring the beauty of his works, and the improvements he had introduced, commanded him by a special decree to publish in twenty-two plates, accompanied by proper explanations, illustrations of all the different processes employed in the manufacture of porcelain."* The fifth book of M. Julien's work contains the commentary of Thang-ling, which is said by one of his contemporaries "to bear throughout the stamp of intelligence, of talent, and of genius." Unfortunately, the imperial library at Paris does not possess a copy of the plates above-mentioned; but the translator has endeavoured to

remedy this deficiency by the introduction of other plates of the same nature, selected from albums in the imperial library.

The next part of the work will, we are sure, obtain the approbation of all collectors of old china. It consists of a catalogue and explanation of the principal marks which serve to distinguish the productions of different periods and different artists from others. For these we must of course refer to the work itself. It may, however, be interesting to the reader to know that these marks are of two kinds: "the first denoting in Chinese characters under what part of a reign certain vases were manufactured; but without indicating, in general, the date of this period, which always includes a certain number of years. The second mark expresses, either by a peculiar design, or by figures in enamel colours, the names of men or of manufactories; and indicates the name of the artist, the place where the piece was made, or its destination."*

As an illustration of Chinese habits and manners, we shall continue M. Julien's explanation of the marks indicating a reign. He observes:—"When a monarch ascends the throne, as he has no proper name of his own during his life, he gives to the reign which is about to commence an appellation which serves to designate not only the emperor, but the whole period or any number of the years of his reign. Thus the words 'the splendour of the right way' expressed not only the name of the last emperor, but were intended to characterise the wise administration which was to prevail during his reign. The words 'universal abundance,' which designate the present emperor, presaged in the mind of the young monarch an era of prosperity which, owing to the sanguinary character of the revolution, has never been realised. When the emperor Tehin-tsong, who ascended the throne in the year 995 A.D., had founded, during the period King-te, the celebrated porcelain manufactory at Tehang-nan-tein, he ordered that on every piece of porcelain there should be inscribed four words, which signified 'made in the years King-te' (1004—1007). But it happened, unfortunately, that the custom of dating the porcelain instituted by this monarch, after having been in use for upwards of six centuries, was suddenly discontinued by a prefect of the district King-te-tein. This worthy (in 1677) prohibited the manufacturers from inscribing in future on their porcelain the names of the years, or from recounting the actions of great men—under the pretext that, if the vases should happen to be broken, the emperor designated by the period of his reign, and the holy personages reproduced in the painting, would be subjected to a kind of offence or profanation."†

M. Julien next gives an account of the geographical distribution of the porcelain manufactories; which is rendered clearer by a map made expressly for the work, and in which the locality of the different establishments is indicated. He informs us that thirteen out of the eighteen provinces of the empire contain manufactories, which are much more numerous in some provinces than in others. The location of the manufactories he considers to be dependent on the abundance or scarcity of the materials required for the composition of the porcelain. The English general reader would gain but little information from a mere list of the porcelain establishments; it will be sufficient to observe that they are most numerous in the northern and eastern provinces, especially in those of Kiang-si and Tcheking. We shall now mention a few of the most celebrated manufactories. The first in point of antiquity is Sin-p'ing, in the province of Ho-nan, the seat of the first manufactory of porcelain. The factory at Nanking is, perhaps, the best known in this country. Its celebrated blue ware is familiar to most persons. There is some doubt, however, whether much that bears this name is not made at Japan. The famous porcelain pagoda is in or near Nanking. The manufactory which usually supplies the European and Indian trade is situated to the west of Canton, but the articles produced are greatly inferior to those of the next mentioned place. The most important of the porcelain manufactories are situated at King-te-tein, a town or village of immense extent in the province of Kiang-si, and upwards of eight centuries the seat of the imperial manufactory. This large village, which only wants

walls to be considered a city, contains more porcelain works than any other district of China; almost all the inhabitants are employed in the works. In the time of Père d'Entrecôles it contained eighteen thousand families, or about one million souls. It will interest the reader to know that the Chinese work, translated by M. Julien, was written with the professed object of giving an historical and descriptive account of the different kinds of porcelain made in the imperial manufactory of this town. We must find room for the following description of King-te-chin by the Père d'Entrecôles:—

"King-te-chin extends for a full league along the bank of a fine river. It is not a mere assemblage of houses, as one might imagine; on the contrary, the streets are laid out with regularity; they intersect each other at certain distances; the whole of the soil is occupied, and the houses are too close together and the streets too narrow. They are so crowded as to resemble a perpetual fair; on every side are heard the cries of the street-porters.

"The expense [of the porcelain works] is much greater at King-te-chin than at Jao-tcheou, because it is necessary to bring thither not only all the materials, but the wood for heating the furnaces. Yet, in spite of the dearth of provisions, King-te-chin is the abode of a multitude of poor families who cannot maintain themselves in the neighbouring towns. Even the young and the feeble find employment: the blind and the lame grind the colours. In former times, says the history of Fou-liang, there were but three hundred furnaces at King-te-chin, now there are quite three thousand. It is not surprising that there should be many conflagrations; and it is on this account that the genius of fire has so many temples there; but the worship and honours paid to this divinity do not diminish the number of fires. A short time ago eight hundred houses were burnt. If one may judge by the number of masons and carpenters employed in that district, they were soon built up again. The profit derived from the rent of shops renders the Chinese very active in repairing damage of this kind.

"King-te-chin is situated in a vast plain surrounded with high mountains. Those on the east, at the back of the town, form a kind of semi-circle; from the mountains on the side issue two rivers, which quite their streams; one is small, but the other is very broad, and forms a fine port, or basin, nearly a league in extent, where its rapidity diminishes. In this large space may sometimes be seen two or three rows of boats moored close together. Such is the spectacle which is presented when one enters by one of the gorges into the port. Whirlwinds of smoke and flames, which rise from different points, mark the length, the breadth, and the boundaries of King-te-chin. By night one could fancy that it was a town in flames, or an immense furnace with many openings. Perhaps this mountain boundary forms a situation adapted for porcelain works.

"It is astonishing that a place so populous, so abounding in riches, frequented by so many vessels, and not enclosed by walls, should be governed by one mandarin only, and that there should not be the slightest appearance of disorder. It is true that it is only one league from Fou-liang, and eighteen from Jao-tcheou—but the local police is admirable. Every street has a chief established by the mandarin, and if the street be a long one, it has several. Every chief has under him ten subalterns, who each preside over ten houses. Their business is to maintain order, to attend the first appearance of tumult, and to give notice of it to the mandarin under pain of the bastinado, which is liberally applied. Frequently it happens that, although the chief has done all in his power to appease the tumult, and alleges that he has done everything he could to allay it, there is always a disposition to blame him for it, and it is difficult to escape chastisement. Every street is closed at night by barriers. The larger streets by several placed at intervals. One inhabitant of the quarter mounts guard at every barricade, and he dares not open it but upon certain signals. Besides this, the presiding mandarin, and sometimes even the mandarin of Fou-liang, patrol the town. No strangers are permitted to sleep in King-te-chin. They must either pass the night in the vessels, or lodge with persons of their acquaintance, who are answerable for their conduct. This rigorous police maintains perfect order, and establishes entire secu-

rity in a place whose riches would arouse the cupidity of a multitude of thieves."²⁶

The administrative organisation of the manufactory is as well regulated as that of the town. It is probably enforced by severe discipline. In their efforts to preserve order, the Chinese do not always consider justice or humanity, and cut off a man's head with as little compunction as they would that of an ox. The labourers are divided into bands, each of which is under the control and superintendence of a person who is answerable for the conduct and diligence of those who are under him. It would appear that the pay of the labourers is regulated by that of the articles made, for it is stated that in order to facilitate the calculation of their wages, the cost of its manufacture is stamped upon every article. The workmen receive their wages in the fourth and tenth months, and a gratuity at the end of the year. The painters, who are workmen of the first class, receive their pay four times a year. Besides the regular wages, every workman in King-te-chin receives, on the day of the new moon in the third month, an extra allowance, which is called "market money, for the purchase of rice."

Whether manufactories of any kind, which are immediately under the control of government, are always advantageous to the nation in an industrial point of view, is a question which does not come within the scope of this article. The porcelain manufactory at Sévres, and the Gobelins tapestry-works, are proofs that these national or imperial establishments are sometimes beneficial; that they are not absolutely necessary is seen by the prosperous state of our own manufactures, which depend for their advancement on the talent and energy of private individuals, and for their maintenance on the support of the country at large. The great advantage of royal manufactories appears to consist in this—that, as the object of the government is to improve the articles manufactured, and not merely to sell them at a profit, national establishments can afford to expend more time and money in the prosecution of experiments than private individuals; and the rewards they hold out to men of talent enable them to secure the assistance of the most able professors and workmen. The imperial manufactory at King-te-chin, although it appears to have been attended with the advantages alluded to, had, certainly, very much the character of a monopoly. Several kinds of porcelain were ordered to be made for the exclusive use of the emperor, and were distinguished as such by a particular mark; at all times the finest specimens were selected for his use.

It was probably advantageous to the porcelain manufactory that in the period Tch'i-te (583) of the dynasty of the Tch'in, the emperor ordered the inhabitants of the place now called King-te-chin, to pay their tribute in porcelain vases of a particular description. Among so many workmen there would of course be dishonest ones, and the inducements offered by private manufacturers were frequently sufficient to induce them to betray secrets, to purloin materials, or otherwise to consult their own interest instead of that of the imperial manufactory. "When," observes a Chinese writer, "the workmen had received an order for the palace, they either furnished the objects required or paid a fine, and worked on their own account. This is the reason why the only flourishing manufactories are those of the people; yet there are very few of these artists whose names have been preserved." "In every manufactory," continues the same author, "there was a register, in which was entered all the porcelain manufactured; those persons who made any clandestinely were rigorously punished. Is not this a convincing proof that porcelain paid duties into the treasury?"

The greatest vigilance on the part of the authorities could not always prevent the workmen from appropriating valuable colours. The governor of Yun-nan, it seems, monopolised cobalt blue, on its first importation from the West, for the use of the imperial manufactory; but when the beauty and importance of the colour were discovered, the workmen, from sordid motives, stole what they could of it, and sold it to private manufacturers. Very rigid enactments were made in consequence, and at last succeeded in putting an end to the practice.

²⁶ "Lettres Edifiantes," quoted by M. Julien, pp. lxi-lxiv.

If the Chinese emperors were monopolists, it must be acknowledged that they were also very good customers to the porcelain manufactory. The early Chinese work on the manufacture of porcelain, already mentioned as having been published in 1325, and as having passed through twenty-one editions, contains a list of five pages quarto of the porcelain that had been furnished for the use of the emperor. M. Julien enumerates a few of the items; the numbers of each article are enormous—31,000 dishes ornamented with flowers; 16,000 white plates with blue dragons; 11,250 dishes with white grounds, with blue flowers, and dragons holding in their claws the two words *Po* (happiness) and *Cheou* (longevity). The increase in the next article is remarkable, and indicates either a great consumption of wine, or a peculiar fragility in the ware used for this purpose; it is as follows—184,000 cups for wine, ornamented with flowers, and with dragons in the midst of clouds.²⁷

In the porcelain manufactories in China and Japan the division of labour is strictly enforced: a simple cup or saucer passes through seventy-two hands before it is finished:—

"Every kind of round vessel, ornamented with blue flowers, is manufactured by hundreds and thousands. If the paintings are not identical, the irregularity will produce an unpleasant effect. For this reason he whose business it is to make the outline does not study the art of applying the colours; and on the other hand, he who applies the colours cannot draw. By this means the hand is exercised on one thing only, and the attention is not divided. Those who sketch and those who paint are placed by themselves in the same atelier, in order that their work may be uniform."

The author then goes on to enumerate the different workmen, all of whom are confined to the use of one tool, or to the performance of one operation. There is no doubt that this arrangement is advantageous to the manufactory, for practice makes perfect; but the effect on the workmen themselves must be far from beneficial; it converts them into mere machines, which are ever repeating the same monotonous action. Where no inducements are held out to the workmen to improve the processes, the duldest man, if industrious, may be as well paid as the most intelligent; and the intellect that is not awakened by exertion, and stimulated by the hope of reward, is sure to retrograde.

The manufacture of an article which passes through so many hands and so many processes as porcelain, must necessarily be attended with much uncertainty and occasionally with failures, not to mention the accidents arising from the extremely fragile nature of the composition. In order to meet these inconveniences, the Chinese manufacturers find it necessary to make double the number of articles required. The difficulties are much increased where the articles to be made are of large size—and some of the vases with covers are nearly two feet and a half in height. Some idea of the extent of the manufactory may be formed from the statement in the Chinese work that an order is sometimes received for 500 or a 1000 of these large jars, for 500 large vases for the gardens, and 300 for flowers; especially when it is considered that the number made must actually be double what is required, in order to allow the manufacturer to select the best articles, and to reject all that are broken and defective.

In connection with this last subject we find in our Chinese work some curious statements and observations. It appears that all defective articles of every description are thrown into a heap, where they remain until they are purchased at a valuation by some itinerant dealer. Many persons, it is stated, have become rich by purchasing these rejected articles. There is at King-te-chin, continues the Chinese author, a class of men extremely skilful, who collect defective articles from the manufactory; they polish on a wheel those which have uneven surfaces, and repair those which are cracked or broken. There is a certain kind of porcelain described as "porcelain to which has been given a false lustre," which, although not broken, is full of concealed cracks. Men who are adepts in deception purchase these at a low price, and coat them with some preparation which, for the moment, consolidates them; but they

* Page lxi.

† Page 272.

full to pieces as soon as boiling water is poured into them."*

Notwithstanding the care with which the Chinese endeavour to preserve all their processes, several of them have been unfortunately lost. Among the latter is a curious process which Père D'Entrecolles thus describes:—"The Chinese," he says, "had the art of painting on the sides of a piece of porcelain fish or other animals, which were not visible until the vessel was filled with some liquid. The following account embodies all that is known respecting this secret. The porcelain to be painted should be very thin. When it is dry, the colour is laid on with great strength, not on the outside, as usual, but on the inside of the sides of the vessel. Fish being most appropriate are usually chosen for this purpose. When the colour is dry, a thin coat of the porcelain paste is applied over it; and this serves to enclose the azure [colour] between two layers of porcelain. This is suffered to dry; when the glaze is applied on the inside. After some time it is put on the wheel, and the outside is ground as thin as possible without laying bare the colour. It is then enamelled on the outside, and fired in the usual way. The work is extremely delicate, and requires a degree of skill which apparently the Chinese no longer possess. They make attempts, but in vain, to recover this magic art. One of them, however, assured me that he had again tried, and almost succeeded."†

The memoir relative to the porcelain of Japan is, as before observed, a translation by Dr. Hoffmann, from the Japanese language. It is part of a work in that language entitled, "Representation and Description of the most Celebrated Productions, Terrestrial and Marine," which appeared in five volumes, accompanied by illustrations, in 1799.

The porcelain manufacture of Japan was founded about B.C. 27, by some emigrants from the peninsula of Corea,—descendants, it is said, from the dynasty of Tsin, who were expelled by the Han dynasty (B.C. 203). This art, observes M. Hoffmann, possessed by the new colonists, may be considered as one of the elements of Chinese civilisation and industry, which procured for these colonists a marked preponderance over the other inhabitants of Corea. Like many other elements of Chinese civilisation, it passed from Corea to Japan. But the art was far from making in Japan the progress it had done in China until, in 1211, a Japanese manufacturer, accompanied by a house, repaired to China, and learned all the secrets of the art; so that, on his return to Japan, he was able to manufacture some objects that were much admired. As late as the end of the 17th century, a Japanese prince brought workmen from Corea to make the porcelain called Paqui-yaki. For several centuries Japanese porcelain has formed an important and valuable article of commerce, and now ranks, with its lacquer-work, among the most beautiful articles of oriental industry. Japan porcelain is of more recent introduction into Europe than Chinese, and was probably unknown in this country until the latter half of the 16th century. The best of the many kinds of porcelain made in Japan is that known as Imari-yaki. It is not made at Imari (a much frequented port of the province of Fizen), but in the factories, twenty-four or twenty-five in number, situated on the declivity of the mountain Idsonmiyama, whence is procured the white earth of which the porcelain is made. Some of the best productions of Imari are imitations of Nanking china; and the earth of which they are made, though procured near Imari, is called Nanking earth.

The system of the division of labour, so generally carried out in the Chinese porcelain works, prevails also in Japan. Dr. Hoffmann states that every work, even the smallest saucer, passes through the hands of seventy workmen, from the moment of forming the paste until it has received the last finish. The blue substance used for colouring the Nanking porcelain, as it is called, is brought from China; it is a native mineral, consisting of a cobaltiferous peroxide of manganese.

We propose in a future number to give a brief description of the composition and mode of fabrication of the Chinese porcelain, and of the pigments employed in painting the china; preceding our notice by a few general observations suggested by the perusal of the work. M.

* Page 274.

† Pages 240, 241.

THE ROYAL PICTURES.

MILKING TIME.

P. Potter, Painter. J. Godfrey, Engraver.
Size of the Picture, 1 ft. 9½ in. by 2 ft. 6½ in.

PAUL POTTER, a native of Enkhuysen, in North Holland, was born in 1625. In his history we find one among the many examples which might be adduced to prove that a long life is not essential to gain an immortality of renown. Struck down by consumption ere he had reached his thirtieth year, he yet had accomplished in Art what will for ever ally his name, in his peculiar walk, with the greatest painters of any age or time. We scarcely pass too high an eulogium upon him by saying that, as a painter of what the farmer would call "stock," he stands without a rival; and this opinion is given with a full appreciation of all which both his countrymen and our own have produced in this way. Next to the extraordinary faculty with which he was endowed—for even at the early age of fourteen he exhibited such proofs of talent as to be considered a prodigy in his profession—the great success of Potter may be attributed to his constant and close study of Nature. It has been truly said that "she was, indeed, his nurse in childhood, his mistress in youth, and his constant companion to the end of his days. He bestowed unremitting attention on every object and circumstance that might tend to give beauty or picturesque effect. The dawn of day frequently found him in the field. The dewy freshness of early morning, the dazzling brightness of the mid-day splendour, and the glowing refulgence of the declining sun, together with the variable appearance of the atmosphere, resulting from mists, rain, and wind, are depicted with unequalled truth by his magic pencil."

When about twenty years of age, Paul Potter went to reside at the Hague, but the last six or seven years of his life were passed at Amsterdam, where he died in 1654. In Mr. Fairholt's article, "The Home of Paul Potter," published in the number of the *Art-Journal* for May, the reader will find an excellent account of this fine painter, and of the country which was his studio.

Although he left comparatively few pictures behind him, about 150 genuine specimens have been assigned to him by connoisseurs who have made his works their study; the sizes of some, and the exquisitely delicate finish of almost the whole, proclaim the industry with which he laboured during his brief career. To the extreme beauty of his pictures, no less than to their rarity, must be ascribed the difficulty which the collector finds in meeting with them, and the high price he is compelled to pay when the opportunity is afforded for making a purchase. They may be valued at many guineas the square inch of canvas. Within the last century or longer, his paintings have wonderfully increased in value—for instance, one which was sold in 1780, at Leyden, for £195, in 1816 realised £1480. His famous work, "The Young Bull," now at the Hague, was sold at Haarlem, in 1749, for £57; it is now valued at 5000 guineas. "Four Oxen in a Meadow" was sold, in 1750, for about £25; in 1812, it rose to £320; and in 1815 was purchased for the late Emperor Alexander, of Russia, for about £2500; it is now in the Imperial collection in the Hermitage, St. Petersburg. Numerous other examples might readily be cited to show the increased value of Potter's pictures.

"Milking Time," or, "The Dog and her Puppies," as the picture is usually called by connoisseurs, has been universally classed among the leading works of this painter; Dr. Waagen calls it "Pleasing in composition, and admirable in execution." Its history and its gradual rise in value is traced back for a century in Smith's "Catalogue." In 1754, it was in the collection of M. Lormier, from which it passed into that of M. Braamecamp, who sold it, in 1771, for £364, to M. Randon de Boisset, who parted with it, in 1777, for £372. In 1800, it was sold from the collection of M. Geldermeester for £910. Whether or not it came at once into the Royal Collection, we know not, but presume that it did; it was exhibited at the British Institution in 1815, 1826, and 1827.

The picture is painted on panel; it is in the collection at Buckingham Palace.

A FEW WORDS
ON OUR NEAR NEIGHBOURS' TASTE
AND OUR OWN.*

GENERAL DECORATION.—TRAFALGAR SQUARE AND LA PLACE DE LA CONCORDE—COMMITTEES OF TASTE AND DIVIDED RESPONSIBILITIES—WREN'S REJECTED DESIGN FOR THE MOUNTING OF 1518-STREET HILL—L'ARCHE DE L'ETOILE AND THE COLUMN AND TOMB OF NAPOLÉON—PAINTED WINDOWS AND CLOCK-CASES—SIMPLE STYLES OF DECORATION MOST SUITABLE FOR ENGLAND—HARMONY OF STYLE OF ARCHITECTURE WITH THE HIGHER EFFORTS OF PAINTING AND SCULPTURE A TEST OF ITS SUPERIORITY.

Present—MAGISTER and AMICUS.

Magister.—A great portion of Paris lives, by necessity, most humbly at home, and has to look abroad in the cafes and public places for all that is to please the eye; but when our neighbours do furnish their apartments, they do it with an elaboration unknown to us; and of this pictures and sculptures form but a small part. They are not content with two or three pictures and an ornamental clock, and a statuette or two in bronze or biscuit, but they try to make the whole room a work of Art—walls, doors, and ceilings. In this they do better than we, and are at least right in principle. We, on the other hand, are not really enough to look on the lower classes of Art as of kith with the higher. Painting and Sculpture with us are inclined to ignore their less titled relations; on which account, as it lies in the way of their accommodating themselves to her ideas, Architecture, in her turn, is but too apt to ignore them—their own injustice hardly giving them a right to complain; and so the whole of Art suffers. In this the Art family might well learn from Æsop's "Fable of the faggot of sticks." It is only wonderful to me that the Arts, separate as they hold themselves here (like brothers and sisters not on the best possible terms), effect as much as they do.

Amicus.—For their domestic union then we must look across the channel, and learn from the French? *Magister*.—Or from any other nation or time in which Art has had free scope. Its best things have arisen when it has been conglomerate, and not dispersed.

Amicus.—I suppose decoration is so much a necessity of life with the Parisian that he would rather have his *can sucré* in a handsome café than his "Chateau Lafitte" in a plain room!

Magister.—I don't know: eating and drinking is one of the Fine Arts in Paris, and they hold that as much harmony may be shown in a succession of "plats" as in the details of a picture. However, Fine Art is an essential there in everything—from the decoration of an Imperial Palace down to the gifts in every shop in welcome of the new year. At all times, however, half Paris appears to be employed in amusing the other half. To gratify the public eye is one urgent duty of government, and to employ their workmen is another, and these two requirements work well together.

Amicus.—For themselves and for the appearance of everything.—What a contrast the result presents to our capital!

Magister.—Paris puts his best foot foremost in making his first bow to the stranger. When you come to know him more, he is not quite so perfect.

Amicus.—Think of the Pince de la Concorde!

Magister.—London has no *coup d'œil* like two or three that Paris presents, but building for building, I believe we are richer in fine examples—for instance, where are there parallels to St. Paul's or Greenwich Hospital?

Amicus.—But take the Place de la Concorde as one metropolitan centre—think of our Trafalgar Square as another centre, and be humble.

Magister.—In that we view the sad results of committees of taste. The National Gallery was built by a committee of taste; the square was laid out by a committee of taste; and that lamentable Nelson Column was stuck up in the midst by a committee of taste.

Amicus.—A committee being a body who commit themselves!

Magister.—Sometimes; and the public also, and the nation to which they belong. This is one of the evils of divided responsibility. And thus a despotism, a concentrated one responsibility, is often a state more favourable for evoking fine public works of Art than one where the onus is divided among many.

* Continued from p. 129.



THE
LIFE OF
SAMUEL JOHNSON
BY
JAMES BOSWELL
IN TWO VOLUMES
THE FIRST VOLUME
LONDON
PRINTED BY R. AND J. BELL, ST. MARTIN'S LANE
1791



THE FARMER'S YARD

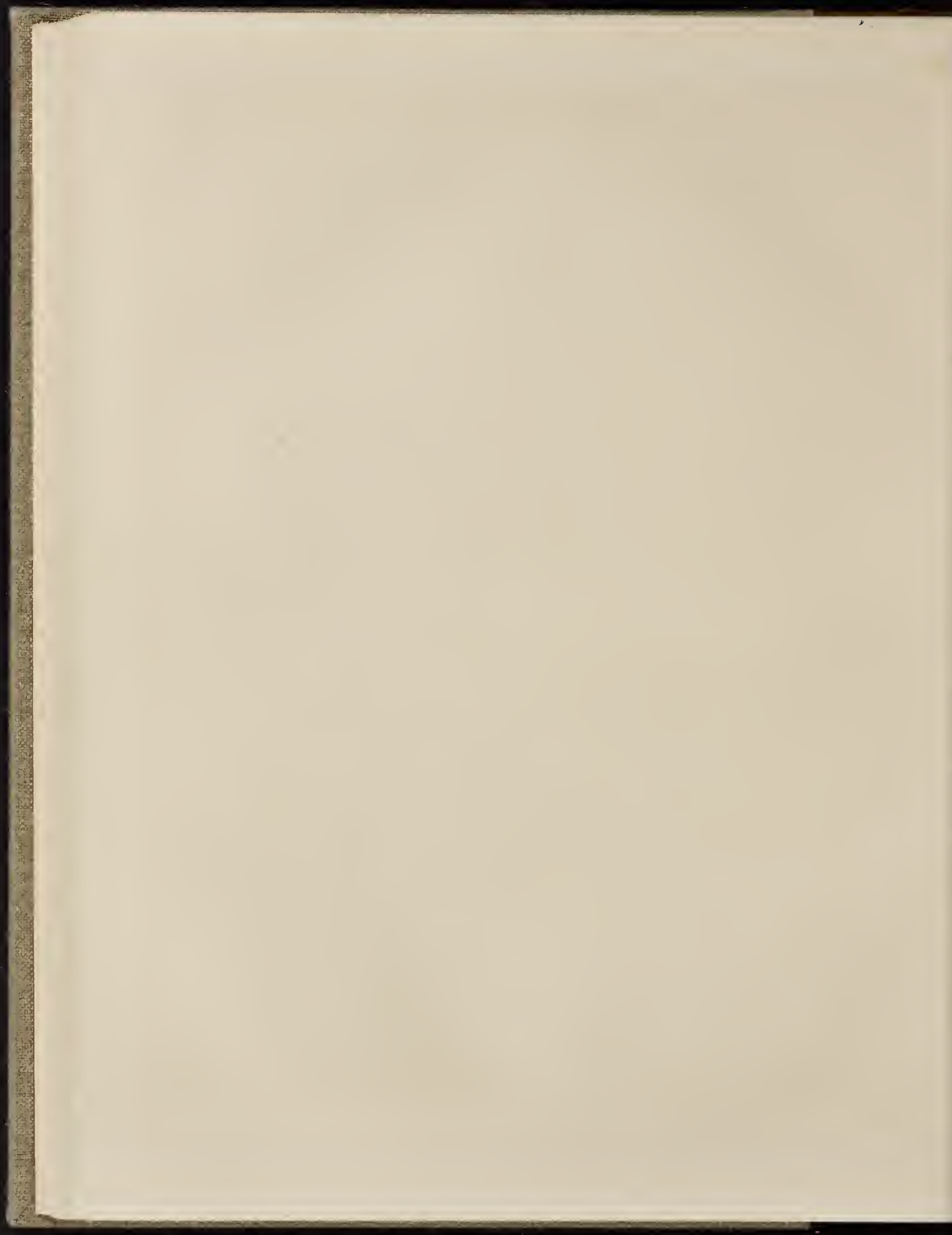

Athenians.—But Athens was a republic, and some good things were done there.

Magister.—In a republic, but ever practically a despotism under some one or other. A republic is often but a name for a succession of ministers. In committees of Art variety of opinion has not infrequently resulted in a compromise of *crochets*—a fine example of which is Trafalgar Square. To commence with the Nelson Column: it was the grossest possible mistake that could be committed, "within the premises," to put up such a tall object directly in front of the portico of the National Gallery—a monster column before a group of little ones; by which unfortunate arrangement, in approaching by Parliament Street, King Charles, the column, and the portico, are all in one line and one another's way; whereas it is evident enough that the centre front approach should not have been interfered with at all; and any high objects added should have been not *our*, but *his*—say one in memory of Nelson, and the other of Wellington, his brother heroes, one on the right hand and the other on the left, in front of the unadorned wings of the Gallery; leaving the portico, the only really free portion of that building, unencumbered and free.

Athenians.—That indeed, seems "on the ends." It is a great pity it can't be pulled down and done over again! and then you might have a centre "Fountain of Britannia," which would have been very proper for our island goddess; and she might extend wreaths, naval and military, much as the figure of France does hers on the Palais de l'Industrie; and you might have other worthies on pedestals all round, and christen Trafalgar Square the "Place of the Heroes."

Magister.—I do not think a centre object of any kind was required or appropriate in Trafalgar Square. There was as much already in the centre line as could exist there advantageously, in King Charles's statue and in the portico. Whatever was added of a lofty character should have been *his*, and have been placed on either side, where the fountains are.

Athenians.—And what poor specimens they are—I mean the fountains! How different to those in the Place de la Concorde!

Magister.—All that he can say for our two is, that they are not worse than nothing, and that perhaps they may lead to something better hereafter by accustoming us, in our public places, to fountains, which are subjects capable of so much high Art. Wherever you see a fountain, you see people amused with looking at it; there is something in moving water that is ever attractive, be it the waves of the sea, or a river, or a torrent, or the lumber Art-efforts of man. The Place de la Concorde fountains are ornamental and pleasing enough, especially when they are both in full play in the warm, clear sunshine of a Parisian summer day.—I have nothing to say against them, except that they possess no marked originality. In truth to say, as a set off to our Trafalgar Square, I view the Place de la Concorde, in spite of your, and, I allow, general admiration, as no marvel in point of decoration. It possesses some naval bronze columns which are really good pieces; but on the whole, in the Art-decoration of that great place, which it is so much the fashion to praise, I suppose I am a great heretic, but I see little to admire. Its situation is everything that is delightful, but what has French Art done to enhance it? The just taste of keeping such a grand open space as a centre of the best part of Paris is unquestionable. But that acknowledged, what more has been done by French Art? What can be more indifferent than the colossal, heavy, sedentary cities of France ranged round the area (not one of them good either in design or execution) on ambiguous-looking compounds of pedestal and sentry-box; and as regards the centre ornament—the eye of the whole area—the culminating point of its attraction—the centre of the Art-centre of Paris, how has that been supplied? by their own Art-power? No! for this apple of the eye of Paris she had to go—at least, she chose to go—back to a work executed some two or three thousand years ago by a semi-barbaric race, and had to send all the way to Luxor for what was originally a unit of two decorations in front of an Egyptian temple. Assuredly, this manifests either a want of resource or a want of taste: a want of resource, if France could not herself produce a more appropriate and pleasing centre decoration for her vaulted square; and a want of taste if it could, and

notwithstanding placed there this great splinter of granite.

Athenians.—Well, they are very proud of it; and the feat of erecting it there has been thought worthy of being inscribed in letter and diagram on the base.

Magister.—The same thing having been done in Egypt, ages ago, against their thinking it worth while to say anything about it. That I am very well pleased to stop awhile in the Place de la Concorde when I am in Paris, and look about me, I would deny; but my pleasure certainly does not arise from the scheme of its Art decorations—for, indeed, it is in my idea very short of what it might have been, especially as regards originality; and I must add that, though there is a vast deal to admire in French public works, originality does not seem their strong point. The Napoleon Column is a copy of Trajan's, the Arc de l'Étoile a compromise between the arches of Titus and Septimius Severus, and the same remark applies, though in less degree, to the Madeleine and the Bourse—which, though impressive from their size and the amount of judicious labour of various kinds bestowed upon them, suggest their types at once.

Athenians.—We can't say much for the originality of our columns—those of Nelson or Duke of York, or that on Fish-street Hill!

Magister.—But that on Fish-street Hill was not the one the great Sir Christopher desired to put up; his design was truly original—a column on fire! a type of the Great Fire of London it had to commemorate—with gilded flames out of the windows of the staircase, forming a spiral succession of decorations up to the top, with a beautiful architectural finish of a plume rising from its ashes, to typify the rebuilding of the great city on an improved plan. I know not which to admire most in the design I have seen of this—the appropriateness of the thought, or the beauty and fitness of the architectural proportions and detail. The one that now stands on Fish-street Hill, with its wheat-sheaf of fire on the top, was erected to meet the wishes of others, not his own.

Athenians.—I suppose there was a committee!

Magister.—Perhaps so; however, it was not the artist's fault; had his wishes been followed, London might have boasted a *thoroughly new column*, a real addition to the architecture of the world—which certainly the Napoleon Column is not. As to the Arc de l'Étoile, its details are good, but its outline is not of a nature suited to its scale; its only originality is its size, and that is, I conceive, a mistake, and a mistake you can hardly get rid of in any part of Paris: for, from its elevation of situation, its huge box-like outline and mass, it asserts itself in every quarter of Paris, dwarfing the very town it is an introduction to, and the approach it should enhance.

Athenians.—Like a large lodge to a small house. But it serves more than one purpose—at least I have been told it is a barrack, and has accommodation for a thousand soldiers.

Magister.—As a colossal guard-room, its size may be useful; but viewed merely as a work of Art, I conceive it to be much too big.

Athenians.—Its proportions are certainly enormous, which is the reason, no doubt, that, like a mountain, no picture or representation gives you a just idea of its size.

Magister.—No; it is hardly till you are ascending it that you can realise this. Its greatest virtue is the ample and beautiful view its summit affords of Paris. However, some of its sculptures are very good—those on the Paris side especially. The group of War is the best, very well composed and extremely splendid—indeed, one of the best specimens of modern alto-relievo, and so recognised in Paris, for you see many a print and photograph of it.

Athenians.—What do you think of the tomb of Napoleon, in the Chapel of the Invalides?

Magister.—The arrangement of the sarcophagus in the open crypt—if it may be called a crypt under such circumstances—and all under the dome, is very fine as you look down on it from above, and was a noble thought. Nothing can be more simple and impressive than this part of it is; but I cannot extend my admiration to the gorgon and rocco of the screen, or to the *chartreuxerie* of the blue and orange lighting—the same thing, only on a larger scale, that is done in the cenotaph of the Princess Charlotte at Windsor. The tableau effects of fairy light are now so artistically rendered in theatrical extravaganzas,

that rivalry with them is ill-judged enough, especially as associated with solemn subjects.

Athenians.—But were this done away with, surely a good deal of the whole effect of the tomb would be lost. It appears to me that much of the impression depends on the peculiar light that is cast on all around.

Magister.—But its very effect fades when the eye gets accustomed to it; the impression it makes does not remain. I give all honour to the thought of the tomb under the dome, and to the circular open vault; but the artifice of the light is not a worthy one in my estimation, and lowers instead of raising the subject with which it is associated.

Athenians.—But why is it worse than other painted windows which we admire in other buildings?

Magister.—They are works of Art in themselves, either as pictures or decorations—the lights they cast are but their secondary effects.

Athenians.—But these secondary effects are surely among their most beautiful results? Milton's "dim religious light" was one tinted by the hues of painted glass.

Magister.—I would not say that painted windows are not appropriate in other buildings than Gothic ones; but assuredly they form a true portion more of that style than of any other, for the pictures in that style of architecture naturally go into the windows. They are these architectural illuminated missals; thus the varied tints arising from them in Gothic interiors are peculiarly harmonious. At the same time they are to be considered as incidental rather than as primary efforts. Even in a Gothic building I should not like plain coloured glass without subject, merely for the sake of the tint it would throw; the artifice would be too evident, as it is in the tomb in question.

Athenians.—However, the architect had to please the public, and the Parisians like it.

Magister.—A great man like Visconti might have afforded to lead the taste. But on the whole, the tomb of Napoleon is a most excellent work, and I hope we may have something half as noble for Wellington in St. Paul's.

Athenians.—But that would be impossible, unless they should put it under the centre of the dome in the same way; and that could never be done, I suppose, for various reasons.

Magister.—Over the centre of the crypt, where repose the ashes of the great Duke!

Athenians.—And of Nelson too. And does not this suggest a united monument?

Magister.—Which would be commemorative too of both naval and military service?—Assuredly. But how could that be done? St. Paul's has already a monument to Nelson by Flaxman, and that could never be ignored.

Athenians.—Well, there seems a great opportunity somehow for something very grand and very new.

Magister.—And very British too, I hope, with no importation of foreign taste unsuited to our simplicity, as coloured windows; but chaste, dignified, explicit, and Anglo-Saxon.

Athenians.—And no French taste in it, I suppose? By-the-by, we use the expression French taste in opposite senses (like the word "nervous"). We use it for praise and for blame. We exclaim, "What a charming display of taste in the French capital, and in the getting up of its festivals; and how tastefully French women dress!" All the goods and bads in our shops are called French to sell them; and yet, on the other hand, if anything offends, as too artificial and elaborate, the cry is "That's too French."

Magister.—All that too without stopping to remark whether what is reproached is really French or in French style. Our attention to subtantialities having allowed our neighbours to get beyond us in details of effect in the ornamental Arts generally, forces our respect to them in these great deeds—hence the use of the expression "French taste" as praise; on the other hand, our innate love of the virtue of simplicity repelling us from the artifice and amount of over-elaboration which we so often witness in foreign works, and which we feel not to be the right thing, although we do not as yet quite know what to put in their place—hence our use of the expression "French taste" as blame. It cannot be denied, indeed, in viewing that part of Art in which we are considered especially deficient—Decorative Ornament applied to Manufacture—that there is hardly a French design which we wholly approve for its taste, although we buy it for its details, and

because on the whole we cannot get anything so good in effect for the same price. Take clocks, for instance—I mean ornamental clocks for drawing-room mantel-shelves—did you ever see a French one thoroughly satisfactory to English taste? I never did. I am sure there is a good field now open for a manufacturer in that branch of trade, to take up the making of clock-cases for the English market, and specially to suit English taste. We make the best movements; why not the best cases? Such a trade would advance British formative decoration in more ways than one. A clock is an important feature in a room, and consequently people will pay more for clock-cases than they will for other things in proportion. In Paris, a high class of skilled workmen is mainly supported by the production of these, which are sold to all the world; and the talent so evoked, is occasionally turned over to other decorative objects; and thus the advantages of the "pendule" manufacture are spread over a large surface of formative ornament, especially in metal-work. Why might not this be the case here? The demand in Paris for statuettes and high-class decorations for clock-cases rears up a corps of modellers, filters, casters, chasers, and bronzists, all working into one another's hands. Thus the modeller lays out his figures so that it shall cut, or divide into pieces, so as to be, firstly, easy to cast—secondly, easy to fit and screw up together, and have its textures so arranged as to be effective in colouring; moreover, he calculates on the effect of the chasing—not finishing too much, but leaving only certain portions to be thus touched forcibly and effectively. Now all this working together, by which the greatest amount of effect is produced at the least possible price, is only to be obtained by the various individual talent required being employed in *union on continuous work*. This is in France, and might be here, the result of a speciality; and as I said before, I do not know a more promising scope for an enterprising and intelligent manufacturer to take up than a "pendule" manufacture, simply because there is a want to be supplied; for if an Englishman wants a handsome ornamental clock for his chimney-piece, he really does not know where to get one to please him.

Amicus.—Then here at once you would enjoin that the path of French taste should be quitted, and this in a department which they have long held as especially their own?

Magister.—You asked me some time ago if I thought French taste really healthful for us, and this is an example of what I think on this head—viz., that French taste is rarely thoroughly in accordance with ours. I will own that most frequently French articles of decoration are all extremely attractive at first; but it is very rarely they will stand the test of pure taste and examination. In looking closer you feel this part is redundant, and ask yourself the question, "What has that other part to do with it?" And then in fancy you begin to lop off this, and to lop off that, till, lo! at last nothing remains. The most showy French ornamental articles are decked out in this way with a redundancy, of which the ingenious confusion alone hides its inconsistency. Now this is not the mode in which really fine things are done—things that you are never tired at looking at—fitted to be standard friends. After looking carefully at the subject of French decoration, out of the multiplicity of attractive designs at first sight, you will find but very few that are really satisfactory, like the fine things of Greek and Roman Art; and, moreover, even in their arabesques, a pruriency is often apparent. The composite creatures, and fragments of creatures, introduced in their designs being scarcely delicate, which is certainly not good taste!

Amicus.—Then if we are to have a national style it is to be a simple one—is it also to be a new one?

Magister.—As to a national style being altogether a new one, the world is too old, I fear, and the human intellect has been too long employed on such matters for it to be that. The French materials for their Art *vivante* are from all styles, from Greek to Chinese; the flavouring, however, is their own; and we must do the like, perforce, at least in degree, for we have no reason to disbelieve that nearly all the best elements of decoration have been grasped already. The distinction might be, as our neighbours select usually the more decorated elements, we should choose the more simple.

Amicus.—But be copyists after all?

Magister.—There is less variety, or rather, perhaps, a less number of simple elements of decoration than you may be at first aware of; you find them existing in common in all styles. It is chiefly in re-arrangement that we must look for novelty. This offers a far wider field than is at first sight to be appreciated; but I by no means by this deprecate novelty—very far from it; only I would say that a moderate introduction of novelty in ornament, whether suggested by fresh natural objects or individual invention, is sufficient to satisfy, and more likely to steadily advance our productions than a rushing after something altogether new. But I should add, as Englishmen, let us ever keep simplicity in view, and never put more ornament than is wanted, but let the little we put be of the best.

Amicus.—Then, if it be injudicious to start off at once after a new style, which is the style that you think at the present day is most in accordance with our tastes and requirements? I do not mean to be followed to the exclusion of the others, but to be most leaned to.

Magister.—In considering the question so, one cannot speak without reference to Architecture, as that is the case and frame of almost all kind of Fine Art: the other Fine Arts, whatever may be their relative height as displays of intellect, being fixed into it as one common setting, of which they are the adjuncts as well as gems. I should say then that the simpler class of Italian architecture was the most suitable for us generally, and that this would give a good keynote to the greater part of our other Arts, as far as they may be effected by periodic styles. The higher walks of Painting and Sculpture hold themselves somewhat aloof from periodic styles, and are cosmopolitan both of country and time; but in as far as they are affected by contemporaneous styles of architecture, they would, I truly believe, be benefited by keeping in mind the simple, effective style of Italian Architecture—in connection with which the best pictures we have were produced.

Amicus.—And the best sculptures with the Greek.
Magister.—I am not sure of that with respect to a considerable number of them. I believe many of the statues viewed as having been done in Greece were done in Rome, although perhaps by Greeks. We know the Antonines was—but to return. In this country I should prefer to see most prevalent a style approximating to the simpler examples of Italian. I apply this especially to Architecture, but through it also to the other arts of Painting, Sculpture, and Decoration. This class appears to me almost to claim the name "European," it lends itself so well to all our exigencies. It is so useful as well as strong, so simply ornamental. It is constructed of the noblest simple forms—the single column, the wall, the true arch, the dome. It affords most effective and varied light and shadows, and the opportunity for the employment of the most varied materials; it also suggests and offers starting-points, and affords spaces for the noblest class of decorative ornament; and last, not least, associates itself better in my belief than any other style with the highest class of Painting and Sculpture.

Amicus.—Then it was a great pity the Houses of Parliament were not in that style, as that is the largest field for the encouragement of the higher classes of the Fine Arts?

Magister.—Indeed, I think so—even as far as Architecture itself is concerned: although Gothic is a charming style for some edifices, and to be largely, though, I think, not exclusively, used for ecclesiastical edifices (for is our Christian creed of universal love to be restricted to one style of edifice? Certainly it is not fitted for our Houses of Parliament. Why, from the very debates there uttered rhetorical ornament is banished, and good substantial straightforward sense is now what is alone sought and attended to; and yet the building in which these are conducted is one mass of elaborate ornamentation—all over crochets, and finials, and grotesques, of which the infinity, outside and inside, bewilders the eye, and makes the very sense ache even while we admire the resources of the accomplished architect. No; I would have had the style of the Houses of Parliament like Whitehall or Greenwich Hospital—plain, substantial, and effective as common sense itself. Moreover, half the money employed in the over-elaboration of the style of the present building would have afforded funds for the noblest additions of our highest Arts to this national monument, had

this simple character been at first adopted. For association with the sister Arts, this style offers peculiar advantages, and is in our climate better perhaps in this respect than even the revered Greek; but poor Gothic, when she attempts to receive her sisters, Painting and Sculpture, in their highest phase, *her best welcome is but a compromise*. There seems, indeed, to be an innate quality in Gothic that can only keep company with a degraded, and pinched, and monastic, and heraldic class of Painting and Sculpture. I like to see the highest efforts of all the sisters together; and so I cannot but lean to that style that affords the freest scope for this. Indeed, it appears to me a fair test of the eminence of a style of architecture—is uniting naturally with the highest class of Painting, Sculpture, and Decoration.

CORRESPONDENCE.

DURABILITY OF WATER-COLOURS.

SIR,—There is a remark in the *Times* newspaper of April 21st, tending to convey an erroneous impression as to the relative permanency of Works of Art executed in water-colours: in a criticism on the Exhibition of the New Society of Painters in Water-Colours, the following passage occurs:—"The ambitious artist will employ a more enduring vehicle," by which the writer evidently means "oil colour." As an observation of this kind, if allowed to go uncontradicted, might have the effect of prolonging the existence of a now nearly exploded idea, that water-colour paintings are less durable than those executed in oil, I trust that you will allow me, through the medium of your very influential Journal, to submit a few remarks for the purpose of showing that the *Times*'s critic is mistaken in this particular.

That "the ambitious artist" may prefer oil-colour, I do not dispute; but I venture to assert that it is not on account of superior permanency that oil-colour can claim to be preferred,—unless the term "enduring" is employed to signify that pictures painted in oil will bear a larger amount of rough usage than those painted on paper in water-colours, without being damaged thereby; but if it is the preservation of the artistic thought unchanged that is meant, then I submit the advantages are greatly in favour of water-painting.

In both methods, the colours employed are the same (with the exception of white lead, which is neither necessary nor suitable to water-colour); the difference lies in the vehicle used to convey the pigment and fix it on the ground. In water-painting, water solutions of gum-arabic or siccative are all that are necessary for that purpose, and for imparting transparency to shadow colours; in oil-painting, resinous matters, oils, &c., are used,—neither will impart durability to colours that are fugitive, or, in other words, liable to chemical decomposition by the action of light. Permanency depends on the judicious selection of such as are not likely to fade or "dry," as it is technically called, and on securing the same in a vehicle not liable to discoloration by time. In the latter, gum has greatly the advantage over oil.

It cannot be denied that oil-colour has certain advantages over water-colour: there is a depth of shadow and a command over the material, to which water-colour has, as yet, no pretensions, and these qualities alone would make oil-colour a preferable vehicle for "ambitious" productions; but in durability, as well as in light and aerial effect, water-colour, as now practised, confessedly stands pre-eminently.

That many of the oldest works of the early water-colour masters have sadly faded cannot be doubted; but those were painted in the days when sap-green, cerise, Spanish-liquorice, tobacco-water, &c., were considered to be proper colours to be used in "Water-colour Drawing," as it was then called; and as water-colour Art and chemical science advanced hand in hand, such colours as these were cast aside, and better and more durable were substituted. The consequences are now apparent. Works executed in what might be termed the "modern type" of water-colour Art are now looking as brilliant and clear as they did when they were first produced.

On the other hand, oil pictures are to be found carrying evidence that the vehicle has not prevented fugitive colours from "fading," where rich glazings have vanished, leaving an under tint sickly and impoverished; at the same time a yellow hue has come over the whole picture, caused by the discoloration of the oily vehicle employed. Thus many the use of an improper material, whether in oil or in water, entirely frustrate the original intention of the painter.

HENRY C. NEWTON.

46, Camden Road Villas.

THE
MINSTRELS OF THE MIDDLE AGES.

BY THE REV. EDWARD L. CUTTS, B.A.*

It is not unlikely that the principal minstrel of every great noble exercised some kind of authority over all minstrels within his lord's jurisdiction. There are several famous instances of something of this kind on record. The earliest is that of the authority granted by Ranulph, Earl of Chester, to the Duttons over all minstrels of his jurisdiction; for the romantic origin of the grant the curious reader may see the Introductory Essay to Perry's "Reliques," or the original authorities in Dugdale's "Monasticon," and D. Powel's "History of Cambria." The ceremonies attending the exercise of this authority are thus described by Dugdale, as handed down to his time:—viz., "That at Midsummer fair there, all the minstrels of that country resorting to Chester, do attend the heir of Dutton from his lodging to St. John's Church (he being then accompanied by many gentlemen of the country), one of the minstrels walking before him in a surcoat of his arms, depicted on taffeta; the rest of his fellows proceeding two and two, and playing on their several sorts of musical instruments. And after divine service ended, gave the like attendance on him back to his lodging; where a court being



we shall have presently to ask the reader's further attention. The oldest existing document of the fraternity is a copy of laws of the time of Philip and Mary. They are similar to those by which all trade guilds were governed: their officers were an alderman and two stewards or sears (i.e. seers, searchers); the only items in their laws which throw much additional light upon our subject are the one already partly quoted, that they should not take "any new brother except he be minstrel to some man of honour or worship (proving that men of honour and worship still had minstrels), or waiter of some town corporate or other ancient town, or else of such honeste and conyng as shall be thought laudable and pleasant to the hearers there." And again, "no myler, shepherd, or of other occupation, or husshaudman, or husshaudman servant, playing upon pype or other instrument, shall sue any wedding, or other thing that pertained to the said science, except in his own parish." We may here digress for a moment to say that the shepherds, throughout the middle ages, seem to have been as musical as the swains of Theocritus or Virgil; in the MS. illumina-

kept by his (Mr. Dutton's) steward, and all the minstrels formally called, certain orders and laws are usually made for the better government of that society, with penalties on those that transgress." This court, we have seen, was exempted from the jurisdiction of the King of the minstrels by Edward IV., as it was also from the operation of all Acts of Parliament on the subject down to so late a period as the seventeenth year of George II., the last of them. In the fourth year of King Richard II., John of Gaunt created a court of minstrels at Tutbury, in Staffordshire, similar to that at Chester; in the charter (which is quoted in Dr. Plott's "History of Staffordshire," p. 436) he gives them a King of the Minstrels and four officers, with a legal authority over the men of their craft in the five adjoining counties of Stafford, Derby, Notts, Leicester, and Warwick. The form of election, as it existed at a comparatively late period, is fully detailed by Dr. Plott.

Another of these guilds was the ancient compay or fraternity of minstrels in Beverley, of which an account is given in Poulson's "Beverley" (p. 302). When the fraternity originated we do not know; but they were of some consideration and wealth in the reign of Henry VI., when the Church of St. Mary's, Beverley, was built; for they gave a pillar to it, on the capital of which a band of minstrels are sculptured, of whom we here re-produce a drawing from Carter's "Ancient Painting and Sculpture," to which

of whom plays a small pipe, and another the bagpipes. Chaucer (3rd Book of the "House of Fame") mentions—

"Pipes made of greend corne,
As have these litte hard grounes,
That keepen beastes in the bromes."

It is curious to find that even at so late a period as the time of Queen Mary, they still officiated at weddings and other merrymakings in their villages, and even sometimes excited the jealousy of the professors of the joyous science.

One might, perhaps, have been disposed to think that the good minstrels of Beverley were only endeavouring to revive usages which had fallen into desuetude; but we find that in the time of Elizabeth the profession of minstrelsy was sufficiently universal to call for the inquiry, in the Injunctions of 1559, "Whether any minstrels, or any other persons, do use to sing any songs or ditties that be vile or unclean."

Ben Jonson gives us numerous allusions to them: e.g., in the "Tale of a Tub," old Trve talks of "old Father Rosin, the chief minstrel here—chief minstrel, too, of Highgate; she has hired him, and all his two boys, for a day and a half." They were to be dressed in hays, rosemary, and ribands, to precede the bridal party across the fields to church and back, and to play at dinner. And so in "Epicoene," act iii. sc. 1:—

"Well, there be guests to meet now; how shall we do for music?" [for Morose's wedding.]
Clermont.—The smell of the venison going thro' the street will invite one noise of fiddlers or other.

Dauphine.—I would it would call the trumpeters hither!
Clermont.—Faith, there is hope: they have intelligence of all feasts. There's a good correspondence betwixt them and the London cooks: 'tis twenty to one but we have them.

And Dryden, so late as the time of William III., speaks of them—

"These fellows
Were once the minstrels of a country show,
Followed the prizes thro' each paltry town,
By trumpet cheeks and bloated faces known."

There were also female minstrels throughout the middle ages; but, as might be anticipated from their irregular wandering life, they bore an indifferent reputation. The romance of Richard Cœur de Lion says that it was a female minstrel, and, still worse, an Englishwoman, who recognised and betrayed the knight-errant king and his companions, on their return from the Holy Land, to his enemy, the "King of Almain." The passage is worth quoting, as it illustrates several of the traits of minstrel habits which we have already recorded. After Richard and his companions had dined on a goose, which they cooked for themselves at a tavern—

"When they had drunken well afe,
A minstrale com therein,
And said, 'Gentlemen, wittily,
Will ye have any minstreisey?'
Richard bade that she should go,
That turned him to mickle woe!
The minstrale took in mind,
And said, 'Ye are now unkind;
And if I may, ye shall for-drink
Ye gave neither meat nor drink.
For gentlemen should beate;
To minstrels that abstonen yete?
Of their meat, wine, and ale;
For for || rises of minstrale.
She was English, and well true
By speech, and sight, and hide, and hue."

Stow tells that in 1316, while Edward II. was solemnising his Feast of Pentecost in his hall at Westminster, sitting royally at table, with his peers about him, there entered a woman adorned like a minstrel, sitting on a great horse, trapped as minstrels then used, who rode round about the tables showing her pastime. The reader will remember the use which Sir E. B. Lytton has made of a troop of tymbesters in "The Last of the Barons," bringing them in at the epoch of his tale with all the dramatic effect of their habits is too sadly truthful. The daughter of Herodias dancing before Herod is scornfully represented by the medieval artists as a female minstrel performing the tumbling tricks which were part of their office. We give on the following page a representation of a female minstrel playing the tambourine, from the MS. Royal, 2 B. vii. folio 152.

A question of considerable interest to artists, not less than to antiquaries, is whether the minstrels were or not distinguished by any peculiar costume or habit. Percy and his followers say that they were,

* Was offended. † Repent. ‡ Give.
§ Travel. || Prateology.

tions we constantly find them represented playing upon instruments; we give a couple of good ones from the exquisite MS. Q. B. vii. folio 83, of early fourteenth century date.



Besides the pipe and horn, the bagpipe was also a rustic instrument: there is a shepherd playing upon one in folio 112 of the same MS.: and again, in the



early fourteenth century MS. Royal Q. B. vi., on the reverse of folio 8, is a group of shepherds, one

* May we infer from the exemption of the jurisdiction of the Duttons, and not of that of the court of Tutbury and the guild of Beverley, that the jurisdiction of the King of the Minstrels over the whole realm was established after the former, and before the latter. The French minstrels were incorporated by charter, and had a king in the year 1326, forty-seven years before Tutbury. In the ordonnance of Edward II., 1316, there is no allusion to such a general jurisdiction.

* Continued from p. 187.
† One of the minstrels of King Edward the Fourth's household (there were thirteen others) was called the waote; it was his duty to "pipe watch." In the romance of Richard Cœur de Lion, when Richards, with his host, has come silently in the night under the walls of Jaffa, which was besieged on the land-side by the Saracen army:—
"They looked up to the cavel,
They heard no pipe, no dangel,
They drew em aigh to land,
If they mighten understand,
And they ne could nought espie,
Ne by no voice of minstrale,
That quiek man in the castle were."
And so they continued in uncertainty until the spring of the day, then
"A wait there came, in a kernel,
And piped a nott in a flagel."
And when he recognised King Richard's galleys,
"Then a merrier note he blew,
And piped, 'Selgneours or sus? or sus!
King Richard is comon to us!'"
a Flagelot. b Battlement.

and the assertion is grounded on the following evidences.—Baldolph, the Saxon, in the anecdote already related, when assuming the disguise of a minstrel, is described as shaving his head and beard, and dressing himself in the habit of that profession. Alfred and Aulaff were known at once to be minstrels. The two poor priests who were turned out of the monastery by the dissolute monks were at first mistaken for minstrels. The woman who entered Westminster Hall at King Edward the Second's Pentecost feast was *adorned like a minstrel*, sitting on a great horse, tramped as minstrels then used. A story is recorded in a MS. of the time of Edward III. of a young man of family, who came to a feast in a vesture called a coat-harely cut short in the German fashion.



resembling the dress of a minstrel; the oddity of it attracted the remark from an elderly knight, "Where is your fiddle, your rible, or suchlike instrument belonging to the mystrelle?" to which the young man replied that he had no craft in using such instruments. "Then you are much to blame," replied the old knight; "for if you appear in the garb of a minstrel it is fitting you should perform his duty." In the time of Henry VII. we read of nine cells of *taeny* cloth for three minstrels; and in the "History of Jack of Newbury," of "a noise (i. e. band) of musicians in *townie* coats, who, putting off their caps, asked if they would have music." And lastly, there is a description of the person who personated "an ancient minstrel" in one of the pageants which were played before Queen Elizabeth at her famous visit to Kenilworth, which is curious enough to be quoted. "A person, very meet seemed he for the purpose, of a forty-five years old, appalled partly as he would himself. His cap off; his head seemly rounded tonsterwise,* fair kumbed, that with a sponge daintily dipped in a little capon's grease was finely smoothen, to make it shine like a mallard's wing. His beard smugly shaven; and yet his shirt after the new trick, with raffs fair starched, sleeked and glistening like a paire of new sbocs, marshalled in good order with a setting stick, and strut, that every ruff stood up like a water. A side (i. e. long) gown of Keudal Green, after the freshness of the year now, gathered at the neck with a narrow gorget, fastened afore with white clasp and keeper close up to the chin; but easily, for heat to undo when he list. Seemly begirt in a red caldis girdle: from that a pair of capped Sheffield knives hanging a' two sides. Out of his bosom drawn forth a lappel of his napkin (i. e. handkerchief) edged with a blue lace, and marked with a true love, a heart, and a D. for Damian, for he was but a bachelor yet. His gown had side (i. e. long) sleeves down to midleg, slit from the shoulder to the hand, and lined with white cotton. His doublet sleeves of black worsted: upon them a pair of paynets (perhaps points) of tawny chanmet laced along the wrist with blue threden points, a well towards the hand of fustian-a-naps. A pair of red nether socks. A pair of pumps on his feet, with a cross cut at the toes for corns; not new, indeed, yet cleanly blackt with soot, and shining as a shoeing horn. About his neck a red ribband suitable to his girdle. His harp in good grace dependant before him. His wrest tyed to a green lace, and hanging by; under the gorget of his gown a fair flaggon chain (pewter for) silver, as a squire-minstrel† of Middlesex that travelled the country this summer

* Which Percy supposes to mean "tonsure-wise," like priests, and monks.

† Percy supposes from this expression that there were inferior orders, as yeomen-minstrels. May we not also infer that there were superior orders, as knight-minstrels,

season, into fairs and worshipful men's houses. From this chain hung a sentcheon, with metal and colour resplendent upon his breast, of the ancient arms of Islington,* to which place he is represented as belonging.

From these authorities Percy would deduce that the minstrels were tonsured and appalled very



much after the same fashion as priests. The pictorial authorities do not bear out any such conclusion. There are abundant authorities for the belief that the dress of the minstrels was remarkable for a very unclerical sumptuousness; but in looking through the numerous ancient representations of minstrels we find no trace of the tonsure, and no peculiarity of dress; they are represented in the ordinary costume of their time; in colours blue,



cheon, like that of the Islington minstrel. In short, a careful examination of a number of illustrations in illuminated MSS. of various dates, from Savon downwards, leaves the impression that minstrels wore the ordinary costume of their period, more or less rich in material, or fashionable in cut, according to their means and taste; and that the only distinctive mark of their profession was the instrument which each bore, or, as in the case of the Kenilworth minstrel, the tuning wrest hung by a riland to his girdle; and in the case of a household minstrel the badge of the lord whom he served.

The forms of the most usual musical instruments



of various periods may be gathered from the illustrations which have already been given. The most common are the harp, fiddle, cittern or lute, hand-organ or dulcimer, the shalm or psaltery, the

over whom was the king-minstrel? for we are told "he was but a bachelor (whose chivalric signification has no reference to matrimony) yet." We are disposed to believe that this was a real minstrel. Langham tells us that he was dressed "partly as he would himself;" probably, the only things which were not according to his wont, were that my Lord of Leicester may have given him a new coat; that he had a little more capon's grease than usual in his hair; and that he was set to sing "a solemn song, warranted for story, out of King Arthur's Acts," instead of more modern minstrel ware.

red, grey, particoloured, like other civilians; with hoods, or hats, or without either; frequently the different members of the same band of minstrels present all these differences of costume, as in the instance here given, from the title-page of the fourteenth century MS. Add., 10,293; proving that the minstrels did not affect any uniformity of costume whatever.

The household minstrels probably wore their master's livery (liveries were not used until a late period); others the badge of their guild. Thus in the *Morte Arthur*, Sir Diuadan makes a reproachful lay against King Arthur, and teaches it an harper, that light Elyot, and sends him to sing it before King Mark and his nobles at a great feast. The king asked, "Thou harper, how durst thou be so bold to sing this song before me?" "Sir," said Elyot, "wit you well I am a minstrel, and I must doe as I am commanded of these lords that I bear the *armes of*;" and in proof of the privileged character of the minstrel we find the outraged king replying, "Thou saest well, I charge thee that thou like thee fast out of my sight." So the squire-minstrel of Middlesex, who belonged to Islington, had a chain round his neck, with a sentcheon upon it, upon which were blazoned the arms of Islington.* And in the effigies of the Beverley minstrels, which we have given on the preceding page, we find that their costume is the ordinary costume of the period, and is not alike in all; but that each of them has a chain round his neck, to which is suspended what is probably a sent

chion, and tabor, pipes of various sizes played like clarionets, but called flutes, the double pipe, hand-bells, trumpets and horns, bagpipes, tambourine, tabret, drum, and cymbals. Of the greater number of these we have already incidentally given illustrations; of some of the others we here give illustrations, from the Royal MS., 2 B. vii. And in conclusion we give a group of musical instruments



from one of the illustrations of "Der Weise König," a work of the close of the fifteenth century.

* Heralds in the fourteenth century bore the arms of their lord on a small sentcheon fastened at the side of their girdle.

BRITISH ARTISTS:
THEIR STYLE AND CHARACTER.

WITH ENGRAVED ILLUSTRATIONS.

No. XVI.—JAMES BAKER PYNE.



HEY who are familiar with English Art only as it is seen within the walls of the Royal Academy can know little or nothing of the works of one of our best landscape-painters. It is now some thirty-three years since, when a number of artists, finding that the rooms of the Academy, then in Somerset House, offered but little space for the suitable exhibition of their pictures, associated themselves together for the purpose of exhibiting their own works, in conjunction with those of other artists who might choose to unite with them; and hence arose the "Society of British Artists," whose galleries are in Suffolk Street.

Among the earliest members of this Institution, or regular contributors to its annual exhibitions, were—Haydon, Martin, Holland, D. Roberts, Stanfield, Creswick, Hart, Frith, Linton, &c.; but as by the rules of the Academy no artist who is a member of any other society is eligible for admission into the former, and as it is a very natural ambition to desire the honours which the Academy is entitled to bestow, the association in Suffolk Street has from time to time lost the aid of many who were its strongest supports: one, however, though not among its earliest members, has bravely clung to its fortunes, whether good or ill, and freely acknowledges that the patronage he enjoys is owing to his connection with this society, as here he has the power to place his own pictures where they may be advantageously seen. Mr. Pyne, to whom we allude, is now Vice-president of the Society of British Artists.

In the *Art-Journal* for the year 1849, when we published a series of "Portraits of British Artists," appeared one of Mr. Pyne, with a few remarks on his

life and works: we must, on the present occasion, go back to that report for whatever information it affords us.

James Baker Pyne was born at Bristol, on the 5th of December, 1800. From his earliest years a love of pictures was the ruling passion of his mind, and, as a consequence, his greatest desire was to become an artist; but his father had other views concerning him, and placed him with a solicitor, in whose office he was employed till his twenty-first year. At the expiration of his term, however, he bade farewell to deeds and parchments, and assiduously set to work to acquire a knowledge of painting. Several years were thus passed in Bristol, in practising his Art, teaching it to others, and in studying and repairing old pictures. In 1835 he came up to London, where he remained a whole year without attempting to exhibit or sell a picture; but in 1836 he sent to the Royal Academy, "Windsor Castle, from the Thames—Morning," and to the Society of British Artists, a "View of Clifton;" the latter picture was, we believe, bought by the late Mr. Carpenter, the eminent bookseller of Old Bond Street, father of Mr. W. H. Carpenter, author of the "Life of Vandyck," and Keeper of the Print Room in the British Museum. Mr. Carpenter senior was a man whose taste and judgment in Art-matters is unquestionable; Mr. Pyne had received an introduction to him, and there is little doubt he at once saw in the works of the painter evidences of talent of a superior order. He immediately became his patron, bought his first picture, and, as the artist told us some years back, "He gave me excellent advice—cautioned me against money-lenders, and told me to apply to him in any emergency. He never bought a painting of me at a low price when I went to him for pecuniary assistance, but always freely lent me what I wanted, and received it again at my own convenience. I speak of my obligation to Mr. Carpenter with much pleasure—it is his due." We believe that this gentleman was also the first to recognise the merits of another distinguished artist, R. P. Bonington, and to foster his genius; at least, we are certain he aided most effectively in making it known to the British public, through the series of prints from his works which were published in Bond Street. We have heard Pyne speak in most commendable terms of Mr. Rought, the picture-dealer, in Regent Street, as of "a gentleman and friend to whose fine taste, integrity, and enterprise," he has been indebted for more than half the success he has met with since his residence in London.



Engraved by

THE CHURCH OF ST. GEORGIO MAGGIORE, VENICE.

and A. G. P. Niccolis

In the years 1837-38-39 respectively, Pyne exhibited at the Royal Academy, "Clifton, from the Avon," "Nightingale Valley, Clifton," and "Eton College;" and in 1841, "Hostel at Upnor Castle, on the Medway," and "Sandwich, on the Kentish Coast." From this period we find his name no longer on the list of exhibitors at the Academy. His subsequent pictures were to be found at the British Institution, and at the Suffolk Street Society, of which he had now become a member. Almost from the outset of his career he had aimed at the representation of open expansive landscape, where distance demands light and atmosphere, and of lake scenery, where the same qualities of painting are required, united with powerful effects of chiaro-oscuro. We scarcely ever remember to have seen a picture by him of any close subject—shady lanes, entrances to woods, deep glens, &c. We should be inclined to apply the word "clearness" as the principal quality characterising his works, and which is only to be obtained by, or rather is the combined result of—to use his own words—

"aerial perspective, a frequent alternation of the transparent, semi-transparent, and opaque media; distinct detail, and bold chiaro-oscuro. . . . Impalpable in itself, it should pervade every part while destroying all idea of the surface of a work; and so absorbing, when attained, is the full sense of its influence, that the minor and precise beauties of the finished schools vanish, and become dry and opaque when brought in contact with the pure effulgence of this vital quality. Pictures without it have an unpleasant and opaque paleness, and seem really to form part of the useless furniture of a room; while those which possess it in any extraordinary degree, present for the refreshment of the eye so many delicious apertures of more than mimic light and air and sunniness, which glow without heating, and shine without dazzling, and, like the face of health, and youth, and beauty, shed a warmth around them whose brilliancy neglect cannot entirely deface; while all the varnish amendments of the picture-dealer, added to all the wash-leather rubbings of all the emulators of public and private col-

lections in existence, must still leave those which have it not, as at first—dry, lifeless, and repulsive.* In this passage we seem to discover an index to the style of painting adopted by this artist, or, more correctly speaking, to its character. In 1839 he exhibited at the British Institution the first, so far as our recollection serves, of those "Lake pictures" with which his name in subsequent years has been so frequently identified: it was a view of "Rydall Water, Westmoreland," and treated in a manner to illustrate the lines—

"On throne of cloud, with pure and silvery ray,
The young moon steals upon the lingering day."

To Suffolk Street he sent the same year a "View from the Cheddar Hills—Bridgewater Bay in the distance." In this work we recognised the dawning, as it were, of those effects of light and sunshine which have ever been regarded as the great charm of his works. Windsor and its vicinity had, from the artist's arrival in London, been a favourite place of study with him. In the summer of this year there was published a series of sketches, executed by him in lithography, of views of "Windsor, with the surrounding Scenery, the Parks, the Thames, and Eton College"—a volume of great pictorial interest, the subjects all well selected, and most carefully and truthfully represented. His solitary contribution to the Suffolk Street Gallery in 1840—another "View from the Cheddar Hills"—forced from us the following remarks:—"It is one of the

most perfect works in the collection; the mode in which this artist manages to preserve distance is absolutely wonderful. The eye traces miles upon miles; and while every hedgerow seems distinctly marked, there is no appearance of anything like artifice, nor the remotest approach to stiffness or formality." There were two pictures exhibited by Pyne in 1843, which to this day have not passed away from our recollection: one, a distant view of "Shakespeare's Cliff," hung at the British Institution, in which the cliff appears rising from a bank of mist; the sun is low in the horizon, its brightness softened down by the hazy atmosphere, producing an effect of exquisite tenderness and beauty. In the other, exhibited at Suffolk Street, London, as seen from Greenwich Park on a warm summer's afternoon, is presented. The vast extent of the metropolis, the river, and all the distant objects, are dimly apparent through a thick veil of smoke, suffused with the hot colouring of the sunshine. We have often stood upon the spot from which this view was sketched, observing the effects described by the artist, and can testify to their absolute truth.

We have notes of four pictures from his pencil exhibited at Suffolk Street in 1844:—"In the Basses Ville, Calais," a subject scarcely worthy of his talent, but interesting, not less from its novelty than for his judicious treatment of it; "Ujnor Castle, on the Medway," in which the river and the misty distance are rendered in his happiest manner; "Scarborough, from the South Sands," a sunset scene, painted with a perfect harmony and richness of colour, and eng-



Engraved by]

THE VILLA D'ESTE, NEAR TIVOLI.

[J. and G. P. Neohols

gesting an idea of absolute repose; and "Recollections of the Floating Harbour at Bristol," also an evening scene, luminous to a degree. In 1845 we find him exhibiting in the same gallery "Sand-gatherers, Yorkshire Coast," a small picture, remarkable for its brilliancy, breadth, atmosphere, and sweetness of colouring; "The Vale of Nenth, Glamorganshire," the largest picture, we believe, he had painted up to that time. Perhaps in the whole of North Wales there is not a more picturesque locality than this; and in its character one peculiarly adapted for the display of this painter's peculiar style. The manner in which he has arranged his light and shade throughout the picture shows the most consummate skill, and knowledge of the true principles of chiaro-oscuro. "A Daughter of the Emerald Isle," as its name indicates, is a figure subject, and was a novelty from the hand of the artist, but a successful study. "Sunshine after a Storm," another figure subject, small, in which a blind man is led by a dog; "Staithe—Fishing Town on the Yorkshire Coast," a theme of very ordinary interest, but under the glow of Pyne's sunshine made beautiful; "Hastings' Beach," and "Vale of the Taft, North Wales," both of them pictures that would grace any collection.

* "Nomenclature of Pictorial Art," Part II. By J. B. Pyne. *Art-Journal*, September, 1842.

In 1846 Pyne set out on his first pilgrimage to Italy; but before starting he sent to the British Institution one of the finest landscapes he had as yet exhibited—a view of "Snowdon," the grand old mountain literally enveloped in a garb of dazzling sunlight, but without any exaggeration of truth. Nothing that we have seen from the pencil of this artist carries out more satisfactorily his own principles of Art, which we believe to be true principles, than does this glorious picture. To the gallery at Suffolk Street he sent also this year—"The Floating Harbour at Bristol, with St. Mary Redcliffe Church restored;" another view of the "Floating Harbour;" "Grist and Felling Mills on the Machno, Denbighshire," one of the few close scenes painted by him; the precipitous watercourse, and the whole of the hard, rugged, natural materials which make up the composition, are admirably represented. But his principal picture in the rooms was "The Menai Straits," seen from an elevated point, below which the landscape spreads out into a vast expanse of country of infinite diversity of character. This is treated by the artist in his most felicitous manner; air and light seem to have been the pervading influences of his mind while working on the canvas, and they are forcibly presented over the beautiful scenery that meets the eye of the spectator.

Mr. Pyne's first visit to Italy was made for the express purpose of study in the snow-country—that is, in the neighbourhood of the Alps—to satisfy his

mimic on the subject of the variously described phenomena attending the Alpine regions under the effects of snow, modified by various degrees of coloured light from mid-day to twilight. The Bernese Alps, and those visible from the Northern Lake district, principally furnished him with such experiences. The result of his observations confirmed him in a pre-conceived opinion—that artists have been much misled by those writers who have stated that these phenomena, though always represented as exceedingly beautiful, are unaccountable. He asserts they are by no means so, except to persons altogether unacquainted with the most ordinary laws of Light and Colour, with their reflection, and that they obey a law in every way certain and sequential. We would take the liberty of suggesting to him a paper on this subject for our Journal: it would be of value to our artist-readers, many of whom, we know, have derived much instruction from his contributions to our pages.

He returned to England in time to "put in an appearance" at his accustomed places of exhibition, and of course his pictures presented the results of his foreign travel, though not of the "snow-crowned hills" he went out to see. He contributed to the British Institution in 1847—1848—"On the Margin of Zurich's fair Waters"—Market Boats with Saints' Sails," a luminous and brilliant work; and to Suffolk Street—"The Neckar, at Heidelberg," "Lago di Garda," and another view of a favourite spot, frequently painted—"The Floating Harbour at Bristol." In the "Heidelberg" picture the spectator has a kind of bird's-eye

view of the town, beyond which flows the river, till it is lost in a distance of misty light, painted in a manner we can only designate as "delicious," so soft and tender is the atmospheric effect. The "Harbour" picture is a triumph of sunlight painting. In this year the artist received a commission from Mr. Agnew, of Manchester, to paint a series of twenty-four views of the English lakes, and their immediate vicinity, for the purpose of being lithographed on a large scale, and published. This work has made its appearance at intervals within the last two or three years, and has been included within our "Reviews" as the parts reached us. It is a beautiful pictorial exposition of our picturesque lake country.

Pyne sent to the British Institution in 1848 two pictures—"Staithes, Yorkshire Coast," and "Night at Merthyr, South Wales," the latter representing the effects produced over the landscape after dark by the Welsh Iron Works; and to the Society of British Artists—"Pallanza, on the Lago Maggiore;" "Mill at Plassyant, North Wales," a dark picture, differing materially from the majority of his works, yet distinguished by originality and truth of treatment; a "View of the Dogana, Venice, on a Saint's Day," a picture so full of light as to be almost shadowless, and yet most effective; and "Caeruarvon," in which the appearance of a rising storm is finely represented. His exhibited pictures of 1849 were only to be seen in the last-named gallery: they were—"The Wreck Ashore," a small painting; and "Oberwesel, on the Rhine," in



Engraved by J.

THE SCREES AT WASTWATER, CUMBERLAND.

[J. and G. P. Nicholls.]

which the artist has adopted a low tone of colour very unusual with him, but nevertheless applied with the nicest discrimination, and with the most pleasing results. Among his works contributed to Suffolk Street in the following year were—a view of "Ehrenbreitstein," painted, we believe, from the sketch from which our print is taken, with some slight alterations; "Thames Recollections;" and another "Wreck Ashore;" and to the same gallery, in 1851—"Landing Herrings on the Yorkshire Coast," a work in which light, air, and space, were never more skilfully idealised. In 1852 we remember to have seen in Suffolk Street two pictures painted from his "Lake Sketches"—"The Head of the Wastwater, with Scawfell and Scawfell Pike," under the effects of a storm; and "The Scree at Wastwater," of which we shall have to speak presently.

In 1851, Pyne started a second time for a tour in the south of Europe, having received another commission from Mr. Agnew to execute a series of pictures—commencing with the Rhine, and extending to the furthest part of Italy. He returned, after an absence of three years, with an extraordinary mass of sketches, in the production of which he acknowledges to have received most valuable aid, with regard to details, from his friend and *compagnon de voyage*, Mr. W. Evans, of the Water-Colour Society, and with a very considerable number of large finished drawings, all of them painted on the spot. We

had the gratification of passing an evening in his studio a short time since, looking over the portfolios containing these drawings, as varied in subject and treatment as they are numerous. Those only who have been through Italy to study the characteristics of its scenery can form any idea of the extraordinary labour and perseverance, to say nothing of talent, required to produce such an accumulation of subject matter. For nine months of the year study out of doors is considered at least injudicious, and frequently dangerous, independently of the annoyances and discomforts to which every traveller is exposed who does not journey as "*Milord Anglais*." One has only to see this series of drawings to be satisfied they must have been made under circumstances of much difficulty, and by a man whose constitution was proof against peculiarities of climate and atmosphere. To attempt any thing approaching to a detailed description of them would occupy the entire space we have given to this notice, and would still leave us much to say. There are towns and cities, mountains and valleys, rivers, lakes, and sea-coast, represented at all hours of the day, and under every variation of weather—clear and bright with the freshness of morning, parched with the noontide heat, blazing with the crimson hues of sunset, dark with the shadows of the thunder-cloud. Highly as we have always estimated the talents of the artist, they have risen immeasurably in our opinion after seeing these charming works. We hope he will be prevailed on to exhibit

them publicly: we are quite sure they will be as much appreciated by others as they are by ourselves.

There was a picture exhibited by Pyne at Suffolk Street, in 1853, which we presume was made from one of the sketches taken on his first visit to Italy; it had no title in the catalogue, but the subject was a passage of Alpine scenery under an effect of sunlight; in treatment it was eminently successful in the quality of light. His two contributions to the same gallery in the following year were also of foreign scenery; one a "View of Berne, Switzerland;" the other entitled only a "View in Italy." Of his last year's picture, also in the Suffolk Street gallery—"Evening at Chelsea," we shall only repeat the remarks it suggested to us at the time:—"We had expected to have sainted this painter on the Rialto at Venice, or to have picked him up somewhere in Sicily; but lo! we find him painting Chelsea Church, and writing "mixed teas" on the thresholds of the Chelsea grocers. The sunny glow of this admirable picture is felt over the whole of this end of the room. It has no exaggerated colour, yet it is powerful in that quality by a treatment which raises all the warm and cool greys into colour at once rich and harmonious. It is, in short, a production embodying the rarest qualities of Art."

The four subjects we have selected as examples of this painter's style of composition and treatment include views of English and Italian scenery, and are chosen chiefly on account of their diversity. The view in Venice, introducing the "CHURCH OF ST. GEORGIO MAGGIORE," is a simple, well-arranged compo-

sition, in which the purity of an Italian atmosphere is admirably exemplified. "THE VILLA D'ESTE, NEAR TIVOLI," sketched from the gardens, is represented under the effects of morning; it is painted with great tenderness, but the picture acquires force from the group of dark trees rising up almost in its centre. "THE SCREES AT WATSWATER, CUMBERLAND," is a passage of lake scenery, which in itself offers little to charm the eye as a picture, yet the artist has made it one of great interest by the broad play of transitory light he has thrown over the side of the mountain. "EISENBREITSTEIN," is gilded with the red rays of the setting sun:—

"The moon is up, and yet it is not night;
Sunset divides the sky with her:"

in strong opposition to the brilliant hues on rock and castle is the deep, rich colouring of the objects in the foreground. The great charm of this picture is perfect repose; its intense heat would seem to render exertion impossible.

With the exception of Turner, no painter of our school has so thoroughly mastered the difficulties of aerial perspective and atmospheric phenomena as Pyne; without detecting the least approximation to the copying of that great artist, his pictures very often remind us of those by Turner. He never aims at the same extraordinary, and often apparently unnatural, effects; he does not exhibit such a redundancy of poetical imagination in his compositions, such a profusion of what may be called the "flowers of painting;" and yet his mind is amply stored with visions of the true and the beautiful, gathered from a close and attentive



Engraved by]

EISENBREITSTEIN.

[J. and G. P. Nebolds.

study of Nature in her most attractive aspects, and these he transfers to his canvas with a bold and unflinching pencil, that shows his mastery over his materials, as well as a perfect knowledge of their individual and relative value; while to this freedom of execution are superadded great delicacy and attention to form and detail. We have frequently heard similar objections taken to his colouring, as have been made to Turner's—especially in the too abundant use of white; but such objections can only come from those who have not closely analysed the colouring of Nature. We were one day discussing this very question with an acquaintance by the sea-shore on a bright summer morning. Directing his attention to the tranquil surface of the ocean, then brightly reflecting the sun's rays, we asked him its colour. "White," he replied, after looking at it for a few moments; "yes; white, from the horizon almost to our feet, gradually harmonising into a tender blue as far as the eye reaches left and right."—"Are Turner and Pyne wrong, then?" we again asked.—"No; right—there cannot be two opinions on the matter."

It is this inability to see things as they are in Nature which produces so much false and unsound judgment among the frequenters of our Art-exhibitions; they have not yet learned the "art of seeing," and are therefore incapable of pronouncing a verdict upon truths. It is only when they have acquired this power that they are in a position to form something like a just opinion of the relative merits of artists; "for, although with respect to the feeling and passion

of pictures, it is often as impossible to criticise as to appreciate, except to such as are in some degree equal in powers of mind, and in some respects the same in modes of mind, with those whose works they judge; yet with respect to the representation of facts, it is possible for all, by attention, to form a right judgment of the respective powers and attainments of every artist. Truth is a bar of comparison at which they all may be examined, and according to the rank they take in this examination will almost invariably be that which, if capable of appreciating them in every respect, we should be just in assigning them."

But a word, before we close, respecting the writings of Mr. Pyne; for, unlike too many of our painters, he is desirous, and has the ability, to impart to others the knowledge he has himself acquired. The series of papers—"The Nomenclature of Pictorial Art"—commenced in the *Art-Journal* some years since, and, after a considerable lapse of time, continued during the last year and the present, contains a very large amount of theoretical information, most valuable to every amateur and artist; and his "Letters on Landscape," which appeared also in our publication in the years 1846-47, must take their place, if published separately, as we trust they may be some day, among the best manuals of instruction which can be placed in the hands of the young landscape-painter.

THE DUTCH GENRE-PAINTERS.

BY F. W. FAIRHOLT, F.S.A.

WITH ILLUSTRATIONS FROM ORIGINAL SKETCHES
BY THE AUTHOR.

THE Hollander, as represented by his own native artists, is as distinct from the rest of the *genus homo* as the style adopted by the hands which have immortalised his peculiarities. He is known everywhere—by the rich connoisseur who glories in the possession of the original works of Ostade, Gerard Dow, Brauwer, or Jan Steen; and by the poorer lover of Art, in the many copies produced by the facile hand of the engraver. The entire truth of these pictures, and their quaint originality, thus enforce full claim upon attention, even when divested of the charm of Colour. Well, then, may the wealthy collector of taste rejoice in the possession of genuine works so remarkable for both qualities, as are the pictures by the painters of the Netherlands. With them originated that peculiar choice of subject from ordinary life which has received the *soubriquet* of *genre-painting*, from the impossibility of classing it with the grander imaginings of the Italian school. Art was in that school principally devoted to the sacred service of the Church, or the dignified realisation of historic scenes; it therefore always possessed a certain elevated dignity when it approached ordinary life in portraiture: but in no instance did it free itself from conventional or scholastic education, and give itself up to the delineation of everyday life with the zest of an Ostade, who would bestow all the graces of Art on an old woman threading her needle; or with the dashing joviality of Jan Steen, who would revel in a tavern scene with greater gusto than had ever been seen before in the history of imitative Art. Their success as a school produced a revolution in the general canons of criticism, and the ability displayed in their works asserted a position for a new body of painters then struggling into notoriety, who, discarding the *grandiose* (by this time become a little absurd from the scholastic tendencies of its devotees, who too frequently indulged in mixing the real and the fanciful,—the present world with the past, history and mythology in unreal conjunction), placed their starting point in Nature alone, making her works the limit of their studies, and bringing only the graces of Art to the proper adornment of what she placed before them—believing no created thing unworthy their earnest attention, and no attention ill-bestowed that could present it to their fellow-men surrounded by all the artistic graces consistent knowledge could bring to bear on its delineation.

This term, *genre*, was applied somewhat scornfully by the French critics, in the days of the *Grande Monarchie*, to designate a school of Art they could not comprehend, and which they chose to consider as out of the pale of Art-proper, or rather the Art of Versailles. Louis XIV. would never admit a Dutch picture into his galleries, which were, however, open to the travesties of scripture subjects his native artists painted with so much complacency, as well as to the theatrical flatterings of Bernini's sculpture. The *grandiose* trifling, which then passed for dignity, and the constrained manners which made up an etiquette as wearisome as if it were Chinese, gave no scope for the moods nurtured in formal conventionalities to understand the charm of simplicity or Nature. The lowest grade of a true Art takes higher stand than the Art produced in the hotbeds of the French court, nurtured under unattractive aspects: its despised products have passed away like all other "whims of a day," but the greater works of the honest Dutchmen remain.

Though Ostade is inseparable from Dutch Art, and by his genius was the earliest to raise it to renown, he was not a native of the country. He was born at Lubbeck, in Germany, in 1610. Hence some biographers unwittingly place him among German artists; but he was unquestionably German only by the accident of birth—for abandoning his native country early in life, the formation of his mind and the knowledge of Art he possessed were essentially Dutch. Like many a foreigner undergoing the change of thought and habit produced by a residence among strangers, he became ultimately more national than the native born; and earnestly

devoted his ability to the delineation of the people of his choice with a zest and power hitherto unknown. Holland did not in his time wait for wealthy amateurs, and, although the long life of Ostade was spent amid political turmoil, the country was improving in wealth and importance beneath the rule of great public men. It is to Frank Hals, of Haarlem, that he was indebted for the knowledge he obtained of the mere manipulation of Art. Frank was a free, dashing painter, but a perfect tradesman in his profession. He had considerable tact in producing saleable pictures, and also in discovering young and needy men of genius who would aid him in multiplying them quickly. His wife, as avaricious as himself, fostered the trading spirit, and between them they made the studio a mere shop, and the pupils mere mechanics. At the time Ostade was in this state of servitude he had as a fellow-pupil Adrian Brauwer, with whom Hals had accidentally become acquainted, and whose ability he had detected in the humblest employ. His mother was a poor milliner at Haarlem, and he used to sketch on paper for her the flowers and other ornaments with which she embroidered the caps and collars of

her customers. The ability shown by the boy in designing these decorations induced Hals to examine his sketches, and ask if he would like to be a painter. The boy readily replied in the affirmative: his mother was consulted on the subject, but she would agree only on condition that Hals should entirely provide for him during his pupilage. He consented; but, with wretched parsimony, when he found the lad's ability, locked him in a wretched garret, and made him labour continuously with hardly sufficient food, without money, and without relaxation. His fellow-students, however, behaved more mercifully by him, and commissioned him to make them sketches for a few pence each in such few moments as he could snatch for that purpose. His master discovered this, and punished the poor lad by making him work harder on still less food, until, persecuted more than nature could bear, he broke from his prison and escaped. With the childish experiences of a boy, he made provision for the first day of his liberty by purchasing as much gingerbread as he could carry in his pockets; and then ensconcing himself beneath the carved case of the famous great organ in the principal church of

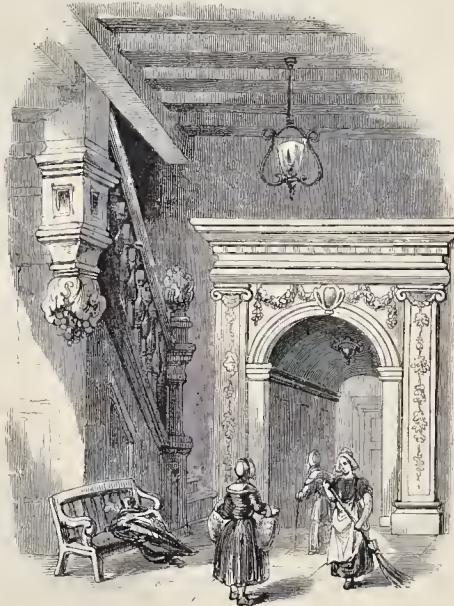

HALL OF AN OLD HOUSE, LEYDEN.

the town, leisurely enjoyed this delicacy. After a few hours his situation became irksome; he was lonelier than in Hals' studio, for his artistic implements were wanting; hunger, too, outmatched his gingerbread, and he ventured forth manfully to the church porch. Here he was recognised by a passer-by, who had known him in his master's house; from the poor boy he learned his melancholy story, and at once offered to be the mediator between them—succeeding so well that Hals behaved better to him; for he was anxious to profit by his genius, and had sold many of his works at high prices, as the production of a foreign artist of great merit.

It was at this time that Ostade came into Hals' studio as a pupil, and fully appreciating Brauwer's ability, and indignant at the manner in which he was treated, urged him to try his fortune on his own account, and escape to Amsterdam, which was then full of connoisseurs. Brauwer took his advice, and luckily went on his arrival to an inn kept by one Van Sommeran, who had been a painter in early life, and whose son still practised the Art. Here he was well received, and his talent appreciated. It was soon discovered by an amateur, to whom his first picture was shown, that he was the "foreign

artist" whose works Hals had sold so highly. He was well-paid for his work, and became, from the depth of poverty and privation, free and comparatively rich. It is little to be wondered at that he revelled in the change. He gave himself up to tavern life, painted sottish scenes, and the rude brawls they engendered, and spent his money among the drunken boozers he painted—caring little to work before it became absolutely necessary to obtain money for his creditors.

Ostade, possessed of true German pluck, went on a steadier course. Disgusted with his master, he quietly abandoned him, but settled down beside him in the city of Haarlem to honestly obtain patronage for his own talents. He tried them in various ways; but being a young and inexperienced man, he fledged his wings in imitative Art, and endeavoured to rival the works of Rembrandt and Teniers. He did not succeed; yet he did not fully feel his own power of originality until his old fellow-pupil Brauwer paid him a friendly visit, and urged him to throw away conventionalities, and depend on the strength of his own genius. The hearty advice of the grateful young painter, to whom he had once tendered advice as useful, determined his course,

and he struck out a style which has invested his pictures with a charm all his own.

Unlike Brauwer, Ostade was a quiet, industrious man. He married the daughter of Van Goyen, the marine-painter, and a large family was the result of the union, for whose support he laboured unceasingly until the necessity for improving his monetary affairs induced him to make a change, and he decided on returning to his native town to settle there; but he got no further on his road than Amsterdam, where he found so much patronage, that about the year 1662 he settled there, making the neighbouring villages the scenes of his study; and, with the characteristic quietude of his life, having found out his forte, a fair field for study, and a due amount of patronage, he never left Amsterdam; and died among his patrons in 1685, at the ripe age of seventy-five.

In his pictures we see the best transcript of Dutch life in that era: the happier and better class of subject was chosen for his delineation. The tavern brawls, the drunken orgy, or the coarse village fête, had no charms for his pencil; but the rustic at home amid his family, or enjoying himself with his pipe, or listening over the trellis-hung door of his cottage to the travelling minstrel's simple hurdy-gurdy, often employed his pencil. He never caricatures their simple life; and, while displaying it in the most complete homeliness of its character, never offends by want of taste, however low the grade of the persons he may represent. Poor though they may be, they are seldom repulsive, as in many of the works of the artists of the Low Countries; while the heartiness of their joy as they look on their children, or revel in the simple pleasures they can obtain, gives them an interest and a claim on attention that pure honesty always may command. They show how much poetry there is in common things, and how much lurks beneath

"The short and simple annals of the poor."

The life of Bramer possesses great stirring interest; indeed, it may be said to be the most eventful career led by any Dutch painter. They generally passed through their course of life so quietly and simply, so industriously and prosperously, that we know little more of them than that they lived, painted, and died. The adventurous spirit of Bramer, and the erratic nature of his tastes, led him into a more chequered path. Cradled in poverty, a slave to a bad master, as he emerged to manhood he ran a reckless course when liberty and money came into his possession. He must have been occasionally taken for a madman by his stolid countrymen. Many are the quaint stories told of the painter—his recklessness and his buffooneries, which must have frequently set the tavern in a roar. He had much castie humour also; and it is narrated of him, that being invited to a wedding, and feeling it was only because he had discarded the slatternly clothes he usually wore, and donned a suit of velvet, he soaked his new coat in the richest sauces on the table, declaring that the good cheer could only be properly bestowed on the thing invited; and then casting it on the fire, he coolly walked back to his old tavern companions. Immersed in his studies of low life, and enjoying only such scenes as he loved to paint, he never sought to amass money; and it is recorded of him, that on one occasion, when a considerable sum was paid him, he abandoned his pencil and home for nine days, until he had spent it all, returning penniless, and praising heaven that he had at last got rid of it.

This reckless life naturally produced the usual bad results, even to a man of so few wants as Bramer. His debts accumulated, and at last were so portentous that he saw no escape from his liabilities but flight. He left Amsterdam, and hurried to Antwerp; but when he reached that city he was at once arrested by the soldiery, for the thoughtless painter had no passport, and the Hollanders were waging fierce war against the Spaniards, who claimed to be their governors, and in whose hands Antwerp was held. He was at once marched to the citadel* as a Dutch spy, and in it encountered the

* Our engraving exhibits the aspect of the citadel of Antwerp at the time when the painter was prisoner there; it is now a much stronger position. In his time it was fed by a canal connected with the Scheldt, and the ramparts economically served the purpose of foundations for wind-mills to grind the corn of the garrison. The necessary houses for troops are arranged with Dutch formality; a chapel is also contained within its bounds, and an open space for the exercise of the soldiery. It was constructed by the celebrated engineer Paeletti, that the cruel Duke

Duke d'Artemberg, who was imprisoned there by order of the Spanish king, and whom the painter imagined to be the governor of the fortress. In profound tribulation Bramer told his simple tale, and assured him he was only a poor painter. To test his story, the duke good-naturedly sent a messenger to Rubens, then residing close by, and obtained from him canvas and colours for Bramer, who at once set to work, and painted a group of soldiers who were engaged beneath his prison window in a game of cards. When it was finished it was shown to

Rubens, who at once declared it to be a work of Bramer's. That really great and generous man went immediately to the governor, begged the liberty of his fellow-artist, and ultimately obtained it on becoming personally answerable for his conduct. He did not rest here; but took Bramer to his own princely mansion in Antwerp, where he gave him a chamber for his exclusive use, clothed him anew, and assigned him a place at his table.

Fortune now seemed to have done her best for Bramer, but he was not the man to value her smiles.

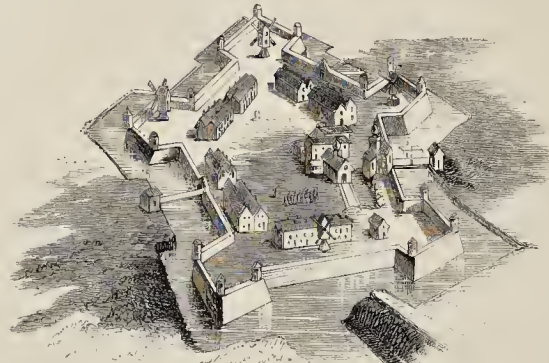

THE CITADEL OF ANTWERP IN 1603.

His short residence in the house of the courtly Rubens, who lived more like a prince than a painter, instead of elevating only depressed a man whose chief joy centred in tavern life. Like old Walter Mapes, his aspiration was—

"In a tavern to be till the day of his death,
With no sliht to the fall-flowing bow,
That angels might sing, as he drew his last breath,
'Rest and peace be to this thirsty soul.'"

He made a precipitate retreat from Rubens's house

to the beer-shops, selling his clothes for drink. Becoming acquainted with a boon-companion, one Joseph van Ornesbeck, a baker, he took the offer he gave the painter to board and lodge him on condition that he gave him lessons in Art. Master and pupil were as constantly carousing as painting, until at last all things went so ill with them that flight again was necessary, and both started for Paris. Bramer, however, found the life of the Parisian unlike the beer-drinking of Belgium and Holland, and longed



GATE AT HAARLEM.

to return. But he got no further on his road back than Antwerp, where he arrived, suffering from

of Alva might overawe the men of Antwerp. It was subsequently greatly strengthened by General Carnot.

* Walter Mapes flourished in the twelfth century as Archdeacon of Oxford. This thirsty churchman thus expressed himself in the first stanza of his celebrated convivial song, with a strength above our translation:—

"Mih est propositum in taberna mori,
Vinum sit appositum mortis oris,
Ut decant, cum venerit angelorum chori,
Deus sit propitius huic potatori."

disense, exhaustion, and neglect. As a pauper he was received in the old public hospital of the city, and there died wretchedly, in the year 1660.* His body, wrapped in the straw pallet upon which he died, was inhumed in the burial-ground devoted to the plague-stricken; but his old friend Rubens,

* The public hospital of Antwerp is appropriately named after St. Julian, that saint being the patron of travellers. It is still a large and useful establishment, but preserves no traces of its antique features except the old Gothic doorway engraved on the following page.

hearing of this, and much moved at the untimely end of so true a genius and so great an artist, had him re-buried at his own cost, with all honour, in one of the principal churches of the city, and determined to erect a monument to his memory. He perfected his design, but was himself numbered among the dead ere he could have it executed.

In Gerard Dow we find the quietude of an Ostade. Throughout a long life he resided at Leyden, and devoted his whole thought to his Art. Pains-taking in a most extraordinary degree, he laboured unremittingly on his pictures; and Sandrart, in recording a visit he paid him in company with Baudouin, narrates that Dow declared he should bestow three days more in finishing a broom in one corner of the picture, which had already attracted the attention of both by its laborious manipulation. In all his works he indulged the same love of minute finish; and he was as careful of the colours he used, grinding them himself, and treading his studio on tiptoe, lest he should raise dust on his palette to injure their brilliancy. The richness and purity of his colouring is still unrivalled; and though with some painters such extreme love of minute finish might sink their works to tawiness, those of Dow have a vigour and an expression never excelled by any artist of his age. His pictures of Dutch life are perfect. The "Village School," in the Museum of Amsterdam, is often quoted for its peculiar power, and the difficulty the artist created for himself only to conquer it. It represents a large room filled with figures, and lighted by four candelas at different parts of the composition. But a finer, if not the finest work by Dow, is the picture in the Louvre, known as "La Femme Hydropique," which displays his wonderful colour, drawing, composition, and knowledge of effect, in the most satisfactory manner.

In Gerard Dow's works we view the superior life of the Dutch. He has no love for the delineation of vulgar or coarse scenes, such as delighted too many of his competers, and gave too much weight to critical objections to their works in general. Refined minds, used to the purities and high resolves of the Italian schools, received a repulsive shock from the scenes of Brauwer and Jan Steen, and could scarcely tolerate the simple truth of Teniers, or the grand imaginings of Rubens, accompanied by the coarseness which seemed almost inseparable from the governing ideas of these masters. Ostade, on the contrary, elevates all he touches; his youthful figures breathe health and win affection; his men and women are not the tanned and wrinkled creatures repulsive to eye and mind; but rather lovable from the deeply-traced furrows with which sixty winters of genial thought have seamed their faces—"frostily" the end of their life scarcely seems, it is so "kindly" wistful; and if we would pleasantly dream over the old time in Holland, and live in imagination among the people of the seventeenth century, we must go to the works of Ostade and Dow.

It is by studying the paintings of Jan Steen we become most intimately acquainted with the everyday life of the Dutch. Like our own Hogarth, he had the keenest sense of humour; and, like him, he has been too frequently stigmatised as a slovenly painter, or as a caricaturist. Both artists handled their pencils freely enough, but they only did as much by one touch as less impassible minds could do by a dozen; while their equally powerful perception of humorous character led them to fix its broadest features on their canvas. Careful execution, free conception, vivid and powerful colour, and vigorous chiaro-oscuro, are declared by Dr. Waagen to be found in the works of Jan Steen. Dr. Kugler says, "They imply a clear and cheerful view of common life, treated with a careless humour, and accompanied by great force and variety of individual expression, such as evinces the sharpest observation. He is almost the only artist of the Netherlands who has thus, with true genius, brought into full play all those elements of comedy. His technical execution suits his design; it is carefully finished, and, notwithstanding the closest attention to minute details, is as firm and correct as it is free and light." In the landscape backgrounds of some of his pictures—such as "The Game of Skittles," in Lord Ashburner's gallery—we find qualities which the greatest English landscape-painter, the late J. M. W. Turner, declared "worthy of Cuyper." Some of his scenes of better-class life—such as that known as "The Parrot," in the gallery at Amsterdam—are full of

grace and careful manipulation. It is, however, chiefly by such pictures as his "Feast of St. Nicholas," in the same collection, that he is best known; here his humour and expression are so great, that a French critic says you seem to know the thoughts of each person in the picture. In Mr. Baring's gallery there is a marvellous instance of his power—an old woman looking up with a grotesque earnestness into a doctor's face, who has come to attend her daughter. The life-like energy and vivid expression of fleeting



GATE OF ST. JULIAN'S HOSPITAL, ANTWERP.

humour in each feature are perfectly wonderful. It is at once simply and boldly painted, as if the expression had been caught by the daguerreotype.

As reckless as Brauwer, Steen lived a happier life: he was idle, gay, and thoughtless, but not vicious. Always poor, and careless of money when he had it, he rattled through life, taking its rough lessons with perfect good humour, and never caring for the morrow. He was born at Leyden, in 1636, and died there in 1689. He married early, and had



LEYDEN.

mix up agreeable knowledge with his farcical jovialities; and the orgies of Jan's tavern proved so fascinating, that it is recorded Mieris was nearly drowned one night in a dyke as he returned home in one of what Burns calls "The wee short hours ayont the twal," rather the worse for liquor. The painter was fished out by a cobbler, who, astonished at his velvet dress and gold buttons, was still more surprised to find the saved man only a poor painter; but most astonished of all when the artist, in his gratitude,

several children. His wife, like himself, was careless and equally improvident; she appears to have been quite as neglectful of all household duties and provisions for the future as her husband. If what is affirmed of some of his paintings be true, they represent her in no creditable state of ebriety, and her whole household in confusion. Unluckily they both started in life in a brewery at Delft, which was furnished for them by the artist's father, who was in that trade. The young couple, however, kept their taps constantly running for their own use and that of their friends, until bankruptcy closed the doors, and he took up Art for a fresh living. The life of a tavern-keeper had, however, too great a charm for Jan to relinquish readily, and he came back to Leyden on the death of his father, and opened house as one of that fraternity. Hither soon came all the toppers of the town, and many a careless artist to boot. Among them were Mieris and Lievens, the figure of Peace extending her olive-branch, which Jan painted for his sign, was indicative of the little trouble the painter-publican chose to give his customers. Hence the toppers never troubled themselves to pay, and Jan, faithful to his sign, gave them no uneasiness about it, until again compelled to close his too friendly doors through debt. His careless wife died soon after; and his neglected children frequently became the models for many of his pictures. He contracted a second marriage in a very humble way with a woman who sold sheep's beads and feet in the butchers' market; and he painted, and drank, and took the world easy until his death, when he left his wife with nine children, one of whom took to sculpture as a profession.

In spite of his culpable carelessness, and love of slatternly ease and tap-room life, he had superior friends. The gentlemanly Karel da Moor painted his humble second wife's portrait to gratify them both; Gabriel Metz, the quiet and elegant delineator of Dutch aristocratic life, was also his friend, and sat with his wife to Jan for their portraits; and Mieris, we have already noted, was his boon-companion. The elegance of the pictures by this latter artist, who always chose the higher life of Holland, like his fellow-artist, Metz, for the subjects of his pencil, and delineated such scenes so admirably, would scarcely have led to the conclusion that he could have found pleasure in Jan's tavern at Leyden. But the fact is that Jan was a sound artist, and could

made him a present of one of his pictures, for which he obtained 800 florins.

It is in the works of Jan Steen that we more particularly see the ordinary life of the Dutch people depicted. Their manners and customs may be there truly studied. "The Feast of St. Nicholas," in the museum at Amsterdam, and "The Marriage," in the collection of Mr. Baring, illustrate our meaning.

[To be continued.]

SUGGESTIONS OF SUBJECT
TO THE STUDENT IN ART.*

BY AN OLD TRAVELLER.

CHAPTER VI.

Helen the Beautiful—Sacrifice to Diana Artemis—The Bride of Sparta—A Place of Peril—Otho the Sanguinary—Otho the Wonder—Pope John XVI.—Crescentius—Thy Sin shall follow thee!—The City of the Roman—Conrad of Franconia—The Soldier's boot—A Picture from the *Times*—The Sheik-ah-Islam—The Patriarch—The Armenian—The Rabbi—The Cranes of Ibycus—Might of the Emanciples—A Legend of the Bruce—St. Filian the Hermit—The Luminous Hand—The King's Vision—A Frenchman to be painted—Lea Hurst—England's Angel of Mercy—The Wide-World's Florence Nightingale—English Cathedrals—Ancient Oratory of St. Martin—King Ethelbert the Christian, and Bertha the Queen—Travelling, Past and Present—The Fackhorse—Pussant Girls of England—The Gay and Roving Carriers—The Flying Coach.

Of Helen the beautiful, as her bright eyes beamed over the world when the best of their light had departed, and after her downfall had deprived their gaze of its firm self-assurance, we have representations in abundance; but not so of that better period, the fair morning of her life, when as yet there had arisen no cloud to dim the radiance of her beauty—when the faultless features had contracted no expression that could mar the effect of their pure outline, their delicate texture, their soft and chastened coloring; while the perfections of her form retained all that nameless grace of motion which results from merited self-approval, and some portion of which must needs be lost with every step towards wrong. No: we have not enough of Helen as she was in that young day; and the sculptor may look to it with advantage, for it is his affair. Let him give her, for example, to our delight and admiration, as she is prepared to lead her young companions, when all are going up to sacrifice in the temple sacred to Diana Artemis. She lifts the wreath of triumph, and a moment later shall see it placed on her unsullied brow; but as yet we have the faultless contour unbroken: wherefore take now thy chisels, Sculptor—wait not till those candid brows be shadowed, though it be by congenial blossoms; let the chaplet still remain half suspended, and give us the glad sweet face of the peerless princess as she stands *now*—blameless.

For the painter there is also place—but his moment is not the same, and the subject he shall take is of different character: he will find it in certain stanzas from the *Lyrics of Stersichornis*, which do precisely the thing we have been talking of—they take the artist back, *ad libitum*, to the blissful period when he may most frankly delight in the study which that all-beautiful Helen presents. The words are these:—

Roll'd the refulgent car along,
Bearing the fair bride of the Spartan king,
Who, in her radiant beauty, like a star
Or earth-born Venus, shone afar.
And see! with dance and choral song
Myriads dark-hair'd daughters bring
Their choicest gifts, and golden quinces throw
In her elastic lap—and boughs of myrtle bloom,
Odorous and white as snow—
And roses, on Eucrates' banks that blow—
And violet flowers, the earliest of the spring,
To break the winter's gloom.

"Beautiful Helen! in thy queenly pride
To thee we bow, great Menelaus' bride,
With downcast eyes and bended knees;
Sweets to the sweet—we offer these to thee." †

The painter will be at no loss for beauty of site fittingly to exhibit the lovely train called before him by the words of the poet. Softly undulating, the sun-lighted landscape lies fair beneath the rich deep blue of the Grecian heaven; cypress, vine, and olive, lend the variety of their tints; on a gentle acclivity there gleams the pure white marble of a delicate Ionian fane; and, glittering afar, is the calm unruddled surface of a boldly-curving bay, heaving slightly, but only as with the peaceful breath of a joy-fringed life; white sails, as were they sea-birds, may be discerned on the waters, but all are in the remote distance—they do not mar the Elysian tran-

quility of the hour by any thought of sinister arrivals—those barks pursue their unheeded way, and no evil that may loom in the future is now apparent.

To him who ascends a throne in his boyhood, a great and splendid destiny may seem to be appointed, but it by no means follows that his lot is a desirable one; on the contrary, a more than common amount of evil and suffering is but too frequently the result of his position—the rule of his life. Examples of this unhappy truth crowd on the memory. The life of Otho III., Emperor of Germany, who assumed the perilous seat in question when but twelve years old, is among the most prominent—as may with almost equal truth he said of that of his father, Otho the Sanguinary, into whose hands were given the reins of sovereignty before he had well numbered eighteen springs.

Studies from the life of the first-named emperor, Otho III., namely, were made some years since, at the instance of the present writer, by a young Bavarian artist then painting in the Pinacothek of Munich. They were subsequently much admired by certain amateurs of Art at that time assembled in Venice; but the falling health of their author made it but too obvious that his work on earth must end before it had well begun, and not one of them was ever completed.

One of these sketches represents the unfortunate pontiff, John XVI.,—elevated to the chair of St. Peter, as most of you will remember, principally by the influence of the Consul Crescentius,—at that moment, when, made prisoner by Otho, he is brought forth to die the cruel death inflicted on him by command of the infuriated monarch. The scene of our picture is the summit of the Castle of St. Angelo: Rome, in all the pomp of her regal beauty, lies immediately at our feet; the seven hills are before us; and beyond lies the wide-spreading Campagna: but our interest is all centred on the melancholy group gathered within that narrow space which constitutes the topmost level of the fortress.

Otho has caused the eyes of the pontiff to be put out, and has otherwise cruelly mutilated his face; but the artist judiciously withholds the more revolting details, and we do but see that the prisoner, thus helpless in the hands of his executioner, is on the brink of doom: another moment, and those ruffianly figures, two of whom are already leading the blind captive forward, will close around him; they are preparing to cast him from the battlements to the court below, and a few fleeting moments only have to pass before they shall have accomplished the cruel mandate of their lord.

The second study gives us the Consul himself, at the moment when his head is about to be laid on the block: he, too, has been condemned, as you will also remember, by Otho; and for that same revolt wherein his influence had prevailed, to the expulsion of Gregory V., then pontiff, and to the substitution of the unhappy John.

The principal merit of these sketches is the correctness of drawing exhibited in the figures of the executioners, which, in both instances, give proof of more anatomical knowledge than is usually attained in the first youth of the student.

A third cartoon of the same series represents Otho himself. He is reclining on the purple couch of sovereignty, in a magnificent apartment of his palace. Impeachable in his resentments, and otherwise tainted with the vices of his age, Otho was nevertheless brave and resolute, just and generous. The man here taking a short repose from the toils of a laborious life is of noble presence, and a not unpleasing aspect: the flower of his youth has scarcely departed, for the summers he has seen do but number twenty-nine; yet are the marks of care and suffering become apparent on his brow, and you would give him some ten years more, if you judged of his age by his expression. He is extending his right hand towards a woman of singular beauty and richly attired, who is in the act of presenting him with a pair of gloves: one of these he has already drawn on, and his hand is extended, as we have said, to receive the other.

And she who presents it to him?—She does so without hesitation; yet is there in her eyes a strange rigidity of gaze, and in her whole aspect a character all unsuited as it should seem to the features of one who is performing a service of affection, and might

be expected to exhibit some pleasure in her office; whereas this woman's hard compressed lips betoken the stern resolution of one determined on some desperate act, rather than the soft sweet loving glance of her who, bringing a fair gift, is gratified by the gratification she is giving.

But this is the widow of Crescentius, and the gift she offers is the death of the recipient; hence those hard eyes, fixed observingly on the face of her unconscious victim, and hence the resolved sternness of the lips.

Otho, affecting to lay the crown of Germany at her feet, has reduced the proud wife of Crescentius to the condition of his paragon; but he has refused to fulfil his promise of espousal, and the Roman is avenging her wrongs by a murder. Those gloves are poisoned, and Otho dies by the gift.

In his mode of treating the third of these subjects, our artist made a slight deviation from the truth of history, which does indeed affirm the death of Otho by means of poisoned gloves, and that these were sent him by the widow of Crescentius for the cause assigned, is also a well-authenticated fact: but nowhere did it asserted that the gloves were presented by her own hand, nor is it, indeed, probable that this was the case. The dramatic interest of the picture is, without doubt, greatly enhanced by the mode of treatment adopted, but of this part of the subject it is not now "our host to speak."

Another study, and from a period of German history immediately subsequent to that just treated, but not by the same painter, has been taken from the reign of Conrad II., Duke of Franconia, who succeeded Henry II., the immediate successor of our previous acquaintance, Otho III. This represents the somewhat singular spectacle of an event which certainly did take place, and, being true, we may suffer it to come in, by way of relief to the painful effect produced by the stories preceding.

Conrad of Franconia was remarkable for the generosity of his disposition—not in the narrow sense of mere liberality, and the free hand of giving only, but in the wider acceptance also: the story alluded to is related among other instances. A gentleman whose possessions were not equal to his birth and bravery, had lost a leg in the imperial service, while performing prodigies of valour in the effort to save a standard, which he brought off at the hazard of his life. Conrad, informed of the circumstances, and hearing also that the noble was poor, sent to bid him to an audience; and it is this meeting of the emperor with his mutilated subject that the painter has represented. The high officers of his court surround the monarch, and one of the most dignified of their number holds in his hands a riding-hood, filled to overflowing with gold coins of the empire. This has been presented to the successful soldier of the standard, and the dignitary is now resigning it to the care of an old servant of the mutilated man, whose look of pride and old affection is so earnestly fixed on his master, that he scarcely seems to bestow a thought on the value of the deposit: with him,—a fine old warlike figure himself,—as with the soldier of Napoleon, "Honour is all." The story proceeds to say that Conrad, declaring his resolve to confer a liberal pension for life on the former possessor of the hood, thenceforth useless, demands the gift of his second son in return—assuring his gratified subject that the child shall henceforth be reared in the palace, and in due time be ennobled among his pages. This, too, the painter depicts. The boy, a remarkably beautiful one, is approaching from the outer hall; he is led forward by his tutor, a pale and grave-looking ecclesiastic, whose placid but highly intellectual countenance comes in strong contrast with the bright, glad, youthful aspect of the child, while his sombre robes stand in equal distinction with the gorgeous habits of the figures more immediately around the throne.

The *Times* is a great magician. This truth is so deeply felt, so universally admitted, that many voices will at once arise to say, "We knew all that before." But the *Times* is also a great painter; and if there be any yet ignorant of the fact, let him read what follows, and his education shall in so far be amended.

"The reading of the imperial firman, granting equal rights to all the subjects of the sultan, was fixed for Monday last. * * * * *

"The apartment destined for the ceremony was

* Continued from p. 154.

† These lines, a fragment only, are given by Mr. Jesse, as the translation of his friend, the Rev. J. Milford. They will be found in a much-adorned work of the first-named writer, namely, the "Favourite Haunts and Rural Studies," pp. 307, 308.

the great council-hall, spacious enough in itself, but by no means sufficient to contain the numbers of people who wished to be present at this important act.

* Beside the ministers surrounding the Keimekan of the Grand Vizier, Mohammed Kibrisi Paslia, there were present all the members of the Council of State and the Tanzimat, with all the other high functionaries of the Porte. The Sheik-ul-Islam,* the patriarchs, the archbishops and bishops of the different religious communities, with a good number of the most prominent men among the Mussulman and non-Mussulman population of Constantinople, likewise took part.

"This assembly, composed of the most distinguished men in Turkey, would have formed an interesting study for a physiognomist; nor would it have been found inferior to any similar assembly as regards intellectual countenances. The most prominent feature was earnestness. Notwithstanding the contact with Europe, and the history of so many deposed and assassinated sovereigns, the person of the latter is still held in religious veneration. Even the rather turbidly disposed crowd outside became silent when the firman, signed by the sultan's own hand, was taken out. Everybody seemed to be penetrated with the solemnity of the moment.

"The firman was read by Ihsat Effendi, the *Mektûbi*, or Chief of the Chancery of the Grand Vizier. When the reading was over, the Sheik-ul-Islam, Arif Effendi, read a prayer appropriate to the occasion; after which the grand vizier made an address to those present, in which he touched upon the most prominent points contained in the firman.

"When the ceremony was over, printed copies of the firman, in the original Turkish, were distributed among the crowd. Translations into all the languages of the empire are in course of preparation, and when these are completed they will be distributed through the various provinces." * * *

So far the mere statement of the facts by an eyewitness; but how significant are these facts! In another part of the paper are the remarks that follow; and if the simple declaration that so grand an event has been accomplished has not inspired you at once to commence the transmission of its details to the never-dying canvas, here are certain words that cannot fail to make your heart glow, and wake up your imagination, or the one is colder and the other more torpid than belis that glorious name of Painter which you bear.

Dear friend *Times*, *toigüter*:—"If the will of an Eastern potentate be indeed supreme, and like the centurion of old, he has only to say 'Do this,' and it is done, then may we consider that the greatest revolution of any age has just been accomplished beneath our eyes. A firman of the sultan, establishing absolute equality between all his subjects, has been read before the assembled dignitaries of his empire. That empire is the dominion of Constantinople and of the Caliphs in one. From the frontiers of Austria to the shores of the Persian Gulf; in Belgrade and Adrianople; in Constantinople, Jerusalem, Alexandria, and Tunis; in the holy cities of Arabia, at the birth-place, and at the grave of the Prophet, the imperial edict, translated into many tongues, will be read and pondered. Those who listened to its ordinances a fortnight since at the Porte, were the representatives of the East in its widest sense. The grand vizier of the Ottoman sultans and the Sheik-ul-Islam, clad in the green robes of his office, impersonated that conquering and ruling faith, which, even to the days of our own William III., threatened Europe and Christianity. The patriarch of Constantinople, still the successor of Chrysostom, and the head of the earthly Church to 80,000,000 of men, stood surrounded by bishops, whose sees were famous cities when France was a Roman province, and England a wilderness of scattered Celtic tribes. The metaphysical disputes of a forgotten theology were represented by the patriarch of the Armenian Church, the chief of a nation isolated in features and language from any that now lives on earth. Last of all, there was the chief Rabbi of the Jews, who came to receive for his oppressed race the promised equality in their own holy land, from the lips of a Mussulman sultan.

* Few will now require to be told that the Sheik-ul-Islam is "Chief of the Faith." He is head of the law no less than of the priesthood, and is a dignitary of the highest distinction.

Whatever be its results, the event which has just taken place must always remain one of the most interesting in the history of mankind."

It must, beyond all doubt—must and will. Think, then, if it be not well your part to prepare for the visible presentation thereof in the highest place of our noblest gallery. I say "prepare," because I know well that worthily to depict this great event will require all the energies of an earnest mind, powerful to comprehend the great and good, with all the devotion of a pure warm heart—loving that good cordially when and wheresoever it may be found, and desiring fervently that its beneficent influence may prevail. To these must be added a keen perception, quick to comprehend all the strongest points in every case and question, that no portion of the interest may be suffered to escape; an imagination capable of enhancing the force even of the most salient features, yet chastened by a delicacy recoiling sensitively from the baneful vulgarity of exaggeration; and, joined to the rest, must be that excellent servant, the cool judgment, guiding a firm well-practised hand, ever ready to obey the dictates of the master-spirit within.

All these, and much besides, are demanded by the great and lasting work before you—but then you have them all; or if you do not fully possess them at the present moment, they are increasing to you with each advancing day—you are in culture for such a condition of being, you labour earnestly to secure it, you look with reverence to the older aspirants who have attained to these qualities before you, and with sympathy towards the comrade who is treading the upward path at your side? Surely yes! but if not, if you do not feel conscious to any one of these qualities, feelings, or aspirations, begone! it is not for you that a task so exalted has been reserved; and what still remains to be added, from the words of our good friend, is for such as shall better deserve to hear it.

For these, then, is written that which follows, and which is taken in like manner from the *Times*:—"

"Historians have discussed the causes of the French revolution, and have attempted to find its origin far back in the annals of the country. They could not conceive that a single age could produce by itself so marvellous a change. But what demolition and reconstruction of society will have been so complete as this great Eastern revolution, which, beginning some twenty years since, has lately hurried onward so rapidly, and seems destined still to pursue its portentous course? To practical minds, the domestic events of our own community may have a greater importance, but they must be few who can look on what is passing in those ancient lands, the cradle of the human race, the home even now of venerable nations, without a strange and peculiar interest. That religious freedom should have been proclaimed for the first time to the followers of churches persecuted both by emperors and sultans—that material progress should be in store for regions almost forgotten by the busy enterprise of the West, are facts which must call for the attention of all, even amidst the most earnest discussion of our own affairs. It is like a vision of dry bones—dry bones called to life on the disinterment of a city hidden for ages."

There, then, is your picture. We have said that the artist who shall paint it will perform a great work, and he will do so; but is it a difficult one? To him who is fit for it, certainly *not*. Let him read again, and he will see that the picture is already painted to his hand; he has but to copy—that great brother of the brush, whose words we have just given, has indeed left him little else to do. Being, then, what he is, our painter will let none of that "earnestness" which, we are so significantly told, was the most striking characteristic of those assembled, escape him; but, going to his work with the consciousness of its high significance exalting and ennobling his conceptions, and with all his powers devoted to the worthy expression of its import, he will set before us the glorious event of that fortunate Moudai in such sort as to make the representation, no less than the thing itself, an abounding "joy for ever."

Inexhaustible are the riches of Germany's beloved and justly boasted Schiller. No man takes from their abundance but to his profit: be your purpose

* See March 1st, 1856.

what it may, never—provided only that purpose be good—can you turn to his pages without benefit. For the artist, more especially, there are pictures of the highest import and most entrancing beauty; they rise at every instant to his delighted gaze. Nor is this all, or even the most important and valuable portion of the advantage to be obtained by the study of that divine writer: the least impressionable finds himself influenced by the purity of his spirit, and the warpath of his feeling; the most obstinate must needs yield to the force of his reasoning, the most refractory cannot refuse to be moved by the gentle compulsion of that heart-inspired and heart-appealing eloquence, which in his jugos constantly enforces lessons ever tending to the right and good.

To cite two short poems only, the "Words of Belief," and the "Words of Error,"† where else will you find truth so full and glorious in words so few, yet so effective? Read but these only, and be sure that if they should chance to be the first of your acquaintance with their immortal author, they will by no means be the last of your study in his works.

Leaving these, nevertheless, for the present, let us turn to "The Cranes of Ibycus;"‡ and if you reproduce on your canvas the effective picture given in the stanzas, you will perform a work that can scarcely fail to satisfy even yourself. The story may be told very briefly to such as yet remain unacquainted with its details.

Murdered in the groves of Neptune, while on his way to take part in the games of Corinth, Ibycus, the beloved of Apollo, invokes a flight of Cranes, which aloof are witness of the deed, to avenge his fate. His mangled remains are found by the grieving Corinthians, who decree vengeance on his destroyers.

All are assembled in the theatre—the chorus enters, and here commences your portion of the work. You have the open theatre with its crowding masses, before whom the chorus:—

"Streng und ernst, nach alter Sitte,
Mit langsam abgemessnem Schritte,
Hervortritt aus dem Hintergrund,
Aufwendend des Theaters Raum:
So schreiten keine erlöseten Welter;
Die zugepöte kein sterblich Haas;
Es steigt das Riesensmiesz des Leiber,
Hoch über menschliches hinaus.
Ein schwarzer Mantel schließt die Leender;
Sie schwingen in entsetzten Händen,
Der Fackel die-terrore Licht;
In ihren Wangen flusst kein Blut;
Und wo die Haare leblich flattern,
Um Menschenströmen freundlich wahn;
Da sieht man Schlangen hier und Nattern,
Die giftigselwölmen Baliche lähn."

Thus faithfully and efficiently translated by Sir Edward Bulwer Lytton:—

"True to the awful rites of old,
In long and measured strides, behold
The chorus from the hidden ground,
Thee the vast circle's solemn round,
So this world's women never stray,
Their race from mortals ne'er began—
Gigantic, from their grim abode,
They tower above the sons of man!
"Across their loins their dark robe cling,
In fleshless bands the torches swing,
Now to and fro with dark red glow,
No blood that lives the red cheeks know!
Where flow the locks that woo to love
On human tresses, gladly die!
The serpents, cold the brow above,
And the green asp with prison swell."‡

Pacing around the circle as here described, the awful "Daughters of Night," having announced their avenging power in a hymn of great solemnity, for which I have not space, are disappearing in the background, when across the open space of the roof comes sudden darkness, proceeding from the flock of

"The slow cranes, hoarse murmuring,"

that just then pass over. A voice is instantly heard to proceed from the countless masses:—

"Behold! behold, Timotheus!
See there—the cranes of Ibycus!"

are the fateful words it utters, and the crime of the speaker stands revealed. In vain would the murderer retract his words; his white and quivering lips complete the confession he would so fain recall. The

* "Would you touch the hearts of others,
First your own must feel the glow."

† "Die Worte des Glaubens." "Die Worte des Wahns."
‡ "Die Krane des Ibykus."
§ "The Poems of Friedrich von Schiller." Translated by Sir Edward Bulwer Lytton.

audience, well prepared for the awakening of his conscience by the hymn of the chorus, rise—an imposing mass—declaring as one man—

"The truth we seize!
Thy might is here, Eumenides!

"The murderer yields himself, contest:
Vengeance is near, that voice the token.
"Hail him who yonder spoke arrest,
And him to whom the words were spoken!"*

This is done, and "the dark unvisited crime," to borrow from the same translator, is "struck by the lightning that revealed." Your moment for this work you will have no difficulty in choosing, and may cause it to serve, as does the whole poem, remarks Sir Edward, to illustrate furthermore those lines where Schiller declares in his "Artists"—

"Secret Murder, pale and shuddering, sees
Sweep o'er the stage the stern Eumenides;
Owens, where law falls, what powers to Art belong,
And, screamed from justice, finds its doom in song."†

"There is a curious piece of traditional superstition connected with Bruce and Bannockburn," says Alexander Fraser Tytler, in a note to his Lives of Scottish Worthies; "but this, as it was not to be found in Fordum or Winton, I have omitted from the text."

"Perhaps I have done wrong," he adds, "since the circumstance is characteristic of the times." And he would have "done wrong" without doubt, the excellent writer, had he persisted in his exclusion of the story; but he has happily repeated him of the evil in good time, and for your comfort and mine, O painters, has inserted the legend in that chapter of Antiquarian Illustrations which he has appended to his work. There the reader who may desire to read more will find it: the words, so far as they seem to be required for our purpose, are these:—

"Our story relates to an alleged miracle regarding the luminous arm of St. Fillan, who has given his name to many chapels and holy fountains in various parts of Scotland. Canonicus tells us that he was Abbot of Pittenweem, but afterwards retired to the wild and romantic district of Glenorchay, where he died a hermit in the year 649. The legend asserts that when engaged in transcribing the Scriptures, he was compelled to desist from his labours for lack of light; but while grieving over this circumstance, he suddenly found that his left hand and arm emitted a supernatural effulgence, by which, without either torch or candle, he was enabled to proceed at midnight as at mid-day.

"This luminous arm was ever after preserved as a relic; and Bruce, who neglected nothing that might give confidence to his soldiers—nay, whose own mind was probably not insensible to the influence of the legend—carried it with him, enclosed in its silver shrine, to Bannockburn.

"But the king's chaplain, fearing lest that precious relic might fall into the hands of the English, or be otherwise lost, abstracted it secretly from the tent of the king, wherein he left nothing appertaining to the saint, save only his silver shrine.

"On the night preceding the battle, Robert, whose mind was filled with anxiety, could not compose himself to sleep, but passed the hours in earnest supplication to the saint, whose arm he believed to be slung up within the reliquary. Suddenly, and after long prostration of mind and body, a more than ordinary light appeared to fill the tent, and looking up, the Bruce perceived an arm extended above his head, and in the act of withdrawing itself from the shrine, the door of which stood open. Starting to his feet, in the belief that some bold robber was attacking the sacred deposit, he beheld the refrigent arm reposing within its jewelled receptacle, the doors whereof were even then closing slowly, of their own movement, as the astonished king gazed on them in awe and wonder. Turning then to examine if any man were concealed in the tent, the Bruce beheld a majestic form in the entrance of the pavilion. This appearance was in the act of departing, yet Robert recognised St. Fillan by the portrait of that holy archbishop, suspended over the altar of his oratory. Being strictly questioned, the chaplain subsequently confessed what he had done, when Bruce could no longer doubt that the saint had restored his arm to the shrine as an assurance of victory; the result of the battle, decisive as it was, the complete

triumph of the Scots, and the flight of Edward to Dunbar, could not fail to confirm his conviction."

To the Scottish artist, more especially, this tradition of the Bruce can scarcely fail to offer an attractive subject for his pencil, although we do not remember to have seen it chosen by any one of them; yet there may be more than one who has done so—seeing that the works of Tytler are deservedly popular, and are in the hands of all who read.

We are not so good, we dear people of this excellent world, but that some day or other we may find it possible to make ourselves better; and one means to that desirable result is assuredly in the hands of the painters. Let them but set before our eyes the living presentment of such things as any one among us may do towards "being good," as nurses say to the children, and the glow that one cannot but feel at heart when some great and noble action stands confessed and clear before us, may do something towards helping forward the result whereto we have just hinted. Nay, there does not always need even so much to wake up the ready sympathies of our better nature; and here, in few words, is a proof that he who does but obey an impulse, provided it be a pure and upright one, will, in so far, serve as "the electric chain wherewith" the hearts of others may, for the moment, at least, be aroused to the love and appreciation of the good and right.

In the early part of the year 1760, Commodore Thurot, an officer in the service of France, then at war with England, threw himself on the coast of Ireland, entered Carrickfergus by surprise, and for some short time was master of the town. While the French troops and those of the small garrison were then fighting in the streets, a little Irish child, unconscious of its danger, ran between the parties just as each, having drawn off for a moment to reload and prepare, had commenced the renewal of the carnage. Perceiving the presence of the infant, and moved to compassion by its innocence, a French grenadier cast down his musket, rushed into the midst of the fire, caught the child in his arms, sprang with his charge towards the shrieking mother, who, discovering her loss, was hastening to seek the boy, and having placed him within the porch of a neighbouring house, whence the terrified woman could take him without peril to either, he hurried back to his place amidst the loud shouts of all who, on either side, beheld his humane action.

Many a deed of admirable humanity, as well as heroic bravery, you will doubtless find recorded in the annals of the late war: paint them all then, for we can scarcely have too many such; but do not refuse to let this also stand beside them—there will be room for the whole, whether on the walls of our galleries or in our hearts, do not doubt it.

Again, if in some dark day we should any of us feel more than commonly disposed to evil, here is a prescription that, if we be not wholly incorrigible, may go far to cure us of the malady. It is a pilgrimage to Lea Hurst—the home in youth, if not the birth-place, of one whose name can never henceforth be uttered in any land, but that a throb of pride, as well as a warm feeling of respect and affection, must rise spontaneously in the heart of every Englishman who shall hear the sound. Nay, we have no longer the sole property in that revered name; the virtues of her who hears it have made her an object of love and reverence to men of all nations—all claim part in her as in one who has exalted humanity—dwellers in every land are uniting to do her honour; and if those so late our enemies still look doubtfully on the mass of our country-people, they make an exception in her favour. Even the Muscovite raises his ruff cap from his brows, as he would before the Panagia,* when he hears that sweet and heart-warming music, the name of FLORENCE NIGHTINGALE;† that angel of mercy, for the sight of whose very shadow the sick man kept hourly vigil, and at whose approach he who lay deprived of half his members, strove to lift his mutilated form that he might look upon her.

The domain of Emblay House, in the varied and beautiful county of Hants, may likewise claim some interest in this admirable lady; and far be it from us to neglect the justly prized rights of any, in a possession so deservedly valued; but it is with Lea

Hurst, in Derbyshire, that we have now to do, and if the landscape-painter should "go in search of beauty," he too, no less than the worshipper of the morally beautiful, may find all that even his fancy can set before him in the delightful region wherein the mansion and domain are situated.

The building is of the Elizabethan style; its stone mullioned windows opening beneath many gables, and the substantial clusters of chimney-stacks rising from its roofs, giving promise of abundant hospitality; the pleasant gardens and shrubberies are enclosed within a wide-extending park, whence delightful views of the country richly diversified with hill and valley, wood and stream, gorgeously tinted rocks and emerald fields, present themselves at all points. "The Dmid-crowned Riber," with the bold hills around and beyond Matlock, are perhaps among the most prominent. Scarthin Nick and the heights beyond Cromford are also to be seen from the park. It is, indeed, a place not unlikely to have assisted in the development of a pure and holy creature; for what is there so elevating, morally or intellectually, as the perpetual contemplation of great natural beauty? what so well calculated to foster the nobler impulses, to awaken the more generous sympathies, to produce, at a word, that large-hearted beneficence which has given to the subject of our present remarks that first place among women certainly now occupied by Miss Nightingale, as a constant abode in the visible presence of Him who has made us all? and this privilege is without doubt secured to the fortunate possessor of a home placed and formed as is Lea Hurst.

We do not repeat any one of the many anecdotes now current in society, and become "familiar in the mouths" of all, that might be adduced in exemplification of the remarks here made; your memory will supply you with such most amply, to say nothing of the many that cannot fail to be added to your store, whether your choice be the "faire manor-house in Hampshire," or the beautiful Lea Hurst.

Much has been said, much written, and perhaps some little painted—although scarcely so much as might be desired—of our beautiful cathedral churches; nor has the noble metropole of Canterbury failed to obtain its share of notice. But within a mile of that structure is one which has scarcely been "marked of the painter," although few better merit his attention. The fame to which we allude is the more lowly Church of St. Martin; and there are those who maintain that this is the very building described by the venerable Bede, when he relates the fact that "in a church dedicated to the honour of St. Martin, and built while the Romans were still in our island, did Bertha, the queen, resort to hear mass and pray, until Ethelbert her husband, being converted to the faith of Christ, endowed his teachers with a settled place in this metropolis of Canterbury, bestowing on them at the same time all needful muniments, and permitting them to preach freely, wheresoever it might seem good to them."

Many proofs of its high antiquity will be found in the Church of St. Martin, by the artist who may desire to present us with a memorial of our first Christian king, for the baptism of Ethelbert is believed to have been received from its font, without doubt one of the first made in England. Other circumstances of interest attach themselves to the church: it was here that St. Augustine uttered his earliest exhortations to the people of Canterbury; here that the excellent Queen Bertha had her oratory; and here that they still reverently exhibit her tomb. To him whose heart and mind are attuned to the subject, not one of these will be without significance; and if, since the interior, although perfect in its exquisite restoration of an ancient oratory, is a restoration, he should feel chilled by the evidences of that fact presented within, let him betake himself to the pleasant churchyard without the building; the proud towers and aspiring pinnacles of the vast cathedral, though visible from that gentle eminence, need not too forcibly distract his attention from the primitive St. Martin, with its low square tower darkly mantled in luxuriant ivy; revered yew-trees offer him their shade of ages, the purple glow of sunset shall enrich the landscape to his utmost desire, or the silvery morning sunlight, newly beaming from the dawn, shall come stealing softly over the rich green sward, where it slopes gracefully

* Sir Edward Bulwer Lytton, *ut supra*.
† Sir E. B. Lytton's Translation.

* The Panagia is the Virgin of the Greek Church.

to the plain beneath. Should he then need further inspiration for that scene of past days,—which he cannot but meditate reproducing for us, as he makes all the beautiful picture his own, while reclining beneath those majestic witnesses of an older age, the century-crowded trees that bend their broad arms over him,—let him read what Wordsworth has said concerning the place, and he can scarcely fail to find it:—

"For ever hallowed be this morning fair,
Blest be the moonless shore on which ye tread,
And blest the silver Cross, which ye instead
Of martial banner in procession bear;
The Cross preceding him who floats in air—
The pictured Saviour. By Augustine led,
They come, and onward travel without dread,
Chanting in barbarous ears a tuneful prayer,
Sung for themselves and those whom they would free.
Rich conquest waits them: the tempestuous sea
Of ignorance that ran so rough and high,
And heeded not the voice of clashing swords,
These good men humble by a few bare words,
And calm with fear of God's divinity."

Who that has haunted picture-galleries, whether at home or abroad, but must have remarked the eager interest with which all crowd round the artist having a story to tell—more especially if he tell it adly. This was done to some extent, a few years since, in respect to "Travelling in the Olden Time," by one of our living artists; but there is ample room for another—not to say for many another—labourer in the same field; and if he who may enter on this pleasant avocation, do not find that he has wiled all observers from the "Portrait of a Gentleman," and even "Portrait of a Lady" painters—to say nothing of many another—why then "*je perds mon Latin*," but he will, and never doubt it. For whether he take Stow's "long waggon" of two hundred and seventy years since, then in the fiftieth year of their existence, or thereabouts, or give us the "flying coaches" of a later period, ambitiously aspiring to rush on at the frantic rate of "four miles in the hour," he has but faithfully to delineate "life in travel" as the animalist and wayfarer of the period have described it—boasting its advance, or bemoaning its evils, each according to his humour—and he will produce a picture well worthy to be painted in these present times, were it only as a memorial of what must else be forgotten.

For the string of packhorses, winding gravely their laborious way across vast undulating moorlands, a thick mist falling heavily, and the carriers puzzled to discern the track, there might be a claim put forward; and if a disconsolate passenger were added, doing penance between the two packs of a horse, as he wanders to seek his fortune in that London whose streets were then paved with gold, there would be all the more room for the delineation of character. Or permit the moment to be a more genial one: let the sun be shining cheerily, and the vigorous train sweeping joyously forward through the fair bright uplands on a gladsome morn of May: there be those of our artists who would give us to hear the very chime of their bells as they pass; and who can marvel, though the peasant maids, depicted for us as meeting that train by the way, do linger long to behold its bravery? How lovely are they, those sweet maids of England! but alack the while, how completely deaf to the words of their matronly companion! She is doubtless warning them of dangers that may lurk in such gleams as the bold drivers are bending on their beauty—but they heed her not a jot: alas, and woe is me!

Or say that you care but little for packhorses—then, though differing from you widely, let us beg of you to look at this "coach" of some hundred and eighty years back, as described by various writers of that day. "It wears two boots," says John Taylor, the water-poet; "two boots, but no spurs—nay, sometimes it hath two pairs of legs in each one of these boots; and oftentimes, against nature, most preposterously doth it make fair ladies wear the boot. Moreover, people who ride therein are forced to imitate sea-crawls, and go sideways, as do all men who sit in the boot of a coach."

Mr. Charles Knight tells us that these boots were uncovered seats "projecting from each side of the carriage;" and hearing this, one can scarcely marvel that a writer quoted by him, as travelling in this contrivance, should declare his journey to have been "noways pleasant." "For," says he, "I was forced

to ride sidelong in the boot all the way; and this travel hath so much indisposed me, that I am resolved never to ride up again in the coach." Even the dignity of his companions does not appear to have consoled our traveller, since he announces this resolution after having recorded that "the company that came up" with him were "persons of great quality, as knights and ladies."*

Neither were the roads of those days altogether irreproachable of character; and a second complainant, writing in the latter part of the seventeenth century, asks piteously, in reference to them and to the coaches:—

"Is it for a man's health to exchange the convenient fashion of travelling on horseback, for this weary cumber of sitting behind tired jades, who do not seldom lay him fast in the foul ways, whereby he is forced to wade up to the knees in mire, and then to abide in the cold until horses can be found to pull the coach out? Is it for his health to sit, long shaken in a rotten box, to have his tackle, perch, or axle-tree broken; wait half a day to have it mended, and then journey all the night to make good his stage?"

Perhaps not; but our grumbler may have found consolation in the merry supper eaten nightly at his inn, during the fourteen halts of "a quick passage" between York and London: or if not, the painter who shall desire to preserve for us a lasting memory of those times, may find something germane to the matter, in this singular contrast to our railway doings of the present day, when we all pass prosaically from our English capital to that of Scotland within the narrow limits of some short twelve hours.

PHOTO GALVANOGRAPHY;

OR, ENGRAVING BY LIGHT AND ELECTRICITY.

PHOTO GALVANOGRAPHY is the name of a process invented by Mr. Paul Pretsch, the late manager of the Imperial and Government printing-office at Vienna. The manipulatory details by which the copper plate, with its photographic representation, is produced, have been obligingly shown and explained to us: the results are so very different from anything which has hitherto been produced, they are of such exceeding promise, and the process involves so many interesting particulars, that we have resolved on giving the readers of the *Art Journal* some account of an art which cannot fail to be of importance.

One of the points towards which attention has been constantly directed, since the discovery of the process by which the solar rays were made to delineate external objects upon chemically prepared tablets, has been the invention of some mode by which those impressed tablets could be easily employed to multiply the original image. Several methods have been introduced from time to time—each of them of more or less promise—although up to the present day it does not appear that any have been entirely successful.

We have seen *heliographs*—as the pictures by M. Niepce were called—etched, and some tolerably successful experiments have been made, by electro-chemical and simple chemical action, to bite into the silver surface of the Daguerrotype plate. Mr. Henry Fox Talbot patented a process by which etchings were obtained upon steel plates; but all these differ in many essential particulars from the process of photogalvanography. In order to render our description of this new and important invention complete, it is necessary that we sketch out briefly what has been done in this direction. Niepce's *heliographs*, as they were amongst the earliest photographic efforts, claim our first attention. Bitumen of Judea, in some cases softened by combination with a little of the essential oil of lavender, was spread uniformly over a plate of metal, which was then warmed, so

that the essential oil evaporating, a very smooth surface of resin covered the plate. The object which we desired to copy was placed upon this prepared plate in an ordinary copying frame, and it was exposed to the sunshine, or the sensitive plate was placed in the camera-obscura until the images of external objects were impressed upon it. On account of the slowness with which the change takes place on the resin, several hours exposure in the camera-obscura were required, and hence, from the alteration of the shadows during this prolonged period, the pictures were defective.

By exposing this bitumen, or any resinous surface to the action of the solar rays, it is rendered more or less soluble, according to the character of the agent employed. If, therefore, after exposure, the heliographic plate is subjected to the action of a solvent, one portion will be removed, while the other part will remain untouched. The resulting picture is therefore produced by the contrast between the resinous surface, and the metallic plate, from which the resin has been removed. It will be evident to all that the result thus obtained is, in fact, that of an ordinary etching surface, except that the resin has been removed by the action of the solar rays, and a solvent, instead of the etching needle. If an acid is now poured upon the metal plate, it bites into the metal, and the result is an etching from which prints can be taken. The great defect of those productions was, that the high lights and the deep shadows were alone represented. In the experiments which have been made within the last few years, these defects have not been overcome. Some results obtained upon lithographic stones, through the medium of this process, have been of greater promise. M. Lemaître has done much towards improving the etching process of Niepce; but owing to the imperfections already indicated, it has not yet been successfully applied to any useful end.

The Daguerrotype picture is produced by the deposit of mercurial vapour, which combines with the silver, and the polished surface of the silver surface itself. As the electro-chemical relations of these two metals are dissimilar, it was thought that the Daguerrotype plate could be etched by the agency of the voltaic battery. Dr. Berres, of Vienna, M. Fizeau, in France, and Mr. Grove, in England, succeeded, either by direct chemical action, or by electro-chemical processes, in engraving these plates, and in many examples the details were preserved in a very charming manner. Mr. Claudet was very successful in engraving the Daguerrotype picture by a modification of the process of M. Fizeau. We have now before us some copies printed from those plates, consisting of images of anatomical preparations, of portraits, and representations of statues, which are curious examples of the perfection obtained at a very early period in this art.

The next step in progress was the process patented by Mr. Talbot in 1853. This process consisted in spreading upon a steel plate a solution of isinglass or gelatine, in which had been previously dissolved some bichromate of potash. The plate being dried by warmth sufficient to coagulate the gelatine, the object to be copied is placed upon this tablet in the copying frame, and then exposed to sunshine. A curious change takes place during this exposure; one equivalent of chromic acid is liberated from the potash, and this combining with the gelatine, it is rendered insoluble. After exposure, the plate is placed in water, and all those parts which were protected from the action of the solar rays are dissolved out. The picture is now formed by the yellow brown combination, of the gelatine and chromic acid, and the steel from which the coating has been removed. There is much of interest in this

* See "Victoria Half-hours," vol. i. p. 56.

stage of the process; and the author says, "If the plate is examined in this state, it appears coated with gelatine of a yellowish brown colour, and impressed with a white photographic image, which is often eminently beautiful, owing to the circumstance of its being raised above the level of the plate by the action of the water. Thus, for instance, the image of a piece of black lace looks like a real piece of very delicate white lace of a similar pattern, closely adhering to, but plainly raised above the brown and polished surface of the plate, which serves to display it very beautifully. At other times the white image of an object offers a varying display of light, when examined by the light of a single candle, which indicates a peculiar molecular arrangement in the particles of gelatine. These photographic images are often so beautiful that the operator feels almost reluctant to destroy them by continuing the process for engraving the plate."

The subsequent engraving process is essentially an etching operation. Bichloride of platinum, diluted with water, is poured over the plate, and as the gelatine exists in different degrees of thickness over its surface, the action is first established through the thinner films. The acid bites into the steel, and, by carefully watching the result, a very pleasing engraving on the steel may be obtained, which prints well. Fern leaves, grasses, pieces of lace, and objects of a like description, may be copied in a very pleasing manner by this process of Mr. Talbot. It is but justice to Mr. Mungo Ponton to state that that gentleman, in 1838, first directed attention to the peculiar changes which the bichromate of potash undergoes when it is exposed, in connection with organic matter, to the action of the solar rays. Subsequently, the writer of the present paper, in 1843, used this salt, combined with the sulphate of copper and nitrate of silver, in the production of positive pictures by one process—this process is known as the *chromotype*.

We must now advance to an examination of Mr. Pretsch's process. It will be evident in what respect it resembles, and in what it differs from the inventions we have already described. A plate of glass is thoroughly well cleaned. A quantity of glue is dissolved, and three different solutions are made, which we will number respectively:—1. nitrate of silver; 2. iodide of potassium; 3. bichromate of potash. To each of these some of the glue is added; the largest portion to the solution No. 3, then No. 2 is added to No. 3, and both solutions mixed together. The previously yellow solution becomes a fine red, from the formation of chromate of silver, which is held in suspension. Solution No. 2 is now added to the mixture of 1 and 3; the mixture loses colour slightly, but it still remains of a fine red colour. This mixture, which involves some very curious chemical phenomena, is poured over the glass plate, and by skillful manipulation, a perfectly uniform film of a red colour is produced. This part of the process is performed in a room illuminated with yellow light, and maintained at a tolerably high temperature. When solidified, the plate is fit for use. A photographic view, a portrait, or an ordinary engraving is placed upon the gelatine tablet, this arrangement is fixed in the copying frame, and duly exposed to the solar rays. In the course of a short time all the exposed parts blacken to a fine brown, and the lines beneath the superposed photograph or print are darkened or preserved from change, as the case may be, until eventually a copy is obtained the reverse of the original. All the dark lines, or portions of a print or of a photograph remain unchanged, all the light lines or portions darken—the degree of darkening being determined by the relative transparency of the several parts.

The glass plate is, at the proper time, taken from the copying frame and plunged into water. The picture is now perceived to be gradually developing itself with extraordinary beauty. All the unchanged portions of the plate are rapidly dissolved off, and consequently the picture is produced not merely by differences in the colour of the surface, but by variations in the thickness, corresponding with the amount of actinic action which has taken place during the exposure of the plate.

When the proper effect is obtained the process is stopped, the surface is dried off with blotting paper, and the plate preserved for the subsequent manipulation. It will be understood that the chromic acid of the bichromate of potash at the moment of separating from that salt, when the actinic change is effected, combines with the gelatine, and renders it insoluble. Hence in the picture we have several thicknesses of the gelatine film, representing the high lights, the middle tones, and the deep shadows, with all the beautiful gradations between these which are obtained in a highly-finished collodion photograph.

This constitutes the photographic part of the process of Mr. Pretsch, the remainder of the manipulation being the preparation for, and the carrying out of, the electro-chemical preparation of the copper plate from which the photogalvanographs are to be printed. The photograph being placed upon a firm bed, a sheet of elastic gutta percha is spread over it, and subjected to some pressure; this receives a very perfect impression of the picture, all the lines, howsoever delicate, being faithfully preserved. When this hardens, its surface is prepared so as to render it conducting, and it is then subjected to the ordinary electrotype process; being placed in a cell filled with sulphate of copper, and connected with a plate of zinc in a porous cell excited with dilute sulphuric acid. Thus a sheet of fine copper is precipitated upon the mould, and a plate, the reverse of the mould, is obtained. It will be evident to our readers that we are thus enabled to obtain either a raised image or an engraved impression. At present, the processes for printing from plates *in relief* are not sufficiently perfect, but the prints taken from the engraved plates are in a very perfect condition. In these, for the first time, we see all the minute details represented, with the half-tones as finely given as the high lights or the shadows.

In the establishment at Holloway, arrangements are made for carrying out Mr. Paul Pretsch's patent commercially upon a large scale; and from the specimens we have examined, we are satisfied that the productions of the camera-obscura must soon be commonly employed for all purposes of illustration.

We have heard much of the fading of photographs; we have repeatedly stated our conviction, the result of upwards of sixteen years' experience, that photographic pictures need not necessarily fade. Where they do fade—and we know that some of the finest works which have been produced have rapidly perished, or are perishing—it is due to imperfect manipulation. Much of the deterioration is due to the practice, as it is called, of *toning*. By this practice agents are introduced into the paper which act slowly but surely upon the silver of the photograph, and eventually effect the destructive change. Every condition of tone can be produced without any of these *toning* agents, by the use of different chlorides in the preparation of the paper upon which the positive print is obtained. Photogalvanography, however, relieves us from the risk of possessing fading pictures. Here we have pictures possessing in the highest degree the perfection of the original photograph, and the permanence of a copper-plate print.

R. HUNT.

THE ROYAL PICTURES.

MARY ANOINTING THE FEET OF CHRIST.

P. P. Rubens, Painter. W. Greatbath, Engraver.
Size of the Picture, 1 ft. 8 in. by 1 ft. 3½ in.

RUBENS, among all the painters of the Dutch and Flemish schools, was undoubtedly the most consistent exponent of Christian Art. By the term "consistent" is meant that his conceptions are most in unison with those lofty and holy feelings which should always be found in everything connected with sacred subjects. None of the works of Rembrandt, Van-dyck, Jordaeus, or any other painter of these schools, approach in religious sentiment the compositions of Rubens. And yet how far is he behind the great artists of Italy!—Guido, Carlo Dolce, Paul Veronese, Raffaele, the Caracci, and the host of stars of lesser magnitude: even his visit to their country, and the study of their works, in Venice especially, had but little effect on his style in the particular referred to. The truth is, the mind of the great Flemish painter wanted the repose necessary to qualify him for the task of an illustrator of the facts narrated in New Testament history: it was too active, too energetic, too full of movement, to express the tranquil and devotional sentiments which harmonise with all one reads of in the lives and actions of Christ and his immediate disciples—of too exuberant and florid a character to be restrained within such limits as can only be legitimately assigned to such subjects. In all the Italian painters, distinct as they are from each other in style and manner of treatment, there is a uniformity of feeling which seems to unite them together. In the works of Rubens we are captivated by the richness of his conceptions, the vigour of his drawing, and the brilliancy of his colouring—these all speak to our senses in the most powerful language; but we turn from looking at one of his pictures—we are speaking of his scriptural subjects only—with an ardent wish that the fire of his genius had been chastened by the devotional feeling visible in the Italian painters. Even in the noble picture of the "Descent from the Cross," in the Cathedral of Antwerp—perhaps the most sublime and affecting subject presented in the whole range of scripture history—there is comparatively little to elevate the thoughts to the solemn dignity of the scene portrayed: the masterly grouping of the figures cannot be surpassed; the grandeur of the conception, the powerful execution, and the richness of the colouring, unite to excite our admiration; but the heart of the spectator is not stirred into reverential awe, nor will a tear of pity be wrung from his eyes by any amount of pathos he will find therein.

The genius of Rubens, it has been correctly said, "was adapted to the grandest compositions; and his powers appear to have expended themselves in proportion to the scale on which they were called upon to act. He did not, like Raffaele, possess that mild inspiration of sentiment which manifests itself in the graceful and beautiful, but he was animated with that poetic fire that displays itself in effects, which astonish and surprise. His most abundant compositions seem to have been produced without effort, and creation appears to have been an operation of his will."

This picture of "Mary anointing the Feet of Christ," in the collection at Windsor Castle, is a sketch—executed in bistre, or some colour of a similar tint—for the large painting in the Imperial Gallery at St. Petersburg. "It is conceived," says Mrs. Jameson, "with that dramatic power, and touched with that vigour and ease, which characterise Rubens when he painted from out of his own soul and fancy." On these points there cannot be a second opinion; but at the same time it manifests in a high degree what we cannot but consider the defects of this great painter. Life and action seem here out of place altogether: the act of Mary is of solemn import, and must have been witnessed by the disciples with wonder, awe, and silent admiration, and yet life and action are displayed to an extent almost painful to the eye—even the draperies seem in motion, in the multiplicity of their folds and the tortuous motion in which they are disposed; still the arrangement of the whole group is most masterly, and the general effect rich almost to a fault.



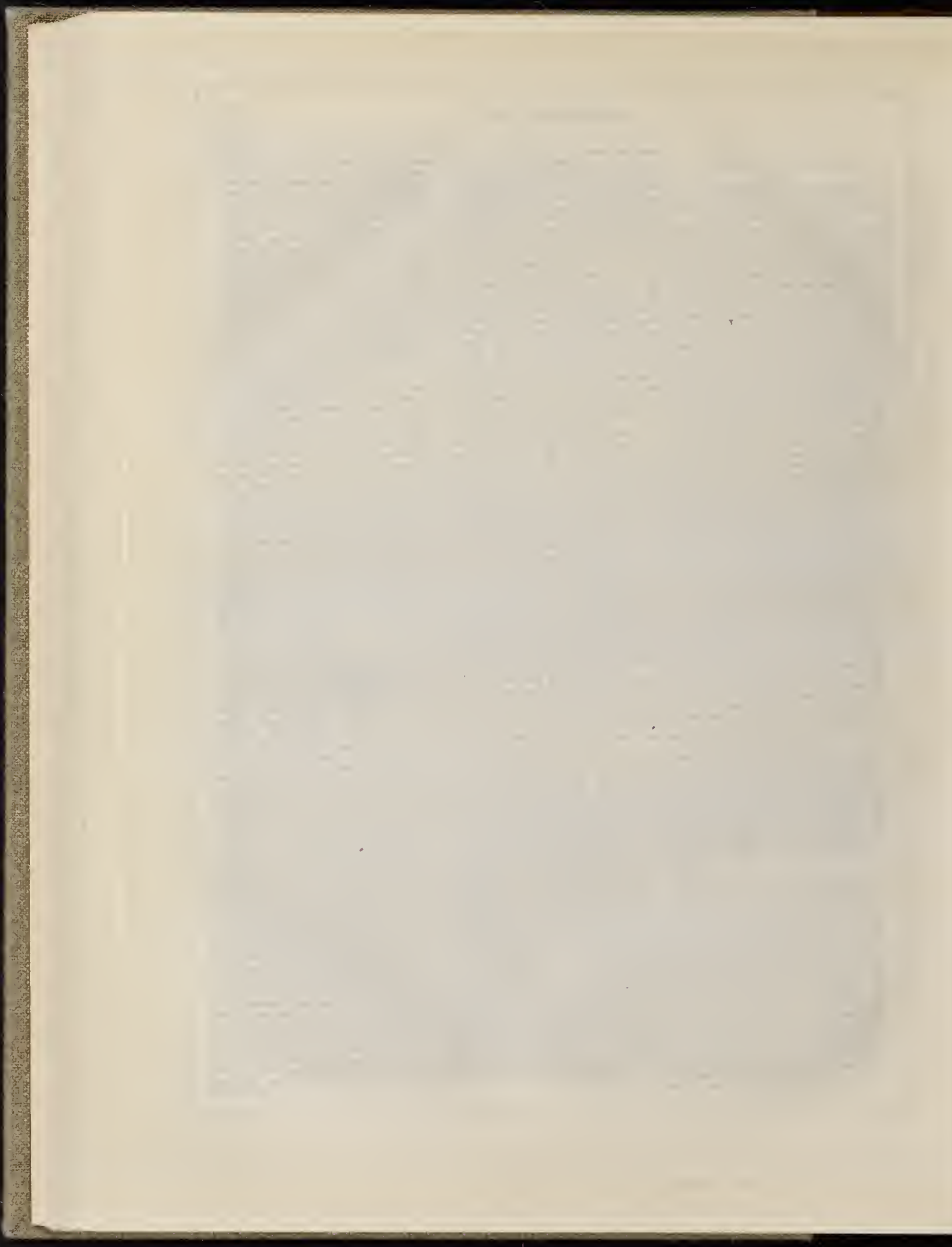



THE CRYSTAL PALACE,

AS A TEACHER OF ART AND ART-MANUFACTURE.

PART I.

It is our purpose to describe in the *Art-Journal* a series of ILLUSTRATED VISITS to the Crystal Palace at Sydenham; undertaken with a view to draw more general attention to the many remarkable features in which it abounds, in order that the educational advantages offered by this institution, beyond the attractions of a mere "London sight" (in that respect alone unrivalled), may be more fully recognised and appreciated.

We are induced to this notice principally from the fact that, although to a large extent popular, still it has not hitherto met with that cordial, steady, and general support which its purpose merits, and which can alone adequately remunerate the immense cost of its establishment. The resources of the Crystal Palace present the means of aiding educational progress without a parallel in this country, and every inducement should be held out to encourage the operative classes to select its locality for the enjoyment of the periodical holidays which national custom has established; while to those more favoured in circumstances we may recommend a frequent attendance as a source of intellectual gratification and improvement. Its influence cannot but have a most beneficial tendency; the association, even by uneducated minds, with such examples of Nature and Art as there arrest the eye at every step, insensibly induces a spirit of cumulative action. The suggestions

afforded by the various objects, both in regard to the tasteful arrangement of natural productions, as well in their separate features in combination with works of Art,—suggestions which, to a considerable extent, are easy of adaptation to the refinements of ordinary homes,—are such as will gradually but surely attest the value of their lessons.

Intuitive taste is not altogether of rare occurrence among the humbler classes, and it arouses a grateful feeling to witness its evidence, however simple the manifestations. The homely perch becomes an espalier upon which the woodbine, rose, and honeysuckle, trailed to tasteful growth, bloom with a luxuriance and grace that palatial gardens seldom rival. The advantages which have been almost exclusively those pertaining to a rural population are now offered to the inhabitants of our crowded metropolis, and we are sanguine that their enjoyment will eventually exercise a marked and hopeful influence upon the national character. For it is worthy of remark, that the feeling excited by contact with the beauties of Nature and Art generates a propriety of demeanour in itself of an improving tendency.

We cannot adduce a more forcible and conclusive illustration of this assertion than by reference to the orderly conduct of the people, even when congregated in crowds in our public exhibitions and parks. A few years since, such a result would have been doubted, if not denied; and the fact pleads strongly for a more general extension of such humanising influences as these attractions give rise to.

Moreover, it is worthy of especial note as a peculiarity of this institution—the opportunity it affords to ladies of enjoying intellectual amusement in such

a manner as is compatible with the requirements of the most unexceptionable taste. In this respect the Crystal Palace stands alone. A day may be pleasantly and profitably spent there without the risk of subjection to a single casualty that might interrupt its enjoyment or mar its retrospect; ladies may at all times visit this establishment unaccompanied by "protectors."

We have frequently heard expressions of regret that the portions of the Exhibition which are essentially of the highest character, are those which are least appreciated. But this, we submit, is a very natural result of an experiment so novel and elevated in its aim. The majority visit it as a show—a show on a grand scale it is true, but omit to accept it as a SCHOOL; and yet in the latter capacity is its chief utility and its highest purpose. Still there is a large and increasing minority who are becoming alive to the value of the educational advancement which the material compressed within the exhibition range of the Crystal Palace is capable of forwarding; and we are most anxious to assist in further demonstrating the value of its resources, not only in their intellectual ministrations to the pleasures of the public at large, but especially to that portion of the industrial classes whose labour is in any degree connected with, and influenced by, Art-knowledge. To the MANUFACTURER, and DESIGNER in connection with MANUFACTURES, it opens a field of suggestive study as useful and essential as it has hitherto been unattainable. The examples of decorative ornament in various styles exemplified in the Art Courts are invaluable as references and guides to the artist in adapting established principles to modern applications. There



THE CERAMIC COURT, CRYSTAL PALACE.

is now no excuse for the anachronisms which have formed so marked and melancholy a feature in the bulk of English Art-manufacture. Ignorance on this ground is now absolutely wilful, and therefore culpable. Not only are the best examples in the various distinctive styles of ornament separately classified, but distinguished as to the period of their execution, and the localities from which they were taken. Permission to sketch from any of the examples is, we believe, readily given upon application to the Secretary.

Unprecedentedly rich in all the elements which are

essential to success, we are sanguine that with judicious direction this will be permanently secured. But we must remark, at the outset, that no course should be adopted, however it may recommend itself by a temporary addition to the finances of the establishment, if the ultimate effect may be derogatory to its character. The permanent interests, even in a commercial view, are jeopardised by such expedients, which are as short-sighted as they are fallacious.

We would advocate the maintenance of such a character for the Crystal Palace as should eventually secure its adoption by the nation, should circum-

stances render such a course necessary or advisable. A grant for such a purpose would be both popular and judicious, and will probably be its final destiny: let it preserve a position worthy of such a conclusion.

This can only be done by realising the high aims which, upon its foundation, were claimed as its basis, and urged as motives for its support. It was to contain a selected epitome of the most noted marvels of Science, Art, and Manufacture. The matchless site, and accompanying requisites of space and other appliances, offered facilities for the deve-

lopment of natural beauties on a scale of surpassing magnitude and splendour.

To a very considerable extent, and in some of the most important and difficult portions of the task



JEWEL VASE.

these promises have been realised. failure has followed almost entirely where success was most easily obtainable.

From the special nature of our work, we are restricted—except in general and cursory remarks—to the consideration and illustration of those portions of the Exhibition which refer directly to Art and Art-manufacture of a purely ornamental character.

The taste and judgment demonstrated in the selection of the Art-exemplifications furnished by the decorations of the various Courts, and which crowd every part of the building available to their fitting display, are of a high order; and the enterprise and energy employed in the collection of such a mass of material, in many instances unique, are deserving of all commendation.

It is almost superfluous to allude to the perfect disposition and arrangement of the floricultural department of the Palace and Park, or to do more than refer to the grandeur of the water-works,—in these respects alone, independently of the novel beauty of the structure, it stands a proud evidence of the skill and taste of Sir Joseph Paxton.

Here is a success—probably in some minor details qualified, but still a positive if not a complete success. Herein lay the essential and unavoidable difficulties, and they have been overcome. Failure ensues where it might have been least anticipated, and where it seems by want of ordinary judgment to have been provoked.

As a medium for the illustration of manufactures, especially those in connection with Art, the Palace presented advantages altogether unparalleled. A building with almost unlimited capacity to receive, and unexampled facilities for exhibiting, industrial products, combined with attractions that necessarily insured a large publicity, presented a desideratum at once apparent and admitted. Unfortunately, its commercial aspect alone was estimated, and the consequence was that, presuming upon what has since proved an exaggerated value, so high a demand was made for exhibitive space that the highest class of manufacturers, with few exceptions,—those whose works would have formed attractive and worthy features in the programme,—withdrew from all co-operation, and left its occupancy to those who, deciding to accept terms so highly rated, did so with the determination to seek a return for their investment by any means which their commercial interests might require; and these naturally were of such a charac-

ter as to inflict a serious and lasting injury upon the best interests of the institution.

The question of "rental" for exhibitive space has hitherto been a fatal one to the management of the



PASTORAL VASE.

Crystal Palace, and for this reason, and knowing how much the position and success of the scheme depend upon its judicious settlement, we devote more time to its consideration than we should otherwise deem necessary, for though past experience has inculcated some useful lessons on this point, still it appears to have enforced but a qualification, instead of an abrogation, of the old, unwise principle.



GROUP OF PORCELAIN, OF SEVRES, DRESDEN, ETC.

The amount of rent paid will always be in an inverse ratio to the value of the works exhibited, and the status of the exhibitor. No manufacturer of eminence, whose productions are costly, and of

a merit placing them beyond the demands of ordinary trade requirements, will be content to pay largely, if at all, for the admission of a class of works whose exhibition must form an attractive and

elevating addition to the materiel of the Crystal Palace.

It is on this ground that we advocate the abolition of all claims for space in the principal courts erected

for the reception of special branches of manufacture, and the substitution of a system determining the qualification of "exhibits,"—so as to secure such works as shall be in themselves either individually or collectively a source of remunerative attraction. Certainly all direct trading should be confined to the galleries, where no possible objection would be made to its operations.

The Industrial Courts might then be devoted to the purposes for which they were erected; and upon such a system as we advise would, without doubt, be gladly accepted by the trades as a PERMANENT LOCALITY for their illustration.

This arrangement effected, we would recommend every manufacturing town of established importance, and every town whose industrial efforts are working out a prospective fame, to have its staple trade fully and adequately represented in the Crystal Palace. This task should not be treated with indifference, or left to the individual enterprise and judgment of one or two persons interested in the trade; but should be incurred as a responsible duty by a local committee, formed in the town, and acting for the general body, whose interests it should represent.

Whatever objections might have been in times past urged against the practicability of such a plan, they will not, we believe, now apply. The petty spirit of trade jealousy is gradually weakening with the increased intelligence of the commercial world,

and it is felt that the interests of one are the interests of all.

It is impossible that one or two manufacturers, however eminent their position and admirable their productions, can efficiently and comprehensively represent the capabilities and resources of any trade which presents varied fields of action.

Our impression is, that eventually the special branches of all important manufactures will each absorb the capital and energies of separate producers; and the result will be such a development of mental application, and such a perfection of manipulative facility, as is altogether unattainable and hopeless, while the attention is divided amongst a variety of claims.

We might, in corroboration of our assertion, cite instances of branches of manufacture, but a short time since considered of secondary and minor importance amidst the prominent demands of more established trade sources, which, when separated and worked apart, have, by a concentration of mind and action, grown to significant and engrossing specialities.

Manufactures of the national importance of Man-

chester, Birmingham, Sheffield, Glasgow, the potteries of Staffordshire, Worcester, Coalport, &c., &c., should be represented by separate and complete groups of illustrations, selected by local committees in each district, duly qualified to estimate the merit and extent of its productions. Such an arrangement could not fail to have an important influence on the trade of those towns, more especially in connection with their foreign commissions. Scarcely any foreigner of distinction, either in rank or commerce, but would have his attention arrested by such a display in a locality which attracts all.

We have frequently had occasion to remark that British manufacturers, when they produce meritorious works, find it extremely difficult to have such works appreciated, *merely because they cannot be seen*. It is a leading feature of the *Art-Journal* to engrave, as well as to describe, productions which the producer desires to place before the public,—not alone that their value may be understood, but that, by elevating the general character of the manufacturer, the requisite recompense of his labour may ensue.

But although we do much in this way, and very materially advance Art-manufacture by our frequent reports of progress, our means are necessarily limited. Some place was needed where a large collection of improved productions might be examined. This want is now supplied by the Crystal Palace, under the best possible circumstances: they are daily ex-



THE SHAKSPEARE SERVICE OF MESSES. KERR AND BINNS.

hibited to the wealthiest and most intelligent classes; may be seen at leisure; may be purchased, or duplicates ordered; and an estimate can be formed of the capabilities of the manufacturer to produce works more varied or more common than those he here exhibits. In short, those who have "wants" may be here led to consider how their requirements can be best supplied. We desire to see the Crystal Palace converted into a huge "pattern-room," so to speak, where every good producer of Great Britain shall have place and space; and believe that thus the highest duty of the Directors will be fulfilled, and the interest of manufacturers be best promoted.

With these general remarks and suggestions, we proceed to report upon the special objects we have selected for illustration and comment. And we commence with THE CERAMIC COURT, now in progress—as it not only embodies the principle with regard to the admission of its "exhibits," which we advocate for general adoption, but also most satisfactorily attests the success of an experiment. For this Court

is to be regarded as an experiment; if an admitted success, it will certainly be followed to a large extent; and that it will be successful is, we think, proved beyond a doubt—successful as a school, as an exhibition, and as an advertisement (using the word in its higher sense) for the exhibitors.

The Directors have been singularly fortunate in obtaining the assistance of a gentleman admirably qualified for the task; they have placed this Court entirely under the control of MR. THOMAS BATTAM, who for many years superintended the Art departments of the works of Mr. Alderman Copeland, at Stoke-upon-Trent. No one in England has had larger experience in all that appertains to Ceramic Art: he is learned in its history and intimately acquainted with its practical details, entirely independent of any special interest, and entitled to and receiving the confidence of all British producers. It will be seen also that he is powerfully aided by "collectors," whose stores have been placed at his disposal. The result is, consequently, a very great

success; but although Mr. Battam's advantages for this post have been many and great, we do not doubt that the Directors of the Crystal Palace may obtain equally beneficial co-operation in reference to the other branches of Art-manufacture which they design to honour and to represent.

In this part of our Journal then, we shall confine ourselves to THE CERAMIC COURT, treating, in succession, THE OTHER COURTS OF ART-MANUFACTURE.

With Mr. Battam, as we have intimated, originated the proposal to form a Ceramic Court, which should contain an historical collection of pottery, from the earliest ages to the present; it is under his direction, and by him the examples have been selected and arranged.

No work is admitted but what, in regard to ancient and foreign manufacture, is interesting as illustrating the heavy or peculiarity of a special style; and, as regards modern manufacture, no work will be received for exhibition but what is of the highest excellence. This was promised at the announcement

of the project; and this promise, as far as at present developed, is entirely and faithfully realised.

Whilst looking at the marvellous beauty of the various works which adorn the collection, the zeal that has linked so many names of historical eminence with the early prosecution of the labours connected with this Art, is fully justified and explained. Its operations are "specialised" by the repeated similes which Holy Writ furnishes as suggested by their observance—operations which in some instances remain to this day practised in modern manufacture with but little modification. Indeed, were it possible to resuscitate the mummy of an Egyptian Throver, he could readily find lucrative employment at our Minton's and Copelands—the lapse of more than three thousand years having left unchanged the manipulative process of his handicraft.

As we have in a previous number of the Art-



Journal detailed the system upon which the Ceramic Court is based, and the object its completion is intended to effect, we shall proceed to describe some of the principal examples, and continue this illustra-



tion from time to time, selecting specimens the most perfect and interesting, both ancient and modern, of English and foreign manufacture.

To the HON. GENERAL EDWARD LYON, the Directors of the Crystal Palace Company, and the public generally, are deeply indebted for the liberal spirit which prompted him to permit the exhibition of a costly and large assortment of specimens from his famous collection. It was a noble act, and will, we are confident, in its results be gratifying to him. To manufacturers engaged in this branch of Art it must be especially interesting, and its examination highly suggestive and useful.

The excellence and beauty of these works fully account for the almost fabulous prices realised for such articles in recent sales—we have written "such articles;" but unfortunately the prestige and value

which virtually belong to works of such rarity are, through want of judgment and the mania of the day, extended to a class comparatively worthless.

The figure-painting on the productions of Sévres and Vienna, the jewelled ware and portraiture of Sévres, are marvellous both in their richness of colour, elaboration of finish, and brilliancy of glaze. It seems a matter of regret that in many instances such exquisite gems should decorate articles of mere ordinary utility. To put them to the uses which their forms denote would be an act of desecration.

We have selected for illustration from this valuable and beautiful collection a jewelled vase of great richness, and exceedingly good in form; a vase, also of Sévres, the principal feature of which is a pastoral subject, extending over its circumference, representing a Bacchanalian procession, the groups on which are worthy of Poussin. The variety and grace of these, together with the brilliancy of the colouring, are of the highest class of Art.

We have also a group representing a jewelled cup, and vase with portrait, of Sévres, together with a chalice of Limoges enamel, mounted in gold. All these are of the rarest excellence; indeed, judging from the uniform merit of the specimens which, by General Lygon's liberal kindness, Mr. Bataam has selected, we can form a very high estimate of the judgment and taste of the collector.

Of the modern works, we have selected for engraving in the present number a group from the Shakspeare Dessert Service, from the Royal Porcelain Works, Worcester, under the spirited proprietorship of Messrs. KERR and BINNS. This work is executed by a combination of parian and porcelain; the figures being in the former material, and the ornamental portion of the service in the latter. The junction of the two is very judiciously managed, so that the unity of the work is strictly preserved.

"A Midsummer Night's Dream" is the play selected for illustration, and is happily chosen—its character being light and ideal; and its locale being in classic Greece, suggests the adoption of those forms which have become the acknowledged perfection of Art. The service is of great extent, and its production must have been a labour involving a large expenditure of time, talent, and capital. Among the groups are those of the "Athenian mechanics rehearsing the lamentable comedy of 'Pyramus and Thisbe,'" "Sweet Bully Bottom and Wall," "Moonshine and Thisbe," "Quince and Flute," "Bottom with the ass's head and the Tinker," each of which forms a base to an elegantly-formed fruit-basket. The centre piece is entirely devoted to fairy ground; it is a fanciful construction, divided into three groups, illustrating the jealousy, revenge, and reconciliation, of Oberon and Titania. In arrangement, design, and decoration, the work presents claims to very high consideration; the individuality of character in the various figures is most admirably expressed.

The plates are decorated with medallions of Shakspeare, Melpomene, and Thalia, supported by Grecian chimera, embossed on the ware; the centre displays some classic symbols of Night—as Diana's head, the owl and torches, &c. &c., each centre being different. The borders on the verge of the plates are of an appropriate character, and varied.

A figure of Shakspeare is represented sleeping on a bank whilst in the act of planning his comedy; and the deification of the bard is illustrated by Fame. Two statuettes of Tragedy and Comedy also form portions of a work which, as a whole, we must pronounce to be highly creditable to the manufacturers, evidencing a spirit of taste and enterprise rarely equalled. The figures were designed and modelled by Mr. W. B. Kirk, an artist of unquestioned ability; and the forms and general arrangement of the decorative devices were designed by Mr. R. W. Binns, one of the proprietors. We shall refer to other works by this eminent firm in a future number.

We give also on this page a few of the translations of the ancient Etrurian vases contributed by Messrs. BATTAM and SON, and produced at their establishment in Gough Square. The class of work to which these examples refer may be ranked under the head of Reproductive Art. The historical, mythical, and domestic events which their illustration typifies, form vivid and instructive records of the manners and customs of the ancients. The date of these original productions extends from the second to the fifth century of the Christian era. The

diversity and elegance of their forms bear conclusive evidence of the grace and beauty with which a refined and cultivated intelligence can mould even the objects which minister to the humble and familiar purposes of household wants. These works have been imitated in nearly all the cities of the continent; but it is only just to Messrs. Bataam and Son to say, we have never examined any of merit equal to theirs.

We have selected various examples from the collection of Messrs. Minton, Copeland, and other eminent firms, which are in the hands of our engravers; but the illustrations that immediately succeed will probably bear reference to the contents of one of the other Courts of Art-manufacture. This exhibition—that of THE CERAMIC COURT—though necessarily incomplete at present from the comprehensiveness of its grasp, and the short time as yet



devoted to its formation, is still of unrivalled excellence. Such a display has never before been presented to public inspection, and it is not too much to assert that to few will its examination be other than a



source of admiration and astonishment at the capabilities of a manufacture in many respects presenting features so startling and peculiar, and one in which England at the present time takes so high a rank.*

* In preparing these Engravings, we have derived much valuable assistance from the photographs of Messrs. Negretti and Zambra, whose establishment is in the Crystal Palace, and who are always at hand to execute any orders they may receive. Their works are of the best class; indeed, as specimens of photography, they are of rare excellence. This fact should be known to manufacturers; inasmuch as, by the aid of these gentlemen, they may at once obtain an accurate copy of an object, or part of an object, of which they desire to avail themselves for purposes of their Art. It would be well if every workman's atelier in our manufacturing districts were filled with photographs of ever useful "authorities;" and arrangements for such a supply might be made on "easy terms" with Messrs. Negretti and Zambra.

THE ROYAL ACADEMY.

SCULPTURE.

In view of those new arrangements which at no distant period are destined to affect the lecture-halls and exhibition-rooms of the Royal Academy, it might seem needless here to throw away any large amount of remonstrance on the character and dimensions of that material dungon to which, so far as regards the institution in question, the most spiritual of the Arts has been for many years consigned. When those arrangements shall be actually in progress, it will be the fault of the sculptor-academicians themselves if—numerically strong enough in the governing body for the purpose as they now are, and certain to be supported by the friends of Art in parliament and of the press—they fail to hestir themselves effectually for the redress of a wrong in which their body has too long acquiesced; and for this reason it is that a few words on the wrong itself should, nevertheless, not be deemed out of place. The injury to that branch of Art for which, to a certain extent, the sculptors of the Academy are trustees, has been of more kinds than one; and, if the Sculptor is, as we believe, the great spiritus in Art, and the keeper of those canons to which its professors in other departments must again and again return for refreshment from the seductions of fancy, and recovery from the bewilderments of caprice, then the interests of which these academicians have charge extend far beyond what seem to be immediately their own. Of injury to themselves, the most direct and obvious form is that which presents itself in the impossibility of finding spaces for, or lights under, which the individual works of Sculpture can be viewed. All the accessories that help this form of Art, in its more imaginative displays, are disturbed by such a fact. On the floor of this dim sculpture den, the pale marble forms combine with each other, and with the living forms that vainly hover around them, in a way that defeats all Art intention, and substitutes for it a succession of epigrams. The familiar here inevitably jostles the transcendental, and unspiritualises it; the real so trends on the ideal as to disincant it; the mischief produced on the material aspects of the works themselves is fortified by the mischief induced in the mind of the spectator. For abstraction there can, under such conditions, be no chance whatever. The sentiment proper to Art in the most transcendental of its forms takes flight at the very door of the temple. The aspect of the room inevitably lets down the elevated mood necessary for the appreciation of Sculpture to the inspiration of a china-shop. The *genius loci* amid such accidents has no room for the sole of his foot. The feeling—almost solemn, always serious—that breathes from the marble forms which the hand of genius has invested with the spirit of beauty, is disturbed by the mischievous associations of the place. Nor let it be supposed that a fact so seemingly extraneous and unessential as an unfavourable place of exhibition, if long continued and under authoritative sanction, will have no effect on the final destinies of the Art. Like most other things—and more than most other things, because of its highly sensitive nature—Art will reflect the accidents amid which it has to strive. All the penances to which it is exposed will show in the relaxation of its muscles and the maceration of its limbs. The growth of a national Sculpture will represent the sum of all the influences by which it is surrounded; and of all the forms of Art this one is likely to accommodate itself most sensibly to the dimensions and capacities of its visible tenement. At any rate, if the method of neglect to which we have alluded were not an original injury to the Sculptor himself,—as, in his highest manifestations, the greatest of Art-teachers,—it would still be a serious wrong to the people whom he has to teach. We call, therefore, on those who represent him within the walls of the Academy to look well to it, that in the apportionment of the new galleries which must ere long, in the same locality or elsewhere, replace the present inconvenient exhibition-rooms in Trafalgar Square, his future interests and those of the public—derived through him—shall be cared for after a fashion very different from that of the past and of the present.

Whoever the sculptor may be who has had the

arrangement of the present exhibition, appearances would seem to indicate that his zealous co-operation towards the better condition of things here enforced may be confidently reckoned on. It would appear to have been his deliberate object, in prospect of the coming changes, to give to the absurdity of the present accommodations such an emphasis as shall render anything approaching to a repetition of these impossible. More than ever does the floor of this preposterous cavern seem crowded with its marble population, and more unpromising than ever seems the enterprise of steering through the intricacies of its scattered groups—gliding safely round its dangerous corners, and passing into its narrow and mysterious recesses, that at once invite and repel, like the uncertainties of an Eastern tomb. The difficulty, and at the same time unfruitfulness, of this enterprise, the arranger has contrived to increase by withdrawing one half of the imperfect light which at any time found its way through the single window that looks upon this cellar-Olympus. The means by which this ingenuity is achieved is extremely simple—merely the device of raising the canvas screen to the entire height of the window in question; and the perfect success of the experiment we had the opportunity of proving in more than one unsuccessful attempt—during some of the gloomy days which at the opening of the Exhibition were favourable to the artist's design—to read the catalogue in almost any part of the room. Of course, under such a dispensation, it is not to be expected that the works should give any definite report of themselves; and we, who have by dint of patience and perseverance achieved such an acquaintance with them as was possible under the circumstances—who have waited for partial illuminations and followed on the track of struggling beams, to dodge round awkward projections and dive down questionable lanes—can state that, if an attempt to bring out this strong expression of the incapacities of the place could at any time be justifiably made with a view to a different future, the present year was not ill chosen for the purpose, as one in which it could be done with less of sacrifice than on many other occasions,—since, as an exhibition of national Sculpture, the one before us is, in some respects, more discouraging than any that we have had at the Royal Academy for several seasons past.

As this, in view of that onward progress in Art generally which is visible amongst us, is a startling circumstance, it is pleasant to be able to state that it is not by any means so significant as at first sight it seems. A further examination shows that the blame is due less to the sculptors themselves than to the influences amid which they work; that, in fact, the genius of Sculpture has been accommodating itself, after the common law, to the conditions of its lot. In the first place, let us observe, that the whole of the case as regards British Sculpture is not represented within the walls of the Academy. For a number of years past there has been a diminished eagerness on the part of some sculptors, and a growing reluctance on that of others, to exhibit their works amid a system of accidents which ensure an imperfect, or threaten a false, interpretation; and the exhibitions at the Royal Academy have, in consequence, been more or less affected by a diversion into other quarters from those items which contribute to make up the sun of the year's sculpture account. In as far, however, as the exhibition of the present year must be taken to represent the general condition of the Art, let us turn to the catalogue, and see if it furnishes any clue to this condition. Here we find that the works claiming to be considered as works of Sculpture, are one hundred and fifty-six in number; and of these, quite two thirds are portraits,—the very large majority belonging to that least satisfactory form of portrait, the bust. Now, admitting that in many of these busts the marble takes as much of the character of life as seems possible to the limited conditions of the class—that, exhibiting all the qualities which contribute to the perfection of that form of Art, they report, so far as the class can, most satisfactorily of the excellence of the school to which they belong; yet, let us ask, what high things are to be expected of a school thus habitually exercised? The sculptor—who has to live by his art—can pipe only to those tunes which will be danced to,—and if the public have no love for transcendental Art-music, all that it can expect from him is, that he shall be a master of his instrument even when he applies it to com-

mon themes. It is very obvious, however, that by such themes the highest capabilities of the instrument can never be brought out. If the talent of the great majority of English sculptors be driven by the set of the current too far and too long into the stream of portraiture, it will be difficult for the artist to struggle back into the fields where, of old, the Greek found and embodied the Immortals. Fancy, the most transcendental of the Arts degraded to the merely mechanical office of the teeth transmission of faces, foolish or otherwise,—too often of faces which an art whose first principle is eclecticism would shun as its natural death! This steady settlement of the spiritual Muse towards low contemplations must unspiritualise her: the habit, carried too far, of working from such ordinary models (where they are nothing worse) will leave an influence upon Art, which an occasional return to the fountains of beauty will be powerless to counteract. Even where the living subjects copied belong to the better types which humanity can supply, still, there can be no doubt, that this continued practice of the mere materiality of Art, this constant modelling of cheeks and noses,—where, even in the best instances, the consummate hand does all, and the poetical heart nothing, where loftiness of conception, tenderness of thought, and the sentiment of beauty, are all faculties unemployed,—must have a tendency to deaden the sensibilities and narrow the powers of the Sculptor. His very success in this department is one to which his art itself was not a motive, and to which its spiritualities have made no contribution.

From that minority of the works in the present Exhibition, in which the poetry of the Art has been attempted, we gather the same report,—favourable to the Sculptor himself, but denunciatory of the conditions amid which he works. All the qualities of the Art short of the highest—but without the highest, he it observed, the true Artist should consider all the rest as nothing—have for years past proclaimed themselves in the practice of the English Sculptor:—excellent modelling, clear intelligence of the capabilities and limits of the Art, consummate workmanship, and on his own part sufficient evidence of a leaning towards the abstract and imaginative, amid all the outward discouragements by which that leaning is repressed. Year after year (we speak, of course, generally, for there have been many exceptions), he has exhibited less of extravagance, and a nearer return to that pure school which has the old Greek canon for its guides. A simpler style of Art, and a more careful manipulation, have to a large extent replaced the allegorical perillities and florid exaggerations of his predecessors; and the Sculptor has been gradually learning to admit that the history and poetry of his own land may furnish the materials of Art in its highest expressions; and that to go to the Greek (generally, for there are the exceptions of those rare and beautiful abstractions, like Psyche, which the poetry of every nation has taken into its heart) for his themes, while in search of his principles, is exactly to miss the letter at the same time that the appeal to the English heart is missed. In a word, the technicalities of the Art have been steadily perfecting, its sounder principles spreading, and its language consummating. Here, then, we have the Sculptor so far, as becomes his mission, lending that forward move in Art which is announced by many signs, and which cannot leave him behind because it cannot complete its work without him. Here we have him at that point of progressive Art when the full growth of its capacities may be said to have been attained, and he is ready in his matured strength for loftier efforts when they shall be required of him—waiting, in fact, for that appreciation of its higher aspirations which (apart from the material rewards that it includes) is the element on which genius lives. Here we have him, furnished, and waiting for the Patron by whose means alone can be kept fed and burning the emble which is to transmute all these qualities into the fine gold of the highest Art; and the unsatisfactory aspect of this present exhibition is accounted for by the fact that neither in the public, nor in the government which should replace it, has that Patron yet been found by the Sculptor. We could say much on these heads: both as to the character of the shortcomings on the part of the English Sculptor, and as to the manner and degree in which they are traceable

to the neglect which he has met with from the authorities at home—where that neglect has not been substituted for injurious treatment. If the English Sculptor be not a prophet in his own country, it is the country's fault, not the English Sculptor's. But we shall have, and mean to take, other opportunities of urging these matters on the attention of the public, and, if possible, of those in high places who are responsible to the public in this matter; and, meantime, we must content ourselves with a few short remarks on such of the individual works of Sculpture in the present exhibition of the Royal Academy as seem to call for it.

We are in the month of June, and a month is really a gain both to the visitor and the sculptor, for the outline of some of these works—the most remote from the window—which were invisible in May, can in June be faintly traced, with the assistance of a light distributed by a balloon-blind, which booms into the cellar like the well-filled foresail of an American clipper.* We recognise in the sites of honour two busts of the Queen, one by the BARON MAROCHETTI, the other by DURHAM. It is painful to contemplate the former work, and the only relief experienced by the spectator is that he knows not the destination of the bust. The visitor might presume that it was intended as a portrait of some member of the Royal Family, although it is characterised by resemblance to no member of it. It is a "pretty" work, and that is all. The second is a most graceful production; on the head is worn a tiara, and the drapery of the bust is a composition of much elegance. No. 1223, 'The Pet Bird, or Killed with Kindness,' E. H. BAILY, R.A., is a small statue of a child caressing a bird to death; and No. 1224, 'The First Thorn in Life,' P. MACDOWELL, R.A., is a group of two children, a boy and girl, the latter extracting a thorn from the foot of the other; the expression of the boy is strikingly natural, and the incident is altogether set forth with impressive truth. No. 1225, 'Sabrina,' H. CARBYELL, has a head too antique for a subject from modern poetry. The distinctions observed by the Greeks themselves should never be forgotten. She has not yet responded to the invocation to listen, but is still braiding her "amber dropping hair," with a disposition of the arms remarkably graceful. No. 1226, 'The Prisoner of Love,' G. FONTANA, is by no means a happy title, nor is the idea felicitously rendered—being realised by a female figure disconsolately seated, having her hands bound with a wreath of flowers: there is some beautiful modelling in the figure. No. 1227, J. S. WESTMACOTT, is a subject from "Lalla Rookh"—

"One worn a Peri at the gate
Of Eden stood disconsolate;"

we have accordingly a figure of the size of life, winged and semi-draped, standing in a *pose* of relief, with the right foot raised, and resting both hands on the thigh; the sentiment is amply and elegantly interpreted. In No. 1228, a 'Statue of a Nymph Surprised,' E. G. PAPWORTH, the lower limbs strike the observer at once as somewhat heavy; the nymph is seated, and the point of the subject is the surprise occasioned by a bird of prey having borne down to her feet a smaller bird, which it has seized. No. 1229, 'Venus and Cupid,' B. E. SPENCE, is a group of much beauty, and a subject in which the artist has felt that he dared not be original, and therefore reminds us of some of the most beautiful statues that remain to us—relics of the "Rhodian Art." Venus holds up a butterfly, which Cupid is all anxiety to obtain; in the extremities, and in every passage of the figures we recognise the antique. No. 1230, 'Titania,' J. LAWLOR, is a charming work, and pronouncedly an essay in modern poetry; she is active in thought, and the modelling of the limbs is ex-

* Of the Catalogue a few words. We intended last month to have made an observation on this subject, but in the pressure of other things it was forgotten. To go no farther than the sculpture, when we find such *errata* as No. 1240, 'Igeria,' and a little farther on such Latin as 'Dulce videmur Lalagen,' we may well ask again, as we have inquired before, "if there is nobody in the Academy who can correct a proof of the Catalogue?" We have been working with a first edition of the Catalogue—these and the many other inexcusable errors may have been charitably corrected in subsequent editions: it is, however, altogether inadmissible to say that a first edition of the Academy Catalogue cannot be correct—the Academy are masters of their own occasions, and respond to neither pressure from above nor below; and we submit that if there really be any one who can revise the Catalogue, that it should appear, even its first edition, faultless.

pressive of the warmth of life. No. 1231, 'A model for a bronze statue of the late Earl of Belfast, erected to his memory by the inhabitants of Belfast, and inaugurated by the Earl of Carlisle, Lord Lieutenant of Ireland, 1855,' P. MACDOWELL, R.A., is an erect figure treated with a loose drapery, but without allusion in anywise to classic form, being disposed with reference rather to modern taste. It is a fine example of pure Art; but as we shall have much to say on the subject ere long (having prepared an engraving of it), we postpone our remarks. No. 1232 is 'Angelica,' from "Ariosto," J. BELL; she is bound to a rock near the sea, to be devoured by a sea-monster, but is delivered by Ruggiero; the subject is dealt with in a manner extremely simple, being interpreted by a nude figure having the hands bound behind. The story of Angelica is not so well known as that of Andromeda; the impersonation will, therefore, most commonly be presumed to represent Andromeda, the daughter of Cassiope, more beautiful than Juno and the Nereids. The same number, with an asterisk, stands against 'Imogen Asleep,' W. C. MARSHALL, R.A.—

"To your protection I commend me, Gods!
From the fairies and the tempters of the night,
Guard me—beseach you."

This is a small figure extended, according to the title, and covered with an elegant arrangement of drapery. It is altogether a chaste and carefully studied work; but in sculpture all recumbent figures have the disadvantage of suggesting monumental designs. It may be said that a difference is markedly maintained, but this is not always the case; any recumbent figure in a holy sanctuary becomes a monument, while the same in a sculpture-gallery is a sleeping figure. No. 1233, 'Queen Boadicea inciting the Britons to avenge the loss of their liberty, and the wrongs inflicted upon her children and herself,' J. THOMAS, is an upright heroic figure, which can be intended to impersonate no other historical character than Boadicea, who is here raising on high her sword, and calling down on the Romans all heavenly and earthly vengeance. Her daughters are intended to assist the narrative, one cowering on each side; but these figures are too little seen, and perhaps fall into a *pose* too identical. No. 1234 is a 'Group of Euphrosyne and Cupid,' by E. B. STEPHENS; and No. 1235, 'Charity,' T. AMBUCH, consists of one principal female impersonation, with subordinate infant figures; but in the modelling of the group there is generally much poverty of form. No. 1236, by G. G. ADAMS, is a recumbent figure of a little girl, intended, we may suppose, for a monument, as to the number is appended a quotation of elegiac verses—

"The strife is o'er, death's seal is set
On ahy lip and marble brow;
'Tis o'er, though faintly lingers yet
Upon her cheek a life-like glow."

No. 1238, 'The Youthful Achilles,' H. BANDEL, is the story of his being disguised in female attire among the daughters of Lycomedes. He has put on the helmet, and has taken the shield which Ulysses, in the character of a hawk, had brought for sale. There is some originality in the idea, but the figure is carelessly modelled and badly cast. No. 1239, 'The Skipping Girl, a statue in plaster,' by Mrs. THORNYCROFT, a figure of the size of life, is studied to represent graceful movement, in which it is highly successful; the work looks like a portrait statue. No. 1240, 'Egeria,' J. H. FOLEY, A., is a large figure of much sweetness of character, presented in a *pose* of relief, and conceived rather in the spirit of human charity than of glorified deity. It has been executed in marble for the Corporation of London, to be erected in the Egyptian Hall, in the Mansion House. 'Hermia and Helena,' No. 1241, W. C. MARSHALL, R.A., is a charming subject from the "Midsummer Night's Dream." No. 1245, 'The Model of "Lalage,"' from Horace, J. BELL, is perhaps somewhat difficult of recognition. No. 1247, 'The Milton Vase,' W. J. WILLS, is an admirable subject; the bas-reliefs here are from the sixth and eleventh books, and the narrative pronounces at once the source of the subject-matter. No. 1250, 'Rachel, the daughter of Laban,' J. THOMAS, presents a very elaborate study of drapery; and the accessories of pastoral life assist the spectator to determine the subject. No. 1251, 'The Racket Player,' by J. E. THOMAS, is a nude figure, a study of action sug-

gested by the antique athletes. No. 1255, 'Maidenhood,' J. HANCOCK, is a subject from the verse of Longfellow—

"Standing with reluctant feet
Where the brook and river meet,
Womanhood and childhood meet," &c.

It is a statue of great refinement of conception, beautifully modelled, though the appearance of the lower limbs through the drapery is scarcely a feature coincident in spirit with the rest of the work. No. 1256, 'Rebekah,' E. DAVIS, is a large life-sized figure, semi-nude, bearing a water-cruise on her right shoulder; it is a graceful figure, but the two divisions of the nude and the draped are perhaps too arbitrary. Among the other striking productions may be mentioned No. 1267, 'A Boy Playing with Tali,' W. M. THOMAS; No. 1270, 'Statuette of the Rev. Robert Montgomery,' E. G. PAPWORTH, Sen.; No. 1271, 'Statue of Robin Hood,' Miss S. DURANT; No. 1293, 'Figure in alto-relievo of Miss Helen Faneit,' J. H. FOLEY, A.; No. 1296, 'Marble bust of Lady Macaine,' E. B. TUSSAUD; 'W. Stuart, Esq.,' E. DAVIS; No. 1307, 'John Propert, Esq.,' J. E. THOMAS; No. 1315, 'Bust of the late Lord de Manley,' T. CAMPBELL; 'Bust of the late Sir Charles Hulse, Bart.,' J. H. FOLEY, A.; 'Bust of the late Duke of Beaufort,' G. G. ADAMS; 'Bust of Mrs. Wilson,' T. EARLE; 'Bust of a Gentleman,' A. MUNRO; 'Love,' T. WOOLMER; 'George Lauce, Esq.,' E. DAVIS; 'Bust of Lieut-Gen. Sir Colin Campbell,' G. G. ADAMS; 'Marble bust of the late Sir Charles Adam,' 'Bust of the late Lord Truro,' H. WEEKES, A., &c. &c. Thus we find contributions from some of our most eminent sculptors, but their works generally, especially those that are imaginative, are below that standard which has won them the reputation they bear. Again, however, we must say that the light in this room is, we think, reduced by the means taken to diffuse it, inasmuch that but few of the works are really seen; dare we hope in a new sculpture-room that the designs will be so successful, as to obviate all the evils which are now so justly and so bitterly complained of?

THE BRITISH INSTITUTION.

The collection of "old masters" is this season brilliant and well-conditioned; we have never seen on these walls any collection in more perfect preservation—many of the works have been cleaned, re-varnished, and some perhaps touched upon, but against none can any objection be urged on the score of condition. Here are represented a number of the best galleries in the country—not perhaps by the best works in those collections, because many of these may have been recently seen here; but by productions which, if they afford only an average of quality, declare a vast amount of wealth, a selection from which would furnish forth one of the richest catalogues in Europe. From the Queen's collection there is one picture—one of Wilkie's Spanish subjects, 'The Guerrilla taking leave of his Confessor,' as about to enter upon a campaign during the late civil war in Spain. As a pendant to this work, there is another, perhaps also in the Royal Galleries—'The Guerrilla's Return,' which shows the same man returning wounded to his home. The picture is executed with that sketchy freedom which distinguishes the manner of all Wilkie's latter works. The Duke d'Annable contributes two Salvator Rossas and a Guercino. The South Room, as usual, contains examples of our school, with a mixture of older works. Among the former we always look for striking instances of portraiture, and now we find, as heretofore, brilliant works by some of the most eminent of our painters—those who have shared among them the mantles of Antony Vandeyck and Diego Velasquez. Over the fireplace in the North Room is a large portrait by RUBENS—'George Villiers, Duke of Buckingham, on Horseback,' with allegorical figures. The duke, mounted on a prancing steed, is en-

wreathed by cupids and aerial figures in a sea-shore composition; it is throughout, in its qualities and disqualifications, worthy of Rubens. 'The Fish-market,' by DE WITT, is hard in execution and artificial in effect. Near these are two works by VANDERWELDE, which should be pendants, but they belong to different proprietors, Lord Enfield and Lord Derby; they are small, simple pictures, that of the latter nobleman being the preferable. 'An Incantation,' by TENIERS, is a curious piece of witchery in a garland of toadstools and brambles, all admirably studied from Nature, but, we think, with little connoisseurship in fungoids on the part of Teniers. A picture, entitled 'A Boy showing a Trick,' is attributed to LEONARDO DA VINCI, but it is not characterised by his usual feeling in anything. 'St. John,' ANDREA DEL SARO, is a study of the back of a youth, apparently executed at one sitting. The two JAN STEENS, the property of the Duke of Wellington—'A Wedding Feast,' and 'A Merry-making'—are well-known pictures. The artist will never be a favourite with lovers of the finer qualities of Art. 'A Landscape and Figures,' by BOTH, is evidently a composition, but it is a successful imitation of the way in which Nature herself composes; it is full of light and genial warmth; all the objects, the trees especially, have been studied with the nicest care. Near this is a very remarkable portrait—that of Parmigiano, by himself—brilliant in colour, full of thought and character, and picturesque in attire, almost in too good condition to be of the time of Parmigiano; but he was one, it is true, that worked with the simple indestructible earths, before the chemistry of the Art introduced pigments of transient effect. Another 'Landscape and Figures,' by PYNAKER, is a production of infinite beauty, distinguished by a profitable tone of thought, and a masterly appreciation of the executive material of Art, in so far as it is available in the interpretation of the phenomena of Nature; and near this, yet another 'Landscape and Figures,' in which shine two stars, though of different constellations: these are RUYSDAEL and BERGHEM, the former of whom we recognise, but not the latter, because Bergheim's effect is wanting to Bergheim's figures; yet it is a picture of rare merit, although too composite in a variety of parts. 'A Dutch Family,' by N. MAAS, is a gem; and the VAN DER HEYDEN—'A View of a Town'—the property of the Duke of Wellington, is a most literal study from a street subject, in which no brick has been forgotten.

In the same room there are, moreover, a number of other pictures, which at once proclaim their high merit:—as 'The Marchese di Savorgnano,' TITIAN; 'A Sea-port,' CLAUDE; 'A Guard-room,' TENIERS; 'Portrait of Paul III.,' TITIAN; 'Hobbima's Village,' by himself; 'The Crucifixion, from the Church of Vittoria, Rome,' GUIDO; 'A Portrait,' by MURILLO; and 'The Temple of Jupiter Panellenus, Island of Egina—Athens in the distance,' by TURNER, one of those charming works to which Turner gives a feeling more reverentially classic than Claude. Turner qualifies his earthly landscapes for the abode of gods, but Claude disqualifies his deities as the mortal inhabitants of an earthly landscape. This is a magnificent work—one of those of his most intelligible period. In the Middle Room are three VANDYKES—'Penelope, Lady Spencer,' 'William Cavendish, Duke of Newcastle,' and 'Philip Herbert, Earl of Pembroke and Montgomery'—but they are not among his finest works—not to be compared with the Dresden or the Petworth Vandykes. 'The Holy Family,' by GIULIO ROMANO, is evidently a studious essay in colour, very highly wrought, and full of material. There are two SALVATORANS, in which the landscapes are very careful,

and the figures unusually imperfect. They are severally entitled—'St. Paul Preaching,' and 'St. Peter taking the Piece of Silver from the Fish's Mouth.' And after these we find three gems hung over the fireplace:—the famous 'Bonnet Rouge' of TENIERS, which it is unnecessary to describe; a 'Head of a Female,' (modest title,) by GREUZE; and a 'Landscape,' by BOTH. The head is from the same model that Greuze worked so much; we find her, accordingly, in various pictures, younger and younger, or older and older, according to the period of the work. The tints here are extremely delicate and varied. The picture by Both is a small landscape, charming in airy, broken, and unpositive colour, and most masterly in retiring and unpedantic execution. In this room there are four Canalettos, all the property of Sir J. C. Jervis—and all in excellent condition. We never look at Canaletto without feeling that he alone, of all painters, has dared to be faithful in his pictures of 'Venice.' We look at his houses and recognise them as habitations; his palaces are not scenic and visionary, but venerable and historical; he looked at Venice through a microscope, others look at her through a telescope. The remnant of the Cartoon of Pisa (so well known from engravings), a drawing by Michael Angelo and Pontorno, is in much better condition than drawings of that period generally are: this drawing is not less curiously unscenic than 'The Fall of the Damned.' In this room are many other admirable and valuable works—as 'A Hawking Party,' PAUL POTTER; 'Venus Wounded,' PAGI; 'The Ferry-boat,' BOTH; 'A Concert,' DE HOOGHE; 'The Embarquement of Van Tromp,' 'Portrait of himself,' VANDERWERF, &c. In the South Room the visitor will be struck by the excellence of three small pictures by P. NASMYTH; we instance them thus, because those we generally see under this name look like meagre imitations in comparison with these: we commend them to the attention of Pre-Raphaelites. 'Mrs. Gage and Child' is a small life-like study by GAINSBOROUGH, and near it is a picture by COLLINS, 'A view on the Beach near Cromer.' 'Sigismunda,' by HOGARTH, is an essay in the grand style, in which we should have been surprised if the famous ethnic painter had succeeded. Two pictures, each respectively called 'Ruins' and 'Figures,' afford good examples of the manner and material of GUARDI; and near these, in 'A Dutch Coast Scene,' by Sir A. W. CALLCOTT, we recognise the expressive power possessed by that artist, in the description of heat and a breadth of hazy light. The portrait of 'Lady Ladd,' by REYNOLDS, will, as years roll on, cause increased wonder that such an extraordinary head-dress ever could have been worn. 'The Crucifixion, with portrait of Martin Luther,' by ALBERT DURER, is a small picture in three compartments, very highly wrought; but the drawing is not so satisfactory as that in other works by him. 'Garrick in the character of Richard the Third,' by HOGARTH, is a well-known work—perhaps the best portrait Hogarth ever painted, save always that of himself. Other valuable works here are:—'View in Italy,' WILSON; 'Peasants in a Wood,' MORLAND; 'The Bridge of Rimini,' WILSON; 'Elizabeth, Charlotte, and Horatio Waldegrave, Countess of Waldegrave, Duchess of Grafton, and Lady Hugh Seymour,' a group of life-sized figures, by REYNOLDS; portrait of 'Miss Imter,' by the same; 'Landscape with Sheep,' GAINSBOROUGH, &c. The collection abounds with small works of much excellence, and, indeed, with many gallery pictures of high character. Year after year may the enthusiast visit this collection with ever increasing admiration at the exhaustless stores of pictorial wealth which annually adorn these walls with examples of Art so captivating.

ART IN CONTINENTAL STATES.

PARIS.—Death has recently deprived France of two artists—Jazet, the engraver, and Ducornet, the painter, an obituary notice of whom appears in our present number. Jazet was aged only 40; his principal works are:—'The Slave-market,' after Horace Vernet; 'Edward's Children separated from their Mother,' after Gosse, for which he gained a gold medal in 1842; 'Galileo at Florence,' after Gosse, and two subjects after Schopin, from the tale of 'Paul and Virginia.'—It has been decided that a monument shall be erected at Rheims to the memory of Colbert, the celebrated minister of Louis XIV., that town being his birth-place. The committee is presided over by M. A. Fould: the monument will take the form of a statue; the artist to be decided by public competition.—In the street 'Quincampoix,' on demolishing an old house, four paintings were recently discovered; an amateur passing by bought them for a few francs; this fortunate person is now in possession of two beautiful paintings by Chardin, and two by Oudry.—M. Lazerges has just finished a chapel of great merit at the Church of St. Eustache; it is dedicated to St. Anne.—The Gallery of the Luxembourg, lately shut for repairs, is again open, with several additional paintings.—A fine female statue has been discovered near Cherebell, which has been placed in the Museum; it is six feet in height.—Letters from Bagdad state that the splendid sculptures sunk in the Tigris by the Arabs have been recovered; they were excavated at Nineveh by M. Place. Nerraud-Bey, aide-de-camp to the Governor of Bagdad, directed the work for their recovery with great intelligence; we are in hope of soon seeing them in Paris.—The Emperor has visited the Louvre, in which are soon to be installed the different individuals who are to reside there; several fresh rooms are to be appropriated to various departments of Art, there being still an immense quantity of paintings, sculptures, &c., in the warehouses, stored away, which are to be brought to light.—The Louvre has just made a most valuable acquisition in a manuscript volume in folio, filled with sketches by Leonardo da Vinci. It has been purchased from M. Villardi, of Milan, for the sum of 35,000 francs, or £1400 sterling. It is a well-known fact that, in 1797, thirteen manuscript volumes of Leonardo were transferred from Milan to Paris; one of these, which had been deposited in the Bibliothèque Impériale, was restored by the allies in 1815. The other twelve are still in the Bibliothèque de l'Institut.—The Italian review, *Arti del Disegno*, notes the recent discovery of a little picture by Michael Angelo, differing from that from which it would seem, Bonsoni, Beatrice, Cavalieri, Rota, and Landon, have given engravings. This little canvas represents Christ dead, on the knees of his mother, who lifts her head and arms to heaven, she being sustained under the arms by two angels.—A bust of the composer Lesueur has been placed in the Gallery of the *Académie Impériale de Musique*, by order of M. A. Fould.—A statuette has lately been discovered at Antwerp, representing Salvius Brabo holding the mutilated hand of the giant of Antwerp, and treading on a warlike instrument; this statuette, marvellous in execution, is attributed to Quentin Matsys; it was found in a garret of the *Hôtel de Ville*; it is of iron, gilt.—The demolition of old Paris continues on a large scale; at the *Hôtel de Clugny* large portions of the *Palais des Thermes*, built by the Emperor Julian, have been brought to light, having been hitherto shut out by the houses of the *Rue de la Harpe*; it is said they will be preserved "en place," and a garden formed, surrounding one side of the *Hôtel de Clugny*.—The "Hemicycle," by Paul Delaroche, which was damaged by fire, has been successfully restored.—An exhibition is announced to take place at Amsterdam, to be opened on the 9th of September; all pictures, &c., sent must arrive by the 25th of August next.—On dit, an "Arc de Triomphe" will be erected in honour of the campaign of the Crimea.—The Emperor has ordered of Horace Vernet the portraits of Marshals Bosquet and Canrobert for Versailles.—At the *Hôtel Drouot* was recently sold a Cupp, "Interior of a Stable," for 14,000 francs.—A gallery of a Roman prince has also been disposed of in Paris; when a "Diana Hunting," by Vandyck and Sneyders, sold for 4500 francs; "Virgin and Child," Macchiavelli, 5500

frances; "Zingarella," Correggio, 10,200 francs; "Virgin and Child," Ghirlandajo, 1700 francs; "Portrait of Taddeo Taddei," by Raphael, 14,000 francs. These three last were part of the Gallerie Giustiniani.

LYONS.—A *Museum of Lace*.—What, as we stated in a previous number, a public body is about to effect for Lyons, a spirited individual, M. Theodore Falcon, has undertaken to do in respect to Pay; wherein, it appears that, as a manufacturer of that delicate article, he has acquired an independence. It need not be remarked that an extremely interesting and various collection of specimens of that most ancient and elegant tissue can be brought together. At Honiton, or Limerick, it may not be known that St. Francis-Regis of the Roman Calendar is to lace, what St. Crispin is to the less refined pursuit of shoe-making—viz, its patron. M. Falcon meditates, it seems, erecting in his museum a statue of the said saint, representing him at the moment when, in the year 1629, he cheered the hearts of the lace-workers of Pay, depressed and full of apprehension in consequence of certain sumptuary laws just enacted, and exclaimed to them, "Ayez confiance en Dieu, la dentelle ne perira jamais."

OBITUARY.

LOUIS-CESAR-JOSEPH DUCORNET.

This artist was born at Lille, the 10th of January, 1806, and was one of a large family in poor circumstances. Nature had made him the subject of sad bodily deformity, for he was born without arms or thighs; he had only four toes to his right foot, which otherwise was admirably formed. Until the age of six he was weakly, and could with difficulty support himself; this state was probably the means of developing his talent as an artist. The rest of the family being busy in their daily occupations, young Ducornet was left to roll about on the floor, and thus acquired the habit of picking up bits of charcoal from the hearth, and amusing himself in drawing on the wall all the objects that presented themselves to his eye. In the same house dwelt the nephew of M. Watteau, professor of drawing at the school, whose children were in the habit of playing with young Ducornet. One day they requested their father to show him how to draw a flower, who answered that he would teach him the principles of drawing, on condition that M. Dumouelle should also teach him to read and write; the proposition was accepted, and Ducornet continued to work with the children of Watteau. The Mayor of Lille, the Count de Mussyard, seeing the rapid and intelligent progress of the child, obtained for him a pension of 300 francs from the municipality. Some time after, M. Pottesau, deputy of the department, with the assistance of M. de Mussyard, caused him to be sent to Paris, and placed in the atelier of Lethiere, where he was treated by that painter as a son, and by the pupils as a teacher. Through the intervention of Baron Gerard, Charles X. assigned him a pension of 1200 francs per annum, which was paid him until the downfall of that monarch in 1830: it was never renewed, notwithstanding Baron Gros interested himself greatly to obtain it.

Before 1830, he painted the "Parting of Hector and Andromache," also several portraits. At Cambrai he gained a bronze medal for his picture of "Repentance;" in 1840, a gold medal, 3rd class, for the "Death of Mary Magdalen;" in 1841, one of the 2nd class in gold, for the "Repose in Egypt;" and in 1845, a gold medal, 1st class, for "Christ in the Sepulchre." In 1853, he exhibited his last painting, "Edith," a commission from the Emperor; these paintings were all large life-size. He also gained several medals in various provincial exhibitions. This artist presents an interesting proof of what may be accomplished by perseverance and study, with even limited powers. Ducornet died in the arms of his venerable father, who never deserted his darling boy; he is now left in poverty in his old age. At the Paris Exhibition might frequently have been seen the extraordinary spectacle of a poor aged man, with a short middle-aged one on his back, mounting slowly the long and steep flight of stone steps of the *Palais des Beaux Arts*—this interesting group was Ducornet and his father. A sale is being organised of the paintings left by Ducornet; let us hope that the bidings will be sufficiently liberal to enable the survivor to end his days in peace and comfort.

PAUL AND VIRGINIA.

FROM THE GROUP BY W. C. MARSHALL, R.A.

The sculptor of this group has chosen a subject which must have severely tested his powers of conception, if we examine it by those principles which are presumed to regulate the rules of Sculpture. Thus, for example, the arrangement of the figures throws the whole *weight and substance* of the composition into the upper half; the result is that when viewed from the point presented in the engraving, the work has the appearance of being what is commonly called "top-heavy"—a defect, if we may so term it, that might have been obviated by the introduction of a mass of rock, or something of the sort, at the base to act as a counterpoise. The stump of the palm-tree placed there merely to support the weight of the figures is not sufficient to restore the balance which the eye requires to remove from the mind the sense of insecurity, and to produce an impression of general harmony of the parts.

On the other hand, it must be admitted that Mr. Marshall has succeeded in overcoming a very difficult task in representing two figures thus circumstanced: they are of nearly equal size; and, ordinarily, the act of one person carrying another in his arms has an awkward, if not a ludicrous, appearance; but by a skillful arrangement of the upper limbs, and a judicious disposition of the heads, the group, in the upper division, becomes a graceful object. The sculptor has carefully avoided all sharp angular lines, not very easy to do when we consider the action of the figures. The work is not a recent production of the sculptor; it was exhibited at the Academy as far back as 1845, the year after Mr. Marshall had been elected associate.

We apprehend that few of our readers have read, since their school days, the charming little tale of Bernardin de St. Pierre; it may, therefore, be necessary to refresh their memories with the incident which forms the subject of Mr. Marshall's sculptured group. Paul and Virginia, returning from their mission on behalf of the runaway nigger, contrived to lose themselves, and wander about till they came to a river, which threatened to arrest their onward progress. "The noise of the waters alarmed Virginia, and she was afraid to wade through them; Paul then took her on his back,"—the sculptor has very rightly placed her in the arms of her young companion, instead of following the indelegant mode of transport indicated in the text,—and passed thus loaded over the slippery rocks which formed the bed of the river, regardless of the tumult of its waters. "Do not be afraid," he cried to her, "I feel very strong with you." The features of the two forcibly indicate their respective feelings—the apprehensions of the girl and the bold encouraging words of Paul—the head of the latter is admirably modelled; so, indeed, is that of Virginia, but there is something in the expression of the mouth which is not quite agreeable: it is so long since we saw the original that we cannot determine whether the defect rests with the sculptor, or whether it is to be attributed to the way in which the shadows fall on the face when our artist made the drawing from it; we rather suspect the latter to be the cause, and that, therefore, he could not remedy what appears a fault without violating the laws of light and shade.

To those who can see no beauty in Sculpture, save that which is after the similitude of the ancients, works of such a character as this must appear "flat, stale, and unprofitable," yet in reality they are not so, though we must allow this especial subject is better adapted for the painter's art than the sculptor's. To us, whose duty it is to mark everything that issues from the studio of the latter, almost any change is a relief: we are wearied with Cupids, and Venuses, and Psyches, and Musidoras, *et hoc genus omne*, and are glad sometimes to pass the boundary of the land of fiction, and find ourselves in that of fact, or of that which seems to approach to it. Moreover, subjects that belong to the class we may term "domestic," ought never to be considered perle, or beneath the notice of an artist of genius: he cannot go far wrong who addresses us in a language we understand, and in a manner with which our common feelings and sympathies are in some degree in unison.

THE ART-UNION OF LONDON.

The following pictures have been selected by the prize-holders of the current year up to the time of our going to press. The initial letters after the names of the artists indicate the respective exhibitions out of which the works were chosen.

'Old Bridge in Pella,' G. E. Hering, 206l., B. I.; 'Shades of Autumn,' A. W. Williams, 150l., N. I.; 'The Mid-day Meal,' H. B. Willis, 100l., N. I.; 'Hotel de Ville,' W. Callow, 73l. 10s., W. C. S.; 'Oyster Dredging,' E. Duncan, 105l., W. C. S.; 'Cochem on the Moselle,' V. Cole, 75l., S. B. A.; 'View in Dove Dale,' J. C. Ward, 80l., S. B. A.; 'Scene from the "Gentle Shepherd,"' W. Underhill, 60l., B. I.; 'Early Moring,' H. B. Willis, 60l., N. I.; 'Medmenham Abbey,' H. J. Boddington, 60l., S. B. A.; 'Youthful Gamblers,' T. Clater, 60l., S. B. A.; 'A Summer's Mornings,' H. J. Boddington, 60l., S. B. A.; 'A Group of Wild Flowers,' Mrs. Withers, 50l., N. I.; 'Landscape with Sheep and Figures,' G. Cole, 50l., R. A.; 'Dutch Vessels entering Lillo,' T. S. Robins, 50l., N. I.; 'On the Conway,' J. C. Ward, 50l., S. B. A.; 'Holy Island,' W. H. Paton, 50l., R. S. A.; 'A Welsh Fireside,' D. W. Deane, 50l., R. A.; 'Landscape with Cattle,' J. E. Meadows, 40l., S. B. A.; 'The First Buttons,' D. H. Friston, 30l., R. A.; 'A Somersetshire Lane,' G. Frupp, 47l. 5s., W. C. S.; 'An English Lane,' H. J. Boddington, 40l., S. B. A.; 'The Plough Church of Bethanan,' A. P. Rolfe, 35l., S. B. A.; 'Homestead,' C. Davidson, 40l., W. C. S.; 'Thames Tow-barge,' W. S. Rose, 35l., N. I.; 'The Woodman's Repast,' H. P. Parker, 40l., N. I.; 'Ruse de Guerre,' T. M. Joy, 35l., B. I.; 'Scene near In-y-sy-bath,' J. Pennant, 50l., S. B. A.; 'Goat Field, Isle of Arran,' G. Cole, 30l., S. B. A.; 'Summer Shade,' E. G. Warren, 23l., W. C. A.; 'Yorkshire Farm-house Kitchen,' E. Colburn, 21l., S. B. A.; 'Way-side Inn,' R. Brandard, 25l., B. I.; 'View in Barmouth,' A. Clint, 25l., S. B. A.; 'The Mummies, in Swansea,' G. Wolfe, 25l., S. B. A.; 'Gipsies in a Wood,' J. E. Meadows, 35l., N. I.; 'All Saints' Church, Hastings,' C. Davidson, 25l., W. C. S.; 'Surrey Scenery,' W. Lukner, 25l., N. I.; 'Rain, Coast of Boulogne,' J. J. Jenkins, 26l. 5s., W. C. S.; 'On the Look-out,' J. Hensell, 25l., S. B. A.; 'Welsh Ford,' G. Shalders, 25l., S. B. A.; 'A Ferry-boat, Loch Leven,' W. Luker, 26l. 5s., R. A.; 'Vegetable-market, Venice,' J. H. Degville, 26l. 5s., N. W. C. S.; 'A Weary Journey,' C. Dukes, 25l., R. A.; 'Old Gateway, Guernsey,' J. P. Nattal, 25l., W. C. S.; 'A Forest Stream, Evening,' E. Gill, 30l., R. A.; 'A River Bit, North Wales,' J. Dentle, 25l., B. I.; 'Afternoon,' A. J. Stark, 25l., S. B. A.; 'Laura,' T. M. B. Marshall, 25l., R. A.; 'Head of Loch Lomond,' P. C. Auld, 30l., S. B. A.; 'Dutch Vessel beating out of Harbour,' E. Hayes, 20l., N. I.; 'A Beech Grove,' F. O. Finch, 20l., W. C. S.; 'The First Scrape,' R. Farrier, 20l., R. A.; 'The Evening Gun at Castle Cornet,' J. P. Nattal, 25l., W. C. S.; 'Surrey Cott Scenery,' J. J. Wilson, 20l., R. A.; 'A Water-Mill, Dolgelly,' A. Barland, 20l., S. B. A.; 'Goldfinch, and other Singing Birds,' Mrs. Withers, 20l., S. B. A.; 'Rouen,' A. Montague, 20l., N. I.; 'A Farm Pond,' J. Stark, 20l., B. I.; 'Highland Courtship,' Jessie Macleod, 25l., S. B. A.; 'Trellis Vine,' W. W. Penn, 20l., R. A.; 'The Last Gleam in the West,' H. B. Gray, 30l., N. I.; 'Roman Peasant Girl,' T. Godderson, 20l., B. I.; 'Fresh Breeze,' J. Meadows, 20l., S. B. A.; 'Favourite Retreat, North Wales,' F. W. Hulme, 20l., R. A.; 'Distant View of Edinburgh,' J. Callow, 21l., W. C. S.; 'Turk Boats,' M. A. Hayes, 21l., N. W. C. S.; 'Dunkirk,' A. Herber, 30l., R. A.; 'Fresh from the Garden,' O. Oakley, 21l., W. C. S.

ART IN THE PROVINCES.

STOKE-UPON-TRENT.—The committee appointed to promote the erection of baths and washhouses in Stoke-upon-Trent, towards which Mr. H. Minton lately offered £500, have unanimously resolved, "That his recent liberal offer of the sum of £500, towards the erection of public baths in this town, affords a desirable opportunity for giving public expression to the regard generally entertained throughout the country for his public and private character." The project (according to the *Stafford Advertiser*) is to erect a public building by subscription, which shall adjoin the baths, and be appropriated to the advancement of Art and Literature, particularly amongst the young, and with which Mr. Minton's name is to be associated in perpetuity. Few gentlemen have deserved better of his neighbours than Mr. Minton; he has been foremost in every good work in the district for which, as a







PSYCHE AND CUPID

SCULPTURE BY MESSRS. SCOTT AND BROWN, 1841

THE SCOTTISH ARTS AND MANUFACTURES GALLERY

manufacturer, he has done so much. But his useful labours have been far more widely extended: he has elevated the repute of British porcelain in all parts of the world, and so increased the trade in one of the most important of the Art-productions of his country. Although the Potteries are more directly interested in this "Testimonial," there is no reason why it should be limited to them, and we hope it will not be so.

GLASGOW.—The town-council of Glasgow recently had a long debate on the propriety of purchasing the "M'Lellan Gallery," described in the *Art-Journal* of December last. We had understood that the late Mr. M'Lellan had presented his pictures, and the edifice he caused to be built for their reception, to the citizens of Glasgow, and we so stated; but it seems, from the discussion referred to, that a sum of above £40,000 will have to be paid for their acquisition. A motion was made, that "the purchase of the property, on the terms proposed, be not agreed to," to which the Lord-Provost proposed an amendment, that the "Council take over the buildings and pictures at the price of £44,500," which was agreed to on a division, by a majority of five; forty-three councillors being present, and voting. Some curious remarks were made, during the discussion, on the state and quality of the pictures: one speaker objecting to the purchase on the ground that the collection contained too many representations of the nude figure; another said that Mr. M'Lellan himself used to attempt to *improve* the paintings by touching them; and that the first thing the council must do, if the purchase were effected, would be to "bring them back to their pristine state." Another connoisseur remarked, "that he never saw anywhere such a large collection of rubbish in the shape of paintings as was to be seen in this gallery." The majority, however, were of a different opinion, and testified it by their votes.

ROVRSOR.—The small town of Roxton, in Hertfordshire, which contains a population of not more than 2000 persons, now has its Institute, devoted to literary, scientific, and educational purposes, with a Museum—comprising more than nine hundred specimens of artistic and scientific objects—library, reading-rooms, class-rooms, and a spacious lecture-hall. At the inauguration of the building, which has just been completed, Mr. Robert Hunt, F.R.S., delivered a lecture on the purposes to which the edifice is devoted, and on the general character of the contents of the museum. The number of subscribers to the Institute, paying for the privilege of attending it, is already 240, or about one-eighth of the entire population.

MINOR TOPICS OF THE MONTH.

THE NATIONAL GALLERY OF PORTRAITURE.—Parliament has granted £2000 as its first annual contribution to a National Gallery of Portraiture; so far the wise and patriotic recommendation of the Earl of Stanhope has been carried out. The work is at all events commenced; although the sum is so small, it was not given without a murmur: the objections urged might have been urged against any project by which the people are to be enlightened and encouraged—against any tax that was to pay a thousandfold, by removing from the future the national reproach we have had to endure in the present and the past. If "history is biography teaching by example," there can be no teachers like the portraits of great and good men, who have been public benefactors. Nelson is not the only hero whose incentive to victory was a niche in Westminster Abbey; and who shall say what heroism of intellect may not be stirred into action by the prospect of a place among British worthies in this gallery? It will be at once a stimulus and a reward. Some apprehension was expressed lest the collection might be sectarian and not enthrone. We know that a narrow and shallow prejudice kept the statue of Cromwell from the Palace, and Byron from the Abbey, at Westminster; but we cannot dread the influence of so poor a spirit in forming a collection that will be so emphatically the property of the people. Probably the first effort to familiarise the public with this valuable novelty will be to borrow from various sources authentic portraits, and exhibit them at Kensington—a more graceful inauguration of the new building could scarcely be desired. It would then be seen what works it might be most advisable to copy; for many years must elapse before a collection could be formed by purchase or bequests.

Original portraits are for the most part heirlooms in families, and can rarely be obtained; nevertheless, in time many acquisitions may be looked for. The sum to be expended is small; but judiciously expended on good copies it will go a long way—perhaps so far as to obtain thirty or forty portraits in a year, and these of the best order; so good, indeed, that the ordinary eye shall not be able to distinguish them from the original. The Government has done well and wisely by urging and sustaining this movement; it is another step in the right direction for the intellectual advancement of the people, and we congratulate the estimable president of the Society of Antiquaries on this result of his patriotic labours.

THE SCUTARI MONUMENT.—We blush to write it—Parliament has passed a grant of £17,500 for the abortive attempt of M. Marochetti to record the triumphs and the losses of the British army in the East. "A portion of the monument" was sent off before the sum was granted; government, having, it appears, safely calculated upon removing all objections to the work and the amount. Mr. Bowyer, indeed, in his simplicity wished to know, "before the committee agreed to the vote, what the monument was to be, what artist was to be employed, and how it happened that so large an amount was required,"—as if all these things had not been settled long ago, and the country had to do any more than pay the money. Lord Palmerston, in reply, described the monument as "of extreme beauty," which would, he was sure, be "the admiration of all who saw it." We presume to differ entirely from his lordship, and venture to assert that nine out of ten who see it will consider it only as a work of Art of inferior character, meagre in design and weak in execution. But that is not the main point at issue—there are half a dozen great sculptors (unhappily for them *British* sculptors) who would have produced this monument for less than one half the amount which the British people have paid for it; we do not hesitate to name them—Baily, Foley, MacDowell, Bell, Calder Marshall, Behnes,—reference may be made to either of all of these for confirmation of this fact: and in estimating the work at less than one half of £17,500, we include the cost of its transfer to Scutari, and its erection there. Any protest against this discreditable "commission" is now useless; with the support of the Government and the all-powerful aid of the *Times* newspaper, Baron Marochetti may laugh at any efforts to obtain for British Sculptors a share of the honours and emoluments he is destined to receive from the British people; but in the name of the public and the profession, we protest against patronage entirely uncalculated and unmerited, and which acts as "a heavy blow and great discouragement" to prejudice an Art in which our artists surpass those of any other country, but which requires especial sustenance at the hands of the nation, in order to remove the difficulties which must always stand in the way of its prosperity. We say again, there is no honest man in Great Britain, if he do his duty, who will not raise his voice against this act of gross injustice and absolute treachery.

THE ILLUMINATIONS.—Unhappily upon this subject we have very little to say: the resources of Art seem to have contributed nothing to the memorable 29th of May—if we except the colours with which professors of pyrotechny so lavishly filled the atmosphere. The streets were indeed abundantly garnished with crowns, stars, and letters V. R. and N. E.; but instances in which thought was exercised, and taste had laboured, were extremely rare. "Stars of gas," and "stars of lumps," might have been counted by hundreds; and there can be no doubt that a very large sum of money was expended on "orders" to purveyors to make "something that would do," we looked in vain, however, for a solitary sign of originality, elegance, or appropriate grace. The result is certainly humiliating, and says less than nothing for the advancing progress of the age. There are but two examples which call for especial comment—the illumination at the National Gallery, and that at the Board of Trade in Whitehall. The public had a right to expect that some evidence of proceedings within should have been indicated without. In the former, the exhibition of the Royal Academy was at its zenith: our best artists are members thereof, and might have been called to conneil by the trustees: all they could do, however, or all they did do, was to put up a monstrous black board, with holes in it, through which holes were seen a couple of stars, a crescent,

a couple of crowns, letters V. A. and letters N. E., and a couple of laurel branches, not forgetting the name of the designer—some one at "Houndsditch"—which figured in illuminated letters a foot long in the corner. It was a display that might have been creditable to Madame Tussaud—but was to the last degree deplorable as the contribution of our National Gallery and Royal Academy, in combination, to tender homage to the great festival of a nation. The "show" at the Board of Trade was worse: this Board has the direction of the Government School of Art, and the masters thereof are at its beck and command. All that could be accomplished here was to put up seven gigantic letters—the word PEACE, with the letter V. before, and the letter N. at the end: these seven letters being linked together by a huge red cable, from which issued blue bands, to which the letters were suspended—the A, as a centre, having leaped a few feet above the rest. Both instances were proofs of low judgment and wretched taste; and may supply sufficient apologies for shortcomings everywhere. A glorious opportunity has thus been lost: surely the Royal Academy should have come to the rescue; and as surely the Board of Trade might have shown what its staff of Art-teachers and Art-students could do at Marlborough House. Verily, "they manage these things better in France." In Belgium, and in any of the German states, such an occasion would have been eagerly seized upon to give lessons in Art, and "the people" would not only have been delighted but instructed. Here it has been worse than lost. No one of the hundreds of thousands who walked the streets of London on the 29th of May went home a whit more enlightened, or with an iota more of veneration for, or love of, Art.

A GALLERY OF PICTURES has been formed at the CRYSTAL PALACE. The idea was suggested some three or four years ago: it has now been carried out; and, although of a character by no means satisfactory, it will be readily understood that many difficulties—some of them insurmountable—had to be encountered. On the whole, perhaps, the exhibition is as good as was to be expected; but another year may see, and ought to see, one much better. The Directors will do wisely to intrust this delicate task to one of their own body, in whom the artists may have confidence, giving due notice of their intention; for it will not do to make up a collection out of the "rejected" of the Royal Academy, and the "hang-on-hand" works of dealers, such as we now see in the Gallery at Sydenham. The principal object of the exhibition is, however, to accomplish sales; and it very rarely happens that artists of eminence have pictures unsold; consequently, to render the exhibition attractive, there must be a mixture of borrowed works; such is the case at present; there are two paintings—entirely by Sir Edwin Landseer and one by De Keyser—lent by the King of the Belgians; and scattered about we observe other loans, such as the "Charbonnier" of Rosa Bonheur. By far the majority of the collection consists of importations from France, Belgium, and Germany; a few of these are of value, but nine out of ten will find neither admirers nor purchasers; while the specimens of our English School, with a few exceptions, do little credit to it, and rather confirm the verdict of the Royal Academy bangers than justify a protest against their fiat. Anything painted and in a frame seems to have been welcomed by the collector, come whence or from whom it may; consequently, there is an immense mass of rubbish, making up a large assemblage, indeed, but which requires to be abundantly weeded to give pleasure or to do good. Still the exhibition, inferior as it is, adds another to the many intellectual enjoyments supplied by the Crystal Palace.

THE ROYAL ACADEMY.—It has been observed with no little indignation, that Mr. RICHARD COOK continues to be a member of the Royal Academy, although another year has passed and no work of his has been seen upon its walls. We perceive the word "Trustee" is appended to his name in the catalogue—what this word means we cannot say; but if we are rightly informed, not only months but years have gone by since he has attended even a business meeting of the members—contributing just as much to their official labours as he does to their annual exhibitions. There is but one word for conduct such as this—and that word we do not care to use. Year after year this "member of the

Royal Academy" keeps out of that body an artist of industry and genius who would be a credit to it, and to whom the distinction would be of value. If the Academy have no power to prevent this outrage, it is to their discredit that they do not obtain a remedy:

"He who upholds oppression shares the crime."

THE WOOD-CARVINGS IN ST. PAUL'S CATHEDRAL.—The attention of those interested in the preservation of the fine wood-carvings by Grinling Gibbons having been directed to those executed by him in the Cathedral of St. Paul, Mr. Rogers, whose name is so intimately identified with this Art, has, by the courtesy of Archdeacon Hale, made a close examination in order to ascertain their present condition. We believe the substance of his report to be this:—Taking first the outside of the choir, which is enriched with garlands of flowers and palms, he found that these have been so patched and mended at different times that the original intention can only be made out by the marks left on the wainscot ground; and even these have been disfigured by black dirt being rubbed into the grain of the wood, which has rendered them rather unsightly objects than agreeable architectural ornaments. Examining next the inside of the choir, Mr. Rogers ascertained that the lower tier of lime-tree carvings has white mildew in all the diaper cuttings. On looking down upon the sculptured work from the upper gallery, he found it covered with a black dirt a quarter of an inch thick, which the damp atmosphere is forcing into the open grain, and under this mass of dirt is the white mildew. The same may he said of the canopied stalls, the bishop's throne, and the enrichments of the organ; in fact, the whole of these beautiful works are rapidly perishing, and in a comparatively few years will crumble into dust unless means be taken for their preservation. The success which has attended Mr. Rogers' restoration of the carvings at Belton,—a report of which we published two or three months ago,—will, we trust, induce the Dean and Chapter of St. Paul's to entrust him with the task of repairing the Gibbon work in their cathedral. We understand he has formed a plan by which this may be effected without interfering with the daily use of the choir.

SALE OF DRAWINGS BY TURNER.—Ten small drawings by Turner were sold by Messrs. Foster and Son, on the 7th of June, at their rooms in Pall Mall; they were the property of Mr. J. Dillon, of Croydon, and realised nearly £1600. "Mount St. Bernard" realised 45 guineas; "The Pyramids of Egypt," engraved in Fuden's "Illustrations of the Bible," 87 guineas; "Nazareth," engraved in the same, 125 guineas; "Old London Bridge," engraved by Goodall, 235 guineas; "Junction of the Greta and Tees," engraved in Turner's "Yorkshire," 190 guineas; "Florence," engraved in Hakewell's "Italy," 160 guineas; "Plymouth," engraved by Lupton, 115 guineas; "Samar," 195 guineas, and "Nantes," 170 guineas, both engraved in the "Keepsake;" and "Llanrwst, Conway," formerly in the possession of Sir John Pilkington, 260 guineas. A set of early proofs of Turner's "England and Wales," with the etchings and intermediate proofs, was sold at the same time for 150 guineas.

THE NEW NATIONAL GALLERY.—A bill prepared by the Chancellor of the Exchequer and Mr. Wilson provides a site for a National Gallery, and after a lengthy preamble empowers the lords of the treasury to select and mark out such part of the land purchased by the exhibition commissioners, at Kensington Gore, as may appear suitable for the purpose of the site of a new National Gallery, with proper surrounding or adjoining space and approaches. This arrangement may then be considered final; and although there are strong objections to the site, perhaps objections equally strong might be urged against any other. We trust the building, when erected, will be worthy to contain the Art-treasures of the nation. Probably it will be the privilege of the next generation to witness the removal of the pictures; for Parliament, always reluctant to grant money for Art-purposes, will scarcely be induced to give a sufficiency except by slow instalments. We presume the present building in Trafalgar Square will then be given up to the Royal Academy; but we trust, whenever this is done, arrangements will be made for a wiser regulation of that body, and a government more commensurate with the spirit of the age and the requirements of the profession.

THE FOXLEY COLLECTION OF PICTURES, belonging to Sir Charles Price, was sold by Messrs. Foster and Son last month; the most important works among them were:—a small equestrian portrait of the Duc d'Orléans, by Velasquez, which realised 240 guineas; a companion picture, an equestrian portrait of the brother of Philip IV. of Spain, 176 guineas; and "The Battle between Alexander and Porus," by N. Berghem, 235 guineas. The entire collection, upwards of fifty lots, only realised about £1000.

THE GENERALS IN TENT AT BALAKLAVA.—A work of great interest and considerable merit—painted by A. Egg, A.R.A.—is now exhibiting at No. 6, Pall Mall; it is based on the photograph with which the public are familiar, and which represents the Generals Raglan, Pelissier, and Omar Pasha, in consultation. The picture is very carefully and very admirably wrought; the likenesses are of acknowledged excellence; and altogether few works are better calculated to make an effective print—a print which cannot fail to be acceptable as preserving portraits of the moving and guiding spirits of the war, whose names must be ever famous in history.

THE ALLIED GENERALS BEFORE SEBASTOPOL is another result of the war: a picture of very remarkable talent, and of the highest possible interest, has been painted by Mr. T. Jones Barker, to whose merits we have often referred, and especially in a late notice, which directed attention to his picture of "Napoleon on the Field at Bassano." The allied generals at Sebastopol are but the centres of groups—groups which represent no fewer than eighty of the more remarkable officers of both armies; the likenesses have been generally made from the photographs of Mr. R. Fenton, but many of the heroes have given sittings to the artist, and the result is an assemblage of portraits singularly faithful. The picture is of the very highest excellence—it is not too much to say there is no living painter who could have produced a better; each of the persons represented is distinctly portrayed, while there is no confusion, nor any undue pressing forward; it is a collection of portraits (and here is the chief object); but it is a picture admirably composed, in perfect harmony, and of very great interest, considered merely as "a subject." It cannot fail to elevate the character of the artist, who, in triumphing over many obvious difficulties, has given evidence of abilities of a remarkable order. It is to be commended to the skilful and able hands of Mr. C. Lewis for engraving, and is meanwhile exhibiting at the German Gallery, Bond Street. We regret that our space will not permit us to accord sufficient justice to this very interesting and attractive work.

STATUES OF BURKE AND CURRAN have been ordered by the Government for St. Stephen's Hall, at the cost of £7000 each. Mr. Thred is commissioned to execute that of Burke, and Mr. Carew the other. Thus the authorities are proceeding by slow degrees in the work of perpetuating the "forms and lineaments" of our great men: hitherto the selection has been made with judgment.

TESTIMONIAL TO MR. GEORGE GODWIN, F.R.S.—In our remarks on the stage-improvements introduced at the Princess's Theatre, we had occasion to remark on the valuable assistance Mr. Kean had received from Mr. Godwin—not only with regard to the "Winter's Tale," but to other plays of Shakspeare, which have been produced, not merely as acted dramas, but as practical lectures on pure Art—to instruct while they amuse, and to teach the most valuable of all lessons—truth. Mr. Kean obtained the best assistance; calling in the aid of those whose help could not have been purchased, but who, partly from respect to him, and partly from a desire to see the stage devoted to its high purpose of "educating," ably seconded the efforts of the liberal and intelligent manager. Among these, Mr. George Godwin was indefatigable in his exertions;—no one was better able to give assistance, and no one could have rendered it with better effect. In order to mark his sense of these services, Mr. Kean has presented to Mr. Godwin an elegantly designed CLARET JUG, in silver, bearing the following inscription:—

"To George Godwin, F.R.S., from Charles Kean, as a slight token of the high appreciation entertained for valuable assistance in Architectural Details, while carrying out the design of placing before the public correct Historical Illustrations of 'Macbeth,' 'Henry VIII.,' and the 'Winter's Tale,' produced in the years 1853, 1856,

1856, at the Royal Princess's Theatre, under Mr. Charles Kean's management.—May, 1856."

THE ROYAL SOCIETY is, it appears, to be located at Burlington House, giving up its present rooms in Somerset House; it has been resolved:—"That the proposal be authorised to accept and carry out the proposal of the government as to the occupation of Burlington House, on the understanding that the hall, which it is proposed to construct in the west wing, and which is to contain the portraits belonging to the Royal Society, shall be placed in the custody of the Royal Society, subject to the free use of it by the senate of the University of London at all times at which it may be required for their examinations and public meetings." The library of the Royal Society now comprises 45,000 volumes. The Linnean Society and the Chemical Society will also have accommodation given to them in Burlington House; and we presume in course of time the Society of Antiquaries will follow.

SOMERSET HOUSE.—The new wing of Somerset House, in Wellington Street, Waterloo Bridge, is rapidly approaching completion; within a very short time we may expect to see the scaffolding removed. The architecture is in strict harmony with the more ancient portion of the edifice; and when the new part is finished it will not only be a vast improvement to the locality, but it will constitute one of the most imposing frontages in the metropolis.

THE SCHOOLS OF ART.—Mr. Norman Maceled (the Registrar of the Government Department of Science and Art) has printed a list of the schools of Art throughout the united kingdom, in connection with the department, completed to May, 1856. From this list the following abstract may be given:—Established as schools of design, between 1841 and 1852, nineteen local schools. Established as schools of Art, since 1852, when the department was constituted—in 1852, two schools; 1853, fourteen schools; 1854, fourteen schools; 1855, two schools; 1856, four schools—thirty-six schools: total, fifty-five schools; including the nine London district schools, sixty-four schools. Number of persons under Art-instruction in public schools, 18,198; in central schools, 9041: grand total, 27,239 persons.

MEISSONIER A FOLLOWER OF IZAAK WALTON.—The *Artiste*, in a recent number, tells us that Rachel ordered a picture of Meissonier, of which she gave the piquant subject—"Fontaine reading his *Fable* of 'The Two Pigeons' to Racine and Boileau." Each figure was to have the price of 5000 francs, or £200, attached, and the work was to be finished, it is presumed, within a certain time. The subject was sketched, and one 5000 francs handed over, when, unfortunately, the fishing-season, with a tempting aspect, came in. Away is flung the canvas, back go the frames, and the painter abandons his study for some streamlet, there to illustrate the Johnsonian definition of an angler—a rod and a line, with a fool at one end, and a worm at the other.

KNIGHT'S COSMORAMA STEREOSCOPE.—This is a modification of the very popular instrument by Sir David Brewster. The advantages which it professes to afford are the greater facility with which the double images are made to form one picture, less fatigue to the eyes of the observer, and the ready adjustment of focus to different sights. By employing lenses of greater focal length, larger pictures may be viewed, hence its distinguishing name, the Cosmorama Stereoscope. Its peculiarities will be understood from the following description:—In place of the two small semi-lenses employed in Brewster's lensular stereoscope, Mr. Knight takes a plano-convex lens, $\frac{3}{4}$ inches diameter; this he cuts down the centre into two halves; these being placed together, an equal portion is removed from the opposite diameters. These two halves are now reversed, and the cut edges are brought together; this forms the cosmorama stereoscopic lens. Thus the outer diameter of the original lens is now the centre, and the centre of the original now forms the outer portions, on which the eyes of the observer rest in looking through it. This being the best part of the lens, may, in some measure, explain the reason of the presumed superiority of this form of stereoscope. We cannot refrain from expressing our hope that with some modification of this form of instrument, we may have public exhibitions on a large scale, in which Nature in all the perfection of her dimensions may be viewed, and the eye may be gratified by looking on realisations of scenes hallowed in history, without the fatigue of long and tedious

travel. In the charming miniature-scenes which are now familiar to most persons, the great want, especially when the human figure is not introduced, is the means of appreciating the size of objects. The mind does much, but not all that is necessary.

PHOTOGRAPHY UNDER WATER.—In a recent number of the *Journal of the Society of Arts* is an account, by Mr. W. Thompson, of Weymouth, of the means he has adopted for taking a photograph at the bottom of the sea, at a considerable depth. The camera was placed in a box, with a plate-glass front, and a movable shutter to be drawn up when the camera had reached the bottom of the water. The camera being focussed in this box on land, for objects in the foreground, at about ten yards, or other suitable distance, was let down from a boat to the bottom of the sea, carrying with it the collodion plate, prepared in the ordinary way. When at the bottom the shutter of the box was raised, and the plate was thus exposed for about two minutes. The box was then raised into the boat, and the rocks and weeds then lying in the bed of the ocean appeared represented in the usual manner. There is no real novelty in all this, for it has long been known among scientific photographers that such pictures could be taken under water; but the advantages have not hitherto been thought to be commensurate with the cost and labour of carrying out the process effectually. We hope Mr. Thompson may succeed in perfecting his process, so as to render it actually useful.

COUSIN'S "BOLTON ABBEY."—An early proof of this well-known engraving was recently sold by auction in the rooms of Messrs. Sothby and Wilkinson for 40 guineas—it was originally published at 12 guineas.

TAKING THE BUCK.—*Sir Edwin Landseer, R.A.*—We have been much gratified by the inspection of an important picture by the above eminent artist, at Mr. Bryant's Gallery, St. James's Street; and are anxious to draw attention to a production so fully and favourably embodying those peculiar felicities of conception and execution in which Sir E. Landseer has long stood, and still stands, unrivalled. The picture depicts most graphically an incident of exciting action. A fine stag is just fastened by the hounds, having been secured by a rope firmly grasped by the huntsman. The whole picture, painted some years since, is a masterly effort, and evidences, together with the special facility and power of this artist's pencil, an amount of elaboration which he rarely bestows on his present works. The subject is of large dimensions,—8 ft. 6 in. long by 7 ft. 6 in. high,—the figures and animals being the size of life. There is no doubt that an engraving of this work would be extremely popular. We recommend the numerous admirers of Sir E. Landseer (and they include all lovers of Art) to inspect this picture; indeed, Mr. Bryant's Gallery will well repay a visit, as it contains a number of admirable pictures, both by ancient and modern masters.

THE FIRST VISIT OF QUEEN VICTORIA TO HER WOUNDED SOLDIERS.—This is another offspring of the war, and one that chronicles its holier influences. It is recorded in the annals of the day that soon after the home-coming of several wounded soldiers, her Majesty visited them at the hospital at Brompton, and personally expressed her sympathy with their sufferings: the Queen did this accompanied by the Prince and their children. So touching an incident forms a theme worthy of Art; and the artist, Mr. J. Barrett, has very effectively dealt with it. The picture is now exhibiting at 162, Piccadilly, and is about to be engraved. A more desirable contribution to English homes cannot well be devised; happily, in all things the example of the Queen of England influences for good every class and order of her subjects.

AN APPEAL TO THE BENEVOLENT.—We are desirous of directing the notice of such of our readers as are in a position, as well as disposed, to render charitable aid, to an advertisement in our columns headed as above. The ease to which it refers is one eminently worthy of assistance.

IRON-WORK IN MILAN.—A correspondent writes to us to say, that "if some one of the numerous societies for the promotion of Manufacturing Art in England were to procure drawings, or even photographs, of the many iron gates, &c., in Milan, they would be a great acquisition to the British iron-trade." A published book of designs from the beautiful iron-works of the Continent is greatly needed here.

REVIEWS.

AN INTRODUCTION TO THE STUDY OF ÆSTHETICS. By JAMES C. MOFFAT, Professor of Greek in the College of New Jersey, Princeton. Published by MOORE, WILSTACH, & Co., Cincinnati; S. Low, Son, & Co., London.

The study of Æsthetics has, from the time of Christian Wolf, about a century back, been a favourite subject of inquiry with many German writers, whose speculations are rather curious than satisfactory; this is evident from the fact that scarcely any two of them arrive at a similar result as regards the principles of the science. The truth is that any attempt to theorise beauty, or to bring the perception of it within certain definable laws, as we would any ordinary branch of science—for this is what we understand by the somewhat indefinite term Æsthetics—must be only speculative; for, inasmuch as the sense to realise beauty varies according to the faculty a man possesses to perceive it, it seems impossible to reduce the subject to such a system as can be universally accepted. This appears to have been the opinion of Kant, who denied the possibility of the science of beauty—strictly so-called—because beauty is not a property of objects, as affirmed by Baumgarten and Winkelman, but has its origin in the disposition of our mental faculties.

Within the last half century this branch of philosophical inquiry has engaged the attention of other continental writers, as well as some in our own country and in America, the latest of the Transatlantic idealists who have given publicity through the press to their theories being Professor Moffat, who announces that the design of his treatise "is to draw a line around that portion of philosophy which pertains to Art, indicating the main sources of the wealth which it contains, and the limits which its cultivators have assigned to themselves." The professor includes within the word Art a much wider range of subject than that popularly assigned to it, and to which most writers on Æsthetics limit it; for to painting and sculpture he adds poetry, oratory, and a certain class of literary productions. His book is by no means a dry, mystical, and uninviting compound of theories; but a readable and instructive volume, containing a large portion of truth, good sense, and sound moral, and even religious, teaching with a very little alloy of unprofitable speculation: the perusal of it cannot fail to benefit the reader. There are two passages we have marked for quotation: the one because, for the most part, we agree with the writer; the other, because we entirely dissent from his opinions. In the former he says:—"The relations of modern Art to society are unprecedented, and full of obscure but lofty promise; . . . architecture, painting, and statuary, especially, are in the present day in a woeful state of chaos and indecision. Some, looking back to the lofty and well-defined purpose and masterly execution of former times, are turning their hopes to a revival of exclusive formalities as the only means of correcting the present disorder. But all such attempts are vain; history never repeats herself. We are evidently in the transition state to something greater than has yet appeared—an age of Art, where no exclusive caste or profession shall dictate style, but the enlightened taste of a whole people, under the nobler, moral, and religious light of a pure Christianity. The transition state must necessarily be chaotic, but the elements will arrange themselves correctly in the end, and the greater their number and diversity, the higher shall be that Art which effects their harmony."

The other passage is this—it is from the chapter headed "Critical Authority":—"Whence does criticism derive its authority? From the dictatorial style of the anonymous and mysterious reviewers of recent times, one is haunted with the impression that they must be something more than men, enjoying revelations on the subject of taste, which it must be impious to controvert. All the leading reviews of the day are addressed to such an impression. Taking for granted that they alone are correct, and that none other has a right to any opinion at all, they never manifest the shadow of a suspicion that they can, by any possibility, be guilty of a mistake. Behind the screen of the review, and the editorial *we*, the critic, no matter how ignorant or stupid, assumes to himself infallibility, and writes as one having authority. Constituting himself a judge, and regarding the author as a culprit arraigned at his bar, he proceeds, in the awful majesty of office, to pronounce that sentence which he deems must be final—incontrovertible, because he has said it. Very rarely is there any, the least, show of reasoning on common principles, or any attempt to justify the decision by clear and cautious argument. The unknown critic is supreme—his word the law."

Now in these remarks, both ungenerous and unjust, Professor Moffat is not alluding to compar-

tively obscure publications; for he immediately refers to the *Edinburgh*, the *Quarterly*, and the *North American Review*; and adds, that "many a decision received as the authoritative voice of the very Delphi of criticism, has afterward been woefully shorn of its glory, contracted in its dimensions, and treated with a contemptuous everyday familiarity, when found to be only the private opinion of Lord Jeffrey, Sydney Smith, or Mr. Macaulay." Why Mr. Moffat has singled out the Whig critics for his animadversions rather than Lockhart, Professor Wilson, Alison, and others on the same side of politicians, we know not; but sure are we that no review of any pretensions, in our own country at least, exhibits the spirit imputed to it in the foregoing remarks. As a general rule the critics of the present day deliver their judgments—dictated by sound learning and a thorough acquaintance with the subject they undertake to discuss—not as tyrants or dictators, but as scholars and gentlemen: Mr. Moffat would rank them with the public executioner; he would make Macaulay a literary Robespierre, and would couple Lord Jeffrey with Judge Jeffries. We protest against his verdict; his own judgment must have been terribly warped to arrive at such a conclusion, while it seems an absurdity to have to defend such men from such an attack.

THE FRESCOS OF GIOTTO. NOTICES OF SCULPTURE IN IVORY. Published by the Arundel Society, London.

The Arundel Society has issued another set of engravings, by Dalziel, from drawings by W. O. Williams, from the frescoes of Giotto, in the Chapel of Santa Maria dell' Arena, at Padua. In noticing a former series of these works, at the commencement of the last year, we asked, "What possible benefit, either to artists or the public, can arise from the circulation of these prints?" and the sight of the four just placed in our hands only suggests to us the same inquiry. With all our veneration of the antique, and our respect for the name of Giotto, we cannot, for the life of us, supply a satisfactory argument for thus revivifying him from the sepulchre where he has lain for five centuries and a half. It is one thing to visit Padua on a tour through Italy, and see there what his mind and his hand wrought, as we should go to see anything else that is curious or historically interesting, but quite another thing to have his works brought home to us in their present form; however, this is rather the affair of the society at whose cost they are executed, than our own: we only think that its funds might be employed far more profitably to its subscribers and to the public. In the first print—the "Marriage at Cana"—are eleven figures: Christ on the extreme left of the picture, speaking to a servant; to the right is the "governor of the feast," holding a cup to his lips—a coarse, corpulent figure, the type of the composition are successfully expressed. The second print represents the "Raising of Lazarus"; the resuscitated disciple appears to have been studied from an Egyptian mummy; he has not burst under his cerements, but stands closely bound hand and foot, and with the most ghastly aspect. A man so encumbered could never, except by the influence of a second miracle as great as the re-animating of the spirit, have obeyed the Divine command—"Come forth!" The prostrate figures of Martha and Mary are ludicrously drawn. "Christ's Entry into Jerusalem" is next in rotation. In this also are some good studies of heads, and the composition, as a whole, has fewer defects of drawing than the three others; but the figures in the trees "cutting down branches" are absurdities; and the manner in which one of the "multitude" is "casting her garments in the way," by drawing it over the head, can only excite a smile. The "Expulsion from the Temple" is the last of the series: the scene lies outside of the building—a sort of Byzantine edifice, with a pulpit at the angle of the porch. Christ is represented striking with his clenched fist a man who carries a birdcage. Though Giotto, like David, kept watch over the sheepfold, and was thus employed when Cimabue found him sketching, it seems he paid little attention to the anatomy of the animals he had the care of, for it would puzzle the most learned zoologist to determine the creatures here intended for sheep. Certainly this publication does not increase in our favour as it proceeds; and we willingly turn from it to the other which the Arundel Society has issued at the same time—the *NOTICES OF SCULPTURE IN IVORY*. This work consists of a lecture by Mr. Digby Wyatt, delivered last year at the first annual general meeting of this society, on the history, methods, and chief productions of the Art; and it also contains a catalogue by Mr. E. Oldfield, M.A., of the specimens—casts of which are in possession of, and are sold by, the society—of ancient ivory carvings in various collections. In

the illustrations which ornament this book photography has done the work of the engraver. There are nine of these, by Mr. J. A. Spencer, representing some of the most beautiful specimens of ivory carving in the collection, principally of book-covers, tablets, diptychs. We see here works of real Art, which one can examine with pleasure and profit. Mr. Wyatt's lecture offers an intelligent and interesting history of sculpture in ivory from the earliest period.

THE COMPLETE ANGLER; OR, CONTEMPLATIVE MAN'S COMPANION OF ISAAC WALTON AND CHARLES COTTON. Edited by EDWARD JESSE, Esq. To which are added PAPERS ON FISHING-TACKLE, FISHING-STATIONS, &c. By HENRY G. BOHN. Published by H. G. BOHN.

A book containing five hundred pages, two hundred woodcut illustrations, and twenty-six engravings on steel, at the price of 7s. 6d., is a marvel even in these days of cheap literature and cheap Art. Many of these prints have indeed already done duty elsewhere; but they are valuable none the less, and are for the most part highly meritorious in execution, while they are true and interesting as portraits of the things and places they represent. As a manual for the angler, it is without precedent in value—nothing has been omitted; all he likes to see, and think about, and talk of, and use, he will find here; while a practised, and not a "practise hand," has gone over the whole, so as to bring it together with rare value and effect. Published just now, when the lakes and rivers are inviting pilgrims, and the fish are absolutely eager to be caught, the book is more than welcome, for it contains all that can be required for instruction and enjoyment as concerns "the gentle craft." Old Isaac cannot be read too often; one of the sweetest, humblest, and most gracious of God's creatures, who thoroughly loved his art, and who desired that all who would should share his pleasure, he bequeathed to the world a legacy which furnishes forth to-day capital as it did yesterday—and remains the source to which all must go who angle by the river-side amid the rich beauties of Nature. The time of the angler is never idly spent; and we maintain, upon the highest authorities, and against those who have written otherwise, that in this sport there is no cruelty, for fish have little or no sense of pain; abundant proofs might be adduced in support of this assertion. Mr. Bohn has thus added another to the many valuable books he has issued—books so cheap that they are attainable by all classes, and so good as to satisfy those who can afford to pay high prices for luxuries, but who may be, and are, well content with these editions of standard works in British literature.

MEMOIRS OF JOHN KITTO, D.D., F.S.A., COMPILED CHIEFLY FROM HIS LETTERS AND JOURNALS. By J. E. RYLAND, M.A. WITH A CRITICAL ESTIMATE OF DR. KITTO'S LIFE AND WRITINGS. By PROFESSOR EADIE, D.D., L.L.D., Glasgow. Published by W. OLIPHANT & SONS, Edinburgh; HAMILTON, ADAMS & CO., London.

There are few literary men of the present age whose editorial labours have been more productive of advantage to the public than those of the late Dr. Kitto, who died at Cannstatt, in Germany, whither he had gone, in 1854, in the vain hope of recruiting his health. As the editor of "The Pictorial Bible," and "The Cyclopædia of Biblical Literature," and as the author of "Daily Bible Illustrations," with other works of a similar religious tendency, he has earned a reputation in matters of biblical study and literature, which men of much higher pretensions might envy. This he attained through a life which, as Mr. Ryland truly observes, "was, from childhood to the grave, a strenuous, unintermitting conflict with difficulties and trials of no ordinary kind." Sprung from a family of low origin, the grandson of a Cornish miner, he worked his way to his position by his strong energy, his unwearied labours, and his deep, earnest piety. "In whatever aspect we view him," writes Dr. Eadie, "he is a wonder. It is a wonder that he rose in life at all; a wonder that he acquired so much; and no less a wonder that he wrote so much. Many have excelled him in the amount of acquisition, but few in the patience and bravery which he displayed in laying up his stock of knowledge, in the perfect mastery he had over it, and in the freedom and facility with which he responded to it in magazine, review, or treatise." The history of such a man is pregnant with fruitful instruction: a large portion of the biography presented to us consists of letters written at various periods—some of them dated from Plymouth Workhouse, of which, as a boy, he was for years an inmate; others when on his travels in Russia and in the East—and of extracts from his private journal. It is an interesting narrative.

THE SCIENCE OF BEAUTY, AS DEVELOPED IN NATURE AND APPLIED TO ART. By D. R. HAY, F.R.S.E. Published by W. BLACKWOOD & SONS, Edinburgh and London.

Having "said our say" upon Mr. Hay's theories as they have been propounded in his books that have come under our notice at various times, we need not enter upon a critical examination of this volume after the information we find in his preface. We are there told—"My theory of beauty in form and colour being now admitted by the best authorities to be based on truth, I have of late been often asked, by those who wished to become acquainted with its nature, and the manner of its being applied to Art, which of my publications I would recommend for their perusal. This question I have always found difficult in answering. * * * Under these circumstances, I consulted a highly respected friend, whose mathematical talents and good taste are well known, and to whom I have been greatly indebted for much valuable assistance during the course of my investigations. The advice I received on this occasion was to publish a *résumé* of my former works, of such a character as not only to explain the nature of my theory, but to exhibit to the general reader, by the most simple modes of illustration and description, how it is developed in nature," &c. This quotation will sufficiently explain what is to be found in the volume, while it relieves us from the task of wading through it.

THE LIVES AND WORKS OF MICHAEL ANGELO AND RAPHAEL. By R. DUPPA and QUATREMEIRE DE QUINCY. Illustrated with Fifteen Engravings. Published by H. G. BOHN, London.

This volume forms one of the series of Bohn's "Illustrated Library;" but, with the exception of the engravings now introduced, it is precisely the same book as that published a few years since in Bogue's "European Library;" it is, in fact, a reprint of the latter form, we presume, stereotype plates. De Quincy's "Life of Raphael" is perhaps the most comprehensive biography of the great Urbinese painter that has yet been written; the translation used here is by Hazlitt—both that and Dappa's "Life of Michael Angelo" are well worthy of being again brought into notice. The engravings which illustrate the volume include "The Cartoon of Pisa," a fragment of "The Last Judgment," "The Temptation and Expulsion," and "Christ Scourged," all after M. Angelo; and from the works of Raphael, "The Draught of Fishes," "The Charge to St. Peter," "The Death of Ananias," "Paul and Barnabas at Lystra," "Peter and John Healing the Lame Man," "Elymas the Sorcerer," "The Transfiguration," &c.—compositions that, however well known, never fall on the senses.

A CYCLOPEDIA OF GEOGRAPHY, DESCRIPTIVE AND PHYSICAL. BY JAMES BRYCE, M.A., F.G.S. PUBLISHED BY RICHARD GRIFFIN & CO., GLASGOW.

A good general gazetteer of the world, comprehended within moderate limits, was much wanted. We have several bulky volumes, varying in their degrees of correctness and completeness, but all of them more or less objectionable on account of their size. We have carefully examined the "Cyclopædia of Geography;" we have sought for sundry out-of-the-way places, and have found them, with sufficient descriptive matter to satisfy us, and much also we did not expect to find. We can therefore conscientiously recommend this gazetteer as a useful companion in every library. In one volume of great compactness we appear to have all that is desired in a gazetteer, and some additional matter of much usefulness, in the form of a guide to the correct pronunciation of the names of cities, &c.

BRITISH POISONOUS PLANTS. By CHARLES JOHNSON, Botanical Lecturer at Guy's Hospital. Illustrated with Twenty-eight coloured Plates, transferred from "English Botany." Published for the Proprietor, J. E. SOWERBY, 3, Mead Place, Lambeth.

This is a little book which no school-room of high or low degree should be without. It has been suggested by the frequent occurrence of death by poison, from inadvertently—or ignorantly, we should rather have said—eating of pernicious plants growing in our fields, hedgerows, and wilds in gardens. It was not very long since the papers announced the deaths, in Scotland, of two or three gentlemen, if we remember aright, who partook of Monkshood, taken up from a garden in mistake for Horseradish. Had the gardener's boy, the unfortunate author of the calamity, received the instruction to be derived from Mr. Johnson's book, this sad occurrence might have been averted. We cannot

too highly commend this valuable treatise to the notice of heads of families and of schools everywhere.

PRACTICAL PERSPECTIVE. By R. BURCHETT, Head Master of the Training and Normal School. Published by CHAPMAN & HALL.

Among the many treatises on Linear Perspective which have of late years come before us, Mr. Burchett's must hold a good place: it forms the course of lectures on the science delivered by him at Marlborough House. Perspective offers to the young painter no one of those pleasing studies which are associated with all else he has to learn, and yet he must make its acquaintance practically, and to some extent theoretically, ere he can accomplish what he has to do: he must first learn to draw correctly ere he attempts to colour; and as Mr. Burchett observes, "he must be warned that he must not begin at the end or in the middle; he must not expect to understand fig. 15 before he has mastered fig. 5; but that he must be satisfied to acquire his knowledge in the order of the pages; that he must not be content with reading, but must assure himself that he understands both text and figures." This advice is not very satisfactory to those who look for a "royal road" to the acquisition of the science; but it is nevertheless perfectly true. All the student can expect from the teacher is a guide to show him the way, and a friendly hand to aid him over the stumbling-blocks—and perspective has many—in his way: he will find both in this work.

PRIZE ESSAY ON THE STEREOSCOPE. By WILLIAM O. LONIE, A.M., &c. Published by the London Stereoscopic Company.

A prize of twenty guineas was offered by the London Stereoscopic Company for the best Essay on the Stereoscope. Fourteen essays were submitted to the judgment of Sir David Brewster, whose award was in favour of the present essay, as giving "the most correct account of the laws of binocular vision, and of the theory of the stereoscope." This intimation from an authority of such eminence is a sufficient recommendation of the essay. It may, however, be thought by many that it is one of a high philosophical character, and hence requiring much previous scientific knowledge to render it intelligible. This is not the case: the essay is written in a clear and simple style; and every one possessing a stereoscope should learn the principles upon which its phenomena depend, which they may do without difficulty by a careful perusal of what Mr. Lonie has written.

A PRACTICAL SWISS GUIDE. By an ENGLISHMAN IN SWITZERLAND. Published by LONGMAN & CO., London.

English tourists on the continent will soon be "on the wing" across the channel. To those who meditate a visit to Switzerland we would strongly recommend that before starting they provide themselves with this useful little guide-book—really a "pocket" one, but it contains a large amount of useful information as to the best routes, distances, hotels, charges, the most interesting features of the respective localities—in fact, all a traveller requires to know, whether he meditates a run through, or to proceed by easy stages.

SONGS OF THE BRAVE. Published by S. LOW, SON, & CO., London.

A small collection of war-poems and odes by Campbell, Wolfe, Collins, Byron, Tennyson, and C. Mackay, illustrated with some charming little woodcuts, from drawings by B. Foster, E. Duncan, G. Thomas, and A. Huttala, beautifully engraved by Hartal, Evans, and Cooper, forming an elegant and appropriate literary tribute in honour of the soldiers and "mariners of England." Most of these poems are already well-known; but it was a good idea to bring them together and illustrate them in the style we find here.

A FEW REMARKS ON THE PICTURES OF 1856. Published by HARRISON, London.

What could have induced the anonymous author of this pamphlet to incur the cost of printing it? A few commonplace, ignorant remarks upon about fifty pictures in the Academy, and a score or so in the gallery of the Old Water-Colour Society, are all it contains: to call it a criticism would be an absurdity. A man who can only "devote a few spare moments" to the inspection of upwards of a thousand works of Art, should not wildly rush into print with his observations, even if he had the ability to criticise them—which this writer certainly has not.

THE ART-JOURNAL.



LONDON, AUGUST 1, 1856.

THE PORCELAIN MANUFACTURE OF CHINA.*

THE TECHNICAL PROCESSES.



N the foregoing number we gave a short summary of the historical portion of M. Julien's interesting work on the manufacture of Chinese porcelain: in the present number we shall first make a few observations which, in strictness, belong to the preceding

part of our subject, and shall then endeavour, with the assistance of M. Salvétat's excellent preface, to give some account of the technical processes of the Chinese, and to point out the principal differences between the Chinese and European methods of manufacture and decoration.

The manufacture of porcelain in China divides itself into two great branches, which are carried on systematically and with true Chinese perseverance. The first of these is the manufacture of original kinds of porcelain. In this branch there is apparent a constant endeavour to produce varieties, and to take advantage of every improvement, domestic or foreign, by the adoption of colours imported from Europe, and by the study of European porcelain—many examples of which have found their way to the imperial manufactory at King-te-ehin. The second observation which occurs to us relates to the *imitative* habits of the Chinese, in which they are not surpassed by any people upon earth. The same fidelity of imitation which induced the Chinese tailor to put a patch upon the knee of a new pair of trousers that he had made to pattern for an English officer, because the pattern had a patch in that situation, induces the Chinese manufacturer to make imitations—which are, in fact, reproductions—of every description of porcelain to which any value is attached, or which present any peculiarities in their composition or mode of decoration. The great value set upon many kinds of old porcelain is undoubtedly a great temptation to the manufacturer to produce facsimiles of them, and to dispose of them as genuine specimens of certain kinds of porcelain. Some of these imitations, even when known to be such, have, as before observed, been sold to Chinese collectors for a sum equal to 7500 francs. The third book of the Chinese work consists entirely of an account of the imitations of ancient Chinese porcelain made at King-te-ehin. In the sixth book is another catalogue of enamels and ancient vases imitated at the same manufactory. Among these we find enamels on metal—an art which we ascertain from the first book the Chinese received from the Arabs, and also from the French—and several specimens of European china of different colours, and probably of different modes of fabrication, including the Dresden or Sèvres porcelain, ornamented with figures in relief. Upon these counterfeits the Chinese author remarks—"The European taste, literally the spirit of the pencil, is closely imitated in the manner of painting and of applying the colours."

The last remark we shall make is for the benefit

* Continued from p. 206.

of our English collectors of old china. It is to the effect that *the Chinese make porcelain expressly for the foreign market*. This circumstance, coupled with the passion of the Chinese for collecting examples of their most ancient and valuable porcelain, and the abundance of spurious specimens, renders it extremely problematical whether the finer and more scarce descriptions of porcelain ever find their way into this country.

It may be necessary to remind the reader that the Chinese and Japanese porcelain, as well as almost all that is made in France and Germany, is of the description called "hard porcelain;" and that the manufacture of hard porcelain in England is at present limited. The material first claims our attention.

Porcelain, as the reader is probably aware, is composed of two ingredients, one of which is fusible, the other infusible. The infusible portion consists of an argillaceous paste, the common European name of which, *kaolin*, is borrowed from that of the principal locality in China where it is found. The fusible portion constitutes the transparent glaze to which porcelain owes its peculiar character; it is composed of felspar, or petrosilex. The Chinese call it *pe-tun* (white paste) or vulgarly, *pe-tun-tse*. The use of the kaolin is to give firmness to the porcelain, in the same manner as, to use a Chinese comparison, the bones of the skeleton support the softer mass of the flesh. The kaolin is prepared for use by washing; the pe-tun by grinding and levigating.

There are several kinds of kaolin in China, but they are all obtained from the department of Jaotcheou-fou, in the province of Kiang-si. The specimens of kaolin sent from China, at the request of M. Julien, yield, on washing, abundance of mica, which M. Salvétat considers to be a proof that they are produced by the decomposition of true granitic rocks. In this respect the Chinese kaolin differs from that of Saint-Yrieix, which owes its origin to the disintegration of pegmatites; the latter are composed entirely of quartz and felspar. In the preparation the mica is carefully separated; for, if suffered to remain, it would cause the porcelain to crack.

The mountains which produce the Chinese pe-tun are twenty leagues from the porcelain manufactories. The stone is dug out of the solid rock; and the best kind is that which, on being split, is found to be dendritic. This appearance is owing to the presence of oxide of manganese. The inhabitants of the district take advantage of the streams which descend from the mountains to erect water-wheels, by which the stone is ground. After being washed and purified it is formed into bricks, called *pe-tun*, or white paste.

The mode of preparation is detailed in Books v. and vii., and in the notes to the same (pp. 117—124, 255) will be found the results of M. Salvétat's analysis of the Chinese kaolin and pe-tun, as compared with those of Saint-Yrieix. Most of the Chinese pastes contain more or less of oxide of iron, which communicates to the porcelain a disagreeable tint.

It may be mentioned here that M. Salvétat found that in general Chinese porcelain contains more silica than that of Sèvres; but that the latter, together with the German porcelain, contains more alumina than any other description of pottery which has been examined. The Chinese pastes have been analysed by M. Salvétat; the result, as compared with the paste used at Sèvres, will be found stated at page lxxxiv.

For coarse stone-ware the Chinese use kaolin alone; but for porcelain this material is combined with petrosilex (pe-tun). For the coarser kind, the petrosilex is in greater quantity; for the finer kinds most argile is used. The ingredients are ground together in a mortar for a long time, and then purified by washing. The supernatant particles, being the most valuable part, are collected in another jar. The finer portion is purified a second, and also a third time, in the same manner. The last produce is used for the finest porcelain.

Instead of kaolin, the Chinese sometimes use steatite,* or soap-stone, for the "bone" of small articles in porcelain. The material is said to be excellent; but when glazed the colour is not so fine as

* The steatite, called by the Chinese *hoach*, was found to be composed of white amphibole (?), dolomite, and steatite.

that which results when the enamel has been applied upon a biscuit composed of pe-tun, which causes it to appear more polished and brilliant, as well as more agreeable to the eye. Pêre d'Entrecôlles says that porcelain made of steatite is rarer and dearer than other kinds; that it has a very fine grain, and as regards the painting, it bears to other porcelain the relation that vellum does to paper. It is remarkably light in weight, extremely fragile, and there is great difficulty in regulating the burning. Sometimes, instead of making the "bone" of steatite, this material is made into a kind of glue, into which the dry porcelain is plunged, and becomes coated with steatite, after which the glaze is applied. This process renders the appearance of the porcelain more beautiful.

A square reservoir or tank is then built of bricks close to the furnace, in order to take advantage of the heat. The paste is put into this tank to evaporate the water. When dry, it is pounded with pure water, and made into vases and other articles. For this purpose the wheel is sometimes used, and sometimes the clay is cast or fashioned on moulds. The moulds consist sometimes of one piece, sometimes of several. Many of the articles are finished on the lathe.

The wheel used in China is a round table of wood, pierced by a vertical axis, the lower extremity of which is fixed into the earth, and is so contrived that it can be made to turn continually. A man, seated on a bench, which forms part of the machine, pushes against the wheel with a bamboo stick, which causes it to revolve. He supports the mass of paste with both hands, and shapes it at will, and with the utmost precision. The vase is suffered to dry in the sun, and the shape perfected; water is then thrown upon it from a large camel's hair brush. It is afterwards washed and polished, and, after receiving the enamel, is ready for firing.

Ornaments in relief are attached by cementing them with *barbotine*—a composition consisting of the porcelain paste mixed with glue.

So far the European and Chinese processes are not very dissimilar; we must notice some particulars in which the Chinese processes differ from the European.

These variations refer chiefly to the following points:—1. The composition of the glaze. 2. The mode in which the glazing is effected. 3. The application of the glaze before the firing. 4. The mode of attaching the foot of the vase or other article. 5. The preparation of the colours.

1. The composition of the Chinese glaze differs from the European in being more fusible. At Sèvres the glaze is composed entirely of the pure pegmatite finely ground, and deposited by immersion on the baked porcelain (technically called *dégourdi*). In Germany the fusibility of the felspar is modified by the addition of other substances. The glaze of the Chinese and Japanese porcelain is a compound, the ingredients of which are varied and determined in different proportions, according to the nature of the product required. The fusible properties of the Chinese glaze are attributed by M. Salvétat to the lime which it contains—sometimes in the proportion of one-fourth of the weight of the glaze—and not to the ashes of fern leaves which are mixed with it. The only object in mixing the fern leaves seems to be to purify the lime. The Chinese, who have compared the kaolin and pe-tun, of which their porcelain is composed, to the bones and flesh which constitute the human body, carry on the comparison by calling the lime the soul of the glaze. The glaze, like the kaolin and pe-tun, is brought to the manufactory in lumps: it is white and liquid. The Chinese frequently defraud their customers by the addition of water, which increases the bulk of the article, while they conceal the cheat by throwing in sufficient gypsum to prevent the mixture being too liquid. As a fraud, this is certainly objectionable; yet the addition of fibrous gypsum to the glaze is not always hurtful. It is employed for specific purposes as well by the Germans as the Chinese. In some cases coarse sand is added to the quartzose felspar, which forms the base of the enamel.

2, 3. The European method of applying the glaze is founded upon the observation that China clay, like other argillaceous earths, ceases to be diffusible in water after it has been exposed to a red heat. Before, therefore, the pieces are immersed in the glaze,

they are fired, and in this state are, in France, termed *dégradés* [Aug. bisuit?]. By this process they are rendered porous and absorbent, and the material can no longer be diffused in water. The articles are then glazed by simple immersion in water, which holds in suspension the glaze.

This practice, at once so economical and so rapid, although practised in Japan, is almost unknown in China, where its use appears to be limited to the manufacture of two kinds of porcelain only. The usual method of applying the glaze is by aspersion, or by the immersion of the article formed of the *zao* paste only, which of course is easily acted upon by water. The process is sufficiently difficult when large pieces are to be glazed; much more so when they are small and thin. In the latter case another method is resorted to. The end of a tube of bamboo is covered with gauze, which is filled with the glaze, either coloured or uncoloured; the workman blows into the other end of the tube, and the glaze is detached from the gauze, and fixes itself upon the porcelain. M. Salvétat thinks that these different methods, which he describes in detail, are deserving of being tried by European manufacturers.

4. After being glazed, the next process is to apply the foot upon the still unburnt porcelain. When this is done, the piece is ready for the firing. The furnaces are situated at a distance from the workshops, and the persons who attend to them do nothing else. The porcelain is carried to the oven on long planks, two of which the workman carries at a time on his shoulder.

There appears to be some doubt as to the form of the furnaces now used by the Chinese. The following description is taken from Book v., and agrees apparently with the representations in the woodcuts. M. Salvétat is inclined to think that a change has taken place in the form of the furnaces since the Chinese text was written, and the drawings made.

The ovens or furnaces are described as being bell-shaped. Above each, and not touching it, is a sloping roof, supported on timber or bamboo. The furnace is ten feet in height and width, and about twenty feet in length and depth. The chimney, twenty feet high, rises above the sloping roof. The floor of the furnace is covered with a thick bed of gravel, which serves to support the *seggars*.

The *seggars* or cases in which the porcelain is baked, are made of several kinds of clay, distinguished by the colours, which are black, white, red, and blackish-yellow. After being baked they are fit for use. The best Chinese *seggars* cannot be used above ten times, and in many cases not so often, whereas those used at Sévres can sometimes be employed forty times. In this respect the European manufacturers have nothing to learn from the Chinese.

Unless the piece of porcelain is very small, it has a *seggar* to itself; but in all cases care is taken to prevent the adhesion of the porcelain to the *seggar*, by the interposition of a bed of sand and coarse kaolin. Great care is also necessary in the arrangement of the pieces within the cases, because the glaze, having been applied upon the raw and yielding material, the form of the vase is very liable to injury.

The porcelain having been placed in the *seggars*, the latter are laid in piles, the upper ones serving as covers to those which are beneath. They are then put into the furnace, space being left between each pile to allow the flame to pass. The *seggars* next the chimney, as well as the two lower and the upper one of each pile, are empty, for in these the porcelain would not be properly burnt. The vases are arranged in that part of the furnace which is best adapted for them, according as the enamel or glaze is hard or soft. The finest porcelain is placed in the centre. When the furnace is filled with the *seggars* the fire is lighted, and the opening blocked up, except one hole, through which the fuel is, by the care of two men, continually inserted. Five openings, covered with a piece of tile, are also left in the roof, in order to observe when the porcelain is sufficiently baked. When the *seggars* in front are of a vermilion-red colour, no more fuel is added, and, after waiting a day and a night, the furnace is opened. This generally takes place about three days after the lighting of the fire. The perfection of the porcelain, observes the Chinese author, depends in a great measure upon the temperature of the furnace, and the regulation of this depends entirely on the experience

of the fireman. On the fourth day, very early in the morning, the furnace is opened. The *seggars* which cover the vases of porcelain still retain their red colour, so that they cannot be approached except by the workmen, who make themselves a kind of gloves of linen, ten times doubled, and wetted with cold water, to protect their hands from the heat. They also cover their heads and persons with wet rags; thus defended, they enter the furnaces, and carry away the porcelain. When they have removed all the *seggars*, they take advantage of the remaining heat to put fresh ones into the furnace. The humidity being soon absorbed, these frequently crack. Speaking of the shrinking of the paste in baking, the Chinese author says that a vase a foot high will, after firing, be reduced to seven or eight inches.

5. The skill with which the Chinese decorate their porcelain has been justly celebrated. The variety of the grounds is not less remarkable than the originality of the decoration, and the harmonious richness of the painting. The Chinese possess in perfection many of the decorative processes employed in the European manufactures. They not only engrave with the point, and model figures in relief after the fashion of the Sévres china, but they also execute with great skill ornamental perforated or network.

The decoration of porcelain forms a very interesting part of the manufacture, especially when the processes used in China are compared with those of Europe.

To appreciate the difference we cannot do better than give a brief *resumé*, interspersed with such information as we can collect from the Chinese work, of M. Salvétat's remarks on this subject. After mentioning that in Europe various processes are employed, M. Salvétat observes:—"Sometimes pastes of different colours are employed, sometimes the colouring matter is introduced into the glaze, sometimes the colours are laid upon the surface of white porcelain. The first two modes of decoration require to fix them a temperature as high as that which is necessary for the firing of the porcelain; such colours are technically called *couleurs de grand feu*. When, on the contrary, the colours are painted on the surface of the porcelain, those colours only are employed which require for their vitrification a temperature much lower than the preceding. These are called *couleurs de moufle*. It is by the use of the moufle colours only that European manufacturers have, during the last fifty years, been able to produce on porcelain effects previously attainable by oil-colours only, and to imitate perfectly on porcelain the works of the great masters of Art."

The colours used by the Chinese in the decoration of porcelain may be arranged under the same classes as those employed in Europe. We shall notice first those which require a high temperature. It requires but a slight acquaintance with Chinese porcelain to observe that the colour most frequently used in China is blue. We are not, therefore, surprised to find several chapters of the fifth book of M. Julien's work devoted to the description of the material which supplies this colour, also the mode of preparation and of application.

The Chinese distinguish the porcelain painted with blue flowers into four epochs:—namely, first the porcelain of Siouan-te (1426—1435); second, of Tch'ing-hoa (1465—1487); third, of Kia-tsing (1522—1566); and fourth, of Wan-li (1573—1619). The first three belonged to the great dynasty of Ming. Although the porcelain of the period Tch'ing-hoa, in the artistic qualities of the painting, greatly exceeded that of the Siouan-te period, yet the blue employed in the latter was far superior to that used by the artists of the former time. The employment of this colour for painting or colouring porcelain in China is of great antiquity. The china of Toung-neou, made during the dynasty of the Tsin (A. D. 265—419), and very celebrated in its day, was blue.

The blue used in China is the product of a native mineral, which has been ascertained to abound in almost all the provinces of the empire. From the description of the Chinese author, as well as from a minute analysis of specimens brought from the province of Yun-nan, M. Salvétat is satisfied that the substance in question is a cobaltiferous peroxide of manganese. It is called by the Chinese *you-ming-i*. The mineral, which is of a blackish-yellow colour, is first washed in baskets in the mountain-streams, it is then conveyed by merchants to the place where

the furnaces are situated; there, after being enclosed in a porcelain vessel, it is roasted. It is then removed, carefully washed, and sold to the manufacturers. The loss in roasting is from 20 to 30 per cent. The blue pigment is of three qualities: the first, or best description produced, when burnt, a fine blue; the second, a pale blue; the third, grey. For every pound of fine blue the produce is scarcely seven ounces; the second and third qualities suffer a proportionate loss by roasting. The value of the first quality is equivalent to 180 francs for the Chinese *li-chel*; of the second quality, 90 francs per bushel; of the third quality, 25 francs per bushel. The colour is washed and ground before it is used, and is black until after it is burnt, when it is a fine blue. Before using it on the porcelain it is tried on a fragment and baked. When the whole vase is to be coloured blue the colour is applied beneath the glaze, and one of two methods is adopted. 1st. The colour is diluted with water, into which the vessel is plunged. 2nd. The colour is applied by blowing it through a tube, in the manner before described. Pere d'Entrecolles remarks—

"This kind of porcelain is dearer and more scarce than where the colour has not been blown, because it is more difficult to produce by this process a uniform tint. The glaze is applied after the colouring. When blowing on the blue, the workman takes care to preserve the colour which does not settle on the porcelain by placing the vase on a pedestal which stands on a large sheet of paper. When dry the blue is separated by rubbing the paper with a small brush."

The rapid and economical plan of colouring the porcelain before the application of the glaze has been successfully practised at Sévres. M. Salvétat observes that the Chinese bake their porcelain at a much lower temperature than the French manufacturers. This is no doubt owing to the more fusible nature of the Chinese glaze. The Chinese author remarks that if the temperature of the furnace be too high, the greater part of the blue flowers will disappear.

Besides the native blue pigment the Chinese use cobalt blue, properly so called. This, which is a finer colour than their own, they receive from England.

Among the *couleurs de grand feu*, which may be easily produced by attending to the prescriptions in the Chinese books, are the lake-coloured grounds, varying in tint from orange to purple; these sometimes have a bronze-like lustre. The description of the colouring substance is so precise, that there is not the least doubt as to the nature of the mineral employed for this purpose, which, according to M. Salvétat, is a ferruginous earth. The directions for producing the above tints are, he adds, perfectly exact: they also indicate extremely well how the Chinese avoid colouring those reserved spots on which blue designs are afterwards introduced.

Some of the grounds belonging to this class of colours (*couleurs de grand feu*) have not yet been produced in Europe. Among these are red and orange grounds, which owe their colour to the protoxide of copper, and those of the light bluish-green colour, called *celadon*, so much admired by amateurs. In chapter xi., of Book vi., which M. Salvétat considers one of the most important in the collection, the composition of the different kinds of coloured enamels is described. It is rendered more valuable by the notes of M. Salvétat.

The last of the *couleurs de grand feu* of the Chinese which we shall notice, is black. This, we are told, is sometimes the result of the coloured glaze applied in a mass; sometimes of the superposition of several colours of different tones—as, for instance, of a brownish lake (*brun de laque*) upon a blue glaze, or of a blue upon brownish lake.

M. Salvétat next notices some colours on oriental porcelain which have been applied upon the biscuit, that is to say, upon porcelain which has already been baked at a high temperature. These are always found to be covered with minute cracks, like fine network. Upon touching the colours with fluorhydric acid, it is found that oxide of lead enters largely into their composition. Hence, as these occupy a sort of intermediate position, M. Salvétat distinguishes them as *couleurs de demi-grand feu*, and remarks that there are no colours analogous to them at Sévres. Among these colours are violet, turquoise-blue, yellow, and green, which he thinks might be easily

initiated; the green and the blue with copper; the yellow with lead and antimony; the violet with manganese slightly fractured with cobalt. M. Salvétat's account of his own experiments on colours fusible at a low temperature is well deserving of the attention of the manufacturer.* Directions for preparing these intermediate colours will be found in M. Julien's work, to which the reader is referred. Concerning these directions, M. Salvétat remarks that from the analyses he had been able to make, and the syntheses that he had attempted, frequently with success, he had come to the conclusion that the greater part of the prescriptions given in the Chinese books are sufficiently exact, at least as regards those of which the synonyms were easily produced. The Chinese prescriptions, or recipes, for producing the colours so much admired, are now, by the industry and exertions of M. Julien, placed within the reach of European manufacturers. We trust, therefore, it will not be long before they are reproduced in this country. One observation of M. Salvétat's should not be overlooked—namely, that many of the coloured grounds on Chinese porcelain seem to be the result of accident, and not altogether of design; and that colours composed as these are, of different minerals with the white glaze, will always be subject to variations, according to the predominance of one or more of the ingredients, and to the temperature of the furnace. Although the actual imitation of certain shades of colour must always be the result of direct experiment, yet when once the colour has been obtained by this means, the European manufacturer has a great advantage over the Chinese; inasmuch as the education of the former, in all that relates to the Art-Manufactory, having been more scientific, he understands better the causes and effects of the different processes and combinations, and is, therefore, in a situation to reproduce on scientific principles those colours by the production of which the Chinese, with much more limited knowledge, have attained a world-wide celebrity.

Before speaking of the muffle colours, M. Salvétat notices shortly the colours which, in Europe, and especially at Sèvres, constitute the palette of the porcelain-painter, and the properties which they should possess.

These colours, he says, should be capable of fixing themselves firmly to the surface of the porcelain, and of acquiring at the same time, by fusion, the glaze which is one of the indispensable conditions of the brilliancy of this kind of painting. They are all produced by mixing either an oxide, or a composition of different metallic oxides, with a vitreous flux (*fondant*), the composition of which varies with the nature of the colour which is to be developed. The flux which is most generally used is called *fondant aux gris*. It is used for greys, blacks, reds, blues, and yellows, and is composed of—

Mintum	6 parts
Siliceous sand	2 "
Glass of borax	1 "

The colours are generally obtained by mixing together three parts of the flux with one part of the metallic oxide. The general formula may be thus expressed:—

Silica	10.7
Oxide of lead	60.9
Borax	8.3
Colouring oxides	25.0
	100.0

Sometimes, as in the case of cobalt, it is necessary that the oxides and the flux should be fritted before being used. Sometimes they are only mixed together, and used as pigments without being fritted or calcined. In Europe it is considered especially requisite that these colours should all melt at the same time, and present, after the firing, a sufficient and uniform glaze.

The colours on the Chinese paintings do not fulfil these conditions: some are glazed, others dull; some are flat, others raised above the surface. The style of the painting is also very different from ours. It is always strictly decorative, never pictorial. There is no gradation of light and shade, no modelling of the figure, the outlines of which are defined only by red or black lines. The colours are applied in flat tints, reminding one of the mosaic-like stained glass of the 13th century, in which the design was made

out by red or black lines traced upon the coloured or white glass.

Considering the thickness of the colours employed, and yet their want of intensity, M. Salvétat concluded that the Chinese pigments contained but a very small proportion of the colouring matter. This opinion was confirmed by experiments, in which it was proved that "the colours which the Chinese have employed so advantageously, as regards the brilliancy of effect and the harmony of the decoration, have greater analogy with the vitrified substance known as enamels, than with any other substances."

Besides their great simplicity, a general characteristic of the Chinese colours for porcelain-painting is, that the flux, which is not distinct from the pigment, is always composed of silica, oxide of lead,—which is not subject to great variations in its proportion,—and a greater or less quantity of alkali. The flux holds in solution, as silicates, a very small portion of colouring matter. The colouring matters are—oxide of copper for greens and blue-greens; gold for reds; oxide of cobalt for blues; oxide of antimony for yellows; arsenic and stannic acid for white. The only exceptions are the oxide of iron, and the impure oxides of manganese, which yield, the one red, the other black—these last-mentioned colours cannot be obtained by solution in the flux.

Some of the colours are employed in the state they are supplied by commerce; others require additions, in order that they may all be fusible at the same temperature. The manufactory at Sèvres has been fortunate enough to obtain two sets of colours, ready prepared for porcelain painting, from artists in China. Lists of these colours will be found in the work of M. Julien (pp. 215—220). The analyses of their composition, by MM. Ebelmen and Salvétat, have been published in the "Recueil des Travaux Scientifiques de M. Ebelmen," tom. i. p. 377. Precise recipes for composing the Chinese colours, or as they are called, *enamels*, are also contained in Book vi. of M. Julien's work. These are elucidated by the notes of M. Salvétat. The proportions of the different ingredients are given in Chinese weights, which are explained at p. 223.

It has been remarked,* that in Europe the colours for painting on porcelain are formed by the mixture of certain oxides and certain fluxes; that the Chinese colours differ not only in the composition of the flux, but in the proportions of the colouring matter, and in the number of the colouring agents, which are so limited in the Chinese, and so extensive in the European manufactory. "The palette of the European porcelain-painter comprises many substances unknown in China. Thus the colour of cobalt is modified by combining it with the oxide of zinc and alumina, or with alumina and the oxide of chrome. The pure oxide of iron furnishes about ten shades of red, varying from orange-red to very dark violet; from ochres are obtained pale or dark yellows or browns, by combining in different proportions the oxides of iron, of zinc, of cobalt, or of nickel; browns are made by increasing the quantity of oxide of cobalt contained in the composition which furnishes the ochres; blacks, by the suppression of oxide of zinc in the same preparations; yellows are varied by additions of zinc or tin to render them paler, by oxide of iron to deepen the colour. The oxide of chrome, pure or combined with the oxide of cobalt, or the oxides of cobalt and zinc, gives yellow or blue-greens in infinite variety. Metallic gold yields the purple of Cassius, which can be changed into violet, purple, or carmine. Besides these, we possess the oxide of uranium, the chromates of iron, of barium, and of cadmium. We shall close this list of colours by alluding to the very recent application of metals incapable of oxidation by fire, the discovery and preparation of which require chemical knowledge far beyond that which the Chinese possess. All these different colouring matters are in the European colours in the form of simple mixture; in the Chinese colours, the oxides are, on the contrary, dissolved, and in this respect they bear a great resemblance, not only in the colouring principles, but in the composition of the flux, to what are called in France, *enamels*."

The resemblance has been confirmed by the manner in which the colours imported from China behaved in the firing. Experiments were made on

European and also on Chinese porcelain. Upon the Chinese porcelain the colours were developed at a lower temperature than that which is used for retouching the paintings of flowers in the manufactory at Sèvres, and they did not scale off. On the Sèvres porcelain the colours, though developed, scaled off. It has been long known that, on account of this very defect, enamels could not be used for the decoration of European porcelain. This want of adherence is to be attributed to the different nature of the glaze of the two kinds of porcelain—that of China being rendered more fusible than the European by the addition of lime, which perhaps modifies its dilatibility, and assimilates its physical properties to those of enamels. "If," continues M. Salvétat, "Chinese porcelain differs from ours in its appearance, if the harmony of their paintings is more varied, the cause is to be sought in the methods employed by the Chinese. Their pigments contain but little colouring matter, and their effect depends upon a certain thickness, which gives to their paintings a relief impossible to be attained by other means; the harmony of their paintings is the result of the nature and composition of their enamels." It may be observed that the resemblance of the colours used for painting on porcelain to enamels, is noticed in the Chinese work (p. 171); and the colours used on porcelain are, in another part of the work, called enamels (p. 206, &c.)

The Chinese colours are diluted for painting either with a solution of mastic, with animal size, or with pure water. The first causes the colours to flow with facility; the second is useful in retouching; water is employed where the colours are thick, and also for filling in. M. Salvétat gives the preference to water as a vehicle for the colours.

When the colours have been applied, the porcelain is again baked to fix the painting. Two kinds of furnaces or muffles are used for this purpose—the one sort are open, the others closed. The latter are employed for small works, and resemble those used in Europe for enamels, properly so called. They are fully described at pages 172—174. There is a very quaint representation in the last woodcut, of a Chinese stoking a furnace, filled apparently with coal. He holds before his face a large screen, in which is an aperture for him to look through. His head and back are protected by a hood, and his hand by a kind of glove.

We must now bring our notice of Chinese porcelain to a close, but before laying down the pen, we should like to call the reader's attention to a few points in which the manufacturing processes of the Japanese differ from those of the Chinese. The former people burn their porcelain twice—in this respect adopting the European process. After the first firing, the biscuit (*dégourdi*) is washed, cleaned, and painted. The colour, which is generally blue, is mixed with water; two coats of the glaze are then given, and the porcelain is re-baked in the principal furnace.

The Japanese do not appear to be generally acquainted with the art of painting with enamel colours like those of the Chinese. It is related that one manufactory in a certain locality practised this art, as well as that of laying on gold and silver, but the processes were kept secret. Vitreous colours were reported to have been used. It is also stated that vitreous matter was mixed with the glaze of the old Nanking porcelain, and that the glaze had partially sealed off, whence it was called "worm-eaten porcelain." This ware is now extremely rare, being only met with as presents or objects of curiosity. "One of the beauties of the Nanking porcelain," observes Dr. Hoffman, "is that the designs appear to be above the glaze, whereas, in the blue porcelain of Japan, the painting was applied before the glaze. The first effect can only be obtained by having recourse to vitreous compositions, which are not used in Japan; but the method adopted in that country is, from its greater durability, better adapted for articles of domestic use." M.

[At the present day the Ceramic Arts of every kind seem to possess a peculiar interest in England; a fact which would, if excuse were necessary, furnish a sufficient apology for the introduction of this and the preceding paper. At no former period of its history have such enormous sums been paid for antique porcelain ware; indeed, the enthusiasm of collectors has reached a point which almost amounts to an absurdity.—Ed. A. J.]

* See Preface, p. civ.

* See Preface, p. cx.

THE ROYAL PICTURES.

"GO, AND SIN NO MORE."

E. Corbould, Painter. C. H. Jones, Engraver.
Size of the Picture 4 ft. 2 in. by 3 ft. 3 in.

"ALL Scripture," we read in the Sacred Volume, "is given by inspiration, and is profitable for instruction" &c. To those who are able to realise the truth of this statement there are few narratives contained in Bible history of which the artist, no less than the preacher, may not make a wise use, under such laws and conditions as time, society, and circumstances, may impose upon him. The incident related by the Evangelist St. John, which Mr. Corbould has illustrated with so much simple yet affecting feeling, is a lesson to the self-righteous—unhappily the world is too thickly populated with this class of individuals to render such teaching unnecessary. We are all too ready to estimate others by a standard of excellence we ourselves form, and which generally is in ourselves, or assumed to be. We hail the transgressor to our self-constituted tribunal, and condemn him without the reflection that our own acts, if brought to the bar of conscience in all truth and sincerity, are not less reprehensible. We may not be guilty of a direct theft, but we may be extortioners, and may "oppress the hireling." We may not take away the life of a fellow-creature, yet may fall down before the graven image, and yet may offer idolatrous worship at an altar whose deity is the author of all unrighteousness. And thus the Temple of Jerusalem is not the only place from which the command should go forth—"He that is without sin among you let him first cast a stone."

The artist has treated his subject according to the literal version of the evangelist. Christ had entered the Temple, and all the people were assembled to hear the lessons of wisdom from the lips of Him who "spoke as never man spoke." The great opponents of his ministry—the scribes and self-righteous Pharisees—bring in the fallen woman, and set her in the midst of the congregated throng. This appears to be the point in the narrative Mr. Corbould has illustrated, rather than that which appears in the title he has adopted; for when those words were spoken, the accusers had all gone out, and "Jesus was left alone, and the woman standing in the midst." Here, however, we see her cast down on the ground in the attitude of deep humiliation, her hand concealing her face, expressive of grief and shame. The figures seated, and those standing behind them on the left, we may presume to be the people who had come to listen to their Divine teacher; but among those seated is one habited as the high priest. The accusers stand, according to the custom of such; and one of them has advanced, as if for the purpose of arguing with one of Christ's disciples. He who "came not to condemn the world, but to save it" stands in an attitude of dignified authority, but with a benignant expression of countenance, more significant of pity for the transgressor than of sympathy with her accusers.

There is a broad treatment of chiaro-oscuro in this painting, which is well calculated to make an effective picture. The principal light falls full on the two figures most prominent in the scene, and the draperies of each being buff and white respectively, additional force is produced by this arrangement. The draperies of the other figures are richly coloured. The faces and extremities are finished with the care and delicacy always apparent in the works of this artist.

The picture, a drawing in water-colours, is in the collection at Osborne. It was purchased by Prince Albert soon after his arrival in England, from the Gallery of the New Society of Painters in Water-Colours, of which institution Mr. Corbould has long been one of the strong supports in historical subjects. We have heard this was the first picture his Royal Highness bought here, and that it attracted more than usual notice when exhibited—as those who interest themselves in Art-matters, and had heard of the purchase, were curious to know what kind of taste the Prince Consort possessed. When the young branches of the Royal Family were of a suitable age to derive benefit from instruction in drawing, Mr. Corbould was selected by Her Majesty to teach them the accomplishment he so ably practises.

SUGGESTIONS OF SUBJECT

TO THE STUDENT IN ART.*

BY AN OLD TRAVELLER.

CHAPTER VII.

Confessors of the early Church—Vivia Perpetua—Renunciation of the God—A General of other days—Brasidas at Methone—The Port of Pylos—Sea-fight—Fall of the leader—Vows to Minerva—Crowned at Scione—Death at Amphipolis—General Wolfe—Marsupis of Montcalm—Richard the Good—Spirits appellant—The Duke's dictation—The offender cited—Miracle—Varied views—"The Water Lady"—Harvest-time—A city in the waters—The Protector—A republican envoy—Royalty and its defenders—Spanish fashion under Philip IV.—A statue in spectacles—Colour, or the marble?—Venus Victoria—The nymph and the god—An Ordeal—The Pleiad Minerva—The Camena—Hesiod.

To the reader of early Christian history, the touching story of Vivia Perpetua is well known; her life was made familiar to a yet wider circle, some years since, by the admirable drama of a writer too early lost to the world of letters;† but lest there should still be some among our readers not yet acquainted with it, the mere facts shall be related in a few brief words.

Dwelling with her family in Carthage, but of Roman descent and nobly-born, Vivia Perpetua had been converted to the Christian faith: this is discovered by her father, by whom she is at once denounced to the priest of Jupiter: he furthermore drives her from his home in implacable displeasure, and she is thrown into prison. Here every effort is made to win her back to the rites she has abandoned, but all are vain: in her prison she becomes the associate of slaves, but her Christian faith has taught her to consider these, not as beings of an inferior order, as indicated by the code of the heathen, and as she once believed, but as fellow-creatures, to whom the common rights of humanity are due, even as to herself: nay, when ultimately condemned to death, it is with one of the despised race, formerly a slave of her own, that Vivia Perpetua advances to meet her fate.

But first the noble convert has repaired in silence and loneliness to the Temple of Olympian Jupiter—of that idol whom, in other days, she devoutly adored—her purpose, to renounce her allegiance to the false god. And here, O Sculptor, have you, no less than the Painter, a subject worthy of your utmost devotion. Evening shades are falling, the great and sumptuous fane is solitary, save for the one figure, deeply mournful, though firmly resolved—the once pious votary, who has sought the shrine for such unvoiced purpose. Majestic in its soul-given force is the form, and beautiful in holiness is the face of her now solemnly raising alighting hands towards the deity so long revered. She is not kneeling—that day has passed; firmly, yet with no arrogance of mien, she stands before the abandoned altar, and these are the words she utters:—

"Lo! where all trembling I have knelt and prayed,
Where vow and sacrifice at morn and eve,
Shrouded in incense dim, have risen to appease
The wrath, great Jove, of thy once dreaded thunder—
Up to the might of thy majestic brows,
Yet terrible with anger, thus I utter:—

"I am no longer worshipper of thine!
Witness the firm farewell those steadfast eyes
For ever grave upon thy marble front;
Witness these hands—their trembling is not fear—
That on thine altar set for evermore
A firm renouncing seal—I am a Christian!

"The shadows blacken, and the altar-flame
Troubles them into motion—god of stone,
For the last time, Farewell!" ‡

This for the Sculptor more especially—yet the Painter can scarcely do better than choose it also; and the rather as there is no impediment to his reproduction of Olympian Jove in all the pomp described by Pausanias. The grandeur of fine architectural effects—the awful presence of the Sphinxes—the imposing aspect of the Victories—the varied beauties of the Olympian gods, richly clustering around their chief—the inspiring loveliness of the

* Continued from p. 215.

† The late Mrs. Adams.

‡ With the somewhat illogical character of the set rec'd in these graceful words, it is not lawful for us to cavil; we are to leave that ungracious task to the critic, in whose darkness of life the detection of a spot on the sun serves for light and gladness: sufficient to us shall be the picture.

Graces and the Hours, are all for him: nay, the ebony and ivory, the gold and the precious gems, also lending their aid to enhance the effect of the gorgeous whole, are not forbidden to his pencil, although the Sculptor must feel restricted to a much less complete exposition of the eloquent historian's felicitous picture. But leaving these questions, and returning for a moment to Vivia Perpetua—the drama that is to say—it may perhaps be not out of place to remark that there are many other studies, whether for the Painter or the Sculptor, within the comparatively few pages of that graceful work, and the votaries of either art would do well to accept the inspiration, breathing its salutary influences from so pure a source.

It cannot be but that some one or more among the youth of our Studios will be turning their attention to themes of war for some time to come—the declaration of a paper-peace notwithstanding; and here is a General whose life will supply them with many a fair theme.

The Lacedæmonian, Brasidas, is the commander in question, and some portion of what Thucydides has related of his noble deeds, is briefly transcribed below; but whosoever shall determine to make the glorious history of the Spartan the subject of his meditations, must turn to the pages themselves, and to these, with that understanding, we propose to refer as we proceed.

Thus it is then that our historian—who, he it remembered, was an Atheian, the contemporary, the opponent in arms, and, in so far, the enemy of Brasidas—first speaks of the Lacedæmonian general, by whom Athens was so effectually kept in check even to the close of his life: nay, by whom her pre-eminence was all but entirely destroyed—since it was the untimely death of Brasidas which alone saved Athens from certain, if not immediate, subjugation.

The Athenians, with the Coreyreans, had effected a landing at Methone, in Laconia, and were assaulting the city, which was wholly unprepared for defence; of this event it is that Thucydides speaks as follows:—

"Now Brasidas, the son of Tellis, a Spartan, happened to be in command of a guard for the defence of those parts, and on hearing of the attack, he came to the assistance of those in the place, with a hundred heavy-armed. Dashing therefore through the army of the Athenians, which had its attention directed towards the wall, he threw himself into Methone." It is true that he lost some few of his own men in thus entering Methone, but he saved the city, and for this daring deed "he was the first who received public praise at Sparta in that war."* Here then you have the first of your pictures from the life of Brasidas.

Wise in council as brave and ready in arms, we next find our Spartan hero dispatched to Alcidas, the Lacedæmonian admiral, whom he greatly assisted in the preparations then making against Coreyra.† Subsequently we have the discussion of an event, which, in the dearth of all movement now suffered by the painter of sea-fights, can scarcely fail to rivet his attention: we alight to the part taken by Brasidas, in the renowned attack on that fort erected by the Athenians at Pylos. Let us hear what Thucydides says concerning it.

Encouraged by a most inspiring speech from their commander, Demosthenes—for which I refer you to the author—the Athenians were well prepared to receive their enemy, when the Spartan ships—of which there were forty-three, their admiral being Thrasymedidas, the son of Cratesicles—advanced to the attack. "So the Athenians defended themselves on both sides, landward and seaward, while their opponents, divided into detachments of a few ships each, because it was not possible for more to bring to, came against them with all eagerness and mutual exhortation, each seeking if by any means he might force the passage, and take a place in the fight.

"But the most distinguished of all the Spartans was Brasidas; for, being captain of a trireme, and seeing that in consequence of the difficulty of the position, the captains and steersmen, even where it

* See Thucydides' "History of the Peloponnesian War," book II. The translation used by the present writer is that of the Rev. Henry Dale, made from the text of Arnold.

† Hist. Pel., *ut supra*, book II. II. 12.



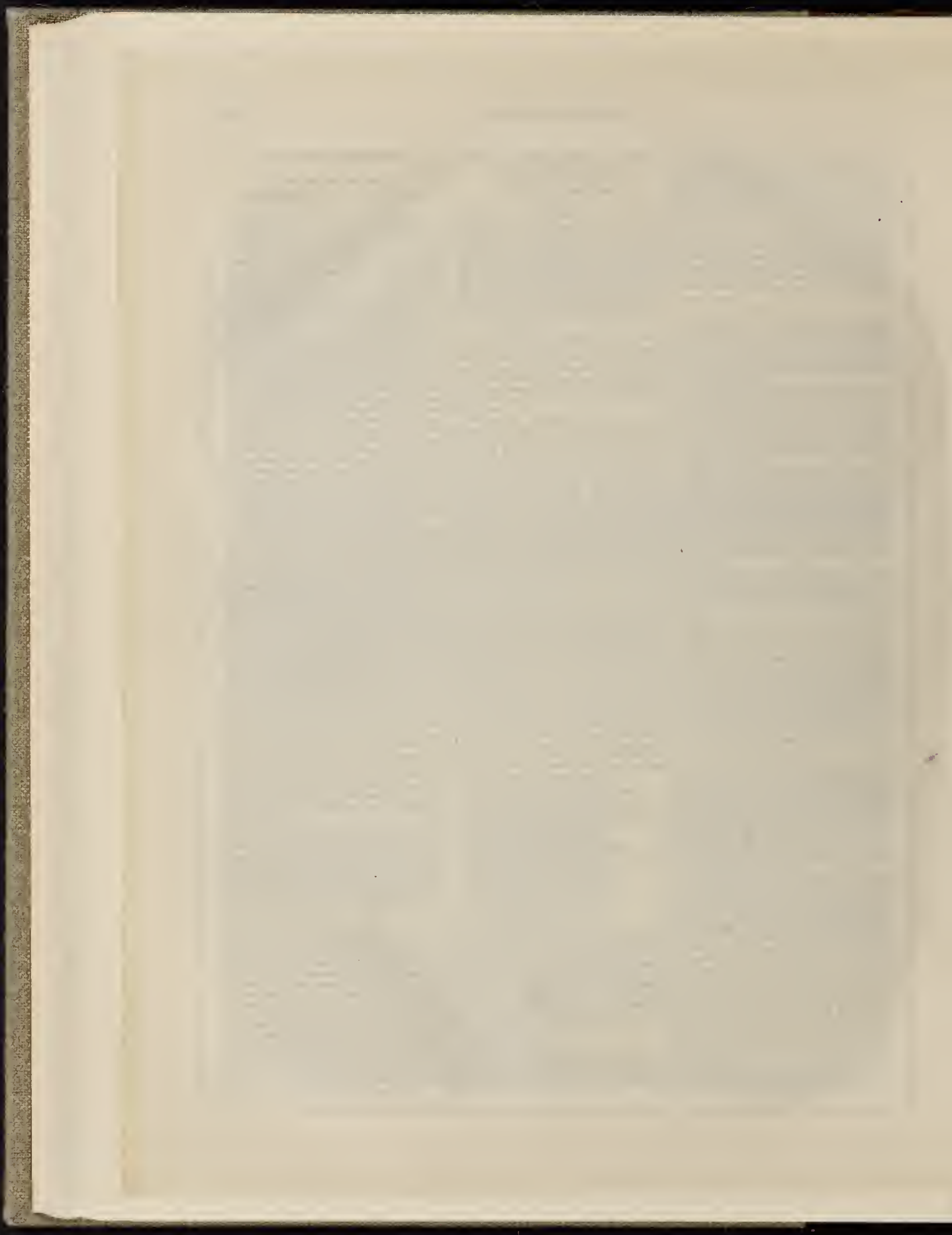



THE PEOPLE OF THE MOUNTAINS
BY J. H. STIMPSON

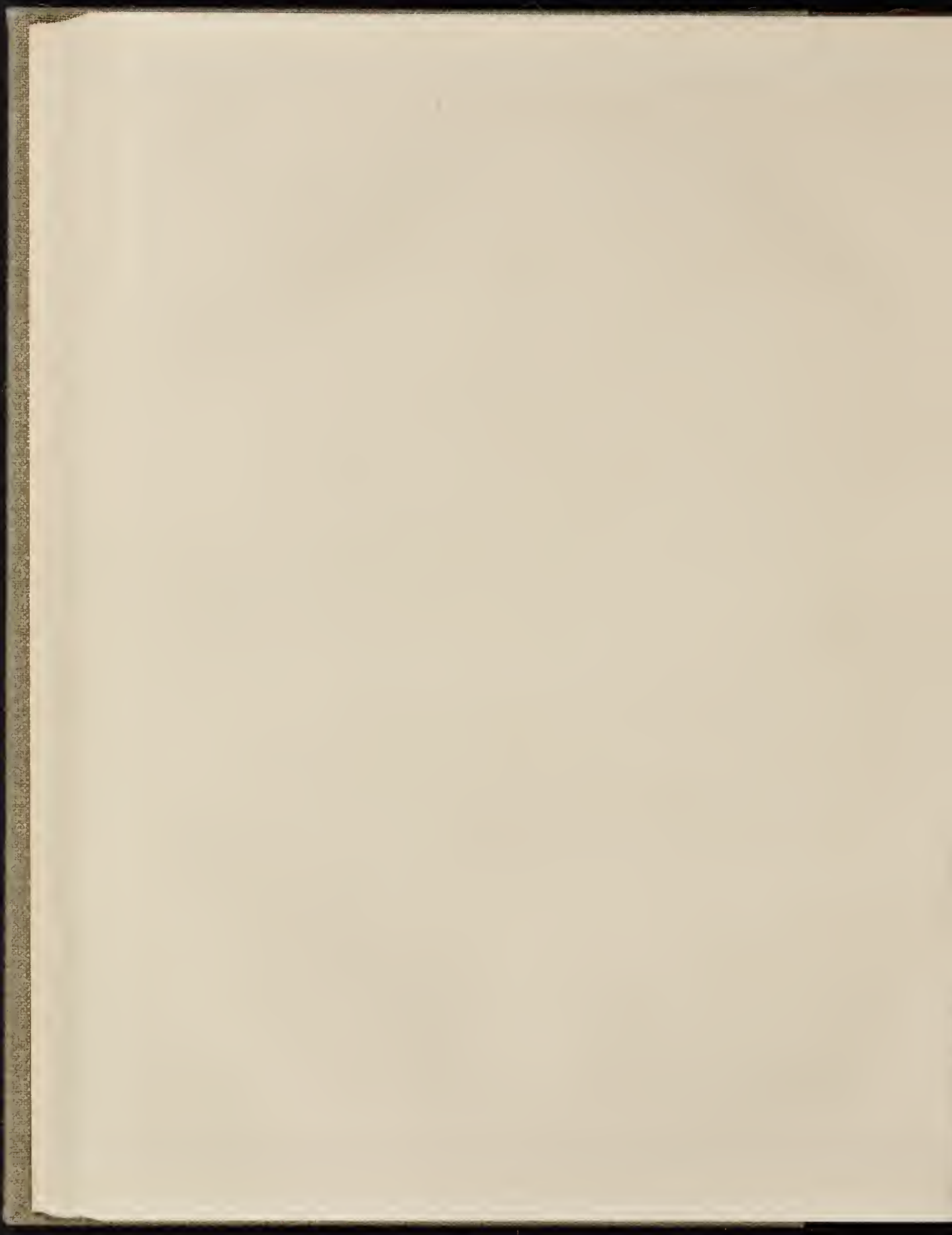

did seem possible to land, shrunk back and were cautious of wrecking their vessels, he shouted out and said, that it was not right to be chary of timbers, but he bade them shiver their vessels rather than fail to force a landing. The allies of Sparta he exhorted not to shrink from sacrificing their ships, in return for the great benefits they had received from the Lacedæmonians, but to prove their gratitude on the present occasion, and run their ships ashore, so as to land by any means, thus securing both the men and the place.

"In this way did Brasidas urge on the rest, and having compelled his own steersman to run the ship ashore, he stepped on the gang-board, and was preparing to land, but before he could wholly effect his purpose, he was cut down by the Athenians. It was not until he had received many wounds that Brasidas fell, but at length he dropped fainting into the ship's bows, his shield at the same moment slipped from his arm into the sea, when, being thrown ashore, it was secured by the Athenians, who afterwards placed it conspicuously on the trophy they erected."

Ships from Zacynthus reinforced the Athenians, and the Spartans were compelled to retire; but if Brasidas had not secured success, he had done more—as we have high authority for declaring—by so effectually desiring it, wherefore let this event also find place on your canvas.*

Recovered from his wounds, Brasidas next proceeds to Megara, which he saves, not from the Athenians only, but from the fatal irresolution of its own citizens, and from the consequences of the factions struggling and intriguing of parties, each for itself, within the walls. He then makes a rapid march through Thessaly into Thæce; and at a later period of the war, it was the probity and ability of Brasidas that most availed to detach from the Athenians the best of their allies, and to win over to the Lacedæmonian interest the cities thus estranged. Of this fact the wise counsels offered to Perdicas, at the Pass of Lynceus, shall suffice as proof: by his own steady persistence in acting on the principles announced in these councils it was, that Brasidas ultimately succeeded in detaching the King of the Lyncestian Macedonians from his alliance with Athens, a most important advantage to the Lacedæmonian cause.†

For the admirable oration of Brasidas to the Acarnanians, I refer you to the author;‡ his surprise of Amphipolis, must also be passed over; but your conception of our hero's exalted character may be aided by the recollection that his clemency to the Amphipolitans caused other cities, previously in the alliance of Athens, to send messengers desiring the protection of Brasidas. It was thus that the Spartan obtained possession of all the towns in the territory called Acte—Sane and Diuna alone excepted.

Torone he brought over to the Lacedæmonians in like manner, and in like manner were the inhabitants conciliated by the wise measures of Brasidas. To Leocythus he granted a truce of two days, when one only had been demanded by the citizens for the burial of their dead. Devout as brave, the Lacedæmonian general had no sooner captured the city, than he commanded that a large sum of money should be presented to the Temple of Minerva—that goddess having, as Brasidas believed, secured his success by causing the fall of a formidable tower, erected by the defenders to oppose his progress; and in further proof of gratitude, the whole site was declared to be sacred when the city of Leocythus had been razed to the ground.

Having compelled the Athenians to accept a truce, the following clause was inserted among others, by the influence of Brasidas, and may further help you to a clear appreciation of the piety, integrity, clemency, and moderation which he joined to his other great qualities as a general—

"With regard to the temple and oracle of the Pythian Apollo, we agree that all who desire access thereto may be permitted to have it, without deceit and without fear, according to the laws of our several countries. The Lacedæmonians, and such of their allies as are present, agree to this, and declare that they will use their best efforts to persuade the Boeotians and Phocians to do so, by heralds sent for

that purpose, proceeding uprightly in respect to the treasures of the god, and acting in accordance with the laws of our respective countries."

At Scione the same policy produced similar effects; and here Brasidas, having convened an assembly of the people, did so effectually win their hearts, that a crown of gold was decreed to him, as to the liberator of Greece. This was conferred on him publicly with other marks of honour, and you can scarcely do better than exhibit to us his fine face and noble figure, as he stands amidst his glad compatriots, expecting the glorious tribute about to be placed on his brow by the Scionean archons.

Of his advance on Potidea, and much besides, we must be silent for lack of space; proceeding to give a brief account of his glorious death in the arms of victory, and refraining from the reproduction in this place of more than a very few words from the commencement of his address to the troops, when leading them, for the last time, to meet Cleon, the general of the Athenians.

"Men of the Peloponnesus, with regard to the character of the country from which we come—namely, that by its bravery it has always maintained itself a free country, and that you are Dorians about to engage with Ionians, to whom you are habitually superior—let a brief declaration suffice."

He then proceeds to give good reasons for confidence, exhorts all to their duty, affirms in very few words his own readiness to do and dare, as he advises others to do, and ultimately marches at the head of his troops.

But the descent of Brasidas from Cerdylina—where he had taken up his position—could not be made without attracting the attention of his antagonist, Cleon, the general of Athens, whom he found prepared to receive him. The Athenians were routed nevertheless, and it was while harassing their retreat that Brasidas received a mortal wound, and fell dying to the earth. Taken up by certain soldiers of the Chalcidian horse, he was carried, still breathing, into the city (Amphipolis), where he lived to hear that his troops were victorious, but expired after a short interval.‡

He was buried, at the public expense, in front of what is now the market-place. All the allies attended in arms; and the Amphipolitans, having enclosed his tomb with a fence, have ever since made offerings to him as to a hero, giving him the honour of games and annual sacrifices.¶

The Athenian commander, Cleon, was also killed in this battle—or rather was slain, as he fled, by a Myrcianian targeteer.¶¶

You will all be reminded of our own general, Wolfe, by more than one passage of the life of Brasidas: the death of each in the arms of victory carries on the parallel, while the fall of the English commander's noble antagonist, the brave and accomplished Marquis of Montcalm, is represented, in a certain sort, by the fate of Cleon.

Of the various points of time proper to your purpose, each will judge for himself; the costume, in all its details, is sufficiently familiar to all; the form of the ships, more especially that of the trireme, is known to every schoolboy, and needs no description.

Among the "Judgments of Richard the Good," as set forth in the quaint old Norman French of Wace, many a curious scene of varied interest will be found; now full of a raucy humour, and anon most deeply pathetic. You will find more than one instance of both kinds in the "Romance of Rollo;" here, for example, is a narrative that may be translated something after this wise.

Now there sped forth a certain monk on an evil errand; he looked behind him fearfully as he left the abbey-gate; but there was none to spy his purpose, and noting this, with heart well satisfied, he passed joyfully on his way.

One step followed fast on another, and the wayfarer came to the brink of a river. Yet the waters, though roaring angrily, do not stop him; he crosses deftly by the bridge, until he comes to the midst thereof, then did there open to him a chasm, which he had not marked till the yawning mouth received him, and the monk sank drowning in the torrent.

Thereupon came the devil, who had gone with him step by step, though he wist it not; he now draws the soul from the body of that monk, and is hearing it to a fiery dwelling; but the sinner's guardian angel rushes to earth, and requires the fiend to resign his prey.*

"Herein you do me wrong," remonstrated Satan, "for I found this monk on an evil path, and he belongs to me."

"Not so," replied the angel; "since he was only on the way, and might have returned, repenting him of his intent."

"Nay, but he is mine of right," insisted the demon; "seeing that this was not the first of his journeys in the direction you wot of; and even as he fell into your wave, was that sinner meditating a return on the morrow, should the continued absence of his superior afford him occasion."

"Touch him not, for all these things," rejoined the guardian spirit; "neither will I take him—but let us bear him to Richard the Good; he shall judge between us, and by his judgment will we abide."

"Thou hast said well," assented Satan; and keeping the soul in their charge, vigilantly watched between them, the Spirits of Light and Darkness repaired to Richard: they found him sleeping in his bed, but he awoke himself to bear them.

Their story told, the good duke declares that neither shall have the soul, which he bids them return to the body, commanding them to place the monk on that precise spot of the bridge whence he had fallen, but by no means to let the chasm opened in the midst thereof be apparent to him.

"If then he take but one step on his evil path," continued the upright judge, "he is thy property, O Fiend of all mischief—take him and work thy will; but if he turn him from his purpose, let him depart in peace—so may thine hour to claim him, fair Spirit of Light, be yet permitted to come."

This being done as commanded, the monk made no further step towards the mischief he had meditated, but hastened back to his cell; the Spirits also went their way, each to the work appointed them.

Passing over the contention of Satan with the guardian angel,—as already sufficiently indicated when discussing the before-mentioned passage from Dante,†—let us consider if there be not the elements of a picture, in the audience accorded to him by Duke Richard to his remarkable clients, as described in the story. The rude walls of the good duke's chamber, the unglazed aperture preceding the window of a later period,‡ giving ample views of the country without, may serve for background. Before them is the simple couch whence he has just risen; his tall stature and large form, with the rich fair hair and clear blue eyes, all common to men of the Gothic race, are well contrasted by the delicate beauty of the ethereal spirit, and by the dusky, yet also beautiful presence of the fallen angel; while the shadowy appearance representing the soul of the monk, will serve usefully to exhibit that mastery over his art which we are surely not wrong in attributing to that one among our youthful painters who may take this work in hand.

A second picture, from the same source, might show us Richard the Good when, repairing on the following day to the abbey whence our monk had attempted the notable escapade recorded above,—and to which the latter had returned *tout penaud*, as aforesaid,—he requires that erring brother to appear before him.

This the poor monk is compelled to do. But see the miracle! his habiliments are pouring streams from the river as he walks—they threaten to inundate the church wherein our present scene is laid; for these garments cannot be dried until the culprit hath made confession of his fault in the presence of all his brethren. Here, then, we have him constrained to perform that penance, and he is opening a rueful month for the purpose, to the boundless terror and amazement of the simple-looking old abbot, who is standing with his attendants near the duke.

But there are other and differing expressions in

* An incident of closely similar character is related by Dante. See the "Purgatory," canto vi.

† See *Art-Journal* for April of the present year, p. 104.

‡ It is true that glass had been then used for some time by the more luxurious of the Norman great; but Duke Richard had been reared hardily, and taught to hold such indulgence in contempt.

* For minute details of all these things see Thucydides, vol. I., book iv. 2—15.

† Hist. Pel., book iv. 83—84.

‡ Thucydides, book v. 83—87.

¶ Hist. Pel., book v. 10, 11.

the faces of the brethren scattered at intervals about the choir. One stand rooted in holy horror; others exhibit varying emotions; some would fain look more shocked than they feel, if they knew how to set about it; while some few, and they not far from the abbat either, 'tis sorrowful to say, have the air of men who could very easily look as much amused as shocked, did the presence wherein they stand permit the free expression of their feelings.

Has any painter reproduced on his canvas the pictures originated by Hood in the verses that follow? It would seem to be impossible that they should have escaped the notice of artists; yet we do not remember to have seen a work on this theme in any one of our exhibitions—neither have we remarked designs from it in the various portfolios that have been from time to time permitted to our inspection. Be this as it may, here are the lines in question:—

THE WATER LADY.

"Alas! that moon should ever beam
To show what man should never see:
I saw a maiden in a stream,
And fair was she.

"I staid awhile, to see her throw
Her tresses back, that all best
The fair horizon of her brow
With cloud of jet.

"I staid to watch a little space
Her parted lips, if she would sing;
The waters closed above her face
In many a ring.

"And still I staid a little more;
Alas! she never comes again,
I throw my flowers from the shore,
And watch in vain.

"I know my life will fade away—
I know that I must vainly pine;
For I am made of mortal clay,
And she 's divine."

It will not greatly task your ingenuity to find much more than meets the ear in the fanciful and beautiful verses just recited. Hear also the following—they transport you to a wholly different region; but in every clime the fervid hours of these glowing harvest-days invite the reproduction of the charming picture presented by them. Make no delay—such skies as these do not always light our godly fields, even when the rich amber of their abundant harvests waves over them in changeable hues, as now. Let the painter take his picture while he may, then; so shall many rejoice in the gladsome brightness of its fair being, even when the hour days of winter are upon us. Place! ample and honored place, for the lovely scene and its lovely occupant, as the poet has set them before us:—

RUTH.

"She stood, breast-high, amidst the corn,
Clasped by the golden light of morn;
Like the sweetheart of the sun,
Who many a glowing kiss had won.

"On her cheek an autumn flush
Deeply ripened—such a blush
In the midst of brown was born,
Like red popples grown with corn.

"Round her eyes her tresses fell,
Which were blackest none could tell;
But long lashes veiled a light
That had else been all too bright.

"And her hat, with shady brim,
Made her tressy forehead dim,
Thus she stood amidst the stocks,
Praising God with sweetest looks.

"Sure, I said, Heaven did not mean,
Where I reap thou shouldst but glean;
Tay thy sheaf adown, and come,
Share my harvest and my home."

A pleasant town is the Hague, always providing, and be it herely enacted, that none but the worst of men shall be compelled to remain within the somewhat level precincts thereof—save "during pleasure." Let him who, not being in the above-named category, finds his patience early washed out of him by the watery influences of the place, have permission to depart, but not until he hath painted—for my rule extendeth only over such as take pencil and pallet in hand—not, I say, until he hath painted for me some features of the following incident. The facts were related to the writer in the year 1841, by one whose ancestor of the period had taken part therein.

During a portion of that time when Oliver Cromwell made the name of our country to be respected in all lands—accuse him who will of his *forfaits* and *malfaits*—the stern republican St. John, a man of haughty and repulsive manners, held the post of English plenipotentiary at the Hague. At the same time it chanced that the Duke of York, who had found refuge in Holland, was one day pacing sadly along the public walk, when he was observed by Mr. St. John; and the latter, needlessly changing his course, to the surprise of certain persons with whom he was conversing, took pains to cross the path of the duke, at whose downcast features he looked half-contemptuously as he passed, but without eliciting the slightest remark from the prince, who, absorbed in his reflections, did not appear to perceive the interruption.

Arriving at the place of departure as the duke was leaving the walk, Mr. St. John rudely stepped forward, and, with his hat on his head, took precedence—James of York modestly drawing back as he became aware of the Englishman's intention, but with an expression of astonishment at the discourtesy of his unbidden-for intrusion.

The Prince Palatine, who came up in time to see what was done, instantly lifted off Mr. St. John's hat with his cane, remarking, with pretended politeness, but with a manner which he took care to make sufficiently significant, that the English ambassador had failed to perceive the presence in which he stood.

St. John felt the sarcasm, and laid his hand on his sword, but disapproval of his unhandsome conduct was written in all faces: every man of distinction there present gave point to the reproach by standing respectfully unheeded, and with more than ordinary observance, around the prince, and as in attendance on his person. The populace, taking part with fallen royalty, began to express their opinions in tumult; the harsh republican was driven ignominiously from the grounds, and, after being for some time in imminent danger of his life, was glad to accept the protection of the very man whom he had sought so needlessly to offend, and took refuge in the duke's lodging.

The scene of this incident was that really beautiful promenade known to all visitors of the Hague as the *Bosch*, or Wood. Magnificent trees are found at intervals throughout the not inconsiderable length of the space; and these, however short may have been your stay in Holland, you will have learned thoroughly to appreciate; deep shadows fall over bright green slopes, their exquisite colour making large amends for that lack of boldness which the nature of the surface renders inevitable: handsome sheets of water vary the character of the whole. If to these be added the widely differing appearance of the personages forming your chief group, the diversified expression proper to each of the actors; to the nearer bystanders, and to the more distant people,—now preparing to repay the discourteous ambassador in his own coin, as exhorted thereto by the energetic fishwoman of Scheveningen, conspicuous by her shadowy head-gear, and coming prominently forward in their foremost ranks,—you will at least not fail of variety in your picture, and may produce a work of which the interest will certainly not be inferior to that of many now occupying space on the walls of our galleries.

When the brilliant courtiers of Philip IV. of Spain did not venture to gaze on his august countenance until they had first mounted spectacles,—"broader," says the Countess D'Aulnoy,† "than the palm of my hand,"—a certain marquis, first among the foremost, and who would assuredly not fail to have his glasses of the orthodox amplitude, was pleased to command the erection of a statue to his own honour and glory.

And the sculptor completed his work; but, strange to say, he neglected to place marble spectacles on the nose of the marble *hidalgo*, and was forthwith "turned back," as schoolboys have it, to supply the omission. Of his ultimate success the chronicles do not speak; but that the Marquis of Astorga's effigy was duly furnished with spectacles, we may not

* Speaking of the Protector's funeral, Evelyn says, "This was the merriest funeral I ever saw; no one howled but the dogs, with which the soldiers made barbarous sport."

† See "Voyage en Espagne," Lettre viii.

doubt, although no statue exhibiting such appendage hath met the ken of the writer. In any case, would not the Spanish ancestor prove the most zealous of patrons to that sculpture in colours, now menacing ruin to the noblest of the Arts? How glory in the joy in the brilliancy that might now be given to the velvet of his habiliments! how glory in the dazzling glitter that would now be imparted to every jewel in all his orders! Alas for the Marquis of Astorga! why did he live so long before the time?—for do but think of the rare delicacy with which we could now reproduce, for his delectation, that refinement of complexion which it is but civil to conclude that he derived from his indubitable *sangre azul*—the unquestionable "blue blood" of his race!

But the subject is after all scarcely fit to be laughed at—nay, rather, since this deplorable innovation is to a certain extent sanctioned by an authority so much respected as is our admirable Gibson, we are compelled to treat it with the utmost seriousness. Not that all one's admiration for the artist can blind one to the fallacy of his reasonings on this subject; nay, even while listening to his zealous defence of the new theories—or newly revived, for we do not here enter into any discussion of that question—you feel more than ever rooted in your attachment to the old ones. The delicacy and reserve with which the Sculptor has applied his theory to practice, in such specimens of the new manner as we have seen in his Roman studio and other places, could not render us unfaithful for one moment to our earlier loves among his previous works; on the contrary, the grace and beauty of these last caused us ever more to lament that the earnest speaker should be disposed to adopt a manner which, with all due deference to his judgment, we could not but think a mistaken one, both for his own fame and the future delight of the world in his works.

Among the first of his productions treated by Gibson in this new or newly-adopted manner, was a statue of the Venus Victrix,—if we remember rightly,—the apple lying at her feet, involved—if our memory do not fail us—amidst the gracefully depending folds of her drapery. That the beauty of the work was not impaired so seriously as we had feared it would be, is a fact not to be denied, and which we distinctly remember. Yet did we return with increased delight to those chaste forms of the artist's earlier day, all but breathing around us, and seeming to reproach their creator for his abandonment of that happier phase in his and their existence, when he had called them into that lovely life, from the cold insensate blocks of their else unmarked abode; we retraced with even new delight, I say, to those earlier works; and when reluctantly leaving them, after long and repeated contemplation, it was with the conviction fully confirmed that Sculpture, as the great old masters presented her to the love and worship of all times, late and early, does indeed need nought from the "foreign grace of ornament," but *is*, "when least adorned, adorned the most."

If then there be any among our aspirants doubting whether it be desirable to adopt the new method, let him be assured that colour is not for the purposes of the Sculptor; for since, even in the hands of Gibson, the addition, though admitted only with the utmost reserve, and applied with an exquisite delicacy, is yet no improvement—to use the gentlest form of phrase permitted by truth—what would you look to find it in hands less competent, under treatment less refined? Do not your most cherished recollections combine to warn you of the perilous venture? would you suffer a pair of blue eyes to glimmer from beneath the veil of Vesta? or have you any mind to affix black locks to the head of Apollo Delphinus?

I know it may be said that no such enormities are contemplated; well, they are not; but beware the sharp end of the wedge, never does it fail to bring the broad one in its train, and be sure that a law so general will be held inviolate, here as elsewhere.

Do you then hold fast to the practice as it has been, whether that be of the oldest or not; evoke from the willing stone those proud and haughty forms wherewith your imagination is doubtless ever teeming, but eschew the desecration of colour; let the Marquis of Astorga rejoice in the glories thereof, with those of his spectacles, if so it please him, but do you content yourself with the purity of the marble.

Here, for example, is a group which would by no means be embellished by colour; you will find it in some one among those masses of marble awaiting the moment of inspiration in the recesses of your studio—provided only you do not seek it until the propitious day has dawned upon you. One of the loveliest of the Corycides is that nymph with her sweet, imploring looks, and graceful attitude of such entirety as one immortal may address to another.*

She has risen to a certain height on the sacred mountain, at the foot whereof is her birth-place, and meets Apollo Ismenius, as he descends to that temple of Bœotia whence the name he bears. The god is looking with approval on her beauty, as you see well, and she beseeches him to endow the lyre in her hands, and which she holds towards him, with such perfection of tone as may render it worthy to sound his praise. That Apollo will grant her prayer is made manifest by the expression on that god-like brow, and on the fine arch of his lips; but let there be no rumour of colour in the air, lest your visitants, seeking defence from that outrage to their divinity, should return to their refuge in the sheltering stone.

Or say you give us the fairest of the Orads, as she prepares to join in attendance on the Dolian mistress; beautiful are the free limbs appearing from beneath her high-looped tunic; full of spirit is her action, as, holding the well-filled quiver in one hand, she throws its fill over her firm and rounded shoulder with the other; her bow, which she will presently resume, laid beside her on the earth. Elastic will be the bounding step of the Orad on the dewy glades she prepares to traverse, and gladsome is the expression of the full but sweet and chastened lips, half opening as about to give utterance to the joy of her heart, as the sports awaiting her rise, with all their genial delights, to her thought.

Or suppose you take the brilliant Maia for your theme: whether, as the most luminous of the Pleiades, you present her alone and star-crowned, or, approaching her as one of the Caneneæ—all but immortal,—you engage us to wait reverently and in silence while her votaries offer sacrifice. And these last, should your intent be the more ambitious one, will aid you effectually to form such a group as might be worthy of a temple fairer than might now reared by man. For in this case you will invest the daughter of Atlas with her most imposing dignity, and the shepherd about to present his offering must exhibit all the perfections of youth, strength, and beauty. The victim offered may be a kid, sporting playfully with the flowers that mark his doom; or a lamb, caressing the fingers that have bound him for the sacrifice. Or, if you hold them more appropriate, let your shepherd-boy bring fawns only, or the produce of his hives instead—since of these, or of gifts yet more simple, were the offerings most commonly made to the nymphs.

Yet I incline for this occasion to the more important offering, for see, there leans upon the shoulder of the youth, a man whose age, or some malignant influence, has robbed of his pristine force; it is for him that the boy implores the favour of Maia—and affection offers no niggard gift. It may perchance be length of life that the elder votary seeks at her hands, and in that case he would make ample sacrifice, attributing to the Caneneæ such power to prolong the days of her worshipper as might content the desires of him who best loves life; since he knows that she may confer any length of existence short of that accorded to herself; and of this, what says Hesiod, or rather, what sing the swains to whom he listens when the dooks are in the fold:—

"Nine times the life of the oldest man have the gods assigned to be the life of the Crow; four times longer than the crow lives the Stag; three times the life of the stag is that of the Raven; to the Phoenix is granted nine times the life of the Raven, and ten times do the Nymphs outlive the Phoenix." The boon our shepherd is asking may be thus of no trifling moment, and in proportion must be the sacrifice, but not even here must you endure the presence of colour—no, not though it were but to lead the faintest of hues to the smallest of the blossoms that your votaries have twined around the neck of their offering.

* If the nymphs are not immortal, in the strict sense of the term, they are sufficiently so for the purposes of the artist.

CORRESPONDENCE

FROM THE
UNITED STATES.

[For a long time just we have been anxious to cultivate a closer intimacy with the Artists and Art-producers of the United States; believing that by so doing we may essentially promote the interests of this country, as well of the people on the other side the Atlantic. If our language is the same, so is our Art also, to a great degree; and whenever the Art of the one is promoted, that of the other is advanced. The ART-JOURNAL has obtained extensive circulation in the United States; and we receive abundant proofs of the service it has there rendered: we do not expect that by frequent communication to the English reader as to the progress of Art in America we can effect as large an amount of good; but we feel sure that occasional reports, while they cannot fail to be interesting, may be at the same time instructive; and we shall rejoice if we find means to draw nearer and closer those relations that must be of advantage to both,—by cultivating the Arts of peace, which are at all times a safeguard against disunion.]

We shall therefore, we hope, be enabled from time to time to report duly and with integrity the progress of Art, Fine and Industrial, in the United States; conveying useful information to all classes of readers in Great Britain, on the continent of Europe, and in America. We have no doubt that by the aid of competent associates, we shall thus add much of interest and value to our Journal while rightly representing the progress of a great people, who in Art, as in all things else, are making rapid advances to perfection. Meanwhile, we print the first communication we have obtained: pledging ourselves, as far as we can, for the accuracy and integrity of the views and statements of our able and experienced Correspondent.]

DEAR SIR,—I am very glad that the substantial proof which you have received of the good and growing estimation of your beautiful JOURNAL on this side of the water, has awakened so lively an interest among you in respect to the condition of our public taste. The subject, I assure you, well merits all the study which you seem disposed to devote to it; and for my own part, I shall certainly be most happy to assist your inquiry with all the propulsion and power of the heartiest sympathy, and not a little fair opportunity. You may therefore rely upon me as a faithful sentinel, ever watchful for every information and intimation which may help in the wisest disposition of the forces you can send to fight with us, under the banner of the Beautiful, against that great gothic Attila—*Utilitarianism*, which has overrun, and overruled, our country. Assuredly the strength is hers, however scattered and inactive, for much and true Art achievement; and the good time is, I hope, not far distant, when, with earnest and persistent battle, the present gross and glaring materiality of popular feeling shall be toned and sweetened in the softening shadows of our victorious flag.

We have good soldiers already in the field, and better backing on their armour, with patriot-prayer and voice enough to second and cheer them on their way. Here, as in other of our larger cities, we have brave regiments of Artists, which, rough troops though they be, for the most part, need only discipline and organisation to become a manifest and conquering power in society; while every hamlet within the three points of our political triangle—Maine, Texas, and California—has its humble recruiting office in the shape of some little still-voiced studio. Academies of Art, such as they are—and they might be worse and will be better—are growing up about us; and within the circle of a day's journey from my *sanctum*, there are annually held half a dozen very considerable reviews of new, original "works," which the people flock lovingly to see; while but few good pictures, after all the lamentation, go "a begging" for liberal purchasers. Not long ago, one esteemed landscapist, Cropsey (who will have taken up his temporary abode amongst you—to your gratification and our regret—by the time this despatch arrives), sold his accumulated pictures, sketches, and scraps, at public auction, and realised

willing thousands where only dubious hundreds had been predicted.

But, returning to the ranks: it is the portrait-painters who are at present doing most execution—taking off the heads of the people; oftentimes, it must be confessed, cruelly enough. And after this irresistible infantry, there comes the light cavalry of the landscapists, successfully carrying Birnam Wood to Dunsinane! What we are most wanting, unfortunately, is the heavy ordnance of history, though now and then a big gun bangs away triumphantly. Mr. Edwin White has lately discharged such a piece effectively, in the shape of an admirable picture of the "Pilgrims signing the compact in the cabin of the May-flower." Mr. H. P. Gray, another, in a charming "Hagar;" and Mr. H. K. Brown, one of our most able sculptors—though he lives in Brooklyn instead of Florence or Rome—is at this moment erecting a battery in Union Square, from which he will take the town by storm on the coming 4th of July; for he is going to do nothing less than to trot out General Washington himself, mounted on his war-horse, and both grand in bronzed bravery. I must though be serious here for a moment, as the subject is important. A few years ago some liberal-hearted private citizen made up a generous purse to procure for the city a colossal equestrian statue of the country's idol. The commission was entrusted to the joint care of Mr. Greenough and Mr. Brown. The lamented death of the former left the task to his colleague alone, and he has accomplished it with a success of which I shall speak hereafter.

I shall endeavour to advise you in regard to our Art-history, with all profitable observation of present performance, and deep backward when opportunity may come. At this moment I have sought only to report myself ready for service as your Correspondent here.

Very sincerely yours,

T. A. R.

New York, June 6, 1856.

DEAR SIR,—I am afraid that it was very rash—the promise which I lately made you, to watch the wide and varied course of Art, *Esthetic and Useful*, in this great land. The labour grows into most grave magnitude as I come near to it; and I might even now be tempted to shrink from the task, did I not feel its vast importance and worth,—and were it not an inexorable dogma of our national faith to go-ahead when once assured you are right!

Before I can intelligibly follow the daily progress in our studios and manufactories, I must inquire, briefly as may be, into their past and present fortunes. Such a review I shall have an admirable opportunity of making during the coming summer months—the annual interregnum in Art-production; when the ateliers are closed, and their occupants, as the cards on their doors intimate, are "out of town," consulting with the great teacher, Nature, as to their future toils.

In this note I propose to give you such information about the Arts here, as you may be able to gather from a knowledge of their money value in the higher departments. I am very sorry thus to begin with the all-mighty dollar, but it is the truest standard; and whatever "figure" we, as well as you, might cut, would still be but a miserable one, unless led by the magic "\$" or by the "£ s. d." As with all other things, so with Art—to know whether it "pays," is to know whether it prospers.

However diffused the political power in the United States may be, the Art-strength clearly tends towards centralisation, and that, in this our chief metropolis, with a partial exception in respect to portraiture, and in a few notable instances in other departments. At least no more can be said of other cities than of this, which may thus speak fairly for all the rest. In our population of half a million there are scarcely less than from five to six hundred painters, sculptors, and engravers, who live solely by the practice of their professions. The greater portion, of course, are men of very moderate ability, and only very moderately known to fame. The "works" of nearly two hundred are from time to time adulated upon the walls of our Academy Exhibitions, and half of these might be entirely excluded with great advantage, while the productions of a yet smaller number only are desirable. The highest prices paid for

portraits—and which but few command—are from one hundred and fifty to two hundred dollars for a head, from two hundred to two hundred and fifty with hands, and five hundred and one thousand dollars respectively for half and full-lengths: five hundred and one thousand dollars were once the official prices paid by our city authorities for the portraits of the retiring mayors and state governors, but these fees have, within a few years, been reduced to exactly one half. The painters of course disapproved of this economy, and one of them, when coaxed to compromise the matter, by "doing only what he could afford for the price," grew merry at the order (as he said) for "five hundred dollars-worth of governor!" The corporation, alas! won the day, and their price-current still controls the market. The only retaliation within the power of the artists, and which some of them unfortunately seem careful to make, is not to give more than the worth of the money.

When our "city fathers" once upon a time desired Mr. Ex-President Van Buren to sit for his portrait on their account, and to select the artist himself, he went of course to the studio of the late Henry Inman, the leading painter of his time. His work completed, Inman presented his bill, one thousand dollars, to the authorities. The price was disputed; whereupon the artist coolly replied that it was of no consequence, as since they declined to pay he would send the account to his sitter, who had ordered the picture. It need not be added that the municipal purse-strings were very speedily loosened. This half-price business is in strict keeping with our government estimation and patronage of Art—excepting only in the instances of the national commissions of ten thousand dollars each, for the eight large historical compositions in the rotunda of the Capitol at Washington, and of a few works of statuary there and elsewhere.

In landscape—the department in which, and for many years to come will continue to be, our chief Art-strength and hope—the prices received by some half-dozen of our best men range from fifty to one hundred dollars for a study, or a small picture, to five hundred for a canvas four feet by six—the maximum landscape dimensions here: a few works of this size are sold for one thousand dollars, and occasionally for yet larger sums.

The prices of historical and genre-pictures—of which we have comparatively few—run very little above those paid for landscapes. There are in the possession of gentlemen in this State two very large pictures by Lentz, purchased each at the cost of ten thousand dollars.

The collections of the late American Art-Union were purchased at the rates I have indicated. I am speaking now only of the works of a few of the most popular painters—and they are not all overburdened with orders. No fortunes are yet made here at the easel. Two or three thousand dollars a year is a successful income, and five thousand is a marvel. The purchasers of pictures are few in number as yet, and their means are limited. Others will by-and-by be paid for the toil of the artists of to-day—by-and-by, when their works will be resold at double and treble the prices they themselves receive. Of this there is clear indication in the greatly advanced value of good pictures of the past, as they come from time to time under the auctioneer's hammer. The last yearly collection of the American Art-Union, when thus sold—the law having forbidden its distribution by lot as before—brought almost the liberal amount at which it was purchased. I recall here the instance of a certain little picture, which was recently bought by a distinguished gentleman in Washington at ten times the price which the painter received not very long before.

Is there not in all this, promise that the true love of Art lives among us; and that in due season, and under proper circumstances, it will become gloriously manifest?—that with the daily increasing means for the gratification of daily advancing taste, the public estimation and support of the higher Arts will soon grow, even in a greater ratio of progress than that already made in the more useful and practical departments? May not the young men of to-day, even, hope to gather their share of the ripening harvest?

But to leave this agreeable future, and to come back to the less inviting present, of which labour and patient waiting are the watchwords. While we

have amongst us, happily, a few gentlemen who buy pictures simply for the love they bear them, certainly as yet the greater number of our connoisseurs look only to the vain pleasure of a showy and costly decoration of their parlours and halls; ordering works of Art for this and that especial niche and nook, in precisely the same spirit in which they order fresco flowers and angels for their ceilings, and carpets for their floors. Thus the Art in our drawing-rooms is always well-displayed, and never thrown away in portfolios, unless it be in expensive engravings. Little hidden treasures, which do not astound the vulgar gaze, and thus minister to the idle vanity and pride of their possessors, are looked upon as unprofitable extravagance. So we have no works and no painters in water-colours, and cannot for the present hope to have any; though a beginning has been made even in this, by a little society of hopeful labourers, from whom we shall, I trust, have good reports before long.

We have very successful annual exhibitions in this and the neighbouring cities of Philadelphia and Boston; and as I write, vigorous efforts are being made to establish a similar gallery in Baltimore. The collections of the National Academy of Design, in New York, are the only ones entirely renewed each season. They have now continued without interruption through thirty-one years—the catalogues numbering from four to five hundred items, and the receipts varying from three to five thousand dollars per season of six or eight weeks. In 1826, the first year, the exhibitors were themselves called upon to pay, *pro rata*, the costs of the exhibition; during the second season (1827) over five hundred dollars came into the treasury; and ten years later (1837) a no less sum than six thousand two hundred and seventy-eight dollars was received from visitors. Since that time the income greatly decreased; but during the past three years has been gradually coming up again. The financial condition of the Academy was greatly improved recently by an advantageous sale of its galleries; and its real and personal property now amounts (without debt) to about one hundred thousand dollars. The available means are soon to be re-employed in the erection of new and more commodious buildings.

Besides the annual exhibitions of the Academy, we possess an excellent beginning of a permanent collection of American pictures, established some years ago under the name of the New York Gallery of Fine Arts. It is closed temporarily from the want of suitable exhibition rooms. Next we have, and have had for a number of years, a collection of German pictures—some hundred and fifty in number—known as the Düsseldorf Gallery. These pictures, which are fair examples of the school to which they belong, were very popular when first exhibited; and with some ups and downs they have kept their place in public favour to the present moment. During the past year the receipts of the Düsseldorf Gallery have averaged about twenty-five dollars per day. The fourth and last permanent exhibition in New York is the Bryan Gallery of Christian Art, a very excellent and most interesting collection of old pictures. But our people do not much affect the old masters (except when they can plaster their walls with them at a cheap rate), and so Mr. Bryan's pictures are displayed chiefly at his own private cost.

For a number of years the attractive and ever-changing galleries of our late Art-Union were a favourite and always thronged resort of all classes of our population.

Besides the exhibitions proper, we see a great many works of Art in the shops of our frame-makers and colourmen. Messrs. Williams, Stevens, and Williams, always make an attractive display at their large and elegant establishment in Broadway, giving us from time to time peeps at the works of your own artists. Just opposite to them is the well-appointed store of Goupil and Company, where we occasionally obtain sight of a Delacroix, a Veret, a Scheffer, and other pictures of the French school.

The receipts of the Pennsylvania Academy, in Philadelphia, hardly fall below our own. In 1851 the gross income of sixty-four days amounted to four thousand six hundred and two dollars and seventy-one cents; while that of the current exhibition (the thirty-third) is still larger—more than three thousand dollars having been received during the first thirty-six days. This, too, with the deduction of

about six hundred free family-tickets issued to stockholders—for the Pennsylvania Academy, unlike the National Academy, is a joint-stock institution, controlled by lay as well as by professional members. The real and personal estate of the Pennsylvania Academy (invested in admirable buildings for exhibitions and schools, and in a permanent collection of pictures and statuary) amounts to one hundred and thirty thousand dollars, with a venerable debt of thirteen thousand.

The only gallery supported in Boston is that of the Athenæum—a permanent and an annual exhibition united, as in Philadelphia. The receipts last season were four thousand four hundred and forty-three dollars and thirty cents, an income very much exceeding, thus far, their present year.

In each of the three cities of which I have spoken there is a respectable Art-library, and free schools for the study of the antique and the living model. At the National Academy the roll of students varies in number from twenty to sixty.

One very important means for Art-development, in which we are unhappily quite wanting, is a well-informed and honest criticism.

A few of the leaders of Art-opinions here, who really seem disposed to be honest, have unhappily fallen of late into a most lamentable misunderstanding of the true spirit of the reform in Art which in England you have called Pre-Raphaelism; and instead of urging upon us the importance of that more rigid discipline of eye and hand—that more faithful study of Nature, and that more careful and patient manipulation, which we really so much need, they insist that we shall absolutely eschew all imagination, all poetry, all feeling, and be slavish imitators of Nature, with no presumptions preference of her beauties—no choice between "a mulier and a mountain."

I forgot to mention in my last letter that it would be accompanied in its voyage across seas by Professor Morse, the illustrious inventor of the electric telegraph. The artists here are especially proud of Professor Morse, as he has successfully gone out, like Fulton, from their own ranks into the world of practical scientific achievement. He was the founder, and for twenty years the President, of our National Academy, which office he resigned only when he found himself entirely withdrawn from the profession into other labours. Notwithstanding his triumphs elsewhere, I am sure that he sometimes looks back regretfully to the long years of his former artist-life. Indeed, I once heard him say, at one of our Academy *réunions*, when it was lamented that he so rarely visited the exhibition, "That such visits were always painful to him, as he never found himself among pictures and painters without feeling very much like one who comes into the presence of an old love in the possession of another!"

I am very sincerely yours,

T. A. R.

New York, June 21, 1856.

CORRESPONDENCE.

To the Editor of "THE ART-JOURNAL,"
MILLAIS' "BLIND GIRL."

SIR,—Last year I had occasion to direct attention to the violation of truth in Mr. Millais' picture of "The Rescue," in which it will be remembered a monochromatic red light was diffused over the picture, though, in reality, the flames of burning wood emit yellow and green rays in abundance. A yet more glaring want of attention to natural phenomena is observable in "The Blind Girl," by the same artist, exhibited this year. The story of the sightless girl is told by the introduction of a rainbow, which, with its very beautiful play of colours, is delighting the younger girl, who is blessed with sight. Not only is the primary bow represented, but the complementary bow is also shown. If Mr. Millais had looked at a rainbow, and its complementary arc, he would not have painted both with the colours in the same order, as he has done. Let him observe, when next he has an opportunity, and he will find that the order of the colours in the complementary bow is the reverse of the order which prevails in the primary rainbow. Surely, with all the boasted attention of this school to the truth of Nature, such errors as those which I have pointed out should not have been committed.
I am, &c.
CHROMAS.

BRITISH ARTISTS:
THEIR STYLE AND CHARACTER.

WITH ENGRAVED ILLUSTRATIONS.

No. XVII.—WILLIAM POWELL FRITH, R.A.



LOOKING at the histories of the various schools of painting since the revival of Art, it may be affirmed without much fear of contradiction that not one presents a parallel case of rapid improvement to our own. It occupied the Italians three centuries, from the thirteenth to the fifteenth, to develop their school, and another century firmly to establish it. The Spanish school, commencing about the middle of the fifteenth century, reached its climax, in the works of Murillo and Velasquez, towards the close of the seventeenth. That of the Flemings and Dutch, which bear so close a resemblance, and therefore may be coupled together, began in the middle of the fifteenth century, and attained its highest point about the end of the seventeenth.

The foundation of the French school was laid early in the seventeenth century; and though it has at present neither a Nicholas Poussin nor a Claude, it can scarcely be said to be on its decline.

Till the latter part of the last century England had no school of painting; and in fact till the appearance of Hogarth, who died in 1764, she had no artist of any eminence, except the portrait-painters of the reign of Charles I.—Cooper, Dolson, and Oliver. But the founders of our school—Reynolds, Wilson, Gainsborough, Barry, Northcote, Opie, Romney, &c.—some of whom were

living at the commencement of the present century, were the pioneers of a numerous and successful body of artists, whose works, except in the department of history, will bear comparison with those of any age or country. Fifty

years have sufficed to place England on a level with the best Art-epoch of the Continent; for if we have not produced a Raffaello, a Guido, or a Leonardo da Vinci, it ought to be borne in mind that we have exhibited a greater diversity of talent and more originality than the most famous schools of Italy ever sent forth. If we are behind all others in historical painting, it is the result of circumstances rather than of any deficiency of talent: as we have often had occasion to remark, where there is no demand there can be no reasonable expectation of a supply; this has been, and still is, in a great degree, the case with us. Italy, throughout her long period of artistic excellence, required little else than the representations of saints, and martyrs, and sacred history—consequently the talents of her painters were limited to such subjects; and we may trace throughout the whole of their works more or less resemblance to those who preceded them. Protestantism effected almost as wondrous a change in Art as in religious forms and ceremonies. It opened a wider field for the talents of the painter; and as the doctrines of Calvin and Luther soon spread over the Low Countries, there arose in them the numerous classes of landscape and genre-painters who have served more or less as models for those of our own school. The artists of France have found few imitators among ourselves—we cannot call to mind a single example of a British painter so closely adopting the style of any French artist as to be recognised as his copyist, or even follower; and although we have seen pictures by Turner which have been, and not inappropriately, likened to those of Claude and Nicholas Poussin respectively, no one, we presume, would call Turner an imitator of either.

What sacred and legendary Art suggested to the schools of Italy, the manners and customs of their country to those of Holland and Flanders, our own painters have found, to a very considerable extent, in English literature; less perhaps in our history than in works of fiction, much of which, however, possesses the character of fact. British Art has drawn largely, though not deeply, from the writings of the dramatist and the novelist—so largely and with such constant repetition as to render it desirable they should seek elsewhere, or in some new channel, for such fountains of inspiration as they stand in need of. Our prose writers and our poets are far from exhausted, nor would we have them neglected, but we should like to see the treasure-hunter looking deeper than the surface, and into springs that have not yet lost all their freshness, or,



Engraved by]

THE VILLAGE PASTOR.

[J. and G. P. Nicholls.

in other words, if their reading were more discernive their pictures would exhibit greater originality. Shakspeare and Goldsmith, Sterne, Scott, and Byron, have been "on duty" during the last quarter of a century. It is quite time they were relieved. We do not intend these remarks as applicable especially to the artist whose works we are about to introduce to the reader; they refer to our genre-painters generally, of whom Mr. Frith is one, but one also far less amenable to our strictures than the majority of his compeers; particularly in the works he has exhibited within the last four years.

William Powell Frith, R.A., was born in 1819, at Studley, a village near Ripon, in Yorkshire. His father, a man of taste, and an enthusiastic lover of Art, encouraged in his son the earliest indications of the talent which it was evident the boy possessed; every opportunity was afforded him to copy the best pictures and prints that came within reach, and thus the groundwork of future success was laid without any of those obstacles which so frequently impede the progress of the young artist. The father desired to see his child grow up to be a great painter; the prospect of his arriving at excellence

was the darling hope of the parent, who, unhappily, did not live to witness his success, as he was removed by death when the lad had scarcely reached his sixteenth year. The loss did not, however, affect the career of the young artist; he continued his elementary studies, and in 1835 was placed in the Art-academy in Bloomsbury Street, then conducted by Mr. Sass, and now by Mr. F. S. Cary, from whose schools many of our most esteemed painters, and several who have gained distinguished rank at the Royal Academy, have come forth. During the three years Frith continued here, his aim was to perfect himself in drawing and the art of composition, well knowing that these must ever be considered the primary elements of a good artist. To colouring he paid comparatively little attention. In 1839 he exhibited at the British Institution his first picture, a small portrait of one of Mr. Sass's children; and to the same gallery, in the following year, "Othello and Desdemona," of which at the time we thus spoke:—"The artist's name is not a familiar one; if he be young" (he was then twenty-one) "he will ere long produce works of a much higher character. His groundwork is safely laid. He has given us a proof that he thinks while he labours." Mr. Frith made in this year his first appearance within the walls of the Academy by his contribution of a picture representing "Malvolio before the Countess Olivia," a subject which Maclise has so ably portrayed in

the picture now in the Vernon Collection. In 1841 he sent two pictures to the Academy, one a portrait, the other "The parting interview of Leicester and Amy," as narrated in Scott's "Kenilworth," a composition in which the characters are very faithfully delineated. In the British Institution, in 1842, he had one picture, but it was so unfavourably placed that those who only saw it in the gallery must have formed a very inadequate idea of its merits. The subject is from Sterne's "Sentimental Journey," where the traveller feels the pulse of the attractive French *modiste*, and receives the gracious acknowledgment of her husband for his attention. The picture is elaborately finished, and elegant in conception; nor did we prove a false prophet when, after seeing it—but elsewhere than in the gallery—we wrote:—"A time will come, and that as surely as we now write the sentence, when the painter will obtain the most distinguished station in any collection of the works of British artists." Mr. Frith's solitary contribution to the Academy Exhibition of the same year was also an illustration of a passage from one of our Novelists—Goldsmith, whose "Vicar of Wakefield" has perhaps proved a more profitable mine of wealth to the painters of our school than any other tale that was ever written. The scene he selected is that where, at the suggestion of Mrs. Primrose, Olivia and the Squire are standing up, *dos-à-dos*, to ascertain which is the taller. Other characters, the



Engraved by]

SCENE FROM THE "BOURGEOIS GENTILHOMME."

[J. and C. P. Nicholls.

Vicar and the younger members of his family, are also introduced into the work, forming a group of exceeding interest, each one of whom seems to be the veritable personage drawn by Goldsmith. The picture was purchased on the day of opening the exhibition.

Of the two pictures sent by Frith to the British Institution in 1843, one—"Dolly Varden," from Dickens's "Barnaby Rudge"—is too well-known by the engraving executed from it to require description; the other, the "Duel Scene," in the play of "Twelfth Night," had been exhibited the preceding year at the Gallery of the Birmingham Society of Artists, where it soon found a purchaser. The subject had evidently been well studied, and the characters are placed on the canvas most faithfully—perhaps a little too much so; for the disinclination which the combatants exhibit to enter the lists is rather too conspicuous—they both appear such absolute cowards that it seems absurd to suppose they will ever cross swords. His single contribution to the Academy this year was also a subject from Shakspeare—"Falstaff and his Friends with the Merry Wives of Windsor." The picture, like one we have just adverted to, was so wretchedly bungled, in the den called the "Octagon Room," that it was impossible to see it. The fat knight and the comely dames have often been the themes of our artists, but we have rarely seen them more successfully represented than in this admirable work.

Mr. Frith's pictures of 1844, were two only, and both of them in the Royal Academy; one "An Interview between Knox and Mary, Queen of Scots, respecting her marriage with Darnley;" the subject is one not suited to the powers of this artist, though the character of the stern Reformer is well sustained, and that of Mary Stuart, represented in a passionate burst of grief at the remonstrances of Knox, is scarcely less so; but the composition does not come well together as a whole. The other picture, though an oft-repeated subject, pleased us better as a work of Art; it is a scene from our old acquaintance the "Vicar of Wakefield"—the Squire describing to Mrs. Primrose and her two daughters sundry passages of his town-life; like all the young female heads painted by Frith, those of the two girls in this picture are very sweet and beautiful; his finish is just enough to produce delicacy of texture without that over-elaboration, the result of which is, very generally, *wooliness*, and oftentimes a refinement quite contrary to nature.

"Sterne in the Shop of the Grissette," is the title of a little picture exhibited at the British Institution in 1845; it offers some valuable artistic qualities, but must not be compared with other works by the same hand. In the Royal Academy he had a "Portrait" of a young lady, sweet and elegant in expression; and the "VILLAGE PASTOR," which forms the subject of one of our

illustrations; it has been engraved on a large scale by F. Holl, and is deservedly one of the most popular prints published within the last three or four years. The readers of Goldsmith's "Deserted Village" will easily recall to mind the lines selected by the artist for illustration, though the numerous incidents he has introduced into the composition render it rather the epitome of the entire poem than the embodiment of a solitary passage. We have often wished, when looking at this deeply interesting picture, that some other figure had been substituted for the consumptive girl: it is so perfectly true a realisation as to produce pain in any mind, though such mind may not be over-sensitive. The picture was the means of placing the artist on the roll of Associates of the Royal Academy, to which he was elected in the autumn of the year.

In 1846 he exhibited at the British Institution a small figure-subject, "Norah Creina," engraved in Pinden's "Beauties of Moore;" and at the Academy "The Return from Labour," and a scene from Molière's "Bourgeois Gentilhomme;" both of these were novel subjects from his pencil, especially the former, while the treatment of this varied so much from the painter's usual style, that we remember to have found it difficult to ascribe the work to his hand. The subject is an inverse reading of the lines in Gray's "Elegy"—

"No child: a ran to lisp their sire's return,
Or climb his knees the envied kiss to share."

Accordingly the artist has represented the interior of a cottage, to which a labourer has returned from his daily toil; his children are running to meet him at the door. The most successful study in the composition is an old dame, the grandmother of the youngsters, it is presumed. The scene from the French comedy, "Madame Jourdain discovering her Husband at the dinner he gave to the Belle Marquise and Count Doranto," will, we believe, take rank with the best dramatic pictures of the English school, so pointedly and effectively is each of the characters brought forward; the artist, ere he painted it, must have very closely studied the *dramatis personæ* of the writer.

Mr. Frith's accession to the lower honours of the Royal Academy induced him, we presume, to discontinue his contributions to the British Institution, for his name has not since appeared in the catalogues of the latter, except in the year 1852, when he sent a small portrait of a girl, under the title of "Wicked Eyes." In 1847 he exhibited at the Academy the largest picture, if we recollect rightly, he had hitherto painted—"English Merry-making a Hundred Years ago," a composition of numerous rustic figures, appropriately costumed in the dresses of the period, and variously engaged in making holiday under and about a huge tree on the village-green, the amplitude of whose branches affords a goodly shade for the principal group in the picture, who are dancing merrily to the music of a violin, pipe, and tabor. The figures are grouped with



Engraved by]

SANCHO AND DON QUIXOTE.

[J. and G. P. Nicholls.

very considerable skill, are all full of life, energy, and activity; it is altogether one of the best, if not the best, picture of its class we remember to have seen. His other contribution of the same year, the "Saracen's Head" story from the "Spectator," is a brilliantly-painted work, illustrative of the true spirit of the narrative.

Of all the pictures, however, which this artist has produced, not one in our opinion surpasses, for originality of thought and powerful treatment, the first on the list of three exhibited in 1848—"An Old Woman accused of bewitching a Peasant Girl," in the time of James I. The scene lies in an apartment of a fine old mansion, in which the owner, who is also the justice, sits to hear the accusation; the room is filled with numerous individuals assembled either as curious spectators, or as persons interested in the case. To describe the composition in detail would occupy far more space than we can allow to it; it must suffice that we repeat the opinion we expressed in our critical report of the year, that it is a work exhibiting "a rare combination of genius and industry." The reader must form his own judgment, from the engravings on our pages, of the other pictures hung at the same time:—"A STAGE-COACH ADVENTURE IN 1750," and another scene from Molière's "BOURGEOIS GENTILHOMME," that in which M. Jourdain, dressed in a red coat trimmed with

gold lace, is bowing Dorimène out of the room: the costumes and characters of the two figures are painted with undoubted truth and vigour of touch.

We confess to be so far behind the spirit of our own age as to entertain no inconsiderable share of respect for that of our forefathers two or three centuries back; we love to ramble through old mansions—

"Where steel-clad knights, and dames in rich attire,
The grey-capped yeoman and the obsequious squire,
In crowds were seen, while scarce the music ceased
With closing day its joyous revels ceased."

We like to read of old English customs and manners—of maypoles and rustic entertainments—of the hospitality shown by the noble and wealthy to their dependents; we hold the antiquated notion that landlords and their tenants in those days,—notwithstanding the comparative ignorance of the one with reference to education, and the aristocratic bearing of the other,—somehow were more influenced by mutual feelings of kindness and regard than are now manifested by each respectively. After such an admission, Mr. Frith—and our readers too—will not be surprised to hear us say that we admire his picture of 1849—"Coming of Age"—far beyond those of which we last spoke; it carries us back to the era of the "Virgin Queen," the "golden age" of England, as some not

inappropriately consider the days of Shakspeare, Bacon, Drake, and a host of others eminent in literature, science, and arms. The picture represents the eldest scion of a noble house standing on the steps of a magnificent baronial mansion, his paternal home, and surrounded by his family, to receive the congratulations of his father's tenantry, for whom a substantial repast is being set out in the court-yard. There are upwards of sixty figures introduced into the composition, each one a character carefully studied, and sustaining its individuality no less than its presumed right to be present on such an occasion. Most of our readers have doubtless seen Mr. Holl's fine engraving from the picture, which was presented last year to the subscribers to the Art-Union of Glasgow.

In the Academy Exhibition of 1850 Frith exhibited three pictures: the first on the list, a "Portrait of a Lady," the face in profile, very gracefully drawn and delicately coloured; the second, a subject from "DON QUIXOTE," the passage of the narrative which describes Sancho as telling a tale to the Duke and Duchess, to prove that the Knight of La Mancha is at the bottom of the

table. Sancho is placed with his back to the spectator, consequently the interest of the composition is centred in the figures of the duke and duchess, and in that of Don Quixote, who is rising from his seat as if to address his host.

There are other personages introduced into the composition—the duke's chaplain, and a group of ladies-in-waiting; the faces of the latter, as in all Frith's pictures, possessing charms enough to woo an anchorite from his cloister. The third picture of this year was selected from Goldsmith's "Good-Natured Man." Mr. Honeywood introducing the bailiffs to Miss Richland as his friends: the work has numerous points of excellence in character and execution, but the subject is not agreeable to our taste, and however clever the artist has proved himself in delineating the emissaries of the sponging-house, his natural genius is too refined, and of too high an order, to exercise it on such persons without manifest disadvantage to himself: every painter should study "things of good report" rather than those of a contrary nature.

"Hogarth brought before the Governor of Calais as a Spy," one of two pictures exhibited by Frith in 1851, is among the best works of its class that the British School has produced. The story, derived from Horace Walpole's letters, is most dramatically and truthfully told, and with great originality of conception and power of treatment. Poor Hogarth has been seized by French soldiers while in the act of making a sketch of some picturesque locality in the neighbourhood, his captors mistaking him for an English engineer drawing a plan of the town; in the picture he is represented as offering to show his sketches to the governor. The room in which the examination is conducted is filled with a large crowd of individuals, all of them exhibiting much interest in the proceedings. There was also in the gallery a pretty little picture of a pretty little "Gleaner" by Frith, the landscape painted by Creswick.

Of the four pictures exhibited by this painter in 1852 two were female portraits, another a "Child repenting to its Mother her Evening Prayer"—a sweet and unaffected composition, and the fourth, "Pope makes love to Lady

Mary Wortley Montagu." In this year Mr. Frith was elevated to the full honours of the Academy.

The following year his name did not appear in the list of exhibitors, but he amply compensated for his absence by contributing five pictures—the largest number he had ever exhibited at one time—to the Academy in 1854. One of these, "Life at the Sea-Side," for variety of incident and character is doubtless one of the most remarkable pictures of modern times, as it was unquestionably the great point of attraction in the gallery where it hung. The subject presents difficulties which required no little amount of ingenuity and delicacy of feeling to overcome without degenerating into caricature; but there is nowhere the least approach to this quality, although an abundance of humour and character. Our space will not permit us to enter into details, nor is it necessary we should, for we apprehend few of our readers who visited the Academy have it not vividly in their recollection. The picture was purchased, when on the easel, by Messrs. Lloyd Brothers, the print publishers, but when the Queen saw it on visiting the Academy, Her Majesty at once expressed a desire to

possess it; but ascertaining that it was already sold, Her Majesty commissioned Mr. Frith to paint another. Messrs. Lloyd, however, hearing of the facts, relinquished their title to the work under conditions not unfavourable to themselves, and the picture is now royal property; the Queen allowing Messrs. Lloyd to have it for a time, that it might be engraved. Mr. C. W. Sharpe, to whom it was entrusted, is rapidly advancing with the plate—a very large one; it will make an admirable companion to Holl's "Coming of Age," of which we have just spoken.

But we have almost exhausted our limits, and must hasten on just to enumerate—for we can do no more—the remaining pictures painted and exhibited by this artist; the other four contributed in 1854 were "Anne Page," a portrait, we think, so designated; "The Love Token," a scene from the "Bride of Lammermoor"—Lady Ashton cutting the ribbon asunder, and offering the bro-

ken piece of gold to Ravenswood; "The Poison Cup," from "Kenilworth"—the daughter of Poster about to drink the draught intended for Amy Robsart; and a "Portrait of Mrs. E. M. Ward." In 1855 he sent an illustration of a scene in Twelfth Night—"Maria tricks Malvolio," "Lovers," "A Lady at the Opera," and "Feeding the Calves," in which Frith painted the figure, a country girl, and Ansell the animals. Frith's pictures of the present year are, "A Dream of the Future," in which he was aided in the landscape by Creswick, "Many Happy Returns of the Day," and "Garden Flowers." We have so recently spoken of all these works as to render further comment superfluous.

Our notice of this accomplished artist is little else than a *catalogue raisonné* of his productions; but what more can be done in so small a space as that to which we are restricted, with such a subject and with such an abundance and variety of materials? Happily, we are not, however, writing of a dead painter, or of one whose pictures are but little known—thousands have seen and admired them; and through many years to come, we trust—for Mr. Frith has yet scarcely reached the prime of life—thousands will have the opportunity of witnessing what, year by year, he may produce for their intellectual gratification.



Engraved by]

A STAGE-COACH ADVENTURE IN 1750.

[J. and G. P. Nicholls.

WOOD CARVING BY MACHINERY.

WHEN the artist has created a beautiful form, there is a desire on all sides to multiply it, with every perfection faithfully preserved. If the mind from which the image sprang could bend itself to the task of reproduction, and if—which is always questionable—the artist could preserve the speaking details of his first work, the labour so expended could only be remunerated at great cost. If the work of reproduction is entrusted to other hands, a copy mechanically perfect may be the result, but the *feeling* vanishes; and, even then, the charge for labour renders the work too costly, and it is only the wealthy who can possess the admired creation of the artist's mind.

Mechanical minds have, from time to time, directed their attention to the construction of machines by which facsimiles of statues and other carved objects in stone or wood could be produced. Several such machines have been invented: the illustrious Watt constructed one, and made many copies of pieces of statuary, which are reported to have been of much excellence. Several small machines of great merit have been constructed for seal-engraving, cameo-cutting, and similar objects; and one, devised by Mr. Cheverton, is now worked for the purposes of multiplying reduced copies of the works of the sculptor. We have, on a former occasion, drawn attention to, and described (*Art-Union Journal*, 1848), Jordau's patent for carving by machinery; and it is with much satisfaction that we feel called upon, by circumstances of peculiar interest, to devote a portion of our space to a further consideration of this important invention. For some time past, although the machines have been constantly employed by the Government for the purpose of executing the work required for the Palace of Westminster, the business of the wood-carving establishment has been somewhat diverted from its original channel into others which were, commercially, of more pressing importance. The Art element has been clouded by the commercial one. In fact, in the manufacture of gun-stocks, under the pressing demands of the war, a large business has been done. From the facility with which repetitions of the same pattern can be made, nothing can be more perfect than the way in which those carving-machines make the stocks, and cut out all those parts necessary for fitting on the locks and barrels.

The war is over, and in our repose from the excitements necessarily attending the conflict of great nations, we are turning our attention again to the advancement of all the Arts of peace. What is true of the nation is true of the individuals constituting the nation. The gun-stock is now to be turned into the ornamental bracket to support the statuette of Peace; the block of wood which was to have been converted into an instrument of destruction, is now to take some form of beauty; and, instead of becoming a weapon of offence or defence, ministering to the evil genius of sorrow and of death, it is destined to increase human happiness by multiplying those small adornments of our hearths and homes, which add to the enjoyments of life. The Wood-Carving Company are now resolved to show the public what their machines can do in the way of ornamentation, and to convince them that with such a fair share of patronage as may require the reproduction of many copies of the same artistic work, that a much higher form of Art-decoration, than we have been accustomed to, may be brought within the limits of nearly all classes of society.

It may appear to many of our readers, that it is not easy to produce a machine which shall possess the power of removing the surface of a slab of wood in such a manner as to leave

traced upon it some artistic design. It may be understood that, upon a plane surface, a cutting tool, driven by machinery, may be directed to cut an arabesque tracery, but that a figure in the highest relief could be thus formed, it may not be so easy to conceive; yet nothing is more easy than the manner in which this is effected: and the machine produces, without difficulty, the beautiful foliage and fruit of a Gibbons, or the bas-reliefs of a Flaxman.

We will endeavour to explain the principles upon which this adaptation of mechanics depends, and to describe the machines now in use at the works. If any of our readers will take a flat bar of wood, about a yard long, and attach to one end a pencil, and to the other a blunt pointer, he will be furnished with a simple piece of apparatus which will explain the whole affair. If he takes a medallion, and passes the pointer across its face, in parallel lines, following this parallelism irrespectively of the elevations or depressions, and, at the same time, allow the pencil at the other end to mark lines upon a sheet of paper, which by an assistant is kept steadily pressed against it, it will be found that by the inequalities and curvatures of the lines we thus obtain a rough copy of the medallion. Upon this principle, modified for convenience in its forms of application, several engraving-machines have been constructed.

Supposing, instead of the pencil, we place a cutter at the end of the bar, and give to it a rotatory motion, keeping it pressed upon a cake of plaster of Paris, or any yielding material, it will be evident that, if when the tracer is on the point of greatest elevation, it then corresponds with the surface of the plaster—that as the pointer descends, the cutter will penetrate in the same degree, and thus produce, eventually, a copy of the medallion. The rough experiment thus described will not give

such results as would be satisfactory,—they will necessarily be exceedingly rough and imperfect; but, incomplete as the whole arrangement may be, it faithfully represents the principle involved in the wood-carving machine. The nice mechanical appliances, upon which depend the perfection of the work executed, must now be more accurately described.

The wood-carving machine consists of two parts, each having its own peculiar movement quite independent of the other, but each capable of acting simultaneously, and in unison with the other. The first or horizontal part is the bed-plate and floating table, on which the blocks of wood to receive the carving and the copy are to be placed. This floating table will be presently better understood; but it may be as well to explain as we proceed the general principle of each part. Now if we place two perfectly smooth pieces of wood one upon the other, and while we move the under one to and from us, we give a motion from left to right, or the contrary, to the upper one, it will be evident that by these combined motions we can describe almost any curve; such is the floating table of the wood-carving machine. The second, or vertical part of the machine, is that which carries the tracing and cutting tools, the only motion of which, except the revolution of the cutters, is vertical.

We have now the horizontal table, capable of moving about in every possible direction in its own plane, and we have a point over that table capable of moving in a vertical line only. If the point remains fixed and in contact with the table while moving over various curves and right lines, lines corresponding with these movements will be described on the table in the same manner as they would have been had the table been fixed and the point moved; but if while these horizontal movements are going on, we add the vertical movement of the point,

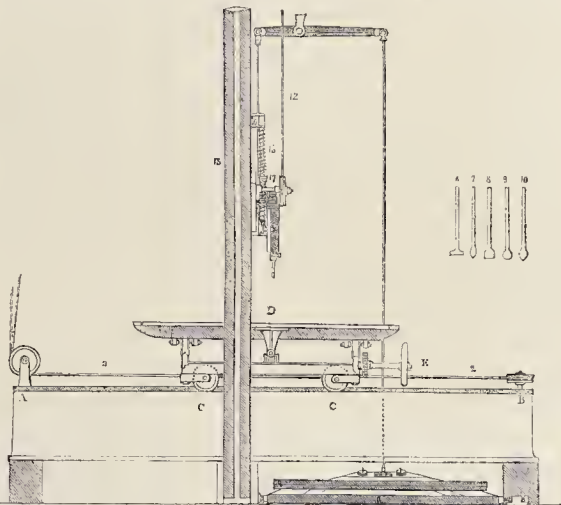

we then trace a solid figure which has for its plane, the outline described by the horizontal motion of the table, and for its elevation, the outline described by the vertical motion of the point. The pointer in our former illustration we will suppose now to have a vertical movement only, while the medallion, or any simple solid form, is moving horizontally under it in the required directions by means of the floating table.

The accompanying wood-cut represents a section of the wood-carving machine. A B is a cast-iron frame forming the bed of the machine,

the upper portion of the sides A B are planed perfectly straight, smooth, and parallel, and they serve as a railway for the wheels C C to run on. These wheels are mounted between cutters, which are fixed to a frame, and are so adjusted as to ensure the steady motion of it in an horizontal plane, and in the direction of the lower rails only; above these is the floating table D, or chuck of the machine, to which the work and the patterns are attached, and it is furnished with wheels, which roll on the upper edges of the frame, the like precaution of nice adjustment being observed. It will readily be seen

that this arrangement gives the workman the power of moving the work above in every possible direction in an horizontal plane. 2 2 are the supports for the vertical slide, and the other parts connected with the cutting and tracing apparatus. Motion is given to the mandrils by the band 12, which is driven by a steam-engine at such a rate as to produce from 5000 to 7000 revolutions of the cutter per minute. The treddle, which is seen below the table, is managed by the workman's foot, and by it he is enabled to raise and depress the cutters, it being connected with the horizontal bar carrying the pulleys. Weights act as a counterpoise to the slide, and the parts connected with it, which can be varied at pleasure, according to the number of mandrils in use. 15 is a top screw, which regulates the range of the slide to which it is fixed, so that it cannot turn in its bearings; it passes through a free hole in the bracket, which serves as a stop to the locking-nuts, as at 17, and those may be fixed on any part of the screw, so as to determine the distance through which the slide shall move. In very large machines, it is requisite to introduce some mechanical arrangement for giving the workman more command over the movements of the floating table, and the plan shown in the drawing at *e* has been found effective. This arrangement consists of the steering wheel and its axle, which passes across the centre of the lower rolling frame, and is furnished with a drum of three or four inches diameter, about which is coiled the centre of a wire line, while its ends are fixed to screws, which pass through sockets cast on the floating table, consequently, on turning the steering wheel to the right or left, will give a corresponding motion to the work. Just inside the steering wheel, and on the same axis, there is a small cogged wheel, which serves to fix the axle, and consequently to stop the motion from right to left whenever the detent is dropped into its cogs. Of course there are many arrangements of the pinion and screw which might be used to produce the same effect.

In the following wood-cut is shown more distinctly the tracer and cutters: *p* is the tracer,

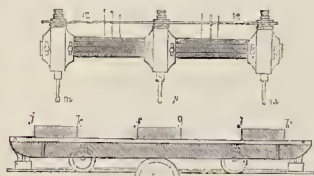

and *m m* the cutters; *f g* represents the object to be copied, and *j k* the wood upon which the carving is to be made. It will be evident upon examining this drawing that since both the cutters and the tracer are fixed upon an unyielding bar, that they obey exactly the same vertical motion; as the tracer is raised or depressed in passing over the model, so are the cutters lifted from, or sunk into, the wood. By the very rapid motion which is given to the cutters, the wood is speedily removed, and in a very short time a rough copy of any, even an elaborate, work is made.

The patentee has described the advantages and purposes of his machine; in part, we borrow his words. He believes that machinery will do for the sculptor and carver what engraving has done for the painter; and he also believes that it will do it without throwing out of employ any class of artists or artisans, however talented or however humble,—for machinery cannot do the work of the mind, although it can assist very materially its creations. Neither can machinery produce that smoothness of surface and delicacy

of finish requisite in good works; or perhaps it would be safer to say that it is not desirable to attempt it. The whole object of the machine is to produce the work quickly and cheaply; and in approaching towards the finish of a piece of carving, there is a point at which machine becomes more expensive than hand-labour. It is, therefore, a matter of commercial calculation as to how far it is desirable to finish on the machine, and when to deliver the work into the hands of the workman. The machine, as it is at present employed, executes about two-thirds of the work—the nice manipulation required for the production of choice carvings being committed to well-qualified wood-carvers.

One of the best features, remarks the patentee, so far as the progress of Art is concerned, is that it still leaves the artist full power over the material he employs, and enables him to give to the world repetitions of his best works, with his own ideas and his own touches embodied on their surface. A clay model, or a cast from one, can be placed on the machine, and by careful manipulation, in a few hours, three or four copies of the work can be produced; and, then, a few hours more of his talented labour will make the production of the machine equal to the original design. Any solid form which the hand of the artist can execute, can be reproduced by these machines. An examination of the productions in the show-rooms of the Wood-Carving Works in the Belvedere Road, will carry conviction to all of the truth of our statement. It may appear no easy matter to send a cutter round corners, and even to remove the substance from below, without disturbing the surface, as in the case of a bird's wings, or of foliage; this is, however, effected with great facility by means of bent cutters. In the first wood-cut in this article are represented a series of cutters of the different shapes employed: it will be quite evident upon inspection, that No. 6 would undercut wood in the easiest possible manner, and that by varying the shape and kind of cutter, that undercutting to any extent may be carried out. We have executed by this machine—that which has long been done, but which still remains quite a puzzle to many persons—the cutting of ivory balls one within the other, now done by the ingenious turner—though formerly these ornaments were solely of Chinese manufacture.

We have seen some of the most beautiful works of Grinling Gibbons reproduced by the carving machinery, and we cannot but fancy, if those delicate productions were rendered more familiar than they are to the public, that for internal ornamentation, copies of them, such as this machine could furnish, would be much used. The fine doves, palm-branches, and pelicans of the chapel at Windsor, or the decorations of the side aisles of St. Paul's, would bear repeating, and might be applied with much advantage, where meaner ornaments are now employed. The foliage, flowers, and feathers of Chatsworth, with their delicacy and their truth, might form fitting ornaments for many a drawing-room; and all these the carving-machine has the power of reproducing. We know not if the flying cutters and the floating table could reproduce the celebrated point-lace collar of Mr. Gibbons, but we have seen the most delicate of leaves and tendrils, cut by the efforts of the steam-engine impelling these exact tools.

To produce cheaply works similar to some of these would be an important achievement; and we have seen this machine do so much, that we are certain it is capable of doing much more.

The whole of the carved works in wood of the Houses of Parliament have been executed by these carving-machines. Every form of architectural ornament can be produced by the machine, requiring but very little hand-labour

to finish it. We have seen examples of the Ionic anthemion, and of the Doric fret, nearly finished on the machine: volutes, and indeed all the geometrical traceries employed by the architect, are readily produced. Every form of Gothic ornament, such as are now so common in our more recently built churches, can be cut with great rapidity and precision. With the revival of a taste in decorative architecture for the ornaments of the mediæval periods, we may expect to see full employment given to these machines, for the production of the multitude of similar ornaments which will be required for the churches now in course of erection.

The operations of these machines do not limit them to wood—they are capable of executing work upon the Bath, Oolite, and the Portland, or on the Caen stone; indeed, upon any stone which is not harder than statuary marble. A series of the ornaments in front of the Treasury, at Whitehall, were produced by these machines. Corinthian capitals, and highly ornamented friezes, have been carved at these works.

Left-hand copies can be made from right-hand models, and thus are all the conditions met which are demanded, where repetitions of the same object are required, and where certain conditions must be met. Within certain limits too the machine can produce reductions from the original works; and by a very simple adaptation of the principle of the pantograph, this power of reduction might be carried out to any extent.

Having endeavoured to describe these very interesting machines,—which are now largely employed in the manufacture of gun-stocks, and by which can be produced, with almost equal ease, the barber's block, the shoe-maker's last, and the finished work of the artist's band,—it only remains for us to remind our readers, that we have, after a lapse of eight years, again called attention to it, because we have believed it capable of fulfilling one of the objects which the *Art-Journal* has ever kept in view.

We desire to see chaste and elegant forms take the place of the unmeaning ornaments to which the public have become accustomed; instead of the unsightly things which now meet the eye at every turn, in all our dwellings—which are only endured because we have grown familiar with deformity—we wish to find beautiful forms, such as Nature gives us, continually making their mute appeals to us. This is only to be effected by cheapening the productions of the works of our best artists, and we see no other way of cheapening them than the reproduction of them by machinery. Our Schools of Design are spreading over the land, and we hope they are diffusing a taste superior to that which recently existed; the elegant designs which we have seen produced by the students in those schools remain unexecuted in any material, and are therefore valueless. With the powers which these machines possess, why might not the student of the school of design learn to mould his thoughts in clay, and then the object could readily be reproduced in wood, or in the softer varieties of stone?

We learn that the Wood-Carving Company are now making new arrangements for carrying out fully the Art principle, and with this object in view, they have appointed Mr. Rogers, the well-known wood-carver, as the Art-director of the establishment. We need not say a word in commendation of this appointment. For the sake of themselves and for the public, we especially desire to see the experiment of Art-reproduction fully and fairly tried, and we are confident the experiment could not be committed to better hands.

R. HUNT.

THE NATIONAL GALLERY.

THE unaccountable success, in the House of Commons, of Lord Elcho's recent motion, by which he aspired to defeat the bill for at length determining the future site of the National Gallery, has once more postponed indefinitely what, after a host of difficulties overcome, had for some time past been considered ripe for action, and was understood to have given way only to the reasonable obstruction of higher objects and more imperious events. What serious ends are to be served by this new delay in a matter which, not only is important in itself, but has other important interests necessarily awaiting its solution, we feel it far from easy to understand; but certain immediate consequences are clear enough, to which it would be difficult to assign any value beyond that of their being illustrations of the national character. In the first place, the people are thus made, by the mouth-piece of their representatives, to practise, as is not very unusual with them, a piece of self-stultification; having, when last they had time to attend to this matter, voted a sum of upwards of £170,000 out of their own pockets with a direct view to the plan now for the time defeated. In the second place, John Bull is by this vote once more handed over to an exercise with which he is sufficiently familiar,—but which does not present him in the most sagacious aspect before his neighbours, while it stands between himself and many a useful, practical result. The exercise in question is, that of inquiring into previous inquiries—sitting in commission on labours and completed commissions—investigating accomplished investigations—making, in fact, as the most extreme advocates of this practice do, the thorough sifting of a subject the reason for sifting it over again. We suppose, the wisdom involved in this process would be defended as belonging to the kind which suggests the repeated testing of a sum in arithmetic, for security's sake; but we can only say that, after all the education which it has had, we think the nation should, by this time, be more confident in the use of its figures,—and that the public business is seriously impeded by its want of faith in its own working out of a problem. To us, this practice of re-integrating resolved doubts seems rather to resemble the idle pastime of replacing the nine-pins that have been bowled down, for the express pleasure of bowling them down over again. The third consequence which the nation derives from this remarkable vote, is, that of remaining, certainly for another year, in that wondrous state of inefficiency and confusion which had already led to all these finished inquiries (while we are inquiring if these had been properly inquired about),—and so riding in a circle; a species of exertion dear to the heart of John Bull, but inconvenient as leading him nowhere. It is wonderful, the love we have in this country for lavish establishments that serve no purpose for want of organisation—costly collections brought from long distances, and stowed away in cellars—valuables sorted, and then put elaborately out of their places—keepers with nothing to keep, and things to be kept with no qualified keepers—officers without an office, and offices where no one can find out who is the proper officer—directors having no direction—trustees without a trust—institutions where, in the matter of responsibility, everybody is behind somebody else—and museums in which, for the purposes of teaching, every thing is in every other thing's way. In like manner, we have been fond, till of late, of setting up a costly organisation of one kind or another, and when it was complete and well endowed, setting up and paying another to do its work. Things are greatly mended now-a-days,—and they will cer-

tainly mend much more if we can only get rid of unmeaning obstructives like this motion of Lord Elcho's; but it is not very many years since the principal operation of the wealthy old societies was that of propagating others. The Royal Society had a numerous offspring in its dignified retirement; the Zoological was born of the indolent old age of the Linnean; and the Archaeological were established to perform the unexecuted commission of the antiquaries. One advantage obtained by this separation of a whole into its parts, was, that the strength which resides in their union was liberally sacrificed,—to be recovered somewhere else, and at some further cost, if it could: and this peculiarly English form of economy was enhanced to the utmost by such a careful separation from one another of all the Arts and Sciences as *wholes* (as well as of the parts which made up each whole), as dispensed with the benefits that they mutually confer by their natural connexion, and by the incidental illustrations that they offer to one another. A noticeable form of the gain in this case of separate action has been that certain portions of the machinery which would have been common to all in their union, had to be repeated for each in their disjunction, with the double advantage of increased expense and diminished efficiency:—and it will readily be seen, that this practice of constituting one association to do the work of an association previously constituted, and this augmentation of cost by duplication of machinery, resulted both from the same quality in the national mind which prompts it now to the appointment of a live committee to go again over the ground of a committee defunct. In a word, whether from indolence, or from over timidity, John Bull is easily persuaded to be content with the provisional:—and so, the provisional is to continue in this matter of the National Gallery, because it has pleased Lord Elcho to demand an inquiry into topics that have all been thoroughly inquired into already, and to object to a measure which is the direct logical sequence of a series of measures all previously affirmed by the same assembly that has now granted his demand.

However, Lord Elcho has got his commission,—and his commission will proceed to inquire; and, though we have ourselves no doubt whatever as to what the result of that, and of every other inquiry (in case there should be yet a few more) will be, it may be as well, just for the exercise's sake, to examine, with our readers, the beaten ground over which the commission has to travel.

The subject matter of the proposition which is to furnish the text of a new Blue-hook—or, more properly speaking, of a new and revised edition of the old ones—divides itself into two heads:—Can the National Gallery remain where it is? If not, whither is it to go? The negative which the first of these questions has received is made to rest on two several grounds, either of which singly is more than sufficient to sustain it, and which form together a position impregnable to any twenty commissions. One of these grounds is, that a treasure whose value is essential and not submissive to any common standards, whose properties are subtle and transcendental, and which, by the conditions of the case, is irreplaceable, is visibly deteriorating where it is, owing to certain atmospheric and other influences which are active in the locality. On this head of objection to the present site, it is true that there are diversities of opinion; and they who admit the objection meet it by the statement of certain disadvantages of another kind which, in their opinion, will attend a removal. Now, reserving to ourselves the right to question these alleged disadvantages—we say, that were they real, and tenfold what they are, they must of necessity be subordinate to that which, if also real, affects the very existence of

the pictures. The integrity of a treasure is a condition necessarily precedent to any and every question of its uses. Admitting, then, the differences of expressed opinion as regards this question of local injury, we have to say, that if the weight of authority on the two sides were equal, we would still give the collection the benefit of our fears, and, just for security's sake, set the warnings of the one side above the confidence of the other. In that case we would make the latter's—

“ Assurance doubly sure,
And take a bond of fate.”

But, both as regards the number and the quality of the witnesses, there is, in fact, such a preponderance of evidence against the present site, on the ground stated, as must of itself affirm the question of removal in every field of inquiry except the field of polemics.

The other ground on which the proposition for the removal from its present site of the National Gallery rests, is, as we have said, one which would amply sustain that proposition by itself, even if it had not the corroboration of the life-and-death argument to which we have alluded. The second argument is, that, while the present building is insufficient for the mere reception of the treasures which we possess, the nation is constantly losing new treasures for want of space to put them in; and that, by no possible expansion which the capabilities of the existing site will admit, can room be obtained for such an arrangement and classification of our Art-possessions, and their probable additions, as can raise a collection to the dignity which should be implied in the title of a National Gallery. It was well observed in the House of Commons, in the debate on this important subject, that before we had even our present narrow accommodations, the nation had lost several magnificent collections because its fortunes had not yet enabled it (or such was its opinion) to keep house for the Fine Arts. The Dulwich and Fitzwilliam Collections were mentioned as instances:—but our readers know well that there were others. Since we have set up as housekeepers in Trafalgar Square, the Blue-hooks report of a variety of intended gifts which have been diverted, or suspended, because the munificent donors disapproved of the narrow scale of the national establishment. Of two collections which *have* reached the nation, in spite of its penurioseness, it is not very long since one, the Vernon, was taken out of the coal-hole (where it had had to be stowed away), and put out to board; while the other—the Turner pictures—will have, when it shall please objectors like Lord Elcho to let us at length provide due accommodations, to be disinterred from some unknown recess:—none the better, in all probability, for the twelve months' further exhumation to which the noble lord has succeeded in consigning them. What the country is proved to have lost for want of suitable accommodations, may be taken as the probable measure of what it will gain when such accommodations shall have been provided. But besides more space as measured by numbers, it is now at length well understood amongst us that a National Gallery, to embody its true ideal, must be something more than a mere collection of examples, however illustrious; and that in the building which contains it we should have all the space necessary for such a disposition of those examples as may compose them into a complete history—genealogical, chronological, and geographical—of the art which individually they illustrate. This, as regards the national pictures alone,—which should be so complete, and so classed, as to exhibit the whole development of the art of painting. But, largely understood, the matter does not end here. Properly speaking, a National Gallery cannot illustrate one province only in the domain of Art: painting, sculpture, architecture, anti-

quities, engraving, and even the lower arts of decoration, all subsidise and throw light on one another, and belong to the same history. The business of classification once begun, it will be seen that it can be carried out in its completeness only by an assemblage, either in one establishment or in adjacent ones, of objects illustrating the entire range of the Arts of Design. There is yet a larger view of the subject, which sees the relations that all the Arts and Sciences have to one another, and the interdependence of each on all and all on each,—and would gladly have them all gradually assembled in a single neighbourhood, for the purposes of illustration and of reference. The question of removal, therefore, we fancy, the new commission will find pretty well settled to their hands; and their differences of opinion, should they have any, will, in all probability, be limited to the other question of the future locality.

There are two methods in which an argument for the future location of the National Gallery on the Gore Estate may be conducted. One is, by asking *where*, if it be not to go thither, *shall* the Gallery go? We have little doubt that, if due regard be given to the demands of the case in conformity with the views which we have already laid down, the process of exhaustion by this method will inevitably land the commission on the site to which the hill defeated by Lord Elcho's motion would have taken us if he would have let it. Sites which permit the realisation of our present plans in such a manner as shall leave them expensive to any proportions which the future is likely to suggest, will not be found so abundant that we can afford to overlook this important quality of the one which here is ready to our hand. The very terms of Lord Elcho's own motion, which proposes that the new commission shall report "on the desirableness of combining with it [the new National Gallery] the Fine Art and Archaeological Collections of the British Museum, in accordance with the recommendation of the Select Committee on the National Gallery in 1853,"—a measure in the exact direction which we have been recommending, and which, besides, would relieve one institution to illustrate another,—might themselves induce him to turn a loving eye on the broad acres of the Kensington Estate.—It seems to us, however, that a readier method than the one suggested of arriving at the same result will be, that of inquiring, in the first instance, why the Gallery should *not* go to the Kensington property? Because, if all the arguments designate this as in every way a most fitting locality, there can be no good reason why we should mount behind Lord Elcho on his hobby for a site-hunt in cloudland, or discuss with him the inconvenience for our practical purposes of a Fine Art *Chateau en Espagne*.

Now, not only do we find a multitude of reasons, besides its large acreage, which point directly to the site of the Gore Estate, but we know of no reason good against it in any sense which is not good against every other. The argument against it on the score of distance—which, however, we intend to dispute—must, by those who employ it at all, be equally employed against the ground on which Kensington Palace stands, and against all other sites that abandon the London streets; while, all sites suggested in the streets themselves have this strange radical defect, that if there be no objection to them on the score of their exposure to the smoke and dust and idlers of the metropolis, then there is no reason for the removal at all of the Gallery from its present site on the plea which is most freely admitted. Pausing for a moment, to allow to the supporters of Lord Elcho's motion that the site of Kensington Palace would certainly be a magnificent location, if it had not already another appropriation which renders its introduction into the discussion simply idle,—we may, at the same time,

observe, that, with the exception of its somewhat readier command of the more northern line of metropolitan thoroughfare, we know of none other of the adaptabilities to the purposes of an institution like the one in question which is not shared with it by the Gore Estate. The two locations form one neighbourhood, and have identical incidents. It has been said, for instance, by those who supported Lord Elcho in his measure of obstruction, that if a removal of the pictures, for their health's sake, from the metropolitan malaria be a necessity, the removal to the Gore Estate is not far enough,—and that the collection would be there only settled down in a spot to which the causes that occasioned its abandonment of Trafalgar Square will ere long follow it. Now—not pausing to take exception to the spirit of those objectors who think Kensington too too far away and not far enough,—and who, again, on the question of distance, consider Kensington Palace well placed, but have both sides of the argument to bring against the estate of the Royal Commissioners at Kensington,—who, in fact, for the sake of objecting at all, accumulate all sorts of inter-contradictory objections, like the counts of a legal indictment which neutralise each other to the sense of simple logic,—we will reply, that, as regards the matter charged, the Kensington Estate shares all the immunities of the Kensington Park, and that the conditions of its site preclude all chance of its ever being surrounded in the same unwholesome sense, or subjected to the same prejudicial influences, as in Trafalgar Square. "From no probable circumstance," well remarked Mr. Disraeli, in the debate on this question, "can it be inconveniently close to any surrounding buildings. It will always have a space of seven hundred acres—the area of Kensington Gardens and Hyde Park—in its front; and it will always have in its own garden a considerable area free behind it. The houses which will rise in its vicinity will probably be houses of that high class that will never exercise upon this building that injurious influence which has been so generally acknowledged and expatiated upon."—We remember, that certain gentlemen riding hobbies in search of a site for the new National Gallery, came upon Hyde Park; and, as the elevation at which the hobby is usually ridden is apt to suggest abstract views, they forthwith mapped out a location or two as speculative Fine Art conquests, and gave provisional notice to the Dryads. Now, while we are in the way of admissions, we are, again, free to admit, that a sufficient slice out of one of the parks would furnish admirable ground for a Palace of the Fine Arts. But, as we agree with Mr. Disraeli in thinking, that "the question as to where our National Gallery is to be placed, and the building of a National Gallery, are of *very pressing necessity*," we are irresistibly attracted to the region of facts; and we cannot but remember, also, how vehemently the people resist all attempts at invasion of these their breathing spaces, even for a temporary purpose, and how eagerly they defend every inch of the green sward, as if it were fairyland. For practical purposes, then, we may as well return to a simple enumeration of the many advantages offered by the site of the Kensington Gore Estate.

In the first place, this estate—which consists of eighty-six acres, has cost £342,000, is worth more now than its original cost, and is necessarily increasing in value—is, as we have said, expansive to the extent of any conceivable demands which the future may bring for the purposes of either perfecting or supplementing the Gallery which we are all desirous of seeing raised to the dignity of a national illustration.—Then, we have the authority of Mr. Tite for saying, that the ground has frontage for "a building 700 or 800 feet long, and displaying much architectural beauty."—It is out of the smoke

of London; yet at easy walking distance, as the thousands who poured through the first Crystal Palace can testify, and of most commodious access, having all the great west-end parks as its distant avenues.—It has a dry gravelly soil, so notoriously, that the soil has given its name to the neighbourhood; and a consequent climate which has long recommended its quarter as the residence of the consumptive Londoner, and may recommend it now as a very fit home for consumptive pictures.—And when all these advantages of natural position are told, there remain to this site two crowning recommendations of another kind, which the advocates of other localities have no chance of matching, and which should surely settle the question. One half of it is a *free gift* to the nation; while the other half is already the *nation's own*, and paid for, as we have said, with its own money. The logic involved in these last two arguments is as authoritative as the economy. Out of the Great Exhibition, held in this very neighbourhood, which exhibited to us our national inferiority in the Arts of Design, issued the funds that will help to provide us here with the ample site of a great institution for the teaching of the Arts of Design to the nation:—while, the people's own large contribution to the purchase of that site demands, as we have already hinted, that they shall now be logically true to the purpose which suggested it,—and renders the delay interposed by Lord Elcho's motion at once an inconsistency and a calamity.

We have, in an earlier part of this article, reserved to ourselves the right to contend, that the argument which is derived from the alleged advantages of a central metropolitan position against *any* removal of the Gallery—and which argument, on the first statement, is not without an apparent plausibility—has little force when it comes to be examined. There is, in fact, scarcely any class of the community to whom a distance such as is involved in the removal to the Gore Estate is a disadvantage. To the easy and luxurious classes, of course, the distance is nothing,—and the objection has never been offered for their sakes. But, it is a great mistake to suppose—as has been apprehended and urged by the objectors—that the working population of London make that habitual use of the Gallery, in the short daily intervals at their disposal, which has been deemed a leading argument for keeping it in the streets. They who have seen how, on such occasions, the people pour through the Galleries at Greenwich and at Hampton Court, know that distance, instead of being an obstacle, is in itself an inducement,—surrounding their air of popular *diletantism* with the pleasures of an excursion, and dignifying their love of excursion with a *diletant* air. To them, Art has a more intelligible voice when its appeal is made amid the flow of waters, and the song of birds, and the scent of flowers. To all such influences may they be ever, and by all means, kept actively alive!—and, for their sakes, we could be prepared to argue a removal of our National Gallery into the country on its own ground. It is wise statesmanship which adds a new inducement to the people, in their unoccupied moments, to wander away from the stifling streets,—and introduces into the rare banquet by which nature refreshes their weary spirit some of the food by which Art may nourish their awakened minds.—If there be any class on whose behalf, for certain reasons, this removal of the Gallery might, perhaps, be deprecated, it is that of the Art-student; to whom it might be more convenient to have his schools nearer. But, out of the completeness to be obtained by the removal, *he*, in the end, will gain incalculably more than he loses by the removal itself:—to say nothing of the fact, that the disintegration of the pictures, where they are, would be the eventual loss of his school altogether.

THE DUTCH GENRE-PAINTERS.

BY F. W. FAIRHOLT, F.S.A.*

WITH ILLUSTRATIONS FROM ORIGINAL SKETCHES
BY THE ARTIST.

STOLID and unchanging as Dutchmen appear to be, two centuries have not passed over their country without producing very considerable changes in it. While the tourist will note, as we have already done, much that reminds him of his first impressions of Dutch life obtained from Dutch pictures, there is also much that has passed away from the land for ever, and which only exists in such representations. You still observe the ivy-grown farmhouse, with its "thick-planchard orchard," and its quaint walls and gates; but you see no longer the loosely dressed boor, with his wide Spanish doublet and balloon-breeches—Paris has invaded Holland, and the *Magnan des Jolies* has had power enough to transform a Dutchman into a comparatively fashionable being. Village life now is not the village life of Ostade and Gerard Dow—it is less picturesque and less slatternly; it displays more of Dutch formality than we see in their works, but it has more of comfort and respectability. It is in the quiet village inns that are still scattered over the land we may now detect the last relics of old manners. As you approach the principal towns you see many of these welcome hostelries, the doors bowered over with grape vines, and looking worthy the pencil of an Ostade, while the long shed beside their trim gardens may, mentally, be easily peopled by the skittle and tric-trac players of Teniers. In the open space before the house a tall pole, some thirty feet in height, is frequently to be observed; it is crowned on gala days with a sort of weathercock, and the wooden bars, placed at some distance around it, are the marks where the men stand to shoot at it. It is the old *poppegay*, or fictitious parrot, which exercised the ability of the young villagers at a time when archery was generally enforced as a practice. In our country the custom was also adopted, and shooting at the poppegay was as usual in an English village of the time of Elizabeth as it was among the Dutch, who still preserve their village life more unchanged than we do. Popular customs are at all times the last to succumb to fashion; and while large towns vary continually, and take the most recent tone of manners, the village goes on in the present generation pretty much as it did in the last. Novelties are not so welcome there, and are looked upon generally with a characteristic distrust.

But while we speak of changes in Holland since the days of the old painters who have made its past age famous, it must be borne in mind that they are the slow results of nearly two centuries, and after all by no means make so great a change during that long period as has been effected elsewhere. Even in the towns many old customs are retained that have been in use time-out-of-mind, and which have been immortalised in some picture of one or other of the old masters of Holland. We have already noted the humorous works of Jan Steen as the truest transcripts of the manners which he saw around him. One of them depicts a fellow dancing joyously into a room with a fresh herring in his hand, exultingly upheld by the tail. His antics are received with a broad smile from all present. It would be difficult for an ordinary spectator to understand all this, did he not know that a fresh herring is considered by the Dutch a panacea for every complaint; and their arrival on their shores is hailed with so much joy, that the first who hears the news generally makes it publicly known by hanging at his door a frame, decorated with evergreen flowers and coloured paper, in honour of the joyful event. This silent mode of communicating intelligence is used on other occasions. Thus, at Haarlem, it is a custom on the birth of a child to stix to the principal door, to denote the event, a pin-cushion, which is constructed of red silk, covered with lace, and deeply fringed. The sex of the child is denoted by a small piece of white paper placed between the lace and cushion if it is a girl, but the absence of all mark denotes a boy. This custom has other and solid advantages; it not only prevents intrusive curiosity, but for a certain period the house is protected from actions for debt—no

bailliffs dare molest it, no soldiers can be billeted on it, and when troops march past the drums invariably cease to beat.*

One Dutch town is so much like another that but for a few remnants of an ancient kind they would become monotonous to the stranger. Some of these relics are extremely picturesque; and at Haarlem the old Butchery is so costly and beautiful a building, with its varied walls of white stone and red brick, and its richly-carved decorations, as to make it one of the principal features of the town. We must, however, go back to old engravings if we



THE HERRING SIGN.

would see the very streets in which the men of the days of Dow and Mieris walked. Fortunately, their features have been preserved in old engravings scattered through books sometimes devoted to subjects of another kind. Our view of the stadtholder's house at Haarlem, and the surrounding buildings, is of this nature; and is copied from La Serre's very curious volume descriptive of the reception given to the queen-mother, Queen Catherine de Medicis, by the principal Dutch towns, in the year 1635, when she paid a visit to the Low Countries on



THE STADTHOLDER'S HOUSE, HAARLEM, 1635.

most; indeed, there has been a visible desire to make it accord to the refinements and tastes of modern high life, as much as can be consistent with national character. It is the residence of the count, and is to Amsterdam what the Versailles of the days of Louis XIV. was to Paris. There is one characteristic feature of the Hague which has remained unchanged,—and that is the favourite promenade on

* The custom is traditionally reported to have originated owing to the death of a merchant's wife, whose house had been entered nightly and riddled by officers, on the occasion of his bankruptcy, during her confinement.

her way to her daughter Henrietta Maria, the queen of our unfortunate Charles I., performing the journey from Bar-le-Duc to Gorlem, and crossing the sea from thence to Harwich.

Some of the Dutch towns are less altered in their general features than might have been imagined, and this is strikingly the case with the chief of them, Amsterdam. The peculiar nature of its foundations, and the difficulty of tampering with its necessary arrangements, may have induced this. The visitor at the present time who may row across the arm of the Zuyder Zee to the shores of the boggy district oppo-



THE BIRTH-TOKEN.

site, known as "Waterland," will see a city in no degree changed in its broad aspect from the days of Rembrandt. When Catherine de Medicis made her "happy entry" into that city, in 1635, its features from this point were delineated by De Vlieger, and have been copied in our cut. It might have been sketched yesterday, so completely does it give the striking characteristics of this old city of the sea.

The Hague, as it appeared during the palmy era of Dutch Art, is seen in another of our cuts, and that being the "fashionable" locality has changed

the road to Scheveningen, or Schevelling, as it is sometimes called. It is an avenue of oaks and limes, nearly three miles in length, perfectly straight, and bounded by the little steeple of the parish church of Scheveningen at the further end, which may be seen from the Hague. The trees are here allowed to grow in full luxuriance, and shadow the road, which is never lonely—for the Hague is the most pleasant and healthy of Dutch towns, and the favourite resort of the Hollander. The refreshing sea-breeze may always be inhaled here—hence pedestrians and equestrians choose this road, and the idle find constant

* Continued from page 241.

amusement in sitting under the trees, and watching the passers-by. Scheveningen is a little fishing village on the sea-shore, occupied by about three hundred fishermen, and their carts may be met on this road in the morning, drawn by strong dogs, conveying fish to the Hague. The situation of the village itself is particularly dreary; the sea-margin is a sandy desert, planted here and there with rushes to prevent the sand from blowing over-land in stormy weather. It is of interest in English history as the place from whence King Charles II. embarked to resume the sovereignty of England.* It might have been better for England if its historians had no such record to write. It is pleasanter to remember the Hague as the birth-place of a nobler king of England—the immortal William III. But the region of politics is too stormy for our consideration—let us rather return to the happier one of Art.

The pictures of Metz, Mieris, and Terburg, exhibit the highest tone of Dutch society. The wealth and comfort of their indoor life, the richness of their apparel, the simple dignity of their bearing. A Dutchman may feel proud of the ancestry delineated by his native painters, of the patriots who fought and bled more determinedly for their liberties than the men of any other nation have been called upon to do. In the really grand picture at Amsterdam, representing the city-guard met to celebrate the important treaty of Munster, which gave independence to the Dutch after long years of Spanish treachery and cruelty, the painter has truthfully portrayed men, certainly without ideal gracefulness, but with innate manly dignity which gives a lifelike charm to the picture, and has obtained for Van der Helst the highest position in this branch of Art.† To a morally-balanced mind the home-scenes of such painters are as capable of imparting pleasure as the more ambitious attempts of the heroic school, inasmuch as they generally steer clear of anachronisms and false sentiment. Art is catholic in its views, and should be received on broad principles; it would be unfair to disregard a Greek canoe because it does not overpower the eye like a bas-relief by Phidias—particularly as a study of both would assure us that the same great principles governed the mind which produced each. The minute finish which some find objectionable in such works as those of Dow and Ostade, may be excused as necessary results from minds schooled to patient labour, but they never forgot the true fundamental principles of Art; for however laboured their works appear, their design and general arrangement of colour are broad and bold. As compositions they may be viewed at any distance satisfactorily, but they will also reward the nearest scrutiny.

The painters just named were particularly happy in the delineation of what are sometimes termed "conversation pieces"—an old-fashioned designation which is singularly and usefully characteristic of such designs. In them we see a sort of daguerreotypied view of old Dutch manners. The wealth of Holland peeps forth in every one of them. The costly silks, velvets, and furs of the ladies, are rivalled by the velvets, feathers, and gold lace of their gallants. The ebony cabinets, carved chairs, and massive furniture, which generally fill the rooms delineated, display the wealth and love of comfort which reigned paramount in the dwellings of the rich merchants of the Low Countries. The very ponderosity of the various articles are characteristic; so also are the Indian jars and carpets, the parrots and monkeys, which hint very plainly the far-sighted spirit of trading enterprise that gave the Dutch nation a well-deserved pre-eminence in the seventeenth century. The traveller may yet trace in Holland the old love for the products of Eastern taste and skill, and the porcelain of China and Japan is still the ordinary ware of the Dutchman; he also revels

* There is a very interesting and curious picture, representing this event with true Dutch minuteness, in the Gallery at Hampton Court.

† Sir Joshua Reynolds has given his opinion of this noble picture in the strongest manner; he says it is "perhaps the finest picture of portraits in the world, comprehending more of those qualities which make a perfect portrait than any other I have ever seen." Kneller also testifies to its truth, boldness, and brilliancy. It has been recently very carefully and beautifully engraved, but we lose in the engraving the admirable colouring which gives so great a charm to the noble original, making it rival in attractiveness the "Night Guard" of Rembrandt, which hangs opposite to it in the Gallery of the Hague. Two such pictures may be sought in vain elsewhere.

in a Chinese summer-house, and delights in a monkey or an aviary of birds, whose notes secure but the outpourings of a sad reminiscence of a sunny land far away, to which they will never return.

Imitative Art can never be carried farther than it was by Terburg in his famous picture known as "The Satin Gown," a picture which has been made more known by the notice it has received by Goethe in his "Wahlverwandtschaften." He describes it as representing a noble, knightly-looking man, who sits with one leg over the other addressing himself to the conscience of his daughter, who stands before him. "She is a majestic figure, in a full and flowing dress

of white satin; her back only is seen, but the whole attitude shows that she is struggling with her feelings. The mother, too, seems to be concealing a little embarrassment, for she looks into a wine-glass out of which she is sipping." Whether the poet has read aright the painter's story cannot be safely declared—it is one of those pictures that want the artist's own interpretation; but the extraordinary qualities it possesses as a transcript of Nature is unrivalled, and the satin gown of the principal figure is reality itself.

There was a still lower class of imitative Art practised with unremitting patience and assiduity by



AMSTERDAM, 1635.

some few Dutch painters. They devoted themselves to "still-life," and produced representations of the humblest furniture of the kitchen. At the head of this class stands William Kalf, who was born at Amsterdam in 1630, and died in 1693, having devoted his life not only to the delineations of the gold and silver cups* of the wealthy burghmaster, but to the humblest utilities of his establishment. Yet do such simple subjects give the painter opportunities for composition, colour, and chiaro-oscuro of the finest kind. He brought great rules of Art to bear on all he delineated, and he elevated the common-

place to the poetic. "In the treatment even of these things there is an ideal, or beautiful, as distinct from a literal imitation."*

The camp-life of the Dutch was ably represented by a series of painters, who delighted to depict

"Battle's magnificently stern array."

It was, unhappily, too common a sight in Holland; the history of the country is that of one continuous struggle for freedom. The frightful scenes which Callot has depicted in his "Miserics of War" were enacted over and over again by the cruel agents of



THE HAGUE, 1635.

the Duke of Alva upon the devoted and suffering people. While they must have hated the sight of a Spanish trooper, they must have looked with joy on the native defenders of their country. Certainly, never were soldiers braver than the soldiers of Holland; never did men fight more devotedly for a

* The Dutch poet who composed his epitaph declares in it, that all the plate he ever painted would not be sufficient reward to so virtuous a man, as was the refined and patient painter of these metallic treasures, many of which are remarkable for their fancy and taste in design.

country; never were imperishable deeds of pure patriotism graven deeper on the eternal tablets of fame. We see only in the painting of the Hollander the picturesque features of war, the

"Mounting in hot haste, the steed,
The mustering squadron and the clattering car,
That pouring forward with impetuous speed,
Doth swiftly form the solid ranks of war."

The price of painters in this branch of Art is

* Leslie. "Lectures on Painting," p. 243.

Philip Wouvermans. There is a picturesque beauty given by him to camp-life, which has an irresistible charm for the eye. We see the bustle which follows the trumpeters' call to horse; we notice the readiness of the well-caparisoned officer, the grudging departure of the common soldier, absorbed in gambling or drinking till the last moment has arrived to fall into the ranks. The gaiety of the uniforms, the beauty and vigour of the horses, the entire "pictorial element" which reigns over the scene, makes us feel that war thus

"Had in magnificence, and drowned in state,
Loses the fiend."

It is a proof that the world has increased in humanity as the last two centuries have past over it; for it has been the province of modern Art alone to rob war of its false glories, and teach us to look on the reverse of the picture. Never was a poem more touchingly written than that which Sir Edwin Landseer has painted in his pictures of "Peace" and "War," which Mr. Vernon has made the property of his countrymen; never did philosopher descend more convincingly on the text that it is chiefly

"— man's inhumanity to man
Makes countless thousands mourn."

Wouvermans was the perfect type of a Dutchman—reserved, industrious, and eminently fond of home. During his whole lifetime he lived in Haarlem—unvarying the calm tenour of his course. From such a reserved man one would hardly expect these vivid pictures of peculiar phases of life. He also delighted in painting jovial parties of sportsmen—sometimes riding out with ladies, equipped for hawking, and sometimes galloping over heath and plain after the hunted stag, or reposing in the cool shade near a spring. Kugler, who notes this, also remarks, that "one of the points of interest in these pictures is the feeling for well-bred society and decorum, assisted by some little hint at a novel-like relation between the personages represented." The other main point of interest in Wouvermans' pictures is derived from the taste and knowledge with which he delighted to paint the horse, that constant companion of the out-door-life of a gentleman in all its various and manifold situations. In many of his works the horse is treated as the principal figure; he painted him in the stable, being saddled, in the *manège*; when taken to water; or to the fair. Other subjects which afford opportunity for prominently displaying the figure of the horse—such as battles, attacks by robbers, or adventures of carriers—were frequently painted by him." He had a somewhat ideal mode of treating landscape accessories, which are all subservient to the general effect of the figures introduced. Although his brother Peter was one of the most successful imitators of his peculiarities, Philip may be safely said to have originated and upheld by his own genius a peculiar phase of Art, which has never since been so successfully cultivated.

Van der Meulen, more ambitious, and less caring for the quietude of home-life, actually became a camp-follower of Louis XIV., and painted the campaigns of that monarch from observation, industriously covering the walls of Versailles with pictures of its master's heroism; and here the little *Grande Manœuvre* could repose amid the contemplation of his own glories, and listen to the adulations of Boileau and Racine, also bribed to be camp-followers, and narrate in fulsome strains the heroism of one who could fight in embroidered costume, attended by his favourite ladies in gilt coaches. The full-dressed glories of his battles, as depicted by his Dutch servant, seem to render war a mere showy masquerade, did we not see the devastation which proceeds far away from king and courtier in the distance, and know from the truer page of history the wanton and wicked invasions this cold-hearted voluptuary continually made upon better men than himself.

Marine-painting more naturally fell within the scope of the Hollander, and nowhere else did the art flourish so well as among the Dutch painters. Ludolf Backhuysen and William Van der Velde are names which take highest place in this department. It is recorded that Admiral de Ruyter ordered cannon to be fired from his noble vessels of war, for the express purpose of its effects being studied by the latter artist when engaged in painting his sea-fights. It therefore is in "the actual," as exhibited in

every phase of life and nature, that the artists of Holland achieved their position; but paramount as their claims may be in this particular, we find sublimity combined with it in the works of Rembrandt, and poetry in Cuyt and Ruysdael. All is, however, strongly tinged with native feeling, so unmistakably pronounced that we could not mistake a Dutch picture for the production of the painters of any other nation. It is as visible in the landscapes of Hobbema, as it is in the peasant scenes of Ostade. But it was chiefly the popular scenes of Dutch life by the genre-painters that gave celebrity to this new school of Art, and made it generally popular.

We by no means intend in this place to combat the objections made to this style of Art by the admirers of the ideal school, or the elevated conceptions of the great masters of Italy; but simply to plead for the fact of as much idealism and poetry existing in the works of the Dutch as their sphere of action will allow. We plead for their truth, for the perfect Art-power they have in displaying this truth; for the sentiment and feeling that continually lurk beneath it, to gratify all who will diligently search for it, there as elsewhere in the world it remains—hidden from merely superficial observation. M. Charles Blanc has grappled with the most difficult portion of this subject when treating of the works of Rembrandt; we will only, therefore, refer to the labours

of such artists among the other painters of the Low Countries as make ordinary life the subjects of their pencils. Lesbe, in his "Lectures," has put these claims clearly; he says, "The great merit of all Flemish and Dutch painters is the absence of all affected and mawkish sensibility—all that stage trickery on the spectator, by which he is made to believe himself touched at heart. This false sentiment began with Greuze, and has ever since more or less infected Art." Their power of conveying interest to the most ordinary actions he illustrates by one public example. He says, "There are few pictures in our National Gallery before which I find myself more often standing than the very small one by Maas, the subject of which is the scraping of a parson. A decent-looking Dutch housewife sits intently engaged in this operation, with a fine chubby child standing by her side watching the process, as children will stand and watch the most ordinary operations, with an intensity of interest as if the very existence of the whole world depended on the exact manner in which that parson was scraped. It is not the colour, and light and shadow, of this charming little gem, superlative as they are, that constitute its great attraction; for a mere outline of it would arrest attention among a thousand subjects of its class, and many pictures as beautiful in effect might not interest so much; but it is the delight at seeing



THE ROAD TO SCHEVENINGEN.

a trait of childhood we have often observed and been amused with in Nature, for the first time so felicitously given by Art. I have noticed the natural manner in which Raphael and other great painters represented children as wholly uninterested in that which engages the attention of their elders. Here the incident is exactly the reverse, and treated with equal felicity." It may startle some few minds to find this conjunction of the names of Raphael and Maas; but no happier instance could prove the fact that

"One touch of Nature makes the whole world kin."

If we owe the artists of Holland no other gratitude for their labours, let us at least award them this their just due—all honour for the true and persevering study of Nature. The world had been in danger of losing simplicity in Art, and getting the laboured results of scholastic rules instead; an art that every one might comprehend, and be improved by the comprehension, was evolved from the ateliers of Holland. It taught that the world around us is filled with poetry to reward the ardent seeker of the beautiful, and it displayed this truth with all the vigour of an honest nature.

The lives of these artists are instructive even in their unobtrusiveness. Brief as our notices have necessarily been of their career, there is little more to record of them. They passed their lives in the closest study of Nature, and found in her varied beauties enough to employ it well in imitating her

charms: content in the sphere of action to which their genius had assigned them, they worked on regardless of the more prosaic men around them, and patiently waited the recognition of the inherent truth of their works. Some were honoured in their own day, and reaped the harvest they had sown, but others lived poor and died neglected; yet who shall say they were not happier men than the wealthier merchants of their land? Untrammelled by the cares of trade, and freely roaming in scenes his heart responds to, the painter, however poor, is wealthy in his nobler aspirations after the beautiful, implanted in the world by the divine hand of its Maker. The maumoon-worshipping professor of Art may be endowed with genius occasionally, but he is a *rara avis*, and is considerably outnumbered by his less wealthy brethren. It is, however, essential to greatness that it be allied to devotion, and that cannot be without some abandonment of self. The world, it has been said, frequently knows nothing of its greatest men; but are not such men made great by abstraction from its narrowing jealousies, its struggles for power, its sacrifice of simplicity and pure-mindedness at the shrine of wealth and worldliness?

In the course of these notices of the artists of Holland, we have hitherto left unrecorded a most important section—the Landscape-Painters. In a concluding paper we shall detail their claims to consideration as the successful originators of this as a distinct art.

THE ROYAL PICTURES.

THE STAR IN THE EAST.

H. Warren, Painter. R. Brandard, Engraver.
Size of the Picture, 2 ft. 4½ in. by 9½ in.

No artist whose mind was not thoroughly imbued with true poetical feeling would have attempted such a subject as this; or it might, perhaps, rather be said that only a painter so gifted could have made it what it is—a scene so picturesque in its simplicity and so impressive in its solemn quietude as to invoke a feeling of religious awe. In the hands of an ordinary artist a few camels travelling along the arid desert would have proved a very commonplace theme; Mr. Warren has found the materials ample for a most attractive picture.

St. Matthew alone of the four evangelists relates the history which has supplied the subject:—

“Then Herod, when he had privily called the wise men, enquired of them diligently what time the star appeared.

“And he sent them to Bethlehem, and said, Go and search diligently for the young child; and when ye have found him, bring me word again, that I may come and worship him also.

“When they had heard the king, they departed; and, lo, the star, which they saw in the east, went before them.”

Biblical students have been at some pains to ascertain whence these wise men, or Magi, as they are generally called, came. The term Magi was commonly used among Eastern nations to denote philosophers, and those who devoted themselves to the study of the moral and physical sciences, especially astrology and medicine. The wise men who went to Jerusalem to seek the infant Christ were doubtless philosophers of this description. As they were constantly studying the face of the heavens, the star or luminous body which appeared on this occasion could not have escaped their notice; and as it was a current notion that any extraordinary appearance in the heavens denoted some remarkable event, they were in a great measure prepared for what was about to happen, especially as a report prevailed throughout the civilised world, that at this time a king was to arise, and rule over the country of Judea. Most commentators are of opinion that the wise men alluded to by the evangelist were inhabitants of Persia or Mesopotamia—countries in which astrology was, perhaps, more closely studied than in any other to the east of Jerusalem. Presuming this to be fact, it opens up another interesting question—namely, the religion which these Magi professed; for it is scarcely to be supposed that such a communication would be addressed to idolators, though it would probably be made to the Gentile world.

Other writers think they came from Arabia, because the gold, myrrh, and frankincense they presented to the object of their worship are the productions of that country. We confess to attach but little weight to this argument by itself; but when the geographical positions of Arabia and Judea are taken in connection with it, it has some force. Arabia, or at least a portion of it, lies south-west of Judea, and the inhabitants of the former country would therefore see the “star” in an easterly direction; while Persia is situated to the east of Jerusalem, so that to the Persians it must have appeared in the west; on the other hand, it is distinctly stated they came “from the east to Jerusalem.” These differences may, however, be reconciled if we are to assume, as we have a right to do, that the miraculous light first appeared in the eastern heavens, and that it travelled westerly, leading the travellers in that direction. Still there is no mention made of such a phenomenon till after the wise men had reached Jerusalem, and been commanded by Herod to “go and search diligently for the young child;” then “the star which they saw in the east went before them.”

Mr. Warren, as it seems to us, inclines to the Arabian side of the controversy, if the matter had his consideration. The figures in his drawing are certainly of that country, and are passing one of its numerous deserts. The picture, in the collection at Osborne, was purchased by the Queen from the New Water-Colour Society, of which the artist is President, in 1850.

NATIONAL ART
AND NATIVE ARTISTS.

THE SCUTARI MONUMENT.

The Sardinian government have determined to erect a monument in honour of their late king, Charles Albert; and the Sardinian Chambers, affirming the design, have voted a sum of £25,000 for the purpose of having it carried into execution. Having, then, a commission of this importance at their disposal, the government of that country have felt themselves called on to remember that they have a *native sculptor* who has achieved considerable reputation; and, although that sculptor is an absentee from his country, and notwithstanding the disadvantage at which they are proverbially said to stand who are out of sight, they have thought it right to assign the work to the Baron Marochetti. Two propositions are maintained by this decision; both of which, we confess, affect us with a sense of their fitness. One is, that the national monuments shall be executed by national art; the other, that the national artist has a right to such encouragements and beneficences as his nation has to bestow. Strangely enough, however, it is in this country the tendency of government action in the matter to ignore these important principles, and to reverse this sound and reasonable practice. In a nation rich beyond any other in the talent needed for this species of national illustration, and in the number of its Art-professors awaiting their rewards, it would seem nearly incredible that a valuable commission should have passed behind the backs of all the sculptors of England into the hands of a foreigner. Will no one so placed as to make his voice heard stand between our native artists and this official repudiation? Will no member of the Lower House of Parliament elicit for us some more precise and satisfactory information than we yet possess respecting the Scutari Monument, for which £17,500 was the other day asked from that assembly, and which has been silently given away to the Baron Marochetti? When was this commission assigned, and how? and why to a stranger, when we have amongst us sculptors who have year after year been amassing up great titles to such employments, and illustrating the country that thus neglects them by the production of works which place its sculpture at the head of the European schools. It is high time that there should be an end of this arbitrary dealing with the national commissions; it is fit that it should be made distinctly visible to the ministerial minds that our public works are not to be looked on as pieces of pocket patronage. It is idle to appeal, in answer, to commonplaces about the cosmopolitan character of Art; no undue jealousy of the foreign sculptor is involved in the sentiment that we have naturally the support of our own. That country overlooks one of its great means of self-illustration which forgets to foster its own Arts—a process not to be attained by overlooking their professors. As matters stand, Baron Marochetti gets properly the commission which his own country has to bestow on her son, and improperly that which our country takes from her sons to give to him. Again, we ask, will some one help us to a clearer understanding of this matter? and we ask it the more emphatically because there are other Art-matters waiting for decision which render a better understanding of the subject highly important to the interests of our own great English sculptors.

Since the above was written, the Earl of Harrington, in the House of Peers, asked some questions of the Government in reference to this painful and very humiliating “Monument;” but his lordship was ill informed on the subject—nor was his criticism very pointed or enlightened. He did, however, inquire—

“1. By whose authority the Scutari Monument had been undertaken? 2. Who had selected Signor Marochetti to undertake the work? 3. From what fund the payment was to be made? 4. Why the work had not been subjected to public competition, so that the sculptors of England, France, Italy, and Germany might have sent in models, and an obelisk have been produced that would have immortalised our warriors and the sculptor for ages to come.”

But his lordship made no remarks on the enormous cost of a very inferior work—a work that, we repeat, is unworthy of the subject, and not creditable to the

art of sculpture as it exists in England in the nineteenth century. If the Baron Marochetti desires to be considered a British artist (which he is not considered by the Sardinian government) we can take no pride for our country out of this production; and although Lord Panmure, in his reply, affirmed that “he had heard very little complaint about it,” we assert it to be an opinion, general if not universal, amongst any of our leading sculptors would have produced a work of far higher merit, and have been amply rewarded by one half the sum the Baron received. The answer of the noble lord is merely to the effect that Government ordered the work, commissioned Baron Marochetti to execute it, did not invite a competition (by which their “commission” would have been *ruled*), and that when everything was done that ought not to have been done, they called upon Parliament for a grant to pay for it:—“Signor Marochetti having been selected because he was famous on account of some colossal works that he had executed.” Most unappreciated, although every branch of trade and commerce, almost every imaginable “interest” is represented in Parliament, the Arts are entirely without this vast advantage. The most absurd opinions may be uttered, the most irrational dogmas promulgated, and the most disreputable “jobs” perpetrated there, without a single member raising his voice to expose or avert—aided by knowledge, experience, and courage. Surely an evil so manifest cannot endure much longer; surely some intelligent and enlightened nobleman or gentleman will stand in the breach.

In the course of his very restricted observations, Lord Panmure said, that “British sculptors declined to compete for public monuments;” who can be his lordship’s authority for so entire and incalculable an error? When did British sculptors decline competition?—when and where? There are but two sculptors who have ever so declined—Mr. Gibson and Baron Marochetti! But Mr. Gibson is a resident in Rome, and the Baron very naturally believes success to be more certain without competition than with it. Upon this very important branch of the subject, the following letter has been published (in the *Times*) by E. H. Baily, R.A.

“SIR,—My attention has been called to a report which appeared in your paper on the 9th inst., under the head of Parliamentary intelligence, which is not only an error, but a statement which, if allowed to pass uncontradicted, may prove injurious to the interests of British sculptors.

“Lord Panmure, in reply to Lord Harrington’s inquiry for particulars relative to the Scutari Memorial, thus spoke of public competitions:—‘As to public competitions, the noble earl (Harrington) must be aware that the sculptors and artists of this country declined to furnish plans to compete for the erection of public monuments.’

“It may be—in fact I know that Mr. Gibson has long objected and refused to submit designs in competition; but I know of no other English sculptor who has declined to compete, although they have been strongly impressed with the injustice and partiality which most often attend this mode of selection; and I have yet to learn that Mr. Gibson is the representative of British Art and sculptors.

“Lord Panmure says,—‘The noble lord (Harrington) must be aware that the sculptors of this country declined to furnish designs.’ Can Lord Panmure, Lord Harrington, or any other noble lord, say there was want of response by the British artists for the Nelson Testimonial? Or can it be said that British artists declined to compete for either the erection of the Parliament houses, or, more recently, for their decoration? Did they not cordially reply to the invitation of the city in the cases of the Ped and Wellington competitions? And lastly, did not two British sculptors out of four selected (one being a foreigner and the other Mr. Gibson) submit designs for the Government Wellington Monument, and, although rejected, offer again and again to provide other works? I, for one, never heard of the Scutari Monument until I read in the public papers that it was completed, and I may say that, had I been applied to, I should most readily have met the views of the government, and have been proud to have done so for the honour of England’s arms and Art.

“I have the honour to be, Sir,

“Your obedient humble servant,

“E. H. BAILY.”

“11, York Place, Portman Square.”

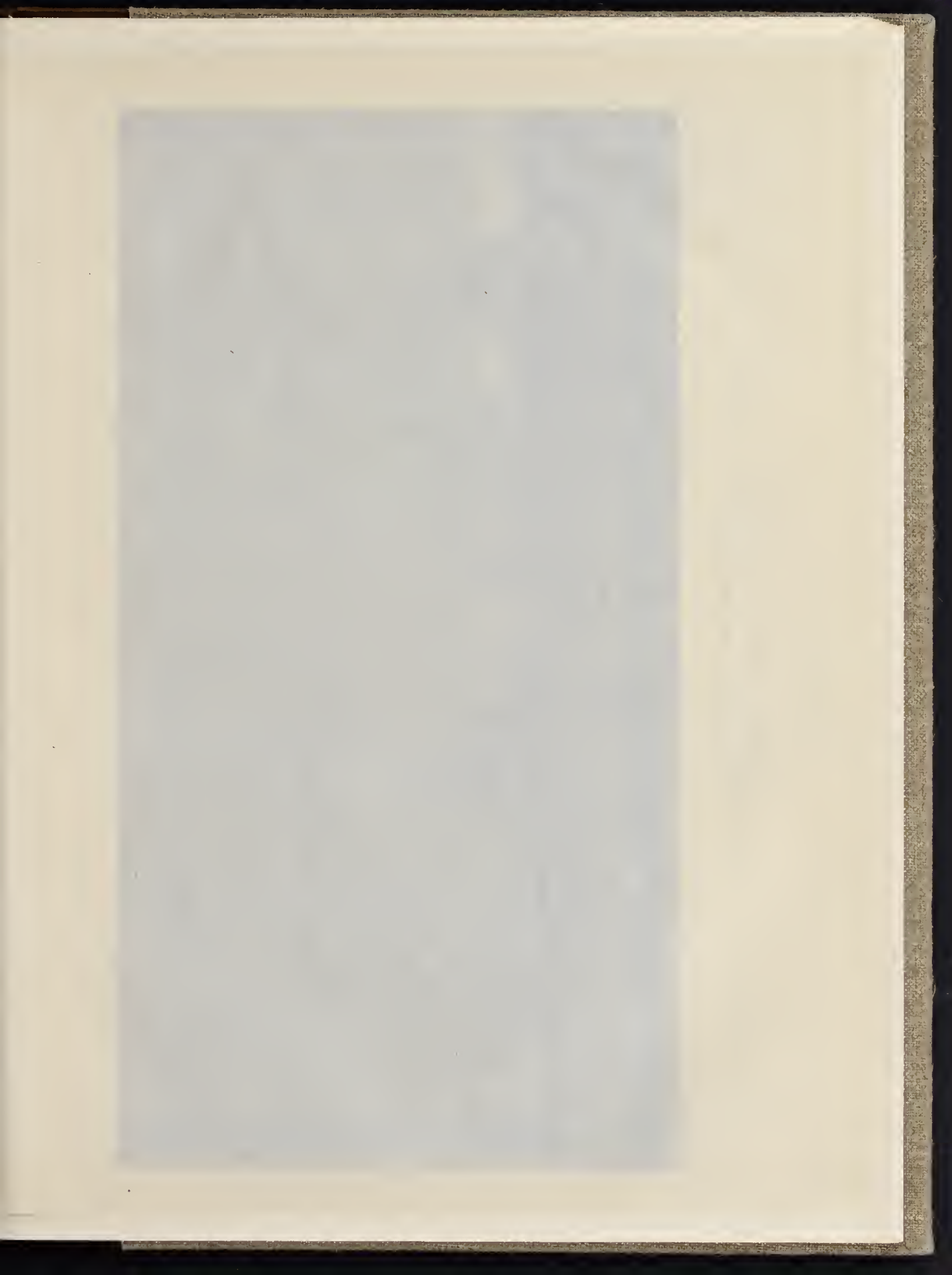

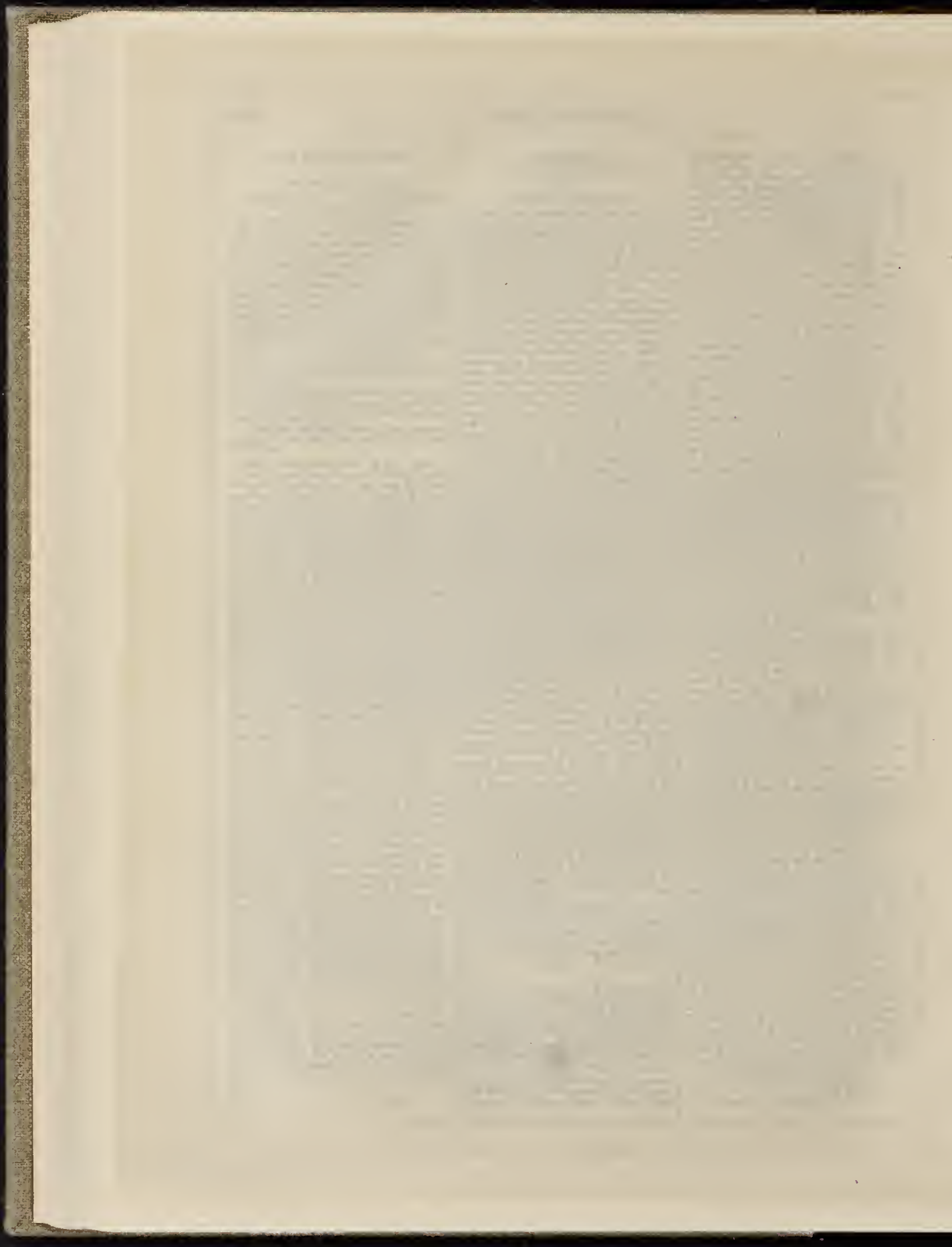



THE CARAVAN OF THE DESERT
FROM THE MOUNTAINS OF THE HIMALAYAS

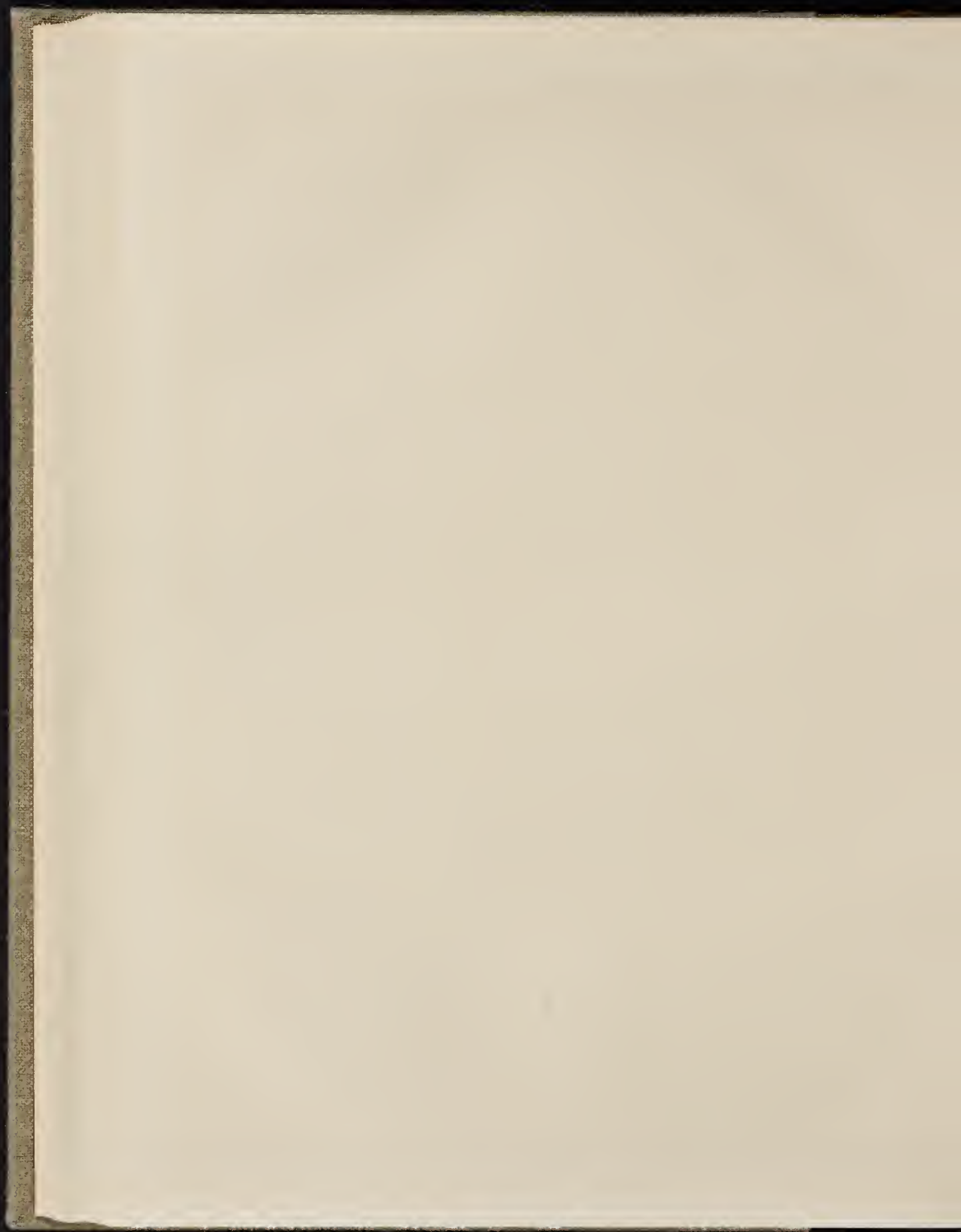

THE EXHIBITION OF
ART-TREASURES IN MANCHESTER.

HIS ROYAL HIGHNESS PRINCE ALBERT has addressed the following letter to the Earl of Ellesmere, in reference to the Exhibition which is to take place at Manchester in 1857. It is a most lucid and judicious communication—another proof that whenever the Prince brings his mind to bear upon any subject, he thoroughly comprehends it: the course he advises is generally the best; he seems to know almost by intuition that which others acquire by experience and study; and it is beyond question, that if the Arts of this country already owe him a large debt, that debt is certain to accumulate. It is a privilege of no common order to be guided by the counsel of a man so wise and good; who, occupying the highest place in the realm, has thought and consideration for all that concerns the true welfare and surest interests of the country. There can be no doubt that the Manchester Committee will act upon the suggestion of the Prince; they may thus obtain a collection of pictures such as have never been seen together; for it is notorious (and we have even better evidence than that of Dr. Waagen) that if our National Gallery be comparatively poor, there are Art-treasures scattered throughout England that, collectively, would form a richer and more valuable assemblage than those presented by any three public galleries of Europe combined. If the best of these can be obtained—and we imagine the letter of the Prince in a great degree removes all difficulty—the Exhibition at Manchester will be for ever memorable in the history of British Art. The following is the letter of His Royal Highness:—

"MY DEAR LORD ELLESMERE,—I was very sorry not to see you with the deputation from Manchester that came to me yesterday upon the subject of the Exhibition of Art-treasures which it is proposed to open in that city in May, 1857. Lord Overstone, however, as well as the other members of the deputation, left nothing to desire in explaining the objects which they have in view. I could not fail to admire the public spirit which had prompted the people of Manchester to enter upon so large and magnificent an undertaking.

"We had a good deal of discussion upon its general principles, upon the soundness and fitness of which much of its future success must necessarily depend.

"Manchester enters upon this undertaking at a certain disadvantage. It has been preceded by the Exhibition of 1851, that of Dublin in 1853, and that at Paris during the last year. That a mere repetition of what has thus gone before would fail to attract sufficient notice and public support appears to have been felt by the Committee; and they most wisely gave a distinctive character to their scheme, by making it an exhibition of what may emphatically be called the Art-treasures of this country. How to succeed in collecting such treasures, fondly cherished as they are by their owners, who are justly jealous of their safety, is the problem to be solved.

"In my opinion the solution will be found in the satisfactory proof of the usefulness of the undertaking. The mere gratification of public curiosity, and the giving an intellectual entertainment to the dense population of a particular locality, would be praiseworthy in itself, but hardly sufficient to convince the owners of works of Art that it is their duty, at a certain risk and inconvenience, to send their choicest treasures to Manchester for exhibition.

"That national usefulness might, however, be found in the educational direction which may be given to the whole scheme. No country invests a larger amount of capital in works of Art of all kinds than England, and in none, almost, is so little done for Art-education. If the collection you propose to form were made to illustrate the history of Art in a chronological and systematic arrangement, it would speak powerfully to the public mind, and enable, in a practical way, the most uneducated eye to gather the lessons which ages of thought and scientific research have attempted to abstract; and would present to the world, for the first time, a gallery such as no other country could produce, but for which, I feel convinced, the materials exist abundantly in private hands among us.

"As far as printing is concerned, I enclose a catalogue exhibiting all the different schools, with the

masters who illustrate them, which able hands have compiled for me, and which was communicated to the National Gallery Committee of 1853, and printed by them with the evidence.

"If such a catalogue, for instance, were to be filled up with the specimens of the best paintings by the different masters enumerated in it which exist in this country, I feel certain that the Committee would come with very different powers of persuasion, and a very different claim to attention to their owners, than when the demand for the loan of certain of their pictures were apparently dependent upon mere accident or caprice.

"A person who would not otherwise be inclined to part with a picture would probably shrink from refusing it, if he knew that his doing so tended to mar the realisation of a great national object.

"The same principle might be adopted with regard to the other branches of Art, extending even into the field of Manufacturing Industry.

"Whatever may be the decision of the Committee, I assure you that it will give me the greatest pleasure to give you any feeble assistance or support which I may be enabled to render; and I may at the same time repeat to you the assurance of the Queen's best wishes for the success of your labours.

"Ever yours truly,

"ALBERT."

"Buckingham Palace, July 3."

"The site of the building has been fixed at Old Trafford, about two miles from the Manchester Exchange, lying contiguous to the Botanical Gardens, which will form an agreeable promenade in connection with it. The total ground covered by the building will be 15,273 square yards. The front, which has been designed by Mr. Salomons, a local architect, will be of red and white bricks, and the sides of cast and corrugated iron, which latter material, in combination with glass, will also be used for the roofs."

Drawings of the building have been shown during the month at Messrs. Phillips, the eminent jewellers, in Cockspur Street. Without being remarkable for novelty or beauty of design, it appears to be well suited to the object in view—and if not handsome, is certainly not the opposite. It seems to be in all respects satisfactory.

It is not, however, without much regret we learn that the Industrial Arts are not to be represented by this great gathering of 1857 in Manchester. This decision has been probably arrived at mainly in consequence of the long announced intention of "the Manchester Mechanics' Institution" to hold such an exhibition in the autumn of 1856. To this always interesting and important topic we shall presently refer.

Frequent occasions will be supplied to us of communicating with our readers concerning the progress of the Directors of "the Exhibition of Art-Treasures in Manchester;" meanwhile, we cordially and hopefully wish it success.

We may now express a hope that the Committee, having taken a wise step in reference to pictures, will consider also how *sculpture* can be best represented—modern sculpture, that is to say. It will readily occur to them that, scattered about the building in appropriate places, works of this class will not only be seen to advantage, but add materially to its general effect, giving grace and interest to the Exhibition. We trust our British sculptors will make early preparations for the call that no doubt will be made upon them; and we have no fear of their thus establishing their supremacy, and supplying the most emphatic proofs of their right to such patronage as the nation can supply. They may never again have so valuable an opportunity; let it not be lost.

We may respectfully offer a word or two in reference to a very essential matter. The Exhibition at Dublin betrayed a lamentable want of care, in regard to the pictures, &c., entrusted to the Committee; we do not dwell much on this point, for we have no desire to create alarm. The gentlemen who undertake the trust in Manchester are practical men of business, while those of Dublin were not; they will incur—and will willingly incur—a heavy responsibility: let them give ample assurance that, in this respect, no contributor need be uneasy concerning the issue.

MECHANICS' INSTITUTE,
MANCHESTER.

EXHIBITION OF ART AND ART-INDUSTRY.

THE MECHANICS' INSTITUTE of Manchester is a new building, commensurate with its augmented numbers and increased requirements: that building it is proposed to inaugurate by "an Exhibition illustrative of the Fine Arts, Antiquities, Scientific Inventions, Raw Materials, Industrial Products, Machinery at rest and in Motion, and comprising Selections from Mechanical Employments in actual operation," such Exhibition to be opened in September next.*

We rejoice to learn that what the Exhibition of 1857 is not to do, will be done by this Exhibition of 1856—viz., to collect productions of Art-Manufacture; hence, to show its progress, and hence, to promote a most essential branch of Art-education. Circulars have been issued by the Directors, requesting loans of all kinds; and we understand a large proportion of our leading manufacturers have responded to the call made upon them—first, in order to promote the interests of a most valuable Institution, that has existed more than thirty years, and achieved an immense amount of good; and next, with a view to inform the public—rightly and properly—who are the producers who best minister to public wants. We earnestly hope this good cause will be upheld, and that the Directors will receive such liberal aid as may essentially assist them in their very meritorious undertaking. After all, unless the Artisan be properly taught, little real service can be rendered by those who teach. It is in this respect mainly that France excels England; there the workmen—"the mechanics"—are made to understand the nature and fitness of what they undertake. It is to their intelligence the world is mainly indebted for results that in certain classes of produce keep exclusively to them the markets of the world.

We rejoice to know, then, that in Manchester there is again to be an Exhibition of Art-Industry; and that this portion of the design is to be a main purpose. No doubt the Committee are aware that many serious difficulties will have to be met and encountered. Producers generally will be averse to exertions unless some steps be taken to overcome objections. The only case in point is the Exhibition which, in 1853, took place in Dublin; it followed perhaps too soon upon that of 1851, and it was notoriously ill-managed. We have no desire to enter into this matter now, but unquestionably the whole affair was a series of mistakes, "confusion worse confounded;" and the result was a serious pecuniary loss.

The Exhibition which occurred in New York was worse than failure—it was judicial, and not serviceable, to all who in England took part in it. That of Paris, however, was a success, and is likely to lead to very beneficial consequences; it was a first great step to that free-trade which must ultimately secure the great interests of the world, and especially of France and Great Britain. But there will be an indisposition on the part of our leading manufacturers generally to aid the views of the Manchester Committee, by making arrangements commensurate with the magnitude and value of the occasion. We hope the Committee have considered how this difficulty can best be met.

To see a collection of fine and rare pictures will be no doubt a boon of magnitude to the people of Manchester, and the immensely populous district that surrounds this great city of industry; but a gathering together of objects of manufacture, and of Art-manufacture especially, will be infinitely more instructive—more permanently and practically useful.

For ourselves, we shall gladly aid and assist it by every means in our power, and we trust, with advantage to the Committee and the contributors. It was in Manchester, so far back as 1846, that we commenced the task we have since so often repeated—of

* The floor space in the building, applicable to the purposes of the Exhibition, exceeds twenty-one thousand square feet, with the additional accommodation afforded by the walls for the display of Paintings, Engravings, &c. With this space at their disposal, and with the experience the Directors possess of the successful working of similar Exhibitions in this Institution, they confidently hope to collect materials, and arrange an Exhibition which will sustain the reputation of the Institution, and be not only an object of general attraction, but an important educational instrument throughout the densely populated district, of which Manchester is the centre.

reporting and illustrating works of Art-industry: in England that is to say; for previously, in 1844, we had published an Illustrated Report of the Exposition of Industrial Arts in Paris; and, in 1845, the *Art (Union) Journal* contained, under the title of the "Mercantile Value of the Fine Arts," a report, with many engravings, of the Bazaar at Covent Garden, which, although it took place in order to raise funds for the Anti-corn Law League, was so liberally supplied with contributions from manufacturing localities as to be in reality an exhibition of Art-Manufactures; and it no doubt led (as at the time we said it would do) to the consideration of schemes in which the example of France might be followed by England.*

The Illustrated Report of the Exposition of British Industrial Art at Manchester at the close of the year 1845, published in a supplementary part of the *Art (Union) Journal*, contained a hundred engravings. It was a fair and sufficiently ample report of the first attempt in England to follow in the footsteps of France. And it is to the honor of Manchester that it took the lead in a course which subsequently, in 1851, delighted and instructed the world. Then, as on all occasions, we laboured to show that England was capable of rivaling France in collecting together a display of Art-manufacture, urging upon all who had power, the duty of their adequate representation in England. In 1851 we had the happiness to receive our reward in witnessing an exhibition infinitely beyond our hopes. We rejoice, therefore, that after a lapse of twelve years Manchester will make another effort; and we hope and trust British Industrial Art will be, on that occasion, as largely and liberally represented, patronised, and protected as it was in 1845—in due proportion, that is to say, for Art-industry was then in comparative infancy in England. The benefit of publicity was more than doubted by producers—it was a novelty they could not understand; there was no royal or aristocratic influence to support it—no "guaranteed fund" to meet expenses; it owed its existence, its sustenance, and its results to a few enterprising and enlightened men, and by them the cost and consequent loss was borne exclusively.

We hope and believe that the issue, in 1856, will be as honourable to the conductors, to the city, to the contributors, and to the public, as was the winter of 1845; but, we repeat, in due proportion to the means that may now be commanded to obtain a more brilliant and a more useful success.

We do not lose sight of the fact that the results of the Exhibition at the Manchester Mechanics' Institute, in 1856, will be infinitely more important than were those of 1845; for the prosperity of a very useful and long-established Institution will in a great degree depend upon the success arrived at. The building is, we understand, one of an admirable character—properly arranged for all requirements: it is costly, of course, in proportion. And if this Exhibition be what it may be, and ought to be, it will relieve the Committee and the Society of a heavy responsibility. This may be a narrow, but it is a necessary view. We sustain the Exhibition also on higher grounds: those who contribute to it will—while they extend their own repute, and thus advance their own interests—have the satisfaction of knowing they are largely promoting the true welfare of a class which may be almost described as the most important class of the community—the operative class, the workmen, the "mechanics,"—who, if rightly instructed, trained to good order, properly encouraged, and justly rewarded, may be safely considered and described as "the pillars of the State."

* "A National Exposition in London would attract visitors from every quarter of the globe; and the rent which manufacturers would gladly pay for the use of the space necessary to the display of their goods would more than cover the cost, even if admissions were gratuitous. Such a project is worthy the combined efforts of the Board of Trade and the School of Design. They would be nobly supported by the country, and the Temple Palace of British Industry would surpass anything which this world has ever witnessed. A more perfect National Exposition of the products of British Industry would lead to the display of high and noble feelings with greater intensity and wider extent. It is for this reason chiefly that we so strenuously urge the project. We value taste, we esteem industry, we love every form in which intelligence embodies itself; but, above all, we estimate the influence of artistic beauty in developing emotions of moral loveliness, and the influence of the triumphs of Britain's industrial prowess in strengthening every man's interest in the prosperity of the British nation."—*Art (Union) Journal*, 1846.

A NYMPH SURPRISED.

FROM THE STATUE BY E. G. PAPWORTH, JUN.

WITH the knowledge we have of the present condition of sculpture in this country, we cannot but feel a considerable amount of regret, acting as an alloy to our pleasure, whenever we mark the appearance of a young sculptor whose talent is of such a character as, under ordinary circumstances, would fully justify his continuance in the profession. Nothing, we are persuaded, but a love of the art which he finds it impossible to restrain, would induce any young man to enter upon a career that, even under the most favourable conditions, must be one of infinite labour, difficulties, and disappointment. And how much are all these increased by the present aspect of our school of sculpture with respect to the patronage it receives, and the hold it has upon the minds of those who alone are able to help it forward? For what are the facts which come within the cognisance of every one who interests himself at all in Art-matters? A few of our leading sculptors receive commissions from Government for works at prices which, in comparison with the productions of other artists, and with the profits realised by an active, "pushing" tradesman, leave him but a scanty income; and occasionally from private patrons on scarcely more liberal terms. But by far the larger majority cannot boast of even this niggardly amount of patronage. Year after year, clever and even beautiful models in clay—for speculative marbles are too costly to be executed by men who have only their own head and hands to assist them—are produced, exhibited, and then returned to the studio, only to add to the disquietude and chagrin of the disappointed artist. We have said such works are "exhibited"—they are not; they are admitted within the walls of the Academy, and then placed in a room where, like the poor fellows in the "Black Hole" at Calcutta, they smother each other. The Academy is not altogether to be blamed for this, though we are satisfied arrangements might be made throughout their rooms by which the sculptor might stand a chance of having his works seen. For instance, a line of statues, enclosed within barriers, could be formed along the centre of the great room, a part rarely occupied by visitors. Statues might also be arranged, without any great obstacle to a proper inspection of the paintings, at certain intervals in the other rooms. However, this grievance will, we trust, continue but a little longer. The plan in agitation for giving up, on certain conditions, the whole of the edifice in Trafalgar Square to the Royal Academy, will enable that body to afford the sculptor the space to which he is entitled for the suitable exhibition of his productions.

Our other complaint on behalf of the sculptors still remains in full force, and we fear, will so remain till public opinion forces upon Government the claims of our own artists to its primary consideration, and the wealthy patron of Art shall learn to notice sculpture at least as highly as he now estimates painting. We have seen within the last month a nobleman purchasing a single picture at the cost of £4300, or thereabouts—a work of which, whatever its merits may be, time in a century or two will in all probability leave little else than the bare canvas. Now this sum would have procured its possessor three, certainly, of the most beautiful sculptures of modern times—works that, carefully preserved, would endure for ever. We confess ourselves quite unable to comprehend this prodigal outlay upon one art, and the total indifference to another.

These remarks, although not bearing on the subject immediately before us, have arisen out of it. Mr. E. G. Papworth, jun., the sculptor of the statue here engraved, is a young artist, who was fortunate in getting a commission for the work from the late Mr. J. Neeld, M.P., one of the very few of our wealthy countrymen to whom our sculptors have been indebted. But Mr. Papworth's case is an exception to the general rule, and is therefore no argument against the foregoing observations. The statue, exhibited this year at the Academy, possesses merits which are an earnest of greater things for the future. The "Surprise" is created by a hawk having fallen at the feet of the nymph with its prey in its talons.

THE SKETCHER.*

ALL lovers of Art—and who is the lover of Art who is not also a lover of nature?—all lovers then of Art and nature have, or ought to have, made the spiritual acquaintance of "The Sketcher," in the pages of *Blackwood*. "The Sketcher" was also a contributor to this Journal, but we believe, for years before his death, he had written but little on Painting. We had expected long ago to have seen these papers gathered into a collective form; truly the harvest is late, but the fruit has all the freshness and fragrance of nature. We read these papers with pleasure, as they appeared periodically in *Blackwood*, and we read them again with increased pleasure, because we meet with so little that is readable on the subject. "The Sketcher" was not an exhibitor, therefore he was known but to few beyond a certain circle; he was not a professional artist, but should have been one. The Rev. John Eagles was born at Bristol in 1784, and was placed at Winchester about the age of thirteen, whence he was in due time removed to Wadham College, Oxford, where he evinced that love of Fine Art which he cherished till the latest period of his life. He took his degree in Arts, and entered holy orders, and at an early period settled into domestic life. His first curacy was that of St. Nicholas, Bristol, to which he was appointed by the Rev. John Eden, the vicar. In 1822, he removed to the curacy of Halberton, in Devonshire, where he resided for twelve or thirteen years, during the last five years of which period the Rev. Sydney Smith was his rector; and it may be remarked that, at the time of his decease, he was engaged on a review of the works of that remarkable man. From Halberton he removed to the curacy of Winford, near Bristol, and thence to Kimmersley, in Herefordshire; but, in 1841, he relinquished parochial duty and returned to Clifton, where he resided till his death, in November, 1855. His contributions to *Blackwood's Magazine* were not confined to papers on Art, but comprehended also compositions on classical subjects, as well in verse as prose, and also essays on the topics of the time; his connection with *Blackwood* extended over a period of twenty-five years. The essays, which are now collected into a volume, are those which immediately interest us; the book bears the same title, "The Sketcher," which headed the papers in their periodical form, but the date assigned to their appearance is incorrect. They are said in the Introduction to have been "written in 1833, and the two following years." If this means that they were written and published then, as may be inferred from the statement, it is we think wrong, because we remember their appearance ten or twelve years later than this. We confess never to have seen anything painted by Mr. Eagles; it would be satisfactory to be acquainted with his works, although, without such acquaintance, it is not difficult fully to estimate his powers and understand his aims. In the brief prefatory memoir of him it is said, "His painting was a kind of hieroglyphic poetry. No artist ever loved Art more purely and entirely for its own sake. And it was a subject of regret to his friends that the exercise of the faculty of painting was in itself frequently sufficient to him as an end, and that he was himself so indifferent to the value of his own productions, that he would paint pictures one upon another, so that the same canvas bore upon its surface many pictures, no less characteristic and beautiful than the last, which disguised or hid the rest." To the friends of "The Sketcher" these records seemed worth preserving; but they had not the same value in the eyes of Eagles himself. It would never have occurred to an artist to make this observation, because every painter has expunged or cast aside the products of months—of years of labour. Not very long ago we were turning over in the studio of an eminent painter a store of long forgotten and rusty sketches, when, to an observation on the merit of some of them, the guardian of the studio observed, with even more assumption than Brummell's man, "All these, sir, are *our* failures."

With respect to his feeling, his biographer proceeds to say:—"His style was formed on the great Italian masters of landscape; amongst others Gaspar Pous-

* "The Sketcher," by the Rev. John Eagles, A.M., Oxon. William Blackwood & Sons, Edinburgh and London.



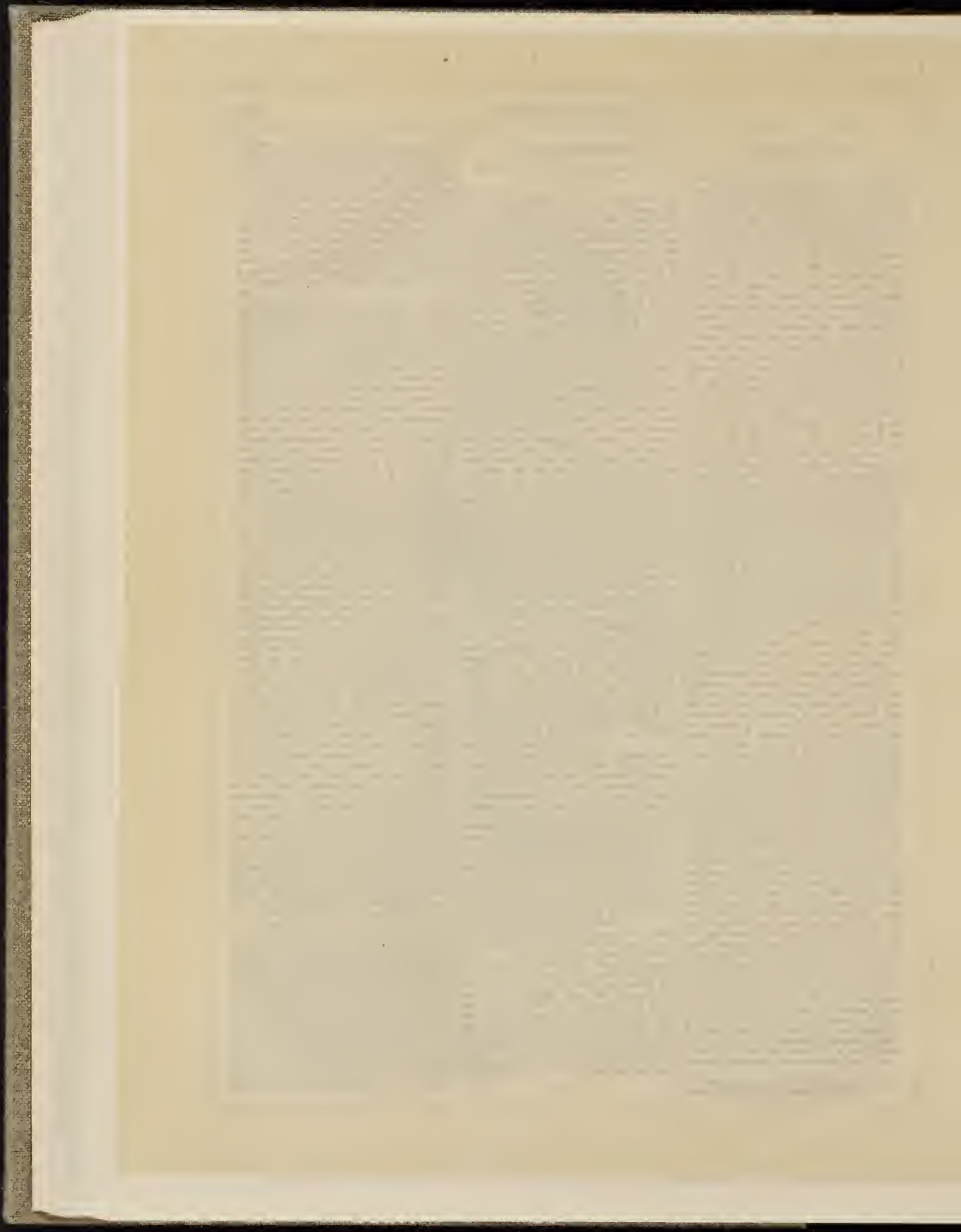



LIBERTÉ PAR M. BARRAS

SCULPTÉE PAR M. BARRAS. DÉPOSÉE EN 1793. N° 1000

sin, and Salvator Rosa, enjoying to the last his admiration and respect. He held that almost every beautiful scene in nature contained in itself many pictures, but that there existed generally one which was more living and forcible than the rest, which it was the business of the artistic eye to select and appropriate. He even wished, if it were but by a few broad dashes and sweeping hues, to seize and secure on paper and canvas this soul of every scene." From this passage it is at once understood that, although "The Sketcher" was a student in the school of nature until the end of his life, he was yet in practice attached to the Art-philosophy of the older English school of painting.

Years ago, when we read these papers, we envied their author his clypeum of Art—he has spent his life amidst all that is lightsome and gladsome. His precept was to give his scenes the charm of the *dolce far niente*; if the god had denied us the *olium*, we are to make it for ourselves, and our scenes are to be such as shall induce Astræa again to take up her abode among us. A painter of ducks and thistles is not a landscape-painter, and less is a painter of styes and barns. Repose, and repose alone, is the beauty of the landscape, which in every other essential should be a poetical shelter from the turmoil of the world; and should there be any earthly and discordant element, its proportion should only be as much as should show our faucial *aurea regio*—our golden home—a debatable land between the land of fairy and the every-day hardware world. "The Sketcher" does not spare Turner, and the *servum pecus* who followed him, in speaking of pictures that make you long for a parasol, put you in fear of yellow fever and a suspicion of jaundice—scenes assuming to be subjects painted after the poetry of the elves, as hot as capsiuum, where any Undine would be driven off in steam in an incredibly brief space. It is, then, nature in her middle tones that "The Sketcher" most admires; he prizes the sobriety of Poussin, and the severe grandeur of Salvator. For ourselves we are not so exclusive; we can walk with Vanderveer in the moonlight, and listen to the whisperings of the prophetic stars—though Dutch they be; we can sit in "pleasant harmonie" with Albert Cuyp, even on the banks of the Dort, without wishing his canvas a whit less warm; or pass a Venetian *après-midi* with Turner, even in his sunniest hours, without wishing for a diminution of sunshine, even by one ray. As an example of Mr. Eagle's enthusiastic manner of writing, on material immediately available to the artist, we extract the following—"Beautiful June! why is it that all painters have failed to represent the many green hues of this luxuriant month? In the early part of it, I spent some time in study among the woods opposite Clifton. They are, as I have stated in a former paper of "The Sketcher," the very best painting ground of a close kind. Their peculiarity of form and character I have before described; but I cannot now forbear remarking that I never was before so forcibly struck with the greens; they were of all shades, but rich as if every other colour had by turns bleached with them, yet unmixed—so perfect in predominance was the green throughout; so varied likewise was the texture, whether effected by distance, by variety of shade, by opposition, or by character of ground. There was much of the emerald—not in its colour only, but in its transparent depth. The illumination, brilliant even under the shadows of the trees, in the hollows and fern-covered ascent, under the foliage, was most lovely. There, amid the depth of wood, the tall thorns, with newly-assumed elegance, mingling their blossoms, fresh and pearl, and jewellery over a regal mantle of green, yet all with such modest dignity, and, if the expression be allowed, such affection, interweaving and interspersing the innocent gaiety; and here, retiring into the depth of shade, relieving and making the depth still deeper, yet delighting—yet delighting, as the Latin happily expresses it, *conoscere*—rendered the smaller passages complete pictures. Bring the critic to this test, and mark how nature will laugh at him in her pleasant mockery, and bid him unfold the bandage from his eyes." *Days!* excellent Sketcher! Pontifex Maximus of Pan and the Nymphs! here we are in the splendid temple of the Dryads, inimitable by the hand of mortal man: where is the sculptured acanthus like that glorious coronal of verdure, one leaf of which you could not withdraw without derange-

ment to the entire composition? Where is the Corinthian shaft like yonder pine trunk, with its red sly rind mocking the mathematics of all plated monotomies? It is nothing to us that one Mindert Hobbina had a lark for his bedfellow to whistle him up before twilight broke into morn, who breakfasted on brown bread, and drank his earliest draught from the cups of the dew-distilling leaves: it is nothing, we say, that Mindert Hobbina has worshipped in the greenwood by sunshine and moonshine, by sober day and every other kind of light—after all, and sad to say, he is but as a donkey cropping thistles; and yet, only tell us where Mindert Hobbina was buried, and we should yield to none in ardent expression of veneration for his sylvan dust. Then there is his master, Raab, by no means so good; and also Claude, working foliage according to the old prescription—mass upon mass, light upon dark, and *vice-versa*. "The Sketcher" places before us one of the most difficult propositions in nature—photography is even at fault here; for, to say nothing of colour, the exceedingly delicate gradations of tone are wanting. We cannot proceed *per saltum*—by octaves, but we have an extensive range, from great depth to the unattainable coruscations of the sunlight. These wooded passages are always painted hopelessly flat; few things are more difficult than the determination of distances—that is, the proper relief of foliage masses, and the assignment of its place to each bouquet of leaves. Sketching in this case is of no use; nought availeth save industrious drawing and honest painting—day after day, my, week after week, will scarce suffice for one exacting and inexorable study: any studio picture, painted from a half-hour's memorandum, were but a sorry mockery. And with respect to colour, trees have been painted of every hue—black, brown, yellow, red, and even blue; this variety, however, is gradually diminishing; yet in their attempts at green, the artists of the living school frequently fall into a cold metallic line unlike anything in nature. Will the conventionality of tree-painting ever rise into natural representation? We are not told that our author made a sketch of the subject he so well describes—and he was right. We always thought these papers wanting in practical precept; the writer is most eloquent upon natural phenomena, but each paper should have been seasoned with a little practice. Yet he has his discovery to communicate; and although the day for the trial of new "vehicles" and texture surfaces he gone by, we will describe in "The Sketcher's" own words his process of making a copy with his starch medium—"Having to make my priming, I wanted a substitute for glue. For this purpose I mixed up a quantity of colour, of red lead and chalk, with starch, and added to it, mixing it all up together with the spatula, such a quantity of linseed oil as I thought would fasten it. With this I made my priming, and painted my copy with the medium supplied by my scientific friend. The canvas was, however, bad, I must confess, and gave me a good deal of trouble, not from this mixture, but from other causes, and I was not satisfied with my copy. I determined to attempt a second; to accomplish this in time it was requisite to have something that would dry very fast. Finding the ground I had made of the priming to be very firm, I thought of using the same medium for my painting; and after a few trials on a small scale, which were all more or less satisfactory, I began my picture thus.—I had some starch made into a gelatinous state, and with the palette-knife mixed up with it a quantity of oil, perhaps two-thirds starch. With this I painted in the sky at once; it worked very freely and pleasantly, and looked so fresh and unlogged with oily matter that it was quite agreeable to the eye, and I could not help thinking it looked very like the Venetian method of getting in a picture, such as we find observable in Paolo Veronese. I should mention that I used no bladder-colours, but with this medium mixed up all my colours in powder. I then proceeded in the darker parts of the picture, for which I used less starch, and found in the process that it was best in its less gelatinous state, and that perhaps, for general use, it was best to have the starch made only so strong as just to escape being gelatinous: thus, as a fluid, it mixed better with the oil, and the proportion of equal quantities of each; it should be well mixed up with the palette-knife, and it becomes whitish or creamy in the mixing." This is the pith of the

communication; but starch and other materials have been repeatedly tried; but in what have they resulted? There are other qualities wanting in pictures besides durability; we know of hundreds of works which, had they mouldered into dust centuries ago, it had been better for Art. Again, in speculating upon media and varnishes, he says—"The old masters used some colours which we cannot—verifier, for instance; with our oils it will change in a few days, and so of other colours. I have heard picture dealers declare that they can easily get off the paints or retouches a century old, by a process which will not touch the older. Now, these facts are grounds for inquiry; much valuable matter might be accumulated, and successful experiments made. Sir Joshua must have seen something he did not possess, or he would not have destroyed old pictures to find out the medium wherewith they were painted." Had "The Sketcher" been a professional painter, he would have given but little attention to speculation on the so-called secrets of the early painters. Reynolds believed in some alchemy known to the old masters; but simplicity in all things is the last and really the dearest lesson we learn. In what condition are now those productions of Reynolds which he himself complacently noted as successful experiments with this or that golden nostrum? They are either in tatters, or have been long since repainted by other hands. But these papers were written in the days of the vehicle mania. We have read them, we repeat, with renewed pleasure; but let not the tyro suppose that he will find elementary instruction in them—they are addressed only to experience; but so meaningless and incompetent are most recent essays on Fine Art that have fallen in our way, that we rise from the perusal of these with a double sense of gratitude.

PICTURE SALES.

ON Thursday, June 26th, Messrs. Christie and Manson offered for sale the gallery of pictures, about seventy in number, known as the "Wolterton Collection." They were the property of the Earl of Orford, and had been removed to the rooms of the auctioneers from his lordship's seat at Wolterton, Norfolk. The collection included specimens of the Italian, Spanish, French, and Dutch schools, with a few examples of our own. Several of the pictures bore a high character among connoisseurs, and this attracted a large and distinguished company to the sale. It is only necessary we should note down the most important of the paintings, with the prices they realised.

'A Court-yard in Venice, with Figures in Galleries, supported by Columns,' extraordinary in perspective, and brilliant with sunlight, 160 guineas; 'The Staircase of the Doge's Palace, Venice, with a Cardinal and other Figures,' equalling, if not surpassing, the former in power and effect, 240 guineas. These two pictures were painted by CANALETTI, so we heard, for Count Albrecht, of St. Petersburg, and were purchased by Lord Orford from the executors of the count. 'Two Peasant Children,' by ORIB, 310 guineas, a richly-coloured work, and excellent in composition, that would do honour to any school—we were well pleased to see it estimated at its real worth. 'Amateurs performing the "Merchancy of Venice" before a Party of the Aristocracy at Lord Mansfield's,' ZOFFANY, 140 guineas; 'Italian Landscape,' painted by SIR C. L. EASTLAKE at Rome, in 1829, 170 guineas; 'St. Mark's, Venice,' CANALETTI, 260 guineas; 'The Front of St. Mark's Church, from the Piazza,' CANALETTI, 274 guineas: both of these pictures are in the artist's best manner. 'An Italian Landscape,' by BERGHEM, who has introduced into it a peasant in a red dress, two cows near a pool of water, a man on a mule, and figures on a road rising below a rock: this picture is in the finest condition—the colouring pure and silvery, its general treatment elegant, and delicate in finish. The canvas is by no means large, but it realised 470 guineas. An Altar-piece, by GIOVANNI LO SPAGNA, representing the Virgin in a red dress and blue drapery, enthroned on the clouds with the infant in her lap and a lily-branch in her hand. She is surrounded by angels; and seated below her are two cherubs with musical instruments.

The works of Lo Spagna, the contemporary of Raffaele, are exceedingly scarce in England. Speaking of this picture, Dr. Waagen says, "It is noble in feeling, and graceful in motive; the most important I have yet met with in England by this rare master, who has so much affinity with the earlier pictures of Raphael." It was purchased at the sale for our National Gallery for the sum of 620 guineas. A figure-subject by REMBRANDT, called 'The Converted Jew,' by no means a good specimen of the master, was sold for 140 guineas. The convert is standing with his hands folded; an open Bible lies on the table before him; he wears a yellow dress and black cloak, and his head is covered with a white and gold turban. A 'Coast Scene,' by RUYSDAEL, with a storm effect. We have no doubt that this was once a brilliant picture, but it has become so black that we had some difficulty in making out the details of the subject in several parts; moreover, it has been damaged in two or three places; still it realised 300 guineas. Dr. Waagen calls it "highly poetical, and of astonishing effect." 'The Duchess d'Ossuna,' attributed to VELASQUEZ, but certainly unlike the female portraits we have seen from his hand, 170 guineas. An Altar-piece, with laterals, ascribed to MATTHEUS GRUNEWALD, an artist of the early German school. In the centre is the Virgin, in a green and blue drapery, enthroned on the half-moon, between St. Catherine and St. Barbara. She is offering some grapes to the infant Christ, whom she holds in her lap, while angels above are crowning her. On the inside of the laterals, or wings, are St. Ambrose in robes, and St. George in armour, standing on the dragon; on the outside, St. George, St. Clement, and a third figure. We again quote Dr. Waagen, who says, "This is the only picture by this great and rare German master that I know of in England; it displays in full measure that nobleness and grandeur of heads and figures, good style of drapery, and powerful and clear colouring which are proper to him." It sold for 130 guineas. 'A Dutch Landscape,' by PHILIP DE KONINGH, a large and coarsely-painted work, but with an extraordinary effect of sunshine, 390 guineas. 'Christ falling beneath the weight of his Cross,' MULLO, a picture so full of deep religious feeling, such intense expression of pain and sorrow, and so delicate and transparent in colour, that in our humble opinion it is worth all the rest of the collection *en masse*; we have rarely, if ever, seen a picture that so impressed us with the idea of the sublime: it was knocked down for 600 guineas. 'The Ratabou Landscape,' RUBENS, one of a pair formerly in the Babbi Palace, at Genoa; the other is now in our National Gallery. We had heard so much of this celebrated picture, that we expected a rich treat when we attended the private view of the collection of which it was considered the greatest ornament, no less than it is thought by many connoisseurs to be the *chef-d'œuvre* of the master; but we admit we were woefully disappointed; the picture will bear no comparison with its *quondam* companion now in Trafalgar Square, nor with the 'Farm at Lacken,' the 'Summer,' and the 'Autumn,' by the same painter, in the collection of the Queen. The composition is good, and that is all the praise we can award it; in our judgment all other attributes of good painting—drawing, colour, and expression—are manifestly deficient. Lord Orford bought it, we believe, at the sale of Mr. Watson Taylor's collection for 2600l.; it was knocked down to the Marquis of Hertford, as we heard, on the present occasion for 4550l.—some one, on behalf of our National Gallery, bidding as high as 3800l. for it, at least it was so reported in the room. We rejoice that in this case a private purse was heavier than the public one; but even the lower sum would have been monstrous for such a work. The last picture in the catalogue was the 'Marriage of St. Catherine,' by SASSO FERRATO; the figures life-size, and altogether a work of considerable importance with reference to its peculiar character. The Marquis of Hertford became the possessor of this also, at the price of 1025 guineas.

The whole of the Wolterton collection realised 11,500l.; it may be called the winding-up sale of the season, for though other pictures have more recently been offered to public competition, they were not of a character to call for any special notice. Looking at the prices which paintings, both ancient and modern, have realised this year, artists and collectors need not complain.

ART IN THE PROVINCES.

STIRLING.—A meeting, at which nearly 10,000 persons assembled, was recently held in Stirling, for the purpose of taking measures to raise a national monument to the memory of Sir William Wallace, to be erected on the summit of the Abbey Craig, near that city. The design for the monument is to be submitted to public competition among native artists—that is, we presume, Scottish artists: if so, the example is one which it would be well for us who live south of the Tweed to follow, whenever a national testimonial in honour of some distinguished character is proposed: so far, that is to say, that it should be the work of a *British* artist, from whatever part of the United Kingdom he may chance to come.

NORWICH.—The annual distribution of prizes to the pupils of the Norwich School of Art took place on the 3rd of July, the Mayor, Mr. J. G. Johnson, presiding on the occasion. At the same time, the Report of the Committee for the past year was read to the visitors: from this document we learn that the attendance of pupils, and their general progress, are of a nature to afford entire satisfaction to those who interest themselves in the welfare of the school. The male public class now includes 122 pupils, and the female public class 16. There are also 32 in the male special and intermediate classes, and 29 in the ladies' class: the total number of pupils, therefore, is now 190. At the recent exhibition in London of drawings and designs from the Schools of Art throughout the kingdom, the pupils of the Norwich School carried off a greater number of prizes, in proportion to the population of the city, than any similar institution elsewhere. The scholarships were awarded thus:—Mr. Gurney's, M.P., of £20, to George Easter; Mr. Warner's, M.P., of £12, to James Reeve; Mr. R. Chamberlain's, of £10, to H. E. Blazby. Prizes given by Mr. Claude Nursey, head-master of the school, were awarded to James Reeve and J. Huggens, for the most regular attendance. The next Fine Art Exhibition in Norwich will be opened in the month of October.

CHELTEMHAM.—A testimonial which must have been most gratifying to the noble recipient, the venerable Lord Northwick, has recently been presented to his lordship by the inhabitants of Cheltenham and its vicinity. Lord Northwick, as many of our readers are aware, is one of the most liberal patrons of Art of modern times: his mansion, Thirlestane House, near Cheltenham, is filled with pictures of all countries and periods; consequently, it is one of the "Ions" of the town—especially as the inhabitants and visitors are permitted free access to the galleries on frequent and suitable occasions; it was to testify their sense of his lordship's courteous liberality that the testimonial was presented to him. Nothing could have been more appropriate to the occasion. Lord Northwick, surrounded as he is by such an infinite number and variety of beautiful works of Art, paintings, sculptures, and articles of *art*, would have probably been indifferent to a vase or cup—the ordinary kind of testimonial—except as a mark of the good feeling of his neighbours. The committee, therefore, decided upon having a suitable address, written on vellum, and beautifully illuminated, and to enclose it in covers of carved ebony, with massive mountings of oxidised silver and gold, in the style of the fifteenth century: the Northwick arms occupy the centre, surrounded by emblems of painting, sculpture, &c.; the large medallions being enriched, in relief, with medallion portraits of some of the most distinguished ancient artists—Cimabue, Raffaele, Michael Angelo, Cellini, &c. The address was written and illuminated by Mr. G. Shaw, the eminent medieval decorator; and the execution of the covers and the silver-work, were entrusted to Messrs. Martin, Baskett, and Martia, extensive silversmiths in Cheltenham, whose taste and skill in this matter are highly creditable. The address, containing upwards of seven hundred signatures, headed by the names of Earl Fitzhardinge and Lord De Saumarez, was presented to Lord Northwick by a numerous deputation of the inhabitants. It would be unfair to omit from this notice the name of Mr. E. Williams, an artist residing at Cheltenham, whose portraits are not unknown at the Royal Academy Exhibitions; he took great interest in the "getting up" of the testimonial, to which his taste and artistic knowledge lent considerable aid.

LIVERPOOL.—At a recent Special Meeting of the Liverpool Architectural and Archaeological Society, it was unanimously resolved, "after due consideration of the correspondence printed by order of the House of Commons, on the subject of the difference between Sir Charles Barry, R.A., and the Government, as to the rate of remuneration for that gentle-

man's services as architect of the New Palace at Westminster; this Meeting is of opinion that the grounds upon which is based the refusal of the rate of payment, established by long custom, of 5 per cent., are altogether untenable." The resolution proceeds to state the reasons for the opinion held by the members of this Association, which are too long for us to quote, and calls the attention of the Royal Institute of British Architects, as the chartered Representatives of the profession generally, to the subject, with a request that they will take such steps as may seem to them advisable to assert and maintain the due claims of the profession.

A memorial of the late Archdeacon Brooks is about to be placed in St. George's Hall, Liverpool: it is to consist of a statue of the Archdeacon, habited in his clerical robes. A sum of upwards of £1800 has been collected by voluntary subscription to defray the cost of the work, which will be executed by M. B. E. Spence, an English sculptor resident in Rome, some of whose productions have been engraved in the *Art-Journal*. Mr. Spence was the successful competitor out of several sculptors who sent in designs.

Paisley.—On the 28th of June the annual meeting for the inspection of the works of the students in the Paisley School of Art, and for the distribution of awards, took place. The meeting was held earlier in the year than has been customary, in consequence of the alterations recently made in the arrangements of the department of Art in London, among which is the plan now adopted of sending an inspector to the various provincial schools to examine the works of the pupils and award the prizes; and it is his duty to see that the drawings, &c., which have gained for their authors these marks of merit are sent off to London. The Paisley School, during the past year, numbered 156 pupils, of whom 72 were new ones. Sixty drawings and paintings, the work of twenty-four students, were exhibited at this and a previous meeting in November last, and to twenty-four works out of this number of sixty, medals were awarded. The school appears by the Report to be in a satisfactory state. We see that the directors have in some instances awarded as prizes volumes of the *Art-Journal*: we may, perhaps, be permitted to say without being accused of egotism or presumption, that the varied information on all matters of Art offered in our pages renders it a book of peculiar value to the student, whatever branch of Art he may practise, whether appertaining to the Fine Arts or the Industrial.

EDINBURGH.—A statue of the late Professor Wilson is about to be erected in this city: Mr. Steel is the sculptor to whom the work has been entrusted; his model for the cast is, we hear, in a very forward state.

The prizes for the competition drawings, paintings, and models of the students attending the School of Design, under the auspices of the Board of Manufactures, were distributed at the National Gallery, in Edinburgh, on the 7th of July. Lord Murray occupied the chair, and distributed the prizes. Mr. A. Christie read the report on the department of architecture and ornament, which stated that the number of students who attended the classes in this department during the session was 411, and the number during the previous session 314; showing an increase of 97. Among the students were—painters, 14; sculptors, 3; architects and engineers, 30; draughtsmen, 4; engravers, 6; house-painters, 8; ornamental painters, 1; general engravers, 10; ornamental engravers, 3; wood-carvers, 16; glass-stainers, 6; brassfounders, 3; joiners and cabinet-makers, 7; marble cutters and stone-carvers, 3; mechanical engineers, 3; pupil teachers, 37; schoolmasters, 3;—total attendance on the male classes, 231. In the female classes there were—amateurs, 87; schoolmistresses, 20; and pupil teachers, 73;—total female pupils, 180. The class for practical architecture had suffered from the severe illness of Mr. Christie during the winter, and the drawings were therefore few in number; but during the vacation the students in this class had executed a number of drawings, which Mr. Bryce examined. The report adverted to the want of accommodation in the present rooms. During the session the number of students in these departments had amounted to ninety. In the autumn, the progress of many of them had been very gratifying, and in general was very good.

RICHMOND.—An Art-exhibition was opened here on the 15th of July, under the patronage of the Duchesses of Gloucester and Cambridge. Pictures, bronzes, porcelain, and other works of Art, are among the numerous works contributed by the inhabitants of this locality,—one of the most picturesque in the vicinity of the metropolis, and a favourite resort of numerous wealthy and aristocratic families. The charge for admission is sufficiently moderate to allow the humbler classes to visit the exhibition.

THE CRYSTAL PALACE,

AS A TEACHER OF ART AND ART-MANUFACTURE.

PART II.

We rejoice to know that, under a more liberal and enlightened administration, such arrangements have been made to meet the requirements of Art-Manufacture as cannot be other than satisfactory; as yet, however, results are not sufficiently manifest in the Art-Courts, or in passages that lead to them, where several valuable exhibitors "show" their goods. We repeat our conviction, that so desirable an opportunity for the exhibition of improvements has never been offered to the producer; every advantage he can require is here placed at his disposal—ample space, good light, and his own arrangements for display; while visitors of all orders and classes, from the very highest to the comparatively humble, are continually present by thousands to ascertain their wants, and to study the best sources from which they may be supplied. These are gains of no little moment; and we cannot doubt their being appreciated by those who will give the subject consideration. But it is quite certain that to achieve the great object of rendering the Crystal Palace usefully available in this respect, the public must be induced to resort to it for the purpose; which can be done only by activity among the manufacturers, who *must*, if they desire advancement in this quarter, furnish with proper "samples" the Courts dedicated to their several Arts. By a judicious arrangement the Directors, although they require that a distinction be made between

works for exhibition and works for sale—placing the former in the Courts and the latter in the Galleries—willingly accord the aid in their power for giving publicity to *all* the productions of the exhibitor; and there is no difficulty in the way of making known, that he who labours for reputation in one place strives for remuneration in another. We desire to see the principle more entirely carried out, and we have no doubt it will be so when "good things" are supplied more abundantly: we hope ultimately to see in the Art-Courts only what is really excellent, and to be referred to the bazaar galleries for productions of the ordinary character of trade. At present there is a mixture, both above and below, which is to be regretted; many productions of merit being in the former, while in the latter we find a supply of articles that bear but little, if any, relation to Art.

THE SHEFFIELD COURT, to which we now direct the attention of our readers, may be described as full, or nearly so; but while of works in steel there is a very ample contribution—and it is such as largely sustains its "world-wide repute" in its staple trade—there is but one contributor of that for which the town has been also long celebrated; so closely indeed have PLATED GOODS been associated with Sheffield, as to have very generally obtained distinction as "Sheffield ware." We naturally look into this Court, therefore, to know who are its various producers, what their relative merits, what their several classes, and to whom a purchaser is to apply for that which he requires. In illustrating this branch of our subject, we are limited to the works of Messrs. JAMES DIXON and SONS—a firm long established and of

admitted supremacy, it is true, but by no means the only one in Sheffield by which works of excellence might have been contributed. This want of fair rivalry—of wholesome competition—is therefore to be deplored. But we may expect that, ere long, the evil will cease to exist; indeed, we have reason to believe that at the present moment arrangements are making in Sheffield by which this important branch of its commerce will be adequately represented, and that a competent agent has been engaged, to whom the charge of its interests will be intrusted.

The supremacy which Sheffield has maintained for nearly a century, has been of late years sustained and advanced by a system of plating goods on nickel silver (still continuing the fire-plating process), and *mounting* such articles with silver—by this mode a far better and much more lasting article is produced; for fine effects no mischievous results by wearing away the coating, and making the copper appear; indeed, for all purposes of use, and even elegance, the object thus supplied has all the value—except the intrinsic value—of the pure metal. It is to this important feature of their produce that Messrs. Dixon require us to direct special attention, and which demands consideration on the part of all who examine the large cases of "goods" so prominent in the Court, and which contain varied and numerous specimens of the manifold productions of their extensive factory; this fact will be therefore borne in mind while reading the observations we shall presently offer. It may be well, however, here to state that a hundred years have passed since the art of plating on copper by the "fire process" was discovered. An ingot of copper and silver are united



THE SHEFFIELD COURT, CRYSTAL PALACE.

in a red-hot furnace, and adhere so firmly that they become as one metal; and to whatever length this is "rolled" the metals continue united. Recently the house of James Dixon and Sons have adopted this mode of plating on nickel silver, and, as we have said, mounting the ornamental part with silver. The foundation of the plate being harder and whiter, this description of "Sheffield-plate" consequently becomes superior to that for which Sheffield has been so long celebrated.

THE SHEFFIELD COURT is one of a range of courts on the south side of the Palace; it is sur-

rounded by small glass cases, which contain examples chiefly of cutlery; in the centre is an ottoman decorated with specimens of a more refined order, while at either side are the large cases of the manufacturers under notice: various "tools," principally contributed by the world-famous firm of TURTON, are scattered (but with due regard to order) about; but excepting knives and razors, the goods thus exposed have not been much subjected to the influence of Art; it is likely, however, that in the course of these papers we may be called upon to engrave and to describe some of these objects upon

which more than ordinary care has been exercised, and which have been, as far as they can be, made ornamental as well as useful.

Surmounting the ottoman which occupies the centre of the hall (and on which is about to be placed a statue emblematic of the town) are arranged some very fine specimens of manufactured steel—richly engraved and ornamented razors of Messrs. Nowill and Sons, skates of Messrs. Marsden Brothers, and scissers of Messrs. Thomas Wilkinson and Son. As we have intimated, in the cases around the walls are varieties of goods—the famous

fabric of the great capital of the manufacture; the more prominent are—a case containing at least a hundred different patterns of razors, the works of Stephen Martin; knives of as many different kinds, steel and plated, the contributions of John Walters and Co. Almost as numerous is the collection of Urwin and Rodgers. The case of Wilkinson and Son is full of very beautiful examples of scissors of many and varied forms—those which manifest design, and are exceedingly elegant, and those which are for common use. Three of these we introduce on this page. The steel and plated knives and spoons of Messrs. Parkin and Marshall will attract and deserve notice; while the case of needles of Messrs. Cocker and Sons demands especial attention, as exhibiting the process, from the raw bar to the finished article with the gold eye.

The two cases of Messrs. Dixon, which range at either side of the ottoman, contain a large number of examples of the produce of their justly-celebrated factory in Sheffield—an establishment with ample resources, so extensive, indeed, as to give employment to more than six hundred persons, and producing a considerable amount of those results which find their way not only throughout England, but into every part of the world. In the one case is the "plated ware," and in the other is the "Britannia-metal ware"—a ware that has acquired universal fame for its usefulness in "constant service," which is manufactured in every possible variety of form and shape, and applicable to almost every conceivable

purpose of domestic requirement. From the very abundant objects supplied to us by these two cases we select but four objects—a tray of remarkably good design, and engraved skillfully and gracefully;

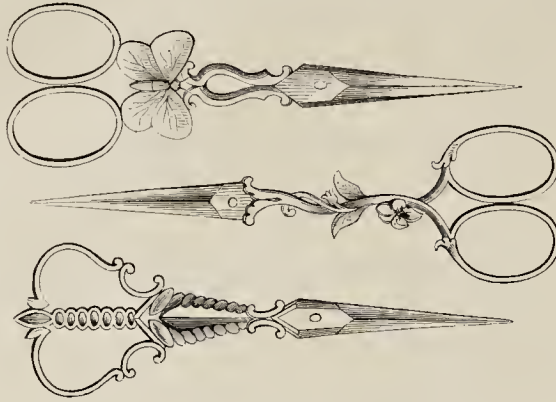

a tea-urn of excellent and convenient form; a soap-tureen of admirable proportions; and a side-dish of exceeding elegance. Among those we have passed over will, however, be found many most desirable

examples of Art-manufacture; and, as a collection, it undoubtedly manifests great advance—an advance fully keeping pace with that improved taste, that desire (so general as to be almost universal) for the judicious combination of elegance with utility which is becoming more and more a leading characteristic of the manufactory and the workshop in all our productive cities and towns.

Still, as we have stated, Sheffield is not sufficiently represented—its stores of wealth are barely indicated here. Before these papers are finished it is probable, therefore, we shall return to this branch of our subject; for we believe arrangements are in progress for more adequately and justly exhibiting to the world the numerous productions of this renowned capital of wrought-iron produce.

The trade of Sheffield to all parts of the world is immense; its reputation for articles of steel dates back to a very remote period: Chaucer celebrates the "Sheffield whittle," and long before his time, when Sheffield was "near Rotherham," and the serfs gathered about the castle of their liege lords the Talbots, "great Earls of Shrewsbury," the knives of their production were famous throughout the land. As we have said, however, it is little more than a century ago since it was discovered how nearly plated goods could be made to represent silver; hence has grown a commerce which gives employment to tens of thousands, and has made "Sheffield" almost as well known as London "the world through."



THE PLATED WARE OF MESSRS. DIXON AND SONS.

Hence, we again pass to THE CERAMIC COURT, which, now near its completion, more than realises the anticipations formed of its success, and worthily ranks amongst the most valuable and attractive features of the Crystal Palace. Sufficient works have been received to fill the spaces allotted to their reception; the greater portion of them are arranged, and the whole plan, now fully developed, assumes a character of the highest importance and utility.

Such a collection, submitted to public inspection, cannot fail to be largely influential in stimulating our manufacturers to still advancing efforts in a branch which has of late years made such considerable progress; and we learn from Mr. Battam, with

much gratification, that the collectors, who have so generously favoured him with loans of specimens, have also further extended the value of their co-operation, by permitting sketches to be made for illustration of the most remarkable and valuable works, thus affording an additional means of publicity, tending to facilitate the realisation of the advantages we predict from their study. The exhibition will also foster and extend among the general public a due appreciation of the capabilities and resources of a manufacture, which includes within its range the production of works of such varied beauty.

The Ceramic Court is divided into two compartments, which are thus appropriated:—the inner one,

which fronts the terrace side of the building, is devoted to a classified arrangement of plastic art, from its earliest operations to the present time, and abounds in illustrations of great interest. The pottery and stone ware includes examples of the early Roman, of the vases of Etruria, the enamelled fabrics of Luca della Robbia, amongst which one with a Virgin and Child, encircled with a garland of fruit and flowers, is an extremely fine specimen, as also a Negro Boy, life-size, the face being most truthful and expressive. Proceeding on, we come to a remarkably important collection of majolica ware, chiefly lent by ISAAC FALCKE, Esq., from his private collection; and these examples testify to considerable judgment

on the part of the collector, for they are of very high merit and value. We have in this series illustrations of the earliest productions, in which the Moorish type is strongly evident, together with the wares of Pessaro, with their various metallic lustres, those of Castel Durante, Gubbio, Urbino, Faenza, &c. &c., including authenticated examples by Gerouimo, Andreole, Giorgio (who invented the ruby-gold lustre in 1525), Orazio Fontana, &c. &c.

Of the stone ware of the Rhine (sixteenth century) there are many interesting specimens. The celebrated Jacqueline of Holland, after her abdication, in 1433, retired to the Castle of Peyllingen, near Leyden, and there gave her personal superintendance to the advancement of this manufacture. The result of the trials and labours of the immortal Bernard Palissy, also find registration in some important examples,—the inspection of which naturally and forcibly awakens the recollection of that indomitable energy and perseverance, which, amidst scenes that would have crushed any ordinary spirit, sustained this "glorious potter" to a protracted though final success, which has lent an imperishable lustre to his name and country.

Other examples of manufacture of less importance, but necessary to the completion of an historical collection, bring us to the pottery of our own time and country.

The porcelain commences with examples of the Chinese, with whom it appears, according to M. Stanislas Julien, it was common in the time of the Emperor Ima, B.C. 163. Amongst the specimens are three magnificent vases, upwards of five feet in height, a pair of large cisterns, and a variety of miscellaneous articles: also specimens of the porcelain of St. Cloud—Böttcher's Saxon porcelain leading successively to the marvellous productions of the best periods of Dresden, Sèvres, Berlin, Vienna, &c. &c. The early English of Chelsea, Derby, Worcester, Bow, &c. &c., is also well represented.

The collection of Dresden manufacture is of very considerable extent and beauty, including the variety of styles for which that royal establishment has been so long famous. In painting and gilding there are many remarkably fine examples of the early oriental patterns, of the pastoral vignettes, and subjects historical and mythological. The figure-painting of the Marcolini period is extraordinarily fine, and fully

warrants the estimation in which the works of that time are specially held. The porcelain figures and groups of the same



manufacture are represented in some number, and of considerable size. A most important work is the group of

"Apollo and the Muses on Mount Parnassus," the base of which is three feet long, and the subject nearly three feet high. It is a fine example of the style, and of great value—lent by Mr. DAVID PALCKE, of 92, New Bond Street, who has also contributed some very beautiful examples of the various decorations applied to the highest class of the foreign manufactures.

This portion of the collection has been considerably enriched by a very liberal loan from HENRY PORTER, Esq., of Wenslade, who possesses, amongst a large and valuable miscellaneous collection, some singularly fine specimens of old Dresden ware, purchased during a lengthened residence in that city, where his family occupied the Marcolini Palace, in which the finest examples of the manufacture, executed while under the directorship of the Count Marcolini, were deposited. Amongst these is a group of large dimensions, representing a People of Bacchus, with groups of Bacchus and Ariadne, and fawns dancing, &c. The modelling is of rare excellence, and makes us regret the glazed surface, which so materially detracts from the sharpness of the work, and causes a flicker that destroys the effect of the light and shade. This group was used as a plateau upon the banquet tables of the electors of Saxony.

A pair of pheasants, life-size, from the same collection, is also remarkable for the fidelity and spirit of the modelling, and the success with which the difficulties of their manufacture have been overcome. These birds, together with another pair, also in the possession of Mr. Porter, formed prominent objects in the state rooms of the Marcolini Palace, at the time it became the residence of Napoleon I. at the siege of Dresden.

In examples of Sèvres porcelain the Court is singularly rich. We referred, in our last number, to the magnificent specimens of the painted and jewelled ware, together with the exquisite portraiture embellishing so many of the beautiful and costly works lent by General the Hon. Edward Lygon. To these is now added a very important addition from the collection of Mr. David Palcke; and first in importance of these examples are the exquisite specimens of the service of *pâte-tendre*, made by the express order of Louis XVI., and exhibited at the Christmas fête at Versailles, in 1783. A large portion of this service was bought by George IV., and is now in the possession of Her Majesty, at



THE VASES, ETC., OF MESSRS. MINTON AND CO., EXHIBITED BY PHILLIPS BROTHERS.

Windsor Castle. Each piece contains five medallions of historical and mythological subjects, painted

with a power, freedom, and, at the same time, finish of detail surpassing anything we have ever seen on

this material. Popon and Guet are the artists whose taste and skill have imparted so high and

permanent a value to these productions—a value not dependent upon the duration of a fashionable caprice, but resulting from the intrinsic excellence of the works themselves.

A number of vases, *déjeûner* trays, plates, cups and saucers, also of Sèvres manufacture, furnish varied exemplifications of its perfection.

The specimens of Vienna are numerous and of high quality, the painting of the figure subjects successfully rivalling that of Sèvres; whilst the gilding, both in colour, delicacy of manufacture, and the peculiar prominence with which it is raised upon the ware—presenting quite the appearance of a fine embossment—is altogether unique.

We can but note in our present number the examples of Berlin, Naples, Spain, Venice, St. Petersburg, &c. &c.—these we shall take a future opportunity of bringing under review.

We have much pleasure in stating that LADY ROLLE has kindly and liberally lent some valuable specimens from her important collection. Prominent amongst these is a pair of magnificent vases of the imperial manufacture of St. Petersburg, presented to Lady Rolle by the Grand Duchess. These vases are above three feet high, and of excellent manufacture; indeed, the painting of the landscapes, seaport views—one a sunset, and the other a moonlight scene—are wonderful examples of the art. We shall hereafter refer to other works generously deposited here by Lady Rolle.

The English examples present very fine specimens of Old Chelsea, Derby, Worcester, Bow, &c. &c.

The Ceramic Court also possesses one of the finest selections of the Wedgwood-Flaxman wares ever offered to public inspection. It numbers upwards of three hundred specimens, and is indeed so important, both retrospectively and prospectively, that we shall comment fully upon it in a future number. England may well be proud of what we must now regret to call *past successes*—successes we trust this exhibition will tend to revive and extend. One of the original fifty copies of the Portland Vase, together with a great variety of vases, candelabra, caskets mounted in jewel cases, watches, &c. &c., a service of terra-cotta, mounted in silver, formerly belonging to Queen Adelaide, are conspicuous objects. This series of the Wedgwood-Flaxman ware is kindly lent by Isaac Faleke, Esq. We purpose selecting some of the specimens for illustration. For our illustrations this month, we have selected only those of Messrs. MINTON & CO., of Stoke-upon-Trent. A very brief description of these articles will suffice. They contribute a number of large and important works in the style of the majolica, but adapted with such taste, and at the same time originality of treatment, as to give them quite a special character. The Minton-majolica is one of the most successful revivals of modern pottery; the spirit of the early works is evidenced in the reproductive style, and there is, both in the materials and manufacture, in the models, in their decoration, a very marked and acknowledged superiority. Some of the examples are of large dimensions, as cisterns, vases, &c. &c. These have been manufactured expressly by Messrs. Minton, and are *exhibited by them*. There are also a number of porcelain vases, several of which were included in the works that gained for Messrs. Minton and Co. the "*grande médaille d'honneur*" at the Paris Exhibition last year. We have selected some of these for illustration (*vide* page 255). The first in the group is of graceful form, the figures exceedingly well painted, and with a degree of boldness not usual in porcelain; the next vase is of the celadon-green, extremely beautiful in tint, with Allamhresque borders, well relieved in colours and gold; the Cupid Candelstick, in Parian and gold and turquoise, is a very tasteful design; the vase with medallions (one of the last works of this firm) is of exceeding beauty, the turquoise ground very brilliant,

and the general features of the design very happily rendered—the perforations introduced in the or-



naumation give a lightness to the work both novel and pleasing. The fourth vase is of Ita-



plaiques character, arranged and coloured with great care.

These works are exhibited by Messrs. PHILLIPS,

the present proprietors of the London dépôt of the old Worcester Works in New Bond Street, formerly Messrs. Chamberlain's—the manufactory belonging now to Messrs. Kerr and Binns, to whose spirited exertions we have frequently had occasion to refer.

The other illustration on page 255, represents one of the most prominent pieces of the celebrated dessert-service produced for the Exhibition of 1851, and purchased by Her Majesty for presentation to the Emperor of Austria. This was the most costly and extensive work ever produced in England, and the quality of design, merit of the models, and technical talent displayed in the various manufacturing processes (of formidable difficulty in such a work), have rarely if ever been surpassed in modern Art. It is executed in Parian, in combination with porcelain, enamelled and gilt with great delicacy.

The tripod of Messrs. Minton, on this page, is placed in the centre of the outer court, and is a very beautiful and attractive feature, as well as a great triumph in the "potter's art." It is a duplicate of the work which created such a sensation at Paris last year. We should be gratified to hear that commissions were given for a production that entails so much credit, both as regards taste and enterprise, on the manufacturer. The two garden-seats, at either side of this tripod, are very beautifully decorated; and the smaller *jardinière* which heads the page, is of much grace and originality.

Many important works from the manufactory of Messrs. Minton & Co. are near completion, and will be deposited in due course. These will include a colossal vase, modelled by the Baron Marochetti expressly for that firm. The important collection from Mr. ALDERMAN COPLAND'S manufactory shall have our attention in next number, when we shall engrave some of the most remarkable of his productions.

A large number of the best examples of Messrs. RINGWAY, BAYES, and Co., of the Staffordshire Potteries, have been arranged, but too late for our present notice; and we hope and believe that arrangements are making, by which all the leading potters of Great Britain may be fairly and adequately represented. Indeed, we shall consider that Mr. Bittam's task is not complete until this great purpose has been accomplished—that of exhibiting Ceramic Art as it now exists in this country—by one or more examples of every meritorious producer.

In thus giving prominence to the many admirable works exhibited by Messrs. Minton, we do but justice to the high position which that firm occupies in the estimation, not only of England, but of Europe and America. Mr. Herbert Minton, an enlightened and liberal gentleman, has been indefatigable in his efforts to advance the Art of which he is a foremost representative. Wherever talent was to be found, he sought it out and made it available; some of his principal artists are Frenchmen, and their employment must have given strong impetus to movements at "the potteries"—stirring up those energies which competition and wholesome rivalry always excite, and which are ever productive of public benefit. Mr. Herbert Minton may review his long career of success with justifiable pride; for while it has been honourable to him it has been beneficial to his country. He can remember when a good work produced in Staffordshire (always excepting the pottery of Wedgwood) was rather the result of accident than of design. It is not so now; excellence begets excellence; to improve public taste in any branch of public requirement, is to advance a desire for improvement in all; the changes for the better which have taken place in the productions of the potteries—and which are patent to the world—are only parts of that general progress in Art-Manufacture which has, undoubtedly, of late years elevated the national character, and essentially promoted British commerce. Foremost in the list of men who must be—now and ever—regarded as public benefactors, will be the honoured name of HERBERT MINTON.

THE TURNER BEQUEST.

The number of pictures, including those of "every kind," some of which are slight sketches, or merely "trial in," bequeathed to the nation by the late J. M. W. TURNER, R.A., and now national property, amounts to three hundred and sixty-two. The following is a list of ninety-eight of the principal works. Many of these are of high finish and of great value, but some of them are of comparatively little worth. How many of these will be eventually "bung" is, however, uncertain.

1. Richmond Hill.
2. The Decline of Carthage.
3. Death of Nelson.
4. Apollo in search of Apollo.
5. Bay of Bala.
6. Hannibal crossing the Alps.
7. Crossing the Brook.
8. Frost Scene.
9. Avalanche.
10. Steamer in a Snowstorm.
11. Fifth Sands.
12. Fort Raysdale.
13. Greenwich Hospital.
14. Kingston Bank.
15. Hattie of Trafalgar.
16. Companion to Ditto.
17. The Garretter's Petition.
18. View in Venice.
19. Ditto.
20. Ditto.
21. Ditto.
22. Lord Percy.
23. Waterloo Painting.
24. The Youth Planché.
25. Ulysses deriding Polyphemus.
26. The Wallhalla.
27. Apollo and Bacchus.
28. Queen Mab's Grotto.
29. Scenes relating his Story to Ditto.
30. Mercury sent to admonish Æneas.
31. The Departure of the Fleet.
32. The Visit to the Tomb.
33. Steam Speed and Rain.
34. The Génératrice.
35. Van Tromp.
36. View in Venice.
37. Ditto.
38. Ditto.
39. Ditto.
40. Ditto.
41. Shadrach, Meshach, and Abednego.
42. Bural at Sea.
43. The Sea Nymph.
44. Marsanello.
45. The Angel of the Sea.
46. Blacksmith's Shop.
47. Eye of the Deaf.
48. Moses writing the Book of Genesis.
49. Windsor Park.
50. Rome.
51. Childie Harold's Pilgrim.
52. Vislon of Melea.
53. Caligula's Bridge.
54. Shipwreck.
55. Orange Merchant going to Pleace.
56. Calais Pier.
57. The Morning of the Chase.
58. Apollo and Pythion.
59. Hero and Leander.
60. The Field of Waterloo.
61. The Deluge.
62. Boat's Crew running an Anchor.
63. Rome.
64. Destruction of Sodom.
65. Carriage (Mr. Bivard-Inr's Commis-sion).
66. The Garden of the He-berides.
67. Phrygingo to the Bath.
68. The Loreto Nocturne.
69. A Holy Family.
70. Abdington.
71. Windsor.
72. Jason.
73. The Bridage.
74. Waterfall.
75. Platewashing his Hands.
76. Whale-fishing, No. 1.
77. Ditto, No. 2.
78. Ditto, No. 3.
79. Regulus.
80. Landscape with Ralabow.
81. Orestes.
82. Ripeish.
83. Tapping the Furnace.
84. Rome.
85. St. Malves.
86. Cattle in Water.
87. Richmond Bridge.
88. Scenes and the Sibyl.
89. Cows on a Hill.
90. The New Moon.
91. Baedon and Arlaide.
92. Portrait of J. M. W. Turner.
93. Welsh Cattle.
94. Monumental Scene with Castle.
95. Study of Trees.
96. River Scene, Moonlight.
97. Town View.
98. Marine Subject.

The remaining two hundred and seventy are, we presume, little better than canvases; but the collection of pictures is independent of the drawings, which are also very numerous—from mere sketches to finished works; these will probably go to the British Museum—at all events for the present. We trust at no very distant period, however, the productions of pure Art—the property of the nation—will be gathered into one collection.

When the "Turner Bequest" will be exhibited to the public is still uncertain; it is not, we believe, intended to be seen at the National Gallery; and will probably be kept apart until the building at Kensington Gore is ready for its reception. To show it in Trafalgar Square is out of the question. It would be difficult to estimate the value of this magnificent bequest; which may be accepted, however, as another proof how rapidly the national wealth in pictures would accumulate, if the nation really courted such acquisitions, and erected a building fit for their reception.

In consequence of the apathy that has prevailed, we have lost several rare and valuable collections, and it would seem as if the evil were likely to continue; for, in consequence of the recent decision of the House of Commons, we appear to be as far off as ever from a consummation of long cherished hopes.

The "Turner Bequest," and the "Vernon Gift," ought surely to convince the Government—and Parliament also—that "delays are dangerous." We could name several "collectors" who are awaiting a decision in this respect, to know whether the country is to be enriched, or the auctioneer employed.

THE GIOVANNI BELLINI.

The following letter—addressed by Dr. Waagen to the *Times*—will, we imagine, entirely disabuse the public mind in reference to one of the national pictures. The letter had best be left, without note or comment, to speak for itself:—

"TO THE EDITOR OF THE TIMES.

"SIR—I had hoped that a letter signed 'William Coningham,' regarding a Virgin and Child, by Giovanni Bellini, in the National Gallery, which was printed in the *Times* of last Friday, the 11th, would before now have been replied to by one of the numerous English gentlemen known to possess a true knowledge as well as love of Art. To my surprise, no such reply has appeared, and I therefore feel myself justified in requesting a place in your columns, which I should not otherwise have assumed. It is possible that those gentlemen may have considered any refutation of Mr. Coningham's letter as unnecessary; and, were the general public as enlightened on these subjects as they, I should entirely concur in their silence; but this is not the case. The inordinate presumption, therefore, which asserts this Virgin and Child by Giovanni Bellini to be 'spurious and vamped up,' of the lowest type of Art, 'extensively dabbed over and repainted,' for educational purposes utterly worthless, &c., without taking the trouble of giving a single proof of the truth of such assertions, is, unfortunately, but too well adapted to mislead; for it is natural to believe that a writer who assumes such a tone of commendation must be very sure of the correctness of what he advances. Under these circumstances, and considering the deep interest I have for many years taken in all matters concerning Art in England, and the confidence which many in this country are pleased to place in me, I feel it my duty towards those who love Art, as distinguished from those who may be supposed to have a knowledge of it, to point out somewhat in detail the untruthful and intenable nature of Mr. Coningham's statements.

"I am acquainted with most of Giovanni Bellini's works, in Italy, France, England, and Germany, and, setting the indubitable signature on this picture in the National Gallery entirely aside, I know of no Madonna and Child by him which, as regards the question of genuineness, more decidedly bears the stamp of his hand. At the same time, in intensity of religious feeling, regular beauty of the heads, masterly rendering of every portion, and deep and full harmony of colour—in short, in all that most constitutes the merit of a picture, it surpasses every other example of this subject by the master I have hitherto seen. The mother and the divine infant are both holding the apple—the symbol of the fall; and in the expression of elevated and resigned sorrow which pervades the heads, the painter has intended to depict the pathetic consciousness of the Saviour's stupendous mission. The heads and hands of each, and the body of the child, are modelled with a plastic power and roundness which bear witness to the painter's having devoted all his energies to the task; while the warm brownish tones of the flesh, the dark but luminous colouring of the red and blue draperies, and of the green curtain, are in deep and earnest harmony with the solemn import of the subject.

"Further, as regards the preservation of the picture, I have met with few specimens of the old masters which can be said to be so faultless in this respect. Seldom, indeed, is the original surface—shown in the draperies commonly by a ridgy inequality, and in the flesh parts (in the masters of the fifteenth century who painted in oil) by a fused and enamel-like smoothness—seen in such a perfect state of preservation as in this picture. To any one the least versed in such matters the mere idea of overpainting is in this case simply ridiculous; and it must be owned that Mr. Coningham has showed no common degree of boldness in challenging the public to support him in such a declaration.

"For the reasons above stated, therefore, I am at a loss to discover any better grounds than ignorance or malice for all Mr. Coningham has advanced in his letter. Here the proverb, 'Ex ungue leonem,' may be justly quoted, for to these sources may be traced every article regarding the National Gallery

with which Mr. Coningham and his in every respect worthy conditor, Mr. Morris Moore, have for a number of years favoured the public. It is true that in these same articles I have also had a large share of abuse; and, though I have always felt it as unnecessary for me as it would be unworthy to descend into the arena which these gentlemen occupy, yet, before concluding this letter, I may add that I am proud of having been the first to introduce that system of chronological arrangement of pictures which characterises the Berlin Museum. The utility of this plan has gained me the approval of some of the worthiest and most distinguished men of Europe, and has further been evidenced by its adoption in the largest European collections—namely, in the picture gallery of the Louvre, and in the sculpture department of the British Museum. Under these circumstances I can afford to be utterly indifferent to the censure of such a critic as Mr. William Coningham.

"I am, Sir, your obedient servant,

"GUSTAV WAAGEN."

"*Athenæum*, July 14."

Mr. Coningham has attempted a reply to this letter, in which, after speaking of the "insolence" of Dr. Waagen, he seems content to let the public judge by whose "authority" they will be guided; and the public will so judge. Dr. Waagen is known all over Europe as a gentleman of the nicest honour; his integrity has never been questioned; his judgment, based on large and long experience, is admitted in all the galleries of the Continent, and by all the learned in Art, as a guide as unerring, at least, as that of any living connoisseur; his published works are open to all. In this contest, therefore, the combatants do not enter the arena on equal terms.

ART IN CONTINENTAL STATES.

PARIS.—M. Yvon has been commissioned by government to paint a picture of the "Capture of the Malakoff" on a large scale. The artist has just returned from the Crimea with a portfolio of studies and sketches, in the execution of which he has passed the last six weeks. It is also said that Couture has received an order to paint the "Baptism of the young Prince Napoleon," and that the sum of 50,000 francs is allowed for that purpose.—The editor of the *Revue des Deux Mondes* has been condemned in 200 francs, and M. Gustave Planche in 300 francs and expenses, for having severely criticised a portrait of the Queen of Spain, by M. Madrazzo, the celebrated Spanish painter. This painting was represented as in the Grand Exhibition, which was not the case; hence the judgment, founded on the opinion that the remarks passed the fair bounds of criticism.* M. Gustave Planche is celebrated as a severe critic, and has not in this affair found much sympathy among the artists of Paris.—The embellishments round the *Arc de Triomphe* are being executed on a large and magnificent scale; the various architectural monuments, façades of hotels, statues, &c., will make this entry to Paris more like a fairy-scene than a reality. The improvements and decorations in the *Bois de Boulogne* will also add greatly to its attractive features.—The objects of Fine Art taken at Sebastopol have arrived in Paris; they consist of two sphinxes and a pediment, and have been placed in the *Orangerie* of the *Palais-Royal*.—A monumental column is about to be erected in commemoration of the campaign of the Crimea.—The *Salle des Trônes*, at the *Hôtel de Ville*, was decorated, for the first time, on the day of the baptism of the young prince, with an equestrian portrait by Horace Vernet. Medals, to the number of 120,000, commemorating the baptism have been distributed to all children in the colleges and schools, to the national guard, &c.—Although the season this year is not as yet in favour of the landscape-painters, the ateliers of Paris are nearly deserted, as is usual in the summer time, when all those who have it in their power are roaming the woods, forests, sea-shore, mountains, and meadows in search of subjects and health; there will be no *Salon* this year, we therefore look forward to grand doings next season.

* We think our correspondent is wrong here in his inference. The fact upon which the verdict was given, from the report of the trial as copied into the English papers, was, that the picture in question was actually not painted, but only in progress, and, therefore, that an unfinished work ought not to have been subjected to such strictures as the critic thought proper to pass upon it. The mere statement of a picture being where it was not, could never effect the reputation of the painter; and, therefore, would not entitle him to receive damages.—Ed. A. J.

MINOR TOPICS OF THE MONTH.

THE MEMORIAL OF THE GREAT EXHIBITION.—It will be the recollection of our readers that, not long after the close of the Exhibition of 1851, the then Lord Mayor of London (Alderman Challis, M.P.) called a meeting at the Mansion House, the object of which was to raise by subscription a sum of money, in order to place in Hyde Park a work in sculpture, by which the memory of that great event might be worthily perpetuated. The project was hailed with enthusiasm—for the subject was still warm—but it received a check from the public press, and was not encouraged by Prince Albert, mainly because it was announced that a statue of His Royal Highness would be a leading feature of the contemplated work. Notwithstanding, a sum amounting to between £5000 to £6000 was subscribed and paid, and a further contribution "promised" but not paid, on the ground that the proposal was not to be carried out in its integrity. We believe the Prince, on being consulted, advised that the money should be distributed among societies for the encouragement of Art and letters. This suggestion did not meet the views of the Committee and the subscribers, and consequently all proceedings were suspended. The money is, however, still in the hands of Alderman Challis; he has added the interest to it, and we believe it now amounts to £5600. That gentleman is anxious to know what course he had best pursue; he desires to rid himself of responsibility, and yet not to relinquish the trust reposed in him until he can do so with honour, and with due regard to the wishes and intentions of the subscribers. Three or four meetings have been held with this view, and it was a general impression that, however desirable it would be to defer to any feeling of His Royal Highness, it was not in the power of the Committee to expend the money subscribed in any way, other than that declared at the time the subscription was entered into. Arrangements are, therefore, in progress for carrying out this project in its integrity—by inviting designs (or models) from sculptors—not confining the invitation to British artists; and meanwhile, Dr. Booth, of the Society of Arts, and Mr. George Godwin, have consented to act as Hon. Secs., a sub-committee having been appointed to co-operate with them. At present we can give no further information; but it is probable that ere long we shall be in a condition to do so. It seems a desire to place the intended sculptured record of the Great Exhibition in Hyde Park, on the spot where the memorable Palace stood in 1851; but to this there may be objections in high quarters—to us it does not seem a necessity; it will, we think, answer equally well as "a memorial" if it be made to occupy a centre of one of the squares which will be formed at Kensington Gore. This arrangement will probably not be distasteful to His Royal Highness, especially if the original plan be so far modified as to lessen that prominence of portraiture which was the chief ground of his objection. At all events, we believe that at length there will actually exist a lasting memorial of the Great Exhibition. We hope and trust it may be one that will be worthy the event it commemorates, and honourable to the nation.

THE COLLECTION OF M. SOULAGES OF TOULOUSE.—This renowned collection—which consists of a large number of works of high interest and marvellous beauty, chiefly of mediæval furniture and objects of *voûte*—is at this moment the subject of an arrangement, which is more than likely to secure it for England; to be added probably to the stores now at Marlborough House. It has been valued at £11,700; and at that price it is to be purchased by several noblemen and gentlemen who have subscribed sums for the purpose, varying from £1000 to £100. The purchase is to be effected, however, only to prevent the collection from being taken elsewhere; it will be in due course offered to Government, and, if declined, will be sold in some other way; or, if necessary, it will be submitted to public auction, and so be dispersed. We trust that no spirit of mistaken economy will prevent the Government from purchasing this rare, interesting, and most instructive collection. Parliament will, we are sure, grant the sum required—and it will be a wise grant; such acquisitions *pay* in the highest sense. They are teachers who are continually giving value for

what they cost. Under existing circumstances, when our manufacturers and artisans are advancing in every branch of Art-Manufacture, it is most essential that the country should lose no occasion of coming to their aid, or to manifest care of, and interest in, their progress. The collection will be publicly exhibited, and "public opinion obtained on its merits, before the Government is asked to purchase it for the nation."

STATUE OF THE LATE DUKE OF SUSSEX.—It is a rare occurrence in our time to find a sculptor in a position—even when he has the desire, which we know many have—to be liberal; that is, to give, rather than sell, what has cost him much thought, labour, time, and some amount of money to produce. Mr. John Thomas, the sculptor principally employed in the new Houses of Parliament, has, however, made a gift to the Royal Free Hospital, in the Gray's-Inn Road, which is most honourable to his good feelings and to his skill as a sculptor. The presentation is nothing less than a life-size statue of the late Duke of Sussex, in his robes as a Knight of the Garter; the work is a fine, bold example of portrait sculpture; and there is a peculiar appropriateness in the gift, as the duke always took a warm interest in the success of the institution where the statue is now located. The Committee of the hospital unanimously passed the following resolution immediately after the inauguration of the work:—"That the warmest thanks of the Committee of the Royal Free Hospital be, and are hereby presented to John Thomas, Esq., for his most valuable and gratuitous modelling and superintending the execution of the statue of his late Royal Highness the Duke of Sussex, recently placed in front of the Sussex wing of this Hospital. And that the Committee hereby record their high sense of Mr. Thomas's great generosity in giving his distinguished services to the Hospital on this occasion, and also of the admirable likeness and consummate work of Art with which his genius has adorned and imparted an additional interest to this charitable institution."

THE NATIONAL GALLERY.—A document has just been printed by order of the House of Lords, of the pictures in the National Gallery which have been exhibited, but do not now form part of such exhibition. There are two pictures—"Leda," by P. F. Mola, and "Serena rescued by the Red Cross Knight Sir Calpine," by W. Hilton, R.A.—which do not now form part of the exhibition. Both the pictures are damaged. The number of pictures bequeathed, or given, to the nation which are not exhibited in the National Gallery, is 34.

A COLOSSAL BUST OF HER MAJESTY THE QUEEN has been executed in marble by Mr. Noble, for Robert Barnes, Esq., the late Mayor of Manchester, by whom it is designed to be presented to the Corporation, in order that it may be placed in the Town-Hall of the city. It is a work of considerable merit, and is, we understand, highly satisfactory to Her Majesty, who gave to the sculptor several sittings.

THE PICTURE GALLERY AT THE CRYSTAL PALACE.—The Directors have acted wisely in wooding this collection; a still bolder hand is required; but it is certain that a very material change for the better has been wrought; and the gallery may now be described as a most agreeable and useful addition to the many attractions provided at the Crystal Palace. There is a large number of interesting and beautiful pictures of the several schools of Europe; an hour may be very profitably spent here, and we have no doubt in course of time it will vie with the best exhibitions of the metropolis. We entreat the Directors, however, to remove an evil of so glaring a character that its existence is a marvel: slips of printed paper, containing the name of the picture and that of the artist (very desirable adjuncts in their way), are pasted on so coarsely and clumsily as to create absolute disgust; continually, they deface the frame—but that is of comparatively small moment; frequently these pieces of yellow paper—sometimes as large as six inches by two—are pasted on the painting, or, in cases of drawings, on the glass. This is quite intolerable—it is an insult to the artist, for it destroys the value of his work: it is evidence, moreover, of careless and slovenly habits on the part of those who have the care of the gallery, and leads very naturally to a conviction that the charge of good works has not been committed to good hands.

THE PEACE TROPHY of Baron Marochetti, at the Crystal Palace, has been for some weeks undergoing "alterations and improvements," which had better be let alone; the thing is a failure—has been discreditable to the Directors—they know it—the wisest course would be its removal; so long as it remains it will be a perpetual reproach, which all the gold and silver and bronze they can put upon it will not lessen; if it were good it would be out of place, for it entirely destroys the fine view of the structure obtained before this monstrosity was there; as it is, it is injurious to the Company: for those of their visitors who do not grieve, laugh.

DEPARTMENT OF SCIENCE AND ART.—It is announced that in the spring of 1858, an Exhibition of Works of Ornamental Art will take place under the auspices of the Department of Science and Art; its main feature will be "an Exhibition of those Works of Ornamental Art, produced since the establishment of the Schools of Art, as articles of commerce, which, either in their original design, or in their entire or partial execution, have been carried out by those who have derived instruction from the Schools of Art." The works to consist of Carvings in all materials, Furniture, Decorations, Metal Working of all kinds, Jewellery and Goldsmiths' Work, Pottery, Glass, and all kinds of Decorative Woven Fabrics. The object of this early announcement is, "that the public may have an opportunity of performing their part by giving liberal Commissions to Manufacturers and others to produce useful works, which, exhibited on this occasion, will be calculated to show fully and fairly the influence which the Schools of Art are exercising in the country."

A NATIONAL GALLERY OF ENGRAVINGS.—A suggestion has recently been thrown out in the *Bidder* which is too good to be lost sight of, and which we should rejoice to see carried into effect. The "print-room" of the British Museum contains a large and valuable mass of engravings of all kinds, and of all countries, from the earliest period of the art to our own times: these are known to, and have been seen by, only the comparatively few individuals who take especial interest in such matters; the public at large are almost entirely ignorant of their existence. But why should not they be acquainted with them? nay, why not exhibit prints as well as pictures, either in our new National Gallery when erected, or elsewhere, as may be considered advisable? Such is the hint offered by our contemporary. The writer says, "Some years since it was proposed, we believe by Mr. W. Carpenter, the present obliging keeper of the prints, to erect a gallery for their exhibition to the public. The plan was submitted to the late Sir Robert Peel, and much approved by him; and the long apartment which now contains the Murch Machles was originally intended for that purpose." The untimely death of the statesman, however, put an end to a scheme which would otherwise, in all probability, have been carried into effect. Although a considerable number of the prints are bound up in volumes, for their better preservation it is presumed, still there must be hundreds that, framed and glazed, and hung up, would convey a large amount of Art-instruction to the people, and form an exhibition of no ordinary interest and importance. We trust the subject will have the attention of all who can aid in carrying the project into effect; for what use is there in hoarding up treasures that profit not one in ten thousand of our population, and for which the public money has been liberally expended?—liberally, that is, in proportion to the sums paid by the nation for works of Art.

MR. GEORGE GWILT, F.S.A.—We extract from our contemporary, the *Bidder*, the following notice of this gentleman, whose death took place on the 26th of June, at his residence in Southwark:—"Mr. Gwilt was the elder of two sons of Mr. George Gwilt, an architect and surveyor, also of St. Saviour's, Southwark, where his family have resided more than a century; the younger son being Mr. Joseph Gwilt, the well-known author of 'The Encyclopedia of Architecture,' and other important works. Mr. Gwilt, sen., was surveyor for the county of Surrey; and, amongst other buildings, he erected Horsemeneg-Lane Gaol and Newington Sessions-House. He died on the 9th of December, 1807. His son George was born on the 8th of May, 1775, and he was consequently in his 82nd year at the time of his

death. He was brought up to his father's profession of an architect, and succeeded his father in his professional practice on his death. His chief work, and that with which his name will always be worthily associated, was the restoration of the choir and tower of St. Mary Overy's Church, and the Lady Chapel, which Mr. Gwilt executed with much taste and judgment; though as regards the choir and tower, at a very great expense to the parishioners of St. Saviour, who, although proud of their fine church, were not well pleased to have incurred a debt of £35,000 for the restoration of a part of it. This work was performed between 1822 and 1825. With Mr. Gwilt such works were labours in which he delighted, and when, through the indefatigable exertions of the late Mr. Thomas Saunders, F.S.A., the Lady Chapel was rescued from destruction, and its restoration effected by means of a public subscription, exceeding £3000, Mr. Gwilt liberally undertook the professional direction and superintendence of the work, and performed it gratuitously.

ELECTRO PLATE MARKERS.—We may be rendering a service to some of our lady readers—and we know there are many—by directing their attention to the Patent Electro Silver Plates for marking linen, &c., manufactured by Mr. Cullerton, whose advertisement appears in our columns. These plates will serve other purposes than that for which they are more especially designed—such as the insertion of the name in books, &c.; and when the crest is added to the name, the combination becomes ornamental. The application of the plate is so simple that any one can use it successfully.

THE LIONS FOR TRAFALGAR SQUARE.—Mouth after mouth—may, year after year—goes by, and finds the Nelson Monument still incomplete. There must be good deterioration of duty somewhere.

THE NIGHTINGALE BROOCH.—Mr. Waterhouse, Her Majesty's jeweller, of Dublin, has evinced his zeal in the cause of humanity and Florence Nightingale by producing a Commemorative Brooch, appropriate in design and elegant in execution, and has resolved to devote the proceeds of the sale of this highly-wrought jewel to "the Nightingale Fund." We record this act of liberality and devotion to a good cause with the more pleasure, because it proves how wide-spread is the interest excited by the heroism of this noble woman. The tablet represents a wounded soldier, to whom a female is administering relief; this is surrounded by a motto, which in its turn is encircled by a rich garland of laurel tied with a ribbon, and surmounted by a crown. The design is based on the jewel presented to Miss Nightingale by the Queen, but it is so altered as to suit the purpose of a brooch for ordinary wear. It is very beautiful, and does high credit to the eminent Dublin jeweller who has produced it.

ROYAL ACADEMY SCULPTURE.—In our notice last month we commended the statue of "A Boy Playing with Tali," but we wrongly attributed it to W. M. Thomas. It is the work of Mr. Charles B. Bireh, a young sculptor of considerable talent, who has been for some years studying at Berlin, where he was the favourite pupil of Herr Wichmann. He has produced several admirable busts; and in this, his more ambitious work, he justifies the high hopes that have been formed of his future career in Art.

FORGED ANTIQUITIES.—The reports of the committee of inquiry on the authenticity of the Merovingian Cemetery, called "La Chapelle St. Eloi" (Département de l'Eure), have lately been published by the members of the Society of Belles Lettres of that department, who formed it, and which consisted of the president, the Marquis Ernest de Blouville, M. Colombel, the secretary, and seven of its principal constituents. After much patient investigation, they have come to the unanimous conclusion, that the discovery is a well-arranged trick, and the objects pretended to be found are clever forgeries. The discovery was made known to the world by M. Charles Lenormant, of Paris, whose position is that of a leading official in the national collection there; and his elaborate detail of the whole *trouville* unquestionably affects his reputation as an antiquary. The attempt to induce the French government to purchase these forgeries as precious historic data, contradicting, as they did, other and genuine monuments, is a grave offence. The pertinacity of M. Lenormant and his son has forced this commission to sit and examine evidence so damatory; but the

committee should go still farther, and expose the movers of this attempt to poison the well-springs of history.

WOOD CARVINGS.—It would seem from recent public sales, that pictures are not the only works of Art which may be calculated on as "safe investments." Some carvings by Mr. Rogers, consisting of cornices, glass-frames, &c., that belonged to Mr. Strahan, realised considerably more than the artist received for them; and at the sale of Lord Orford's pictures and articles of *verrà*, two pilasters were bought by a dealer for 210*l.*, a dead cock, &c., for 46*l.*, and other carvings—all the work of Mr. Rogers—at prices much beyond their original cost. The bust, in wood, of Charles II., by Grinling Gibbons, which, we believe, Mr. Rogers disposed of some years ago to Lord Orford for little more than 20*l.*, realised 55 guineas; it was purchased, as we understood, by some agent of the Government, for the nation.

HOME FOR GENTLEWOMEN.—Since the establishment of this Institution some seven years ago, we have on more than one occasion advocated its claims upon the favourable consideration of the benevolent. We are again induced to bring them before our readers, and we do this with the less hesitation because the Institution is one peculiarly worthy of their notice and assistance; its object being, as its name implies, to afford a home for those ladies who have been in comfortable and even affluent circumstances; and we expect there are comparatively few of our subscribers who can so far calculate upon the future as to be able to urge, as a plea for refusing aid, that such a "Home" may not hereafter prove a blessing to them or their friends. The two houses in Queen Square at present devoted to the purposes of the Institution will accommodate fifty-seven residents only; it is usually quite full, and there are generally candidates waiting admission. During the late war, the funds of the "Home" have been materially affected, both by diminished subscriptions and by the increased cost of maintaining an establishment of some sixty persons, in consequence of the great advance in the price of provisions generally. Were it not for these two causes, the Committee would doubtless have been able to announce the liquidation of a considerable debt arising out of the heavy expense of furnishing and adapting the premises for so large a number of inmates. However, with the view of relieving the Institution from such an obstacle to its efficient working, some friends have resolved to contribute a sum of £10 each to this special object—twenty-one names are already on the list out of forty required for the purpose; surely the remaining eleven cannot be long absent from the list when these facts are made known. But we would not only desire to assist in procuring these £10 subscribers, but would appeal generally for pecuniary aid to this excellent Institution, as one requiring large and general sympathy, and eminently deserving of it.

PICTURE DEALING IN GLASGOW.—Under this heading a statement appeared in our June number, of some transactions in connection with the sale of a picture said to be painted by Mr. Brauwhite. In our remarks we asked, "all we now desire to know is, what has become of 'the copy?'"—the copy having been returned to Mr. Flatow with the original, the latter his own property. Mr. Flatow has given us the assurance that the copy is destroyed, and also that so far from making "a good thing" of the business,—as it certainly appeared he had done from the information which had reached us,—he has actually been a loser by the transaction.

THE QUEEN has recently purchased a little gem of wood-sculpture, executed by Mr. Perry, late of Taunton, but now settled in London, some of whose works have been engraved in our Journal. It is circular in form, and represents a nightingale pouring forth his song from a hawthorn bough, well covered with leaves and flowers, the graceful and natural disposition of which is admirably preserved; the under-cutting of these must have given the sculptor considerable trouble. The whole group is carved out of a solid block of lime wood, and is mounted upon a background of eriuison velvet, which shows up the work to great advantage; a dome-shaped glass secures the delicate white wood from dust and damp, and this is again mounted on, or rather affixed to, an outer frame of the same wood, decorated with carved wreaths of lilies of the valley.

REVIEWS.

LIFE OF THOMAS GAINSBOROUGH, R.A. By the late G. W. FULCHER. Edited by his SON. Published by LONGMAN & Co., London.

Nearly seventy years after the death of Gainsborough, we have here a history of his life: it is true that in Allan Cunningham's "Lives of British Painters and Sculptors" some thirty pages are devoted to the same subject, but these are quite insufficient for the purpose. It is very probable, however, that Cunningham's record is all the world would ever have known of the painter, if Mr. Fulcher, who, if we mistake not, was an inhabitant of Sudbury, the town in which Gainsborough was born, had not been at some pains to collect such materials as he could get together for compiling a biography of the artist. Our own experience assures us of the difficulty there is in writing a history of the living painter: how much greater must it then be when the subject taken in hand by the author has long passed away, leaving behind him few memorials of his existence, except the pictures which have immortalised his name? And yet Mr. Fulcher has succeeded, with the help of preceding writers, and of Gainsborough's surviving representatives, to get together a very pleasant story: true it is that, with the exception of sundry letters written by the artist, there is little we have not heard or read before; but the author's own comments on the painter's life and works, some anecdotes connected with the latter, which are new to us, and the collected opinions of other writers upon his pictures, contribute altogether in making this a very welcome volume of artistic biography. As we were preparing some engravings from the works of Gainsborough, to appear in our series of "British Artists," and shall then find it necessary to refer to this book, we postpone for the present any extracts we might otherwise have been induced to print from it. A list of Gainsborough's works, with the names of their present possessors, so far as they can be ascertained, is appended at the close of the "Life;" it forms a very useful portion of the volume.

THE OPENING OF THE GREAT EXHIBITION OF 1851.

Engraved by S. BULLIN, from the Picture by H. C. SELOUS. Published by T. Boys, London.

At length this long-looked-for engraving has made its appearance; a work which has occupied nearly five years in the execution—a period of long duration, and yet not long when we look at the size of the plate, and count the number of portraits—one hundred—which it contains: portraits of the leading personages who took part in the ceremony—the Queen, her Royal Consort, and several members of their family, lords and ladies in attendance, commissioners and jurors of the Exhibition, both British and foreign; in fact, of almost every individual prominently connected with that vast undertaking, all of whom, we believe, with two exceptions, sat to the artist. It may, perhaps, be considered by many that this engraving, from the lapse of time since the event took place which it commemorates, will have lost much of the interest that would of necessity have attached to it had it appeared two or three years ago; we do not think such will prove to be the case—nor is there any valid reason, but the contrary, why it should. The Industrial Exhibition of 1851 was a great epoch in the commercial history of the world—the precursor of other events of a similar nature elsewhere: to this day the nations of the earth feel the influence of its results, and are deriving advantages from it, and will, doubtless, for ages to come. Such a memorial, therefore, as this print offers can never be out of time, any more than the representation of some important historical event that happened long years ago would be considered in the same light. As regards the engraving itself, we would merely say it is unquestionably the only worthy pictorial record of this imposing ceremony that has appeared; the composition, for a work of its class, is singularly picturesque; and Mr. Bullin, in his skillful and effective translation, has done ample justice to the painter. Of the many hundreds who took part in the Exhibition, there must certainly be a large number to whom this memorial will prove most acceptable.

BOLTON ABBEY IN THE OLDEN TIME. Engraved by W. T. DAVEY, from the Picture by SIR E. LANDSEER, R.A. Published by T. Boys, London.

The unparalleled success of the engraving, by S. Consins, of this picture has induced Mr. Boys to reproduce it on a smaller scale than that first published several years since, the early proofs of which now realise an almost fabulous sum. It is scarcely too much to assume that fine impressions of Mr.

Davey's plate will "follow hard" upon their antecedents, for, without any disparagement to the splendid production of Mr. Cousins' graver, the new plate, in brilliancy, power, expression, and finish, will, with those connoisseurs who care not for size, prove a formidable rival to the older work. We heartily congratulate Mr. Davey on his entire success, and the publisher on his good fortune to be so ably supported in his speculation; scarcely a speculation, however, we expect—rather a certainty. The plate has, we understand, had the benefit of Landsker's superintendence and touches; of this there can be little doubt, judging from its character: it is almost wholly in line, with a mixture, where force or extreme delicacy is required, of etching and stipple.

HERTHIA. By FREDERIKA BREMER. Published by A. HALL, VIRTUE & Co., London.

HERTHIA is the most remarkable, though not the most pleasing, book that has been produced by the fluent pen and thoughtful brain of Frederika Bremer. It is not the most "pleasing," simply because it deals with a "social evil" which it cannot be pleasant to contemplate. It is, however, an evil well worth thinking over, more especially now, when our legislators have debated, and are still to debate, concerning the position that women occupy in England: this is not the place to argue whether English women have, or have not, reason to complain of the laws as they stand; but only to solicit attention to what seems to us, as it has done to Miss Bremer, the state of positive bondage in which unmarried women are held in Sweden. Miss Bremer has wrought the evils arising from this bondage into a deeply interesting tale, carefully developed, manifesting something of her old philosophy, but still more of the new light, whose beams are penetrating into her inmost soul. We imagine such a work, from such authorities, must excite considerable interest in Sweden. Miss Bremer is respected by all; she leads many; and we cannot but think this a very brave book, written with a firm hand, and a high motive. The English reader must bear in mind that it was written for Sweden; but it has enough of world-wide interest and sympathy to create a home for itself, both here and in America. Those who are disheartened with some of the phases of social English life would do well, while reading the trials which "Hertha" so heroically endured, to balance the good and evil that belong to women's position in England; and if they do so, disabusing their minds as much as possible of the influence "party" insensibly acquires—comparing "this" and "that" together—those who are clear-sighted as well as strong-minded, will have much to be thankful for in the enjoyment of such a birthright as England gives her daughters. "Hertha" possesses also the advantage of being translated by Mary Howitt.

KIRBY & SPENCE'S ENTOMOLOGY. Published by LONGMAN, BROWN, GREEN, & LONGMAN, London.

It is the sign of a healthy and earnest spirit, when editions of books connected with natural history "go off" rapidly. This is the Seventh Edition of what might be called "the practical poetry of the insect-world," it is now published at one-sixth of the price of the sixth edition, "so as to bring it within reach of all desirous of becoming acquainted with the natural history of insects, and thus carrying out more effectually the object of the authors—that of introducing others to a branch of science which they had found so delightful. It is matter of regret how much enjoyment we lose through want of observation, and also ignorance of what we do observe; dwellers in the country, even when "town-bred," would find their happiness increased by cultivating an acquaintance with the life to be found, not only by every way-side, but on every herb and blade of grass. Nothing increases our own vitality so much as sympathy with the vitality of this abounding world. We cannot feel "dull" or "lonely," if we seek acquaintance with those atoms of life which the great Creator does not consider beneath His care. This volume teaches that not only are we to consider nothing "common or unclean," but that we must not think more highly of ourselves than we ought to think, when the bee and the ant, and scores of others of the insect world, are gifted with an instinct so akin to reason that the distinction is almost a myth. The present volume is really a boon to young and old.

ANCIENT CROSSES AND OTHER ANTIQUITIES IN THE WEST OF CORNWALL. Drawn and Engraved by J. T. BRIGHT. Published by SMITHKIN & MARSHALL, London.

This work is entirely the production of the local press of Cornwall, a county long and deservedly

celebrated for its antiquities. Some of the most ancient and interesting of these are depicted in this unpretending and useful volume. The descriptive portion is very brief, but the pictorial one extensive; the volume consisting of a series of boldly executed wood engravings of nearly seventy antiquities of a remarkable kind; evincing much careful research on the part of the artist who has devoted himself to their delineation. The antiquaries of England owe much to the unpretending labours of such men, who bring to the shelves of the student the result of much wearisome travel in outlying districts, for the general aid of science and history.

LECTURES ON CHURCH-BUILDING. WITH SOME PRACTICAL REMARKS ON BELLS AND CLOCKS. By E. B. DENISON, M.A., one of Her Majesty's Counsel. Published by BELL & DALDY, London; G. & T. BROOKE, Doncaster.

The rebuilding of the fine new church at Doncaster, in lieu of that burnt down about three years since, induced Mr. Denison to doff his silk gown for a season, while he delivered to the inhabitants of the town this interesting series of lectures on ecclesiastical architecture—a subject in which the learned gentleman seems as much at home as he doubtless is in the weighty matters of the law. Mr. Denison is a great admirer of the Gothic; and would have every place of sacred worship—whether church, meeting-house, or synagogue—built in a style of magnificence worthy of its objects. He is no advocate of lath-and-plaster churches, and ridicules justly, as we think, the utilitarian spirit of an age that will expend thousands upon a railway-station, and grudge its tens to aid in the erection of a church. As an example, he refers to the Great Northern Railway Company, the shareholders of which, with an income of about one million a-year, and having its principal works at Doncaster, employing "a locomotive population large enough to form a separate parish, would neither contribute anything towards rebuilding the church of the parish where they own this vast property, nor even allow their directors, when they proposed it, to spend as much as the value of a couple of railway-engines, or a dozen carriages, in building a church for this population of their own." The style of these lectures is colloquial, and free from all unnecessary technicalities, and therefore the exact kind of addresses which should be delivered to a general audience; and yet nothing relating to the subject, both externally and internally, is omitted. The materials as well as the architecture suitable for church-building are fully discussed.

SIX VIEWS OF OPERATIONS IN THE BALTIC IN 1855. From Sketches by Commander B. KING, R.N. Lithographed and published by DAY & SONS, London.

These views are illustrations of some of the minor transactions in which our fleets took part during the late war; transactions of small importance in themselves compared with the great events that occupied so much of our thoughts during the last year, yet contributing in no small degree to bring the contest to a termination. Commander King is the son of Captain J. D. King, an amateur artist, and an old honorary contributor to the exhibitions of the Royal Academy: he served during the war on board one of the vessels—the *Magicienne* or the *Arrogant*—the former we believe, and was present at the operations he has sketched—the "Blowing up of Fort Roischensolm," the "Engagement of the *Magicienne* with the Russian Horse Artillery," "Burning by boats' crews of twenty-nine Russian vessels," &c. &c. The subjects, as may be supposed, have little pictorial beauty to recommend them, but the incidents appear to be very faithfully represented, and with considerable artistic power. The best portions of the pictures are the skies and water; there is a liquid transparency in the one, and a luminous quality in the other, that show attentive observation of nature.

THE COLLODION PROCESS. By THOMAS H. HENNAH.

Mr. Hennah is well known to be one of the most successful operators in Photography, especially with the Colloidion process. His manual he has given in simple words his modes of manipulation, and where necessary he has added something in explanation. The value of this small treatise is proved by its having rapidly passed through three editions. In this, the fourth edition, we find some new and valuable matter. We confidently recommend "The Colloidion Process," as a useful text-book to the Photographic amateur, and it will be found of considerable value to the practised artist.

THE PRINCIPLES OF FORM IN ORNAMENTAL ART. By CHARLES MARTEL. Published by WINSOR & NEWTON, London.

There is a vast deal of information crowded into this little manual—information of a kind with which those whose business it is to know the canons of ornamental Art, ere they attempt to practise it, ought to be acquainted. Mr. Martel's remarks refer chiefly to form in its relation to Architecture and Ceramic Art—those arts of which the Greeks have left us such illustrative examples. In the chapter on "Imitational Ornament" he speaks of Wallis, of Louth, as a rival in wood-carving to Grinling Gibbons, but does not even mention Rogers. Mr. Wallis is an artist of very great merit, but precedence ought not to be given him over Mr. Rogers.

HOOPS AND FRAILS. Engraved by W. HOLL, from Drawings by J. J. JENKINS. Published by FULLER & Co., London.

These two prints form another artistic contribution to the events, real or imaginary, that have grown out of the late war. They represent respectively the inside and exterior of a cottage at the time of evening: in the former, a young mother, whose infant sleeps soundly in a cradle by her side, is kneeling on a kneeling mat, and looking out the window; at her back is seen the profile of her husband, recognised, or about to be, by his dog in the room, for his head is pointed that way with marked attention. In the other print appears the soldier, looking earnestly through the window at his wife and child; his left knee is bound up from the wounds received in his encounter with the enemy. We do not quite see the application of the titles to the subjects, the only indication of "fear" consisting in the soldier having allowed his stick to fall from his hand when he perceives his wife thus engaged, as if he were apprehensive some calamity had overtaken her during his absence; but, nevertheless, they make a very pretty and interesting pair of prints: the figures are French.

COMPENSATION: A STORY OF REAL LIFE THIRTY YEARS AGO. 2 vols. Published by PARKER, West Strand.

There is much to interest and instruct in these volumes—a fair share of incident, and some characters life-like and vigorous. It is trite to repeat that "truth is strange—stranger than fiction;" but some of the incidents recorded in these pages are so "strange," that we are bound to believe they are not fiction. There is enough matter to spread into three volumes; and the multiplicity of actors rather impedes the progress of the story. The strife between interests and affections is by no means confined to time or class, but passes surely on, carrying thousands to misery and destruction. We recognise a good deal of the actual past in COMPENSATION. Amongst many, the sketch of the poet's breakfast, in the second volume, is certainly more faithful to the reality of the scene in St. James's Place than anything on the subject yet given to the public; and the conversations abound with spirit.

THE VOYAGE OF LIFE. Engraved by J. SMILLIE, from the picture by T. COLE. Plate 4. Proprietor and publisher, the REV. GORHAM D. ABBOTT, Spinger Institute, New York.

In our number for March last we reviewed the first three plates, forming a portion of this series of pictures; the fourth and concluding plate has just reached us, and, as we anticipated, it is fully entitled to all the favourable remarks which the preceding prints called forth. In the last we left the voyager on the stream of time, hurrying down its waters amid all the dangers and temptations by which manhood is beset: in the plate now before us we see an old man, in his slattered and worn bark, calmly issuing from the river towards a vast interminable ocean, over which the spirit of darkness sits brooding; the upper part of the sky is bright, revealing a troop of angels prepared to receive him to his final and instructive lesson; who has attended him through the journey directs his notice to the glory that awaits him. The subject, though exhibiting only the slightest materials, is most poetic; indeed, the entire series possesses this element of Art in a very eminent degree. The painter, who, we regret to say, has not lived to see the result of his labours, aimed to make landscape-painting teach a valuable and instructive lesson; his pencil has spoken eloquently and picturesquely the ordinary story of life. We have rarely had before us a series of engravings that afforded us so much pleasure to examine: they must materially tend to advance the Arts of America, not only in that country but in the opinion of Europeans.

THE ART-JOURNAL.



LONDON, SEPTEMBER 1, 1856.

THE ROYAL ACADEMY.



VERY high authority, in matters of taste as in other things, has pronounced Trafalgar Square to be "the finest site in Europe." Declining in this case, as has happened to us in many a case besides, to ratify the verdict of "very high authority," we can still admit the claim of Trafalgar Square to be considered the finest location in the metropolis of England; and all the improvements which time will surely bring in the grand line of avenue that stretches away from it to the Palace and Abbey of Westminster, will add more and more to the beauty and dignity of the site. On the highest ground of this commanding area—on that chosen spot of a chosen space which groups all the great features of the growing avenue into its point of view—the National Gallery and the Royal Academy have, by favour of the nation, for many years kept house together.

It is in the natural progress of youthful institutions that are well housed and generously nourished, to outgrow the accommodations devised for their childhood; and these two establishments have, accordingly—notwithstanding some original defects of constitution in each case, and a more than ordinary oversight on the part of the nurses in the case of the first (the National Gallery)—so expanded in limb and stature as long since to jostle each other in the building which they occupy in common, and to be each in the way of a full and fair development of the other's proportions. The National Gallery, in especial, has grown into so rich a promise, and so great is the future projected for it, that the entire edifice of which it occupies only half, with all its capacities for enlargement, is, as we argued last month, wholly inadequate to their realisation.

Were this not so, it must be distinctly understood, that the entire edifice was available for the purposes of the national collection. It is important to the argument which we have hereafter to maintain, to have it clearly borne in mind, that the Royal Academy, though occupying in common, has no right concurrent, with the National Gallery. It is established by the evidence of official witnesses, and affirmed by the reports of consensive committees, that the occupancy of the Royal Academy in Trafalgar Square is merely expedient and provisional, contingent on the convenience of the neighbour institution, and determinable at any time on the demand of its trustees. The present President of the Royal Academy, himself, takes no larger view, in that respect, of the rights of the institution over which he presides, than one which admits its liability to removal, on the condition of its having accommodations not inferior to its present ones provided for it elsewhere. There are many among the public who, looking at the Academy, as a private society, working out its own objects irresponsibly and in its own way, and possessed of large funds of its own, drawn to a great extent from the public through a sort of trading medium, deny its right to be housed at the national cost at all. For ourselves, we can

take no such narrow view of the matter. Seeing the long period of years during which this institution has been so lodged by the nation, the many useful objects which it has carried out in the accommodations thus provided, and the many noble uses which it has made of the funds there acquired, we think the Academy has an excellent case of prescription supporting its claim to at least such amount of aid in this respect as was originally provided for it, by George III., in Somerset House. But, to its present apartments in Trafalgar Square, we repeat, the Royal Academy has no right beyond that of a tenancy at will;—and it follows *à fortiori*, that, to any suggested enlargement of such accommodations it must show a title on grounds altogether new and distinct from those which sustain its present prescription. The claim to subsidy *at all*, apart from the prescription, must build in this day on arguments very different from those which justified the original beneficence of George III. That in the time of the early struggle of our native Arts into academic figure and corporate action, the king should save the young society the expense of house rent, which it had not means of its own to pay, is intelligible now, as it was reasonable then;—but, that the nation should be held to have thereby contracted an obligation to enlarge indefinitely its provision in this kind with the enlarging figure of the institution, when the very growth which creates the necessity for the enlarged provision has supplied amply to the institution itself the means of furnishing it, is an inference too violent and illogical to be suggested in terms. If the Royal Academy, now a rich and prosperous body, has something of great value to ask from the nation, to which it can show no existing title, then, we suppose, it is prepared to give to the nation, in return, something which the nation already has not, and which it is important that it should have.—Well, then, the matter stands thus. The building in Trafalgar Square is, as we have said, far too small for the combined objects of the two institutions which at present it houses,—and that one of the two which has had at any time the right to the whole, enforceable by the expulsion of the other (the Royal Academy), is, nevertheless, about to emigrate in search of yet larger capabilities than even that whole would supply. Thereupon, the Royal Academy, for whose more limited objects the entire building about to be thus partially vacated would furnish a majestic space, aspires to extend its tenure, which at present is of a part and for a time, into a possession of the whole and for ever. This is a very large demand, and should have something very substantive to show as a consideration. Why should the nation give away its finest site (and a site by some prized over all other sites in Europe) save for some important national object? The Government that bestows this grand location will have to show good cause for its appropriation. The very courage to ask for such an endowment can have been inspired, it may be assumed, only by the disposition to concede whatever can properly be demanded on behalf of those for whom the government granting are trustees. To make a title, the Academy should be prepared to renege itself in the spirit, and to the dimensions, of the gift. Such a title we, for one, would be disposed freely to accept. We can, for ourselves, see good grounds of public policy why the Academy should have this building,—but then, the Academy must be ready to give to those grounds of public policy their due place and weight. In a word, this palace and its site, the property of the nation, must be paid for, if not all in money (and the money value would absorb the funds of the Academy, large as they are, four times over), in something which the nation deems to be money's worth. Now, it has long been widely felt that—much for its own sake, and more for the sake of the public—for a great addition to its own dignity, and for the far more complete fulfilment of its mission—certain reforms are needed in the Royal Academy which the public has had no power to enforce on a private association. The time to make terras is now, when the Academy is a petitioner to so vast an extent. To a private society this magnificent property, built for a national institution, and admirably fitted for some great national object, cannot—or should not—be given away. In every respect the Academy has, we think, a great opportunity just now before it, which, if it neglect, must ultimately fall to the adoption of some other institu-

tion than itself; and it is in a spirit of respect for it and its history—for its workers and their works,—and almost as much, we repeat, in its own interest as in the interest of the public,—that we think it well to discuss here the conditions on which Government might wisely treat with it for a full possession of the building in Trafalgar Square, when the removal of the National Gallery shall leave that great property open to a new destination.

That the Royal Academy has pressing need of further space, to enable it to carry out worthily the objects of which it has charge, no one who has looked with interest on the growth of Art and the struggles of artists in this country will deny;—and we, for one, would gladly see such space liberally assigned to it, on the sole condition that it shall understand in a far larger sense than it now does the nature of its trust,—and rise, as it has never yet done, to the dignity of its mission. There is no year that does not bring this insufficiency of space painfully before the public; and part of the resentment which is not properly visitable on the Academy on this account falls on it, nevertheless, because of that narrowness of view in other respects which is felt as constituting a sound objection to its endowment with more extended means. In its moments of irritation or of disappointment, the public does not readily distinguish between that which the Academy does not do because it cannot, and that which it does not do though it might;—particularly if there be a feeling that the latter failing has some relation to, and dependence on, the former.—Take as an instance of the insufficiency in question, the treatment which the highest branch of the Arts, Sculpture, has received annually at the exhibitions in Trafalgar Square; and it will be felt that it would be difficult to find a more striking expression than this of the utter inadequacy to the true purposes of such an institution, either of the Academy or of its means.

We fear, that in this case the blame is to be shared between them,—the body itself, and the means which it commands. While there is, beyond all question, within the present walls a lamentable want of spaces suitable to the exhibition of sculpture, it is equally certain that the academicians have not made, in favour of their sculptor brethren, a generous use of the spaces which *have* been at their disposal, and have not shown generally such an interest in this most spiritual portion of their trust as they could now put confidently forward for a title to a larger endowment.—Then, as another instance, the multitude of deserving pictures which are constantly rejected from the exhibitions of the Royal Academy for want of wall to hang them on, forms, from the extent of its application, the most distressing incident of the artist-year. When we take into account the long months of toil, and anxiety, and aspiration which have preceded the birth of each one of these pictures, it is impossible not to feel sensibly the disappointment of the painter at a repulse which is not upon the merits. They who have the arrangements of each year have many hard things to bear in adjusting the comparative claims of the excellence for which there is room; but they must feel as hardest of all the necessity under which they labour of turning merit absolutely away on ground so merely extrinsic as that of want of accommodation.—Unhappily, however, under the present narrow dispensation, there is a worse fate even than that of being rejected. By the necessities of the case, for many an unfortunate picture the true road to non-exhibition is to be hung on the walls of the Royal Academy. The vast disproportion between the amount of wall which *can* be occupied, and the number of works claiming to be its occupants, brings all the high lines and dark corners of the former into requisition.—Some picture into which the artist may have wrought his passion for the beautiful and his thirst for fame, and on which he has expended the labour that was, perhaps, to buy his children's bread for the year, is, on the suspicious May-Monday which, as he hopes, is to re-admit himself and introduce the public to its presence, by him discovered only after an anxious hunt—counting obscurity in some secluded nook, under the shelter of two neighbouring frames,—and by the public never discovered at all. Whole rows of works, each one the exponent, after its kind, of a glowing sense or of a patient thought, are ranged along the roof-line,—placed for immortality according to that material version which looks *up* for it, but missing it by the distance which reduces their themes

to simple riddles—as if the hanger had been the Sphinx, and the catalogue were *Œdipus*. Many a wound of the heart is carried home from the crowded rooms of the Royal Academy on that first Monday in the merry month of May. There is, as we have said, most pressing need of a remedy for all this,—for spaces at the disposal of the Academy in which every candidate picture can be exhibited that deserves exhibition, and no one shall be hung where it cannot be fairly seen.

For these latter expressions of the existing insufficiency the body of the Royal Academy are, of course, not to blame,—save in that secondary sense in which they fail so to attract the public esteem to the greatness of their trust, as to command from the public sympathy ample means for its whole fulfilment. To this end they must give to that trust in many particulars a new and enlarged interpretation. The spirit and requirements of the age have far outgrown the narrow scheme of the institution; and in our desire for a reconsideration of that scheme, in view of the opportunity which now presents itself of providing the means to carry out its reconstruction on a grander scale, we have, as we know, the sympathy of the artist body in general, and of some intelligent and far-seeing members of the Academy itself.

The first thing to be amended in conformity with the spirit of the times in which we live, is a radical defect in the original constitution of the Academy itself. We have, in the course of this article, more than once spoken of this institution as “a private society,”—and we dare say there is a large body of the public, accustomed to look on the Academy, in its national palace, as the custodian and representative of national Art, to whom the term will seem to convey a misdescription. Nevertheless, a private society the Academy is,—and that closest and most exclusive kind of private society which has a royal master. No great and comprehensive national aims can be with certainty carried out under the dispensation to which it belongs. That liveried service which Art, like some of her spiritual brotherhood, was content to enter a century since, is wholly unworthy of the position which an enlightened nation desires that it should hold for the future, and which, so far as depends on the artists themselves, they should determine that it shall hold now. Ninety years ago, the Royal Academy was born in a royal palace,—and conveyed to its first apartments, in Somerset House, down the back stairs. The academicians held, and hold, their title individually by diploma from the king,—and are dismissible, on any ground of delinquency, only by his consent. The treasurer and librarian are appointed by the king,—and the nominations of the secretary and keeper must have the royal approval. The president is elected annually; but, as the practice has been to continue the individual once elected in the office for life, and as all other officers and professors remain such only during the king's pleasure, he and they are in effect little better than officers of the crown. The accounts of the Academy are laid before the king;—and, in a word, the Academy, instead of being what the age demands, a national, continues to be what it was born, a Royal Academy. Nor let it be supposed that this incident of royal patronage has remained only a constitutional theory,—or that the right of royal interference, even in those cases where the elections appeared to be free, has existed as a mere dead letter. The whisperer has found his way into the royal closet at election time, and the veto has been exercised, and on political grounds. —It may amuse our readers if we record here, as an illustration, an instance in which this veto was worked, as related in a contemporary publication, to the effect of a practical self-stultification. The keeper of the Royal Academy has charge of the nascent Art of the country in the persons of the students, whose progress in its schools he has to superintend and direct; and for this office, so important to the future of the profession, the academicians at one time selected, from amongst themselves, as one most highly qualified, the elder Smirke. The appointment was forwarded to the king, George the Third, for confirmation, according to the constitutions. But some one had been up the back stairs before it came, and whispered in the royal ear a ground of disqualification. Mr. Smirke, it was alleged, had been seen at Thelwall's lectures,—and democracy was a necessary inference in the logic that in those days used the

back stairs. It was also logic in the closet that a democrat could not teach painting;—and George the Third, accordingly, put his veto on the nomination. It is difficult to suspect the academic diplomacy which drank from these court waters, of a royal mystification; but certain it is, that the rebuked academicians offered for the acceptance of the rebuking monarch, as a substitute for the mild democracy that was suspected, the close friend and ally of the democracy that was notorious and apostolic. Somehow, however, the whisperer this time missed the back stairs:—and the king, who had rejected Smirke, confirmed the election in his stead of Fasel, the ally of Godwin and of Mary Wolstoncroft!—The illustration our readers will, we dare say, think was worth the digression; and it will be easily seen, as we have said, that this is not a wholesome constitution for an Academy of the Arts. A body whose independent action within is restrained by the prerogative cannot pretend to a large and independent action without; and a society which has no accountability anywhere, save in so far as it may choose to acknowledge the authority of public opinion, must not complain if it fails to win the public confidence. Nor do we think it accordant with the spirit of the times in which we live, or hitting the position which Art has now taken up as an influence amongst us, that the Crown should *desire* to take some particular Art-institution under its wing, and maintain it prerogatively as against the rest of the artists of England. While it does so, those outside the pale of the privilege are, by royal decree, fighting the battle of their lives at a disadvantage,—carrying heavy weight in the race for fame and the strife for bread. They have to contribute their bricks to the temple of English Art without the help of the straw which the Crown dispenses to the more favoured workers within the walls of the Academy. There can be no great action of the kind which we seek to recommend under this narrow and antiquated scheme:—and it will be well, therefore, that we should pass on to a consideration of the other changes which we desire to see carried out as embodying that enlarged action, that these may assist us in afterwards suggesting the fit method of cure for this defect of constitution.

It is, as we have said, nearly ninety years ago—on the 10th of December, 1768—that the Royal Academy of Arts was founded; and either the scale of the establishment was far too large for that early time, or it is far too narrow now. If forty academicians and twenty associates, with the few engravers added, were then no more than a sufficient representation of the body of English artists, they must, even on the false principle in use, form a wholly inadequate representation after the constituency has increased certainly more than fourfold. If ninety years ago, sixty men could be found worthy of the prizes of the profession,—then, either the prizes are now far too few, or the Arts have declined in England in exactly the same ratio as the artists have increased. Here, the absurdity of the arbitrary and unelastic principle is at once apparent. But, the real error is, that there should be any limitation at all,—that rules should affect to define what must make its own definition, to adjust that which can only adjust itself. To say, that there shall always be sixty persons worthy to wear the laurel, is, to decree that which no Academy, Royal or National, can command:—to say, that there shall never be more, is to put fetters on the wing of Art, which, nevertheless, whenever it is strong and vigorous it will shake off:—to say, that there may be a hundred such persons, but only sixty laurel crowns, is, to wrong the other forty. We have never watched an election for a vacant associateship, in which half a dozen men, perhaps, of equal merit stood for the honour, and the one success made five bitter disappointments, without a feeling of pain. Even if the course of years should ultimately place the six side by side in the Academy, the inequality in the measure of justice severally administered to them has still to be calculated by the length of precedence which one has had over the other. Even as between *them alone*, the matter never comes wholly right:—while, behind them, new candidates, in whose way they must stand, are yearly coming up,—till, in the press of those who crowd the narrow avenue by which the Academy is reached, many a brave heart goes down, never to rise again. By the system of limitation, it cannot be but that many *must* be left behind as well

entitled to wear the academic honours as those who won them:—and the institution which so operates on the Arts of which it affects to have charge, is but a private benefit society,—not a national and fostering institution, and not entitled to be lodged in the palaces of the nation. Instead of a great reconciling and harmonising influence, which the Academy should be, artist-life has been soured and saddened by the heart-bruings and heartaches which its privilege creates. The wrong and the evil fall everywhere:—as much on the Academy which loses the distinguished artist, as on the distinguished artist who misses the Academy. Every man of the qualification who is excluded from an association that undertakes to present in itself the body of recognised English Art, suffers an injustice, and has a mark of depreciation set on him by authority:—and the great corporate figure of the association itself loses something for every great artist that it omits from its list of associates. Surely a scheme that should sweep into the system of the Academy all that is illustrious in the Arts of England, must of necessity give to it a grander presence in the eyes of Europe. The means seem very simple. Why, if an Englishman of eminence knocks for admission at the door of the Academy, should there be the slightest difficulty in opening and letting him in? Why should the academic recognition of his merit be made contingent on death? Why should not the associateship be in the nature of a degree conferred at a university—a certificate of excellence—call it what you will,—but which every artist should be entitled to claim who had proved the excellence which is the qualification? The details of such a scheme need not be here discussed. When the principle shall have been affirmed, they can easily be settled so as to invade no existing right while recognising rights that have hitherto been ignored. It might, for instance, be thought well to give a diploma of associateship not implying membership,—leading, or not leading, to an associate-membership,—as that should lead, or not, up to the academicians' chair:—but nowhere any limitation save the limit of desert. In any case, it would be necessary to have two classes of associateship at first, in order to save the privilege of those who have already acquired it. Whether or not the present number of full academicians should be increased, is a matter of little importance; though probably some augmentation—say, to fifty, or sixty—might be desirable, on account of the greatly enlarged constituency from which the academicians would have to be chosen. At any rate, the academicians' chair would remain, as it is now, the great final prize of the profession,—and would surely gain in dignity from the larger and more enriched basis on which it would be made to stand. In order yet further to enhance that dignity, the academicians should in future be elected, not, as now, by themselves, but by the whole body of associates:—which, under the new constitution, would be, all that is illustrious in the profession. The academicians would elect amongst themselves, as now, their own president, council, &c.—though it might, perhaps, be made a question, how far it would subserve the interests and dignity of Art, that an honour so great as that of the presidentship should pass periodically from hand to hand among the distinguished members of the body,—as it does in the academies which compose the Institute of France. But, as we have said, all these details, and a hundred others, remain for consideration hereafter. All that we desire now, is, to suggest a machinery of some kind by which a long-standing evil may be redressed, and an illustrious private body of artists may elevate themselves into a great National Academy of Art.

The Academy having thus acquired the power of associating to itself all the Art ability which could minister to its illustration, the enlarged figure would naturally suggest larger views, and a new and vigorous constitution would stimulate to a more vigorous course of action. We should probably get quit of all such prescriptions as “a chaplain of high rank,” all nominal memberships and non-professing professorships, and such other slow appurtenances as could only have hung themselves round a system born into the spirit and wearing the livery of a court. Would it be believed, that a body assuming to be teachers of the Arts which they also illustrate, and having faith in the dignity of their own mission, should have “a Professor of Ancient History,” and “a Professor of Ancient Literature,” who are for-

mally elected only that, being "men of distinguished reputation," they may throw the light of that reputation on the Academy,—from whom no duties are demanded, and by whom none are paid? How all this measure of trust and second-hand state! One only wonders how the illustrious men whom the Academy thus contrives to make part of its pageantry consent to hold their offices as "dummies." It is probable, too, that the regenerated institution will get rid of the annual dinner,—if it were only for the purpose of shaking off the spirit of favouring and subservience embodied in the law which regulates the invitations. "The guests," says this enactment, "shall consist exclusively of persons in elevated situations, of high rank, distinguished talents, or known patrons of Art." Of what a concentration of sordidness and sycophancy is this law the expression!—and how is the figure of a great Art-association lowered in its use!—It is scarcely necessary that we should pause here to remind our readers that for these offences in the language and spirit of the constitutions, the present body of academicians are in no degree responsible. They belong to the original conception of the Academy, and to the influences which surrounded such institutions as this in England a century ago. We know that some of the academicians now—and we have no doubt all—would gladly get quit of these and other obnoxious clauses which present them in so unsuitable an aspect before the great body of the public and the profession in general.—But, for another abuse of the privilege which their rank confers—an abuse to which we have more than once had occasion to call attention in this Journal—the academicians must be held answerable now,—as they will be expected to make some provision for its abatement hereafter. We allude to those occasional instances of membership in which the attainment of the full honours of the Academy has been held by the recipient as dispensing from its duties,—wherein the academician maintains his claim to be considered a pillar of the institution by contributing nothing to its illustration or support. We need not refer more specifically here to those individuals who have repaid their admission into the high places of the Academy by a withdrawal of their works from its walls, and justified their title to its dignities by ceasing to deserve them. The cases are familiar to our readers;—and we insist, that theirs is a reading of the diploma which calls loudly for the parliamentary commentator. To understand the document which is an affirmation of the value to the Academy of their work, as an authority for ceasing to work for the Academy—to wear the badge of recognised ability as a dispensation from its exercise—is a discredit to the defaming artist himself, and an insult to the body in whose exhibitions he is a defamer. It is something like stamping a coin as gold currency, for the purpose of withdrawing it from circulation. It might be well to provide, in any reconstruction of this institution—which, by its theory, is meant to be a working institution, not a privileged asylum for indolence—that absence from its exhibition walls for more than a given time, for any other cause than sickness, infirmity, or some other reasonable ground of dispensation, to be pleaded and allowed, shall operate as an abdication of the honours to win which those walls had, before, been perseveringly used.—We would recommend, too, that in the compilation of its new laws, the Academy should exclude all express enactments which are not intended to be faithfully carried out in practice. The first section of their present constitutions defines the qualifications essential to membership;—and one of these is, that the member shall be "resident in Great Britain." The definition is precise; and the policy on which it proceeds is analogous to that on which we have been insisting, that the academicians are bound by his very privilege to be an exhibitor on the walls of the Academy. It is intended that he who wears the academicians' crown shall share his cares;—that he shall be in the way, to take his due part in the execution of those offices, and the division of those responsibilities that belong to the governing body into which he has been elected. As in the case of James the Second—to gratify the royal academicians with a royal smile,—the academic chair should be proclaimed vacant in consequence of any prolonged absence from the seat of his government. Now, this law so positive in its terms, the academicians have taken on themselves to deal with after a fashion which in

itself was a caprice, and in its effect was a wrong. It is well known to our readers, that one of the most distinguished sculptors of modern times—whom death has, alas! removed beyond the possibility of that measure of redress which we trust is at hand—was, in conformity with the enactment, excluded from the honours of the Academy while he lived, on the express ground of his residence in Italy,—while, in violation of it, another distinguished member of the same branch of the profession wears those honours in full, though he has been a resident in the very same Italian city, we believe for twenty years.

The schools of the Royal Academy have always been ably conducted,—as they have been liberally founded, and liberally furnished with all necessary means. We suggest, indeed, that their system is too liberal,—and that under the new constitutions the demerit principle on which they are conducted might well be dispensed with. The system of gratuitous instruction tends only to invite to the schools many who have little other skill thither,—to sow the field of Art with weeds, many of which spring up rankly and perish miserably by the way. It is as much a proper function of an academy to discourage incompetency as it is to encourage genius. An education of any kind that may be had for nothing is a temptation in itself,—whereas, an education to be paid for is usually bought to satisfy an impulse or to cultivate a talent. We do not see why the privilege of attending the schools of the Art Academy should not be purchased by fees, on a moderate scale (with perhaps a power reserved to meet exceptional cases), as it is at the universities, at the medical and anatomical schools, and at all our other educational establishments.

But a National Academy has a far higher mission than any that we have here assigned to it yet, and the business of its professors is not ended when they have taught and lectured in the student schools. Here it is, that the Royal Academy has most signally failed to apprehend its office. It has a commission—when it shall learn to read it aright by the new lights which we hope to see supplied—to educate without as well as within its walls. It has to form as well as to feed the taste of the nation. It has to comment on all the great texts which the walls of our National and other public galleries supply,—and the Art-wealth which the nation has acquired by purchase or by gift, it has to prepare the nation to enjoy. For this purpose, its professors,—working professors all, and all paid for their labour—should lecture, not to the pupils alone, but to the public, and not in the sense only of special training, but in that also of general instruction; and the public, as well as the pupils, should pay an annual subscription or a small fee for admission to such lectures—as they do at the Royal Institution, and at other establishments of the kind in the metropolis. The exhibition admission fee, as a very large source of revenue, legitimately levied by the genius and industry of the artists themselves, and from those only who voluntarily enjoy them, and expended in a humane and generous spirit, would be of course retained; but the Government should require, that certain sufficient days in the course of the season should be set apart for the free circulation of that large body of the public to whom the charge of one shilling is a sentence of exclusion. In a word, the office of a great national incorporation like this is, by all available means, to promote the flow of the fertilising Art-waters throughout the whole framework of the society in the midst of which it is organised;—and the figure of the Academy itself, as the Genius of the waters, should be found sitting and teaching at once by the fountains and by the full stream.

Surely, such objects as these, if they constitute the duty, are also worthy the ambition of a body seeking to stand before Europe as the exponent of British Art, and asking to be magnificently endowed. They suggest, as we anticipated in an early part of this article, the means of their own accomplishment. The Academy must rise, if it would achieve them, from a royal into a national institution. It must have a charter conferring on it powers commensurate with the great action sought,—embodying the conditions and recognising the demands of its new existence,—bringing it into relations with the State, instead of with the Crown,—and giving it a responsibility to the public, instead of only to itself. Again we omit details;—they will be matter for far more serious consideration than the limits of an article will permit.

But the time has come when the Academy must determine whether it will enlarge its scheme and lead the Arts of England, or remain a private society and leave that great office to some other body. The widely expanding influence of Art amongst us has made such an office a want of the times,—and somewhere the mission must fall. Nowhere would the public so willingly see it fall as on a body illustrated by a long tradition of greatness. But the academicians will do well to remember, that the Society of British Artists—the plea for whose establishment arose out of their failure of comprehensive action, and whose own successful action their large figure hitherto impedes—is seeking to follow on their track, and probably needs only their final abdication of their proper function to spring into a vigorous life. Without any public endowment, this society has already attempted to establish schools; and its want of success so far, is likely to make it only the more eager to seize on any opportunity which may present itself for taking steps to redeem its failure;—while it has a charter of its own, which it should not have required had the action of the Royal Academy been equal to the demands of the age. Nor have we forgotten that, some time since, this same Society of British Artists memorialised the Government to locate it in the galleries now occupied by the National Collection, in the event of that collection being removed elsewhere. No minister, we trust, will venture to appropriate so magnificent a property, save for the service of the public, to whom it belongs, largely secured in return. But an institution such as we have attempted to sketch, the public will willingly, we believe, see located in its palace in Trafalgar Square.

ART IN CONTINENTAL STATES.

LILLE.—The Competition for the New Cathedral.—We learn from a statement in a recent number of the *Builder*, that artistic competitors abroad sometimes meet with as little justice as they generally do in our own country. Our readers were lately informed that Messrs. Clutton and Burges, of London, were the successful candidates for erecting the proposed new cathedral at Lille—their designs having been selected from a large number submitted to the committee from all parts of the Continent; but it has just been determined that these gentlemen shall not carry their own plans into execution—the "exigencies of public opinion" requiring that the work should be done by a native, in whose hands the designs of the British artists have been placed, after procuring from them too "explanations and suggestions as to various proposed modifications." Unquestionably the committee had no right to call upon foreigners to compete, if they had foreseen, as they doubtless must, that public opinion would have interfered with their adjudication: their conduct is an example of bad faith which cannot be too strongly condemned. Yet, with a recollection of what is done at home, we ought to be gentle in our reproaches: in England we offer public works to the foreigner, without condescending to invite our countrymen to compete; abroad the foreigner is invited, succeeds in the competition, and the native enjoys the fruits of his labour: we scarcely know which most deserves animadversion.

PARIS.—A new regulation has just been adopted for the Louvre, which is now open to the public every day except Monday.—Intelligence has been received from Rome of the death of M. Bonnardel, the promising young sculptor who gained the first prize in the London Exhibition of 1851, and executed the first prize medal.—Ary Scheffer has sent to his native town, Rotterdam, his painting of "Christ in Gethsemane" for exhibition.

TURN.—A marble statue of the distinguished statesman and author, Cesar Balbo, has just been inaugurated with great ceremony in this city. The statue is the work of Vela, a sculptor of high reputation in Italy: when it was uncovered, the assembled multitude recorded their approbation by a loud burst of enthusiastic cheering.

MEXICO.—The plan for the erection of an edifice for the convenience of artists and Art-societies is likely to be carried out. Above the saloons, which will serve for Art-Union Exhibitions, it is contemplated to erect two stories, one for an Art-Casino, the other for the meeting of learned societies: as many of these already exist here, so others would be formed, all of which would find in such an institution a centre of union. The building is to be erected by a company, and shares have been already taken.

THE ROYAL PICTURES.

CONSTANTINOPLE: THE GOLDEN HORN.

J. Jacobs, Painter. T. A. Prior, Engraver.
Size of the Picture, 3 ft. 2½ in. by 2 ft. 3¼ in.

CONSTANTINOPLE has within the last two years become almost a household word; not only by every hearth throughout the British empire, but wherever the languages of England and France are spoken. Millions have had their thoughts turned with the deepest anxiety or the utmost interest towards a spot of which few comparatively knew much more than the name; and now its mosques and its minarets, its kiosks, its streets, its harbours, and its suburbs, seem almost as familiar to us as the localities in which we dwell. Dioramas and panoramas, pictures and prints, in short, everything which Art can do, have contributed to show what the metropolis of the Moslemite is. Turkey now forms a large and important page in our history; one too which both we and our children may read with mingled feelings of pride, sorrow, and shame; for over the glory of final victory hoods a shadow that obscures our national self-sufficiency, though it cannot dim one spark of the brightness which rests upon the valor, fortune, and endurance of our countrymen.

Under any circumstances, the beautiful picture which is here engraved would find numerous admirers, but as the representation of a place on which our attention has been so long and anxiously fixed, it possesses a double interest. The painter, James Jacobs, is a native of Antwerp; he was born in 1812. A pupil of the Academy of that city, he made his first appearance as an exhibitor by contributing to the *salon* of Brussels, in 1833, three pictures—"Fishermen Disembarking," "Interior of the Citadel of Antwerp after the Bombardment," during the last revolution, and a "House destroyed by a Bombshell;" these pictures attracted notice by the vigour of the artist's touch, and the variety and harmony of his colouring. In the Antwerp Exhibition of 1834, and especially in that of Brussels in 1836, these qualities yet more distinguished his works. In the last-named gallery he had three pictures—a "Seashore in Holland," a "Lighthouse," and a "Calm at Sea;" the first of these was purchased by the government, and the last by the Prince de Ligne. From that time to the present, Jacobs has devoted himself almost exclusively to marine-painting, or to subjects in which the sea or a navigable river forms a principal feature in the composition.

The works of this artist generally show an exuberance of rich and powerful colouring; like our own Daubly, he loves to paint the gorgeous tints of sunrise and sunset; his effects are highly poetical, though perhaps sometimes a little overdone. "The truth of his pictures," writes a foreign critic, "is more poetical than real: without this defect, which is no longer one when it is not greatly exaggerated, this painter would be placed in the first rank of the modern Belgian school." This remark, we must however add, was made when Jacobs was comparatively young—study and experience have now "toned down" his flights of poetical fancy; he retains his brilliancy and rich imagination, but restrains them within the limits of probability.

About two years since he visited the Mediterranean, the Greek Archipelago, and other places in the East; from one of the sketches then made he painted the picture in the Royal Collection—it represents the port of Constantinople, called the "Golden Horn," a safe, capacious, and beautiful harbour which divides the city from Pera; the painter has treated the subject as if every object in it were literally of gold, the whole is lighted up with the deep yellow and crimson tints of an Eastern sunset. In the foreground is a group of picturesque buildings of highly-decorated Saracenic architecture, constituting a wharf where vessels are unloading; this is judiciously balanced on the other side of the composition by several vessels at anchor, whose shadowed sides are opposed to the strong light behind them, while the reflected light of the sun on the water is broken by the figure and the boat, or barge, in the foreground.

This picture—a rich and gorgeous piece of painting—was, we believe, purchased of the artist by Prince Albert: it is now in the collection at Osborne.

GRANITE.

THERE are but few subjects of more interest than the study of those formations, which, from their being seated deeper beneath the earth's surface than other rocks, have been called Primary. It may appear, seeing that many of our mountain ranges, which rise high above the earth's surface, are composed of granite, that there is no sufficient reason for regarding those rocks as more deeply seated than slate and limestone. Examination will, however, prove that all the other rocks, except those which have, like the trap rocks, been forced through the more recent formations, rest upon the granite as a base. In some examples the granite has forced its way through the more recent rocks, which then lie contorted around it; or, as in others, the stratified slates repose upon it in the state in which they were at the time of their consolidation.

"Granite," says Macculloch, in his *System of Geology*, "is one of the most universal rocks, forming some of the highest and most remarkable chains of mountains. It is not, however, limited to such high ranges as the Himalaya or the Alps, or even to the much lower ridges of Britain, since it also occupies many extensive tracts of comparatively level land. This rock has been commonly supposed to be characterised by the pinnacled and serrated form of its mountains, such as the well-known summits of the Alps, and of the Isle of Arran; but this is not the case, for it assumes every variety of outline. The mountains about Loch Etive, in Scotland, have a simple conical form, which is particularly marked in Cruchan; the extensive ridge which surrounds the sources of the Dee, forming the loftiest tract of land in Britain, presents a series of heavy rounded elevations; in Cornwall, in Galloway, and in Sutherland, it offers the same uninteresting aspect; while in many parts of Aberdeenshire it occupies the lowest grounds, presenting large tracts of level surface."

When a granite country is characterised by elevated and precipitous hills and mountains, its surface is covered with numerous detached rocks, diversified here and there with projecting tors or cairns of various fantastic forms, according to the nature of the rock, and of the eroding influences to which they have been subjected. Whenever a granite country is composed of undulating hills, with occasional level spots, though the latter are commonly marshy, the former not unfrequently possess a good soil.

There are many peculiarities in the external features of a granite country. Standing upon a hill, and viewing any wide-spread district of the primary rock, the surface commonly exhibits a system of valleys which run parallel with some central ridge of granite; these longitudinal valleys are intersected by others, which cross them at right angles; and as the intermediate hills are more or less rounded, the surface of the country has an undulating appearance in both directions, which has often been compared to the roll of waves—and these varying, the curves being sometimes regular and gentle, at other times contorted and abrupt, have aptly enough been regarded as resembling the sea when agitated by the wind with different degrees of violence. The valleys thus formed become the channels of rivers, and many a romantic and beautiful scene is thus created, which show in a striking manner the dependence of the picturesque in nature upon great geological phenomena.

We have not now, however, to deal with the picturesque beauties which render the districts of primary rocks special favourites with the landscape-painter. We have to consider merely some of the conditions of a rock which ex-

hibits many varieties, and which is of the utmost importance to the engineer and the architect. Granite, from its extreme durability, is employed in the construction of all great works which are exposed, in a peculiar degree, to the action of one or more of the elements. Our magnificent docks, in which float the largest mercantile navy in the world, are generally constructed with this stone. English and Scotch granites are considered so valuable for this purpose, that the Danish Government are now receiving large quantities of English granite for the construction of docks at Copenhagen; and some very large orders are now being executed in this stone for lighthouses and docks in the Indian seas. The great works going on at Portland will owe their strength to the use of granite, in all those parts which are exposed to the beat of the waves. The Plymouth Breakwater is constructed with blocks of limestone, which have been raised from the neighbouring quarries of Oreston. It was found, however, that this stone, between the high and low-water marks, was subjected to a curiously destructive influence—marine insects perforated it in a remarkable manner. These creatures—*Pholas dactylus*—by burrowing in the stone, were rapidly destroying it. Those perforated blocks have, however, been removed, and granite substituted, which is a stone far too hard for these borers to penetrate.

The bridges which span the Thames have been built chiefly of granite. London Bridge is a remarkable example of granitic architecture—alike for the character of the stone, and for the size of the blocks of which it is constructed. The new works at Westminster Bridge—which are, however, unfortunately suspended, owing mainly to the discussions which have arisen as to the durability and economy of the principles which have been adopted—consist of combinations of granite and iron.

Aberdeen granite, from the quarries of Dand-eingairn, Rubislaw, and Tyrbagger, are extensively used in the Metropolis for kerb and paving stones; and from these quarries the base of the Duke of York's Monument was obtained. The granite of Aberdeen is a grey granite, while that of Peterhead is mainly red, and approaches more nearly to the red granite of Egypt than any other in Great Britain. The Peterhead granite was largely used in the construction of the docks at Smeerness. The pillar of the Duke of York's Monument was from the Stirling Hill quarries, and the abacus from the Seafeld quarries. The beautiful pillars in the library of the British Museum were from the neighbourhood of Peterhead. These were worked at a time when our mechanical appliances were far less perfect than they are at present; they had to be dragged from the quarries over several miles of peaty ground, and in this portion of the labour alone upwards of seventy pounds' worth of timber was expended before the four columns reached the place of shipment. The granite pillars in Fishmongers' Hall were obtained from the Stirling Hill quarries; and the bases of both the Pitt and Fox monuments came from Peterhead. The polished granite which appears on the front of the club-house in Pall Mall has been derived also from this district, as was also the polished stone employed in the new building in the Poultry, near the Mansion House. The quantity of granite shipped from Peterhead in 1855 was 368 tons; the prices obtained varying according to the quality of the stone, from 2s. to 5s. per cubic foot.

Cornish granite, and that obtained from Dartmoor, has long been celebrated. The most extensive workings at the present time are at Lenorna, a few miles from Penzance, which quarries produce a very fine granite, in blocks of almost unlimited size. The district of Constantine, near Helstone, and Carnsee, near Penryn,



Faint, illegible text, possibly bleed-through from the reverse side of the page. The text is arranged in several columns and appears to be a formal document or report.



A. FRIEDLÄNDER

CONSTANTINOPLE, THE GOLDEN CORN

FROM THE VILLAGE IN THE BAY OF CONSTANTINOPLE

have furnished stone for many of the most important metropolitan works,—amongst others, the granite employed as the base and supports of the bronze railings at the British Museum may be named as having been derived from these quarries. The stone for the Scutari Monument is obtained from this region. The Hensborough granite is also largely employed. This and several other varieties worked in quarries in the neighbourhood of St. Austle is shipped from the port of Par. The granite obtained in this neighbourhood presents many peculiar characteristics; some of it is of a porphyritic kind, and its red and black surface renders it available for many ornamental purposes. The sarcophagus for the tomb of the Duke of Wellington is being constructed from one of the porphyries of this curious region, while the supports are worked from the finest specimens of granite obtained from the quarries of the Cheesewring district, near Liskeard. This granite has been selected for the docks at Copenhagen, for many of the more important works in our naval arsenals, and the new docks in London. The tomb of Sir William Molesworth, in the cemetery of Kensal Green, is wrought from this stone; and many persons must remember the beautiful Corinthian column which stood without the western door of the Great Exhibition, which was a fine example of the character and architectural qualities of the Cheesewring granite.

The Cornish granite exported in 1855, was 473,716 feet, which is equal to about 35,000 tons, and its value is estimated at £75,700.* The granite of the Dartmoor range varies much in character and quality, and is used in some of our largest works: at Laina, Plymouth, and Tolness, 5000 tons were shipped last year.

Granite, from its durability, is commonly employed for external work, but it is capable of being worked into objects of ornament, and for decorative purposes might be used with much advantage, and would give variety to many architectural works. In the lower hall of the Museum of Practical Geology, are many examples in illustration of this. In the table-cases will be found cubes of granite from nearly all the districts producing granite in this country. These cubes show the stone in its rough state, dressed, and polished. A pavement of the Aberdeen and Peterhead granite, some pilasters, an enormous vase and pedestal, exhibit the working qualifications of these stones. Pedestals of the more ornamental varieties of the Cornish granite will also claim attention, showing, as they do, the variety of colour and of crystallization which can be obtained; the degree of polish of which these stones are susceptible, and their working capabilities. Granite, in the common and original acceptation of the term, denotes a rock composed of felspar, quartz, and mica. It frequently contains, in addition to these, some other minerals, but they are not essential to true granite.

The component minerals of this stone are united together by a confused crystallization, not only mutually penetrating and interlocking with each other, but sometimes the small crystals of one are completely enveloped in the large crystals of a different kind of mineral. It is a very common occurrence for one, or even more, of these minerals to be developed in large crystals, in a granular basis of the whole, so as to constitute a porphyritic granite.

Granite has usually been considered as a rock which has been produced, by a process of slow cooling, from a condition of igneous fusion. There are, however, some objections to this

view; and there are certainly some conditions observable which are scarcely reconcilable with the theory which refers this rock to an igneous origin; but this is not a question for consideration at the present time. There are, however, some conditions which deserve more attention than they have received, which appear to bear strongly upon the question of the durability of the stone.

Granite will be found to possess a certain kind of stratification; the quarrymen commonly speak of beds, and they state that considerable differences are observable in the solidity of the different beds. This stone is also jointed, and these joints have almost always, in the same district, the same general line of direction; these lines of natural dislocation in Cornwall and Devonshire frequently agree, very nearly, with magnetic north and south.

There are also lines of cleavage. The cleavage of granite into regular forms, depends on the structure of the rock—this is proved by its only taking place in one direction, which corresponds with its crystalline arrangements. The workmen are well acquainted with this fact, and therefore never attempt to break a rock in a line diagonal thereto. Mr. Kays has collected much useful information on this point. The granite of Pearyn is principally composed of two kinds; one is a hard and compact rock, which is extensively worked and shipped for the London market. It runs in parallel ranges, bearing N.E. and S.W., through the other kind, which is of a softer and a coarser texture. The hard granite is cleaved into quadrangular blocks; and it has been ascertained by long experience that the cleavage cannot be effected in any direction, but only in three, with any regularity, and that each of these require a different degree of force; thus, if the horizontal cleavage demand a power denoted by two, the perpendicular cleavages, crossing each other, will be in the proportion of three and five; the latter commonly intersects the larger felspar crystals, whilst the former is parallel therewith, and may be termed the longitudinal cleavage. Near Pearyn the last mentioned cleavage runs N.N.W. and S.S.E., varying 15° or 20° either way; it generally coincides with one of the vertical natural joints, though in many instances it does not correspond therewith, but crosses them often at an angle of 30° or 40°.

At the Cheesewring the weakest line is found to be that which corresponds with the line of bedding; the next line of cleavage, corresponding with the general range of the felspar crystals, varies from nearly N. and S. to about 35° west of magnetic north.

These facts cannot fail to lead ultimately to some important information, and must determine the lines in which the granite can be most advantageously placed, so as to ensure the greatest amount of durability.

It is not usually thought that granite is much effected by change of temperature; during frost, however, it is worked with difficulty, and the rapidly with which, upon a thaw, it again softens, and becomes *free* before the tool is not a little singular.

Granite, in certain situations, appears liable to decomposition; its felspar crystals giving way, and producing the valuable Kaolin, or China clay, so largely used in our porcelain manufacture. Cornwall, in 1855, produced of this China clay 60,188 tons, worth £51,159; while Devonshire exported 1100 tons. The granite in a semi-state of disintegration, is sold as China stone for glazing porcelain; of this was exported from Cornwall 19,961 tons, valued at £17,964. Such is an outline sketch of the more interesting facts connected with this most important building stone.

R. HUNT.

SUGGESTIONS OF SUBJECT TO THE STUDENT IN ART.*

BY AN OLD TRAVELLER.

CHAPTER VIII.

Predilections of the Early Painters—Subjects from Scriptures—From the Legends of the Saints—Practices of our own time capable of Amelioration—Rome and her Visitors—The Museo Capramonti—The Nuovo Braccio—Statue of Demosthenes—The Sculptor and his Subject—The Stranger on the Hearth—Abraxas the Suppliant—The Lustral Rites are granted—Admiration at the Chase—Death of Atys—Inundation of the Nile—Men of Corinth at Petra—The Mother in the Portico—Hesitation of the Ewings—Laila Hestering—Escape of Cypselus—Fulfillment of the Oracle—Issus—Idra and Armida—The Eneatress in the Camp—Instructions—Godfrey before Jerusalem—Clorinda—The Leader wounded—Ariosto—Orlando and the Dead Palmyre—The Peasant and the Peasant—Fidelity—Barrel of the Fathers—Words of Wisdom—Fidelity and Ingenuity—Childhood—Youth—The Ocean-bark—The Torrent—Demand of the Bride—Lovers at the Shrine of Balder.

THE earlier schools of painting are reproached with too exclusive an attachment to one class of subjects—those derived from Holy Writ and from the Legends of the Saints, that is to say: nor is the charge without foundation. But, to say nothing, at the present time, of all the many reasons that might be assigned to explain, if not entirely to justify, their choice, might we not more profitably turn our attention to the question, whether we do not ourselves too rarely lift our thoughts to the grand inspiring themes presented by those inexhaustible treasures, more especially by the first named? For how largely extended are the vistas opening to the sons of Art with every page they turn in the long period of the Hebrew history; and how numerous are the yet more touching episodes offering themselves to their holiest aspirations in the later annals of the New Testament!

Not to every man is it given to tread this high and hallowed ground, you will say, and you are right—the most exalted among you may well feel awe-struck, and pause long before he approach the solemn subjects in question; but for him, the true artist—and to none of inferior character could they be fittingly named—the hour does come when all things are permitted to his research. There are moments when the grandest reveal the most awful of their mysteries to his perception—when the holiest are not too sacred for his reverential gaze. For him it is that the pencil of immortals has been imbued with those hues of heaven, vouchsafed to such as he is, in their purest dreams. Let him accept in all humility the high privilege thus conferred upon him; let him seize the moment, ere the glory of the vision shall become too resplendent for his mortal eyes, and so be lost for the multitudes less favoured, who might else rejoice therein through all coming ages.

We do not now name any special instance of the treasures reserved for the most favoured son of Art in these, the first and richest of his sources; although more than one great task—destined for the noblest only—rise with impressive majesty before us. These are subjects that should be self-inspired—taken as they present themselves, at the rightful moment: they will then emanate, as should be, from the mind awakened to their momentous importance—from the heart enlarged for their reception: firmly shall the priest-like artist then fix his gaze, with power to meet, undazzled, the light ever beaming from those lofty regions wherein his clutched imagination shall then have unfolded all the force of her pinions. Thus alone can they be worthily treated; but let him to whom the moment shall be vouchsafed, see that he suffer it not to pass unfructified—let him “work while it is called to-day, for the night cometh wherein no man can work.”

Much has been said, and much written, of the various emotions experienced by such as stand for the first time before the gates of Rome—much and truly; since there are few events, among those of secondary importance in the life of man, better calculated to make a profound impression, than is the first arrival of the traveller in Rome. Yet, with a more effective eloquence, might that speaker expatiate, who should describe the feelings agitating the heart of him who returns for the second, third—nay, tenth or twentieth time, to that true centre of

* For a detailed statement of the total value of our mineral produce, and much information respecting the building stones of the United Kingdom, see “Mineral Statistics of the United Kingdom of Great Britain and Ireland for 1855.” By Robert Hunt, F.R.S. Published by order of the Lords Commissioners of Her Majesty’s Treasury. Longmans & Co.

affection for all whose love is given to Art in its highest manifestations.

But, like other feelings deeply seated, these are less frequently insisted on, nor will any attempt to describe them be made here; confining ourselves within narrower limits, we will but ask the frequent sojourner in the beloved city, if—even at this broad distance, though seas are rolling and half a world is interposing its diminishing influence between him and the seven hills—his heart do not even now leap in his bosom, as he recalls the passionate eagerness wherewith he hastens to revisit the more immediate objects of his predilection—once those gates are past?

Is not that moment, when these—whatever, among Rome's myriad treasures, may be the chosen—once more stand, revealing their beauties to his gladdened gaze—so long to be remembered, and ever returned to with new delight? Happy they whose lives can reckon many such! still happier those to whom fair Hope gives promise of yet many to come in the future!—you, who read these words, are for the most part in the last-named category. So much the better; and in your case may the bright-eyed syren prove even fairer than her promise, although to do so be not always her wont.

In that part of the galleries of the Vatican known as the Museo Chiaramonti, in the hall usually called the Nuovo Braccio, and standing on the right of him whose blessed hap it is to pass his hours in that glorious treasure-house; on his right, I say, as he descends the gallery from its entrance in the great corridor of Brunnate,* is the one object ever devoutly sought and reverently approached with the first salutations of return, by the present writer—even before the Apollo—nay, even before the Laocoon, which last obtains the second visit. This is a statue of Demosthenes, somewhat larger than life, and obviously produced in the best period of Art's development.

With the exception of the hands, and the scroll held by the orator in his right hand, no part of the work has suffered restoration—all beside is of the purest Greek workmanship. The attitude of the figure is noble and dignified; the face is full of thought; the expression is calm and grave; the draperies are simple and graceful; and over the whole is breathed a spirit of repose, investing the presence of this majestic form with a power forbidding the approach of every trivial thought: nay, suffering none save the best and purest feelings to have birth within the space made sacred by that hequet of beauty, wherewith the grand and solemn past hath enriched all future time.

And how gladly would the beholder resign himself to those salutary influences, undisturbed by recollection of the frailties that marred the life of the original! how fain would one believe the statesman and orator as noble in his life as the sculptor has rendered him in his looks! but this may not be. To Art alone do we give all our worship here; for the subject, we have only the wish that we could forget the cowardice marring the soldier; the yet harsh corruption that disgraced the statesman. We cannot fail to glorify the fine conception, so happily executed, of the certainly exalted Sculptor—whose name we have not been able to make certain, among the conflicting testimony assigning it to the few that could be supposed capable of its production—but for Demosthenes himself, apart from his power as an orator, to which we can offer nothing better than admiration, the memory supplies few recollections of his career that are not shaded by regrets.†

The statue was discovered in excavations made near the Villa Aldobrandini, at Frascati, and was immediately secured for the sovereign pontiff, then Gregory XVI., who placed it where it now stands. It will one day be removed, without doubt, into some fancied, set apart for special objects, as are those well-remembered "Gabinetti," assigned to the Antinous, the Laocoon, the Apollo, and some few others, all dearly familiar to the artist, whose best-loved haunt is the matchless sculpture galleries of the Vatican.

It was while ourselves privileged to listen to the discussion of some few among the lovers of Art who

* So called, as the reader will at once perceive, from that excellent master by whom the magnificent gallery thus named was constructed; and to whom is indeed due very much of the credit, more commonly attributed to Michael Angelo, for other parts of the Vatican and St. Peter's.

† See Becker, "Demosthenes als Staatsmann und Redner." Halle, 1816 and 1830.

have most worthily paced those halls of beauty and greatness, that we were made acquainted with designs, never carried beyond the first thought, although well meriting a more extended existence. And who shall say that they may not yet secure such from some young aspirant of the coming times? Let us, at least, lay the subjects before him; and if the student in sculpture or painting shall find any one among them awaken a congenial chord in his bosom, he may, perchance, be tempted to look further into their sources.*

You have first a youth, or one who has but just attained to manhood, for the authorities do not tell us his exact age; he is seated amidst the ashes of the hearth in a Lydian dwelling.† Covered almost entirely by the robe, wherein, complying with the custom imposed on all in his condition, he has carefully involved his person, you do but see the profile of his face, yet this, no less than his attitude, gives evidence of profound grief and humiliation. The expression is not that of guilt, still less is there any touch of baseness in the aspect, which is indeed both noble and beautiful. The eyes of the mourner are bent on the ground; and beside him, fixed firmly into the earth, is the weapon wherewith it has been his unhappy chance to commit the homicide which compels him thus to seek protection and aid from one powerful enough to shield, and of condition conferring the ability to absolve him from the consequences of his involuntary crime. To that end then is the stranger now seated on the hearth of Cressus; and it is the King of Lydia, a man of ripe age and imposing figure, whom you see looking gravely on the suppliant, imploring refuge and the rites of expiation at his hands.

And the looks of Cressus show us that these will not be refused. In reply to the king's inquiry, the afflicted youth has said—

"I am the son of Gordius, and grandson of Minos. My name is Adrastus: unwittingly have I slain my brother. Driven to exile by my father, and left of all, I come here thy suppliant, O king!"

And the king replies—
"You are the child of my friends, and you are come to your friends; abide in my house, where you shall know no want, and hear this calamity as meekly as you may."

The lustral waters are prepared accordingly, with all beside demanded by the ceremonies of expiation; ‡ the Furies receive their propitiatory offerings; and these rites accomplished, invocations are duly made to Jove the Expiator, when Adrastus takes up his residence in the palace of the king.

In our second subject we again have the manly and graceful figure of Adrastus, but he is now engaged with Atys, the beloved son of the Lydian King, in chase of a monstrous boar.—Ah! Vellati, how wouldst thou depict him for us, and how would thy Rome, the beloved, rejoice in the work!—a boar that has ravaged the country, and for the destruction whereof Cressus has reluctantly, and in dread of menacing omens, permitted his son to go forth; but not until he has solemnly confided him to the guardianship of Adrastus, who accepts the charge with upright mind, well resolved to fulfil it at risk of his life.

But who shall alter the decrees of the gods?—the powerful boar-spear, held in watchful readiness for the defence of his companion, has been poised in his vigorous hand, still raised for the act, the weapon has gone, making its own wild music through the air, and now stands quivering in the side, almost not of the boar, but of that other beautiful youth, the treasure of his benefactor, the doomed Atys, whom you see falling to earth, and who must die beneath the stroke. Woe! woe! for the unhappy Adrastus; see the sorrow to death that is already gnawing at his heart! He has fulfilled the oracle which had foretold this fate for his son Atys to Cressus, who had vainly

* The student will find the three next to follow in Herodotus, Hist. book i. 24—45; book v. 92. If he prefer a translation, a faithful and good one may be found in that used by the present writer—to whom the Greek original is unknown—the work of Laurent, namely, translated from the text of Gaisford, vol. i. book i., vol. ii. book v. Oxford, 1846.

† In Homer, "Odyssey," vii. 153, we have a remarkable instance of the custom here alluded to. Ulysses, after imploring the assistance of Alcinous, seats himself on the ashes of the hearth. See Laurent's Herodotus, *supra*, vol. i. 19, note.

‡ See Apollonius Rhodius, "Argonautics." Oxford, 1771 or 1779. See also Laurent, *supra*.

striven to avert the misfortune by withholding the youth from arms and the chase, until, yielding to his entreaty, he had permitted him to come forth on this fatal morn—ad for this! Woe! deep, irremediable woe for Adrastus! Nor will he further seek to struggle with the destiny that oppresses him—pass some few short, fleeting hours, and he too will join the shades below. Self-immolated, he shall fall on the tomb of Atys, and the god, before implacable, shall at length be appeased.

From the same peculiar series of histories, but of widely different character, here follows another of the subjects in question.

Standing beneath the vestibule of a house at Petra, not far removed from the radiant and luxurious, yet wild and refined and learned city of Corinth, whose domes may be discerned in the distance, is a company of ten men, to whom and from the house (there has advanced a woman: she is not remarkable for beauty, nor in her first youth, but is invested with the interest ever accorded to the character of a mother, and such is the relation she bears to the fair infant whom you see her placing in the arms of the man standing foremost of that company. You cannot doubt this, as you mark the looks of tender love and pride that light up her face as she resigns her treasure to his hands. The woman is Labda, a daughter of the Bæchiæde, "but being half from birth, no man of her own people would take her to wife;" wherefore her father, Amphion, has bestowed her on the son of Echarras, even Ælion, and to him she has borne the son but now confided to the arms of the stranger.

But of this infant the oracle has said:—
"He shall be a lion on your path, O Corinthians! Strong, a devourer of flesh, his power shall relax the joints of many. On these things brood well, ye who dwell around fair Piræne and in frowning Corinth!—an eagle in the rocks shall bring him from afar to be your bane."

These men are the envoys of Corinth, sent hither to destroy the son of Ælion, and resolving that he who first receives the child shall dash him on the rocks beside the dwelling. But the boy smiles brightly in the face of his intended murderer, and the latter, rendered incapable of his dark design by that sweet aspect, has placed his charge in the hands of the next: disarmed by the innocence of the babe, this man also refrains from doing him injury, and he passes ultimately through the whole of the ambassadors, the tenth delivering him unhurt to the arms of his mother. What follows may supply you with a second picture.

The baffled Corinthians retire to a short distance, but they pause before a second door of the dwelling, and concealed within the shelter of this, Labda—who had first brought her infant forth, supposing the strangers to seek it for the love they bore to its father, but had now become suspicious of their intent—hears them reviling each other for the weakness that all had displayed in sparing the child. Then, fearing they might yet return, she resolves to hide her boy in a bee-hive standing near, or as some authorities have it, in a chest.

The event was as her fears had suggested, the Corinthians came back, but the place of concealment chosen by the mother eluded their search.—The gods had decreed that calamity should arise to Corinth by means of Ælion's progeny; and the men departed to the city whence they had come, determined on reporting to those who had sent them that their errand had been accomplished.

Thus the child lived to fulfil the oracle; he was called Cypselus, from the chest, or beehive, wherein he had lain concealed; and ultimately, as most of you will remember, became the tyrant of that name, by whom Corinth was so cruelly misgoverned during thirty years.

Admirable are the pictures, constantly rising to the eyes of the reader, as he lingers over the noble and graceful stanzas of the "Jerusalem Liberata." You can open no page wherein they do not abound; how then does it happen that from a book so much read in our country there is yet so little painted? "The Erminia" you will say—and I remember that Erminia has been made familiar in our galleries; but Rinaldo, but Tancredi; but the pious Godfrey himself—to say nothing of the pagan leaders, all legitimate subjects for painting—have appeared but very rarely on the canvas. Of Olinda and

Sophronia the episode is familiar to all readers, but is not so widely known in our galleries. Neither is the radiant Armida so frequently represented as one might fairly suppose she would be, her wondrous beauty and the power of her fascinations considered. What, for example, could you do better than exhibit her? I will not say when casting her toils around Eustazio, as she threads her way across the crowded camp, nor when she subsequently sets forth her plausible story before the Christian chief himself and his most trusty councillors, although either occasion might serve your purpose well; let us take her at an earlier period, and show her listening to the lore of the Danaeene Idraote, as he prepares her for that enterprise of deception which she ultimately carries out with so much success.

Hear first but some few of the words wherein our author describes this "fairest maid in all the East," as one of Tasso's numerous translators renders his—

" Donna cui di bella le prime lodì
Conecchia l' Oriente."

One stanza shall suffice; nor is even that required for the aid of your imagination, ever ready as she doubtless is to supply all riches for every need—

" Fa nave crespè l' aura al erin disolto
Che natura per se rinterza in onda.
Stassi l' avam s'guardo, in se raccolto,
B' i tesori d' Amore, e i suoi naucoide.
Dolce color di rose in quel bel volto
Fra l' avorio sì stupido e i coralloi.
Ma nella bocca, om' esce aura amorosa,
Sola rosseggia, e semplice la rosa."

The translation that follows is from the work of Captain Alexander Robertson:—

" The unbound masses of her silken hair
In waves, like from the breezes, float,
Within herself she treasures up her care,
Looks freighted with rich stores of amorous thought.
A rosy hue upon her visage fair,
With ivory's hue is mingled and interwrought,
But on her lips, whence breathes a rich perfume,
Blushes, unmixed, the simple rose's bloom."

Hear, furthermore, the opening portion of the words addressed to this fair vision by her hapless kinsman—the dark enchanter Idraote; for in them you shall find significant intimations as to the character of beauty wherewith she is to be endowed:—

" Dice: o diletta mia, che sotto bianchi
Capelli e fra sì tenero scambianza
Cunतो scemo e ost' viltie assennali,
E già nell' arti mie me stesso avauze;
Gran pensier vulgo, e se tu lui secondi,
Seguiterai gli effetti alle speranze.
Tessè la tela est' in every virgin who,
Di tanto vecchio essentrice aridla."

" Vanne al campo nemico: ivi s' impleghi
Ogni arte femminil eh' amore allieti;
Bagna di pianto e fa melati i preghi;
Tromba e confondi ost' sospiri d' affetti:
Bella doicente e miserabil pieghi
Al tuo volere i più osinati petti:
Vola il soverchio andar con la vergogna,
E fa matto del vero alla menzogna."

" Prendi, s' esser potrà, Godfredo all' esca
De' doli e sguardi e de' bel letti adorni;
Sì chi all' uom vengiato omal ritercesca
L' inimicizia guerra, e la distorni.
Se ciò non puoi, gli altri più granuli adescava;
Mene gli in parte ost' atom mai non torni.
Poi distingue i consigli. Al fin le dice:
Per la fe, per la patria il tutto lice."

Thus rendered by Captain Robertson:—

" He said, "O dearly loved! thy looks are fair,
And thy sweet face seems innocent of guile;
Yet old thy heart, and thou dost hold thy heart to dare;
And skilled art thou in every virgin's wile,
By thy assistance I great plans prepare,
Great ends I hope to gain if fortune smile.
Weave thou the web, as my advice directs;
Nobly perform what timid age projects."

" Go to the hostile camp, and practise there
All arts of woman that to love allure;
Let tears flow freely, speak soft words of prayer,
And mingling sighs with broken words, adjure:
So shall the charms of beauty in despite
By love or pity hardest hearts secure.
Let modesty your daring hopes disguise,
And spread the garb of truth o'er all your lies."

" Endeavour first Godfredo to ensnare
With sweetest smiles by flatteries outlured;
For men who love, from war would fain bebar,
And in war's toils have seldom persevered.
If he resist, some of his chiefs lead where
They may be kept secure, and no more feared.
If other counsels gave, and lastly said,
"All things are right our king and faith that aid."

* Tasso, Ger. Lib. canto iv. stanza 20.
† Edinburgh and London, 1833.
‡ Tasso, *id supra*, canto iv. stanza 24—23.

Differing entirely in character, but of equal merit, and equally appropriate to the purposes of the painter, is that passage in the eleventh canto, which describes the assault on the walls of Jerusalem, wherein Godfrey appears in person, and is wounded by Clorinda. First you have the bold and beautiful amazon, her bow, menacingly bent on the Christian assailants, in her hand:—

" E il macchinè e d'arme han pieno avanti
Tutto quel muro a cui soggiace il piano:
E quindi, in forma d'orion gigante,
Dalla cinctura in su sorge il Soldano;
Gialli tra' merli il balucastro Argante
Torreggia, e disceperlo è di lontano:
E in su la torre all'oscura angolare,
Sovra tutti Clorinda eccelsa appare."

" A costei la faretra e il grave incarco
Dell' acuto qualtralla al tergo pendè.
Ella già nel' armi ha preso l' arco,
E già lo stral' v' ha sotto corda, e l' lente:
E disiosa di ferire, al varco
La bella archera i suoi nemici attende,
Tal gli credian la vergine di Belo
Fra l' alte nubi scettar dal cielo."

Rendered by the same translator in the verses that follow:—

" On the north wall there had been stored before
Missiles, and every species of machine;
There, rising like a horrid giant o'er
The wall, was, from the waist, the sultan seen;
There, 'twixt two merlons standing, like a tower,
Far off was seen Argante's threatening mien;
There, on the loftiest tower, where emils the wall,
Was seen Clorinda, far above them all."

" Her quiver, with sharp-pointed arrows stored,
Was from her back—a weighty load—suspended.
A shaft she chooses, fits it to the cord,
Already in her hand the bow is bowed:
Thus eager to reel her foes adrovered
The lovely archer their approach attended.
So was cresswile the maid of Helos seen,
When from the clouds she showered her arrows keen."

Thus prepared, the fearless amazon receives her enemies; and constantly aiming at some prominent leader, has had many among the noblest of the Christian captains low: Clothaire, Ademar, the Count of Anboise, and Palanede, have already fallen, when Godfrey himself, advancing towards the tower she thus stubbornly defends, and which now seems tottering to its fall, is wounded by one of those merring darts. The state of things, as required for your purpose, is described as follows:—

" Così la torre sopra, e più di sotto
L' inquietoso si balza per arca;
Omè eminata omal furato e rotto,
A disceper l' interno vie scerete.
Essi non lunge il capitano condolto
Al compassato e tremolo petto,
Nel suo senno maggior tutto ritrilluso,
Che rade volte ha di porlar in uso:"

" E quindi cauto rimando spia,
E scende velle Solimano abbasso,
E per il' alta difesa, ove s' apra
Fra le ruine il periglioso passo;
E rimando della sublime via
Clorinda in guardia e l' cavalier Cressno.
Così guardava; e già sental il core
Tutto avvanpar di generoso ardore."

" Omè rivolto, dice al buon Sigiero
Che gli portava un altro senno e l' arco:
Om ni porgi, o fedel mio scendiero,
Cotesto meno assai gravoso incarco;
Che tentò di trapassar piantiero
So dirupati sassi il dubbio varco:
E tempo è ben, eh' adema nobili opra
Della nostra virtute omni si scopra."

" Così, mirato scudo, appena disse;
Quando a lui venne una saetta a volo,
E nella gamba il colpo, e la trasse
Nel più nervoso ost' è più acuto il dolo.
Che di tua man, Clorinda, il colpo uscisse,
La fama il conta, e tuo l' onor n' è solo;
Se questo di servaggio o morte schiva
La tua gente paguina, a lo s' ascriva."

Translated by Captain Robertson in the stanzas that follow:—

" The tower above, still more the ram below,
Battered the wall; this, shaken to its base,
Began, through perforated rents, to show
The paths it screened, and the lateral ways;
Godfrey, who thought it near its overthrow,
Approached the wall, its shaken strength surveys,
Completely covered by an ample shield,
One seldom a set, which all his form concealed:"

" With cautious eyes examining the rent,
He from above saw Soliman descend,
And mid the ruins his bold front present,
Resolved the perilous passage to defend,
Clorinda, to protect the battlement,
With the Cressian cavalier remained;
This seeing, he already felt within
A generous heat to fire his heart benign."

* See canto xi. stanza 27, 28.
† Tasso, *id supra*, canto xi. stanza 31, et seq.

" To goot Sigiero then, who he re his bow
And a light shield, thit Godfrey, turning, say,
"O faithful servant, let me now forego
This shield for one more light, that so I may
First mount the breach, and to the host first: now
Amid these toppling stones a dubious way:
Full time it is, by some illustrious deed,
My valour should be shown to those I lead."

" Scarce had he changed his shield, had uttered senno
These words, when from the walls a shaft they shot
Which struck the chief, and deep his leg did pierce
Where nerves abound, and pain is most acute.
By this, Clorinda,—so does Fame rehearse,—
The wound was given; all the renown impute
To thee alone, that death and servitude
Ded, on that day, thy pagan race dede."

No lack of picture for him who revels amid the rich pages of Tasso, as even from these few passages is proved abundantly. Others of the Italian poets present them in almost equal abundance; yet is the writer compelled to admit that in Dante alone will you find matter of equal interest. Many are the striking portraits wherewith we would fain direct your attention in the last-named author; but, for the moment, let us bestow the small space yet remaining to us on another, also much admired by excellent judges, although by no means so well beloved by your poor scribe and servant now in presence.

In the latter part of the twenty-ninth, and the first stanza of the thirtieth canto of his "Orlando Furioso," Ariosto—to whom it is that we refer—describes the following, among other strange vagaries performed by the Paladins in his madness. He has dragged the dead paltry of Angelica* to a broad estuary of the sea, where—

" Gli fu forza il calavro fuscicare,"

says the poet, "he was compelled to leave the carcass," since he can no longer drag it outward. If then crosses the river by swimming, an accomplishment wherein he is equal to the otter, says Ariosto; and on the shore thus gained, he finds a shepherd mounted on a good horse. To this man Orlando approaches with the following words:—

" Vorrei del tuo rimin, gli disse il matto
Colla giovanca mia far un baratto
" Io te la mostrero di qui, se vuoi;
Che morta la sull' altra riva giace:
La poltra far in mollear il pol.
Altro difetto in lei non mi dispiace
Con qualche giunta il rimin far mi puoi
Smuttiane in cortesia, perchè mi piace.
Il pastor ride, e senz' altra risposita
Va verso il gando, e dal pezzo si scosta.
" Io voglio il tuo cavallo d'ora, non d'oggi
Suggiuste Orlando, e con d'ora si mosse,
Avea un baston con molti spessi e sottili
Quel pastor scese, e il pallino percosse.
La rabbia e l' ira passo tutti i modi
Del Conte."

This, to him who shall make choice of the subject, is perhaps the most favourable moment for his purpose. Useful studies of unsecular action, or of the animal form in death, might perhaps be declined from the earlier portion of the passage; and the approach of Orlando to the brink of the river might, for those purposes, be judiciously selected as a second subject—but this is a question that may safely be left to the taste and judgment of the student.

Turning from the Ausonian poets, and seeking other climes, let us try whether we may not find

* See canto xxix., stanza 67, et seq.
† Not being able to obtain one of the accredited translations of Ariosto in time for the present occasion, the writer substitutes the following in preference to leaving any reader, who may prefer an English rendering to the original, with his desire unfulfilled.—

" I want thy wretched horse! " the maniac cried,
" Dismount, and take thou mine—there, on the stream's
far side
She lies, stark dead. Thou'lt cure her at thy leisure;
No other fruit she hath. Hast, give me thine,
With one bit beside in fair exchange—the measure
I make not too exact—so thou heliue
Thy will in dulcious haste to do my pleasure.
Give me thy horse, I say, and take thou mine!"
The shepherd hears, then silently rides on
Smiling, and to the water-side is gone.
But after him Orlando. " Halt! ho there!
Dost thou not hear me, man? I want thy horse!"
Then doth the swain his knotted staff prepare
To strike the Paladin.—The raging bore
Of that blind fury, words may not declare,
Rushing, as this he saw, with heading course
Thro' the mad Count's hind breast!—he springs to meet
The upraised hand.—
Canto xxx., stanza 5, et seq.

something to our purpose in a work, greatly admired at the time when it was first made known to the English public, but which has not attracted much attention from our students in Art, so far as the present writer has been able to ascertain. We allude to the Swedish poem of "Frithiof," the most important production of its author, Esaias Tegner, Bishop of Vexjö, and, in the estimation of his compatriots, the first poet of Sweden.

The tale related is one of true love; but within it—and therefore should there not?—are interwoven words of eternal wisdom; here, for example, are a few of those uttered by Thorsten Vikingsson to his son Frithiof, the hero of the poem. Let us premise, for the better comprehension of such as do not know the work, that Thorsten is the vowed friend, the "warrior-brother" of King Bele, who has called his own two sons, together with the son of Thorsten, to receive his dying farewell; that part of the ceremony—of which you shall presently have a slight description—concluded, Thorsten speaks, and as follows:—

"Thereafter arose Vikingsson—he spake in manly tone—
"It seemeth fit that Bele king must pass away alone;
We twain have shared the chances of life's adventurous game,
And time is coming fast, when we may share our death the same.

"And length of days, son Frithiof, hath told a tale to me,
And whispered many warnings, which now I give to thee;
As Odin's black-winged messengers descend upon the tomb,
So on the lips of aged men there sits the surest doom.

"First, hold the holy gods in awe—in awe for good and ill,
Like storm and sunshine come of heaven, and visiting at will,
The eye of heaven sees the thoughts that dwell within the mind,
And later days repay the sins of years that lie behind.

"Thyself shalt die, and all shall die belonging unto thee,
But one thing mark me, Frithiof, shall live eternally—
The judgment over dead men; so strive both day and night
To think the thoughts of noble minds, and do the thing that's right."

Here, you will say, is no picture, and you are right; but preceding these are lines wherein you will find a highly effective one, setting before us all the chief characters of the story—one only excepted, who shall appear in due time. The words are these:—

"King Bele stood in council-hall, he leaned him on his staff,
Beside him Thorsten Vikingsson, that Bretwald* bold and brave;
His aged warrior-brother, a hundred years had he,
With scars like runes, and hoary hair, so silver white to see.

"They stood within the presence-hall, their looks were haught and high,
Were like two ancient heathen shrines, that half in ruins lie;
* * * * *

"Then Bele king was first to speak—"My days are well-nigh sped,
The sweetest mead is tasteless now, my helm weighs down my head;
But even as each earthly bliss is fading into gloom,
Valhalla seems more bright and clear—I turn me towards the tomb.

"And hither have I called my sons, and called me also thine,
That each may hear in heedfulness these latest words of mine;
That I may speak, admonishing, before those eagles young."
* * * * *

"So, as the king had bidden them, they entered in the room;
The first and foremost Helge came—a man of craft and gloom;
He loved to live with priest and seer, and by their altars stand;
He came from groves of sacrifice, and blood was on his hand.†

"And after him came Hjalman, a light-haired youth was he,
His looks had come of noble blood, yet looked he womanly;
It seemed as tho' the sword he wore had but been donned in jest,
He looked like maiden fair, disguised beneath a hero's vest.

* Bretwald, or Bretwald— a leader or chief.

† This may serve to show that it was not with the priest of a true religion, the seer of a pure creed, that the darkness Helge loved to dwell. Our author is indeed not the man to intimate disrespect of aught truly venerable, as will become obvious in our further progress.

"The last of all came Frithiof—he wore a garb of blue,
Was taller by a head's height than the taller of the two;
He stood between the brethren twain, as day, so calm and bright,
May stand between the ruddy morn and dark discoloured night."

To these youths, thus assembled, the old monarch addresses words of wisdom, adapting his counsels to the necessities arising from the character of each listener; thus, to the elder he says, remembering his narrow and ascetic fanaticism:—

"O Godhead's great, O Helge king, in Disarsala* dwell,
But not as snails or limpets do, in close and shut-up shell;
As far as day's glad light may shine, as far as sound may thy,
As far as thought may wing itself, are Godheads great and high."

And further, referring to the harshness and cruelty which subsequently appeared in the character of the elder son, he says:—

"Be not too stern, O Helge king, yet ready to defend;
The swords that be the best to bite, are eye the best to bend."

with much beside to the same purpose.

To the lightness of his younger child the wise parent applies an exhortation to more earnestness of purpose, in the lines that follow:—

"O Hjalman, mark! a joyful mind is e'er a joyful thing,
But levity befiteth none, and least of all a king;
With hops and honey, well combined, the hydromel is made,
Put greatness in thy sports, my son, put steel into thy blade."

The old men die, and the young men enter on their inheritance, of which, in Frithiof's case, a somewhat minute description is given; but we are seeking pictures, and must not be delayed. Here is one that shall bring our heroine into presence:—

"In Hilding's hut, and Norway's climate,
Grew two sweet plants, in perfect prime;
And ne'er before were fairer given
To smile on earth, or gaze at heaven.

"There grew the sturdiest of them,
Like sapling oak with spear-shaped stem,
Whose crest, as 'o'n a helmet's plating,
Wood ead wild wind to keep it dancing.

"And one was like a rose:—the day
That Christmas chills have passed away,
And spring, with its burbling broom,
Dreams of its fast unfolding blossom.

* * * * *

"I say they grew towards flowers and fruit,
And Frithiof was the saying shoot,
And Ingeborie the rose that vied it,
The lovely rose that blushed beside it.

"Who sees the pair while sunbeams shine,
May deem himself in Freya's† shrine,
Where urchin Loves he deftly going,
With wings of light and tresses flowing.

"Who sees them with the pale moonlight,
To lead their dancing steps aright,
May deem there trips it light and airy
The Elf King and Queen of Fairy.

"What Frithiof learned the day before
He taught the next to Ingeborie;
And proud was he when Bele's daughter
Had learned the runes that Frithiof taught her."

Here have you choice of season and occupation—sunshine or moonbeam; the light sports of childhood, or labour—light as they, with beauty in each and all: the painter has mistaken his vocation if he do not long to reproduce every fair moment so charmingly depicted by the poet. Two more delicious scenes for him whose love is for the ocean or the gladsome river, and then we pass on:—

"If long and late they sat afloat
On dark blue sea, in rudest boat,
It pleased her, as the sail was filling,
To clap her hands and help its swelling."

Or again, and think only what the floods and streams of Norway give you as the site of what follows!—

* Disarsala—the Hall of the Gods.
† Freya—the Scandinavian Venus. See Latham's "Frithiof," notes, p. 159.

"When floods were deep and streams were hoarse,
He bore his tender charge across,
Pleased if the currents lashed around him,
And her small arms the lightlier bound him."

Oh for your genius, sons of blessedness that ye are! all true artists. Would that your power had been the appanage of this your scribe! what galleries would not then be mine to wader through in joy perpetual! But no, for me they may but stretch their clustering columns in the light that imagination lends them; to you alone belongs the magnificent destiny of realising what for the common world is but a more radiant manner of dream.

And so be it! Do you but work for us only; suffer not that all our aspirations return unsatisfied to earth: give to a life of ages on your canvas, if it be but a portion of the good and beautiful that we cannot else retain beyond the fleeting moment, and your hearts shall rest content therewith, no less than our own.

But our Frithiof!
Yes, he is not forgotten. You next have him standing before the brothers who have succeeded to Bele's throne: he is there to demand the daughter of Bele, promised by her father. Hear some few of the words he addresses to Helge and Hjalman:—

"Chieftains, he said, 'the royal maid is very dear to me,
And here I come to claim her home,
A lovely bride is she;
On Bele's laws I plead my cause,
He wished such match to be."

More follows, but this shall suffice. His Ingeborie is related to him, and he departs in anger, uttering words of defiance. An aged sutor, King Ring, then demands her hand; but he too is rejected, and Ingeborie is sent for safety to the shrine of Balder, where she is visited by Frithiof. For a description of that "Meeting," I refer you to the poem; but in consequence thereof Helge subsequently accuses Frithiof of sacrilege. The surrounding warriors urge the hero to deny the charge, which they believe to be false:—

"Frithiof, say No! and Ingeborie is thine!"

they exclaim, but Frithiof replies:—

"No hope or fear can be
In earth or heaven to wring one lie from me:
I saw thy sister, Helge. Eve was come,
'Twas then we met, and under Balder's dome;
But not in sacrifice or sin—unless
The simple meeting shook his holiness."

The warriors now all shrink from his side as from a thing accursed. Helge imposes what he believes to be an impossible task by way of penance, and Frithiof retires in rage and despair. He then repairs once more to the shrine of Balder, where he relates what has occurred, to his Ingeborie, whom he implores to join her fortunes to his own at once. Unconvinced by the many causes assigned by Ingeborie for her refusal, Frithiof is then leaving her in "high disdain":—

"He cursed himself, for that he strove to move
So much of prudence and so little love,
Then from his lips these savage accents fell,
'Farewell, King Helge's sister, fare thee well!'"

But not so can his hapless betrothed endure to see him part; her words arrest his steps:—

"Oh, Frithiof! Frithiof! must we part us so?
Hast thou no kinsfolk look before we go?
No softer word to soothe the soul's unrest
Of that fond maiden who hath loved thee best?
Deemest thou I lie on roses, and can see
My life's whole hope departing smilingly;
And lightly tear from an unbending heart
What grew with it, and never dwelt apart?"†

These gentle entreaties, with more of similar import, prevail. Frithiof acknowledges the power of the Normas, or Destituics, and they separate; he to attempt the achievement of the task imposed by Helge, his Ingeborie to become eventually the prize of the aged, yet brave and noble warrior, who obtains her from her brothers "by his spear and his bow." Here for the present we must leave them, but may possibly recur to the subject.

* See "Frithiof," Latham's translation, canto v., p. 60.
† See p. 72.

BRITISH ARTISTS:
THEIR STYLE AND CHARACTER.

WITH ENGRAVED ILLUSTRATIONS.

No. XVIII.—JAMES DUFFIELD HARDING.

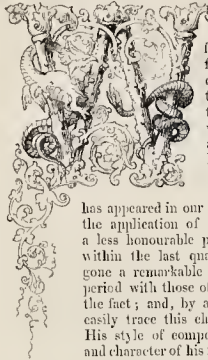

WE are requested to point out the British artist whose talents have been most usefully exerted for the good of his profession, and for the benefit of that large portion of the community to whom Art is in any degree interesting, we should, without the least hesitation, name Harding. We care not to ask whether he is entitled or not to take his place among the great landscape-painters the country has produced—this must be matter of opinion after all; our own is decided; but we maintain that the most distinguished artist that

has appeared in our school, if his reputation depended alone upon the application of his talents to the good of others, deserves a less honourable position than Harding. Landscape-painting within the last quarter of a century has, in England, undergone a remarkable change,—a comparison of the works of this period with those of the preceding cannot fail to convince any of the fact; and, by a careful examination of the former, we may easily trace this change to the influence of Harding's example. His style of composition, arrangement of materials, the forms and character of his foliage, the drawing and grouping of his figures, his distribution of light and shade, are more or less apparent in

the works of many of our most popular artists. We do not presume to say they are copyists, but we believe his writings and his drawings have been

so carefully studied, and have left so strong and favourable an impression on the mind, that his contemporaries have insensibly, perhaps, become imbued with his principles of Art, and have carried them out in their own practice, but in a style and manner peculiar to each individually—that is to say, in harmony with each one's perception of nature.

And if we pass from the professional artist to the amateur this influence is still more strikingly obvious. Harding's published works on Art have long been text-books wherever the lead pencil is applied to the purposes of drawing, and men can read the English language—and even where the majority cannot; for his books are to be seen in almost every Art-repository of reputation Europe, in British India, and in America; wherever the study of Art is now made an essential feature of education, they are, we believe, the standard books of instruction. Instances are within our own knowledge of individuals who have become really excellent landscape-painters from the study of his written and illustrated lessons without any other instructor. As a teacher, either by his published precepts or by his personal superintendence, his name stands in the highest rank for the success of those who have resorted to his studio, or have had recourse to his various Art-publications.

In this matter of Art-instruction Harding has shown himself possessed of a capacity to which few painters, by comparison, can lay claim. A man may be a very clever artist without having the faculty of imparting his knowledge to another; and, on the other hand, he may have a thorough acquaintance with the principles of Art, and be able to initiate his pupils as thoroughly into them, and yet may himself be but an indifferent artist. We have frequently met with such characters, and but very rarely with those who, like Harding, can use the pencil and the pen with an equal degree of skill, so that the judgment is enlightened, and the mind instructed, while the eye and the taste are gratified.

The writer of these biographical sketches is indebted to the works of Mr. Harding for whatever amount of knowledge he has acquired in the principles and practice of Art; and from the various conversations—for *we*, to resume our editorial personality, have had the pleasure of his acquaintance many years—it has been our privilege to hold with him, we have gained much information concerning his career as an artist, and the feelings that actuated him to pursue his



Engraved by]

OLD BRIDGE AT ANGERS.

[Mason de Koot.

profession in a way so honourable to himself and so beneficial to others. No man interested in Art can be in Mr. Harding's company without *learning*—not merely *hearing*—something about it.

James Duffield Harding was born at Deptford, in Kent, in 1798. His father, a pupil of Paul Sandby, was an artist in excellent repute as a teacher, and was desirous of educating his son for the same profession, to which the latter was by no means disinclined. The youth at once began to study perspective with great earnestness; but finding that even a very considerable knowledge of the science did not advance him one step in pictorial expression, or what is properly called Art, he had recourse to the soft ground etchings by Prout, which at that period were held in high estimation by students of drawing. These he copied eagerly; and when he had reached the age of fifteen he received a few lessons in colour-

ing from Prout—that is, he saw the latter make two or three drawings, learned the pigments he used, and how to mix them. Harding now thought he would try his hand at sketching from nature, but soon found he dare not attempt anything beyond an old building, such as he had seen Prout draw. A tree with its foliage was a mystery he could not penetrate: everything he did at this time was, as we have heard him remark, *à la Prout*. He began to despair of ever getting beyond a dilapidated cottage, a ruined tower, or some other picturesque bit of architecture; but there was at home a wise and loving counsellor, whose advice and encouragement he felt it his duty no less than his pleasure to follow. His mother asked him one day, when she saw him drawing some old building, "Why trees, and skies, and hills, God's handiwork, were not as worthy of his time and attention as the objects of man's production seemed to be?" The hint

was immediately taken; he unhesitatingly devoted himself to the study of the works of nature, for which he had favourable opportunities, as he was then residing near Greenwich Park. Seated before some one or other of the noble chestnut, elm, or fir-trees which ornament the park, he passed many an hour with his pencil in hand, labouring diligently, yet almost broken in spirit at never finding on his paper aught that in a remote degree resembled the original object. Again he resigned all hope of becoming an artist, for at that time difficulties beset the learner of which the student of the present day knows nothing. Few, if any, examples were within his reach; no works of instruction worthy of the name could be purchased; no knowledge of principles obtained. Harding resolved in his extremity to abandon the pursuit of painting, and attempt engraving, and was accordingly placed by his father under Mr. Charles Pye, with whom he remained for a year.

But the yearning to be a painter was yet strong, and he could not withstand the temptation of reaching to his colour-box and pencils whenever he had leisure. He had been taught the then prevailing fashion of first washing over the paper on which the drawing was to be made with what was called a "harmonising tint," composed of light red and gamboge, or yellow ochre: this was always done without the slightest reference to the contemplated effect, or time of day,—if, indeed, such matters then obtained more than a momentary consideration. The primary operation effected, every object in

the sketch was coloured in a grey tint, made of Indian-red and indigo, except the brightest parts; and when various colours had been washed over each object as were respectively adapted to each, the drawing was considered to be finished. Now it occurred to Harding, as he was pondering over this unsatisfactory method of imitating nature, that this grey was employed to represent shade and shadow, and their modifications by the atmosphere. "Why then," he asked himself, "should the colour be placed over the grey, when in nature the shades and shadows and the air lie over the objects, and therefore between them and the eye? Here is a system the very reverse of nature adopted as a means of imitating her." He took the hint with which his observation of nature had furnished him, reversed his operations by using the local colours first, and the greys over them, and was so satisfied with the result as to follow with a good heart his "first love."

When Mr. Pye removed from London to Upton, near Windsor, he was very desirous to take his young pupil with him, but all entreaty was useless,—the latter had overcome one grand obstacle to his becoming a painter, and, moreover, had always regarded engraving as a painful drudgery; so he left it, and once more turned his face towards perspective, which now wore a pleasanter aspect than formerly, as it afforded him profitable employment among architects: from these engagements he gained a knowledge and love of architecture, which has ever since been of great value to him. But the natural craving of



Engraved by J.

BERNCASTEL, ON THE MOSELLE.

[Various Artists.]

his unsatisfied desires for higher things rendered this occupation irksome, and as he had frequent opportunities of lucrative engagements in the way of teaching, he accepted them; in a short time, to adopt his own expression, he "gained money and misery," for he found the teacher required to be taught. He could place before his pupils an example, could point out to them when and where the copy was like the original, or differed from it, but knew not how to answer the question frequently put to him,—“Why should I do this?” he had no answer to give: his only reply was to direct the ruler to the vanishing points of the object. He felt keenly the humiliation of being unable to instruct the *reason*.

At the age of eighteen Harding gained a silver medal from the Society of Arts for a water-coloured drawing; his visits to Greenwich Park were still continued, where a constant study of the works of nature enabled him to discover those laws of her operations he had so long looked for: he could now reason on what he did, and could give a reason for what he did. It was not very long after the period of which we are writing that lithography first made its appearance in England, and promised to become an art. He soon saw its capabilities, and attached himself to it—the more eagerly as it gave constant occasion for the employment of his pencil, and he was perfectly satisfied no one could become a painter who was not a skillful draughtsman. So thoroughly

had this conviction impressed his mind that he continued to draw unceasingly till about 1830, rarely producing during the whole of this time more than one water-colour picture in the year; yet he found that whatever he could accomplish with his pencil or chalk, he could with equal power produce with the brush; and as evidence of this fact he had already established himself among his contemporaries by several admirable water-colour pictures, as “The Corsair’s Isle,” “Modern Greece,” “Byron’s Dream,” and other subjects from the writings of the noble poet: some of these have been engraved on a scale of considerable size. Previously, however, to their production, he was elected a member of the old Society of Water-Colour Painters, his admission being gained by a drawing chiefly of foliage. Soon after his election, the late Mr. Robson, one of the oldest members of the society, called on Harding to congratulate him on his election, and to compliment him on the probationary drawing he had sent in. Robson took occasion, on this visit, to urge upon his young friend the advisability of his “sticking to trees,” and also recommended him to aim at suppressing a “power of execution” which, if not relinquished, would ruin him as an artist. Advice from such a quarter—for Robson was then in the zenith of his popularity—could scarcely be unheeded with impunity, yet it greatly troubled him to whom it was offered; again and again he looked at nature, pondering over the reasons on which he had based

his mode of execution, and at length feeling satisfied that he had the authority of nature for what he did, made his election as to which should have his respectful submission, nature or Robson, wisely chose the former, and continued the career he had begun. Yet alarmed lest circumstances and his own inclination might compel him to "stick to trees," he sought out other subjects, and visited France and Italy to procure such as he considered suitable for the *Landscape Annual*.

About this time impressions of some of his lithographic drawings found

their way to Paris, and were on two occasions exhibited at the Louvre; as an acknowledgement of their merits, Harding received from the *Académie des Beaux-Arts* two gold medals, one of a very large size.

Simultaneously with the study of foliage he acquired a knowledge of the laws of nature with regard to shades and shadows; and being convinced of their truth, and, by experience, of their value, he placed in the hands of the public his work on "Elementary Art," as the result of what he had himself learned. This knowledge had undoubtedly been purchased by much toil, which



Engraved by

BROOK IN DELAFORD PARK, NEAR IVER, BUCKINGHAMSHIRE.

[Nelson Jackson.]

he was desirous others should be spared, for no portion of such instruction was elsewhere to be found: that it has done good service thousands can now testify.

In 1836, Harding produced his "Sketches at Home and Abroad," in which was exhibited for the first time the appearance of chalk drawings done on tinted paper, and touched with white. The work gave an extraordinary impetus to lithography, for it was very soon followed by similar publications from drawings

by Stanfield, Roberts, Nash, &c. &c. The "Sketches" were dedicated by permission to the then reigning monarch of France, Louis Philippe, who, to mark his approval of the artist's labours, ordered a splendid breakfast service of Sèvres china to be forwarded to him; but an accident befalling one of the principal pieces, the king sent him instead, through the hands of Count Sebastiani, a magnificent diamond ring, with an autograph letter—a well-earned compliment to the artist's talents and industry.

He now practised painting in water-colours almost exclusively until 1842, when he set earnestly to work to prove again, by painting in oil-colours, the reality of his knowledge; for as a thorough acquaintance with mathematical science will make a man indifferent to what he applies it, and skilful in all, so a true knowledge of Art must render an artist comparatively indifferent to the materials he employs: the difficulties are not in the instruments, but in the acquisition of the knowledge which can alone direct their use. While painting on his canvas and paper, he continued to put forth at intervals various works and lithographies which, as we have before intimated, have spread universally, and found their way not only into the hands of those who regard Art as a part of education, but of those who make it the pursuit of their lives. It is quite needless that we should enumerate these artistic publications, or point out the ability and knowledge displayed in them; the world—not the British people only—knows them well, for there is scarcely a school-room, private or public, or an artist's studio, where they are not found; Art, at home and abroad, has, through their influence and teachings, become better known, appreciated, and encouraged. From all parts of his own country—as well as from every foreign land into which they have penetrated—Harding has received the most flattering acknowledgments and thanks; they have done as much—more we might assuredly say—to make English Art recognised and

respected abroad, than the finest oil-picture ever painted in Great Britain. The works of Perogio of Paris, and of Calaneo of Geneva, manifest the influence of Harding's labours.

Our observations on the works of this artist have been principally directed to those he has published, because his fame—and it will be an enduring one—has largely arisen from these. But we are not, therefore, to suppose that his painting in oils and in water-colours entitle him any the less to a distinguished place in the roll of British artists. The Royal Academy, and the gallery in Pall Mall East, have shown abundant proofs that the brush is in his hands as powerful an instrument to produce the picturesque and the beautiful as a piece of chalk or a lead pencil. One scarcely knows in what class of subject to find him most "at home;" whether in the forest, the rural lane, the village common, or by the sea-shore of his own land,—whether in the mountains of Switzerland, the frowning fortresses of Germany, the villas and campagnas of Italy, or the mediæval architecture of continental towns and cities, he makes them all his own—so that it may be truly affirmed he is equally successful in the delineation of all. There is, however, one characteristic of his talent as a landscape-painter which we may almost call peculiar to himself, and that is, the admirable drawing, expression, and 'placing' of his figures,—they are always where they should be, and as they



Engraved by]

THE RETURN FROM MILANK.

[Edwin Cooper sc.]

should be. We have heard him say he has studied the anatomy of the human form with as much care and attention as he ever did the forms of foliage and plants.

A question has frequently been asked of us, one too we have often put to ourselves,—“How is it Harding is not in the Royal Academy?” but we have never yet been able to offer a satisfactory solution of the query. Whatever influences may have been at work to withhold from him a position he has more than won,—yet in his case especially a place among the members would be nothing more than honorary,—they are certainly “strange and unnatural.” Not one, we presume, of the privileged “forty” would, if asked pointedly, declare him other than fully worthy to be their associate, and yet they have never done him the justice to elect him. The Royal Academy is, undoubtedly, a body of very clever artists; but as certainly it is not a body wise in its generation or politic. If the Academy is what it ought and professes to be—the chief Art-school of the nation, how is it that artist has been passed over who, beyond all others, has laboured to teach the world what Nature is, and then to try what Art is—the artist whose works, we know, are earnestly studied by the pupils of the Academy? and who, in imparting information, has presented a test by which the merits of his own works could be tried—who has sought to teach the artist “to study not alone what the object is as he sees it *externally*, but what it is to himself *internally*, and what it must be to others”—who has worked to place Art among the pursuits of the intellectual

faculties, and not of the mere fancy. It is not to say too much to assert that, by means of Harding's instructions, thousands now admire Art who would otherwise have been indifferent to it; and because their admiration is based on knowledge, it is lasting, and is given to Art worthy of the nation, whilst it is not subject to the capricious changes of ignorance, or, what is the same thing, of fashion. Moreover, he is in the true sense of the word a gentleman, a man of enlarged and progressive views, energetic, and in every way capable of originating and carrying out measures by which the Art-talent of the country may be more widely developed, and made more extensively useful, both to the artist and the public. We wonder if any of these qualifications are barriers to his admission within the corporation that reigns supreme in Trafalgar Square—if the admixture of such ingredients into the quiet conclave would disturb the equanimity of those who rest so contentedly and unmoved under the shadows of the Academic retreat? Such an opinion prevails, we know, very generally outside its walls; as does also another, that his exclusion is not the way to advance the Arts of the country. Within the last month he has been re-elected, without a dissentient voice, into the Society of Water-Colour Painters, of which he had so long been a member; the rules of the Royal Academy absurdly requiring that any one who seeks admission therein should withdraw from whatever other institution to which he may belong. Of course, Harding thinks he has now knocked long enough at the doors in Trafalgar Square, as he has withdrawn his name from the list of candidates.

ELEMENTARY INSTRUCTION IN DRAWING.*

THERE is an opinion to a certain extent prevailing, and by no means among narrow-minded and illiberal persons exclusively, that the endeavours which almost on every side are being made at the present time to instruct the lower classes, and release them from the bondage of ignorance, must ultimately have a pernicious rather than a beneficial influence. The argument generally used by the opponents of education is, that we are giving to the children of the poor thoughts and ideas tending to make them discontented with the condition in which Providence has placed them; that education excites hopes and aspirations which never can be realised except in a very few instances; that, inasmuch as it is ordained that the "poor shall never cease out of the land"—that there must always be "hewers of wood and drawers of water," it is worse than folly to attempt to make anything else of them. We are quite willing to admit that in this, as on all other controversial questions, much may be said on both sides. There is no denying the fact that knowledge is not always power, and also that it very frequently generates

tion is to call up a race of world-be artists, whose legitimate sphere is the factory, the workshop, or the field; and, in support of their theories, they point to the large number of indifferent pictures on the walls of some of our exhibition rooms, the productions of men who would have gained a better livelihood had they followed some trade or handicraft instead of the Arts. This is no doubt true to some extent; but we believe the good far outweighs the evil, and that to teach the elements of drawing is to lay the foundation of superior skill and intelligence in the artisan, and to instil ideas of the true and the beautiful into the minds of all. No man will make a worse mechanic because he has been taught the principles of the Mechanical Arts,—and the instruction to which we refer rarely goes beyond this,—neither will the furrows of the ploughshare be less true, because the hand that guided it may perchance have learned in early years the art of drawing the outline of a barn-door or a cottage window. And while speaking on this subject, we would incidentally remark that there is abundant evidence of the interest felt by the lower classes, generally, in all Art-matters, as well as of increasing knowledge of them; we do not mean to infer that the mechanic or the artisan has yet attained the position of a true Art-critic, but he is fast learning what is truth and what falsehood in nature as he sees her represented.

We have been led into the foregoing remarks by having before us two publications, the titles of which appear in the foot-note on this page, intended as books of instruction for the lower classes of our population; they are by the Rev. C. Richardson, Canon of Man-

chester, who has devoted, during several years, a large portion of the time he could spare from his ecclesiastical duties in the preparation of these and other elementary works of an educational character. We always rejoice to see the clergy occupying a prominent position—and a prominent position is their legitimate sphere of action—wherever instruction is to be conveyed; and especially are we pleased to find them advocating a knowledge of Art. Some observations on this subject made by a clergyman, the Rev. J. B. Dickson, at the annual meeting, in June last, of the Paisley School of Design, struck us very forcibly when we read them; he said:—"I am a lover of the Fine Arts, and especially because I am a clergyman. I feel that there is a debt lying upon the clergyman of our day to come forward much more frequently and commonly than they have yet done, to express their profound sympathy with the educational movement now abroad in reference to the young. It appears to me highly inopportune, as well as unmanly, in the clergy to stand back and withhold their influence in the struggles of the people of the land to secure for themselves a thorough education. The time has gone by when we could exhibit one set of opinions in private and another in public; when as clergymen we could appear with a stiff formal demeanour in public, an unnatural demeanour, and in our own private study or drawing-room exhibit all the ease and elegance characteristic of the well-educated clergyman." It is this feeling, that the time has gone by for holding and acting upon two sets of opinions, which has induced me to come forward so frequently to express what I think on the great subjects occupying the public mind. I believe that if clergymen are to maintain the influence

which they ought to possess, they must come forward and exhibit to the world boldly and frequently their whole mind, their whole heart. If the people take a deep interest in literature, philosophy, science, and the Fine Arts, the people will look to the clergy to sympathise with them. They will ask, 'Does he know anything of the Fine Arts? what does he think of the great writers? what does he know of the great painters whose works shall live for ever?' If a clergyman does love literature, and if he does love the Arts, and if he does not declare that he loves them, he is untrue to himself and false to the people. If ministers of the gospel are to exercise a mighty influence in these strange times—if they are to give their form and pressure to the age, they must conceal nothing, they must fully and boldly tell them what they think on the subjects of every-day interest, and then the people will listen to them more attentively when they speak on the subject of religion."

It is evident that Canon Richardson coincides with this opinion, and he acts upon it by employing a portion of his time, and a portion also of his means—for his books are published at a price to exclude all hope of pecuniary profit—in practically supporting his views. The two publications we have before us require but little explanation. They are founded upon principles strictly philosophical, although quite elementary; evincing due attention to system, progression, and diversity, while concealing under varied forms the most careful discipline of the hand, the eye, and the intelligence. The larger of the two works is intended for collective instruction, and contains a considerable number of simple geometrical forms, drawn on a bold scale—as seen in the example we have introduced—the peculiarity of

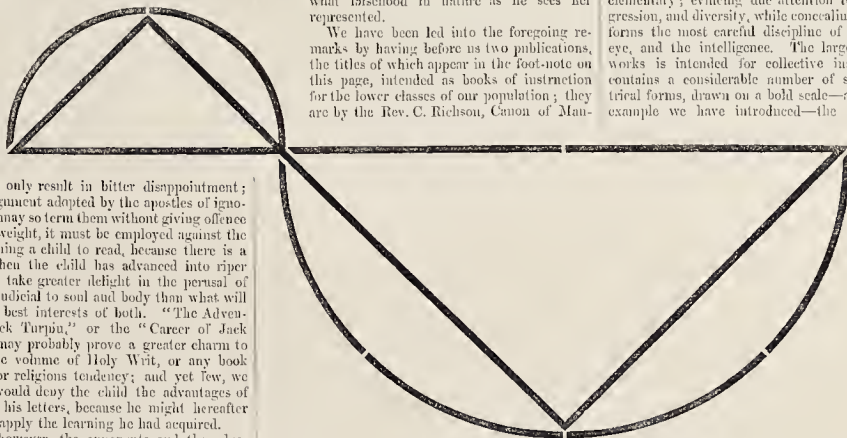

hopes which only result in bitter disappointment; but if the argument adopted by the opposites of ignorance—if we may so term them without giving offence—be of any weight, it must be employed against the duty of teaching a child to read, because there is a possibility when the child has advanced into riper years he will take greater delight in the perusal of what is prejudicial to soul and body than what will promote the best interests of both. "The Adventures of Dick Turpin," or the "Career of Jack Sheppard," may probably prove a greater charm to him than the volume of Holy Writ, or any book of a moral or religious tendency; and yet few, we apprehend, would deny the child the advantages of being taught his letters, because he might hereafter abuse or misapply the learning he had acquired.

Leaving, however, the opponents and the advocates of education to discuss the matter as they please, it is quite clear that in the present day the work of instruction must go on—it would be as useless to attempt to arrest the progress of the sun towards his meridian, or the ebb and flow of the ocean, as to erect a barrier against the march of the schoolmaster. Whether friend or enemy to the social, moral, and religious economy of the country, he must and will find admittance throughout the length and breadth of the land. It is therefore the duty of all in a position to control his movements, and exercise an influence over his actions, to see that they are rightly directed—to watch the course of education, lest a false step should defeat the object which ought to be the end and aim of all instruction—the welfare and happiness of our fellow-creatures, both in this life and the next.

Now if education in the abstract admits of argument, certainly the propriety of teaching the rudiments of drawing as part of a system of instruction to the poor may fairly be questioned; and it is questioned—by many lovers of Art too, for whose opinions and judgment on most matters we entertain the greatest respect. They assert that such instruction

is that the lines and curves are broken at regular intervals, or with as much regularity as the figure will admit of, to help the pupil in acquiring precision of hand and correctness of line. Instructions for the drawing of the figure are given under each diagram. In the second book, consisting of five parts, the geometrical forms are combined with familiar objects, illustrating and applying the geometrical exercises previously learned. These are intended as examples for the pupil to copy, as the "DIAGRAMS" are for facilitating the instructions of the teacher. Accordingly, we have here something like a repetition of the larger work, drawn on a smaller and less bold scale, but accompanied with familiar objects various in kind, represented respectively by straight lines and curved, and by a combination of both—so that a pupil, having once acquired the art of drawing such lines, will find little difficulty in applying them to any ordinary object he may desire to sketch. Perhaps the greatest novelty in this series of examples is the use of lines indicating heraldic colours, as preliminary exercises for shading. Mr. Richardson's plan is exceedingly simple, and therefore just what is wanted for those he desires to benefit. Moreover, the extreme accuracy of all the figures, and the beauty of some, are matters for strong recommendation; while the prices at which they are published respectively—about 40 examples in the primary book of instruction for fifteen pence, and in the other upwards of 120 for half-a-crown—and their being entered on the RECOMMENDED LIST of the "DEPARTMENT OF SCIENCE AND ART," whereby they may be obtained in the form of grants at very reduced prices, constitute them emphatically *Elementary Drawing-books for the humbler classes.*

chester, who has devoted, during several years, a large portion of the time he could spare from his ecclesiastical duties in the preparation of these and other elementary works of an educational character. We always rejoice to see the clergy occupying a prominent position—and a prominent position is their legitimate sphere of action—wherever instruction is to be conveyed; and especially are we pleased to find them advocating a knowledge of Art. Some observations on this subject made by a clergyman, the Rev. J. B. Dickson, at the annual meeting, in June last, of the Paisley School of Design, struck us very forcibly when we read them; he said:—"I am a lover of the Fine Arts, and especially because I am a clergyman. I feel that there is a debt lying upon the clergyman of our day to come forward much more frequently and commonly than they have yet done, to express their profound sympathy with the educational movement now abroad in reference to the young. It appears to me highly inopportune, as well as unmanly, in the clergy to stand back and withhold their influence in the struggles of the people of the land to secure for themselves a thorough education. The time has gone by when we could exhibit one set of opinions in private and another in public; when as clergymen we could appear with a stiff formal demeanour in public, an unnatural demeanour, and in our own private study or drawing-room exhibit all the ease and elegance characteristic of the well-educated clergyman." It is this feeling, that the time has gone by for holding and acting upon two sets of opinions, which has induced me to come forward so frequently to express what I think on the great subjects occupying the public mind. I believe that if clergymen are to maintain the influence

* DIAGRAMS AND INSTRUCTIONS FOR FREE-HAND EXERCISES IN GEOMETRICAL FORMS, to be used in the Collective Teaching of Elementary Linear Drawing. By the Rev. C. RICHARDSON, M.A., Canon of Manchester. With Prefaces by G. WALLIS and J. A. HAMMERSELEY. London: Depository of the National Society, Sanctuary, Westminster; Chapman & Hall; Dutton & Co.—A COMPLETE AND SYSTEMATIC COURSE OF ELEMENTARY FREE-HAND DRAWING EXERCISES. By the Rev. C. RICHARDSON, M.A. With Introductory Observations by J. A. HAMMERSELEY and G. WALLIS. London: Chapman & Hall, Dutton & Co., and Depository of the National Society.

A FEW WORDS*

ON EXHIBITIONS AND HANGERS—EARL STANHOPE'S BRITISH WORDS—GOVERNMENT PATRONAGE—PICTURE DEALERS AND PICTURE PRICES—MR. RUBENS AND PEE-RAFFAELISH.

Present—STUDENS and AMICUS.

Studens.—I am "Magister" no longer—a visit to the Academy Exhibition is enough to humble any contributor, and is a cure as efficient for professional conceit as a photograph for personal.

Amicus.—Do you then think your work ill-placed? It is on the line, and I thought it looked very well. Not so well, of course, as in your own room by itself; and smaller; but—

Studens.—Yes, smaller in every way; not only in size, but in drawing, painting, chiaro-oscuro—even in conception. All the poetry, if it ever had any, is knocked out of it.

Amicus.—Others will not think so. But are not pictures always deteriorated in individual effect in exhibitions? Is it not the common lot—do not all suffer?

Studens.—Well, not always. I have really seen some few pictures look better in the exhibition than out of it, but I own these are not many; they are the very few exceptions to a very large rule. And those perhaps are not the best works—it is some comfort to feel that!

Amicus.—It is however, I suppose, an advantage to every artist to see his works in the exhibition by the side of others. It must tell him where he stands, and his faults; and in some degree may, I should imagine, instruct him how to amend them.

Studens.—Yes; it is a true monitor, though a stern one.

Amicus.—Yet friendly in the long run. No doubt it must be one of the severest tests an artist can have of his own cherished works, to see them side by side with the cherished productions of others, all struggling to be first.

Studens.—It is a mutual lesson. We teach one another, and should receive the admonition with equanimity. The real friend is he, no doubt, who tells you the truth even at the chance of displeasing you; and in this sense an exhibition is a true friend to each exhibitor, and saves, or should save, his intimates an unwelcome office. It shakes him, and wakes him from his dream, and bids him open his eyes. I do believe every one is more or less under an hallucination while he is painting a picture, and moreover fancies there is a great deal more in it than there actually is.

Amicus.—"Great wits to madness nearly are allied," which I take to indicate the mentally half-sea's-over state under which great works are produced. All mortal productions must have faults, and few of the highest of these would probably ever have been finished had the author been alive, while producing them, to all their demerits. In any great effort I can well fancy that the *furor*—the youth of the work—should be kept up as long as possible; though it may be well in the latter stages of finish to appeal "from Philip drunk to Philip sober." I mean to bring in common sense to prune off redundancies, emphasise excellences, and harmonise and complete the whole—in *se teres atque rotundas*.

Studens.—Horace's recommendation to the poet was, as you know, to put his effusions on a shelf for seven years ere he received his final annotations; but I doubt if the dear little round man, and exquisite bard, ever thoroughly adopted his own rule—it is so much easier to give than to take good advice, even if it be our own! He wrote his verses for all time, and it may be well predicted that they will reach their destination, by the hold they have on us now. And all Arts have much analogy, but it may not be denied that in painting, some works that have been struck off comparatively at a heat are among the most successful.

Amicus.—Oh surely the best works of Art are those that evidence long study?

Studens.—Not those of Rubens! except you mean previous study not individual to the work. His are corporeal rather than mental works, and appeal more to the eye than to the intellect. But I did not mean what you object to. I mean comparatively "at a heat;" for instance, one could not let one's

picture wait on a shelf for seven years for its final touch! I don't think one can define any time exactly as the best for doing a picture in. Different artists pursue such different methods. Some like to concentrate themselves wholly on one work from its commencement to its end, while others prefer two or three to be going on at the same time, now working on one, now on the other. And then different works by the same artist will take such unexpectedly various amounts of time. Moreover, painting is rarely all plain sailing; there is generally an agony-point to double somewhere in the voyage, and the time you arrive in port a good deal depends on the weather you meet with at this Cape! (of Good Hope or no, as it may be) so you see—

"You gentlemen of England who live at home at ease,
How little do you think upon the dangers of the seas."

Amicus.—But apart from smiles you must think that ample time is essential to the production of fine painting as to other fine works.

Studens.—"Ample" means enough; I don't suppose it involves much to spare. In Pope's recipe for an epic poem, he recommends spreading out thoughts warm—adding, "they will be sure to cool." Now fresco-painting has all to be done in this hot state—there is no retouching.

Amicus.—But the cartoon is carefully studied first.

Studens.—Yes; but the artist in doing the real work is sure to attempt something beyond his preparatory level, or he is no true artist. We have it on authority, how Michael Angelo did the whole ceilings of the Sistine Chapel without assistance, in three years. That, it must be allowed, was very rapid; and from the multitude of works which the divine Raffaele produced in his short life he must have worked as rapidly too.

Amicus.—These men, at any rate, could not have had many "agony-points" to double. They must have begun by knowing exactly what they wanted to do, and have gone straight on to the end; going over so much ground every day, like a house-painter. I suppose these men are to be taken as exceptions.

Studens.—They were wonders for power. But they had no doubt their trials too; of this, one at least has left evidences—Michael Angelo—in the many works in marble he has left unfinished.

Amicus.—That might be from his impatience.

Studens.—No; of the marble works he has left incomplete several could not be finished. There is not stone enough left—it is cut away; and all sorts of incorrectness occurs—limbs of all kinds of lengths; but there is always the "great gusto." But I like them as they are with all their faults, and love them more than other people's perfections; however, he certainly worked in a hurry.

Amicus.—And in an hallucination?

Studens.—Oh yes; great as his achievements were, they were no doubt no more up to his dreams than other people's achievements are to theirs—only his dreams were higher as well as his grasp. However, there were no exhibitions of Art—in our modern sense of the word—in those days; artists had not to work up to time—to a particular day.

Amicus.—I have heard more than one artist say that he *prefers* to be thus tied to time, and can work better so than under other circumstances.

Studens.—Well, so have I; however, then it must be quite requisite to get into an hallucination, and railroad-paced *furor*. The artist withdraws himself from the world, and shuts himself up with his picture like an enchanter with his abracadabra, in his studio for a cave. Strict are the orders given, "Mr. So-and-so can see no one; he is finishing his picture for the Royal Academy." Thus saith his servant, as he or she opens the door, stationed in the midst an incarnate emblem of no thoroughfare. The artist meanwhile in his inner cell (crouched over his picture, or standing at distance, palette, maulstick, and brushes, held out wide at different angles, contemplating the next touch ere he rushes again at his canvas) lives in a delicious dream of hardwork and glory. Hour after hour, day after day, week after week passes; his vision takes form, expands into life, and lives on the surface of his canvas. At last the fated hour comes when it must go. The moment taps at the door. The arrival of the frame has only preceded its departure with the picture it embraces, a short half hour. The artist has had but just time to contemplate it in its appropriate wreath of

gold, without which it appears that no easel picture can be complete. It is taken out carefully, it is put into the van, with various associates for the same destination, carefully by careful men. It is gone—a weight is off the artist's mind! The bow that has been long so tightly strung is unloosed, and the overwrought spirit extends and stretches itself to the utmost extent in unwonted but delicious laxity. After awhile, however, his eye re-seeks his easel. It seems to gaze like himself in vacancy. He tries to realise his picture on it. "Well," he exclaims, "I could have given it a few more touches, but I am glad it is gone. I have worked hard, and now I'll luxuriate. I'll think no more of pictures for the next week." With this laudable resolve he steps across the threshold, but, vain thought! after awhile the image of his picture follows him.

"Post equitem sedit atra cura."

Not *atra* now, however, for everything is *couleur de rose*. It rises up before him like an exhalation, with a halo of the fancied glory it will reflect on its author! Of course he feels quite sure it will be accepted—the contrary consciousness is among the impossibilities of nature! Moreover it will be well hung—of course.—A good place could not be denied to such a work, and he reckons on the quiet absorption he will have of the meed of praise. He thus bolsters hopes up into certainties, and is a happy man. Still it must be owned that as the time which is to decide its fate approaches, his confidence and courage (like Aeres') oozes out somewhat from the palms of his hands! However, we will suppose the powers to be propitious. His two first hopes come *quite* true. His cherished work is accepted and well hung. In addition, moreover, it is very passably admired, but not by himself. Among the first who rush into the exhibition rooms on the opening day is our artist. He walks rapidly through the rooms and sees it not, and almost prepares himself for the lowest depth of Art-fate—"Rejection;" but his hurry has given him a needless pang. On returning with less hasty steps he recognises his cherished work, in what also he cannot deny, is a very fair place; but, "Oh flesh, how art thou fishified!" "Is that my picture! can that be my work!" he exclaims. He goes closer. It actually seems to stare at him like an embodied vital being, and to reproach him, its author, as the monster did "Frankenstein," for the miserable appearance it makes! "Ah!" he exclaims again, after a few moments of sorrowful contemplation, during which his excited heart-beatings have slackened down to a more equable pulse, "I am a sleeper awakened indeed! O child of my brain and Art, thou art indeed but the Iphigienus of the Hercules I thought thee. What I falsely thought deficiency in thee is feebleness; thy force is blackness; thy warmth hot, and thy freshness cold—cold as the North Pole!" Down goes the artist's own thermometer of spirits considerably below zero; in which condition he re-crosses the threshold of the National Gallery.

Amicus.—What! without looking at the other pictures?

Studens.—I am only supposing a very extreme case, where the shock of the disorder has been of a very malignant character indeed! In usual cases he looks with so much attention over the other works that he almost forgets his own, and is carried away, perhaps, quite by admiration of some other work; for really British artists are not a jealous class, whatever the world may say. But to return to my theme, and to speak in sober truth—I doubt whether any contributor to the exhibition passes out of its doors at his first visit to it *happy*—at least, if he does, he has a most enviable degree of self-content!

Amicus.—Or a most unenviable degree of blindness. But if an exhibition is so fraught with disappointment to those whose pictures are accepted and well hung, what must be the feelings of those who have their works rejected altogether?

Studens.—There seem to be three degrees of disappointment: that of the man whose work is well hung, and he does not like the look of it; that of him whose work is badly hung; and of him whose work is not hung at all. And I hardly know which situation is felt most acutely. The man whose work is well hung can put no flatteringunction to his soul that it is the disadvantage of place that gives it so incomplete an appearance. His shortcomings, his

* Continued from p. 202.

errors, are all his own; but he, whose work is badly hung, clings to this mishap as an excuse for all its defects—a loophole to escape from self-reproach. "It can't," he exclaims, "be seen there at all—how that picture injures it!" How differently it would have looked here!" and kind friends chime in with his remarks, and aid his resources of throwing the blame on other people.

Amiens.—But he who is rejected altogether?
Students.—Oh, he is an injured man, of course; and he sears in his mind envy, hatred, and malice, and all uncharitableness, hovering over the Academy and all its inabilities, hovering over the Academy like harpies, or presiding at her councils like amiable compounds of Fates and Furies! But even in this third and ultimate case, as regards self-judgment, the aspirant escapes the hard competitive rubs of other works against his own. He thinks quite as well of his picture as ever, and is left free to imagine to himself and others the effect his work would have had if it had been accepted—only accepted: "It would not have mattered where it were hung—even in the Octagon Room; it would have made its public for itself; it could not have been hid." This, if he does not say or think himself, some dear mother or kind sister suggests it as balm to the wounded spirit, which his ready ear drinks in only too readily—for the ouns of his rejection rests probably with himself.

Amiens.—But you would not say that injustice is never done?

Students.—R.A. does not stand for "Real Angel." The Royal Academy are but men, and therefore they are not perfect, nor are they always right in judgment; but I believe they are as fair as any other body of men would be. The selecting council take vast care and attention in their selection; and as for the poor hangers—I fully believe that were each weighed at the commencement and at the end of their month's labour and anxiety, they would be found much lighter for their work.

Amiens.—Such a statistic might shield them from vituperation.

Students.—Apart from the responsibility of having to arrange in a short time, and within a confined space, the principal British Art-labours of the year, it is really a very difficult thing to arrange pictures well. They injure or harmonise with each other in juxtaposition to a far greater extent than any but artists can appreciate. One of the best pieces of picture-hanging I ever saw was the British portion of the Beaux-Arts at Paris last year; but there the arrangers had the advantage of their materials being the selected works of years, instead of the efforts of one year. If our artists do not paint better than the French, they certainly "bang" better.

Amiens.—I wonder if our neighbours have the same idea. I suppose we have all something to learn. I like to see the Art-works of various countries together. That Beaux-Arts Exhibition was a great benefit to all lovers of the gentle craft of brush and palette. It was well to see our British works there, and I like to see foreign works here, in our exhibitions—the reciprocity is useful.

Students.—If it is not, as the Irishman said, "all one side!" The worst of it is, that though foreign works are purchased here from our exhibitions, ours would not be bought abroad.

Amiens.—I suppose that is a penalty we pay for being the richer country. However, we are sufficient for ourselves. There is a large current sale of British pictures in this country.

Students.—Oh! we have no reason to complain on the whole of the general encouragement for our Art. It is at the present time far more than could have been predicted forty, thirty—nay, twenty years ago. It is not perhaps the highest style of Art that is most encouraged in this country; but then we must recollect that this also applies to literature.

Amiens.—Macaulay's works are surely not only highly appreciated, but are most extensively read; and a bookseller would add, "profitable speculations."

Students.—Yes, they are exceptions to which one turns with pleasure. Assuredly Macaulay's works are among the few in the present day that will live. That they are appreciated is very hopeful for literature and the taste of the people; and I believe the taste in Art is on the rise, too; and that those buyers who began by only relishing a bit of rustic landscape, or rustic beauty, or pictures of animals, will end by equally cherishing the higher

sions of the muse. When I talk of bits of landscapes and animal pictures, do not think for a moment that I decry them, or ever wish to see them have less encouragement than they have now, only I should like to see the other walk have its due proportion too. Art to be a truth must be the exponent of the time and people, and British Art would cease to be British if it did not bud and blossom out into all those familiar scenes and objects that we British love so much; but I am always glad to see encouragement and appreciation attach itself to a style of Art ungenious, we may say, to Macaulay's province in literature.

Amiens.—I have heard some one mention as the characteristics requisite of an historical work, that there should be a man with a brown back in the foreground, and that the whole work should be intensely uninteresting!

Students.—And you would be the first to say, too, that Macaulay is not uninteresting, and that his style might be appropriately brought in to illustrate what an historical picture should be—not a collection of dry details and date, but instinct with vital existence and character—epic, dramatic, biographic, individual. Macaulay has the power to make his people move and speak; you see them—hear them, and in analogy so should painting.

Amiens.—And so, I am sure, do some of our painters of the present day. We are not obliged to look abroad to Paul Delarocbe and others; we have men who do this here—and they are encouraged.

Students.—But they are obliged to paint on a less scale than is desirable.

Amiens.—That is on account of the size of our houses, which do not admit of very large pictures.

Students.—Exactly; I have no objection to small pictures, but let us have large ones too. If individuals encourage the small scale, so should Government encourage the large. She should set apart a certain annual sum out of our national resources for such full-sized works, as should be best illustrative of our historical, actual, poetical, biographical facts and character, past and present.

Amiens.—Earl Stanhope has originated an advance in that direction by his excellent notion of a portrait gallery of British worthies, and the house has endorsed it.

Students.—I trust it is the smaller end of the wedge. Excellent in itself, I hope greater things will follow. Anything in that way carried out by the legislature will be well appreciated by the people. We are a commercial people; and who are now the great supporters of Art in this country—the great buyers? Why, the men who have made their money by commerce; and they appreciate what is done judiciously in the furtherance of Art by the powers that be. For why? They love it themselves. What would our painters do without Manchester and Liverpool? It is not our hereditary peerage now that supports Art; it is our wealthy aristocracy of energy and commerce. And this is what gives the highest hope for Art, and of that continued and substantial nourishment by means of which alone Art can be expected to put forth its best bloom. Artists must live to be able to paint. And this renders the prices of pictures of so much importance. It is only of late years that modern Art has really become of commercial value. The spirit of our country is commercial, and with this our Art must be in some way united to advance. Art has never stood alone; it has been ever supported by something stronger than itself,—the agent of a creed or a state policy. It must here have a basis of commercial value to rest on. This it has gained. What a difference from former times!

—When Wilkie sold his "Village Politicians" for £30, his associates and contemporaries thought him a lucky fellow; and, without making invidious comparisons, the exhibition of this year will yield us strong examples of pictures not nearly as good yielding to the authors ten or twenty times as much. What would such a picture sell for if it were produced now?

Amiens.—And how has all this been done? I suppose picture dealers have helped it.

Students.—I own it so; and we must not be too keen in finding fault with the staff that has propped us. It is but a few years ago that nothing but old pictures would go down, and that unfortunates of Raffaelles, &c., supplied those unfortunate country gentlemen, who, unappreciating for their pockets, fancied

they had a taste. The public dealer then decried recent pictures, and would allow no genius to a modern brush. The pseudo-Raffaello and Correggio trade, however, became somewhat overblown and blown upon too; and some of the more intelligent among those who had turned their attention to trade in Art began to perceive that there was a field for making money in the works of the day, which were pressing their way upwards in spite of the "old masters." I do not give picture dealers in general much credit for an abstract attachment to Art for its own sake, although there are honourable exceptions doubtless. It was their keen sense of interest that saw that the time was come for modern pictures to have a commercial value. It became their interest to raise the public estimation of this branch. No doubt the dealers take up pets among the artists, but on the whole they have been useful to modern Art; and for their good incomes and pleasant establishments many of our painters are very considerably indebted to them.

Amiens.—And such men as Mr. Ruskin do good too.

Students.—Yes—the dealers buy pictures to sell; and Mr. Ruskin writes books about Art to sell; and they both do good to the subject they treat. They both work at their mission, and I give both credit for not being wholly influenced by personal motives. Even the predominance of Mr. Ruskin's organ of destruction is a great agent for good. He sweeps his goosequill this way and that; he makes a clearance. He is a good pioneer; he takes up his axe and strides forth into the woods, and, like Billy Kirby, in Cooper's admirable tale of the American border, delights in the destruction he makes. Whether he could utilise into an edifice the materials he fells, is another matter.

Amiens.—Talking of Ruskin is next of kin to speaking of Pre-Raffaellism. What think you of it this year in the exhibition?

Students.—Van-ekism rather—to which it is more allied in execution than to the art of Cimabue, Giotto, and that ilk. The success of an episode in Art like "Pre-Raffaellism" depends on a good many things, and at the time it first came out the town was just ripe for a diversion of archaeological art; and the especial phase it took could not have been better devised to hit the public had it been suggested by a shrewd picture dealer. There is "vix" in the men who took it up, and some admirable pieces of mere painting owe their existence to the effort; but as a style it is doomed.

Amiens.—Well, at one time, it seemed as if it were going to sweep all before it.

Students.—A sudden flow has by nature a sudden ebb. In my artistic recollection, which now spreads over a good many years, I can recollect several phases of Art that the public have overpraised which have had a sudden downfall. Taste is always oscillating, and is never but a moment in its true place of rest, but swerving either on this side or that, especially as regards works of the day; and no little injustice is sometimes attendant upon this. When the public have overpraised an artist very much, and the time comes to find out its mistake—which is always done in the long run—it revenges itself on the former subject of its adulation for the error it has committed; and having before deeded him out with attributes to which he had no real claim, when the reaction has taken place, will not even allow him the excellences which he really does possess!

Amiens.—And would you include the press?

Students.—I will give you a case in point years ago. A leading journal, some fifteen years ago, praised me, I think beyond his merit, the most imaginative perhaps, or at least the most inventive of the "R.A.'s," then quite a young man, whose multitudinous and poetic works took the artist-world quite by storm. Nothing was too great to be said of him, and half a column was not enough mention of his excellences. His works had many great merits, but did not deserve to be set forth as equal to those of Raffaelle. They have the same qualities now as they then had; and yet we find the same journal, a few years ago, presuming to congratulate the public that the annual Royal Academy Exhibition that year had no work by that artist, coupling him with another high name—that of a fellow-countryman of his—whose works are standard! Thus do we adulate an image into a god, and find

ing we are wrong, revenge ourselves by dashing it all to pieces!

Amiens.—And is Pre-Raffaellism in danger in like manner?

Students.—I should not wonder if a few years hence it is ranked lower than it deserves.

Amiens.—It does not appear even now to be so much in the ascendant as it was last year, which perhaps may have been its time of crisis. But you do not deny great merit in it? such a public success is not without some foundation.

Students.—There is the merit of fogging out in it; it is a kind of Daguerreotype painting. But critics have not discriminated its qualities. With some few exceptions, Pre-Raffaellism has had the merit solely of execution, and not of sentiment. The extremeness of ugliness has been very truthfully displayed by it; but it is much easier to portray ugliness than beauty, and meanness than dignity. There can be no substitute for beauty. There has been much pseudo-faithfulness in Pre-Raffaellism, obtained by emphasizing ugliness both of form and tint. It thus gets the praise of truth for actual untruth, and for power from want of power. Pre-Raffaellism has dealt largely in ugliness; and if that were allowable before the time of Raffaele, it assuredly is not so after, when that great master left so many examples of the most human and faithful expression, combined with the greatest beauty. What would the world think if a corps of sculptors were to be Pre-Phidias, and give us a number of Cyclopean and Assyrian rude idols?

Amiens.—But surely you agree in the Pre-Raffaellism having done good to the English school?

Students.—There is a vigour in the episode, and there is a definition in its art that is well opposed to slipshod. But I hold most of the Pre-Raffaellistic effects to be false; they have a similar reference to nature, in regard to relief, as a plant pressed in a "hortus-siccus" has to the free flower in nature—flat and distorted. Forms are set forth by them with such confidence, that the world hardly ventures to call them ill drawn—hardly supposes the artist would venture to put them forward with such startling earnestness if they were not true. You will say, perhaps, I am talking illiberally of this school; but I am simply expressing what I cannot be blind to, and opposing an untrue cry for certain peculiarities which have no foundation in true Art. There is no excuse for disagreeableness in Art; and though I may see some excellent qualities in the Pre-Raffaellistic school, I hardly know a picture among their productions which I covet, or that I believe will hold the ground it at present occupies.

Amiens.—But do not you think that the young men who have commenced this school will do great things when their peculiarities are modified by time?

Students.—I should hope so; I believe there is an excellent likelihood of it. But I have lived long enough in Art not to put faith in promises; I believe in works when they are done, and not till then.

Amiens.—They certainly number among them men of great talent.

Students.—Undoubtedly. Moreover, it is not, perhaps, that I estimate the productions of the Pre-Raffaellists lower than other people, but that I estimate those of a more unaffected style higher. Out of the present exhibition, even among the productions of the young men, it is not the Pre-Raffaellistic pictures I should wish to have, either for my own pleasure or for their abstract merit. I see other pictures there which have their excellences without their demerits. Pre-Raffaellism is an overstrained style in all its material points; and its sentiment, even when effective, is apt to be overstrained too. But to this there are exceptions; but as a style it does not appear to be a working out of unaffected, simple thought.

Amiens.—Rather legendary too, perhaps, than historic or epic; and for its success in some degree to be obliged to Mr. Ruskin.

Students.—Perhaps.

Amiens.—And to the picture dealers?

Students.—I do not say that.

Amiens.—You do not say that. Still these gentlemen must be very powerful with the public. This reminds me of what I heard a sculptor exclaim the other day at an Art-discussion, in which the press and dealers were severely handled:—"I wish Mr. Ruskin and the dealers would only take me up too, and my Art!"

THE LATE EARL OF BELFAST.

ENGRAVED BY R. A. ARTLETT, FROM THE STATUE BY P. MACDOWELL, R.A.

It is our intention occasionally to introduce into the *Art-Journal*, as circumstances may seem to render it advisable, engravings from some of the numerous statues which have recently been erected to the memory of distinguished individuals. Portrait sculpture has, within the last few years, met with great encouragement, and, as a consequence, has advanced in style and character. In making our selection of such works, it will be our object to choose those only which appear to us worthy of being classed with the poetical conceptions of ideal sculpture.

We commence then with an engraving from the bronze statue by MacDowell, recently erected by public subscription in the town of Belfast, to the memory of the late Earl of Belfast, son of the Marquis of Donegall. We must borrow some fragments from the eloquent address delivered at the inauguration of the statue by the Lord-Lieutenant of Ireland, the Earl of Carlisle, as a more fitting tribute to the worth of his young friend than any words we can offer:—

"For what purpose, let me ask, is it that we are now assembled? To pass what, in both ancient and modern nations, has been always reckoned as the highest and culminating honour which can attach to the departed—to raise a statue to their memory, in the full light of day, when the concourse of men is thickest. And to whom, let me ask also, is this honour to be assigned? Is it to the successful warrior, who has defended the freestates and upheld the glories of his native land? Is it to the veteran statesman, whose long career of honoured years has been numbered by benefits bestowed on his fellow-countrymen? Is it to the powerful monarch, whose will is law, whose breath is patronage? No; but to a young man who had only attained the age of twenty-five years, who had never filled any public station; and who, if connected with the people of this district by the ties of hereditary descent, and anticipated inheritance of property, yet now, from his cold grave, cannot remunerate, or even thank, one human being. . . . It is some praise that a young man of one of the first families in the country, born, so to speak, in the purple, reared amidst all softness, inclined as well by temperament as by training to the keenest susceptibilities of refinement—to the polished and imaginative side of human existence—to the soft influences of Art, and music, and song, should not yet have confined himself to those smooth limits and trim enclosures, from which the bleak winds of our working-day world are shut out so carefully, but should have taken the more real as well as the more generous view of the true purposes of human existence. From the days of his early boyhood he had a strong, I may say a fervent wish to apply the facilities which his Creator had given him to the service of his fellow-men, and especially of his fellow-countrymen. . . . I have hinted at his aptitude for musical composition, in which he showed such remarkable proficiency. Well, I find that the sale of his earliest musical compositions brought him the sum of £100, which he applied to the relief of the sufferers by famine in the dreadful years of 1846 and 1847. He had long entertained an eager hope of founding in this city an institution containing reading and lecture-rooms for the working classes, with a gallery for painting and sculpture—arts which he loved and appreciated so well. I have a mournful satisfaction in referring to him as an associate in the delivery of lectures in public assemblies; and many of you, I doubt not, will remember with pleasure the promptitude with which he came forward to make his first speech in public, on a sudden emergency, at the opening of the Belfast School of Design."

Such is a brief sketch of the man whom the citizens of Belfast, who could perhaps best appreciate his worth, have delighted to honour. MacDowell's statue of this gifted young noble realises his person and character with unqualified success; it is not alone a beautiful work of Art, but it reflects the beauties of the mind and person of him who—

"Gentle, wise, and good,
Manhood's loftiest aims pursued
With a heart of maidenhood."

He died of consumption, at Naples, in 1853.

THE ART SEASON OF 1856.

We are not so ungrateful as to give the sum of the season as—*pas et pretere nihil*; the glad tidings of peace came in time to give happiness to many hearths; the impide was soon felt—men of genius, who, at the end of last year, knew not when they might again be employed, have been gradually yet fully re-commissioned. But sculpture does not so soon recover from a state of depression as painting. We could name artists of eminence in this department who have not received a commission during the last twelve months; hence the meagre exhibition of sculpture this year. We very ingeniously declare ourselves destitute of taste for large Art; but verily there must be somewhere a craving appetite for minor productions. We see yearly thousands of pictures; and of these, hundreds are good enough or bad enough to impress the memory inasmuch that they may be remembered; but having disappeared from the walls of the exhibition rooms, how rarely do we again see any of them! Of some few of paramount excellence we learn the destination; we may know their whereabouts, though we may never see them again. We have seen known works distributed and re-distributed by the hammer of the auctioneer, yet these bear an insignificant proportion to those purchased directly from the painter, and indirectly from them through dealers. The great proportion of collections now in progress of formation are the property of the middle classes, to whose patronage in a very great measure the prosperity of Art is indebted. Those of our countrymen who are facetiously termed the "cotton lords" and the "iron princes" of our land, are munificent buyers of the works of living artists, and all therefore of the productions which they acquire will hereafter be property unquestionably genuine; whereas those collections, generally, of so-called old masters, formed under the insufficient warranty of foreign dealers, will, under the matter-of-fact test of the auctioneer's hammer, realise one twentieth of their cost.—With reference to the sales of our modern Art, and the channels into which it flows, the fact we state would be attested by the sale-books of the different Art-societies, if we were to refer back during the few last years to these records.

We had last year to note a falling off in the receipts of the Royal Academy, but we believe that this season the amount derived from visitors is an improvement upon that of 1855, though yet far below that of 1851, the Great Exhibition year. The summing up of last year was a source of consternation to the royal body; it showed that their course of prosperity might be interrupted by causes even difficult of explanation. Many really sensible and practicable hints have been lately thrown out with a view to their adoption for the improvements of the institution, but as a body they are not yet sufficiently advanced to admit of any liberal chance. They have a considerable measure of justice to fulfil before they can enter upon any course of what will be called liberality. Alas! the lady whom they have pedestalled as their deity of justice is not blinded, and her scales and weights are adjusted to an infinitesimal *avoirduis*. But of the exclusiveness of the Academy enough has been said; the ill-judged elections must bring about the ultimate remedy. The long list of portraits and pictures previously sold that are sent for exhibition to the Academy renders the question of the amount of sales somewhat difficult of solution: the prices at which the more important works have been commissioned and disposed of are generally known, but we have no space to individualise—it is enough to say that the worst have realised the largest sums. In comparison with the amount paid into the Academy those received by the other institutions are small, but they are generally considered average returns, some even beyond a mean computation. The Society of British Artists exhibited eight hundred and forty works, of which two hundred were sold, independently of those disposed of before exhibition, and the amount received was £6000. The catalogue of the National Institution gives a list of five hundred and eighty works, of which a proportion was sold to the amount of £3000. The Society of Painters in Water-Colours have exhibited three hundred drawings, of which two hundred and twenty-two were



[The text on this page is extremely faint and illegible. It appears to be a list or a series of entries, possibly organized in columns, but the individual characters and words cannot be discerned.]



STATUE DE LA LIBERTÉ PAR M. BARYE

HAUTEUR TOTALE 36 MÈTRES

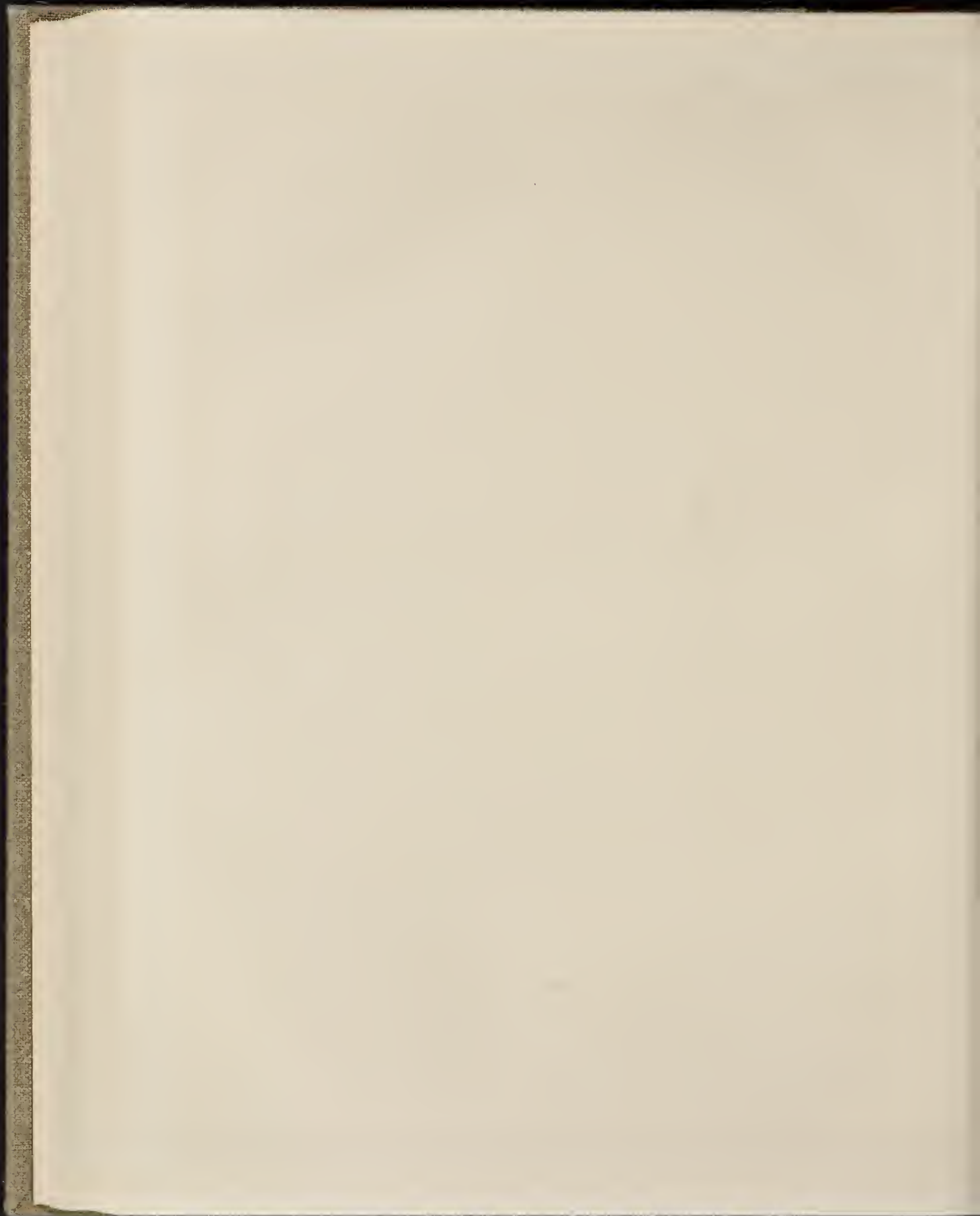

sold, including all the large and principal works. To this gallery there has been a great increase of visitors this season—an augmentation of eight thousand beyond that of 1851, when the doors were kept open a fortnight beyond the accustomed term. Upon several occasions, at the early part of the season, the press of visitors was so great that the staircase was most inconveniently crowded, as was also the room, and numbers were obliged to postpone their visit until a more favourable opportunity. This institution, in its policy, is a model well worthy of imitation by the Royal Academy; it never rejects any candidate of a certain degree of merit; and perhaps the circumstances attending the last election are unique in the history of such institutions—we mean the withdrawal and re-election of Harding and Holland, both of whom have been treated by the Academy in a manner pointedly insulting. The New Society of Painters in Water-Colours exhibited three hundred and forty-nine drawings, of which one hundred and fifty were sold, realising an amount between two and three thousand pounds; and thus supposing the British Institution to have exhibited five hundred and fifty pictures, there have been seen in the various exhibitions more than three thousand works of Art never before exhibited.

In a list so numerous the landscape subject-matter is of every variety; there is no leanness of any pictorial interest that is not represented—and, for the sake of a *varietatem*, very many of no pictorial interest at all—abstracts of every region lying between the sunniest parallels of the polar latitudes, and the perennial obscurity of others condemned to lie for ever countless fathoms below zero. Rome is no longer the "eternal" city; Venice now rejoices in that epithet—an everlasting theme in brick and mortar, which makes us long for the novelty of Hampstead and Wandleton Common. Then there are the travelled landscapes—those of Egypt and India, with subjects even of Algerian scenery: hence, perhaps, we may be invited to perch like sea-birds on some islet-rock of the classic Archipelago; visit the site of Carthage, seasoned with a suggestion of Marius; or the ruins of Corinth, still guarded by the ghost of the Consul Mummius. We have scenes from Arcadia, teeming with flocks

"Sweeter than the lids of Juno's eyes;"

and subjects among the sublimest Alps, veiled in snow, and suggesting themselves to the spectator as the gigantic handiwork of some outraged conglomeration, and thus condemned for ever to stand mysteriously veiled. The Italian peninsula has supplied its quota, but without much variety—for painters, like sheep, tend in each other's footsteps; hence the continued reproduction of the Italian lakes, the villages which lie scattered on their shores, and the mountains by which they are surrounded—their surfaces and the skies by which they are enshrouded afford but little variety of feature. We frequently turn from them with a sense of refreshment to the surging waters of the North Sea. But after all, what is there equal in freshness to the landscape of our own isles? The trees are picturesque beyond everything elsewhere to be seen, and the combinations of lake and mountain in the lake districts of England, Wales, Ireland, and Scotland, are unequalled in the world. Switzerland and the Italian lakes are much praised by travellers; but all travellers are not painters, and it requires some knowledge of Art to learn that mountainous Switzerland does not paint well; and all that can in any wise vie with our romantic landscape are the lakes of Switzerland and Italy, while there is nothing that approaches the verdure of our wooded landscapes, which, be it understood, is much more difficult to paint than Italian scenery.

In our first glance of the contents of the Academy this year we were struck by the number of large portraits, and the quantity of small pictures. The community of painters seemed to have been laid asleep by the wail of some enchanter during the greater part of the year, and to have shaken off the soporific influence only just in time to paint a picture for the exhibition, without a thought to give to the selection of subject. If this were once the case it would not excite notice, but it is always the same. We repeat what we have before so frequently said—these exhibitions betray a melancholy want of reading among our pro-

fessors of Art. There are a few works which are invested with the dignity of historical narrative. Elmore's "Charles V." is one; it has been painted before, but never so well; we wish he had painted a subject entirely original, and equally well. Ward's picture is also full of earnestness and thought, but he is painting too much from the first French revolution. In such melodramatic subjects as "Andrew Marvell returning the Brébe" (Wallis) there is much interest, but the subject is not made the most of. "The Death of Chatterton," by the same, is better. "Crommer at the Traitor's Gate" (F. Goodall) is an admirable subject, and treated with a becoming sentiment. It is extraordinary, that of more than thirteen hundred works there should be so few painted with a real feeling for originality and the dignity of historic and didactic Art. There can be no hope of anything great from Pre-Raffaellism, as all compositions in this manner are constituted of *minutiae*. Paton has never professed Pre-Raffaellism, but his picture, "Home," combines breadth and finish with a feeling that the new school would do well to imitate. In bygone years we have protested against the abuse of Don Quixote, and the Vicar of Wakefield; they have disappeared from the scene, but there is no improvement—we seen rather to have receded. Dr. Primrose and the knight of the riefed countenance are succeeded by a rapid sentimentality and the most commonplace vulgarity. If a novel and telling subject be exhibited by one painter, it is dwelt upon by others for years afterwards. Incident and accident of the most ordinary kind are elaborated with a care which, applied to a worthy subject, must result in a first-class picture. We are weary of theatrical rusticity and improbable vagabondism, cottage scenery and prim-looking charity-girls. It is true that the public have bought largely of these things; but then the public in matters of Art are not their own keepers,—yet it appears that it rests solely with them to raise the standard of subject-matter, if painters will not make any effort at self-instruction.

CORRESPONDENCE.

To the Editor of "THE ART-JOURNAL."

THE NATIONAL GALLERY.

[We have received the following letter on this subject. By our notice of last month may be seen how entirely we differ from the writer of it. We deem his proposal visionary, nevertheless we insert it—considering it one of the duties of our Journal to afford an open arena for the discussion of such subjects.]

SIR,—In the *Art-Journal* of this month (August), in your article concerning the National Gallery, and its removal (which you advocate) to the Gore Estate, Kensington, the question is put, "Where, if it be not to go thither, shall it go?" *A propos* of this question, I address to you the following remarks; and if they be given in a somewhat roundabout way, I hope you will excuse it.

"Are our Art-institutions to be central or suburban?" appears to be a question that will soon again occupy the attention of Government. As an abstraction there appears to me but little doubt as to the reply. If Art is to enter into the heart of the people of this great metropolis, it is not to be effected by removing it to the outskirts. If benefiting the people be an object, by affording them all those civilising and intellectual and refining advantages derivable from the contemplation of fine works of Art; and if benefiting Art be also an object, by accustoming the people to the delights of it, and rendering it more a necessity to them than it is now, evidently such a site as would offer to the people and the pictures the readiest facilities for being together would be the best.

Charing Cross is now very nearly the centre of London, as a glance on the map will show, and it is from this point that it has been proposed to remove the national pictures to the beautiful suburb of Kensington. A reason presented for this is the evils they suffer from the smoke of London. Now the smoke will eventually either be done away with by artificial means or it will not. If it be done away with, which there are excellent reasons for believing the ingenuity of man will ere long effect, the great argument for the removal of the pictures equally vanishes; and if it be not done away with, London is so rapidly increasing to the westward that in a

few short years, perhaps by the time the new arrangements are completed (for the pace of Government proceedings is well known), the smoke will have overtaken the pictures again in their new site! I am not a believer, at all to the extent that has been alleged, in the destructive influences of smoke; but I would rather have all the pictures covered with glass, as some of them already are, where the people should have facilities for visiting them, than uncovered—as is undoubtedly the best mode of exhibiting oil-paintings—where but a tittle of the same numbers would ever go to visit them.

I am for the centralisation of Art, but not for its centralisation on the edge of London. I am for its centralisation in the centre of London, where I would have not only the national works of painting and sculpture, but also all those Government institutions of Art which are connected with the Board of Trade—viz., the central schools of design and museums of ornamental art. I do not say under one roof or under one management, but I hold that all these departments of Art, as associated in elements and objects—those of improving the tastes of the people—should not be far separated in situation, but be so placed in regard to each other as to be visited and consulted, whether for pleasure or study, by an easy transition. The more, indeed, they might seem to belong to each other the better,—as in itself involving a useful lesson much wanted here, that all these various departments are but higher and lower branches of the same great Art tree.

Now for the site. We have consulted the map once, let us do so again. You see Charing Cross, with its adjacent buildings, is situated on the *outside* of an angle of the Thames. What is situated on the *inside* of this angle?—I mean on the opposite—"the Borough" side of the water. Let us cross Hungerford Bridge, and see. Why, with the exception of a few wharves, warehouses, and manufactories, on the edge of the Thames, the space comprised between this portion of the bank of the river and the South-western Rail contains but a mass of small houses, tumbledown property, and waste ground. Moreover, see how the bridges of Westminster, Hungerford, Waterloo, Blackfriars, Southwark, and London, all converge to this spot, offering direct routes for transit hither, and rendering it more really the centre of London than any other spot. Some of us hardly, I believe, contemplate the Borough side of the town as in truth belonging to London, nor associate it in idea with anything but manufactories and warehouses; but, in an Art point of view, let them be assured that no spot on the river affords so fine a view of our magnificent metropolis and its various river attractions,—the new Houses of Parliament among them,—as is presented by this exact locality, as any one may verify any clear day at the farther end of Hungerford Bridge.

It is this spot which I would suggest to be occupied by British Art, with all her varied national treasures of tasteful instruction of that character. It is in this angle of the noble Thames that I would house them, and in such architectural accommodations and on such a terraced elevation as not only to command the finest river-view in London, but to offer equal beauties in turn to the London bank, and to the bridges, over which such ceaseless tides of population are continually pouring. Here should be located the government central school and museums of ornamental art, whose teachers are practically and more directly addressed to the manufacturing population, to whom such a situation for the consulting of their treasures as would enable them to visit them in an unoccupied hour or so, would be a vast boon. And here, too, should be the sister collections of painting and sculpture, and all which to them belongs; and here should be lecture halls for the people, where they might hear explained the principles on which the benefit of these things depend.

But this is not all that occurs to me. The contemplation of this site for British Art, and its neighbourhood to Charing Cross, leads at once to the vision of the vast advantage that might be taken of all this to endow London, at this central point, with a wide, expanded, free space, analogous to that of the Place de la Concorde, at Paris, opening out and introducing one bank of our great metropolis to the other, and the river to both. It is this mutuality that gives a great charm to this spot in Paris,—the Louvre and the St. Germain's side, and the river and the old city, all forming the *ensemble*.

The advantage to Paris of the great opening of the Place de la Concorde cannot be over-estimated. I would suggest another such in London—uniting the two sides of our metropolis to our great river at its best point. For this it would be requisite for Government to occupy the before-mentioned portion of the Borough side which is comprised between the angle made by the river

at that end of Hungerford Bridge, and that portion of the South-western Railway which is near the Waterloo Station, and to lay this area out into a wide esplanade, with the requisite Art buildings. Also, to remove all the buildings between Charing Cross and the Thames where they most nearly approach, opening out that square to the river, and, in fine, to connect the two banks by such a bridge, or series of bridging edifices, as would, no doubt, under the hands of our architects, produce the grandest architectural passage of a river the world has yet seen.

Sir Robert Peel is said to have characterised Trafalgar Square as the noblest site in Europe! what would it be then? And think what a *bang* it would be to London! The old town might draw in a long breath at the very thoughts of it! Government might then let the Royal Academy have the whole of that building of which they have now barely half, which would enable them, I hope, to rectify most of their present shortcomings; and across the water at either end of one great square, our academic Fine Arts would have in sight the cognate establishments of our national Art-treasures, and also of our schools and museums of ornament applied to trade, manufactures, and commerce. This would be real centralisation!

My letter has drawn out so long that I will not go into any details; but I shall be very ready, if it interest at all yourself or your readers, to fill up the sketch somewhat more at a future time.

I am, sir, yours, &c.,

W. L., A LOVER OF ART.

[We think our correspondent had better be content with the "sketch" he has sent; the "filling up" satisfactorily, even to himself, we fancy, he would find a difficult task. Many a pen-and-ink sketch will not "paint," and there is no severer test to a visionary scheme than to pin its author down to a completion of its details.

We acknowledge readily that an open expanse in the centre of London would be an advantage to it. Thus far, and no further, can we go with our correspondent. But as regards the special subject on which he hangs his observations—viz., "the location of the National Gallery," nothing can be wiser of the mark than the point he indicates. The immediate propinquity of the Thames (which forms such an element in his plan), in its present state, with its villanous variety of exhalations, would certainly be no advantage to the national pictures, which are considered with justice to be injured by even the atmosphere of their present site. Our correspondent is very hopeful as to the speedy doing away of smoke—we wish we had grounds for a similar faith! Our views as to the proper site for our treasures of Art are already before the public; and the objections of our correspondent are mainly anticipated and answered in our article of last month. We will just now, therefore, add little more on this subject; yet we would assure our correspondent that, unresponsive as our houses of legislature usually are to the calls and interests of Art, they are not so indifferent to them as for a moment to entertain the idea of placing our national pictures amid the fetid steams of home and hide warehouses, or manufactories of pyrolytic acid and vitriol.

Notwithstanding the success of Lord Elcho's motion in the House of Commons, and the report of a committee which we are to look for in consequence, the Art-buildings will be erected at Kensington Gore!

All the arguments put forward have failed to carry conviction that this site—Kensington Gore—is not, all things considered, the best. Indeed, there has been no attempt to point out any other, except that which is still more distant from the heart of the metropolis—Kensington Gardens. Surely we may lay some stress on the fact that the large amount of space at Kensington Gore is bought and paid for—a moiety of its cost having been met by the surplus fund of the memorable year 1851—a great fact!

The delay caused by the proceedings of the House of Commons is much to be deplored; it will do some mischief, but no possible good; for, of a surety, the result will be—when certain meetings have taken place, a score or two of witnesses have been examined, and the proceedings carefully printed—the issuing of a report recommending Parliament to proceed to erect buildings at Kensington Gore, for the erection of which annual grants will be moved for and voted.—Ed. A.-J.]

THE ANTECEDENTS OF OUR CABINET AND ORNAMENTAL BRONZES.

A most prolific school of Art is the French quasi-sensitural; that which teems with little bronzes of every imaginative form and character—at least, those productions which are good-naturedly called in the mass "bronzes"—heroic, poetic, eccentric, cinquecento, Renaissance—everything. The cradle of their earliest manner was Nuremberg; but the crisp and hirsute curiosities of the progress of the art have nothing in common with the sober dignities of Peter Vischer and Veit Stoss. The Nuremberg bronze art of the last quarter of the fifteenth and the first quarter of the sixteenth century is one thing—the bronze art of the present day is another: and yet the latter has marked relations with the former. Our memories of Nuremberg are refreshed by Kugler in an article in the *Kunstblatt*, though we cannot assent to all his conclusions: we have never been able to divest ourselves of an opinion, deliberately formed, that the present period of German Art is not its most admirable epoch—certainly not that by which its earlier stages are to be criticised. What a deep impression does the St. Sebald monument, by Vischer, leave upon the mind of every lover of Art! he is struck with wonder at the amount of the artist's information—for in those days the means and appliances of Art were few and limited. It is true that he has worked rather from his feeling than from any fundamental knowledge of those early principles of the Gothic, which were gradually developed from the classic traditions that in Italy had begun to reign paramount. The entire construction of the tabernacle which encloses the reliquarium of St. Sebald is essentially Gothic, and the somewhat obtuse pyramidal coronals remind us of the very earliest Gothic; while the capitals, basements, &c., suggest all the license of the Renaissance, and the compositions which accompany the figures recall Dürer's colossal wood carving in honour of the Emperor Max. It is thus curious to contemplate the variety of style, and even the infirmitates of taste which prevail in this and other contemporary works; but we pass at once from complaints to well-merited admiration, even of the manner in which these influences of the columns of the tabernacle, and the smaller ones of the propylæa, evidence an inclination to the older types of the German style; and it is not at all difficult to understand this, when we remember the tyranny of manner in the execution of figures at this time. In the reliefs from the holy legend is traceable a certain classical freedom and beauty; and in the decorative compositions of a symbolical and ideal kind, the artist revels in that naturalism which declared itself in a manner so pronounced at the epoch of the Renaissance—this is especially seen in the draped female figures of this monument, and also in Vischer's allegorical designs descriptive of the Reformation. The same predilection is obvious in the numerous figures of children which enter into the composition, both in the upper and lower parts, and these are qualified by a captivating simplicity. The mythic decorative figures are very attractive, as possessing in full force the charm of the Renaissance—the most felicitous being the syren-like torch-bearers at the corners of the tabernacle, which are amongst the most original conceptions that could under such circumstances be realised. With respect to mechanical execution, that still bears the mark of the modelling-tool, inasmuch as to have left the work in some degree rough; but the greater part is distinguished by much original freshness and decision of touch. By no means the least remarkable feature of this great work is the manner in which it is put together, composed as it is of an infinity of minute parts. The resemblance already mentioned to certain of the works of Dürer may be further traced in the treatment of the nude, and in the introduction of a classic element. Thus not only is the degree of relationship between these artists declared, but also their respective differences, for Dürer does not participate in that disposition to Germanism so manifest in the peculiarities of this work. The beautiful Romhild monument is attributed to Peter Vischer, but it is evidently the production of different artists; and if Vischer had any share in the work, it extended

perhaps no farther than the bronze casting. There are also among the monuments in the Cathedral at Bamberg tombstones with the figures of prelates and bronze bas-reliefs, which are attributed to Peter Vischer; and it is satisfactorily shown that two of them are of Nuremberg execution—that of the Bishop Henry IV., and that of George II.; the latter cast after a drawing by the Bamberg artist Wolfgang Katzheimer; but inasmuch as this work is not to be compared with the St. Sebald's monument, it cannot be supposed that Vischer prepared the models. The ornamentation is of much beauty, but the figures are deficient in animation and artistic feeling. Portions of the monument of the Elector John Cicero, in the cathedral at Berlin, which are contemporary with these works, are infinitely superior in execution; so that even this composition, which was certainly cast by Vischer, is also doubted, on very plausible grounds, to have been a production of this master. But the reputation of this artist rests upon his Nuremberg works: his friends do his memory no service in attributing to him others with which his name may be associated only as to the bronzing. We cannot quit Nuremberg for any of the merely probable sites of monuments attributed to the St. Sebald's artist. And by the way, who was St. Sebald? we only know that this was his resting-place, and the scene of his miracles; he was canonized only in 1370, and immortalized by Vischer in 1519. But we cannot think of Nuremberg without remembering also other stars of that constellation that has now for more than three centuries shone with a steady light on the world of Art. Despite its mingled histories, we cannot withhold our most honest applause from the beautiful fountain by the Rupprechts and Schönhof; there are sixteen admirable figures—let them be, if you will, the Electors of Mayence, Treves, Cologne, Bohemia, the Palatine, Brandenburg, and Saxony; and let the rest be Joshua, David, Judas Maccabeus, Hector, Alexander, Julius Caesar, with Charlemagne and others—a society selected with a singular predilection for fighting men; but there they are, figures that we have recognised in all the Art-capitals of Europe, and with whom we have established a nodding acquaintance. Then there are the nude Virtues at the fountain in the Lorenzplatz, as old as the latter part of the sixteenth century; and then the famous Gänsesüßwäucher, in the fruit-market, with a goose under each arm—everybody knows this most original figure, but nobody knows the name of the artist—most singular that the name of a public work so celebrated should be lost! It is not surprising that the author of a picture, which is private property, should be forgotten in its passage through the hands of many possessors; but (*parvum magno componere*) Cologne Cathedral and the Gänsemännchen are two curious examples of public forgetfulness. Of Veit Stoss, Adam Kraft, Wohlgemuth, and others, it is unnecessary to speak at any length; we have instanced enough for our purpose, which is to point out the excellence of the Nuremberg school, as abounding with material, not only for small bronze-work, but for metal compositions of any scale. Continually do we recognise the old guild figures from the walls of Florence (excellent for costume), only reproduced; and continually do we meet with some or other of these figures from Nuremberg undisturbedly as originals in modern works. This is not the use that an artist of any calibre at all makes of the productions of the great masters: they should be employed as stimulants and correctives. We cannot help admiring the excellence of the casting of the numberless minute objects which are now produced in metal, but we cannot in an equal degree prize generally the subjects which are adopted for execution. All these productions are of foreign manufacture; many are indeed admirable—those which are really artistic; but all persons of taste must deem otherwise of those which are merely mercantile. The Germans have carried zinc and iron castings to great perfection: and for large productions and copies, these casts are very effective—but at present we have seen few of them in this country. It is much to be regretted that there is among ourselves no enterprise in small bronzes; when this does arise, and we think that it must soon, it is much to be desired that, instead of the ultra-grotesque, our artists will essay something of the earnest nature-worship of our old and inestimable friend, Peter Vischer, of immortal memory.

HERALDRY MAY HAVE MEANING!

HERALDRY may be considered now by some as a merely decorative display, adopted by families for distinction alone, and being without import or any rational indicativeness. But this could not have always been the case with the "blazon of arms;" for if its usage had no more purpose than is now often applied to the art, its use would have died out long ago. Scholars have from time to time found in heraldic history an important branch of archaeology; and in times not very remote it was made auxiliary to family records, and the better determining of descents and alliances. Some of these heraldic histories would, if recited, be found curious and entertaining at least, if not instructive also; but, passing these more gravely indistinct applications of heraldry into other hands, permit it to be stated that some of the legends conveyed in blazonary are romantic, others are classical, and a still larger number are poetical and pleasing enough to engage attention for a brief while; and as a filling up of some minutes with at least one of the pleasant relaxations of literary leisure.

Many persons now adopt crests and coats-of-arms; would it not then be a step in literary progress if the meaning of these signs became somewhat of a living language to those who use them; and that the pictures chosen, or assumed, should again speak to the mind as well as to the eye, as they probably did to those who displayed coats-of-arms formerly?

PRACTICAL PURPOSES OF HERALDIC DEVICES.—It is found convenient to have a crest stamped on family plate, so as to identify it as property. Those who have carriages mark them with some emblem of this kind, to discriminate the ownership of the vehicle in a crowd. Many have their arms, or crest, printed neatly on paper, so as to be able to paste them into books, or put them on other portable property, which is done more conveniently than painting or writing names on them; these and other domestic uses for heraldic marks will be easily remembered; but family history may be sometimes helped out by heraldry; a tradition may by this key be turned into probability, or a probability may assume the consistency of facts.

AN HISTORICAL APPLICATION.—Unda often heard that Bandon, the town of my nativity, was colonised by English settlers brought there by the great Earl of Cork; and as my family had been manufacturers in that town for a period as long as tradition ran, I, in the year 1827, asked Sir William Betham, Ulster King-at-Arms, whether there were any armorial bearings known to belong to the name of Dowden. Sir William made a regular search, and with friendly politeness handed to me a copy of the crest and shield of "Dowling, of Somersetshire," now "Dowlen," of Bandon, county of Cork. Its description is:—"Crest.—A Catherine-wheel, azure. Shield.—Argent, on a chevron Gules, bearing three fleurs-de-lis Or, between three doves of the second."* The motto superadded is, "Fide et Fervore." Now to give a meaning to these emblems. First, the crest—the Catherine-wheel. The indication of some form of martyrdom is very usual in heraldic types, but this form of its infliction is among the least frequent. Saint Catherine, her legend says, was by the pagans immolated to their gods, and the instrument of her torture and death was a wheel armed with sharp knives; this wheel and its cruel blades being of steel, the steel, whitish-blue tint is the metal colour of this indication of suffering and endurance. This is our nearest history of the Catherine-wheel; but if we go back to times antecedent to Christian martyrology, we find legendary lore connected with the "pota," or wheel, which has a less painful translation and import; mythological meaning, and classical characteristics, are revealed from its use. The wheel, we find, was one of Minerva's chosen emblems. We know that the wise goddess was a great spinner; indeed, somewhat too jealous of that art, and of her textile

techniques, we remember how, with a blow of her shuttle, she "knocked the conceit" out of her rival in that Fine Art, and made poor Arachne into a spider, thus dooming her, for her daring, to "work at the web" for ever. Now as spinning is the pre-eminence of weaving, weavers claim high patronage—indeed, no less than that of Minerva herself; and as tradition in the family of the Dowlings says that they were weavers long ago, and modern fact declares that their descendants, the Dowdens, did not disgrace the continuance, or leave the patriarchal caste, that family may claim the wheel of Minerva as their emblem, having for a couple of centuries followed in their manufacturing manipulations the "art and mystery" of the goddess. A few other families also claim "a wheel" as their crest; he it then the spinning-wheel, it is the kindest key to their history, and I present to them freely this medium of intelligence, with its honours and its pleasures; the dignity of which is not severely limited to hand-cruising, but points out the protecting influence of the patroness of mind-wisdom as well. And now can any one desire a higher feather in his cap than that which may surmount a Catherine-wheel crest in front of it? Again for awhile returning from the blue-eyed goddess Minerva, we come to our christianised mythism, and find all the appellatives of Pallas revived and continued in St. Catherine of Alexandria. This lady was the patroness saint of intellectual philosophy; she disputed in "the schools," and is in her pictorial history represented as putting no less than fifty logomachies to silence! Surely this was a vigorous put forth of the disputations powers possessed by a lady saint. Brudee, the antiquary, tells us in his "History of Popular Antiquities" something about her consequent beneficences as follows:—

"St. Catherine figures learned men,
And gives them wisdom large;
And teacheth the resolving doubts,
And always yieldeth aid.
Against the scolding sophister
To make the reason slant."

So that we find wisdom and spinning have long been associated, and this successor of Minerva, in the curious old book called the "World of Wonders," is styled "St. Catherine, the Protectress of both Art and Science."

The floral distinction of St. Catherine is the well-known annual, with the blue blossom and extended calyx, made up of rays or filaments of green, somewhat resembling a cluster of thorns. Here we have the Catherine-flower, with its true-blue blossom, showing constancy, which persists for its time, although beset and encircled with these apparently thorny difficulties. The scientific name of the genus to which this flower belongs does not assist the legend in any way—*Nigella* only telling us of its black seeds; but the name "Damascena," which distinguishes the species botanically, turns our recollection to Damascus as one of its habitats, takes us in thought to the early crusading struggles for the possession of "the Holy Land;" and thus we find our flower within the series of badges proper to floral ecclesiastical ornamentation. These notes seem to contain the principal matters connected with the heraldic Catherine-wheel; we take leave of that portion of the subject, and, following out the attempt to read heraldic history, the shield comes to be described in its import. The three doves are presented "Gules," or tinted in one of the shades of red, the colour of the African and Portuguese doves—"the collared turtles," tamed birds which our Crusaders probably knew familiarly; we describe these, a little out of their order in succession, but as animals are more noble than plants, we give them place and precedence. Doves have much emblematic significance, but all in keeping with the same series of sentiments. They appear constantly in ecclesiastical imagery, and are introduced in various religious rites. In some cases the living bird itself, and in others representations of it, have been made emblematic in ancient and in modern ceremonies. The introduction of this bird on a shield under a crest, in memorial of St. Catherine, is appropriate—for the doves suggest the patient and pure endurance attributed to that martyr. There are, we know, much more lofty imaginings which the religious history of the dove conveys, but we appropriate only its less solemn indications, and use them merely to portray human feeling. We may also glance at their mythological considerations, and remember

that these birds were the equipage of Venus; as they were chosen to draw the Queen of Love down to earth, they became emblems of her attributes, and remain dedicated to her, and the feelings of which she was the promoter and accredited patroness. The doves have always retained this attribute, for it was those with the flesh-coloured breast plumage that our own Shakspeare made to portray extremely affectionate gentleness in "Hamlet;" he makes the queen say—

"Anon as patient as the female dove,
When that her golden tapers are disclosed,
His silence will sit drooping."

Classical history, through Elian and Tibullus, tells that doves delivered oracles in the forests of Dodona; this story might associate them with the wheel emblem of the goddess of wisdom; but as it would be rather a severe kind of duty to impose on the messengers of Cytheree, we shall not dwell on it further.

We now come to the flowers on the shield—the fleurs-de-lis, or, as they have been read, fleurs-de-lies; these appear "Or"—in gold, the nearest metallic colour, and they are the well-known showy yellow iris, or flag-ily of all our marshes. To adapt this plant as the heraldic flower of the French nation, when under the Bourbon dynasty, the derivation of its name was made arbitrarily to be from "fleur de St. Louis," and fleur-de-lis was adopted as its abbreviation; but an origin of its name from its fine showiness, "fleur de-lies"—a delighting flower, is more applicable, and possesses the universality of meaning proper to a plant which is very generally distributed, and is not at all limited to the decoration of wild nature in France. The classical history of our plant tells us that its "deliciousness" was sufficient to induce Juno Matrix, when nursing the infant Mars, to delight his young godship with it. The Queen of Olympus holds it in her royal hand during that pleasing time of royalty. Shakspeare also introduces it in its Gallic symbolism, when he makes King Henry V. pronounce it so doubtfully in a love question to his foreign love, that the French lady, Catherine, coquets a little, and pretends not to understand him; the king says, "What sayest thou, my fair flower-de-luce?" and she replies archly, "I know not dat;" however, they soon understood this much of the language of flowers. But elsewhere Shakspeare, true to nature and observation, gives to this plant its due English habitat from his memory, when he describes a garland thus, in the "Winter's Tale:"—

"Lilies of all kinds, the flower-de-luce being one."

And although the pretty Perdita who wreathed the flowers was a Bohemian maiden, the flower-de-luce was presented to our poet's observation in his own England. Spenser too, in his melodious stanzas, sings of this strikingly handsome wild flower as follows:—

"The lily, lady of the flowering field,
The flower-de-luce her lovely paramour,
Did thee to them the fruitless labours yield,
And soon leave off this tedious weary store;
Loe! loe! how brave she decks her bounteous bow'r,
With silken curtains and gold coverlets,
Therein to shroud her sumptuous balmour;
Yet neither cards nor spins, nor cares nor frets,
But to her mother Nature all her care she lets."

There could be much more gathered to give to our iris poetical and legendary position, and that too as an heraldic armorial bearing, but my purpose is merely to show what might be done in readings of heraldry, I need not exhaust this subject. But I hope I have by this time succeeded in showing that heraldry has its history and its poetry; that formerly it was not held to be an idle, arbitrary, and incongruous agglomeration of monstrous distortions, but was intended to convey a mind and a meaning when investigated and displayed. If other persons who have access to heraldic history would seek to unravel its blazonry, there can be no doubt that the reading of these pictorial rebuses aright would afford many pleasant pages in mediæval literature.

It is in this view—and with this hope—these remarks have been offered to the reader; and the writer will be largely rewarded if it be his good fortune to draw attention to the subject, and induce its consideration in the light he has attempted to supply.

RICHARD DOWDEN (RICHARD).

RATH-LEP, COBK.

* The chevron which supports the shield, in heraldry, is generally a well understood part of the armorial, and is in heraldry called "a common ordinary;" but as some readers may not like the trouble of learning its meaning, it may be noticed here that it is intended to represent two rafters in the roof of a building—**V**A; it indicates sustentation or support, and assumes competent stability in a house or family which can show or produce "a chevron proper."

THE ART-UNION OF LONDON.

The Prize Exhibition of the Art-Union of London was opened on the ninth of last month with a catalogue of one hundred and fifty-nine works, of which thirty-six are in water-colour. The highest prize, of the value of 200*l.*, was Hering's picture from the British Institution, 'Old Bridge near Pella, Piedmont'; the next, of the value of 150*l.*, is, 'Shades of Autumn,' by A. W. Williams; those of 100*l.* are—'Stretey Mill, on the Thames'; a 'Summer's Noon,' H. J. Boddington; 'On the Conway, Caernarvonshire,' H. B. Willis; 'Loch Long,' G. Cole; and 'The Mid-day Meal,' H. B. Willis. Of the value of 75*l.* there are four prizes—'The Wealth of Sussex—Chantembury Downs in the Distance,' G. Cole; 'The Hotel de Ville, Brussels,' W. Callow, a water-colour drawing; 'Oyster-Dredging off the Anablies' Head,' E. Duncan, also in water-colour; 'The Town of Cochin, on the Moselle—Winnberg Castle in the Distance,' V. Cole. Of the value of 60*l.* there are ten prizes, and all the others are below that amount. As we have seen and have already noticed the best of the works in this selection—although many of them look better than they did in the positions from which they have been removed—it is not necessary to re-examine them; we may mention, however, some of the most meritorious of those that have been chosen. Besides those already named there are—'Bianca'—The Taming of the Shrew, P. S. Cary; 'A River-Bit, North Wales,' J. Dearle; 'A Summer's Morning, North Wales,' H. J. Boddington; 'Dean Swift and the Messenger,' T. P. Hall; 'Cottages at Pyrford, Surrey,' F. W. Hulme; 'Near Coniston, Cumberland,' J. E. Hardy; 'Sunny Moments,' F. W. Hulme; 'The Deer Park,' H. Jutsum; 'Shades of Autumn,' Alfred W. Williams; 'Swaledale,' J. Peel; 'Scene from the Gentle Shepherd,' W. Underhill; 'Moel Sabod, from near Bryntyrch, North Wales,' F. W. Hulme; 'Trellis Vine on the Lake of Lugano, North Italy,' W. W. Fenn; 'A Bright Day on the Thames,' J. Dearle; 'A Favourite Retreat, North Wales,' F. W. Hulme; 'Medmenham Abbey, on the Thames—Summer Evening,' H. J. Boddington; 'On the Brook, Vale Pengwern, North Wales,' P. Deakin; 'A Farm Pond,' J. Stark; 'A Somersetshire Lane, near Bristol,' G. Fripp; 'The Passing Cloud,' E. G. Warren; 'Summer Shade,' E. G. Warren; 'The Homestead,' C. Davidson, &c. Thus the bulk of the selections are landscape, and many that we have not mentioned are inferior in quality. Having seen what is, and has been done, by another similar institution—the Glasgow Art-Union—we cannot think the plan still pursued by the London Art-Union works well—that of confining the selection of the works to the taste and judgment of the prizeholders. The figure pictures are few; none approach a high tone of didactic sentiment, and they bear an insignificant proportion to the number of mediocre landscapes. We should not have been led to make these observations, but that the Exhibition of the Glasgow Art-Union shows that it is not only not impossible, but that it is easy, to procure productions of high class. We have had some experience in counselling prizeholders, and we have generally found that in their eyes the *largest* picture at a given value was always considered the best. We have watched carefully every exhibition, from the foundation of the institution in 1837, and know that a lengthy catalogue of low class painters speculate in works for prizeholders, and generally succeed in disposing of them. It is not the intention of the institution to foster, year after year, Art deficient of all promise. We do not wish to be unduly harsh, but it is necessary to be just; we can point to the works, in this exhibition, of artists who, though without reputation as painters, are in sufficiently easy circumstances—a tolerably prosperous condition of life, accomplished by means from which men of real talent would shrink. It is not our purpose to go into any analytical comparison of the results effected by the two institutions, but we cannot help mentioning one fact, which is, that while the Art-Union of London purchases pictures to the amount of only 6440*l.*, the Art-Union of Glasgow expends 7990*l.* The plates for the ensuing year will be 'The Piper,' engraved by Mr. E. Goodall, after the picture of that title by P. Goodall, A.R.A., and 'The Clemency of Cœur-de-Liou,' engraved by

Mr. Shenton from Cross's picture, which it will be remembered was exhibited at Westminster Hall during the competitions for the decoration of the Houses of Parliament; and for a future year a series of wood-engravings from the best pictures of deceased British artists are under the superintendence of W. J. Linton. It cannot be doubted, if these are judiciously selected, this last will be a work of much interest. An arrangement has been entered into with the Etching Club for a volume of etchings. The works of that society are always of high merit; this, therefore, may be earnestly looked forward to. In addition to the pictures, the distribution comprehended also eleven bronzes of 'Her Majesty on Horseback,' five bronzes in relief of 'The Duke of Wellington Entering Madrid,' thirty iron vases, twenty porcelain statuettes—'The Stepping Stones,' fifty porcelain statuettes—'The Dancing Girl Reposing,' thirty-four porcelain busts—'Clytie,' forty silver medals of Flaxman, and thirty other medals, also silver, of Vanburgh. Of 'The Supper Scene' there were five hundred lithographed impressions, and of 'Tyndale Translating the Bible,' two hundred and fifty mezzotint impressions. Examples of all these works are added to the exhibition, and many are admirable in execution.

THE GLASGOW ART-UNION.

THE prize pictures of the Art-Union of Glasgow are exhibited in the gallery of the Old Water-Colour Society, in Pall Mall East. It appears to be the policy of this society to exhibit their selection in certain of the principal towns of the kingdom, and being now located "next door" to the temporary abiding place of the prizes of the Art-Union of London, the collection of the northern society appears to great advantage, as far transcending the collection of the metropolitan institution. The number of pictures is two hundred and eight, among which are many works of a very high degree of merit. The first prize, of 400*l.*, is 'Conquered, but not subdued,' by Thomas Paed; the next, of 367*l.* 10*s.*, is a 'Landscape and Figures,' by Creswick and Ansell; then follow a 'Highland Deer Forest, Isle of Skye,' 350*l.*, R. McCulloch; 'The Graces and the Loves,' W. E. Frost, A.R.A., 350*l.*; 'The Infant School in a Country Church,' R. M'Innes, 250*l.*; 'Storm on a Highland Coast—Ben Blavon, Isle of Skye,' H. McCulloch, R.S.A., 200*l.*; 'Burns in Edinburgh, 1786,' W. Johnston, R.S.A., 200*l.*; 'The Kiosk—Lalla Rookh,' F. Wyburd, 200*l.*; 'Cottage Window,' R. Gavin, 150*l.*; 'Isola di San Giulio—Lago d'Orta, Piedmont,' G. E. Hering, 150*l.*; 'Ye Lymere his Dreame,' E. H. Corbould, 150*l.*; 'Whew! caught again!' E. Nicol, A.R.S.A., 130*l.*; 'Summer Trophies,' J. Sant, 120*l.*, &c. &c. This selection must be unhesitatingly pronounced the best that has ever been exhibited by any Art-Union Society, inasmuch as it contains pictures which have done honour to the collections in which they have been shown, and many others which have never before been seen by the public—works that have been commissioned immediately from the artists, and transferred from their respective studios to the walls of the room in which they now hang. The first prize, 'Conquered, but not subdued,' by Paed, we have not before seen; it is a subject from cottage life, the unsubdued one being a ragged barefooted urchin, who, for some unexplained misdemeanour, has been placed in the corner against the wall by his mother, who sits calmly peeling potatoes for the mid-day meal. The brother and sister of the delinquent are indulging in pleasantries at his disgrace, which he fiercely threatens to avenge when an opportunity shall present itself. The figures are very intelligently characterised. The whole is a triumph in expression; and the nicest balance prevails throughout the composition. The cottage is a reality, not overdone with furniture and utensils—there is space for the figures, and they have room to move. It is a production of a very high degree of merit; but we must confess some regret at seeing such an amount of labour bestowed on a subject which is comparatively worthless as an excitant of any wholesome emotion. Wilkie has had a thousand followers, but

he has yet far distanced every one. The 'Landscape and Figures,' by Creswick and Ansell, is a large picture, a composition in which the painter of the landscape introduces a windmill—that which has already appeared in some of his recent works. It is an open composition, presenting a breadth of light—an effect not frequently painted by the artist. A shallow river occupies nearly the whole of the nearest section, in which a group of farm-horses have stopped to drink while passing the ford. The picture is marked "unfinished," we cannot, therefore, tell what final treatment it may be subjected to; but it can only be observed that it waits point, which will doubtlessly be communicated to it when again returned to the easel. The 'Girl at the Mountain Well,' by Sant, is a life-size half-length of extreme simplicity, the features being endowed with a quality of expression far above the level of a rustic drudge. The commonplace costume is most skillfully concealed by a piece of drapery, which in its turn is rendered unobtrusive by subdued colour—this art is fully understood by the painter. The other work by the same artist is 'Summer Trophies,' presenting a child in a sylvan retreat, busied with the Flora of the leafy wilderness. She has decorated her head with a coronal of poppies, and is further occupied in forming bouquets of a variety of wild flowers. This picture forms a striking contrast to the other, being full of colour, while the other is entirely without it. Another work which has not been exhibited is 'Homeward Bound,' by J. W. Carmichael. The subject is a transport off Gibraltar, apparently returning from the Black Sea. The rig and sailing of the vessel are beyond all praise; every rope and spar is in its place—indeed, we never see any marine subjects painted with such a knowledge of seamanship as the works of this artist. The movement and liquid depth of the water are strikingly real. 'The Crimean Story,' by Hugh Cameron, is the production of a painter whose works we have not before seen. The subject is a wounded soldier, returned from the scene of war, narrating his achievements to a small knot of wondering rustics. It is painted with a modesty rarely to be seen combined with so much talent. Among other works chosen by the society may be mentioned—'The Lynx Spout, near Dalry,' H. McCulloch, R.S.A.; 'Birk Craig, near Harrogate, Yorkshire,' George Stafield; 'Sunshine and Showers,' H. Jutsum; 'French Interior,' Eliza Goodall; 'The Dancing Lesson,' R. T. Ross, A.R.S.A.; 'Lindow Castle,' D. O. Hill, R.S.A.; 'A Woodland Pool,' B. Williams—a most careful study from nature. We must in conclusion observe of the Glasgow Art-Union, that its exhibitions have from the first been of a superior kind; and should the selections in years to come evince a proportionable degree of improvement, it must become the first institution of its class in the kingdom.

We record these opinions with a feeling akin to regret, for it is not pleasant to see the old society so effectually distanced by the new. But that such is the case is certain; and unless the Art-Union of London adopt some plan by which it may successfully compete with its rival, the result must inevitably be that Glasgow will receive the guineas of London. The evil—if evil it be—is very greatly enhanced by the fact that the two exhibitions are so near each other, that visitors to one will visit both, and the contrast between the strength of the one and the weakness of the other cannot fail to produce a prejudicial effect upon the interests of the Art-Union of London. If it be wisdom to "learn to be wise by others' harm," it is surely wise to imitate or to follow the excellences of which we have experience. During many years past we have been endeavouring to induce the Art-Union of London to appoint a committee of selection, if not of the whole, certainly of a part of their purchases. We say again, emphatically, "to this conclusion they must come at last." The earnest gratitude of the artists, and, indeed, of the community, is due to the Committee of the London Art-Union, and especially to its earnest and indefatigable secretaries; but they must advance—they must introduce those improvements of the value of which they have indisputable evidence "close at hand."

Much that is good has been done—and well done; but the time has arrived when a review of the constitution of the Art-Union of London is necessary to its existence.

THE CRYSTAL PALACE,

AS A TEACHER OF ART AND ART-MANUFACTURE.

PART III.

The several Art-Courts are certainly advancing, although still very incomplete; that of Sheffield, to which we directed attention in the second part of this series, is now much more perfect than it has been: the cases are all full, and a statue emblematic of the town—the work of a native sculptor—occupies the centre, and has a very striking and agreeable effect; it is also a production of considerable merit. The Birmingham Court is by no means satisfactory. It was our intention to have treated this subject in our present number; we postpone this duty, however, in hopes of a better arrangement—by which we may be enabled to do justice to this great city of the most important branch of British Art-manufacture. If Birmingham be not fully represented by its manufacturers—who are numerous and powerful, and who can do much to uphold and extend its repute—its fame is at all events amply sustained by the now eminent firm of Elkington and Mason; to their extensive and admirable collection we shall have chiefly to refer when we treat an always interesting and important subject—the produce and manufacture of Birmingham.

That we have now to bring under notice, is the STATIONERY COURT, which, indeed, contains no very large assemblage of Art-works, but which is in itself a very elegant construction. It was designed and erected by J. G. Craec; "the style is

composite, and may be regarded as the application of cinque-cento ornamental decoration to a wooden structure;" so at least says the guide-book. It has no pretensions to architecture of a pure order, but produces a good effect, and is undoubtedly a light and graceful erection, well suited to the purpose intended. "Over the opening through which we enter, and between the stained glass windows let into the wall, have been introduced allegorical figures of the Arts and Sciences applied to the manufacture of the articles exhibited in the Court; and over the opening at the back, the artist has depicted the geni of Manufacture, Commerce," &c. The interior walls of the Court are divided, in the upper portions, into panels; these have a ground-work of white colour, and borders of a deep morone, richly decorated with designs in gold; in the centre of each is a medallion, on which are represented Cupidons, engaged in one of the various mechanical and scientific arts having reference to paper, printing, engraving, &c.: the spaces between the compartments are of a rich blue colour, also decorated with patterns in gold. The ceiling—or what is presumed to be such, for, as in all the Courts, a part only stands for the whole—is supported by deep projecting beams, very light in construction, and having the form of pendants; they are painted in imitation of dark oak, the mouldings being picked out with gold and colours. Above each of the compartments or panels is a small panel, running horizontally, and of a blue ground, to harmonise with the others. This Court, as its name indicates, contains examples of ornamental painting, fancy

stationery, drawing, specimens of chromo-lithography, photographs, and all the varied requirements of the writing-desk. The most striking object in this Court is, however, the stereoscopic stand, in carved box-wood, the work of Mr. Rogers, executed for Mr. Claudet, and exhibited here by him. It was one of the most meritorious of British contributions to the Exhibition in Paris, but there obtained comparatively little notice among so many "matters more attractive;" placed where it now is, it can be seen to advantage. The general design of this work is by Mr. W. Harry Rogers; the architectural details having been supplied by Mr. Charles Barry. The height is about seven feet and a half; it is in the purest Italian style, as will be shown by the engravings of two of the panels, printed on the succeeding page. The form is hexagonal. As an example of wood carving, it has been rarely surpassed; and although used for the purpose of exhibiting the stereoscopic views of Mr. Claudet, there are few productions of modern Art which surpass this in merit.

Among the principal contents of the Court which will attract the notice of the visitor, we may mention a large ornamental case that stands in the centre,—it contains specimens of all kinds of useful and ornamental stationery, exhibited by Messrs. Waterlow and Sons; another large and elegantly arranged case of articles in papier macé, by Messrs. Spiers and Son, of Oxford; numerous examples of chromo-lithographic prints, by Messrs. Hanhart, and Messrs. Rowney and Co.; a number of specimens of Owen Jones's forthcoming work, "The Grammar of Ornament," printed by Messrs. Day and Son; a

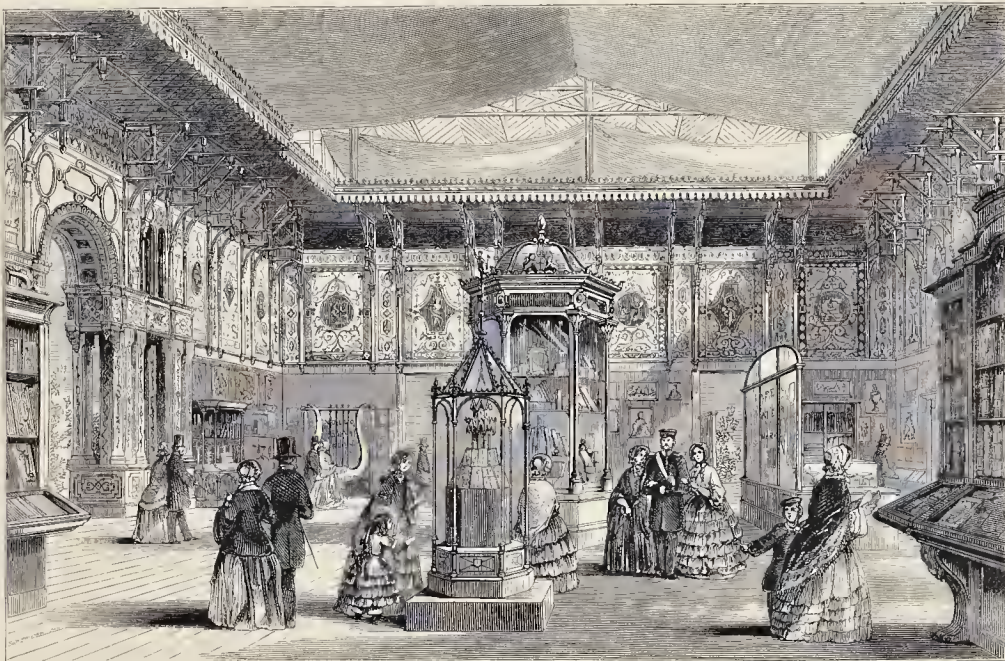

THE STATIONERY COURT, CRYSTAL PALACE.

variety of Baxter's examples of printing in oil-colours; bookbinding by Mr. J. Leighton, and Messrs. Leighton, Son, and Hodge; water-colours and drawing materials of every description, by Messrs. Rowney and Co.; maps of the Ordnance Survey, &c. &c. The varied and pleasing character of the contributions to the Stationery Court cannot fail to invite attention.

Behind the Stationery Court, but connected with it by one of the entrances, are several collections of value; the passage which contains them, indeed,

runs the whole length of the three Courts, that of Birmingham, that of Sheffield, and that under immediate notice; while on the opposite side are large apartments, fitted up and occupied by Messrs. Batham and Sons for stoves and ranges, Messrs. T. H. Finner for household furniture, Messrs. Craec for church furniture, from the designs of Mr. Shaw, and other objects of less importance. The passage should be examined carefully, for here the visitor will find many works of merit,—such as the cast-iron of Messrs. Kennard; the inlaid tables, pillars, &c.,

of Mr. Stevens; the Cornish Serpentine vases, chimney-pieces, &c., exhibited by the London and Penzance Serpentine Company; the Matlock specimens of Mr. Smedley; ornaments, vases, chimney-pieces, balustrades, &c., of Ransome's patent siliceous stone; iron and brass door furniture of Messrs. Hart and Son; the patent Derbyshire stone-ware of Messrs. Bourne and Son, &c. &c. with a collection of works in terra-cotta, the manufacture of Mr. Blashfield, which we shall be hereafter called upon to notice more at length.

The group we introduce upon this page is from a variety of striking productions, contributed by ZIMMERMAN, of Frankfort, and manufactured by him at his famous establishment, situated a few miles from that great city. The works are all in cast-iron; but it will be by no means at once apparent that they are of the inferior metal; being generally coloured to imitate bronze, for which they may be easily mistaken.

They are singularly sharp and clear, and exhibit skill in casting which we believe to be unrivalled, although the castings of Liege, of Paris (André), and Colebrook Dale, are of great excellence. Certainly, in such minor utilities as those we have selected for engraving, there are none that rival the productions of the factory of M. Zimmerman. We had the pleasure to visit it about four years ago, and personally examined the several processes through which the iron passed. By a judicious overlooking of very skilful workmen these effects are pro-

duced, which the visitor will do well to examine, giving to iron almost the value of more costly

stands, wafer boxes, envelope cases, &c.; and these we have selected for engraving, together with one of the miniature mirrors, of which there are many of a very pleasing and striking character. We have not engraved any of the statuettes, although, perhaps, these are the more extraordinary productions of the factory. They will be mistaken for bronze by ninetenths of those who examine them, until very carefully



metals at something like a third of the price. The designs are by no means always good, although

looked into, and even then the result will be by no means unsatisfactory.



frequently there is evidence of thought and originality; the best are those which are auxiliaries to the writing-table—instands, alumet cases, candle-

tribute to elevate taste and promote enjoyment among those who covet such productions of Art as circumstances place beyond their reach.

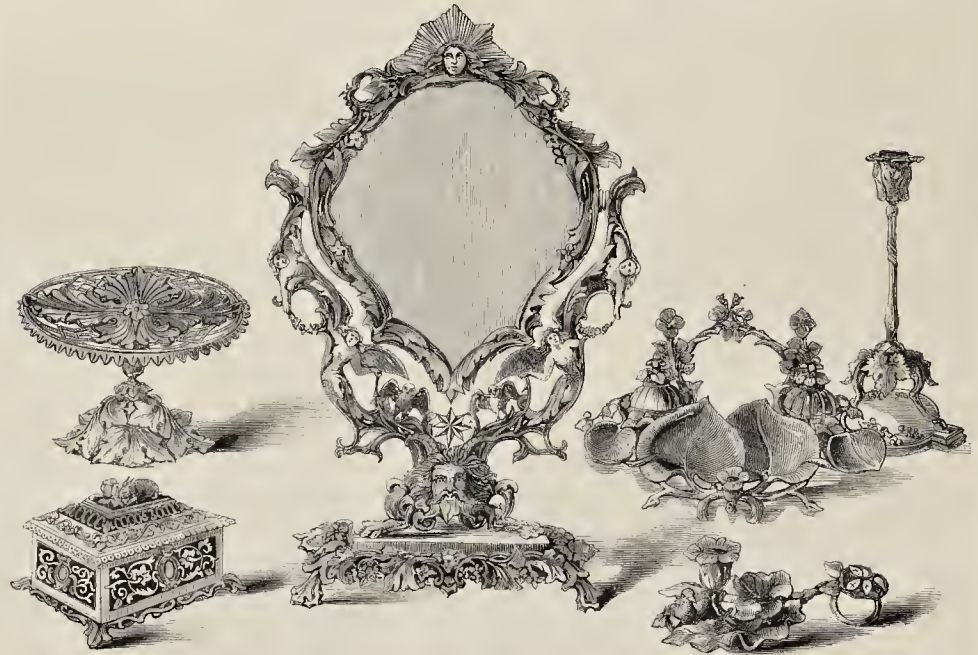

THE CAST-IRON WORKS OF ZIMMERMAN, OF FRANKFORT.

We resume our notice of the CERAMIC COURT: it is, indeed, the only one of the Art-Courts that may be considered as complete, and, because of its interest and importance, our readers will expect that we treat it frequently and at length. Our comments on the other Courts are made less as reports than as inducements. We desire to see them receive that completeness which at present they are without, but the necessity for which, we trust, will be perceived by the leading manufacturers in the several localities which ought to be, and may be, duly and properly represented. The Ceramic Court, however, leaves us nothing to desire, unless it be a larger exhibition of modern works, the productions of existing British manufacturers. We are

well aware that Mr. Battam finds difficulties in this respect; of a surety the second class producers of porcelain and earthenware do not produce much that will not sadly "dwindle" beside the produce of old Dresden, old Sèvres, old Chelsea, and old "Wedgwood;" but there are not many of them who can contribute nothing worthy: a few really good works may be sent by nearly every manufacturer in Staffordshire: these should be sought for, sent, and exhibited; and Mr. Battam will not have properly finished his allotted task until this be done. We rejoice to know that the Ceramic Court has attracted universal attention; it is thronged daily, not alone by admiring, but by studious, groups: the productions of Minton, Copeland, and Kerr and Binns, excite ad-

miration equal to their deserts,—and that is saying much. Undoubtedly the result has been to elevate British Ceramic Art in public estimation, and to convince the most accomplished connoisseur that England in the nineteenth century need fear nothing in competition with France and Germany of the same epoch, although perhaps our recent productions fall short of those of a century ago, as much as do those of Dresden and Sèvres in comparison with their exquisite produce during their high and palmy days.

We have to announce the receipt of further loans of great value and importance. The co-operation which Mr. Battam has received from the possessors of many valuable collections fully evidences the interest

felt in the success of this exhibition. Indeed, offers of loans have been made beyond the capacity of the space now at disposal. These will remain available for a future opportunity, and thus secure a permanent and varied attraction. We have great pleasure in adding to the list we have already given of those who have so kindly and liberally placed their "fragile treasures" at the service of the Exhibition. His Grace the DUKE OF DEVONSHIRE has furnished some valuable specimens of Chinese and Japanese porcelain, together with some fine examples of Sèvres.

LADY MOWBRAY has also generously lent a valuable series of Dresden, Capo de Monte, and Chelsea porcelain. We would draw special attention to the group of the "Grecian Daughter," and the statuettes of the Seasons, of old Chelsea porcelain, which may well sustain comparison with the Dresden productions of that class. A statuette of Bacchus, of the Nymphenburg manufacture, from the same collection, is a remarkably fine work. There are also some excellent examples of bird-painting upon the Dresden specimens. SIR GARDNER WILKINSON has lent a most interesting series, illustrating the pottery of

ancient and modern Egypt, early Etruscan, from Chiusi (ancient Clusium), Samian ware, &c.

The examples of Egyptian ware are further enriched by a number of specimens of that manufacture lent by ARTHUR ANDERSON, Esq., who has likewise added some specimens of early Peruvian, of considerable interest.

We now proceed in detail to notice the exhibition of the modern manufacture, and in the present number illustrate some of the most remarkable productions of MR. ALDERMAN COPELAND'S famous works. We have frequently had occasion, in commenting upon the progress of the Staffordshire potteries, to refer to the great excellence of the different class of wares emanating from this manufactory, which has exercised so marked an influence in creating and extending the fame of English Ceramic Art.

The specimens in this exhibition exemplify very fully and successfully the various branches which this celebrated manufactory includes in the wide sphere of its operation. The range is very comprehensive. We have here a large collection of vases

of various sizes and design—one of immense magnitude—panels for fireplace coverings, statuettes, groups, dessert baskets, &c., in statuary porcelain; many examples of the beautiful jewelled ware (a special feature of this exhibition), in vases, tazzi, and specimens of the service in possession of her Majesty. To this last must be added an elegant assortment of *jardinières*, conservatory vases and pillars, toilet ware, and an assortment of the ordinary printed ware. In one branch of Art, and that of a most important character, this house has unquestionably stood pre-eminent. We refer to the manufacture of statuary porcelain, which has since given rise to so many imitations. While for many years these works were under the Art direction of Mr. BATTAIN, the productions of such artists as GIBSON, R.A., WYATT, R.A., FOLEY, R.A., MARSHALL, R.A., THEOD. DURHAM, PAPWORTH, &c., were published; thus not only elevating the standard of the productions of this manufactory, but also exercising a most valuable and stimulating influence upon the exertions of others in the trade. The co-operation of artists of such eminence has been most valuable, both directly and indirectly. Not



GROUP OF WORKS IN PORCELAIN: MR. ALDERMAN COPELAND.

only has the branch of Art with which they were immediately connected been raised to a high position in Art-manufacture, but this success has induced an improvement in the general production, and has in a considerable degree tended to arouse that feeling of honourable rivalry which has given so valuable an impulse to the exertions of the pottery districts.

Nor while referring to this subject, should the value of the encouragement given by the Art-Union of London be forgotten or under-estimated. To this society the Ceramic Art of England is largely indebted. At a time when the manufacture of the statuary porcelain was struggling into publicity—when those who should have been the foremost to recognise the value and importance of such an adjunct to the manufacture, were blind and indifferent to its merits, the Art-Union of London at once

acknowledged them, and gave such encouragement by their commissions as finally stamped the invention with a complete success. To this society the credit of fostering, by early patronage, a branch of Art which has since become so important, both in its artistic and industrial relation to English manufacture, is eminently due. The works executed for this society by Mr. Alderman Copeland have been from the models of GIBSON, MARSHALL, FOLEY, and the antique.

Amongst the examples of statuary porcelain are three remarkably fine busts, life-size, of CLITIA, JUNO, and ARIADNE, from the antique. As works of pottery they are extraordinary productions; and, considering the many difficulties attending the manufacture—including a contraction of nearly one fourth in the dimensions consequent upon the process of "firing"—their perfection is astonishing. With such illustra-

tions as these as to the capabilities of this material, we look for its application in a variety of ways not hitherto developed.

The designs on the panels for fireplace coverings are of varied character, all in good taste and admirable in point of execution. This branch has of late years become most important as a trade demand, and appears still increasing. We have on former occasions detailed the peculiar fitness of this material for the purpose, not only as regards the facility it offers for decoration in conformity with the style of room in which the stove is fixed, but also for its durability, and the economy of labour which its surface offers as to cleanliness, in comparison with that of metal. Among the most remarkable of the works exhibited is the great Alhambresque Vase, so prominent a feature in the Paris Exhibition last year. This vase,

upwards of five feet high, and fired in one piece, is a most important achievement, and proves the perfection to which the manufacture has been wrought.



Two large vases, *gros bleu*, and Grecian design in gold, are also of great excellence; the blue grounds



are remarkable for quality and uniformity of tint, and challenge comparison with some of the best examples of Sèvres.

A large vase of Etruscan form, with garlands of flowers and ornamentation in blue and gold, is of extremely good character, and had the flower-painting been less heavy in tone and execution, it would have been a perfect work.

The specimens we have engraved exhibit several varieties of the works of Mr. Alderman Copeland; we do not pause to describe them; they will be recognised in the cases, and their value and beauty appreciated.

It may be observed, that the engravings on this page are repetitions of some which have on previous occasions been introduced to the readers of this



Journal, but inasmuch as they are the most prominent and meritorious of the works exhibited by Mr. Alderman Copeland, and as all who visit the Ceramic Court will expect to see them pictured in this report of its contents, it would disappoint the visitors, and be unjust to the manufacturer, if they were on this occasion omitted.

We must refer in terms of great praise to several specimens of the *common printed ware* of the manufactory, as it is in this branch that so great an amount of good may be done in the advancement of public taste. We have patterns here which, from the style of design and quality of manufacture, are of the very highest merit, and produced at about

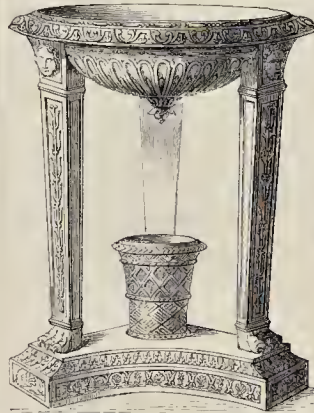

the same price as the execrable willow pattern. Indeed, some of the designs are of such a character as to satisfy the most exacting taste; and yet we are grateful to record that they have been generally popular in an unusual degree, the sales having been very great and continuous. This augurs well, and should induce persistence in such a course, alike creditable to producers and consumers.

We shall have occasion in a future number to refer to the productions of other manufacturers, several of whom are now sending in examples, and of others who have solicited space for works they

are expressly engaged upon for exhibition in this Court—the Ceramic Court of the Crystal Palace.



The importance of such a medium of publicity is now fully acknowledged, and the exhibitive space



will have to be enlarged to include all who desire and deserve to avail themselves of its advantages.

THE
MONKS OF THE MIDDLE AGES.

BY THE REV. EDWARD L. CUTTS, D.D.

OUR business in the present article is to give a sketch of the monks of the middle ages, so far as Art is concerned with them. One branch of this subject has already been treated in Mrs. Jamieson's "Legends of the Monastic Orders." This accomplished lady has very pleasingly narrated the traditional histories of the founders and saints of the orders, which have furnished subjects for the greatest works of Medieval Art; and she has placed monasticism before her readers in its noblest and most poetical aspect. Our humbler aim is to give a view of the familiar daily life of ordinary monks in their monasteries, and of the way in which they enter into the general life without the cloister;—such a sketch as an Art-student might wish to have who is about to study that picturesque mediæval period of English history for subjects for his pencil; and who is aware that the religious orders occupied so important a position in middle-age society, that they cannot be overlooked by the historical student; and who feels that the tawny black robe and severe intellectual features of the Benedictine monk, or the coarse frock and sunbaked feet of the mendicant friar, are too characteristic and too effective, in contrast with the gleaming armour and richly-coloured and embroidered robes of the sumptuous civil costume of the period, to be neglected by the artist. Such a student would desire first to have a general sketch of the whole history of monachism, as a necessary preliminary to the fuller study of any particular portion of it. He would wish for a sketch of the internal economy of the cloister;—how the various buildings of a monastery were arranged, and what was the daily routine of the life of its inmates. He would seek to know under what circumstances these recluses mingled with the outer world. He would require accurate particulars of costumes and the like antiquarian details, that the accessories of his picture might be correct. And, if his monks are to be anything better than representations of monkish habits hung upon lay figures, he must know what kind of men the middle age monks were intellectually and morally. These particulars we proceed to supply as fully as the space at our command will permit.

Monachism arose in Egypt. As early as the second century we read of men and women who, attracted by the charms of a peaceful contemplative life, far away from the fierce, sensual, persecuting heathen world, betook themselves to a life of solitary asceticism. The mountainous desert on the east of the Nile valley was their favourite resort; there they lived in little hermitages, rudely piled up of stones, or hollowed out of the mountain-side, or in the cells of the ancient Egyptian sepulchres, feeding on pulse, and herbs, and water from the neighbouring well.

One of the frescoes in the Campo Santo, at Pisa, by Pietro Laurati, engraved in Mrs. Jamieson's "Legendary Art," gives a curious illustration of the eremitical life. It gives us a panorama of the desert, with the Nile in the foreground, and the rock caverns, and the little hermitages built among the date-palms, and the hermits at their ordinary occupations: here is one angling in the Nile, and another dragging out a net; there is one sitting at the door of his cell shaping wooden spoons; and here, again, we see them engaged in those mystical sears in which an over-wrought imagination pictured to them the temptations of their senses in visible demon shapes—beautiful to tempt or terrible to frighten; or materialised the spiritual joys of their minds in angelic or divine visions: Anthony driving out with his staff the beautiful demon from his cell, or wrapt in ecstasy beneath the Divine apparition.* Such pictures of the early hermits are not infrequent in mediæval art: there is a good small one in a fifteenth-century Psalter MS. in the British Museum. (Domit A., xvii. f. 54. C.)

* There is no need to put down all these supernatural tales as fables or impostures—spiritual excitement induces such appearances to susceptible natures; similar tales abound in the lives of the religious people of the middle ages, but they are not unknown in modern days; Luther's conflict with Satan in the Wartburg, to wit; and Colonel Gardiner's vision of the Saviour.

We can picture to ourselves how it must have startled the refined Græco-Egyptian world of Alexandria when occasionally some man, long lost to society and forgotten by his friends, reappeared in the streets and squares of the city, with attenuated limbs and mortified countenance, with a dark hair-cloth tunic for his only clothing, with a reputation for exalted sanctity and spiritual wisdom, and vague rumours of supernatural revelations of the unseen world; like another John Baptist preaching repentance to the luxurious citizens; or fetched, perhaps, by the Alexandrian bishop to give to the church the weight of his testimony to the ancient truth of some doctrine which began to be questioned in the schools.

Such men, when they returned to the desert, were frequently accompanied by numbers of others, whom the fame of their sanctity and the persuasion of their preaching had induced to adopt the eremitical life.

It is not to be wondered at that these new converts should frequently build or select their cells in the neighbourhood of that of the teacher whom they had followed into the desert, and should continue to look up to him as their spiritual guide. Gradually, this arrangement became systematised; a number of separate cells, grouped round a common oratory, contained a community of recluses, who agreed to certain rules and to the guidance of a chosen head; an enclosure wall was generally built around this group, and the establishment was called a *lavra*.

The transition from this arrangement of a group of anchorites occupying the anchorages of a laura under a spiritual head, to that of a community living together in one building under the rule of an abbot, was natural and easy. The authorship of this cenobitic system is attributed to St. Anthony, who occupied a ruined castle in the Nile desert, with a community of disciples, in the former half of the fourth century. The eremitical institution did not supersede the eremitical, both continued to flourish together in every country of Christendom. The first written code of laws for the regulation of the lives of these communities was drawn up by Pachomius, a disciple of Anthony's. Pachomius is said to have peopled the Island of Tabenne, in the Nile, with cenobites, divided into monasteries, each of which had a superior, and a dean to every ten monks; Pachomius himself being the general director of the whole group of monasteries, which are said to have contained eleven hundred monks. The monks of St. Anthony are represented in ancient Greek pictures with a black or brown robe, and often with a tau cross of blue upon the shoulder or breast.

St. Basil, afterwards Bishop of Cesarea, who died A.D. 378, introduced monachism into Asia Minor, whence it spread over the East. He drew up a code of laws founded upon the rule of Pachomius, which was the foundation of all succeeding monastic institutions, and which is still the rule followed by all the monasteries of the Greek church. The rule of St. Basil enjoins poverty, obedience, and chastity, and self-mortification. The habit both of monks and nuns was, and still is, universally in the Greek church, a plain, coarse, black frock with a cowl, and a girdle of leather, or cord. The monks went barefooted and barelegged, and wore the Eastern tonsure, in which the hair is shaved in a crescent off the fore part of the head, instead of the Western tonsure, in which it is shaved in a circle off the crown. Hilarion is reputed to have introduced the Basilican institution into Syria; St. Augustine into Africa; St. Martin of Tours into France; St. Patrick into Ireland, in the fifth century.

The early history of the British church is enveloped in thick obscurity, but it seems to have derived its Christianity from an Eastern source, and its monastic system was probably derived from that established in France by St. Martin, the abbot-bishop of Tours. One remarkable feature in it is the constant union of the abbatial and episcopal offices; this conjunction, which was foreign to the usage of the church in general, seems to have obtained all but universally in the British, and subsequently in the English church. The British monasteries appear to have been very large; Bede tells us that there were no less than two thousand one hundred monks in the monastic establishment of Bangor at the time of St. Augustine's connection with it, in the sixth century, and there is reason to believe that

the number is not overrated. They appear to have been schools of learning. The vows do not appear to have been perpetual; in the legends of the British saints we constantly find that the monks quitted the cloister without scruple. The legends lead us to imagine that a provost, steward, and deans, were the officers under the abbot; answering, perhaps, to the prior, cellarer, and deans of Benedictine institutions. The abbot-bishop, at least, was sometimes a married man.

In the year 529 A.D., St. Benedict, an Italian of noble birth and great reputation, introduced into his new monastery on Monte Cassino—a hill between Rome and Naples—a new monastic rule. To the three vows of obedience, poverty, and chastity, which formed the foundation of most of the old rules, he added another, that of manual labour (for seven hours a day), not only for self-support, but also as a duty to God and man. Another important feature of his rule was that its vows were perpetual. And his rule lays down a daily routine of monastic life in much greater detail than the preceding rules appear to have done. The rule of St. Benedict speedily became popular, the majority of the existing monasteries embraced it; nearly all new monasteries for centuries afterwards adopted it; and we are told in proof of its universality of acceptance, that when Charlemagne caused inquiries to be made about the beginning of the eighth century, no other monastic rule was found existing throughout his wide dominions. The monasteries of the British church, however, do not appear to have embraced the new rule.

St. Augustine, the apostle of the Anglo-Saxons, was prior of the Benedictine monastery which Gregory the Great had founded upon the Celian Hill, and his forty missionaries were monks of the same house. It cannot be doubted that they would introduce their order into those parts of England over which their influence extended. But a large part of Saxon England owed its Christianity to missionaries of the native church still flourishing in the west and north; and these would doubtless introduce their own monastic system. We find, in fact, that no uniform rule was observed by the Saxon monasteries; some seem to have kept the rule of Basil, some the rule of Benedict, and others seem to have modified the ancient rules, so as to adapt them to their own circumstances and wishes. We are not surprised to learn that under such circumstances some of the monasteries were lax in their discipline; from Bede's accounts we gather that some of them were only convents of secular clerks, bound by certain rules, and performing divine offices daily, but enjoying all the privileges of other clerks, and even sometimes being married. Indeed, in the eighth century the primitive monastic discipline appears to have become very much relaxed, both in the East and West, though the popular admiration and veneration of the monks was not diminished.

In the illuminations of Anglo-Saxon MSS. of the ninth and tenth centuries, we find the habits of the Saxon monks represented of different colours, viz., white, black, dark brown, and grey.* In the early MS. Nero, C. iv., in the British Museum, at folio 37, occurs a very nice group of monks in white habits; another group occurs at folio 34, rather more stilly drawn, in which the margin of the hood and the sleeves is bordered with a narrow edge of ornamental work.

About the middle of the ninth century, however, Archbishop Dunstan reduced all the Saxon monasteries to the rule of St. Benedict, not without opposition on the part of some of them, and not without rather peremptory treatment on his part; and thus the Benedictine rule became universal in the West. The habit of the Benedictines consisted of a white woollen enscock, and over that an ample black gown and a black hood. We give here an excellent representation of a Benedictine monk, from the book of St. Albans, in the British Museum (Nero D. vii. f. 81); he is represented as holding a golden taukard in one hand and an embroidered cloth in the other, gifts which he made to the abbey, and for which he is thus immortalised in their *Catalogus Benefactorum*. In working and travelling they wore over the cossack a black sleeveless tunic of shorter and less ample dimensions.

* Strutt's "Dress and Habits of the People of England."

The female houses of the order had the same regulations as those of the monks; their costume too was the same, a white under garment, a black gown, and black veil, with a white wimple around the face and neck. They had in England, at the dissolution of the monasteries, one hundred and twelve monasteries and seventy-four nunneries.*

The Benedictine rule had now been all but universal in the West for four centuries; but during this period its observance had gradually become relaxed. We cannot be surprised if it was found that the seven hours of manual labour which the rule required, occupied time which might better be devoted to the learned studies for which the Benedictines were then, as they have always been, distinguished. We should have anticipated that the excessive abstinence, and many other of the mechanical observances of the rule would soon be found to have little real utility. We are not therefore surprised, nor should we in these days attribute it as a fault, that the obligation to labour appears to have been very generally dispensed with, and that some humane and sensible relaxations of the severe ascetic discipline and dietary of the primitive rule had also been very generally adopted. Nor will any one who has any experience of human nature, expect otherwise than that among so large a body of men—many of them educated from childhood to the monastic profession—there would be many who were wholly unsuited for it, and whose vices brought disgrace upon it. The Benedictine monasteries, then, at the time of which we are speaking, had become different from



BENEDICTINE MONK.

the poor retired communities of self-denying ascetics which they were originally. Their general character was, and continued throughout the middle ages to be, that of wealthy and learned bodies; influential from their broad possessions, but still more influential from the fact that nearly all the literature, and art, and science of the period was to be found in their body. They were good landlords to their tenants, good cultivators of their demesnes; great patrons of architecture, and sculpture, and painting; educators of the people in their schools; healers of the sick in their hospitals; great almsgivers to the poor; freely hospitable to travellers; they continued regular and constant in their religious services; but in housing, clothing, and diet, they lived the life of temperate gentlemen rather than of self-mortifying ascetics. Doubtless, as we have said, in nearly every monastery there were some evil men, whose vices brought disgrace upon their calling; and there were some monasteries in which weak or wicked rulers had allowed the evil to prevail. The quiet, unostentatious, every-day virtues of such monasteries as these were perhaps not such as to satisfy the enthusiastical seeker after monastic perfection. Nor were they such as to command the admiration of the unthinking and illiterate, who are always more prone to reverence fanaticism than to appreciate the more sober virtues; who are ever inclined

* This is the computation of Tanner in his "Notitia Monastica;" but the editors of the last edition of Dugdale's "Monasticon," adding the smaller houses or cells, swell the number of Benedictine establishments in England to a total of two hundred and fifty-seven.

to succor at religious men and religious bodies who have wealth; and are accustomed to attribute to a whole class the vices of its disreputable members.

The popular disrepute into which the monasteries had fallen through their increased wealth, and their departure from primitive monastic austerity, led, during the next two centuries, viz., from the beginning of the tenth to the end of the eleventh, to a series of endeavours to revive the primitive discipline. The history of all these attempts is very nearly alike. Some young monk of enthusiastic disposition, disgusted with the laxity and the vices of his brother monks, flies from the monastery, and betakes himself to a cremitial life in some neighbouring forest or wild mountain valley. Gradually a few men of like earnestness assemble round him. He is at length induced to permit himself to be placed at their head as their abbot; requires his followers to observe strictly the ancient rule, and gives them a few other directions of still stricter life. The new community gradually becomes famous for its virtues; the Pope's sanction is obtained for it; its followers assume a distinctive dress and name; and take their place as a new religious order. This is in brief the history of the successive rise of the Cluniacs, the Carthusians, the Cistercians, and the orders of Camaldoli and Vallombrosa and Grandmont; they all sprang thus out of the Benedictine order, retaining the rule of Benedict as the groundwork of their several systems. Their departures from the Benedictine rule were comparatively few and trifling, and need not be enumerated in such a sketch as this; they were in fact only reformed Benedictines, and in a general classification may be included with the parent order, to which these rivals imparted new tone and vigour, as the Benedictine family.

The first of them was the CLUNIAC order, so called because it was founded, in the year 927, at Clugny in Burgundy, by Odo the abbot. The Cluniacs formally abrogated the requirement of manual labour required by the Benedictine rule, and professed to devote themselves more sedulously to the cultivation of the mind. The order was first introduced into England in the year 1077 A.D., at Lewes, in Sussex; but it never became popular in England, and never had more than twenty houses here, and they small ones, and nearly all of them founded before the reign of Henry II. Until the fourteenth century they were all priories dependent on the parent house of Clugny, though the Prior of Lewes was the High Chamberlain, and often the Vicar-general, of the Abbot of Clugny, and exercised a supervision over the English houses of the order. The English houses were all governed by foreigners, and contained more foreign than English monks, and sent large portions of their surplus revenues to Clugny. Hence they were often seized, during war between England and France, as alien priories. But in the fourteenth century many of them were made denizen, and Bermondsey was made an abbey, and they were all discharged from subjection to the foreign abbey. The Cluniacs retained the Benedictine habit. At Cowfold Church, Sussex, still remains a monumental brass of Thomas Nelond, who was prior of Lewes at his death, in 1433 A.D., on which he is represented in the habit of his order.

In the year 1084 A.D., the CARTHUSIAN order was founded by St. Bruno, a monk of Cologne, at Chartreux, near Grenoble. This was the most severe of all the reformed Benedictine orders. To the strictest observance of the rule of Benedict, they added almost perpetual silence; flesh was forbidden even to the sick; their food was confined to one meal of pulse, bread, and water, daily. It is remarkable that this the strictest of all monastic rules has, even to the present day, been very slightly modified; and that the monks have never been accused of personally deviating from it. The order was numerous on the Continent, but only nine houses of the order were ever established in England. The principal of these was the Charterhouse (Chartreux), in London, which, at the dissolution, was rescued by Thomas Sutton to serve one at least of the purposes of its original foundation—the training of youth in sound religious learning. There were few nunneries of the order—none in England. The Carthusian habit consisted of a white cassock and hood, over that a white scapular—a long piece of cloth which hangs down before and behind, and is joined at the sides by a band of the same colour,

about six inches wide; unlike the other orders, they shaved the head entirely.

The representation of a Carthusian monk, which we here give, is reduced from one of Hollar's well-known series of prints of monastic costumes.



CARTHUSIAN MONK.

About one hundred and seventy years after, viz., in 1098, arose the CISTERCIAN order. It took the name from Citeaux (Latinised into Cistercium), the house in which the new order was founded by Robert de Thierry. Stephen Harding, an Englishman, the third abbot, brought the new order into some repute; but it is to the fame of St. Bernard, who joined it in 1113 A.D., that the speedy and widespread popularity of the new order is to be attributed.

The order was introduced into England at Averbury, in Surrey, in 1128 A.D. The Cistercians professed to observe the rule of St. Benedict with rigid exactness, only that some of the hours which were devoted by the Benedictines to manual labour, they affected a severe simplicity; their houses were to be simple, with no lofty towers, no carvings or



CISTERCIAN MONK.

representations of saints, except the crucifix; the furniture and ornaments of their establishments were to be in keeping—chasubles of fastian, candlesticks of iron, napkins of coarse cloth, the cross of wood, and only the chalice might be of precious metal. The amount of manual labour prevented the Cistercians from becoming a learned order, though they did produce a few men distinguished in literature; they were excellent farmers and horticulturalists, and are said in early times to have almost monopolised the wool trade of the kingdom. They changed the colour of the Benedictine habit, wear-

ing a white gown and hood over a white cassock; when they went beyond the walls of the monastery they also wore a black cloak. St. Bernard of Clairvaux is the great saint of the order. They had seventy-five monasteries and twenty-six nunneries in England, including some of the largest and finest in the kingdom.

The Cistercian monk, whom we give in the woodcut, is taken from Hollar's plate.

There were other reformed Benedictine orders arose in the eleventh century, viz. the order of CAMALDOLI, in 1027 A.D., and that of VALLOMBROSA, in 1078 A.D., but they did not extend to England. The order of the GRANDMONTINES had one or two alien priories here.

The preceding orders differ among themselves, but the rule of Benedict is the foundation of their discipline, and they are so far impressed with a common character, and actuated by a common spirit, that we may consider them all as Benedictines.

We come next to another great monastic family which is included under the generic name of Augustines. The Augustines claim the great St. Augustine, Bishop of Hippo, as their founder, and relate that he established monastic communities in Africa, and gave them a rule. That he did patronise monachism in Africa appears probable, but it is not clear that he founded any distinct order; nor was any order called after his name until the middle of the ninth century. About that time all the various denominations of clergy who had not entered the ranks of monachism, priests—canons, clerks, &c.—were incorporated by a decree of Pope Leo III. and the Emperor Lothaire into one great order, and were enjoined to observe the rule which was then known under the name of St. Augustine, but which is said to have been really compiled by Ivo de Chartres from the writings of St. Augustine. It was a much milder rule than the Benedictine. The Augustinians were divided into Canons Secular and Canons Regular.

THE CANONS SECULAR OF ST. AUGUSTINE were in fact the clergy of the cathedral and collegiate churches, who lived in a community on the monastic model; their habit was a long black cassock (the parochial clergy did not then universally wear black); over which, during divine service, they wore a sur-



CANON OF ST. AUGUSTINE.

plice and a fur tippet, called an *almuce*, and a four-square black cap, called a *barret*; and at other times a black cloak and hood with a leather girdle; according to their rule they might wear their beards, but from the thirteenth century downwards, we find them usually shaven. The canon whom we give in the woodcut, from one of Hollar's plates, is in ordinary costume.

There are numerous existing monumental brasses in which the effigies of canons are represented in choir costume, viz. surplice and amice, and often with a cope over all; they are all beheaded and shaven. We may mention especially that of William Tannere, first master of Cobham College (died 1418

A.D.), in Cobham Church, Kent, in which the almuce, with its fringe of hell-shaped ornaments over the surplice, is very distinctly shown; it is fastened at the throat with a jewel. The effigy of Sir John Stodley, canon, in Over Winehendon Church, Bucks (died 1505), is in ordinary costume, an under garment reaching to the heels, over that a shorter black cassock, girded with a leather girdle, and over all a long cloak and hood.

THE CANONS REGULAR OF ST. AUGUSTINE were perhaps the least ascetic of the monastic orders. Rayol de Provins, a minstrel (and afterwards a monk) of the thirteenth century, says of them, "Among them one is well shod, well clothed, and well fed. They go out when they like, mix with the world, and talk at table." They were little known till the tenth or eleventh century, and the general opinion is, that they were first introduced into England, at Colchester, in the reign of Henry I. Their habit was like that of the secular canons—a long black cassock, cloak and hood, and leather girdle, and four-square cap; they are distinguished from the secular canons by not wearing their beard. According to Tanner, they had one hundred and seventy-four houses in England—one hundred and fifty-eight for monks, and sixteen for nuns; but the editors of the last edition of the "Monasticon" have recovered the names of additional small houses, which make up a total of two hundred and sixteen houses of the order.

The Augustine order branches out into a number of denominations; indeed, it is considered as the parent rule of all the monastic orders and religious communities which are not included under the Benedictine order; and retrospectively it is made to include all the distinguished recluses and clerics before the institution of St. Benedict, from the fourth to the sixth century.

The most important branch of the Regular Canons is the PREMONSTRATENSIAN, founded by St. Norbert, a German nobleman, who died in 1134 A.D.; his first house being in a barren spot in the valley of Coey, in Picardy, to which the name of Pre-montre was given, and from which the order took its name. The rule was that of Augustine, with a severe discipline superadded; the habit was a coarse black cassock, with a white woollen cloak and a white four-square cap. Their abbots were not to use any episcopal insignia. The Premonstratensian nuns were not to sing in choir or church, and to pray in silence. They had only thirty-six houses in England, of which Welbeck was the chief; but the order was very popular on the Continent, and at length numbered one thousand abbeys and five hundred nunneries.

THE TRINITARIANS, also, from the name of their founder, called Mathurin, and from their object, Brethren of the Redemption of Captives, were a confraternity of the Augustines, founded in 1180 by John de Matha and Felix de Valois—"the Clarkson and Wilberforce of their time," Mrs. Jamieson appropriately calls them—for the redemption of slaves and captives. In the first year of their labours these two men redeemed one hundred and eighty-six Christian captives from the hands of the Moors in Africa, the second year one hundred and ten, the third one hundred and twenty. They were introduced into England by Sir William Lucy of Charleote, on his return from the Crusade, who built and endowed for them Thellesford Priory in Warwickshire, and subsequently they had eleven other houses in England. St. Rhadegunda was their tutelary saint. Their habit was white, with a Greek cross on the breast of red and blue—the three colours being taken to signify the three persons of the Holy Trinity, viz. the white, the Eternal Father; the blue, which was the transverse limb of the cross, the Son; and the red, the charity of the Holy Spirit.

Under this rule are also included the GILBERTINES, who were founded by a Lincolnshire priest, Gilbert Sempringham, in the year 1139 A.D. There were twenty-six houses of the order, most of them in Lincolnshire and Yorkshire; they were all priories dependent upon the house of Sempringham, whose head, as prior-general of the order, appointed the priors of the other houses, and ruled absolutely the whole order. All the houses of this order were double houses, that is, monks and nuns lived in the same enclosure, though with a rigid separation between their two divisions. The monks followed the Augustinian rule; the nuns followed

the rule of the Cistercian nuns. The habit was a black cassock, a white cloak and hood, lined with lambskin. The "Monasticon" gives very effective representations (after Hollar) of the Gilbertine monk and nun.

The order of our Saviour, or, as they are usually called, the BRIGITTINES, were founded by St. Bridget of Sweden, in 1363. They were introduced into England by Henry V., who built for them the once glorious nunnery of Lion House. At the dissolution, the nuns fled to Lishon, where their successors still exist. Some of the relics and vestments which they carried from Lion House have been carefully preserved ever since, and are now in the possession of the Earl of Shrewsbury.* Their habit was like that of the Benedictine nuns—a black tunic, white wimple and veil, but is distinguished by a black band on the veil across the forehead.

THE NUNS OF FONTEVRAUD was another female order of Augustinians, of which little is known. It was founded at Fontevraud in France, and three houses of the order were established in England in the time of Henry II.; they had monks and nuns within the same enclosure, and all subject to the rule of an abess.

THE BOYNDOMIES were another small order of the Augustinian rule, of little repute in England; they had only two houses here, which, however, were reckoned among the greater abbeys, viz. Esserig in Bucks, and Eldulou in Wilts.

Other small offshoots of the great Augustinian tree were those who observed the rule of St. Austin according to the regulations of St. Nicholas of Arrosia, who had four houses here; and those who observed the order of St. Victor, who had three houses.

There were besides a great number of HOSPITALS; the last edition of the "Monasticon" enumerates no less than three hundred and seventy of them; founded originally by the sides of the high roads for the relief of travellers, and especially of pilgrims, they were at length devoted to the relief of poor and impotent persons, answering to our modern almshouses. These had usually two or three Augustine canons, the prior acting as master of the house, the brethren acting as chaplains and confessors; and it is probable that the almshouse-people observed some of the usages of a religious rule. The canons of some of these hospitals had local statutes in addition to the general rule, and were distinguished by some peculiarity of habit; thus the canons of the hospital of St. John Baptist, at Coventry, wore a cross on the breast of their black cassock, and a similar one on the shoulder of their cloak.

ART IN THE PROVINCES.

LEEDS.—Mr. J. White, who has recently been appointed Master of the Leeds School of Practical Art, delivered at the commencement of last month his inaugural lecture on the "Importance of Art-Education," in which he argued that drawing should form a part of general education, whatever the condition of life: "Reading," he said, "was taught as a means of acquiring knowledge; writing as a means of retaining and extending that knowledge; and drawing should be taught, in conjunction with the latter, and to the same intent."

WOLVERHAMPTON.—The annual meeting of those interested in the School of Practical Art at this town was held on the first Monday in August. The report read by the Secretary is by no means discouraging, though not so satisfactory as could be desired, owing to the debt still encumbering the finances of the institution. Efforts have been made to relieve the School from this pressure, and nearly £700 have been collected for this purpose; but there yet remains a sum of £150 owing. The evening classes showed a deficiency of sixteen pupils in comparison with the number who attended the preceding year; this falling off was attributed in some degree to the establishment of a class at the Free Grammar School, under the superintendence of Mr. Chittenden, the Master of the School of Art. On the other hand, the day classes had increased in numbers, and the aggregate fees had also advanced to something beyond the amount received in 1855. Eighteen pupil teachers, connected with the parochial schools of the town and its vicinity, were training in the school, having been admitted upon payment of half the usual fees.

* Mrs. Jamieson, p. 137.

THE ROYAL PICTURES.

ST. CATHERINE.

Guido, Painter. J. M. St. Eve, Engraver.
Size of the Picture, 10½ in. by 7½ in.

GUIDO RENI, generally known by his christian name only, was born at Calvenzano, near Bologna, in 1574-5. His works rank not only among the best of the Bolognese school, but also with the highest of the Italian painters. He was the son of a musician, and in his early years studied music with the purpose of making it his profession. He soon, however, altered his intention, and turned his thoughts to painting; placing himself first under Denis Calvart, a Flemish artist of high repute settled in Italy, and subsequently, in 1595, in the school of the Caracci, which had not then been very long established in Bologna. Of the three Caracci, Ludovico's style was that which most pleased Guido, and which he followed. In 1602 he went to Rome, and carefully studied all the great masters there, especially Raffaele; but the works of Caravaggio seemed above all others to excite his admiration, and for a time he followed the style of this painter—so forcible and true, yet coarse, and with strong contrasts of light and shade. He did, it is true, long continue to take Caravaggio as his model, but formed a style of his own, in accordance with the prevailing taste of the more refined painters of the Roman school, and of his former masters, the Caracci. It is said that Caravaggio, who, prior to the appearance of Guido in Rome, stood highest among all the artists in popular favour, was so enraged at the success achieved by the new comer that he loaded him with calumnies. Annibal Caracci, who was also in Rome at this time, and Guido's friend and fellow-student Albino, showed him so much hostility that he at length quitted Rome in disgust; not, however, till he had executed works which have immortalized his name; among these his grand fresco of the "Hours preceded by Aurora," in the Palazzo Rospigliosi, stands most prominent. This work has been beautifully engraved by Morghen, and has thus been made known to thousands who have never seen the original. It is painted in what is considered Guido's second manner, exhibiting in a remarkable degree the effective treatment of light and shade he had learned from Caravaggio.

Guido returned to Bologna, and painted his famous picture of the "Murder of the Innocents" for the Church of St. Dominic, and the "Repentance of Peter" for the Palazzo Zampieri. But the Pope Paul V., who much regretted his departure from Rome, prevailed upon him to return thither to decorate his chapel in Santa Maria Maggiore. This work being completed, he once more went back to Bologna, and was no sooner settled there again than commissions flowed in upon him from all parts of Italy—so numerous were they that he was absolutely compelled to refuse many.

It is a fact too apparent to be contradicted that the lives and actions of men are rarely in harmony with their creeds and doctrines; many is the writer whose history negatives all the truths he has taught others; poets are known to have had but little real sympathy with scenes they have described in most glowing language, and painters to have felt no heart-reverence for what they have represented with such profoundly religious sentiment and expression. It is a curious problem this in the constitution of man, but it is nevertheless one most humiliating to our nature and character. Here was Guido, for example, whose head and hand were ever engaged on the most serious, and often the most sublime, themes—themes in which, one might reasonably suppose, his heart would have some share—exhausting his gains by extravagance and gambling, and his life by dissipation, so that his latter years were embittered by poverty and privation; notwithstanding, he received large sums for his pictures—as much as one hundred guineas for a full-length figure, an enormous price at that period. He died in 1642.

His "St. Catherine," in the collection at Windsor Castle, though a small picture, is a very beautiful example of his sweet and graceful pencil; the face is noble in expression, and the draperies exhibit the bold and massive forms peculiar to most of the Italian painters of Guido's time.

CORRESPONDENCE
FROM THE
UNITED STATES.

DEAR SIR.—The happy subsection of "Yankeeedom" from whose attractions in Nature and Art I pick suggestions for my present letter is—in area—the very smallest daughter in our great family of nations—so small, comparatively, that she is pettingly and patronizingly called "Little Rhody" by her bigger sisters—prone to brag (with a native orator) of the possession of "larger lakes, broader valleys, higher hills, longer rivers, and freer folks than England, or anywhere else *dar* have!" Her entire domain is but thirty-seven by forty-seven miles in extent; her population hardly reaches one hundred and fifty thousand; and she sends (senators excepted) but two representatives to Washington to the thirty-three of New York. Diminutive, though, as she thus is in body, I shall show you that she has a very large soul, and, is, though least, by no means last here, in the grand march of human progress. Her enterprise gave birth (it may be almost said) to our now stalwart commerce, and in her workshops was sung the lullaby of our mighty manufacture. Stately ships from all seas sought her ports long before our present chief maritime towns grew into their fame; and she can now show you within her territory the first cotton-mill ever built in America, and (in a ratio with her area and population) a greater variety, extent, and success in Art-industry, than any other state of the Union. Physically, nature has decked her with becoming grace, and, in moral and mental growth, as well as in social refinement, she is eminently distinguished. She has sent out into the world her quota of Art-workers, and she possesses a fair share of Art-treasures. Lastly, she is a liberal and appreciative patron of the *Art-Journal*; for your agent in this city tells me that his monthly sales exceed two hundred copies! here, you see, is a varied and interesting text wherever you to reach.

It was in other days, long gone by, that the Indian and the Whalers, at which I have hinted, whitened their waters with their venturesome sails. It was not ordered that commerce should be the "mission" of "Little Rhody;" so she has slipped her great cables, and now holds only to a respectable foreign intercourse and a very lively coasting trade. Enough, though, of Indian and of ocean-wealth comes in to help the development of the liberal spirit in which she was born and nurtured, and to lay the foundation of the prosperity and happiness everywhere so evident in the homes and in the hearts of the people.

As the commercial life of Rhode Island subsided, the manufacturing activity began, and grew, until now, as I have intimated, its achievement is not surpassed in any part of the Western world. This industry is developed in every variety of product, but more especially in the making and in the printing of cotton goods; in machinery and all kinds of iron-work; and in jewellery and silver ware of form and value *ad libitum*. The total value of the annual product of the cotton-mills in Providence is set down at nearly a million of dollars, and that of the print-works (which are among the chief establishments of the kind in America) as little less than three millions. The rollers used in the printing are all engraved at home, and, as far as possible, the designs employed are made in the factories, or produced from native artists.

The jewellery of various kinds made in Providence amounts yearly to more than two and a half millions of dollars, and the iron products contribute as much more to the annual industrial estimates of the city. In the first of these manufactures no less than fifty-six establishments are actively employed, and in the second twenty-two—producing immense supplies of gold and silver wares, both of ornament and of use; all kinds of steam machinery, and every variety of tools and of other iron implements and articles.

The manufacture of screws is a matter of special interest here, both from the fact of the very admirable and efficient manner in which the work is done, and from the remarkable circumstances that, of the entire product of these little implements in the United States, the greater part (eighty-seven one-hundredths is the exact figure) are made in the

Providence establishments. The labour occupies one thousand hands, with the result of an annual value of over a million dollars. More than six hundred different sizes and kinds of screws are made in the two factories here, which turn off each day fourteen thousand gross, with a daily residuum of three tons and a half of iron turnings or chips. Screws were first made here by machinery, in 1834, in a very humble way, but since that time the business has been constantly increased, and the manufacture has been wonderfully facilitated and perfected by the continual simplification and improvement of the machinery employed. The precision and rapidity, and the almost life-like mode of work of the three machines used to complete the screw is most curious and interesting; first the cutting of the wire of the required length, with the formation of the head—nearly per minute; next (which is the labour of the second machine) the trimming of the head and the cutting of the groove; and afterwards, with the third apparatus, the making of the thread; the last two of these wonderful little machines seemed to me to possess a most precise knowledge of their duty, and to take the greatest delight in the performance of it.

Another special manufactured product of Providence—with the mention of which I must pass on from the Industrial to the Fine Art labour of our little state—is that of butt-hinges. This labour was begun here (and for the first time, to any extent, in the United States) in the year 1842. It was also almost the first manufacture of loose-joint butts in the world—and, in this want, Providence has ever since continued to supply nearly "all creation."

Have I not, even thus lastly, demonstrated my fact—the contributions of Rhode Island to American Art-labour in its more material shapes? and is there not something yet left to be said for her in a more æsthetic manifestation? Attend: Gilbert Stuart, one of the two or three "old masters" in American Art, and one of the first of our painters in respect both to time and talent—he who has left to his country and to the world, the accepted memory of the form and face of Washington—was a son of Rhode Island, born in days long passed, on the shores of the Narraganset,—near where the waters of that beautiful bay (the great heart of the state) come out from the sea,—in an old snuff-mill, yet standing, and carefully chronicled in my sketch-book, with other venerable and honoured shrines of poetic and historic association here. It is not necessary that I should discourse at this time upon the scope and characteristics of Stuart's genius, of his vigorous and truthful portraiture, his clear, hold, honest execution, and his magic colour, vivid upon his canvas to-day as once upon his palette;—this is all familiar to the Art-lover the world over, and will be re-told in every history of the Pencil. The pictures of Stuart may be found among the heirlooms of many families in Rhode Island. The state possesses two repetitions, from his own hand, of his famous full-length of Washington—one is preserved in the Capitol at Newport, and the second in the other state house at Washington.

Another honoured son of Rhode Island was Malbone, one of the happiest painters in miniature which this or any country has produced. "Whoever," it has been rightly said, "writes the history of American genius, or of American Art, will have failed to do justice to the subject if he omit the name of Malbone." Many of his best works (they were not numerous, for he died very early) are to be found in this vicinity; a famous group of three three-quarter length female figures, called "The Hours," is carefully treasured in the Athenæum of this city. It was presented by the artist to his sister, and after her death was purchased for twelve hundred dollars, and given to the present owners—the money being subscribed through the solicitations of a few patriotic and Art-loving ladies. The picture was painted during the artist's visit to London in 1801, and was praised by West as a work which "no man in England could excel."

Washington Allston, who was an intimate friend and fellow-student of Malbone, said of him that, "He had the happy talent, among his many excellences, of elevating the character without impairing the likeness; this was remarkable in his male heads; and no woman ever lost any beauty from his hands—nay, the fair would often become still fairer under his pencil; and to this he added a grace of execution



Date	Description	Amount
1880	Jan 1	
	Feb 1	
	Mar 1	
	Apr 1	
	May 1	
	Jun 1	
	Jul 1	
	Aug 1	
	Sep 1	
	Oct 1	
	Nov 1	
	Dec 1	
	Total	



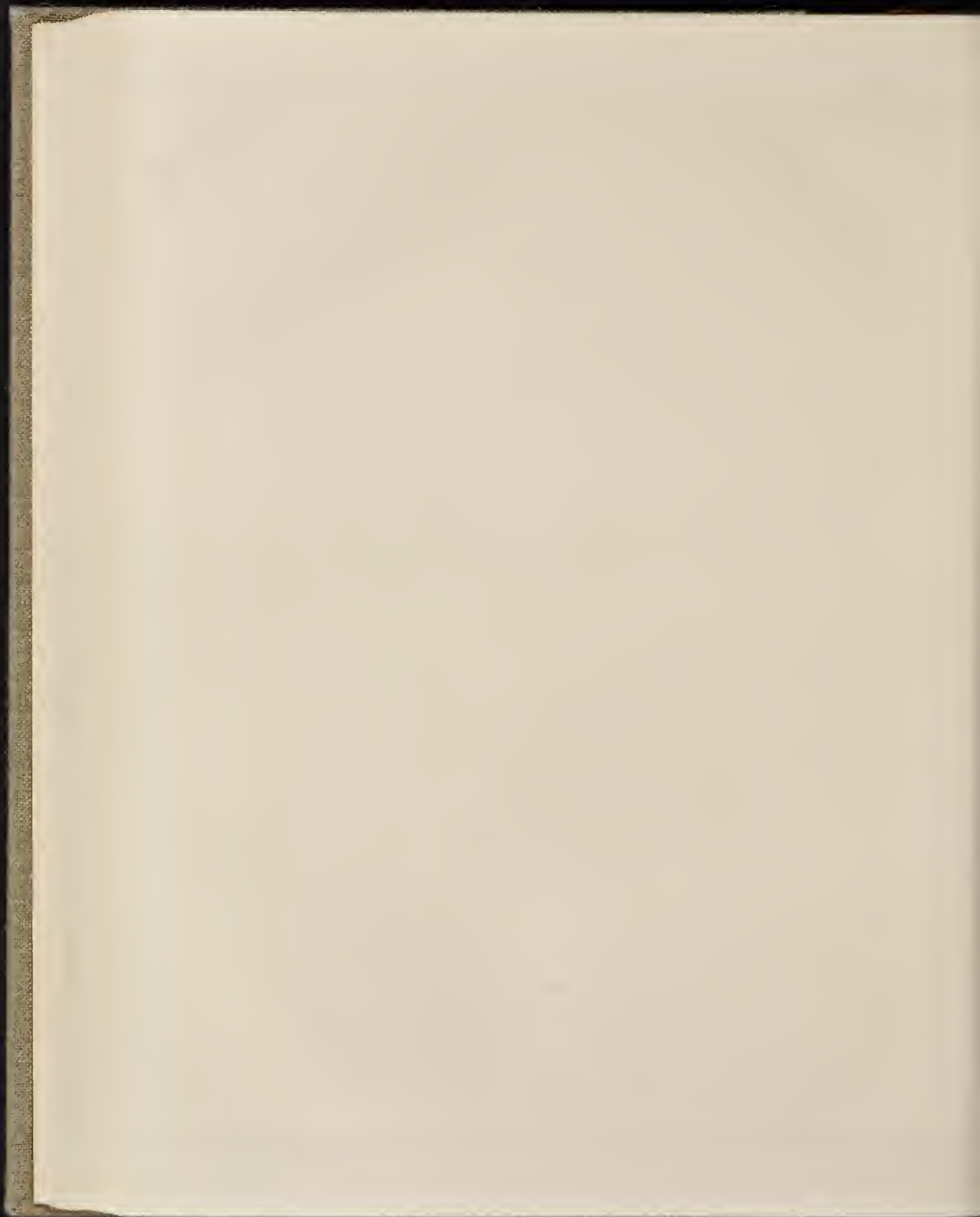

all his own." There is, or was, a work of Malbone's in Boston, which Stuart used to visit once a year, charging the owner to take great care of it, "as it was decidedly the finest miniature in the world."

The picture of "The Hours," by which Malbone will be best known hereafter, is in size six by seven inches, upon a single sheet of ivory. It contains, as I have said, three young female figures, representing the past, the present, and the coming hours, or, according to the Greek personification, and to the artist's inscription upon the back of the work—"Ennomin, Dice, and Irene." In composition the work is remarkably simple; and in the subtle changes of expression and character, the sentiment of the story is daintily and clearly revealed, while in colours it is marvellously pure and brilliant. The only grave mistake in the work, to my feeling, is the careful representation of the costumes and headdress in vogue when it was painted, but obsolete and disagreeable now. Malbone was a native of Newport, and he died in Savannah, in Georgia, in 1807, at the age of thirty-two.

Among her living artists, Rhode Island has a worthy successor, in many points, to her departed Malbone, in Mr. Richard M. Staigg. There is a force and fullness and flexibility of manner in Mr. Staigg's miniatures, a strength and massiveness of portraiture and character, and a rich fleshiness of colour not often seen in even good works in his department. He is well employed in his studio at New York in the winter, and through the summer months at his native home of Newport. This ancient capital of Rhode Island is at this time one of the most fashionable of American watering-places: but happily the good old truthful spirit of the town seems to leave the hollow hum of the exotic influence, instead of being itself dissipated and destroyed. This fortunate result is helped out a little by the circumstance that the intrinsic attractions of the region—in its healthy climate, its beautiful nature, and its genuine social life—lead the best of its visitors to make it their permanent summer abode, in their own villa homes, instead of in the demoralising vagabondism of hotels. Thus, in Newport, the explosive, high-pressure temperature of an ever-moving throng is powerfully controlled by the healthful conservative faith and grace of domesticity.

But I am wandering somewhat from my immediate theme. Let me sail, by island and headland, twenty-five miles up the bay back to Providence. The stranger in this charming city will not fail to remark a novel speciality everywhere in the architecture, public and private. Here the stately, and there the picturesque edifice—the church tower and the cottage porch; and all of such humble material as the despised brick. Looking thus upon the "deformed transformed," he will feel at once that the wand of some magic magician has been waved over all. The city owes this great and peculiar beauty to its wise and honourable appreciation of the genius of one of its own young architects, Mr. T. A. Yell, who has most successfully made the use of brick in picturesque construction a matter of especial study. Of his works, here and elsewhere, I shall have occasion to speak more particularly when I write, as I shall soon, about our Architectural Art. Mr. Yell is a Rhode Islander, born, I believe, somewhere in the neighbourhood of the painter Stuart's ancestral snuff-mill.

Rhode Island possesses an Art-association, located here, in Providence. It is a new society, and thus far has presented only two annual exhibitions. It has eligible apartments, very moderately furnished with busts and casts for the use of students. In the preface to the last year's catalogue the managers say, "That we must one day have a School of Design here, supported by our own manufacturers, and in turn supporting them, appears inevitable. The only question is one of time." The preface is right; and I am sure the decisive "question" will be satisfactorily answered before long. Let the people see to it. Of this "Rhode Island Art Association" I shall have more to say at another season. Among the Art-possessions of Providence is a Madonna and Child (an oil picture) by Overbeck; works by Stuart, Conley, and Malbone; some of the productions of Madeleine Rosa Bonheur; pictures by Lentz, Mornel, Durand, Dougherty, Woodville, Kensett, Stearns, Healy, Hinckley, Osgood, Silly, Morse, Terry, Hopkin, Gigney, Coleman, and Weber, and other American artists, with a reasonable sprinkling of "old

masters," good, bad, and indifferent. *A propos*, let me here ask your congratulations upon the promising circumstance of the rapid disappearance from our private galleries of the "old masters," who have ruled there so long and so dominantly, to the detriment of the better productions of our own cases.

I regret that I must close my letter with the sad record of the death of that Nestor of American landscape-art, Thomas Doughty. He died in New York, after a long illness, on the 24th of July last, at the age of sixty-three years. He was one of the earliest of our painters who distinguished himself in that department of study to which he was devoted; and at one time he deservedly held a very high position—but he outlived both his genius and his fame. He has left behind him, scattered all over the country, a great number of works of very unequal merit. Those executed in the acme of his power will be always treasured as rare examples of true Art. His favourite and happiest themes were brooky nooks and pastoral passages, with alternating coase and lawns, and far-off peeps of gentle hills and water: all seen in such moistened, vapoury atmosphere, and such greyish-clouded skies, as the climate of England so often produces. His works owe their charm—though generally very carefully and nicely wrought—less to their individuality of character in the objects represented, than to the general sentiment which they always either exhibit or suggest. He worked more from feeling than from knowledge; and thus it was, perhaps, that when in years and cares, in privations and pain, his heart failed him, so failed his hand also. He went to the case from the humble position of a leather-dresser, quite uneducated in Art or otherwise, at the late age of twenty-eight, and burthened with a wife and child dependent upon his labour. "Contrary to the wishes of all my friends," he once said, "I resolved to pursue painting as a profession, which, in their opinion, was a rash and uncertain step. My mind, however, was firmly fixed; I had acquired a taste for Art which no circumstance could unsettle." In respect to material reward, those predictions of his friends were unhappily better realised than were his own stout hopes; for despite his best successes, his life was one of great pecuniary struggles,—though this painful sequel met in justice be charged to his own faults of character, as much as to the faithlessness of his Art.

Very sincerely yours,

T. A. R.

Providence, Rhode Island, Aug. 5.

THE HARBOURS OF ENGLAND.*

We are glad to meet with this series of Turner's works in the form in which it is presented to the public. It is to the taste and enterprise of the publisher that we are indebted for a set of these engravings, and in a form most convenient and accessible to those by whom they will chiefly be esteemed—we mean students of Art; not that all are models for imitation, but that the principles they involve are indispensable to good Art. We are glad, we say, to meet with them in this form; for whatever may be said of Turner's colour, we find him generally right in a roduction to black and white. Those who do not know that Turner never completed a series that he commenced, will be disappointed to find that the number of these plates extends to only twelve; and will be mortified to find that Liverpool, Shields, Newcastle, Sunderland, and other similar places are omitted, while such places as Margate, Ramsgate, and Deal, are included in the series—which, in addition to these, contains also Dover, Plymouth, Catwater, Sheerness, Portsmouth, Falmouth, Sidmouth, Whitby, and Scarborough. In his preface the editor essays to account for Turner's habitual interruption of projected serials; but he assigns no intelligible reason. If any cause for such not unexpected, abrupt, and unsatisfactory conclusions, is to be given, it will be found in the *ἀνοσιγγοσία* of the artist as mirrored in his works, of which we need see but one, to learn that it is the production of a man

who shelters himself from a declaration of subordinate form, natural and factitious, in the sublime informalities of the phenomena of nature. Turner could be formal in nothing; it was enough for him that Margate was an English harbour; that position did not assert that Liverpool and Bristol were not; and although, in his "Rivers of France," the Rhone and the Garonne were omitted, there was no inference that these rivers were not rivers of France. Mr. Ruskin has spoken of some of Turner's last works in such a strain as to induce a belief that he ranked them among the best productions of the artist's best time. He now says that "The Femeiraire" was his last really worthy picture. We agree with him in this; it is, as a whole, unsurpassed by any similar work of any time—though still disfigured by that imperfection in form and infirmity of execution which degrades so materially from many of Turner's best works. Look at the thing that fows the venerable hulk; but for the chimney you could not resolve it into a steam-tug. We remember when the picture was in the hands of the engraver, the latter was in the utmost embarrassment with regard to this passage of the picture, and ventured to make the thing like a steam-boat—a liberty which excited in the artist a paroxysm of wrath. What had he to do with form? what had he to do with the forms of steam-boats?—he who was for ever shrieking like a sea-new to the music of the "felon winds"—who now overwhelms us with the dark oppression of his storm-cloud, and now administers his sublimous nutil, like the bad angel, we are

"Drunk with excess of light."

The steam-boat, however, remains in the plate as the engraver shaped it. Mr. Ruskin's letter-press to these plates does not panegyricise Turner with anything like the devotional homage which characterises his "Modern Painters"; his criticism is more reasonable; he aims at intelligibility, and does not always fail. In his introduction he says, "Of one thing I am certain—Turner never drew anything that could be seen without having seen it—that is to say, though he could draw Jerusalem from some one else's sketch, it would be, nevertheless, entirely from his own experience of ruined walls; and though he would draw ancient shipping (for an imitation of Vandevelde, or a vignette to the voyage of Columbus) he had such data as he could get about things which he could not more see with his own eyes, yet when of his own free will, in the subject of Ilfracombe, he, in the year 1818, introduces a shipwreck, I am perfectly certain that, before the year 1818, he had seen a shipwreck, and, moreover, one of that horrible kind—a ship dashed to pieces in deep water at the foot of an inaccessible cliff. Having once seen this, I perceive also that the image of it could not be effaced from his mind. It tancnt him two great facts, which he never afterwards forgot—namely, that both ships and sea were things that broke to pieces. *He never afterwards painted a ship quite in fair order.*" This is a specimen of that kind of composition by which Mr. Ruskin mystifies his non-artistic readers into profound respect for his penetration, at some expense to the reputation of Turner. What is here meant is that Turner in imaginary composition drew upon nature and Art until these sources were exhausted, and then drew on his own invention for the remainder—the simple resources of every other artist. Had we been told that Turner declined altogether to treat the subject of Jerusalem, because he had never been there, it would raise the memory of Turner in the estimation of strangers, who may desire to learn something of this great painter. "I said," continues the editor, "that at this period he first was assured of another fact, that the sea also was a thing that broke to pieces. The sea up to that time had been generally regarded by painters as a liquidly composed, level-seeking, consistent thing, with a smooth surface, rising to a water-mark on the sides of ships; in which ships were scientifically to be imbedded and wetted up to said water-mark, and to remain dry above the same. But Turner found, during his southern coast tour, that the sea was not this; that it was, on the contrary, a very uncalculable and unhorizontal thing, setting its 'water-mark' sometimes on the highest heavens as well as on the sides of ships; very breakable into pieces; half of a wave separable from the other half, and on the instant carriageable miles inland," &c. This is mere senseless verbiage—a

* "The Harbours of England," engraved by Thomas Lupton from the original drawings made expressly for the work by J. M. W. Turner, R.A., with illustrative text by J. Ruskin. Published by E. Gantart & Co., London.

tissue of absurdity, which could only be said of some creature whose senses were in their earliest dawn. Mr. Ruskin alludes here to circumstances which gave rise to Turner's picture of "The Shipwreck," a large composition, in the possession of one of the directors of the British Institution. It is well known by the engraving; but we believe this picture was painted before 1815; and in this picture Turner has not shown his scrupulous observation of probabilities, for he has placed a boat in a sea in which no such small craft could live a minute. But we must proceed to the plates. In the view of Dover the spectator is placed near the end of the jetties, at the entrance to the harbour, whence the Castle Cliff is seen to cross the composition, having the town at its foot, with the citadel cliff on the left. The castle and cliff are lighted by sunshine, but dominated by a dark and threatening sky, to which in tone the water responds. We know very well the appearance of Dover from this point—it is by no means like what Turner has represented; the town is altogether shrunk into nothing, while the castle hill is much exaggerated. As an effect it is most successful; but thus it was that Turner made pictures. Ramsgate is the next; and what we observe of the town is seen from near the lighthouse; but this is not so successful as Dover. The view of Plymouth is taken from the shore, looking at the town, with the citadel on the left. Here the sea is calm; over the town hangs a black cloud, on which is relieved a rainbow. Although an effect of calm, this plate is full of movement, even to distraction. It is followed by Catwater, the entrance to Plymouth Sound, another breezy subject, with a rolling sea. We agree with Mr. Ruskin in pronouncing Sheerness not only one of the best works of the series, but one of the best of Turner's marine subjects. We are again at sea off the harbour, which appears in the distance on the left, where are also seen a cutter and a light collier brig, both going to sea; while on the right is seen moored a slip of the line. A stiff breeze is blowing; and from the short crisp seas we understand that we are in an estuary. On the right the sky is darkened, and a wedge-like scudding shadow is thrown across the near section of water, and expanding to the right distance. This plate is really full of grandeur, suffering in nowise from the enfeebling sparkle of distributed light. The view of Margate is taken from that side called Buenos Ayres, but it lies principally in shadow; it is extremely indefinite as a view of the town, but spirited as a coast composition. The view of Portsmouth is more recognisable as the representation of a place than the last we have noticed. The sky is admirable; and it were much to be desired that the water were equally well composed, but there are evident, here and there, scratchings of the artist's knife in search of relief where no relief is wanted, the sea being already sufficiently broken up. Falmouth is an excellent plate, full of detail, and distinguished by drawing more careful than usual. The evening sky, and the gen-like setting of the town in the composition, are most masterly; the nearest passages are not so agreeable. We look at Sidmouth from the sea, which is drawn in shade, and with greater breadth than usual. The effect is windy—a very favourite aspect with Turner, as affording fitting lights and a wild sky. The view of Whitby is a charming drawing; we are placed as usual on the sea, with the cliffs and monastery on our left, and looking directly into the harbour, into which a brig is sailing. The sea has breadth and movement, and the sky is deep and full of atmosphere. We view Deal in like manner from the sea. This subject is almost entirely an expression of wind, and as such highly successful. Scarborough is really the most quiescent picture of the whole, and all the parts come together, so as to form a most agreeable composition. All these plates are in mezzotint; and it were much to be desired that a more extensive selection of Turner's works could be thus published; for, independently of their charm to all lovers of Art, they are, as we before remarked, of infinite value to the student. The prints are all well and carefully engraved by Mr. Lupton, and it is certain that they have received much benefit from the "touches" of Mr. Ruskin; altogether the work is a valuable acquisition to the artist and Art-lover, and its production is highly to the credit of the enterprising publisher.

MINOR TOPICS OF THE MONTH.

THE ROYAL ACADEMY "EVENING."—The close of the Exhibition was marked, as it has for some years been, by an assemblage of the exhibitors, and by calling together a number of the patrons and lovers of Art, whom the Academy "entertained." The rooms were, of course, lit with gas, and the pictures were seen to great advantage by the light thus produced—many of them, indeed, for the first time; the upper row having the full benefit of that which the day-time kept from them. The evening was in all respects gratifying; every exhibitor had a right of admission—the great majority in attendance were consequently artists; but mingled with them were many whose association with Art is only obtained by their love of it. A very liberal supply of refreshments was provided, and all the guests seemed content as well as delighted.

THE ART-TREASURES EXHIBITION AT MANCHESTER.—The foundations of the Art-palace at Manchester have been laid, and the works progress in a manner so entirely satisfactory as to leave no dread of ultimate success. The architect, Mr. Salomons, seems, next to the chairman, Mr. Fairbairn, to have gained "golden opinions;" while the contractors pledge themselves, in a manner not to be misunderstood, that the building shall be ready to receive its "treasures" early in the year 1857. The Committee are evidently labouring "with a heart and with a will;" and they are fully justified in anticipating an amount of public co-operation which cannot fail to realise their hopes. Their labours will now be devoted to the collecting from all quarters pictures and other works of Art. They are no doubt fully aware of the difficulties in their way; they are by no means insurmountable, and will be overcome by that energy and perseverance which have heretofore marked all the proceedings of the enterprising gentlemen who have taken this weighty matter in hand. We trust that ere long we may be able to report a number of noblemen and gentlemen who have placed their galleries at the disposal of the Committee.

THE MANCHESTER INSTITUTION.—The Committee announce their intention to open this Exhibition on the 9th of the present month of September, and they will do so under circumstances of great encouragement. The "Institution" is, as our readers know, a building eminently suited to the occasion; and we may indulge the hope that by its "inauguration," in so appropriate a manner, it will be the property of the trustees remembered by debt—the milestone round the neck of many valuable institutions, the power of which for good is thus often so embarrassed as to be rendered comparatively unavailing. The ceremonial of the 9th will be presided over by Lord Palmerston—a gratifying fact, and one that cannot fail greatly to promote the object in view; it will be, we believe, the first instance of a prime-minister ever having taken an active and prominent part in the formation of a society of this kind, and must be accepted as one of the most unequivocal signs of the times. His lordship is sure to be well supported; and the result will no doubt be among the most satisfactory of those events which have marked his long political career. Our purpose in again drawing attention to this subject is to express an earnest hope that the project will receive the aid of all by whom it can be rendered; that manufacturers especially, by contributing to the Exhibition, will assist to accomplish the many important advantages—to them and to all classes—which must arise out of this effort to improve and benefit the hundreds of thousands of artisans who people the greatest manufacturing city of the world.

THREE PICTURES of very remarkable character have been exhibited in London (on their way to Manchester); they are painted by Mr. W. Wyld, an English artist, but who, in consequence of his long residence in Paris, where his abilities have been recognised by a decoration of the Legion of Honour, has been generally classed among the painters of France. These works are large, and are designed to be the ornament of one of the best modern houses of Manchester, having been commissioned by Joseph Bull, Esq., an "ironmaster" of that great city, and one who, we rejoice to know, is foremost among the wealthy "patrons" to whom British Art must now-a-days look for its prosperity. They are pic-

tures of great merit, and are intended to illustrate in some degree the merchant's calling, and the repose he covets, as the recompense of labour. The one represents Venice in its palmy days; the other, Rotterdam in its zenith; and the third exhibits Tyvoli. They are, however, rather recollections than portraits, for the artist has allowed himself a full licence in treating his subjects poetically, and has introduced into one a gorgeous ceremonial of the olden time—the Queen of Sheba embarking; while in the other merchants congregate, and there is all the incidental bustle of traffic and prosperity. Tyvoli is a charming production, and "tells" with singular felicity, in its calm yet grand repose, between the two cities of commerce. The works are very honourable to the painter, and will add much to the Art-wealth of Manchester.

THE NATIONAL GALLERY.—Three or four new pictures were added to the National Collection on the eve of our going to press. Several more have been purchased, and, we expect, will be hung in time for us to notice the whole together in our next publication.

A STATUE OF THE LATE GENERAL SIR CHARLES NAPIER will shortly be placed at the south-west corner of Trafalgar Square, workmen being now employed in preparing the foundation for its erection. The statue—the cost of which will be defrayed by public subscription—is the work of Mr. G. C. Adams, and is cast in bronze by Messrs. Thompson, of Pimlico; we defer any remarks upon it till we can see it on the pedestal in its place. But why leave the pedestal which has been so long at the north-west corner still unoccupied? might not Sir Charles have stood there? and thus so far have produced a little harmony in this unfortunate square, that seems, somehow or other, always to have something "out of joint."

SOCIETY OF PAINTERS IN WATER-COLOURS.—At a general meeting of this society, held on the 30th of July, Mr. J. D. Harding was unanimously re-elected a member. Some time since he withdrew from this society, with the intention of devoting himself to painting in oil; but having now returned to the Society, we hope to see a continuation of those works whereby he has earned a reputation so widely extended. The unworthy treatment of Mr. Harding by the Royal Academy is a flagrant instance of the suicidal policy of that body, who, having themselves exhibited no landscape, properly so called, yet decline to elect one of the most eminent living masters in this department of Art.

LONDON AND MIDDLESEX ARCHEOLOGICAL SOCIETY.—The first annual general meeting of this Society was held on the 24th of July, at the Architectural Museum, Cannon Row, Westminster. After the business of the meeting, presided over by Lord Robert Grosvenor, M.P., was transacted, the members and visitors—a number of the latter being ladies—adjourned to Westminster Abbey, under the guidance of Mr. G. G. Scott, A.R.A., and the Rev. C. Boutell, where the former delivered a brief but interesting lecture on the Abbey; and the latter, as the company inspected the monuments, pointed out those most worthy of notice, and made appropriate comments upon them. We were among the visitors on this occasion; and strange as it may seem to many of our readers, though almost daily passing for the last ten years this noble edifice, and enjoying a near view of its time-worn roof and towers from the room in which we write, we have not, to the best of our recollection, been inside its walls for a far longer period than that just mentioned. What was our surprise and regret after so protracted an absence to find every available nook and corner crowded with the statues of distinguished individuals who have died during the last fifteen or twenty years, placed too, as it would seem, just wherever there was room for them to stand, without reference to suitability of position, and without the least regard to the ancient monuments, which, in many instances, they half conceal. Now, we assert at once that Westminster Abbey is not the proper depository of mere statues, however excellent they may be as works of Art; statues are not monuments reared in memory of the dead, they are testimonials to worth or genius, whether living or dead, and churches should be the receptacles of monuments only. But presuming statues to be what they are not, to crowd them into such a place as the Abbey, is an act that every one who

values taste in Art ought to protest against. Here is a museum of monumental sculptures, extending through a period of about five centuries, such as no other city in the world can show; but its value is rendered comparatively useless, not so much by the absence of the chronological arrangement of these works—which, however, we feel to be unavoidable—as from the intrusion of objects dissimilar in character, and which act as screens to hide the legitimate adornments of the sacred temple. We find the *living* portraits of Peel, and Campbell, and Mackintosh, and Watt, and scores of other worthies, standing, as they appear to us, in mockery of the dead who sleep below, or whose deeds are recorded on the surrounding walls. Public opinion has succeeded in closing the grave-yards of London against new occupants; let us hope it will be equally urgent in denouncing that the Abbey of Westminster shall no longer be the receptacle of mere portrait-sculptures—the National Gallery is the only suitable receptacle for such works. When the new one is erected, a gallery should be especially appropriated to the statues of our great men, and (thither those now in the Abbey, and St. Paul's too, should be removed. At present the right men are in the wrong places.

ARTISTS' GENERAL BENEVOLENT INSTITUTION.—The last Annual Report of this Institution, submitted to the subscribers on the 11th of August, has been placed before us. It alludes in gratifying terms to the continued and progressive advancement of the funds of the society,—the subscriptions at the annual dinner, in June, having reached the sum of £624 18s. 10d., including a donation of 100 guineas from Earl Stanhope, as the first fruits of the "Peel Memoirs." The council expresses its thanks to Lord Yarborough for his gift of the copyright and steel plates of Turner's "Wreck of the *Mioutan*," and "The Vintage of Macon," which will shortly be published for the benefit of the institution. The following are the receipts of the last financial year, ending June 30th, 1856:—

Life subscriptions and donations . . .	£601 16 10
Annual subscriptions	74 9 0
Dividends on funded stock	494 4 4
Gifts on the Jerseyan bequest	12 2 0
Income tax returned to July 5	13 13 9

£1196 6 5

Relief has been granted during the year to sixty-eight cases, at the half-yearly meetings, by sums amounting to £1060. The following gentlemen were appointed directors for the three ensuing years, in lieu of those who went out by rotation:—Messrs. T. S. Cope, E. W. Cooke, A.R.A., T. M'Lean, W. E. Frost, A.L.A., A. Elmore, A.R.A., E. P'Anson, T. Webster, R.A., and F. S. Cary. We shall rejoice if any recommendation of our own, or any influence we may have, should avail in promoting the enlarged utility of this excellent institution.

MR. PENNETHORNE, the Government architect and surveyor, has recently received a gratifying testimonial of the regard in which he is held by his professional brethren; upwards of seventy of whom, including a very large proportion of the most eminent, have signed a congratulatory letter to him on the completion of the new wing of Somerset House. They have also taken advantage of the opportunity to express their "cordial respect for his character as an architect and surveyor, and for his bearing as a gentleman." It is proposed to present Mr. Pennethorne with an impression, in gold, of the medal of Sir William Chambers (the first architect of Somerset House), which the Art-Union of London has in preparation for its subscribers.

ART IMITATIONS IN LEATHER.—MR. WILLIAM SANDERS, of 7, Mornington Road, has submitted to our inspection some works in cut leather, which are unquestionably of rare and singular merit, and fine examples of an art which he teaches as well as practises. They consist chiefly of birds and flowers, and are composed of bits of light leather, cut by hand, and so ingeniously put together as to be very accurate representations of wood carvings: it is difficult otherwise to describe their effect. They manifest industry as well as talent, and cannot fail to be admired wherever they are seen.

HER MAJESTY'S THEATRE.—The auspicious opening of this theatre was the prelude to a satisfactory close; and a very strong public feeling among all classes exists to support Mr. Lumley in his

arduous undertaking. He has carried his "season" through with even more than former triumphs; there was no evidence whatever of straitened resources; on the contrary, the general impression is that he did too much rather than too little. All parties are more than content, and the hope is universal that next year he will again obtain those "golden opinions" which have been this year his reward.

MR. AND MADAME GOLDSCHMIDT have returned to Dresden, having made a very extensive tour throughout England, and given enjoyment to thousands in all its principal cities and towns. We believe we are correct in saying that she will not again appear in public in this country; although she has taken no formal farewell, she has permitted it to be understood that her voice is not hereafter to minister to her fortune—in other words, she is wealthy enough, and, although in the zenith of life, with her rich gift of nature as capable as it ever was of delighting and astonishing, she prefers the calm quiet of domestic happiness to the labour and excitement of even a "concert stage." She has made "friends" everywhere, but nowhere are they more numerous than in England; in no country of the world is she more truly esteemed or more highly respected—not by any means alone for her genius, but for her private worth. Few public characters have mixed so little in what is called "society"—few have seen her who did not see her discharging the duties of her profession; but we have learned to regard her and to estimate her none the less—and certainly no public person of our time has so thoroughly carried with her into private life admiration so closely bordering on affection. It will consequently gratify all who may read this notice to know that in private life no woman was ever more entirely happy; a foolish and wicked rumour to the contrary preceded her visit to England; the "thousand tongues" of slander had circulated a statement, as regarded Mr. Goldschmidt, in which there was not a syllable of truth—for which, indeed, there was not even a shadow of foundation. We have seldom known a gentleman more entirely admirable than Mr. Goldschmidt—as generous in disposition as she is, as entirely devoted as he is to that profession of which they are the ornaments—his taste for Art forms one of his best resources, and contributes, next to music, to the home-happiness of both. There is no liberal thought, no good deed which Madame Goldschmidt can devise or do, in which she will not be zealously seconded by her excellent, amiable, and accomplished husband; and we have good grounds for the belief that no woman has in wedded life a safer or better security for domestic happiness and prosperity.

THE NIGHTINGALE FUND.—This fund, the creation of which it will be recollected, we were the earliest to announce, has now reached the very large sum of about 37,000*l.*, and there is little doubt that it will amount to 40,000*l.* (clear of all expenses) before the committee are called upon to complete their contract with the public by transferring it to Miss Nightingale. That is all the committee have to do; their purpose was limited to its collection, to be handed over to Miss Nightingale, and expended by her for the benefit of that public by whom it has been contributed. It is, however, well known—in fact, it has been publicly announced—that Miss Nightingale, by the aid of a council (selected by her from the committee), will devise and mature, and subsequently promulgate, a plan for the formation of an institute for the education of nurses, to be attached to some existing hospital in London. There can be no doubt of the enormous amount of good that will hence result. Providence has endowed this admirable lady with faculties which peculiarly fit her for this important task; the public have supplied means by which she may work freely and untrammelled; and we entirely believe that the benefits she is destined to confer hereafter on her country and humanity will be infinitely greater and more extensive than those which followed her steps at Scutari and in the Crimea. We can, and perhaps may, fully detail the objects in view, and, under God's blessing, the certain results; but at present to do so would be premature. Miss Nightingale has returned to England; she is "at home;" but some time will no doubt elapse before she gathers health and strength to resume labours which have been rightly described as "superhuman."

REVIEWS.

THE SOLDIER'S DEPARTURE.—THE SOLDIER'S RETURN. Executed in chromo-lithography by VINCENT BROOKS, from the Pictures by J. RITCHIE. Published by T. BOYS, London.

Arma virosque pingo, has been the motto recently adopted by a large number of artists both here and in France. Of late years, the stirring martial incidents of flood and field were but sparingly set before us; and inasmuch as few of the living know anything of such deeds, except as they are inscribed on the pages of history, to the biographer and the historian, rather than to the painter, must be awarded the merit of kindling whatever warlike enthusiasm has been generated in those whose profession is not that of arms. The last year and the present have, however, overwhelmed us with war-pictures; we have seen the "Guards" marching out, and—marching home again; thousands of troops encamped and reviewed at Cholham and Aldershot; ships of prodigious size and armament floating quietly, or gallantly performing mimic fights on the waters that wash our southern coast. We know every part, town, and battery in the Baltic and Black Seas; we are positively better acquainted with Sebastopol, as it was two years since and as it now is, than we are with the Tower of London in its present condition; we have been in the trenches and the ravines of the Crimea, on the heights and in the camps, with all the brave fellows whose fortune it was to suffer heroically or to die gloriously on that well-fought field. All these things the pencil of the artist, and the camera of the photographer, have placed before the people of England.

"Who live at home at ease."

And now that the last hostile shot—for very many years, we trust—has been fired, let us hope the artist will turn his thoughts to subjects of a more pleasing nature, and more in harmony with those arts over which Peace loves to spread her gentle influences and her protecting wings. One of the two prints that have called forth these remarks indicates such a return. The first, "The Soldier's Departure," represents a detachment of Highlanders marching, at sunset, through a defile of Scottish mountain-land; one of the men, having lingered behind the rest to take his final leave of his family, assembled at the cottage-door, is now seen hurrying forward to overtake his companions: in the other plate he is meeting them again, all sound and well. Mr. Ritchie is an artist of considerable notoriety in Edinburgh; these subjects show him to possess the poetic feeling of a true painter; his style is peculiar, but very effective, and he is a rich colourist. All we need say of Mr. Brooks' success as a chromo-lithographer is, that when we saw these prints in a shop-window, before they came into our hands, we mistook them for highly-finished water-colour drawings. Few works of their class deserve to be more popular.

THE CHALK WAGONER IN THE LIMOUSIN. Engraved by E. GOODALL, from the picture by ROSA BONHEUR. Published by R. GAMBART & Co., London.

This, we believe, is the first line-engraving executed from the works of Mademoiselle Rosa Bonheur, and it is also the first publication issued in England from one of her pictures; all prints that have hitherto appeared are lithographies produced in Paris. The "Chalk Wagon" was one of two pictures, the other being a "Drove of Cattle in Brittany," sent by the artist to the first exhibition of French works in Pall Mall, in 1854, and was there purchased by William Wilson, Esq., of Banknock, the liberal and well-known collector, who has courteously allowed it to be engraved. It is well for the reputation of Mademoiselle Bonheur that her picture was placed in the hands of so skilful an engraver as Mr. Goodall, for there are but few of those who handle the *burin* who would not have failed in imitating the peculiarities of her style; Mr. Goodall has copied them perfectly. We have here not alone her bold conceptions, and her accurate knowledge of the anatomy of the figure, both of man and horse, but we recognise also the singularity of texture which distinguishes her works from those of any other artist—a peculiar softness or indistinctness of detail, that does not, however, become "woolly," as it is technically called—for if we did, we should consider it a defect rather than otherwise. To our eyes, this lady's style of painting imparts richness and delicacy to her works; most certainly it does to the engraving, which manifests these qualities in a high degree. The print is small, but it will be pronounced a gem of its class.

FERNY COMBES, A RAMBLE AMONG FERNS IN THE GLENS AND VALLEYS OF DEVONSHIRE. By CHARLOTTE CHANTER. Published by LOVEL REEVE, London.

This charming little volume is dedicated by its author "to the Rev. Charles Kingsley, and to Mrs. Kingsley, as a small token of the gratitude due to them for awakening and fostering in their children a love of nature and beauty; by their daughter, Charlotte Chanter." We thus learn that Mrs. Chanter is the sister of *the* "Charles Kingsley," whose "Glauceus" was the companion of our rambles amid the sea-side beauties of Devonshire, last season; and truly these "children" have much cause for additional gratitude towards parents who fostered in them a "love of nature and beauty"—a love that has yielded such an abundant harvest. We expressed our gratitude last year to Mr. Charles Kingsley for having not only opened a new volume of nature for our perusal, but for having so paged and noted it, that pleasure and information were blended with the happiest skill; and now his sister, Mrs. Chanter, presents to us a brilliant little chronicle of ferns—the very gipsies of the underwood—the most graceful of all the leafy tribe that adorn our paths, and enwreath our hedge-rows and forest glades with their evergreen beauty.

Mrs. Chanter disclaims all pretension to supersede the scientific or necessary works already published on the study of ferns; her object being simply to give a short account of those that may be found in Devon, in such a manner as may render them readily recognised by the novice in botany, and to describe some few of the beauties of the beautiful districts of the West. "My humble effort," she says, "is designed to lead the youthful, and to cheer the weary spirit, by leading them with a woman's hand to the Ferny Combes and dells of Devon, where my best reward will be their innocent amusement, or their restoration to health under the soothing influences of a rambling tour." Mrs. Chanter advises the lounge-tourist "to leave the train at Bridgewater, and take the road which runs through Minhead to Lynton. Now that we have passed," she says, "Coleridge's 'Nether Stowey,' and Southey's 'Kilne by the green sea,' which shines in the sun away to our right, with the hills of Wales beyond; after crossing the beautiful Quantock Hills, we see in front of us the country to which we are bound." "The lady assures us this is the best entrance into Devonshire; though we confess we think it wiser to suffer the scenery to increase in beauty upon us than to dash into it at once; however, that is a matter of opinion. Mrs. Chanter's book is a sweet companion, whatever road is taken. "Combe" is the Devon name of "valley," and the valleys of Devon are rich in other growths besides ferns; the botanist will find a rich abundance of nearly all he seeks, and we need not remind our artist friends of the landscape treasures of the shire. The illustrations are exactly what we should expect, arranged, as they have doubtless been, by the taste and knowledge of Mr. Reeve, to whom the lovers of natural history are already so largely indebted for many of the most useful and delightful books in our language.

CHROMOLITHOGRAPHERS. Printed by M. & N. HANHART, London.

The establishment of Messrs. Hanhart has put forth another batch of coloured prints, all of them so good that it would be difficult to have a preference for one over the others. We have on many former occasions spoken so favourably of this comparatively new form of Art-productions, that our vocabulary of eulogistic terms is well-nigh exhausted; indeed, nothing seems now left for us to do but to record the appearance of these prints as they come into our hands. Of the number just received, the largest is from a picture by J. D. Harding—"Cluses," a picturesque mountainous scene in the kingdom of Sardinia; it is a bright sunshiny print, but the trees want the vigour and sharpness of touch which characterise this artist's works; the sky, mountains, and broken foreground are capital; the print is published by Lowrey & Co. "Broadstairs," after J. Callow, "Andernach," and "Pe-trarch's House," after S. Prout—three prints published by Lloyd Brothers—are all good; in the first, the sea is dashed in with remarkable vigour and truth, and the "pair of Prouts" are as fresh and as faithful as if they had just come out of the lamented artist's quiet studio at Camberwell. An "Interior of a Cathedral," is the facsimile of a sketch by D. Roberts, R.A. "Ben Nevis," after T. M. Richardson, is noticeable for the transparency Lons advocates in his pamphlet; and yet which the mountains are expressed; it is a charming subject, most felicitously treated. "The Meadow-side,"

sheep and cows, from a drawing by T. S. Cooper, R.A., is slight, yet brilliant and effective. The "Approving Child," a peasant urbin standing before an easel, with a lighted candle in his hand, possibly contemplating his own portrait—for the back of the picture only is seen—is one of those droll conceptions which are always identified with W. Hunt's figure subjects: the copy is inimitable. All these last-mentioned prints are published by the lithographers, Messrs. Hanhart. We see the name of J. Coventry upon most of the prints; the artist who has transferred the originals to the stone; we are bound to compliment him upon the satisfactory manner in which he has executed his respective labours—not a very easy task it would seem to us, to imitate the various styles of the artists whose works were placed before him.

BLACK'S PICTURE-SKETCH TOURIST OF SCOTLAND. Published by A. & C. BLACK, Edinburgh.

The words "twelfth edition" on the title-page of this book render it almost unnecessary for us to add anything by way of recommendation, especially as former editions have received our favourable notice. We are told in the preface to this new issue, that the work has undergone a thorough revision and correction—the information in several instances having been entirely re-written, from notes taken during tours recently made expressly for this edition. It certainly appears to contain all the tourist can desire to know, while the subject-matter is conveyed in the simplest and most ready form. We observe that the map of Scotland which is introduced, is printed on thin cloth instead of the usual material—paper: this is a vast improvement where reference has so frequently to be made to it by the traveller.

THE STRANGER'S HANDBOOK TO CHESTER AND ITS ENVIRONS. By THOMAS HUGHES. Published by T. CATHERALL, Chester; J. R. SMITH, London.

It is an undeniable fact that hundreds, my thousands, of Englishmen, and Englishwomen too, are far better acquainted with certain parts of continental countries than with their own; and yet nowhere has nature spread out with such a lavish hand such temptations, in the way of the picturesque and the beautiful, to the traveller to home enjoyments as he may easily find within the limits of Great Britain and Ireland, if he will only look for them. We have no desire to place a bar across the harbours of Dover or Folkestone, at this or any other season of the year; but we have "a pretty stiff notion" that if the Englishman entertained only half an idea of what there is to be seen between the Land's End and John o' Crow's House, and across the Irish Sea, he would feel little disposition to explore the marvels of other countries, at least until those of his own are exhausted. This propensity for foreign travel, almost to the entire neglect of our own country, has within the last few years grown to such an extent that the subject has at length been taken up by some of the leading public journals—and not before it was needed—with a desire to turn the thoughts of their readers to the sources of health, enjoyment, recreation, and instruction that surround us at home. Here, for example, is "rare old Chester," a city the like of which is not in Europe—full of antiquarian interest and stirring historical associations, and envied by landscape scenery that is sweet and soothing to look upon. Though our recommendation comes rather late in the season, it may not be too late to advise those who have a week or two yet to spare out of town, to take a run thither and explore its beauties and antiquities with Mr. Hughes's excellent guide in their hands; and we would tell them who have not such an opportunity, that, as the book is full of illustrations, they may receive from it a good idea of what is to be seen both within and without the walls of the city.

PAINTING WITH BOTH HANDS; OR THE ADOPTION OF THE PRINCIPLE OF THE STEREOSCOPE IN ART, AS A MEANS TO BINOCULAR PICTURES.

By JOHN LONS. CHAPMAN & HALL, London. An artist of our acquaintance, for many years past holding a distinguished rank in his profession, but whose earlier life was occupied in painting for the stage, once told us that scene-painting was "capital stuff; you see, we have our colours in palette, we get a long-handled brush about as big as a birch-broom, and then we go boldly to work with both hands." Making all proper allowance for the enthusiastic exaggeration of our friend in his description of scene-painting, we do not suppose that his method of working is exactly that which Mr. Lons advocates in his pamphlet; and yet we should have been half-inclined from the writer's remarks to think it is, were it not for a note on one of the

pages, which informs the reader that his plan is to employ two pencils at the same time, one in each hand. How this is to be done, however desirable its adoption may be, we are not told; nor can we imagine how it would be possible so to direct each eye to its corresponding hand as to watch its operations and note its doings. But, supposing even this difficulty overcome, painting being an effort of the mind as well as of manual labour, what artist could fix his thoughts on two separate and distinct objects, or portions of his picture, at the same time, so as ultimately to combine them into one harmonious whole? In truth, Mr. Lons's theories are ingenious, but fallacious, to our notion—for we cannot see how the principles of the stereoscope can be applied to the art of painting; the stereoscope does not create the picture—it only serves to show it to us in a peculiar and true aspect; it is nature, or in the case of painting, the artist, who makes the picture: the man and the instrument do not stand on equal terms with respect to the work each has to perform.

THE BRITISH WORKMAN.—THE BAND OF HOPE.

Published by PARKERDIDGE & Co., London. There is nothing more cheering than to find "angels amongst us unawares;" and these publications—which we have put together, as being under the control of the same editor—go a long way to prove the fact that such are labouring earnestly for the "workman" and the "child." Both publications deserve the patronage of every employer and landholder in the kingdom, and should be found on the table of the "workman" as well as in the cottage of the peasant. We cannot recommend these cheap and admirable works too highly. Mr. Smithies deserves to be classed amongst the philanthropists of modern times, labouring as he does in comparative obscurity, and yet diffusing a mild beneficent light among "the people." Both THE BAND OF HOPE and THE BRITISH WORKMAN are miracles of cheapness; and many of the illustrations would do credit to our own pages.

PHOTOGRAPHIC PORTRAITS OF LIVING CELEBRITIES, Nos. 1 & 2. Executed and published by MAULL & POLYBLANK, London.

An attempt, and by no means an unsuccessful one, is made in this work to supersede the labour of the engraver, by the camera. The portraits given in these respective numbers are those of Professor Owen, and the Right Hon. T. B. Macaulay; the former is excellent—bright, intellectual, and life-like; the historian and essayist is just the reverse—"His eyes are heavy, and he fain would sleep."

The contour and the physiognomy of the man are here, but they convey a very imperfect notion of the brilliant historical romancer of the nineteenth century. A short biographical notice, by Herbert Fry, accompanies the portrait of each "celebrity."

GRACE HAMILTON'S SCHOOL DAYS. By ENMA JANE WORBOISE. BINNS & GOODWIN, Bath.

There are numbers, young and old, who will be greatly pleased with this volume, as it contains more than the ordinary incidents of school-girl life, combined with much that is sound morality and religion. But books intended for the amusement as well as the instruction of youth should avoid all manner and appearance of lecturing—the moral should spring out of the incident without force or constraint; the young do not like being trapped into a lesson or a sermon when they expect a story; and when any extra reasoning is indulged in, it should appear inevitable—not to the writer, but to the reader. The introduction of poor literature into a school is a serious evil, and cannot be too cautiously guarded against; but girls who have passed the years of childhood are naturally prone to seek amusement, during their leisure hours, in light literature, and every establishment should have a well-selected library, with which education has apparently nothing to do. We say "apparently," because everything is education until the mind is formed; and those who are properly skilled in training well know that taste, feeling, expression, truth, honour—all the higher as well as the beautifying qualities of mind and matter—can be taught without reference to a school-book or a lesson.

A TREATISE ON THE CURE OF STAMMERING. By JAMES HUNT, M.D.S.L., &c. Published by LONGMAN & Co., London.

To those who are afflicted with the distressing ailment this book may be very strongly recommended; it is the production of a gentleman of great intelligence and much knowledge, who inherited from his father (long famous for the cure of this defect) the duty of lessening it, or removing it, by a system based upon common sense, careful study, and matured experience.

THE ART-JOURNAL.



LONDON, OCTOBER 1, 1855.

THE NATIONAL COMMISSIONS.

THE WELLINGTON MONUMENT.

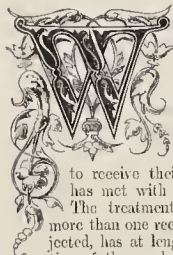

We have good grounds for believing that the cause of the British sculptor will find a larger advocacy in the next session of Parliament—when questions deeply affecting his interests will have to receive their settlement—than it has met with for many years past. The treatment to which he has in more than one recent instance been subjected, has at length arrested the attention of those who can render powerful assistance in a matter in which this Journal has ever been willing to do earnest battle; and the feeling which has long been our own is spreading amongst those who have another voice and audience than ours for its utterance—that it is high time the artists of England should have some clear and distinct understanding of the relations in which they stand to the public works of the country. The manner in which questions of competition for the execution of such works have occasionally been solved of late, by those who represent the Government action in this matter—and a part of whose office as such representatives it is to assist by the means at their disposal in fostering a native school of Art—has startled many into a remorseful recollection of the fine creations of the chisel which year by year have illustrated that school, and given it a place second to none in Europe. Forms of power and shapes of beauty rise up in men's memories, to rebuke the official neglect which passes them carelessly by, the official insolence which waves them superciliously away, or the official obliquity which sees only the Art that comes to it from abroad. The too frequent use of the foreign tongue in our Art dedications is reviving the passion for the rich, sweet language of our English Academe. A sense at once of national wrong and of national waste is stirring in the public mind; and we are glad to know, that some who can question with effect are prepared to question, when the proper time shall come, the ministerial doctrine which holds it part of the official privilege to deal with the artist according to the minister's own good pleasure, and regards the national monuments as pieces of private patronage, to be dispensed at his caprice.

The Scutari job has not been without its redeeming incidents. While it has disgraced our Arts—which it affects to represent—abroad, and wronged our artists—whom it affects to ignore—at home, it has brought the feeling of national injustice and national oversight which we have been describing to a point of sensitiveness that must find vent in determined

expression when the House next meets. This is the compensating law of extremes:—a great evil often generates a great good. In morals, as in physics, out of corruption we get wholesome life. The Scutari job was so monstrous, that it startled even the parliamentary conscience, familiarised with monsters as that conscience is. For ourselves, we have been unable up to this hour, and with all the aid that we have sought, to penetrate the mystery by which that job has been surrounded; and when the large proportions of the job are considered, our readers will see that more than common pains must have been taken to make the cloud thick enough for its effectual concealment. The monument did, however, grow up to its full estate in the dark:—and may, by the by, owe a portion of its deformities to that unwholesome condition. No hint that such a creation was in progress did the public receive, by any of its organs, till the work had been shipped away, to proclaim to the East, in its inflated language, that we have no sculptors of our own in England,—and that same public was requested, in an off-hand manner, to pay for the proclamation. The sum of £17,500 was coolly demanded for a declaration of British Art-incompetency:—embodied in Art-phraseology, the adoption of which by Englishmen operates as a further proclamation to Europe, at their own expense, of their utter want of taste. In the days of Charles I., when our country looked abroad for its Art, it did take care that the Art should at least justify the importation. But the whole of this Scutari monument affair is extremely curious. When the monster job was first produced in Parliament, a feeling of surprise—judging by our own sensations, we should be inclined to say panic—seems to have paralysed the Houses. A random shot or two was, it is true, aimed at it in each House; but, under the influence of these feelings, feebly and with no effect. In the Lower House, Lord Palmerston saw his advantage, and fired a great gun. The monument, he said, "was of extreme beauty:"—and Mr. Bowyer at once went down before the shot. The honourable gentleman has, however, we are happy to say, recovered,—and we expect him in the field for our native sculptors next session. In the Upper House, the tactics of Lord Pamure were, as our readers know, equally bold and still more remarkable. When the Earl of Harrington charged with the British sculptors, the war secretary declined to meet them in full front, but by a dashing manœuvre he turned their position. To quit the metaphor, he gave the House to understand—and we are informed, without the slightest trepidation of voice or hesitation of manner—that, in matters of the kind, it was useless to apply to "the sculptors and artists of this country," as it was well known that these gentlemen could not be induced to compete for the public works! Of course, we reckon on the House having received with considerable scepticism the circumstance thus offered by Lord Pamure as the spring of the foreign movement:—of the astonishment of the sculptors themselves at the statement we know something. It was the first intimation to them of the fact of their having as a body "struck" against the Government. They are, we believe, anxious to have it understood that this is not so; and we venture to state, on their behalf, that they hold themselves free to emend, on any fair and open scheme, to the lucrative commissions which the country has to offer.

We have spoken of the monster proportions of the Scutari job,—and the question of mere *dimension*, our readers will think, is tolerably well expressed by the figure of £17,500 as the price paid for a column. But the question of *proportion*, as regards scale, is best illustrated by an example; and that example will, at the

same time, serve as an illustration of the estimation in which a Government, that can be so lavish in matters of Art when it pleases, holds the native sculptor. After the exhibitions of British talent held in Westminster Hall, twelve years ago, the question of decoration of the new Houses of Parliament came, as our readers know, under the notice of the Royal Commissioners of the Fine Arts; and, as the first sculpture fruit of their deliberations, it was determined to commission English sculptors to execute twelve statues of England's worthies for St. Stephen's Hall. For the first two of these commissions given out, the sum paid was £1200 apiece; but then, the Commissioners began to feel that, as they were dealing only with their own countrymen, the estimate was too liberal,—and the price to be paid for the remaining works was reduced to £1000 each. For *twelve* statues, then, by English sculptors, chosen as the result of a general competition, before the Pamure strike had set in—statues designed at once for the artistic and the historic illustration of our great national palace,—the price paid was £12,400. For the *one* Scutari Monument, got up no one knows how, and given to a foreign sculptor no one can tell us why, the remuneration—demanded from Parliament without explanation, and granted with scarcely an inquiry—is, we repeat, £17,500. About half as much again for the single work sent abroad to announce to the nations the death of native sculpture in England, as for the sum of all the twelve set up in St. Stephen's Hall, to prove to our children's children how vigorous and life-like at that very time our native sculpture was!

Our readers know, that, amongst other national works of the kind on which the Government action will have ere long to be exercised, the scheme of the long-deferred Wellington Monument has expanded, in their hands, into such proportions as make it of the utmost importance that the commission shall keep free of all taint, and the resulting work soar above all cavil. Into the particular circumstances of the case we shall have more specifically to enter later in this article; but we desire here to urge, that the matter involved is quite as important to the public as it is to the artist himself. The great sculpture prizes in this country are comparatively few—painfully few, when we remember what great sculptors there are amongst us; and when such prizes do occur, to take the children's Art-bread and give it to the stranger, is at once unnatural, uneconomical, and unpatriotic. Other governments so understand the case,—and sustain their national monuments by the national art, and the national art by means of their national monuments. The opposite course could be justified anywhere only by a deficiency at home of the art, or a superfluity of the monuments:—with us the art is great, and the opportunities are few. No such sculpture prize as this of the Wellington Monument has England had to give for many years past; and her own sons have surely a right at once to the material henceforth involved, and to that more spiritual reward which the great artist derives from his connexion with a great national work. So much for the sculptor:—now for the public. Where the people have so large a sum to bestow on Art—for this sum is the people's,—they have a right to expect that it shall go to feed the arts of their own country, in which they have a deep interest. It is not the same thing to any nation whether its monuments be the work of its sons or the work of the stranger, so the art be equal. In the last case, a nation has in its monuments the incident of beauty and the means of instruction; in the first case, it adds to these the pride of production. Art is universal, no doubt:—but it is a part of the greatness of an individual nation to build her

a native home; and in order to do this she must encourage the native builders. Is Rome illustrations for the works of Art which she accumulated, in the same sense that the Greek cities are which produced them? Besides, there is an idiosyncrasy in nations, which renders it questionable whether it be possible for any other than the national genius ever to give a true and adequate expression of the national hero to the national heart. The foreign phrase is almost sure to detract something from the full English feeling of the sculpture-song of triumph. In subjects which may be treated more or less as abstractions or generalizations, this will be felt in greater or less degree; but a monument to Wellington—like a monument to Nelson, or one to the first Napoleon—is, amid all the largeness of its theme and of its scope, a work emphatically and intensely individual and national.—For these reasons it is, and because we know, as we have said, that there are those members who are prepared to maintain in Parliament the views which they involve,—that we think it well, in the meantime, before either the decision shall be taken in the matter, or the discussion shall arise, to lay down, for consideration, some of the principles which seem to us essential to be kept in view, if we would arrive at a result in which the public mind shall fully acquiesce, and which shall leave to the sculptor no reasonable ground of complaint.

There are three several modes in which commissions for the national monuments may be dealt with by those having the responsibility of their distribution. The first is, that which selects arbitrarily one tried and well-known talent for the execution of an important work of Art. In this course, the government commissioning rests its responsibility on an established reputation, which is a credential won by repeated successes and bestowed by competent authority. The minister has the guarantee of the artist's previous performances, and of the professional character which he has personally to invest. Nevertheless, it must be observed, that, subject to these securities, the particular work in hand is thus committed to the mercy of a single accident,—and, to make the guarantee complete, it would be necessary to assume that a rich mental soil will yield an equal harvest on all occasions. The other reasons which have been urged in objection to this course are:—that it is one which leads itself to jobbery in its abuse, and which, even in its honest use, tends to create a monopoly of Art-employment in a few hands. Another—and just the opposite—course which may be adopted, is, that which received its first public recognition in the well-remembered government competitions in Westminster Hall; and which, summoning the universal body of English artists to an unrestricted competition, had the beneficial effect of bringing a mass of talent out of greater or less obscurity into the strong light of day, and helping to strike a balance which the accident of patronage tends constantly to disturb. To this course, however, besides that for ordinary purposes and individual works of Art, it is unwieldy and impracticable, there are objections of a very serious kind. Seeing that the commission can go finally to only one sculptor, as the prize of the labour and the thought that produced the model, it is no light matter to multiply that labour and that thought by scores, and to have nothing but the disappointment to offer in return for the great sum of the exertion that the summons has called into play. In the case of fifty candidates, for instance, exactly fifty times the work is done that is intended to be paid for; and the lost time and anxieties of forty-nine artists go to enhance the triumph of one. The amount of aspiration recklessly invoked and wasted, is a thing to grieve over, where that aspiration was in itself wholesome, as

founded on a real and sufficient power;—and yet more so, where it was not. The announcement of a general competition brings into the field,—on some vague dreamy hope of they scarcely know what—young and inexperienced artists, who lavish their fancy—irrespective of means, and unconscious of the grand epic simplicity of sculpture—on models which, should they unhappily attract the prize, the sculptor tyros would be wholly unable to carry out on the scale demanded. These are some of the evils which render general competition a scheme to be avoided, save in a case, and with an object, so exceptional as those of the Westminster Hall exhibitions. The third course which may be followed in the commissioning of the public monuments, is one which combines the advantages of the other two. It adds to the principle of selection the principle of competition;—makes known enunciate the general qualification in a joint appeal, more or less extended,—and leaves the particular qualification to be won out of this by competing models from the individuals answering to such appeal. This last method—of limited competition—from its reconciling qualities, has become the favourite practice of our time wherever the commissioning of works of Art is a trusteeship; and was, for example, all but universally adopted in reference to those monuments which arose all over the country after the death of Sir Robert Peel. All the objections incident to general competition are eliminated by the fact and the manner of the limitation. For instance,—the reduction of the competitors to a given few, enables the commissioning body to assign to all others than the prize model a sum sufficient to pay the mere labour and expenses of the unsuccessful artists, on a scale adjusted to their rank;—and this is a course that we should desire to see always followed in the case of the Government commissions, and in all others in which the funds are sufficient for the purpose.

But, in order that the principle of competition, whether general or restricted, may have any wholesome operation at all, it is absolutely essential that all the incidents and conditions of the competition shall be stringently observed. There can be no deviation after the fact from its prescriptions without a violation of its constitution. The principle of the thing, it has been well observed, is so delicate, that it can flourish only in an atmosphere of perfect conscientiousness. The conditions on which a competition was originally summoned make the law of its being, are binding on all the parties concerned, and cannot be ignored or altered, in whole or in part, by any one, without the consent of all. The terms of such a challenge are, within its wider scope, as precise and obligatory as is a direct engagement with a single sculptor. With each one of the sculptors so brought into competition, the government, supposing it to be the summoning party, has made a conditional contract, as it has made an absolute one with the body of the whole;—and the interest of each can be defeated only under the conditions which he has himself accepted. The subject is most important. Whatever is most wholesome in the principle of competition becomes most mischievous by the perversion of its laws; the right at which it aims is readily convertible into a wrong. For instance, any personal leaning, on the part of the judges, towards some one of the artists engaged in a competition, is an unconscious acting on the narrower principle under the false pretence of the larger one. In a word, the principle of limited competition, skilfully applied and conscientiously worked, seems to combine all the best securities and conditions for obtaining the best work that can be had on any given occasion; but evasions of many kinds have been practised under it, that defeat the very ends for which it was devised, and are gradually

rendering it unpopular with the profession. Some of these forms of evasion it will be convenient to point out,—drawing only from real instances within our own knowledge,—in order that we may do what in us lies to bring this instrument into good working order by the time when it will be needed for the Wellington models.

In the first place, then, our readers are aware, that this very Wellington Monument itself has been already the subject of a wrong such as we desire to denounce. They know the circumstances under which the late Sir William Molesworth invited to a competition for this work four eminent sculptors,—Mr. Baily, Mr. Gibson, Mr. Foley, and the Baron Marochetti;—and each of these sculptors was carefully informed, as one of the elements of the competition, who were the other sculptors against whom it was intended that he should have to compete. Mr. Gibson, who resides abroad, and the Baron Marochetti, who seems to have preferred relying on his private influence, declined the competition,—and the contest, consequently, lay, of course, between our two eminent English artists, Mr. Baily and Mr. Foley. Both these gentlemen sent in models for the work,—of neither of which, however, did Sir William Molesworth approve; and the artists, then, following the course usual on such occasions, offered to make such modifications as might suit the minister's views, or to supply fresh models. Sir William, however, intimated, that it was not intended to proceed further in the matter;—and a rumour got abroad, that it was designed to give the commission quietly to the Baron Marochetti,—one of the recusants in the proposed competition! The rumour may or may not have been well-founded,—though, what has transpired in the matter of the Sentari Monument gives it every appearance of probability. Mr. Baily, however,—who is at the head of the profession in this country, and whose works are, after those of his great master, Flaxman, the highest illustrations of the English school,—undertook, on behalf of the body of British sculptors, to vindicate the principles assailed; and a correspondence took place between him and Sir William Molesworth, and afterwards with Sir Benjamin Hall, which, if it failed to obtain the justice sought, in all probability prevented the job intended. The principle which Mr. Baily laid down was this,—and to any but official organs it will probably seem clear enough. When a sculptor is invited to furnish competing designs for a national monument, and, as one of the conditions of his competition, is informed of the names of those against whom alone he is assured that he will have to contend,—he naturally concludes, that the statement which represents the extent of the chances against him, represents also their limitation,—and that somewhere within the area of selection so reserved by the government to itself, the commission must fall as a matter of contract. It is, thus, with a full knowledge, as he believes, of the risks and the prospects offered to him, that the artist enters on this species of conditional engagement in case it suits his views. "For myself, I avow," said Mr. Baily,—“and I suppose that the avowal represents the feeling, on the same subject, of my brother artists,—that I would not enter into any competition in which it was understood that the authority summoning it retained within his own breast any right or condition not apparent on the face of the challenge which invited me. That is not competition, in any reasonable sense of the word, for which it may ultimately be declared that there was no prize.” On his own position and Mr. Foley's in the competition, with reference both to the models supplied and to the offer of each to make fresh ones, Mr. Baily reasoned to the following

effect. When a commission of this kind is given directly and at once to a *single* sculptor, the party giving it either takes his chance of what the sculptor will send him, good or bad,—or, as is more reasonable to suppose, he expects that sketches for the work shall be submitted to him before they are carried out; and though the commission itself is held to be absolute, the design made under it is to be approved ere it becomes the national monument. A commission to four takes exactly the place of this commission to one. Here, too, the engagement is absolute,—not with one sculptor in the first instance, but with that one of a given number of sculptors whose designs shall be most nearly to the taste of his judges. But, as in the case of the single sculptor, the sketches of the sculptor so coming out first of many, have to be shaped and modified according to such suggestions as may offer, until they meet the final approval of the parties responsible to the country for procuring a satisfactory work of Art. These repetitions and modifications are precisely what the two sculptors had offered to make. "The original call to compete," said Mr. Baily, "was a commission given amongst four artists:—its individual incidence to be determined amongst themselves in the way prescribed by the call. The field of the commission was subsequently narrowed to two sculptors, by the failure of the other two to compete. To give away the commission now to any other than the sculptors invited and accepting,—above all, to either of the two sculptors who declined the invitation,—would be a wrong of many kinds to those who did accept and work under it, and on its faith. The door of this competition, opened not by me, cannot be shut without my consent." Whatever may have been the intentions of Sir William Molesworth as regards some other sculptor at the time when this correspondence commenced, it failed, as we have said, to procure the justice demanded for the sculptors concerned. But Sir William Molesworth, by what seems to have been an after-thought,—at any rate, the offer was not made at first,—requested the two competing sculptors to name such sum as they thought severally would be a fair remuneration for the labour and cost which they had incurred in the matter. This, Mr. Baily, for himself, refused to do;—and Sir William Molesworth then awarded to each of the two competing artists a sum of £150. This money, Mr. Baily, seeing that he could obtain nothing more near his claim, received under protest;—a protest which he has since repeated more than once to Sir Benjamin Hall. "I deny," he says, "the authority of Sir William Molesworth, or any one else, to commute my right under the argument for £150, or any other sum,—or to convert the right into anything else than the right itself. I refused then—and I now again refuse—to consider the money as a satisfaction of my claim. If I am compelled to put up with it, as all I have been able to get from Sir William Molesworth or yourself, to represent my right, the right nevertheless remains—in the character of a wrong."—For some time after this correspondence closed, no further step was taken in the matter of the Wellington Monument,—and what was next heard of it involved such an enlargement of the scheme as at once changed the conditions of the work. The sum proposed to be devoted to the work for which Mr. Baily and Mr. Foley were competitors was £5000; but it now appeared that the money voted by parliament for the funeral honours to the great Duke had left a residue of some £25,000,—and the whole of this sum it was considered might appropriately go to the crowning and abiding honour of the monument,—thus commanding a work on a great scale, suited to the large proportions of the subject, and reflecting credit

on a country not over-rich in high-class monumental illustration. By its passage into this new phase an easy and natural solution of the matter in dispute was attained. The principle of right had been resolutely asserted on behalf of the body of British sculptors,—and the menaced or suspected wrong had not been committed by the Government. The models which the two sculptors had prepared were, of course, in any view of the case, insufficient for the extended scale of the commission,—and the right to £5000 was not necessarily a right to £25,000. Something of a right there, doubtless, still remains,—but it is not easy to define it in the new scheme. Practically, all that the two competitors in the lesser project can well now demand is, that they shall be the first artists invited into the enlarged competition which we assume will be summoned for the execution of the great Wellington Monument.

It is curious to observe, how surely this laxity of practice in the matter of Art-competitions, as in other things, has descended from headquarters to the subaltern stations of power and responsibility,—how faithfully corporations and committees, in their several degrees, reflect the haltings and obliquities of the Government whenever they have to imitate its action. Apart from the duty of consistency for its own sake, governments might learn to feel more strongly their responsibility for every step which they take if they only noticed how all the moral time-keepers of our provincial towns set their watches by the great clock in Downing Street. It is not very long since circumstances took place in the good town of Leeds—in the matter, too, of one of these very Wellington monuments—which, but for their precedence in point of date, might be looked on as a parody of the London competition affair,—and which, as the matter stands, reflect the unsound principles in the management of such affairs that have been extracted from the practices of the highest authority. But, as generally happens in cases of second-hand action, the thing was awkwardly done at Leeds. They cannot perform their jobbing in the provinces with the grace of the metropolis,—where a job is enacted after "the high Roman fashion." In London, a minister answers a remonstrating artist with an air and tone indicating a sort of surprise that an artist should expect a reason at all;—in Leeds, they *did* reason on their wrong,—and this was a blunder where the case was not reasonable. A London secretary of state would refuse, along with a certain authority whom our readers will recall, to give a reason if "reasons were as plentiful as blackberries;"—a Leeds committee-man volunteers reasons where he has no reason to give. The facts were these. The men of Leeds resolved to have their statue of the great Duke,—and placed, as is usual, the management of the fund collected for the purpose in the hands of a committee. This committee proceeded to summon five eminent sculptors into the field of competition,—and a certain number of these sculptors responded to the call. So far, the action of the committee was according to the precedents,—but at this point they struck out a novelty of their own. The contract was after the manner of such contracts elsewhere, and gave, of course, to each of the sculptors invited, and having accepted, a conditional right:—the form of renunciation of that right was original and peculiar. The committee simply affected to overlook, as things of no significance, its own summons and the high Art then working under it,—and quite coolly announced to the distinguished artists concerned, that it had changed its plan of operations, abandoned the scheme of competition, and given away the work for which they were then competing to a certain one of the invited competitors. This was highly magisterial,—and so far, a very good imitation of minis-

terial irresponsibility;—but no minister, as we have hinted, would have done what follows. A contemporary remonstrated,—and the committee, by its mouthpiece, had the weakness to explain. The explanation, in default of being satisfactory, is extremely curious:—but we doubt if we can make it intelligible to our readers. We know, that the sculptors to whom it was addressed have never understood it to this day. It was, however, to this effect,—and is worth giving as a specimen of logic in difficulties. It appears, that two out of the five sculptors invited to compete had declined the invitation,—and thereupon, says the Aristotle of Leeds, the competition was *ipso facto* at an end, notwithstanding the acceptance of the other three. If this were a conditional contract, says the mouthpiece of the committee, the committee had as much right to demand the performance of the conditions as the artists had. Now the conditions, he goes on to say, are these. "If A. B. C. D. and E. consent to compete, the work shall be open to their competition; but A. and B. having declined, the condition was broken, and the contract, if it ever existed, void." So much for a Leeds "argal!" We confess, we have more than once tried ourselves with this argument as an intellectual exercise,—but have always found ourselves entangled, and glad to escape from its meshes. Take this as an example of the difficulties with which we find ourselves contending. A. B. C. D. and E. are, for the purposes of the argument, raised into a corporation, without their knowledge, (for, it need scarcely be observed, that the application to each several artist took no such form, and hinted at no such condition,)—so that, the refusal of two is a refusal not for themselves alone, but also for the other three, although the other three have for themselves accepted! Well, but then, by the same method of reasoning—and *a fortiori*, because here we have the majority,—why should not the acceptance of the three bind all the five, notwithstanding the refusal of two,—so that, the recusant two might be compelled, against their will, to work on models for the Leeds committee!—Our readers will see, that we cannot deal seriously with the argument put forward on behalf of these Yorkshire gentlemen; but we have adduced the instance as showing the sort of reasoning to which they who reason on the matter at all are obliged sometimes to resort, in the attempt to justify their unceremonious dealing with some of the names most dear to the Arts of the country.

While the instances which we have given are instances severally of a great injustice committed as between the two contracting parties,—there are, besides, various forms of an injury, consciously or unconsciously, done, or attempted to be done, by some advantage, of one kind or another, given to some one or more of the competitors over the rest, after the competition has begun.—Of these forms of injury we will refer to two, as instanced in cases known to ourselves; and these two may stand for the rest,—because the principle in all is the same. In matters of competition, it is quite clear that the terms must be precise and final, in order that they may be equal for all,—and that men who are working under inequalities of condition are not *competing* in the strict and logical sense of the word. If a subsequent alteration of the original terms be made—whether as regards time, for instance, or any other element of the competition—in favour of any one or more of the competitors, of which the whole had not the benefit, it is obvious that this equality of condition is disturbed. Take time, for instance; and, as we have hinted, we have a case before us in which an extension of that element was sought to be allowed by the committee having charge of the competition, even after certain of the com-

peting models were finished, and had actually been sent in! The wrong here seems very glaring;—yet the proposal was made only in thoughtlessness, without the least intention to do a wrong, and was at once abandoned when it was perceived in what way it would operate as a wrong. First, the artists who completed their work within the time prescribed had probably, for that object, to lay aside other arrangements, and the profit attending on them, (and with two of the competitors we ourselves know that this was, in fact, the case,)—which arrangements they might well have reconciled with the work of the competition, if they might have had the extra time now demanded for some other of the competitors. That these other competitors needed the extra time, was simply because they did not put aside their other arrangements, to enable them to comply with the terms which they had accepted. If the time were sufficient for one, it must be supposed to be sufficient for the rest:—if more time were needed, it should have been demanded, and given, at first, and for all. To enlarge, afterwards, the time prescribed to all in favour of a few, is to give to the procrastinating sculptor an advantage out of his own neglect,—and put the sculptor who wrought in conformity with his instructions at a disadvantage precisely because he did comply with them.—But this is not all. It is a well understood principle in competitions of the kind, that it is an injustice to give to any competitor the opportunity of working on his designs after the designs of another have gone from his studio,—or even after they have been completed in his studio, unless he has, for his own convenience and at his own risk, completed them earlier than the time fixed. A competitor so unfairly working, has obviously a chance given to him of embodying hints not originally his own, and drawing the prize of thought which was due to another. It is not a sufficient answer to this, to say, that in the latter case the sculptor can guard his own studio,—and as regards the former, that no one but the judges will see the works. To a certain extent this is doubtless true:—but in either case, the early designer is at the mercy of accidents.

Another form in which an allowed departure from the prescribed conditions of an Art-competition has wrought injustice more than once, may be illustrated by the second of the two instances to which we referred above. In, we think, the year 1843, the council of the Art-Union of London offered the sum of £100 for an original bas-relief in plaster, on certain specified conditions. One of these conditions, we believe, actually prescribed the very *measure* of the in-hist,—but, at any rate, the work was to be a bas-relief. Twenty-five competing works were sent in; and the prize was adjudged to a work of great merit, very well deserving of a prize. To the particular prize which it obtained, however, it had no title whatever;—not being a bas-relief at all, but a work of very high *rilievo*. A bas-relief could, of course, have no chance against it for effect; and consequently, the other competitors, who doubtless would have wrought also under the bolder conditions had they not supposed them inadmissible, are wronged for their compliance with the terms imposed on them, in favour of the artist who defied the terms. A prize is here offered for one thing, and given for another! The prescribed in-hist was a positive law of the competition,—and the prize is given to him who broke that law! The terms laid down, are so laid with the direct purpose of ensuring uniformity of qualification,—and he is crowned who disturbs the uniformity by the introduction of a new qualification, in his own favour! A certain number of artists are set down to the game of Art-competition, with rules made expressly for securing fair play,—and he is

allowed to win who plays avowedly with loaded dice! By the law to which the losing artists conformed, the character of the work to which the prize was given did, in effect, exclude it from the competition. Not to compete on the terms laid down as constituting the competition, is really not to be a competitor,—and so, the winner of this prize won it without competing! The prize was given away *outside* the competition, as tested by the advertisement of the council themselves.—Now, all these forms of laxity in the handling of the instrument of competition make that instrument operate simply as a snare. Once more, we say, all must be clear, precise, open, fair, and equal in its use, if it is to have a beneficial action in helping the public to great monumental works.

There is one circumstance which is too commonly overlooked in the commissioning of the national monuments,—and which, yet, in the case of any monument is of great importance to the law of its completeness:—we mean, the assignment of the site which it is to occupy. No great work of sculpture can fulfil all the conditions of its being which has not a premeditated reference to the accidents amid which it is to stand. The Athenian sculptor, who finally missed no one quality that was essential to the perfection of his art, gave full effect to the architectonic principle in sculpture. Both the grouping and the character of a great monument will be to some extent determined or modified by the nature of its surroundings. The painter makes his own background, and fits it to his incidents,—the sculptor has his background given to him, and should have the opportunity of adapting his incidents to that. A great work of sculpture falsely placed, is like a great thought injured by some flaw in the grammar which expresses it. A grand monumental group composing badly with the objects about it, is like a choral harmony hurt by a discord. Every commission for a national monument should be accompanied with a communication of the place in which it is to stand,—and independently of the intrinsic merit of the work itself, an element of the competition should be its fitness for its place. With regard to the Wellington Monument, the scale on which it will now have to be executed, should Sir Benjamin Hall's proposal for the appropriation of so large a sum of money to its execution be carried out, renders it probable that it will have a location somewhere in the open air:—in which case, in this foggy land of ours, it will have to be cast in bronze. Under these conditions, the fit site for such a monument seems almost to proclaim itself. The large area at the back of the Horse Guards, over which the warrior Duke presided so long, and from whence the moral of his presence will never depart—in this generation at least,—expressly offers itself for the monument in question. This space *seems* a monument,—and the monument in question will want just such a space. There is room here for the great scale to be uninjured by the too close interruption of surrounding objects; and the fine natural and architectonic features which would group at this spot with his sculpture masses, are amongst the things which the artist will have to consider when he designs this great national work.

But, when all these requisites towards a fair trial of the strength of the country, for this important national monument, shall have been secured, there is one essential yet to be demanded, without which all the rest are thrown away:—and that is, a competent tribunal. If there be really any one thing, beyond the irregularities of its application, which discredits the doctrine of Art-competition amongst us, it is the knowledge on the part of the artist of the sort of judges to whom, in too many cases, his pretensions have to be submitted. That the

duty of selection should imply some knowledge of the qualities to be selected, reads like a truism when we write it down,—but is very commonly rejected as if it were a fallacy in practice. The utmost purity of intention cannot secure justice to the artist on the part of a court which is ignorant where the justice lies. In the hands of incompetent judges, there is little doubt that the tendency of competition can only be to lower the standard of sculpture,—by occasionally giving to mediocrity the sanction of the excellence over which it appears to have triumphed, and inaugurating the bad in Art with the solemnities due only to the good. An uninstrusted Art-tribunal, with the best purposes, has errors of many kinds lying in wait for it. Even where it might chance to judge well of the relative values of the works submitted, it has no means of judging of their relative practicality. With such judges as have at times assumed to themselves the decision of Art competitions, the showy and complex will be too apt to prevail over that clear and simple, yet elevated, sculpture utterance which is the high poetry and consummation of the art:—but the mischief does not end there. Models are too often sent in to sculpture competitions which the clever modellers could not themselves carry out on the large scale at any price, and which no sculptor whatever could execute at anything like the price offered. Of all this, in most instances, the unprofessional judge knows little or nothing. It is not for us to suggest the constitution of a tribunal which should command the confidence at once of the public and of the profession:—save, that we may say, it should contain enough of the professional element to ensure the necessary knowledge, and not enough to leave professional prejudices or jealousies without the needful counteraction. We would recommend, too,—as has been recommended in the memorial which a large and leading body of British sculptors recently addressed to Sir Benjamin Hall, and which has been published in this Journal,—that in all cases of government competition, “a public exhibition of the models of all competitors should precede the selection of any one of them.” It is highly desirable, in all contests for the public monuments, both for their own sakes and for the sake of the final work, to have the opinions of the people—subject to such correction by competent authority as we have described. Such an appeal before the result would tend to give satisfaction to the public and authority to the selection. In the atmosphere of so large a supervision, the job could scarcely flourish. The judges would thus, as it were, be giving judgment in open court,—instead of sitting, as is too generally the case, with closed doors. The Government itself ought to be desirous of dividing its responsibility in the matter of the public works of Fine Art, and securing as much of the public consent as it can. The time has gone by when it can affect to look on the Arts of the country as the affair of coteries. The coterie is opposed to the spirit of the age. The people are fast learning Art; and as the public monuments are amongst the books of instruction from which they have to read, the Government should adopt all the means by which it can have its editing most perfectly and most conscientiously performed.—We believe, that the observance of the views which we have in this article sketched out, in all cases of sculpture competition, would, as we have said, leave the competing sculptor without any ground of complaint,—or, at least, without that public sympathy in respect of his complaints which now gives to them most of their significance and force.*

* Since this article was written, Government has invited the competition of artists for the monument we have elsewhere referred to in the proposals.

BRITISH ARTISTS:
THEIR STYLE AND CHARACTER.

WITH ENGRAVED ILLUSTRATIONS.

No. XIX.—J. M. W. TURNER, R.A.

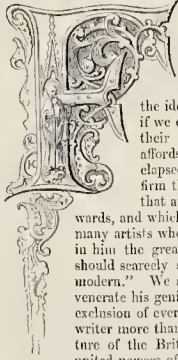

EW, if any, painters, whether ancient or modern, have caused so much discussion among Art-critics as Turner: while some have extolled him as the greatest landscape-painter the world has seen, others regard him as little better than an artistic madman: he has been the jest of one party—the idol of another; nor is this much to be wondered at, if we call to mind the peculiarity of his works as well as their originality, for the whole range of Art-history affords nothing analogous to them. Each year that has elapsed since his death, in 1851, has only served to confirm the opinion we expressed in the biographical notice that appeared in the *Art-Journal* a month or two afterwards, and which we now repeat:—"It is no disparagement to the many artists whom he has left behind, to affirm that we have lost in him the greatest landscape-painter of the English school; we should scarcely say too much if we add, of any other—ancient or modern." We are quite willing to cast in our lot with those who venerate his genius, though by no means, as some do, to the entire exclusion of every other artist. It was truly said by an anonymous writer more than twenty years ago, that "the glorious superstructure of the British School of Landscape, in part erected by the united powers of Wilson and Gainsborough, has now in our times

received its final acme of excellence, its triumph of beauty and grandeur, from the genius of Turner."

Had Mr. Ruskin, in his ardent and enthusiastic admiration of the works of this painter, showed a more just appreciation of the talents of his contempo-

raries, we believe that Turner would have been a considerable gainer; but the indiscriminate laudation of his idol, at the expense of, and in comparison with others, created, there is little doubt, a wide-spread feeling of opposition to the opinions and sentiments of the author of "Modern Painters," and through him to the subject of his eulogy: an injudicious friend often inflicts more injury on the cause he advocates than its avowed opponents.

Our opinion of the works of Turner, and the estimate we have formed of his genius, have been already recorded; it is unnecessary to travel over the same ground again; we shall only refer to our previous notice for a few facts which require to be stated in this place, and then fill up the pages at our disposal with such remarks of our own, and of other writers, as they occur to us, and are suited to our purpose.

Turner was born in 1775, in Maiden Lane, Covent Garden, where his father carried on business as a hair-dresser; he had, however, sufficient discrimination to allow his son to follow the pursuit to which he was most inclined. How and where his earliest studies in Art were carried on we have no precise information; we only know that he was largely indebted to Dr. Munro, who possessed an extensive collection of water-colour drawings, for permitting him to copy them under his own immediate direction and advice. The doctor's collection was rich in the works of Paul Sandby, Rooker, Cozens, Hearne, and others whose names are now almost lost to the public, and in sketches by Gainsborough. Turner and Girtin, as well as the late John Varley, Francia, Edredge, &c., were among the disciples of the Munro school, as it was called, and "occasionally copied and studied from the same prototypes. From the elaborate and tasteful delineations of Hearne and Rooker they acquired the rudiments of a just and accurate insight into the properties of topographical design; and from the drawings of Cozens a practical knowledge of breadth and simplicity, united with the charms of aerial perspective." To Turner and Girtin, between whom an honourable rivalry existed—for both seemed equally gifted with genius and perception, and alike endowed with executive powers—are we chiefly indebted for the high position which our school of water-colour painters has reached. Girtin unfortunately died at the comparatively early age of twenty-seven, in 1802; had he lived to the years of his fellow-student, there is little doubt he would have achieved a reputation second only to that of Turner—for their merits were so equally balanced, and the drawings of one bore so



Engraving by

THE GUARD-SHIP AT THE NORE.

[J. and G. P. Nichols.]

close a resemblance to those of the other, that no one who has not very carefully studied the works of both would be able to distinguish between them. We are speaking of those executed when the artists were fellow-pupils, or soon after that time, for Girtin in his latter years lunched out into a more free and a bolder style than Turner did at the same period; while the drawings of Turner during the last thirty or forty years of his life are as unlike his own earlier productions as they are to those of any other painter:—latterly

"None but himself could be his parallel."*

* After the above paragraph was written, we incidentally met with the following passage in Mr. Ruskin's last volume of "Modern Painters;" it occurs under the chapter

Turner entered the schools of the Royal Academy in 1789, and in the following year he sent his first picture, a drawing in water-colours, to the

headed "Of the teachers of Turner."—"What help Turner received from this or that companion of his youth is of no importance to any one now. Of course every great man is always being helped by everybody, for his gift is to get good out of all things and all persons; and also there were two men associated with him in early study, who showed high promise in the same field, Cousen and Girtin (especially the former), and there is no saying what these men might have done had they lived; there might, perhaps, have been a struggle between one or other of them and Turner, as between Giorgione and Titian. But they lived not, and Turner is the only great man whom the school has yet produced." Mr. Ruskin here falls in with our own opinion, only he gives to Cozens—not Cousen, as he calls him—the position with regard to Turner that Girtin should have.

Exhibition—the subject a view on the Thames, taken from the banks of the river, nearly opposite the episcopal palace at Lambeth; three years afterwards he exhibited his first painting in oil. Two pictures he exhibited in 1800 attracted great attention, the "Falls of the Clyde," and the "Teuth Plague of Egypt"—subjects very dissimilar in character, yet both distinguished by masterly treatment. To show how varied were the subjects painted by him in the early part of his career, we would instance a picture which many years ago was in the collection of Lord de Tabley; it represented a blacksmith's shop, in which was a butcher, who appeared to be disputing with the owner of the forge his charge for shoeing a pony; all the implements used by the smith were introduced with remarkable truth and firmness of painting, while in the foreground of the picture were groups of poultry, finished almost as highly as if they had come from the pencil of Hondelcoeter, or Jan Fyt.

The early pictures of Turner have so rarely passed under our own observation, that there are but few—and with those the public generally are almost as well acquainted as ourselves—on which we ought to venture an opinion. Mr. John Burnet, who perhaps knows them better than any other individual, and certainly is as well able to offer a critical remark upon them as any one else with whom we are acquainted, has recorded the following observations upon their peculiar features:—"The early compositions of Turner are of a simpler character, and contain fewer parts than his later works; this not only arises from his being engaged on representations of extensive scenery, such as the

embellishment of engraved subjects demanded—where a multitude of objects was required to be given in a small space—but also from his changing his conduct of light and shade from a breadth of shadow to a breadth of light, which gradually expanded to almost a want of solidity in his last paintings; this was also the reason for adopting a more brilliant style of colour—for objects to be rendered sufficiently distinct, without cutting up the breadth of light, could only be produced by the contact of hot and cold colours. In these pictures he more resembles Wilson and Claude than in his later pictures, both on account of largeness of forms and his breadth of shadow."

Speaking in the chapter to which reference has been made in the preceding foot-note, of the Art-education of Turner, between whom and Walter Scott Mr. Ruskin presumes a kind of mental relationship to exist, he thus writes:—"Turner, from the beginning, was led into constrained and unnatural error; diligently debarred from every ordinary help to success. The one thing which the Academy ought to have taught him (namely, the simple and safe use of oil-colour), it never taught him; but it carefully repressed his perceptions of truth, his capacities of invention, and his tendencies of choice. For him it was impossible to do right but in a spirit of defiance; and the first condition of his progress in learning was the power to forget. . . . Turner acquired his knowledge of architecture at the desk, from academical elevations of the Parthenon and St. Paul's, and spent a large portion of his early years in taking views of gentlemen's seats, temples of the Muses, and other productions of



Engraved by]

VENICE: THE GRAND CANAL.

[J. and G. P. Nicholls.

modern taste and imagination; being at the same time directed exclusively to classical sources for all information as to the proper subjects of Art. Hence while Scott was at once directed to the history of his native land, and to the Gothic fields of imagination, and his mind was fed in a consistent, natural, and felicitous way from his youth up, poor Turner for a long time knew no inspiration but that of Twickenham, no sublimity but that of Virginia Water. All the history and poetry presented to him at the age when the mind receives its dearest associations, were those of the gods and nations of long ago; and his models of sentiment and style were the worst and last wrecks of renaissance affections. Therefore (though utterly free from affectation) his early works are full of an enforced artificialness, and of things ill-done and ill-conceived, because foreign to his own instincts; and, throughout life, whatever he did, because he thought he ought to do it, was wrong; all that he planned on any principle, or in supposed obedience to canons of taste, was false and abortive: he only did right when he ceased to reflect; was powerful only when he made no effort; and was successful only when he had taken no aim. And it is one of the most interesting things connected with the study of his art, to watch the way in which his own strength of English instinct breaks gradually through fetter and formalism; how from Egerian wells he steals away to Yorkshire streamlets; how from Homeric rocks, with laurels at the top and eaves at the bottom, he climbs at last to Alpine precipices fringed with pine, and fortified with the slopes of their own ruins; and how from temples of

Jupiter, and gardens of the Hesperides, a spirit in his feet guides him at last to the lonely arches of Whithy, and bleak sands of Holy Isle."

Mr. Ruskin arrives at the conclusion that the classical education of Turner "hindered or hurt him;" we do not think so; but Mr. Ruskin sees no beauty in the architecture of Greece and Rome; we do, although, with the author of "Modern Painters," we have a decided preference for the Gothic; and therefore, because we admire both, we derive as much pleasure from looking at Turner's "Building of Carthage" as from his "Dogana, Venice," or any other of his later Italian scenes. We conceive the difference of merit in his pictures throughout the whole of his life is not so much of kind as of degree; and it puzzles us to understand how any one of pretension to a feeling for the beautiful in Art can stand before the "Carthage," the "Bay of Baie," or the "Daphne and Leusippus," and speak of them, as the "Oxford Graduate" does, as works which, "with infinite accumulation of material, are yet heartless and emotionless, dead to very root of thought, and incapable of producing wholesome or useful effect on any human mind, except only as exhibitions of technical skill and graceful arrangement." What is it that constitutes a great painter as well as a great poet or other writer? The faculty of originating noble ideas, and of describing them in lofty and truthful representations, equivalent to language, so that the mind of others receives the impress of their grace, beauty, and power.

Had Turner's Art-education been transferred from classical mythology to Gothic legends, England would never have seen a large number of the best pic-

tures of her greatest landscape-painter; and those, too, upon which we are satisfied his fame must ultimately rest, inasmuch as they will, after a few years, be the only surviving exponents of his genius. Mr. Ruskin even acknowledges that, "while making drawings of flower-gardens and Palladian mansions, Turner had been taught sympathy with whatever grace or refinement the garden or mansion could display, and, to the close of life, could enjoy the delicacy of trellis and parterre, as well as the wildness of the wood and the moorland, and watch the staving of the silver fountain at its appointed height in the sky with an interest as earnest, if not as intense, as that in which he followed the crash of the Alpine cataraet into its cloud of wayward rage." How much, it may be asked, which Mr. Ruskin sees of the true and the beautiful in Turner may not be traced to the lessons he learned "while making drawings of flower-gardens," &c.? It seems only reasonable to presume that his mind at that period imbibed such sympathies and acquired such tendencies as led him to the deepest study of material nature, and onwards from what, for want of a better expression of our meaning, we may call the "trivialities" of that nature to the development of her grandest and most brilliant characteristics. Who can tell by what processes of thought and intelligence, inspired first of all by the influences of some simple home-scene, his mind and imagination rose to the perception of those marvellous creations which deserve to take their place by the side of the descriptive passages of Shakspeare and Milton? What these men are in poetry Turner is in Art. Engraving will transmit to posterity some of his greatness; by it his compositions will endure, though his magic colouring will, we fear, be lost.

In the year 1800 Turner was elected Associate of the Royal Academy, and two years afterwards, at the early age of twenty-seven, an Academician. Such a rapid rise to the full honours of the Academy has, we believe, no parallel in its history.

We remember seeing, several years ago, at the gallery of Mr. Griffiths, in Pall Mall, three pictures, hanging side by side, so entirely differing from each other in style and character that no one could possibly have supposed them to be painted by the same hand. With the exception of one, we cannot call to mind the subjects, but each was an example of the style practised by him during the three periods into which his Art-life was divided. The picture that has left its impress—an imperfect one, however—on our memory was a large landscape—trees and mountains, with heavy, rolling thunder-clouds, such as Gaspar Poussin would have painted; all the forms and details marked with vigorous and decided touch, the colouring rich and full, but deficient in those soft and delicate half-tones, which constitute half the charm of his subsequent works. We may regard as specimens of Turner's first epoch the three pictures in the National Gallery; of his second, the two Venetian views in the Vernon Collection; and of his third, the majority of the pictures painted within the last twenty years of his life. Some of Turner's critics divide his works into two classes only—his dark and his light manner. The "Venice," engraved on the preceding page, is an example of the "light" style, and our other two illustrations of the "dark."

In writing of Turner on a former occasion, we remarked, "that the present generation must not sit in judgment on his works;" its ears have heard too



Engraved by]

THE FALL OF CARTHAGE.

[of and G. P. Nodding

much of the contradictory evidence, so to speak, and the feelings have been too strongly excited by one or other of the counsel who have argued the case, to admit of a totally unbiased opinion; moreover, they are not to be understood by a mere superficial inspection, but require close study, united with a considerable knowledge of the true principles of Art: a bare acquiescence in, or denial of, the merits of any picture, particularly of one by such an artist as Turner, without a reason for or against, is the verdict of ignorance, and must stand for nothing. And yet how many persons are there who judge the artist upon no other evidence than their own "untutored minds," or vague and uncertain notions of what is truth? Undoubtedly, the question, "What is truth?" would naturally occur to many individuals possessing a knowledge of Art on looking at some of Turner's pictures, and the reply would as naturally be dictated, not by the established rules of Art, but by each person's own conception of it—by what he believes, because it is present with him, or, at least, is thought to be so; for through the eye the understanding becomes enlightened, and belief is confirmed. Yet what we look upon may be so transformed from its original state, so dressed up in the garb of adventitious ornament as to convey a very imperfect, and even erroneous, idea of the reality. Thus, if a person stands upon some lofty eminence at eventide, and sees a rich and luxuriant landscape stretched out before him, and the distance closed in by the towers, and spires, and edifices of a densely-populated city, every portion of which is steeped in the brightness of the setting sun, the picture would be brilliant to the eye and

pleasant to the imagination. But let him descend from his elevated position, and minutely examine the scene which has elicited his admiration, the illusion would vanish at the sight of stagnant pools and marshy swamps, and uncultivated fields, and wildest thickets, and the dwelling-places of want and misery, vice and crime—there would be no charm in the reality, though much in the aspect under which it is seen. Is there, then, a departure from Truth in either case? Certainly not; for both are alike portions of the same visible creation, their apparent difference being the difference of circumstances under which they are seen.

With all Turner's apparent singularities and inconsistencies, his pictures contain the best materials for a fine work of Art, and show their author in the light of a great poet-painter. We could point out many of his works which are perfect epic poems, wherein grandeur of conception, vivid fancy, and beauty of language, as spoken by the pencil, have not been surpassed by any writer. But the meaning, as we have just observed, is not to be got at in a momentary glance, any more than a canto of Spenser's, or a drama by Shakspeare, can be understood and appreciated by one who runs as he reads; for the imagination must be called into exercise to fill up many seeming vacancies of subject-matter, and the mind must be imbued with a feeling in unison with that of the painter. His pictures are often a study of profound, sometimes almost inexplicable, mysteries, but well repaying any amount of time and thought which may be bestowed upon them—they are allegories of nature, wherein her loveliness and grandeur are overlaid with a gorgeous manifestation of Art.

THE FÊTE SALOONS OF BADEN.

THE "Palace of Conversation," the name given to the edifice in which the visitors to Baden assemble *pour passer le tems*, has, somewhat recently, under-

gone a vast transformation. The former building, erected under the "administration" of M. Benezat, sen., a Parisian gentleman of considerable wealth, who had become the presiding genius of Baden, having been found too contracted in size for the yearly increasing number of visitors, M. Beuzat, jun.,

who succeeded, on the death of his father, in 1848, to his distinguished post, signalled his accession to the direction by rebuilding a portion of the "palace" on a scale of magnificence that cast all the splendours of its predecessor, great though they were, into the shade. Four new saloons were added, re-

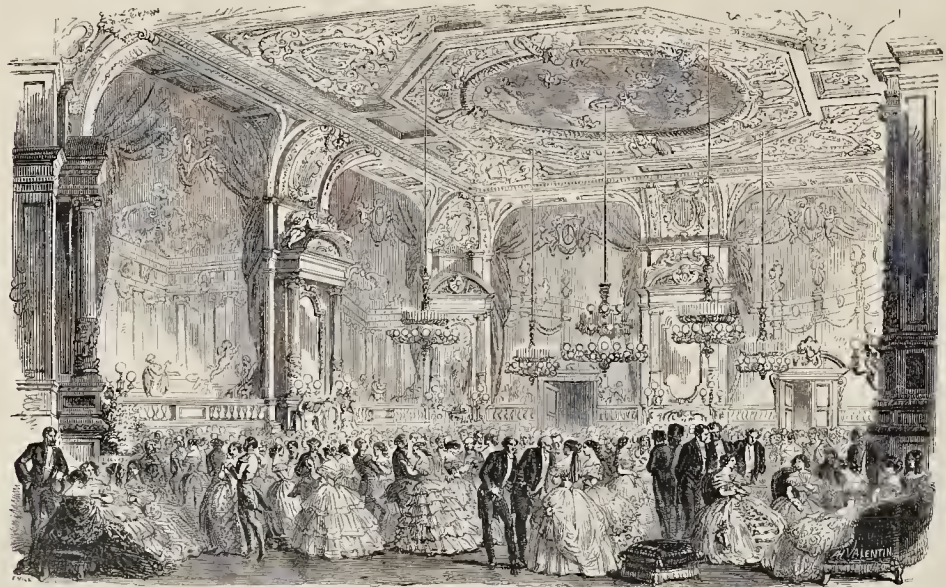

THE BALL AND CONCERT ROOM.

spectively called the "Pompadour Saloon," the "Flower Saloon," the "Saloon of Louis XIV.," and the "Ball and Concert Room;" engravings

from the two last are here introduced. They are taken from an interesting and well-illustrated work, entitled "*L'Elé à Bade*," by M. Guiuot, of Paris,

and published by M. Bourdin, to whose courtesy we are indebted for the loan of the cuts.

The "Saloon of Louis XIV.," the name given to



THE SALOON OF LOUIS XIV.

it from the style of its architecture and decorations, has an arched ceiling and a cupola ornamented with sculptures and allegorical paintings. On the panels of the wainscot are arabesques ingeniously interlaced on a groundwork of gold. The "Ball

and Concert Room" is in the style of the *renaissance*: the ceiling is designed in compartments that inclose, in an open-work "balustrade," a sky in which hover an aerial orchestra of winged figures, cupids, and genii; in the corners are allegorical

figures distinguished by their attributes. The four saloons were erected from the designs, and under the superintendance of, M. Séchan, assisted by MM. Dieterle and Haumont: the whole of the works, from the floors to the ceilings, were executed in Paris.

THE HOUSES OF PARLIAMENT.

IN our last notice of the progress of the decorations of the Houses of Parliament, we had occasion to observe that the pressure of the war had retarded the less necessary parts of the buildings. The substantial portions of the works advance, but the frescoes and Fine Art embellishments have for the last two years been in a great degree in abeyance. This, at the commencement of such a war as we have just concluded, was to be expected. The series of statues in St. Stephen's Hall has not recently received any additions. The only painters at work are Mr. Dyce, Mr. Ward, and Mr. Cope. It is now two years since we noticed at length Mr. Dyce's subjects from the life of King Arthur, in the Robing Room; some were completed, others were advanced at that time, but the series is not yet finished. Mr. Ward and Mr. Cope are preparing their cartoons in the Clock Tower. The only additions that are now actually being effected are the bronze reliefs in the Prince's Chamber, by Theed, the plaster casts for which we noticed some time since in the studio of the artist. A composition in plaster, coloured like bronze, has for a lengthened period occupied a place over one of the fireplaces, for the purpose of trying the effect of such a work. The subject is, "The Queen of Edward III. interceding for the Lives of the Burgesses of Calais," and when this bas-relief was first placed there, we ventured to express a hope that it was not set up as a model of style, as it was pointedly in the monkish taste of the fourteenth century, with that kind of perspective which represents the figures standing in a plane inclined downwards to forty-five degrees. We are glad, we say, that these compositions have not been brought forward in that spirit, although we see that the devices in the stained-glass windows are characterised by a most objectionable mediæval infirmity of drawing, and false perspective—defects which, of course, are intended to identify them as much as possible with early style. But we must submit that, inasmuch as these works were the very best Art that that period could afford; so should all the embellishments of the Houses of Parliament be executed in a spirit to represent the state of Art at the present time. Barbarous Art has always been considered necessary to Gothic architecture—the conjunction is an article of architectural faith; yet are we so horrid as to desire improvement. If the style of the composition over the fireplace in the Prince's Chamber were set up as a suggestion to the taste of the sculptor, it will be a source of satisfaction to all who may see these works that he has ventured to depart from this prescription, and to essay to qualify his works with the best spirit of modern sculpture. Of these compositions two are in their places—"Lady Jane Grey declining the Crown," and "The Trial of Catherine of Aragon." In the former there are but two figures—Lady Jane, and, we presume, Northumberland; that of the lady being a conception of much sweetness and delicacy. Nor are there many in the latter, wherein Catherine is kneeling before the King, having on her left two cardinals, and on the right the judicial officers of the court. Those not yet placed are—"Sir Walter Raleigh spreading his Cloak for Queen Elizabeth to tread on," in which, from a desire to give importance to the queen, the figures are too close to each other; "Queen Mary Stuart on her Voyage from France to Scotland" is a relief of much elegance, and very skillfully disposed, considering the difficulties to be dealt with. Facing the entrance from the Royal Gallery is the niche intended for the reception of the statue of the Queen, which will shortly be settled in its destination. Between the smaller bronzes there will be others, equal in size to those over the fireplaces, and above these are panels for pictures; but in this room, as in so many others of these vast suites, the light is ill-calculated to show works of Art, especially bronzes, which for their details require a powerful light; but it must be observed that the most important chambers are indifferently lighted, while the committee rooms and minor offices, especially those above the ground floor, receive an uninterrupted breadth of daylight. The difficulties in the way of the most advantageous disposition of these numerous chambers are very great; but the inconvenience will be felt to the exclusion of this consideration. Now, with respect to the Prince's Chamber, we have to observe that

the objects selected for its embellishment are altogether inappropriate. There is in our history an abundance of material for the embellishment of a "Prince's Chamber," without touching upon subjects suited only for the resorts of deliberative gravity. The decorations of this room might have more appropriately commenced with some incident in the youth and education of Alfred; then, perhaps, some like instance from the early life of Edward the Confessor. The Norman princes were not distinguished either for public virtue or filial piety, but for the sake of serial consistency one example might be chosen from their variegated biographies. Then Edward's nomination of the first Prince of Wales, followed by reminiscences of the Black Prince—Prince Henry and Judge Gascoigne, with other similar subjects, bringing the narrative down to our own time; and, instead of a statue of her Majesty, for which a more fitting abiding place could be found, the niche should be filled by a statue of the Prince of Wales—such embellishments alone are those suited for a "Prince's Chamber." The restoration of Henry the Eighth's Chapel has not yet been commenced; it is earnestly to be hoped that the proportions of this beautiful interior will not be disturbed; the only fault in its construction is that it is too low—if the floor could be sunk, such a change would infinitely assist the effect. The Peers' Cloak Room is advancing towards completion. This is a chamber vaulted in Caen stone—the arches springing from columns of very massive construction, and meeting at their crests in a florid device. The fireplace, which is elaborately carved in Caen stone, is contained within one of the arches. A scroll—which, by the way, is rather stiff—occupies the place of the chimney-piece, bearing inscribed on it in old English letters, "St. George," "St. Andrew," "St. Patrick," surmounted by shields respectively bearing the national cognizances of one of those countries. This crypt-like chamber is lighted by painted glass windows, each of which displays the armorial insignia of a peer; an upper composition presenting the visored helmet, with the crest, and sometimes the cap of maintenance, sometimes the coronet, and a lower shows the shield, below which is the style of the peer, and the initial letter of his Christian name. Among the peers whose armorial bearings are thus set forth are the first Duke of Marlborough, the Duke of Greenwich, the Earl of Oxford, &c. This chamber is in a line with those that run immediately parallel with the Guard-Room Court, the Peers' Office Court, the Boiler Court, the Cloister Court, and the Star-Chamber Court, and the range of offices above face the Abbey and Old Palace Yard, being abundantly lighted by windows of ample dimensions. These rooms are plainly furnished, being wainscoted round within three or four feet of the floor—the panels containing that neat and simple device which prevails throughout the Houses of Parliament, and is, we believe, by machinery under Jordan's patent. Some of the ceilings are coffered, others are plain, but all are painted in imitation of oak. The fireplaces are ornamented with a ribbon instead of a chimney-piece, wherein is inscribed, "Fear God—Honour the Queen," or, "God save the Queen," in order to remind the gentlemen who may be employed in these rooms at once of their allegiance and their religion.

At the commencement of the building of the Houses of Parliament we expressed a hope that the utmost care would be exercised in the selection of a stone that would preserve, if possible, the sharpness of the carvings which were exposed to the atmosphere of London. To all who have seen the venerable rags in which the elder of the colleges at Oxford, and many of our public buildings now stand, this could not be otherwise than a question of much importance. All the Caen stone employed is within the buildings, being too costly, and of a nature too perishable, for exterior work; and the indigenous material of which the edifice is principally constructed was, we remember, selected from among others which recommended themselves by their qualities of resistance to atmospheric influences. Notwithstanding such care decomposition has already shown itself in the buildings, so distinctly as to attract the attention of the legislature. The circumstance was brought under the notice of the House of Commons on the 20th of June last, and mentioned in the House of Lords, by Lords Lyndhurst and Harrowby, in July. Our attention has been called to certain portions of the external surface, amounting in all to fourteen hundred square yards, which have been

coated with a preparation called Daines' Patent, which appears to arrest the decomposition of the stone. If this can be effected it will be a most valuable discovery, not less to architecture than to sculpture, as the most delicately carved details may be exposed to the outward air without fear of that dissolution which has destroyed the most beautiful of our ecclesiastical sculpture. Could, for instance, the front of Wells Cathedral have been subjected to any such process as that to which we allude, we should possess in that structure alone an example of mediæval sculpture as beautiful as anything of its kind and period in Europe. The opinion of Sir Charles Barry of this method of preserving stone is full of interest. He says, "I have carefully examined the three portions of the external masonry of the new Palace at Westminster, which were covered with the stone preservative solution about two years since; and I have the pleasure to inform you that I have reason to be perfectly satisfied with the efficiency of the solution, with reference to the object of its application. It seems to have checked all the efflorescences arising from oxidation from within the body of the stone, and all vegetation on the surface due to atmospheric influences. The absorbent properties of the stone, which are mainly the cause of all decomposition in that material, are to a considerable extent obviated by the indurated coating on its surface produced by the solution, which is so hard as not to yield freely to the stroke of the chisel, and even to be capable to a certain extent of bearing a polish. In those portions of the stone where symptoms of decay existed at the time of the application of the solution, no signs whatever of decomposition now appear, nor, indeed, in any other portion of the surface of the stone subjected to the process. Where, in one instance, the solution was applied to stone which had long been exposed to the atmosphere, and had acquired a considerable amount of its filth and impurities, a dark and disagreeable colour is the consequence; but where, in the other instances, it was applied to newly-iced stonework, or such as was not in a filthy state, the colour is by no means objectionable." Such is the report of Sir Charles Barry, and it is more reliable than any interested representation. We shall look forward with some interest to the inquiry about to be instituted into the subject.—When the Houses of Parliament were commenced, a time was assigned for their completion, and the majority of the living generation hoped to see these works finished; but half a generation has already passed away, and there is yet much to be effected before even the most recently proposed additions can be entered upon. When we walk round the works, and see what yet remains to be accomplished, we scarcely can see our way to the commencement of the proposed additions—the building on the north side of Palace Yard, the building on the west side of New Palace Yard, including the entrance gateway; the building forming the centre of the front towards (the new) St. Margaret's Street, and southwards to St. Stephen's Porch; the building in the proposed new quadrangle of New Palace Yard, west of Westminster Hall; the Speaker's stables; alterations of the front of Westminster Hall; purchase of block of houses in New Palace Yard; removal of St. Margaret's Church; raising the roof of Westminster Hall; purchase of houses for the enlargement of Old Palace Yard. At the present rate of the progress of the Fine Art decoration, half a century will not see this department completed; which of us then can promise himself that even his children shall see the whole accomplished? Since the above was written we find that the statue of the Queen, intended for the Prince's Chamber, is arrived, and is now being placed in the niche opposite the Royal Gallery. It is by Gibson, and has been executed by him at Rome. The statue is supported by three other figures personifying Astronomy, Commerce, and Architecture; and we believe that the sculptor intends to colour his work. There are many reasons why this statue should not be placed in the Prince's Chamber. In the first place, as a statue of the Queen, it is not suited to the Prince's Chamber. The apartment is comparatively small, and this work will be found too large for it, reducing to nothingness everything else in the room. Again, the light in the apartment is not sufficiently powerful to show the detail of bronze reliefs; when, therefore, a marble statue is placed in opposition to these works, they will become entirely invisible.

THE ROYAL PICTURES.

HYDE PARK IN 1851.

J. D. Harding, Painter. J. B. Allen, Engraver.
Size of the Picture 2 ft. by 1 ft. 10 in.

It was a perfectly natural desire on the part of the Queen to possess some pictorial record of the great "Peace Congress," as it has not inappropiately been called, which London witnessed in 1851, and which owed so much of its success to the influence of her Majesty, and the exertions of her illustrious Consort. The "Exhibition of all Nations" called into action a host of artists of all kinds, who illustrated it internally and externally in all its variety of details, and in every possible mode of treatment; and doubtless a considerable number of these pictorial works found their way into the presence of royalty; but the Queen wished to have a picture painted expressly for herself—one that should be commemorative of the event, and yet not too circumstantial in its character—a picture of the locality and its visitors rather than a portrait-like representation of the building which—

"— Like a wondrous vision rose
Where the green turf luxuriant grows,
And stately elm-trees nod;
Where, in the pleasant months of spring,
Through the tall boughs young voices ring,
And o'er the verdant sod,
Mingled with roll of chariot-wheels,
And tramp of horses' iron heels,
"It stood all glittering in the day;
No pile of marble, stone, or clay,
As palaces are reared;
But a vast edifice of glass,
Through which the merry sunbeams pass;
Arched roof and walls appeared
As if some hand with magic strong
Had stretched those crystal aisles along.
"And thither from remotest bound
Of the 'white earth's encircling round,'
Came men of every clime,
Laden with all that mind conceives,
Or human industry achieves,
Or science holds sublime;
From east to west, from south to north,
Their tributary gifts poured forth."

Mr. Harding received the royal commands for the picture just as the doors of the Crystal Palace were about to be closed to the public. The honour could not have been conferred upon one better qualified for the task; and yet, with a recollection how often the subject had already been the theme of the pencil, he must have felt the difficulty of imparting to it anything of an original and novel treatment. But this artist is never out of his element where green sward and waving trees are to be the chief ingredients of his picture, and Hyde Park supplies full materials of this description. The view of the "Palace" is taken from the western end of the park, where the trees are larger and more picturesquely situated than at the opposite end. We see comparatively little of the building; it is almost entirely screened by the continuous masses of foliage, under which groups of visitors, native and foreign, rest and regale themselves, giving a Watteau-like character to the picture. The drawing and disposition of his figures are, as was remarked in the biographical sketch of Harding in the *Art-Journal* of last month, qualities of excellence which must always excite attention in the works of this artist. He knows where to place them so that they shall constitute a pleasing as well as, in an artistic view, a necessary part of the composition. They never seem introduced for any other purpose than because they ought to be there as an integral portion of the work, and they are always so circumstanced, in action and costume, as to appear so.

The picture is in the collection at Buckingham Palace. It illustrates, with reference to the time when, and the circumstances under which, it was painted, almost the closing scene of that great drama which, during so many previous months, had engaged the attention of every civilised people in the world, either as actors or spectators, or both. The first "Crystal Palace," having fulfilled its purpose of enlightening the nations in the Arts of peace, and of engaging them in honourable and peaceful rivalry, has been levelled to the ground, but only like the second Temple at Jerusalem, to rise again in greater splendour; and, with more varied attractions than the first offered, it has now become one of the wonders of the modern world.

PROJECTED AND OTHER MONUMENTS.

THE monumental movement has been very active during past months; and, as English sculptors do not refuse to take private work, though, according to Lord Pauncefote, they will not "complete" for the Government commissions, we are likely to have further specimens of our native talent ere long,—unless other bodies shall follow the example of the Government, and call in the foreigner, on the pretext of an English sculpture "turn out."

The inhabitants of Grantham are moving, somewhat late—but assuredly never too late—in the matter of a monument to their greatest citizen, Sir Isaac Newton; and we have heard whispers on the subject which certainly suggest to us misgivings, though we will not just now more particularly allude to them, in the hope that they may not be true. A statue to Newton, even if it shall be determined that the place of his birth is its proper site—and, indeed, why not? since questions of limitation, either in space or in time, are of no force where his mighty name is concerned—will scarcely be confined to a local subscription; and should the project take the larger proportions which are probable, it is to be hoped that more genial and natural counsels will prevail,—and that when a monument to our great astronomer is in question, it will be felt that all the paths on which is written "*sic illic ad astra*" can be trod by Englishmen.

The friends of Sir Henry Bishop are projecting a monument to the memory of that most popular of modern composers;—and the Scotch have somewhat suddenly remembered, after the sleep of a good many centuries, that they have no monument to the national hero, Wallace.

To these instances of monumental commemoration in project, we may add, as one of completed fact, that Lord Ellesmere has recently placed a slab of marble, inlaid with brass, to mark the spot, in the north aisle of Henry the Seventh's Chapel, where Addison has been sleeping for a hundred years.

And we may record that Mr. Noble's statue of the Duke of Wellington, executed for the city of Manchester, has ascended its pedestal, at one extremity of that area—the statue of Peel occupying the other—where a sheet of standing water, so long the strange frontage feature of an infirmary for the sick, has at length given place to a fine esplanade and a very magnificent Fine Art site. We have treated this subject elsewhere.

Nor is it out of place to record among these tributes to the dead a memorial to a good man recently gone from amongst us, though it takes another form than that of the Art-monumental. The Council of King's College, London, have received the sum of £500, to be applied in commemoration of the late Sir Robert Harry Inglis,—with, we believe, no other indication as to the identity of the donor than the touching one which records that it is "from one who loved him." Working in the spirit of him whose memory is thus committed to their charge, the council have determined to apply this sum, and any other contributions to the same cause which may reach their hands, in the establishment of a prize or scholarship for the encouragement of the study of modern history and English literature. The precise nature and value of the reward to be thus created must, of course, depend on the final amount of the subscriptions; but Sir Robert Inglis has left behind him many who could come in to this list of subscribers under the same signature of men "who loved him."

The Arctic episode of our day is beginning to yield its melancholy memorials; one of the least sad being a testimonial, presented by the officers recently employed in the search for the missing ships *Erabus* and *Terror*, to Mr. Barrow of the Admiralty, for the good offices rendered by him to them in that touching service,—a service which, if it failed of the leading object for which it was nobly undertaken, has solved the great geographical problem of centuries.*

The Mayor and Corporation of Lincoln are taking measures to erect, in that city, a monument to the

hero and chief victim of the same dreary tale,—Sir John Franklin himself.

Sir Roderick Murchison reports that, in addition to the granite obelisk which now rises—at a cost of between six and seven hundred pounds—on the quay of Greenwich Hospital, to record the devotion of the gallant Frenchman, young Bellot, who perished in the generous cause of Franklin's attempted deliverance, a sum of £1610 has been divided amongst the sisters of the former lamented officer from the proceeds of the subscription.

And, while alluding to the generous part which other nations took in this cry to the rescue, which has had so sad a final response, we may step aside from our direct subject to record our gratification at the fact of the Royal Geographical Society having awarded its founder's gold medal to Dr. Kane, for his services and discoveries in the Polar regions during the American expedition in search of Sir John Franklin.

The war just concluded will no doubt yield its large contingent to our monumental records. The officers of the brigade of Guards already propose to raise a monument to the officers and men of the brigade who have fallen in that struggle. According to the terms of the meeting at which the project was discussed, the thing is likely to be done on a great scale,—and the officers have already appointed a committee to see it carried out, with Sir Alexander Woodford at its head.

A monument to the memory of the gallant and good Captain Lyons is on the eve of completion, by Mr. Noble;—who, by the way, has produced an admirable bust of Sir W. F. Williams of Kars.

Many other works are in preparation to commemorate losses during the war;—of which we shall be able to render a detailed account ere long.

Meanwhile, in the aisle to the right of the great western entrance of St. Paul's Cathedral, a eulogist has been erected to the memory of certain of those same heroes,—eight officers of the Coldstream Guards who fell at Inkerman. Lieutenant-colonel the Hon. Vesey Dawson, Lieutenant-colonel J. C. Murray Cowell, Captain L. D. Mackinnon, Captain the Hon. G. C. C. Elliot, Captain H. M. Bouverie, Captain F. H. Ramsden, Lieutenant E. Adisbrowe, and Lieutenant C. H. Greville, are the officers thus commemorated. Of this monument a more particular account appears on a subsequent page of the present number of the *Art-Journal*.

It is not out of place here to add, that an imperial decree prescribes the erection in Paris of a monumental column in honour of the army of the Crimea; and our readers may be quite sure that French valour will be illustrated—as it should when the nation is the illustrator—by French Art.

From the close and terrible relation of the Emperor Nicholas to the war, it is also a convenient occasion here to state, that preparations are making in St. Petersburg for the erection of an equestrian statue of that ambitious and baffled autocrat. The site is to be, the square which lies between the cathedral Church of St. Isaac and the palace of the Grand Duchess Marie;—and the pedestal will exhibit on its sides *bassi-relievi* representing four leading incidents in the reign of the czar. The sculptor commissioned is the Baron Klodt;—and we take it, he will scarcely select the march into the Principalities for one of his "leading incidents."

From all these coming war memorials we turn to one intended to record as gallant a deed, done on a far different field, as ever was achieved by the British soldier. The same calm courage which kept him immovable, throughout a summer's day, in the terrible square at Waterloo, while the French artillery was cleaving through their human walls—and extorted the admiration of the fiery foe who again and again charged and broke against the unflinching rampart,—stood here to meet, with no applauding spectators, a charge more dread and a destruction more certain,—mixed up with an ancient chivalry and a modern tenderness which gave to the laurel that day won a touch of the true immortal. Our readers will not have forgotten the wreck, on the 25th of February, 1852, of her Majesty's ship *Birkenhead*,—a large troop vessel employed in carrying out to the Cape of Good Hope drafts of various regiments, under the command of Colonel Moore, to the number of six hundred men, besides a crowd of women and children. The only boats available were filled by the soldiers, amid the terrors

* The testimonial, which has been on view at Mr. Nicholson's, in Duke Street, Lincoln's Inn, represents the Arctic regions rising out of an icy sea.

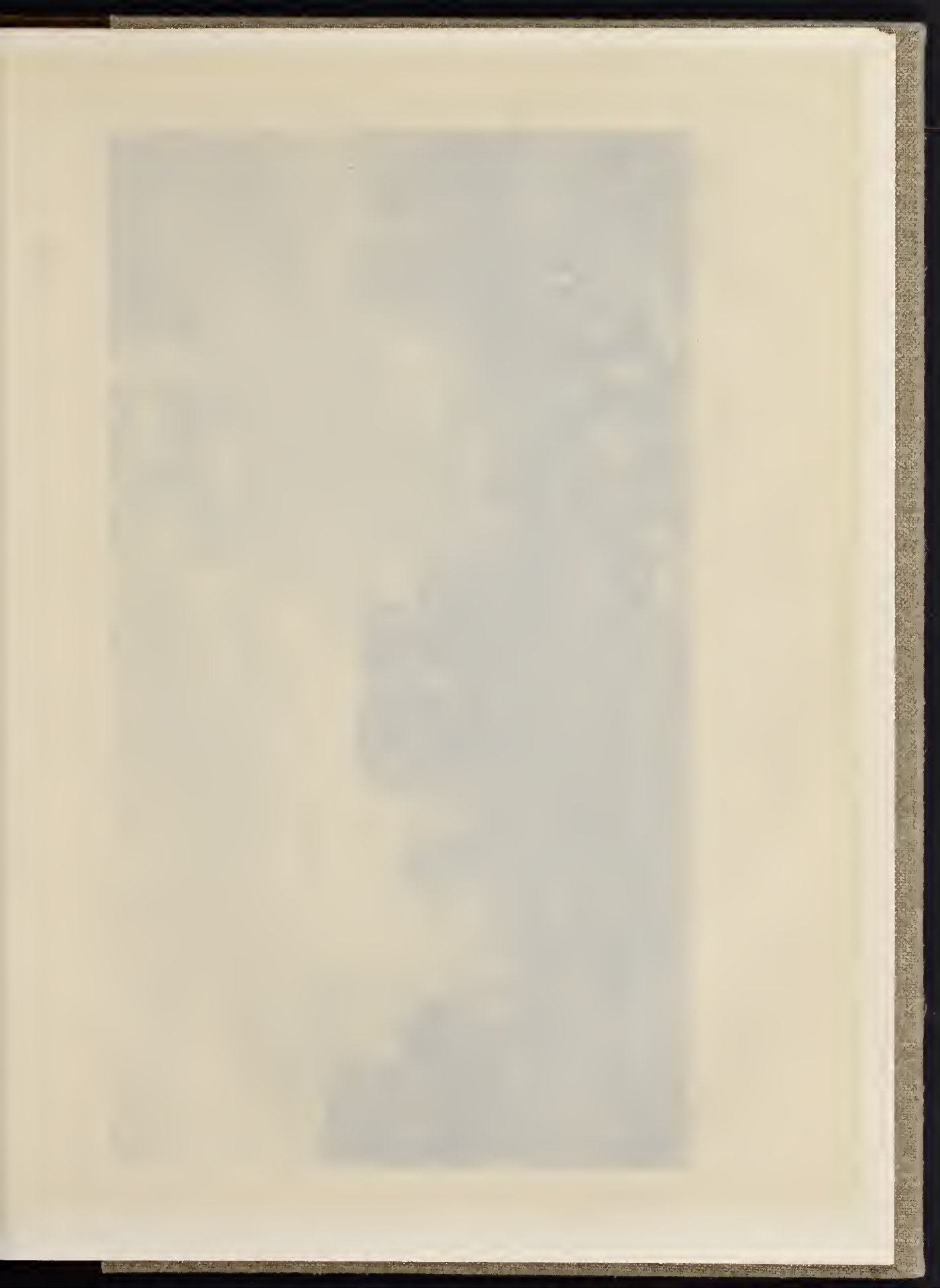

THE
LIBRARY
OF THE
MUSEUM OF
COMPARATIVE ZOOLOGY
AND
ANATOMY
OF THE
MUSEUM OF
COMPARATIVE ZOOLOGY
AND
ANATOMY
OF THE
MUSEUM OF
COMPARATIVE ZOOLOGY
AND
ANATOMY



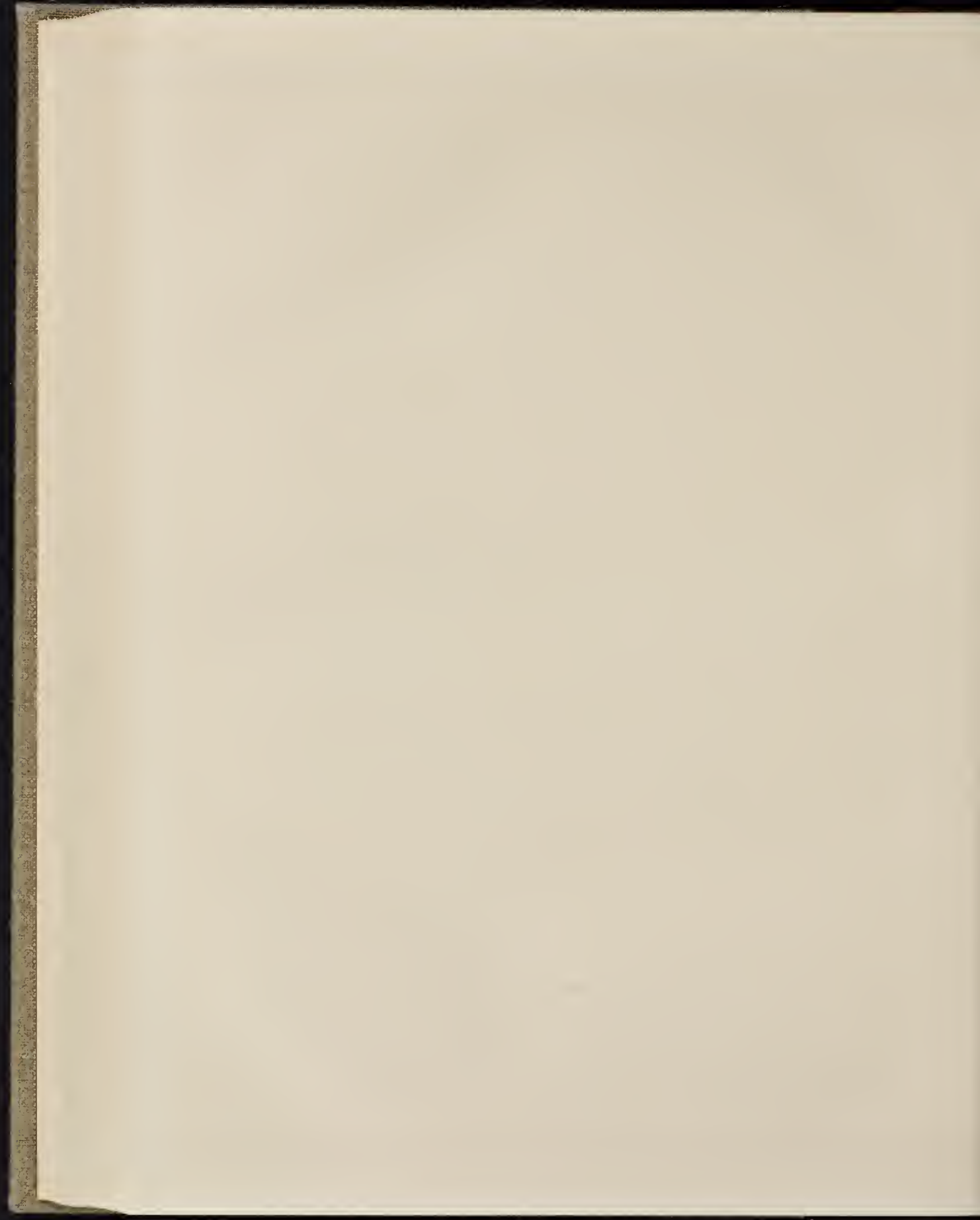

of the storm, with these women and children, and sent away from the ship's side; whilst the brave men remained behind to meet the death which they had thus rendered certain,—drawn up on deck, with their officers by their sides and their colonel at their head, as calm and steady as if on parade. Young hearts many of these were, by whom bright prospects were thus self-sacrificed and high hopes self-extinguished for ever; and, in order to estimate the merit of this great deed, it must be borne in mind how all the "pomp and circumstance" which are the inspiration of the battle-field were wanting here. Not to the sound of the rallying trumpet, but amid the roar of the ruthless sea—and not with the prospect of a soldier's rewards, but in full view of the vast and inevitable grave that yawned drearily all around them,—did these gallant men await the hour when the vessel should break up beneath their feet. For these heroes Mr. Gordon, at the close of the session of Parliament, demanded a monument from the nation,—and the first minister declared his willingness to give effect to the demand.—It should be mentioned here, that Colonel Moore, urged by his own soldiers to leave the ship with the last boat, refused to quit his post at their head in the hopeless struggle which was at hand,—and it is very affecting to add that his widow, catching the spirit of him whom she had lost, followed the band of noble ladies who risked their lives in the East to soften the sufferings of the soldier, and *lost* hers:—dying, like her husband, in the cause of humanity. Her name might well have a place beside his on this monument.

Our readers know well that the age in which we are living has been emphatically that of statues and testimonials; but, unluckily, they have not always been the worthiest names that have had the best places in such records. It is not in all cases that the commemorations of brass and marble are for those with whom our sympathies are most warmly engaged,—and we would make many a substitution in the world's list of honours if we had our will. The men who have laboured in the cause of intellectual light, or of moral health, should stand, if we might place them, on the pedestals that have too often been usurped by more vulgar figures. But the clients of the philanthropist are for the most part the low castes of the world,—and these have not often been consulted in the distribution of the public crowns. This, however, is a condition of things which of late there has been some disposition to redress; and, as an instance, a great meeting just held at Bombay has determined to erect, by public subscription, a statue to a man for whom we should certainly claim the pedestal of some one of the old world's deposed idols. The object of this public tribute is a Parsee; and men of all creeds and castes in India are consenting to this memorial,—as all creeds and castes have partaken of his benefactions. Sir Jamesjee Jejeebhoy began life with a few rupees; and has amassed a princely fortune,—which he has dispensed on objects of public and private beneficence to an almost fabulous extent. No less a sum than a quarter of a million sterling is said to have been invested by this great moral economist in works, which testify publicly and permanently the munificence of the philanthropy from which they flowed, and a quarter of a million more in those private charities, the account of which is kept only in the perishable registry of grateful human hearts,—and in the book of the Recording Angel. Schools, hospitals, bridges, waterworks,—whatever could minister to the physical or moral health of the community and which he lived, like a blessing,—have grown out of his bounty; and the seeds of his benefactions takes such proportions as—£1000 granted for the relief of Irish famine; £750 to the Patriotic Fund; £700 to the Wellington Testimonial; £30,000 (d) for the founding of a benevolent institution at Bombay for the education of the children of the most indigent of the Parsees,—and £20,000 for a hospital in the same city for natives of every caste and creed; £20,000 for a causeway between the islands of Bombay and Salsette,—and £20,000 for a dam (to husband the water) across the river at Poonah. It is said, that he is now negotiating with the Government for the establishment of a School of Design at Bombay,—to which he offers himself to subscribe £10,000. Some years since, the Queen conferred the honour of knighthood on this princely man;—and we see with pleasure,

that a powerful body of persons influentially connected with the affairs of India have waited on the minister, as a deputation, to urge that the memory of such an example may be perpetuated by the perpetuation of the honour that recognised and crowned it,—that Sir Jamesjee's knighthood may be converted into a baronetcy.

To this long monumental and testimonial record we add a couple of bits that have, more or less, a kind of relation to it.—Mr. Hart's portrait of the present Lord Mayor, Mr. Salomons—recently exhibited in the Royal Academy—has, on the requisition of the Court of Common Council of the City of London, been presented by his lordship to that body, for the purpose of being hung in their Guildhall.—And, the late Dean of Westminster, Dr. Buckland—whose death demands a word of specific record in our Journal, for the sake of the pains which he took to let the public have easy access to the monuments and other features of artistic and historic interest in the Abbey under his control, and of the example which he thereby set to the chapters of other cathedrals in England—will in all probability enterb an addition to the list of monumental honours that we may have to record on some future day.

THE NEW PICTURES IN THE NATIONAL GALLERY.

THERE is substantial evidence that the authorities are in earnest in the formation of a national collection. The additions to the Gallery no longer occur at the rate of one picture in two years, but we have to announce an augmentation to our pictorial wealth of numerous pictures, certain of which are already hung, others are not yet placed. Hitherto our national catalogue has only been interesting; but if judicious purchases continue to be effected at a similar, or a proximate ratio, our public gallery will become not only attractive, but must before long vie with all but a few of the famous collections of Europe. Although containing works which in quality yield to none, and in reputation but to few, the National Gallery has been regarded by continental visitors as inferior to private collections; and for a national exhibition only a sorry apology; but for a series of such additions as the Francia and the Perugino would raise any gallery to permanent importance. The power vested in the trustees, enabling them to dispose of works ineligible to form a part of such a gallery as would be worthy of a permanent place in the Gallery, but also solves a difficulty with respect to any unconditional bequests and presentations which may be more or less valuable, but still not sufficiently so for the national catalogue. It is, however, probable that the known existence of such a power will suggest the attachment of conditions to bequests to the National Gallery—conditions that hypothetical pictures shall not be sold, but returned to the estate of the testator if not pronounced of such a quality as to secure them a permanent place in the Gallery. It is well that the public voice should be heard in reference to those additions to the Gallery which are acquired by public money. On the subject of the recent purchases there has been much violent declamation, but all that has been written, all that has been said, is but idle verbiage in the absence of argument tending to show that such pictures are spurious. This has been done in one case, that of the presumed Holbein—the only picture that has been purchased without its history being known. Since the verification of that work, no picture has been purchased without a knowledge of its antecedents. Our National Gallery should not contain one questionable picture; and if proper care be exercised, the entire catalogue will be beyond suspicion. Of the recent additions there can be but one reasonable opinion; and should future selections be made with as much judgment, there will be no ground for complaint, but ample cause for congratulation. There are but two conditions on which pictures can be recommended to the Gallery—the first is unexceptionable quality of Art; the other is, that the proposed work should assist the history of painting by the definition

of an era, or the illustration of a school. It is to be hoped that mere curiosities of Art will never be admissible. The Perugino, which is the most valuable work that has for a length of time been hung in these rooms, was long known as an altar-piece in the Church of Certosa, near Pavia, for which it is believed to have been painted. It was purchased for the National Gallery of the present head of the Melzi family, at Milan, for, it is said, £3600—and had it not been acquired by ourselves, it would now have been one of the gems of the imperial collection at Vienna. Whether this valuable picture passed directly from Certosa into the possession of the Melzi we know not; but it is certain from the fine condition of the work that it cannot have gone through many hands; yet few as these are, it appears to have been touched upon. It is small for an altar-piece, and consists of three compartments, a centre, and two wings. The principal subject is the Virgin worshipping the infant Jesus, who is held by St. John; the *agroupment* is completed by a third figure—that of the youthful St. John. In the upper part of the composition three angels are seen standing on the clouds. The left wing contains two figures—the archangel Raphael, with Tobias, who carries the fish. The right wing consists of only one figure—that of the archangel Michael, whose sword—

—“From the armoury of God
Was given him, temper'd so that neither keen
Nor solid might resist that edge;—”

and he, the leader of the angelic cohorts, appears, accordingly, in a full suit of plate-armour. The head of the Virgin is a charming study, most successful in its life-like *maestrienza*—the glowing warmth that would yield to the pressure of the finger. The hair is Auburn, and painted with exquisite delicacy; but, as usual in all the works of the fathers of the art, the extremities are defective in drawing. The hands are long, bony, and have evidently cost the artist great trouble to paint. All the faces have been finished with a full glaze of sienna and lake, or some other red, which, having, of course, flattened the higher lights, it would appear that some *ignoramus* has been attempting to superimpose these above the glaze, and has left the vermillion so raw that it tells distinctly from the charming glaze with which Perugino finished the picture. If the operations of this mischievous bungler are not to be thus accounted for, it is difficult to find any other cause for them, as the picture does not seem anywhere to have required emendation. In addition to these apparent retouchings, the upper sky of the centre-piece seems to have been repainted. And with respect to the identity of the picture, we have one observation to make, which is, that those Italian writers who speak of Perugino and his works, describe two similar pictures; and with respect to this composition, there appears to be a discrepancy. Should this upon further inquiry be confirmed, we shall quote the passages we allude to in another article. This work is far superior to the small Madonna, by the same master, which hangs near it. The latter is in the dry Florentine manner of the painter, without any approach to the luscious colour of this work. It is also certainly far superior to “St. Catherine” opposite, by Raphaelle—the hands of which are coarse, the colour destitute of richness, and the eyes out of drawing. St. John holds the infant, and looks up to the Virgin; in other works of Perugino, as the fresco at Rome, the figures are in much the same relation. The heads also of Tobias and the angel, in the other compartment, repeat this relation. Tobias looks up to the angel in the same manner that St. John looks up to Mary. Thus we may conclude that the heads of Mary and the archangel Raphaelle have been painted from one study; as also have those of St. John and Tobias, with a little difference as to size. We cannot believe that these recurrences arose from poverty of resource; it was, however, such monotony that originated against this master the reproach that he continually repeated himself, against which he defended himself by the assertion that he copied no one else. But Perugino saved money, and was exceedingly penurious, and it is probable that he would make one study from the life serve for many pictures rather than pay a model for another. Tobias is presented in a velvet tunic and crimson hose, cut in the most approved fashion of the youth of the end

of the fifteenth century, and on the other side the angel Michael wears a magnificent suit of Milan plate-armour, painted from the reality with the utmost nicety. It is a plain tilting-suit, with the usual lance-rest on the right side—the large shield-like pauldron on the left. The head is lightly covered by one of the fanciful berets of the time. The pose of this figure is neither graceful nor dignified—being that of Donatello's St. George, which forms one of the endless enrichments of the Church of Orsanmichele, at Florence. The angel holds his shield between his divided legs—Donatello could scarcely have imagined a less agreeable attitude. As an example, however, of the master, it is the best of his works that we have ever seen; it is better in colour than, and equal in every other quality to, the "Madonna and Saints" in the Tribune at Florence, and an infinitely more pleasing work than the "Deposition from the Cross" in the Hercules Saloon of the Pitti Palace; the "Madonna and Saints" in the Berlin Museum will not stand a comparison with it, nor will the pictures at the Hague, Frankfurt, and Munich.

The picture by Benozzo Gozzoli represents a Madonna and infant Saviour surrounded by saints; it is a large picture, in the dry and hard manner of the early period of the Florentine school. We have always looked at the works of Benozzo with some surprise that, having been preceded by Masaccio, and as a pupil of Angelico, he should not have endued his figures with more grace than we find in them; but when we remember the amount of work he executed at Pisa in two years, and the crowded altar-pieces which he has painted, it is easily understood that such efforts leave no leisure for accuracy of design. Such a painter is ever impatient of accurate imitation; the work is thus elaborately worked out, but with little observation of nature. This artist groups with the Lippi, the Peselli, and Sandro, and with them was patronised by the Medici. There are three Madonnas, each with the infant Jesus—one by Francesco Taceoni, the other ascribed to Girolamo dai Libri, and a third by Bartolommeo Vivarini. The last bears the abbreviated inscription, "Opus Bartolommei Vivarini de Murano," and was purchased for £97 in November, 1855, from Count Bernardino Corriani degli Algarotti. It is mentioned in the *Atti dell'Accademia di Venezia*. The picture ascribed to Girolamo dai Libri was in the Galvagna collection; but while in that collection it was believed to have been painted by Pellegrino da S. Daniele, and such is the opinion expressed in the work "*Venezia Monumentale e Pittorica*;" but it is stated that, on comparing the work with those of Girolamo dai Libri, it was determined as rather a production of this master. That by Taceoni is inscribed, "Opus Francisci Tachoni, 1489, Octo." It is mentioned in the dictionaries of Ticozzi and Nagler under the article Taceoni. These pictures are by no means so interesting as the Perugino; but if we insist upon the formation of a gallery as entirely of gems, we must be content to possess a collection deficient as an historical series. What we must especially contend for is the authenticity of the works, and if our catalogue is indisputable, we shall at least, in this respect, possess a collection superior to that of every other public gallery in Europe, with perhaps the exception of that in the Pitti. At Berlin, Dresden, Munich, and in the Louvre, there are many ill-conditioned and doubtful works—in every way ill-qualified to constitute parts of collections distinguished by so many of the finest productions of the art. Every well-selected national collection ought to reflect the history of the art, and consequently must contain works of little interest beyond the exemplification of schools. As, for instance, the greater number of the works lately added to the National Gallery, are such as afford little pleasure to the spectator, and no profit to the student—we except, of course, the Perugino and others of that class, which really show that little has been done in religious painting since the date of their execution. If these works are Pre-Raphaelite, we commend them to the observation of the young gentlemen of the spasmodic school, whose modellings in granite may become more plastic by due regard to the quality of these works. It is therefore not only the pictures constituting large national catalogues that are valuable for their beauty and excellence; there are, indeed, productions of certain masters which ought to form a

feature in every large collection, although positively objectionable as to the intrinsic value of their art. To explain what we mean we instance one—Carlo Dolce, who is little known out of Florence. The public infatuation and want of taste is, however, very markedly shown by an ardent desire for copies of some of his works. There hangs in the Italian school, in the Palazzo Vecchio, his "Magdalen," made famous by thousands of copies, commissioned principally by English and American travellers. There are copyists who live by this picture alone—they began the study of their art by copying it forty years ago, and they are yet before it, grey-headed old men. We know not how these men have lived so long near such a picture; it is true the "Magdalen" is one of his best works, his "Poetry" being the other; but Dolce was an icicle, whose works we have never seriously contemplated five minutes without experiencing subsequent tendencies to rheum and cough.

There is yet a picture which we had almost forgotten; it is a portrait of a young man by Bartolommeo Veneto, and is inscribed, "Ludov. Martinezzo, Etatis Ann. XXI, Bartolom. Venetus Faciebat, M.DCCCXVI. ann." This picture was purchased at Venice, in November, 1855, for £48 10s., from the representatives of the Count Girolamo Michele Pisani, heir of the Count Girolamo Martinezzo. The costume of this figure, which is of the period of Venetian splendour, is mentioned in the "*Habiti Antichi e Moderni*" of Cesare Vecellio. A portion of the dress which had been injured has been restored. It is distinctly a Venetian portrait by one of the followers of Titian, but the artist has not made the most of his subject, the face looks mean for want of breadth, and the presence might have been made much more imposing. There are multitudes of portraits for sale in Italy better than this as to Art, but not authenticated as this is, and therefore useless to a public collection—in which the history of every picture should be known so circumstantially as to silence the crude speculation of pseudo-criticism. Fifteen pictures have been purchased from the Manfredi collection alone for the National Gallery—whereon, at the very earnest instance of the Venetian Academy, the Austrian Government has granted funds for the acquisition of seventy works from the same property. As long ago as 1851, the purchase of the entire collection was recommended to the Government by Sir Charles Eastlake, on which occasion Mr. Woodburn was sent to report formally on the quality and value of the works. The result of his mission was, the selection of one hundred and twenty pictures, which were recommended for purchase at a valuation of £22,340, but at that time it was not thought expedient to propose to the Government a purchase so extensive.

There is but one way to consider the recent acquisitions to the Gallery. They have been purchased so judiciously, that the history of each work is known, and all are in unquestionable condition considering the period of their execution. If all future purchases be effected with the same discretion and circumspection, our collection must ultimately be the purest of all those which have been made by purchase since the famous Italian galleries, that were called amid the splendours of the studios of the great masters.

It is not unreasonable to expect that some portion of the great pictorial wealth of this country will become national property when it shall be seen that there is a place fit to receive, and adapted to show, valuable works of Art. There are distributed throughout England numerous beautiful and authentic pictures, which may be said to be concealed in family mansions in the country. Now they are unknown, but in the national collection they would be seen and appreciated. Mr. Rogers, and other collectors, have lately shown a worthy example; but greater and even more valuable bequests than these may be expected. All the great private collections in the country should be represented in the National Gallery. If contributions are made in certain cases, it is not too much to expect them in others; but presentations now must be only first-class work—none others will be in anywise effective with the character which the collection is now assuming. The brilliant simplicity of recent acquisitions, darkens even the Titians and the Rubenses which we once thought would never be outdone.

MR. HOLFORD'S HOUSE IN HYDE PARK.

This beautiful house, we might say "palace," which is one of the objects that make foreigners stare,—inasmuch as it is for the residence of a private gentleman of England,—is about to receive its interior decorations. It is a noble edifice, and worthily adorns the regal situation it occupies in Park Lane; reflecting equal credit to its owner and to its architect, Mr. Vulliamy. Truly it may be said that an untaught Englishman with refined taste and ample means is a king without the trouble of crown and sceptre! With the wide powers with which ample means endow him, he has no vested claims to acknowledge; no responsibilities built up stronger and stronger by generations to crib, cabin, or confine him, but the "world all before him where to choose!" Honour to those who in such an enviable situation choose well! We, of course, in our speciality, deem such to choose well who worthily and with discrimination encourage Art. Mr. Holford's name is not unknown as a Mæcenas in this respect, but we now hope still more from him from the step he has taken in the erection of the house we allude to.

We are much rejoiced to hear that the internal decoration which is now about to enhance and complete the structure, is likely to be in the hands of an Englishman,—and of one who, we are quite sure, will perform his part worthily. Mr. Stevens, of Kensington, is already intrusted with the decoration of the dining-room, with respect to which he is given a "*carte blanche*," and this with the full concurrence of the architect, which speaks well for that gentleman's liberality of feeling. Under these circumstances, there is no fear as to the result; nor, we should think, that the whole of the apartments will not eventually be placed in Mr. Stevens' hands. The exterior of the edifice is highly effective in its unity, and is harmonious and complete in itself, from one feeling pervading the whole. The same advantage should be accorded to the interior. We have often had occasion to speak of Mr. Stevens' works in ornamental Art with high praise. The style in which he is strongest is Italian (so called), the most appropriate, on the whole, for English edifices of the class of Mr. Holford's house; yet he is no servile copyist—his compositions, though fully enhanced with the full and fervid character of the Italian school, are yet no mere *refaccimenti*—he thinks for himself. In any other European state he would have achieved by this time a much wider celebrity than has as yet fallen to his lot. This arises from no shortcomings on his part, but from the fact of there being no proper "status" yet for an ornamentalist in this country—at least, for a British one. We trust, however, this will ere long, cease to be the case, and that ornament,—without a strong feeling for which, we reiterate, as we have often done, there can be no true union of the other Arts,—will have its due rank acknowledged. The success we predict in the present instance will give its aid, which we reckon on, inasmuch as our own impression would not hesitate to venture Mr. Stevens' powers in his own style by the side of those of any living ornamentalist, and this notwithstanding that he may be more generally known to the public by the assistance he has given in the best class of ornament connected with stores and grates than by his other compositions.

This may strike some of our readers as "bathos"—ending our acknowledgment of an artist's talents with a reference to his designs for grates and fire-irons; we, however, do not so deem it, holding that the power of designing a first-rate, high class example of this nature evidences at least probable competence for much more extended efforts! As regards Mr. Stevens, we believe him equal to any efforts in high class Italian ornament; for which he possesses also the peculiar advantage of being equally successful in his effects of colour as in those of form, thus grasping a far wider and more varied range than would otherwise be the case.

Mr. Holford's splendid mansion, Mr. Hope's, in Piccadilly, Lord Ellesmere's, near the Stable Yard, St. James's, and others we could enumerate, unquestionably evidence an improved taste on the part of the wealthy and aristocratic classes, which it is most satisfactory to see.

THE CRYSTAL PALACE,

AS A TEACHER OF ART AND ART-MANUFACTURE.

PART IV.

WE regard the Crystal Palace as a great teacher; if less effectual, not the less powerful because its lessons may be neglected—as those of many public instructors have at all times been; and if in these articles we have seemed to enter more especially for the rich, and those who are able to indulge in luxuries, we are by no means indisposed to give its due weight to the fact that here the people may be taught—that here they may learn. It is, indeed, impossible but that the frequent contemplation of forms of grace and beauty must—inensibly it may be—induce the coarser mind, and induce comparative refinement:—

“The attentive mind,
By this harmonious action on her powers,
Becomes herself harmonious; woe so oft
In outward things to mediate the charm
Of sacred order, soon she seeks at home
To find a kindred order.”

Our feelings and opinions on this subject have been well expressed by the anonymous author of a small sheet, printed, we imagine, for private circulation; and of which, no doubt, the writer will freely permit us to transfer a portion to our columns:—“The Crystal Palace at Sydenham, with its beautiful grounds—its superb situation, upon a hill, overlooking the rich woodlands of Surrey and Kent, and one of the loveliest districts of country in the world—its

near proximity to the metropolis—its well-ordered attractions in all the Arts that administer to the cultivation of the understanding and the taste—the judicious admixture of the beauties of antique architecture and sculpture with the triumphs of modern Art—and the still more happy blending with all these, not only of the wonders of the vegetable and floral kingdom, but of those zoological, zoological, and ethnological marvels, which it is the privilege of this age, and the glory of the scientific men of this country, to have brought to light or methodised,—all these things will give a new and higher character to the amusements of the British people. Were it simply for the beneficial effects which may be anticipated to ensue from this attempt at refining the pleasures of the multitude, we might well be thankful to the far-seeing enterprise of the Directors of the Crystal Palace Company. But, great though such a result may be, it is not the only one that will follow if the palace and its treasures prove but half as attractive as they deserve to be, both to those who have time and money at command, and to those who have little of either. It will educate the people in the knowledge and appreciation of the beautiful. It will aid in the accomplishment of a task which the state has neglected, and which private enterprise never before sought to effect. It will create a taste for the elegancies and refinements of life in the deepest strata of society, and the results of which will exhibit themselves hereafter in an infinitude of modes of improvement, of which we can at present form no estimate. A too exclusive attention to money-making, and a too intense forgetfulness of the public amenities, in the commercial worship of that

great idol—*Self*, will be corrected by that love of Art and Nature which familiarity with the treasures of the Crystal Palace will, after a time, induce among the trading and labouring classes. By these and corresponding inducements exerted in every direction in civilising the people, and encouraging among them a love of Art, and of intellectual purity and refinement, they would be imperceptibly, but surely, weaned from the coarse and brutal indulgences which have been but too popular, both in town and country, and into which they have been in a manner forced by injudicious legislation, as respects drinking and its accompaniments, and many interferences with their harmless enjoyment. If the new Crystal Palace be as successful in its appeals to the higher faculties and emotions of the public as its predecessor, the Great Exhibition, proved to be, we may anticipate that the next generation of Englishmen will reap many advantages which have been denied to the men of the present day. In the meantime the people will enjoy a place of recreation to which the world can as yet offer no parallel.” And the people do fully enjoy the wholesome and instructive recreation here provided for them; it is impossible for any visitor to the Crystal Palace, on its most crowded day, to perceive in the conduct of the humbler classes aught that may induce a dread that the elegancies and refinements of the place are lost upon them.

The Crystal Palace is yet in its infancy; for what are three years in the great work of education? Yet already, we are assured by competent judges, visits here have “told” upon the thoughts and plans of the artisan. Those who have been half a dozen times within it—and this has been the fortunate lot

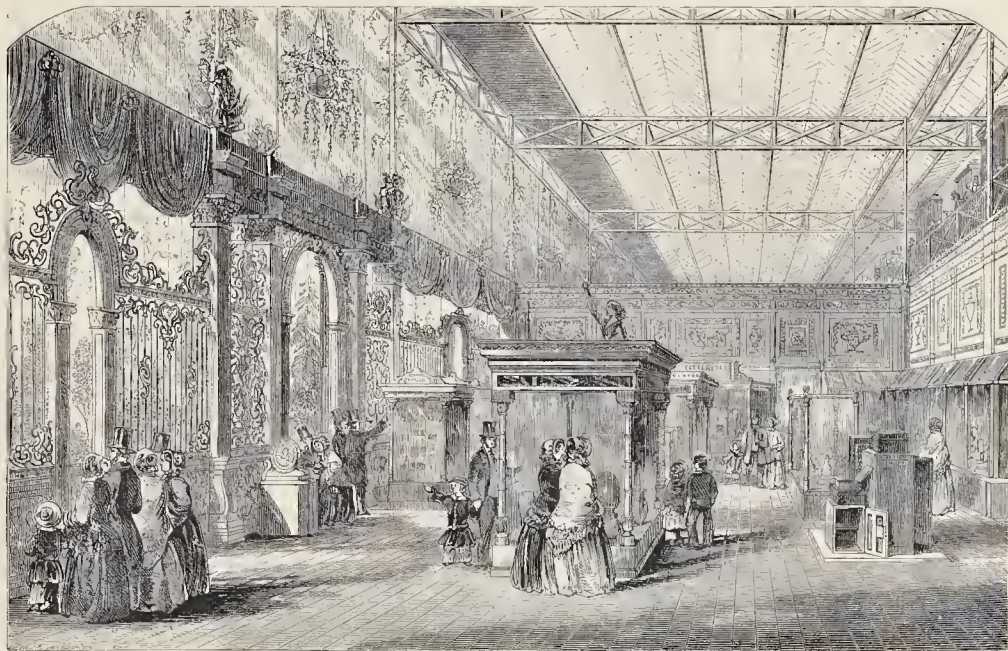

THE BIRMINGHAM COURT, CRYSTAL PALACE.

of comparatively few, except such as have been sent as assistants—are far less easily content with mediocrities than they used to be: to suppose otherwise would be to believe nature untrue.

Our allotted task this month is to introduce our readers to THE BIRMINGHAM COURT; it was designed by Mr. Tite; and its principal decorations are derived “from the uses of iron in architecture.” The panels are designed and executed by Mr. Sang. In the centre is a group in bronze, cast by Messrs. Elkington; the sculptor being Mr. John Thomas.

This is a work of considerable merit—of which, indeed, we have prepared an engraving, and it will ere long appear as one of the sculptural plates of the *Art Journal*. It tells the sad historic tale of “*Boadicea*.”

But, alas! in reporting the contents of this Court—THE BIRMINGHAM COURT—we are grievously restricted. When we consider what this great town could supply of its wealth in Art-manufacture, and see what it has supplied, we are vexed almost to the extent of indignation that so little is done for its proper and becoming representa-

tion. Except a reasonably good supply of electroplate utilities, contributed by Collis, and a few very creditable objects furnished by Mr. T. Wilkinson, there is nothing of the class of art in which Birmingham rivals Sheffield; while a few spoons and forks, the produce of the works of Messrs. Cope and Son, comprise the whole of an order of “goods” of which Birmingham issues millions every year. Surely, this is not as it ought to be! surely the manufacturers of Birmingham are, to say the least, short-sighted.

There is, indeed, one case of glass that will attract, as it ought to do, very general attention: it is the contribution of Messrs. LLOYD AND SUMMERFIELD. It is constructed to show the applicability of crystal bars or pillars to exhibition cases, as well as to windows, for which they were originally intended. Hence, the case has an appearance somewhat heavy, inasmuch as the pillars are of a size suited to large windows or shop fronts. Improvements have been, we understand, made in the manufacture—especially in the doors, which now move upon concealed hinges, impervious to air and dust. This principle of hollow glass bars grooved has been successfully adapted to fern cases and the aquarium, either for fresh or salt water. An example of this valuable and interesting production is exhibited, and engraved on this page: it is highly creditable to the manufacturers; and Messrs. Lloyd and Summerfield have thus conferred a boon of magnitude on the many who are making a home-enjoyment of the vivarium. It will be at once understood how much more elegant, and how much better suited to the drawing-room, is the aquarium composed

entirely of glass, than that of which the pillars and joints are of zinc or iron. We cannot say what is the cost of this beautiful acquisition; but if it be not much greater than that hitherto in use, a great success must follow a great improvement. The large glass case to which we have referred contains several choice examples of ent glass for table use; and on a table in another part of the Court will be found the medallion portrait of Prince Albert, for which Messrs. Lloyd and Summerfield obtained a medal at the Great Exhibition of 1851.

Before we enter the Birmingham Court, however, we will ask the courtesy of the reader to examine a few of the imitations of Irish fibulae (used as brooches), which, although their allotted place is in the gallery, properly belong to this branch of our subject. In our Catalogue of the Great Exhibition of 1851, and also in that which represented the Exhibition of 1853 in Dublin, we engraved several of these interesting works; additions are, however, frequently made to them, as new discoveries are made, or the stores of collectors are referred to. One of the latest and best is that which graces the "up-stairs" stall of Mr. Mahood, who is a dealer in those minor curiosities of Ireland which invite customers by their originality and agreeable variety—such as bracelets formed of the black bog-wood, brooches of Irish gems and pebbles, ornaments made of fish-scales, &c. &c. Such productions have obtained extensive and useful employment for a large number of artisans in Ireland, many of whom are self-taught. They are not often good as works of Art, but they are always interesting; and the sale of them is very serviceable to poor workmen and workwomen, who in that country seldom find occupation that is profitable. These little articles, however, added to the lace and croché, have been the sources of remunerative labour there, and the means of achieving a large amount of good. Every purchaser is, therefore, to some extent a benefactor to Ireland; for to employ the humbler classes of the Irish, is to render essential service to that country.

"The Talbot Brooch"—for that is the name given to Mr. Mahood's example, which we engrave—is so

called in honour of Lord Talbot de Malabide, who is the possessor of the original. In the ancient Breton laws it is stated that "the size and value of the *aicde argiot*, or silver brooch, should be in proportion to the rank of the wearer." The original

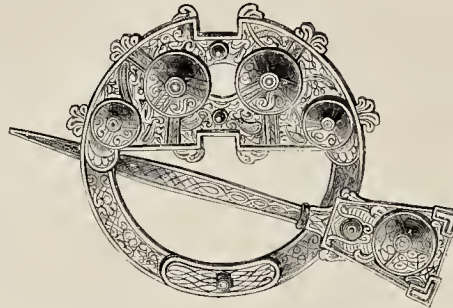

fibula being nearly five inches in diameter, of elegant design and workmanship, and one of the largest yet

apple, the animals and hieroglyphics on its surface, are all emblematic of matters connected with Irish history. The above is the exact size this interesting antique has been reproduced by Mr. Mahood, and which he exhibits in the Crystal Palace.

In the Birmingham Court there is a glass case, which contains several of the productions of the famous establishment of Messrs. Jenmens and Bettridge, who maintain their supremacy, and excite the admiration they deserve—for it is certain that as examples of papier maché manufacture they defy competition. We might engrave some of these with advantage, or reproduce a few of those which have already appeared in our pages; but having so lately exhibited some of their latest productions, we postpone to a future period illustrations of their merits.

A work in silver, executed as the "TESTIMONIAL" to DR. HASSALL, whose efforts for the public weal in reference to that necessity of mankind—food, have entitled him to public gratitude, is exhibited in this Court. It is produced by Messrs. BARNARD AND represents "Ithuriel touching the toad spear." The work is of high merit, it is admirably modelled, and may be classed among the foremost of those modern productions which have rescued testimonials from the character of commonplace. We regret that the name of the artist is not inscribed on the base of the statuette, for to him no doubt a large part of the honour belongs, although we have to acknowledge the services of the manufacturer in the cause of Art.

Notwithstanding these accessions, but for the very large collection contributed by Messrs. ELKINGTON AND MASON, the Birmingham Court would be conspicuous for poverty, and would certainly be discredit to the great town of iron. Their collection is so extensive, and in all respects so admirable, as almost of itself to repay a visit to the Crystal Palace.

Until the formation of the Birmingham Court, the productions of Messrs. Elkington and Co. could only be seen in the gallery of the Crystal Palace; a kind of systematic division has now taken place, which involves a visit both to the court and the gallery, by those who desire to have a perfect acquaintance with the numerous beautiful works exhibited by this firm. Some such division had indeed become necessary, from the primary arrangement made by the Directors, which excluded manufactures from those parts of the palace which the public generally visited; the consequence of this mistake was—a "mistake" to cast any impediment in the way of the manufacturing interest—that the stalls of the contributors of Industrial Art were comparatively unknown to, and unvisited by, many of those who daily and weekly throng to the Crystal Palace. To Messrs. Elkington it was especially unsatisfactory; they had in the gallery a most valuable and extensive display of articles, which might almost as well have been in their own workshops, for the benefit the manufacturers derived from exhibiting them at Sydenham. Even the division is not without some disadvantages, for the accommodation afforded in the Birmingham Court is so limited, that a large and important portion of their stock still remains in the corridor of the gallery.

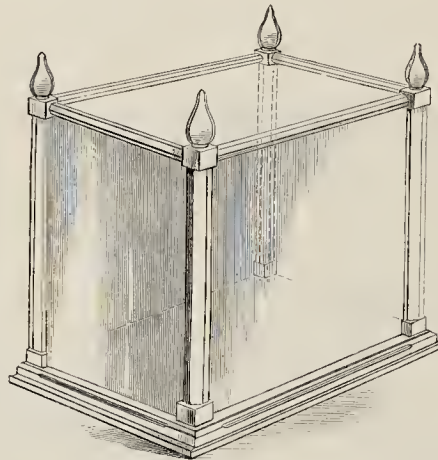

discovered, we are justified in describing it as an ornament worn by some Irish chieftain of the highest

rank. It is curious to inquire how, in such remote ages, the jewellers could design and execute an ornament of such taste, being very superior in many respects to similar ornaments of the present time. The tracery and representations of the serpent and



The "ILIAD SALVER"—of which we give an engraving on this page—is designed by Mr. Charles Grant, one of the artists employed by Messrs. Elkington, and does him infinite credit. It will be observed that the several compartments are bas-reliefs of subjects taken from the "Iliad:" the centre compartment representing "Thetis supplicating Jupiter to render the Greeks sensible of the wrongs done to Achilles;" the four angular compartments exhibiting her attendant nymphs. The subjects in the two small circular panels are, "Thetis consoling Achilles," and "Thetis brings to Achilles the armour

made by Vulcan." Of the bas-reliefs there are eight; the subjects of them are—"The Contest between Agamemnon and Achilles;" "The Heralds conducting Briseis from the tent of Achilles;" "The Greeks driven beyond their fortifications;" "Menelaus and Meriones, assisted by the Ajaxes, bearing

off the body of Patroclus to the ships;" "Achilles driving the Trojans from the intrenchments by showing himself on the walls;" "The grief of Achilles over the body of Patroclus;" "Achilles dragging the body of Hector round the walls of Troy;" "Priam soliciting from Achilles the body of his son Hector." These sculptured pictures—for such they are—show consummate skill in drawing; although many of them contain numerous figures, each is perfected with rare skill, and will bear the test of the minutest scrutiny as regards either composition or manipulation: the work, as will be seen,



THE ILIAD SALVER.

is very elaborate, and may be regarded as a proof of the capabilities of this establishment to encounter and overcome any difficulties.

On the succeeding page will be found engravings from some few of the excellent Art-manufactures to be seen in this Court; two of these engravings, the JUG and the WINE-COOLER, are not new to our readers, but they are so beautiful, and attract so much attention in the Court, that we felt it would have been unjust to the producers to omit them on the present occasion. The TANKARD, the VASE, and the FLOWER-STAND, are among the more recent contributions; they manifest the taste and superiority

of design which have gained for the artists employed by Messrs. Elkington such well-deserved credit, as well as the care and the skill which are identified with the labours of those whose duty it is to carry out the intentions of the designer. The manufacturers are at present engaged upon a variety of new works of this description, some of which we

expect to be able to afford our readers an idea of by means of engravings now in preparation, and which we hope to introduce at an early period.

The "Iliad Salver," although it is the latest, and perhaps the best, of the numerous salvers produced by Messrs. Elkington, is certainly not the only work of the kind which will interest the visitor: there are many others in the Court that will well repay close inspection; so too will the large collection of shields, vases, dishes, candelabra, statuettes, and bronzes of infinite variety, and for useful and ornamental purposes. We would particularly direct attention to the bronze groups, illustrative of

"Warwickshire History." Since those now in the Crystal Palace were executed, others have been produced, as "Guy of Warwick and the Dun Cow," the



"Lady Godiva riding through Coventry;" these have not yet made their appearance at Sydenham, though we



presume they will do so in time. The "Lady Godiva" has just paid a visit to the King of Belgium, at Brus-



sels, who expressed a great desire to see her ladyship; it has, we hear, elicited the admiration of all who have seen it, especially of the gentlemen of the turf, who

pronounce it one of the most splendid prizes ever seen on a race-course; for, we should remark, it was executed for a prize, and was won recently by Lord Clifden. We presume it will be reproduced by the manufacturers.

Referring to the exhibition of the works of Messrs. Elkington in the corridor of the gallery, we must point out the collection of life-size statues—all, if not most of them, from the sculptures of British artists: here is MacDowell's "Day-dream," Dur-



ham's "Fate of Genius," Thomas's "Rocket Player," the latter two exhibited in the Great Paris Exhibition; and others after Gibson, Weekes, Bell, Kirk, Cumberworth, &c. Perhaps nothing shows more the value of the electrotype process than these beautiful productions; year after year, since its introduction, have we seen it making sure and rapid progress,

beginning with ordinary objects of domestic use, till it has grappled with and overcome the greatest difficulties in its application to the highest embodiments of artistic conception; while the thoroughly



satisfactory result it has yielded has shown to the world that "Science has presented Art with an offspring of real genius, which has not only talent, but also courage and perseverance enough to fight

its own way." To Messrs. Elkington and Mason must be assigned a very large portion of the merit of electrotyping, and of the estimation in which works so executed are held all over the civilised world.

SUGGESTIONS OF SUBJECT
TO THE STUDENT IN ART.*

BY AN OLD TRAVELLER.

CHAPTER IX.

Turin the Magnificent—Piazza Castello—Piazza Madama—Triple of Martyrs—Catalan Girardet—Barthelemy Hector—Geoffrey Varaille—The Pastor of Anserogna—Midnight—A scene on the Ice—Keep at home!—Sclerithya—War in the Olden Time—The Captive—A Student—Alfred la Comeli—The Grief-Leeuwson.

Few cities present to the traveller a more cheerful aspect than is that first offered to his view by Turin; but how sorrowful are the recollections oppressing his heart as he traverses that fair metropolis of the Sardinian dominions! how gloomy are the pictures rising before him as he crosses the handsome squares of the city, or lingers beneath the long colonnades that surround the regal abodes of her kings!

Omitting all mention of matters purely political, we confine ourselves within the comparatively narrow limits of her ecclesiastical history, and even of that will touch only on the period when Francis I. of France was contending for supremacy in Piedmont with the Emperor Charles V.; yet see within how few mouths do we find the melancholy Triptica by whose lurid tints the heart is saddened, and all power of enjoyment suspended, as now we pace the superb length of the Piazza Castello, and cross that portion of the splendid square known in the present day as the Piazza Madama.

We are in the year 1535: the unhappy Waldenses—in our day, thanks to the improved spirit of the times and to their present sovereign, unhappy no more—have presented to Francis, then riding them, their humble "entreaties for some liberty of conscience;" but he replies to the effect that he had not "burnt heretics by hundreds, in all parts of France, with intent to suffer a reserve of their pernicious borders in the Alps." Here, accordingly, stands Catalan Girardet, one of the first to whom Francis gave proof of his determination to endure no heretic in the lauds under his rule: the pile of martyrdom awaits him; his ominous form is reared but a few short paces from the spot whereon we stand, in this proud and magnificent Piazza Castello. The noble sufferer is brought forth: he looks around on the assembled multitude, the congregated masses regarding him with mingled feelings of reverence and grief, or of contempt and exultation, as their modes of belief and the varieties of their character prompt them.

Passing between the martyr and the foremost ranks of the spectators is a labourer driving an ass, on whose back there are paucers filled with stones. From these Girardet has selected two; you perceive that he presses them between his hands: he is speaking, and these are the words he addresses to certain ecclesiastics standing prominently forward—men who were among the most active of his persecutors:—

"Ye think to destroy our churches by the might of your persecutions, but as soon shall my weak hands avail to crush these hard yielding stones."[†]

Here, too, did Barthelemy Hector; his offence the dissemination of the Scriptures; his fate such as that of Girardet—his last words ascribing "glory to God, for: that he was judged worthy to suffer death in so righteous a cause."[‡]

The same beautiful site, but a somewhat later period, furnishes your third picture, and shall complete the sorrowful series, as presented by these shining haunts of the gay and fair,—although in truth they do but form a very small part of the dreary spectacles to which the pompous dwellings rising around us have borne witness. It is Geoffrey Varaille who is now to suffer for the faith.

"The only son of a distinguished commander in the invading army of 1488," says our author,[§] "himself the inmate of a royal palace—first an admired courtier, and subsequently placed high among the most favoured members of the Catholic hierarchy, he is yet content to become the humble pastor of the despised Waldenses." And here, on the beautiful square before us, in this same Piazza

Castello, did he too seal his testimony with his life.

Unlike Girardet—whom we looked on ere yet the fetters had been placed around him—Geoffrey Varaille is fastened to the stake. He does not regard the bystanders; "the deep mysterious joy," declared by more than one eye-witness to have "irradiated his countenance" as he late addressed them, has given place to an expression of the tenderest pity; all his thoughts and care are at this moment devoted to the heart-broken creature whom you see beside him, the fatal cord falling from his nerveless grasp; to him "whose trembling hands," to cite the same authority, "were on that day to perform strange offices."[¶]

For the hapless executioner is no other than the faithful servant of Varaille; one who has attended him from his childhood, and whose aged form shall be made to quiver beneath the scourge of the persecutor—as his plying master but too well knows—when the cruel office here imposed on him shall have been performed.

Some influence, friendly to the martyr, or perchance the desire of his murderers to shorten his appeal to the multitude—thousands of whom bore subsequent testimony to his constancy—caused the severity of the sentence to be somewhat diminished in his case by strangulation, previous to the kindling of the flames. But by a refinement of cruelty, which makes the latter the more probable inference, and of which there is unhappily but too many instances in these annals, the attached servant of the martyr was the man doomed to effect this purpose. Furthermore, for he too has been fondly guilty of listening to the words of truth, the wages that await him are the loathsome dungeon, the scourge, the rack, and finally the branded brow, reducing him to a level with the convicted felon,—for to all these has the unhappy traveller here before you been already condemned.

During the same sorrowful period, but not within the walls of this fair city of Turin, did the Vandois pastor, Martin Gorin, assume that crown of martyrdom which his judges vainly exhorted him to forego; but the life they pressed on his acceptance must have been purchased by apostasy, and the noble confessor could not hesitate. Of him, too, we find mention in that history of the Waldenses so frequently cited, and it is in the following words that Miss Wilyams commences her narration of the facts relating to his death:—

"One of the most distinguished pastors of the poor scattered flock, Martin Gorin of Anserogna, was entrusted by his brethren with the conduct of certain ecclesiastical affairs, for the arrangement whereof he had repaired to Geneva: returning thence to the valleys, he was apprehended as a spy, but on examination was found innocent of the charge. His jailer searched him nevertheless, as he was about to leave the prison, when papers were discovered involving him in a charge still heavier. A spy might hope for mercy—a heretic never. The Vandois pastor was tried a second time; he was condemned to death by drowning, the sentence to be carried into effect amid the silence and darkness of night, on the 25th of April, 1536. In pursuance of that decree the missionary's burning light was quenched in the waves of the Isère."[¶]

There were circumstances of painful interest connected with this midnight murder," says our author, in conclusion; "but we will not dwell on those protracted agonies. The cold river of death has long been passed, and angels have welcomed the pilgrim on the other bank, and introduced him to the company of the redeemed."[‡]

To the painter who may choose this melancholy episode of a dark history for his theme, the Isère here offers some of the most picturesque features of its course: the artist will remember that it is night, and the general heaven is even lowering in darkness, but between two clouds, which she has richly fringed with silver, there appears the cold bright moon. A radiant belt of light is thus thrown across the distant reaches of the river, while that portion of its waters soon to be desecrated by an act of cruel wrong and violence, lies lurid beneath the torches wherewith those darksome ministers of

an evil will—in whose impure hands the martyr lies bound—have sought to diminish the perils besetting the latter portion of their way. These flash on wild rocks of varied hues; they call forth strange effects from all the objects, animate or inanimate, immediately surrounding the scene of crime and suffering; the former, comprising the executioners, their victim, and attendants, with a group concealed from them, and visible to the spectator only. On more than one face among those surrounding the doomed man you read pity and compunction; a youth is even gazing into the darkness beside him, as with the lingering hope that reason might yet be near. The martyr takes no part in these emotions; his fettered hands are clasped in prayer, but on his countenance is none of the agony of one who "wrestles with his God;" peace ineffable is beaming from that face of holy trust, and every beautiful feature—clearly revealed by the torches—is bright with that foretaste of heaven already vouchsafed to the servant of truth.

On the edge of the circle of light produced by the torches, and all but beyond their influence, three figures are concealed within the foliage; the depth of shadow prevents you from perceiving them until after close examination, but this given, you behold a woman on whose features there is the anguish of despair: she has fixed her dry and grief-hollowed eyes on the martyr, and your prayer for her is, that her soul—so manifestly wedded to his own—may be permitted to depart with it, and be at rest. Beside, or rather partially behind her, are two others, whose faces you do not see; but you discern the grey locks that shade the cheek of the one as she turns to support the sinking form of the other—a girl methinks, for her dark tresses, falling over the arm of her companion, can scarcely belong to aught but youth. The child perchance of the martyr! Almost is one tempted to echo the awful denunciation of that master in song, who, speaking of this hapless country somewhat more than a century later,—when the atrocities committed by the troops of Pianezza drew forth letters of remonstrance from Oliver Cromwell to its ruler, then Charles Emmanuel II., and to his wicked instigator, Louis XIV. of France,—burst forth in words that cannot be unknown to any one of you. I repeat them nevertheless, as does our author, from whose pages it is that I now take them,[¶] the latter lines excepted, which are there omitted:—

"Avenge, O Lord, thy slaughtered saints, whose bones
Lie scattered on the Alpine mountains cold;
E'en them who kept thy truth so pure of old
When all our fathers worshipped stocks and stones,
Forget not; in thy book record their groans
Who were thy sheep, and in their ancient fold
Slain by the bloody Piedmontese, that rolled
Mother with infant down the rocks. Their moans
The vales redoubled to the hills, and they
To heaven. Their martyred blood and ashes sow
O'er all the Italian fields, where still doth sway
The triple-tyrant: that from thence may grow
A hundred fold, who, having learned thy way,
Early may fly the Babylonian woe."[¶]

MURON.

"South and north" there is some one who is exclaiming; and he asks, "Have we nothing at home, that we should wander so far a-field?"

Quickly do we reply to the patriotic—or, if that be too sublime a word, to the jealous—querist, "We have, and in abundance." What do you say, for example, to another survey of the quaint old chroniclers? or, to begin with the beginning, will you go first to that region of fable within whose shadowy precincts the earliest annalist of every land finds the more remote of his researches ever prone to land him? Here, to commence with, is a picture grouped for us in very far-gone days, and by actors who did certainly not calculate on having their proceedings depicted in these present times. It has never been painted; but so much the better, and your story will look all the fresher in the eyes of the beholder for that circumstance: the facts are these.

Towards the close of the sixth century, and no long time after the foundation of East-Anglia into a monarchy by Uta, there lived a brave and powerful king of the Varni, to whose heir, called Radiger, was betrothed the East-Anglian princess, Sclerithya. But, subsequently preferring the alliance of Theodebert the Frank, whose sister was his own

* Continued from p. 268.

† See "History of the Waldensian Church," by Jane Louisa Wilyams, p. 112, et seq. London, 1852.

‡ See Miss Wilyams, *ut supra*.

* History of the Waldenses, chap. viii. p. 117.

† See "History of the Waldensian Church in the Valleys of Piedmont," book viii. p. 113.

* History, *ut supra*, book x. "The Slaughtered Church," p. 161.

wife, the king of the Varii compelled Prince Radiger to marry into the family of Thierri, King of Austrasia—now France—his betrothal to the lady of our land notwithstanding.

But the two Varnian chiefs had neglected to ask the consent of one person, whose goodwill was yet found to be essential to the peaceful conclusion of the business—this was no other than the East-Englian princess herself; and our gentle Scelthrytha—whose name, as the learned tell us, signifies nothing less than "an earnest threatener"—no sooner became aware of that oversight, than she resolved to make all parties repent of their omission: to that end she gave herself no repose until she had stirred up her countrymen to fall upon the people of the Varii with fire and sword.

But now, lest your displeasure with this lady, who so well knew how to assert her own rights, should influence you to the degree of rejecting her, as Prince Radiger did, I must remind you that the indignity she had suffered was then held to deprive the party enduring it of reputation; and the injured princess had no longer the right to hold up her head among the noble virgins and matrons of her nation, as one equally honourable with themselves. Your recollection of this will serve in some measure to excuse her in your eyes, as it did in those of her people, by whom it was considered so complete a justification, that they embarked heart and soul in her cause.

To no leader less profoundly interested than herself would the offended lady entrust the duty of avenging her. It is true that the fleet, in the foremost of whose galleys she sailed, was commanded by her brother, whom she commissioned to bring the principal culprit to her feet; but it was to herself that she reserved the right of inflicting the death she had already awarded to his crime.

Many battles ensued, but these I do not describe, although none who love such theme is forbidden to paint them: let it now suffice to say that our islanders were victorious; they cut all opposing them to pieces in the most approved method of the time, and returned to their lady with songs of triumph.

But the trophies laid before her were rejected with disdain; Scelthrytha drove her defenders from her presence with reproaches that did honour to her name: they had done nothing, the officiating Radiger was still at large, and until they had given him bond and helpless to her hand, let them look for little credit for their work.

Again the furious tribes of Suffolk and Norfolk were poured, a fiery stream, upon the shores of the Rhine; and when all had been rendered desolate to the gentle lady's fullest content, her enemy was himself found to be among her captives.

And now begins your work—if you have not already commenced it at some moment more congenial; and in that case now proceeds your pleasing toil, for you can scarcely refuse to paint me the scene we have before us.

She stands proudly within her tent—the beautiful rejected; the lofty stature she derives from her large-limbed race not surpassing the limits proper to the perfection of womanly beauty, and the whole figure utterly faultless in its richly-developed proportions. One finely moulded arm is raised with a most graceful action; the firm full hand—not hard of outline, or masculine in its character, as might have been, had Scelthrytha given evidence of cruelty in any cause less sacred than the defence of her honour—but most feminine in its soft flexible form, and of colour and texture such as ivory might exhibit, were the spirit of a blush-rose breathing through its veins: this irrepensible hand, I say, is lifting aside the heavy clusters of her hair—a sunny brown—and gives to view a clear candid brow, beneath which there beam two lustrous eyes, well opened, beautifully formed, and now fixed with unflinching steadfastness of gaze on the features of the doomed Radiger.

He, too, is of noble port and lonely presence; he stands before her with a glance direct and fearless as her own. The axes of her people are uplifted for his death; they glitter coldly, they quiver in the hands that unwillingly restrain them, impatient of delay. Did he now seek her pardon, did he bend beneath the haughty looks that question his own, did he move so much as an eyebrow as the menacing weapons rise bright around him, she would doubt-

less give the signal for them to fall, and the days of Radiger would find their end. But the proud, firm gaze she bends on him is met by one yet firmer: nay, after looking for some few seconds at the handsome face before him, the captive prince, unmindful of the gleaming axes, begins to change the look of bold defiance with which he had first sought the eyes of his enemy, for one of frank admiration and delight; he has forgotten all but the radiant loveliness of that bright vision, and the captor, fairly baffled, feels a blush threatening to steal over the whiteness of her brow: this time not entirely of anger.

Conscious then, perchance, to that approach of manifest defeat—for her terrors have clearly failed to make her enemy quail—perchance, too, remembering that the offensive marriage of Radiger had been forced upon him for purposes purely political, and was not of his own seeking, the lady closes her scrutiny by waving a sign to her warriors, who draw back to the utmost limits of the pavilion, and she is at liberty to confer with her captive.

The words of their dialogue I am not prepared to repeat, but the result of it was, that the sister of Theodebert was sent back to Austrasia, and the East-Englian princess, returning as the wife of her southerner foe, considered herself to have worthily vindicated her name from the reproach that might have fallen upon it, and felt that she might henceforth hold her head well up among the noblest matrons of her country.*

And now, may not the semblance of this handsome pair and their surroundings help to make us a picture worthy of its place in some fair gallery? You will treat the subject in such sort as shall ensure it welcome in the highest—there can be no doubt of that. For the eyes of our Scelthrytha, what is their colour?—through those long silky lashes, and in certain lights, they look almost black, yet black they are not—"over-gods forbode!" they are not even grey, although they might be such with less to startle one's sense of the right and fitting; and the rather as grey eyes, supposing them of the right colour and quality, have also that property of looking black which some admire; but oh! better than all blackness—unless it be that of the large eastern eye, which, by the way, is *not* black—is *your* colour, ye thoughtful and earnest eyes of grey. But Scelthrytha's eyes are not grey, they are blue, and if they have not that rare and priceless tinge of the violet which proves that love, deep as the love of seraphs, is in the nature of the possessor, and quickening every pulse of the true and steadfast heart below them, yet neither are they of that cold, glittering, snake-like hue sometimes called blue, but chiefly for lack of some more closely descriptive name for the colour, or rather no-colour, in whose steely paleness you see nought better than the concentration of self-worship. No; give my proud, resentful, nay, fierce, if it must be so, and cruel princess, no eye such as these; her orbs are blue, full-tinted, and, if without that hue of heaven aforesaid, the ever-blessed violet, that is because the distinction thereof is vouchsafed to few in the world we breathe in. Many shall wear it in a better region—'tis the faith we hold to; but here below, if you see it more than twice in a life-time, believe that you are favoured beyond your fellows. A good, bright, generous tone of blue then are the eyes for my Scelthrytha's wear, and here enough; the rest I leave to your excellent good judgment and never-to-be-questioned taste.

In the same work, and with relation to the most admired of our early sovereigns, I find an incident of later period, described by the friend and biographer of Alfred—the churchman Asser, namely—which has also a certain interest, as marking the habits of a man respecting whom we could scarcely know too much or see too many delineations in our galleries. The words, as altered somewhat for my present purpose, are these:—

Passing over the time, "when a young man, and of a youthful mind," as we learn from the reluctant

* The facts of this legend are taken from the Greek historian Ptolemy, an author not known to the present writer, by Mr. Sharon Turner, from whose "History of the Anglo-Saxons," and from Gibbon's "Decline and Fall of the Roman Empire," it was taken some years since for a work then published; it is from the last-mentioned publication, "Stories and Studies from Chronicle and History," namely, that the above has now been, not extracted, but adapted to the writer's present purpose.

admissions of his attached biographer, he would not hear the oppressed when they came to him, but treated the poor "as of no estimation," and when his kinsman St. Neot admonishes the king with all faithfulness, exhorting him to "cease from wandering in depraved manners," his sin "with alms to redeem, and with tears to abolish;" when the same unflinching monitor adds, "depart entirely from thine unrighteousness, or much shalt thou suffer in this life, and surely shalt thou be deprived of the kingdom thou art misruling." Passing this, nor yet lingering on that fulfilment of some portion thereof to be found in the sufferings endured from "that swain's evil wife, whom he feared because she would scold," as the same writers tell us, and the story of whose burnt bread is so well known, let us come to the time when, all youthful errors abjured, Alfred had won for himself the titles of "the just," "the wise," and "the truth-teller," even from those severe judges and true friends, of whose rectitude in his behalf you have proof above.

Many works of great importance to the future advancement and culture of his people have now proceeded from the pen of the learned monarch—singularly learned for his day, and it is as a student that I want you to set him before us. Thus it is that we have him. The time is a wild night in autumn of the year 893; the wind whistles fitfully through the many crevices of the royal abode and its ill-fitting doors and windows; the latter, but recently furnished with the luxury of horn panes, shake and rattle as the blast raves around them. The noble-looking occupant of the rude chamber suffers little interruption from this circumstance, but sometimes, as a gust of more than common violence comes raving through the building, his head, previously bent over his employment, is slightly raised, and a glance of satisfaction is given to the tall waxen tapers that supply him with light; these, steadily burning in the clear horn casings, which he had himself contrived for them, bid calm and successful defiance to the airs that, blowing unheeded around the head of the observer, were seen with pleasure to assail as vainly the good shelter he had invented for his light.

At one a lamp and a timepiece, the slender shaft now permits one of the small metal globes, attached to its length at equal distance, to drop with ringing sound into the brazen bowl prepared for its reception, thus giving King Alfred to know that the short time which alone his many avocations permitted him to bestow on the object then filling his thoughts was expended; and rising from a board whereon he had been tracing certain lines, segments of circles, &c., the foreshadowings of improvement contemplated in the naval architecture of the period, the earnest student lays his rough pencil aside.

He now gives the signal that an official, appointed for that hour, and who, as he doubted not, was waiting without, might enter his presence, when the Gerfa Lucamon—punctual, as is ever the servant of a master exact in the measurement of his own time—stands instantly before his lord.

But the marks of heavy care are on his brow, and his compressed lips are eloquent of something much amiss, although as yet no sound comes thence.

"Then it is true that the restless Hæsten hath left his lair on the Norman coast, and it is indeed to our own shores that the Sea-king shapes his course?" observes King Alfred, the face of the Gerfa* being a sufficiently speaking exponent of the information his master had sent him to gather, in consequence of rumours lately brought him.

"It is even so, noble king," replies Lucamon; "his ships are off the Kentish coast; already has he destroyed the forts constructing by your orders in the fens, and his barbarian hordes have well-nigh completed a strong line of defence along the Rother."

"He is a noble leader," rejoins the generous Alfred, "and must be worthily met. Behold! Sigeric and Ethelwyn come to share our council," he adds, as the thunes he mentions are seen entering the chamber. "Summon our trusted Ceolwulph,

* Gerfa; the officer bearing this name, from which it seems probable that we derive our modern "sheriff," was one of much consequence in the executive; but his duties were of a character so widely varied that we know of no office now existing that could be called strictly equivalent. There were three classes of gerfa. See "Stories and Studies from Chronicle and History," vol. 1. p. 124, & seq.

with the Bretwalda* Eithelwald; let our honoured kinsman Neot also know that we crave his presence; pray our good Asser to accompany him, and return thyself to take part in this matter."

"But see thou bring more cheerful looks with thee," continued the speaker, with a friendly smile; "thy wisdom hath added me through as dangerous a juncture: redoubled as this Hæsten is, fear not, my good Læmmon, thou shalt see me well through this, our best efforts, and the blessing of Heaven upon them to aid."

That the confidence thus expressed was well-founded, you will all remember, a series of victories followed; the wife and family of Hæsten, twice brought as prisoners to the presence of Alfred, were twice returned, with costly presents, to their natural protector, the beaten and baffled Sea-king; and the Danes, with their allies, the Frisians, were ultimately driven from the land.

Take now either or all of the scenes suggested by these events, unless you prefer the din of battle rather, and in that case you may depict the death of the Gericfa Læmmon, who fell to the lasting grief of Alfred, in the last battle fought on this occasion.

The fearful ravages to which the country had been exposed were followed by a pestilence that for three years "filled the nation with the bitter death of straw,"† offering but too many occasions for the exercise of those virtues which placed Alfred high among the greatest, if they did not render him the very greatest sovereign the world has ever produced.

THE BRITISH ASSOCIATION IN ITS RELATIONS TO ART.

The twenty-sixth meeting of the English Parliament of Science has recently been held at Cheltenham, under the presidency of Dr. Daubeny. A careful review of the proceedings has convinced us—notwithstanding the cry which we have heard, that science shows no signs of progress—that a healthful vitality stirs the body of philosophers; and plodding industry is displayed on every hand, gradually developing those beautiful truths, by the accumulation of which man advances to a knowledge of nature's grandest laws.

The *Art-Journal* is not the place in which to discuss the numerous matters brought before the respective sections; yet a brief notice of the general bearings of the questions brought under consideration, showing their practical value, and a more especial comment on those points which have any relation to Art, cannot fail to interest its readers.

In the address of the president many most important advances in chemical and botanical science are fully explained. As botanist and chemist, Professor Daubeny has wisely chosen to dwell more fully on his own departments of science, rather than to wander into those domains of physical investigation with which he cannot claim such intimate acquaintance. The rapid progress made in organic chemistry was clearly shown; the useful products which it has already given us explained; and the probable results of the inquiries, which are pushed forward with much energy, detailed with much exactness.

When the British Association commenced its useful labours, all—of chemistry—that could be quoted as worthy the name of a science was comprehended within the limits of the mineral kingdom. "Here, at least," continues the president, "the outline had been traced out with sufficient precision; the general laws

established on a firm basis; the nomenclature framed with logical exactness; the facts consistent with each other, and presented in a scientific and luminous form. Thus, a philosopher, like Sir Humphrey Davy, who had contributed in so eminent a degree to bring the science into this satisfactory condition, might, at the close of his career, have despaired of adding anything worthy of his name to the domain of chemistry, and sighed for other worlds to subdue. But there was a world almost as little known to the chemists of that period as was the western hemisphere to the Macedonian conqueror—a world comprising an infinite variety of important products, called into existence by the mysterious operation of the vital principle, and therefore placed, as was imagined, almost beyond the reach of experimental research. This is the new world of chemistry, which the continental philosophers, in the first instance, and subsequently those of our own country, have, during the last twenty years, been busy in exploring; and, by so doing, have not only bridged over the gulf which had before separated, by an impassable barrier, the kingdoms of inorganic and of organic nature, but, also, have added provinces as extensive and as fertile as those we were in possession of before, to the patrimony of science."

Many of the discoveries in organic chemistry will at once occur to all. The production of fruit essences, for example, from the waste matters of cities, and of the perfumes of flowers from the refuse of manufactories, are now well known; our fancy soaps and cheap confectionery deriving their odour and their flavour from these sources. From the putrifying heaps of the dye-works, a colour rivaling in brilliancy the original madder reds is now extracted; and we may reasonably hope within a very short period to be enabled to reproduce in our laboratories all those useful products which have hitherto been obtained only direct from natural sources. In discoursing on these advances of chemistry, Dr. Daubeny says, "Already, indeed, chemistry has given tokens of her powers, by threatening to alter the course of commerce. Thus, she has discovered, it is said, a substitute for the cochineal insect in a beautiful dye producible from guano. She has shown that our supply of food might be obtained at a cheaper rate from the antipodes, by simply boiling down the juices of the flesh of cattle, now wasted and thrown aside in these countries, and importing the extract in a state of concentration. She has pointed out that one of the earths which constitute the principal material of our globe, contains a metal as light as glass, as malleable and as ductile as copper, and as little liable to rust as silver; thus possessing properties so valuable, that when means have been found of separating it economically from its ore, it will be capable of superseding the metals in common use, and thus of rendering metallurgy an employment, not of certain districts only, but of every part of the earth to which science and civilisation have penetrated."

The beauty of the lakes and carnines rendered them especially valuable to the artist. It has ever been a matter of regret that such pigments should not possess the desired degree of permanence. It is said that the colour obtained from the guano has the valued persistence, and that, as far as experiment has been able to determine the problem, its resistance of atmospheric and luminous influences is great. The metal aluminium promises to be available for many purposes in the Arts. At present, owing to its high price, this beautiful metal has only been employed in the manufacture of watch wheels, by a maker in Paris, in the formation of small weights (for this purpose its lightness renders it exceedingly valuable), and for coating some of the more delicate philoso-

phical instruments. Aluminium is now nearly the price of gold. This arises from the cost of production, the process being, in brief, as follows:—From pure clay—such as the finest porcelain clay—a chloride of alumina, is formed; this is exposed to heat, in a closed vessel, in contact with sodium; by this the aluminium is liberated and distilled over. Sodium is, it is well known, obtained from commercial soda; and as the production of aluminium depends upon the cost of sodium, it cannot but be interesting to know that this singular metal is said to be obtained by a chemist of Glasgow at five shillings the pound, and that it is expected that it may be manufactured at even less than this. When this manufacture comes fairly into operation we may expect to obtain aluminium at less cost than silver; and endless are the Art-applications of this metal, which exists in every variety of clay spread over the surface of our globe.

The Stereoscope has largely engaged our attention; there are, however, some curious points connected with the instrument, and bearing on the phenomena of vision, which are not satisfactorily explained. Mr. Claudet brought before the physical section some remarks on the refraction which occurs in semi-lenses, tending to explain the cause of the illusion of curvature given to pictures representing flat surfaces. It was shown that all vertical lines, seen through prisms or half-lenses—which are virtually the same in physical character—are bent, presenting their concave side to the thin edge of the prism, and, as the two photographic pictures are bent in the same manner, the inevitable result of their coalescence, in the stereoscope, is a concave surface. It is proposed to obviate this; and the suggestion is deserving of every attention by those in possession of these pleasing instruments. By employing the centre of the lenses *only* to examine the two pictures, the defect is overcome. The centre of the lenses do not, however, refract laterally the two images, consequently their coincidence cannot take place without placing the optical axes in such a position that they are nearly parallel, as if we were looking at some very distant object—such as the moon. By practice, there are but few persons who could not use such a stereoscope. Mr. Claudet, by a simple experiment, illustrates the above conditions. If, holding in each hand a prism, a person looks through their thin edges at the window from the opposite side of the room, he will see, first, two windows, with their vertical lines bent in contrary directions; but by inclining gradually the optical axes, we can converge them until the two images coalesce, and we see only one window; as soon as they coincide the lateral curvature of the vertical lines ceases, and they are bent projectively front back to front: we have, then, the illusion of a window concave towards the room, such as it would appear reflected by a concave mirror.

A process for introducing clouds and artistic effects into photographs engaged the attention of the physical section. The pictures produced were very pleasing; but it must not be forgotten that they were printed from a *negative*, which had been so far tampered with as to lose all its photographic character. The gentleman communicating this subject, Mr. E. Vivian, speaks of enabling the photographer to *compose* pictures in accordance with the rules of Art, without the least sacrifice of detail, or departure from the truth of the original negative, *so far as the latter is true to nature*. Nothing can possibly be more dangerous to photography or more detrimental to Art than this. The truth of the solar picture is to be sacrificed to the fancy of the artist; and the work of Art is to be degraded to the mechanical process of "supplying the deficiency of the yellow ray, modifying the excessive action of

* The Bretwalda was a leader of high command, whether in peace or war.

† Among the fierce Northmen of those days all who did not die in battle were said to "die a straw death," the expression, if uttered in scorn, not infrequently procuring for either the offending utterer, or the affronted listener—nay, sometimes perhaps for both—an exemption from the disgrace and bitterness thereof, by the more violent and more congenial mode of ending life consequent on the quarrel thus occasioned.

the blue, toning down its glare, and mending the *unnatural* whiteness of slate roofs and water."

Photography has its proper field; and within its legitimate limits there are few applications of science which take a wider range or produce more beautiful effects. The defects of a photograph are well known; but these are compensated by that truthfulness of detail now so reliable. We value a photographic picture of the Temple of Minerva for that fidelity which the human hand cannot attain to; we treasure a "sun-picture" of Thermopylae, or of the plain of Marathon, not as we would treasure a Turner-esque picture of these hallowed spots, but for the *mechanical* truth which gives us the minutest objects on the scene. The lover of photography desires no artistic effects beyond those which he can obtain by a careful study of nature, and close observation of those physical conditions which exist in the marvellous sun-beam. If once the photographer is permitted to *paint* in shadows, and *rub* out lights, we may have pretty positive pictures, but all the interest of the art is gone.

To Art, photography is a dangerous handmaid; the true artist may use photography as a study of nature's grouping and detail; but if he goes beyond this the result is injurious. In the Exhibitions of the Royal Academy, and of Water-Colour paintings, there have been too many evidences of the uses made of photography. Much of the minute and often admired detail seen in the foregrounds of the landscape-painter—the reedy pool and the ferny comb—are too evidently the produce of the camera-obscure. Minute-ness has been gained in the pictures—mind has been lost.

Mr. Nasmyth made some observations on the form usually attributed to lightning by painters in works of Art, both ancient and modern. He said the differences which he had observed between the electric flash of the artist and the same phenomena in nature were very considerable. He believed the error to originate in the form given to the thunderbolt in the hands of Jove, as sculptured by the Greeks. The form of lightning, as exhibited in nature, was simply an irregular curved line, shooting from the earth below to the cloud above, and often continued from the cloud downwards again to another distant part of the earth. This appearance was conceived to be the result of the rapidly shooting point of light, which constituted the true lightning, leaving on the eye the impression of the path it traced. In very intense lightning offshoots of an arborescent form may be observed to proceed at several places from the primary track of the flash. There are many of these great natural phenomena to which it is extremely desirable that the attention of the landscape-painter should be directed.

Mr. H. R. Twining exhibited models to illustrate a new method of teaching perspective. The advantages of a knowledge of the principles of perspective to every one—even those learning to draw—are too obvious to be insisted on. Mr. Twining's principle has many points of great merit. He arranges his solid forms in an agreeable manner; and places an image in the exact spot which the observer ought to occupy, and which serves to mark the true focus of the picture. Thus is obtained a combination by which perspective principles can be studied in all their detail.

In connection with the phenomena of colour there were several communications. Dichromatic phenomena are scarcely known to artists; yet they are constantly occurring in nature, and are frequently observable in the productions of Art and manufacture. The German poet and philosopher, Goethe, has, with his usual perception, dealt with this somewhat complicated subject. The chapter on these phenomena, in Eastlake's translation of Goethe's

"Theory of Colours," deserves close attention. There was one communication by Dr. Gladstone on some dichromatic phenomena among solutions, and the means of representing them, which detailed many remarkable facts as to the power possessed by fluids under different chemical conditions of transmitting some rays and reflecting others.

The theory of compound colours, with especial reference to mixtures of blue and yellow light, was the subject of a communication from Mr. J. C. Maxwell. The principal point of the paper was to prove that, although mixtures of blue and yellow pigments made green, that the green ray of the spectrum was not—as is frequently stated—the result of a combination of the blue and yellow rays. Plateau, J. D. Forbes, and Helmholtz, have severally drawn attention to the fact that when we whirl a disc upon which the two colours blue and yellow are painted, the result is not a green, but a neutral grey. Mr. Maxwell had another paper, "On the unequal sensibility of the *fovea centralis* to light of different colours." This paper can scarcely be said to have any artistic bearing; but as explaining the want of sensibility in some eyes to colours of a particular order, it was of interest.

The communication of the session—regarded as to its scientific value and practical application—was that of Mr. Bessemer on his new method of manufacturing iron, by which all the laborious operations of the puddling furnace are avoided. The importance of this metal—iron—to this country, entering as it does into every branch of our manufactures, renders any discovery by which it can be produced in a purer state, at a much cheaper rate than ordinary, of the first moment. Although Great Britain possesses an abundant supply of iron ores of various kinds, and an almost unlimited supply of fuel, yet the British iron has only in a few instances proved equal to the iron of Sweden and of Russia. The superiority of these foreign irons has been thought to be due to the charcoal fuel employed; and the charcoal iron of the Ulverstone furnaces has been considered equal to the Swedish. It would appear, however, that by the process of Mr. Bessemer, any of our irons can be rendered—either as steel iron or as bar iron—quite equal to that obtained from the Continent.

Our iron manufactures may one day form the subject of an article for this Journal; at present we have only to state that the process of Mr. Bessemer—which has created much sensation in the iron trade—consists in forcing air through molten iron immediately after it is drawn from the blast furnace. The operation of this is remarkable. The oxygen of the air, combining with the carbon which is always mixed with pig-iron, increases the combustion, and consequently the fluidity of the whole mass. Under the operation the fluid iron boils violently, and all the impurities which tend to the deterioration of the metal are thrown up to the surface in an oxidised state, or ejected as carbonic acid. It is said that in a short time steel of fine quality is obtained; and by continuing the process a little longer, refined iron of the purest nature.

Ornamental castings in iron, equal to those of Berlin, may now be easily produced in this country; and where we have hitherto been compelled to employ iron of inferior quality, we may now use steel, or metal of the most superior malleability. If the process of Mr. Bessemer—when tried on an extended scale—equals the experimental results obtained, this discovery will be one of the most valuable ever made in this important branch of human industry.

R. HUNT.

THE ROYAL PICTURES.

THE MADONNA.

Carlo Dolci, Painter. F. Hal, Engraver.
Size of the Picture, 10 in. by 8½ in.

CARLO DOLCI, as we learn from his friend and biographer, Baldinucci, was of a Florentine family, of whom his father Andrew, and his grandfather and uncle by his mother's side, Pietro and Bartolomeo Minari, were all painters, much esteemed in their native city. Carlo was born in Florence in 1616, and died there in 1686. At the age of four years he had the misfortune to lose his father, and his mother having a numerous family to support, placed him, when he was only nine years old, with Jacopo Vignali, who had studied in the school of Roselli, and acquired great reputation as a teacher. In four years, it is stated, he could paint so well that he attracted the attention of a distinguished amateur, Pietro de' Medici, who introduced him to the court of Florence, where he found constant and profitable employment. About the year 1670 he was invited to Tanspruck, to paint the portrait of Claudia, daughter of Ferdinand of Austria. On his return he became subject to attacks of melancholy, which continued at intervals till his death. He left behind him one son, who entered into holy orders, and seven daughters, one of whom, Agnes, painted in the style of her father.

Carlo Dolci, from the first, determined to paint none but sacred subjects. Baldinucci attributes his excellence to a special gift from heaven as the reward of his pious intentions. His pencil was, accordingly, employed chiefly on ideal portraits of the Madonna, Magdalens, and saints; they are characterised by pleasing and gentle expression, peculiar gracefulness, and a delicacy of execution which, for oil-painting, is carried to excess—the high finish and the texture of his pictures frequently giving to them a cold and artificial appearance. It is these qualities of refinement and finish that make his works so popular in Italy, where they have always been in great request among the wealthy religiousists as ornaments and objects of veneration in their private apartments. His pictures of this class, for which he was usually paid about 100 crowns, are extremely numerous, for he painted many duplicates, and all now realise very high prices; but copies also abound, which were principally made by his daughter Agnes and his pupils, Alessandro Lomi and Bartolomeo Mancini.

His principal pictures, of a class that scarcely belongs to portraiture, are—"Madonna and Child," and "St. Andrew praying at the Cross," both in the Pitti Palace, at Florence; "Christ breaking Bread," "St. Cecilia," and "Herodias," in the Royal Gallery of Dresden; "St. John the Evangelist," in the Berlin Museum; and the "Daughter of Herodias with the Head of John the Baptist," in Windsor Castle. The Earl of Ashburnham possesses a duplicate of the "St. Andrew," and the Marquis of Westminster one of the "Herodias," in the Dresden Gallery. Dr. Waagen asserts that the Marquis purchased his picture from Lord Ashburnham. The same author gives a list of twenty-eight pictures by Carlo Dolci in this country; the chief of which are—the "Virgin and Child," belonging to Mr. Wombwell; the "Nativity" and "Christ taking the Cross from Joseph," in the possession of Lord Cowper; the "Virgin and Child, with Saints," in Lord Ward's collection; the "Adoration of the Kings," at Blenheim, and the glorious half-length of the "Virgin with a Crown of Stars"—perhaps the finest example of the master in existence—in the same gallery; "Christ and the Woman of Samaria," in Mr. Harford's collection; a repetition of the Dresden picture, "Christ blessing the Bread," belonging to the Marquis of Exeter; another *replica* of the same work, in the possession of Mr. Methuen, of Corsham; and the "Marriage of St. Catherine," belonging to Earl Spencer.

The "Madonna" here engraved is in the collection at Windsor Castle; it is one of the many pictures of the same subject, and similarly treated, that exist in England and elsewhere; they are all easily recognised by the blue mantle covering the head. The Windsor picture is painted on copper.



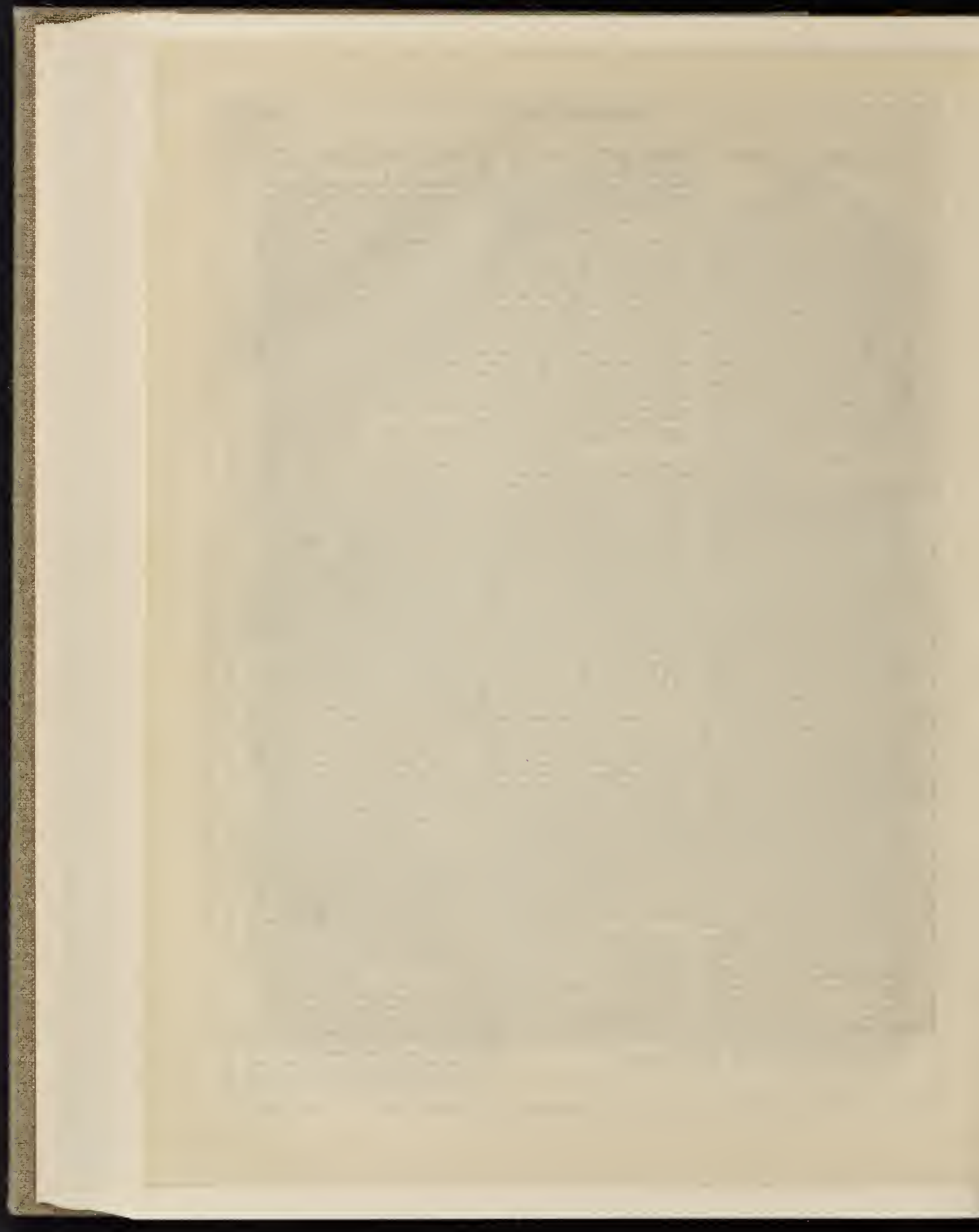



1868. PIN.

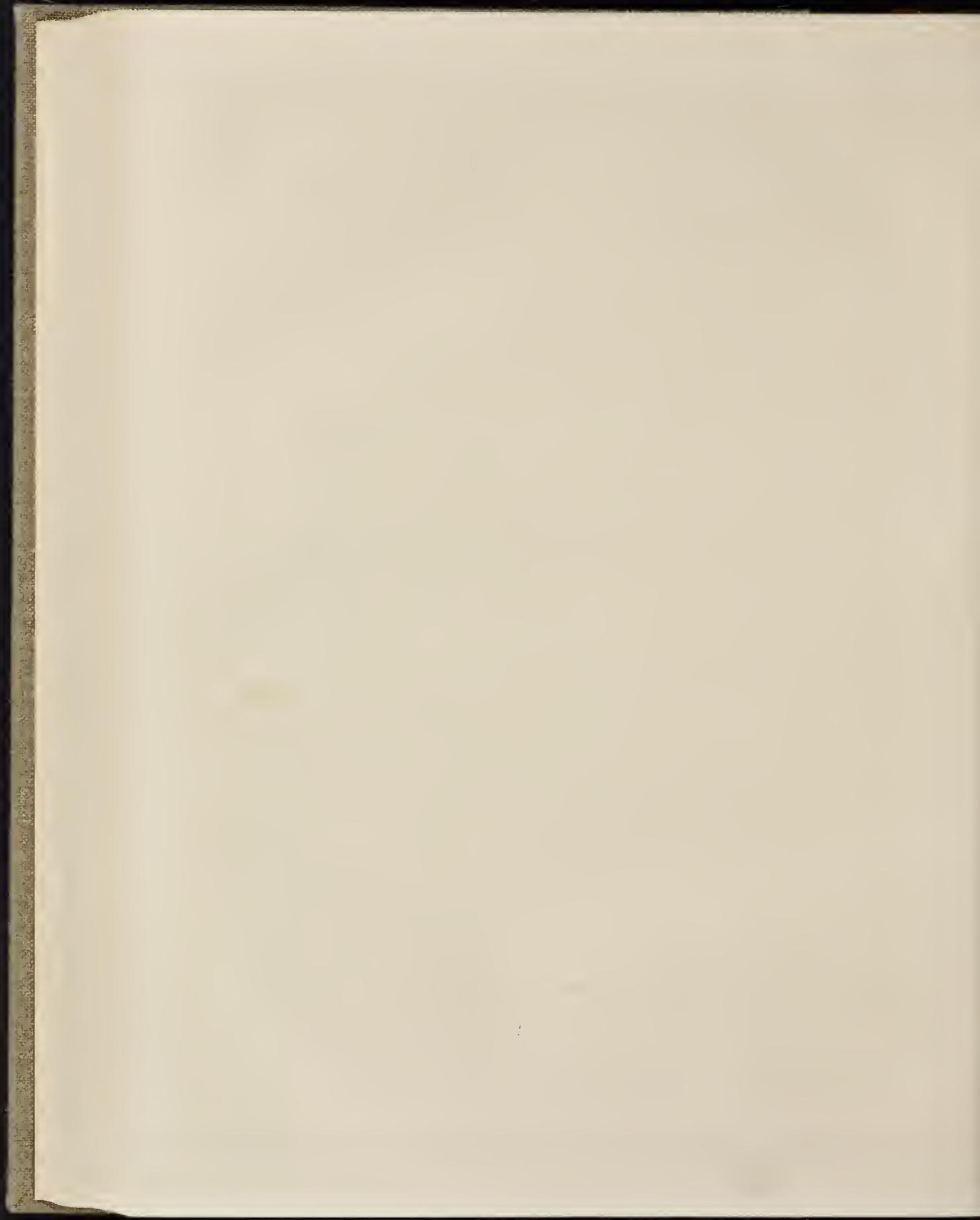

THE
MONKS OF THE MIDDLE AGES.*

BY THE REV. EDWARD L. CUTTS, B.A.

We have already sketched the history of the rise of monachism in the fourth century out of the groups of Egyptian eremites, and the rapid spread of the institution, under the rule of Basil, over Christendom; the adoption in the west of the new rule of Benedict in the sixth century; the rise of the reformed orders of Benedictines in the tenth and eleventh centuries; and the institution in the eleventh and twelfth centuries of a new group of orders under the milder discipline of the Augustinian rule. We come now to a class of monastics who are included under the Augustinian rule, since that rule formed the basis of their discipline, but whose striking features of difference from all other religious orders entitle them to be reckoned as a distinct class, under the designation of the Military Orders. When the history of the mendicant orders which arose in the thirteenth century has been read, it will be seen that these military orders formed the characteristic of the friars, as opposed to the contemplative religious spirit of the monks. But that which peculiarly characterises the military orders, is their adoption of the chivalrous crusading spirit of the age in which they arose: they were half friars, half crusaders.

The order of the KNIGHTS OF THE TEMPLE was founded at Jerusalem in 1118 A.D., during the interval between the first and second crusade, and in the reign of Baldwin I. Hugh de Payens, and eight other brave knights, in the presence of the king and his barons, and in the hands of the Patriarch, bound themselves into a fraternity which embraced the fundamental monastic vows of obedience, poverty, and chastity; and, in addition, as the special object of the fraternity, they undertook the task of escorting the companies of pilgrims from the coast up to Jerusalem, and thence on the usual tour to the Holy Places; for the open country was perpetually exposed to the incursions of irregular bands of Saracen and Turkish horsemen, and death or slavery was the fate which awaited any caravan of helpless pilgrims whom the infidel described as they swept over the plains, or whom they could waylay in the mountain passes. And, besides, the new knights undertook to wage a continual war in defence of the Cross against the infidel. The canon of the Temple at Jerusalem gave the new fraternity a piece of ground adjoining the Temple for the site of their home, and hence they took their name of Knights of the Temple; and they gradually acquired dependent houses, which were in fact strong castles, whose ruins may still be seen in many a strong place in Palestine. Ten years after, when Baldwin II. sent envoys to Europe to implore the aid of the Christian powers in support of his kingdom against the Saracens, Hugh de Payens was sent as one of the envoys. His order received the approval of the Council of Troyes, and of Pope Eugene III., and the patronage of St. Bernard, the great preacher of the second crusade; and when Hugh de Payens returned to Palestine, he was at the head of three hundred knights of the noblest houses of Europe, who had become members of the order. Endowments, too, for their support flowed in abundantly; and gradually the order established dependent houses on its estates in nearly every country of Europe. The order was introduced into England in the reign of King Stephen; at first its chief house, "the Temple," † was on the south side of Holborn, London, near Southampton Buildings; afterwards it was removed to Fleet Street, where the establishment still remains, long since converted to other uses; but the original church, with its round nave, after the form of the Church of the Holy Sepulchre at Jerusalem, still continues a monument of the wealth and grandeur of the ancient knights. They had only five other houses in England, which were called Preceptories, and were dependent upon the Temple in London.

The knights wore the usual armour of the period;

but while other knights wore the flowing surcoat of the twelfth or thirteenth centuries, or the tight-fitting jupon of the fourteenth, or the tabard of the fifteenth, of any colour which pleased their taste, and often embroidered with their armorial bearings, the knights of the Temple were distinguished by wearing this portion of their equipment of white, with a red cross over the breast; and over all a long flowing white mantle, with a red cross on the shoulder; they also wore the monastic tonsure. Their banner was of a black and white striped cloth, called *beuseant*, which word they adopted as a war-cry. The rule allowed three horses and a servant to each knight. Married knights were admitted, but there were no sisters of the order. The order was suppressed with circumstances of gross injustice and cruelty in the fourteenth century. The knight here given, from Hollar's plate, is a prior of the order, in armour of the thirteenth century, and the bulk of their estates was given to the Hospitallers.



A KNIGHT TEMPLAR.

The KNIGHTS OF ST. JOHN OF JERUSALEM, or the Knights Hospitallers, originally were a purely religious order, founded about 1092 by the merchants of Amalfi, in Italy, for the purpose of affording hospitality to pilgrims in the Holy Land. Their chief house, which was called the Hospital, was situated at Jerusalem, over against the Church of the Holy Sepulchre; and they had dependent hospitals in other places in the Holy Land, which were frequented by the pilgrims. Their kindness to the sick and wounded soldiers of the first crusade made them popular, and several of the crusading princes endowed them with estates; while many of the crusaders, instead of returning home, laid down their arms, and joined the brotherhood of the Hospital. During this period of their history their habit was a plain black robe, with a linen cross upon the left breast.

At length their endowments having become greater than the needs of their hospitals required, and incited by the example of the Templars, a little before established, Raymond de Puy, the then master of the hospital, offered to King Baldwin II. to reconstruct the order on the model of the Templars. From this time the two military orders formed a powerful standing army for the defence of the kingdom of Jerusalem.

When Palestine was finally lost to the Christians, the Knights of St. John passed into the Isle of Cyprus, afterwards to the Isle of Rhodes, and, finally, to the Isle of Malta, maintaining a constant warfare against the infidel, and doing good service in checking the westward progress of the Mohammedan arms. They are not even now extinct. The order was first introduced into England in the reign of Henry I., at Clerkenwell; which continued the principal house of the order in England, and was styled the Hospital. The Hospitallers had also dependent houses, called *Comanderies*, on many of their English estates, to the number of fifty-three in all. There were many sisters of the

order, but only one house of them in England. The superior of the order in England sat in Parliament, and was accounted the first lay baron. When on military duty the knights wore the ordinary armour of the period, with a red surcoat marked with a white cross on the breast, and a red mantle with a white cross on the shoulder. Their churches in England seem to have had circular naves, like those of the Templars; out of the four "round churches," which are all popularly attributed to the Templars, three really belonged to the Knights of the Hospital. The Hospitaller here given, from Hollar's plate, is a (not very good) representation of one in the armour of the early part of the fourteenth century, with the usual knight's *chapeau*, instead of the mail hood or the basinet, on his head.



A KNIGHT HOSPITALLER.

Other military orders, which never extended to England, were the order of TEUTONIC KNIGHTS, a fraternity similar to that of the Templars, but consisting entirely of Germans; and the order of OUR LADY OF MERCY, a Spanish knightly order in imitation of that of the *Trinitarians*.

Before turning from the monks to the friars, we must devote a brief sentence to the ALIEN PRIORIES. These were cells of foreign abbeys, founded upon estates which English proprietors had given to the foreign houses. After the expenses of the establishment had been defrayed, the surplus revenue, or a fixed sum in lieu of it, was remitted to the parent house abroad. There were over one hundred and twenty of them. Edward I., on the breaking out of war with France, seized upon them, in 1285, as belonging to the enemy. Edward II. appears to have pursued the same course; and, again, Edward III., in 1337, Henry IV. only reserved to himself, in time of war, what these houses had been accustomed to pay to the foreign abbeys in time of peace. But at length they were all dissolved by act of Parliament in the second year of Henry V., and their possessions were devoted for the most part to religious and charitable uses.

We have seen how for three centuries, from the beginning of the tenth to the end of the twelfth, a series of religious orders arose, each aiming at a more successful reproduction of the monastic ideal. The thirteenth century saw the rise of a new class of religious orders, actuated by a different principle from that of monachism. The principle of monachism, we have said, was seclusion from mankind, and abstraction from worldly affairs, for the sake of religious contemplation. To this end monasteries were founded in the wilds, far from the abodes of men; and he who least often suffered his feet or his thoughts to wander beyond the cloister was so far the best monk. The new principle which actuated the friars was that of devotion to the performance of active religious duties among mankind. Their houses were built in or near the great towns; and to the majority of the brethren the houses of the order were mere temporary resting-places, from which they issued to

* Continued from p. 287.

† All its houses were called *Temples*, as all the Christian houses were called *Charterhouses* (corrupted in England into *Charterhouses*).

make their journeys through town and country, preaching in the parish churches, or from the steps of the market-crosses, carrying their ministrations to every castle and every cottage. They were, in fact, home missionaries; and the zeal and earnestness of their early efforts, falling upon times when such an agency was greatly needed, produced very striking results. "Till the days of Martin Luther," says Sir James Stephen, "the church had never seen so great and effectual a reform as theirs. . . . Nothing in the histories of Wesley or of Whitfield can be compared with the enthusiasm which everywhere welcomed them, or with the immediate visible result of their labours." They took great pains to fit their followers for the office of preachers and teachers, sending them in large numbers to the universities, and founding colleges there for the reception of their students. With an admirable largeness of view, they did not confine their studies to theology, but cultivated the whole range of Science and Art, and so successful were they, that in a short time the professional chairs of the universities of Europe were almost monopolised by the learned members of the mendicant orders.* The constitutions required that no one should be licensed as a general preacher until he had studied theology for three years. Then a provincial or general chapter examined into his character and learning, and, if these were satisfactory, gave him his commission, either limiting his ministry to a certain district (whence he was called in English a *hiltown*, like Chaucer's Friar Hubert), or allowing him to exercise it where he listed (when he was called a *hister*). This authority to preach, and exercise other spiritual functions, necessarily brought the friars into collision with the parochial clergy; and while a learned and good friar would do much good in parishes which were cursed with an ignorant, or slothful, or wicked pastor, on the other hand, the inferior class of friars are accused of abusing their position by setting the people against their pastors, whose pulpits they usurped, and interfering injuriously with the discipline of the parishes into which they intruded. For it was not very long before the primitive purity and zeal of the mendicant orders began to deteriorate. This was inevitable; zeal and goodness cannot be perpetuated by a system; all human societies of superior pretensions gradually deteriorate, even as the Apostolic Church itself did. But there were peculiar circumstances in the system of the mendicant orders which tended to rapid deterioration. The profession of mendicancy tended to encourage the use of all those little paltry arts of popularity-hunting which injure the usefulness of a minister of religion, and lower his moral tone. The fact that an increased number of friars was a source of additional wealth to a convent, since it gave an increased number of collectors of alms for it, tended to make the convents less scrupulous as to the fitness of the men whom they admitted; so that we can believe the truth of the accusations of the old satirists, that dissolute, good-for-nothing fellows sought the friar's frock and cowl, for the license which it gave to lead a vagabond life, and levy contributions on the charitable. Such men could easily appropriate to themselves a portion of what was given them for the convent; and they had ample opportunity, away from the control of their ecclesiastical superiors, to spend their peculations in dissolute living. We may take, therefore, Chaucer's Friar John of the Sompuour's Tale as a type of a certain class of friars; but we must remember that at the same time there were many earnest, learned, and excellent men in the mendicant orders—even as Mawworm and John Wesley might flourish together in the same body.

The convents of friars were not independent bodies, like the Benedictine and Augustinian abbeys; each Order was an organised body, governed by the general of the order, and under him, by provincial

priors, priors of the convents, and their subordinate officials. There are usually reckoned four orders of friars—the Dominicans, Franciscans, Carmelites, and Augustines. They were called *Friars* because, out of humility, their founders would not have them called *Father* and *Dominus*, like the monks, but simply *Brother* (*Frater, Frère, Friar*).

The DOMINICANS and FRANCISCANS arose simultaneously at the beginning of the thirteenth century. Dominic, an Augustinian canon, a Spaniard of noble birth, was seized with a zeal for converting heretics,



FRIARS.

and having gradually associated a few ecclesiastics with him, he at length conceived the idea of founding an order of men who should spend their lives in preaching. Simultaneously, Francis, the son of a rich Italian merchant, was inspired with a like desire to establish a new order of men, who should spend their lives in preaching and doing good among the people. These two men met in Rome in the year 1215 A.D., and some attempt was made to induce them to unite their institutions in one; but Francis was unwilling, and the Pope sanctioned both. Both adopted the Augustinian rule, and both required not only that their followers personally should have no property, but also that they should not collectively as a body possess any property; their followers were to work



A DOMINICAN MONK.

for a livelihood, or to live on alms. The two orders retained something of the character of their founders; the Dominicans of the learned, energetic, dogmatic, and stern controversialist—defenders of the orthodox faith, not only by argument, but by the terrors of the Inquisition, which was in their hands, even as their master is said, rightly or wrongly, to have sanctioned the cruelties which were used against the Albigenses when his preaching had failed to convince them. The Franciscans retained something of the character of the pious, ardent, faithful enthusiast.

The wood-cut which we give of two friars with their names, DOMINIC and FRANCIS, inscribed over them, is taken from a representation in a MS. of the end of the thirteenth century (Sloan 346), of a legend of a vision of the Dominic related in the "Legenda Aurea," in which the Virgia Mary is deprecating the wrath of Christ, about to destroy the world for its iniquity, and presenting to him Dominic and Francis, with a promise that they will convert the world from its wickedness.

Dominic gave to his order the name of Preaching Friars; more commonly they were styled Dominicans; or, from the colour of their habits, Black Friars*—their habit consisting of a white tunic, fastened with a white girdle, over that a white scapular, and over all a black mantle and hood, and shoes; the lay brethren wore a black scapular. The Dominican nuns wore the same dress with a white veil. They had, according to the last edition of the "Mounsticon," fifty-eight houses in England.

The Franciscans were styled by their founder Fratri Minorī—lesser brothers, Friars Minor; they were more usually called Grey Friars, from the colour of their habits, or Cordeliers, from the knotted cord which formed their characteristic girdle. Their habit was originally a grey tunic with long loose sleeves, but not quite so loose as those of the Benedictines, a knotted cord for a girdle, and a black hood; the feet always bare, or only protected



A FRANCISCAN MONK.

by sandals. In the fifteenth century the colour of the habit was altered to a dark brown. The Franciscan nuns, or Minorresses, or Poor Clares, as they were sometimes called, from St. Clare, the patron saint and first nun of the order, wore the same habit as the monks, only with a black veil instead of a hood. The Franciscans were first introduced into England, at Canterbury, in the year 1223 A.D., and there were sixty-five houses of the order in England, besides four of minorresses.

While the Dominicans retained their unity of organisation to the last, the Franciscans divided into several branches, under the names of Minorites, Capuchins, Minims, Observants, Recoillets, &c.

The CARMELITE Friars had their origin, as their name indicates, in the East. According to their own traditions, ever since the days of Elijah, whom they claim as their founder, the rocks of Carmel have been inhabited by a succession of hermits, who have lived after the pattern of the great prophet. Their institution as an order of friars, however, dates from the beginning of the thirteenth century, when Albert, Patriarch of Jerusalem, gave them a rule, founded upon, but more severe than, that of St. Basil; and gave them a habit of white and red stripes, which, according to tradition, was the fashion of the wonder-working mantle of their prophet-founder. The order immediately spread into the West, and Pope Honorius III. sanctioned it, and changed the habit to a white frock over a dark brown tunic; and very soon after, the third general of the order, au

* In France, Jacobins.

* As an indication of their zeal in the pursuit of science it is only necessary to mention the names of Friar Roger Bacon, the Franciscan, and Friar Albert le-Grand (Albertus Magnus), the Dominican. They cultivated the Arts with equal zeal—some of the finest paintings in the world were executed for them, and their own orders produced artists of the highest excellence. Fra Giacopo da Turrata, a celebrated artist in mosaic of the thirteenth century, was a Franciscan, as was Fra Antonio da Negroponte, the painter; Fra Filippo Lippi, the painter, was a Carmelite; Fra Bartolomeo and Fra Angelico da Fiesole—than whom no man ever conceived more heavenly visions of spiritual loveliness and purity—were Dominicans.

Englishman, Simon Stork, added the scapulary, of the same colour as the tunic, by which they are to be distinguished from the Premonstratensian canons, whose habit is the same, except that it wants the scapulary. From the colour of the habit the popular English name for the Carmelites was the White



A CARMELITE MONK.

Friars. They were introduced into England, direct from Palestine, by Sir John de Vesci, in the early part of the thirteenth century, and became more popular in England than elsewhere in Europe, but they were never an influential order. They had ultimately fifty houses in England.

The AUSTIN FRIARS were founded in the middle of the thirteenth century. There were still at that time some small communities which were not enrolled among any of the great recognised orders, and a great number of hermits and solitaries, who lived under no rule at all. Pope Innocent IV. decreed that all these hermits, solitaries, and separate communities, should be incorporated into a new order, under the rule of St. Augustine, with some stricter clauses added, under the name of *Ermitti Augustini*, Hermits of St. Augustine, or, as they were popularly called, Austin Friars. Their exterior habit was a black gown with broad sleeves, girded with a leather belt, and black cloth hood. There were forty-five houses of them in England.

There were also some minor orders of friars, who do not need a detailed description. The Crutched (crossed) Friars, so called because they had a red cross on the back and breast of their blue habit, were introduced into England in the middle of the thirteenth century, and had ten houses here. The Friars de Penitentiâ, or Friars of the Sark, were introduced a little later, and had nine houses. And there were six other friaries of obscure orders. But all these minor mendicant orders, all except the four great orders, the Franciscans, Dominicans, Augustinians, and Carmelites, were suppressed by the Council of Lyons, A.D. 1370.

We have now completed our sketch of the rise of the religious orders, and of their general character; we have only to conclude this portion of our task with a brief history of their suppression in England. Henry VIII. had resolved to break with the pope; the religious orders were great upholders of the papal supremacy; the friars, especially, were called "the pope's militia;" the king resolved, therefore, upon the destruction of the friars. The pretext was a reform of the religious orders. At the end of the year 1535 a royal commission undertook the visitation of all the religious houses, above one thousand three hundred in number, including their cells and hospitals. They performed their task with incredible celerity—"the king's command was exceeding urgent;" and in ten weeks they presented their report. The small houses they reported to be full of irregularity and vice; while "in the great solemn monasteries, thanks be to God, religion was direct well observed and kept up." So the king's decree

went forth, and parliament ratified it, that all the religious houses of less than £200 annual value should be suppressed. This just caught all the friaries, and a few of the less powerful monasteries for the sake of impartiality. Perhaps the monks were not greatly moved at the destruction which had come upon their rivals; but their turn very speedily came. They were not suppressed forcibly; but they were induced to surrender. The patronage of most of the abbeys was in the king's hands, or under his control. He induced some of the abbots by threats or cajolery, and the offer of place and pension, to surrender their abbatial offices only, into which he placed creatures of his own, who completed the surrender. Some few intractable abbots—like those of Reading, Glastonbury, and St. John's Colchester, who would do neither one nor the other, were found guilty of high treason—no difficult matter when it had been made high treason by act of Parliament to "publish in words" that the king was "an heretic, schismatic, or tyrant"—and they were disposed of by hanging, drawing, and quartering. The Hospitaliers of Clerkenwell were still more difficult to deal with, and required a special act of Parliament to suppress them. Those who gave no trouble were rewarded with bishoprics, livings, and pensions; the rest were turned adrift on the wide world, to dig, or beg, or starve. We do not defend the principle of monasticism; and it is not our business now to inquire whether, with the altered times of the Church, the day of usefulness of the monasteries had not passed. But we cannot restrain an expression of indignation at the shameless, reckless plunder which ensued. The commissioners suggested, and Bishop Latimer entreated in vain that two or three monasteries should be left in every shire for religious, and learned, and charitable uses; they were all shared among the king and his courtiers. The magnificent churches were pulled down; the libraries, of inestimable value, were destroyed; the alms which the monks gave to the poor, the hospitals which they maintained for the old and impotent, the infirmaries for the sick, and the schools for the people—all went in the hands of the monasteries, were swallowed up indiscriminately—they were not men to strain at such gossamers while they were swallowing camels—some three thousand parishes, including those of the most populous and important towns, were left impoverished to this day. No wonder that the fountains of public munificence in England have been dried up ever since; and the course of modern legislation is not calculated to set them again a-drawing.

ODE FOR THE INAUGURATION OF FRANKLIN'S STATUE.

SEPTEMBER 17, 1856.

GIVE welcome to his sculptured form!

The artist's perfect work is done,—

Here let him stand, in light and storm,

Our sea-girt city's greatest son.

His lineage sprung from honest toil,

Swart Labour trained his youthful hand,—

Want led him from his native soil,—

Where first he breathed let Franklin stand.

His genius stamped the Press with power;

His glance the glowing future saw;

His science carbed the fiery shower;

His wisdom stood with Peace and Law.

The world his story long has shrined,—

To Fame his spotless deeds belong;

His homely truth, his ample mind,

His Saxon hate of human wrong.

Room for the grey-haired patriot-sage!

For here his mental life began,—

Thus let him look, from age to age—

And prompt new Thought, ennobling man.

J. T. FIELDS.

Boston, U. S.

OBITUARY.

SIR RICHARD WESTMACOTT, R.A., D.C.L.

A VACANCY occurs among the members of the Royal Academy by the death of Sir Richard Westmacott, R.A.: this veteran sculptor died at his residence in South Audley Street, on the 1st of September, in the eighty-third year of his age.

It is now nearly twenty years since the public has seen any new work from the hand of this sculptor, but his previous life was one of great activity; a large number of the national monuments and statues of the period were executed by him, as well as of ideal subjects commissioned by private individuals: in fact, for some years he and Chantrey engrossed a very considerable portion of the patronage of the public in their art,—for though the death of Flaxman did not take place till 1826, his works of a former character were comparatively few during the closing period of his life.

London has been the birthplace of many of our greatest sculptors—Wilton, Banks, Nollekens, Bacon; the metropolis has also a certain right to claim Flaxman, for though he chanced to be born in York, while his parents were staying there for a short period, London was their home, and hither the embryo sculptor was brought soon after his birth. To this list must be added Westmacott, who was born in 1775, in Mount Street, Grosvenor Square, where his father, a man of education, carried on the business of a statuary. The son, showing early signs of the talent which after years developed, was instructed by his father in the elements of his art, and was then sent to Rome, in 1793. There he entered the studio of Canova, under whom he made such progress, that he obtained the first gold medal from the Academy of St. Luke, for a bas-relief of a subject in the history of "Joseph and his Brethren," the year following his arrival in Rome; the prize was one offered by the Pope. In the next year he received a prize from the Academy at Florence, and was elected a member of that institution. Having passed about five years among the Art-treasuries and schools of Italy, he returned to London, and established himself in London, not far from the residence of his father; unwilling, however, that love affairs and matrimony should at any future time distract his thoughts from his profession, and occupy the time that ought to be devoted to it, he at once, though only twenty years of age, married both "wisely and well," the lady being the daughter of Dr. Wilkinson. The young sculptor soon rose into public favour, his reputation having mainly arisen, according to a statement in the *Literary Gazette*, "upon the occasion of a design for some public work being thrown open to general competition. Westmacott's design was so remarkable as to induce the judges to issue a second and higher prize for studies of the same subject." In 1805 he was elected Associate of the Royal Academy, and Academician in 1812.* In 1827 he was appointed Professor of Sculpture at the Academy in the room of Flaxman, and held the office till his decease, although his last lectures were delivered in 1854. He received the honour of knighthood in 1837, and was made a D.C.L. of Oxford in the same year.

The principal public works executed by Westmacott are the monuments to Sir Ralph Abercromby, Lord Duane, Lord Collingwood, Sir Isaac Brock, Captain Cook, General Gibbs, and General Pakenham, in St. Paul's; the statues of Addison, Pitt, and Sir John Malcolm, in Westminster Abbey; the monuments to the Duke of Montpensier, Mrs. Warren, Spencer Perceval, and General Villettes, also in Westminster Abbey; the statue of Lord Erskine, in the old hall of Lincoln's Inn; of Locke, in the library of University College; of the Duke of York, on the column in Pall-Mall; and of the late Duke of Bedford, and of Fox, in Russell and

* All the public journals that have noticed the death of this sculptor, so far as they have been seen by us, give 1814 as the date of his election into the Academy; but on referring to our file of catalogues, which does not, however, extend so far back as that year, we find in some of a more recent date that the work he presented on his election—"Ganymede," an *alto-relievo* in marble—is dated 1812; the same year stands also against the diploma works of James Ward, Sir Robert Smirke, E. H. Baily, and the late H. Jones, F. Reubens, and Sir J. Walsh. It is scarcely probable Westmacott would have given his diploma sculpture four years before his election.

Bloomsbury Squares respectively; of Nelson, in the Liverpool Exchange; the colossal Achilles, in Hyde Park; a monument to Warren Hastings, in the Cathedral of Calcutta; and, conjointly with Flaxman and Baily, a portion of the figures on the frieze of the marble arch removed from Buckingham Palace to Cumberland Gate; and the sculptured pediment in front of the British Museum.

Of his principal ideal works we may point out his "Psyche," and "Cupid," in the possession of the Duke of Bedford; the "Distressed Mother," executed in 1832, and now in the possession of the Marquis of Lansdowne; the "Happy Mother," exhibited in 1835; "Euphrosyne," executed for the late Marquis of Westminster—all of which have been engraved in the *Art-Journal*: "A Nymph preparing for the Bath," in the collection of the Earl of Carlisle; a "Sleeping Infant," in the possession of the Countess of Dunmore; a group entitled "The Dream of Horace," an *alto-relievo*, exhibited in 1825, under the title of "Afflicted Peasants;" "Devotion," a statue in marble, exhibited in 1835; a "Gypsy," in 1833; "The Abolition of the Suttees," a group in bronze for the pedestal to a statue of the late Lord W. Bentinck; a beautiful *basso-relievo*, exhibited in 1820, entitled "Maternal Affection," part of a monument erected in Hursi Church, Berkshire, to the memory of a lady; "Cupid Captive," exhibited in 1827, now at Petworth: nor must the *basso-relievo* be forgotten which ornaments the pedestal of the statue of Addison; it represents the "Muses," and displays much taste and gracefulness of design, with care and delicacy of execution. A monument to the late Countess of Rockingham is another of Westmacott's monumental compositions that is much admired.

With the exception of the "Psyche," which belongs to the "Canova School" of sculpture, the works of Sir R. Westmacott have more of the feeling of the old Roman sculptors, than of the artists of a later period; that is, they exhibit simplicity of style almost approaching to severity, rather than the graceful and softened expression which is generally the characteristic of modern sculpture, and, in a higher degree, of the works of the Greeks in their best time; he was less idealistic than naturalistic, even in his imaginative subjects. He utterly rejected all superfluities of ornament, everything approaching to a florid style, and was satisfied to present his figure as the result of a thoughtful, reflective mind, rather than of one under the influence of poetical imagery; and yet he was far from being prosaic. His purity of taste, and his knowledge of what constitute the highest qualities of his art, elevated him as much above the poverty of the one as it restrained him within a reasonable expression of the luxuriance of the other. If he never reached the highest points of grandeur or beauty, he was always chaste, dignified, and impressive.

Sir R. Westmacott's lectures at the Academy were indicative of the scholar; in simple, yet forcible, language he set forth the knowledge he had acquired by the study of the antique; without any attempt at rhetorical display, he gained the attention of his audience by the truth and earnestness of his remarks. We presume his son, Mr. R. Westmacott, R.A., will succeed him in the professor's chair—a distinction to which he is eminently entitled: for the Academy has no better scholar, nor any more accomplished gentleman.

M. JEAN MARIE ST. EVE.

We record, with much regret, the recent death, in Paris, of M. St. Eve, a French engraver of very considerable talent, whose "St. Catherine," after Guido, appeared in our last publication. He engraved several plates from the works of Raffaele, and, at the time of his death, was engaged upon a large plate, a commission from the French Government. His decease was not altogether unexpected, as he had been, for some time past, in a very delicate state of health. He was in the forty-sixth year of his age.

* This very beautiful and affecting group was originally executed for a monument to Mrs. Warren, widow of the Bishop of Bangor; but when exhibited at the Academy, the Marquis of Lansdowne so greatly admired it, that he solicited to have it surrendered to him. The request was courteously acceded to, and a duplicate was afterwards finished for the monument. A third group has subsequently been executed for Mrs. Ferguson, of Beal, near Raith, in Scotland. *Vide Art-Journal*, 1849.

ART IN CONTINENTAL STATES.

PARIS.—The church of Notre Dame was completely painted and decorated for the ceremony of baptising the young prince; the decoration has been left, in order to judge of its effect, with a view to its being properly executed if after due deliberation it is approved of; the opinion seems at present to be that it detracts from the solemnity of a Gothic cathedral.—A group in marble, by Emile Charroux, has been placed in the Versailles Gallery, representing "Queen Hortensia educating Louis-Napoleon in 1822." The minister of state has commissioned M. Lazerge a picture of the Emperor distributing money to the sufferers at Lyons.—M. Raffel has received an order from the Archduchess Sophia for five drawings.—In digging a foundation at Troyes, a magnificent mosaic for a saloon has been discovered in perfect preservation; it is of the period of the third or fourth century.—The Museum of Nancy has been enriched with four medallion portraits of Prince Charles, Madame Charlotte, Madame Elizabeth, and Marie Antoinette; they formerly belonged to the last unfortunate royal lady.—M. A. Fould has purchased for the Government the statue of "Angelica chained to the Rock," by M. Trapheme.—A collection of drawings has also been purchased, for a sum of 24,000 francs, for the Louvre; it is known under the title of the "Collection Valardi, of Milan," and consists principally of drawings of the early schools of Florence, Bologna, and Milan, including six by Leonardo da Vinci.—M. Amarty Duval has finished the decorations of the Church of St. Germain en Laye; the subjects chosen by the artist are—the "Sermon on the Mount," the "Good Samaritan," the "First Place at Table," the "Parable of the Vineyard," the "Prodigal Son," and "Christ crucified;" they are executed in *rescso*.—Several pictures have been ordered by the Government, and will be placed in the gallery of Versailles: M. Glazie received a commission to paint the "Distribution of the Eagles;" M. Jalsbert, the "Visit of Queen Victoria;" M. Larivière, the "Entry of the President into Paris;" M. Ange Tessier, the "Completion of the Louvre;" Mademoiselle Rosa Bonheur is engaged on a large canvas, the subject of which is "Spanish Contrabandists." M. Antigna has proceeded to the scene of the late inundations on the Loire, to collect materials for a large picture commissioned by the Government, representing the "Emperor at Traiazé relieving the Distressed."

BERLIN.—The King has commanded that the marble statues of the heroes of the Seven Years' War, which ornament the Wilhelmsplatz, shall be reproduced in bronze, as they were beginning to be much discoloured, and to exhibit symptoms of decay. The models for those of Ziethen and Seidlitz are completed, and they will be followed by those of Dessau and Keith. Schwerin and Winterfeld, who have been presented in Roman costume, will be remodelled by Kiss in the costume of their time. The pendant to Kiss's Amazon, and intended to be placed on the other side of the entrance to the Museum, is in progress under the hand of the sculptor Albert Wolff. It represents a naked youth mounted on a horse, and contending successfully against a lion that has attacked him.

ROME.—Signor Zahris, director of the Papal Academy of Arts, has just sent to Ripa Grande, to be conveyed to Civita Vecchia for shipment to St. Petersburg, the last portion of a work of extreme colossal dimensions. For many years nothing on so large a scale has been executed at Rome, as it exceeds in size even Crawford's Washington. The subject of the work is the athlete Milo in his last moments—he who was victor in the games at Delphi in the 50th Olympiad. He is said to have possessed such bodily strength as to bear on his shoulders a living ox across the arena, and slay the animal with his fist. In his advanced age, he saw an oak by the way-side partially riven, perhaps by lightning, and he conceived the idea of severing the tree entirely; he made the attempt, but in the effort his arm became fixed in the cleft of the unyielding tree, and he, thus helpless, became the prey of a wild beast. The subject has often been treated by sculptors, but never on such a scale as this.

VENICE.—Mr. Parker has purchased from the proprietors of the Manfredi Collection a number of works, among which are the famous "Giorgione," one of the *chefs-d'œuvre* of the collection, also the Perdonnes, the portrait of Avisto, by Titian, and others at the price of 8000 anecchi. The Academy of Venice is treating with the proprietor of the gallery for the purchase of other works, for which purpose the Emperor of Austria has placed a considerable sum of money at the disposal of the Academy.

BRUSSELS.—The artists of Brussels have just founded a Water-Colour Society similar to those in England.

TITANIA.

FROM THE BAS-RELIEF BY F. M. MILLER, IN THE POSSESSION OF J. H. FOLLY, A.R.A.

WE introduce an engraving from this small but elegant example of sculpture with more than an ordinary feeling of pleasure, for the original is the result of a commission given by one sculptor, who has justly achieved fame and honour, to a younger brother artist, who has yet a name to win. Mr. Foley, having seen the plaster model of the work, immediately requested that it might be executed for him in marble, and has caused it to be inserted, as a pendant, in a piece of furniture in his drawing-room.

"A Midsummer Night's Dream," in which, as all are presumed to know, Titania is ushered into our world, has always been admired as one of the most marvellous creations of Shakspeare. The most eloquent critics and the most subtle metaphysicians have confessed their total want of power to analyse its beauties. One can no more divide and detail its parts than we can separate the colours of the rainbow—it is a *dream*. As the reader peruses the play he attempts to rouse himself from the beautiful vision, and to test his real vitality by some tangible effort. The boundary line between mind and matter is so imperceptibly fine that actual existence seems an enigma. Whether the poet intended to convey to his readers the spirit of the season we love so intensely under the name of "Summer," or to place before us, as in a mirror, the contrast between Material and Intellectual Beauty—the one liable to decay and death, the other imperishable and infinite—or between Ignorance and Knowledge, may be a matter for argument or speculation. The tendency of such illustrations of Shakspeare that before us must be to enlighten and to elevate, by awakening the reflective powers, enlarging the ideas, and alluring mankind to as much solid earthly happiness as is founded upon moral purity and a love of the simple beauties of nature.

Few of the writings of our immortal dramatist present so many varied subjects for the painter and sculptor as "A Midsummer Night's Dream," though there are in it scenes and characters which would almost baffle the power of any artist to illustrate. The fairies, however, are not among the number; a refined and poetical imagination may hold converse with the "tiny people," though, to quote the poet's own ideas in another play, they "feed not upon the same meat as ourselves;" and may not we suppose that a group of them was at the side of the sculptor when, with a gracefulness almost Atheian, he portrayed the spouse of Oberon, slumbering in beauty—

"Quite o'er-canopied with luscious woodbine,
With sweet mask-roses, and with eglantine—"

beneath the soft moonbeams of a summer night? Her subjects, the elves, have crept into acorn cups, or have hidden themselves beneath hellebore, or have climbed up the stem of the foxglove, and laid down in its purple flowerets. The queen, whose jealous husband has squeezed the juice of flowers on her eyelids, having cast aside her diadem—the pearls of which are dewdrops—and her sceptre—

"The graceful stem of some fair plant"—

reposes on a bed of leaves, exquisitely beautiful in form and arrangement, with a flower-bud for her pillow. The sculptor, with a refinement of feeling that proves his true and thorough appreciation of Shakspeare, has, by a few dextrous, yet perfectly natural, curves of the foliage, traced the form of an angel's wing beneath the round and polished shoulder.

The conception of this work is, to our minds, eminently beautiful; the delicacy of the composition is equalled, we think, by the gracefulness with which it is carried out, and the disposition of light and shadow renders the whole subject most effective. The sculptor has judiciously placed the limbs in that easy, careless position which suggests to the mind's eye that it is not merely a dream which the fairy queen is enjoying, but "A Midsummer Night's Dream"—lulled into slumber by "the melodies of the spheres" and on a couch fragrant with the sweets of a thousand flowers.



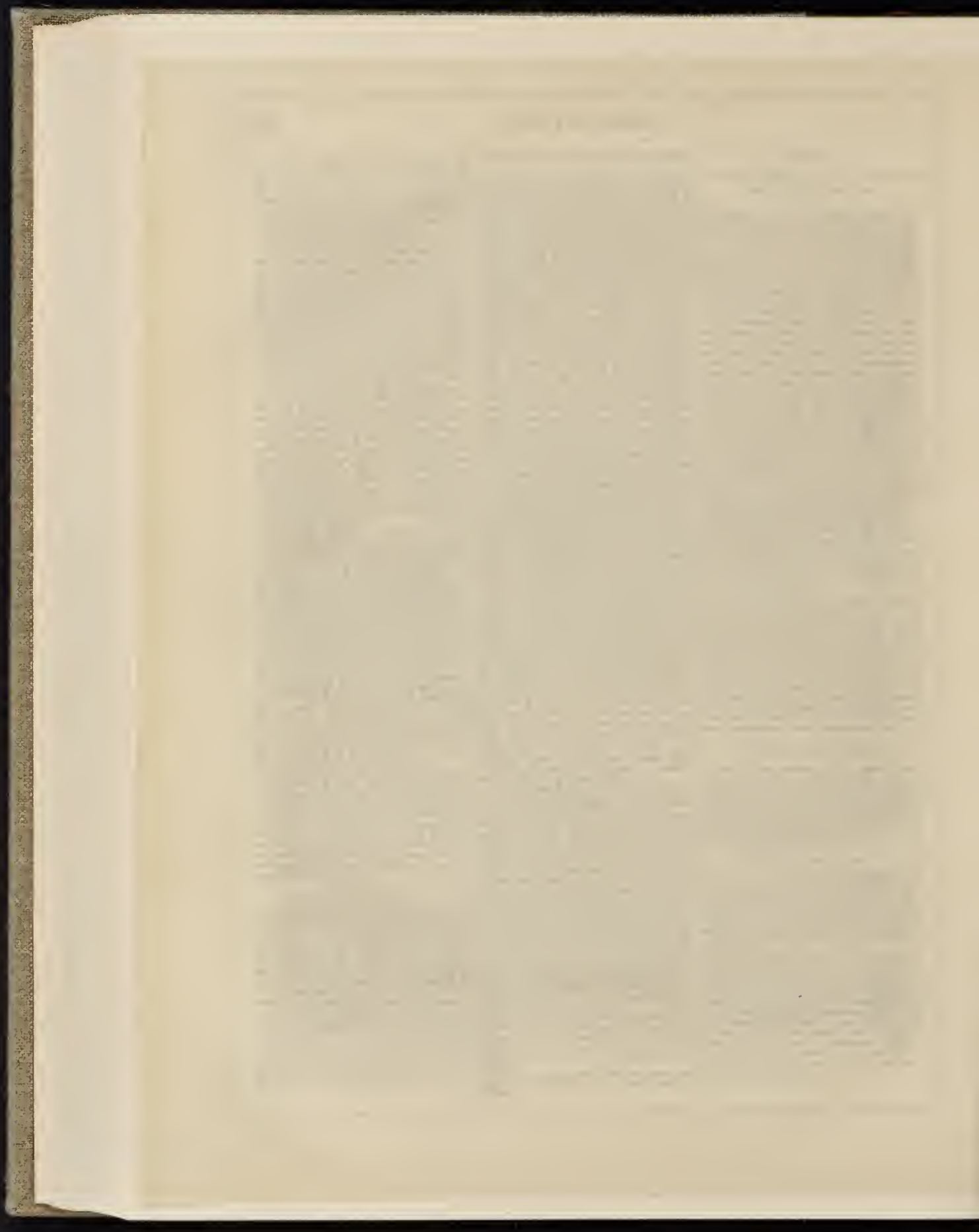



TITANIA

ENGRAVED BY J. H. BAKER FROM THE BAS-RELIEF BY F. M. MILLER

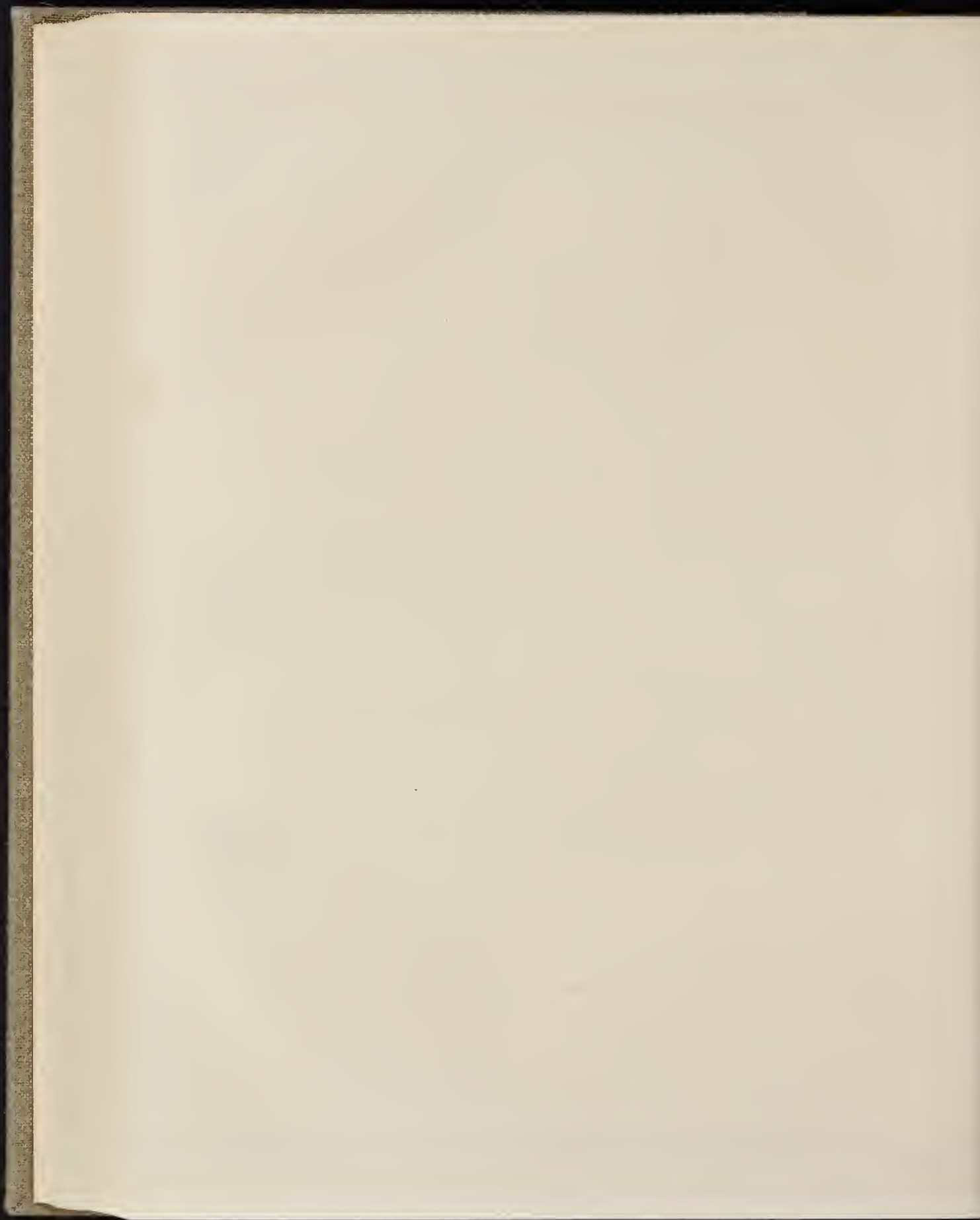

THE MANCHESTER MECHANICS' INSTITUTION:
ITS INAUGURATION.

THE Mechanics' Institution of Manchester is now a structure as aristocratic in character as any modern edifice of the kingdom; it is the result of no sudden enthusiasm, the birth of no accident; but the growth of thought and labour, energy and enterprise; and its members are well entitled to the monument they have raised—an ornament and an honour to the great city of commerce and manufacture. Although we believe very few of these "members" are actually "mechanics," they are no doubt generally of the class for whose mental improvement it is a solemn duty to provide: such provision has been made in that liberal spirit which characterises all the movements in Manchester. Its wealth is great; it has been obtained by no wild speculation, nor by any spasmodic effort, but by continual toil—perhaps, indeed, by toil overmuch; but nowhere is there to be found a more valuable illustration of the proverb, "diligence maketh rich." It is "grand," in the better sense of the term, to note the large number of costly buildings rising in every quarter of the city; and especially so in reference to those prodigious warehouses in which the graces of architecture are added to those of necessity or convenience. "Institutions" are increasing, national monuments are accumulating, the perpetually-brought streets are assuming a character of elegance; and from having been among the cleanest and "dirtiest" town of England, Manchester has become already a city in which wealth has combined with taste, in which public spirit has gone hand in hand with prudence, and judgment has laboured as the coadjutor of liberality. The quarter in which stands the New Manchester Mechanics' Institution has less than other parts been subjected to improvement; but ere long, no doubt, it will be the centre of an assemblage of structures dignified and graceful in motive and in appearance. The building is rather appropriate than fine; it is impressive from its stern simplicity, and does credit to the architect, the late Mr. Grogan, who carefully studied fitness and propriety. Its exterior is that of a building designed to accommodate a third or fourth generation of those who erect it. The several rooms—lecture-rooms, class-rooms, &c.—are spacious, admirably constructed as to light and sound, and partake of the general character of the edifice—that of substantial convenience.

Our business, however, at this moment is with the Exhibition of Art and Art-Industry by which it was inaugurated.—"The Exhibition was projected for the double purpose of contributing to the intellectual improvement and æsthetic enjoyment of those who may visit it, and also of obtaining money to liquidate the debt which rests on the Institution. There have been five previous exhibitions in connection with the old institution, which were progressively successful, realising to it a considerable amount of pecuniary profit, and affording no small degree of gratification to many thousands of persons."

The ceremony of inaugurating the new building took place on the 9th of September; the domestic loss which the prime-minister has sustained prevented his being present—a circumstance very prejudicial to the society, and for which it is to be hoped his lordship will make compensation by honouring the Institution with a visit during the autumn or winter—for we believe its exhibition will continue open for six months. Instead, therefore, of an imposing ceremony, as intended, the proceedings were confined to a brief address by the president, Oliver Heywood, Esq., who spoke entirely to the purpose, with much good sense, and occasionally with a degree of earnestness amounting almost to eloquence, in the presence of a very large number of the magnates of the city. He commenced by a brief reference to the origin of the building:—

"We thought that the past history of the institution, which was among the earliest of its class, and which has contributed so largely to the intellectual, social, and moral improvement of the community, might be traced with interest and advantage from its day of small things, during a long and successful career, until when, self-supporting, free from debt, with 1600 members, of whom 900 were in regular attendance at its day and evening

classes, and with a library of 16,000 volumes, with an annual circulation of 55,000 volumes, the building which it had occupied for a quarter of a century—let it be remembered to the credit of Manchester that it was the first erected in this country for such a purpose—was found inadequate to meet the demands of a growing community, and an appeal was made for assistance to enable us to provide accommodation for those to whom, for lack of space in Cooper Street, we were under a necessity of refusing admittance into the classes. With what success, you see!"

He continued:—

"The Exhibition which we open to-day is the fifth which has been undertaken, and successfully carried out, by the directors of this institution. Their fame is long gone by, eclipsed by the grander conceptions of later times—by the exhibitions of London, Dublin, and Paris, yet Manchester may recollect with pride that she was the first to set the example of these industrial exhibitions, and that the announcement which the directors were able to make at the conclusion of the first, now twenty years ago, that although, after having been visited by upwards of 60,000 people, it had closed without wilful injury to any single article exhibited, led to the opening of the museum and other institutions in the town, and was the circumstance upon which Mr. Hume, in the House of Commons, grounded his motion for the opening of the British Museum."*

The national anthem having been sung, the exhibition was formally declared to be open, and the assemblage divided to walk through the rooms and examine their contents. We shall follow them. The exhibition, though not supplied with a very varied collection of the works of Art-Industry, has this strong recommendation—it contains the best productions of the best manufacturers; such contributors as Hancock, Elkington, Minton, Copeland, Jackson and Graham, Whitehead, the Colebrook Dale Company, Jenons & Bettridge, &c. &c., have expressed their respect for Manchester, and their value of its judgment, by selecting nothing upon the "it will do" principle, but have forwarded the choicest specimens of their several establishments. Consequently, as a practical lesson to those who examine the exhibition for study, it will be of the highest importance.

As usual, the first days were partly occupied in unpacking; the contribution of "the Emperor" was late, yet in sufficient time to be displayed at the opening, at three o'clock, although an hour or two previously all things seemed in confusion; labour, however, was not left to hired hands, the committee "set to with a will," and although many additions have been since made, and works are daily arriving, yet the visitors, in traversing the rooms, saw what was amply sufficient to justify a warm congratulation to the directors on the very elegant and appropriate inauguration of the New Mechanics' Institute—to which in the course of a few months its members will remove.

Immediately on entering a sufficiently spacious hall, and at the foot of a wide stone staircase, is the news and reading-room; here have been placed, arranged on a circular stand, about forty of the fine productions of Sévres—sent by express order of the Emperor of France: they are of varied character, from the *petite toilet* service to the huge vase six feet high. Besides these are several "paintings on porcelain," of the highest possible interest, and a number of examples of the beautiful work of Beauvais—the latter gracing one of the wide passages which lead from the reading-room to the principal entrance. In this room also are several bronze pilasters and lamps, contributed by Mr. Potts, of Birmingham; several doors and panels of much excellence, by Messrs. Crowther and Son, of Manchester; a small collection of articles in hardened Indian-rubber; some table tops and pillars in glass mosaic, by Mr. Steverson, of Pinlloe; a recess con-

* The president paid a well-merited compliment to the directors:—"I should like, too, to say that during the four years it has been my privilege to preside over this institution, the average attendance at the board, which consists of eighteen members, has been seventeen, and for the present year they have on no occasion met less than the full complement of eighteen, saving the misfortune of one member absent from sickness, and one only from an unavoidable engagement." We ourselves may bear testimony to the energetic exertions of those who were entrusted with the arrangement of the exhibition, and the placing in order of the various contributions; and especially we are bound to attribute to the merit of the diligent secretaries, Mr. HENNINGSON, who deserves and will receive the thanks of all parties—the society, the exhibitors, and the public.

tains the famous silk hangings, table-covers, &c., of Messrs. Houldsworth, of Manchester. But unquestionably the most attractive and important feature in this division of the building is supplied by the works of the justly renowned establishment at Colebrook Dale. The apartment is partially divided by gates of much elegance, suited for the entrance to grounds of ordinary character; they are of comparatively small cost; the design is purely Italian, and present a happy mingling of strength and lightness. It is worthy of record that these gates were in pig-iron only a week before they were placed in the position they now occupy. To give anything like a detail of the several objects contributed by this company is out of the question; it must suffice to say that they consist of vases, table ornaments, kitchen ranges, chimney-pieces, garden fountains, garden chairs, tables, chandeliers, sun-dials, fenders, and numerous others, all of great excellence in design, and of workmanship so skillful as fairly to rival the best of their competitors in bronze. But the company employ not only good and skilful artisans—they apply for models to the best artists; and foremost among those of whose aid they have wisely availed themselves is Mr. John Bell, whose mind is perceptible in various works, from the beautiful statue which sustains the fountain to the stand which is to contain the umbrella. For the perseverance they have exhibited, the liberality they have displayed, and the accomplished skill with which every department of these famous works is conducted, their directors deserve the honours they receive, and the success by which their labours have been rewarded.

A passage, occupied, as we have observed, by the exquisite productions of Beauvais, leads into a beautiful drawing-room, fitted up by Messrs. Jackson and Graham, and containing the cabinet which obtained not only golden opinions, but the great medal of honour at the Exhibition in Paris. This room is so perfect in its contents and in its arrangements, as to present a model which the refined and the wealthy might follow with advantage: its sofas, chairs, flower stands, chandeliers, mirrors, picture frames, chimney and table ornaments, tables, work tables, &c. &c.—all the produce of this eminent firm, or its special importations—are of the highest excellence. Mr. Graham has paid to Manchester the compliment of believing, and of acting on the belief, that their wealth and taste must be ministered to by a supply only of what is rare, beautiful, and thoroughly good.

Passing from this room, we enter one that is chiefly devoted to the contributions of the India House; these have been judiciously selected by Dr. Royle, chiefly with reference to the great trade of Manchester. Here also we find a looking-glass, tastefully designed and carefully executed by Mr. H. White, of Manchester, and some good tables of hahl and marqueterie, contributed by Mr. Wells, of Regent Street, London.

A room leading hence, and through it into the side entrance, contains a large number of the productions of Messrs. Minton and Co., and Mr. Alderman Copeland; two large stands contain the best productions of these eminent firms. They are such as the public are well acquainted with, and duly estimate; and it will suffice to say that the selection has been made so as to comprise a very large proportion of their best works of the several classes—statuary, vases, &c. &c. In the same room, also, is a collection of the works of Mr. Alcock, which, although by no means to compare with those that stand beside them, are creditable as mingling utility with elegance.

Of glass we regret to find there are no specimens exhibited—an evil we trust to see amended; for an accession might thus be made that would materially increase the interest of the exhibition.

Ascending the staircase, we arrive at the LECTURE HALL; at present this large and happily constructed room contains little except some garden chairs of the Colebrook Dale Company, a few large pictures, several busts, and a series of about twenty statues, which are here seen to great advantage. These are the works of MacDowell, Foley, Bell, Marshall, and Lough—our readers are acquainted with all of them; here also are two or three bas-reliefs of delicious character by F. M. Miller, Mrs. Thornycroft's bust of the Queen, and Belnes' statuette of Godiva. A gallery runs round the hall; here are the busts; the

statues are admirably placed, and we trust that circumstances will not cause their removal.

A long and comparatively narrow chamber leading hence, contains a number of beautiful works in silver, contributed by Mr. Hancock, of New Bond Street. The most important of these are the Commemoration or Testimonial Groups, and especially those which are the work of Mr. H. Arnstead. Several of these, although of small proportions, are of excellence sufficient to justify criticism as if they were models for execution the size of life. The artist is evidently a man of genius—yet one who willingly condescends to "small things," for an exquisite tazza, and an inkstand of very true and graceful character are also of his design. Mr. Hancock has been a liberal and valuable contributor, and the committee owe him much for the good service he has rendered. In this room also are three large cases filled with the best productions of Messrs. Elkington; of these it will suffice to say there seems to have been omitted nothing that could manifest their zeal for the cause they have thus generously—and it may be added wisely—assisted in Manchester. Here also is a very pleasing, although limited, selection of the productions of Messrs. Jennings and Bettridge; and a bedstead of brass and iron, and an elaborately wrought cradle, the work of Messrs. Winfield and Son, of Birmingham.

In a small room off this—the second floor—are exhibited the admirable stamped leather works of Leake and Co.; three or four beautiful examples of the decorated slate of Messrs. Magnus; while the walls are hung with the chromo-lithographs of Hanhart and Rowney, and the remarkable works executed under the patent of Mr. Baxter.*

Ascending to the third floor we have but one apartment, the ceiling of the lecture-room absorbing the remaining space. This room contains eighty drawings from the pictures of Her Gracious Majesty the Queen and his Royal Highness Prince Albert, which it has been our gratifying privilege to contribute to the exhibition of the Mechanics' Institute. Under the charge of Mr. Thomas Agnew, the Manchester publisher of the "Royal Gallery," they have "fared well," receiving the full honour to which they are undoubtedly entitled; not alone because of their exceeding value and interest as works of Art, but as bringing palpably before the visitor the Royal Collections at Osborne, Windsor Castle, and Buckingham Palace, to which it is impossible the people can have access. The majority of these pictures are from the collection at Osborne; it is here are gathered the works of modern artists, of which the other galleries contain few; and these are entirely the private purchases of her Majesty and her illustrious consort, many of them being "birthday gifts"—for it cannot, we think, be amiss to state that annually the gift of the Prince to the Queen is a picture, and the same on the birthdays of the Prince, when the present of her Majesty to him is a painting, either by a British or continental artist.

Of these eighty pictures many are heirlooms of the crown, acquisitions of the several sovereigns, her Majesty's predecessors; there are three of the famous Canaletto's, of which the corridor at Windsor Castle contains forty; there are two examples from "the Rubens Room," three from "the Vandyeke Room," and one from "the Zucarelli Room," at Windsor Castle; several others are from the collection of the Dutch and Flemish schools at Buckingham Palace; this collection is undoubtedly the

* Among the many instructive objects which at the moment appear to be of small consequence, but which are really of great importance, we are anxious to select one for special notice. There are few things in Art less satisfactory than map engraving; it is no easy matter to introduce upon a given space a large number of names, which can have neither order nor arrangement, but must stand exactly where they are to indicate places. It is seldom the engraving is clear and distinct, as well as of unquestionable purity. A map of Lancashire and Yorkshire, with the view to act as a guide to the railways of the district, we may accept as a model of entire excellence. It is a lithograph; but we imagine a transfer from copper, and is produced and issued by Mr. Falkner, the eminent lithographic artist and publisher of Manchester. It is impossible to convey a just idea of the extreme elegance with which this small map has been executed; every word is so skilfully engraved as to bear the scrutiny of the magnifying glass, while the lines are equally clear and satisfactory. As a specimen of "map draughtsmanship," we have seen nothing so excellent; the artist is consequently an acquisition of no slight importance in a city like Manchester, where so much of that class of work must be required.

choicest in the world as regards these masters—so Dr. Waagen considers it; a fair idea of its contents may be formed from the examples which these copies exhibit—in the works of Wouvermans, Cuyt, Teniers, Mieris, Vanderheyden, Rembrandt, &c.

These eighty drawings have been very judiciously framed and placed by Mr. Agnew; the room is hung with crimson cloth; the royal arms surmounts the entrance; and all has been done that could be done to give due effect to the collection, and to manifest the estimation in which they are held by the committee: even considered apart from the other attractions of the building, this exhibition alone is a valuable acquisition to Manchester, and may prove, as we trust it will do, very beneficial to the cause of its Mechanics' Institute. So rare and beautiful a collection of drawings has never been, and probably never will be again, gathered together. Thus the design of her Majesty and the Prince in granting to us this magnificent boon will be extended in its beneficial influence; their purpose was to enable others to enjoy the Art-luxuries they have acquired; the Work in which they are engraved, largely disseminates this enjoyment; but it will be still greater to the tens of thousands who are thus enabled to examine the true and beautiful collection of copies here placed for their pleasure and instruction.

Ascending to the highest floor of the building, we arrive at a series of class-rooms, in which are placed a collection of paintings, a large assemblage of photographs, and in one comparatively small chamber a "rich and rare" museum of ancient Art, chiefly the contribution of Charles Bradbury, Esq.—one of the many admirable gentlemen who, in the midst of labour to acquire wealth, find time to think of intellectual luxuries, and to learn how much of happiness may be derived from intercourse with the ministers of mind and taste. A list of this gentleman's contributions would occupy a page; they are chiefly of ancient and Medieval Art, and are of exceeding value. In this room also are a few exquisite gems—carvings in wood by Rogers, and one deliciously carved flower, the work of Wallis, of Lowth, who has justly earned a reputation that has gone over the world, and in his particular line is unrivalled either in England, Germany, or France.

To examine the picture gallery with anything approaching accuracy would require more space than we can allot to the whole of our report. It consists of some 500 pictures, so judiciously selected that assuredly in the whole there are not a dozen works of mediocrity; while, as certainly, more than half of them are the best productions of the best artists of Great Britain.* This will not appear at all strange when it is remembered that Manchester, and the districts adjacent, have been during the last ten years the great purchasers of the most excellent works annually produced—of almost all of them; for when the case of an artist of the highest eminence is giving birth to a picture of more than ordinary merit and value, it is safe to foretell that its destiny is Manchester, or "thereabout." In Preston alone there are four collectors, each of whom has expended some £10,000 a year in the acquisition of British pictures. And he it remembered this is—to speak in merchant phrase—a new market. Some ten or fourteen years ago, it was to this neighbourhood the dealer in "old masters" invariably wended his way. At the doors of the manufacturers he unloaded his carts, and with them he left his "Raffaels," "Titians," "Rubens," and "Teniers," obtaining in return sums which gave him a profit of a thousand per cent upon his investment with the poor painter who had worked up an aged and worn canvas to bear the names of the great masters in ancient Art. Such miserable frauds are now matters of gone-by history. It would be more easy to deceive Mr. Hancock into buying a piece of pebble for a diamond, than a manufacturer of Manchester into purchasing a Titian, for the authenticity of which he had only the word of a dealer—in the belief that he was hanging upon his walls a veritable example of the painter. The consequence is that "the dealer in old masters," when he approaches

* The collecting of these works, and the subsequent hanging of them, was confided to Mr. Thomas Agnew, jun., who must have had immense labour in so admirably performing his allotted task. The hanging is especially judicious; the rooms are exceedingly good as to light; and the pictures have been almost invariably so placed as to "look their best."

Manchester now-a-days, turns off the road, while the modern artist finds there his best recompense of homage and substantial reward.

We are compelled to postpone for a month an examination of this collection; it is impossible for us to find space for it now; but we ought not, therefore, to omit an essential duty in expressing our high admiration of so many gentlemen who have thus for a long period deprived their homes of their most cherished enjoyments—sacrificing so large a portion of their pleasure for the pleasure of others.

We have given to this interesting topic the utmost space we can this month afford. The inauguration of the Manchester Mechanics' Institute has been a great success. In the city which, next to London, holds the highest rank in importance, population, and perpetual service to the world and to mankind, it is above all things essential that taste should be, as far as possible, auxiliary to improvement. In this exhibition much may be learned, and nothing that is to be hereafter unlearned. But the advantages to be derived from it are by no means limited to its duration. It is one of the plans by which benefits are to be extended to many generations yet to come. The Manchester Mechanics' Institute, now located in an extensive, convenient, and elegant building, to the erection of which the inaugural exhibition will largely contribute, is an institution for the instruction of its people. We cannot do better than quote from the *Manchester Examiner* a passage which gives eloquent expression to this essential part of the subject under consideration; and have but to add that we shall next month increase our report by such further communications as may seem expedient or necessary:—"What would the last generation of workpeople have given for advantages such as these? Young men of this city, the responsibility is fairly thrown upon you! No sort of excuses will acquit you twenty years hence if you grow up in ignorance. There is no defect in your previous training, no educational misfortune, springing from the unpropitious circumstances of your earlier years, which you may not now remedy if you will. It is impossible to estimate the good which has accrued from the Manchester Mechanics' Institute during the thirty years of its existence. Directly, it has been the means of affording a useful education to thousands who are now discharging the duties of life, how much the better for the blessings they reaped within its walls! Many hundreds of young men who started life with an average elementary education, have found in its classes the means of improving themselves in one or more of those branches of knowledge which are necessarily in demand in a commercial and manufacturing city like Manchester."

THE ART-TREASURES' EXHIBITION AT MANCHESTER.

The success of this great experiment is now assured. It was scarcely doubtful from the first, for, placed as it was in the hands of a number of gentlemen of thorough business habits, there was assurance that all needful details would be practically worked out; and that the *idea* was merely as the title-page to a book—a huge volume, of which every sentence is to be closely and carefully considered. The committee is a "working" committee, who do not content themselves with leading their names and consigning their duties to subordinates; they are among the first men of Manchester in wealth and position, but they are of those who know that wealth and position are acquired and retained only by thought and labour; and they are willing to think and to work, in order that in their allotted task there may be no hazard of failure. They are now arranging their staff. Mr. Scharf, whose name is so honourably associated with many useful and able works in Art-literature, is appointed their Art-secretary, Mr. Minchin continuing as financial secretary. It was a wise step to divide duties so opposite, and which never could have been satisfactorily performed by one person. Mr. Peter Cunningham, a gentleman eminently qualified for the task assigned to him, is to form the catalogue, and generally, we believe, to

superintend the arrangements of those departments which embrace the various interests not included in those which appertain to pictures. There can be no question of his ability, and as little of his zeal and industry. Any portion of the stupendous plan will be safe in his hands. Mr. Deane is the general manager, whose business it is to act upon the suggestions and work out the plans of the committee. He is the hand which many heads will guide; and ample and beneficial employment will be found for him under their wise administrative faculties.

The building is already rising rapidly. It is distant two miles from Manchester; but the space is shortened by a railway, which conducts to one of the gates, and omnibuses will run every five minutes for a sum of twopence from all parts of the city. It is worthy of remark in passing that this machine in Manchester is spacious and convenient—a comfortable vehicle, such as we of London have no conception of. Mr. Salomons, the architect, Mr. Dredge, the engineer, and Mr. Young, the contractor, are proceeding fast with their work, which will be finished—and well finished—by the stipulated time. The site is in a quarter where the city smoke is little felt; and, by the way, the smoke consuming act has had great effect in Manchester. Although the front and back of the building are of brick, the huge sides and roof are of iron; security is thus obtained against danger from damp; and the floors are raised about three feet from the ground, there being a full circulation of air underneath.

The building is not, and is not intended to be, handsome. The front is sufficiently elegant: taken alone, indeed, it is a graceful example of what may be done in the way of beauty with coloured bricks; but it would have been worse than idle to waste decoration upon dead walls; and no other than dead walls are required; for all that is looked for in its space, upon which to hang pictures closely, commencing about three feet from the ground, and terminating about the same distance from the roof.

There will be space to hang between four and five thousand pictures; and that the committee will obtain so large a number there cannot be a doubt. It is probable they will be enabled to select from thence that amount, for already nearly all the best collections of pictures, ancient and modern, have been placed at their disposal, commencing with the gallery of Her Majesty the Queen (who lends forty pictures), and terminating with the dealers in London and elsewhere (who will gladly be contributors) and embracing almost half the nobility of the kingdom.

As regards a supply of pictures, therefore, all doubt is at an end. England contains enormous wealth in this way. That is well known; but it is hidden in venerable receptacles, out-of-the-way mansions, or in galleries which a strange footstep seldom treads. Such a collection of Art-treasures will be gathered as will astound the world.

But pictures form only a part of the approaching Art-fest; sculpture will come in for its full share of glory; and the produce of ancient Art, with the achievements of modern genius, will be adequately represented for the honour of the nation.

The gathering will by no means end here; Art-productions of all ages will be contributed. To enumerate the several objects, down to the grains an inch square, that will be sought for and obtained from "collections," would be to fill a volume.

Neither is the Art-industry of our day to be neglected; for all manufacturers who produce works of special grace and beauty, or whose productions are in a high degree meritorious, will be invited to contribute—not, indeed, the ordinary produce of trade, but the extraordinary fruits of extraordinary efforts in Art-manufacture.

Thus, the month of May, 1857, may be looked forward to as of interest second only to that which greeted the May of 1851, and to which the coming event is a most appropriate successor, attempting no rivalry, but pursuing another road to accomplish the same high, and refining, and ennobling principle—the delight and instruction of millions.

We shall from time to time report the proceedings of the committee, to aid and co-operate with whom it will be our duty, as it is the duty of all who have interest in the enlightenment and gratification of a community by the purest and most intellectual sources through which it can be enlightened and gratified.

ROYAL MANCHESTER INSTITUTION.

EXHIBITION OF PICTURES.

THE annual exhibition of modern pictures was opened early in September. It consists of five hundred and fifty works, of which there are a few in sculpture, and several drawings in water-colours. We believe there is no "Society of Artists" in Manchester, and that the periodical exhibitions are the results of the labours of several gentlemen by whom the pictures are collected. This is somewhat strange, and to be regretted. If Birmingham and Liverpool can sustain an institution composed of artists, and that there is an honourable distinction conferred by membership, surely there can be no just reason why Manchester should not be equally thus advantaged. A time is, we hope, at hand when "the coming artist," so to speak, will meet with patronage in this wealthy city—when, at his outset in life, and not at its close, his pictures will find purchasers there; at present, certainly, mediocrity, although it be the mediocrity which gives promise, is not often fostered into excellence by the patrons who in Manchester bestow munificent aid where it is little wanted—

"Giving the sum of more
To that which hath too much."

We presume to hope, and that with some confidence, to find the Stanfields, the Creswicks, the Mulreadys, and the Wards of the future dating their earliest helps on the road to fame and fortune from the day they received their first commissions at Manchester.

The character of the present exhibition, although not altogether good, is not unsatisfactory. The line is occupied by pictures of much excellence. Several of them are old favourites; but some we see here for the first time. These are for the most part the loans of Mr. H. Wallis, a very liberal contributor, or such as have been sent thither from the walls of the Scottish Academy. These are enough to give a character to the exhibition. The names of E. W. Cooke, the Linnells (we may now associate father and son, for the one has become a worthy competitor of the other), S. Cooper, Fied, Harding, Lauder, Creswick, Dobson, Ansell, will sufficiently guarantee the value of the more prominent parts of the collection. Moreover, it contains "The Charcoal Burners" of Rosa Bonheur, and a work of John Lewis, "Encamping in the East," sufficient to tempt a visitor to enter these rooms with a certainty of recompense.

There is but one picture we are just now enabled to select for special notice; we allude to a work of Mr. F. Leighton, the painter of that marvellous work which, by exciting so much admiration at the Royal Academy in 1855, led to proportionate disappointment in 1856. The picture here exhibited is "The Reconciliation of the Montagues and Capulets;" the scene takes place over the dead bodies of Romeo and Juliet. Although not an agreeable theme, it has been treated with masterly skill. The faces of the hapless lovers are exquisitely painted. The composition has been carefully and well considered; the drawing is indisputably good; and the work contains ample proof that the accomplished artist's comparative failure at the Academy this year was the result of an unhappy choice of subject, and from no lack of power to redeem the promise he has given to the world.

The exhibition is held in the great rooms of the Institution. There are several fine works in sculpture; among them MacDowell's statue of the lamented Lord Belfast, the "Angelica" of John Bell, Calder Marshall's "Imogen asleep," and the "Egeria" of J. H. Foley, with three exceeding beautiful bas-reliefs by J. M. Miller (one of which, the "Titania," we have engraved). They are in marble.

But here, as elsewhere, sculpture is treated as an art that needs no help, and requires no encouragement; for the works we have enumerated are thrust aside into a corner of one of the passages, called "a corridor," crowded together without order or arrangement, and treated with as little respect as if they were so many "images" dragged out of an Italian's workshop to be hawked through the city.

Under other circumstances, the exhibition would be more than satisfactory; but, unhappily, it is seen at the same time as the collection at the Mechanics' Institution, and it suffers much by comparison.

THE WELLINGTON MEMORIAL, AT MANCHESTER.

THE monument to the memory of "the Great Duke" was inaugurated on the 30th of August, in the presence of a large number of the magnates of Manchester, headed by Mr. Alderman Barnes, the chairman of the committee. It is happily located—the square in which it stands fronts a graceful building, the Infirmary, and it is "the pendant," so to speak, of the group which commemorates Sir Robert Peel—the work of Calder Marshall, the pedestal of which has been raised some four or five feet in order to harmonise with the companion group, the work of Mr. M. NOBLE. This memorial of the services of Wellington, in peace and in war, is envied, but at reasonable distance, by several palace-warehouses, truly magnificent establishments, out of which issues the wealth that, on the one hand, sustains the hospital, and, on the other, confers honours upon those British worthies whose words and deeds are incitements and examples.

We cannot speak of the work of Mr. Noble as of the highest order; but it is unquestionably entitled to considerable praise, and will certainly add much to his reputation: a far worthier achievement than was generally looked for at his hands, it will reconcile many opponents of the decision which gave to the young sculptor this important task. It is one of the valuable Art-acquisitions of Manchester.

Perhaps, if the work were a model upon which criticism was sought with a view to arbitration, we might be disposed to examine it more closely than we are—now that it is a *fait accompli*, it is useless to inquire whether better might or might not have been done; the work is there, and is entitled to much respect. Those who think that the Duke should have been represented as the soldier, and not as the mere gentleman, riding and not standing, indicative of heroism and not of reflection, may still be disappointed with this work; but they will not regret that their city has added another to the many good works which are designed and calculated to stimulate and to reward.

The Duke stands on a pedestal of granite; at the corners are four colossal figures, representing Wisdom, Valour, Victory, and Peace; there are to be four bas-reliefs, commemorative of his triumphs as a soldier and a statesman. The figures are of massive character, the draperies broad and effective, and the expression of each is in all respects to the purpose. They have been thoughtfully modelled and carefully executed. The figure of the Duke is entirely satisfactory—we believe there is no better likeness of him in his declining years; we may prefer to see his effigy in his prime, but that is matter of opinion. Certainly this will bring him palpably before us as he walked down Piccadilly some four or five years before his death, when his vigour of mind outlived that of his body, and the eagle eye still seemed to gaze upon the laurels he had won in a hundred battle-fields. We fully agree with Mr. Alderman Barnes that in this statue we "recognise his familiar features, and are reminded of that indomitable valour which, ever aided and directed by his extraordinary wisdom, secured for him immortal fame."

The statue was "uncovered" in the presence of a large number of the foremost men of Manchester, in whose presence the sculptor received one of those compliments so seldom bestowed on artists and men of letters—who work usually apart from crowds, and to whom the "voice of the charmer" comes rarely until it can bring with it neither honour nor reward. It is, therefore, not often that we have to record an expression of thanks and approval delivered before a worthy audience in the presence of the artist, who, having done his work, covets the recompense which no mere payment for labour can ever bestow. The Bishop of Manchester addressed the assemblage, and his words were warmly and cordially responded to when he had said—"I ask you to join with me in rendering your tribute of approbation and thanks to him whose artistic skill has enabled us to show you this great, this good, this noble work—this lesson to posterity, that here, among the other eminent men this city delights to honour, we can show what pure virtue, simple greatness and grandeur, unblemished integrity, and military skill, united with civil ability, deserve at the hands of Englishmen. I call upon you to give three cheers for Mr. Matthew Noble!"

THE PUBLICATIONS OF MESSRS.
DAY AND SON.*

It is now a considerable time since we have had the opportunity of reviewing the Art-publications of this long established and well-known printing firm; consequently their works have so accumulated on our hands as to justify a separate and distinct notice from our ordinary "review" columns; while the importance of the majority of these publications may be adduced as an additional reason for a departure from our usual course in matters of this kind.

The first work to which we desire to call attention is the republication of D. Roberts's SKETCHES IN THE HOLY LAND, SYRIA, &c. &c., lithographed by Louis Haghe, constituting, from its size, a "Library edition." The extraordinary success which attended the first issue of this most interesting publication, when in the hands of Sir F. G. Moon, made it almost certain that at some future time another edition would be circulated to come within the reach of those whose means would not permit the purchase of the earlier and more costly work, which, by the way, is now but rarely to be acquired. When the original proprietor and publisher retired from business, the "Holy Land" passed into the possession of Messrs. Day and Son, who, with a little delay as the circumstances of the case required, commenced preparations for issuing the edition which is now before us. To assure positive identity between the two, the whole of the plates were reduced to the required size by means of photography—a process which has ensured the reproduction of the excellence of the originals, both as regards effect and artistic touch. The result is a work which, save in the advantages of size, whatever such advantages may be, possesses all the beauties of the larger publication. On a careful examination of these volumes, the only difference we can discover is that the plates, two hundred and fifty in number, seem to exhibit even more delicacy and finish of execution than their predecessors; we should scarcely have supposed that the art of lithography could have carried these qualities so far. Of course the historical descriptions, from the pen of Dr. Croly, that accompanied the first issue are printed without abbreviation in the second. The text forms by no means the least valuable portion of the work. No writer of the present day is better fitted for the work he undertook than this eloquent and learned churchman.

Ten or twelve years have, we believe, elapsed since the first publication of the "Holy Land." The public has during this time so well tested and appreciated its artistic and literary worth, as to render it unnecessary for us to do more than announce the completion of a series that deserves to be in the possession of every family which has the means of procuring it, and hundreds may now purchase where teus could not before.

The next publication we have to notice is of a different kind from the preceding; it is, THE GRAMMAR OF ORNAMENT, by OWEN JONES, the plates, one hundred in number, drawn on stone by F. Bedford. Writing last month about the "Stationery Court" at the Crystal Palace, we mentioned, among other printed works exhibited there, a number of the specimen plates of this "Grammar," which will not be quite completed till the end of the year, some little delay having occurred from the desire of the artists and printers to make it as perfect and beautiful as possible. It was in the first instance estimated that five hundred stones would be sufficient to produce the one hundred plates, at an average of five printings to each stone, but it was subsequently deemed advisable to use seven hundred stones, or seven to each plate, in order to produce the work in an entirely satisfactory manner. These few statistics will do something to enlighten the uninitiated as to the cost and trouble which such artistic productions entail. These hundred plates will contain no fewer than three thousand examples of Ornamental Decoration from various styles, exhibiting the fundamental principles which appear to reign in the composition of ornament of every period and of every nation, commencing with various savage

* ROBERTS'S HOLY LAND. Library Edition. 8 vols.—THE GRAMMAR OF ORNAMENT. By OWEN JONES. 100 Plates.—SCENERY AND PLACES OF INTEREST IN THE CRIMEA. By CARLO BOSOLI.—CHROMO LITHOGRAPHIC. Printed and published by W. Day and Sons, Lincoln's Inn Fields.

tribes, and the earliest examples of Egyptian ornament, down to the Italian, the whole being divided or classified into twenty chapters, one to each epoch; but the number of examples varies according to the importance of each style. Thus, Egypt and Greece have each eight plates assigned to them; while for the ornaments of the Arabs and Turks three each are considered sufficient. The descriptive letter-press, from the pen of Mr. Owen Jones, will accompany the last part that is issued. In it the author proposes to define the apparent origin and trace the development of the several styles of ornament, and will then proceed to ascertain the laws that govern their composition—both those which are general to all styles, and those which are peculiar to each.

These plates are of imperial folio size, and they are printed with all the care, accuracy, and brilliancy which the chromo-lithographic art is capable of realising; it would be unjust to all who have a share in producing them were we to refrain from acknowledging the enterprise, skill, and talent that have created so beautiful and useful a publication.

THE SCENERY OF THE CRIMEA, a large folio volume containing fifty-two plates, from sketches by Carlo Bossoli, will lose none of its interest from the fact that, happily, the country is no longer occupied by devastating armies; moreover, the artist shows it to us before the ravages of strife had made it desolate; and thus, by placing his views side by side with the numerous "war-pictures" which have appeared during the last two or three years, we can draw our own comparisons between a country naturally picturesque and often luxuriant, and the same scenery when covered with the footprints of which "Discord, dire sister," leaves upon it. Carlo Bossoli was for a considerable time a resident in the Crimea, in the suite of Prince Woronzoff, hence he had the most favourable opportunities of exploring its beauties, and sketching whatever he desired; his pictures are, we have understood, much esteemed by the Russian nobility. The fifty-two views—we can only speak of them generally—include most of the places which interested us as Englishmen during the war, and which we yet, and generations after us will, associate with so much that is glorious in our national annals, and so much to call forth national and individual regret. There is very considerable artistic merit in these lithographic pictures, which are printed in three colours besides the black, or chalk.

We come, lastly, to three works of a totally dissimilar character to any of the preceding; some of those extraordinary productions which, when we look at them, puzzles the eye to discover whether it is not contemplating the results of the pencil, and not those of the printing-press. The first is a large chromo-lithograph from Haghe's picture, called "The Happy Trio," exhibited, if we recollect rightly, two or three years ago at the New Water-Colour Society; of the numerous "stone-pictures" we have seen, this certainly equals, if it does not surpass, the best in its close imitation of the original; all the accessories are wonderful in their finish and texture, and the light throughout is expressed with the brilliancy and truth of real sunshine penetrating the old windows of the apartment, and reviving the colours of the accessories—ancient damasks, tapestries, coverlets, &c.

DOLLY VARDEU, after Frith's well-known picture, is another chromo-lithograph of marvellous power of colour; the broad and dashing touch of the artist is as closely imitated as it is possible for copyist to do; a coat of varnish and a frame are only required to render it a "genuine original" for any dealer in modern Art.

LAVINIA, after Saut, is the last we have to speak of; more sober in tone than "Dolly Vardeu," it is not a point behind the latter as a charming picture—such works ought scarcely to be called prints—and as a faithful transcript of the artist's work. Mr. Risdon, who transferred these three subjects to the stone, is entitled to honourable mention for the successful result of his labours.

In conclusion, we may remark that the issue of these respective publications shows that the establishment of Messrs. Day and Sons still maintains the high position it has long held as the producers of artistic works of the best character; many of them got up at a vast expense, entailing a large amount of capital, and manifesting much energy and enterprise on the part of the publishers.

"PIZZARRO,"
AT THE PRINCESS'S THEATRE.

THE introduction at the Princess's Theatre, during the month just brought to a close, and after an interval of only ten days since "The Winter's Tale" was laid aside, of one more of those remarkable scenic displays which have distinguished the management of the Kean's, seems to demand at our hands not only some notice of this last, and, in some respects, most brilliant of all these dramatic illustrations itself, but also a few words of remark on the principles of management which this and the others involve. The mere amount of picture which any one of these extraordinary performances brings into play would alone command, as a matter of right, the comments of a journal devoted to the report of all Art manifestations among the people; but when this picture is raised into dignity by being employed as the vehicle of all the Art archaeologies—when Mr. Kean's allotment of the eye of his audiences is made by him the means of instructing their understanding—when the showiest kind of ornament takes in his hands the character of severe truth, and picture becomes document—and when these representations have succeeded each other in such numbers and with such regularity as to imply system,—we feel called on to do something more than report on the mere fact of a revival,—to take some account also of the value of the system of which it forms a part.

Year after year, since Mr. Kean began this series of illustrated dramas, he has seemed to set up as against himself, in the one year, a test before which in the next he must almost necessarily break down. The success of each revival has made the success of another more difficult. The profusion of illustration in one has become the measure of the illustration below which Mr. Kean must not fall in the following; and the amount of interest which in any particular case he has been able to awaken indicated the craving condition of the public mind which he has had to address in that which succeeded. It is much to say, that the expectation so kept alive and progressive he has never yet disappointed. Constantly competing against himself, he has been a constant winner. Beginning years since at a point which seemed to forbid advance, he has been advancing to this day. Subjecting himself every season to a trial more severe, he every season gets a fresh verdict. Illustrating history of very varied characters,—where the subject immediately in hand will not yield him one sort of triumph, he makes it yield another. His present theme, for instance, and any possible method of its presentation, are wanting in that refined interest which, in his getting up of "The Winter's Tale," ministered to the classic sympathies as on the stage they had never been ministered to before;—and in that piece, we confess, we thought the long-threatened limit to the power of scenic decoration had been reached. The first night of "Pizarro" proved to us that we had underrated the resources of taste and ingenuity. The art which last season was employed to illustrate the splendours over which Art in its palmy days presided, passed at once to the illustration of another magnificence, the absence from which of Art, in its more refined meanings, is revealed with equal power in the light of the art which presents it. From the forms and manners of a luxurious civilisation, Mr. Kean plunges at once into the pageantries of comparatively barbaric wealth; and while, as we have said, the result is one which does not appeal to our most refined and graceful associations, as do the pictures of Greek life shown at the court of Syracuse, out of the rich and ruder materials here at his disposal he has contrived displays of grouping and of colour which throw everything else of the kind that he has done into the shade. It is perfectly wonderful, the art by which all that the imagination of man has been accustomed to consider as symbolic of taming riches is here introduced to the sense. The marvellous reports of the old Conquistadores, which made of Mexico and Peru vast treasure-houses of all that the Old World had held most precious, are here made probable,—as in those ancient narratives they were only true. The *ébro* is shown as *ben trovato*. The moral of El Dorado is made present to the mind with a vividness which leaves Pætoclus scarcely a golden legend. The spirit of gold pervades every-

thing, as at the marriage of Miss Kilmasegge. We are visibly in a land where the mountains are made of gold, where gold is, as the natives say, "the tears wept by the sun," and where all the whirl and excitement of tropic life are made, as it were, to turn on golden wheels. History glows in Mr. Keen's page with the actual life which Pizarro saw, and gleams with the golden ore for which Cortes was a scoundrel. But again we say, the great and peculiar triumph of this piece is in the arrangement of its groups and the massing of its hues. The artist has here presented to him wonderful studies of colour; and the common eye reposes on these rich pronouncements and moving rainbows as it would on huge beds of the brightest flowers. The setting of picture would seem to have reached its perfection in this revival. Nothing so gorgeous, striking, and many-hued was ever put on the stage as Mr. Keen's version of "Pizarro."

It is beside the question here, to institute any inquiry into the causes which have produced the decay amongst us of what is called the legitimate drama:—it is enough that we have to accept it as a fact. The causes, doubtless, are of many kinds; some not easily disentangled from the complex tissue of social and intellectual motive, and some obvious enough,—some, it may be thought, tending to permanency of character, and some, it may well be hoped, which will yield to time. There are playgoers yet living who are able to measure by their own memories all the distance between the condition of the public drama even as lately as the time of the Kembles, and that of its present day,—and who have seen growing around them, without being conscious of the process at the time, or able to find all its threads now, the web of circumstance by which that difference is determined and explained. Amongst many social changes, of custom and of thought, which have been all working to the same result, it may be remarked, that the progress of club life and the spread of literary associations have created a state of things wholly unlike that in which the idler had no resource but the theatre, and the hungerer after intellectual food no lecture-room but the stage. Men who flocked to the theatre once as a place of common resort, for amusement or for education, have since set up institutions of their own where the one or the other may be had, with the greater profit of comparative seclusion, and with something of the ease and dignity of home. The withdrawal from the theatre of any large class of the community, unless it be substituted by another, is practically equivalent to the withdrawal of the whole; because in a country wherein the theatre has no government support, and is maintained as a private speculation, its doors can be kept open at all only on the condition that the public enter them in remunerative numbers. It follows, that the withdrawal, in particular, of that best class who sought the theatre for its teaching,—and formed always the sound and thoughtful element which was at the core of dramatic prosperity,—involved, as its natural consequence, the death of high drama, even supposing that a public could be found, on some other temptation, to fill their place in the theatre. To lure the idler back from his luxury, then, managers had recourse to the sensualities of Art. The stage where Garrick trod has been surrendered to the gnomes of mere puzent, and Shakspeare has been dragged at the tails of horses. Before we examine more particularly what Mr. Keen has done under these circumstances, it is right that we should refer here to what he tried first to do; because the value of the good thing which he has achieved can be emphasized only by showing that what would have been a still better thing he had found to be impossible. No one has done more in recent times to test the practicability of that better thing than Mr. Keen; no man fought more perseveringly than he for high drama against the influences by which it had been hest. If Mr. Keen could have made his stage the head-quarters of the legitimate drama, he would have done so. In the early years of his management he did what he could to woo her back. Year after year he gave the public the opportunity of pronouncing for a more wholesome state of things, by the production in each of some new example of the dramatic talent which, in spite of many circumstances of discouragement, we have still amongst us. When the public had sufficiently pronounced its determination not to follow him in

that direction, what did Mr. Keen do? Determined that the stage should, in his hands, be a teacher in some way, he took to teaching the people history in the form of Art. He had, of course, observed the love of picture which was one of the influences fighting against him on his old ground; and that love of picture he determined to turn to the account of something better than itself. He had seen, too, that the thinking class who had abandoned, for the lecture-room, the public arena in which Shakspeare was the great and successful lecturer years ago, were exhibiting signs that their hearts yearned once more to that wise old teacher who taught them as none other can. Driven from his ancient home by their desertion, the great poet was gradually following them, on their own invitation, into the new homes which they had established for themselves. The practice of Shakspeare reading was growing into an approved portion of the courses of amuse-ment and instruction, combined, which most of these institutions arrange for themselves,—and becoming also a popular method of addressing the public elsewhere than within their walls. This seemed to suggest to Mr. Keen a course of action, by which an unwholesome phase of the public mind might be actually seized, and directed to a wholesome issue. To the lover of picture he determined to re-introduce Shakspeare,—while the lover of Shakspeare he tempted back to the theatre by all the ministries of Art. Summoning the archaeologist to his aid, and bringing into his service all the Muses, he has given us a series of Shakspeare revivals which, for completeness of illustration and beauty of presentment, have never been equalled. Marvels of Art-docu-ment they are,—illustrations of history such as can nowhere else be seen. They are full of instruction of many kinds:—and it is our hope that the public will take some means of testifying personally to Mr. Keen their approbation of the partial regeneration which he has effected, and the sound direction in which he has led. The matter is even more important than it seems; for we are satisfied that if there be an early way back for the people to the temple of high drama, it is this. That finer and more thoughtful spirit which exhibitions such as Mr. Keen offers, tend to cultivate, are means of popular redemption from vulgar taste and unintellectual pursuit. They help to beget the habits of mind on which only can grow the worship of that highest of intellectual inspirations, the dramatic Muse. Accustom men to look for meanings even in what appeals directly to the sense,—and they will end by aiming at the highest meanings of all. Mr. Keen is leading his audiences back to the temple, and at once amusing and instructing them by the way.

Not, however, confining his historic illustrations to the creations of our great dramatist alone, Mr. Keen has resuscitated for the playgoers of London the extinct races of Assyria, on the authority of documents that had themselves been buried for thousands of years:—and he now brings before us a people who in the quaint and picturesque strangeness of their manners and institutions seem almost as far removed from ourselves as the ancient Assyrians do, though disinterred as a living race for Europe only three centuries ago.—"When," says Mr. Prescott, "the Europeans first touched the shores of America, it was as if they had lighted on another planet,—everything there was so different from what they had before seen. They were introduced to new varieties of plants, and to unknown races of animals; while man, the lord of all, was equally strange, in complexion, language, and institutions. It was what they emphatically called it, a New World. Taught by their faith to derive all created beings from one source, they felt a natural perplexity as to the manner in which these distant and insulated regions could have obtained their inhabitants. The same curiosity was felt by their countrymen at home, and European scholars bewildered their brains with speculations on the best way of solving this interesting problem."—Of a play so well known as "Pizarro" it is no part of our present purpose to speak critically, save to say, that it presented itself naturally to Mr. Keen in his search through the drama for the means of opening up "a fresh chapter in the pages of the past." It gave him at once a striking variety, and a subject for abundant illustration. It took him to a land where, as he says himself, "while nature appeared to reveal

in her grandest and most picturesque aspect, the land abounded with precious gems and metals to such an extent, that, amidst the gardens of temples and palaces, trees and plants of gold and silver, most exquisitely manufactured, stood intermingled with natural productions." It took him among a people whose monarch ruled them from a chair of gold. All this, and infinitely more, in the way of magnificence and detail, Mr. Keen has rendered. As usual, he has taken such liberties with the text as suited his purpose of historical adaptation; but, for the most part, the alterations are unimportant as regards the text itself, with the exception of that which omits the death of Pizarro as an inebriation on the unity of action. But this incident Mr. Keen must in any case have dispensed with, on his principle of making his dramatic representations, where he can, conform to the facts of history.

The charm of completeness which Mr. Keen has carried into the getting up of this piece, he has contrived also to attach to its performance. The play is thoroughly well acted throughout; and nothing occurred, even on the first night, to disturb the sentiment of the action, or clash with the perfection of the illustration. It may be observed, that melo-drama—which "Pizarro" unquestionably is—lends itself well to the highly-coloured and picturesque species of illustration which Mr. Keen had to employ on the ground chosen,—and that the somewhat stilted virtue and sententious dialogue of Kotzebue's play have a pleasing appropriateness where everything that is hung around it in the way of picture or archaeological comment is so pronounced and emphatic. The principal parts, male and female, are, of course, sustained by Mr. and Mrs. Keen,—and so sustained as to give the finish to the whole which must come (if it be attained at all) out of them. To the part of Rolla full effect is given by Mr. Keen; while he renders it without exaggeration,—a fault to which it tempts. The part of Elvira, in Mrs. Keen's rendering, gets colour from an originality of her own. On the early refinement and passionate nature of the companion of Pizarro she has grafted a touch of brusqueness, and of that ruder manner which belongs to her exceptional position and her long camp following.—Nor would it be just, that we should close this notice without a word of warm commendation to the music. Nothing could well be more characteristic, or more in harmony with the other accidents of the representation. The Indian airs are said to be founded on melodies published in Rivero and Tschudi's work on Peruvian antiquities, as handed down by the Spaniards after the conquest; but the merit implied in the manner of their use is the composer's own,—and the original music accompanying the more impressive situations is, at once, distinguished for intrinsic beauty, and marked with local colour. Mr. Hatton's is an important contribution to the completeness of this rich and striking whole.

ART IN THE PROVINCES.

GLASGOW.—Mr. James Ballantine, of Edinburgh, the distinguished artist in glass-painting, who executed the decorated windows in the House of Lords, has, at the request of the Lord Provost of Glasgow, submitted to him, as the head of the corporation, a complete plan for ornamenting with stained glass the windows of the Cathedral of Glasgow. The subjects he has selected for the four principal windows are, with the exception of those for the largest window, from the New Testament. The whole series of designs are the following:—*Large West Window*:—"Christ's Entry into Jerusalem;" "The Last Supper;" "The Crucifixion;" and "The Ascension," or "The Life of Christ," illustrated in a series of medallions. *Large South Transept Window*:—"The Transfiguration;" "The Resurrection from the Tomb;" "The four lateral upright lights to be filled with architectural ornamentation, similar in character to the opposite window, the *Large North Transept Window*, the designs for which are—"St. John Preaching in the Wilderness;" "Christ Preaching on the Mount;" "The Day of Pentecost;" "The Angels opening the Prison Doors for the Apostles." For the *Large East Window*, effigies of the twelve Apostles and heads of twelve Prophets, in medallions, with geometric and foliated adjuncts. Mr. Ballantine proposes that the entire series should be executed under the superintendence of one artist, that unity of purpose and harmony of connection may be attained.

THE WELLINGTON MONUMENT.

In an early part of our Journal for the present month, we have given a somewhat lengthened exposition of the views entertained strongly by ourselves and others as to the principles which ought to control the distribution of the Government Commissions for the execution of national works of Art; and much of that exposition had direct reference to the great intended monument whose title we place at the head of the present article. Since those remarks were written, an announcement has issued from the office of works, to the effect, that, "it is the intention of Her Majesty's Government to erect a monument in St. Paul's Cathedral to the memory of the late Duke of Wellington, and that they are prepared to receive designs for the same from artists of all countries." Each competitor is required to state the sum for which he will be prepared to execute his model, if called on to do so—and the maximum price is fixed at £20,000 sterling. The monument is to be made of marble, stone, bronze, or granite, or any of these materials combined; and the models are to be sent in, in June, 1857. They are to be delivered at Westminster Hall, or some other place to be hereafter determined,—and which is to be a place of public exhibition for them in July of the same year. The instructions to artists are accompanied by a ground plan and elevation of the site on which it is proposed that the monument shall stand, and a perspective view of the arch under which it is to be erected. Nine premiums are announced to be given for the nine most approved designs:—one of £700, one of £500, one of £300, one of £200, and five of £100 each:—the models to which premiums are awarded, to remain the property of the Government;—and it being, of course, provided, that the artist to whom the highest premium shall be assigned will not be entitled to receive it in case he shall be employed to execute his design.

They who have taken the trouble to follow our remarks on all this subject elsewhere, will see, that there is much in all this of which we should approve, were it not contradicted by other clauses which have our strong disapprobation,—and were we not for the present compelled to take objection to the whole. The provision for a set of premiums, and that for public exhibition, and the communication of particulars respecting the site, are among the points which we have urged most strongly in the recommendations on the subject which we have ventured to offer in our present publication. But,—to begin with our general objection,—we see in Sir Benjamin Hall's action in this matter, warned as we are by what has already occurred on the subject of this monument, a disposition to override his commission, which we greatly distrust. No parliamentary appropriation has yet been made of the surplus fund out of which Sir Benjamin Hall proposes to pay for this work; and he can scarcely show sufficient authority for his summary dealing with a matter which, at once, disposes absolutely of a very large sum, and solves arbitrarily very important principles. A work so significant as this Wellington Monument, and involving so many points for consideration, has a right to the protection of Parliament.

The clause which provides for a public exhibition of the competing models, gives no hint as to the kind of tribunal by which that competition is to be decided; but rather leaves us to infer,—from the direction given, that models are to be addressed "to the First Commissioner," and, from the First Commissioner's previous attitude in the matter,—that Sir Benjamin Hall considers, that he himself is that tribunal. Sir Benjamin may be assured, as we have argued elsewhere, that he will fail entirely to give satisfaction to either the public or the profession, unless a court shall be established for adjudicating on this competition, learned enough to escape all suspicion of a mistake, and numerous enough to soar above all suspicion of private influence. In matters of Art, we have a strong notion that even a First Commissioner of Public Works will be the better for assessors.

But what we most strenuously object to in this ministerial announcement, is, the clause which for this great work of national Art calls in the competition of the foreign artist. With so many sculptors of eminence at home needing commissions, why

is it, when we have a valuable commission to give, that we look abroad? For the life of us, we cannot understand either the necessity or the policy of going to the foreigner in the matter. Why can we not do our own work with our own hands? The principle which lets in the foreigner in such a case has not even reciprocity to recommend it. This doctrine of international free-trade can have no fit application in matters of Art. The logic of free-trade is, that it cheapens whatever it addresses itself to:—and we presume, that even Sir Benjamin Hall will not avow that his object in this matter has been to cheapen the Art. The thing wanted is excellence; and excellence we have—and of the first order—amongst ourselves. The argument against sharing our commissions for the execution of public works of Art with foreign artists, we have stated at length in the article to which we have already alluded (page 293):—and we earnestly solicit Sir Benjamin Hall's attention to it. Perhaps Sir Benjamin may be disposed, on reconsideration, to recall this portion of his instructions ere it be too late. If not, parliament *must* at length take up the cause of the British sculptor:—and we believe, a parliamentary opinion on the question at issue will be taken next session.

We object, too, to the site chosen for the work:—and on more grounds than one. Placed in St. Paul's, a monument which should have a strong mark and significance of its own falls into the mere category of works that make the decoration of a temple. The only fitting place for such a monument in St. Paul's, if in St. Paul's it *must* be, is the centre of the floor, beneath the dome. But while the crowd of works of Art that surround St. Paul's are, as we have said, mere decorations of a temple,—they are, in our opinion, inappropriate decorations of a Christian temple; and we had hoped the time had come when it was understood that two distinct ideas are thus brought together having no inter-relation, and so, weakening one another. We hope to see the day when England will have a Pnyteum of her own, within whose walls—for, a London Pnyteum would probably require to be an interior—the memory and monuments of her illustrious dead may create their own special sanctity:—but meanwhile, for this particular monument the site which we have pointed out elsewhere is emphatically the true site. If not, there are others in the metropolis far more appropriate for the purpose than St. Paul's.

MINOR TOPICS OF THE MONTH.

THE "COLDSTREAMS" MONUMENT.—An early instalment of that great body of monumental commemoration which, in all probability, will, ere very many months be past, write the legend of the sorrow that the recent war has bequeathed in most of the cathedrals and churches of England, has already set up its sad record in the chief of them all—our great metropolitan cathedral of St. Paul's. The monument in question is erected in the south aisle of the vast nave, not far from the great western gate; and is the work of that most petted of sculptors, the Baron Marochetti. It has a rich burden in the names of eight gallant officers of the Coldstream Guards, who fell fighting side by side on the fatal day of Inkermann, and found a common grave in the far Crimean solitude:—"Brothers," says the inscription, "in arms, in glory, and in death." The record says, that it is, "Sacred to the Memory of Lieutenant-colonel the Honourable T. Vesey Dawson, Lieutenant-colonel J. C. Murray Cowell, Captain Lionel D. Mackinnon, Captain the Honourable Granville C. C. Elliot, Captain Henry M. Bouvier, Captain Frederick H. Ramsden, Lieutenant Edward Adishrove, and Lieutenant C. Herbert Greville." Notwithstanding some touching aid from the surviving comrades of the gallant dead, we cannot say that the Baron Marochetti has set to a very fine chord the key-note of that dirge music which the multitudinous graves of the Crimea have to wring from the Sculpture Muse. Some better utterance might fairly be expected than this of the great grief that flings over ten thousand English hearts to-day the shadow of Cathcart's Hill. A pathos there doubtless is speaking from this marble memorial—but it consists mainly in the written inscriptions, and the facts which they reveal.

The chisel of the Baron contributes, we must say, little to the sentiment with which we look on this mournful record. With such eloquent materials in his hands, it is impossible to resist the conviction that Baron Marochetti has contrived to be more than reasonably commonplace. The sculptor has done so little here, that we wonder *they* who are content with it should have thought it necessary to go beyond the statutory for the work. The mere marble-yard would have furnished just some such model with such means. The Baron has reposed mainly on matter of fact; and though it is true that the real pathos in cases of monumental record in general does lie in the matter of fact—and that it does so certainly in this,—yet, when sculpture undertakes its expression, we expect that her utterance shall be more spiritual. Let our readers judge. A white marble tablet bears in full the names of the eight "brothers in arms, in glory, and in death." Over the tablet there is a small sculptured representation of the tomb, with its inscription (giving, thus, the names again), raised above their common place of rest beyond the Euxine; and the circular top of the plane on which this presentment rests is bordered by a wreath twisted of the leaves of that exceedingly well-known and much used tree, whose groves of which are growing in the marble-yards and grave-grounds of London and elsewhere—the laurel. This is the symbolic part of the work—scene in its prescription; over it comes another *fact*, the star of the military order, and the motto, "Nulli secundus." Above this, again, is the legend, supplied by the Dean of the cathedral—"And the victory that day was turned into mourning;"—and over all wave the colours of the regiment, with this record, "These Colours belonged to the Coldstream Regiment of Foot Guards, and were presented by Colonel the Honourable George Upton, C.B., and the Officers of the Regiment, with the sanction of Field-marshal the Earl of Stratford, G.C.B., Colonel of the Regiment, as a tribute to the gallant and devoted conduct of their Comrades who fell at the Battle of Inkermann, and whose names are recorded on this cenotaph." This is the most touching incident of the monument, save only the names on the memorial slab; and it is the well-devised contribution of those who were companions of the dead in that terrible field, and are mourners over them here. The poetry of the piece lies in this episode, and it is not written with the chisel. On either side of the tablet which bears the names of the dead bends a sorrowing soldier of the regiment, in the uniform of his corps, and with arms reversed; and in these figures only has the Baron Marochetti made the slightest attempt, so far as this monument is concerned, to write himself sculptor. The characters in which he does so are, however, of no great mark. The relief is low, and becomes so flat at the inferior extremities as, aided by the poverty of expression with which the limbs are in that part made out, to suggest the notion of figures cut out of eard. The modelling here is of the poorest kind. The upper portions of these sentries by the tomb are far better. Above, the forms are well defined, and in the faces the sentiment of the place and purpose is successfully conveyed.—On the whole, however, we repeat, we may reasonably hope for far higher strains than this from the Sculpture Muse, for the sleepers on Cathcart's Hill, and in the valleys of dry bones that lie everywhere around it.

THE ROYAL ACADEMY AND ART-TEACHERS.—A correspondent throws out a good hint for the consideration of the Royal Academy in any future alteration in its constitution and government. It is suggested that much service would be rendered to educational Art if the Academy granted to artists who have been educated in its schools, and approved of,—as well as to others willing to subject themselves to examination,—a certificate or title, that should prove them competent to undertake the office of teacher, just as the College of Preceptors does. There cannot be a doubt that, if this were done, it would greatly tend to elevate the class of "drawing-masters" throughout the country, and would also raise their standing in the staff of those employed in general education. At present, the connection of drawing with education,—especially as regards the middle and higher classes,—is far from being rightly understood.

THE CITY MONUMENT TO WELLINGTON is in progress at Guildhall, where the accomplished sculptor, John Bell, is superintending its erection. The

statue of Alderman Beckford, which forms one of the proudest memorials of London city, has been removed—but only to a short distance—in order that the monument to the Duke may companion that to Nelson, so that the two may occupy the two compartments at the sides of the entrance to the council chamber. We shall next month be enabled to notice this work in detail.

THE ART-MANUFACTURE ASSOCIATION.—We have to report on this subject that probably an exhibition of objects of Art-manufacture will be held—first at Edinburgh—in December next. The project has been generally well received—so well that we believe an ample subscription is obtained for a satisfactory commencement. The committee is carefully constructed, although apparently somewhat too national—to be accounted for on the ground that the origin of the society is exclusively Scottish. Mr. Christie has, we understand, visited Paris, in order to "select" some fine examples of French workmanship. Our report must be somewhat qualified until we have larger experience of the projects and plans of the society, which, however, we are well disposed to assist, as promising to be a valuable auxiliary in the progress of taste, and a probable reward to the able designer and skilful artisan.

PORTRAITS AT OXFORD.—The beautiful hall of Christ Church, Oxford, is undergoing repair—gas-pipes are being laid, the floor is partly taken up, and the ceiling is about to be opened: consequently, the dust and lime form a sort of atmosphere, yet, strange to say, the valuable and interesting portraits by Vandike, Hogarth, Reynolds, Gainsborough, Lawrence, &c., remain upon the walls without the slightest covering, and without the least effort to preserve them from the injuries to which they are exposed, and which they will be sure to suffer! This is altogether unpardonable. We know not who is responsible, but it should be made to answer for his crime to the university and to the country.

THE LONDON STEREOSCOPIC COMPANY, whose valuable establishment in Cheapside we have heretofore brought under the notice of our readers, have recently issued a series of coloured photographic slides, representing several of the most effective groups in "The Winter's Tale," as placed upon the stage by Mr. Charles Kean. The subjects are highly interesting; and by this process the most attractive points of the drama are preserved with admirable effect. The groups were of course taken "from the life." The principal persons of the play were posed for the purpose, and the result has been a new and very gratifying source of pleasure from the efforts of Mr. Kean at the Princess's Theatre. This important company has done much, and in the best possible way, to render the stereoscope a source of universal instruction and enjoyment. All the works they issue are good; where any are defective they are rejected. Confidence has thus been established; and from their enormously large store of views, figures, groups, and incidents, nearly every city and town of the Kingdom now obtains a supply.

THE PEACE TROPHY AT SYDENHAM.—This blot is about to be removed from the Crystal Palace, and we believe there are few who will hesitate to exclaim, "Good riddance of had rubbish!" It has been a very expensive mistake, but the Directors have done wisely in removing so grievous a record of so obvious an error.

THE PICTURE-DEALER "HART."—The picture-dealer Louis Hart, whose name will be familiar to our readers as the person who brought an action for libel against the *Art-Journal*, died at Manchester about two months ago. "Not nisi!" His trade in old masters preceded him to the tomb; no one thinks of buying, and consequently no one proposes to sell, now-a-days, a "veritable Titian," or even an "authenticated Rubens," in the manufacturing districts.

THE RESTORATION OF SIR JAMES THORNHILL'S WORKS IN ST. PAUL'S.—The reproduction of Sir James Thornhill's pictures from the life of St. Paul, in the cupola of St. Paul's, has been effected by Mr. Paris after a long term of arduous labour. There remains yet a portion of the scaffolding, at which we look up from the floor of the expansive area below, and wonder not only how the wooden structure was raised to that giddy elevation, but also how it is sustained there; and contemplating such a lofty suspension, there is little question of what would have been the fate of Thornhill, had his friend

not hit upon the expedient of smearing a favourite feature of his work at the moment that he was about to back off the edge of the scaffold. Mr. Paris has very efficiently discharged the duty confided to him; we can recognise the Apostle before Agrippa, the Conversion, and the Sacrifice at Lystra—all of which, and not only these, but the other five subjects, were entirely veiled by the atmospheric deposit of nearly a century and a half. The subjects are eight in number, consisting of—in addition to those already mentioned—Elymas the Sorcerer, the Conversion of the Jailer at Philippi, Preaching at Rome, and his shipwreck at Malta. The works have been restored in the same colour in which they were originally painted—not precisely *grau in grau*, but in warm tones, so as to resemble drawings in sepia. The pictures come out now with as much force as ever they did, and the highest praise is due to Mr. Paris for his enterprise; but when the spectator looks up at these compositions, he is struck with surprise that at these, or any other pictures, should be placed so that either they cannot be seen at all, or seen with great difficulty. If, however, such a "bad eminence" has its disadvantages, it has also its recommendations; for if the beauties of works of Art so far removed from the eye cannot be seen, it is certain that their imperfections are equally secure from observation. With the similar examples that we find at Rome, Parma, and other places, we have nothing to do—it is at all times an act of weakness to follow a bad example. Had these works decorated the nave and transept, they would have been visible and interesting; it would have been quite enough to have broken the interior of the cupola with any bold ornament—had it been offered and the groins gilt there are greater anomalies in architecture than this. But, moreover, St. Paul's is the worst lighted cathedral in Europe; we take not in comparison, cathedrals and churches at Rome, Antwerp, Nuremberg, and other places where the light is immediately obstructed by bouses—the principal windows in St. Paul's are entirely clear of obstruction, but they are too small, too plain, too few, too severely square. We cannot help feeling that there are windows in the building, but when we look for them they seem but temporary—simply oblong apertures intended to assist the workmen in finishing the interior. There are in reality but four windows by which the breadth of the interior is lighted, if we may so speak of the prevalent twilight, and these are over the four doors; and when the doors, that are usually open in summer, are closed, the extremities in which they are placed are in darkness. With respect to the lighting of the works that have just been restored, since they are there, it is worth considering how they might be shown—an improvement which might be effected at a comparatively small expense. The windows below the cupola are numerous, but they are glazed with small panes, and the frames are so heavy as to obstruct perhaps a fourth of the light that such windows should give were the panes larger and the frames thinner. A little improvement in these windows would give a fourth more light, and by means of ceateled reflectors the whole of the detail would be fully shown from the whispering gallery: but under any circumstances it is a mere absurdity to remove works of Art so far from the eye. There is no edifice of its class with so few internal attractions as St. Paul's. This was painfully felt by Reynolds and other contemporary artists when they offered gratuitously to embellish it—a proposal which was negatived by Cornwallis, Archbishop of Canterbury, and Tarrick, Bishop of London. The small square windows are not at all adapted for such an edifice, they should be enlarged and filled with painted glass; and instead of lead sculpture, the pannels should be appropriated to good painting. The sumptuous adornments of our Houses of Parliament will reduce to meanness every other of our undomated interiors.

BELGIAN SCULPTURE.—A large accession of sculptured works has recently been made to the collection in the Crystal Palace; they consist of more than one hundred of the original models of the statues executed by the late Charles Geerts, professor at the Academy of Louvain, for the Hotel de Ville in that city, and of the statues of saints erected in the Cathedral of Antwerp. These works are contributed by Madame Geerts, widow of the sculptor: they form a very pleasing addition to the sculpture exhibition at Sydenham.

REVIEWS.

DESCRIPTIVE CATALOGUE OF A CABINET OF ROMAN FAMILY COINS BELONGING TO HIS GRACE THE DUKE OF NORTHUMBERLAND. BY REAR-ADMIRAL W. H. SMYTH, &c. &c. Printed for private circulation.

Coins, as verifiers of ancient history, are now so universally esteemed that the excuses once timidly made by those who collected them, in defence of their taste, are no longer needed. Since the days of the poet Addison, whose classic tastes led him to their study, and whose graceful pen recorded their interest and historic value, they have been accorded their due place as important aids to the knowledge of past ages, assisting the historian very frequently to minute facts unrecorded elsewhere; for we must always bear in mind that the Roman series of coins was not, like the modern currency, merely stamped to give legal and mercantile value to the metal—"the image and superscription" was not only that of Caesar, but it also recorded some important act of his reign. The money of the Romans is thus a currency and a medallion comment on their history, shadowing forth their acts, their wars, their triumphs, their home and foreign policy, by the aid of apposite emblems or more positive pictures; and all this with an epigrammatic force admirable in its conception and terseness. Truly then does our author assure us that such "infallible vouchers" assist us to "a clear understanding of many customs, offices, and historic events" and he properly thinks "no one can be disparaged by a pursuit which engaged the attention of, and enrolled among its votaries such men as Alfred, Cromwell, Napoleon, Selden, Wren, Canova, Camden, Evelyn, and Chautrey." This list of names might be swelled without trouble; and there are few among the educated who will not own, with our author, that "he who can examine them without thinking gravely, has the misfortune to be deficient of a very gratifying sense." Admiral Smyth is already favourably known by his volume on Roman large brass coins, printed at Bedford some years ago. All who read the book were agreeably surprised by the amount of quiet humour employed to season its profound scholarship. It is so frequently the fault of the antiquary to be heavy, that dullness is looked on by many as an essential peculiarity. The author denit in this instance with a subject apparently dry, but brought into his pages so much geniality, such a happy method of describing persons and events, and so true an appreciation of the minutest trait which would give life to a dull catalogue, that his book was a history of Rome and its rulers far more amusing and instructive than the duller pages of the historian. Unfortunately his present book is "privately printed," but we believe that the liberality of the Duke of Northumberland will make it sufficiently public in our libraries and institutions. We congratulate his Grace as much in having such a work prepared as in possessing such a collection. He is indeed fortunate in securing the aid of Admiral Smyth, whose book is not only a catalogue of a valuable cabinet of coins, but an admirable addition to our numismatic literature. The author amusingly illustrates the objections made by the ordinary world to spending money on high-priced coins, that "can hardly be worth sixpence," by comparing them to those who would "deery a valuable painting on discovering that it was on a shilling's worth of canvas." But he also shows that a really good and useful series may be formed of good coins at a moderate rate. Of course extreme rarities, or uncommon types, will always command a *prix de luxe*; yet when we know that genuine and interesting coins may be had from one to three shillings each, and that they fix upon the mind historic personages and events more forcibly than the pages of a school history, we sometimes think that their utility in an educational point of view has not been yet duly considered.

The collection here described was formed by the present Duke of Northumberland many years ago, when, as Lord Prudhoe, he was familiarly known as an earnest explorer in the Levant, forming there a fine collection of antiquities now safely deposited at Alnwick Castle. Yet it was not as a selfish collector that he was known, but as a liberal student of science, and the preface of this book records the facility with which he parted with his gatherings to aid the good general cause. The present volume may be safely considered as an addition to the same liberality; for it enables the student to enjoy this collection of coins equally with its owner; and whatever accident may happen to it in future years, as long as a copy of this book exists, so long will the collection remain intact for general use and instruction. Admiral Smyth's labours have also invested it with a value which we believe few other scholars could give. We hope yet to see an edition that may be accessible to all.

BLAIR'S CHRONOLOGICAL TABLES, revised and enlarged. By J. WILLOUGHBY ROSSE. Published by H. G. BOHN, London.

In glancing over a catalogue of the works reprinted and published by Mr. Bohn we are surprised at the multiplicity of books it contains, and the variety of subjects it includes. He is unquestionably a publisher of no ordinary enterprise, and what is more to the purpose, a man of no common judgment, knowledge, and ability, in selecting the best writings of the best authors—in placing them, as we almost invariably find he does, in the hands of the most able editors for revision and comment, while he not unfrequently supplies the latter with notes and suggestions of exceeding value. It is a wonder with so much business matter to occupy his attention he can find time for the exercise of his thoughts and pen upon what is peculiarly the duty of the compiler or editor; but so it is, and it is quite evident the reading public are considerable gainers thereby. We do not by these remarks intend, or desire, to detract anything from the labours of Mr. Rosse in the production of this new and greatly enlarged edition of Blair's Chronological Tables; but as he very properly acknowledges that the plan and arrangements of his work are due to the publisher, the latter is entitled to whatever merit, and it is not a little, attaches to the system adopted. But even with the plan laid down for him, the task of the editor, in reconciling the differences of previous chronologists, and in determining dates with the nearest approach to accuracy, must have been one of great labour and magnitude; and there seems to be little doubt of his having accomplished it satisfactorily: to determine this, however, the reviewer would necessarily have to pass through the same ordeal of research and comparison as Mr. Rosse. The table of events is brought down to a date as recent as the execution of Palmer, at Stafford. The volume forms a "Double Number" of "Bohn's Scientific Library;" it is to be followed by another of equal dimensions—nearly eight hundred closely-printed pages—to be entitled a "Complete Index of Dates."

A KEY TO THE PROPORTIONS OF THE PARTHENON. By JOSEPH JOPLING, Architect. Published by the AUTHOR, Bridge Road, St. John's Wood.

We confess that our knowledge of geometry as applied to the principles of Greek architecture does not enable us to pronounce an opinion upon Mr. Jopling's pamphlet; the object of which seems to us to be to prove, by mathematical calculations, the accuracy of the work of the ancient Greeks, as well as of the measurements which Mr. Penrose has made of the Parthenon. But we can only direct the attention of those whom the subject more immediately concerns to the publication before us. Mr. Jopling is under the impression that the teachers of practical geometry are, in our day, all wrong—that they are comparatively ignorant of the "truths of form." He is desirous of inducing a systematic and most extensive and comprehensive practical advance in the knowledge and varieties of true form and proportions applicable to Art, and would like to see a "Gallery of Geometrical Models" in our new National Gallery, or some other appropriate locality, in which "some of the laws by which the Greeks proceeded" might be set out full-size for general instruction. We presume, however desirable this may appear to be, there is little probability of its being carried out.

ANNOTATED EDITION OF THE ENGLISH POETS. By ROBERT BELL. Published by J. W. PARKER & SOX, London.

Such a work as this had almost become a desideratum to the literary necessities of the present time; for though some of our English poets have found able editors and commentators, no complete series has hitherto been issued, nor even an edition of an individual poet which, combining careful and truthful revision, typographical excellence, and low cost, would meet the requirements of the day; there seems now to be the fairest prospect of such a want being well supplied. The task could not have been confided to a more competent editor than Mr. Bell, whose "Lives of the English Poets" has become a standard book of biographical reference. The volumes now on our table are, eight containing the works of Chaucer; one of "Early Ballads," illustrative of history, traditions, and customs; and one of the poems of Ben Jonson, Dryden, the Earl of Surrey, Cowper, Sir Thomas Wyatt, Oldham, Edmund Waller, Shakspeare, Thomson—we name them without reference to their chronological order, or to the position each occupies in literature—have also appeared; but we shall now only advert to those immediately before us. It must be self-evident that to present anything like a truthful and correct copy of the writings of

these early poets—one which may be presumed to be free from the corruptions and speculations of careless and incompetent editors—would be a task involving an immense amount of research, industry, and labour. Mr. Bell has adopted, as the basis of the text of Chaucer's poems, the Harleian MS. in the British Museum, selected by Mr. Wright in his edition of Chaucer, which has hitherto been generally accepted as the only safe interpretation of the writings of the poet; but he has collated the text of Wright with that of Tybitt, published about the middle of the last century, and has adopted the reading of the latter when it seems to bear evidence of authenticity, and has also introduced his own version of such portions of the original MS. where it appears desirable to employ it; but all deviations from Mr. Wright's version, or from the original, are pointed out in the foot-notes "for the ultimate satisfaction of the reader." Even the most cursory glance at the foot-notes will convince the reader of the diligence, pains, and research the editor has shown to reconcile apparent inconsistencies in the remarks of previous commentators, and to explain what is dark or unintelligible to those unacquainted with the phraseology of the early English writers. An ample glossary of obsolete words, and of words the meaning of which, as introduced in some of the poems, is appended to the concluding volume; it will materially assist the reader in mastering the difficulties of understanding the "Father of the English poets," while it will enable him the better to appreciate his beauties. A general "Introduction" to the writings of Chaucer, reviewing his style and peculiarities, and a particular "Introduction" to each respective "Tale," form valuable arguments, and the poetry of Ben Jonson, and the "Ballads," are edited in a like spirit of care and research, and that is all it seems necessary we should say concerning them. The publication of the entire series is so arranged that the writings of each poet form a separate and distinct issue; and as cheapness is now regarded as a necessity in reprinted books, these are sold at half-a-crown each volume.

CHROMOLITHOGRAPHS. Printed and published by G. ROWNEY & Co., London.

The rapidity with which the printing-press is now sending forth the productions of the chromolithographic process is such that we can scarcely keep pace with the movement; in truth, these coloured prints seem now-a-days to be occupying the windows of the print-seller, almost to the entire exclusion of the works of the engraver. We have no fault, however, for the latter, inasmuch as there is ample room for both, and each will maintain its own position, and receive its share of public patronage, according to the taste of the purchaser. The publications of Messrs. Rowney & Co., now before us, are—"A Sketch of St. Paul's from the Shot Tower," from an engraving by G. Dodgson: the view—a "bird's-eye"—one—is taken from the Surrey side of the Thames, a portion of Blackfriars Bridge crossing the foreground of the picture; it is a clever facsimile of the original, but the church-tower on the right is very much too dark, and obtrudes itself on the eye far too prominently. "Notre-Dame, Rouen," after E. Dolby, is a highly-finished work; the architecture of the fine old cathedral is very carefully drawn and tinted; the part of the street which is in shadow is coloured rather too heavily. "Whitby, Yorkshire," a small subject after C. Bentley, is an excellent copy of this artist's style of work, who delighted in strong contrasts of light and shade; it is a sunny little bit. "Ruins at Newtown, County Meath," after H. Gasteneau, is another small landscape which we may call "pretty;" but the gem of the whole is in our opinion the "Gipsies' Camp, Claygate, Surrey," from a drawing by R. P. Noble; it is small, but remarkably rich and truthful in colour, and as close a copy of a drawing as if it were entirely executed with the pencil.

NOLAN'S ILLUSTRATED HISTORY OF THE WAR. Part 19. Published by VINTAGE & Co., London.

Though this work reaches us regularly in its monthly issues, we have not noticed it for some time past, and do so now only to observe that the interest of the subject is not permitted to diminish. The last chapter in the present part brings down the events of the war to the correspondence between Sir F. Williams and Lord Stratford de Redcliffe. The intermediate history is ably and fully discussed, and in a spirit of entire impartiality; nothing seems to be omitted which, even in the remotest degree, connects with our subject. In the present war, we read the record with mingled feelings of admiration and disquietude.

THE SALAMANDRINE.—SONGS FOR MUSIC.—BALLADS AND LYRICAL POEMS. By CHARLES MACRATY, author of "The Lump of Gold," &c. Published by G. BOURLEIGH & Co., London.

Dr. Mackay is among the first of the lyric poets of our day; his verse is always fresh, and healthy, and natural, while it is distinguished by a graceful-ness of expression that bespeaks a cultivated intelligence, and by a high moral tone indicative of a right understanding. He teaches by the precepts, and charms by the melody, of his muse; though we have occasionally thought that in some of his writings may be traced the inclination to elevate one class of the community at the expense of another, a rather strong bias in favour of extreme liberal opinions; still his writings generally are calculated to be of good service, and we are therefore glad to see them issued in so cheap a form as to come within the reach of almost everybody. The three little volumes, whose titles are given above, are published at one shilling each. The "Salamandrine," and many of the poems contained in the other two volumes, have passed under our notice before; we have only to recommend them again to the perusal of those who, in this unpoetical age, have happily not lost their relish for "pure thoughts in measured rhyme."

JAUFRY THE KNIGHT AND THE FAIR BRUNISENDE. A Tale of the Times of King Arthur. Translated from the French version of MARY LAFON. By ALFRED ELVES. Illustrated with Engravings by G. DORÉ. Published by ADDEY and Co., London.

We learn from the preface to the French version of this romantic story, that it is one out of the mine of literary "jewels," which for six hundred years have been buried in the catacombs of the libraries and archives of France. Dugged from the dust beneath which it has lain for so long a period, it is now translated for the first time, and given to the world. The romance was originally written in verse in the Provençal tongue of the twelfth century; begun by a troubadour who heard the story related before Pedro III., King of Aragon, "by a strange-knight of kin to Arthur and Sir Gawain," and finished by a poet whose modesty caused him to conceal his own name, and that of his colleagues. The Imperial Library of Paris possesses two manuscript copies of this story, which will assuredly find favour with all who delight in the early romantic history of Britain, especially in the deeds of the bold knights who sat at the Round Table of King Arthur. Jaufray is one of the most renowned of these specimens of most ancient chivalry: confiding in the justice of the cause, and in the strength of his right arm, he wages war against giants and wizards and enchantments; rescuing captive lords and beautiful ladies from all kinds of bonds and servitude; receiving, of course, the hand of the "Fair Brunisende," and all her broad sars, as the geridon of his valorous achievements. The translator, in giving a prose version of the tale, has preserved much of its early poetic character; hence a quaintness of language and an easy regular flow of words that would convey a tolerably good notion of the original, had it been written in the English tongue of that period. The illustrations are quite in keeping with the text—strange and unnatural, yet exhibiting considerable talent of picturesque description. The imagination of M. Doré is richer and more facile than his pencil is ready in carrying out his thoughts; and he has not yet learned the art of "effects."

COTTAGE PICTURES FROM THE OLD TESTAMENT. Published by J. H. and J. PARKER, Oxford and London.

A series of twenty-eight subjects judiciously selected from the principal events recorded in the Old Testament. There is no artist's name attached to any one of them, except that of the lithographer, B. Lummel, nor any letter-press to afford this information, or information of any kind. We suspect, however, that the designs are of German origin; they are excellent in conception and drawing, and are very carefully coloured, so as to render them most suitable for the purpose indicated in the title. Half-a-dozen of these prints hung in a cottager's room would not only ornament it, but would prove instructive to its inmates in matters both of religion and of Art. Surely the time is come when such works must take the place of the abominations in tinsel and gold, which one has so often seen defacing the homes of our peasantry and artisans, vitiating their tastes, and not unfrequently demoralising their minds. There is now literally no excuse for the circulation of such trash as the masses have had offered to them, till within the last few years, as their only "pictorial food."

THE ART-JOURNAL.



LONDON, NOVEMBER 1, 1856.

NOMENCLATURE
OF PICTORIAL ART.*

BY J. B. PINE.

BEAU-IDEAL.



By beauty thus stands out by itself, prominent as distinguished from deformity, intentional as a work of the Creator, self-repeating and self-sustaining, as is every other work of creation, there will be little difficulty in adjusting its position in connection with the third and intermediate theory, which would make beauty and deformity depend the one on the absence, and the other on the presence of fitness. The deeper the insight we gain of nature, the more we are able to see that this exquisite fitness is equally a characteristic of the beautiful and the deformed, and that there is as yet nothing discovered in which it may be said that this fitness is even comparative. On the contrary, so transcendent does it appear in all instances, so universally beyond the conception of man, that he acknowledges himself to be left without a scale by which to measure the fitness of one thing with the fitness of another. He cannot thus qualify a particular instance in nature by attributing to it some one particular amount of fitness, as nature herself, in this respect, presents us with no degrees; but merely may it be discovered to possess for him some particular degree of fitness or unfitness for some particular arbitrary or foreign purpose to which he would force it. Barely can he do so by supposing it to have different degrees of any apparent present utility—depending, most likely, on his own comparative ignorance, rather than knowledge of the possible ultimate future uses of that which, at any one precise time, may appear to be useless; but to do so he is forced to resort for a comparison to a greater or less beauty or deformity. Thus, then, if anything in nature has in it anything in common besides its own particular identity and presence, it is this invariable fitness. If it have beauty or deformity as well, it has also fitness. Fitness being invariably found, it cannot be called in as a distinguishing mark to separate one thing from others, all which other things having the same amount of ultimate fitness as a general all-pervading quality. This appears to be as plain as that one cannot identify some one particular letter, in a book that may be printed altogether in black ink, by stating the letter to be black; and in the instance before us, the great distinguishing external characteristic of things resolves itself into beauty and deformity. If

utility and this fitness could be said to constitute beauty, all the world would be beautiful, as it is all possessed of this fitness, and neither the fact nor the term for deformity had ever been felt or discovered; while beauty itself, either morally or physically, had never been appreciated, from the very want of some antagonism by which to rate its amount.

It were impossible to overrate this fitness of all creation, its necessity, its ultimate completeness; though in the equally necessary absence of infinite knowledge it were, on the contrary, easy to underrate it, and to imagine the possibility of its possessing degrees by which one thing may be rated as in some measure unfit when compared with the admirable fitness of another: and this imagined possibility, untenable in itself, has been at the base of an erroneous theory of a beauty constituted of an admirable fitness contrasted with a deformity arising out of a fitness less admirable; and, ultimately, out of a great unfitness constituting an ultimate deformity. A notable instance of an error growing out of this absence of knowledge, occurs in the first estimate formed by naturalists on the construction and animal powers of the sloth. It must be that specimens of this singular animal had been first transferred to this country before those persons who actually captured them had thoroughly become acquainted with the whole of their habits. They were then placed in the ordinary den, or cage, of our museums, and created much attention by the then unaccountable fact of their walking, or attempting lamely to move, on the outside of the paw, instead of—like other animals—with the bottom of the paw on the earth; their long hooks, or claws, in this position lying parallel with, instead of perpendicular to the ground. Upon the appearance of this singular phenomenon, the whole of the half-philosophical world were very much inclined to the delusion that they had caught creation napping in the production of an animal with four legs and feet, but at the same time without the power of readily walking; while at first sight a very natural notion prevailed that it necessarily should be capable of walking, if only in search of food. However it might have been, this fact of the absence of a power of easy locomotion much perplexed people, and the perplexity set afloat numberless more or less strange theories to reconcile it with the generally received belief in the universal fitness of things.

The two most singular of these theories being, the one that it offered an extraordinary proof of the as generally received axiom that there is no rule without an exception—this being an exception to the rule of the universal fitness of created things; and the other that some animals, perhaps being at the same time epicurean as well as carnivorous in their tastes, and loving sloth, this derangement of the locomotive powers in the latter animal might have been an arrangement for rendering it a more easy prey.

These little delusions, however, vanished under a fuller knowledge of the habits and locale of the animal in question, up to this time considered the most "injured, unfortunate, and melancholy of all living things;" and those peculiar structural characteristics which at first view seemed to threaten its probable long existence, were ultimately discovered to be as felicitously contrived to continue the species to eternity. In no respect could they have been otherwise so well adapted to this end, either as regards the sloth itself, or the food that was to sustain its life. Hing by those long crook-like claws under, instead of upon, the branches of trees, the sloth was thus suspended amidst the fullest and richest supplies of its constantly accumulating food, which position it was enabled to keep for any length of time from the

great strength of its feet and the crook-like character of its suspending claws. We have now nearly done with these opinions, which would disturb the position of beauty on the earth, hustle her from her throne in the heart of man, and warp the beneficent intentions of the Creator in the great object of creation. This third and intermediate theory, then, carrying with it all the weakest characteristics of an invention of man rather than a discovery, falls to pieces from its own want of fitness. The want is self-evident in its own premises, which disappear in every evolution to establish themselves; and if anything said here may even tend to dissipate what I imagine to be the errors of the second and third theories, much good will have been achieved, as by a constant displacement of error, and a re-agitation of any subject, truth will be the more likely to make its appearance.

There is one grave error indulged in by the inartistic public arising of the term *ideal*, which goes far to weaken the claims and obscure the real character of the beau-ideal. It is, perhaps, unfortunate that the term *ideal* has been adopted, as it has created a notion, and a widely-spread one, that the beau-ideal is an inventive beauty, which though under an easily appreciated form, as illustrative of man, is, nevertheless, never actually found in nature. This supposition that the beau-ideal is never found in nature is entirely erroneous. That the exquisite perfection of the details of the human form, found in those sculptures to which we assign the characteristic of the beau-ideal, is incompatible with the powers of nature, is equally so. It may be said, in opposition to this view, that a search through a thousand instances of the human form may not present one perfect individual. The obvious answer to which is, search through ten thousand. If ten thousand will not yield one, try ten million. If Europe itself prove unproductive, try the remaining quarters of the globe; and if the whole world itself present but one individual at any one time equal to compete with the beau-ideal of the *elite* of the sculptures of antiquity, it will be a sufficient vindication of the power of nature to produce that which has been all but universally considered to be an invention of man; morosely considered as an egotistical illustration of himself; and beneficently, as one of his most fervent as well as purest aspirations after perfection.

The existence of the beau-ideal then is, on the contrary, one of the great facts in nature, and not a gratuitous invention of, but a mere reproduction by, man from its original type. It demonstrates the highest intention of creation as to form; and if realised but rarely, so much the more value attaches to it when found. The general everywhere-to-be-found character of the human form is merely a vacillating line which degrading influences have been able to warp round this high central one, to which, or from which, the same vacillating line may be said always to either tend or deviate. It is the want of a due sense of the grandeur, the purity, and the beauty of this intention of creation towards the beau-ideal, that gradually depraves the mind itself; and, ultimately, in its lower states of pictorial degradation, induces one man to paint you a Jesus Christ with bunions and bony legs, and another to disguise the world's Redeemer in a watchman's greatcoat, and a countenance that would undignify a watchman; while the same mental depravity, with a little more ignorance super-added, are sufficient to produce a crowd to admire them.

These eccentric and vacillating lines, playing round the pure one of the beau-ideal, may be compared to vice, in its thousand forms, surrounding virtue—slinking her pedestal without destroying her, but at the same time shrouding

Continued from p. 93.

her from public contemplation; and it is only through this busy, hoisterous, and gibing mob, that it may be approached with the constantly-increasing risk of being permanently fascinated on the route by some less worthy object than the one originally sought for.

The Greeks—whatever might have been their mode of study, and guided by whatever principles—seem to have been possessed of a more indomitable constancy than the moderns, in this pursuit of the unvitiated beauty of the primal form. It is now pretty generally considered that their search was principally for a mean and central line, dividing equally the erroneous and varied lines that presented themselves in the common nature round them; and it is more than probable that long before the time when in this country instances of the beautiful may become as frequent as they must have been with the Greeks of the artistically classical period, this mean or central line in nature will again be the great object of study. It is quite evident that the power cannot be gained by the classical sculpture alone, though more than likely that it may be approached through it, as an unexceptional source through which to acquire the power of drawing, but a very equivocal one for imitation; for a man must rise above it to be able to do the like, as execution is always below conception.

As a great artist, better to have never known the antique than to suffer it to absorb the entire affection. Better by far begin afresh, and look again upon man in the aggregate as the beautiful of that nature out of which he has been called. And may we not find, by a comparison of himself with his constituent nature alone, a path by which to arrive at a comprehension of his beautiful? It were easy to broadly answer this query negatively by stating, that if it may not be arrived at by this process, there is no other open by which it is so likely to master the solution. The Greeks either might or might not have proceeded upon this broad ground of centralising man. If they did, there is no record of their aim or plan, except as derivable by supposition from their works. This supposition, as given by the older critics to the world, is an entirely gratuitous one, without why or wherefore, and has consequently been altogether discredited, or held in very weak faith, except by those few who—without any such intimation—would, in their own sound mode of reasoning, have struck out again the same theory.

The aim will now be, instead of giving again the unsupported dictum, to establish the fact of the existence in actual nature of the beautiful, and clear a path to it by analysing man in his state, form, place, and scientific and mental qualifications, as affected by the simple and single test of centralisation.

It may be admitted as a starting point, though with the risk of somewhat vexing the question, that man is not strictly, entirely an original; for what can he strictly so in an eternal order of things, in which all is either concentrically or excentrically analogous? For, allowing the universal dictum that he is within himself an epitome of all creation, or of the world—taking more confined grounds—this duplex character limits in some degree his entire originality, in establishing his reflected and composite nature—an union of all the elements of nature, differing in form, with superadded mentality and future life. Take at first, for instance, the most general and least particular of all other qualifications—that of size. He may be stated as exhibiting a perfectly central position, off which to measure upwards to the largest, and downwards to the smallest instances of animal life useful or employable in labour; that is, midway between all those who have to sustain life "by the sweat of the brow." Take a next general and com-

prehensive point as affecting his existence—his place on the earth, and this will be found to be central or mean also, nicely poised between the hotter and colder regions. For however it may be possible to find human organisms capable of sustaining life imprisoned in snow dens in the frigid, or like an animal of the field lying under the shelter of leaves in the tropic zones, the temperate portions of the earth are best suited to the production, cultivation, and sustentation of the moral, intellectual, and physical man; while his reproductive powers, under temperate climates, doubles the ratio to be arrived at in either tropical or frigid countries. Many will insist that there are organisms as fitted for the one extreme as the other. Granted! And there is nothing lost by the admission, for it may be asserted that, for every one fitted for either one or the other of such extremes, there are twenty who are not, and those fare equally well under a temperate sun. At any rate, take man in the aggregate, at the zenith of his capabilities, and he is only to be found in those parts of the earth enjoying a middle temperature.

Again, in assigning him a place in relation to his size and its necessary proportions; their characteristics will be found to be central—midway between the large and the small, the light and the heavy, the attenuated and the bulky; their proper range alternating in degrees between the elegant, the beautiful, and the dignified. Taking the both together it never rises to the grandeur of the pillared and domed elephant, nor descends so far as ever to hear a humiliating comparison with those lesser animals whose fragile structures are disarranged by a breeze or destroyed by a shower, but holds a medial position between the two. Man never ascends to eminent grandeur by means of his general outline alone. His arms would appear to hang, and his legs to stand in the way of an ultimate grandeur; and by the head alone, burning in its intellectual intelligence, and glowing under the effulgent influence of high passion, does he ever achieve it. By the exhibition of intellectual power in forcing an adverse situation, the head alone, with even the weak accompaniments of arms and legs, may become sublime. On the contrary, an intellectual man by means of his general form alone under no circumstances may ever become grand, though he may be born eminently beautiful, though he may have even those proportions which a sculptor may, in courtesy, pronounce grand. As regards, again, the mechanical forces, he remains about the centre of animated life, neither possessing the quickness of one species, nor the mastery over weight of another.

The most difficult thing perhaps of all others to accede to is, man's mean state as regards the senses, or some of them, inasmuch as through these he receives the first intelligence on all subjects that lead to the completion of his intellect, and render him ultimately the most intelligent of creatures; and so much so as to induce him to pronounce all the rest of the animal creation to be destitute of the reasoning faculty. It would, therefore, be more consonant with our preconceived notions of the necessities, and, at the same time, more flattering to the ingenuity of our egotisms, to find ourselves possessed in every instance of better and more perfect senses than our subordinate fellow animals. Be it as it may, however, he is found to be inferior to the bird in precision, if not general force, of vision; to the dog and many other animals in that of scent; and to many others in point of hearing.

It is far from an unamiable, unsocial, or rebellious feeling that induces this expression of opinion, and, while holding it, it ought at the same time to be inferred that this superior power of sight, scent, and hearing, in the lower

animals may be confined to certain modes only, and not to embrace a range so wide and diversified as that possessed by man, whose necessities, requiring a highly varied power of sense, have given him one of less precision as applicable to some one given purpose. This mean state of sense, therefore, instead of derogating from man, constitutes his gloriously general superiority over every other sentient being, giving him general while refusing him particular power.

Taste and touch, however, remain the comparatively sole property of our species, in which powers we transcend all other animals—if touch may not be made an exception in favour of some few whose locale precludes the use of what visual power they may have.

It is unnecessary here to speculate too minutely on the possible motive in the creative power for positing the human family in this medial state. It will be sufficient to draw particular attention to the fact for the purpose of establishing some grounds for future induction. A few words, however, bearing on our own particular subject may be admissible. By reflecting the whole of creation on the constitution of man, and making him—as a matter of necessity—medially an epitome of the universe, he is thus intimately associated with the universe itself. It gives him an instinctive interest and solicitude in the whole order of things as they are; and his mean state enables him to the more readily reach, as it were, mentally from one of their extremes to the other; the more so than if he were more closely allied to the greater or lesser instances of it. If, for instance, his natural proportions were less, he could not so readily acquire control over the large; and if much larger, he had lost power over the more minute; if either one or the other he had never been in close associateship with either. In fact, had he been of the size of the ant, his largest ships would have been less than a washing-tub, and he had never crossed the Atlantic; and if of the size of the elephant, he had never found earthly materials out of which to construct a vessel capable of holding two thousand of his huge companions. With the dimensions of one he had numbered the earth; while with those of the other he had merely infested it.

In looking at any apparently incomprehensible fact in nature it is useless to wonder at the whys and the wherefores that it may raise, or to entertain them at all in the manner of doubts as to a perfect fitness. The time spent in doubt on this particular point is time thrown away, and one only begins to save this time when it shall be determined to receive all nature like a schoolboy receives the elementary portion of his education, in perfect faith and reliance on its being all right and necessary. The metaphor which describes creation as a sealed secret was conceived in a moment of hellions ingratitude and mental idleness, and has been merely received unquestioned by the world on account of an apparent ingenuity during its period of weakness. The more informed world discovers it to be merely locked, and at the same time finds itself to be the key. No rude instrument by which force is made to supply the place of skill, and through which fracture takes the place of discovery, nor any sneaking agent by which the wards may be passed; but the key itself, made for the express purpose, with a nicety of adaptation which finds a point of unerring and ultimate fitness in every minute phase of his nature. A more subtle ingenuity, and a more extended information will be able to carry this analysis through other and more striking channels than are here touched on, by which to further illustrate this general central position of our species, and deduce its perfect necessity from its resultant fitness.

Having in accordance with the previous views centralised man in the aggregate, examine

him now as an individual, always bearing this inquiry in the van:—Where is his beau-ideal? Where his ultimately perfect form and development? Does it obtrude itself in the giant, or does it hide itself in the dwarf?

The hope of finding it wallowing in bulk is just as preposterous as that of discovering it dwindling away in stunted proportions. It must then be looked for in the mean or central dimensions and proportions, like everything else having truth or beauty for its character.

If we descend from the general form to the members, it would be as hopeless to expect it in either the large or the small. The too largely developed head, with its either extravagant or sullied projects, no more than the one of contracted and inefficient organism, realises beauty. That the small hand pertains to nobility must be a sheer conceit; but, if true, added to its weakness, merely dissociates nobility from beauty equally with the large one, which is merely indicative of power. The feet would go by the same rule; and the legs must follow. On looking at the most classical works of the ancient Greeks it is impossible to refuse the conviction, long ago surmised only, that their search for beauty lay through some imaginary central or mean line, at once avoiding the full as well as attenuated, the big and the little, and that the proportions adopted for the minor parts were as studiously projected on the same medial adjustments. But it is not so certain that they decided these dimensions and proportions from a mean line deduced from the whole of the human races; and much more likely that they were content with those derived from the Greeks themselves, Greek giving to Greek. At the same time it is most unlikely, from what may be collected from their writings, that their conclusions were drawn from, or were biased by, considerations connected with the centralism of man himself in the creation. This may not be determined without a minute and extensive acquaintance with Greek literature, but it is to be inferred that the character and object of it did not tend in this direction, and that we are indebted more to the general inventive and tasteful powers intuitively possessed by that people, along with that well-developed form consequent in some measure on their climate, but more on their habits and manners, for that much of the beau-ideal that we have inherited from them in their sculptures. It may be said that we—that is the moderns—can do the same thing again, having access to the same principles. If it were not that such principles are no principles at all; and added to which we may, or may not, be in possession of the same amount of intuitive perception of the beautiful, and certainly not of the same advantages of climate, habits, and manners.

If we are—like so many savages—to look upon these sculptures in silent and unproductive admiration, as something very extraordinary, done by some now extinct very extraordinary people, it may or may not be all very well to go on admiring, spinning cotton, staining paper, daubing canvases, and emigrating. An aspiration, however, lies burning around the soul to transcend these glorious Greeks. It occasionally, at a single flash, consumes all these thoughts about cottons, papers, and canvases, and leaves in unclouded effulgence the inner orb of our civilising natures, prone only to transcend and beautify. We have already done it in politics, in diplomacy, in machinery, and in war, but Art has been left to thrive as it best may on empiricism and native courage, un-protected, and, in a great measure, unrecognized; and if ever we transcend in the production of the beautiful it will be by having access to more comprehensive grounds to proceed on, acknowledged to be at once rational and certain.*

* To be continued.

SUGGESTIONS OF SUBJECT TO THE STUDENT IN ART.*

BY AN OLD TRAVELLER.

CHAPTER X.

Old English Towns and their Market-places—A Morn of May—"Doing observance" *more* Yarmouth—The First Merchant—A Custom—To Penny!—A Wish and its Frustration—Better Prospects—An Apology—The Privilege of Labour—Church and Trees—Chariots—Prototype in the Sign of the Vatican—Chariot Races of Padua—A Charioteer—A Horse of "worthie race"—The Rows—Venice—Verona—The Lustricata—Night in Verona—Home! still Home!—Burlington House in '55—Amateurs, Royal and Noble—Richard and Kate—Poets, Kings, and Commons of England—The Pride of Pembroke—A Hat from Mistress Gölpin—Fisherwomen of Norway—October departing—Consolations in November—Gaston Phibus—Charles the Bad—The Banquet and its Events—A Great Misfortune—Messire Jehan Froissart—Raymond de Corasse—Messire Peter of Bearn—A Procession to Our Lady of the Woods—The Count's Hunting-party—The Vision—Forgiveness—Hunting at Home.

Nor a few of our brave old English towns still make their boast of a market-place; so fair and spacious in every extent, so grave and dignified, or so quaint and rich in pictorial effects, that no painter, worthy of the name, could be dropped into the midst of one without resolving to perpetuate its every characteristic feature on the choicest canvas of his studio—soon to become the best loved, also, as successful progress should bring the beauty and value of his work into greater prominence.

Such a picture, as the artist so determined will produce, was presented to our fortunate eyes no longer since than the summer just by-gone—alas! for the bright and fair departed! when the last delicious morn of May was exhibiting her wealth of loveliness—as who should say—

"Let the June your hearts are turning to welcome, O ye fickle sons of men! bring you aught more lovely than these my charms, which you will presently be forgetting."

"Was then the fair month envious of her sister?" Nay, boy! do her no such grievous wrong; some shade of sadness there might be passing over her peerly brow, but for so black a cloud as that within whose folds pale Envy shrouds her ugliness, far be this from the Queen of months. She did but heave one sigh for the loss of your love, ye poor children of mortality, and methought the softness of her beauty grew ever sweeter as she mourned for that best of treasures—affection; affection born of heaven, and heaven's fairest boon to earth.

May! but the last of May! And the hour? 'Tis that early one of morning, the first to follow the sunrise, when the heavens exhibit that delicious paly-gold of their youth, unknown to such as keep closed eyes until their mid-day splendours blind the world. Over all the fair broad market-place are scattered numbers of small, slender, dim-coloured fabrics, each much resembling a sentry-box; they are now lying, leaning, or standing about in rare confusion, but shall soon be all marshalled in trim array, such as Order prescribes in the mart when Traffic rules the hour.

As yet we have trace from the turmoil that shall prevail anon—the hour is yours, O Painter! One merchant alone is in the "receipt of custom," to apply for our own purposes a phrase due rather to him who gathers the fiscal tributes—one only, but a prosperous and well-appreciated chapman, as you see; since, of the few now but thinly peopling the ample space, a large proportion is either demanding, or in process of consuming, his wares.

"The cup
That cheers, but not inebriates,"

is that which you see dispensed, with appropriate edibles, by the "son of the morning," now adjusting his clean white apron (no true painter will start from the seeming bathos) for your especial benefit; and his consoling appliances are attracting within his orbit whatever can muster the respectable penny that shall pay for each steaming and well-odoured libation.

Ah! good, broad, honest, helpful piece, with thy clear brown ample disk, its huge weight all unfeet by the hardy palm of him, but too well pleased to enfold thee in his grasp, the boy with blithe frank

* Continued from p. 311.

visage and firm determined step, that now approaches the tempting board;—not on reddest gold or fairest silver is the welcome face of our sweet liege lady so dear to the eyes of youth, in another class of her loving subjects, as it is on thy much begrimed surface, stout, gladsome penny of my heart! Dear, and doubly dear art thou to the "chews and si-news" of the nation, as it makes its way to manhood, after the rough, yet not unhappy fashion familiar to the youth now resigning thee for a something, at this moment yet more precious and more needful—great as is the store he sets by thy comely self.

Now I would that at no point throughout the fair breadth of our lady's realm were there one child to be found who could not command thee, much-availing coin! but even as we utter the wish, come the longing eyes of you poor pale mother, making sorrowful confession that no son of hers may this morning boast of possessing the potent wealth represented by thy good round bulk. Voe is me, penny! can there not be some means found for enriching the group around her to that extent?

There can, for the well-to-do labourer, sitting there swinging his substantial yet not unshapely legs from the rail that he has chosen for a seat, while he waits for his comrades, who will come to aid him upon the fabricacles for the sellers, *he* has turned his glance in her direction. He looks careless and unmoved just at present, perhaps—yet never doubt him; the daughter of wretchedness comes nearer, and ever as she does so, that great brown hand of his gets closer to the pocket within whose depth thy beneficent presence hides unseen. A moment more, and the consciousness thereof shall gladden the poor, lost, ragged, lazy-looking creature, slowly coming within reach of him who toils, and who can therefore give, eye, even thee, O penny!

You will say she has the trailing gait of the practised beggar, and affirm that her indolence cannot fittingly be upheld by the labours of the industrious. Well, I grant you that there will be a misappropriation of funds—for the woman evidently is a beggar from habit, perhaps from choice; but look at her four wretched children! There is not much to reassure one as to her future in those faded looks, and it may not be denied that her dingy rags have an air of the parish workhouse; neither is that gait, inert and purposeless, without its significance. Still there are the children, and for this moment what can be done? they cannot wait for a breakfast until the mother has been rendered provident and industrious, wherefore let the rigour of your judgment be relaxed, and suffer industry to bestow on idleness his hardy-won penny.

She has not yet detected the good provided for her by our friend on the rail; but wait a moment, and if it were not that we prefer to have her as she now stands, and must fix her so, and not otherwise, you should presently behold a spurious kind of energy informing those languid movements, and the half-dead eyes would gleam, for at least some few short seconds, as her perceptions became awakened to the fact of that large hand, stretching forth, as it surely will be, to endow her with the wealth you wot of.

A fine old church, shadowed beautifully, as we now see it, by trees—rarely found standing on similar sites—give peculiar character to our market-place; and this is further heightened by the dashing approach of a carriage, also peculiar to the place—Yarmouth, in Norfolk, namely—nay, which you will find in no other. In form it is not unlike the Roman *biga*, as most of you have admired it in the rich white marble specimen giving its name to the "Hall of the Chariot," or "Salla della Biga," in the Vatican, where it forms the fairest ornament of that well-filled chamber of the gallery. Others of your number may have seen the same form of chariot, but in widely different material, as it whirls around the arena of Padua, and some few other Italian cities, where the chariot-race is still the rare exhibition of some extraordinary festival.

But to such as have not beheld that inspiring sight, the Yarmouth carriage will give a most sufficing idea of the vehicle; while in picturesque effect the English charioteer is in no respect surpassed by his Italian compeer. Frank of aspect, bold and fearless of demeanour, and bearing a whip, which he holds chiefly as a staff of office, he stands, a hero accepting a triumph, rather than a hireling driving a fish-cart.

"Woe is no now for *that* hithos, for this time it seems real." Yet not it is again but in seeming, friend Zolus; do not look at the spirited air where-with he stands erect as he now comes dashing towards us at the speed of his swift, yet powerful horse; no cropping, cart-like pace is his—nay, the whole man is altogether different from those of his class elsewhere. Well set on his handsome shoulders, the head now has its crisp brown curls covered by a sturdy son'wester; but how becoming is the confidence of its carriage, that head! and if he were to lift off the covering, what a good fair brow you should see! A short canvas frock next comes into view, with very loose trousers of some nondescript material, with which you have the less to do, since they are almost wholly concealed by the classic form of the vehicle wherein he "comes spanking along." Spring aside, good friend, or he may chance to crush his critic, though to do evil be not in his habits. Mark him as he passes in full career, what a cheery-looking creature it is!—brown hues of health adorn his rough-hewn features,* a good-humoured word seems all but visible on his lips, ready to greet you; and his expression is such that if you wanted help in a crowd, it is just to his very self that you would turn to ask it. And you would choose judiciously—earnest in his labour, ready for all things among his mates, dangerous, perchance, if wrongfully assailed and deeply moved, he is yet gentle as the gentlest woman if he find you suffering; and that great rough hand shall lift the street-bred infant from its jeopardy with a tenderness of touch that only the mother's self could equal.

Then his horse—no unworthy portion of your group is he—strong, but not heavy; in the best of his age, and thoroughly up to his work, he puts the stones behind him at a pace such as no ordinary cart-horse "ever saw in a dream—he nor his fathers before him," as Eastern writers say. Is he not pleasant to look at—his small tapering ears pointing cheerfully forward, the bright clear eye, yet calm, and somewhat grave withal, bespeaking the excellence of his temper and the prosperity of his condition? How easy, and even pleasurable his task in this delicious morning air! no toiling, overwrought slave is he—"Warm and duly aired is my well-strawed stable, good and abundant is my hay, and my corn is of the best; pure is the water I drink, and never do the gross impurities I loathe come near the vessels of my service. Well fed and tended am I, and now will I do my work as a brave horse should." These are the thoughts you read in his comely looks, the good horse, and in excellent keeping they are with all else suggested by that group—man, horse, and classed-looking chariot. Let them only have, on your canvas, the life and movement they exhibit, and none shall say that this makes the worst portion of your picture.

Another peculiarity of the town in question is the frequency of those singular passages there called "Rows" of which there are many scores—nay, I think I have even heard that they amount to hundreds. They recall to the writer, as to others acquainted with the Lombardo-Venetian capital as well as the Norfolk seaport, certain remote parts of Venice, all unknown to the mere passing traveller; but still more closely does the "market Row" of Yarmouth—the best and handsomest of these passages—resemble that peculiar passage in Verona called the "Lastricata."

Leading from that great centre of gaiety for all who dwell in the city of the Montagnes and the Caplets, the "Piazza Brà," this place is much frequented by the English and other travellers, who pass through it when returning thence to their hotels, or when proceeding to the amphitheatre, into which look the widows of the Lastricata on one of its sides.

But this assertion of resemblance must be taken with certain grains of allowance—more especially is there a difference in one respect, and that of no slight moment. Never in her wildest glee does Yarmouth pour through her decent thoroughfare so fearful a volume of sound as makes night hideous in Verona—yelling, howling, whistling, shrieking, roaring, hellowing, stamping, and tearing the af-

* I am told that features very finely cut, yet always in manly mould, are by no means rare among this fine race of men, and there is no reason to doubt the truth of that assertion; but I write what I have seen, and as I saw it.

frighted air by whatsoever means their brazen lungs and ready limbs present—so does the crowd come rushing from the Piazza through that else fair paved-way called, because of that pavement, the "Lastricata."

And with this is the city afflicted at all hours of the night—nay, till deep in the morning; but less shall suffice you—listen to that unimaginable uproar but for one half hour, and the howlings of Pandemonium itself shall scarcely amaze you after that.

"We don't mean ever to make acquaintance with those howlings," some one is saying, in half-affronted tones.

So much the better, and your resolve is altogether praiseworthy; but then you must not venture within miles of Verona after nightfall, seeing that permission to roar their loudest is the sole form wherein a particle of liberty is accorded to the Veronese; and since they know it under no other, they make the most of their one privilege, to the sore discomfiture of the stranger—loving quietude—who dwells within their gates.

Your chief magistrate, Mayor, or whatever else may be his designation, would presently teach you better manners, O respectable Yarmouth, were you ever to forget yourself to such extent!—but you never will. You have voices, and know how to use them—aye, in mighty volume—what should ail you else? But you do not care to abuse the power, and that makes all the difference.

Yet—would you believe it?—when we have made our boast that neither by people nor rulers would these senseless outcries be tolerated in our own free townships, have not these benighted Veronese moaned in pity over our fettered state? They have—incredible as this may seem to you, ye men of Yarmouth; they are blind enough to view the matter thus, and that's a fact!

For those peculiar passages, the "Rows" then, are the picturesque English chariots you are here to paint constructed; they suit each other to perfection, and long may they sensibly continue to go on together prosperous and harmoniously as now.

Remaining still in the sweet motherland, nay, penetrating into those recesses of our domestic history as a nation, that no stranger, save as he be more than commonly privileged by that adoption of us and ours implied by love for what is best in us, may claim to follow, let us turn to one of the most touching episodes in the home-annals of the bygone year. Calling memory to our aid, let us suppose ourselves to be once again proceeding through that heart-appelling gallery then established at Burlington House, that is to say, for the works of amateurs labouring in a most sacred cause,* and tell me whether any collection, though it were the most renowned and long-desired of all fair Art's wide-reaching domain, hath ever won from you so much respect as was accorded from your heart of hearts to that exhibition?

For ourselves, we can truly say that many a collection, to the sight of which we had long aspired, and had at length attained—purchased at no small sacrifice, and considerable, yet freely expended, cost—has failed to impress the writer as did that one; its contents offered from the hearts of our highest and noblest to alleviate the necessities of those who had laid the vast offering of their best and dearest on the altar of our common country.

Surely none could examine the closely crowded walls of those numerous chambers without the instant perception and acknowledgment that in these were presented to him something altogether different from the ordinary assemblage of mere artistic efforts, always attractive, and often most admirable as these are. No place for the hard-eyed critic was here; from the wearyful hyper-critic in Art we had for that time welcome truce; no cold and harshly judging glance was that head by the deeply impressed visitor on those gifts of the heart, expanding their bright wealth before his moistened eyes; but on every face might be seen evidence of deeply-moved feeling, and the least impressionable felt himself, at least for that moment, a more sympathising, a gentler, and a better man.

* All will perceive that this can refer only to the works of amateurs, exhibited "in aid of the fund for the relief of the widows and orphans of officers engaged in the war with Russia, opened by special permission of Her Majesty's Government at Burlington House."

Passing, on a certain occasion, through the rooms, and listening to the kindly remarks of some accomplished foreigners on the exhibition and its objects, the writer was frequently much interested, and always greatly amused by the various "compositions" grouped by them from the figures, and landscapes, or interiors, as the case might be, so richly abounding around us. With this employment they occupied themselves, as the result of a previous disquisition on that unhappy theme, the tendency of our professional artists to do their talents less than justice by the choice of a subject too frequently treated; this question then attracting much attention from the friendly critic and true lover of Art, as it has done in the season of the present year.

Here are some few of the groups or compositions thus formed—so far as memory has retained them. In the first we had the illustration of some well-known stanzas from Bloomfield's "Richard and Kate;" hard, people, and painters, all specially English, seeing that the verses were those that follow, and the peasants were such as make the pride of our fair country, depicted by her Royal Highness the Duchess of Gloucester, the Marchioness of Waterford, Lady Florence Legge, Lady Catherine Allen, and others, the noble maids and matrons of the land; while the site and structures were equally from English pencils—those, if my recollection serve me rightly, of Major Laard and Mr. Forbes Irvine. The stanzas chosen by our courtneys "visitors from afar" were these:—

"Kate viewed her blooming daughters round,
And sons, who shook her withered hand;
Her features spoke what joy she found,
But utterance had none to stand."

"The father's unheeded feelings gave
A tenderness to all he said—"

"My boys, how proud am I to have
My name thus round the country spread!"

"Through all my days I've laboured hard,
And could of pain and crosses tell;

"But this is labour's great reward—
To meet you thus, and see you well."

Incidents from the poems of Scott and Byron—authors ever highly appreciated by foreigners—were set before us in rich abundance, and with the most life-like effect, by aid of the northern scenery and people, or those of other countries, so abundantly furnished by the pictures before us. Around the Countess of Clarendon's "Cathedral Porch of Ulm" was grouped a melancholy assemblage, in illustration of an event which occurred at that unhappy period when the building, transferred from the Protestant inhabitants, was resigned to those of the Roman faith—but we will not sadden ourselves by the repetition of its details. The great deeds of our early kings, and the marvellous prowess of those who founded more than one of our proud baronial houses, with the sturdy brightness of some who, originally belonging to a different degree, had eventually made themselves a name now pre-eminent among the highest, were in like manner pictured to the view—the works of Colonel Forbes giving good aid to the story of our Norman kings. Nor were the acts of noble daring that so finely illustrate the annals of our popular classes forgotten; the sea-pieces of the Countess of Uxbridge, Miss Campbell Robertson, and some others, gave birth to many a story of heroism displayed along our coasts; among the most striking of these was one suggested by that pride of the southern Cynary—the "Penbrokeshire Fisherman" of Lady Catherine Allen; they would lead us beyond the space permitted by my present limits, but are quite too good to be lost, and are but deferred to some more favourable moment.

Almost incredible instances of bravery, and of the still more beautiful fortitude of endurance, were described by an eye-witness of some among them, in relation to incidents connected with the late war; and of these, illustrations were gathered from various points, and most ingeniously arranged for their purpose by these flattering admirers of English "being and doing;" but I borrow a lesson of discretion from Mistress Gilpin, of undying memory, and withhold them—

"Lest all
Should say that she was proud—"

of the beloved country, that is; and your servant is all the more unwilling to incur such accusation from a kind of consciousness that it could not be successfully repelled; wherefore let us rather take a pic-

ture referring, not to ourselves, but to those of another land; yet one which the artist who loves the ocean or its bold and rocky coasts will do well to rescue from its present condition of non-existence, since it cannot fail, in his hands, to prove a highly efficient work. The subject is a custom, described to the knot of friends then holding colloquy, by one of their number, himself a native of the country where the poetic and touching rites in question are performed; it was suggested by one of the Norwegian fiords, before which the party stood as the speaker proceeded.

"In many of our fishing villages," commenced the animated narrator, "is still maintained the custom of sending forth the fishing barks, as they did of yore the ships of the sea-kings, to the music of a wild chant sung by our women, who assemble on the shore for that purpose, and mingle their voices in lays, which, despite their rudeness, have all the force and fervour of prayer."

"One of your own accomplished countrywomen," continued the speaker, "has rendered these harsh measures into song, that has but the one defect of too elegant a *tournaure*—with this exception, the short specimen that will serve our purpose, and which is known to most of us, presents an exact copy of the original rhymes." The verses were then indicated to such as did not know them, and are those that follow; the grouping of the picture was next completed with great spirit from the figures around us—a process carried on much to the gratification of the parties engaged, but which I do not further particularise, leaving you to group your figures after your own liking. But be very certain that a charming picture will be the result, if you prove only half as successful as were the genial amateurs of another land, then rejoicing, like one of ourselves, in the beautiful, and more than beautiful, exhibition of character, no less than of ability, presented to their respect and admiration by the works around us.

The song chanted by these Norwegian sisters, wives, and mothers, I give below. They do not raise it until the last boat is fairly on its way, since it is rather a cry for the return of their beloved than supplication for success. Thus, your barks are all aloft, a scene of life and movement they make—but we remain with the wives and sisters; let us listen to their lay—

"Come back! come quickly back!
Brother and sire come home!
This cry your loved ones on your track—
Husband, and lover, and son—'Come back!
Over the surge and foam."

"Come back! come back! safe and loving us still, come back!

For our hearths are dark, and our souls are drear,
Till we see the light of your looks draw near."

"Husband, and lover, and son; brother and sire, come home!

The breeze has freshened, the sun gone down
Over the beaten foam."

"Sorrow and joy are ours, beyond what landsmen share;
Sorrow in every woman's farewell,
And joy beyond compare,
When at eve—all doubt and danger o'er—
Your boats bring all to the strand once more."

"Come back! come back! safe and loving us still come back!

For our hearths are dark, and our souls are drear,
Till we see the light of your looks draw near."

Other pictures, illustrative of history, poetry, or manners, and chiefly, as has been said, from our own annals or domestic habits, were formed in that suggestive gallery, and in like manner, during the long and pleasant morning in question, but we have not place for more.

Some one says, "But you promised that we should remain at home awhile, and this Norway 'is out in the bond.'"

Well, and true for you, your honour, Norway is not precisely at home, but neither is it so far off as to be altogether out of sight, in regard to the keeping of our agreement—for, after all, the Norwegians are a kind of consins to us; or, if you want about the kin, they have still a claim, seeing that by them and theirs it was that we were first flogged into shape for making a people. "Floggel," since no milder word can describe the process—scourged rather, and that with a whip of scorpions; but none the less put on the track to become a nation, since it was by them we were compelled to form a navy, as you cannot deny. Admit, then, that in sailing to Norway you are scarcely travelling "that far frae hame," or, if your logical perceptions

suek to convince you that herein is a mere fallacy, bid them carry their subtleties to some other market, and do you begin earnestly to paint me my pictures; or, ut a stroke of your pencil but shall be worth a pocketful of syllogisms, and that you shall see.

Rich coronal of the year's best period, delicious October! Dear to the painter for the gorgeous lustre of her beauty—esteemed of the moralist for the steady rectitude of her character and the evenness of her temper—beloved above all by the traveller for that last quality, seeing that in no English month can he hope for equal consistency of purpose or propriety of department—and valued by each and all for many another virtue which need not now be enumerated, the dearly-prized October is preparing to leave us. Woe is me for the symptoms of that coming sorrow—they are not to be mistaken; already has the golden brown of her flowing mantle begun to exhibit the sere and paly yellow that betokens departure: pass some few short fleeting days, and the last of the year's fair daughters shall vanish from your eyes. O brethren of the pallet, even as we mourn, there come the sounds of her footsteps, fast hurrying from the vapoury leath of her dark kinsmen that are to follow, and leaving many a heart forlorn.

Yet not to all will this, the crochds of October, prove a cause of grief: there are to whom the advent of her grim successor will bring the best-loved of their pleasures. Yea, even among the sous of Art shall you find such, for not unknown to that bright band is the lover of the Chase; nor is he always with the herd who "tail off" before "the dogs run into him," as the men who call their scarlet "pink," are pleased to phrase it.

And they don't mean before the dogs "run into" the artist, as the "mullish" fashion of handling their jargon, proper to this poor scribe, would seem to imply: *à Dieu ne plaise!* they mean into the fox, poor fellow—but catch them giving him the good old ancient respectable name of his family! not they, the goosecaps! he is Charley, or he is Pug—yet wherefore Pug?—or, worst of all, he is "the villain," though why that last it might puzzle the wisest among them to tell; for if there be villainy in the case, it is rather in the two-legged assailant by whom poor Reuëcke is driven to his wiles, than in him who is but struggling for dear life. Or admitting that he does trim and take to crooked ways occasionally, is he the only trimmer? and is not any turn permitted if it save his sous from coming to grief for lack of his surveillance?

"His sons are old enough to take care of themselves, and his daughters are well established."

Let it be so, and I rejoice to hear they have been so fortunate, but—

"But! He'll be taking care of your poultry-yards, if we don't take care of him."

"Ah thin! and small blame to him, if we have the door open; 'tis necessary wolves should eat, have alone foxes. But why would I be talking reason to a fox-hunter, when he'd rather be hearing what he calls music—mauling, dogs that bark?"

"He might do worse," some one says. Well, he might! murder and arson to wit; or he might be given to the cold and cruel baseness of the turf and gaming-table—black as either fire-raising or murder. So, if we can't give the best of our heart's cordiality to those who thus misappropriate too much of their time, yet, for the love of certain traits that embellish the character of the true sportsman, still more for that of some who love the hunting-field, if not "wisely," yet but only a very little "too well," do we at this season listen with patience, if not with warm sympathy, to the gladsome anticipations now succeeding to talk of the moors, the partridges, *et id genus omne*. Nay, further, as eels get to love ressource a repellent when November—but for this so much out of place when November—but for this ressource a repellent when November—but for this ressource a repellent member of the family of months—has brought his lowering face to the homestead.

For the sake of some among your painting fraternity, past and present, then,—their names will not be slow to present themselves,—let us turn to certain passages in the lives of mighty hunters—no lack of such in our frank laud of sylvan as well as all other fame; yet, remembering that high authority who saith—

"Home-keeping youths have ever homely wits."

suppose we first look elsewhere, and take pallet in hand for other times as well as other countries?

You have not now to learn how Gaston—third of that name—the Viscount of Bearn and Count of Foix, was called Gaston Phœbus, chiefly because he was a mighty hunter, as it suits us to believe; certainly because he did without doubt rival Apollo in the beauty of his person if not in the use of the bow, and not, as learned folks, who love to spoil sport, will have it, because he had chosen the sun for his device. The first two reasons are good enough for us, and shall suffice for our purpose.

You know, too, how unfortunate Gaston was in his connexion with that worthless Frenchman, Charles of Navarre, called deservingly Charles the Bad, whose sister he married, and who subsequently caused the son of Gaston unwittingly to attempt his father's life. For the miserable Charles persuades his sister that a certain powder which he brings her will secure the return of her husband's affection, falsely declared by him to be estranged from her. This then the countess encloses in a small purse, and suspends around the neck of her son, then on the point of returning to his father from the court of Charles, where she was herself residing—enjoining the youth to mingle the contents secretly with his father's wine, that so the love of the count might return to them both.

This moment in the life of the unhappy countess would scarcely disappoint the hopes of him who should choose it for his subject, if treated ally; but we leave it, and pass to others.

The poison is discovered by Gaston Phœbus, who takes the purse from his son's neck as he sits at the banquet with his great vassals: and calling to him a dog, gives him a portion thereof, when the animal dies instantly, and the nature of the powder becomes apparent to all.

Placed in durance, the boy will not criminate his mother, and resolves to starve himself in the chamber that serves as his prison. He conceals his purpose so well, by casting his food from the window, and by the help of a dog, that he is all but dying when the attendants discover it, and make the facts known to his father. Gaston at once repairs to the apartment of the captive, with severity in his aspect, but deep grief in his heart; the boy advances to throw himself at his father's feet—perhaps to confess the truth. But Gaston extends a hand to prevent him, and in his haste to examine the features of his child for that change which had alarmed the attendants, must needs have forgotten the small penknife which he was using when summoned by his servants, and which, in his agitation, he had neglected to lay from his hand.

This only can what then happened be accounted for, since all that is known of the matter goes to prove that in this act the point of the knife must have entered the throat of the boy. Yet so slight was the puncture, that at the time it passed unheeded—no one, perhaps not the young prisoner himself, was aware of the circumstance; and his father, after remonstrance and exhortation to better purposes, left the youth to his reflections. But not many hours had passed before Gaston Phœbus received the terrible intelligence that his son—the only one his wife had given him—was dying from loss of blood. Weakened by his previous abstinence, the slight incision, then only discovered, had sufficed to exhaust his remaining strength, and the boy was dead before his unhappy father again reached his prison. From the effects of this calamity Gaston Phœbus never entirely recovered.

These things are known to all, and few will have forgotten that among the learned men—very rare in that day—entertained by the Count de Foix at his court, was the chronicler, Messire Jehan Froissart, from whose enchanting pages it is that what you here find is gathered.

The name of Raymond de Corasse, another favoured baron and frequent guest of Gaston Phœbus, will also be familiar to most readers; but what may possibly have escaped your notice, is the fact that this baron had a familiar Spirit, who, offended by some act of indiscretion on the part of De Corasse, forsook the castle of that feudatory for the neighbouring woods, where the previously gentle and friendly sprite subsequently appeared in the form of a wild boar, exhibiting more than common ferocity. Now, in that day, none would presume to harbour the shadow of a doubt

touching the personal identity of the spirit and the hour—neither are you permitted to do so in this present year of grace, though it do call itself eighteen hundred and fifty-six; seeing that for all the pictures you have already in thought commenced, or presently shall begin, as relating to these matters, you have the sanction of that "learned clerk," the delightful Messire Jehan aforesaid. His sanction for the fact that such things were told, that is to say—for his credence of all the marvels related, we do not vouch, nor does the question greatly concern us.

Thus, then, the story goes. Raymond de Corasse died, declining from the day of his familiar's departure, and expiring before the completion of the year: some time after, it chanced that the brother of Gaston Phœbus, Peter of Bearu,—whose lady-wife, the Countess Florence of Biscay, sister to Peter the Cruel, did herself relate the particulars to Froissart,—set forth to hunt this boar,* who had terrified his huntsmen by turning round upon them with fierce remonstrance, when too closely pressed by their dogs. But Peter de Bearu said, "Let the Boar talk at his pleasure; we are no babes to be baffled by words," and accordingly he was not to be entreated from hunting this boar as above said.

Many hounds and not a few horses died in that encounter, but Messire Peter finally prevailed, he bore home the carcass of the boar in triumph; but every night thereafter was he fanned, by his terrified servants, uttering fearful cries, making a furious attack on the figures of the tapestry that adorned his chamber, and plunging the Bordeaux blade, wherever he had finished the boar, into each and all, because persuaded that each in turn was the very boar in person.

This continued, and he could obtain no rest, until a certain monk from Pampeluna, well skilled in the exercises of spirits, had performed many and potent ceremonies for his behoof.

Thus you may paint Messire Peter, if it so please you, as follows, for therein shall you not depart from historic truth. He has fasted through nine successive days, he and all in his castle, the learned monk not excepted. You now have him walking with his servants in long procession, to the chapel of Our Lady in the Woods; on his person the proud knight bears no other garment than the short and scanty cassolet of penitence, in common parlance called a shirt; barefoot, with uncovered head, and downcast features, he follows humbly after the monk of Pampeluna, a lighted taper now occupying the hand that most commonly bears more formidable weapons. The vessels of Messire Peter are also barefoot, but are else clothed in their ordinary garments, as being less guilty than their lord, by whom they had indeed been compelled reluctantly to enter on that forbidden chase.

All these things were recalled to the recollection of Gaston Phœbus by friends and servants, when his huntsmen reported that the same boar—again in life, notwithstanding the prowess and the penitence of his brother, Messire Peter—was then ravaging the woods of Sanve-Terre. Yet was he not to be deterred from attempting the chase, and on the following day he too went forth with that intent, accompanied by Froissart himself, and by many others, his kinsmen, guests, and nobles.

Five hours the chase proceeded happily; fresh horses were then mounted, and for three hours more the company kept well together. A new pack was then uncompleted, and with these, Gaston Phœbus, with Froissart and some others, continued the chase, but gradually the hunters fall off, Gaston alone cheers on the dogs, and of these few now remain. At length his four staunch bloodhounds, brought at his command by their trembling keepers, alone pursue the boar; twilight succeeds, and even they come trailing on exhausted, and uttering a melancholy howl. But the voice of their master arouses them, they resume the track until darkness shows them the eyes of the animal, ominously casting a lurid light on the else invisible path he pursues. Three of their number then refuse to follow, one dog only now accompanies Gaston Phœbus, and the boar has turned to face him. Boldly the faithful Brux springs onward, but at the moment when his jaws seem fastening on the bristling hide, the wild boar has vanished with an unearthly cry, and the count's

* Or, as elsewhere we have it, a wild sow.

horse slinks beneath him. Fearing himself swiftly from the fallen animal, Gaston Phœbus draws his hanger, and hurries to the point where he had beheld the red eyes of the boar flaming beneath a huge tree, unable to persuade himself that the disappearance he had witnessed could be real; but he finds nothing save his hound, whining mournfully and shaking with terror. Encouraging the faithful creature as he best might, Gaston Phœbus laid himself by his horse to take some rest; the trembling Brux crept close beside him. After a time the count rose to seek shelter, or perhaps only seemed to do so—for there are not wanting persons claiming to be wiser than their fellows, who affect to believe what follows a mere vision; for myself I incline to think—but no matter, permit the chronicler to proceed.

The count rose from his rest, then, in the dark and silent forest, and after long wandering, perceived a castle, whose appearance was not familiar to him. This caused him no little surprise, since he was not so far from his own rhode of Orthez but that every castle should have been well known to him. Hevotund a blast on his horn nevertheless, and the drawbridge being lowered, although no warder appeared, Count Gaston passed across. Yet it was long before he could embolden his hound to follow his example, and not until he had been thrice summoned, did the usually obedient Brux cross the moat.

Astonished that no officers of the household appeared to receive him, no pages and no valets to give the due attendance, Gaston Phœbus was yet further amazed by the strange fact that his footstep awoke no echo, nor did sound of any kind meet his ear. One solitary lamp shone in the distance, and approaching this by a long corridor, Count Gaston perceived it to light a broad staircase, thence he took his way, and at the summit thereof beheld, stretching before him, the ample space of a banquetting hall, with the table spread, but no hospitable castellans to receive the guest.

Reluctantly the hound had followed, but he was there, and Gaston Phœbus was conscious to a sense of relief and comfort as Brux took a place at his feet, when he had assumed the chair of state prepared for his use. A silver whistle lay upon the table, and taking this, he blew the same to summon squire and page with water for his hands. Then the tapestry covering a door at the farther end of the apartment was lifted slow, and as it rose the hound set up a mournful howl. A figure was now seen to draw near through the dim obscurity of the chamber, but faintly lighted by a lamp suspended from the roof; yet was no sound of footstep audible, and the dog, desisting from his plaintive cry, began to tremble in every limb.

Slowly did that form approach the table, and a strange suspicion seized Count Gaston; a few more awful moments and that dread conjecture became conviction. The silent shape was too surely that of his buried child, and the heart of the brave man quailed before it, even though his conscience could not reproach him with wrong done. Gaston held forth his hands nevertheless; he stretched them over the basin presented for his use: that spectral form held the ever aloft, and as the appearance of water fell on him, a sense, as of heavenly blessedness, seemed to pervade his whole being: a something whispered, yet it was not the voice of his son, for the shadowy form uttered no sound; yet a perception was conveyed to him that the child had obtained permission from heaven to wash his rancorously shed blood from the father's hand; the last sensation of Gaston, as he sank lifeless from his chair, was one of infinite consolation—his child had brought him forgiveness.

Many pictures, and those of varied character, present their changeful hues as this page of old tradition unfolds its revelations; the different moments to be treated must be left to the choice of the artist.

But in all this there is little of hunting, as we have it practised in that genial home of the science, an English hunting field, will some one say; and there is no denying that a day with the Quorn, the Cottemore, or the Pytchely, will have more charms for him whose enviable lot—as a hunting-man—is cast in those brilliant lines: nay, the doings of what your Leicestershire "Cot-me-downs" are pleased to call that "slow" shire, which takes pride in the Vue and the Tidworth, would be more germane to the matter, so far as hunting in England is con-

cerned; but with what hope may the uninitiated venture to approach that theme? how attempt to fathom those mysteries, which, if you listen to hunting-men, would seem to render horsemanship and hunting more impenetrable, to all save themselves, than are the riddles of the Sphinx? No, the adventure is all too mighty, it demands more daring than has fallen to the lot of the present writer: your brethren, who mount the scarlet, are alone competent to depict the hunting-field, and to them we leave it.

ARTISTS' COMPETITIONS, AND THE PALACE OF ADMINISTRATION.

At length, probably, steps will be taken to remove one source of inconvenience and extravagance as to the manner of conducting the business of the government offices. People of average intelligence had been long wondering at the system of housing the public departments in various structures originally planned as dwelling-houses—far apart from one another, and entailing enormous outlay in rents, and repairs, and alterations of fixtures. The pecuniary injury from the mere separation of departments, and disorganisation of books and papers in the frequent removals, must, during very few years, have alone cost the country as much as any expenditure upon the structure and decoration of one adequate group of buildings would have done. Moreover, as to money voted for public works, the waste which there has been,—sometimes by what is falsely called economy, sometimes through changes of plan, and pulling down and rebuilding,—has painfully obliterated itself upon the notice of those who appreciate the material value of Art somewhat better than the British Government has hitherto appreciated it. For, in architecture, the requirements of structure and convenience, and the call for Art, are contemporaneous,—that is to say—beyond the operation of any subtle influence of fitness upon decoration—it singularly happens that what is favourable to success in the one object, is ever correspondent with the course which should be taken for the other.

There are two points, however, of which there has long been—and, we are compelled to say, looking at the character of our streets and public works, *still is*—extraordinary want of perception amongst our governing classes: the first point being the fact that the value of mere Art is such as would demand expenditure upon its sole account; and the second point, that where a structure is required, grand architectural effect may be produced with little addition to expense,—if, indeed, the proportion which even elaborate decoration would bear to the whole cost, might not be always of inappreciable magnitude.

But, whilst ornament alone does not realise good architecture, it should be recollected that the union of many branches of Art is required for the highest architectural effect; and those branches, especially sculpture, it may be hoped will be largely brought into play in the Palace of Administration which the Government are projecting.

This building, or rather group of buildings, it is intended should ultimately occupy the large area including the site of the present Treasury buildings, the ground southward to St. George Street, between St. James's Park and Parliament Street, and that east of Parliament Street from Richmond Mews to Bridge Street, and inclusive of a portion to be reclaimed by embankment from the river; and the instructions have been issued preparatory to a competition amongst English and foreign architects. Certain proposed instructions were submitted by Sir Benjamin Hall to a number of architects, who were called together some time since; and premiums are now offered, amounting in the aggregate to £5000. These premiums are arranged in three classes, indicating those portions of the project to be first undertaken—viz., for designs for the Foreign Office and the War-Office, in each case, seven premiums—one of £500, one of £300, one of £200, and three of £100; and for a general "block plan," treating the whole area noticed above, and having regard to the improvement of the leading thoroughfares, including Westminster Bridge, whether on its present or some other site, three pre-

minium—one of £500, one of £200, and one of £100; such designs being required to be sent in not later than the twentieth day of March next. It is proposed to leave the amount of expenditure to the competitors, as well as the style of the buildings; and a mixed jury of professional men and amateurs, and the exhibition of all the designs in Westminster Hall, prior to the decision, are amongst the other features of the scheme.

The actual instructions do not materially differ from those which were laid before the architects who were summoned—on which occasion, indeed, they seemed to have been presented as decided upon, rather than as the subject for consideration. Taking them as so presented, then, it does seem to have been unnecessary to call architects together; and it seems most unwise to receive none of those opinions upon the working of competitions in relation to Art which each architect, in his experience, has been able to form. Limited in proportion to the general question of competition in Art as such experience of individuals must be, the opinions referred to form both the chief and the essential *data* upon which the scheme of a competition should be based. Can it be possible for any individual not familiar with the history and practice of architects' and sculptors' competitions, to know the enormous amount of labour and money which must be given by the competitors, and how insignificant in proportion to it is the largest premium which can be offered; or to know the difficulties which beset the framing of instructions; or of obtaining, even from honourable men, an equitable judgment—in short, to know how prejudicial to the object of the competition, to general Art, and even to morals, is the practice which in varied forms now obtains. On the acceptance of competitions as a principle, we offer no present opinion; it may be consistent with the doctrine of political economy not to ignore it, and to that doctrine we will not for a moment make exception. All that we remark is that, in trade, competition has yet to be made to operate to the precise advantage which it is said to involve. To our unlearned judgment it would seem that the whole point as to competition hangs upon the assumed equality of the articles, where the competition is one of price, or the precise relative value of the articles in other cases. Everything, therefore, implies the capability of the consumer to judge. Were this a matter so easy as the doctrine of political economists would imply, no further trouble would there be about the adulteration of food. The public do not possess the capacity for judging.

The remedy may be discovered: we only say that it must be found,—to allow of the operation of the supposed beneficial principle of competition. Now, as to artists' competitions, there is no material difference here from the case of competitions in articles of food—or rather, we believe, that in the case of architects' competitions, the perception of relative merits is attended with extraordinary difficulty. That the most fortuitous combination of knowledge and acquirements is necessary in the architect, we need not here observe; and to secure this in the judges, along with freedom from bias, and *judicial* ability—along with the devotion of the enormous time required to examine properly hundreds, or perhaps thousands, of drawings, and sheets of description,—from their form as well as their number most inconvenient of examination,—is what we believe has never been accomplished in any case. We can understand it might be maintained that after all possible improvement, a perfect system could not be reached, and that architects themselves might prefer to accept the balance of the situation. Our point, however, is that such amendment *has* to be made. At present a mass of competitors give of their time and money largely, for no benefit to themselves. True, if there were always a public exhibition, and open during a proper length of time, benefit to many deserving competitors would eventually result, and great advantage from the comparison of ideas would accrue to the whole number of artists and competitors; and some of these latter points have been adverted to in the *Builder*, in the course of a recent review of drawings which were sent in for proposed barracks, &c.; and in the same journal it was suggested that it would be desirable, and a thing due, to lithograph the designs, or the bulk of them, and present copies to each competitor,—and something of this sort, we hope, will be taken into consideration in the case

of the competitions which we have in this notice more particularly had in view. But, there are many other points which, in justice to competitors, and for the successful result of the competition in every respect, should be considered; and we discover no adequate desire to get, as to such points, the views of those whose attention has been most directed to them,—those individuals being not necessarily the *older* members of the profession.

Reconsideration of the proposed instructions as to the Palace of Administration is, we think, absolutely necessary. The time allowed for the preparation of the general *design*—for such it must be, and more than a "block plan"—is manifestly too short; and it seems a singularly illogical and ill-advised proceeding to ask for complete designs for the War-Office and Foreign-Office, proposed to be placed between Downing Street and Charles Street, or at one corner of the whole ground, at the same time as the "block plan," or before the latter has been considered and decided upon. As to the admission of foreign competitors, we will make no observation, further than that the idea seems based on the assumption that English architects are inferior to those of the Continent. We need not defend our countrymen more than by reminding all who are interested in the question, how much the architect's work is necessarily dependent upon the manner in which the architect is employed; and in this particular, the contrast between the public works of England and the Continent is unfortunately very great. There are towns in England, however, where private patronage is exercised intelligently, and without undue restriction and interference, and where the Art of Architecture could lay claim to high national distinction.

The importance of the whole subject of competitions was never so great as it is at this juncture. The present case is the forerunner of others, in which Government will make or mar the Art of Architecture—now, in spite of all disadvantages, in no hopeless state in the country, and it will become the precedent for private companies and corporations.

CORRESPONDENCE

FROM THE

UNITED STATES.

HISTORY OF ART IN BOSTON.

DEAR SIR,—I have spoken of our three great Atlantic cities—New York, Philadelphia, and Boston—as the Art centres in the United States, towards which all the talent of the land converges for development, or whence it radiates for employment. Of these three, Boston—in whose nursing arms number of the civilisation of the New World—its sturdiest populations, wealth, activity, and intelligence, grew up—was once the chief. Sole oracle in every matter of taste and opinion, she drew to herself all intellectual capacity in search of recognition or approval: to her came the foreign artist, venturing westward in quest of fortune; and the native tyro, eager to try his young wings.

Excepting only a Scotch portrait-painter, John Watson, who established himself at Perth Amboy in New Jersey, in 1715, the first artists in America, of whom we have any memory, lived and laboured in Boston. These pioneers were of course from beyond seas—from your own English shores—and we have a grateful remembrance of your good timely help, though it was really so slight that, with our first native effort, it was no longer needed; and though we have since repaid you a thousand-fold—sending you, for your Watsons and others for whom you cared not, our Wests, and Copleys, and Leslies, and Newtons, whom you delight to honour.

The first and best of these early painters, whose brief and humble history makes the initial chapter in the story of American Art—the scene laid here, in Boston—was John Smybert, who accompanied Bishop Berkeley, with the "course of empire," westward in 1728. In a picture of his, representing the landing of his patron's party, we have our first historical canvas—the first, at least, ever executed here in which there is more than a single figure. Smybert, though a man of only moderate ability, did more than merely supply the demand for Art-production in his day. He left

behind him, as none other of his fellows did, an influence which worked for good in the professional education of those who came after him. In his pictures there were incentive and examples to Copley, Trumbrell, Stuart, and Allston. "I am," said Allston once of a copy of a Vandyke by Smybert, "grateful for the instruction it has given me." Trumbrell, when he left the revolutionary army in 1766, set up his easel in Smybert's apartments, in which there were still many of his pictures. Smybert is referred to by Walpole, in his "Anecdotes," as a modest man, earnestly and sincerely devoted to his art.

Smybert's most skilful colleagues in the immortalising of the magnates and the beauties of his time was a Mr. Blackburn and others, in Boston; Mr. Watson (already mentioned), in New Jersey; Williams, in Philadelphia (gratefully remembered, for his counsel and encouragement, by West); Feks, Green, and others, in Pennsylvania and Newport; and Theus, of Charleston, in North Carolina.

At a somewhat later period, the art of engraving was practised in Boston, for the first time in America, in the hands of Nathaniel Hurd (1764), of Paul Revers, and of Amos Doolittle (1771). Doolittle did the earliest American historical plate, in a picture of the "Battle of Concord."

This little band, few and feeble, of missionaries from afar was immediately succeeded by a sturdy native *troupe*, in whose genius American Art sprang with a bound into Pallas-like life and strength. Of this second chapter Boston is still the theatre. It begins—and certainly it is a brave beginning—with the lives and works of Stuart, and Trumbrell, and Copley, in Boston; supported by West, in Philadelphia, and by Peale, in Maryland. Of these men but little is left for us to say here, after all which is familiar to all of them and of their genius. Of two of them, indeed (West and Copley), more should be known to you than to us, since from their early and unbroken association with British Art, they belong more to England than to America. To Trumbrell the nation owes the embodiment of many of the chiefest scenes and incidents in its history, and the artists many invaluable and enduring examples and teachings. The works of Gilbert Stuart, while they illuminate the past, serve equally as priceless lights to the future. Peale (Charles Wilson) will be ever gratefully remembered for his professional labours, and still more for those many accessory toils in which his active spirit and his Art-love kept him unceasingly employed. It is to his industry and enterprise that we owe our Museum Collections, and perhaps our Art-Academies. Certainly the first efforts to supply schools for the study of the antique and the living model were made by him, though his ventures were lost—all for the very simple and natural want of students to use them! Still it was the bread, no doubt, which he thus and then cast upon the waters that we are now eating after many days.

Ending here this hasty mention of the second period in the history of American Art, we come—still partly in Boston—to the third; and thence, so insensibly to the fourth and last, that it is difficult to make the dividing line. To this division there may be set down (though many, indeed most of them, are still living and toiling) Harding, Alexander, Fisher, Allston, Frothingham, Greenough, and King, in Boston—leaving Leslie and Stuart Newton to your London muster-roll; Sully and Peale, in Philadelphia; and Durand, Imans, Merse, Vanderlyn, Ingham, Cummings, Dunlop, Weis, Cole, and others in New York. The fourth or present period, the scene now quite removed to New York and Philadelphia, is too long in names of repaite and promise for more than reference at this time—so the chapter must come in by and by. I have linked these names, not as peers in professional skill, but as fellow-workers, all labouring in the measure of their strength, and for such labour gratefully remembered and honoured.

Of the Boston painters of this period, Chester Harding and Francis Alexander are still actively occupied, after a long and most successful service, in portraiture; so Alvan Fisher, in landscape. Charles B. King, whom I should have mentioned in my last letter from Rhode Island, is a native of Newport, in that State. His early life was passed in Boston, but he has for many years past been popularly and fashionably employed as a sort of court-painter in

Washington. Frothingham, born near Boston, and long practising his art there, has been for years past a resident of the vicinity of Newport. Horatio Greenough, one of the most eminent of our sculptors, and the first whose genius was given to the glory of the national fame in Art, was born in Boston in 1805, and here too he died only a year or two since. His "Chanting Cherubs,"—executed to the generous and appreciative order of the novelist, Fenimore Cooper,—apart from its intrinsic worth, is most interesting as the first original group from an American chisel. "Greenough," says Emerson, in his "English Tracts," "was a superior man—ardent and eloquent, and all his opinions had elevation and magnanimity."

Allston, in popular esteem the greatest among our painters, was a native of Carolina; but the glory of his professional achievements belongs to Boston, where he passed his life. It was his fame alone which for years kept up the old Art-reputation of his adopted city, in rivalry with its own decay and the growing renown of Philadelphia, and more especially of New York; and when he died, Boston ceased to be—in respect to the numbers and genius of her painters, at least—the "Athens of America." Let her people see to it, that her proud boast be not forfeited for ever, or that it shall belong only to a brilliant past. Let them set generously and earnestly to work, to discover the smouldering embers of Art-life on their ancient hearths, and to fan them into the glowing vitality which is now stifled by neglect alone.

The universal complaint of the Boston painters at the present moment is that Art is dead, or dying in their midst; and that the people do not know or care what they are about. Half of them are sighing for a more genial and appreciative home; and not a few have lately removed, much to their advantage, to New York, or to other cities. This depressing state of affairs you must not imagine to be the fault of the painters themselves: on the contrary, they are a young, and gifted, and earnest, and brave brotherhood, labouring and waiting patiently and manfully. Among them there are at least half-a-dozen excellent landscapists who, however successful they may be, will never reach the full development of their powers in the stultifying influences of the resthetic east wind which now surrounds them. In the studio of a crayon-artist here, I have just seen some female heads of wonderful refinement and subtlety of feeling. And yet I am told that his siter's chair is not half occupied—even at half the price for which it would be eagerly sought elsewhere.

Some seven or eight years ago, there existed here a society called the "Boston Artists' Association," to which the public was indebted for the new pictures which each season gave life to the old exhibitions of the Athenæum. This good office is now done by a smaller and quite informal organisation known as the "Artists' Club." It is the only Art-society proper, of which the city can boast. The Annual Exhibition by this association of current works, got up as usual in connection with the permanent Gallery of the Athenæum, is a very interesting display. The Athenæum is an ancient and well-to-do establishment, occupying a large and imposing edifice, with a creditable library and reading-rooms, a good collection of statuary and casts below stairs, and well-appointed exhibition galleries above. Among the pictures in the possession of the "Athenæum" is Trumbull's "Sortie of Gibraltar," and his "Priam receiving the dead Body of Hector;" one or two Allstons; portraits of Webster and others, by Chester Harding; Stuart's original study for his portrait of Washington, and of Mrs. Washington, with other works; Ary Scheffer's "Count of Württemberg lamenting over the dead Body of his Child;" pictures by Sully, Copley, Rembrandt, Peale, Leslie, Neagle, Weir,—together with a Titian, a Poussin, an Andrea del Sarto, a Velasquez, and sundry old masters more or less aged. Among the pictures indefinitely "loaned" to the gallery are the five grand Landscapes by Cole, representing the "Course of Empire"—first in the savage, and then in the Arcadian or pastoral state; then the commencement and the glory of empire, and finally its destruction and desolation; numerous works, poetic, historic, and Landscapes, by Allston, among them the grand "Belshazzar's Feast," which, after nearly thirty years of occasional labour, he left at last quite unfinished.

This bold work the artist faced with the encouragement of a commission of ten thousand dollars, subscribed equally by ten or more gentlemen of Boston. He could not possibly have undertaken it at the time he did without such certainty of sale; for, at that period, no artist could provide bread for himself by painting works of the imagination alone. Once when I was alluding to this fact, *à propos* of a mention of Allston,—“Yes,” replied my friend, “most true! Indeed, Allston himself may be said to have lived for a quarter of a century on ‘Belshazzar’s Feast!’”

But, returning to my catalogue, I should mention among the loans, indefinitely or for the season, the fine picture of the "Chorister's Consolation," and the "Dante and Beatrice" of Ary Scheffer; a portrait by Stuart Newton; some pictures of horses, by Rosa Bouheur; "Love's Torch quenched," a portrait by Angelica Kauffman; Sant's "Fortune-teller," among the last year's prizes of your London Art-Union; two pictures by Toermes, a German; a "Stable Scene" by your own Herring; something of Claude, of Carlo Dolce, of Teniers, of Gerard Dow, of Canaletti, and of Greuze.

The artists of New York and other cities contribute liberally to the Exhibition, their works making one of its special features. This contingent includes characteristic and clever examples of Lilly, M. Spencer, Huntington, Gray, Chapman, Rossiter, Page, Cropsey, Kensell, Church, W. Hart, A. D. Shattuck, Edwin White, Edmonds, E. D. E. Greene, A. P. Tait, G. L. Brown, F. B. Carpenter, Paul Webber, Terry, Samuel Laurence, Vincent Colyer, W. J. Hays, W. Heins, Durley, Stillman, Gjuoux, Bontelle, and Johnston.

The Boston painters are themselves nearly all fairly and well represented on the walls.—Champane, Gay, Gerry, Williams, and Frost, in landscape; and Pope, Amet, Hoyt, Ordway, Childs, Wight, Willard, Hartwell, Hineckley, and Wilson, in figures and portrait.

In the statutory hall of the Athenæum there are numerous works of Greenough, statues, busts, and bas-reliefs; a bust of Webster, by Powers; the "Orphans" and the "Hebe" and "Ganymede," of Crawford; "Avengers," Allston; Ball Hughes' "Uncle Toby and the Widow Wadman;" Stephenson's "Dring Indian;" Mackett's "Shipwrecked Mother and Child;" a cast of the statue of Marshall's "First Whisper of Love," lately presented to the Athenæum by the London Art-Union; a statue of the late Judge Story, by his son; some originals and copies of Canova; and numerous casts from the antique. Most of the works I have mentioned here are originals, in marble. Many of the sculptors are natives of Boston, the city taking better care of that art than of painting—very possibly because the "marble people" live abroad, and are thus invested, or so supposed to be, by that prestige of foreign approval, so acceptable to our people in their characteristic respect for authority. This same humour of deference to venerable opinion has sorely afflicted Boston from the earliest antiquity until now with the old-master mania. The private galleries are stifled with their blackness of darkness, with here and there, of course, a ray of purest light. American Art is not as much in vogue here as in other places, since Boston holds yet to the exploded fancy that "nothing good grows in Nazareth;" nothing—unless it be the exception which I have already made, of sculpture. In this department, perhaps, the city may regain its old Athenian repute; for next week famous honours are to celebrate the erection in its streets of a colossal bronze statue of "Franklin," modelled by Henry Greenough, a brother of the late sculptor Horatio. And the people are seriously thinking of persuading Mr. Crawford (already occupied with extensive commissions from the national Government, and from Virginia) to make a colossal equestrian statue ("on horseback" one of the Boston papers says), to embellish their beautiful "common." In addition to all this, they are speedily expecting the arrival of a grand bronze statue of Webster, which they some time ago entrusted to the genius of Mr. Powers.

I have reminded you before of our remarkable achievements in this high art, and the symptoms of a marble and bronze epidemic, not in Boston alone, but the land over, are daily increasing. There is in statutory a tangible actuality and substance which suits our love of the real, and in which we can see,

in a degree, the "worth of our money." Luckily, the good taste of our people in this regard, and the true genius of our sculptors, assure us that it will be in any case "all right."

I shall, at some more fitting time, tell you of Boston as the heart of our chief manufacturing interest; of the great mills of Lowell, of Lawrence, of Manchester, and of many other surrounding lullly-burles of ingenuity and industry. In a few days they will speak for themselves in the annual display of the Massachusetts, Charitable Mechanics' Institution, now on the eve of its Eighteenth Annual Exhibition. This fair, and similar ones in New York and other cities, are always very successful in the arrangements and in the results. As a means of instruction and development in Manufacturing-Art they are becoming a very important power.

T. A. R.
Boston, Massachusetts, September 8, 1856.

ART IN CONTINENTAL STATES.

PARIS.—Death has recently taken from us two artists of considerable talents, though in different styles of art—Theodore Chasseriau, born in Samana (Spanish America), of French parents, died at the early age of thirty-eight; he was a painter of distinguished merit, and has executed many large government works, amongst which the principal are in the *Palais du Conseil d'Etat*, *Quai d'Orsay*, and the cupola of the Church of *St. Philippe du Roule*; his finest picture in the grand Exhibition was "The Defence of the Gauls under Vercingetorix." This artist began in the style of his master, Ingres, and, like him, painted particularly cold and colourless. Of late years he made a most remarkable change in his style, imitating De la Croix rather than his first master, which is the more remarkable, the styles of the two being the extremes. He was a young man of much promise, of great urbanity and kindness, and will be regretted by all who knew him, or had any dealings with him.—The other artist deceased was Jacques Christopher Werner, painter to the Museum of Natural History at the *Jardin des Plantes*, a man of considerable talent, and also much esteemed by his contemporaries: he died at the age of fifty-eight.—The provincial museums continue to be enriched by the various contributions of the vast resources of the Louvre; these mines of pictorial wealth seem inexhaustible.—A fine copy of the "Descent from the Cross," by M. Maindon, has been placed in the Church of St. Gervais; it is beautifully executed.—The *Château de Blois* is at present under restoration, and advances rapidly.—M. De Ray, senior, Conservator of Antiques at the Louvre, has received from the King of the Belgians the decoration of his order.—A bust by Bax has been erected at *Louis-le-Saint*, to the memory of General Lecourbe; it is colossal, and in bronze.—An exhibition of works of Art is decided upon for next year; it is intimated that it will take place in the Industrial Palace, *Champs-Élysées*, the upper part of which will be suitably arranged for the display of the contributions: it is to open on the 15th of May, and to close on the 15th of July.—A statue of Jeanne d'Arc, by M. E. Paul, has been temporarily placed in the *Champs-Élysées*.

BROTHERHOOD IN ART.—A proposal was issued from Düsseldorf last August, signed by most of the distinguished artists resident at that place—as Lessing, Hess, Michels, the two Achenbachs, Krause, Volkhardt, and others, inviting a general convention of German artists, to be held at Bingen on the Rhine, with a view to the establishment of friendly intercourse and mutual acquaintance. We have not heard the result of the proposal, but it was very favourably received. Invitations were sent to and accepted by King Louis of Bavaria, and Prince Frederick of Prussia. What a contrast this presents to the condition of Art-society in our own country! Certainly the artists of no other nation are so divided among themselves as the members of our school. The establishment of provincial meetings for social intercourse has often been attempted, but the results have always been miserable failures. Upon every occasion of so-called social assemblage at which we have ever been present, whether it be dinner, *soirée*, or business-meeting, *Travellers' Square* does not recognise Suffolk Street, or Langham Place; and between Pall-Mall and Pall-Mall East there is little intercourse. We cannot imagine such a thing as social intercourse between members of our different institutions, and yet why should it not be? why should jealousy or presumed position continue to separate them?

BRITISH ARTISTS: THEIR STYLE AND CHARACTER.

WITH ENGRAVED ILLUSTRATIONS.

No. XX.—FRANK STONE, A.R.A.

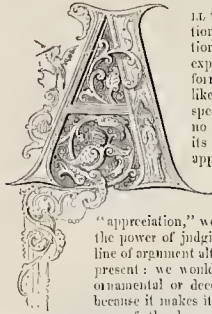

ALL the pleasure one receives from the contemplation of a work of Art is derivable from its association in the mind with our ideas of the true, or the expressive, or the beautiful, either in sentiment, form, action, colour, or in all these united. Art, like speech, is the expression of thought; but speech falls inaudible upon the deaf ear, and finds no sympathy in the heart that echoes not back its meaning—is not responsive to it: so Art is appreciated only by those who feel its awakening influences, but only in such a manner, or in such points, as command themselves to the taste and feeling. In using here the term

"appreciation," we would entirely disconnect its meaning from the power of judging of matters of Art; this opens up another line of argument altogether, which we do not care to enter upon at present: we would simply infer that a picture, a statue, or any ornamental or decorative object which affords pleasure, does so because it makes its appeal successfully to the mind, and, in the case of the learned, to the understanding also. Yet even in instances of the latter how different are the opinions entertained! one man admires a Raffaele, and sees nothing he considers worthy of regard in a Titian

or a Metz; another man hangs his room with pictures of the Dutch and Flemish school, and is wholly indifferent to the finest productions of the Italian masters. Some are delighted with bold, striking, and sublime subjects; others with what is suggestive of beauty and repose: the eye of each being satisfied with the element or quality of excellence which best agrees with his spirit or taste—taste being, in its primary considerations, the result of feeling. A recent American writer thus describes the operations of Taste on minds differently constituted, or rather, it should be said, on minds comparatively ignorant of the truths of Art, and on those who have been educated in them:—"There is no more certain test of good taste than the involuntary selection of subjects by the eye on viewing for the first time ornament in objects of Art. Nature works on so large or true a scale that few judge her amiss. That which is majestic, noble, picturesque, or simply beautiful as a whole, classes itself at once in all minds, and the fact of a common decision on these points demonstrates the genuineness of the laws of Taste. The common mind differs from the cultivated in its knowledge and appreciation of Nature's beauty in detail. The former sees only partially; the latter grasps the whole, and distinguishes the parts; nothing, however humble, which goes to make up the chord of beauty, escapes its notice. Where the appreciation of the one ends, the pleasure of the other is but begun; so that his delight is as true and as firm as Nature herself. The natural eye, therefore, sees all things as in a glass, darkly—the cultivated penetrates the film of Nature, and looks into her heart."

Now may not this train of thought be carried from Art generally to the works of individual painters? We believe it is too much the practice to unfairly criticise and condemn a painter simply because his works are not fashioned according to our taste, or in exact harmony with our own feelings, forgetful that to others, as well capable as ourselves of coming to a right decision, they may embody all that is excellent; and when we do so how great injustice is committed. Another ground on which this superstructure of erroneous judgment is raised is, that hastily rejecting, at a glance, perhaps, what is represented, we take no trouble to ascertain what are its merits; we give to it neither close examination nor



Engraved by]

BASSANIO RECEIVING THE LETTER CONCERNING ANTONIO.

[Daniel Brothers.

patient study; we are unwilling to recognise and accept the spirit which created and formed it, and consign to neglect, or, worse perhaps, publicly condemn, a work of genius, merely because we chance to have an "unwholesome preference" for some other. Suppose such a principle of feeling and action were transferred from the world of Art to that of Nature, we then should have one man arraigning the wisdom of Providence because the sky is not always blue, and another because the sunshine is frequently dimmed by "fleecy clouds;" one because the surface of the earth is not an unvarying extent of gentle slopes and verdant meadows, another because it does not exhibit a continued succession

of lofty mountains and rugged precipices. The proof of true taste and a right and kindly spirit lies in the desire and ability to discover beauty or excellence under every guise, without prejudice or undue partiality. The first effort of the critic should be directed to the divesting himself of every impediment that may hinder his arrival at a just, reasonable, and correct conclusion.

Again, we should accept the artist for what he is, and not repudiate him for what he is not, nor pretend to be: the charlatan, who assumes a position for

* "Art Hints." By J. J. JARVES. S. Low and Sons, London.

which every one sees him to be disqualified, is a fair mark for popular indignation; but the man who so knows himself as to keep within his own proper limits, and to ask from the public sympathy and attention nothing more than what he is entitled to, demands and gains the respect due to him. Men of great and surpassing genius are not created every day; they are the *rare avis* which Nature produces at long intervals of time to stand as examples to the world at large of the ennobling gifts she is able to bestow, and as swas in the intellectual hemisphere round which the lesser lights may revolve, but whose brightness they can never equal, much less outshine. Such men are raised up for the wonder and honour of the nations of the earth, to be followed and imitated, though it will ever be at a far-off distance. Painters, as well as poets, philosophers, orators, and all other kindred minds, must be measured each according to his degree of intelligent power; and it would be as absurd to condemn Addison or Akenside, because the one had not the gifts of Milton, and the other of Shakspeare, as it would be to ignore the works of a second or third-rate artist, because Nature had denied him the genius of Raffaele, Titian, or Tintoretto.

We have been led into these observations by the frequent unjustifiable comments made in our hearing upon the pictures of many living artists. Critics, or those who assume to be, are too apt to draw comparisons that ought not to be made, and which it is ridiculous to make, inasmuch as such works have no right to be placed in juxtaposition with others with a view to comparison. And even where no comparison is instituted, the artist is judged by what he does not pretend to be, and not by what he is. It is assumed he ought to be some-

thing more than he is, when it is self-evident Nature never intended him for anything but what he shows himself—never endowed him with extraordinary gifts: it ought to be sufficient for us if he acts up to the light he has received. Mr. Stone is one among several painters we could name who have been the subjects of much unfair criticism; his merits are too generally overlooked in the sweeping condemnation pronounced on the "sentimentality" of very many of his pictures. No one would declare these works to be significant of great genius; we confess to set but little value on them as productions of an enlarged and intellectual mind, but still we are not insensible to many excellences which they undoubtedly are privileged to claim.

We are unable to give our readers any information concerning this artist's early life. We have never chanced to hear anything about him; and all our efforts to afford our readers such a biographical notice as might be agreeable to them have been fruitless. All that we have heard—and this we cannot vouch for—is, that he came to London about twenty years since, from the neighbourhood of Manchester. He made his *début* as a portrait-painter by sending to the Royal Academy in 1837 two portraits, one of which was the "Lady Seymour." In 1838 he contributed a "Study," and in 1839 three portraits—one of them "Lord Goderich," and another a portrait of the "Hon. Mrs. Blackwood." It would therefore seem that he brought with him some good introductions, which his talent enabled him to turn to a profitable account, for a time at least. In 1840 he contributed to the British Institution a graceful little picture of a young girl, under the name of "Louise." Having, it may be presumed, suffi-



Engraved by]

THE PENDING MATE.

[Lambert Brothers.

ciently tested his powers in portraiture, he now stood forth on a wider field of action, and sent to the Academy in the same year a "Scene from the Legend of Montrose"—the passage which describes Annot Lyle, like David laying with his harp the evil spirit of Saul, soothing the fiery temper of Allan M'Aulay by her song, in the presence of the Earl of Monteith. The picture was an earnest of a talent which, had it not shortly afterwards been diverted into another and far lower channel, would, in our opinion, have placed the artist in a more elevated position than he has ever attained, or ever will attain now, it is to be feared. In 1841 he exhibited at the British Institution another picture, which few of his subsequent works have surpassed in true poetical feeling and careful execution. The recollection of this work, and of three or four others to which we shall hereafter refer, causes us the more to regret he should ever have cast aside his "first love." This picture is a scene from the poetic romance of "Phillip van Artevelde," wherein a youthful husband, "ow'er young to marry yet," amuses himself with a hawk, while his neglected bride stands sorrowfully watching him. It elicited from us the observation, "This is one of the most prominent as well as the most attractive pictures in the collection: it is painted with a master hand." To the Academy Exhibition of the same year he sent another most graceful composition—"The Stolen Interview of Charles, when Prince of Wales, with the Infanta of Spain."

In 1842 Mr. Stone commenced the series of "love-pictures," which, however popular they have been made by the engraver's art—so popular, or at

least so common, as to be seen here, there, and everywhere, wherever a print-shop of any kind exists—were, unhappily, the means of turning his thoughts too often in a direction that has certainly not proved the high road to a good and lasting reputation. Popularity is not necessarily a test of merit in Art, neither does merit always win the suffrages of the many; for the multitude, incompetent to exercise sound judgment, is swayed by caprice, fancy, fashion, and various other motives. The pictures to which we refer possessed that peculiar attractiveness which was almost sure to command a large amount of admiration from those who are readily pleased with pretty faces, elegant figures, and a certain kind of sentiment that is patent to the most casual and careless observer. But such compositions never rise above mediocrity, however well they are put on the canvas—and undoubtedly Stone presented them in a manner which few of his contemporaries could excel, regarding them merely as examples of careful and brilliant painting. Yet in contemplating them one learns nothing but the fact that much technical skill and labour have been thrown away upon subjects so unworthy of what it must have cost to produce these works. The great ends of Art—the instruction and the elevation of the mind—are here unequivocally lost sight of, and that which should "point a moral" scarcely "adorns a tale," or at least, a very indifferent one. If we compare such compositions as "The Last Appeal," and "The Course of True Love," with the most simple landscape placed by the side of either, how low do they fall beneath it as an expression of real worth, or as a medium of intel-

ligent communication between the material world and the mind. The landscape, though it may chance to be little else than a bit of meadow-land, a clump of woods, a silvery thread of running brook, all o'er-canopied with a sky whose brightness is chequered by a few light clouds, at once lifts the thoughts of the contemplative mind

"To Him who formed our world, and poured forth glory on it."

From the coquetish maiden and the love-sick youth we turn as from a matter which concerns none but themselves; which they might settle satisfactorily, or otherwise, in some quiet, unseen nook or corner by themselves, and which, though perhaps true to nature as an incident of common occurrence, elicits neither sympathy, nor pity, nor sensation of any kind from the spectator; one has only to fancy himself the actual witness of such an incident to arrive at a just estimate of its value when transferred to the painter's canvas.

The first of this class of pictures was exhibited at the British Institution, in 1842, under the title of "The Bashful Lover and the Maiden Coy;" it was followed the same year by another at the Royal Academy, "Admonition,"—a work perhaps to which less exception might be taken than to some others, yet partaking of their character: it represents two young girls, one of whom holds a love-letter, it is presumed, in her hand, while the elder is venturing to give her sister a lecture upon the impropriety of receiving such a communication. In 1843 the artist sent to the British Institution two pictures, each of a single figure, one called "Helen," the other "Nourmahal;" and to the Academy

"The Last Appeal," a picture too well known to require explanation. He contributed to the British Institution, in 1844, a costumed portrait of a lady, to which the title of "Retirement" was appended, and to the Academy "The Course of True Love never did run Smooth," the large engraving from which was published with the title of "Cross Purposes," as more comprehensive and explanatory of its meaning than that adopted by the painter. "The Ballad," exhibited at the Institution in the following year, is a charming little picture of a girl reading beside a water-spring: the feeling, sentiment, and execution of this gem deserve all praise. To the Academy Exhibition of the same year he sent a pair of lovers, under the somewhat affected title of "*Ce n'est que le premier pas qui coûte*,"—a title which suggests the idea that the artist was beginning to find himself at a loss for a name wherewith to distinguish his "love-pictures." But a work of a far higher order than any we have yet referred to was hung at the same time—a scene from "HAMLET"—Ophelia singing before the queen as the king enters; a composition that may lay claim to some of the best characteristics of good historical painting.

In the Royal Academy Exhibition of 1846 was a picture by Stone, suggested by a line from Byron—

"Sift hour! which wakes the wish and melts the heart."

An Italian noble, rather advanced in years, is seated on the terrace of his villa, overlooking the sea; near him is a young girl, and beyond them is a youthful pair, no doubt "discussing most eloquent music" in each other's ears; it is



Engraved by]

MATED.

[Daniel Brothers.

the old story, but told in so happy a manner as to render it most acceptable: it is one of the few pictures of the class which we should be proud of possessing.

"The Approaching Footstep," exhibited at the British Institution in 1847, is a graceful, unaffected picture of a girl, in the costume of the last century, reclining on a bank, in the attitude of listening,—

"Some well-known step salutes her ear!"

a small lap-dog the lady holds in her arms appears as eager to welcome the comer as its beautiful owner. The same year appeared at the Academy the two pictures, "THE IMPENDING MARE," and "MATED," here introduced as, perhaps, the most agreeable of these particular compositions, as they are happily among the last we shall have to notice especially; for, with two or three minor, important exceptions, from this time a decided change for the better came over the spirit of the painter's dream; he had before essayed his powers to rise higher, and found his strength equal to his flight; it henceforth increased with action—*vires acquisivisti evado*. We are glad to have our own thoughts also turned into another direction; one wearies with the tales of love, and even with the faces of the same pretty models always before the eyes.

It was perhaps not the most judicious act of the painter, to pass at once from such subjects as those to which we have referred, to that which he exhibited at the Academy in 1848,—"Christ and the Sisters of Bethany;" it takes some time for the mind to be imbued with the devout spirituality essential to the

perfect illustration of sacred history—especially a subject like this; and we were therefore not surprised to find it a comparative failure, showing, indeed, many valuable qualities of Art, but most deficient in the severity and simplicity that ought to characterise works of this class: nevertheless, it was a most acceptable and agreeable change from what we had seen from the same hand.

Two small pictures sent to the British Institution in 1849, "A Girl of Brittany," and "Alice," are very skillfully executed studies, free from all affectations. "The Duett," exhibited at the Academy in the same year, represents a modern drawing-room, with a group of young people, two of whom are at the piano: there is much refinement of taste in the conception of this picture, and it is very highly finished.

"Sympathy" (British Institution, 1850) displays in the treatment of the subject feeling of a right and genuine order; the figures are those of two young girls, one of whom offers words of consolation to the other, whose countenance betokens both bodily and mental affliction. Mr. Stone's contributions to the Academy, in the same year, were "The Gardener's Daughter," and "A Scene from the 'Tempest'."—Miranda expressing her admiration of Ferdinand.

During the last six years, we find the name of this painter only twice in the catalogues of the British Institution. In 1851, when he sent two small pictures, one called "The View,"—two children, one directing the attention of the other to some distant object; the second a study of a girl, with the title of "Blanche;" and in 1854, when he contributed "The Balcony," the name given

to the head and bust of a small female figure. In the former of these years, he sent to the Academy the picture which is engraved on the first page of this notice, "BASSANIO RECEIVING THE LETTER ANNOUNCING ANTONIO'S LOSSES AND PERILS," from the "Merchant of Venice," one of the most ambitious works attempted by the painter, and certainly not the least successful; the composition is good, the figures are well grouped, and the heads carefully studied with respect to character, while the whole is painted with a brilliant and delicate pencil. In the autumn of this year Mr. Stone was elected Associate of the Academy.

Stimulated, perhaps, by the honour paid him by the Academy, he sent to its exhibition in the following year four pictures, the largest number he ever contributed:—"A Scene from Cymbeline," a small canvas, presenting half-length

figures of Pisanio and Imogen; a "Country Girl," "At the Opera," a title significant of the subject; and a "Portrait of Dr. Hooker," surrounded by his native collectors, examining plants in the Rhododendron region of the Himalaya Mountains,—a subject not of the highest pictorial interest, but treated with considerable skill and judgment. His contributions in 1853 were—"A Nile-Flower," a charming study of an Eastern maiden; "Now I'll tell you what we'll do," an affected title given to a group of country girls, grouped in a meadow; and "The Master is come," illustrating a passage in the history of Martha and Mary, as described by the Evangelist St. John: the two females only are introduced, and they are described with much power and truth.

Three pictures were also contributed by the painter in 1854:—"The Mussel Gatherer—Time to go," rather a novelty from his pencil, for it is a coast scene,



Engraved by,

OPHELIA: A SCENE FROM "HAMLET."

[Lalnel Brothers.]

with a real sea-side maiden—not a young lady habited in the dress of a fisherman's daughter—with as much refinement of expression and delicacy of skin as we should expect naturally to find in one who is daily called to face the "briny blasts;" the figure is vigorously painted, yet with the artist's usual careful finish. The second, called "The Old, Old Story," is Mr. Stone's old, old story; but the French maiden, and her admirer, a young fisherman, tell their tale of love to the spectator in a sensible and pleasant manner: here is true nature—not affectation; and the style of the painting is as true and substantial as the narrative that is set before us. The third, "Castle Building," represents a girl in the attitude of earnest meditation; no doubt her thoughts run upon "the old story;" at any rate they have not disturbed the sweet expression of her face—one of the sweetest and most life-like we remember to

have seen on canvas. In 1856 Mr. Stone was absent from the walls of the Academy; and in the present year he sent one picture only, "Doubt," a work of considerable size, but certainly not an advance upon previous performances.

The characteristics of Mr. Stone's productions may be briefly summed up: his strength lies in his delineation of the female figure, where beauty of expression and delicacy of texture are sought after; he rarely attempts elaborate compositions, aware, probably, of his weakness in the art of grouping masses, either as principals or accessories. His colouring is generally truthful, and always brilliant, and his execution careful, even to a high degree of finish in the minutest details of his subjects. His talents will always command respect, though we do not anticipate they will ever cause him to be classed with the brightest ornaments of the British School.

THREAD AND FIBRE GILDING.

THE pressure on our columns arising from the imperative claims of the exhibitions of the season, and other matters directly connected with the Fine Arts, has compelled us to postpone until now our remarks on a paper read by Mr. Bennoch, of the firm of Bennoch, Twentymen, and Riggs, of 77, Wood Street, Champs-Élysées, at the Society of Arts, in April last. "ON THREAD AND FIBRE GILDING."

The subject is one of national importance: and if the remarks of Colonel Sykes, the Chairman of the East India Company, who presided on the occasion, and took part in the discussion, are duly weighed by the manufacturers of England, it would appear that the process of gilding described by Mr. Bennoch may open up a demand in the East for fabrics adapted to the tastes of the people, that may go far to neutralise the inconvenience now felt by the commerce of England in consequence of the excessive shipments of silver to India and China. Whatever portion of such demand can be supplied by the looms of England will be a national advantage.

We transfer to our pages a large portion of the interesting paper, and trust our manufacturing readers will look into the matter, and ascertain for themselves whether they cannot to some extent carry out the suggestions we have offered. Since the paper was published in the *Journal of the Society of Arts*, considerable discussion has been excited on the subject. By command of Her Majesty the specimens exhibited when the paper was read were forwarded to the Palace, and some of them selected by Her Majesty, who, through Colonel Philipps, was graciously pleased to express her admiration of the fabrics.

Waistcoat-pieces and material for neck-ties have been produced by Mr. Sanderson, the enterprising silk manufacturer of Gresham Street, City; while Messrs. Kerr and Scott, the eminent shawl manufacturers of London and Paisley, are preparing specimens in their branch of manufacture, which we cannot help believing will become popular on all occasions of full-dress display. Some shawls made in France have struck us as exceedingly chaste and beautiful; while there is to the fullest extent all the effect producible by the purest gold, there is an absence of that objectionable glitter and glare peculiar to mere tinsel. Those who wish to thoroughly understand, not only the new system, but also the process that has obtained for thousands of years, we confidently recommend to read the following remarks read by Mr. Bennoch:—

ON THREAD OR FIBRE GILDING.

When he consented to write a paper on the subject, he had resolved to confine his observations within the narrow limits of certain recent discoveries, in which he had become interested; but he soon found that, however interesting a paper so limited might be in itself, it would necessarily leave untouched the large and important subject of fibre plating, or covering threads of silk or cotton with gold or silver, so that the precious metals might be used with facility in the manufacture of gold and silver tissues. To clearly understand the several processes required for the production of such fabrics, it became necessary that he should refer to other and apparently distinct branches of industry, such as silver gilding and wire drawing. He therefore resolved to investigate the general subject, and bring the result of his inquiries within the space of a single address.

The history of ornamental jewellery from the earliest times—the purposes it had served—how and why rings, and chains, and bracelets, and wreaths, and crowns, became and continue indispensable ornaments, would form an instructive paper, but his duty was to confine his remarks to the production of threads used in the manufacture of woven or embroidered fabrics.

Innumerable references are made in the sacred writings to the liberal use of gold and silver, not only for personal adornment, but also for the highest ceremonial purposes.

In the Old Testament we are told (Jer. chap. x. v. 9), "Silver spread in plates was brought from Tarshish, and gold from Uphaz, the work of the workmen and of the hands of the founder. Blue and purple is their clothing, they are all the work

of cunning men." It is evident from this and other passages that fire was used in purifying the metal; that it was afterwards founded or cast into certain forms, preparatory to its being beaten or hammered, and fitted for the purposes for which it was intended.

The first important use made of gold was in the construction of the Ark of the Covenant, and Bezaleel, the son of Uri, the son of Hur, of the tribe of Judah, is described (Ex. xxxi. 2—4) as specially called, and by inspiration "possessed of all wisdom, understanding, and knowledge in all manner of workmanship, and to devise cunning works in gold, and in silver, and in brass, and in cutting of stones to set them." Then (in Ex. xxv. 11) the ark is described as being "overlaid with pure gold within and without."

So in the building of the Temple (1 Kings vi. 21, 22), "Solomon overlaid the house within with pure gold, and he made a partition of gold before the oracle, and he overlaid it with gold, and he overlaid the whole house with gold, until he had finished all the house, and also the whole altar that was by the oracle he overlaid with gold."

It is interesting and very suggestive to observe, that, wherever the highest and holiest thoughts and purest motives ought to have existed, and where the objects were of the most sacred nature, the purest of all metals was enjoined to be used, and doubtless intended to symbolise the purity of the purposes to which it was applied. The functions of the priest were the loftiest and purest, and the temple in which he served was designed to last for ever; therefore, the purest metal was adopted as indicative of the purity and endurance of the priesthood and the temple.

After the construction of the ark and the tabernacle we have a description of the garments of the priests (Ex. xxxix. 3):—"And they did beat gold into thin plates, and cut it into wires to work it in the blue, and in the purple, and in the scarlet, and in the fine linen, with cunning work."

As we are not told what breadth the plates were, it would be idle to speculate on the length of the wires. He apprehended, however, that the wires there referred to should not be understood to mean what the word now implied. When they remembered the marvellous particularity with which the minutest details in reference to the building of the temple, the tabernacle, the ark, and the wool of the priestly raiment, were described, he was persuaded that had the gold been drawn into lengthened wires the particulars of the process would have been given. In the absence of such information, and taking the facts as they lay before him, he arrived at the conclusion that the wire mentioned was only narrow shreds of thin gold, which, in all probability, did not in length exceed the width of the web from which the garments were to be made, and these webs need not have been more than a few inches wide. We shall, by-and-by, see that even now in the East certain robes are made of narrow strips, and the fashion may have been handed down from the time of the patriarchs.

From specimens shown it was seen that having succeeded in producing a wire of great length, it was used longitudinally as a warp, avoiding the difficulty experienced when the wire thread is passed from side to side, as in the weft or shuttle.

In covering the sacred places within and without with pure gold, it is not stated how the plates were fastened, and we very naturally, and perhaps truthfully conclude that they were rivetted or fastened with nails. The workmanship was doubtless exceedingly rude; at all events, they were justified in the opinion that had other means been employed they would have been fully described. This view is partly confirmed by the fact that the words "gilt" or "gilding" do not appear in the sacred writings, and there is no data determining the period when gold was first attached by an adhesive medium.

Although the system adopted in the East, and prevailing there at the present moment, may greatly differ from that which existed in the days of Moses, still, in his judgment, there must be some similarity. By ascertaining the method now pursued in India, we may obtain a faint glimpse of the plan adopted by the earliest workers in the precious metals.

The city of Paithun, situated on the river Godavary, is famed for its manufactures in gold and silver tissues—viz., *puggies*, or turbans, *doppattas*, or long shawls, and *sarees*, or women's robes. The highest

qualities of these several productions are sent to the courts of Gwalior, Baroda, and Hyderabad.

The long shawls which are thrown over the shoulders of the native princes on all occasions of state ceremonial frequently cost as much as 8000 rupees (£300) each. The weft is composed of very fine cotton thread, generally scarlet or green, the warp being of silk of a similar colour. The shawls are sometimes in long strips of about an inch in width, and placed alternately a strip of senelet and a strip of gold. The ends are of cloth of gold, about a yard in depth, and the whole shawl is surrounded by a rich border of flowers or birds in variegated silks, woven on a gold ground. Some of the sarees are made of thick shot silk in narrow strips, and finished in a similar manner; while others of the same texture, as the *doppattas*, are flowered, spotted, or striped with gold, and are about nine yards in length. They present a most gorgeous appearance, being in texture like the fine muslin gauze of ladies' dresses, and it is by no means uncommon to have them of the value of 225 rupees (or £22 10s.) each.

Dr. Royle, in his instructive lecture* on "The Arts and Manufactures of India," informs us that, "among the references to silk in ancient authors, there is also frequently mention made of gold and silver as interwoven with silk; even the Coan women are represented as interweaving gold thread in their silken webs, and Calienta as wearing 'a tunic interwoven with gold.' *Babylonium* was the name applied to the splendid productions of the Babylonian looms. These are described as being adorned both with gold and with variously coloured figures. A peacock's train is compared to a figured *babylonium*, enriched with gold; while *septum*, the shawl, had the greatest skill and labour bestowed on its fabrication, and various objects were frequently represented on it; that worn by the Pastophori in religious ceremonies was richly interwoven with gold, and displayed various symbolical and mythological figures; while the *paragauda*—a word supposed to be of oriental origin—we learn was the border of a tunic enriched with gold thread, and worn by ladies. There is no doubt that it has long been the custom so to adorn garments in the East; and we had numerous such specimens sent to the Exhibition of 1851."

Mr. Bennoch then referred to the process that prevails in India in preparing the metal and the thread used in the manufacture of these truly gorgeous fabrics.

A rod of silver, weighing twenty-two rupees, or about eight ounces, after having been roughened by a file, is covered with a leaf of the best gold, weighing one rupee, so that gold forms one twenty-third part of the whole metal. The method adopted to make the gold adhere to the silver is very simple. The rod of silver having been wetted, the gold leaf is laid on, and pressed with the fingers, and afterwards rubbed smartly on the thigh. The small portion of gold that may overlap hangs loose, and is cut off; the edges of the gold leaf that come in contact are beaten a little thinner than the body of the leaf, so as to secure, as nearly as possible, a uniform thickness.

The bar so prepared is heated in a pan of charcoal till it becomes red-hot. It is then taken out and hammered, and rubbed with a piece of wood, and is ready to undergo the first process of being drawn into wire. The rod is, at this time, about the thickness of a man's thumb, and from six to eight inches in length. In the wire-drawer's house there is a pit dug in the floor, about thirty inches deep, containing a rude horizontal wooden cylinder, or beam, turning on pivots fixed into each end, placed in sockets at the side or end of the pit. In this cylinder are fixed four handspikes, over one of which is slipped a ring, to which is attached a chain, with a ring at the other end. Through this ring is slipped the head of a pair of pincers, in the jaws of which is placed the end of the gilt bar, which had previously been hammered at one end, so as to enable it to pass through the hole pierced in a steel plate; through this hole the bar has to be drawn, and, being drawn, is reduced in diameter, and proportionally increased in length. The handles of the pincers

* See "Lectures on the Results of the Great Exhibition of 1851; delivered before the Society of Arts." 2 vols. 8vo. Bogue, London, 1852-3.

being considerably wider than the head, and the ring gripping both handles, it follows that the greater the strain on the handles, the closer the grip of the jaws. The hold is tightened by placing a small piece of mica between the rod and the jaws of the pincers. One man holds the rod steadily and straight to the die, while another man turns the cylinder by pulling with his hands, and pressing with his feet, the handspikes, in the same way as we occasionally see the steersman at the wheel of the rudder of a large ship. As the cylinder revolves, the rod of metal lengthens, and winds round the cylinder. To lessen the friction in passing through the holes, the rod is invariably rubbed over with wax.

Having passed through the holes in the steel plate, each hole being a degree finer than the other, the wire is coiled up and re-heated, or annealed, by which it is softened, or made more malleable. Were this precaution omitted, the wire would become brittle, and break like cast metal. This process of drawing and heating is repeated over and over again, until the wire is reduced to the substance of ordinary whipcord, and it then passes into other hands. The importance of the division of labour is here recognised. The hands best adapted for the heaviest processes are altogether unfit for the more delicate branches of the business.

The workmen into whose hands the wire is now placed sit at a small bench, on which are two reels, or large bobbins, a short distance apart, on one of which the wire is wound; midway between them is fixed edgewise a frame, with a steel plate pierced with fifteen or twenty holes of different degrees of fineness. To make the wire pass easily through the finer hole, it is rubbed at the end between two pieces of porcelain, then slipped through the hole—caught with a pair of nippers, and attached to a limb or spoke of the empty reel, which is turned by the hand, and the wire is drawn through with perfect ease. This operation is continued and repeated until the wire becomes as fine as the finest hair.

In this state it cannot be used, for it is too weak to be woven, and must be united with some other fibre before it can be worked in the loom; and being round, it will not readily attach itself to the thread. It therefore becomes necessary that it should be flattened. This is done by beating it with a highly-polished steel hammer, on an anvil equally well polished, as the least flaw would damage the wire.

Eight or ten threads are wound on as many several small reels, like cotton spools. These are placed in two rows, on pegs fastened to a board, so as to turn horizontally. The several ends are passed through a row of small holes pierced in a piece of thick fish-skin attached to the anvil with wax—the holes being level with the surface of the anvil, and the gold wires pass on to the anvil separately, yet near each other. The operator seizes all the threads with the left hand, and draws them gently across the anvil, while with the right hand he hammers them as they pass. With one stroke he flattens the eight or ten wires with such remarkable skill that scarcely any difference can be detected in the width of the flattened wire, so accurately is each blow given.

The flattened wire now passes into the hands of a spinner or plater of gold thread. The process is very interesting. The orange-coloured silk is wound round two spindles, such as are used for spinning cotton or wool—the ends of the two threads are passed through a ring fastened to the ceiling of the room, and both bobbins are brought to an equal height from the ground; by being rubbed sharply along the thigh they are set in motion in opposite directions, and spin round with great velocity. As they spin, the gilt wire, flattened as described, and guided by the left hand, is wound round the threads with an evenness and regularity almost incredible, considering the rudeness of the implements used; and our surprise is greatly increased on examining the articles afterwards manufactured.

In this very concise description of a most interesting branch of industry there are several facts of detail omitted which it would have been well to have had supplied—such as the time occupied in bringing the rod of six inches long into the wire as fine as hair—the length of the hair so drawn—the value of the labour so condensed, and sundry other points, without which we cannot satisfactorily arrive at any economical result. These omissions, how-

ever, are amply supplied by the processes adopted in London. The same, or very similar methods, prevail in the several cities of Europe where the manufacture of gold lace is encouraged, but he confined himself to what he had seen, and in this branch of his paper he was much indebted to the courtesy of Messrs. Johnson, Simpson, and Simons, whose works had been thrown open to him, and to Mr. Simons he was indebted for many of the details.

Silver being the basis of what is technically called gold thread, it is well to consider what silver is best for the purpose. The silver in greatest favour with wire-drawers is extracted from lead. This may probably retain a certain portion of the nature of the ore with which it was previously in combination, and may be tougher than that obtained from other mines. The manner in which the silver is separated from the lead is very simple, and most interesting. Without detailing the several processes practised by various miners, he referred to an improved plan in operation at the lead mines of the Duke of Buccleuch, at Wanlockhead, in the high district of Dumfriesshire. The process is founded on the property which bodies possess of separating from each other during crystallisation. The argentiferous lead is melted in a large vessel, and the temperature is arranged to such a point, that the lead becomes crystallised. The crystals of pure lead are then removed as soon as formed, by means of a large iron ladle, pierced with holes, and the silver is thus left combined with a smaller portion of lead, which thus gradually becomes more and more rich, until, by successive operations, it is brought to such a state, that further separation can be advantageously effected by the ordinary means of cupellation.

The facility with which silver can be thus separated from the lead gives the owner the advantage of making the lead of the required richness. He need hardly tell his audience that the quality of lead depends greatly on the quantity of silver combined with it. The silver so produced comes to the market usually in the form of a cake, and is afterwards melted and graind. A certain quantity is weighed—say from 400 to 500 ounces,—and placed in a crucible, or, in the common language of the trade, a *pot*, which is placed in a charcoal fire, and there remains until the metal is of nearly a white heat.

The best crucibles for such purposes are of American manufacture, composed of black-lead and a mixture of a peculiar clay. When heated as described, it is ready to be poured into the ingot moulds. These moulds are made of iron, and sometimes of copper; but it has been proved by experience that the iron mould is the best, because the copper moulds, after being used a given number of times, are liable to fracture. Before pouring the metal into the mould, it is important that the mould itself should be heated to a certain point. Unless this is attended to, steam or gas is generated, and causes a spurting of the metal, producing air-bubbles, or flaws, in the ingot, and any imperfection of that nature produces an ultimate defect in the wire. The ingot mould is in two pieces, kept together by very strong clamps and screws. When the metal is sufficiently set, the screws are loosened, the mould separates, and the ingot of silver falls easily out. The ingot so cast is about two inches in diameter, and from twenty to twenty-four inches in length. The bar, or ingot, is then placed in a charcoal fire until redhot, whence it is taken and held and turned on the anvil by one man, while three others, with heavy hammers, hammer it well. This beating and hammering continues until the bar is reduced to a size suitable for the first hole, or die, through which it has to be drawn, and by the hammering is increased in length from four to five inches, or about twenty per cent. The hammering, so fiercely applied, changes the nature of the metal precisely in the same way as iron is changed by rolling and hammering, laying all the fibres one way, and proportionally increasing its tenacity and elasticity. The bar so prepared is pointed, and made to fit the first die through which it has to pass, and laid on the draw-bench with the point slipped through the die. The point is then seized by the jaws of a pair of monster pincers, or draw-tongues, with short bow arms, at the end of each of which is a hook that slips over a ring, attached to the end of a strong chain cable, drawn by a steam-engine exerting the power of sixteen horses. The greater the draught the tighter the grip, and the ingot passes through the first die with

the greatest ease, and is reduced in diameter, but increased in length from ten to fifteen per cent. This process is repeated ten or twelve times, each time the bar is being drawn through a smaller die. The bar is then removed to another bench, where it is placed so as to remove all roughness or other imperfections on the surface, as the slightest blemish would interfere with perfect gilding—such blemishes being best detected by placing over the bar a sheet of foolscap paper, slightly arched, which by its reflection shows every speck instantly and most distinctly. The bar of metal, being so prepared, is considerably reduced in weight as well as in size, and is now ready for gilding. As the richness of the wire depends upon the thickness of the gold laid on, and as all the gold leaves are very nearly, if not absolutely, of the same substance, the quality of the wire is regulated by the number of leaves placed one over the other, and these vary from ten to thirty leaves. The higher qualities are used for military purposes, and pearls and bullions for embroidery. The lower qualities being in demand chiefly for liveries, for the ends of muslins, and also for skin thread exported to India and China. The gold leaves, whether of the depth of ten or thirty, are laid in a row side by side, nearly the length of the bar, on a piece of ordinary cartridge paper; the bar is gently laid on the leaves, pressed close, and the edges of the leaves raised up until the silver is entirely covered with gold leaf; there is no size or foreign matter whatever used; because any such matter would, in the fire, prevent perfect cohesion. Nor is there any water used, as in the Indian process—the natural affinity of the highly-polished silver to the gold appears to be sufficient. The bar so overspread with leaf and enveloped in paper is tied tightly round with cord, and placed in the centre of a heap of lighted charcoal, where it remains until it assumes a bright red heat. One would imagine that the paper must instantly take fire and disappear, but such is not the case. The atmosphere being carefully excluded, it gradually becomes red with the metal, and when the paper has been entirely consumed, the bar is nearly ready to be withdrawn. While redhot, it is placed on a frame, or hench, and vigorously harnished with a hood-stone—a substitute for which, and nearly as good, has been found in a stone discovered in the South Seas, probably the same as that from which the natives of those islands make their spear-heads, hatchets, and weapons of war. This harnishing serves a double purpose—it forces out any air that may have remained between the gold and the silver, and at the same time brings them closer together. When quite smooth, it is permitted to cool gradually.

When quite cool, the surface is covered with wax, and then commences the more rapid reduction of size by drawing the bar through graduated steel dies, highly-polished, as the slightest roughness would damage the metal, and although it might now pass undiscovered, by-and-by it would show itself in defective wire. These slight physical defects, like moral flaws, cannot be always hid, but, sooner or later, will appear on the surface. When reduced to the size, technically called *diagonised*, it is annealed, care being taken to exclude the air from the surface, otherwise the gold, being now so thin on the silver, would partially melt, and present a blackened appearance. After remaining in the fire about an hour, it is placed under other superintendence, and removed to other machinery, moving with greater speed, and rapidly passing through a number of finer holes, each decreasing in size, until it is reduced to the size he held in his hand. After this it is heated and drawn through a hole, which removes all wax and dirt from the surface.

The steel dies are then dispensed with, because, from experience, it had been found that the holes were liable to become what wire-drawers call square; and, until within a comparatively recent period, the ounce of metal could not be drawn into more than 900 or 1000 yards.

One of the firm to which he was so much indebted was the first to suggest an experiment with a jewelled die. Many difficulties were at first experienced, but all were overcome, and a perforated ruby, set in a metallic frame, answered admirably, and enabled the drawer to produce, from one ounce of metal, a wire a mile and a quarter long, and finer than a lady's hair. In connection with this discovery, it is somewhat singular that there are not more than three

men in London capable of perforating and setting these ruby dies properly; one man, who works probably not more than three hours a day on the average, has received from one wire-drawing firm as much as £500 or £600 in a single year, while they only pay from 4s. to 5s. for each die.

Presuming that the finest point is reached, it is found that the colour is not so rich and deep a shade of yellow as fashion desires. To effect this a very simple and ingenious plan is adopted. The wire is wound round a copper cylinder, a small portion of wax being added; the bore or cavity of the cylinder is filled with red-hot charcoal, made from birch wood, that being found the best; so the wire in its finest state is again annealed; and what appears singular, the colour is deepened and rendered permanent.

It is now ready to be flattened preparatory to spinning round the silk, and this is accomplished by winding it from the copper cylinder on to smaller bobbins, ready for the flattening-machine, which is very simple and very small. There are only two rollers for it to pass between, the one being about ten and the other four inches in diameter, and two inches wide, slightly convex on the face.

To impress a substance as fine as a hair, and flatten it to twice or treble its original width, requires the nicest possible adaptation of parts. They would not be surprised to hear that a single pair of rolls cost £120. The metal is of the rarest quality of steel, and the polish higher than the finest glass. At one time these rollers were made in Sheffield, but now they are manufactured in Rhenish Prussia.

The wire so flattened is now wound on small bobbins, which are placed in the centre of circular rings, attached to a bar over a spinning-frame. On the front of the frame are bobbins of silk, the threads of which pass through the centre of the ring to which the reel with wire is fixed. The whole is set in motion, and while the thread is being twisted, the ring with the wire revolves round the thread in the opposite direction, and thirty or forty threads are plated at once—one girl attending to them all; and so the gold thread is finished, and ready for any purpose the consumer may require.

In its new form, though only gold is seen, probably nine-tenths of its bulk is silk, while of the remaining one-tenth only one-fiftieth part is gold; so by labour and ingenuity they were put in possession of a gold thread, of which only one part in five hundred is in reality gold.

It was important to ascertain the quantity of labour required to reduce the ingot of silver, weighing 420 ounces, to the finished wire, weighing 360 ounces, 60 ounces having been cut off—not destroyed—in the several processes of pointing, plaining, and occasional accidental waste:—

	Hours.
To reduce the ingot to the size when it is cut into 10 equal parts, of about 36 ounces each, takes 3 men 20 hours each	60
To reduce from hank to firing off size takes, for each hank, 3 men 8 hours, or for 10 hanks	50
To reduce from firing off to 300 yards per ounce size takes, for each hank, 9 hours, or for 10 hanks	90
To reduce 300 yards to 1200 yards per ounce size takes, for each hank, 18 hours, or for 10 hanks	180
To reduce from 1200 yards to 1800 yards size takes, for each hank, 25 hours, or for 10 hanks	250
If reduced to 2000 yards, each hank would take at least 7 hours, or for 10 hanks	70
	700

Allowing ten hours to the day, it would take one man seventy days or ten weeks to reduce by his labour the ingot of silver, weighing 420 ounces to its finest size. But no one man is equal to the entire duty. The early processes demand the exercise of Titanic powers, while the later processes demand the lightest touch of almost fairy fingers.

In constructing the foregoing table, he had some difficulty, from the fact that, so far as he could discover, the question had never before been looked at from the labour-consumption point of view. There may be some errors, arising from imperfect information, but he believed it would be found sufficiently accurate to enable them to estimate the labour necessary to make four hundred ounces of gold, in a bar twenty inches long, stretch over five hundred miles. Fifty such bars would bind the earth with a golden hoop. But as the four hundred ounces of silver is gilt with only eight ounces of

gold leaf, each leaf weighing eighteen grains, and four inches square, it follows that only one-fiftieth part of the wire is gold. So eight ounces of gold in combination with silver is made to stretch five hundred miles, or over sixty miles for a single ounce. Nothing can more clearly show the wonderful ductility of this most wonderful metal. One would imagine that in passing through so many holes, the gold would be liable to be scraped from the surface of the silver; but it is not so. In passing through the die every atom of the metal is excited and stretched simultaneously, each atom retaining its relative position. As, from first to last, the wire passes through one hundred to one hundred and twenty dies, it follows that the ingot in its course traverses over fifty thousand miles, or twice the circumference of the globe.

Before passing to the last division of his paper, a few observations might be permitted, marking the differences that exist between manual and mechanical labour, as suggested by the Indian and English processes of wire-drawing.

In London five hundred ounces of metal could be drawn into wire while ten are drawn at Pailham.

In London it can be drawn 2000 or even 2200 yards to the ounce, while in Pailham they stop short of 1000 or 1200 yards.

In London the manufacturer depends upon mechanical ingenuity, which enables comparative children to execute a very large proportion of the work; while in India, age and great experience are essential to the production of a marketable commodity.

The difference will increase year by year. Electro-gilding in some way or other must, sooner or later, supersede the present process. Whether its application shall be to the bar of silver in bulk, or to the completed wire, he could not determine; but looking at the conditions of the trade, considering the scientific principles involved, and the chemical processes that may be applied, he had no more doubt of the result desired being accomplished than he had in his own existence.

Certain it is that, ere long, English industry will supply India, and probably China, with all the prepared thread they require for the production of their sumptuous robes; the only surprise is that English enterprise and English looms had not long ago supplied those distant countries with the manufactured article.

When they considered the consumption of the precious metals—the no less precious money, and the still more precious labour consumed in the manufacture of gold thread—it was not only not satisfactory, but very humiliating, to confess that a very large proportion of the quantity produced was flung away and wasted—much being consumed in bars of gold shot in at the ends of webs of muslin or other cloth, to produce an attractive finish, which, when purchased for consumption, was torn off, and cast into the fire.

Having entered so fully into the details of wire-drawing, flattening, and spinning, he now came to the new and patented plan of

FIBRE GILDING.

For many years chemists had attempted every known method of gilding, in the hope of discovering some process by which silk, or other fibre, could be gilded without applying the immense labour, seen to be necessary, before a thread with a covering of gold can be used with facility in the loom, and woven into cloth, but they always failed. In France, where scientific research is liberally promoted by the government, a large reward was offered for a successful plan, but no man ever had the opportunity or satisfaction of claiming it. The electro process gave a fresh impulse to scientific men.

The difficulties of the first stage were soon overcome, and gold was compelled to attach itself to the surface of the thread. Here a new difficulty arose—the thread, being completely soaked, was long in drying, and when dried had lost its lustre; while the foundation on which the gold rested was so soft and flimsy, that to burnish it was impossible. They only produced a gold thread which had not the effect of gold, and was therefore useless. Among the several investigators was Mr. Albert Hock, who, failing to find in chemistry the principle by which fibres could be gilded, succeeded by means of a simple mechanical contrivance.

In the first place, it is essential that the silk used

should be of a superior quality, free from knotty ribs and rough places. The gum must be boiled out of the silk, and the silk tinged to the shade of a light orange. The bobbins containing the silk are placed on a wire, on which they revolve when gently pulled. The end of the thread is passed over a wire, and then under a roller, which works in a trough containing a glutinous but transparent liquid. It then passes over a reel attached to an endless screw, or threaded spindle, so arranged that it lays on a brass cylinder the thread of silk as close as cords are wound round the handle of a whip, without overlapping, until the cylinder is completely covered with the silk, when the thread is broken; the length of the skein of thread depends, therefore, upon the size of the cylinder and the fineness of the thread, but the cylinder cannot be increased beyond a certain size, and that size must not be larger than can be spanned by a single leaf of gold, and the goldbeaters will not produce it larger than three and five-eighths of an inch square. When the leaf was to be four inches square, the London goldbeater declined the order, advancing as a reason, that, were he to demand such a size, every journeyman he had would strike and leave him. The gold leaf was produced from France—another instance of the mischief done to commerce by trade combinations.

The cylinder being covered with silk in a gummy state, the book with the gold leaf is opened, and laid on the palm of the hand; the machine—something like a turning-lathe—is moved; the edge of the leaf is made to touch the gummy silk, and it is quickly drawn round, covering the silk. This is repeated until the entire surface of the silk on the roller is covered with gold leaf. A piece of cloth or washed leather is fastened on a slip of wood, something like a razor-stop. The roller is turned round, and the stop pressed firmly upon the leaf, which not only presses the leaf closer to the silk, but separates the leaf between each of the windings of the finest thread; and so one side of the finest thread is gilded. It is thus apparent that if gold and green, or any other colour, is desired in combination with gold, it is only necessary, first, to dye the thread the colour required, and then, by gilding one side, the combination wished is secured. To gild the entire thread, the half-gilded thread is wound on to another roller. The gilded side of the silk thread necessarily winds next to the brass on the second roller, leaving the ungilt part of the thread exposed, and ready to be treated in the same manner as before described, and so the process is completed. It is then wound on to reels of the usual size, and permitted to dry thoroughly. After this it is reeled on boards, or, as the French call them, *planchettes*, and is ready for the market. The colour is very beautiful, being the natural colour of the gold leaf. The great advantage of this over every other thread is its lightness and perfect flexibility, for it can be wound and woven wherever any other thread can be wound or woven. Its only disadvantage consists in the impossibility of producing by this process that tinelled and glaring effect which ladies seem to consider a prime essential wherever gold is used. In reality it is a new but very expensive colour. The sizes of the threads are regulated by the number of ends of silk wound round the roller at once. The substance used for attaching the gold leaf to the threads unites them, and brings them into one thread.

As regards cost, it is, size for size, considerably dearer than the ordinary gold thread; but as it measures a much greater length for the weight, it virtually becomes, for weaving purposes, very much cheaper. The finest ordinary gold thread measures about 550 yards to the ounce, and costs about eight shillings. A similar size of silk, gilded by the new process, weighing one-third the weight, and measuring the same, would not cost over five shillings. Where fine gold leaf is used it is untarnishable; but copper can be used with the same facility as gold, and costs little more than half the price, while for ordinary purposes it answers quite as well.

In France there is a considerable demand for, and a steadily increasing consumption of, the material. Whether the manufacturers of England will enter the lists, and endeavour to compete with their enterprising neighbours, it is difficult to determine. The patentees seem to have received less encouragement than they had a right to expect from the manufacturers of the United Kingdom.

THE FAUSSETT COLLECTION.*

THE Faussett Collection has recently obtained so much celebrity, as well for its intrinsic excellence as for the strange perversity by which it has been cast aside from our National Museum, that this elegant volume must be peculiarly acceptable to all students of our Saxon Antiquities. A more important addition to our knowledge of the manners and customs of our Saxon forefathers has never appeared. It comprises the detailed results of the opening of nearly eight hundred tumuli, ranging over that part of Kent, from Canterbury to the sea, inhabited by the early Saxon settlers in England—their graves containing in all instances the weapons of the men, and the personal decorations of the women, who thus took with them to "the narrow house" those things they most valued in life. It is impossible to over-estimate the value of so extensive and curious a collection, unique in its power of illustrating a dark period in English history. In looking over the splendid examples of jewellery engraved in this book, or the varied appliances for the ordinary luxuries or wants of life, we cannot fail to be struck by the high amount of taste and civilisation they prove must have existed among the pagan Saxons, who are too frequently considered semi-barbarous. The jewellery particularly excites surprise; and the marvellous brooch discovered at Kingston, and forming the opening plate of this volume, has been pronounced by jewellers of the present day as fully equal in manipulative power to any modern work of their art. It is three inches and a half in diameter; and its surface is covered by five concentric circles of gold, inclosing garnet, turquoise, and mother-of-pearl, cut to fill variously shaped cells, the effect of the jewels being heightened by layers of gold foil. Between many of the stones is gold chain-work, twisted and interlaced, the whole being secured and affixed on a gold base, and the pin which secured it to the mantle also milled and encased with equal splendour. It is the grandest piece of jewellery of its age ever discovered in this or any other country. But even this fine work is rivalled in delicacy of manipulation by some others of a smaller kind in the same collection; and the details of that on Plate II, fig. 4, and the elegant pendants, Plate IV., figs. 4, 7, and 13, assert the high ability of these early goldsmiths.

When we say that the collection contains twenty of these magnificent brooches; more than fifty jewelled pendant ornaments in gold, silver, and base metals; buckles and personal ornaments of the most varied kinds, comprising all that the luxury of the Saxon might require; an abundance of defensive arms for the warrior; an equal abundance of toilette implements, or *articles de luxe*, for "the fair-haired maidens" he defended; glass, pottery, and miscellanea, making up an almost complete picture of the everyday life of this ancient people, an idea may be formed of the extreme value and paramount interest of this unique collection.

Certainly one of the most curious instances of the accidents which beset literature and science is afforded by the history of this collection, which has been allowed to remain in obscurity for nearly a century, and the manuscript account liable to every accident or total destruction. After it had been brought again to the notice of the antiquarian world by Mr. Roach Smith, in 1844, not one of the Antiquarian Societies moved one step towards the publication of any portion, although freely tendered to their use. But more marvellous than all, when the entire collection, including the whole of the manuscripts and drawings, was very properly offered in the first instance to the trustees of the British Museum, that it might find its proper resting-place in our National Collection, then almost entirely wanting in National Antiquities, it was curtly refused by that body! Astonished at such a result, as the price required was extremely moderate, the leading students in antiquities took alarm; the officers of the museum argued with their superior (?) officers, the trustees, and were backed by urgent petitions from the Society of Antiquaries, the Archaeological Institute and Association, by many private individuals, and by the still more important promises of the free gift of

* *INVENTAIREN SUPPLEMENTAIRE; AN ACCOUNT OF SOME ANTIQUITIES dug up in Kent by the Rev. BRYAN FAUSSETT. Edited by Charles Roach Smith. Printed for subscribers.*

other private collections of Saxon Antiquities to swell the national store, should the purchase be effected. The time for the decision of the trustees was extended by Dr. Faussett's executors, and the whole subject in its full bearings again placed before their eyes, accompanied by the fact that three private collectors were only awaiting their decision to purchase the whole at an advanced price, so that even the inbred trading spirit of an English board might be more than satisfied with the whole transaction. We can scarcely ask our readers to credit the fact, but the offer was again refused! and the collection next day passed into the hands of Mr. Joseph Mayer, F.S.A., of Liverpool, who at once made arrangement for the publication of the original records of Faussett's discoveries, securing the services of Mr. Roach Smith to edit the manuscripts, and Mr. Fairholt to draw and engrave every object comprised in the collection.

Although the originals he thus lost to the nation, the printing-press will make them even more useful to the general world; and, thanks to Mr. Mayer's spirited proceedings, the discoveries may belong by this means to every student of our early history. It is quite certain that had the British Museum purchased the collection, its rulers would not have published the manuscript, and caused the antiquities to be engraved for general use, as they have now been done. Thus, out of a great evil a much greater good has arisen to aid science in general; and Mr. Mayer, Mr. Roach Smith, and Mr. Fairholt, have thus given to the world at large the full benefit of Faussett's research; and in doing it have also produced an undying record of disgrace to the trustees of the British Museum, which must last while literature exists.

Of the labour of Mr. Roach Smith as editor we can conscientiously speak in high terms. He has faithfully given the original record by Bryan Faussett, accompanied by notes explanatory and critical, comprising the results of that knowledge which recent experience has given the archaeologist. But he has done much more than this; for in an elaborate introduction to the volume he has written such a clear record of the results of the various isolated researches of investigators, combined with his own experiences, as to realise the truth of his opening words:—"The real value of antiquities should be determined by the extent to which they are capable of being applied toward illustrating history." Seldom have we met a more honest exponent of facts than Mr. Roach Smith, or one who has less desire to argue for favourite theories; he has been imbued with the proper spirit of a truthful inquirer, who values his labour but as the means of eliciting *fact* in all clearness. For the first time he has enabled us to classify the somewhat chaotic mass of Saxon antiquities discovered at home and abroad; and by the careful comparison of their peculiarities, and the thoughtful testing of historic record, made one illustrate the other so completely, that we may safely refer certain ornaments to certain tribes, who had settled in various parts of England, and who brought with them and retained many peculiarities from their original homes. It is this enlarged and philo-sophic system of comparison which can alone clarify the obscure points of early British history where written documents fail; and we therefore regard this volume as a most important introduction to the history of Saxon England. When we turn to the pages of the ordinary histories, and see how brief and unsatisfactory they are, we feel that there is ample space for a new history before the Norman conquest, for which such works as this pioneer the way.

Mr. Fairholt's labours have been conducted in a similar spirit to the editor's, and he has most scrupulously laboured for truth alone. There is no attempt in his work at metrical effect; but wherever the grace of Art was requisite it has been called into play; and the jewels are all coloured by hand—so faithfully that we seem to look on the originals; while the plates of heads are equal to water-colour drawings in delicacy of shadow and variety of tint. They are the most perfect things of their kind that have yet appeared. Various processes have been adopted for the proper delineation of the various objects; and while the sharpness of the engraved line defines the minute patterns on the jewels, the softness of aquatint realises the texture of the glass or pottery.

THE ROYAL PICTURES.

A FÊTE CHAMPÊTRE.

J. B. Pater, Painter. Pelé, Engraver.
Size of the Picture, 1 ft. 11½ in. by 1 ft. 7½ in.

This picture, a companion work to the "Flute Player," introduced in the *Art-Journal* of December, 1855, shows in a more remarkable manner than the other the influence which Watteau had on the French school in the time of Louis XVI. It is an elegant example of the style of Art which comes strictly under the denomination of scene-painting. The figures are well *mise en scene*, to use a theatrical expression; the characters are effectively grouped, and each plays a carefully studied part; they are picturesquely costumed, and altogether compose into a very pretty *tableau*, significant of the dances and cavalliers of France in the beginning of the last century. The proper term to apply to the Art of that period is "decorative" it pleases, but the enjoyment is only transitory; it invites no study, and consequently offers nothing for thought to feed upon; it is brilliant, but its light is of that transient character, with regard to its effect upon the mind, which leaves little else than vague and unsatisfactory results. Hazlitt has written rather a severe censure, yet one not very far from the truth, on the French school generally; his remarks, however, apply, in our opinion, rather to what it was than to what it now is—for the influence of the modern German school may be distinctly recognised in the works of the best artists of France. "The French painters see nature with organs and with minds peculiarly their own. One must be born in France to understand their poetry or their painting. Their productions in Art are either literal or extravagant—dry, frigid facinories, in which they seem to take up nature by pie-points, or else rapid, distorted caricatures, out of all rule and compass. They are, in fact, at home only in the light and elegant; and whenever they attempt to add force or solidity (as they must do in the severer productions of the pencil) they are compelled to substitute an excess of minute industry for a comprehension of the whole, or make a desperate mechanical effort at extreme expression, instead of giving the true, natural, and powerful workings of passion."

But these strictures lose much of the *rationale* of the argument, if we consider, as in justice we ought to do, that the Art of every country has a national character: it is the reflex of the people in their habits, thoughts, and customs, and must therefore be criticised with such considerations. One has no right to condemn a style of Art because it does not harmonise with our ideas, nor pronounce it worthless because we are mentally or constitutionally unable to appreciate its excellence; and there is excellence even in the works of Watteau, Pater, Lancret, Boucher, and others of the same class. The sacred and legendary Art of Papal Italy, the *genre* pictures and the carousing hours of Holland and Flanders, may, even the works of our own school, which possess a distinct nationality, would, upon such evidence, be subject to stricture in countries where they could not be understood; just as the Red Indian, for example, is unable to see any personal beauty except in a face well tattooed, and drenched over with all kinds of colour. Each individual artist, or school of artists, speaks its own thoughts in its own language; and it would be just as reasonable to condemn them for not seeing and feeling as others do, as it would be to be angry with a foreigner who does not address us in our own mother tongue.

The principal defects in the pictures of the French artists, both past and present, with a few exceptions, is an absence of truthfulness and nature; while it is the presence of this most valuable quality in the works of our painters which so surprised, and elicited the applause of, the French critics in the late Exhibition in Paris. Now it is just possible that a number of ladies and gentlemen may have so disposed themselves as they are represented in the "Fête Champêtre;" but the probability is they would not; the artist has therefore erred against truth and nature in this lively but affected composition.

The picture is in the collection at Buckingham Palace; it is painted with much delicacy, and is very harmonious in the tone of its colouring.

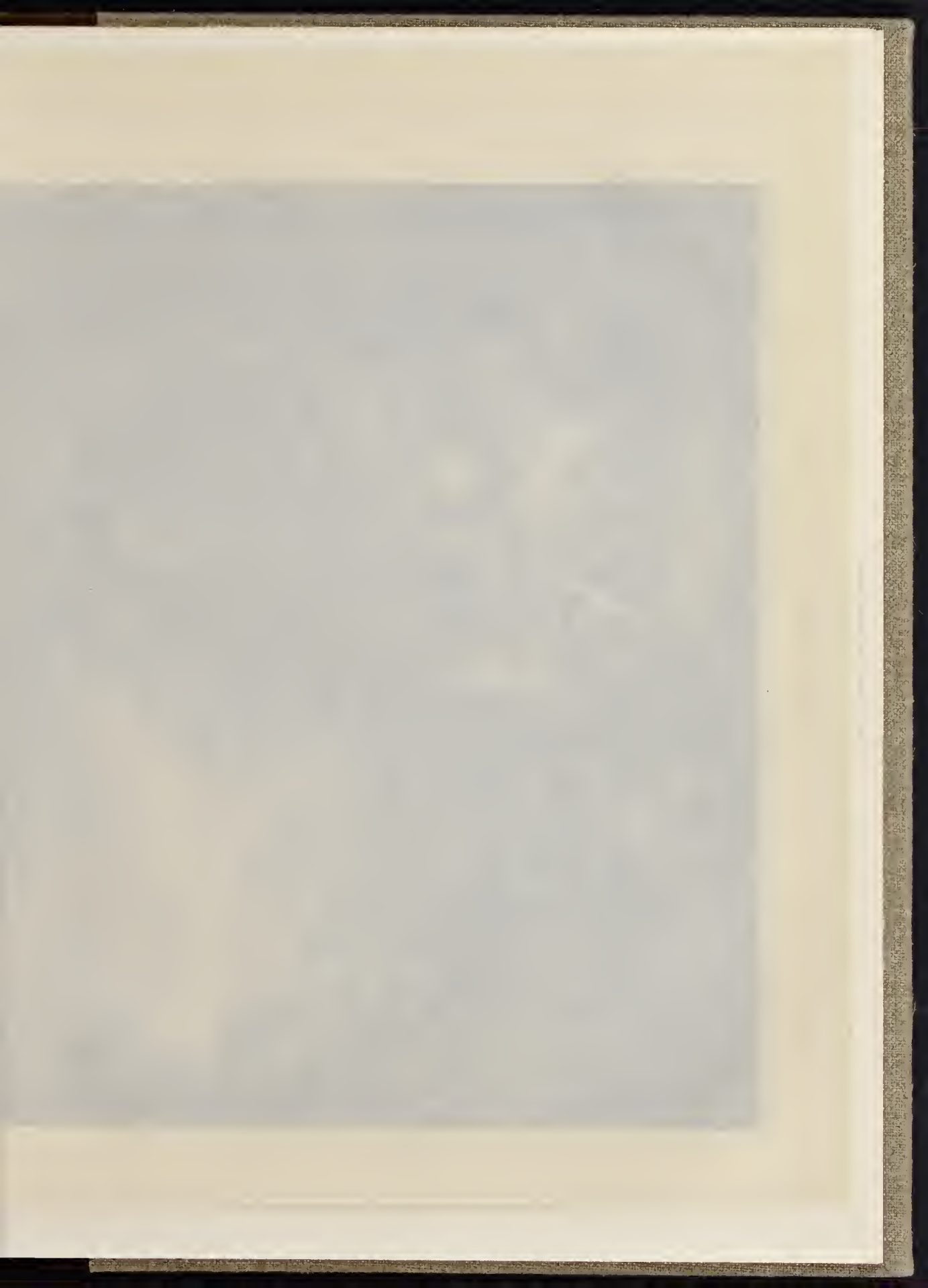

THE HISTORY OF THE
CITY OF BOSTON
FROM 1630 TO 1880
BY
JOHN B. HENNINGSON
VOLUME I
1880



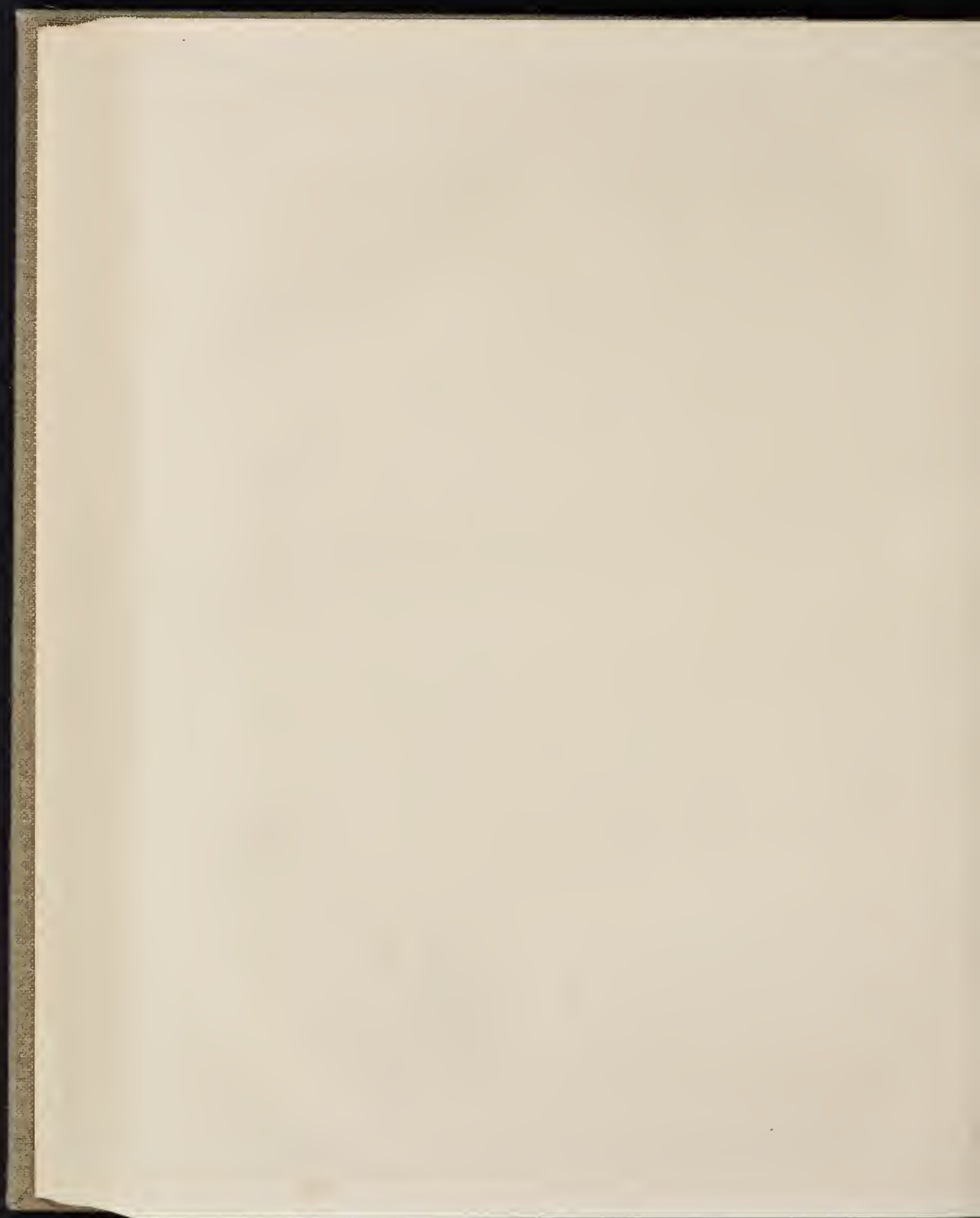

THE
MONKS OF THE MIDDLE AGES.*

BY THE REV. EDWARD L. CUTTS, D.A.

HAVING thus given a sketch of the history of the various monastic orders in England, we proceed to give some account of the constitution of a convent, taking that of a Benedictine monastery as a type, from which the other orders departed only in minor particulars.

The *convent* is the name especially appropriate to the body of individuals who composed a religious community. These were the body of cloister monks, lay and clerical; the professed brethren, who were also lay and clerical; the clerks; the novices; and the servants and artificers. The servants and artificers were of course taken from the lower ranks of society; all the rest were originally of the most various degrees of rank and social position. We constantly meet with instances of noble men and women, knights and ladies, minstrels and merchants, quitting their secular occupations at various periods of their life, and taking the religious habit; some of them continuing simply professed brethren, others rising to high offices in their order. Scions of noble houses were not unfrequently entered at an early age as novices, either devoted to the religious life by the piety of their parents, or, with more worldly motives, thus provided with calling and a maintenance; and sometimes considerable interest was used to procure the admittance of novices into the great monasteries. Again, the children of the poor were received into the monastic schools, and such as showed peculiar aptitude were sometimes at length admitted as monks,† and were eligible, and were often chosen, to the highest ecclesiastical dignities.

The whole convent was under the almost absolute rule of the *abbot*. Sometimes he was elected by the convent; sometimes the king or some patron had a share in the election. Frequently there were estates attached to the office, distinct from those of the convent; sometimes the abbot had only an allowance out of the convent estates; but always he had great power over the property of the convent, and bad abbots are frequently accused of wasting the property of the house, and enriching their relatives and friends out of it. The abbots of some of the more important houses were mitred abbots, and were summoned to Parliament. In the time of Henry VIII. twenty-four abbots and the prior of Coventry had seats in the House of Peers.

The abbot did not live in common with his monks; he had a separate establishment of his own within the precincts of the house, sometimes over the entrance gate, called the Abbot's Lodgings.‡ He ate in his own hall, slept in his own chamber, had a chapel, or oratory, for his private devotions, and accommodation for a retinue of chaplains and servants. His great duty was to set to his monks an example of observance of the rule, to keep them to its observance, to punish breaches of it, to attend the services in church when not hindered by his other duties, to preach on holy days to the people, to attend chapter and preach on the rule, to act as confessor to the monks. But an abbot was also involved in many secular duties; there were numerous of his own, and of the convent's, far and near, which required visiting, and these matters involved the abbot in all the numerous duties which the feudal system devolved upon a lord towards his tenants, and towards his feudal superior. The greater abbots were barons, and sometimes were thus involved in such duties as those of justices in eyre, military leaders of their vassals, peers of Parliament. Hospitality was one of the great monastic virtues. The usual regulation in convents was that the abbot should entertain all guests of gentle degree, while the convent entertained all others. This again found abundance of occupation for my lord abbot in performing all the offices of a courteous host, which seems to have been done in a way becoming his character as a lord of wealth and dignity; his table was bountifully spread, even if he chose to confine

himself to pulse and water; a band of wandering minstrels was always welcome to the abbot's hall to entertain his gentle and fair guests; and his falconer could furnish a cast of hawks, and his forester a leash of hounds, and the lord abbot would not decline to ride by the river or into his manor parks to witness and to share in the sport. A pretty little illustration of this abbatial hospitality occurs in Marie's "Lay of Ywonee." A baron and his family are traveling in obedience to the royal summons, to keep one of the high festivals at Caerleon. In the course of their journey they stop for a night at a spacious abbey, where they are received with the greatest hospitality. "The good abbot, for the sake of detaining his guests during another day, exhibited to them the whole of the apartments, the dormitory, the refectory, and the chapter-house, in which last they beheld a splendid tomb covered with a superb pall fringed with gold, surrounded by twenty waxes tapers in golden candlesticks, while a vast silver censer constantly burning filled the air with fumes of incense."

An abbot's ordinary habit was the same as that of his monks. In the processions which were made on



A BENEDICTINE ABBOT.

certain great feasts, he held his crozier, and if he were a mitred abbot, he wore his mitre: this was also his parliamentary costume. We here give a beautiful drawing of a Benedictine abbot of St. Alban's, thus habited, from the Catalogue Benefactorum of that abbey. When the abbot celebrated high mass on certain great festivals, he wore the full episcopal costume. Thomas Delamere, abbot of St. Alban's, is so represented in his magnificent sepulchral brass in that abbey, executed in his lifetime, circa 1375 A.D. Richard Bewferest, abbot of the Augustinian canons of Dorchester, Oxfordshire, has a brass in



BENEDICTINE ABBESS AND NUN.

that church, date circa 1520 A.D., representing him in episcopal costume, barheaded, with his staff; and in the same church is an incised gravestone, represent-

ing Abbot Roger, circa 1510 A.D., in full episcopal vestments. Abbesses wore the crozier in addition to the ordinary costume of their order. The sepulchral brass of Elizabeth Harvey, abbess of the Benedictine Abbey of Elstow, Bedfordshire, circa 1530 A.D., is thus represented in the church of that place. We here give a representation of a Benedictine abbess from the fourteenth century MS. Royal, 2 B. vii.

Under the abbot were a number of officials (*Obedientiarum*), the chief of whom were the Prior, Precentor, Cellarer, Sacrist, Hospitaller, Infirmerer, Almshouse, Master of the Novices, Porter, Kitchenmaster, Seneschal, &c. It was only in large monasteries that all these officers were to be found; in the smaller houses one monk would perform the duties of several offices. The officers seem to have been elected by the convent, subject to the approval of the abbot, by whom they might be deposed. Some brief notes of the duties of these obedientiaries will serve to give a considerable insight into the economy of a convent. And first for the *Prior*—

In some orders there was only one abbey, and all the other houses were priories, as in the Cistercians, the Gilbertines, and in the Military and the Mendicant orders. In all the orders there were abbeyes, which had had distant estates granted to them, on which either the donor had built a house, and made it subject to the abbey; or the abbey had built a house for the management of the estates, and the celebration of divine and charitable offices upon them. These priories varied in size, from a mere cell containing a prior and two monks, to an establishment as large as an abbey; and the dignity and power of the prior varied from that of a mere steward of the distant estate of the parent house, to that of an autocratic head, only nominally dependent on the parent house, and himself in everything but name an abbot.

The majority of the female houses of the various orders (except those which were especially female orders, like the Brigittines, &c.) were kept subject to some monastery, so that the superiors of these houses usually bore only the title of prioress, though they had the power of an abbess in the internal discipline of the house. One cannot forbear to quote at least a portion of Chaucer's very beautiful description of his prioress, who was among the Canterbury pilgrims, "That of her smiling ful simple was and coy." She sang the divine service sweetly; she spoke French correctly, though with accent which savoured of the Benedictine convent at Stratford-le-Bow, where she had been educated, rather than of Paris; she behaved with lady-like delicacy at table; she was cheerful of mood, and amiable; with a pretty affectation of courtly breeding, and a care to exhibit a reverend staidness becoming her office:—

"But for to speken of her conscience,
She was so charitable and so pitous,
She would wepe if that she saw a mouse
Caught in a trappe, if it were dead or hied;
Of such' houndis had she that she fed
With rosted flesh, and milk, and wastel bread;
But sore wept she if one of them were dead,
Or if men smote it with a yerdle suert,
And all was conscience and tendre herte.
Ful gently her wimple ypinched was;
Her nose tretis; her eyen grey as glass,
Her mouth full swaith, and therto soft and red,
And sleeker she had a fayne freche—
It was almost a squand' broun I trow,
And hardly she was not undergrow." †

Her habit was becoming, and she wore on her arm a set of beads of red coral gauded with green, to which was hung a jewel of gold, on which was—

"Written a crowned A,
And after, *Amor vincit omnia*.
Another nun also with her had she,
That was her chapelleine, and priestes' three."

But in abbeyes the chief of the Obedientiarum was styled prior; and we cannot, perhaps, give a better idea of his functions than by borrowing a naval analogy, and calling him the abbot's first lieutenant— for, like that officer in a ship, the prior at all times carried on the internal discipline of the convent, and in the abbot's absence he was his vicegerent; wielding all the abbot's powers, except those of making or deposing obedientiaries, and consecrating novices. He had a suite of apartments of his own, called the prior's chamber, or the prior's lodging; he could leave the house for a day or two on the business of the house, and had horses and servants appropriated to his uses; whenever he entered the

* Long and well proportioned.
† She was of tall stature.

* Continued from p. 315.

† "On the foundation," as we say now of colleges and endowed schools.

‡ Just as heads of colleges now have their Masters, or Provosts, or Principal's Lodge. The constitution of our existing colleges will assist those who are acquainted with them in understanding many points of monastic economy.

* Ellis's "Early English Romance."

monks present rose out of respect; some little licence in diet was allowed him in refectory, and he might also have refreshment in his own apartments; sometimes he entertained guests of a certain condition in his prior's chamber. In large convents he was assisted by a sub-prior.

The *Sub-prior* was the prior's deputy, sharing his duties in his residence, and fulfilling them in his absence. The especial functions appropriated to him seem to have been to say grace at dinner and supper, to see that all the doors were locked at five in the evening, and keep the keys until five next morning; and, by sleeping near the dormitory door, and by making private search, to prevent wandering about at night. In large monasteries there were additional sub-priors. Neither the prior, nor indeed any of the obedientiaries, wore any distinctive dress or badge of office.

The *Chantor*, or *Precentor*, appears to come next in order and dignity, since we are told that he was censured after the abbot and prior. He was choir-master; taught music to the monks and novices; and arranged and ruled everything which related to the conduct of divine service. His place in church was in the middle of the choir on the right side; he held an instrument in his hand, as modern leaders use a baton; and his side of the choir commenced the chant. He was besides librarian, and keeper of the archives, and keeper of the abbey seal.

He was assisted by a *Succentor*, who sat on the left side of the choir, and led that half of the choir in service. He assisted the chantor, and in his absence undertook his duties.

The *Cellarer* was in fact the steward of the house; his modern representative is the hursar of a college. He had the care of everything relating to the provision of the food and vessels of the convent. He was exempt from the observance of some of the services in church; he had the use of horses and servants for the fulfilment of his duties, and sometimes he appears to have had separate apartments. The cellarer, as we have said, wore no distinctive dress or badge; but in the *Catalogus Benefactorum*



ADAM CELLARIUS. NERO D. VII.

of the Benedictine Abbey of St. Alban's, there occurs a portrait of one "Adam Cellarius," who for his distinguished merit had been buried among the abbots in the chapter-house, and had his name and effigy recorded in the *Catalogus*; he is holding two keys in one hand and a purse in the other, the symbols of his office; and in his quaint features—so different from those of the dignified abbot whom we have given from the same book—the former seems to have given us the type of a business-like and not unjoyful cellarer.

The *Sacrist*, or *Sacristan* (whence our word sexton), had the care and charge of the fabric, and furniture, and ornaments of the church, and generally of all the material appliances of divine service. He, or some one in his stead, slept in a chamber built for him in the church, in order to protect it during the night. There is such a chamber in St. Alban's Abbey Church, engraved in the *Builder* for August, 1856. There was often a sub-sacrist to assist the sacrist in his duties.

The duty of the *Hospitaller* was, as his name implies, to perform the duties of hospitality on behalf of the convent. The monasteries received all travellers to food and lodging for a day and a night as of right, and for a longer period if the prior saw reason to grant it. A special hall was provided for the entertainment of these guests, and chambers for their accommodation. The hospitaller performed the part of host, on behalf of the convent, saw to the accommodation of the guests who belonged to the convent, introduced into the refectory strange priests or others who desired and had leave to dine there, and ushered guests of degree to the abbot to be entertained by him. He showed the church and house at suitable times to guests whose curiosity prompted the desire.

Every abbey had an infirmary, which was usually a detached building, with its own kitchen and chapel, besides suitable apartments for the sick, and for aged monks, who sometimes took up their permanent residence in the infirmary, and were excused irksome duties, and allowed indulgences in food and social intercourse. Not only the sick monks, but other sick folk were received into the infirmary; it is a very common incident in mediæval romances to find a wounded knight carried to a neighbouring monastery to be healed. The officer who had charge of everything relating to this department was styled the *Infirmarer*. He slept in the infirmary, was excused from some of the hours, had two brethren to assist him besides the necessary servants, and often a clerk learned in pharmacy as physician.

The *Almoner* had charge of the distribution of the alms of the house. Sometimes money was left by benefactors to be distributed to the poor annually at their obits; the distribution of this was confided to the almoner. One of his men attended in the abbot's chamber when he had guests, to receive what alms they chose to give to the poor. Moneys belonging to the convent were also devoted to this purpose; besides food and drink, the surplus of the convent meals. He had assistants allowed him to go and visit the sick and infirm folk of the neighbourhood. And at Christmas he provided cloth and shoes for widows, orphans, poor clerks, and others whom he thought to need it most.

The *Master of the novices* was a grave and learned monk, who acted as pedagogue to the youths in the schools of the abbey, and taught the rule to those who were candidates for the monastic profession.

The *Porter* was an officer of some importance; he was chosen for his age and gravity; he had an apartment in the gate lodge, an assistant, and a lad to run on his messages. But sometimes the porter seems to have been a layman. And, in small houses and in nunneries, his office involved other duties, which we have seen in great abbeys distributed among a number of officials. Thus, in Marie's "Lay le Fraire," we read of the porter of an abbey of nuns:—

"The porter of the abbey arose,
And did his office in the close;
Rung the bells, and tapped tight,
Laid forth books and all ready dight,
The church door he unlied," &c.:

and in the sequel it appears that he had a daughter, and therefore in all probability was a layman.

The *Kitchener*, or *cook*, was usually a monk, and, as his name implies, he ruled in the kitchen, went to market, provided the meals of the house, &c.

The *Seveschell* in great abbeys was often a layman of rank, who did the secular business which the tenure of large estates, and consequently of secular offices, devolved upon abbots and convents; such as holding manorial courts, and the like.

But there was, Foshrook tells us, another officer with the same name, but of inferior dignity, who did the convent business of the prior and cellarer which was to be done out of the house; and, when at home, carried a rod and acted as marshal of the great hall. He had horses and servants allowed for the duties of his office, and at the Benedictine Abbey of Winchcombe he had a robe of clerk's

* "And as touching the almshouse that they (the monks) kept, and the hospitality that they kept, every man knoweth that many thousands were well received of them, and might have been better, if they had not so many great men's horse to feed, and had not bin overcharged with such idle gentlemen as were never out of the abbeys (abbeyes)." A complaint made to Parliament not long after the dissolution, quoted in Coke's Institutes.

cloth once a year, with lamb's fur for a super-tunic, and for a hood of hudge fur; he had the same commons in hall as the cellarer, and £2 every year at Michaelmas. Probably an officer of this kind was Alan Middleton, who is recorded in the



ALAN MIDDLETON.

Catalogus of St. Alban's as "collector of rents of the obedientiaries of that monastery, and especially of those of the hursar." *Prudenter in omnibus se agebat*, and so, deserving well of the house, they put a portrait of him among their benefactors, clothed in a blue robe, of "clerk's cloth" perhaps, furred at the wrists and throat with "lamb's fur" or "budge fur;" a small tansure denotes him as a monastic officer, the penner and inkhorn at his girdle denote the nature of his office; and he is just opening the door of one of the abbey tenants to perform his unwelcome function. They were grateful men, these Benedictines of St. Alban's; they have immortalised another of their inferior officers, Walterus de Hamuntesham, *fidelis minister hujus ecclesie*, because on one occasion he received a beating at the hands of the rabble of St. Alban's—*inter villanos Sei Albani*—while standing up for the rights and liberties of the church.



WALTERUS DE HAMUNTESHAM ATTACKED BY A MOB.

Next in dignity after the obedientiaries come the *Cloister Monks*; of these some had received holy orders at the hands of the bishop, some not. Their number was limited. A cloister monk in a rich abbey seems to have been something like in dignity to the fellow of a modern college, and a good deal of interest was sometimes employed to obtain the admission of a youth as a novice, with a view to his ultimately arriving at this dignified degree. Next in order come the *Professed Brethren*. These seem to be monks who had not been elected to the dignity of cloister monks; some of them were admitted late in life. Those monks who had been brought up in the house were called *nutriti*, those who came later in life *conversi*; the lay brothers were also called *conversi* sometimes. There were again the *Novices*, who were not all necessarily young, for a conversus

passed through a novitiate; and even a monk of another order, or of another house of their own order, and even a monk from a cell of their own house, was reckoned among the novices. There were also the *Chaplains* of the abbot and other high officials; and frequently there were other clerics living in the monastery, who served the chantries in the abbey church, and in churches and chapels which belonged to the monastery and were in its neighbourhood. Again, there were the *Artificers and Servants* of the monastery: millers, bakers, tailors, shoemakers, smiths, and similar artificers, were often a part of a monastic establishment.* And there were numerous men-servants, grooms, and the like: these were all under certain vows, and were kept under discipline. In the great abbey of St. Edmund's Bury, in the time of Edward I., there were eighty monks; fifteen chaplains attendant on the abbot and chief officers; about one hundred and eleven servants in the various offices, chiefly residing within the walls of the monastery; forty priests, officiating in the several chapels, chantries, and monastic appendages in the town; and an indefinite number of professed brethren.

In the Cistercian abbey of Waverley there were in 1187 A.D., seventy monks and one hundred and twenty *conversi*, besides priests, clerks, servants, &c. But it was only a few of the larger houses which had such numerous establishments as these; the majority of the monasteries contained from five to twenty cloister monks. Some of the monasteries were famous as places of education, and we must add to their establishment a number of children of good family, and the learned clerks or ladies who acted as tutors; thus the abbey of St. Mary, Winchester, in 1530, contained twenty-six nuns, five priests, thirteen lay sisters, thirty-two officers and servants, and twenty-six children, daughters of lords and knights, who were brought up in the house.

We should hardly have a complete view of the population of a monastery if we neglected to notice that many of them had hospitals of poor men and women attached to them, generally either within the precincts or near adjoining. Thus at St. Edmund's Bury there was St. John's Hospital, or God's House, without the south gate, and St. Nicholas' Hospital without the east gate, and St. Peter's Hospital without the Risby Gate, and St. Saviour's Hospital without the north gate,—all founded by abbots of St. Edmund's. At Reading there was the Hospital of St. Mary Magdalene for twelve leprosy persons and chaplains, and the Hospital of St. Lawrence for twenty-six poor people, and for the entertainment of strangers and pilgrims, both founded by abbots of Reading. One at the gate of Fontaines' Abbey for poor persons and travellers; one at Glastonbury, under the care of

hospital. From the initial letter of a deed in the British Museum (Harl., 1498), by which King Henry VII. founded a fraternity of thirteen poor men in Westminster Abbey, who were to be under the governance of the monks, we take the accompanying illustration, which represents the abbot and monks before the king, with a group of the king's bedesmen, each of whom has the royal badge, a rose surmounted by a crown, on the shoulder of his habit.

And lastly, there were a number of persons of all ranks and conditions, who were admitted to fraternity. Among the Hospitaliers (and probably it was the same with the other orders), they took oath to love the house and brethren, to defend the house from ill-doers, to enter that house if they did enter any, and to make an annual present to the house: in return they were enrolled in the register of the house, they received the prayers of the brethren, and at death were buried in the cemetery. In the book of St. Alban's, which we have before quoted, there is a list of many persons, knights and merchants, ladies and children, vicars and rectors, received *ad fraternitatem hujus monasterii*; in many cases portraits of them are given: they are in the ordinary costume of their time and class, without any badge of their monastic fraternity.

We proceed next to give some account of the buildings which compose the fabric of a monastery. And first as to the site. The orders of the Benedictine family preferred sites as secluded and remote from towns and villages as possible. The Augustinian orders did not cultivate seclusion so strictly; their houses are not infrequently near towns and villages, and sometimes a portion of their conventual church—the nave, generally—formed the parish church. The Friaries, Colleges of secular canons, and Hospitaliers, were generally in or near the towns. There is a popular idea that the monks chose out the most beautiful and fertile spots in the kingdom for their abodes; a little reflection would show that the choice of the site of a new monastery must be confined within the limits of the lands which the founder was pleased to bestow upon the convent. Sometimes the founder gave a good manor, and gave money besides, to help them to build their house upon it; sometimes it was a tract of unreclaimed land, upon which the first handful of monks squatted like settlers in a new country. Even the settled land, in those days, was only half cultivated, and on good land, unreclaimed or only half reclaimed, the skill and energy of a company of first-rate farmers would soon produce great results; barren commons would be dotted over with sheep, and risby valleys would become rich pasture covered with cattle, and great clearings in the forest would grow green with rye and barley. The revenues of the monastic estates would rapidly augment; but little of them would be required for the coarse dress and frugal rattle fare of the monks; they did not, like the lay land-owners, spend them on gilded armour and jewelled robes, and troops of armed retainers, and tournaments, and journeys to court; and so they had enough for plentiful charity and unrestricted hospitality, and the surplus they spent upon those magnificent buildings whose very ruins are among the architectural glories of the land. The Cistercians had an especial rule that their houses should be built on the lowest possible sites, in token of humility; but it was the general custom in the middle ages to choose low and sheltered sites for houses which were not especially intended as strongholds, and therefore it is that we find nearly all monasteries in sheltered spots. To the monks the neighbourhood of a stream was of especial importance; when headed up it supplied a pond for their fish, and water-power for their corn-mill. If, therefore, there were within the limits of their domain a quiet valley with a rivulet running through it, that was the site which the monks would select for their house. And here, beside the rivulet, in the midst of the green pasture land of the valley dotted with sheep and kine, shut in from the world by the hills, whose tops were fringed with the forest which stretched for miles around, the stately buildings of the monastery would rise year after year; the cloister court, and the great church, and the abbot's lodge, and the numerous offices, all surrounded by a stone wall with a stately gate-tower, like a goodly walled town, and a suburban hamlet of labourers and servants' cottages sheltering beneath its walls.

There was a certain plan for the arrangement of the principal buildings of a monastery, which, with minor variations, was followed by nearly all the monastic orders, except the Carthusians, and, perhaps, the small communities of Augustinian eremites. These latter differed from the other orders in this, that each monk had his separate cell, in which he lived, and ate, and slept apart from the rest, the whole community meeting only in church and chapter.† Our limits will not permit us to enter into exceptional arrangements.

The nucleus of a monastery was the cloister court; it was a quadrangular space of green sward, around which were arranged the cloister buildings, viz., the church, the chapter-house, the refectory, and the dormitory. The court was called the Paradise—the blessed garden in which its inmates passed their lives of holy peace. A porter was often placed at the cloister-gate, and the monks might not quit its seclusion, nor strangers enter to disturb its quiet, save under exceptional circumstances.

The cloister-court had generally, though it is doubtful whether it was always the case, a covered ambulatory round its four sides. The ambulatories of the twelfth and thirteenth centuries have usually an open arcade on the side facing the court, which supports the groined roof. In the fourteenth and fifteenth centuries, instead of an open arcade, we usually find a series of large traceried windows, tolerably close together; in many cases they were glazed, sometimes with painted glass, and formed doubtless a grand series of scriptural or historical paintings; the blank wall opposite was also sometimes painted. This covered ambulatory was not merely a promenade for the monks, it was the place in which the convent assembled regularly every day, at certain hours, for study and meditation; and in some instances (e.g. at Durham) a portion of it was fitted up with little wooden closets for studies for the elder monks, with book-cupboards on the wall opposite for books. The monks were sometimes buried in the cloister, either under the turf in the open square, or beneath the pavement of the ambulatory. There was sometimes a fountain at the corner of the cloister, near the entrance to the refectory, at which the monks washed before meals.

The church was always the principal building of a monastery, many of them remain entire, though despoiled of the shrines and tombs, and altars, and costly furniture, and many more remain in ruins, and they fill us with astonishment at their magnitude and splendour. Our existing cathedrals were, in fact, abbey churches; nine or ten of them were the churches of Benedictine monasteries, the remainder of secular Augustines. But these, the reader may imagine, had the wealth of bishops lavished upon them, and may not be therefore fair examples of ordinary abbey churches. But some of them were originally merely abbey churches, and were subsequently made Episcopal sees, such as Beverley, Gloucester, Christ Church Oxford, and Peterborough, which were originally Benedictine abbey churches; Bristol was the church of a house of regular canons; Ripon was the church of a college of secular canons. The Benedictine churches of Westminster and St. Alban's, and the collegiate church of Southwell, are equal in magnitude and splendour to any of the cathedrals; and the ruins of Fontaines, and Tintern, and Netley, show that the Cistercians equalled any of the other orders in the splendour of their churches.

It is indeed hard to conceive that communities of a score or two of monks should have built such edifices as Westminster and Southwell, as private chapels attached to their monasteries. No, it is not so. This is one aspect of the fact, but it is not the true one; they did not build them for private chapels to say their daily prayers in; they built them for temples to the eternal and Almighty, to whose contemplation and worship they had devoted their lives. They did not think of the church as an appendage to their monastery, but of their monastery as an appendage to the church—the cloister under the shadow and protection of the temple was the court in which its priests and levites dwelt. †

* An account of the arrangements of a Carthusian monastery may be found in a paper on the Carthusian priory of Mount Grace, near Thirsk, which was read by Archdeacon Clouston before the Yorkshire Architectural Society, in the year 1850.

† To be continued.



BEDSMEN. TEMP. DEN. VII.

the almoner, for poor and infirm persons. Thirteen was a very favourite number for the inmates of a

* The following notes will give an idea of the occupations of the servants. At Salley Abbey, at the end of the fourteenth century, there were about thirty-five servants, among whom are mentioned the shoemaker and barber, the prior's chamberlain, the abbot's cook, the convent-cook and baker's mate, the baker, brewer, tailor, cowherd, widgeon, pages of the kitchen, poultry keeper, labourers, a keeper of animals and birds, bailiffs, foresters, shepherds, smiths: there are others mentioned by name, without a note of their office. In the time of William Rufus, the servants at Evesham numbered sixty-five—viz., five in the church, two in the infirmary, two in the cellar, five in the kitchen, seven in the bakehouse, four brewers, four members, two in the hall, two shoemakers, two in the orchard, three gardeners, one at the cloister gate, two at the great gate, five at the vineyard, four who served the monks when they went out, four fishermen, four in the abbot's chamber, three in the hall.

THE ROYAL PICTURES.

ST. LUKE PAINTING THE VIRGIN.

L. Steinhilber, Painter. L. Stocks, A.R.A., Engraver.
Size of the Picture 5 ft. 10½ in. by 4 ft. 4½ in.

An opinion prevails very generally in England, among many who hear of the modern painters of Germany, but are unacquainted with their works, that their usual character is dry, conventional, and altogether unlike those of other countries. This is true to a certain extent only: many of the most distinguished German artists are undoubtedly amenable to this charge; they regard less the manner than the matter of their pictures, and aspire to attain excellence in expression, sentiment, and spirituality, rather than in poetical conception and richness of colouring.

Edward Steinhilber is a native of Vienna. He it is who, with Kupciwieser and Fährich, has a reputation among the most popular German painters of sacred subjects. He studied in his native city till about the year 1828, when he left it for Italy, returning in 1834. During his residence in Rome, where he formed an intimate acquaintance with Overbeck, he commenced a large picture of the "Descent from the Cross," which was not completed till some years after; "St. Ignatius and the Virgin Mary," a work of smaller dimensions; "St. Alphonsus de Liguori," and some others. "One of his most remarkable works," says Count Raczinski, in his "*Histoire de l'Art Moderne en Allemagne*," "is the 'History of Sta Maria, the Egyptian,' in the style of Giotto's 'St. Anthony and St. Paid,' at Campo Santo." On Steinhilber's return to Vienna he painted the "Five Angels of the Apocalypse," "Nathan before David," "Jacob wrestling with the Angel," and "St. Luke painting the Virgin"—a work of the highest quality, fine in conception and execution.

We object to the name which Steinhilber has given to the very charming picture here engraved. If he had adopted some such title as, "One of the Old Painters studying the living models for a picture of the Virgin and Infant Jesus," it would have been more appropriate. Its present title is not a "truth," and therefore would assuredly call down upon the head of the offending artist the wrath of Mr. Ruskin, who calls Raffaele's glorious cartoon of the "Charge to Peter" a "monstrosity and hypocrisy," because the fishermen of Galilee are not wearing the clothes in which they are presumed to have been dressed amid the "sea-mists and on the slimy decks." Steinhilber's picture is even fuller of "mistakes" than Raffaele's. First, St. Luke was a physician, and not a painter; the report of his being the latter originated with Nicophorus Callisti, a writer of the fourteenth century; but it is not known on what authority, and is now justly exploded as destitute of foundation and countenanced by no ancient authority. Secondly, supposing him to have been an artist, it is evident he could not have been acquainted with Mary as a young virgin mother, and with Christ as an infant—for St. Luke went with St. Paul to Rome, A.D. 63, where he remained two years. Again, the accessories show more than one anachronism: the covering of the table is a modern Venetian carpet, and the vase with flowers in it is glass of a comparatively recent date as regards form.

Apart, however, from these considerations, Steinhilber's picture is, as the German critic observes, "a work of the highest quality." The face of the Virgin is exquisitely beautiful, soft in expression, and truly feminine. The child is a lovely representation of infancy: these two figures are skillfully grouped. St. Luke is seen in profile—a fine manly figure, whose head, strongly marked with the Jewish expression of feature, is brought out in bold relief against the sky. The colouring of the work is very rich and powerful. The Evangelist wears a dark green coat, or tunic, over which is a dark crimson robe; the Virgin is clothed in a light greyish-blue robe, beneath which is seen a portion of a scarlet dress; the curtain is rich brown, except that part immediately behind the Virgin, which is red, embroidered with gold; the ground of the table-cover is green, corresponding, or nearly so, with the tunic of St. Luke; and the sky is tinged with the golden hues of evening.

The picture is in the collection at Osborne.

BOARD OF TRADE BUILDINGS
ON THE KENSINGTON GORE ESTATE.

At the close of the Exhibition of 1851, various objects contained in the four sections of raw produce—Manufactures, Machinery, and Fine Arts—were presented to the Commission by their exhibitors and owners. These were temporarily housed in the venerable palace at Kensington, with the exception of the Colebrook Dale gates, valued at £1500—an example, of some mark, of a subject's gift to the Crown, for which an appropriate place was at once found on the south side of Kensington Gardens. The collection thus formed comprised examples of great interest and utility to the public: such as arranged collections from different localities of special materials and vegetable produce, and of novel natural substances offering additions to our materials of commerce; also models of improvements in machinery, and specimens of manufacture, and some few Fine Art works, chiefly, however, illustrative of the latter class. Since the closing of the Exhibition, these have not been available to the public. Partly for the purpose of receiving these specimens under such arrangements as to give the public the full advantage of them, the museum building at the Brompton end of the Kensington Gore estate was proposed, and £15,000 voted by Parliament. This edifice is now enclosed and covered in. Its area is 266 feet by 126; the height being 50 feet in the centre of the three longitudinal arches that, side by side, form the roof. A gallery of a third of the width along the sides, and somewhat less at the ends, at 20 feet from the floor, surrounds the interior, leaving an area in the centre of 210 feet by 42 of the full height of the building. The structure is of iron and glass. From the appearance it presents towards the south, it has been christened by some of our contemporaries "the Brompton Boilers," and with every desire to be favourable, we are sorry not to be able to say anything to mitigate the sarcasm. The exterior has neither novelty nor beauty to recommend it. We hope, therefore, no sacrifices having been made to obtain these qualities, that utility and special aptness for its purpose have been attained in the interior—of which, however, we do not feel confident.

Viewing with great interest the steps taken by the sanction of Government in the development of Art in connection with the substantial interests of the country and general education, we would much rather have to give praise than withhold it; and we cannot but view it as peculiarly unfortunate that the first structure presented to the public at Kensington, by what may be viewed as the Government Department of "Taste," should afford so little evidence of that quality, and that it should not be in advance (to say the best of it) of an average "railway terminus."

We take this opportunity, however, as regards the late progress of iron and glass architecture generally, to express our surprise at the little advance it has made, in an artistic point of view, since its first general use in railway stations, and in the Exhibition building in 1851, notwithstanding that the materials lend themselves readily to the utmost scope of form. When we look, for instance, through the pages of such a work as Mr. Ferguson's "Illustrated epitome of architecture of all climes and times,"—which every artist should possess,—we behold a vast variety of outline, which these crystalline materials might well rival by modified imitation. When we turn from these to our practice, even in the Sydenham Palace, we see but repetitions of the familiar flat roof and transept. Not a minaret or dome of novel or beautiful character rises in the air to vary the sky-line, or give interest to the edifice; and this, although iron and glass possess far greater capabilities for attaining that lightness and freedom of effect usually sought in such enhancements of a structure, than the more ponderous materials at the disposal of the architect of former times. We should be glad also to see stone, and brick, and marble more intimately combined as a style with iron and glass. For instance, although the Kensington Gore Museum might appropriately have had an iron roof and galleries, it should have had a stone front, and at least stone and brick walls. The Sydenham Palace would have been better if more stone and brick and less iron had been used in

its construction, and would then have been in truer harmony with the stone terraces, balustrades, and granite steps which lead up to it. These remarks indicate an apology for the "Brompton Boilers," only in as far as they show that they have companions in their shortcomings. We had much rather, however, have had to point to them as an honourable exception from the general want of progress we observe in this respect throughout the country.

But to return to Kensington:—Besides a selected portion of the contributions presented to the 1851 exhibition, the museum building will afford space for the collection of specimens of ornamental Art belonging to the department, and formerly exhibited, in Marlborough House; also for the newly acquired "Solange" collection, &c.; and we have heard reports of the probability of more than one addition of collections of the highest value in Art to the interest this spot will hold out to the public; but we refrain from placing these before our readers at present, as the arrangements in regard to them are in neither case as yet completed; we shall, however, watch any movements that may occur, and report proceedings for the information of our subscribers.

In immediate connection with the museum building, and however opening out in the same direction, but abutting against the "Exhibition road" (one of the two great ways leading from Hyde Park in the direction of Brompton), the special schools of instruction of the department are being erected. Some of these are mere removals, consisting of apartments originally but temporarily constructed at Marlborough House, and now re-erected identically in their new situations. They consist of class-rooms, store-rooms for casts and examples, lecture-rooms, &c. To these are annexed such additions as improved facilities in Science and Art are hourly affording; and among these is to be a special apartment for photography. The Sappers and Miners (indeed, the peaceful influence of Art) are turning, under "the sword into the rap-book," and make excellent photographers. Clureb, who accompanied Dr. Barth on his journey to Timbuctoo, is now among the corps retained at the new structure—and this is not a bad instance of the readiness the department has to gather round it people of intelligence in various ways.

From what we have said it may be noticed that the buildings of the museum and schools now in course of completion are of a somewhat temporary character, and to be viewed rather as an experimental than a permanent nucleus of arrangement. In one broad regard they claim praise: the policy of the administration being to group in one scheme, and locate together, scholastic instruction with those objects of Art, from the lowest to the highest class, as will best serve to illustrate the various departments to which the student's attention may be directed.

Viewing as a whole the establishment of the Museum and Schools at present forming on a corner of the Kensington Gore estate, it presents itself to us, under existing circumstances, as affording a trial, voluntary or involuntary, of that locality for Art-purposes; and we cannot but perceive that the eventual development, on this site, of the scheme of Art and Science, for which it has been proposed, may be much influenced by the hold the early administration of it may take on the public. We have no doubt that the intelligent heads that have the practical direction of the department are fully alive to this view of the question, and of the importance in this respect of the steps they are about to take. That these will be judicious and energetic we have little doubt. For this they possess the advantage this year of having no Paris exhibition to prevent them from concentrating their undivided attention on the subject before them. Beside, but hand in hand with, the more special and obvious duties of their office, their policy will be, doubtless, to enhance the public interest of their establishment by every legitimate means within their power, and to accustom the public to the association of Art with the locality they now occupy. We have registered our belief in this being the best that has been suggested for the large Scheme for which it was originally purchased; and we have good hopes that the steps to lead the public to fully recognise this will be taken with due thought and discrimination.







THE VISITATION

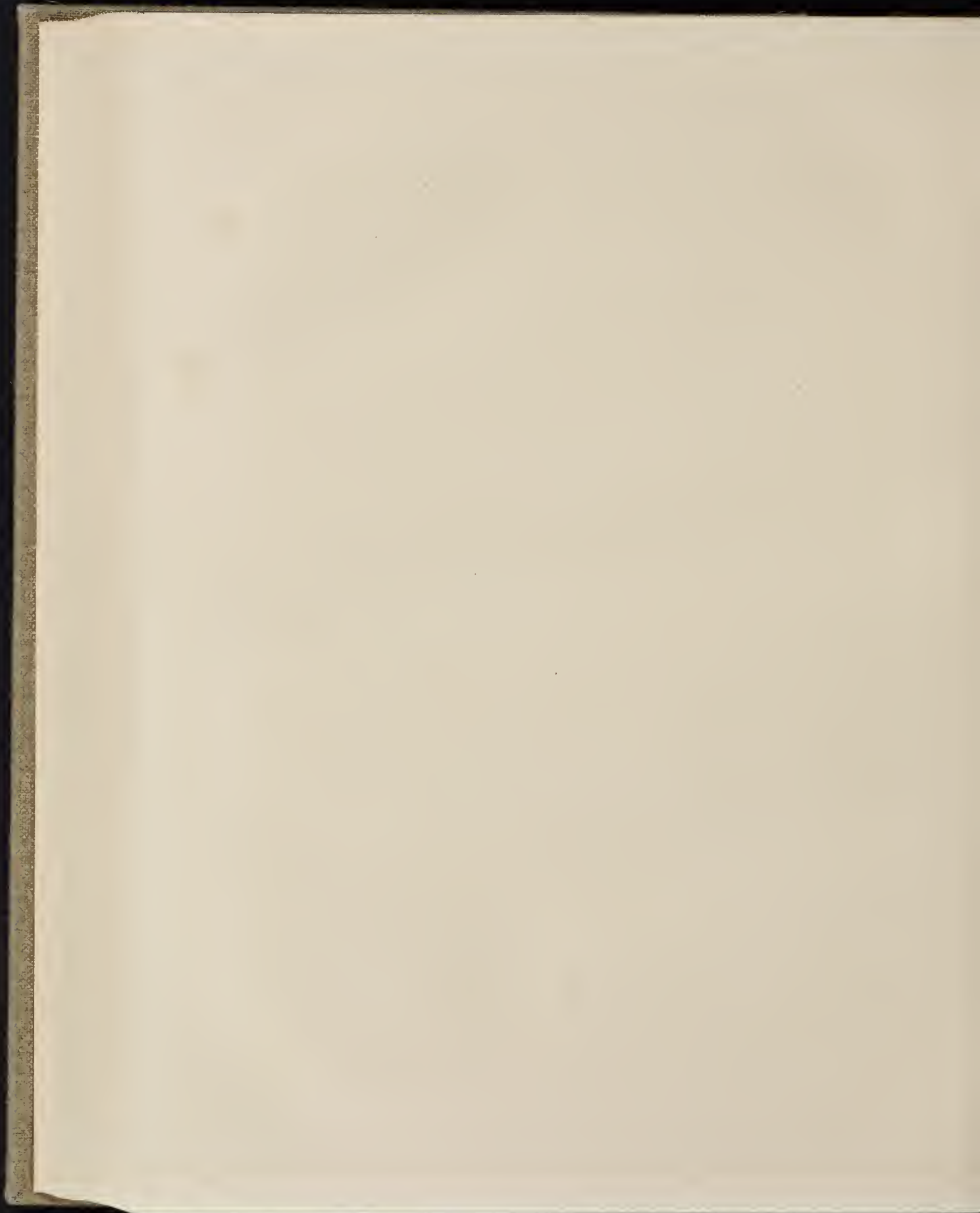

THE CRYSTAL PALACE,

AS A TEACHER OF ART AND ART-MANUFACTURE.

PART V.

We last month made some reference to the Crystal Palace as a means of wholesome and rational enjoyment to the working classes, and expressed a hope that means would be devised thus to minister to their pleasure and instruction. The proposal has been in a measure tested, and with entire success. Early in September the "Early Closing Association," by their excellent and indefatigable secretary, Mr. John Lilwall, resolved upon illustrating the practical working of the "Saturday Half-holiday Movement" (a branch of the Association), by issuing an invitation to all who were thus indulged to meet at the Crystal Palace, and to spend there the afternoon and evening of the day. The result was an assemblage of people approaching twenty thousand; and it was most gratifying to note the good order, steady procedure, and close observation that prevailed throughout the masses thus brought together for recreation. Nothing whatever occurred to disturb the harmony of the occasion: it was an experiment which must be an example—for, while there was ample evidence that all parties were amused, it was certain also that the great purpose of education was at the same time advanced. It is to be recollected, however, that this assemblage was not, strictly speaking, one of "the working classes,"—a large majority of those present were the young men and women employed in warehouses, and shops, and offices in the cities of London and Westminster, and the suburbs of both. But it is on this very account that the meeting is especially cheering. In the early stages of the Early Closing Movement, the great obstacle encountered by the committee—and by Mr. Lilwall, who then, as now, was its earnest advocate—was the argument, generally based on conviction, that if young men were released from labour before nature

became exhausted, the hours placed at their disposal would be misspent, to say the least—perhaps spent in evil company and dissipation. This difficulty it was almost impossible to overcome. Attention was continually directed to the many changes that had taken place of late years, by which young men were afforded opportunities of passing evening hours profitably at societies and institutions, established in every district of the metropolis and throughout the kingdom, and that social habits had become far more rational than they used to be. A concession, alike demanded by policy and necessity, was withheld on the ground that it *might be abused*. Happily this opinion, if not entirely gone, has been materially altered: proof has been had that instead of the young persons who have been released from over toil abusing the indulgence, the hours placed at their disposal have been used to obtain information, rest, or agreeable and innocuous pleasure—pleasure being, we believe, as necessary to life as food or sleep. And the latest fact to be recorded, that of eighteen or nineteen thousand persons meeting at the Crystal Palace without the occurrence of a single instance of broil or even confusion, will go far to remove all doubts that the Saturday half-holiday, and the "closing" at reasonable hours, are hours that may be accorded without the least danger to, at all events, one of the parties interested in the discussion of the subject. To us it is clear that the employer, as well as the employed, will be benefited by a change we confidently expect to be ere long universal throughout Great Britain. But this is not the place in which this view is to be advocated; we may content ourselves with reference to the proceedings at the Crystal Palace on the Saturday evening referred to, as affording inimitable proof that the working classes may be safely trusted to seek for themselves occupations for hours of leisure after labour, and as evidence that in the Crystal Palace the country possesses a teacher more effective for good than any that can be appointed by the legislature.

We earnestly hope the Directors will adopt some plan by which their "school" shall, on the afternoon of every Saturday throughout the year, be placed in a measure at the disposal of young men and women, such as those who studied there on the Saturday in question.

We cannot lay too much stress on the improving influences exercised in every part of this wonderful structure: the gardens, replete with health, are pregnant with instruction; the plants and exotics collected within are of the rarest interest—here are the palm-tree, the cotton-tree, the sugar-cane, the tea-plant, and a thousand other productions of ever-beautiful nature, each one of them an instructor. Birds of various countries are seen in their brilliant plumage; the water contains abundant examples of aquatic marvels—an aquarium, in extent and variety unparalleled in the world, "within doors." The several Model Courts, the Industrial-Arts' Courts, the sculpture everywhere, and especially the Picture Galleries, are teachers of incalculable value at the present moment, when even the very humblest orders are learning something concerning the sources of that pleasure which is derived from beauty, and are gradually acquiring a power to appreciate excellence in Art. On the occasion to which these remarks principally refer, there was no part of the Palace so continually thronged as the Picture Gallery, nor was there any portion of the immense treasure submitted to the gaze everywhere, from which the people appeared to derive so much enjoyment.

The Crystal Palace, therefore, becomes daily more and more a great instructor of the public; and if the nation be called upon to adopt this means of enlightening while gratifying the people, the nation will only discharge its duty by answering such an appeal. There is no way in which a parliamentary grant could be so beneficially expended; and if some member of the House would holdly propose a measure of the kind, we feel assured of its being warmly responded to.



THE FOREIGN COURT, CRYSTAL PALACE.

The Court we introduce on this page is named THE FOREIGN COURT, and it is made in some degree to answer its design:—to which is brought, and

where may be examined, the minor Art-productions of the Continent: of a surety, however, it is not yet what it may become, for its contents are of a very

secondary order—the object being less to show than to sell. Nevertheless, it is well filled with curious and interesting objects—the produce, chiefly, of

Germany and France; and, regarded as a private speculation for profit, the Court is not unsatisfactory.

The Director here is Mr. Holt: it is, we believe, his establishment; and its contents are very varied. To enumerate a few of them:—fauciful inkstands in great variety; jewel-trays; articles in which the "coque de perle" is advantageously introduced; caskets, fitted for work, perfumes, or cigars; jewellery, real and imitative; enamel paintings, mounted as brooches, &c.; flexible band bracelets; carved ivories from Dieppe and Frankfort; the oil-prints of Baxter, and coloured lithographs; scent-bottles; filagree-work; tortoiseshell and pearl-work; writing and card-cases; French and Birmingham bronzes; jet ornaments of all kinds; parasols and fans; leather goods, ornamented and perforated; clocks, toys, perfumery, &c. &c. &c.

It will thus be observed that THE FOREIGN COURT is a "mixon gathering," as perhaps it was intended to be. It is, as we have said, a place for sale, and has been liberally supplied with matters of all kinds that tempt the visitor to carry away a memorial of the visit. But we shall hope to see

mingled with the ordinary articles of trade a better display of those Art-elegancies which, although more costly, cannot fail to find purchasers.

The Court, as will be seen by our engraving, is very elegant: light and graceful in character, and skilfully decorated; a sloping roof contains the names of the several commercial cities and countries of Europe; and altogether it is one of the attractions of the place, which those who enter do not leave without bearing away some remanence of the pleasant day they have passed within the building.

We resume our visits to the CERAMIC COURT.

We have selected for our first illustration a series of the early FLAXMAN-WEDGWOOD WARE, from the large and beautiful collection, comprising some hundred specimens, lent by Mr. ISAAC FALCKE.

The examination of these works will justify the high prices which they now realise. Nothing can exceed their artistic merit, both in design and manufacture; indeed, the latter feature is in some respects quite marvellous. The smaller groups upon the canoes may fairly rank as Art-productions with the finest gems; and those who are aware of the difficulty of executing such works as a *manufacture*

through the ordinary agencies, will duly estimate, not only the high order of the mind to which their conception is due, but the value of the superintending vigilance that could realise so perfect an embodiment. Josiah Wedgwood was the *creator* of all his successes. He found a manufacture devoted to the productions of the ordinary articles necessitated by domestic usage, and these executed in a manner such as was considered suitable to their purpose, and the moderate price of their remuneration. Elevated by the promptings of a superior intelligence, and urged by the facilities which the processes in operation presented, he determined to originate a new field of action, in which the highest capabilities of Art should find scope for ample development. Surrounded only by the ordinary class of workmen of that day, and with the ordinary materials, he applied himself to chemical research, so as to invent and perfect new compositions of pastes and glazes—obtained the services of the illustrious Flaxman for designs and models, and produced a class of work which not only ranks in the highest branch of Art, but marks the proudest epoch in Ceramic manufacture.



GROUP OF EARLY FLAXMAN-WEDGWOOD WARE.

Amidst difficulties which to ordinary minds would have been insurmountable, he created a superiority which is alike the boast of the past and the reproach of the present; and this too without the stimulus of ultimate appreciation, even when perfected. Indeed, it is evident that he did not rely on native patronage, for the catalogue of his finest works was only printed in French for foreign circulation—so hopeless was he of any appeal to home sympathies.

Though meeting, in some respects, much encouragement in England for his ordinary productions, it was abroad that he found recognition and remuneration for those works upon which his fame is based, and by which it will survive as long as pottery exists and Art is valued.

In this collection will be found a large number of his jaspers of various colours—Egyptian red and black, &c.; Vases, including one of the original copies of the Barberini, or Portland Vase; a service of Egyptian red, mounted in silver, formerly in the possession of Queen Adelaide; candelabra, plaques, busts (one life-size of Mercury), canoes mounted as caskets; watches and brooches, together

with a number of specimens of tea-services, &c. &c. We strongly recommend this collection to the examination of all lovers of Art, and especially to those connected with manufacture. The manifestation of a success so marked, cannot but be highly stimulating to those who appreciate the efforts of a refined intelligence allied to commercial industry.

The firm of RINGWAY, BATES, and Co. (Staffordshire) represents a manufactory of long-established position. Its efforts have hitherto been chiefly directed to the class of goods (porcelain and earthenware) in general demand, and to the production of them in a degree of more than ordinary excellence; it may justly claim peculiar acknowledgment. In respect to the *material* part of the manufacture, that is, the quality of "bodies, glazes, colours," &c., this firm is deserving of high commendation, indeed, we may fairly state the very highest. Considerable tact is displayed in adapting these appliances to such efforts as meet a large patronage; but with such chemical and mechanical success as these display, it is a matter of regret that we miss the exercise of a higher order of Art in its productions; and this, we think, is alone wanting to develop

fully and signally the value of the productive resources this house so eminently possesses. The cost incurred in the production of many of the examples exhibited by this firm proves that it does not begrudge expenditure in its aim for improvement, but simply errs in its application. The collection from which we have selected the objects engraved in this group comprises vases, tea, dessert, table, and toilet services in porcelain and earthenware, enamelled and gilt.

MR. W. BROWNFIELD (Staffordshire) restricts his manufacture to earthenware; but this in very excellent material, and in varied styles of decoration, enamelled, gilt, and printed. The class of pattern exhibited is uniformly creditable in arrangement, and in execution very commendable, affording another satisfactory evidence that the manipulative processes of our manufactures are thoroughly understood.

Before concluding our notices of the Ceramic Court, we are induced to give expression to the conviction which examination of the various works it contains has forced upon us, and which our experience beyond its limits fully confirms.

The importance which attaches to a manufacture,

whose exports alone are valued at a million and a quarter, is sufficient to enlist our sympathies, independently of the associations connected with its time-honoured and deeply-interesting processes.

Comparatively few are aware that there are upwards of one hundred and eighty manufacturers of pottery in England, scattered through Leeds, Swausca, Glasgow, Sunderland, Stockton, and North Staffordshire; of which number upwards of *three-fourths* are located in the latter district, in which more than sixty thousand persons are directly employed in this fabrication.

It is remarkable that among so great a number there are so few that have any recognition beyond the immediate area of their operations. Their products are chiefly of a very coarse and inferior kind, for which their utility and cheapness alone ensure a demand.

Though specially an Art-manufacture, evidences that it is so are lamentably restricted; and a very few names will exhaust the catalogue of those who are worthy to rank as its exponents.

It may be argued that this is not exclusively the position of ceramic manufacture, but rather that it is the state of *all* manufactures. To some extent this must be admitted; but the status of a manufacturer in respect to Art must be judged relatively to the facilities it offers for the combination. Now, with none can Art be more cheaply connected than

with that specially under review. The material of trifling value, presenting from its plastic nature facilities of application to forms of elegance, either plain or enriched, by processes as varied as they are rapid—every feature presenting an inviting medium for the exercise of Art-intelligence. We shall allude more particularly to these points as we proceed.

We have already at some length pointed out the value of the productions of Sèvres, Dresden, Vienna, St. Petersburg, &c., which this collection includes—a value we estimate simply from their artistic excellence, for we are uninfluenced in our judgment by the seemingly fabulous sums that attest their commercial estimate. Our manufacturers will do well to study these works, which fully warrant the fame attending their production.

We have also commented upon the eminent works of Minton and Copland, so well represented in their examples here; and also have referred to the revived fame of the Royal Worcester Works, which promises, under the present enlightened proprietorship (Kerr and Binns) to surpass and eclipse the brilliancy of their former triumphs. Still at the same time we must lament that in reference to the higher or even ordinary qualities of Art, how few there are among the great number of English manufacturers who can justly claim an acknowledgment worthy of approval. This arises not from the costliness of Art-application to the necessities of the

manufacture, but simply from want of its appreciation.

Now, as regards form in outline, the regularity and beauty of curve—such as we note in the early Greek vases—is *more easily* attainable as a mechanical result than the disjointed and eccentric shapes which modern pottery so frequently presents.

These caprices are not the results of accident or negligence, but are attained often after a prolonged exercise of perverted ingenuity. They are produced with malice propense and aforethought, as though men had determined to bestow pains upon the creation of ugliness. This could not happen if the manufacturer and artisan possessed that educational preparation which the province of all Art-labour requires from those who would creditably and successfully enter into its field of action; and it is this preparation, resulting in the feeling and expression of Art-intelligence, which so materially enhances the commercial value of the products to which it gives rise.

The pottery to which we have referred, that of ancient Greece, affording examples of marvellous grace and beauty, is, as regards the value of the materials and cost of production, but of trifling and inconsiderable amount: its real value consists in the evidence it presents of the application of classic taste and refined feeling to objects devoted to purposes of familiar and humble requirements. The



GROUP OF PORCELAIN: RIDGWAY, EVANS AND CO.

allotments and subdivisions of labour in England into sections of different branches of manufacture, confining the artisan to a fractional part only of a work, though it facilitates the operation of production, and secures a greater uniformity of executive detail, are a heavy hindrance to his mental growth and intellectual development. The narrowness of the channels to which his powers are restricted materially tends to confine and limit the capabilities of their action. It, therefore, becomes the more imperative that those under whose guidance his efforts are set in motion, and influenced, should be duly qualified for their direction.

That the general standard of English taste must be rated as still lamentably low, even allowing for recent and gradual, though obvious improvement, is a mortifying fact, and to attempt its denial is but to perpetuate the evil we deplore. It "eryeth in our streets," and stares from our shop-windows. If, as is urged, the degree in civilisation of a country be denoted by the class of goods required for export to its markets, then our continental dealers, judging from the worthless trash with which to such an extent they crowd our arcades, bazars, shops, and sale-rooms, and which finds a too ready sale, must indeed deem us in a barbarous plight.

We saw, a few days since, a large importation of French and Saxon porcelain, of so vulgar and offensive a description that we at first doubted the possi-

bility of its being the products of those manufacturers; but we were assured by the proprietor, with much self-satisfaction, that he had been expressly to Paris and Dresden to select the stock, and that it was such as would *exactly suit the English taste*. He had mistaken our surprise for admiration, and we feared his experience was too well grounded to risk a discussion with him.

This fact is quite understood abroad, for during our visit to Paris, in 1855, at the time of the Great Exhibition there, having remarked upon some clocks in ornolu exposed in a shop window at a ridiculously low price and of a proportionally low taste, we were deprecatingly assured by the fabricant that they were expressly manufactured "*pour les Anglais*," who were coming over in great numbers, and would take advantage of their visit to evidence their judgment in the patronage of these examples of the superiority of French Art.

Now, it would be futile to assume that good taste is exclusive, even in France—this is far from being the case, but it is more diffused and more *assumed* than in England. France knows and duly estimates the value which she derives from her admitted superiority in this respect, and whether sharing in that quality or not, her children do not hesitate to lay claim to it as a hereditary right. The remark so often heard from Englishmen, even in educated classes, that they "know little about Art, and care less," uttered rather as a boast than a reproach,

never yet escaped Gallic lips. Assumption, in many instances, it may be, and undoubtedly is, still it becomes a merit—it is a tacit homage to the value of Art itself, and is impulsive, in its general influence, on all connected with its operations. Such a condition of mind at least gives room for hope.

England's manufacturing success, great as it is, depends chiefly upon mere mechanical power and manipulative facilities, and not upon artistic excellence. We submit there is little security in such a position. Mechanical resources are not patent to any particular country, and their application may become as general as policy dictates. As regards the "artisan," also, we would earnestly warn him against a blind dependence on the permanence of any operative process in our manufactures which involves merely *manual labour*. Mechanical science is now so fast supplying the demands of merely manipulative requirements that it is impossible to speculate upon its limits. If, in their own case, the time is past for improvement, still let them at least make provision for a better qualification in their sons—more honourable to their humanity, and more serviceable to themselves and their country.

The greatest successes of which we boast in our Art-manufactures must be attributed to foreign origin. France finds herself fought by us with her own weapons. Artists and artisans, cradled and reared in her ateliers, are transplanted to exert the strength which she has created and strengthened

against its author. The Exhibition of 1851, great and important in its results as it was, proved from this cause quite inconclusive as an evidence of comparative national merit.

There is no weight in the argument that in some branches of manufacture France has sought and obtained help from England's workmen; it is the principle involved that we declaim against, let its exercise be admitted where it may. So long as such means are resorted to, and we are content to shine through borrowed light, we may despair of any innate lustre.

Discrimination in the commercial value of foreign talent and enterprise in offering the means to secure a transfer of its advantages our leading manufacturers may lay claim to, but, with few exceptions, little beyond. Is it not possible for England to realise an original success from her own national resources? Is she ever to remain content with reproductions by French agency, or feeble imitations by her own? In ceramic manufacture she has demonstrated her capability for both these positions. In Wedgwood (the Flaxman-Wedgwood) an original success, alike individually and nationally honourable, was achieved; while our present potters, with a few eminent exceptions, are content to realise the second category.

We repeat that if the practicability of an alliance between Art and manufacture be more intimately and completely demonstrated in one class of industry than another, it is in ceramic productions. Involving the elements of form through a medium presenting special and varied means of decorative

facility, it stands unique in its presentations. For illustration of this fact examine some of the finest works of Sèvres and Dresden—particularly the best modern productions of Sèvres, executed for exhibitive purposes. Now there is nothing mysterious or unaccountable in the marvellous beauty of these works; the means taken are precisely those which must naturally lead to such results, and without which they could not be attained. Reference to the production of one important work will explain what these are. Let us instance that, of the Grand Vase commemorating the Exhibition of 1851, exhibited at Paris last year in the collection from Sèvres, and subsequently presented to Prince Albert by the Emperor Napoleon. By visiting the manufactory during its execution, we became personally acquainted with its progress.

First, we saw the sketches of the primary studies for the composition—light and shade, &c.; then the drawings in tempera for arrangement of colour; and

subsequently, an elaborately-finished painting in oil of the complete work. Now, through these different stages, the work of accomplished and eminent artists, the advantages of enlightened and competent criticism had been secured; so that during its progress it had been submitted to as severe a scrutiny as could possibly await its completion, and thus, before its transfer to porcelain, it was a matured and finished conception.

Can we wonder at the superiority of a work so produced, over the premature abortions which, hasty and inefficient in their primary stages, eventually involve a disproportionate and unsatisfactory amount of labour?—and under this head must the bulk of English Art-products, even of the more pretentious character, be classed.

That the influence of Sèvres has not been so marked upon the French manufacture generally as might have been presumed, we conceive to be caused by the secrecy with which the operations have been carried on. Successful experiments, realised at national cost, should be nationally available. Publicly as to the operation of any new process should be immediate on its perfection; and thus, by advancing the general standard of the national manufacture, would the cost of its attainment be indirectly reimbursed. It is a favourite assertion with those to whom Art is unfeeling, and consequently unappreciated, that such works are not remunerative: this, in some degree, arises from the fact that large sums have been occasionally expended upon the execution of works intended as Art-illustrations, in which the elements of Art have been



GROUP OF DECORATED EARTHENWARE: MR. WILLIAM BROWNFIELD.

outraged through every feature: and because the general feeling has repudiated such perpetrations, the manufacturer exclaims against the want of patronage and public appreciation. Why, they are appreciated—justly appreciated—and condemned. We believe that, directly or indirectly, the production of works in any branch of manufacture of acknowledged superiority to previous achievement in that branch, must exercise a valuable prestige in favour of the general manufacture of the producer, and is not restricted to the mere gain upon that individual work.

In the articles of ordinary manufacture, such a course as that referred to in the production of the Sèvres vase would be superfluous, the decoration suited being of a light and facile character; but experience proves the value of some such preparatory study, even in reference to productions of this class—for it is found that the best Art-worker can do the inferior work in a better style, and at a lower rate, than inefficient hands: this results from a thorough knowledge of his trade giving him a ready and decisive power in lieu of dilatory and besitating weakness.

Though Art-appreciation is lamentably but the feeling of a small minority in England, still it includes sufficient with means to reward those who minister to its enjoyment. The diffusion of wealth in England happily in some degree compensates for the restriction in taste: and consequently, instead of works of Art being scattered generally over our districts, or amongst the members of communities in individually limited numbers, we find them in

special localities, concentrated and absorbed in large and costly collections. The liberal feeling which now generally influences the possessors of these Art-treasures to grant them for public exhibition, and thus extend the elevating influence which such works exercise, will do much for the educational advancement of England. It is the spread of this feeling, and the impulsive action to which it would give rise, that alone is wanting to complete and perpetuate our manufacturing success.

That the French are alive to our manufacturing excellence is shown by the large and increasing demand for English porcelain, notwithstanding the heavy duty and expenses attending its import. This demand, however, is limited to patterns of a very slight character, effected by printed outlines, coloured by women and children. Those which our manufacturers plume themselves upon as of a higher class, find no encouragement there, and for two reasons—first, their merit does not equal their pretence; and next, the price (from this cause) is considered excessive. Art is comparatively cheap in France; it is there a necessity, with as a luxury.

The patronage given to English earthenware at the Paris Exhibition last year amounted to a "range." This pottery, which was under ordinary circumstances prohibited, by a concession of the Imperial Commission was admitted for exhibition duty free during that period. Although twenty per cent. was charged upon sales effected, the French not only bought up the whole available stock, but large orders were also executed during the whole time that the exhibition remained open. The sale of

Minton and Copeland's porcelain has long been very considerable, and within a few days the Worcester manufactory has received large orders, including some thousands of pieces of its famous egg-shell porcelain. Our present superiority in manufacturing excellence over the bulk of the French producers is unquestioned; and it is a matter of sincere regret that indifference to Art appreciation should allow that success—which might be complete and permanent—to remain but partial, and, we fear, temporary.

England must not imagine that other countries will not emulate her mechanical facilities. The improvement in the manufacture of earthenware in France (comparatively of very recent establishment) is most remarkable, and it will ere long enter into important rivalry with our own; let English potters so prepare themselves as to meet it with credit and success. What might not the general operation of such a mind as influenced the great Wedgwood now effect in our ceramic manufactures! Will not English manufacturers more generally emulate this glorious example? With extended and improved resources—with the increased facilities which the advance of Science and Art have placed within our grasp—with a marked improvement in public taste (deficient as it still is), will our manufacturers be content to refer back to the vigorous triumphs of past achievements?—amidst the feeble manities of present incapacity, heedless of the inference which such a position involves, and the result to which it will inevitably lead. Yet too many are content with such a position—conviction may come too late.

THE MANUFACTURE OF PAPER.

THE superior position of man in the scale of created things, is in no respect more strikingly manifested than in the desire which he has ever displayed to convey his ideas to others by material signs.

There is evidence of the exercise of thought in every individual—with a healthful organisation—of the most uneducated of the wildest tribes. Beyond the operations of instinct we constantly find a rude system of induction at work, and, as the result of the advances of man by the aids of sense, we discover the influence of mind in the attempts to give permanence to those truths—or supposed truths, which have been thought out. The great events which have occurred amongst the migratory tribes of men have been recorded upon inscribed stones. The face of precipitous rocks, far beyond the reach of injury by the wilfulness of men, has been carved with legends describing the wars of nations; and on the walls of the tombs of the Egyptians we read the biographies of the dead priests and warriors. The Assyrian temples in like manner record the great adventures of the mightiest hunters, and the most destructive of their heroes.

Pictured story, and symbols of various kinds, the result, even in their rudest form, of much thought, mark in permanent characters the progress of intelligence. The increasing desire of man to record, and to have the means of referring to records, is displayed in the curious inscribed cylinders of the Assyrian and Babylonian people. These appear to have their special histories, and to have been worn, as beads are now worn, on the person, so that the records of the deeds of their heroes were constantly before them to incite to yet more noble achievements. The moulded and impressed tablets are yet another form of record; but these appear to have been employed for the great matters of law and government.

Whether we examine the earliest evidences of man's works which Asia affords, or those rude examples of early civilisation in Central America, the ruin inscriptions of Northern Europe, or the hieroglyphics of the cultivated Egyptians, we must be impressed with two or more facts.

The earliest men thought that deeds had been accomplished by them which would stimulate other men to imitation if they were recorded as examples; and they exerted their mental powers to devise the means of informing the stranger, and those yet unborn who would eventually occupy their place on the earth, that great men had lived, and that noble deeds had been done.

The advance from gravings a sign upon soft clay or on solid stone, to marking the leaves of trees, was easy; but nevertheless it was most important. Men naturally would seek out those plants which yielded, either in the size or texture of their leaves, or of their barks, the best fitted material for their use: hence the discovery of the papyrus, and all the methods by which it was prepared for the use of the scribe. The skins of beasts, too, would offer convenient surfaces upon which, with a properly prepared dye, the signs for ideas could be painted or stained. The history of these discoveries is sometimes written with all the appearance of fidelity; but with the advances of knowledge we are led to believe that they all belong to a much earlier date than that to which they are usually referred. It is not our intention, however, to enter into any examination of this part of the subject. With the accumulation of the records of thought, the value of those records became more apparent, and there was naturally a desire kindled amongst men to possess the stories of the his-

torian and the songs of the bard. Hence the advance to prepared leaves—such as we find in the rolls of antiquity, which have been preserved to us, and gradually from the inconvenient roll to the bundle of leaves, and thus to the bound book.

Vegetable fibre admits of being beaten thin and spread out uniformly—of being deprived of its colour, and smoothed or glazed upon its surface. Thus arose the manufacture of paper, on which we desire to say a few words. With the increased demand for printed and written sheets, the manufacture of paper has become more and more important over almost every part of the world, and every variety of vegetable fibre has been employed in preparing it. The great source, however, of the paper which we employ in our printing operations, and for writing, is linen rags. It would be more strictly correct to say that this should be the source: unfortunately, paper is now largely prepared into the composition of which but little linen fibre enters—and the result will be the comparatively early destruction of many a record which it is important should be preserved.

Let us examine, in the first place, the operations of a paper manufactory, and then proceed to remark upon some of the defects for which it is most important remedy should be found.

Rags are collected from almost all known parts of the world; the Italian beggar and the German peasant furnish much of the material for fine writing paper in England. A large export trade in rags is carried on at Hamburgh and Bremen, from Ancona, Leghorn, Messina, and Palermo. The exportation of rags is almost prohibited in France, Holland, Belgium, Spain, and Portugal; these countries requiring all they can produce for their own paper manufactories. Few persons think of the value of a rag, yet so precious is the waste fragment of a shirt, that strong legislative enactments and prohibitory duties regulate its sale. Rags are, however, obtained, and the operation of paper-making commences. We must first introduce the reader of the *Art-Journal* to a room full of dust and dirt, and bags of rags, in which are a number of women employed in sorting. Each female stands at a frame, which is, in fact, a wire sieve, at one side of which is a knife, placed usually upright. A handful of rags is placed on the wire frame, and they are shaken to and fro to free them from dirt. They are then cut into pieces about three inches square, and thrown, according to their quality, into one of three compartments, which are on the right hand side of the table. All the seams are placed by themselves, as the threads require more grinding to reduce them to a pulp than the other parts—buttons, hooks, &c., are all very carefully removed. When properly cut and sorted the rags are packed in bags, each containing one hundredweight, and sent to the washing shed. All dirty and coloured rags are placed in large tanks with lime, and boiled, usually by admitting steam under pressure into the bottom of the tank: by this the whole is kept in a state of violent agitation for some time. After this boiling operation the rags are removed to the washing-engine; or, if the rags are already white, they pass to the washing engine without the previous boiling. The washing-engine is a trough about ten feet long, four or five feet broad, and two or three feet deep; it is made of wood and lined with lead; in this is fitted an iron roller, with bars or knives projecting radially about an inch. The roller is set in motion, and one hundredweight of rags are put into the trough, and as much water as will raise the whole to within an inch of the brim. Beneath the armed cylinder is a plate with knives of the same kind as those on the roller. The revolutions of this roller, which are about 160 a minute, carry the rags with

great rapidity through the knives; and as the roller is depressed upon the plate, or elevated, so are the rags drawn through and cut or bruised. Adjusted above the roller is a cover, in which are frames of wire-cloth, communicating with the pipes through which the water is supplied. The mass having been agitated for some time is carried up an inclined frame, and subjected to the action of a stream of clean water, at the same time as all the foul water is carried off by another pipe. By this operation the rags are cleansed and bruised down. When they are sufficiently white they are removed to a press for the purpose of squeezing out the greater part of the water which remains in the mass. Foreign rags commonly, even after this operation, retain some colour—the mass having the appearance of brown holland. To free this of colour bleaching operations are had recourse to; these are purely chemical operations, depending chiefly upon the action of oxygen on the colouring matter. The rags are removed to a wooden chamber in a moist state; this chamber, from which all air is excluded, is connected by pipes with a retort in which chlorine gas is generated. The black oxide of manganese, common salt (*chloride of sodium*), and sulphuric acid are mixed together, and heat is applied. In this process the chlorine is liberated, and this intense yellow gas passes into the wooden chamber: here it meets with water in the moist rags, and it seizes immediately upon the hydrogen of the water; the oxygen, in its nascent state, combines at once with the colouring matter and destroys it. The operation of bleaching requires great care, since there is a liability to destroy the linen fibre by the action of the acid. It is important, too, that every portion of chlorine should be removed from the linen pulp, and this is more difficult than at first appears. All porous or capillary bodies have the power of holding with great mechanical force gaseous bodies in contact with their surfaces. Many kinds of paper pass into the market from which the chlorine has not been entirely removed, and if any of the photographic processes are carried on upon such paper, or even if used for water-colours, it becomes apparent by the chemical action which is set up. In some cases the hyposulphites of lime and soda are employed as bleaching agents, and also the sulphites and sulphurous acid. Papers so bleached very commonly retain traces of sulphur, and blacken any of the salts of silver spread upon them. The object in view is to produce absolute whiteness in the fibre employed: any of these chemical bodies will effect this; but great care is required in the subsequent washing processes to cleanse the pulp thoroughly. This washing free from the chlorine gas is effected in the washing-engine already described. From this the rags are passed into the heating-engine, which nearly resembles the washer, but that the knives on the roller and plate are put much closer together, and that the roller is moved with much greater rapidity. Having been subjected to this action for several hours in this machine, the rags assume a beautiful pulpy appearance, like thick milk or cream, and it should be perfectly free of colour.

For many of the common varieties of paper the size is now added. The size is some gelatinous matter, usually prepared from sheepskins, or the refuse pieces of the tan-yard. For the finer kinds of writing paper the size is applied after the sheet is made.

From the heating-engine the paper pulp is conveyed to a large circular vessel, which contains several enginesful; this is technically called *stuff*. This is kept uniformly suspended by means of an agitator, which constantly revolves in the vessel. From this vessel a stream of this fine paper pulp is constantly flowing through a cock into the *vat*, which is thus

always maintained at a uniform height. A portion of the pulp now flows upon a wire frame, which, being connected with a crank movement of the engine in large manufactories, is constantly shaken; this wire frame is called a *sifter*. Having passed through the sifter, the pulp flows still onward to a ledge, over which it falls in a regular stream, like a sheet of water over a smooth dam. Here the pulp passes upon a plane surface of five or six feet in length, upon which it spreads out as a very uniform sheet. This plane surface is constantly moving onward, and uniformly shaken; it is, indeed, an endless web of the finest wire gauze.

The pulp as it passes on, by the motion of the web, becomes more and more solid, but it still retains much moisture and remains soft. Before the paper passes off from this web of wire, it moves under a wire cylinder which presses upon its surface, and now leaves a succession of lines on the paper, marking its passage; it then passes under another cylinder, which is clothed with felt, and kept constantly moist by a stream of cold water. A tightly-stretched surface of flannel advances towards the plane of wire, and receives the sheet. It passes gradually over the flannel, and this absorbs much of the moisture which still remains; two rollers now seize it, and the paper is powerfully squeezed between them. It passes over another plane of endless flannel, and then through another pair of rollers. From the last pair of pressing-rollers the paper is received upon a small roller, which guides it to a large heated cylinder; from this it passes on to another yet hotter, and having a finely-polished surface. From a third cylinder, upon which it is subjected to the pressure of a blanket, the paper passes to the fourth and last heated cylinder, upon which it is perfectly dried, and from this it is handed to the *reel* as finished paper.

It will be evident that the process, from the vessel full of pulp into the formation of a complete sheet of paper, is perfectly continuous. From the commencement, when the pulp flows out of the vat upon the web of the wire, till the paper into which it is formed is received upon the reel, somewhat less than two minutes of time is occupied. A supplementary machine receives the paper from the reel, and as it mounts upon the drum, a circular knife cuts it into two breadths, while a series of sharp teeth which strike against it within, divides it, by a stroke of invariable regularity, into the requisite length.

The sheets of paper, completely formed, are taken from the machine-room and subjected to a very careful examination. This is usually performed by young women, who remove every knot or speck in each sheet, and reject those sheets which are seriously defective. These sheets are next subjected, in their full size, to a powerful hydrostatic press, and the edges are cut by the action of a knife called a *plough*. The open sheets are now counted into quires of twenty-four sheets, folded, and packed in reams of twenty quires.

Hand-made paper is regarded as being in many respects superior to that made by the machine. The only real difference is that the frames are covered with the pulp and shaken by the workman, who has thus an opportunity of examining each sheet in its progress. When paper is made without size, it is necessarily very absorbent—such is our ordinary blotting-paper. To such paper the size is now applied—gelatine, starch, and resin are severally employed by different manufacturers; the most celebrated of the French paper-makers employing starch for their finer varieties of paper.

Writing papers of fine surface are now sold at very low prices. Many of these kinds will be found to absorb the ink very rapidly notwithstanding the hard polished surface which gives the paper its fine appearance. Into the

pulp of such paper large quantities of the white China clay are introduced, and thus weight and body are obtained at the sacrifice of durability; such paper must fail completely in a few years. Many of the ordinary dandy papers, which are used for printing upon, have in the same way body and weight given to them by China clay, or lime. This cannot be regarded in any other light than a fraud: it is true that the manufacturer has been led on to this practice by the demand for cheap paper, and the increasing cost of the vegetable fibre which is employed in the manufacture.

Every person will be familiar with the rice-paper of the Chinese, and with an Indian paper which is very full of straw in fine particles—indeed, some of our own commoner papers exhibit a similar character. These varieties of paper are named solely to lead to the explanation that the barks of the lime-tree, the hawthorn, the aspen, the beech, and the willow may be—indeed, have been—used to make paper. The tendrils of the vine, the bines of the hops, the stalks of the nettles, the mallow, and the thistle make tolerably good paper, and several patents have been taken out for the manufacture of paper from straw. Any fibrous substance, indeed, may be employed for this purpose.

The coarsest materials, since the improved bleaching processes have been introduced, are, however, now employed in the manufacture of paper. Cordage, coarse canvas, and similar substances can now be used.

In the manufacture of the fine varieties of drawing-paper, extra care is of course taken to ensure uniformity of composition and excellence of colour. This is especially the case in the paper prepared for receiving fine engravings, and such as is used for water-colour painting.

In connection with the manufacture of such papers there exists, however, a very serious defect, demanding a close and careful examination. We have lately seen some of the finest impressions of Landseer's pictures which are completely destroyed by the appearance of yellow spots upon every part of the sheet. One of the finest large paper copies of Audubon's "Birds," to which attention was lately called, was found to be spotted in this way over every part—in many of the plates the beautiful colours giving way before those gradually increasing spots. This condition appears to be more readily brought about in a humid climate, or under the influence of a saline atmosphere—as near the sea—than in the midland counties of England; but even in the metropolis this diseased condition very frequently manifests itself.

We are disposed to believe these spots to be the result, in the first place, of a decay—a perfect decomposition of the size employed—which furnished the soil, as it were, for the growth of some of the microscopic fungi. The disease is often generated at the copper-plate engraver's, before the print passes into the hands of the public, by allowing the sheets damped for printing to lie together for some time. We have seen a parcel of engravings through the whole of which the spots have generated with curious uniformity.

In many instances it would appear that gelatine has been employed as a size, when it has already become somewhat putrescent. The chemical change rapidly goes on after its application to the paper, and thus, through want of care on the part of the paper-maker or of the copper-plate printer, the purchaser of expensive prints and of illustrated books is exposed to the annoyance of seeing the objects of his admiration, obtained at much cost, gradually but certainly perishing.

The remedy for this is the use of perfectly pure materials, and a process for consolidating the gelatine, or the size employed, so that it may resist the action of moisture. When the

spots are forming they may be checked by passing an iron, which is not quite hot enough to scorch the paper, over the face of the print. If the sheets are separate, and the stains are very bad, we can, if there is no colour liable to receive injury, sponge the print with a solution of the bichlorate of potash, and then dry it off with a hot iron.

When we remember the value which we attach to the books of antiquity—when we are daily reminded of the importance of possessing editions of books which have been subjected to the revision of the author himself, the importance of manufacturing, for printing purposes, paper of the finest quality, consisting entirely of vegetable fibre, and in which a *size* of the best character has been used, cannot be too strongly urged.

The great error of our age is that we are satisfied too easily with appearances—anything looking good is received without examination; and provided the *seeming good* can be obtained cheaply, we care but little about the final result. In the article paper, equally with everything else, this holds true. Let us hope that, since attention has been directed to the sad defects of adulteration and of carelessness, an improved condition of things will arise.

R. HUNT.

ART IN THE PROVINCES.

MANCHESTER MECHANICS' INSTITUTION. — We have but a limited report this month to make of the progress of the Mechanics' Institution; the catalogue of pictures is not yet "ready" or was not in time for us to avail ourselves of its information. There have been, however, numerous additions—hence, we imagine, the cause of the delay. The Art-industry collection has also been considerably augmented; and we believe the exhibition may now be described as complete. We shall probably be enabled to give further details in our next number. Meanwhile, we understand, the people of Manchester have responded to the call thus made upon them: so it ought to be; for the gathering together of so many rare Art-treasures was a serious labour, but one which could not fail to be extensively useful.

The "Free-trade Hall" of Manchester has been opened; it is a structure of exceeding beauty, admirably adapted to the purposes in view, and confers high honour on the architect. We hope to describe it hereafter.

It is proposed to have an exhibition of the works of artists born or resident in this locality, to inaugurate the new wing of the Museum, Peel Park, Salford: a meeting was held on September 18th in furtherance of this object, at which many influential gentlemen and artists, connected with Manchester and its district, were present. Resolutions to carry out the project were unanimously passed, and Mr. Hammersley, the head-master of the Manchester School of Art, was elected chairman of the committee. The exhibition will probably open on the first Monday in March of next year. Artists are to be at the expense of forwarding the pictures they intend to exhibit, the committee undertaking to insure the works, and to return them free of cost. Pictures by deceased artists will be eligible for admission; these will be collected at the expense of the committee.

BIRMINGHAM.—The Exhibition of the "Birmingham Society of Artists" opened in September last. We have had no opportunity of visiting it, but the local papers speak of it as containing 450 pictures, a large majority of which are landscapes; the portraits are fewer than ordinary. The contributions of metropolitan artists are neither numerous nor of the highest order; the pictures by local artists are considered a decided improvement upon those in former exhibitions.

GLASGOW.—The paragraph we published last month respecting the projected glass-painting for the windows in Glasgow Cathedral appears to have been in some respects incorrect, although we procured our information from what was considered a reliable source, and a similar statement was published both in the London and the Glasgow papers. We are requested to say, that the Lord-Provost of Glasgow entirely disclaims the unauthorised use which has been made of his name, so far as regards his application to Mr. James Ballantine for designs for the windows. At the close of the last meeting of the Committee appointed to report generally

upon the style, subjects, and the best method of securing good artists to execute the windows, the Lord-Provost stated that "his name had been thus used without his sanction, by parties writing to the newspapers, and putting forward their particular views and wishes for employment. He desired to take this public opportunity of stating that this had been done, not only without his sanction, but in the face of his express desire to the contrary. He felt certain that it was the unanimous feeling of the subscribers to keep the field open: it was open—and he trusted that it would be kept so, till the subscribers had time to make up their minds how to secure a first-rate series of windows—works of Fine-Art, and worthy of the cathedral and of this great city."

CHELTEHNAH.—Mr. H. R. TWINGING exhibited at the recent meeting of the British Association at Cheltenham, a series of models to illustrate a new method of teaching perspective. The object of his communication was to explain the principles of perspective in such a manner as might enable those who draw to distribute their objects, not only in a correct manner, but in one agreeable to the eye. It is an intermediary step between those rules which are demonstrated by diagrams in the usual treatises, and those appearances which characterise natural objects themselves. The chief difficulty in enabling an audience to follow out the principles of perspective, when applied to solid objects, is that every individual sees them from a different position, so that such an explanation of the effect observed, as is adapted to one individual, cannot suit another. Mr. Twinging's method aims at overcoming this difficulty, by placing a bust or image (with which each individual is supposed to identify himself) in the exact spot which the observer ought to occupy, and which thus serves to mark the true focus of the picture.

GLONNEL.—A conversion of the friends and supporters of the Civil Mechanics' Institute has been held for the purpose of witnessing the distribution of the Osborne prizes to students of the school in the Mechanics' Institute, and which is under the management of its committee. At the opening of the school, in November, 1854, the inaugural address was delivered by Ralph Osborne, Esq., M.P., to the effect of which on the community the present prosperity of the school is in an eminent degree to be attributed. The prizes in question were purchased with a sum of £20, which Mr. Osborne placed at the disposal of the committee for that purpose the first year, but in consequence of the absence of merit in the students, who had all commenced the study of Art at the opening of the school, the award of prizes was deferred till the present season. The report of the examiners, Messrs. George J. Gould, R.M., and Thomas Seally, M.D., was highly complimentary to the master of the school, Mr. J. Healy, for the marked progress in the students' works, and it also commended the care and attention of the pupils. We learn that the names of Messrs. Robert Malcolmson, Joseph White, and John Bagwell, Esqs. (all local gentlemen), have been put down for the sum of £20 each for the same purpose during the next three years.

YARMOUTH.—Have the gentlemen of the county of Norfolk, to say nothing of the gentlemen of England, lost all recollection of the deeds of their heroic Nelson, that they permit the monument erected at Yarmouth to fall into absolute ruin? Such, we understand, is the fate to which it is destined, and which it seems would long since have befallen it, had not the old Trafalgar seaman, James Sharman, who "shows" the monument, expended no small amount of his earnings in keeping it in some kind of repair. How much of national disgrace, but of individual honour, is recorded in this fact! Sharman, says the *Bury Post*, would not ask the country for a farthing towards preserving the memorial, were it not that his income from exhibiting it has been lately so reduced that the receipts have not sufficed for the maintenance of him and his family: he was one of the sailors who carried the dying Nelson into the cockpit, after he had received his fatal wound. In this age of statues and testimonials, cannot a hundred or two pounds be collected to repair the Yarmouth Monument?

YORK.—Mr. J. C. Swallow, head-master of the York School of Art, delivered, on the evening of September 24th, a lecture, principally to the working classes, on drawing and painting. We may remark, to the credit of Mr. Swallow, and to show his desire to inculcate a knowledge of Art among mechanics and artisans, that he has established a class gratuitously for their benefit, in the hope that when they have learned the elements of drawing they may afterwards be induced to enter the regular classes, on payment of the usual fees. Such an act is worthy of being made known and imitated.

GOG AND MAGOG.

GUILDHALL AND ITS MONUMENTS.

LET not Gog and Magog be considered as foreign to Art. Are they not coloured sculpture? Endued, too, with a vividness and variety of tint sufficient to satisfy the most polyeromatic of the polyeromatic school! May it not even be held as strange that in the vexed question of coloured sculpture they should never have been brought into court? Are they not at least as successful as the coloured Parthenaic frieze in the Crystal Palace? Perhaps some dreadful people may be found who think them more so—inasmuch as colours may be held to be in better accord with their grotesque art than with the purer images of the Greeks! But let that rest. We have a great respect for these time-honoured warders of Guildhall—not only for their art, which, in their grotesque way, is good, but as representatives of the city of London, which has of late been doing more for the Art of Sculpture (to which we suppose the giants hold themselves to belong) than any other institution, body, or locality. Sixteen marble statues (of poetic subjects, too—hear this, O West End!) have been voted by the Corporation for the Egyptian Hall, in the Mansion House, at the cost of £11,200, of which twelve are either executed or in hand. Also the Wellington Memorial, in the Guildhall, the whole expense of which, including the prizes given away in the competition, will not, we suppose, be under £6000, and an admirable bust of the Queen (by Durham, for the Council Chamber, presented by Alderman Sir Francis Graham Moon, Bart.—and all this within three years! The east side of Temple Bar is setting an example which we should be glad to see the west follow. *Apròpos* of this, the other day the Office of Works, before they sent forth their own specifications for the Government tribute to the Great Duke, to be erected in St. Paul's, applied to the Corporation of London to know the steps they had taken in conducting their "Wellington Competition." Is not that a feather for the caps of Gog and Magog?

But to return to these personages. Their early history, like that of other half or whole divinities, is somewhat shrouded in obscurity. Hatfield, in his new view of London, which bears the date 1708, speaking of Guildhall, says:—"This stately hall being much damaged by the unhappy conflagration" (the Great Fire of London) "in 1666, was rebuilt anno 1669, and extremely well beautified and repaired, both inside and out, which cost about £2500, and adorned with two new images of gigantic magnitude, as before." They next appear in history on the 24th day of April, 1685, as taking part in "an high entertainment of wonderful and stupendous fireworks, in honour of the coronation of James II. and his queen, being placed on a raft on the river opposite Whitehall, in front of a huge pyramid of fireworks, the display of which lasted an hour." This seems to witness to the honour in which they were held at this time, inasmuch as so great an occasion was not considered complete without their presence. Such regard, however, appears not to have been universal, or, at any rate not lasting, for their next mention in print is not of the same character. This occurs (we quote from Hone's "Mysteries") fourteen years after the above date, in Ned Ward's "London Spy," published in 1699, in which we are grieved to say the Giants are not treated with becoming respect; but we insert the passage, were it only to show what Goths there were in those days! Describing a visit to Guildhall, he says:—"We turned down King Street, and came to the place intended, which we entered with as great

astouishment to see the Giants as the Morocco ambassador did London when he saw the snow fall. I asked my friend the meaning and design of setting up these two lubberly preposterous figures."—"Procul este profani!" we claim—"for he supposed," he continues, "they had some peculiar end in it. 'Truly,' says my friend, 'I am wholly ignorant of what is intended by them, unless it were to show what great boobies their forefathers were, or to fright stubborn apprentices into obedience to their masters, for fear of having to appear before them, and my Lord Mayor, and the Chamberlain of London—for some are as much in awe of Gog and Magog as little children at the terrible sound of Rawhead and Bloodybones.'" It was on this account, no doubt, that we are told that "by Gog and Magog" was a favourite city oath in those days. In later times even, it was a luddite city myth that they always came down when the clock struck noon, to eat their dinners, as behoved city magistrates; and it is only since their last removal from their then position in the hall to one less prominent, which took place in 1815, that taking it in dudgeon, they have refused to eat their meals, or the story has lost credence. Further, William Hone, *logarithm*:—"Until the last reparation (speaking of the hall), the present Giants stood with the old clock, and a balcony of iron-work between them, over the stairs leading from the hall to the courts of law and the Council Chamber. When they were taken down in that year, and placed on the floor of the hall, I thoroughly examined them. They are of wood, and hollow within, and from the method of joining and gluing the interior, are evidently of late construction, but are too substantially built for the purpose of being either carried or drawn in a pageant."

But we have gone on a great deal too fast. The present Giants, as we have seen, and of which Hone speaks as having stood at the west end of Guildhall, on each side the window, are not the original Simon Pures—far from it. It appears, indeed, that "Giants" partake of the nature of the Phoenix, and are periodically reproduced from their ashes. Thus the "giants" of Ned Ward are not the giants of William Hone. It appears that the artist of the present images was a certain Captain Richard Saunders, who dwelt in King Street, Cheapside, and was an eminent carver; and farther, that they were set up in Guildhall, about the year 1708, in the room of the two old wickerwork giants, which had formerly been carried in processions, and which, it is believed (we quote Mr. Josiah Temple), were first used at the restoration of Charles II., when they graced a triumphal arch erected on that occasion at the end of King Street. We must not, however, pass over a rare old book entitled "The Gigantic History of the Two Famous Giants in Guildhall," that goes back a vast deal farther than this. It affirms that Gog and Magog are corrupted names, and that their original titles were *Corinorus* and *Gogmagog*, who were both brave giants in the good old days of King Arthur; that they were great in virtue and honour as well as inches (the giants are each fourteen feet high). They were also loyal good citizens, and deeply attached to the "vested rights of their town;" and their images thus appropriately came to be placed in Guildhall, as representatives of sturdy civic valour and magnanimity. Somehow or other, it appears that the name "Corinorus" slipped out of the category altogether, as savouring too much, perhaps, of Roman domination; and that of Gogmagog, being thought long enough for two, was accordingly split with an uneven stroke, and *ecce* Gog and Magog. It may be as well, however, here to emphasise that both are representatives of *gentlemen*, for it has been held that one is a *lady*. This is a vulgar error. Were it not so, however, and were they really

man and wife, as some visitors have supposed, it might not be difficult to continue the family tree, inasmuch as in the late alterations in Guildhall, in excavations for the new law courts, and turning the crypt into a kitchen, a wooden image has been found of questionable parentage, which might be well fathered and mothered upon the giants in question. The "babby," in that case, would no doubt become an object of especial and legitimate interest in the city.

But, to return; the expression, "there were giants in those days," gives us a great idea of the antiquity of "those days"—perhaps the greatest possible. Therefore it cannot be expected that we can fix the date when Gog and Magog first appeared on the civic scene. It must have been, indeed, a long time ago—does not every one look upon them as part of the "institutions of our great metropolis?" For ourselves, we confess we look upon them as another "palladium," obnoxious to ruthless reformers, who will have, some murky night, perhaps in the small hours after a civic feast, surreptitiously to steal them away, or they will never *take the City!* As regards, however, images in general, gigantic or otherwise (removable, of course, too, as these were of old), it is evident that they formed important features in the earliest pageantrics and solemn festivals of our forefathers. In 1599, Henry Hardman, a mayor of that year, from religious motives censored "the giants" in the midsummer's show to be *broken*, and the representation of the "Devil in his feathers" to be done away with! (In this is evident the evils that even giants may suffer from getting into bad company) and instead, he provided a "man in complete armor" as less objectionable. That the institution of giants was, however, in some degree, even at that iconoclastic time, fostered and respected, is evident from an account extant of charges for the Chester pageant, for arsenic to put in the paste requisite in the construction of these images, so as to save the giants from the rats! Long may they live—that is, not the rats, but the giants—and if they may not quite agree in character with their marble brethren in the same apartment, at any rate they may claim the right of first possession. "First come, first served," is an adage they might appeal to, which, however, does not appear to have great force in the hall at present. For the monument to Alderman Beckford is for a second time removed. We have seen an engraving representing him as he formerly stood, in the centre at the west end of the hall. Of late years he has bowed a welcome to all as a pendant to the Nelson Memorial, and now he has just again blandly shifted his quarters to make way for the "Iron Duke." For this, however, the judgment of the Corporation will "moult no feather." Though Nelson ended his career at Trafalgar before the commencement of Wellington's successes in the Peninsula, yet history will ever look upon them as brother heroes, who in their different services, during the same war, repelled the tide of iniquitous aggression. The City have availed themselves of this parallelism, and emphasised it into an Art fact as well as an historic fact. This association of these heroes will combine these two central sculptural decorations of their hall into a kind of united service memorial, aesthetically true as regards the period and characteristics of the two men. And where else has this been done? Trafalgar Square *should*, as we have often before said, have had two monuments, one to Nelson and one to Wellington—one on either side, where the two fountains now are, and no pillar in the centre to block up the centre approach: but it can't be done now. In St. Paul's also, where the mortal remains of the two heroes lie, the memorials will not pair. If this parallelism is a

valuable feature for Art as well as history, why then all honour to the Corporation, and may they go on and prosper in their views of Art-encouragement.

But now we have something to say about the hall itself. It is a Gothic edifice with a Greek roof. We are not at all prepared to praise *this*. The roof, however, is fortunately *temporary*, and it is quite time for its *tempus* to end. We know that the architectural movements in the locality are regulated by a mind of great taste, and of a liberality that will excuse our suggesting that the appearance of the great festive hall of London would be vastly improved by a light from above by means of a Gothic roof (perhaps of iron and glass, but we won't commit ourselves to this), and an encaustic tile pavement of bold pattern and solid colours. The fact is, the hall wants a better light, and it wants colour. The latter not all over like the interior of St. Denis or La Sainte Chapelle, but here and there on the walls, and especially in the floor; the very stones of which, broken and uneven as they are, cry out for redress, or rather, we would say, for removal. The length of the hall is 153 feet, the breadth 50, and the height 55.

As it may be of interest to some of our readers, we subjoin some particulars, of cost especially, connected with the memorials to distinguished personages that decorate the hall. The expense of erecting that to the Earl of Chatham, by Bacon, in 1782, was £3421 4s. The inscription was by Burke. That to the great earl's great son, William Pitt, by Bubb, in 1813, cost the City £4078 17s. 3d. The inscription is by Canning. That to Beckford, which has just been removed to the arch to the west of that occupied by the Nelson cenotaph, was executed by Moore in 1770; but there is no record of its cost. The sole inscription on this is a speech to royalty, once made by this worthy alderman in the good old days of George III., which, we fear, would make Mr. Thackeray place him among his "snobs." The last on the list of memorials is the tribute to Admiral Lord Nelson, which was completed in 1810 by Mr. James Smith, at the cost of £4442. The inscription is by Sheridan. It is to be regretted in this memorial that it contains no portrait of Nelson, except a medallion—held, too, by Britannia, with the jealousy of true affection, in such a position that no one can see it but herself! A memorial thus treated rather suggests "Hamlet without the prince;" but with this exception it must be held to be satisfactory, as it possesses all the legitimate adjuncts of such naval tributes—for instance, Britannia, also her lion, and Neptune, and a figure engraving the achievements of the hero on his tomb.

The cost of these memorials strike us as small compared to parallel works in other situations; as, for instance, for that to Rodney in St. Paul's, which is not larger than the smallest we have enumerated, £6000 was paid to Rossi, R.A. Against this, however, we may place the sun paid to the late Sir F. Chantrey by the Corporation for the single statue of King George III., in the Council Chamber, in Guildhall, which we find recorded as having been £3089 5s. These discrepancies in price suggest that advantage might arise from some more definite rule prevailing in this respect. Certainly, as it is, some works of sculpture are paid too much for, or some too little. The results are, in neither case, advantageous to Art. Might not this afford a subject for consideration by our Institute of British Sculptors?

The City of London, as we remarked in the beginning of this article, is setting an example of liberal and judicious expenditure upon the art of sculpture, which we trust will not be lost either on the Government or on the wealthy provincial corporations which have the means of "doing likewise."

SUNSHINE.

FROM THE STATUE BY J. DURHAM.

FLAXMAN, in his sixth lecture, observes, "The sculptor must not forget that his art is limited, in comparison with painting; colours and their effects are beyond his bounds; whether the act he represents was performed in the bright mid-day sunshine, or the darkness of midnight, concerns him not—his forms must be equally perfect. Even in bas-relief, a tree or two, some rude stone, or a wall slightly marked in the background, must indicate a forest, a mountain, or a palace, without detailing a portrait of their component parts." With such restricted powers, as regards design or composition, a work of sculpture that offers to us an original idea must ever invite attention and command respect, even when the execution or carrying out of the idea might probably scarcely justify it. Originality in Art evidences thought, study, independence, and self-reliance; he who seeks it looks away from the past, and onward into some unknown region of fancy, where Thought has not hitherto penetrated, nor Imagination as yet found a resting-place.

In his search after originality, however, the sculptor must be careful that he does not step beyond the legitimate bounds of his own art into the domains of the art of another—as that of the painter, for example; for the conditions of all imitative laws are so true and defensible that they cannot be encroached upon or interrupted without danger to him who makes the attempt. "Though sculpture cannot steal from painting the natural colour of objects, it does, nevertheless, too frequently pretend to dispute with it those kinds of subjects which owe their true value to the effect of colouring and aerial perspective; and the art of the sculptor has been seen to attempt in stone the production of skies, distances, and landscapes. In like manner the painter will be found treating subjects that narrative alone can give a value to, or render intelligible; and the dramatic poet making excursions into the territory of the historian, or the epic poet, &c. . . . Art owes the only superiority its images can possess over reality to their keeping within the bounds of their particular nature; for the happiest results of imitation depend on a faithful adherence to its elementary principle. . . . It is for want of an adequate knowledge of the means or conditions of imitation considered as to the end to be kept in view—it is for want of comprehending the conventions on which the ideal depends, and the force of their consequences, that the artist often commits in his works the most outrageous inconsistencies; so that while we see one looking forward to the right end without following the proper track, we see another entering on the proper track without thinking of the end to which it leads."

Our first impression when looking at Mr. Durham's statue of "Sunshine" was, that the subject is not within the proper limits of sculpture, inasmuch as the idea is not complete in itself; it seemed, on a primary consideration, to require what the art can by no possibility give to render the idea perfect; a little thought, however, was sufficient to satisfy us that our first impression was erroneous. The proper attributes of sculpture are sentiment, or action, allied with beauty of form, and here the last two qualities are united; the light or sunshine, which alone is required to make the idea perfect, is supplied, inferentially, by the action. It follows that such a statue should always be placed where the light would fall upon it according to the laws of nature: it should be neither in the corner nor the centre of a room, unless the windows be so arranged that the rays of light fall down upon the figure.

The figure—that of a young girl—is very gracefully and correctly modelled; the attitude is uncontrived and perfectly natural; the sharpness of the shaded part of the right arm, which seems to cause the limb to lose something of its rotundity, is occasioned by the strong light which falls upon the arm in the room where it stood when the drawing was made. It is of small size, and executed in marble; has not yet been exhibited, and therefore, we presume, is still the property of the sculptor; but Mr. Durham proposes to send it to the forthcoming "Art-Treasure Exhibition" in Manchester, where there can be little doubt it will not long remain unsold.

* De Quincy on "Imitation in the Fine Arts."



Faint, illegible text, possibly bleed-through from the reverse side of the page. The text is arranged in several columns and is too light to transcribe accurately.



TRUTH
SCULPTURE BY M. J. MARTEL
LIBRARY OF THE UNIVERSITY OF CHICAGO

THE WELLINGTON MONUMENT,
IN GUILDHALL.

THE Wellington Monument is now in its place in Guildhall, on the right of the doorway leading to the city offices, and forming a pendant to the Nelson Monument on the other side of that entrance. At the time of our visit the work was seen under the greatest disadvantage, being then, as yet, almost screened by the scaffolding; certain of the details of the erection not having been accomplished: it will not be inaugurated till after the 9th of November. In consequence of the preparations necessary for the usual civic festival on that day, the sculptor has been compelled to suspend his operations for three or four weeks. In comparison with Bacon's monument to Pitt, and that already mentioned to Nelson by Smith, the new monument reads most impressively. Moreover, Mr. Bell's composition consists principally of a portrait statue—incomparably the most valuable object in every monumental erection, and the more valuable in inverse proportion to the quantity of allegorical accessory. In Bacon's work, Pitt is the least significant of the figures—the beehive, even, is more prominent; the composition is full of commonplace, and hence the poetry does not rise above a vulgar strain. In the Nelson Monument the *personae* are not so numerous, the style of the narrative is more solemn; but Nelson himself is not there—an omission which gives to the monument a sepulchral rather than a biographical and commemorative character, which we submit should be that of all honorary memorials. Britannia and Neptune are mourning the death of the hero, and History has just concluded a record of his achievements on the tablet behind; but he whom it most concerns is absent. The Wellington Memorial is as simple as an allegorical composition can well be, presenting a portrait of the Duke, not as a Greek hero, nor in a Roman drapery, but as he was known and is remembered, wearing, as well as the scaffolding permitted the statue to be seen, a plain frock coat. The monument, which is of great weight, is supported by a brick-built pedestal, describing in its projection from the wall the arc of a circle, which is being faced with marble. The only inscriptions above and below the composition are the three words, "Wisdom," "Duty," "Honour," at the base, and above the statue the far-famed title "Wellington." On one side of the statue is Peace, and on the other War, in allusion to the Duke's having passed one half of his career in arms, and the other half as a statesman. Between these figures the hero stands holding in his left hand a marshal's baton, and in his right a copy of the articles of the peace of 1815. The same feeling is observed on the pedestal, as, below Peace, there is an ornamental shield presenting a dove with an olive branch, and inscribed, "*Paxis impare moras*," from the ultimate charge of Achilles to Eneas, in the sixth book of the *Iliad*. Beneath the figure of War is a shield bearing the Wellington crest and motto—a lion's head with the words, "*Triadis fortuna comes*," and between these is a relief illustrating the most critical period of the battle of Waterloo. The age at which the Duke is represented, is between fifty and sixty, some years after the close of his brilliant military career, but yet in the prime of life. The figures have all been modelled to the same scale—that is, a stature of eight feet six inches, and the weight of each figure is about five tons, and seldom have we seen so much marble constituting one monument torn out so well. As far as could be well effected, it forms a pendant to the Nelson memorial on the other side of the doorway; the two works rise from similar bases, and a pediment is placed behind each in the arch. The cost of the work is £3000, and it has been executed and erected in a period a little over two years—a very short space for a work of such dimensions. These three monuments illustrate three remarkable transitional periods in the history of our school of sculpture. Bacon's monument is conceived in the full licence of allegory; Smith's shows its decadence, but is more sepulchrally monumental than the majority of those in St. Paul's and Westminster Abbey. We are now arrived at the historical period of public monuments, in which a portrait statue of the personage commemorated is indispensable as the principal in the composition.

OBITUARY.

DR. EMILIE BRAUN.

The continental papers mention the death of this distinguished antiquarian, at his residence on Monte Caprino, Rome. Dr. Braun was secretary of the Archaeological Society of Rome, and is well known to antiquarians by his published lectures on Roman antiquities, and by his "Handbook" on the same subject. He contributed to the *Art-Journal*, in 1850, some papers on "Electrotyping applied to Art-manufactures;" and a little pamphlet, of which he was author, on "Classical Iconography," was referred to by us in the preceding year, in our notice of the meeting at Birmingham of the "British Association." The model of the Coliseum in the Crystal Palace at Sydenham was made under his directions. Dr. Braun's acquisitions were not limited to a thorough knowledge of antiquities; he was learned in many of the sciences; and his death, at a comparatively early age, must be greatly deplored in the scientific world.

MR. JOSEPH POWELL.

Among the recent deaths among artists to which we are called upon to direct attention, we have to announce that of Mr. Joseph Powell; he died young—his age was about twenty-two, but he had given large promise of future fame, and had already gained the best honours of his profession. To him was awarded two silver medals of the Royal Academy, in 1854, and the gold medal in 1855. There can be no doubt of his great success; had his life been prolonged. When referring to his "honours" in 1856, but a few short months ago, we thus observed:—"With our congratulations we shall also offer a word of advice: he must remember he has only just entered upon the path which leads to fame; he has an arduous journey before him; and if he desire to reach the end of it honourably, and to secure himself a lasting reputation, he must be 'up and doing, laboriously, studiously, and perseveringly.'"

Unhappily, Mr. Powell was not one of those who united prudence to genius—his habits were undoubtedly those which impair intellect and shorten life. With the best prospects, he sought to enjoy the present and not the future—his youth was squandered, and the world has sustained a loss which it has doubly to deplore. There is a lesson in the career of those who fail scarcely less impressive than in that of those who succeed in life, while the one is far more solemn than the other. The cases are few in which men cannot walk in the path they have deliberately chosen; very often failures are things that need not be. Mr. Powell was certainly the author of his own destiny; he had many advantages of which he declined to avail himself. It was our task more than ours (during our intercourse with him, and while employing him to make drawings of several of the statues engraved in the *Art-Journal*) to reason with him concerning the wisdom of husbanding the resources of life; he was, to adopt an emphatic, but commonplace figure, burning the "candle at both ends," misapplying his powers, and wasting his energies, and exhausting his constitution; and it is our sad and painful duty, in recording his death, to warn young men of genius as we did him—we hope not always in vain!

MR. THOMAS HOPPER.

The name of this gentleman, an architect of high reputation, appears among the "deaths" lately announced in the public journals. Mr. Hopper's life was one of unusual length—he had nearly reached his seventy-ninth year—and of remarkable activity. Our contemporary, the *Builder*, gives the following list as some of the edifices erected from his designs and under his superintendence:—the Conservatory, and other works at Carlton House, for George IV. when Prince Regent; Slane Castle, Ireland, for the Marquis of Conyngham; Penryn Castle, Bangor; Margam, in South Wales; "a noble mansion in the enriched Tudor style;" Dunkeld, Scotland, for the late Duke of Atholl; Leigh Court, near Bristol, for the late Mr. Miles; Llanover Court, Monmouthshire, for Sir Benjamin Hall; Gasford Castle, Armaugh; Arthur's Club House, St. James's Street;

the Atlas Fire Office, Cheapside; and the Legal and General Life Office, Fleet Street. Mr. Hopper was a competitor for the General Post-Office, and he subsequently published his designs, as he did also his plans for the New Houses of Parliament. "On the whole," concludes the writer, "we cannot but feel that, by his death, a man of mark and power has been taken from among us."

MR. WILLIAM YARRELL.

Although not strictly within the limits of our necrology, we ought not to allow the death, on the 31st of August, of "the good old British sportsman and naturalist," William Yarrell, to pass without a line or two of notice. In the early part of his life an enthusiastic angler and a keen sportsman, he brought, in after years, the knowledge he had acquired in these pursuits into the world of literature; his "*British Birds*" and "*British Fishes*," are valuable contributions to the science of natural history; while the illustrations that ornament the pages of these books, chiefly we believe from his own pencil, are among the most beautiful examples of their kind to be found in any volume. His contributions of papers to the Linnean Society, the Royal Society, and others, evidence the large amount of information he was possessed of as a naturalist. He died suddenly, while on a trip to Yarmouth by sea, and at the age of seventy-two.

THE

ART-TREASURES' EXHIBITION
AT MANCHESTER.

We have little to report on this interesting subject—except that matters are progressing in a manner entirely satisfactory. The committee are labouring with industry and energy; the several *employes* are actively working; the building is gradually moving towards completion; and, especially, the possessors of works of Art throughout the kingdom are, with scarcely an exception, according to the project their cordial support. The list of noblemen and gentlemen who have arranged to contribute pictures is now so long, that to print it would be to occupy more space than we can afford; it will suffice to say, that the liberal example of Her Majesty and the Prince has been followed by the best of her subjects.

There is consequently a certainty that the collection of Art-treasures, in pictures, will be the most extensive and valuable that has ever been, or perhaps ever will be, gathered in any one building. To see this wonderful sight, the Art-lovers of all parts of the world will no doubt visit Manchester; and we trust the summer of 1857 will be as auspicious to Art as was the summer of 1851. We have now the hope of seeing realised the truth of a statement we made two years ago, in reviewing Dr. Waagen's "*Art-Treasures in Great Britain*," that "if we could gather into one focus the heaps of Art-treasures which are scattered through the broad face of our country . . . if the noble would strip his ancestral halls, the princely merchant his palace, and the wealthy manufacturer his home of luxurious enjoyment, we might challenge any country to produce an exhibition surpassing this—nay, even to equal it."

As our readers know, pictures will not be the only Art-treasures here collected; every conceivable class of Art will be represented—not only from stores in England, but from those of the Continent.

With respect to Art-manufacture—that is to say, the Art-manufacture of the present time—we are not yet in a condition to supply our readers with sufficient information, or to reply to the many communications we have received on this important branch of the subject. We shall be better able to write concerning it in a month or two, when the arrangements of the committee are further advanced.

It is not intended to make the exhibition an exhibition of manufactured works; but such as are of special merit will not be excluded because they are modern; on the contrary, they will be desired and asked for, although the issue of letters applying for contributions of that class are necessarily postponed for a time.

The Exhibition of Art-treasures at Manchester, then, so progresses as to remove all doubts of its entire success.

MINOR TOPICS OF THE MONTH.

MR. E. M. WARD, R.A., has been honoured by another commission from the Queen for a picture; the former, as was announced some time since, being the Investiture of the Emperor of the French with the Order of the Garter; here we shall see the pomp and glitter of sovereigns and nobles arrayed to pay honour to the living. The subject selected by Her Majesty for the new picture is of a very different character—the visit of the Queen to the Tomb of Napoleon, during her short sojourn in Paris, last year. This remarkable historical incident will, no doubt, make a most interesting picture, but it will prove a difficult subject to treat, arising from the peculiarity of circumstance no less than from the diverse materials, of personages and costumes, which must, of necessity, be included in the composition: there will be again the pageantry of regal state, yet not, as in the other, shining in the blaze of day, but enshrouded by the shadows of the sepulchre, inviting expressive silence and solemn contemplation. The task has, however, been confided to competent hands, so that we are under no apprehension as to the result. Mr. Ward is, we believe, at present in Paris, making the necessary studies for his work.

TURNER'S PICTURES.—We believe we are not premature in announcing that the pictures bequeathed by Turner to the nation will be exhibited next year at Marlborough House; the authorities of the National Gallery are now occupied in preparing them for this purpose. About one hundred is, we believe, the number which the trustees consider in a condition to be exhibited; and unquestionably such a wonderful and glorious display of landscape pictorial art as will then be seen, the public can have no idea of. While speaking of this subject, we may remark that the picture, by Turner, engraved in our last number, and called "The Fall of Carthage" is "The Morning of the Chase," representing Dido and Æneas preparing for hunting. Our engraving was copied from an old print, without any name or title; the latter was done at Turner's own expense many years back, from one of his earliest, and, in his own opinion, his finest painting of that class; it is now the property of the nation. We had never seen the picture till after the article was published; and it is many years since we saw the "Fall of Carthage;" hence the error in the title of our engraving.

THE WELLINGTON MONUMENT IN ST. PAUL'S.—It has been suggested to us that in one of the clauses of the specification for this work an ambiguity of wording occurs, liable to be misunderstood—if not at home, at least abroad; we hasten, therefore, to mention it. The clause specifies that the composition models shall be each one-fourth the size of the proposed work. Now size is a vague word, at least it is often used unprecisely, as instanced in the present case. One fourth *scale* is, we presume, what is intended. If so, it might be well to add in explanation that the area of the base of each model is to be three feet three inches by two feet three inches—that in St. Paul's set apart for the monument being thirteen feet by nine. The most usual expression "professionally," we believe, would be that the models are to be done on a *scale of three inches to a foot*. One fourth the *size* is properly one-fourth the mass; but one-fourth the *scale* is one-sixty-fourth the mass: a wide difference, and one calculated to frustrate the judicious intention of the clause, which evidently desires to provide for uniformity of scale in the competing models, and consequent facility of comparison.

EARLY ENGLISH PICTURES.—A correspondent calls our attention to the number of early English pictures that are scattered over the country in various places, especially in the metropolis and at Hampton Court, and suggests the desirableness of collecting these for the purpose of placing them in the National Gallery. He points out especially three paintings in a room in the Bridewell Prison—a building that, we believe, is no longer to be used for the purposes to which it has been lately devoted. These pictures are a half-length portrait by Hindson; a full-length by Mrs. Beale, who lived in the reign of James II.; and a portrait of a mounted cavalier, the joint production of Wootton and Richardson, who flourished in the early part of the last century. "It has always seemed to me a pity," says our

correspondent, "that though our native artists, and especially the predecessors of Reynolds, are not very numerous, we should not make the most of them, and collect specimens in our national institutions." There is little doubt that the works of these painters just named, and even of the Rileys, Walkers, Dobsons, and others, would possess little value as pictures, but they would be interesting as showing the earliest efforts of the British school; and, moreover, were the Directors of the National Gallery to procure specimens of Morland, Barry, Harvey, &c., they might thus form a gallery of our school, which undoubtedly the country ought to possess. We give large prices for early Italian paintings, of little use except as curiosities; surely a hundred or two of pounds might now and then be spared to collect a few works by those Englishmen who laid the foundation of the Arts of their country.

THE STATUE OF CHARLES JAMES FOX, from the chisel of E. Baily, R.A., has recently been erected in its place in the New House of Commons; the work is highly characteristic of the distinguished statesman, whose burly form, energetic but benign expression of physiognomy, and defiant action in oratory, are forcibly, but not offensively, represented by the sculptor.

THE ART-PATRIOTIC EXHIBITION which recently closed has added no less a sum to the general fund, in support of which the collection was made and opened, than £4732; this amount the secretary of the Royal Commission acknowledges to have received from the Committee, as profits arising from the Exhibition.

THE PICTURE GALLERY AT THE CRYSTAL PALACE is closed; and it is intended to replace it during the winter by a collection of photographs. We presume there will be another Picture Exhibition during the spring of next year: the Directors cannot doubt its being prominent among the attractions; no part of the building has been so well attended as the Picture Gallery; and although sometimes inconveniently crowded, we have heard of no accident—of nothing, indeed, that could militate against the continuation of a plan from which visitors obviously derive much enjoyment, while they are instructed. This is after all the only modern picture gallery in England to which the public is admitted altogether free: and we have obtained ample evidence that it is entirely appreciated. We trust the Directors will themselves, more directly than they seem to have done, superintend the arrangements for the next exhibition—that they will take care the pictures are properly and justly selected; and especially that they will prevent in future the very coarse way in which the pictures and drawings have been defaced by pasting large pieces of yellow paper over the frames and glasses, in many instances blotting out important parts of drawings, and in all cases giving proofs of the worst possible taste. We believe the directors may render this exhibition the most valuable part of the Palace, and earnestly hope their attention will be directed to its right and proper management.

THE TWO "BIG" WORKS OF MAROCCHETTI have been removed from the Crystal Palace; and it is now admitted on all hands that the public are great gainers thereby. The friends of Marochetti have also reason to be grateful.

A PORTRAIT OF THE LORD MAYOR, David Salamons, Esq., has been hung in the Guildhall Council Chamber, by the unanimous vote of his fellow citizens. It is painted by Hart, and was in "the Exhibition" of the present year. In a few days his Lordship will have retired from the high office he has held, as chief magistrate of the city of London; and it is not too much to say that he has so discharged his duties as to have obtained the "golden opinions" of all classes and orders. He has, indeed, so acted as to have placed by "his year" a serious impediment in the way of those who seek to abolish the Corporation of London; for no "reform" could give to the city a gentleman more entitled to esteem and respect, of wiser practical knowledge as a magistrate, more thoroughly upright, more "liberal," in the best sense of the term, or with faculties better calculated to discharge honourably and usefully the various and onerous duties which fall to the lot of the Lord Mayor of London. He has upheld and extended its old renown; added to its fame for hospitality; fostered

the arts of peace; promoted the prospects of numerous charities; and seems to have represented and advocated all the private and public interests by which the welfare of the country and its dependencies could be advanced. We tender our tribute of respect to this estimable gentleman; not alone for his exertions to benefit Art, and to honour its professors, but as one who seems to have left nothing undone that ought to have been done during his official year, and who leaves office honoured, esteemed, and respected—not alone in London, but everywhere throughout the kingdom.

UNUSUAL AND CHINESE SCULPTURE.—A most extraordinary collection of water-colour drawings is at present "on view" in the rooms of Messrs. D. Colnaghi & Co., Pall Mall East. These drawings are by Mr. T. W. Atkinson, who, with the permission and under the protection of the late Emperor of Russia, passed seven years hunting, travelling, and sketching in those portions of the autocrat's dominions which comprehend Siberia, Chinese Tartary, and the parts adjacent—a country much of which has never before been illustrated by the pencil of the artist. We could fill a page or two with descriptions of what Mr. Atkinson has brought away with him in his pictures of lakes, mountains, deserts, steppes, waterfalls, tracks which the foot of man seems never to have trodden, and waters whose surface has never reflected ought but the heavens above them and the hills which encircle them; but our space would not permit us to do the collection justice, and we will only ask our readers to go and see for themselves.

ANTIQUÉ IVORIES.—Not very long since three of the most important antique works in ivory were brought to England for sale. The first in point of date is a Roman work of the second century, of the finest possible character: it is conjectured to be a money-box—the "coelus choros" of Martial. Upon the semicircular front is sculptured in high relief a figure of Bacchus holding the cantharus and thyrsus, with a panther at his feet; on his right stands a Bacchante with a tympanum, and on his left a Faun clothed in a leopard's skin, carrying a wine skin and pedum. The box is four inches in diameter; and has a sliding lid, upon which is sculptured a figure of Fortune, greatly resembling that upon the coins of Hadrian. The second of these new importations consists of a diptych of the fourth century, each plaque of ivory measuring 13½ by 5½ inches: having been originally used as covers for an "evangelarium" the sculpture is somewhat rude, but is evidently of Byzantine work,—inasmuch as the figures are giving the benediction of the hand in the peculiar manner of the early Greek Church. The figures are those of the four evangelists, and above them are representations of the Saviour with the woman of Samaria, and the sick man lifting his bed to walk. The third object is even more rare and curious, and is a small *benetioire*, or bucket, for holy water, made in one single piece of ivory, and covered with a series of scripture stories and inscriptions, one of which informs us that it was made for Otho, Emperor of Germany. From the style of work it is conjectured to have been done by Bishop Burward, of Hildersheim, about the year 983, for Otho III. Twelve scriptural scenes cover its surface, embracing the events in the life of the Saviour, from his betrayal by Judas to his appearance before St. Thomas. The details of dress, ornament, and architecture on this ivory are most elaborate and curious; it is by far the finest thing of the kind known to exist. The only similar work is that in the Ambrosian treasury at Milan, but it is by no means so highly enriched as this, which, together with the others we have named, is now possessed by Mr. Chaffers, of Grafton Street, Bond Street, who will be happy to show them to all interested in fine antique art.

PICTURES BY HAYDON.—It may not be uninteresting to those of our readers who are not acquainted with the works of Haydon to know that Mr. Barrat, of the Strand, a dealer in pictures, has in his possession four examples of his pencil, three of which are his best productions—the "Mareus Curtius," "Christ raising the Widow's Son," and "Christ's Agony in the Garden," admirably adapted to adorn the walls of one of our Schools of Design, Haydon's master-mind having been the originator of those academies. The fourth is a small whole-length figure, representing a soldier of the French

Imperial Guard missing at Waterloo; the original figure on this canvas was a portrait of the Duke of Wellington, but the duke taking exception to it as an incident not founded on truth, saying that he "never was alone on the field of Waterloo," Haydon, with his usual impetuosity of temper, transformed the hero of the field into one of his vanquished foes. He speaks of it thus in the third volume of his autobiography:—"At the first dawn of morning I had a flash of an Imperial Guard, missing at Waterloo, as a fitter companion for Napoleon. Finished it over the Duke! This is the first time an Imperial Guard extinguished the Duke."

WAR MEMORIALS.—The return of peace does not appear to shunt out from the public mind all thoughts of the events of the past war, for we hear of proposals in various quarters for erecting tributes to the memory of those officers who died in the Crimea, on the field of action, in the trenches, and the hospital. Eton, Harrow, Winchester, and Rugby, are collecting subscriptions to be applied in honour of the dead whose early life was passed within the walls of these respective public schools; and a memorial window is about to be placed over the principal staircase of the Army and Navy Club, Pall Mall, in commemoration of those members of the club who have fallen. "It is to be," says the *Builder*, "in the Venetian-Italian style, and will exhibit a number of tablets bearing the arms of the club, and the names and dates of the engagements. The architraves will be of Siena marble, with panels of black marble, on which will be inscribed in letters of gold the names of the deceased officers."

MR. CHARLES KEAN has sustained his reputation, and increased the debt the public owe to him, by the manner in which he has brought out the "Midsummer Night's Dream." It is sufficient to say, that this new effort to make the drama a great teacher corresponds in excellence with its predecessors: happily, his experiments have been entirely successful; he has been fully appreciated—not always the fate of men who labour rightly for the general good. We are compelled to postpone the notice to which he is entitled at our hands.

NATURAL CLOUDS—PHOTOGRAPHY.—Nothing shows the importance and estimation in which Photography is held so much as the prominent position given to it at all the exhibitions intended for the advancement of taste, and the instruction of the people. How intimately, too, is Photography connected with Art, and with how much interest are the labours of the "pilgrims of the sun" looked for; this is evidenced by the numbers who attend the annual London and provincial exhibitions. Every good photograph, in fact, helps to extend a juster appreciation of the varied powers and applications of an invention whose influence is, no doubt, destined to play so high a part. Year by year a greater ambition is exhibited, both in the choice and composition of subjects; and every admirer of the art is familiarised with correct forms and truthful representations. We have been led into these remarks in consequence of having just seen a series of photographs of *natural clouds*, which, to artists, must possess immense value. In this series (executed for and under the direction of Messrs. Murray and Heath, of Piccadilly) many of those beautiful and fantastic forms so familiar to artists, and all who have watched the ever-varying changes of the sky, are depicted. Some of these photographs tell of coming storms, while others recall Moore's lines:

"'Twas one of those ambrosial eves
A day of storm so often leaves
At its calm setting—when the west
Opens her golden bowers of rest."

All artists and photographers will not fail to inspect this new addition to the triumphs of Photography; they will be amply repaid by the pleasure they enjoy and the instruction they derive from one of the happiest forms in which Art is made to copy Nature.

SCOTT'S POEMS.—Messrs. A. and C. Black, of Edinburgh, are preparing for publication, and will shortly issue, an illustrated edition of Scott's "Lord of the Isles," "Marmion" with their previous editions of "Marmion" and "The Lady of the Lake." A few of the "proof sheets" have reached us, from which we are able to form the opinion that it will be equal in excellence to its predecessors. We expect in a future number to give our readers the opportunity of judging for themselves of the merits of the illustrations.

REVIEWS.

L'IMITATION DE JESUS CHRIST; ACCOMPAGNÉE DE QUATRE CENTS COPIES DE PLUS BEAUX MANUSCRITS DU VIII^e AU XVII^e SIÈCLE. Published by L. CURMER, Paris.

In bygone times, when books were rare, and one volume occupied many years hard labour to write upon the vellum, such labour was thought worthy the utmost adornment of Art, and hands like those of Julio Clovio were employed to decorate the pages which emanated from the monkish *scriptorium*. Resplendent with colours and gilding, the volumes deserved the term which the French antiquaries of the last century invented for them. They are "illuminated" by a radiance peculiar to themselves; and it is only in recent times that they have been rivalled by modern biblioplists. Colour printing, by means of lithography, has lately done much to reproduce, by the thousand, transcripts of what must have singly occupied years to accomplish in the middle ages. At that period the loan of a book was an affair of anxious solicitude on both sides; and we have records of kings, princes, and churchmen, entering into bonds for the safe return of volumes, if once lent, with all the formalities which would now await the surrender of a city. A library of a few dozen volumes in those days was a highly property; and a single book a thing to be more cherished than gold. On the decoration of valuable manuscripts large sums were spent, and the precious metals often used for their covers; stones of brilliant hue also decorated them, as well as ivory carving, and works in enamel. How, then, can we contrast the time past with the time present better than by instancing such a publication as this by M. Curmer, where we have the finest and most delicate drawings of the middle ages reproduced in all their beauty of finish, and with all their brilliancy of colour and gilding, at the rate of about fourpence each page? The famous old devotional work of Thomas à Kempis will now appear, framed as it were, in the finest medieval drawings, exhibiting a selection of the most beautiful pages from the best manuscripts in the various great French libraries. Truly we live in a marvellous age, when such books can be placed at a cheap rate in the hands of all.

THE HISTORY AND ANTIQUITIES OF ST. DAVID'S. By W. B. JONES, M.A., and E. A. FREEMAN, M.A. Published by J. H. PARKER, London.

Situated at the extreme point of South Wales, in a lonely and desolate country, the ancient episcopal see of St. David's has been rarely visited by the tourist or antiquary. The market town of Haverfordwest is the nearest to it, but that is sixteen miles distant, and the intermediate country dreary in the extreme; wanting in trees and verdure, and exposed to the extreme violence of the sea-winds, the situation chosen for the important monastic establishment founded here, can only be accounted for on the supposition that it was considered desirable to render the contemplation of the world without the cloister as unattractive as possible, and so concentrate the mind on the religious duties within it, rendering their due observance the only pleasure left to the inmates. This arrangement, suitable to the asceticism of the early cloister, and which finds a parallel in the establishments of La Trappe, the Grand Chartreuse, and a few other continental foundations, was of course completely nullified for the reformed church, and, consequently, non-residence and neglect became, after a time, one result of the great changes; from time to time portions of the buildings fell in, and "the final fruits of sacrilege and negligence" exhibit themselves in the ruins now remaining.

It is due to the present dignitaries of the see to note their desire to arrest further decay, and it may also be stated that general subscriptions for restorations of portions of the building have been secured. The publication of the present beautiful volume will, however, do most towards protecting this venerable group of sacred buildings, by drawing attention to their claims, historical and archeological. As a piece of well-illustrated local topography, the work takes a high position. It is well and honestly done, and its authors have told "a plain, unvarnished tale" of the whole, preserving the beautiful without to speak strongly, though calmly, of the neglect and errors of those who were its ordained guardians. It is pleasant to know that they now feel such neglect is over, and that a better fortune awaits this most interesting relic of old Wales, a fate that all Welshmen are especially bound to honour. In the present bishop they gladly recognise a protector as well as a ruler; and the appearance of so able and elegant a volume as this, is a proof of a better spirit now existing for the protection of the relics of past ages.

The reader, or home-traveller, who would wish to be fully acquainted with this comparatively untroubled district, may be entirely satisfied with the labours of the gentlemen who have here devoted themselves to the task. So minutely careful are their notes of the district, that it is visible to "the mind's eye," as we peruse their pages, and we seem to travel the ground in their company. This is a rare qualification in topographers, though the genus abounds; and aided, as the book is, by a series of very admirably executed engravings on steel and wood, it leaves little to be desired by those who study the world in their libraries. The steel engravings are by Le Keux, from drawings by Mr. O. Jewitt, and are highly creditable to both artists. Mr. Jewitt has both drawn and engraved the wood-cuts, and thus added a few more examples to the many hundreds of admirable works of this kind upon which he has been engaged for a long series of years. The details have been selected with much taste, and the descriptive letter-press is written with sound knowledge. Many of the architectural fragments given by the authors are remarkable for beauty; and all display the loving zeal which guided the ancient bishops in the decoration of the cathedral church and its palatial and monastic buildings. We cannot help feeling that the day has gone by for any further irreverence as exhibited by neglect in the modern Church of England; and it is a satisfaction to all true Protestants to see the awakened zeal for a due protection and restoration of the ancient churches of our fathers throughout the length and breadth of the land. Ignorance is always the father of desecration; and such works as the present will do more for the good cause of conservatism than any other thing. "*Tempus fugit—scripta manent*," says the old saw; and we all anxiously look to the preservation of recorded things in History or Art, which, but for the author and artist, might else have rotted in oblivion, unweared for because unknown.

THE MICROSCOPE AND ITS REVELATIONS. By WILLIAM CARPENTER, M.D., F.R.S., F.G.S. Published by J. CURRIE & CO., London.

Doctor Carpenter's work on the microscope has been long expected, and much has been said as to the fresh sources of pleasure and information it would open to the man of science, as well as to the student. It is now upon our table, and we confess ourselves astonished, not only at the vast amount of practical knowledge contained in its pages, but at the clear and concise manner in which that knowledge is conveyed. It would occupy a much larger space than we can give to any one scientific subject, were we to attempt to draw attention to a title of the marvels so happily simplified in this noble volume. A greater boon could hardly be given to the public, and at this season too, when even the dwellers in pent-up cities go forth for their brief holiday, and can bring home so much that will, by the aid of the simplest microscope, enlighten and interest that come during the long and too frequently listless evenings of winter. We are not a little proud at having our own impression of the superiority of the chief English microscope makers over their continental rivals confirmed by such an authority as Dr. Carpenter, and on this point he assures us he not only speaks from his own conviction, but from the authority of a "highly-accomplished German microscopist, who has recently visited London for the express purpose of making the comparison." Dr. Carpenter says, "It has been the author's object throughout to guide the possessor of a microscope to the *intelligent* study of any department of natural history that his individual tastes may lead him to follow out, and his particular circumstances may give him facilities for pursuing; and he has particularly aimed to show, under each head, how small is the amount of reliable knowledge already acquired, compared with that which remains to be attained by the zealous and persevering student." Dr. Carpenter regrets also, in his preface, that so much microscopic power should run to waste in this country, and to a scientific man this is a very natural source of regret; but the very "waste" of such power contains a fertilising principle within itself which cannot but be productive of good. All reading-rooms, and mechanics' institutes, and schools, ought to have a few, appropriated to a microscope, and a drawer properly constructed and filled with "objects." To this plan there are two objections: one, the expense of a good microscope; the other that "the objects" would be destroyed by unskillful or careless hands, if not constantly watched by the curator of the establishment. The first is the great objection; the only cheap microscope is that produced by Mr. G. Fields, of Birmingham, to whom the medal of the Society of Arts was lately awarded. Dr. Carpenter states that "the price of this instrument complete, with two eye-pieces, and two achromatic

objectives, giving a range of power from about 25 to 200 diameters, condenser on a separate stand, stage, forceps, and live-box, in a mahogany case, is only three guineas, and the maker is bound by his agreement with the Society of Arts, to keep it always in stock, so as to supply any purchaser at once." But this microscope is not sufficiently comprehensive for the purpose we have suggested, although of much value to those who seek amusement rather than science. Dr. Carpenter strongly recommends Smith and Beck's Student's Microscope, and that can be procured for seven pounds; but since the introduction of aquaria into our domestic circle, Mr. Warrington's Universal Microscope is "the tempting bait," as, by a peculiar arrangement, the compound microscope is brought to bear upon the living objects in the aquarium, when these might be either in contact with the glass sides, or not be far removed from it. The price of Mr. Warrington's microscope is not given, but we presume it may be obtained at Mr. Salmon's, in Fenchurch Street. For a different class of instruments, those of which the aim is not simplicity, but perfection—not the production of the best effect with limited means, but the attainment of everything that the microscope can accomplish, "without regard to cost or complexity"—we refer our readers to Dr. Carpenter's most valuable manual, only adding that it also contains 345 wood engravings, drawn by Mr. W. Bezz, and engraved under his immediate superintendence.

ORR'S CIRCLE OF THE SCIENCES. Published by HOULSTON & STONEMAN; W. S. ORR & Co., London.

About three years since, so far as our recollection serves us, Mr. Orr entered upon the task of publishing, in cheap serial parts, a set of treatises on the first principles of science, with the application to practical pursuits, embracing every useful branch of philosophy; the entire series written in a style to render it popular, in the most extensive sense of the term, copiously illustrated by wood-cuts and diagrams to aid the reader in his studies, and published at so moderate a cost as to bring it within the reach of all who can spare a few pence each month for the purposes of self-education. To carry out effectively and satisfactorily the object of the projector, he called to his aid a number of scientific writers, eminent in their respective departments:—Dr. Bushman, Professor Owen, Dr. Latham, Dr. E. Smith, and W. S. Dallas, F.L.S., as contributors of treatises on Organic Nature in its various developments; the Rev. J. F. Twisden, and A. Jardine, C.E., on the Mathematical Sciences; Professor Young, Mr. Breen, of the Greenwich Observatory, and Dr. Scott, on Nautical Astronomy, Practical Astronomy, and Meteorology, respectively; Dr. Scofield, on Elementary Chemistry; Professor Ansted on Physical Geography and Geology; the Rev. W. Mitchell on Crystallography; Professor Tennant on Mineralogy; Dr. Bronner, Mr. Gore, Mr. Sparling, &c., on Practical Chemistry; Mr. W. Mitchell and J. Inlay on Mechanical Philosophy.

This array of names, to all who are acquainted with the qualifications of these gentlemen, will prove a sufficient guarantee for the truth and accuracy of their labours, which have resulted in the issue of nine volumes,—or rather of eight at present, for the ninth is not yet quite completed,—forming a sort of miniature library of useful science. We can readily understand how in this age, when the pursuit of knowledge of every kind is eagerly followed by so many with craving appetites, such a table of substantial intellectual viands must prove most acceptable. On a careful examination of these volumes we are particularly struck with the vast amount of information contained in them, and with the concise, clear, yet comprehensive form in which it is conveyed, while there is no sacrifice of learning in order to attain simplicity: the aim of the writers has evidently been to combine the two. There will be no death of philosophers wherever the contents of these volumes have been mastered, and they certainly come within the acquisition of any whose intelligence is purified by a sincere desire to perfect themselves in scientific knowledge—that kind of knowledge which, at the present time especially, is most anxiously sought after, as a "necessity" of our day.

Mr. Orr has done good service to education by the production of these and other excellent educational works; and we hear that he is about to follow up what has been already done, by the publication of another "Circle" of similar treatises on the "Application of Science to Industrial and Decorative Art," a series in the preparation of which he has already enlisted a number of contributors distinguished for their scientific and practical attainments. Of this series the first part is announced to appear in the present month.

CALISTHENICS; OR, THE ELEMENTS OF BODILY CULTURE: ON PESTALOZZIAN PRINCIPLES. A CONTRIBUTION TO PRACTICAL EDUCATION. By HENRY DE LASPÈRE. Published by DARTON & Co., London.

Fully admitting the importance of the subject of which M. De Laspère's book treats, we yet think his end might be attained by a less pretentious volume than this. Upwards of one hundred and sixty explanatory pages, most of them preceded by a sheet of illustrations exhibiting a number of boys and girls performing all kinds of possible—and, as it seems to us, impossible—bodily contortions, are surely unnecessary to the development of his theories: it is dragging out the subject to an absurd length, besides impudently making his book costly, as we presume. At least one-half of these illustrations are in our opinion useless, unless the pupil is intended for a harlequin or an opera-dancer, while many of them must have the effect of making the practice of bodily culture appear ridiculous. M. De Laspère is strongly opposed to gymnastic exercises, as tending to induce a brute physical strength separate and distinct from the intellectual life, and instances the revolutionary outbreak in Germany, in 1818, as the result of the gymnastic exercises throughout the whole of that country. "Just as the practice of gymnastics," he says, "was in full operation, and its effect on body and mind had reached its climax, the unnatural strength of the body, and its thereby excited senses, sought an outlet; thought, reflection, and good sense succumbed; and all that government did to arrest the monster in its progress could not prevent its bursting out into a revolution. The strongest men—the teachers and their best disciples in muscular power—became its leaders. Their strength, at the first outbreak of the revolution, struck every one with awe and terror, and all submitted to their dictates. Thus physical strength once more attained supremacy, and before it lay mighty princes and nations prostrate. Had this bodily agent been the obedient servant of a highly-endowed mind—had it been guided by wisdom and understanding, the conquests obtained by it would have remained in its possession. But it was not so, and strength having triumphed over the weakness around it, its warlike spirit turned against itself, until, at last, refuge from its horrors was sought in the counsel and aid of intellect. The extreme of intellect conquered the extreme of bodily culture."

In the preface "Instructions" are some sensible remarks on mental training; but we cannot see that the utmost proficiency in calisthenic exercises can operate beneficially on the mind, or, in other words, how the culture of the body can promote mental education, except as the health of the body generally produces a healthy tone of mind, and capacitates it for receiving and retaining what it may be taught. M. De Laspère contends for more than this when he asserts that his arguments, though limited to bodily culture, may with equal effect be applied to every other branch of study: we doubt this, but nevertheless recommend his book as a well-directed attempt to carry out a most useful branch of physical education, though, as before stated, his exercises might be advantageously curtailed.

THE MARRIAGE OF POCAHONTAS. Painted by H. BRUECKNER. Engraved and published by J. C. M'RAE, New York.

"During the lovely Indian summer-time, in the autumn of 1605, there was a marriage on the banks of the Powhatan, where the English had laid the corner-stone of the great fabric of Anglo-Saxon empire in the New World. It was celebrated in the second church which the English settlers had erected there. Like their first, which fire had devoured the previous winter, it was a rude structure, whose roof rested upon rough pine columns, fresh from the virgin forest, and whose adornings were little indebted to the hand of Art. The officiating priest was 'good Master Hunter,' who had lost all his books by the conflagration. . . . About five years later there was another marriage at Old Jamestown (the name given to the locality in question), in honour of which history, poetry, and song, have been employed. The bridegroom was 'Master John Rolfe, an honest gentleman, and of good behaviour,' from the realm of England, and the bride was a princess royal, named Matoa, or Pocahontas, the well-beloved daughter of the emperor of the great Powhatan confederacy, on the Virginian peninsula. The officiating priest was Master Alexander Whitaker, a noble apostle of Christianity, who went to Virginia for the cure of souls." We may add to this that the royal bride paid a visit to England, was entertained by Dr. King, then Bishop of London, "with festival state and pomp," and died at Gravesend, in 1617, before she had reached the age of

twenty-two. From her many of the leading families in Virginia trace their lineage.

This little bit of history may be taken as the key to the large engraving entitled the "Marriage of Pocahontas," recently received from New York. The print is not from a finished picture, but from a cartoon, and hence there is an absence of delicacy, as well as of effect, in the engraving, which probably would have been supplied if copied from a finished work. The name of the painter is new to us among the artists of America, but his composition is evidently not that of a "prettice hand;" it is carried out with no little skill, judgment, and spirit, in the grouping of the large number of figures introduced, and to many of the heads he has given character and good expression. The subject is of a highly interesting nature, and well adapted for a picture—the mixed assemblage of the half-civilised, yet not inelegant, natives, and of the early European settlers in the costumes of the period, constitute a most picturesque group. It would be folly to expect in a large historical work like this as much excellence and as few defects, from the hand of an American artist, as we should look for from that of a European with all the means and appliances of Art at his elbow; yet we have seen as pretensions, and far less successful, works of a similar class in England and elsewhere. Mr. Brueckner's great fault—and in a composition of this nature the fault cannot be overlooked—is defective drawing; several of the figures are most incorrect.

There are portions of Mr. M'RAE's work which deserve to be well spoken of; the engraving is a mixture of line and stipple, but it seems to us as if more than one hand had been employed on it. Taking it as a whole, the print is very creditable to the rising school of Art in America, and shows an earnest and laudable desire to strive after an honourable position among the competitors for the artist's wreath. With the "Marriage of Pocahontas" we received two other prints, by the same engraver, from portraits by T. Hicks—one of Dr. Wainwright, Bishop of New York; the other of Mr. H. W. Beecher, brother of Mrs. Beecher Stowe: but so indifferently printed, that it would be unjust to the engraver to offer any opinion on his work.

APHORISMS IN DRAWING. By the Rev. S. C. MALAN, M.A. Published by LONGMAN & Co., London.

Precisely expressed in concise and intelligible language, as we find them in this little book, are more apt to fasten themselves on the memory than when extended to considerable, and often unnecessary, length; mere verbosity is not unfrequently mistakenaken for minute explanation—there is such a thing as "darkening counsel by words." Mr. Malan's "Aphorisms" are not new, but they are quite to the point: he is an amateur only, and professes nothing more; he has, however, studied well the principles of Art, and lays down some rules which may be of service to others. There is a novelty, moreover, in this method of giving instruction that is not without its value.

THE OXYMEL PROCESS IN PHOTOGRAPHY. By P. H. DELAMOTTE, F.S.A. Published by CHAPMAN & HALL, London.

Oxymel, a new chemical, is, according to Mr. Delamotte, "undoubtedly the most valuable discovery in the art of photography that has been made since Mr. Scott Archer introduced collodion. By the help of oxymel all the beautiful delicacy of the finest collodion pictures may be obtained, with the convenience of the paper process, with much more certainty, and much greater ease." We recommend the amateur in photography to look into this pamphlet, which explains the oxymel process, besides giving many hints respecting the art generally.

ILLUSTRATED HAND-BOOK OF MILITARY ENGINEERING, AND OF THE IMPLEMENTS OF WAR. By R. FORREST. Published by DAY & SON, London.

Although this work would probably have found a year or two since, when the public mind was engrossed with the details of warlike operations, a large number of persons to consult its pages, that it is now likely to do, they are still not without utility, inasmuch as the book is designed to illustrate and render intelligible to non-professionals the various necessary technical expressions found in all historical or popular descriptions of modern warfare. It may be termed a dictionary of all words and objects employed in the military service, each of which is fully explained, and, where necessary, illustrated by well-executed engravings. We turn over these illustrated leaves and lament to see how much of genius and ingenuity man has displayed to destroy his fellow-man, in this terrible array of guns, mortars, rockets, and all the other paraphernalia of wholesale bloodshed.

THE ART-JOURNAL.



LONDON, DECEMBER 1, 1856.

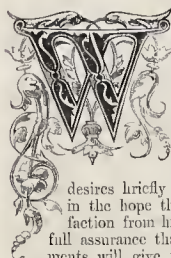

With the New Year will be commenced the third volume of the present, or "Royal Gallery" Series, and the nineteenth annual issue of the *Art-Journal*. The Editor, in compliance with long-established custom,

desires briefly to address subscribers, in the hope they have derived satisfaction from his past labours, and in full assurance that his future arrangements will give increased interest and value to a work that has so long enjoyed

public favour, as a means of rightly directing taste and extending the beneficial influence of Art throughout the community.

Year after year supplies new evidence that Art is advantageously progressing. In nearly every provincial town of note in the kingdom there is now some school or class—public or private—in which Art is an element of education; while in our larger cities it has become almost as much a necessity, as it has heretofore been a luxury, of life.

Many auspicious circumstances have combined to produce this happy result. Previously to the memorable year—1851—when, under the gracious influence of the Prince-Consort, British Industrial Art received its first great impetus, conviction was gradually making way among manufacturers that, while the "mercantile value of Art" was determined only by excellence, that excellence was to be obtained by British energy, enterprise, and capital, if the producer were instructed in what it consisted, and the public were taught its proper appreciation, by contrasting and comparing it with what was inferior or bad. "The Great Exhibition" assuredly did that in one year which twenty years of mere oral or written teaching could not have effected. The general progress of the national mind; the establishment of numerous branches of the Department of Science and Art; the great increase of provincial Art-exhibitions; the continued labours of "the Art-Union of London," and its several huddable imitators; the very large transfer of investments from works of "ancient masters" to those of modern Artists; the wide spread of Photography; the advantages which Art has so extensively derived from Science;—these and other causes have been so beneficially productive as to justify the assertion that in every class of Art and of industrial produce, within the last few years, there has been a large and manifest improvement.

We desire to avoid the self-praise which is never a recommendation; but we cannot appear presumptuous if we enjoy the conviction that our own labours have aided in producing that general advancement in the Arts of our country—Fine and Industrial—which is now

universally observed and admitted. During nearly the whole of the last eighteen years the *Art-Journal* has been—as it now is—their only representative and exponent, not alone in England but in Europe, if we except a few limited periodical issues in Germany and France. At the commencement of our task the manufacturer who strove to attain eminence found publicity beyond his reach; while Science and Literature had many journals devoted to their interests, the Arts had none. The public had no means of ascertaining how to distinguish the producers of excellence from those who circulated inferiority; there was consequently a general absence of that recognition and encouragement, without which rewards are as likely to be awarded to mediocrity as to merit and desert.

Our labours to advance the interests of the Artist, the Manufacturer, and the Artisan, have been largely appreciated—and they have been rewarded: we have earnestly striven to obtain confidence, and we have obtained it; and we may enjoy the satisfaction which arises from the consciousness that success has been achieved by continuous effort for its attainment.

If in Great Britain we have been the means of advancing these important interests,—and we are justified in hence deriving satisfaction,—we may believe that our labours are still more useful—as they certainly have been appreciated—in THE UNITED STATES OF AMERICA. We enjoy, and have long enjoyed, a large circulation among a people who are successfully and earnestly striving to attain excellence in all things; and whose progress in Art has been commensurate with their advance in all the utilities of life.

Our subscribers may be assured of our utmost exertions to keep the place we have secured for this Journal, and to extend its circulation as far as possible, augmenting its interest and value as a medium of communication between Art-producers and the public.

The year 1857 will be commemorated by an exhibition second in importance only to that of 1851: the picture wealth of Great Britain will be developed in Manchester; it will be our task to report fully its assemblage of "Art-treasures."

We have prepared an Illustrated Tour of the Thames, from its rise to its fall (written by Mr. and Mrs. S. C. HALL), with a view to picture the leading places and objects of interest on the banks of "the King of Island Rivers." It is impossible to find a theme more congenial to the artist, or one that affords to the pencil a wider scope. The illustrations of this tour will consist of numerous engravings on wood of the highest order.

The Rev. Charles Boutell, M.A., whose pursuits have peculiarly qualified him for the task, has undertaken for this Journal a series of papers entitled, "The Crystal Palace: a Teacher from Ancient Art," his object being to direct the student to examples available in a school for study, to which there is always access.

Mr. Christopher Dresser, the lecturer on botany in the Department of Science and Art, undertakes a series of articles under the title of "Botany, as adapted to the Arts and Art-Manufacture;" these will be largely illustrated.

Professor Hunt will contribute a series of papers on the application of improved machinery and materials to the productions of Art-manufacture.

We shall continue to represent, by descriptions and engravings, "the progress of British Art-manufacture," selecting such productions as may be honourable to the producer and instructive to the public.

A series of papers will also be issued descriptive of the contents of the leading collections of

modern Art. It will be remembered that several years ago we published "Visits to Private Galleries," these were, in all cases, of the works of ancient masters: galleries of modern Art were then only in course of formation; there are now, however, many in England, in which are gathered famous and valuable productions of British artists; their possessors are, principally, the merchants and manufacturers of the kingdom, who have been of late years the wise and liberal patrons of the artist. The time has therefore arrived when such collections—rare and numerous, and of great value—should be fully described in the *Art-Journal*, for the honour of those who acquire, as well as of those who produce, them.

The articles which have for some time constituted a feature of the *Art-Journal*—"British Artists: their Style and Character"—will be continued monthly, with engraved illustrations.

These announcements refer to such articles as form continued series: our subscribers will believe that in all the other literary departments of the *Art-Journal* we shall avail ourselves of every possible means by which the best assistance can be obtained, in association with our own earnest and continuous labours.

With regard to the more prominent illustrations of the work, we continue to enjoy the distinguished honour conferred upon us by permission to introduce into the *Art-Journal* engravings from pictures in the private collections of Her Most Gracious Majesty the Queen, and His Royal Highness Prince Albert. Among those that will probably appear during the ensuing year are—Wilkie's picture of "King George IV. entering Holywood Palace;" "The Spanish Letter-writer," Philip; "The Princess of Belgium," Winterhalter; "The Beauty of Albano," Heidel; "The Good Samaritan," Sir C. L. Eastlake; "The Marnozettes," Sir E. Landseer; "The Scagliolo," Danby; "The Harvest Field," Tschaggenay; "Henrietta Maria," Vanduyke; "The Sea-port," Claude; "The Farm at Lackeu," Rubens; "St. Agnes," Domenichino, &c. &c.

Examples of the genius of Sculpture—British and Foreign—will also be continued from time to time.

And arrangements are in progress for engraving in line, and publishing in the *Art-Journal*, "The Turner Bequest"—the whole of the pictures bequeathed to the nation by the late J. M. W. Turner, R.A. The plan upon which this great undertaking will be conducted will be explained in due course; but our subscribers will believe that we shall so discharge this task as to be commensurate with its importance, honourable to the memory of the great artist, and worthy of the nation by which so precious a gift has been acquired, for the delight and instruction of its people; and which, by the art of the engraver, will thus minister to all classes and orders throughout the world.

The Editor of the *Art-Journal*, in thus reverting to the past, and communicating his plans for the future, has only to express gratitude for the large support the Journal has received, at home and abroad, and the hope that his efforts, and those of the many excellent and valuable assistants with whom he has the happiness to be associated, will continue to maintain the *Art-Journal* in public favour, and justify the expectation that its circulation will be proportionate to the largely increased and continually increasing interest manifested throughout Great Britain, its dependencies, in the United States, and in all foreign countries, in the Fine Arts and the Arts Industrial.

4, LANCASTER PLACE, STRAND.

THE
MONKS OF THE MIDDLE AGES.*

BY THE REV. EDWARD L. CUTTS, B.A.

The Church of a monastery was almost always a cross church, with a nave and aisles; a central tower (in Cistercian churches the tower was only to rise one story above the roof); transepts, which usually have three chapels on the north side of each transept, or an aisle divided into three chapels by parclose screens; a choir with or without aisles; a retro-choir or presbytery; and often a Lady chapel, east of the presbytery, or in some instances parallel with the choir.

The entrance for the monks was usually in the south side opposite to the eastern alley of the cloisters; there was also in Cistercian churches a newel stair in the south transept, by means of which the monks could descend from their dormitory (which was in the upper story of the east side of the cloister court) into the church for the night services, without going into the open air. The principal entrance for the laity was on the north side, and was usually provided with a porch. The great western entrance was chiefly used for processions; the great entrance gate in the enclosure wall of the abbey being usually opposite to it or nearly so. In several instances stones have been found, set in the pavements of the naves of conventual churches, to mark the places where the different members of the convent were to stand before they issued forth in procession, amidst the tolling of the great bell, with cross and banner, and chaunted psalms, to meet the abbot at the abbey-gate, on his return from an absence, or any person to whom it was fitting that the convent should show such honour.

The internal arrangements of an abbey-church were very nearly like those of our cathedrals. The convent occupied the stalls in the choir; the place of the abbot was in the first stall on the right-hand side to one entering from the west—it is still appropriated to the dean in cathedrals; in the corresponding stall on the other side sat the prior; the



A SEMI-CHOIR OF FRANCISCAN FRIARS.

precentor sat in the middle stall on the south side; the succentor in the middle stall on the north side.

We have given above a beautiful little picture of a semi-choir of Franciscan friars, from a fourteenth century psalter in the British Museum (Domitian, A. 17). It is from a large picture, which gives a beautiful representation of the interior of the choir of the church. On the next column is an engraving of a similar semi-choir of minoresses, which also is only a portion of a large church interior.†

* Continued from p. 343.

† In the same MS. is still another similar picture of an interior of a cathedral, with a choir of secular canons seated in the stalls, robed in short surplices over long black frocks, their furred almuceas are hung over the elbows of the stalls; and they have not the four-square canon's cap, but some have the hood over their heads, and some have not. They are presided over by the bishop, who sits in his

When there was the shrine of a noted saint, it was placed in the presbytery, behind the high-altar; and here, and in the choir aisles, were frequently placed the monuments of the abbots, and of founders and distinguished benefactors of the house; sometimes heads of the house and founders were buried in the chapter-house.

It would require a more elaborate description than our plan will admit to endeavour to bring before the reader's mind's-eye one of these abbey churches



A SEMI-CHOIR OF MINORESSES.

before its spoliation;—when the sculptures were unmarred and the paintings fresh, and all the windows filled with their stained glass, and the choir was hung with hangings, and banners and tapestries waved from the arches of the triforium, and the altar shone gloriously with jewelled plate, and the monuments of abbots and nobles were still perfect, and the wax tapers burned night and day* in the hearses, twinkling on the solemn effigies below, and glancing upon the tarnished armour and the dusty banners which hung over the tombs, while the cowed monks sat in their stalls and prayed. Or when, on some high festival, the convent walked round the lofty aisles in procession, two and two, clad in rich copes, preceded by cross and banner, with swinging censers pouring forth clouds of incense, while one of those angel boy's voices which we still sometimes hear in cathedrals chanted the solemn litany; the pure sweet ringing voice floating along the vaulted aisles until it was lost in the swell of the choruses of the whole procession, *Ora! Ora! Ora! pro nobis!*

The Cloister was usually situated on the south side of the nave of the church, so that the nave formed its north side, and the south transept a part of its eastern side; but sometimes, from reasons of local convenience, the cloister was on the north side of the nave, and then the relative positions of the other buildings were similarly transposed.

The Chapter-house was always on the east side of the court. In establishments of secular canons it seems to have been always multisided,† with a central pillar to support its groining, and a lofty, conical, lead-covered roof. In these instances it is placed in the open space eastward of the cloister, and is usually approached by a passage from the east side of the cloister court. In the houses of all the other orders‡ the chapter-house is a cathedral. Usually, then, the chapter-house is a rectangular building on the east side of the cloister, and frequently its longest axis is

proper stall, robed in cope and amice, mitre and crozier, beating time to the chant; a kneeling canon supports the bishop's service-book.

* Henry VII. agreed with the Abbot and Convent of Westminster that there should be four tapers burning continually at his tomb—two at the sides, and two at the ends, each eleven feet long, and twelve pounds in weight; thirty tapers, &c., in the hearses; and four torches to be held about it at his weekly obit; and one hundred tapers nine feet long, and twenty-four torches of twice the weight, to be lighted at his anniversary.

† The chapter-houses attached to the cathedrals of York, Salisbury, and Wells, are octagonal; those of Hereford and Lincoln, decagonal; Lichfield, polygonal; Worcester is circular. All these were built by secular canons.

‡ There are only two exceptions hitherto observed: that of the Benedictine Abbey of Westminster, which is polygonal; and that of Thornton Abbey, of regular canons, which is octagonal.

east and west—at Durham it has an eastern apsis. It was a large and handsome room, with a good deal of architectural ornament; often the western end of it is divided off as a vestibule or ante-room; and generally it is so large as to be divided into two or three aisles by rows of pillars. Internally, rows of stalls or benches were arranged round the walls for the convent; there was a higher seat at the east end for the abbot or prior, and a desk in the middle from which certain things

were read. Every day after the service called *Fierce*, the convent walked in procession from the choir to the chapter-house, and took their proper places. When the abbot had taken his place, the monks descended one step and bowed; he returned their salutation, and all took their seats. A sentence of the rule of the order was read by one of the novices from the desk, and the abbot, or in his absence the prior, delivered an explanatory or hortatory sermon upon it; then, from another portion of the book was read the names of brethren, and benefactors, and persons who had been received into fraternity, whose decease had happened on that day of the year; and the convent prayed a *requiescant in pace* for their souls, and the souls of all the faithful departed this life. Then members of the convent who had been guilty of slight breaches of discipline confessed them, kneeling upon a low stool in the middle, and on a how from the abbot, intimating his remission of the breach, they resumed their seats. If any had a complaint to make against any brother, it was here made and adjudged. Convent business was also transacted. The wood-cut gives an example of the kind. Henry VII. had made grants to Westminster Abbey, on condition that the convent performed certain religious services on his behalf; and in order that the services should not fall into disuse, he directed that yearly, at a certain period, the chief-justice, or the king's attorney, or the recorder of London, should attend in chapter, and the abstract of the grant and agreement between the king and the convent should be read. The grant which was thus to be read still exists in the British Museum; it is written in a volume superbly



MONKS AND LAWYERS.

bound, with the royal seals attached in silver cases; it is from the illuminated letter at the head of one of the deeds that our wood-cut is taken. It rudely represents the chapter-house, with the chief-justice and a group of lawyers on one side, the abbot and convent on the other, and a monk reading the grant from the desk in the midst.

Dividing the south transept from the chapter-house is usually a narrow apartment; the description of Durham, drawn up soon after the Dissolution, says that it was the "Locutory." In other cases it seems to be merely a passage from the cloister-court to the space beyond.*

* In which space the abbot's lodging is often situated, so that it may have been the abbot's entrance to the

Again, on the other (south) side of the chapter-house is often found a small apartment, which some have conjectured to be the penitential cell.*

The Refectory, or Frater, was the dining-hall of the convent. It is sometimes on the east side of the court, ranging with the south transept and the chapter-house, and running north and south, and has the kitchen behind it: this seems to be especially a Cistercian arrangement. In other cases, it forms the south side of the cloister court, lying parallel with the nave of the church. Very commonly it has a row of pillars down the centre, to support the groined roof. It was arranged, like all mediæval halls, with a dais at the upper end and a screen at the lower. In place of the oriel window of mediæval halls, there was a pulpit, which was often in the embrasure of a quasi-oriel window, in which a novice read some edifying book during meals.

The remaining apartments of the cloister-court it is more difficult to appropriate. In some of the great Cistercian houses whose ground-plan can be traced—as Fontaines, Salley, Netley, &c.—we believe that the long apartment which is formed on the west side of the cloister was the hall of the Hospitium, with chambers over it.

About the middle of the south side there is a long room, whose longer axis lies north and south; and a smaller room on each side of it. We can only conjecture that the larger of these may have been the Miscroecord, a room to which the monks retired after refectory to converse, and to take their allowance of wine, or other indulgences in diet which were allowed to them; and some quotations in Fosbroke would lead us to imagine that the monks dined here on fast days. It would answer to the great chamber of mediæval houses, and in some respects to the Combination-room † of modern colleges.

The Dormitory in these Cistercian houses, we believe, was over the refectory, and the Scriptorium over the chapter-house. But in the uncertainty which at present exists on these points of monastic arrangement, we cannot speak with any degree of certainty; but we throw together some data on the subject in the subjoined note. ‡ What we have called the hospitium, with chambers over it, Mr. Bloxam would call an ambulatory, with the dormitory over it. The Dormitory, wherever situated, was a long room, with a vaulted or open timber roof, with the pallets arranged in rows on each side against the wall. The prior or sub-prior usually slept in the Dormitory, with a light burning near him, in order to maintain order. The monks

church and chapter. Other conjectures are that it may have been sometimes the vestry. At Netley it has a door at the west, with a trefoil light over it, a two-light window at the east, two niches, like monumental niches, in its north and south walls, and a piscina at the east end of its south wall.

* This we believe to be a mere vague conjecture, but we are not prepared to offer any other explanation of its use.

† A room adjoining the hall, to which the fellows retire after dinner to take their wine and converse.

‡ The above appropriation of the rooms which surround the cloister-court differs, in some respects, from that given by recent writers, whose opinion is entitled to great respect. What we have called the refectory, Mr. M. H. Bloxam would call an ambulatory; and the large room on the south side of the cloister, the refectory. Mr. Walbran, in his description of Fontaines Abbey, agrees with Mr. Bloxam in calling the latter the refectory; but he calls the former the frater-house (a term which is usually considered to apply to the refectory).

In the plan of the thirteenth century Benedictine monastery of St. Gall, published in the *Archæological Journal* for June, 1848, the dormitory is on the west, with the piscinas under it; the refectory on the south, with the clothes-store above; the cellar on the west, with the larders above. In the plan of Canterbury Cathedral, a Benedictine church, as it existed in the latter half of the twelfth century, the church was on the north, the chapter-house and dormitory on the east, and the refectory, parallel with the church, on the north, and the cellar on the west. At the Benedictine monastery of Durham, the church was on the north, the chapter-house and dormitory on the east, the refectory on the south, and the dormitory on the west. At the Augustinian Regular Priory of Bridlington, the church was on the north, the frater (refectory) on the south, the chapter-house on the east, the dormitory on the east, up a stair twenty steps high, and the west side was occupied by the prior's lodgings.

At the Franciscan Abbey of Easby, the church is on the north, the transept, passages, chapter-house, and small apartments on the east, the refectory on the south, and on the west two large apartments, with a passage between them. The Rev. J. F. Turner, Chaplain of Bishop Cosin's Hall, Durham, describes these as the common house and kitchen, and places the dormitory in a building west of them, at a very inconvenient distance from the church.

slept in the same habits* which they wore in the daytime.

The Abbot's Lodging sometimes formed a portion of one of the monastic courts, as at St. Mary, Bridlington, where it formed the western side of the cloister-court; but more usually it was a detached house, precisely similar to the contemporary unfortified houses of laymen of similar rank and wealth. No particular site relative to the monastic buildings was appropriated to it; it was erected wherever was most convenient within the abbey enclosure. The principal rooms of an abbot's house are the Hall, the Great Chamber, the Kitchen, Buttry, Cellars, &c., the Chambers, and the Chapel. We must remember that the abbots of the greater houses were powerful noblemen; the abbots of the smaller houses were equal in rank and wealth to country gentlemen. They had a very constant succession of noble and gentle guests, whose entertainment was such as their rank and habits required. All this involved a suitable habitation and establishment; and all this must be borne in mind when we endeavour to picture to ourselves an abbot's lodging. To give an idea of the magnitude of some of the abbot's houses, we may record that the hall of the Abbot of Fontaines was divided by two rows of pillars into a centre and aisles, and that it was 170 feet long by 70 feet wide. † Half a dozen noble guests, with their retinues of knights and squires, and men-at-arms and lacqueys, and all the abbot's men to boot, would be lost in such a hall. On the great fast-days it might, perhaps, be comfortably filled; but even such a hall would hardly contain the companies who were sometimes entertained, on such great days—for instance, as an abbot's installation-day, when, it is on record, that an abbot of one of the greater houses would give a feast to three or four thousand people.

Of the lodgings of the superiors of smaller houses, we may take that of the Prior of St. Mary's, Bridlington, as an example. It is very accurately described by King Henry's commissioners; it formed the west side of the cloister-court; it contained a hall, with an undercroft, eighteen paces ‡ long from the screen to the dais, and ten paces wide; on its north side a great chamber, twenty paces long and nineteen wide; at the west end of the great chamber the prior's sleeping-chamber, and over that a garret; on the east side of the same chamber a little chamber and a closet; at the south end of the hall the buttry and pantry, and a chamber called the Auditor's Chamber; at the same end of the hall a fair parlour, called the Low Summer Parlour; and over it another fair chamber, and adjoining that



A PRESENT OF FISH.

three little chambers for servants; at the south end of the hall the Prior's Kitchen, with three houses covered with lead, and adjoining it a chamber called the South Cellarer's Chamber. §

There were several other buildings of a monastery, which were sometimes detached, and placed as convenience dictated. The Infirmary especially seems to have been more commonly detached; in many cases it had its own kitchen, and refectory, and chapel, and chambers, which sometimes were arranged round a court, and formed a complete little separate establishment.

* The ordinary fashion of the time was to sleep without any clothing whatever.

† The hall of the Royal Palace of Winchester, erected at the same period, was 111 feet by 53 feet 9 inches.

‡ Its total length would perhaps be about twenty-four paces.

§ The above wood-cut, from the Harleian MS., 1527, represents, probably, the cellarer of a Dominican convent receiving a donation of a fish. It curiously suggests the scene depicted in Sir Edwin Landseer's "Bolton Abbey in the Olden Time."

ranged round a court, and formed a complete little separate establishment.

The Hospitium, or Guest-house, was sometimes detached; but more usually it seems to have formed a portion of an outer court, westward of the cloister-court, which court was entered from the great gates, or from one of the outer gates of the abbey. In Cistercian houses, as we have said, the guest-house, with its hall below and its chambers above, probably occupied the west side of the cloister-court, and would therefore form the eastern range of buildings of this outer court. At St. Mary's, Bridlington, where the prior's lodging occupied this position, the "lodgings and stables for strangers" were on the north side of this outer court. The guest-houses were often of great extent and magnificence. The Guesten-hall of St. Augustine's, Canterbury, still remains, and is a very noble building, 150 feet long by 50 broad, of Norman date, raised on an undercroft. The Guesten-hall of Worcester also remains, a very noble building on an undercroft, with a fine carved timber roof, and portions of the painting which decorated the wall behind the dais still remaining.* Besides the hall, the guest-house contained often a great-chamber (answering to our modern drawing-room) and sleeping-chambers, and often a chapel, in which service was performed for guests—for in those days it was the custom always to hear prayers before dinner and supper.

Thus, at Durham, we are told that a famous house of hospitality was kept within the abbey garth, called the Guest-hall, and was situate in the west side, towards the water. The terror of the house was the master thereof, as one pointed to give entertainment to all estates, noble, gentle, or what other degree soever came thither as strangers. Their entertainment was not inferior to that of any place in England, both for the goodness of their diet, the clean and neat furniture of their lodgings, and generally all things necessary for travellers; and, with this entertainment, no man was required to depart while he continued honest and of good behaviour. This hall was a stately place, not unlike the body of a church, supported on each side by very fine pillars, and in the midst of the hall a long range for the fire. The chambers and lodgings belonging to it were kept very clean and richly furnished.

There is a passage in the correspondence of Colliingham Priory (published by the Surtis Society, 1841, p. 52) which gives us a graphic sketch of the arrival of guests at a monastery:—"On St. Alban's-day, June 17 [year not given—it was towards the end of Edward III.], the two monks, with a company of certain secular persons, came riding into the gateway of the monastery about nine o'clock in the morning. This day happened to be Sunday, but they were hospitably and reverently received, had lodgings assigned them, a special mass service performed for them, and after a refectory and washing their feet, it being supposed that they were about to pursue their journey to London the next morning, they were left at an early hour to take repose. While the bell was summoning the rest of the brotherhood to vespers, the monk who had been in attendance upon them (the hospitaller) having gone with the rest to sing his chant in the choir, the secular persons appear to have asked the two monks to take a walk with them to look at the Castle of Durham," &c. †

There could hardly have been any place in the middle ages which could have presented such a constant succession of picturesque scenes as the Hospitium of a monastery. And what a contrast must often have existed between the Hospitium and the Cloister; here a crowd of people of every degree—nobles and ladies, knights and dames, traders with their wares, minstrels with their songs and juggling tricks, monks and clerks, palmers, friars, beggars—bustling about the court or crowding the long tables of the hall; and, a few paces off, the dark-frobed monks, with faces hurried in their cowls, pacing the ambulatory in silent meditation, or sitting at their meagre refectory, enlivened only by the monotonous sound of the novice's voice who is reading a homily from the pulpit ‡.

* See an account of this hall, with pen-and-ink sketches, by Mr. Street, in the volume of the Worcester Architectural Society for 1854.

† Quoted by Archdeacon Churton in a paper read before the Yorkshire Architectural Society in 1852.

‡ The cut represents a group of Cistercian monks, from

Many of the remaining buildings of the monastery were arranged around this outer court. Ingulphus tells us that the second court of the Saxon monastery of Croyland (about 875 A.D.) had the gate on the north, and the almshouse near it—a very usual position for it; the shops of the tailors and



GROUP OF CISTERCIAN MONKS.

shoe-makers, the hall of the novices, and the abbot's lodgings on the east; the guest-hall and its chambers on the south; and the stable-house, and granary, and bake-house on the west. The Gate-house was usually a large and handsome tower, with the porter's lodge on one side of the arched entrance, and often a strong room on the other, which served as the prison of the manor-court of the convent, and often a handsome room over the entrance, in which the manorial court was held. In the middle of this court was often a stone Cross, round which markets and fairs seem often to have been held.

In the "Vision of Piers Plouhman" an interesting description is given of a Dominican convent of the fourteenth century. We will not trouble the reader with the very archaic original, but will give him a paraphrase of it. The ploughman, on approaching, was so bewildered by the magnitude and beauty, that for a long time he could distinguish nothing, certainly but stately buildings of stone, pillars carved and painted, and great windows well wrought. He enters the quadrangle, and notices the cross standing in the centre, surrounded with tabernacle-work; he enters the minster (church), and describes the arches carved and gilded, the wide windows full of shields of arms and merchants' marks on stained glass, the high tombs under canopies, with effigies, armed, in alabaster, and lovely ladies lying by their sides in many gay garments. He passes into the cloister and sees it pillared and painted, and covered with lead and paved with tiles, and conduits of white metal pouring their water into bronze (latten) lavatories beautifully wrought. The chapter-house he says was wrought like a great church, carved and painted with seemly stalls, like a parliament-house. Then he went into the frater, and found it a hall fit for a knight and his household, with broad boards about and clean benches and windows, wrought as a church. Then he wandered all about—

"And seigh halles ful heigh, and houses ful noble,
Chambres with chynneys, and chapelles gaye,
And kychees for an high kynge in castels to holden,
And their dormere yight with dorens ful stronge,
Fermerye, and frater, with fole more houses,
And all strong stone wall, stein open herthe,
With gay garites and grete, and ich hole yglased,
And other houses ynowe to herberwe the queene."

Every monastery had a number of dependent establishments of greater or less size; cells on its distant estates; granges on its manors, chapels in places where the abbey tenants were at a distance from a church; and often hermitages under its protection. Of the monastic cells we have already spoken in describing the office of prior. The one or two brethren who were placed in a cell to manage the distant estates of the monastery would probably be chosen rather for their qualities as prudent stewards than for their piety; the com-

a MS. (Vitellus A. 13) in the British Museum. It shows some of them sitting with hands crossed and concealed in their sleeves—an attitude which was considered modest and respectful in the presence of superiors.

mand of money which their office gave them, and their distance from the supervision of their ecclesiastical superiors, brought them under temptation, and it is probably in these cells, and among the brethren who superintended the granges, and the officials who could leave the monastery at pleasure on the plea of convent business, that we are to look for the irregularities of which the middle age satirists speak. The monk among Chaucer's "Canterbury Pilgrims" was prior of a cell, for we read that—

"When he rode, men might his bridel here
Gingeling in a whistling sound, as clere
And eke as loud, as doth the chapel belle
Ther as this lord was keeper of the celle."

The monk on whose intrigue "The Shipman's Tale" is founded, was probably the cellarer of his convent:—

"This noble monk, of which I yow devio,
Hath of his abbot, as him list, licence;
Because he was a man of high prudence,
And eke an other, out for to ride
To seen his granges and his barnes wide."

The abbot, too, sometimes gave licence to the monks to go and see their friends, or to pass a few days at one or other of the manors of the house for recreation; and sometimes he took a monk with him on his own journeys. In a MS. romance, in the British Museum (Add. 10,293, f. 11), is a representation of a monk with his hood on, journeying on horseback. We give here, from the St. Alban's Book (Nero, D. vii.), a cut of an abbot on horse-



AN ABBOT TRAVELLING.

back, with a hat over his hood; he is giving his benediction in return to the salute of some passing traveller.

The hermitages or anchorages which were dependent on a monastery, were not necessarily occupied by brethren of the monastery, but by any one desirous to embrace this mode of life whom the convent might choose. The monastery often supplied the hermit with the scanty fare which he needed; in a picture in the MS. romance, before quoted (Add. 10, 292, f. 98), is a representation of a knight-errant on horseback, conversing by the way with a clerk, who is carrying bread and wine to a hermitage.

The wood-cut with which we conclude, from the Harleian MS. 1527, represents the characteristic



BISHOP, ABBOT, AND CLERK.

costume of three orders of religions with whom we have been concerned—a bishop, an abbot, and a clerk.

THE ROYAL PICTURES.

THE CHILDREN OF CHARLES I.

Van Dyck, Painter. J. Burnet, Engraver.
Size of the Picture 5 ft. by 4 ft. 4 in.

TITLES conferred upon the illustrious are honourable alike to the giver and the recipient, but they are soon lost sight of in the lapse of time, and the man who may have "borne his blushing honours thick upon him" is known to future ages only by the simple name which his genius redeemed from oblivion. Bacon, Nelson, Wellington, and many other great men, require no lordly title to tell the world who they were—neither does Rubens nor Van Dyck his prefix of knighthood as a mark of distinction.

Sir Anthony Van Dyck was born at Antwerp, in 1599. His father, to whom he owed his earliest instructions in drawing, is said to have been a glass-painter of Hertogenbasch; and some biographers state that his mother, who excelled as a painter of landscape, aided in the work of tuition. But his first master of any eminence was Van Balen, an artist of good reputation, with whom he remained two years, and at the expiration of that time, being then in his sixteenth year, Van Dyck became a pupil of Rubens, whose boldness of style, both in composition and colour, was more congenial to the genius of the young student than the delicate manner of Van Balen. He continued in the studio of Rubens five years, and then, by the advice of his preceptor, or, as some say (without, as we believe, sufficient grounds), instigated by the jealousy of Rubens, quitted him to pursue his studies in Italy.

During his six years residence in this land of Art, Van Dyck visited Venice, Genoa, Florence, and Rome. In the last-named city he was much patronised, and lived in great style. On his return to Antwerp, though he had already given good proof of his abilities in historical painting, he was compelled to have recourse to portraiture; but even in this he found fewer engagements than he anticipated, although the Prince of Orange invited him to the Hague, where he painted several portraits of illustrious personages attached to the court. He therefore quitted the country to try his fortune in Paris; but meeting with little success, once more returned to Holland, where, about this time, he heard of the encouragement which the English monarch, Charles I., was then affording to Art. Some of Van Dyck's biographers state that the king requested Sir Kenelm Digby, who had sat to the painter, to invite him to his court; others, that the Earl of Arundel, also a most liberal patron of the Arts, invited him to this country. However it may be, he came to England, was lodged by the king at Blackfriars, received the honour of knighthood soon after his arrival, and in the following year an annual pension of £200 was granted him for life. England, therefore, has a right to claim the merit of fostering and developing the genius of one of the greatest portrait-painters of his age, as she has the honour of holding his ashes. Van Dyck died in London, in 1641, and was buried in the cathedral of old St. Paul's.

Opportunity will be hereafter afforded when other engravings from the pictures of this artist are introduced,—and several are in preparation,—to comment upon the excellences of his style; for the present our observations must be limited to the work before us. The children of his patron, Charles I., who are here represented, are—Prince Charles, afterwards Charles II.; the Duke of York, afterwards James II.; and the Princess Mary, who married the Prince of Orange, and was the mother of William III. It is a beautiful picture in composition and colour—"the most original and the most charming," as Mrs. Jameson remarks, "of the numerous pictures of the same subject scattered through various collections." It was formerly in Buckingham Palace, and was taken thence to Windsor Castle, where it now hangs. Among the best duplicates of this painting, from the pencil of the artist,—and there are several,—are those respectively in the Royal Gallery of Dresden, in that of Turin, and in the possession of the Earl of Pembroke, at Wilton House.

The subject is well known to collectors of fine engravings by the prints executed by Sir Robert Strange, and by Le Bloude. There is also a fine lithograph of it by Haefstingel.



Faint, illegible text, possibly bleed-through from the reverse side of the page. The text is arranged in several columns and appears to be a formal document or report.



SCOTT AND SCOTLAND.*

THE "Lord of the Isles" forms the fourth volume of Scott's principal poems, which Messrs. A. and C. Black, of Edinburgh, have published as a richly illustrated "Christmas-book," the former poems that have appeared in previous consecutive volumes being, the "Lady of the Lake," the "Lay of the Last Minstrel," and



"Marmion." Of the whole of these the courtesy of the publishers has enabled us to afford our readers an opportunity of testing the merits of the illustrations; the present page places before them examples of the wood-cuts introduced into the volume just issued, the "Lord of the Isles."

The first we have selected opens on Canto 6: the view, it is presumed, takes in Stirling Castle, at the time referred to in the poem,— "Beleaguered by King Robert's powers,"—as the last stronghold, northward of the Tweed, retained by Edward II., but now reposing in peaceful serenity, and overlooking a country whose fields are laden with the golden grain. The second engraving shows Lord Ronald's fleet unmooring from Aros Bay, as described in Canto 1. The group of figures at the top of the page illustrates an incident in the cavern, when Bruce and Roland discover "the slender boy." The fourth



illustration represents Ronald and Duuvegian's chief in the presence of Bruce and his brother Edward, in the Castle of Astornish, at midnight, described in Canto 3.

* LORD OF THE ISLES. By SIR WALTER SCOTT, BART. With all his Introductions, and the Editor's Notes. Illustrated with Eighty Engravings on Wood, from Drawings by BRUCE FOSTER and JOHN GILBERT. Published by A. and C. BLACK, Edinburgh.

Scott's "Lord of the Isles" has not, we believe, been considered so interesting a poetical tale as the author's other poems of a similar character. "In so far as it is founded on historical truth," wrote Mr. Jeffrey, in the *Edinburgh Review*, "it seems to us objectionable, both for want of incident and want of variety and connection in the incidents that occur. There is a romantic grandeur, however, in the scenery, and a sort of savage greatness and rude antiquity in many of the characters and events which relieve the insipidity of the narrative,



and atones for many defects in the execution." The qualities pointed out by the reviewer we would regard as those which peculiarly adapt it for the pencil of the artist; and unquestionably Messrs. Gilbert and Foster have made a judicious selection from the numerous graphic scenes with which the poem abounds. As illustrations of the "savage greatness" of character alluded to by Jeffrey, we should point out two remarkably spirited designs by Gilbert—"Edith kneeling before De Argentine," and Bruce standing over the ruffian whom he has slain in



the cavern. A picturesque and "Turnesque" bit of landscape scenery is Foster's "Carrick Castle;" and the moonlight scene in the same Canto, the fifth; but we might occupy our page with references to the many beauties scattered throughout the volume. To remark that this edition of the "Lord of the Isles" surpasses "Marmion" and the others, would be saying too much; but it certainly equals any, and this is sufficient praise; unquestionably four volumes more exquisitely adorned with wood-cuts have never issued from the press.

THE DUTCH LANDSCAPE AND FLOWER-PAINTERS.

BY F. W. FAIRHOLT, F.S.A.

WITH ILLUSTRATIONS FROM ORIGINAL SKETCHES BY THE AUTHOR.

LANDSCAPE-PAINTING, as an independent art, is the youngest of the category. Beautiful as were the background views introduced into the works of the old painters, they were backgrounds merely, and secondary to the main intention of the picture. As an art self-reliant in its claims, it does not appear to have come boldly forth, and willing to stand on its own merits, before the close of the sixteenth century. It is to the artists of the Low Countries that we owe this now popular branch of Art. The landscape backgrounds of the early German and Flemish masters certainly originated the art, but it was the later painters of Holland who perfected its power. Appended to Nagler's remarks, in his "Handbook of Painting," that "Landscape, in the hands of Titian and Giorgione, sometimes assumed an independent character, and it is said that Titian was the first to treat it as a separate branch of Art," we have this note, by Sir Charles Eastlake—"Landscape-painting in Italy, however independent in its perfection, appears in its origin to have been indebted, in more than one instance, to a German influence. Vasari distinctly says that Titian kept some German landscape-painters in his house, and studied with them for some months. In Bologna it is probable that Denys Calvert, a Flemish artist, first excited the emulation of the Carracci, Domenichino, and others, who, in the end, formed so distinguished a school of landscape-painters. In both these instances a certain resemblance to the German manner, however differently modified by the character of the schools, is to be recognised, especially in the unbelittled treatment of the foliage." It is impossible for any student of mediæval Art not to have been frequently struck by the great beauty of the landscape backgrounds introduced into the historic or religious pictures of that period. It is true that they are always conventionally treated, and rendered subservient to the ruling *motive* of the picture; but we cannot wonder that landscape should eventually assert its own sole power of charming, by the repose and beauty it imparts, even when used as a simple accessory. The works of Van Eyck, Memling, and Durer, frequently allow landscape to share at least one half of the attention of the spectator; and they appear to have intended this, to give a certain *air* to their compositions which would else be wanting. It was their avowed object to delineate great space, and they did this by invariably carrying the eye of the spectator to the extreme distance of the view by concentrating the light upon the horizon: nothing can exceed the brilliancy, beauty, clearness, and depth of space exhibited in these early works. It induced others of the school to go further, and make the figures in a historical or religious picture secondary to it; but it was not until the beginning of the seventeenth century that the grand conceptions of Poussin and Rubens gave entire independence to this branch of Art, and proved its innate power to command alone its own tribe of worshippers. The Dutch painters afterwards persevered in the new track until the triumph was complete.

The fantastic redundancy of details, the conventional forms of trees, and the equally conventional treatment of the general effect in very early landscapes by the artists of the Low Countries, were completely cast aside in the grander and truer works which resulted from the *ateliers* of Holland. Annibal Carracci had sometimes devoted himself to the delineation of the scenery of the Apennines; and contemporary with him there lived at Rome Paul Brill, who, born at Antwerp, combined the taste of his native school with that of the greater Italian. Suddenly, a series of landscape-painters appear upon the stage, and the early parts of the century saw the master-minds of Poussin and Rubens, joined by Claude, the most charming of all. He received his early training from the Fleming, Paul Brill; and one great trait of the early school is visible in his works—the love of repose, and the idea of air and space, given by condensing the light on the horizon, or in the extreme distance of the picture. The ideal beauty thus evolved in the works of these great men kept up and stimulated the school of landscape-

painters in the Low Countries, and contemporary with Claude and John Beth, were Jacob Ruysdael, John Wynants, John Baptist Wenix, and his greater pupil, Nicholas Berghem, who were all occupied on landscape solely; while such master-minds as those of Cuyt and Potter made its beauties an integral part of their immortal works. Rembrandt had devoted his powerful genius to the display of effects hitherto undeveloped in the art, and the grandeur with which he invested a simple landscape by the aid of powerful chiaro-oscuro, and the study of storm and sunshine, as in his famous "Three Trees," vindicated the

art from a low level, and gave it a position that only the genius of our own great Turner could elevate.

This youngest daughter of the Arts, though unquestionably the favourite of the public, has been received by her sisters in some degree as an interloper, and her claim to equal sympathy denied. Surely this is unjust: is God's beautiful world less to be valued, or less worthy our study, than the world of man's passion? "Rocks, trees, mountains, plains, and waters," says Leslie, "are the features of landscape: but its expression is from above. The love of landscape is a love so pure that it can never



DUTCH TREES.

associate with the relishes of a mere voluptuary, and wherever such a love is native, it is the certain indication of a superior mind." Constable declared of one of Gainsborough's landscapes, "I cannot think of it, even now, without tears in my eyes." How many of Constable's pictures are redolent of all the freshness of earth's beauties! so fresh, so pure, that we may almost exclaim with Gray—

"I feel the gales that from ye blow
A momentary bliss bestow."

Any enquiry on Turner, whose pictures are poems

would be inappropriate here: an abler pen has enforced his claims to honour. We would merely remark that it is unbecoming in Englishmen, at any rate, to depreciate this lovely art—for, rivalled as we may be in other branches, in this the genius of English painters is acknowledged to be supreme.

In the pictures by Ruysdael there is a grandeur of composition and a boldness of treatment which belong to no other Dutch landscape-painter. He alone displays mountain scenery and foaming cataracts, which must have been idealisations in a great degree—he could not have studied the grand fea-



STREET IN HAARLEM.

tures he depicts in the monotony of his own land, which some authors assure us he never quitted. It has been conjectured that he rambled to Guelderland and Westphalia; but, allowing this, he must have exaggerated what he could see there, to produce the noble mountains and boldly-dashing waterfalls he delighted to depict.* He was born at

Haarlem in 1636, and was the son of a picture-frame-maker. Of a gloomy and reserved temper, he lived alone, and died poor in 1681; yet his works have a rare excellence. The ideal quality invests his scenes is gloomily grand, worthy of

* It has been asserted that Ruysdael constructed models to paint from, composed of small twigs and fractured stones, which he exaggerated into trees and mountains, and so composed his works. Such antagonism might be doubted, had we not other instances where the artistic

mind has been stimulated by the very opposite means that would ordinarily be supposed were used. Thus it is known of Guido that his most beautiful female heads were painted from a male colour-grinder, who is described as perfectly hideous, and whose features were transformed into a Magdalen, with the same *pose* and *chiaro-oscuro*, but with perfect beauty; the artist evidently using his model as a means of producing beauty by contrast alone.

the solitary man who lived only for his art, and saw only the severe or terrible features of nature. If he painted a native scene, which seldom occurred, it is invested with the mournful gloom of Holland, rather than with the happier features depicted by other artists. His pictures are to landscape-art what the Spanish school is to the French—vigorous and grand, but terrible. His scholars, Hobbema and De Vries, lose his gloom; but the former retains much of his grandeur, though devoted to less ambitious scenes.

Casting away all lugubrious views of his own country, Berghem delighted in representing simple nature in full joyousness. In this quality he differs from most masters of the Dutch school. He is the very reverse of his friend Ruysdael. The gloomy grandeur of his solitary and poetic mind impresses itself on the scenes he depicts; and you cannot study them without a feeling of "divine melancholy" creeping over the mind. Berghem, on the contrary, delights in bright skies, light clouds, and cheerful pastoral scenes. Unlike Ruysdael, he seeks not northern gloom, but rather southern sunshine. He was born at Haarlem in 1624, and was the son of Van Haarlem,* a painter of very moderate ability, who lived by delineating those pictures of still-life in which the Hollanders delighted. He had, however, excellent instruction from the artists who knew his father, and who liked the cheerful disposition of the son; and his uncle Weenix, whose daughter he married, improved his tastes. He was intimate in the best part of his life with Wouvermans, Everdingen, Both, and Ruysdael; and his time passed happily in the varied society of such friends. With them, or with nature, or else in delineating her better features in his own studio, he knew peace; but not with his wife, who was in disposition sordid, while the painter possessed the gentleness of soul which flows forth on his canvas. It is related of her that she constantly spurred him to exertion, by knocking against the wall of his studio; and kept his earnings, that he might not indulge his taste for old prints. In the Chateau of Beutheim, where he resided, he had but to walk to the windows of his studio to gaze on green meadows, luxuriant trees, and cattle in every variety of grouping. Some writers affirm that he must have travelled to Italy; and could not have obtained by the aid of his own large collection of prints the ruins and temples he so well depicted in some of his works. They do not, however, sufficiently take into consideration the great constructiveness of some artistic minds—the way they comprehend one object through another. All Berghem's southern scenes are really translated into Dutch. His power of imitation is known to have been so great, that he could deceive connoisseurs by painting in the precise style of other artists.

He had many pupils, among whom the only happy hours of his life passed. Karel Dujardin is conjectured to have been one; but he certainly taught Peter de Hooze, Dirk Maas, and Artus Van der Neer. This latter artist delighted to paint the effects of evening and night. "A piece of water in a wood, surrounded by high dark trees; a lonely canal, whose tranquil surface reflects the light of the moon; a city in repose, steeped in the quiet moonlight—sometimes the calm peacefulness of night broken by the glaring light of a conflagration; these are the subjects which Van der Neer delighted to repeat in the most free and pleasing style; and with these he again and again rivets the eyes of the spectators."† In our National Gallery we possess a charming specimen of his power of conveying the peculiar effects of moonlight—an effect which could not be secured by sketching, and therefore argues a most retentive memory for the varied hues of nature.

There is another and a distinct class of students of nature whom the Dutch school originated—they who "represent what may be called the still-life of field-plants, under whose friendly shelter beetles and lizards, little birds, and snakes, pass their unheeded existence;"‡ or who depict the magnificent bouquets

in richly-sculptured vases, with which the rich merchant princes of Holland decorated their mansions; or else dispose of them in "most admired disorder, strewn upon a table, or entwined around a picture or bas-relief." John Breughel was one of the earliest artists who delighted in making pictures of these "stars of the earth;" and he was succeeded and outstripped by his scholar, Daniel Seghers, who first grouped their forms and colours into harmonious conjunction, and carried high principles of composition into his works. A peculiar poetic feeling also pervades the flower-painting of David de Heem; and from his atelier proceeded many excellent scholars, and among them some few ladies, to

whom the art has always presented charms. The most celebrated lady flower-painter was Rabel Ruysch, who flourished in the latter half of the seventeenth and beginning of the eighteenth century. At the same period lived John Van Iluysum, whose flowers are said to want only perfume to make them real.

This celebrated artist was born at Amsterdam in 1682, and was the son of a house-decorator. The incidents of his life consist, as usual with Dutch artists, of the catalogue of his works. Between painting at home and visiting the flower-gardens of Haarlem, his days passed quietly away. He died in 1749, after having enjoyed great patronage for



DUTCH GARDEN, 1653.

his works, which were sold at a high rate, and were sought for by most of the European sovereigns and nobles.

The taste for decorative gardening and rare flowers was at this period carried to the greatest extent. Men would ruin themselves to possess a certain tulip-bulb; the records of no country produce parallels to the mania for flowers which once beset the Hollanders. Haarlem was the grand centre of their growth, and thither came rich amateurs from all parts of Holland, as well as from distant countries.* The flower-gardens of this city are still famous, and hyacinth-bulbs are even now sent from thence to all parts of Europe. One of Captain Cook's com-

panions declared that when at sea, opposite the coast beyond Haarlem, when the wind set from the land, "through the placid atmosphere we could distinguish the balsamic odour of the hyacinth and other flowers." There can be no more beautiful sight than these Dutch gardens, with their glorious beds of flowers. The soil of Holland seems to suit their growth, and the brightness of their hues contrasts forcibly with the deep green of the trees and hedges. Wherever you travel in this country you see this love of pleasure-gardens; and over the decoration and "stock" large sums of money are expended. Rows of summer-houses, gay with the brightest colours line the canals, each inscribed



A MODERN DUTCH GARDEN.

with a name or motto, as "Rosenthal," "Lilienthal," &c., or "Lust en rust" (Pleasure and ease), "Niet zoo zwaayk" (Not so hard), "Vriendschap en gezelschap" (Friendship and sociality), "Het vermaak is in't hovenieren" (There is pleasure in gardening), &c. Here the men smoke and the ladies knit, amusing themselves with looking out

on the passers-by. In front of its windows a canal or ditch stagnates, its waters only disturbed by the passage of a boat, or the splash of the enormous water-rats or frogs with which they abound. Thus, in the words of Beckford, "Every flower that wealth can purchase diffuses its perfume on one side; while every stench a canal can exhale poisons the air on the other." The gardens of the ancient châteaux of Holland were much more artistic than the modern: arcades were formed of clipped yews, or trained creepers, over trellises supported by caryatides, as shown in our cut from a Dutch print dated 1653. Now they are generally quite square, bounded by clipped hedges, with every walk geometrically

* The name he is popularly known by is a *sobriquet*, which originated, it is said, in his escaping from the indignation of some chastisement from his father's house to that of the painter Van Goyen, who, fearful that the irritated parent should reach him, called to the inmates, *Zeyt hem* (or, hide him).

† Kugler's "Handbook of Painting."

‡ Idem.

* It is recorded that the anemone was first brought to England from a Dutch garden, whose proprietor was so chary of his flowers that on no consideration would he part with plant or seed. The visitor accordingly arrayed himself in a shaggy great coat, which brushed the seed from the plant in passing, and which was carefully gathered after his departure from the garden from the folds of the garment.

true, and embellished with rows of stiff poplars, or square-cut trees at each angle, to complete the monotony; a fish-pond generally occupies the centre; or, if the garden be a small one, a small plot is placed in the midst, supporting a large glass globe darkened inside, and which serves as a mirror to reflect the neighbourhood all around it. Trim box borders edge each parterre, which is religiously devoted to the display of one kind of flower alone, and nothing like a weed is to be seen anywhere. It would seem as if the constant care a Dutchman must bestow on his land, to protect it from destruction, and "make" the earth fit for produce, induced him to think all nature required his improving hand; hence the trees are mercilessly trimmed and cut, and the stranger in Haarlem is continually amused with the square and oblong masses of foliage which appear so compact upon the summits of the poles in front of the bouses. These stems of the tortured plants are sometimes further improved (and the stranger more completely mystified), by being painted with the bright colours a Dutchman so delights in. These town-trees are most frequently trained over an iron trellis-work, to which each branch is affixed, like an espalier to an orchard-wall, and every straggling shoot or leaf lopped away. Sometimes, at a street corner, a naked stump supports a flat screen of verdure, which faces each angle of the house like a fire-screen. The trees most employed are the yew, the holly, and the box: here the patience of the gardener reaps a rich reward, and in process of time he can torture them into any form:—

"The suffering eye inverted nature sees,—
Trees cut to statues, statues thick as trees."

It would scarcely be imagined that so stolid a people as the Dutch would be carried away by an enthusiasm for flowers. Yet the annals of their tulip-mania, in the seventeenth century, are unequalled in the world. In 1635, the rage among the Dutch to possess them was so great, that the ordinary industry of the country was neglected, and the population, even to its lowest dregs, embarked in the tulip trade. As the mania increased prices augmented, until, in the year 1635, many persons were known to invest a fortune of 100,000 florins in the purchase of forty roots. One tulip, named Admiral Liefskin, was valued at 4400 florins; the rarest, named Semper Augustus, at 5300. At one period only two of these bulbs were in Holland, one at Amsterdam, the other at Haarlem; for the latter, two acres of building ground was offered; the former was purchased for 4600 florins, and a carriage and horses. Munting, a Dutch writer of the day, has written a folio on the rage, which now took the form of gambling, and regular marts for tulip-sales were opened in all the principal towns of Holland; but, though large purchases were effected at enormous prices, the tulips did not really make part of the transaction: they represented but a gambling-medium, and ultimately the holders of the bulbs, who sold to realise their profits, found, when the *farore* had abated, that they represented no real property. Hundreds became ruined men, and it was many years before the country recovered from the miseries this gambling in flowers had produced.

By the aid of our topographic notes and sketches we hope to have made Holland better known to Englishmen. It is a country whose quaint peculiarities have no semblance elsewhere. Its features are unique, its people as national; its history one of the most exciting and glorious that can be offered to the student or the patriot. In its connection with the development of the great Reformation in the Church, or with the politics of our own country, it abounds in interest; and we hope to be the means of directing more attention thereto. It is somewhat singular that a country which offers so much to attract the attention of the educated tourist should be so little visited.

We now bid adieu to the Dutch painters. In the course of our remarks we have inforced the nature of their peculiar claims, and we need not here recount them. No school was more *realistic* in its tendencies, none honester in its truthful delineation of nature, or more capable of evolving the poetry in ordinary life. Spite of all prejudice they worked the mine well which they knew contained the gold, and though some of the dross may adhere to the metal, the gold is there in its native purity also.

THE DRESDEN GALLERY.

TRAVELLERS who may propose revisiting the capital of Saxony, will be gratified to learn that they will see the famous Dresden Collection under circumstances very much more favourable than ever it has been seen before. The collection is now placed in a new gallery, which has been built for its reception by the well-known Dresden architect, Semper; and visitors are now assisted to some knowledge of the collection by an excellent catalogue by Hübner, known as the decorator of the theatre, and by frescoes of great merit in Dresden. The old palace in which the collection has so long been exhibited, contained a distribution of rooms very like that of Marlborough House—a succession of apartments, with all kinds of cross lights rendering it impossible to see satisfactorily any of the pictures, except the small genre works, which were hung near the windows. It is at least remarkable that before the present there should have been no sufficient and reliable catalogue of a gallery so celebrated as that of Dresden; but this is not the only famous collection to which a catalogue has been wanting. Some years ago we inquired in vain for an official catalogue of the collections in the Palazzo Vecchio, and the Pitti, at Florence; but at that time there was no such thing, although in the libraries and record offices an ample and satisfactory history of every remarkable picture is deposited. To M. Hübner the state archives have been opened to assist him in the execution of his task; and the preface to the catalogue contains many interesting and curious revelations. We believe Hübner is a native of Saxony; were it otherwise he might have had some trouble in determining authorities written in old documents strictly according to the vernacular Saxon pronunciation—as "*Pahl*" for *Bol*; "*Hellprigl*" for *Hollenbreughel*; "*Ben*" for *Penne*; "*Tenners*" for *Denner*, with a host of other similar agonising perversions. The history of the gallery is traced to its commencement, in that taste for the collection of curiosities which distinguished the *naïve* sixteenth and seventeenth centuries," among which were early distinguished a *Venus* by Titian, and two of the best works of Claude. The love of Art grew apace; and in little more than the third of a century (1743—78) the collection had acquired its most lustrous gems, and that celebrity which has ever since distinguished it. In 1743 it was enriched by the purchase of the *Holbein Madonna*, and in ten years after by the *St. Sixtus Madonna*; and about the same time by the famous works of Titian, Paul Veronese, Rubens, and Vandyke. The Dresden Vandykes, as a series, were the finest we had ever seen until we visited Petworth, where in quality and condition the Vandykes surpass all the productions we have had an opportunity of seeing by this master. In 1745 a hundred pictures were added from the Modenese Gallery, obtained from the Duke Francis of Este Modena, by purchase, for 426,821—a very inconsiderable sum, when it is remembered that in the number were comprised the six famous *Correggios*, as many *Titians*,—among which was "*The Tribute Money*,"—the same number of works by Paul Veronese, several *Carracci's*, and a number of pictures of the Bolognese school. The collection had its origin in the "*Kunstkammer*," which was founded by the Elector Augustus I., in the year 1560, and received a number of curiosities which had been procured in the time of Frederick the Wise, and the Elector George, the "*Bearded*." Most of the works of Cranach, Dürer, and others of the earliest German masters, are conjectured, with probability, to have been acquired about this time; and the acquisition of some of the best of the earlier Italian pictures, declares, on the part of the Saxon princes, an established admiration of Italian Art. In time the collection gathered strength, inasmuch that the list of works in the year 1722 amounted to no less than 4708 in number, and from these arose the existing catalogue of 1938 pictures. The pictures were then placed in the old *Stallgebäude*, joining the palace; in 1744 they were removed to the Japanese Palace, but only to return to the *Stallgebäude* when that edifice was rendered more suitable for them. They remained there a hundred and nine years, and under that roof the gallery received some of its most remarkable additions. The masterpiece of *Holbein* is known to have been ori-

ginally painted for the hurgomaster of Basle, Jacob Meyer; and when sold it was taken to Amsterdam, and passed in a short time into the hands of several persons. From Antwerp it travelled to Venice, and became the property of the Delfino family, by whom it was not much esteemed. The merit of the work was, however, recognised by Count Algarotti, who purchased it for the Dresden Gallery, two years after which the negotiations commenced relative to the Modenese pictures; and this was about the time that the new rooms were ready for the collection. Hübner gives an interesting account of the manner in which these negotiations were conducted. The correspondence was carried on in a cipher, in which all proper names were changed, so that it was impossible to know the persons or places that were mentioned. They were, for the most part, Italians who were employed by the elector to deal with the diplomacy of their countrymen. As the purchase of the Modenese pictures became known in Italy, there arose at once a just desire, on the part of their possessors, to dispose of masterpieces of Italian Art; and there were offered Raffaele's "*St. Cecilia*" for 15,000 ducats, besides the "*Violin-player*," and the "*Porcariina*," by the same master, as also Domenico's famous "*Diana and her Nymphs*," and even the *Foligno Madonna* was offered by the nuns of the convent, but upon this occasion the emissary was only an obscure German artist, by whose want of tact the picture was lost. In 1748 a very considerable purchase was effected of works from the Imperial Gallery of Prague. This consisted of sixty-nine pictures of the Low Country schools, for which 44285 were paid. Notwithstanding the secrecy observed in the conduct of these purchases, the fact was known at Vienna, and the emperor mentioned certain works which he wished to be reserved from purchase "at the very lowest price." Among these was the "*Picture Gallery*" of Teniers; but yet among the pictures acquired for the Dresden Gallery there were some admirable works—as Vandyke's "*Charles I.*," Rubens's "*Boar Hunt*," and others of equal quality. In 1750 the purchase of the copy of Raffaele's "*St. Cecilia*" was effected, and the "*Predella*," by Ercole Grandi; and in 1752 "*Ninus and Semiramis*," by Guido; and in the following year the gallery received its most precious treasure—the *St. Sixtus Madonna*, which was obtained through the Bolognese painter, Giovannino, for 20,000 ducats and a copy of the picture.

After this, the imposing altar-piece of *Bagnacavallo* was purchased, in 1755, for 300 Hungarian ducats, from the convent of the *Pellegrini*, at Bologna, and this was the last of these incomparable acquisitions; for, shortly after the king, who had so much distinguished himself by his taste for Fine Art, died, from which time no considerable additions were made to the gallery until the Spanish works were purchased from the collection of the late King Louis Philippe. Whatever may be wanting to the special and intrinsic interest of the works themselves, is amply supplied by the narrative of the manner in which they have been added to the collection. In very many cases, the elimination of certain facts establishes beyond dispute the authenticity of pictures which, simply from appearances, have been ascribed to painters by whom they have not been executed; for instance, the copy of Raffaele's "*St. Cecilia*" has been always understood to have been made by Giulio Romano, whereas it has been proved to have been painted by Denys Calvert, called by the Italians *Dionysio Piammingo*. We doubt not that in every gallery there are numerous works falsely attributed; we believe such cases are numerous in the Louvre, and especially in collections of early formation. Hübner also proves a portrait attributed to *Holbein* to be a work of Meunier—a portrait of Antony of Burgundy, son of Philip the Good. The picture was like the work of *Holbein*, and it was accordingly attributed to him. Although there was little beyond similarity of manner in favour of the decision, there was nothing to disprove it until Hübner proved the authorship of the work—not by any judgment or critical argument, but by incontrovertible written evidence.

The information contained in this catalogue will enhance the value of their collection in the estimation of the citizens of Dresden, and, in the eyes of foreigners, will invest it with a double interest.

POETICAL AND ARTISTIC
CONCEPTIONS OF DEATH.

THE various forms under which Death has been represented in the mythology of different countries, in poetry and popular superstition, afford a subject of highly-interesting comparison and research—one branch of psychological investigation. In the earliest mythology of Northern Europe, as well as of Greece, the extinction of life, the transition of the spirit from this world to another, was assigned to the guardianship of a supernatural power—one of the inferior class of deities. The most poetical representative of these beings was the goddess Hali, Halja, Helia, or Hel, as she is variously called, whose character and offices first invite our attention.

The goddess Hel, according to the Eddic poems, was the daughter of Loki, and a giantess. She is represented as either black, or half black and half human-coloured, and her dwelling is in the depths of the earth, under the root of the celebrated tree Yggdrasil, in the cold, cheerless, and shadowy realm of Niflheim; there she holds her court; her dish is named *knugg*, and her knife *sultu*—words of synonymous import, expressing in the most poetical manner her insatiable appetite, a feature which we shall afterwards observe under various forms. This goddess was originally no destructive power; and her office was merely to preside over her abode in the lower world, where she received the spirits of the departed; she neither goes herself, nor sends any messenger to fetch them. The dead are left to enter on the long and dark journey by themselves, and they take with them all the various necessities for travelling, such as shoes, money, servants, horses, clothes, &c.; some ride, others drive, and large troops of souls journey in company—"fara till Heljar," or "travel to Haljar." Properly speaking, only those who die of old age, or from natural causes, are received by Halja—all who are fortunate enough to be slain in battle being transported to Valhalla (the hall of Odin), by the Walkyrian. In two of the finest songs in the Edda we have a description of this journey to the nether world.

Dr. Grimm notices that, in some of the popular Danish legends, Hel is represented as riding about on a three-legged horse, to announce pestilence and sickness; or, according to a more ancient interpretation, to collect and carry off the dead who had fallen to her lot; a chariot was afterwards added, in which she drove about the country. This view is evidently of a popular character, and the offices of the goddess are here much less dignified than those ascribed to her in the Edda, which reminds us of the Mater Tellus, or Mater Terra (Mother Earth) of the Italian mythology, who received the dead into her bosom—a beautiful and poetical idea, which has been perpetuated down to the present day.*

Besides Halja, there were other deities who had power over the souls of the departed, one of the principal of whom was Rán, the sea-goddess, who is described as drawing the bodies of all who have been drowned into her abode with a net; her name signifies to seize, or carry off. There appears to be a tendency common to the mythologies of most countries, to multiply in the progress of time the objects of worship and veneration. The simplest form of faith is generally the most ancient, and the present subject affords an illustration of this remark. It moreover deserves notice that the further we retrace the monuments of Northern mythology, the more refined, benign, and divine does the character of Halja appear: none of the ideas of cruelty, sadness, or terror which arose in after ages attach to her. She is one of the oldest representatives of Paganism, and Grimm notices her correspondence with a Hindoo goddess, who is also represented black, and has power over the souls of the dead. It is interesting to observe a trace of this ancient belief handed down, like so many similar ones, in the popular stories of Germany, where a representative of Halja appears in the form of Mother Holle, who figures repeatedly as a kind of witch.

The goddess Hel, or Halja, has a representative in the Hades, or Pluto, of the Greeks, the Orans,

Ditis, or Dis, of the old Latin religion—the deity presiding over Erebos. It is remarkable that the terms Hades and Orans were, by the ancient Greek and Latin writers, used only to denote persons, deities; and that the application of them to the idea of a place did not come into use until a comparatively late period. In the New Testament, also, Hades occurs several times in this sense. But another curious fact is, that our own word "hell" is merely a similar transformation of the pagan goddess who presided over the dead, into the abode of the dead itself. The place of punishment, in the Northern mythology, filled with poisonous serpents, darkness, cold, and gloom, was "Nastrond," answering to our idea of hell. Christianity admitted no goddess of death, and in the conception of a hideous place of punishment, the Anglo-Saxons united the realm of Hel with Nastrond. "The prevailing idea in the infernal regions of the Teuton," observes Mr. Kemble, "is cold and gloom. Fire was too cheerful in the North to be sufficiently an object of terror: it appeared otherwise in the East, where coolness is the greatest of luxuries. The poisonous snakes which, waking or sleeping, seem ever to have haunted the Anglo-Saxon, formed a convenient point of junction between his own traditional hell, and that which he heard in quotations from the works of the Fathers; and to these and their influence alone can it be attributed, when we find flames, and sulphur, and all the hideous apparatus of Judaic tradition adopted by him. In this fact seems to lie a very important mark of ancient heathendom." Mr. Kemble quotes the following description of hell from the "Salomon and Saturnus": on the defeat of the rebel angels, it is said that God—

"For them made hell,
A dwelling deadly cold,
With winter covered;
Water he sent in,
And snake-dwellings,
Many a foul beast
With horns of iron;
Bloody eagles,
And pale adders;
Thirst and hunger,
And fierce conflict,
Mighty terror,
Joylessness!"*

The converted heathens readily applied the name "hell" to the nether world, or receptacle of the wicked after death, and this notion has continued from the earliest times to the present day.

In these various characters, however, we observe no personification of the idea of Death, but the genuine pagan notion of a deity presiding over the dead; and similarly, in this change of a person into a place, we have merely the removal of the heathen deity, and the substitution of a figurative place—an abode; and, as we shall see at a still later period, of the state or condition of the dead.

A remarkable feature in the notion entertained by the ancients respecting Death is, as we have remarked, that she is not regarded in the light of a destroying being, but simply as the messenger of a god, whose office it was to convey to him the souls of the departed. The destructive powers were distinct—sickness, famine, and the sword. This character, or form of Death, as a messenger or angel, pervades the Northern mythology; but, although of true Pagan origin, it reappears both in the Jewish and Christian Scriptures, as, for instance, in the angels who carried the beggar into Abraham's bosom (Luke xvi. 22). Under the Christian form, the office of messenger became twofold,—that of the angels, who transported the souls of the pious, and that of the devils, who carried off those of the wicked. This idea, it is scarcely necessary to observe, furnished a rich and favourite subject to the early artists both of Italy and Germany.

In the early Greek poets—in Hesiod and Homer—Thanatos, or Death, is represented as the twin-brother of Sleep, the sons of Night, whose abode is in the nether world. But here Thanatos appears as a messenger, as for instance in the *Iliad*, xvi. 676, &c., where, after Sarpedon has fallen by the hands of Patroclus, Apollo washes his body in the stream, anoints it with ambrosia, and clothing it in ambrosial garments, commits it to the twin-brothers Sleep and Death, to convey to Lycia, to be interred there by his friends. This office of Thanatos, therefore, corresponds to that we have remarked in the

Northern mythology; and with it we must also connect the office of the Walkyrian, the female messengers, whom Odin sends to fetch and convey to his heaven the spirits of those heroes who were slain in battle.

In one of the fables of Æsop, Thanatos, or Death, who generally appears as a kind of protecting Genius, is invoked by the old man to relieve him from his toils. And it may be observed that, like all the spirits of the other world, Thanatos is always ready and at hand to obey a summons.

We have seen that, in the Northern mythology, both Halja and the Walkyrian* are represented in the female character. The Greeks, it is true, assigned to Hades a queen consort, Persephone; but she was a mere adjunct to the officiating monarch; and in the old Latin mythology she has no counterpart. In the works of Art too of ancient Rome, Grimm observes, "Death is never represented as female, although we may observe the Latin name *Mors* is feminine." In the Grecian mythology, Hermes performed the office of conducting the spirits of the dead to the realm of Hades; although, Thanatos also officiates as this messenger. In Euripides' drama of "Alcestis," for instance, Thanatos is introduced as a priest or messenger of Hades, coming to fetch away the heroine. Mr. Keightley remarks, that we here "meet the first mention of a remarkable notion of the Greeks—the dead seem to have been regarded in the light of victims offered to Hades; and as it was the custom, in commencing a sacrifice, to pluck some hairs from the forehead of the victim, and burn them on the altar, so Death is here represented as coming to cut off a lock of the hair of Alcestis." On a vase depicted in Dennis's "Etruria," is a representation of the so-called paring of Admetos and Alcestis, with two hideous figures, one on each side, armed the one with a serpent, and the other with a knife: these appear to typify Death.

It is doubtful whether the Etruscan Mantus may be regarded as a representation of Hades, or of Death. On an Etruscan vase we have seen him depicted armed with his hammer, with large wings, and with *talaria*, or wings, on his heels; he is bald, with the exception of a tuft of hair on his forehead. We have been struck accidentally by the curious resemblance between this figure and that of Satan, in Giotto's "Life of Job," in the Campo Santo, who has similar wings, the tuft of hair, and what appear to be *talaria*. If the figure on the vase to which we refer be a representation of Death, the introduction of the hammer is curious. Sin (or Satan) and Death have frequently been confounded in pictorial representation; and the Devil, as Grimm remarks, was from early times compared to two implements—the hammer, and the bolt or bar. The former instrument is clearly connected with Thor's celebrated hammer, and Grimm quotes many instances where the early Fathers of the Church (Jerome, Gregory, &c.) use the name of *Mallens* and *Vectis* for the Devil.

By the later Greek and Latin poets, Death is depicted as a sad and terrific being, although the artists of Greece gave him a more pleasing aspect—frequently in the character of Genii holding an inverted torch, or chambering youths; but these are rather to be classed with symbolic types than personifications, which we pursue here chiefly to consider. Many, indeed, are the curious symbolical notions connected with Death which have appeared among various peoples and in different ages. The celebrated Mastersinger Hans Sachs represents Death as pushing away the stool from under a person, and letting him fall. Another very common figure is, that of Death extinguishing the light (of life), which appears in Germany as well as in the Grecian Genii with an inverted torch. The mild and beneficent character of Death, early prevalent in Germany, is exemplified in the notion of his being an intimate companion and friend. A pretty legend tells of a subterranean cavern, in which burned thousands and thousands of lights, in endless rows: these are the lives of men,—some shining in large tapers, and others burnt down to a small end; but there is always danger of a long taper falling or being overturned. In the same fable, it is said that Death once stood godfather to a poor man, whom he

* Mater Terra was represented as a goddess drawn by lions. See Macrobius, lib. 1. ch. 21.

* *Sal. Sat.* p. 173.

* Sædo Grammaticus calls the Walkyrian *femine nympha sylvestres*.

gifted with the power of seeing him bodily when he approached a sick person, and of knowing, from his position, whether the patient would recover or die. The godson became a doctor, and grew rich. When Death appeared standing at the head of a sick person's bed, the patient was his; but if Death stood at the foot of the bed, the sick man recovered. Once, however, the doctor turned the body of a sick man round, and outwitted Death, who, to revenge himself, at last upset, as if accidentally, the light of his godson.

A beautiful old Northern Saga represents Death sitting before the door, waiting till the souls of the inmates go out, to carry them off to the other world. Another conception of frequent occurrence is, that the souls of the dead are led away by Death bound as prisoners—a notion which agrees with the Hindoo mythology.

The office of a friendly messenger, which was originally assigned to Death in the Northern mythology, became gradually converted into one of a severe and cruel nature. He is represented under various characters (such as a thief, a fowler, a fisherman, &c.), as an enemy who seeks to *steal* away the souls of the dead, and who wrestles with mortals, or rather with the principle of life, which idea lies at the bottom of this fiction. In this strife Death was represented as the leader of a large host, which is constantly increasing.

In Germany, the mediæval conceptions of Death figured a greedy and insatiable *Hölle*—an *Orcus esuriens*, or devouring ogre; and she is represented with a yawning maw, like a ravenous wolf. In the old poems, there is frequent mention of the abyss and the gates of Hell, *Hölle*: and two passages in the Bible refer to similar images:—"Hell and destruction are never full" (Prov. xvii. 20); and, Isa. v. 14—"Hell hath enlarged herself, and opened her mouth without measure."

"As far as we can judge," says Mr. Kemble, "from the descriptions which survive, the Anglo-Saxons represented Hell as a close and covered dwelling—a prison duly secured by locks, bolts, and bars. But the popular fancy had probably even then adopted the notion of a monstrous beast, whose mouth was the entrance to the place of torment. From this peculiar feature, however, we may believe that a remembrance still lurked among our forefathers of the gigantic or Titanic character of the ancient goddess, who, in Norse mythology, was Loki's daughter."

To recur to the goddess Hel: in the beautiful legend of Baldr, whose death afflicted all the gods, we find Odin descending to the abode of Hel, in hopes of persuading the goddess of the dead to relinquish her prey. "He was successful, and returned with the joyful tidings that Baldr would be restored to the gods, if all created Nature would weep for him. All Nature did weep for the loss of the god of beauty, save one old crone. When called upon to do her part in his restoration, she answered, 'What have the gods done for me that I should weep for Baldr? Let Hel keep her dead!' Thus Baldr's fate was sealed; his throne was placed in the shadowy realm of Hel, and weeping virgins spread the eternal pall that was to give dreary honour to the god of light in the cold kingdom of darkness and the invisible."

One peculiar representation of Death we must not omit to notice—that of a figure riding on horseback. The description of Death on the Pale Horse, in the Revelations, will naturally occur to the reader; but Dr. Grimm traces this peculiarity to a heathen origin, and cites references to the superstition in popular sayings and tradition: he reminds us also that the Wislykrian rode on horseback, and that Odinn rides, whilst Thor goes on foot or drives. In some Danish legends given by Thiele, when a person recovers from sickness he says, "*Jeg gav Døden en skippe hær*," i.e., "I gave Death a bushel of oats" (for his horse). In the "Dance of Death," preserved at Lübeck, Death is depicted riding on a lion. In connection with this conception of Death on horseback, we may, by the way, remind the reader of Bürger's celebrated ballad of "Lenore," where Death carries her off in the form of her lover.

From the transitoriness of life being likened in the Scriptures to grass and flowers, Death was naturally converted into a mower, and in this character

the scythe, knife, and sickle, are assigned to him. A fine old German song says—

"*Let ein Schmitter heisst der Tod,
Ist Gewalt vom höchsten Gott;
Heut wezt er das Messer,
Es schneidit schon viel besser—
Hüt dich, seltsames Bündeln!*"

This character of Death corresponds with that of Time; but it does not belong to the earliest class of personifications.

In the poetical conceptions prevalent among the ancients of the strife of Summer and Winter, the latter is often represented by Death, with which many curious popular superstitions and customs in Germany are connected.

In the Hindoo theology we meet with a direct personification of Death—or the god of death—Yum, a remarkable character. An account of Yum is given in one of the Vedas (*Ku'th-ōpnishad*), of which the following is an outline. A youth named Nuchiketa, having offended his father, the latter surrendered him to Yum, who was absent, and Nuchiketa remained there three days and nights without food. When Yum returns, he is addressed by his family in these words—"A Brahmin entering a house as a guest is like fire; good householders, therefore, extinguish his anger by offering him water, a seat, and food. Do thou, O Yum! present him water." Yum, being thus admonished by his family, approached Nuchiketa, and said to him, "As thou, O Brahmin, hast lived in my house a reverend guest, for the space of three days and nights without food, I offer thee reverence in atonement, so that bliss may attend me; ask three favours of me as a recompense for what thou hast suffered while dwelling in my house." Nuchiketa then made this as his first request, saying, "Let, O Yum! my father's apprehensions of my death be removed, and let him recognise me on my return, after having been set free by thee. This is the first of three favours which I ask of thee."

This Yum promised to grant. Nuchiketa then made his second request. "In heaven, where there is no fear whatsoever, and where even thou, O Yum! canst not always exercise thy authority, and where therefore none dread thy power, the soul unmolested by sorrow enjoys gratification. As thou, O Yum! dost possess knowledge respecting fire, which is the means of attaining heaven, do thou instruct me in that knowledge."

This Yum promises to grant. Then Nuchiketa asks, as his third request, Yum to explain to him the question respecting the nature of the soul after man's death. Yum replies, "Even gods have doubted and disputed on this subject, which can never be thoroughly comprehended. Ask, O Nuchiketa! another favour instead of this." Yum then promises to grant him every kind of worldly power and enjoyment; but Nuchiketa refuses all this, and persists in his request, which Yum, finding him worthy of such knowledge, at length grants; after which, "having thus acquired this divine doctrine, imparted by the god of death, with everything belonging to it, Nuchiketa, freed from the consequences of good or evil acts, and from mortality, was absorbed into God; and whatever person also can acquire that knowledge, shall obtain absorption."

In conclusion of the above brief remarks on Death, we may note what appears to be the natural sequence of the popular poetical conception—first, the earliest and rudest form—that of simple personification; the second, or artistic form, that of symbols, embodying the poetry of Art; and thirdly, the latest form, that of emblem. We cannot pass unnoticed, the grandest personifications of Death met with in any poet—our own Milton. The wonderful descriptions of Sin, and her offspring Death, given in the "Paradise Lost," are too numerous to be more than alluded to here. Milton has exercised in these personifications his greatest powers of imagery, and the reader will find an interest in studying them again, in connection with the subject of this article. How grand is the picture of Sin and Death sitting guardians at the portals of Hell!

"Before the gates there sat,
On either side, a formidable sinp:
The one seem'd woman to the waist, and fair;
But ended foul, in many a scaly fold,
Voluminous and vast," &c.

Then the magnificent description of Death:—

"The other shape,
If shape it might be call'd that shape had none
Distinguishable in member, joint, or limb;
Or substance might be call'd that shadow seem'd,
For each seem'd either; black it stood as night,
Fierce as ten Furies, terrible as Hell,
And shook a dreadful dart; what seem'd his head
The likeness of a king's crown had on."

Again, where Sin describes the birth of Death:—

"But he, my inbred enemy,
Forth issued, brandishing his fatal dart,
Made to destroy: I fled, and cried out Death;
Hell trembl'd at the hideous noise, and sigh'd
From all her caves, and back resounded Death!"

In the tenth book also are given other pictures of these wonderful creations of the poet, which embody many of the figures prevalent in the middle ages, to which we have alluded, and which are here grandly illustrated.

Synbulic allusions to Death, under various forms, were very common in the early works of Art in Greece and Rome; direct personification was rarely met with, and we shall here allude to one only, of an interesting character. Petrarck, in his poem, "The Triumph of Death," gives a fine personification of Death, under the figure of an old woman. The whole poem is a perfect picture, and we cannot resist translating a few of the introductory verses. Madonna Laura is returning from her victory over Love (described in the preceding poem):—

"This beautiful and ever-glorious fair,
A naked spirit now, and loosed from earth,
That erst the botry irop of virtue was,
Return'd now with honour from the strife,
Joyful, for she had tamed the powerful foe
Who conquers with his arts the world entire.
Nor other arms had she than a chaste heart,
With beauteous features and with sorrowing thoughts,
With wise discourse, the friend of honesty."

"The beauteous dame, and that fair company,
Her chosen band, from nobis victory
Returning, joined in a godly troop,
Bright stars they seem'd, and in the midst a sun,
That lightened all, yet dazzled not the sight,
With roses and with violets encrown'd;
As gentle heart drew honour to itself,
So came that glorious company along."

The reader will mark the abrupt transition, and the manner in which this introduction depends by contrast the colour of the following pictures:—

"When sudden I beheld a banner dark,
A female form, roll'd up in sable vest,
Move onward with a storm—such that I doubt
Piegrr e'er saw, time was the Giant's war."

Again, the fine description of the realm of Death:—

"She spake, and lo! in its wide circuit round,
The plain was all encompass'd thick with dead,
That neither prose nor verse can comprehend."

"There too were those who were accounted blest,
Pontiffs and reigning princes, emperors;
Now are they naked, poor, and mendicant."

We quote these lines in connection with a celebrated work of Art borrowed from them—Orcagna's fresco of the "Triumph of Death," in the Campo Santo at Pisa. The artist unquestionably took his theme from Petrarck, and indeed has followed his description so closely as to overstep the just limits of his art—a fault pardonable in an age when the *spirit* of poetry was infused alike into the different branches of Art, and the laws which should regulate its *form* or expression were comparatively little studied or understood. Orcagna's hideous figure of Death, with streaming hair, and claws, bat's wings, and wire-woven vest, conveys nothing but a burlesque of the picture which the poet's few but forcible lines suggest.

The most direct personification of Death remains to be noticed—that class of pictorial representation known by the name of the "Dance of Death." The subject is highly interesting, and we shall probably treat of it in a future article, to which the present one may form an appropriate introduction.

* See Kemble's "Saxons in England," vol. i. p. 368.

* Ramohun Roy's translation of the "Ku'th-ōpnishad," of the Ujoor-Ved.

SUGGESTIONS OF SUBJECT
TO THE STUDENT IN ART.*

BY AN OLD TRAVELLER.

CHAPTER XI.

Labour and overmore Labour—Success to the Vaillant—An Exception—The Wherefore—A Portrait of mournful Histories—Look before you leap—Bionardo and his Master—Oration to a Neighbour—The Artist repented—A new Professor—Bishop Guido disappointed—German reverence for Sinckpers—Portia to Bassanio—The Wedding of Petruchio—Skylark and Antonio—Ferdinand and Miranda—Requitions of Pietro Perugino—Favourites of the Tuscan and Umbrian Masters—St. Francis Seraphicus—Santa Theresa—St. Cosmo and Damiano—The Eremitic Fathers—St. Hilardon—St. Efrom—St. Gualfardo—Santa Sofronia—Themes from Hebrew Scripture—The Vatican—The Uffizj—The Pitti—Bologna—Sienna—Gallery of the Florentine Academy—Modern Works—The four greater Prophets—Democritus—The City restored—Ezekiel by the River—The Prophet wailing—Prayer of the Four Children.

NEVER does the excellent Vasari fail to mark with his best approval the progress of that artist who combines the habits of laborious industry with the attributes of a heaven-sent genius. To Francesco Francia, to Domenico Ghirlandajo, to Andrea Mantegna, to his own connection, Luca Signorelli, to Domenico Piuigo, and to some few more, all of high distinction, has the admirable biographer accorded the—from him—exalted praise of thoughtful endeavour and studious application.

That these qualities were also exhibited by the great Masaccio, and by others whose names stand forth most prominently in the scrolls whereon Art's noblest stand inscribed, we all know. Leonardo da Vinci, at whose name all reverently lift the covering from their brows, looked ever favourably on the student envying them; and though exempt by his miraculously endowments from such necessities as attach themselves, in the form of conditions, to the success of the less-riely endowed,—a category wherein all but one other master in Art (the divine Raphael himself, namely) must needs be comprised,—he was yet unusually patient of labour; and when we consider the perfection attained by him in pursuits, each demanding more than the total life of a gifted man, it becomes manifest that not even his brilliant versatility could have raised him to the eminence he gained in so many walks, had not his student-life been more than commonly earnest and laborious.

And to the steady worker, accordingly, it is, that Fortune, no less than the judgment of the world, as expressed by the Biographers, has awarded the palm of success. Some few exceptions there are to sadden us, and among them it has ever appeared to the present writer that Raffaellino del Garbo is one of the most melancholy. As a student, he gave evidence of the very best qualities; "held in the highest esteem among artists," says Vasari, "inasmuch that his master, Filippo, considered Raffaellino to be in some respects a much better painter than himself;" nay, even at a later period, the same unimpeachable authority says of him, after enumerating his various excellences—"from all which the artists formed such flattering expectations of him, that he was long considered to be the first among the younger painters of his time."

How then did it chauce that it is of this same Raffaellino we read the melancholy remarks that follow? Vasari has just completed the enumeration of admirable works performed by the artist in question, when suddenly he breaks forth after this fashion:

"But his manner now deteriorated from day to day. Nor do I know to what cause we are to attribute this misfortune, for the poor Raffaellino could not have lost his power and the knowledge of his art; neither did he cease to be careful and industrious. Yet all availed him nothing." * * * * * And further, when speaking of a still later period—"It was with Raffaellino as though, feeling himself to have degenerated, he had become ashamed of himself, and felt disheartened—remembering the high expectations formed of him in his youth, and conscious of the great difference between his later performances and the works so admirably executed in his earlier days. Thus suffering, and becoming old before his

time (Raffaellino died at fifty) he declined more and more, departing to such an extent from the excellence of his first manner, that the works he produced no longer seemed to be by his own hand; daily forgetting some portion of his art, he descended at length from the ordinary frescoes and oil-paintings of his profession, to paint every kind of thing, even the meanest." * * * * * "In this state of things all his distinction in Art finally disappeared, and his practice became debased to coarseness; sunk into the extreme of poverty, Raffaellino del Garbo miserably finished his life at the age of fifty, when he was buried by the brotherhood of the Misericordia."

And now what explication shall be given of this strange and mournful phenomenon?

I reply by another question:—Have you seen the portrait of this master, painted after a design made by his disciple, Bastiano da Monte Carlo? one of the many distinguished artists reared under his auspices—Bronzino being one of them. If you have, and have well considered its expression, I believe you will agree with me as to that I am about to offer. My theory is, that Raffaellino married an inferior wife; and if you recall the expression of that face, you must, I think, feel assured that no blight of life less complete, and less absolute, could have withered the soul of the artist to the condition you read there. What despair is in those eyes! What heavy hopelessness on all those features! Where is the consciousness of success, that should have kept its seal on that fine brow? It has been driven thence by that other and bitter consciousness, he has degenerated—he is degenerating. The burning pain of that destructive thought has given its own dreary characters where the light of genius should have remained all brightly, and the ruin is such that you feel it to be final—there is no hope of redemption: you gaze sadly, and with increase of sorrow, until the lines turn indistinct, because your eyes have become surcharged with tears. You depart from the melancholy portrait saddened for the living day; and when you next approach it, more sorrowful than ever is the desolate aspect you meet. All the long and grievous history of our hapless Raffaellino's wrecked existence seems revealed in that mournful gaze; you comprehend it all, and you sympathise with all—but so full of grief are the weary details that you do not endure to dwell thereon, and you revert them to none.

Confirmation, if any were required, of this unhappy conviction is but too amply given in the words of Vasari himself: among others to that effect he has the following:—"This artist was truly unfortunate in his connections, being constantly surrounded by people of mean habits and very low degree." And further—"Raffaellino studied drawing so industriously that there still remains a vast number of excellent designs by his hand, although his sons are ever ready to sell them for the meanest price, and to any purchaser."

Now the excellent Giorgio was not himself of so "mean habit" as to speak thus of a man's connections simply for being poor, or of humble rank: they were consequently worse than poor and humble. Then, I ask you, would any sons worthy of their once-distinguished father have proceeded in such sort as to bring on themselves the reproach implied in the words of Vasari just given? and would the sons of a mother worthy to have been the companion of the man our lost and much-lamented Raffaellino was, not have proved incapable of meriting such? Without doubt they would, and my position is established. His unhappy choice in marriage was the bane of Raffaellino del Garbo—wherefore, I shall e'en borrow for this occasion the grave words of the learned, and, involving my trivial proportions in the doctoral robe, shall say—*Verbum sapientie satius est.* Look twice ere once ye marry, O ye men of nature's highest orders!

In the Gallery of the Academy at Florence is a short series of designs, attributed to an artist of career and character altogether different—Bnonamio Buffalmacco, namely—to him "or his disciples," and I incline to believe them by the disciples, since they have all the character proper to him who should take upon him to delineate the myriad pranks of that laughter-loving Florentine. Some of these have already been alluded to very slightly in a preceding chapter. The details are as follow:—Andrea Tafi, Bnonamio's master, aroused

his ire in boyhood by awaking him nightly, hours before the dawn, and setting him incouitently to his work. You now behold the consequences to Andrea.

From an ill-swept cellar, Buffalmacco has collected some thirty hecties; he has fastened to the back of each a tiny taper, and lighting these, has sent the creatures into his master's chamber by favour of a cleft beneath the door. Here the hecties are disporting themselves, to the inexpressible terror of Tafi, whom the lights they bear just enable you to see, half-rising from his low pallet, and gazing on the spectacle with pallid face. From the curtained window of a neighbouring apartment, which commands the sleeping-room of his master, you furthermore discern, carefully peeping, the delighted visage of Buffalmacco, fully enjoying the success of his scheme, which did in fact avail for a time to frighten Andrea from that inconvenient habit of arousing his disciples before daybreak—Bnonamio persuading him that those demons had appeared to avenge themselves on him for his pictures of Saints then painted, and affirming that over night-work only did they possess any power of control.

You have next an act of retribution, similar in spirit and intent, but differing in the place and manner. We are still in the fair city of Florence, but no longer in the studios of Andrea Tafi. The dwelling before us is that of a Florentine citizen "of the meaner sort," a certain "weaver of wool" on whom his neighbours had imposed the name of "Capodoca" or "Goose-head." Compelling his wife to spin yarn for his use, and keeping her at her labours through the greater part of the night, Capodoca thus disturbed the rest of Buffalmacco, now himself a master, and having his abode in close contiguity to that of the weaver, wherein you now see him engaged in making an oration, with all the gossips of the neighbourhood for his auditory.

And the cause of that assemblage is on this wise. Wearied by the perpetual hum of the spinning-wheel, Buffalmacco has avenged himself on Capodoca by contriving a cavity in the wall of his bedroom, immediately over the hearth of the weaver; into this he inserts a long tube, filled with salt, and, choosing a moment when the wife of Goose-head, making soup for the consolation of her husband, has turned her attention elsewhere, he pours the contents of this contrivance as often as he thinks meet into the good woman's pot. This has now occurred so frequently, that the Goosehead's patience is exhausted, and he has been correcting his wife after a fashion but rarely approved by such as hear that name. Soundly beaten, she has roused the neighbourhood by her cries; and here is Buffalmacco defending her, as it is well his part to do.

"Faith, comrade," says he, "you should be a little more reasonable. You complain that your dish is too much salted; but I marvel, for my part, that your good wife can see her way to the pot at all, or do any other thing that is right. Here do you keep her, spending the best of her night at the spinning-wheel; let her go to her rest at a reasonable hour, and you'll see that she'll then have her wits about her, and not make blunders of this sort."

The neighbours of this Goosehead agree with the painter; her husband is compelled to the same conviction, will he, nill he: the poor woman regains her natural rest; the artist likewise remains undisturbed, and every one "lives bappily for ever after."

Passing through Arezzo in the year 1302, Buffalmacco was invited by the prince-bishop of that city, Guido, namely, to paint a chapel which then occupied the site where the Baptistery now stands in the episcopal church.

That work the artist had nearly completed, when a very curious circumstance occurred, and this, according to Saecebetti, was as follows:—"The bishop had a great ape of extraordinary cunning, the most sportive and mischievous creature in the world; this animal sometimes stood on the scaffold, watching the painter at his work, and giving a grave attention to the whole process. One Saturday evening, Buffalmacco left his colours, and on the Sunday, our ape, though encumbered by a log of wood, fixed on him to prevent his leaping about, contrived to get on the scaffold. Here he seized

* Continued from p. 330.

† See Vasari, "Lives of the Artists" (English edition), vol. II., p. 473, et seq.

‡ Filippo, that is to say, the son of Fra Filippo Lippi.

* See Vasari, *ut supra*, vol. I. (English edition) p. 157.

each vase of colour in turn, mingled all together, as he had seen the painter mingling his materials, and plunging the pencils into this mixture, he daubed over every figure, and did not cease from his labours until he had repainted the entire work to his own liking; that done, he departed at his pleasure.

"When Monday morning came, Buonamico returned to his work; but finding his figures ruined, his vessels all heaped together, and everything lying in strange confusion, he stood amazed in sore dismay. Arriving at length at the conclusion that some jealous Aretine had worked him this woe, he bore his plaint to the hishop, who was much disturbed; but, consoling Buffalmacco as he best might, persuaded him to renew his labours; and the mischief was repaired.

"But the hishop now gave him six soldiers, who were commanded to keep guard with drawn swords in the absence of the painter, and to cut down without mercy any man whom they might detect in the act of defacing the pictures.

"One day these men heard a strange rolling sound approach them, immediately after which they saw the ape clamber up to the scaffold, and seize the pencils. In the twinkling of an eye the new master had mingled his colours, and the soldiers beheld him set to work on the figures of Buffalmacco.

"They quickly summoned the artist, and showed him the malefactor, when they all stood watching the animal at his operations, although scarcely able to do so because they were in danger of fainting with laughter. Nor could Buonamico refrain from joining them, and, though much displeas'd by what had happened, he laughed until the tears ran down his cheeks.

"At length he betook himself to the hishop, and said—

"My lord, you desire to have your chapel painted in a certain fashion; but the manner thereof does not please your ape, who is therefore pointing it after a manner of his own."

"He then related the story, adding, 'There was no need for your lordship to send to foreign parts for a painter, since you had the master in your house; but perhaps he did not know exactly how to mix the colours; however, since he is now acquainted with the method, he can proceed without further help. I am no longer required, seeing that we have his talents, but, with your lordship's permission, may return to Florence.'

The hishop, heartily vexed as he was, could not restrain his laughter, and laughed the more because he remembered that the artist thus tricked by an ape was himself the most incorrigible of jesters. When they had talked and laughed over this new occurrence to their hearts' content, the painter went to work for the third time, and the chapel was happily completed.

That done, Bishop Guido set Buonamico to paint on one of the walls of his palace an eagle on the back of a lion, which the bird had killed. But the lion being among the insignia of Florence, and the eagle that of Arezzo, the artist resolved to do the work after his own fashion: he caused a screen to be constructed around the scaffold, and then, painting a lion occupied in tearing an eagle to pieces, he departed to Florence, pretending to require certain colours which demanded that journey.

The hishop was furious when the affront put upon him was discovered; but the artist was ultimately forgiven. Some of the commentators on this passage in the life of Buffalmacco, tell us that Bishop Guido, being a Ghibeline, intended to affront the Guelis, rather than the Florentines, by the work in question.

The admiration—or rather the reverence, the adoration—of the great and thoughtful German people for Shakspeare, is well known to all who have consorted intimately with our Teutonic kinsmen; and the following passage, among many others, has more than once been cited as one eminently worthy of attention from the student in Art,—he will remember that it is Portia who speaks:—

"I pray you tarry, pause a day or two
Before you hazard, for in choosing wrong
I lose your company; therefore forbear awhile.
There's something tells me (but it is not love)

I would not lose you; and you know yourself
Hate counsels not in such a quality.
But lest you should not understand me well
(And yet a maiden hath no tongue but thought),
I would detain you here some month or two
Before you venture for me.*

Turn also to the words addressed by Portia to Bassanio, when he has chosen aright, and admit that both these passages are suggestive of exquisite pictures. Nay, he who shall faithfully render the fair being of Portia—that refined and beautiful head—that noble, yet graceful, and most feminine form—the winning sweetness of her attitude—the eloquent loveliness of her sweet lips, as she gives utterance to the god-like poet's words,—he who shall give us all this, I say, will endow the world of Art with such a form and face as its truest lovers are ever seeking, and may sometimes behold in their dreams, but do not often meet on canvas or in marble. Look to it, then, ye who aspire to be Sculptors or Painters; and if you produce only this one Portia of Shakspeare, as Shakspeare made her, the world to come shall admit that you have lived to a worthy purpose.

Wholly different in manner, but presenting pictures equally vivid, and in all respects equally perfect in their kind, are the lines that follow. They are taken from the second scene in the third act of the "Taming of the Shrew." Gremio, one of the suitors to Bianca, the sister of Katharine, has just returned from the wedding of the latter, and is describing the events of the ceremony to the disguised servant, Tranio, whom he takes for his master, Lucentio. It is Gremio then who speaks:—

Gre.—Tut! she's a lamb, a dove—a fool to him.
I'll tell you, Sir Lucentio. When the priest
Should ask if Katharine should be his wife,
"Aye, by God's wounds," quoth he, and swore so loud
That, all amazed, the priest let fall his book,
And, as he stooped again to take it up,
The mad-brained bridgroom took him such a cuff,
That down fell priest and book, and book and priest.
"Now take them up," quoth he, "if any list."

Tr.—What said the wench when he arose again?
Gre.—Trembled and shook;—for why, he stamped and swore

As if the vicar meant to ezeen him.
But, after many ceremonies done,
He calls for wine. "A health," quoth he—as if
He had been abroad, carousing to his mates
After a storm—quaffed off the muscadell,
And threw the sops all in the sexton's face,
Having no other reason
But that his head grew thin and hungerly,
And seemed to ask him sops as he was drinking.
This done, he took the bride about the neck,
And kissed her lips with such a clamorous smack,
That at the parling all the church did echo.
I, seeing this, came thence, for very shame;
And after me I know the rout is coming.
Such a mad marriage never was before.
Mark! mark! I hear the minstrels.

The lines that follow have, in like manner, been proposed as a subject for the pencil, by German lovers of Shakspeare, to the artists of that nation. The place is a public square in Venice; the principal group consists of Shylock and Bassanio, who are joined by Antonio—Bassanio speaks:—

Dass.—This is Senior Antonio.
Shy. (aside).—How like a fawning publican he looks!
I hate him, for he is a Christian;
But more for that, in low simplicity,
He lends out money gratis, and brings down
The rate of usance here with us in Venice.
If I can catch him once upon the hip,
I will feed fat the ancient grudge I bear him.
He hates our sacred nation; and he rails
Even there where merchants most do congregate,
On me, my bargains, and my well-won thrift,
Which he calls interest. Cursed be my tribe,
If I forgive him.†

Of the dialogue between Ferdinand and Miranda highly effective expositions have come under our notice. Kaulbach has one in his "Illustrations to Shakspeare" and a cartoon, based on the following words, was commenced by one of his countrymen for the annual exhibition of a northern capital, in the year 1853, but was not finished in time to appear. It may perhaps have done so in the following year; but as respects this the writer has no information.

The portion of the words useful to our present purpose are these:—

* "Merchant of Venice."
† Wine was at that time presented to the company immediately after the rite was performed.
‡ "Merchant of Venice," Act i.

Mr.—If you will sit down
I'll bear your logs the while—pray give me that,
I'll carry it to the pile.

Per.—No, precious creature;
I had rather crack my sinews, break my back,
Than you should such dishonour undergo,
While I sit lazy by.

Mr.—It would become me
As well as it does you; and I should do it
With much more ease, for my good will is to it,
And yours against.

Pros. (concealed in the distance).—Poor worm! thou art infected—
This visitation shows it.*

Frequent reproach was incurred by Pietro Perugino, during the latter years of his life, for that he constantly reproduced the figures which had before appeared in his works. This happened more particularly on a certain occasion, when the Servite monks of Florence had commissioned Pietro to paint that picture for their high-altar, which had been commenced by Filippo Lippi, after Leonardo da Vinci, to whom it had first been offered, had departed for France, and which had been left unfinished when Filippo died.

Nay, when the work was uncovered, all complained of this repetition, whereupon Pietro defended himself in the lame manner that follows:—

"I have here painted you the figures that you formerly commended. They then pleased you well, and if they now displease you, so that you no longer extol them, what can I do?"

The reply was manifestly, "You can choose others." But our poor Pietro, discouraged just then by the fact that "the greatness of the name he had formerly acquired began now to be obscured by others—that of his illustrious disciple among the first,"—discouraged by this, I say, he had not energy for new efforts, and the reproaches thus recorded were one of the results.

But others of his day might very justly have shared that odium with him, since, if they did not reproduce exactly the same figures, it is certain that they walked in a very narrow circle of subjects, and frequently came round to the one but lately treated. Hence the numerous St. Sebastians, that weary their admirers of all succeeding ages in every gallery—to say nothing of Holy Families, the mere distinctive titles whereof would make a long catalogue. Next in frequency comes St. Christopher, more particularly among the Tuscan and Umbrian masters—these last delighting, moreover, in pictures of cities, &c., taking shelter beneath the mantle of the Virgin; and then follow St. Francis Seraphicus, receiving the stigmata, and Santa Theresa in ecstasy—both frequently found among the works of the Italian painters. SS. Cosmo and Damiano are in like manner favourite subjects with the early painters. Few but will remember the example by Bacci di Lorenzo, and now in the Uffizi, where these holy physicians are in the act of replacing the amputated leg of a white patient by that of a dead negro, whose corpse, deprived of the member required, is lying near. This is the picture painted for Antonio Ghizzi della Casa, in the year 1430—consequently, during the life-time of the painter's renowned father, Lorenzo di Bacci, who lived until 1453. The work was subsequently suspended on a pilaster of the Florentine cathedral, where it remained until 1843, when it was removed to the first corridor of the Uffizi, where it now remains, as above said. Neither will it be needful to remind our readers of a work on the same subject, left us by Fra Giovanni Anselmo da Fiesole, now in the gallery of the Florentine Academy, with a companion picture—the story of five martyrs—also to be found there.

No objection needs to be taken to these subjects—certainly not; in themselves they are wholly unobjectionable; it is but of their too frequent repetition that the beholder becomes weary, and if, from these—of somewhat kindred character—that follow, it shall please any student to select two, three, or more, let him feel secure from all fear of the reproaches showered on Perugino, as to a too oft-repeated story—always provided that he do not give us the self-same figures in all his paintings, as that excellent master was ultimately charged with doing.

St. Hilariion, the founder of the hermit-life in Syria, as was his master, St. Anthony, in the Theban deserts, is not unworthy of the painter's attention.

* "Tempest," Act iii.

Clothed in skins, and in the flower of his age, he is represented with a dragon beside him, in allusion to the legend setting forth his victory over a creature of the dragon kind, by the extension of the cross, which the anchorite holds in his hand, or has leaning against the side of a dark and low-browed sandy cave, within the shade of which he is most commonly found seated.

There is another Syrian hermit, St. Efram, or Ephraim, whose death, which took place in the Asturias, about the year 378 A.D., is delineated in a Byzantine picture of the eleventh century, still in the *Museo Cristiano* of the Vatican. The saint is surrounded by monks, with whom are certain of the poor, about to be left desolate by his departure, and beavailing their loss; in the background are scenes from hermit-life, depicted with much truth and force: this work bears the name of Emanuel Tzanfaruari—a painter not, at present, otherwise known to the present writer.

St. Nicholas von der Flue exhorting his compatriots to peace, at the moment when the freedom of all Switzerland was in danger of destruction from their discords, is a subject entirely worthy of memorial; it is interesting, and has the further merit of being in strict conformity with historical truth—that event having taken place in the town-house of Stanz, as most readers will remember, during the year 1481.

A second interior will be bestow'd if you devote it to Santo Gualfardo, the patron of saddlers, whom it would ill become us, in this, our land of good horsemen, to leave entirely out of view. You are to paint him in the midst of his work, as that was conducted in his day—the early part of the twelfth century, and in the city of Verona, where it was that he exercised his craft, and ultimately died. This last event we may suppose to be not far distant, since there is a stone coffin descending towards him from the clouds, and now appearing to him through the open front of his hoth, as he kneels in grateful adoration to receive it. This announcement of, and preparation for, his proximate departure, was sent to Santo Gualfardo, says the legend, in recognition of his sanctity, and was seen in its passage through the air by all Verona. Many of the citizens are, in fact, regarding the coffin with varying expressions, while others are gazing on the saint with infatigable reverence and amazement.

Santa Sofronia, also of the eremite body, supplies us with a picture not unlike, in its details, to one which makes the closing scene of that ancient story, "The Bales in the Wood." In the desert—but a desert in name only, since the landscape is one of exquisite beauty—we have the holy woman prepared for death. She has pillowed her head on a fragment of rock, the cross is beside her, and all around are birds, each bearing in his mouth a portion of that leafy covering wherein they have already well-nigh enveloped her whole form, or else departing in search of material for the continuation of their pious office. Three young girls are kneeling at some distance, having been arrested by wonder and awe at the spectacle before them, when arrived thus far on a visit of duty to the saint: older persons, men and women, may vary your picture; these you may deal with as you like: but for them you can have but the warrant of your imagination—all previously given is part and parcel of the authorised, if we are not to say the authentic, legend.

The "Worship of the Lamb," an altar-piece, by the brothers Van Eyck, with its wings on either side, representing the long train of eremite fathers, from Paulus Eremita and St. Anthony downwards, will be fresh in the recollection of our readers. Mary Magdalen, and St. Mary of Egypt, although not always enumerated among the anchorites, likewise appear in this work, as having passed each a large part of her life in the wilderness. The landscape is remarkable for its period, and many of the heads—some of those belonging to the older men more particularly—are full of the most life-like truth and force of expression.

There is a picture of John the Baptist—the great forerunner of all anchorites—in the Pinacothek of Munich, which has been attributed by writers generally to Hugo Van der Goes,* but this is declared by Dr. Waagen to be an error, and Hans Memling is by many good judges considered to be the more

* This work bears the date of 1472.

probable author of the work. Of the St. John by Raphael, in the Tribune of the Uffizj, at Florence, none will need to be reminded. A picture of Mary Magdalen, by the townsman of Raphael, Timoteo della Vite, forms one of the glories of Bologna, and is in all respects admirable; the beautiful head hands with a touching grace, and the long flowing hair, falling to the feet of the saint, renders the mantle given her by the painter well-nigh superfluous. St. Paulus Eremita, and St. Anthony in the desert, painted by Lucas von Leyden, and now in the Lichtenstein Gallery, at Vienna, is also a work of merit. Many others, treating the same interesting series of subjects, return to the memory as these are recalled, but must for the present remain without notice.

It has ever been matter of surprise to the present writer that the greater masters did not more frequently devote themselves to themes from the older Scriptures: I say the greater masters, because it does not appear to me that any other could attempt them without incurring the charge of reprehensible presumption. In my present office I have but rarely specified such, partly because the habits of daily life in our country bring that richest of treasures—for the artist whose aims are of the highest—constantly before his eyes, but chiefly because it is given to few, even of Art's most favoured sons, to approach that sanctuary; nor to them, save only at moments recurring at distant intervals, and but rarely accorded.

And so must it have been felt at all times; we cannot doubt it. Remembering well the instances of selection from the Hebrew Scriptures by the ancient masters—seeing one work after another rise to the eyes of memory, and omitting none, yet do we find them at points so widely distant, as compared with others, that we are justified in describing them as rare and few. As compared with subjects chosen from the lives of the Saviour and the Virgin, for example, or from those of the Evangelists and Apostles, or of the Saints of the Canon, how do they count? Pass in memory through any gallery you may please to select, and the result will be found as here stated. Then how narrow is the range of subjects; a few scenes from the lives of David, the first Patriarchs, or from one or two of the Judges, or from that of Judith, and we have named all. It is as if none, finally, ventured to look at these themes save through the eyes of the bolder adventurers preceding them.

Take, for example, the thirty-six or thirty-seven paintings constituting the gallery of the Vatican,* and say what you there find in disproof of what is here asserted.

The great Florentine Gallery of the Uffizj has some few: but these do but prove the rule, for amidst the vast numbers of that immense collection, how small, may almost imperceptible, is this fragment. We have Esther before Ahasuerus, by Paolo Veronese; Giorgione has taken Moses and Solomon for his themes; Jacopo da Empoli has a sacrifice of Abraham; Botticelli and Allori give us scenes from the lives of Joseph and Judith; while Vasari, a master who rarely has justice done him, ventures on the less hacknied subject of Elisha's miracle of the bitter herbs.

In the Pitti Palace is a vision of Ezekiel, from the pencil of Raphael himself; but not in all the large gallery of Bologna do I recall a work on the subjects in question by the greater masters,—with the sole exception of a Samson, by Guido, who shows us the great enemy of the Philistines, triumphant from their slaughter, and causing water to flow from that jaw-bone of the ass, which has been his instrument. There is a St. Michael trampling the Demon, by Innocenzio da Imola, but this cannot be treated as coming strictly within the category we are now considering.

Nor do examples abound in the public gallery of Siena, which comprises works from early in the 15th till towards the close of the 16th century. Francesco da Giorgio and Leandro—or perhaps, Francesco—da Ponte (Bassano), have pictures, I

* Our readers will remember that the pride of the Vatican, as to extent, is in its many gorgeous halls of sculpture; but—and what a but!—the small picture gallery boasts the "Transfiguration" and the "Last Communion," to say nothing of all beside.

think, from the lives of Susannah and Joseph respectively, but I remember no more. Prophets and saints, used as adjuncts to the lives of Christ and the Virgin, of course excepted: these abounding here as elsewhere.

In the profoundly interesting gallery of the Florentine Academy we have again but few examples among the older masters; in the exhibition of artists belonging to the day they have appeared in larger proportion. Jaham seeking his lost idols, and Dalilah shredding the locks of Samson, are among them, both by Crescentino Roti; these are productions of some four or five and twenty years since.

The four greater prophets have been of late years chosen as themes for their study by German artists. They appear in a fresco, painted by Heinrich Hess, in the Allerheiligenkirche, at Munich; and in the Ludwigskirche, of the same city, there is a group of these prophets by Cornelius. Kaubach's "Destruction of Jerusalem" exhibits them also; they appear in the clouds above the doomed city; and as an instance of a work from one of the greater prophets, all will remember the "Belshazzar's Feast," of our own compatriot. Themes yet untouched remain, nevertheless, and that in rich abundance, for him who feels himself permitted to approach the sublime source: and here, taken from the first among them, in order as in place, is a passage from Isaiah, grandly rendered by a young Venetian artist, whose cartoons did not proceed beyond the first design: the denunciation conveyed in the words, which will be found in the margin, was therefore never painted.

In the same portfolio was an illustration of words from Jeremiah,* all unlike the ordinary tenor of that prophet's works, but the picture was none the less effective for that, and well merited completion. The words will be found below.† From Ezekiel an attempt was made to show the prophet waiting by the river Chebar, as set forth in the earliest verses of the book; but "the great cloud," and "the fire infolding itself," and "the brightness about it," with the powerfully sketched figure of Ezekiel himself proceeding from the mass of "the captives," were all unfinished: what should come of an effort so ambitious it were thus not easy to determine; but it could scarcely be in the intention of the student to venture on more than a part of the vision. From the contemporary of Ezekiel—the prophet Daniel—the four children entreating to be "proved with pulse to eat and water to drink,"‡ rather than with "the daily provision of the king's meat, and of the wine which he drank," assigned to them, was the subject chosen; nor, so far as the cartoon had proceeded at the period to which we refer, was it likely to prove unsuccessful.

* Isa. c. xxxix. :—"1. Woe to Ariel, to Ariel, the city where David dwelt! add ye year to year; let them kill sacrifices.

"2. Yet I will distress Ariel, and there shall be heaviness and sorrow: * * *

"7. And the multitude of all the nations that fight against Ariel, even all that fight against her and her munition, and that distress her, shall be as a dream of a night vision."

† Jer. c. xxxiii. :—"10. Thus saith the Lord: Again there shall be heard in this place, which ye say shall be desolate without man and without beast, even in the cities of Judah, and in the streets of Jerusalem, that are desolate, without man, and without inhabitant, and without beast,

"11. The voice of joy, and the voice of gladness, the voice of the bridegroom, and the voice of the bride, the voice of them that shall say, Praise the Lord of hosts: for the Lord is good; for his mercy endureth for ever: and of them that shall bring the sacrifice of praise into the house of the Lord. For I will cause to return the captivity of the land, as at the first, saith the Lord.

"12. Thus saith the Lord of hosts: Again in this place, which is desolate without man and without beast, and in all the cities thereof, shall be an habitation of shepherds causing their flocks to lie down.

"13. In the cities of the mountains, in the cities of the vale, and in the cities of the south, and in the land of Benjamin, and in the pieces about Jerusalem, and in the cities of Judah, shall the flocks pass again under the hands of him that telleth them, saith the Lord.

"16. In these days shall Judah be saved, and Jerusalem shall dwell safely: * * *

"17. For thus saith the Lord: David shall never want a man to sit upon the throne of the house of Israel."

‡ Dan. c. i. v. 4-12.

EXPENDITURE ON PUBLIC WORKS
IN LONDON AND PARIS.

THERE is as yet no sign of the proposed extension of the buildings necessary to the Houses of Parliament, according to the plan of Sir Charles Barry. The south side of Bridge Street is still standing, and St. Margaret's Church yet occupies its ancient site. Parliament may not coincide with the architect, but we agree with the late Sir William Molesworth, that the removal of the south side of Bridge Street, at least, is indispensable. There are many reasons wherefore it may be inexpedient at present to carry out the estimates of the architect—among which the immediate necessity for new government offices may not be the least pressing. We cannot be accused of proceeding indeliberately with any of our public works—we have nothing, therefore, to expiate on that score. But, were it otherwise, it is not intelligible to us that any dissipation in public buildings could, by causes either immediate or contingent, imperil our government. It is not so in France. Our neighbours have possessed themselves of the lamp of the Eastern tale, and have secured the services of the most wonder-working of all the geni, who, in the spirit of true enchantment, turns their most sordid dwellings into luxurious palaces. But these are the transformations which sow discontent among the masses: so long as the new edifices were national, it was well; but the erection of sumptuous private dwellings excludes them from the *beaux quartiers*—they feel themselves slighted; they who, in their time, have more than once been the law—the enthroned people; and theirs is now the voice that suggests to the French Government that they have attempted too much in a time too limited. Were we to commit a similar extravagance, the results could not be identical. This was seen when the homes of twenty thousand of the lowest classes were swept away in St. Giles's and Clerkenwell, and almost of an equal number in Westminster. There was no care as to their future abiding-places, nobody asked whither they went; but it was soon discovered that the worst of them had migrated, and translated with themselves their pandemonium to the purlieus of Lisson Grove, where they acquired for their locality a name at which even Milton and Dante shuddered; the descriptions, however, of the latter apply to the translation from St. Giles's, for there—

"D'anime nude vidi molte gregge
Che piangean tutta assai miseramente,
E parerá posto lor diversa legge."

Thus, the dislocation of fifty thousand of the labouring, or, what is worse, of those classes that live without apparent means or occupation, has no result; but in France, every movement by which the lowest classes are in anywise effected becomes at once an event of political importance. Our neighbours would have unhesitatingly adopted such propositions as those of Sir Charles Barry without due provisions. We are justified in saying this because they have done that which is to them much more perilous. It would almost appear that between Paris and London there is a rivalry as to the embellishment of the court quarter; but, in a comparison of the two cities, we cannot join in the general depreciation of our capital. The enrichment of the best quarter of Paris may be said to be almost concluded, but in London nothing has been commenced but the Houses of Parliament; and if but a half of the designs which of late have been so thoroughly ventilated, be carried into effect, we shall have no reason to shrink from comparison with Paris. With regard to the additional works considered by Sir Charles Barry necessary to the completion of the New Palace at Westminster, he has proposed that New Palace Yard should be inclosed on the north and west sides, and should form a part of the New Palace, as it had done of the Old Palace; that the principal entrance for the public should be at the north-west corner of this proposed new quadrangle. The new building forming the west side of this quadrangle is proposed to be continued southward until it joins the existing building at St. Stephen's Porch, thereby forming a façade to the new street, to be called St. Margaret's Street, and Old Palace Yard, with the convenience of a covered footway throughout the entire extent of it. Such an addition would undoubtedly rectify the

irregular and disjointed character of the present building, as viewed from the west and north-west; and a degree of unity would be thus acquired such as the river-front presents. Such a disposition would be a means of distinguishing the principal entrance by a prominent feature; and the effect of these additions would also be to appropriate to useful purposes the waste but valuable space which now contributes in nowise either to the ornamentation or good effect of the Palace. The purposes for which these erections might be useful would be, extra committee-rooms, if any number beyond those in the existing building should be required, and again as public offices, or for commissions formed for assisting the legislation of the country;—and it must be observed that accommodation of this kind is frequently and suddenly wanted, and when so required can only be obtained by the hire of some small, inconvenient, and perhaps distant private residence. The proposed additions, with their cost, are as follows:—Building on the south side of New Palace Yard, £67,295; building at the west side of New Palace Yard, including the entrance gateway, £79,052; building forming the centre of the front towards St. Margaret's Street, and southwards to St. Stephen's Porch, £102,594; building in the proposed new quadrangle of New Palace Yard, west of Westminster Hall, £13,993; the Speaker's stables, &c., £3266; alterations of the front of Westminster Hall, £12,085—giving a total of £278,285. This estimate does not include the purchase of the block of houses on the south side of Bridge Street, which must be removed should these proposed additions be adopted. The cost of these houses, together with compensation to tenants in occupation, is estimated at £170,000. These houses are in another direction an obstruction, as, while they stand, it is impossible to obtain a good passage to Westminster Bridge. In this estimate of £278,285 there is no provision for the law courts, which must be removed from Westminster Hall, and not one-fourth of the accommodation necessary for these courts would be found in the erections contemplated in this estimate. In addition to these buildings a committee of the House of Commons has recommended the removal of St. Margaret's Church, which, if these plans be realised, would be highly desirable, for it is not necessary to show how much this edifice would be obtruded on the proper site of the Houses of Parliament. For this church a site has been proposed by Sir Charles Barry between Prince's Street and Tothill Street, the purchase of which would cost £45,000, and the removal of the church is calculated at £23,000. Sir Charles Barry has also recommended the raising of the roof of Westminster Hall, at a cost of £25,000, and the enlargement of Old Palace Yard for the purpose of obtaining space opposite the Victoria Tower—an improvement which could be effected only at a cost of £110,000—a very considerable outlay for the sake of effect; but when we remember that on the Continent, and even in our own country, many of the most splendid architectural essays are obscured by old and ruinous houses of the worst taste, inasmuch that the effect which, under other circumstances, would be really imposing, is entirely destroyed, we cannot wonder at the desire of the architect to secure for his work the advantage of its being seen. The total estimated cost of these additional works would be £681,285, and the entire cost of finishing the whole in accordance with these plans would be considerably upwards of two millions and a half—not, all things considered, an extravagant sum for erections of such importance, contributed throughout a period approaching twenty years, which must be the space before the whole could be effected. Our school of economists have long exclaimed against what they call the profane waste of public money in public building; they cannot exclaim against the sums expended in what the times and the progress of society render a necessity—Art embellishment, that has for two years been all but suspended. Let us see what within a few years our neighbours have expended in building. In 1850 the amount expended in building was £880,000; during the five following years the cost of building amounted to the enormous sum of £23,440,000; and during the present year the estimates are for £10,000,000; and nearly all this for Paris alone. Grievances are all comparative; when we consider the position of the French nation at this moment, it will scarcely excite

surprise that such things should be, after a little better than profitless expenditure of nearly forty millions sterling in six years. What comparison can be instituted between our expenditure of two or three millions, and that of forty millions on the part of our neighbours in one third of the time? We would not seem wise in the discussion of *faits accomplis*, but it has been foreseen that such marvellous outlay in public building must involve the French government in, to say the least, embarrassment. This it was that brought the war to a conclusion when we were only preparing to carry it on. Our economy is our strength, but the embellishment of Paris is the weakness of France; and the worst of her difficulty is that she dares not suddenly stop these public works. It is sincerely to be desired that the French Government money may be the only cost of the embellishment of Paris.

CORRESPONDENCE
FROM THE
UNITED STATES.

THE SUMMER LIFE OF THE ARTISTS.

DEAR SIR,—Now, as wintry days are coming, and the artists are returning from country rambles to city homes, it may not be inappropriate for me, lingering still amidst the autumn glories of the great hills, to tell you something of our summer life, its whereabouts, and its ways.

I take up the tale *con amore*, as you may well suppose, desiring no better success than to win you to even a small share of my own interest therein; for pleasure more pure, simple, and sincere than that of the glad artist, set free with the summer sunshine, to wander as fancy pleases over the hills and far away, is nowhere to be found.

I cannot, perhaps, do better than glance hastily first at the actors in my drama, the artists themselves, their numbers and quality; next, at the stage upon which they are to play, its character and capacity; and then at the action, its pleasures and its pains, its methods and its results.

Landscape art is yet in its youth in America; though a youth of health and vigour, and brilliant in promise, its short life scarcely looks back through one generation. A quarter of a century ago it did not exist at all; and until within a very few years past, its progress has depended alone upon the labours of the three gifted men—Cole, Durand, and Doughty; in whose genius its vitality was first seen and felt. Recently many others, worthy to wear the mantles of these fathers of the art, have sprung up to assist and to continue their toils, and to share their honours; while others again will surely come in their turn, until the present clear promise of high success shall be gloriously performed.

Happily, nowhere is that great hope of modern landscape art, the general and growing practice of patient, earnest, humble, out-of-door study, more reasonably entertained than amongst us. In this spirit we began, and have ever continued our career—impelled by the lack of other sources of instruction, in the absence of all Art-examples, and yet more by the requisition made by the *morale* of people and painter alike, for the "plain, unvarnished tale" of nature's truths.

With the earliest breath of luring summer, then, all our landscapists are turned from their studios to out-of-door study—not in mere superficial memoranda of the forms and colours of nature, but in ever-patient delineation of her minutest charms, and upon canvas which an easel is required to support. So great is the number of these pilgrims that at the high-altars of nature their presence and their companionship is fast growing to be, in the estimation of the summer tourists, one of the chief features of observation and enjoyment.

Whether the traits (coming now to the second point of my discourse) of our American scenery are more or less acceptable and serviceable to the painter than those of the Old World landscape, it is not in my mood, if in my power, to inquire at this time; though, if we must confess to an inferiority in some qualities and characteristics, it will be with the ensouling remembrance of many compensating advantages. We should like to see here,

sometimes, the pretty, joyous, rural sentiment of your English homes—though we can content ourselves with the rude pioneer's cabin, stoutly subduing the wild forest, and bearing the rose of civilisation to the soil of the wilderness. There is beauty to be loved in the picturesque surprises of the wayward and Art-embellished *physique* of nature on "the Continent," but to our feeling there is a higher and nobler charm in the youthful freshness and the luxuriant verdure of our grand mountain solitudes, in the promised wealth and plenty of our vast prairies and tropical savannas, and in the bold floods of our interminable rivers and our sea-like lakes.

Such as it is (and it quite contents us), we have plenty of material within the varied area of the three thousand miles which lie between our Atlantic and our Pacific coasts. We have, indeed, a field rather too extended for our peace of mind as artists; and it is with us quite a task for the previous winter to determine where the next summer shall be passed—though the force of habit and of example, the ease of access, and the assurance of reward, generally lead the greater number, season after season, to a few well-tried, well approved, and convenient localities.

Most of our general resorts are in the vicinages of the northern cities, from the artists being chiefly found there, rather than from the absence of picturesque themes elsewhere. On the contrary, there are galleries of charming pictures to be picked up in the mountains and valleys of Virginia, of the Carolinas, and of Georgia, and through all the windings of the rivers of the West—to say nothing of the immense territories, yet unexplored by Art, beyond the Mississippi, and amongst peaks and gorges of the great Rocky Mountains. Still, fortunately for the convenience of the student, there are no finer examples of many of the best features of our landscape than he can find near at hand in the Northern States; on the waters of the Susquehanna, and of the Juniata, in Pennsylvania; on the Hudson, in the Catskills, or amidst the abundant and beautiful lake scenery of New York; the noble valleys of the Connecticut, and of the Housatonic rivers, in New England, with the Green Mountains of Vermont, and the White Hills—where I now write—of New Hampshire.

Of all these localities, there is none more beloved by the painters than are the Catskills. These noble hills rise in grand array, sometimes to the height of four thousand feet, ten miles west of the waters of the Hudson, forming a salient feature in the famous scenery of that most beautiful of all our rivers. They are thus very readily reached from New York, and many of the painters always make their summer homes within their gorges. Indeed, there are very few of our landscapeists who are not more or less indebted to the Catskills, since nearly all have studied there at some time or other. Close lived and lies buried within their evening shades, and from their heights he drew the themes or the inspiration of many of his most successful works. I once found nearly a dozen artists in sole occupation of a little inn at the entrance to one of the Catskill passes. In their stores of mountain material of all description, these hills are surpassed nowhere in the Union.

After the Catskills, the New Hampshire Hills are the favorite Art Mecca; and just at this time, as for a few years past, they are the shrine *par excellence*. The many bold peaks of this region are all overlooked from the summit of Mount Wellington—their loftiest elevation east of the Rocky Mountains. These "Granite Hills," as they are sometimes called, are visited by hosts of travellers in the brief summer season. Artists are found at all points of the route, though their preferred homes are the quiet places aside. The inn at this little hamlet of Campton has been filled by them all the season through; while another large party has been domiciled in the lovely valley of Conway, a day's walk across the hills to the eastward. Some of our profession have gone this season to the shores of Maine, where (unlike our coast scenery in general) there is much striking rugged rock material. The lakes, which are in number infinite, and in beauty wondrous, are favourite themes of the wandering pencil. Lake George, in New York, and Winnepiscogee here, in New Hampshire, with their bold mountain shores, their fairy islands, and their translucent waters, are among the world's greatest marvels of natural beauty. Then, too, there is the

lake scenery of the wilderness, where, as in northern New York, you may journey for long weeks among the rugged mountains in a boat, passing from one crystal lake to another. The lowland and swamp tracts of the south,—where the rice and the sugarcane, and a thousand luxuriant evergreens, make verdure all the year,—have a peculiar attraction, which would be exceedingly interesting, though they are rarely made so on canvas.

Our sketching-season commences in June and ends in October, with the chance of chilly temperatures at each end, and the certainty of scorching suns in the middle. Our atmospheres, unlike yours in England, are clear to brilliancy, often revealing the minutest markings of distant hills—though prolonged heat will gradually spread a pleasant haze over the landscape, for a thunder-storm to withdraw. With such a climate we, of course, miss the tender, tealish skies, and the juicy, dewy verdure, so grateful in your more moist atmosphere. Our most agreeable and varied cloud-effects come with the passing of the seasons into spring and autumn. The quickly-changing sky—now bright and sunny, now dark and lowering—gives a world of magic and weird aspects to the part-coloured woods at this time of the year, playing with the thousand marvellous hues, as the dextrous painter might vainly seek to play with his most gorgeous palette. Much as you may learn, you cannot, without seeing, put proper faith in the marvels of colour which our October forests present. Apt was the poet's epithet of "rainbow beauty." So riotously varied and brilliant are they, as to upset the gradations from foreground to distance, to the utter bewilderment and dismay of the puzzled painter. Rarely, indeed, is the representation of such scenes attempted, and hardly ever with success. Cole and Cropsey, of all our artists, have been most fortunate in these dangerous ventures. With Cole, they were always subjects of especial and devoted study; and he approached the truth as nearly, perhaps, as we may hope it to be ever reached.

The habit of the artists is to set out in couples, or in larger parties, for some chosen Eden; or to wander until they find an acceptable place, and then to settle quietly down in village inn, or in farmhouse, to study for the season, or until their subjects are exhausted. Their journeys are inexpensive, as they have never very far to go, and, in the quarters which please them best, they live at a very moderate outlay—their board and lodging rarely costing them more than from three to four dollars per week. Thus they can, fortunately, better afford to go abroad than to stay at home. In the humblest, as in the most polished circles, they are always welcome visitants, as I need hardly tell you, who know so well the frank and genial hearts of the craft—the native simplicity, grace, and truth of their manners—their intuitive intelligence, their necessary cultivation, and their ready powers and pleasures of entire adaptation to all natures and circumstances.

Excepting in a few ancient resorts, they and their "mission" are subjects of envious wonderment to the good people. As everybody in this land of active industry is supposed to be more or less usefully employed, the fact that they are simply painting "pictures" for their mere beauty, and the love of the thing, is the last realisation to which the rustics can bring their practical minds. Thus the Art-traveller is mistaken, when acquainted with sketch-box and staff, for a respectable pedlar, and is asked for scissors and combs; or for an ingenious clock-maker, and is invited to step in and correct the cottage timepiece; or for the "census-taker," and is flooded with statistics; or for an organ-grinder, with a solicitation to play, and a wonder where the monkey is kept. When he is seen at work they "allow" that he is making "maps" on the "guess;" he is surveying the new line of railway; or else he must be in search of a suspected coal-bed, or of an iron mine: any "business," indeed, but the incomprehensible one of "drawing pictures." But their native quickness soon explains the enigma, and the latent love of Art-beauty, which they generally possess, is easily brought into intelligent exercise.

An overcast or a rainy day, after a long "spell" of dry weather, gives the industrious student an opportunity to lay aside his over-worked pencil, and to indulge the piscatory propensities which he

is very apt to possess: and this he may generally do with reasonable luck, in any of our mountain waters. Perhaps he may sally out with his rifle, in the well-grounded expectation of adding a venison steak to his humble larder: Rocky Mountain-wards his game would come up to the dignity of buffalo and wild Indian.

Should he chance to be alone, and in the rudest regions even, an artist need not suffer in his hours of leisure from a want of intelligent companionship. In the humblest forest cabin he will assuredly find the "papers," and a host versed and voluble in many lore: perchance in woodcraft, or in agriculture, or in theology; certainly in political history, from the battle of Lexington to the battles of Kansas. Should his landlord's "talk" prove to be dull, he may have recourse to the society of the neighbours, or, perhaps, may assemble them from all the region round, and lecture them acceptably upon any subject, from the beginning of the world, to the "dissolution of the Union!" Artists are naturally inclined to all harmless fun, and a peep at the odd pastimes which they often invent for summer beguilement would be merry work. I once knew a gay party who eked out the season's exhausted amusement by getting up a free, public exhibition of their studies, with explanatory discourses (as in panorama displays), in which there was always a great deal more of the spirit of '76, than of the spirit of Art. A "party" at the inn, to the belles of the neighbourhood, or a general serenade of the country, on the eve of departure, is an agreeable manner of leave-taking. Generally, however, the hours of the summer student are too entirely, and too happily employed, to allow *cumulo* to gather until it boils over into froth.

The long day's earnest and exciting toil, and the arduous "tramps" which his labour often involves, over rude pathways, brings weariness, mental and bodily, which makes rest and sleep occupation enough for a brief summer night—to say nothing about the momentous councils which are daily held upon the condition and the promise of the weather: the fluctuations of the finances are not half so eagerly watched at the *Bourse*, or the strategy of states, in the cabinet, as the uncertain skies by the artist, hopeful and yet fearing for the morrow.

All *couleur de rose* as it seems to the general observer, what a severe school of patience, the summer life of the artist is! How great the courage required to bear with equanimity those treacherous changes of weather and atmosphere, which are ever breaking the trusted word of promise, compelling him to complete in clouds the sketch begun in sunshine! What Roman firmness he needs to breast the angry winds, striving to blow away his easel, his umbrella, and himself together! What resignation he must have to remain quietly in the blinding clouds of dust which passing cart calls up, until he is, in the course of human events, revealed to mortal sight again! How noble in forbearance under the merciless onslaught upon himself and his fair, fresh canvas, of invading mosquitoes, and those countless rank and file of insect allies!

All these, and many other dire *desagréments*,—often bodily fatigue, and sometimes a painful consciousness of the fearful disparity between his best achievements and the everlasting beauty of his model,—are incident to the summer life of the artist: but they fly away like morning mists, in the sunshine of pure delight which he finds in the matchless smiles of ever-charming nature.

OBITUARY.—To the record which I sent you last month of Art-history in Boston, it grieves me now to add intelligence of the death of Sela Cheney, one of the most gifted of our profession in that city. He worked solely in crayons, but with a feeling and power which made that simple material, in his hands, all sufficient. Even his portraits, scarcely less than his ideal heads, were ever characterised by a sentiment of grace and spiritual beauty, which did high honour alike to his holy art, and to his own pure nature.

Mr. Cheney died on the 10th of September, at Manchester, near Hartford, in Connecticut. He was about fifty years of age.

T. A. R.

West Campton, New Hampshire,
October 1, 1856.

THE ROYAL PICTURES.

CAPRI.

G. E. Hering, Painter. R. Brandart, Engraver.
Size of the Picture, 2 ft. 4½ in. by 1 ft. 0½ in.

CAPRI, the *Caprea* of the Romans, is a rocky but beautiful and picturesque island of the Mediterranean, distant about ten miles from Sorrento, and rather more than twenty from Naples, which it immediately faces. "It stands out in bold and rugged majesty, 'like an advanced sentinal,' at the south-eastern extremity of the Bay of Naples, and is separated from the Sorrentine Promontory by a deep channel three miles in breadth. The island is three and a half miles in length, and two in breadth at its western portion, being divided, about the middle, into two mountain masses, of which the largest and loftiest is that on the west, called Monte Solaro, which rises about its centre to the height of 1900 feet above the sea; the eastern division of the island is about 860 feet in its highest part, and terminates in cliffs which plunge precipitously into the sea. The circumference of the island is about eleven miles."* There are in it but two towns, or, more properly, villages: one, Anacapri, stands on Monte Solaro; the other, called Capri, or the "Metropolis," is situated much lower, on a shelving rock towards the eastern extremity of the island; the inhabitants of the two places communicate with each other by means of a flight of upwards of 500 steps, cut in the face of the rock, and carried down it in a very curious manner; these steps are extremely rude, and are supposed to have existed long prior to the time when Capri was under the dominion of the Romans. The population of the island does not exceed 6000 souls, who, with a few exceptions, are either fishermen or agriculturists.

Though Capri, as seen in Mr. Hering's picture, appears little more than a barren, uncultivated rock, the islanders have, by great industry, retained and secured patches of good soil in the steep hill-sides, and in the midst of the cliffs and rocks: these patches, being well cultivated, produce many kinds of fruit and vegetables, olives yielding excellent oil, and vines from which a light but pleasant wine is made, that was held in high estimation by Tiberius, the Roman emperor, who long resided here in a villa, the ruins of which are still shown to travellers. Capri contains abundant evidences of the Roman sway. "Before Naples fell," says the writer before quoted, "under the power of the Romans, the island belonged to the Neapolitan republic; but, in the reign of Augustus, the republic transferred it to that power in exchange for Ischia. For four years, in his old age, Augustus resided in the island, embellishing it with palaces, baths, aqueducts, and other edifices. Under Tiberius it became the scene of atrocities and tyrannies, more shocking to humanity than the eruptions of Vesuvius and the convulsions of nature were calamitous to the shores of the mainland. The ruins of the twelve palaces which he erected on the most elevated points, to the twelve superior divinities, attest the activity of the tyrant in covering the island with the monuments of his taste and power." Very little more than the sites of these edifices is now to be seen, and in some instances it is difficult to trace even these; but many fine sculptures, which have at various times been discovered, are deposited in the Museum of Naples and elsewhere.

Mr. Hering's view of Capri shows how few and slender, by comparison, are the materials necessary to make a good picture, in the hands of an artist of taste and ability: we have here nothing more than the distant island, looking naked and bald; the deep blue ocean—its surface stirred into gentle ripples; a bit of broken foreground, on which a few figures are reposing; and, over all, a bright azure sky, fading so softly into the remote water-line as to blend with it. The scene is impressively tranquil, and the picture remarkable for the *tenderness* with which the subject is treated: it has all the purity and deliciousness of an Italian evening atmosphere.

The picture, which is in the Royal Collection at Osborne, was purchased by Prince Albert, out of the British Institution, in 1845.

* Murray's "Handbook of South Italy, Naples, &c."

MR. BAILY'S NEW STATUE, "GENIUS."

WE have had the opportunity afforded us of seeing, in Mr. Baily's studio, a new work which that artist has just completed, under the above title; and so long as matters remain unchanged in Trafalgar Square, they do desire to make due acquaintance with sculpture productions like this,—which, demanding good light on every side, in the Royal Academy receive it on none,—must endeavour to make their way into the artist's studio, too. This work is a commission from the City of London,—and will, in all probability, form a portion of what is, on the "*Lucus à non lucendo*" principle, called the *Exhibition*, in the cave of sculpture, next year; but its merits are far too essential to have the least chance of revelation in the dim lights which there make even sculpture accident little better than guess-work, and sculpture expression a quality not to be guessed at all. The figure before us is one more addition to that long series of poetical creations which Mr. Baily will leave behind him, to illustrate the elements of an enduring fame. The form is intended to be that of Milton's "Genius," as presented by the poet in his "Arcades," and it may be said that Mr. Baily did a fitting thing when he undertook the personification by his own art of the Spirit which has fed that art through all his days. That the homage has been accepted is proved by the visible fact, that the same Spirit has again presided at the birth of this new creation.

The lines from the poet which determine the action of the sculptor's figure, are the opening ones of the second song:—

"O'er the smooth enamelled green,
Where no print of step hath been,
Follow me, as I sing,
And touch the warbled string,
Under the shady roof
Of branching elm-plant-proof!
Follow me!"

and the *individual* Genius—the "Genius of the Wood"—who is made the agent in Milton's masque; it is Mr. Baily's design in his statue to elevate and generalise into that Genius in the abstract which the mystical and high-sounding verse of the poet indicates as being the inner nature of this visible and helping presence. This is he who leads his votaries "where they may more near behold" the deep secrets of beauty and of truth which "shallow-searching fame hath left untold." This is he who sits at the heart of creation, nursing all its gracious products. This is he who listens to

"the heavenly tune which none can hear
Of human mould, with gross unpurged ear;"

the ravishing harmony which the Muses (or Syrens) make on the summit of the spheres, singing in eternal concord with the revolving spindle of Fate, or Necessity, and her daughters three—the classical Lachesis, Clotho, and Atropos:—

"Then listen I
To the celestial Syrens' harmony,
That sit upon the nine infolded spheres,
And sing to these that hold the vital shears,
And turn the adamant spindle round,
On which the fate of gods and men is wound."

In one respect this work of Mr. Baily's is more than commonly welcome:—in the fact of its being a male figure. The poetry of this sculptor's mind has habitually sought its expression through female models; and, if we mistake not, this is the first ideal figure from his hand taking masculine proportions since his "Youth returned from the Chase," moulded some half dozen years ago,—as that figure had had no male predecessor for many years. For ourselves, we would select the work before us in preference to any other male figure that Mr. Baily has yet produced offering a presentment of youth, whether mortal or in its attributed immortality. It reflects, with great art, at once the poet to whom the sculptor has gone for his text, and the mythology to which that text refers back. We recognise both the Genius of Greek fancy and the Genius of the Arcades. Without being so hard and mystical as Milton, we get from Mr. Baily a satisfactory revelation of the Spirit who catches the celestial harmonies and walks amid the secrets of nature. Perhaps it may be said, that the mind which has wrought so long on female models is visible here in the particular type of male beauty which the sculptor

has chosen. Milton's text might have been as successfully rendered by a sterner presence than is here given; but the sculptor, looking past the poet to the mythology to which the latter referred him, has felt himself at liberty to work out the thought in the gentler spirit of Greek Art. The figure is, of course, entirely nude, and the limbs, necessarily mortal in their contours, have been polished into a beauty beyond any mortal type which could consist with the *maturity* that is necessary to our intellectual apprehension of genius. The *eternity* of the youth—which is a poetical ascription of the same theme—is, however, the reconciling influence. All these things are amongst the evidences of that fine thought in the treatment of sculpture subjects which alone can unlock their true meanings and evolve their spiritualities. Mr. Baily's taste has led him to that refined type of material expression which is the habitual characteristic of his works,—but his understanding has prevented his applying that refinement where it would be esthetically inappropriate. Genius is, perfect maturity in eternal youth,—and Mr. Baily so understands, and renders, it. As we have said, the action of the figure is that of waving his followers on to some revelation which they cannot make without him. As we look into the spiritual face, and on the superhuman beauty of limb, we read the credentials of this Summerer in the true sculpture tongue:—we feel that the wand with which he beckons, is a wand with which also he can unlock.—The City of London will have good reason to be proud of its Statue of Genius,—which is to occupy a niche in the Egyptian Hall.

ART IN THE PROVINCES.

COVENTRY.—The works executed by the students of the school of Art in this city were exhibited during several evenings towards the end of September, and the prizes were awarded to the pupils, after a careful examination of their productions by Mr. H. A. Dowler, the Government inspector, and Mr. H. Rafter, head-master of the school. The students, both of the public and central schools, were also examined in practical geometry, perspective, outline, and model drawings; it was a competitive examination, conducted by the inspector, who put the question, the answers to which were required to be in writing, one hour being allowed to each paper.

FALMOUTH.—During the past month the Annual Exhibition of the Royal Cornwall Polytechnic Society took place, and from the pictures exhibited the Art-Union of Cornwall selected its prizes. The productions of Mr. T. Philp, principally views around the Cornish coast, were very much and deservedly admired. Mr. Williams and Mr. Hart were also exhibitors. Mr. Sydney Hodges, of London, exhibited several portraits which were objects of considerable interest. The latter gentleman has been employed to paint the portrait of our correspondent, Mr. Robert Hunt. At the conclusion of the exhibition, the following resolution was come to by the Committee:—"That the secretary be requested to write to Mr. Robert Hunt, and inquire if he will consent to sit to Mr. Sydney Hodges for his portrait, to be placed in the Polytechnic Hall, as a memorial of the estimation which the Committee and subscribers at large entertain of his long-continued exertions and services in promoting the advancement and welfare of the society." A subscription-list was immediately started, to which most of the gentlemen of Cornwall affixed their names.

PLYMOUTH.—The eighteenth exhibition of pictures at the *Athenæum*, Plymouth, was opened in October: this year it consisted chiefly of pictures painted by artists born or resident in the counties of Cornwall and Devon. Among them we found in the catalogue the names of Sir J. Reynolds, Sir C. L. Eastlake, P.R.A., Northcote, R.A., Opie, R.A., Haydon, S. Prout, &c. Paintings and drawings, by stars of lesser magnitude, and "strangers and foreigners," included the names of D. Cox, Sen. and Jun., Williams, Condy, T. Mitchell, Juny, Francis, McKewan, J. Verity, Copley Fielding, Turner, Bennett, W. Hunt, &c. &c. The works were contributed by the resident gentry and amateurs, who seem to be liberal patrons of the Fine Arts, and to make—as all ought to do who have the opportunity—a liberal use of them.

GREENOCK.—A School of Art, of which Mr. W. Stewart, head-master of the Paisley School, will have the superintendence, was opened at Greenock on the 3rd of the last month, under most favourable auspices. Upward of one hundred pupils were at once enrolled on the books of the institution.

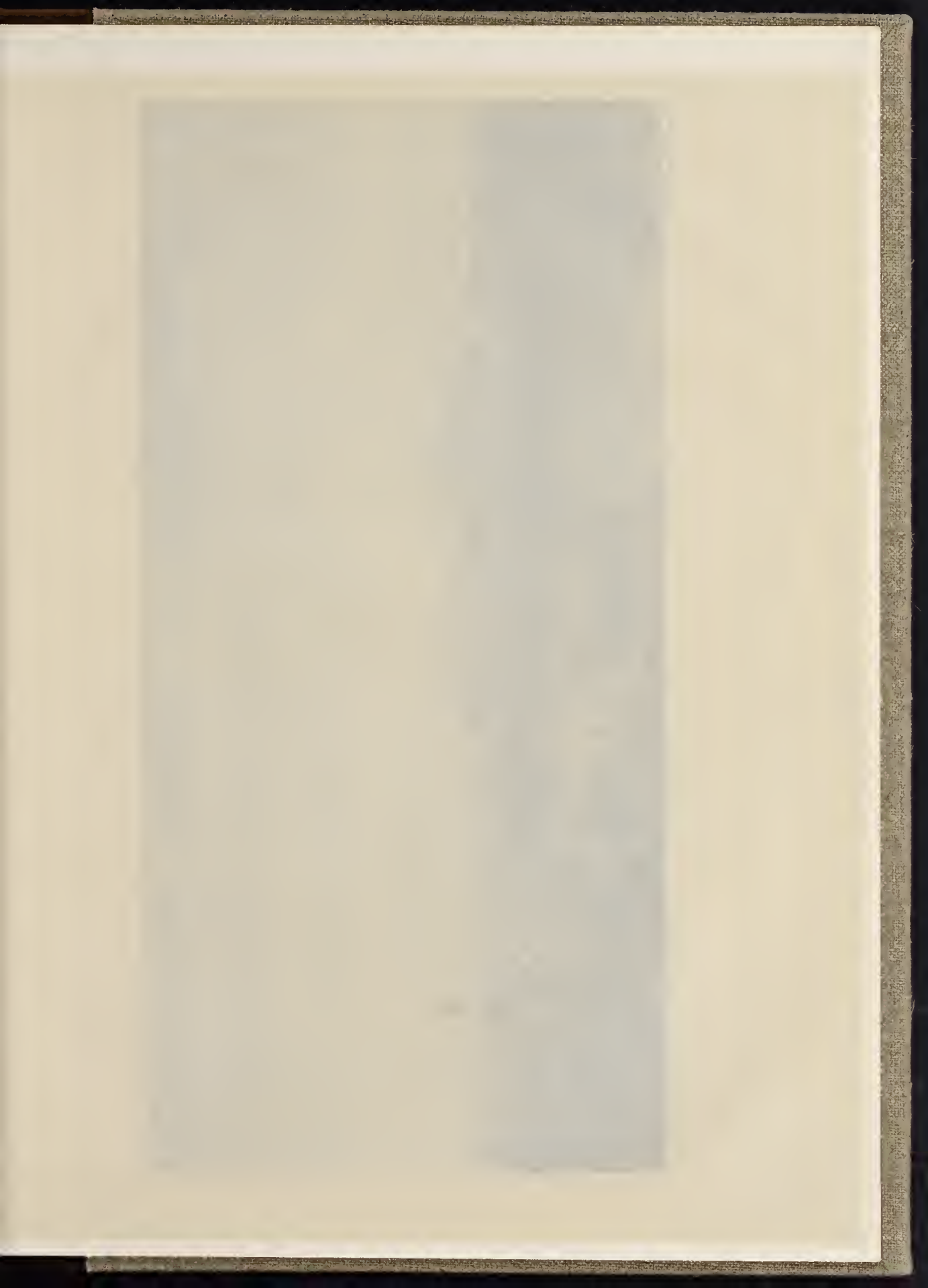

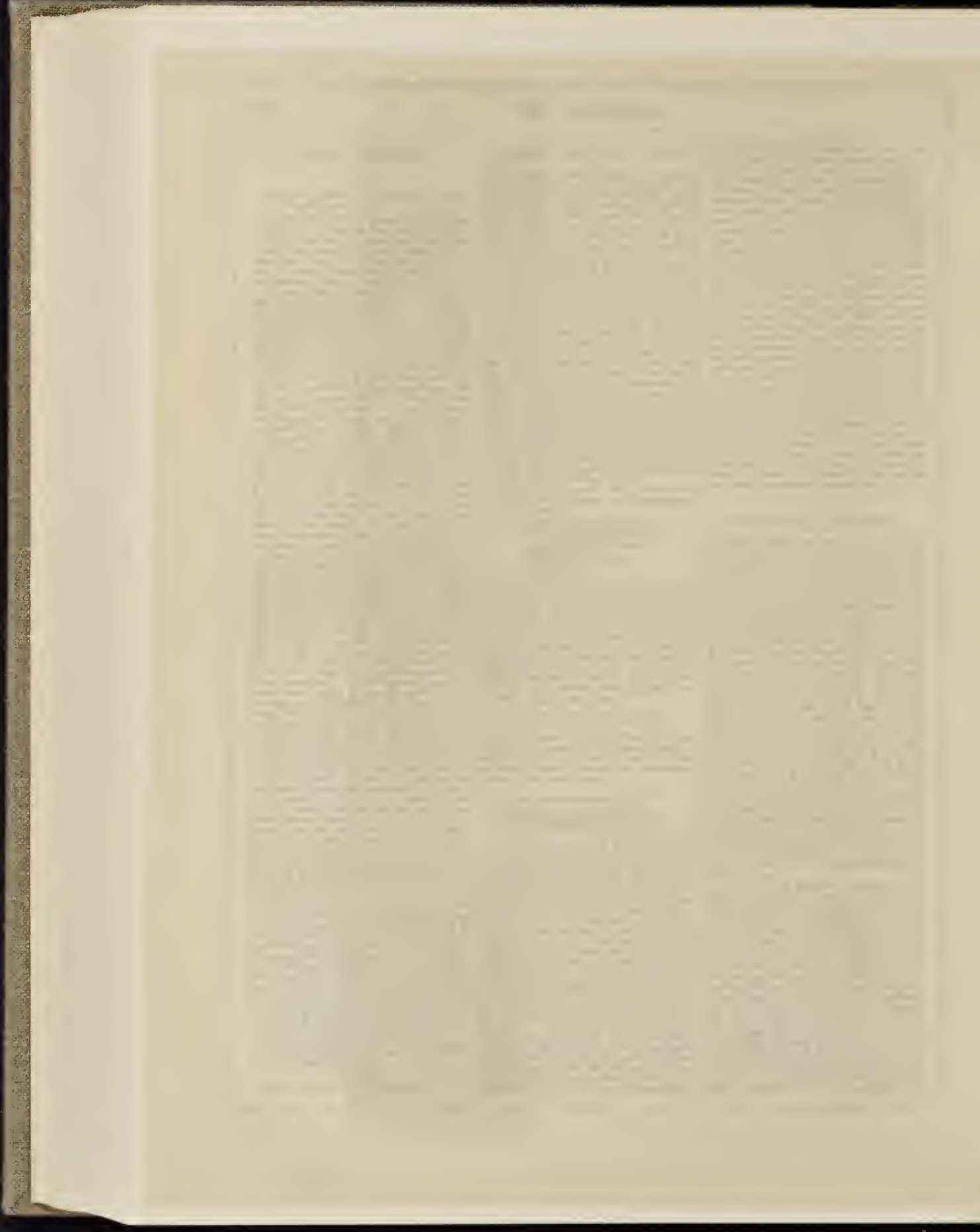



1911

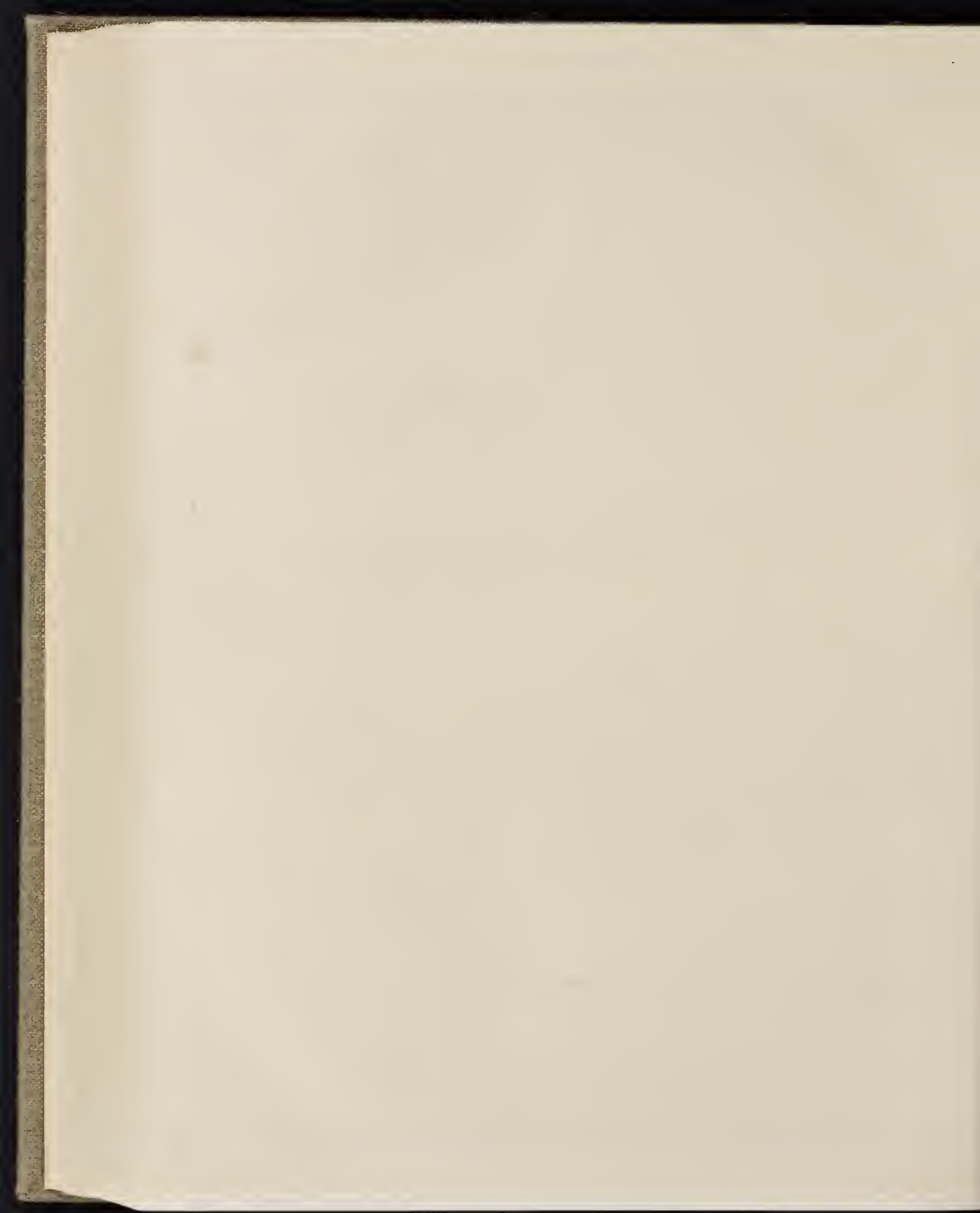

THE CRYSTAL PALACE,
AS A TEACHER OF ART AND ART-MANUFACTURE.

PART VI.

CONTINUING our visits to the Art Courts and depositories of Art-manufacture at the Crystal Palace, we must ask our readers to ascend with us one of the staircases which lead to the North-east Gallery, and examine a recent erection—costly in character, but in very pure taste—in which are displayed the goods of Mr. CHARLES GOODYEAR, of New York, the patentee and inventor of many applications of Indian-rubber to the purposes of Art-industry.

No very long period of time has elapsed since Dr. Priestley ("Introduction to the Theory of Perspective," 1770) stated as one of the marvels of his age, the discovery of a vegetable gum which possessed the singular power to remove pencil-marks from paper; and, until very recently, this gum was used for nothing else,—unless as one of the toys of boyhood, to give "springiness" to playing-balls. Dr. Priestley as little foresaw the uses to which it would be hereafter applied, as did he who first produced an electric spark anticipate the wonders of the "Telegraph." A visit to the Crystal Palace, and an examination of the contents of the stall of Mr. Goodyear cannot fail to create astonishment; for, while it will be seen how numerous are the objects already wrought out of Indian-rubber, these will only convey an idea of the still larger number of uses to which it is destined to be applied.

Indian-rubber is known to be a gum obtained from trees which grow so abundantly in India, in Java, in Assam, in some parts of South America, especially Brazil, and in other places, as to produce a supply which may be described as inexhaustible. Incisions are made through the bark of the tree, at certain periods of the year, from which flows a milky juice; this, when hardened by exposure to the atmosphere, is "the Indian-rubber," which science has rendered

applicable to all the purposes for which wood can be employed, but having many advantages that wood never can have, while it possesses all the valuable qualities of ivory and horn. It is to the objects formed of this material to which we now direct the attention of our readers. The space to which we are limited precludes for the present all comment on the nature and value of this now precious material, or the various processes through which it is passed before it is made available to the manufacturer; we shall, however, ere long, bring the subject, in all its details, under notice,—with a view first to aid the plans of the ingenious inventor—the inventor in so far as regards its many recent applications—and also to show the large extent of its capabilities.

About twenty years ago, various medals were awarded to Mr. CHARLES GOODYEAR, of New York, for "new methods of manufacturing Indian-rubber;" including "applications of Indian-rubber to painting," to cloth, to shoes, &c. &c. From that time to this he has laboured with amazing vigour and perseverance, in spite of difficulties, all but insurmountable, until he has completely triumphed over them all, established large works in various parts of the States, and in Paris, and now in London, at 47, Leicester Square; while his "snow-room" is—as we exhibit it underneath—the Crystal Palace.

This show-room is in the North-east Gallery: it is not one of the Courts erected at the expense of the Company, but is the private stall of the proprietor. In grace and elegance of construction, however, it may be compared with any of those "structures" which ornament the lower division of the Palace; and it will, we hope, act as a stimulus, as well as an example, to producers, who, while they desire to exhibit their productions under advantageous circumstances, are willing also to adorn the building in which they are placed—thus advancing their own interests while contributing to the gratification and

instruction of the visitors. Mr. Goodyear is a public benefactor by the liberality he has displayed; and there can be no doubt that all his "neighbours" in the gallery will greatly benefit by the attraction he has given to the locality in which he has placed the depot of his works. The architect of whose abilities he has availed himself is MR. STANNARD WARNE, to whom the erection does much credit.

The stall, be it remembered, is made entirely of Indian-rubber, and an examination of it will suffice to show the capabilities of the material for all the purposes of the cabinet-maker; within and without, will be noticed many works of his class—such as sofas, chairs, tables, bedsteads, drawers, work-tables, pillars and panels, with bas-reliefs. It is obvious that Art has not yet achieved what it may do for this branch of the "business;" but of the capabilities of the material there can be no doubt; it is safe to anticipate its enormous use by the cabinet-maker for all the purposes of elegant furniture. We must content our readers by a bare enumeration of the other objects exhibited—fruit-plates; card-trays; boxes; boxes inlaid with pearl; watch-cases; bracelets; brooches and rings, set with jewels; fruit-knives and paper-knives; ladies' work-boxes; fans; opera-glasses; jewel-boxes; toilet-boxes in great variety; picture-frames; eye-glasses; ink-stands; paper-folders; powder-tasks; cork-screws; pen-holders; pencil-cases (of peculiar construction); drinking-cups; buttons; syringes; surgical instruments of various kinds; canes and walking-sticks; umbrellas; combs; brushes of all sorts; in fact, it will be necessary to examine the contents of this remarkable stall to obtain an idea of its variety and value, but chiefly to form a notion of the extent to which the manufacture must be eventually carried: for it will be difficult to conceive an object of utility or of Art which may not be ultimately benefited by an invention that may be applied in innumerable ways to the comforts, conveniences, and elegancies of life.

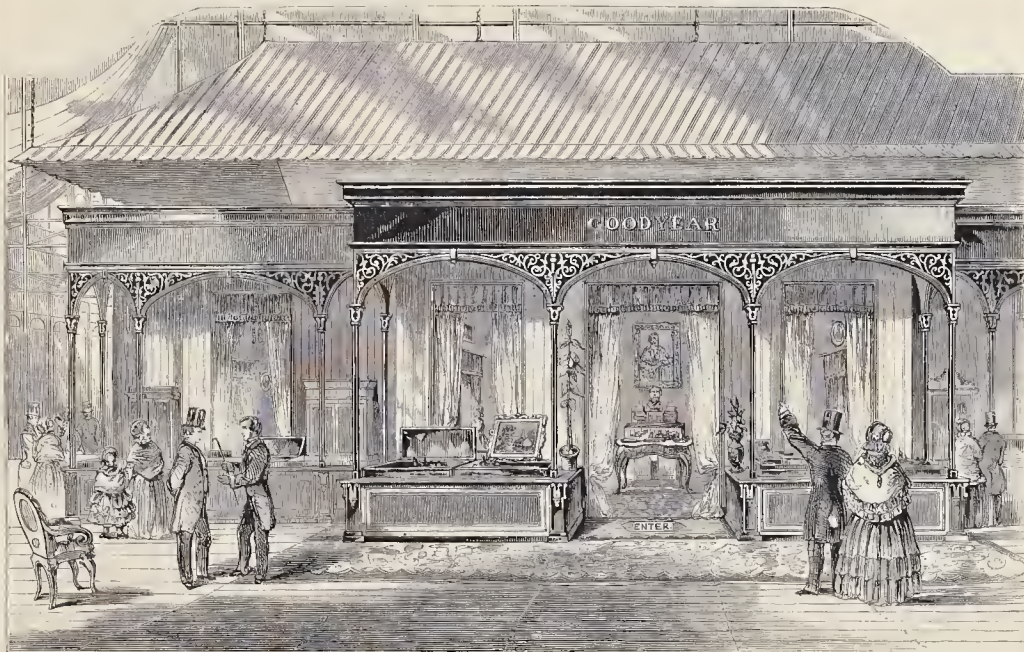

THE INDIAN-RUBBER COURT.

A walk through the passages leading to the several Courts of the Industrial Arts will introduce the visitor to several objects of much interest in Art-manufacture. We have selected for especial notice this

month the works in terra-cotta of Mr. BLASHFIELD, which occupy the extreme end of the passage immediately behind the Birmingham and Sheffield Courts, and near the entrance to the Pompeian Court. The

objects engraved on the succeeding pages, consist of a group of various vases, a pillar surmounted by a vase, a flower-pot, and a pendent flower-pot, and a statue of *Hibernia*, designed by John Bell.

We have made many attempts in England to produce works in terra-cotta; generally speaking they have been unsuccessful. It is, however, undoubtedly due to Mr. Blashfield to say of him that he has carried this art beyond his competitors, and has achieved much that gives it the high character it may be made universally to assume. Several of his productions are copies, but many of them are original—designed, modelled, and “baked” in his own establishment; and we rejoice to know that his efforts are appreciated, and that his trade in these works is very considerable. An examination of his stall will show that “wants” in this way may be here supplied. All his productions are good; some of them being exceedingly beautiful as examples of design as well as workmanship. Especially we may commend his pendent flower-pots—objects now-a-days of ready sale, but which a few years ago were unknown in England. We believe we may in a great degree claim the merit of their introduction into England; some twelve or thirteen years ago, we published engravings of several, which we had obtained at the establishment of Follet, and other fabricants in Paris, and we took the opportunity of pressing the subject on the attention of English manufacturers. Until

then, we imagine, nothing of the kind had been manufactured in this country—certainly they were then unknown, except in conservatories of a rare order; they are now in general use, and their adoption is rapidly extending.

We can do little more than glance at the various other objects of Art-manufacture gathered together in the Crystal Palace; and as we have dealt sufficiently with the various Art-Courts, our observations must be limited to the passages which lead to and about them—as in the case of Mr. Blashfield's terra-cotta.

We may thus direct attention to examples of works in artificial stone, exhibited by Messrs. Ransome, of Ipswich; the glass mosaics of Mr. Stevens; the Derbyshire spar of Smolley of Matlock; the beautiful productions in Cornish serpentine; a case of admirable productions in papier maché, by Alderman Spiers, of Oxford, generally ornamented by views of the “learned city;” some good iron castings, by Messrs. Kennard; the stove-grates and fenders of Messrs. Benham and Sons, which occupy a room opposite the Sheffield Court; a collection of furniture by Messrs. Filmer, of Berners Street, which fill a large chamber adjoining; and near at hand a fine

assemblage of church gariture, and ecclesiastical furniture, placed in a court gracefully fitted up by Messrs. Cree; a large room is also occupied by the carpets manufactured by Messrs. Jackson and Graham, and many fine French bronzes. Messrs. Hart exhibit here also their admirable brass fittings for churches and domestic rooms: here too are some good lamps and chandeliers, by Messrs. Hullet, of High Holborn; the tea-urns, &c., of Warner and Sons; and a vase of great beauty, and other objects in serpentine, contributed by the Lizard Serpentine Company of Cornwall; some excellent works in terra-cotta, manufactured by Messrs. Gibbs, Canning, and Co., of Tamworth. Mr. Pinches has here his presses for die-sinking, and he produces his medals on the premises. To some of these “Courts” it will, perhaps, be our duty to make more distinct reference hereafter.

Of the Glass Court of Messrs. STEIGERWALD, of Munich, we have prepared engravings; but the publication of these we are compelled for the present to postpone. This court occupies a prominent position, between the Ceramic Court and the Music Court; it is filled with the glass of Bohemia, of which Messrs. Steigerwald are the principal manu-



GROUP OF TERRA-COTTA: MR. BLASHFIELD.

facturers, their great depot being at Munich. The collection consists of an immense variety—objects for use and objects for display; of excellence very varied—some being of unquestionable purity in form and manufacture; others being made for sale among the “masses.”

We may not omit to notice that valuable acquisition to the Crystal Palace, the photographic establishment of Messrs. NUGRETT and ZAMBRA; these gentlemen possess the exclusive right to photograph for public sale objects contained in the building; they are always at hand to receive and execute orders, and are supplied with a large collection of views either for the portfolio or the stereoscope, and also produce portraits “on the spot.” These productions are all of very high merit; under no circumstances, indeed, could better copies be obtained. To the artist and the manufacturer, as well as to the visitor, this is a great advantage, for whatever may be required can be thus readily obtained; and certainly as “suggestions,” their offices should be much resorted to by all Art-producers.

The Galleries—although entirely devoted to objects “for sale”—contain also much to which the attention of the Art-lover should be directed. They are,

however, to be regarded chiefly as “a bazaar;” and in this respect certainly are an acquisition, for here “small wants” may be cheaply supplied. But here also may be seen, besides the Indian-rubber Court with its startling treasures, some of the best productions of Messrs. Elkington (a row of statues in bronze being especially interesting); an immense variety of the excellent “utilities” of Mr. Sheriff Mechi, many of them being of great beauty, and all of manifest excellence, consisting of cutlery of every kind, and also the far-famed razor-strop, which is said to have been “a fortune;” papier maché goods of admirable quality, and in great variety; and all the other articles which constitute “the stock in trade” of the fact and fancy “hardwareman,”—many of them beautiful, and all good; a large collection of the imported novelties of Mr. Holt; the Irish jewellery of Mr. Waterhouse, of Dublin, presenting many objects in which novelty is combined with grace, and of admirable workmanship—brooches, bracelets, jewellery in general, and the very beautiful Nightingale Brooch. Here, too, are the stamping-presses of Mr. Jerrett; a large collection of Chinese productions, from fans at sixpence each to costly ivory carvings; and Mr. Mahood's

pretty and pleasant *bijouterie*, manufactured generally in Ireland. All these are in the North-east Gallery; the South-west Gallery is well filled with articles of commerce, among them being some excellent examples of the produce of Glasgow and Paisley. The visitor will find, indeed, much in these galleries from which he cannot fail to derive gratification and interest.

But while pointing out to him the numerous ways in which he may be pleased and instructed *within*, we must not omit notice of those which demand attention *without*.

Among the leading attractions of the Crystal Palace are assuredly the GARDENS—those within and those without the building. They are sources not only of enjoyment, but instruction, while they add very largely to the grace, elegance, and general effect of the Exhibition. One may imagine what a calamity it would be if, by any evil chance, the flowers and foliage were withdrawn from the interior. It is impossible to praise too highly the whole of the arrangements which have been made by Sir J. Paxton—and are, and we hope will long continue to be, under the direction of Mr. GEORGE EYLES, formerly one of the gardeners of the Duke of

Devonshire. The objects which most pleasantly meet the eye are the vases underneath and the pendent baskets above; the latter are of large size, and are always "gay," filled with flowers of positive colour, with trailing plants, running many feet down, and refreshing with the hue of brilliant green: but everywhere, let the visitor walk where he may, he perceives some hotanic specimen, either rare or beautiful: it is not too much to say, therefore, that this particular department of the Exhibition is



of incalculable value—the world contains nothing to compare with it under a single roof.

On entering the Palace from the railway colonnade, the first object that presents itself to the visitor is a group of plants, figures, animals, and birds, intended to represent the botany, ethnology, zoology, and ornithology of Australia. Immediately opposite are similar groups representing the same features of the different countries of the Old World; and on the opposite side of the Nave will be found other groups depicting the like features of the New World; the

small Swiss moss (*Lycopodium denticulatum*) forming, as it were, a green carpet for the figures to stand upon. These groups have always proved a great source of attraction to the many who visit the Crystal Palace.

The basin in the Nave is replete with the finest aquatic plants in cultivation. The *Victoria regia* has also been grown here to great perfection—leaves six feet in diameter. The freshness and vigour of the *Nymphaea*, together with their gorgeous flowers of the most lovely colours and ample foliage, spread out on the still waters of the mimic lake, with gold and silver fish playing sportingly in every direction; then add to that the circular vases, eight in number, inserted in the margin of the lake, as if to make its outline more agreeable, and filled with the most beautiful flowers, ever admired for their freshness. Nearly 26,000 plants are used annually for the supply of these vases alone, and these plants are all raised and perfected at the Crystal Palace propagating-houses.

Standing against the Screen of the Kings and Queens, or in the Exhibitors' Gallery above, the finest view of the plants in the long vista of the Nave may be obtained, and their relative value and fitness as powerful auxiliaries for the decorating the Palace ascertained. The long lines of orange-trees, pomegranates, aloes, and sweet-hays, numbering upwards of 200, and the double row on each side of hanging baskets, filled with the most lovely flowering plants and creepers, which hang down from the baskets, and, in many instances, touching the plants in the beds below, and ascending from them up the suspending wire to the under side of the top gallery, viewed as a whole, create a most pleasing effect, and entirely peculiar to the Crystal Palace. These baskets require from 8000 to 9000 plants to furnish them.

We must notice a few of the larger and more interesting plants in the Nave, first observing that the beds, for the convenience of reference, are all numbered from left to right, and the numbers are fastened to the upright edging of the beds on the south of centre, and on the columns on the north of centre. In Border No. 1 is a fine plant of the New Zealand kakatero-tree (*Dacrydium tarifolium*), which acquires the height of 200 feet in its native country; *Acacia foliosa* 25 feet high; a large plant of *Rhododendron arboreum*, presented by Miss Cox, of Lawford House, Manningtree, Essex, and purchased when five inches high for five guineas: in close contiguity is the *Wisteria sinensis*, a Chinese climbing-plant, and already reaching nearly the centre of the roof.

In Border No. 3, on the west of South Transept, will be found fine examples of the New Zealand spruce (*Dacrydium cupressinum*), of *Camellia reticulata*, bearing in spring its gigantic red flowers, nearly six inches in diameter; of the Paraguayan tea-tree (*Ilex Paraguayensis*), the leaves of this plant are used by the natives of that country for making tea; an hybrid *Rhododendron* nearly 20 feet high, presented by the Duke of Devonshire; an *Auracaria excelsa* 35 feet high, presented by Veitch & Son; and many fine specimens of camellias, azaleas, &c. &c. In Border No. 5, opposite, is a large plant of camellia—Lady Hunt's Blush—quite a tree, nearly 20 feet high, and 12 feet diameter; a beautiful specimen of *Acacia dealbata*, presented by E. H. Palmer, Esq., Cannonhill, Maidenhead, 20 feet high and 50 feet in circumference, and in the spring is covered with its beautiful golden yellow flowers.

At the four angles of the Transept are placed fine specimens of white camellias. In the centre of the Transept is a magnificent specimen of American aloe, presented by Mrs. Jenkins from the Denney, Wells, and brought by her from the ruins of the Palace of the Caesars, in Rome, in 1823, then a tiny plant. At both ends of the basin are fine specimens of *Auracaria excelsa*—those on the north side presented by the Duke of Wellington; on the south, by Thomas Marson, Esq., Croydon. In Borders Nos. 4 & 6, on the other side of the Transept, are fine examples of *Camellia myrtifolia*, 17 feet high; also white *Azaleas*, *rhododendrons*, the new and beautiful *Acacia grandis*, the curious *Ayosotis sinuatus*, with its singular sinuous foliage, and a fine plant, in close contiguity, from Australia—*Ficus macrophyllus*—seldom seen so large in this country, presented by the Royal Botanical Society of London. In the opposite border are fine examples of the indian-rubber-tree (*Ficus elastica*); of *Berberis nepalense*, with its graceful foliage; and several acacias 20 feet

high and upwards: here has been grouped the greatest variety of foliage, in order to produce agreeable effect.



In proceeding down the nave, and opposite the Pompeian Court, are two fine specimens of the *Auracaria*



carica Bidwellii; the seeds of this plant are eaten by the natives of Moreton Bay, and the tree is called



by them *bunya bunya*. At the centre entrance to the Sheffield Court are two magnificent tree-ferns

(*Dicksonia antarctica*) from Van Diemen's Land; they are found in abundance by the sides of rivulets in the shady valleys of that island; and opposite will be found *Podocarpus Totarra*; this tree furnishes the most valuable timber in New Zealand, and the possession of them has often been the cause of war among the savage nations. Border 13 contains a fine specimen of the blue gum-tree of Australia (*Eucalyptus globosus*); these may be called the mammoths of Australia, many of them growing upwards of 200 feet high, and 30 in diameter. In Border No. 19, by Egyptian Court, is a fine lilacaceous plant, the fan-leaved *Rhipidodendron* (*R. plicatella*); many temperate palms are planted here, which look healthy, but do not grow with that luxuriance which warmer climates produce. In these beds are also two large plants of the *Sparmannia Africana*, presented by her Majesty; this is an old favourite conservatory plant, now almost lost sight of. By the Roman Court are two fine *Auracaria excelsa*, also presented by her Majesty. In Border 24, and in many other places, will be found specimens of the Funeral cypress, brought by Mr. Fortune from the Vale of Tombs, in North China, and used by the Chinese much in the same way as we use our weeping willow; this appears to be the plant figured on our china, and known as the willow-pattern.

Proceeding through the curtain, you enter the tropical end of the Palace, where the *Musee* and palms, grouped with other fine-folaged plants, produce an effect quite tropical. Here is a large collection of plants: we may allude specially to one interesting group in Border No. 3, in front of the Assyrian Court, where may be seen the tea and coffee trees; the jujube of the East Indies; the sea-side grape; the celebrated cow-tree of the Caraccas, which affords abundance of nutritious milk to the poor inhabitants of that part; the ginger-plant; the rose-apple of the East Indies; the nutmeg, pepper, and cinnamon-tree; the star-apple of the West Indies; the Avocado pear from the West Indies; the graceful tamarind-tree; the Australian cabbage-palm; the jack-tree, an inferior species of bread-fruit; the castor-oil plant; the custard-apple; the Malabar nut-tree; the banana-fruit; the wampee-fruit of the Chinese; the guava from South America; the honey-berry from Ceylon; the sugar-cane from India; the celebrated orical-tree of Madagascar (*Tanphinia veneniflua*)—this tree stands foremost amongst the poisons, the kernel of the fruit, although not larger than an almond, is sufficient to destroy twenty people (see Lindley's "Vegetable Kingdom," p. 599); the *Mimusops elengi*, also a tropical fruit; the *Melodinus monozygus*; the *Placourtia cataphracta*—both fruit-bearing trees. In the centre of the bed is a fine group of *Musee* plants, so highly esteemed for the abundance of nutritious food it yields to the natives in all parts of the torrid zone—the fruit of one plant often weighing as much as 50 lbs.; the Peruvian bark-tree; the Chinese paper-plant; and many interesting flowering plants interspersed. In the centre of the Nave is a fine specimen of the Palmetto palm—*Sabal Palmetto*; and in Border No. 6 is a tall palm (*Latonia Borbonica*), 40 feet high, formerly in the collection of the Empress Josephine at Poutainebieau; it took thirty-two horses to bring this large palm from Mr. Lodiges' Nursery, Huelcumy, to the Crystal Palace. There is a fine group of *Musee* in Border No. 4, some of the plants reach 25 feet high; and in Border No. 2 is a very large specimen of the Caffee bread-tree (*Eriophthalma tridentata*), 14 feet high, and probably 3000 years old. Situated between the avenue of sphinxes, is a fine collection of palms, containing many rare species. In the basin is a fine plant of *Victoria regia*, or royal water-lily, which has grown and flowered vigorously this season, supported on all sides with the finest aquatic plants. The vases round the margin within the curtain are filled with ferns, variegated plants, palms, and stove-flowering plants. The two outer vases are treated the same as those at the south end, and take 6000 plants per year to furnish them.

We are unable at present sufficiently to direct attention to the models of extinct animals, constructed by Mr. WATERHOUSE HAWKINS, which have been placed around a mimic lake at the lower end of the gardens. These are, we regret to say, not generally visited; the fact is, that people become fatigued by so much to see and think about, and a walk is out of the question towards the close of a

day, for the sole purpose of inspecting these singular works: they do, however, attract the notice of all passers by in the railway-carriages, for they are seen somewhat satisfactorily from the "high-road."

The gardens are improving rapidly; age is having its influence in the growth of shrubs; the "climbers" are covering unsightly objects; the plaster casts are in the course of removal, and are replaced by statues in marble; and ere long this garden will be of unrivalled beauty. The fountains "play" very frequently; not in their "entirety," but sufficiently often to make this feature, also, one of the important improvements which naturally result from time.

We have now carried to a close the series of papers in which we have endeavoured to bring under the notice of our readers the Crystal Palace, as a means of extending the influence of Industrial Art, and advancing the interests of its meritorious producers, by acting as an "Exhibition Room," so to speak, in which their productions may be seen, examined, and estimated.

We cannot but lament, as a grievous error, that manufacturers have not sufficiently availed themselves of the advantages here placed at their disposal—an error which we hope will not be continued, when another season furnishes new evidence of its singular applicability to all the purposes of commerce. It is, indeed, difficult to imagine circumstances more auspicious to the manufacturer—independent of those which always secure to him a large attendance of persons of wealth and taste, by whom his "goods" must be seen, with leisure for a proper scrutiny of the objects they require. These objects are shown too in good lights, with ample space for their display; and where a full and complete exhibition is desired, the Crystal Palace certainly possesses advantages to be found nowhere else.

Yet this fact does not seem to have been understood; the several Art-Courts are far too scantily furnished; Birmingham and Sheffield, for example, contain the productions, each, of only two or three manufacturers, in so far as the staple of the great cities of metal manufacture is concerned. Even these contributors must have felt that the poverty of the display prejudices their interests,—for purchasers are discouraged when they consider the paucity of choice, an evil that would not arise if the courts were full, and conveyed a general notion of the varied and valuable produce of the districts.

We repeat what we have already said—if the great manufacturing cities and towns of England will take this matter up, appoint properly qualified agents, and be rightly represented at the Crystal Palace, very beneficial effects cannot fail to follow. This object has been in a measure accomplished in the Ceramic Court: we say "in a measure," because undoubtedly it is not as yet what it may be and ought to be; for, although Messrs. Minton, and Alderman Copeland, Messrs. Kerr and Binns, Messrs. Ridgway and Bates, and one or two others, are well represented (and that they have hence derived much fame and large profit is certain), the collection is by no means an exposition of the Ceramic manufacture of Great Britain; and will not be until every producer of meritorious works has space, more or less, in which to exhibit his productions. Next season, no doubt, Mr. Batten—to whose persevering industry and great ability we have accorded the praise to which he is eminently entitled—will study to make this Court perfect, by exhibiting fewer of the ancient works, and more of the modern produce of the art of the potter.

Of a surely, then, there is no existing school for study equal to that supplied by the Crystal Palace. We have endeavoured in these papers to stimulate the manufacturer not only to learn, but to teach there; every contributor of excellence is in his degree a teacher; and surely he will be a learner as often as he visits the building.

We shall commence next year another Series, of which the Crystal Palace will be our text-book. The Rev. Charles Boutell, M.A., F.S.A., has undertaken to write for the *Art-Journal* a number of articles, in which the Crystal Palace will be treated as a Teacher from Ancient Art,—not relinquishing our plan of representing and describing, by pencil and pen, the progress of Art-Industry.

Such manufacturers as may hereafter contribute to any of these Courts may be assured that we will do our utmost to make their works known through the columns of our Journal.

THE BELGIAN SCULPTURE AT THE CRYSTAL PALACE.

In one of the smaller compartments of the Crystal Palace which adjoin the Byzantine Court, the attention of visitors has of late been attracted to a collection of works in sculpture of comparatively small size, and consisting of both groups and single figures: with very few exceptions, the subjects of them all are more or less directly impressed with a religious character; and the whole have evidently been produced by the same artist. The name of this artist is set forth to be "the late C. H. Geerts, of Louvaine;" but as to the period at which M. Geerts may have passed away from the scene of his studies, nothing is stated; neither does there appear any explanation either of the circumstances under which his works were produced, or of the causes which have led to their being placed in their present position. There they stand, sculptured by M. Geerts, who may no longer be numbered amongst living artists; a brief MS. notice of its own particular subject is attached to each of the groups; the single figures are, for the most part, distinguished only by a number, the signification of which is altogether a mystery—and, in the case of many of them, even this distinction is wanting; yet these sculptures are most eloquent in their deep silence; there rests upon every figure that palpable impress of a master-mind which empowers it to speak for itself as a work of Art, and constrains the thoughtful observer to ascertain through inquiry the minor details of its history.

We learn then that, by the death of M. Geerts, we have this year lost a true and a truly great artist—one who, like many that have preceded him, in the noble achievements he had realised gave a promise of still nobler things to come. That promise he has not been permitted to fulfil. We propose now to consider what he has bequeathed to us, as his actual contribution to Art in our own times.

There are assembled together in this collection about sixty groups, varying in the number of their figures from two to five and six; and, besides these and associated with them, there are about ninety single figures. The smaller figures, whether in groups or not, vary in height from about twelve to about eighteen inches: a very few are larger. Certain incidents connected with the Crucifixion furnish the subjects for sixteen groups; scenes in the life of our Lord, and more particularly in His earlier years, are exhibited in another series; and various other events recorded in the Scriptures, together with certain legendary occurrences, make up the remaining groups. The single figures consist of representations of the person of the Saviour, various angelic forms, the Apostles, the Virgin Mary, and many sainted personages. All are in plaster, with the exception of a Virgin (the last work of the master), most delicately executed in the purest white marble, and the head of a child in the same material; and the great majority of the figures were designed to be produced in wood, as the decorative accessories of stalls and panel-work. These are the original models; some of the designs have never been carved or sculptured with the chisel, but the larger proportion have been executed in accordance with the original intention of the artist, and they exist at Antwerp, Bruges, St. Gomen à Lieere, and other places, chiefly in Belgium. The present collection is the property of the artist's widow; and it is exhibited in the Crystal Palace both in the hope of securing to Madame Geerts a provision, and also as consisting of remarkable examples of Art. And remarkable examples of Art they are—remarkable in this

very important respect, that they at length have demonstrated the true practical value of the study of mediæval art to the artists of our own day. An enthusiastic student of the noble works of the mediævalists, M. Geerts was led by his enthusiasm to aim far higher than to become an accomplished copyist of the works which the artists of the middle ages had produced. He searched out the principles of Art which inspired, and guided, and governed the artists of those days. He aspired to a sympathy with them in the spirit in which they worked, and he attained to such sympathy. But he was not thus led away from all that Art had done and had taught in other times, and under widely different conditions. Hence he was enabled to render his works the embodied expressions of a most felicitous combination, or rather, of a perfectly harmonious blending together of diversified qualities; the drawing in them is severely true, yet always free and elastic; the composition is well adjusted, regular, and touchingly natural; while breadth, vigour, and simple expressive dignity are enhanced by the utmost refinement of sentiment and delicacy of touch.

Now, this is precisely the result which ought generally to have ensued from the prevailing study of mediæval art; it is, however, but a truism to assert that the results thus actually produced have been altogether of another kind. Mediæval works have been copied—at least, strenuous attempts have been made to copy those works; and such copying has been designated a "reproduction" of a long-lost style. It has not really been—in reality it can never be—anything of the kind. The style of art that sheds such lustre over ages which have been too readily stigmatised as darkened, cannot live again in precisely the same conditions of existence in which it lived before the long suspension of its vital functions. It must revive, if it do revive, in the revival of its spirit, not in the reiteration of its productions. It must become again a living principle, of which the vital energy is measured by its adaptation to existing circumstances, and its fellowship with whatsoever is great and excellent. In a word, if we revive mediæval art at all, we must accomplish that result by making it our own Art, and by striving to render it far better and nobler than it was in the middle ages. M. Geerts has taken the initiative in the actual accomplishment of this: unlike our artists in coloured glass, who consider the imperfect drawing and the crude composition of their mediæval models to be no less essential than their lustrous hues, as characteristic of their own productions, M. Geerts has shown in what manner the grandeur of one period may be elevated by the combined science and cultivation of another; he has shown that to be the most worthy style of art, which exhibits the greatest possible degree of excellence, while it is affected by the least possible amount of imperfection.

Walk up to which of his works you may, mediæval feeling at once declares to you how powerful was its influence with M. Geerts; still, you would not for a moment think of pronouncing the work before you to have been executed in the middle ages. And wherefore not? By no means in consequence of any inferiority in the work itself, but because much is palpably present in it which indicates the operation of principles and sentiments in those times unknown. Take, for example, the panel for one of the Antwerp stalls, with the two Maries arriving with their store of spices at the rock-hewn sepulchre in the garden: the wonderful tale is told with amazing truth and impressiveness. The women can be no other than those two pious ministrants. The very fulness of the energy and point of the fourteenth-century sculpture is here expressed. If

you study the drawing, it is found to be severely truthful; and, at the same time, the most exquisite refinement characterises alike the action of the group, the cast of the draperies, the expression both of the countenances and the hands, and the movement of the figures. Perhaps this is in every respect the gem of the entire collection: certainly none can surpass it, while but very few can equal it, as a true mediæval work of the middle of the nineteenth century. These remarks are, indeed, also applicable to some of the single figures: we would specify those numbered 39, 40, 48, 63, 66, and 71. These are all figures of the smallest size, and they show no less the versatility than the consistent action of the artist's powers. Such is also the case with most of the figures of angels—they are truly angelic in their conception, and rendered with the purest feeling. Amongst the larger figures, those of St. Peter and St. John are singularly fine. The groups which have been executed for Middlemerck Church claim also particular notice. The life of St. Willebrod is here illustrated in a series of groups: the finest is that which represents the saint preaching against false gods. In two others of these groups, the consecration of this saint to the episcopate, and his death, are depicted; and these compositions illustrate, in the most impressive manner, the artist's wonderful faculty of compact, yet never crowded, grouping. From the various other groups we select the following as being truly admirable in every point:—"The gates opening to all the world on the birth of the Saviour, from an altar in the church of the Madeline at Bruges." In front kneels the Virgin with the Divine Infant, and in the background are figures of ecclesiastics, warriors, and persons in the ordinary attire of peace, either entering in at an open portal, or advancing towards it: this approach of the figures is very finely rendered. Five of the Antwerp stall-panels, comprising the Annunciation, the Visitation, the Offering of the Magi, the Purification, and the Virgin seated with the Holy Child, and surrounded by adoring angels—all are impressed with the utmost purity, combined with a simple unaffected dignity: the incidents themselves are made out with a truly articulate expressiveness; and the fine contrasts which several of the situations admit have been rendered with equal force and delicacy. In the Visitation it is impossible to estimate too highly the wondering, yielding, adoring submission of the one figure, and the eloquent, encouraging, respectful earnestness of the others. A "Last Supper" from the Madeline at Bruges, is another of the most effective groups: it is treated somewhat after the Da Vinci manner, though the grouping is much closer. The exquisite group of the "Innocents carried up to heaven by angels" was exhibited in 1851; it is now so placed as to form the central and culminating object amidst several other groups of angels, who are playing upon various instruments of music, and singing hymns of praise. We would direct particular attention to the care bestowed upon every accessory in these compositions; the musical instruments, and the lecterns upon which the scrolls of music rest, are no less worthy of admiration than the beautiful figures themselves.

Not the least striking quality in M. Geert's figures is the happiness of their attitudes: some of them are specially adjusted for a position upon the curved ends of stall-standards; others form finials; others again have no peculiar adaptation to any other circumstance than the conditions of the incident which they represent. In like manner, this artist's groups derive no inconsiderable portion of their effectiveness from the skill and judgment with which the grouping itself is formed and adjusted. In the panels, the true power of subordinated relief

is felt rather than shown; while, in the clear-cut works, the composition of the various sets of figures shows the most consummate art in the apparent absence of all studied arrangement: all is so truly natural, that the work of a great artist is immediately recognised. A certain amount of Roman Catholic feeling, as must have been expected, pervades some of the subjects; but even here the true Catholicism of Art asserts a supremacy which is not to be subdued.

It is to be hoped that this collection will not be altogether dispersed. Certainly it would be well that some portions of it should become the property of the nation; and other portions would find an appropriate final resting-place beneath the roof which now covers them. With the view to disseminate as widely as possible the beneficial influences of such works of Art as these, we cannot refrain from also expressing a hope that many of the single figures, with some of the groups, will be produced in Parian.

We would advise a careful study of these works to all who love Art, and who, because they love Art, desire to see it occupying a pre-eminent position amongst ourselves. We have written in strong terms of commendation of these Belgian sculptures: in so doing, we have both paid a deserved tribute to high worth, and have pointed out upon what grounds this collection bases its claim for study, and rests secure that the result of study must be admiration. A definitive and practical result of the study of these works can scarcely fail to be a recognition of the soundness of the principles which have led to their production. Let these principles be thoroughly mastered and widely applied, and we may indeed hope to welcome a school of artists who may at once carry their Art higher than Art has ever yet attained, and elevate both the taste and the feeling of the age which they adorn.

OBITUARY.

PAUL DELAROCHE.

The modern school of historical painting has just lost one of its greatest ornaments by the death, in the sixtieth year of his age, of Paul Delarocbe, which took place at Paris, on the 3rd of November, after a somewhat brief illness of about three weeks,—though for some time past his health had been so impaired as to compel him to cease from his labours, and to live in comparative retirement. The loss of such a painter cannot be limited to the country of his birth; as the fame of Delarocbe extended wherever Art is known and appreciated, so widely will his death be deplored.

In the volume of the *Art-Journal* for 1845 appeared a biographical sketch of this artist, accompanying his portrait, and illustrations from two of his pictures: we refer to it now for the limited notice to which our space restricts us.

He was born in Paris in 1797; his father held a post connected with Art in the *Mont de Piété*, to which Paul's elder brother, Jules, afterwards succeeded—for both sons indicated at an early age a strong predilection for Art. Paul commenced as a landscape-painter, but soon relinquished this department, and entered the studio of Gros, at that time filled with most of the youth who aspired to the higher walk of history. The "classicism" at that time prevalent in the French school he, however, considered heterodox, so he took up a position between them and the romantic, and laboured to create a style more in harmony with the temper and habits of the age. His first picture, "Naphthali in the Desert," was exhibited in 1819, but it attracted no attention; another, the subject of which was, "Joseph rescued by Joseph," was more successful. In 1824 he produced three pictures that obtained a gold medal: the first represented "Vincent St. Paul preaching in the Presence of the Court of Louis XIII.;" the second, "Joan of Arc examined in

Prison by the Cardinal of Winchester;" and the third, a "St. Sebastian"—the first two of these have been engraved. In 1827 Delaroche exhibited "The Capture of the Trocadero," a picture commissioned by the French Government, and for which he received the Cross of the Legion of Honour. His other principal pictures of about this period are—"The Death of Agostino Carracci;" "Flora Macdonald succouring the Pretender after the Battle of Culloden;" "The Death of Queen Elizabeth," now in the Luxembourg; and "The Death of the President Duraati."

Events recorded in English history were frequently made the subjects of his pencil, as appears by a list of some of the pictures painted subsequently to the time just referred to. In 1831 he produced "The Sons of Edward IV.," which has been engraved and lithographed more than once, and which induced M. Delavignie to write his tragedy on the same subject. This was followed by another well-known work, "Cardinal Richelieu on the Rhone, with Cinq Mars and De Thou," and also by his "Cardinal Mazarin presiding, almost at his last moments, at a game of Lansquenet." In 1832 Delaroche was elected into the "Institute," and in the same year he exhibited his "Cromwell contemplating the dead body of Charles I.," a picture which has gained as much popularity in England as in France; so also has the "Execution of Lady Jane Grey," exhibited in 1834; with two other works—"Gaiello studying in his Cabinet," and a "St. Amelia," the latter intended as a model for the great window of the chapel at the Chateau d'En.

In 1835 Delaroche proceeded, for a short time only, to Italy, where he formed a matrimonial alliance with the only daughter of Horace Vernet, then Director of the French Academy at Rome. Between 1835 and 1837, both years inclusive, he exhibited "The Death of the Duke of Guise," "Charles I. in the Guard-Room," and "Lord Straford going to Execution"—these two last works are too well known in England to require any comment. In 1835 it was proposed to the artist to decorate the walls of the Church of the Madeleine with suitable compositions, but circumstances subsequently led to his resignation of the task; he was, however, fully compensated for any disappointment he might have felt with reference to this matter by having confided to him the adorning of the amphitheatre of the *École des Beaux Arts*—a work to which he devoted three years of most assiduous labour; the result was that fine composition, so dramatic, but dignified, earnest, poetical, and truthful, the "Hemicycle," which recently escaped destruction in the *Palais des Beaux Arts*. The original sketch of this work, as many of our readers will remember, was among the pictures hung last year at the French Exhibition, in Pall Mall. Of late years Delaroche's performances have been "few and far between."

In 1844 he paid a second visit to Rome, where he painted a portrait of the Pope: among the few works of this class from his pencil we ought not to omit the mention of his picture of the Countess Rossi, better known as Mademoiselle Soutag, the distinguished *cantatrice*, and that of Napoleon at Fontainbleau—the last, exhibited at the rooms of Messrs. Colnaghi three or four years since, is so far beyond a mere portrait as to rise to the dignity of an historical subject. By the way, the head and face of the lamented artist were very like those of the late Emperor.

With the exception of Ary Scheffer, no painter of the French school presents so few of the characteristics of that school as Paul Delaroche. Dramatic in his conceptions, he expressed them with an originality, a simplicity, and truthfulness, that carry conviction of their reality to the spectator; his mind seems always to have been stored with images cast in nature's own mould, but vividly stamped with the character of the age in which they lived, and which history has assigned to them as individuals; these he embodied in his art with an utter independence of preconceived systems of painting, though with a practical perfection arising from earnest study of previous works. As a teacher he attracted a large number of pupils, whose regard he won as much by his kindness of manner as by the excellent instruction he imparted. In private life few men drew round him a larger circle of sincere friends; utterly free from any assumption of superiority, frank and affable in his manners, liberal in exposing

the riches of his studio, and communicative in reference to the practice of his art, his society was as much sought after by the amateur from what he might learn of Art when in his company, as it was rendered agreeable to all by his easy and cheerful bearing, and his intelligent conversational powers, as we know from our own experience. His death will cause a void, not easily filled up, in the Art and Literary circles of Paris.

MR. JOSEPH JOHN POWELL.

[In the *Art-Journal* for November we printed some remarks concerning this artist, whose death we earnestly deplored—the more so as we were under the belief that it was hastened by indiseretion. We cordially rejoice to learn that this impression was entirely erroneous; and we hasten to make the best amends in our power, by availing ourselves of the information communicated to us by some of his friends, who knew him better than we did, and who assure us how thoroughly we have been mistaken as to the causes which led to his inability to realise the high hopes that had been cherished as to the fame for which he was early a candidate. It is needless to say how much more happy is the task of recording praise than censure; and it is, therefore, with exceeding satisfaction we recall the few words we printed concerning this accomplished young man, whose death we considered, and still consider, as a public misfortune. We publish, therefore, with much pleasure, the following memoir, supplied to us by one of Mr. Powell's many friends, merely observing that it tallies with notices furnished us by other correspondents:]—

"The late Mr. Joseph John Powell, a young artist of considerable promise, died on the 20th of September last, at Southampton, deeply regretted, not merely by the circle of his private friends, but by all who were acquainted with his works: few as they were, they bear ample testimony to his genius. Mr. Powell was born of English parents, at Douai, in France, in January, 1834. He commenced the study of his art at that town, and continued it until 1851 at Lisle. He then came to England for the purpose of becoming a student of the Royal Academy, where he entered in May of that year. Studious and reserved, he made few acquaintances, and sought no patrons. It was partly owing to this circumstance that his only source of income—the exercise of his profession—was little productive; and as his family could afford him but occasional, and never considerable assistance, he was subjected at the outset of his career to much difficulty and privation. To these early hardships, pressing heavily on a constitution naturally delicate, may be probably traced the ultimate failure of his health, and his premature decease. Poverty and ill-health, however, did not damp the ardour of the young student, whom we shortly find outstripping his fellow-students, and carrying off with ease the prizes of the Academy. In December, 1852, he competed for one prize—the silver medal for the best drawing from life—which he gained *longe optimus*; but the following year, encouraged by the first success, he contended for, and obtained, three other silver medals for the best drawing from life, the best painting from life, and the best draped model. He had also in preparation for that occasion an oil-painting, 'Orestes pursued by the Furies,' but was prevented from finishing it in time to compete for the gold medal. The writer of the present notice has seen this composition, which might favourably be compared with the works of some older artists. In 1855 the gold medal was awarded to Mr. Powell for his historical painting of the 'Death of Alcibiades,' in which he seemed to have laid the foundation for a high reputation. Mr. Powell now proposed to himself to compete for the travelling studentship; and was engaged in preparing for this contest, when the illness commenced which terminated in his death. He was recommended change of air as the only hope. A month's tour in the Isle of Wight and Guernsey produced a fallacious improvement in health, and almost total exhaustion of pecuniary resources; and he was returning to London to resume his labours, when he was again taken ill at Southampton, where he lingered a few weeks, and died. In him Art has lost an earnest and enthusiastic student, and Mr. Cross, to whose instructions he was much indebted, a highly creditable pupil."

THE FIRST CRADLE.

FROM THE GROUP BY A. H. DEBAY.

Few persons, we imagine, who were attracted by the foreign sculpture exhibited at the Great Exhibition in 1851, will not remember, and with feelings of pleasure, the fine group sent from Paris by the sculptor, A. H. Debay, and entitled "Le Premier Berceau," or, to give it an English name, "The First Cradle." A cast from it is now in the Crystal Palace at Sydenham.

In England, it is not an uncommon occurrence to find young sculptors ignoring their art from the want of patronage, and directing their attention to the sister-art of painting; and in France, the reverse is not unusual. Auguste-Hyacinthe Debay is the younger son of Joseph Debay, and brother of Jean B. Debay,—all of them sculptors of considerable reputation, resident in Paris. Auguste was born at Nantes, but went at an early age with his father to Paris; studied some time under Gros, the painter, and commenced his artistic career in this department of Art.

In 1819, while a student in the *Académie des Beaux Arts*, he gained a third-class medal in 1823, for the best historical picture—the first grand prize of Rome, as it is called, because, as in the case of the large gold medal bestowed by the Royal Academy, it entitles the possessor to proceed to Italy to study; and in 1831, a medal of the first class. In the *Palais des Beaux Arts*, at the Great Exposition last year in Paris, he exhibited three pictures:—"The Old Man and his Children," painted in 1835; "The Two Friends," painted in 1841; and the "Portrait of a Lady," painted in 1846. The only sculptured work he exhibited at the same time was that from which our engraving is taken. We know not when he commenced to practice the art of sculpture, but it is evident he was engaged both on this and painting at the same time, for "The First Cradle," was exhibited at the annual *Salon de Louvre*, in 1845.

There is a novelty in the conception of this group that entitles it to the admiration of the amateur, over and above the manner in which the idea is carried out. The disposition, so to speak, of two young children in the lap of their mother, cannot be very easy of treatment; and yet M. Debay has placed them picturesquely and naturally. But we cannot help feeling, especially when we look at the group in profile, as in our engraving, that there is some sacrifice of grace in the attitude of our first mother, Eve—for she it is whom the sculptor has here represented: grace, however, is not a quality we generally expect to find in French sculpture—it has never been a characteristic of the school. "I remember," says Mrs. Jameson, "in the Great Exhibition of 1851, being struck, as all were struck, by the wonderful elegance, fancy, and invention displayed in the French sculpture, including the ornamental bronzes—by the careful design and finished execution of the most minute, as well as the larger objects; but we were also struck by the predominance of the voluptuous and the ferocious sentiment in some of their finest designs—the humane feelings, the moral sympathies, outraged on every hand. The appetite for sensation is as obvious in French Art as in their drama and literature—all react on each other."

In describing this group, the same discriminating critic remarks:—"Eve, our general mother, holds on her knees, and encircled in her arms, her two sons, Cain and Abel, who slumber with their arms entwined in each other. The heads of the two children are well discriminated in character. Cain seems to frown in his sleep; Abel has the soft, pure lineaments which the early painters gave to the heads of the infant Christ. Eve, bending thoughtfully and fondly over them, seems to anticipate their future fate. A group of extraordinary talent and power, both in conception and treatment. The form of Eve has all the amplitude and vigour which ought to characterise the first parent; and thus Michael Angelo has represented her. On the pedestal are three small bas-reliefs from the history of the two brothers."

It is quite unnecessary for us to add anything to the above remarks, which comprehend, in a few words, the leading features of this fine group.



THE HISTORY OF THE
CITY OF BOSTON
FROM THE FIRST SETTLEMENT
TO THE PRESENT TIME
BY NATHANIEL PHIPPS
VOLUME I
BOSTON: PUBLISHED BY
J. B. ALLEN, 1856.



BRITISH INDUSTRIES.

THE COMPOUND METALS EMPLOYED IN ART-MANUFACTURE.—(No. 1.)

THE household gods of the Egyptians in the days of Moses—the sculptured divinities of the Babylonian and Assyrian people—the many-headed idols of the Hindoos, carrying us back into the very infancy of the human race, were all of the same metallic composition. We find spear and arrow-heads at Nimroud, in some parts of the African desert, and scattered over Europe; we also discover tools of various kinds, especially over the Scandinavian regions and in the British Isles, similar, and curious in construction. It is not a little remarkable to find, by chemical analysis, in the pagan idol, the huntsman's arrow, the warrior's spear, and the miner's tool, precisely the same metals in combination—tin and copper, forming bronze. Our Sacred Volume informs us that Thabal Cain was "an instructor of every artificer in brass and iron;" and, in Deuteronomy, we are told that Judea was "a land whose stones are iron, and out of whose hills thou mayest dig brass." Now, we apply the term brass to a yellow metal, which is a mixture of zinc and copper. The metal, zinc, was not known to the ancients, and it is exceedingly doubtful if even the "calamine earth," which was long used to produce brass, was known even to the Romans; consequently the brass of antiquity was, without doubt, our bronze.

Agatharchides, who wrote 180 years before Christ, informs us that the abundance of brass was such, that it formed the chief part of the domestic furniture, as well as of the chariots, the swords, the bows, and the arrows, in use in a prior age. Not long since, a great many Roman swords were found at Kingston-on-Thames in a beautiful state of preservation, and displaying great skill in their manufacture; these were all of bronze—the tin and copper being in the same unvarying proportions.

Copper appears to have been obtained by man in all ages. In the reign of the fourth Ptolemy we are told of the copper mines; "they are near the Mountain Altaki, not far from the ancient Berenice Lanchryos, in latitude 22° north; they were worked by a numerous body of people, including men, women, and children, to each of whom a portion of labour was assigned correspondent to their strength and skill. The discovery of them was made by the kings of the ancient race." The mines of Nubia appear at one time to have supplied the whole of the then known world. Cadmus, the Phœnician, is said by Strabo to have been the first to introduce the use of copper to the Greeks; and the historian tells us, that he, in the year 1594, before Christ, with a party of emigrants, opened the first copper mine in the mountain of Langreus, in Thrace.

Those Phœnician wanderers—the merchants of the world—were noted for their trade in tin, the largest portion of which they obtained from our own islands. The Cassiterides, or the Tin Islands, have been frequently stated to be the Scilly Islands; but the authority upon which this statement is made is particularly loose and unsatisfactory: one simple fact disturbs the often-repeated hypothesis—there is no tin in the Scilly Islands; there are no remains of mine-workings, nor can any evidences be detected which would appear to show that any metalliferous or mineral works ever existed in any part of that curious group of granite islands. The western promontory of Cornwall—abounding even now with tin, and over which are spread the evidences of very ancient workings—was, in all probability, intended by the ancient geographer when he described the Tin Islands of the West.

However this may be, it is evident that the

Phœnicians traded with the Britons of Cornwall for this metal. An oriental race—probably the sailors from Tyre—have left traces of their presence in Britain, which are not even yet removed; and in the tin-beds of Cornwall have been found the skulls of these adventurous orientals. The Etrurians, we are informed by Macrobius, marked out the boundary of their city with a ploughshare of copper; and it was the custom of their priests to have their hair cut with knives or razors made of copper: "these people supplied Rome with the copper from which was coined all the money which circulated in Rome through several succeeding centuries." From this it would appear probable that the Etrurians used pure copper—perhaps they were not acquainted with the process of hardening it by an admixture of tin.

We are now receiving from the sites of the great monarchies of the East, bronzes of various kinds—weapons once wielded by the Assyrian warrior—tools once employed by the industrious and skilled workmen of Babylon—casts mimicking the human form, which were reverenced in the temples of Baal, and others which adorned the palaces of the kings—armlets and anklets, and pins for the hair, which the women of those cities of the plain wore when they were at the height of their civilisation and luxury. Our oriental explorers, Layard, Loftus, and Rawlinson, have recovered from the deserts these memorials of ancient Art-manufacture; and the bronze of which they are composed is the same in composition as that which we employ at the present day. The copper of which they are formed was, no doubt, the produce of Arabia and Nubia; but the tin was obtained for the great empires of Egypt, Assyria, and Babylon, from the Tin Islands of the unknown Atlantic Ocean—from our own native island.

Aristotle informs us that, in his day, a mixture of tin and copper was known, which produced an alloy of the greatest density, but we nowhere find any account of a metallic alloy which corresponds with our brass. The father of natural history has, by some, been supposed to mention brass, but this is merely conjectural. Bishop Watson was of opinion that the *orichalcum* of antiquity was identical with our brass, but the evidence upon which he founds this idea is exceedingly slight.

To the manufacture of brass two things were necessary—copper and zinc. There was no scarcity of the former metal—of the latter there was none. Calamine earth (*Lapis calaminarius*) may have been known, but it is nowhere described. Long after brass had been made by melting copper in furnaces stratified with this ore of zinc, the metal zinc was unknown. Philosopher's wool, the pure *oxide of zinc*, was known to the alchemists, and exhibited as a curiosity by Brandt, and others. In all probability the chemist Brandt was the first to obtain the metal zinc.

It has been supposed by many—amongst others Dr. Pearson—that the bolts and bronze vessels which have been so frequently found in England and in Ireland, were manufactured by the natives—seeing that, in both islands, copper exists abundantly, and tin has been found. There appears, however, every reason for supposing that this was not the case; although our mines in Cumberland and Cornwall, and indeed in other mineral counties of England and Wales, were worked by our own miners, and, as it was supposed, more experienced miners from Germany, under the license of monarchs, many of whom were enriched by the treasures obtained, yet we learn only of tin, silver, and lead, as the metals obtained. In the reign of Queen Elizabeth, by an Act of Parliament, calamine earth was not allowed to be exported—as the "inexhaustible quantities of calamine would occasion much rough copper to be

brought in." This proves that the value of our copper mines was not known, and that the brass made in England, in the time of Elizabeth, was manufactured with our own calamine, but with foreign copper.

It is distinctly stated that previous to the establishment of Christianity in the Roman Empire, their architects used cast works of brass in the decoration of their public buildings. "The vaultings of many of the temples in Rome having been relieved in their lacunaria by pateræ, and other ornaments of brass. At the restoration of the Arts in the fifteenth century, and, indeed, before, most of these articles were removed for the sake of the metal, by the order of different popes, who had the most ingenious artists employed for the adornment of the many churches then erected under their auspices. Brazen monuments subsequently became exceedingly common throughout Christendom. Previous to the Reformation, large quantities of sepulchral brasses were imported into this country from the Netherlands. Few of the walls or floors of our more ancient churches failed to present some quaint portraiture—sometimes a whole family, rudely but spiritedly delineated; some fanciful cross or crozier, or some flowing label inscribed with angular letters, and carefully imbedded in stone. Some of our cathedrals were in this way ornamented with a profusion of brass furniture, to an extent which would scarcely be conceived by those who have paid no attention to the subject. The zeal which afterwards displayed itself in the destruction of popish memorials, found a ready excuse for the indulgence of cupidity in stripping away those brazen treasures, in the fact that they were the symbols or sentiments of the denounced religion. 'The cursed lust for gold,' of the Roman poet, was witnessed in respect of brass in another age and nation; rapacious hands in this Christian country, and, under colour of a holy cause, tearing from the gravestones hundreds of sculptured brasses, will hardly be supposed to have discriminated very precisely between those which bore the offensive *orate pro anima*, and others of a more harmless but massive character. Many of these early plates, however, have been preserved; and many others have been added in subsequent years. As an example of a superior class of workmanship, the brass railings around the monument of Henry VII., in Westminster Abbey, presents a splendid specimen of the brazier's art, as displayed at a time when the knowledge of the methods of working in brass was in general but little cultivated in this country."*

Allusion has been already made to the policy of Queen Elizabeth. She granted many privileges to Daniel Houghsetter, Christopher Schütz, and some other Germans, whom she invited into England in order to instruct her subjects in the art of metallurgy. In 1565, Elizabeth granted to certain Dutch and German miners, licence to dig for alum and copperas, as well as for gold, silver, copper, and quicksilver, in several counties of England, and the English pale in Ireland. The queen granted two exclusive patents to Humphreys and Schütz, who had brought into England upwards of twenty foreign workmen, to dig and search for those metals, and also for tin and lead, and to refine the same in this country. In the same year, this monarch granted them "the sole use of the calamine stone, for composition of a mixed metal called *latten*, and all sorts of lattery works, cast works, and wire." The corporation of "The Mineral and Battery Works" arose out of this: Sir Nicholas Bacon, Lord-Keeper of the Great Seal, and the Duke of Norfolk, joining the Germans in the under-

* See "Manufactures in Metal," revised by Robert Hunt; vol. iii.

taking. The brass works at Baptist Mills, near Bristol, was the first manufacture of brass established in this country; the calamine (carbonate of oxide of zinc), from the Mendip—originally Myne-deep—Hills being used.

In 1720, William Wood published a pamphlet on "The State of the Copper and Brass Manufactures of Great Britain." At that time about thirty thousand people were supposed to exist by those manufactures. The following remarks are instructive:—"We have plenty of *lapis calaminaris* for making brass. Copper ore is found in many counties of England, Wales, and Scotland: and this nation can supply itself with copper and brass of its own produce, sufficient for all occasions, if such duties were laid on foreign copper and brass as would discourage their importation, and at the same time encourage the sale of our own metal." The variations in the commercial ideas of Elizabeth's time, in the days of William Wood, and our own, when, notwithstanding the large produce of our copper mines, the importation of foreign copper ore is relieved from restrictions, are a curious and instructive study. The introduction of the manufacture of brass in Birmingham is thus described by the local historian, Hutton:—"The manufacture of brass was introduced by the family of Turner, in about 1740; they erected works at the south end of Coleshill Street. Under the black clouds which arose from this copulent tunnel some of the trades collected their daily supply of brass; but the major part was drawn from the Macclesfield, Cheadle, and Bristol companies.

"Brass is an object of some magnitude in the trades of Birmingham (1819), the consumption is said to be one thousand tons per annum. The manufacture of this useful article has been long in the hands of a few and opulent men; who, instead of making the humble bow for favours received, acted with despotic sovereignty, established their own laws, chose their customers, directed the price, and governed the market. In 1780 the article rose, either through caprice or necessity, perhaps the former, from £72 a ton to £84. The result was, an advance upon the goods manufactured, followed by a number of counter-orders, and a stagnation of business.

"In 1781 a person, from affection to the user, or resentment to the maker, perhaps the latter, harangued the public in the weekly papers; censured the arbitrary measures of the brazen sovereigns, showed their dangerous influence over the trades of the town, and the easy manner in which works of our own might be constructed. Good often springs out of evil; this fiery match, dipped in brimstone, quickly kindled another furnace in Birmingham. Public meetings were advertised, a committee appointed, and subscriptions opened to fill two hundred shares of £100 each, which was deemed a sufficient capital; each proprietor of a share to purchase one ton of brass annually. Works were immediately erected upon the banks of the canal, for the advantage of water carriage, and the whole was conducted with the true spirit of Birmingham freedom."

It is curious, now, that so large a development has been given to the brass manufacture of Birmingham, to read thus quaintly described the history of its introduction. From what has been said, it will be evident that the art of making *brass* is far older than the manufacture of *brass*. That the terms *brass* and *bracen* have been employed to signify both bronze (copper and tin) and brass (copper and zinc). The ancient Egyptian bronze was said to be composed of two-thirds brass and one-third copper; here we have a striking example of this confusion. The true composition of the ancient bronzes will be given in the next paper, suffice it at present to say, that the Egyptian bronzes are all tin and copper. The Corinthian brass

or bronze which has been deservedly famous, contains silver in addition. The discovery of this alloy is said to be due to the following catastrophe:—Mummius having sacked and burnt the city of Corinth, in the 15th Olympiad, it is pretended that all the metals—copper, silver, and gold—employed in ornamenting that splendid city were, by the fierceness of the fire, melted and mixed together. Three sorts of Corinthian bronze have been described, in one gold was predominant; in another, silver; and in the last, gold, silver, and copper in equal parts. In the present paper a sketch, and that only in outline, has been attempted of the History of Bronze and Brass Manufacture; in the next a description of all the varieties of these alloys will be given, and some special particulars of the modes of casting statues, bells, &c.

ROBERT HUNT.

ART IN CONTINENTAL STATES.

PARIS.—The death of M. Paul Delaroché, to which we have elsewhere referred, has caused a great sensation here in the Art-circles, to the exclusion of almost every other topic.

MUNICH.—The exhibition of Crawford's monument to the memory of Washington has been very attractive, but not more so than is justified by the merits of the work, which was shown at Miller's Poupury. The objections which have been taken to the work, by a writer in the *Allgemeine Zeitung*, are in some degree based upon truth, for it must be confessed that the sacrifices that have been made for the sake of effect are too great, yet the general impression of the statue is extremely imposing. The idea of the artist seems to be to represent Washington not only as the leader but also as the controller of the revolution; and this would appear to be expressed by the fiery impatience of the horse on one side, and the energy with which he is restrained by his rider on the other. The most favourable point of view whence the spectator can see the work is, to stand so as to view on his left; on the other side, the outlines of the horse are somewhat hard. The casting is most successful; the brilliancy of the new bronze contributes not a little to the effect of the statue.

COLOGNE.—The sum required for the completion of the Cathedral will be about 3,600,000 thalers; and, according to the calculation of the architect, the term of twelve years will be necessary for the completion of the building, with an expenditure each year of 300,000 thalers. The statement of the subscription account gives the amount of 39,637 thalers since the last general meeting, of which 39,000 thalers were, in 1855, expended in continuing the works. The total subscriptions, from the year 1842 until the end of 1855, amounts to 1,381,581 thalers, of which the greater part was contributed in subscriptions, and a portion collected by fees, &c., at the Cathedral, and from the town-treasury of Cologne.

NUREMBERG.—A proposition is circulated throughout the cities of Germany, inviting attention and contributions to a museum at Nuremberg, which has for its object the formation of a collection of antiquities in literature and Art, of any date anterior to the year 1650. The view with which this institution is founded is threefold:—1. A collection of every kind of material that can assist the history, the art, or the science of Germany; 2. a museum, library, and collection of objects of Art; 3. to render both of these departments useful and accessible, and in time to contribute to the literature of Germany, by the publication of treatises upon such subjects as may be illustrated by contributions to the collection. There are already appointed two trustees, a committee of twenty-four persons, and at the same time an extraordinary committee, comprehending 206 of the most distinguished names in Germany in literature, languages, art and antiquity; and the library will receive gratis contributions from many learned bodies, and no less than 265 booksellers, who have promised to send to it their publications. The collection contains already 3000 original subjects of antiquity; a library of nearly 18,000 volumes, among which are some very rare manuscripts; 300 sculptural works; 300 pictures, autographs, and miniatures; more than 10,000 engravings; 2000 coins and medals; 3000 seals; 2000 portraits:—all of periods anterior to 1650.

EXHIBITION OF TURNER'S PICTURES, AT MARLBOROUGH HOUSE.

A SMALL instalment of the Turner "Collection" is at length before the public at Marlborough House. There are twenty pictures of various dates, embracing a period of half a century, and exhibiting manners of viewing nature rather diverse than progressive. But time is developing Turner most satisfactorily—age is maturing and mellowing his works; many of them, even now, are in a condition more naturally qualified than when exhibited from the easel. We have employed, by the way, the word collection as if we have seen them; but we have not, because it is impossible to see pictures in Marlborough House: there is but one visible, that is, 'Childe Harold's Pilgrimage.' There were two great periods in Turner's life—the former, during which he painted what he saw; the latter, during which he painted what he imagined. The former was to him a long masquerade—we judge him as he is seen in the few pictures before us, where we find him—pardonable ambition!—emulating his master Louthburgh, standing forth as now Vandervele, now Ponsin, now Claude, now Van derneer, nay, even Callcott. We believed that he exercised this eccentric power not in servile or unconscious imitation, but with a conviction that he could outdo those with whose feeling he might affect to sympathise. This emulation he carried perhaps into later life, when, on the walls of the Academy, he has worked a bare canvas into a picture which extinguished all others near it. His latter period was confirmed by the opening of the Continent after the war: and no sooner was he in Italy than he may be said to have suffered that *comp-de-soieil* which coloured the whole of his after-life—henceforward he asserted himself, and was Turner only. It is simply trifling to say that Turner, from his beginning, predicted his after-self; here he is before us as wearing the mantles of many men, but even with a better grace than they themselves. These magnificent works are a portion of those that are stored in the lower rooms of the Royal Academy, whence there is yet a large number to be brought forth. As we have but a brief space to devote to them, we proceed to name them, preferring their chronological succession to any importance which treatment or subject may confer on certain of them:—

1797. 'A Study at Millbank' is a small moonlight picture, admirable in finish; but we cannot accept as truth the moon shining in an even, flat, and opaque sky—our senses tell us that the moon reflects a light which illuminates the sky to a degree proportioned to the less or greater distance from the planet.

1800. 'A View in Wales.' A small dark picture, an opposition of two breadths—the land and the sky; the former distinguished by great depth and power. The detail cannot be seen.

1802. 'View on Clapham Common.' Also small, and so sketched as apparently to have been painted on the spot; and so like it that we believe the identical trees are still there.

1805. 'The Shipwreck.' This is a large picture of extraordinary power; the story is simple enough—a vessel reduced to a helpless hulk is drifting inshore, and boats are putting off to her aid. This and Lord Yarborough's picture—'The Wreck of the Minotaur'—may be said to be pendants. This production must be regarded in two ways—to its merits as a pictorial composition, and as to the fidelity of its narrative. It is one of Turner's most sublime effusions; it is very much to say that it hefts the mind for the contemplation of the reality: we know of no picture which excites emotion so overpowering. But, as to fact, these boats could not live five minutes in such a sea, they would at once be buried in such irresistible masses of water. Again, the boat that is under sail is making way with a full sheet, having the wind apparently all but dead against her.

1809. 'Greenwich Hospital.' A view from the hill, looking over the trees, and the buildings up the

river, with London, closing the distance: too high for examination, but apparently a most perfect representation of the subject.

1810. 'Abingdon, Berks.' An admirable work as far as can be seen, and unlike all others in the room.

1813. 'Cottage destroyed by an Avalanche.' The composition is not discernible.

1815. 'Bligh Sands, near Sheerness—Fishing Boats trawling.' A work of rare merit; extremely simple; the water-forms rendered in the most careful manner after nature.

1817. 'The Decline of Carthage.' One of those works on which Turner desired that his fame should rest. It is intended as a pendant to the work in the National Gallery, but it has not the substance and maintenance of parts which constitute so markedly the excellence of that work. It is full of figures, but it is impossible to read the personal story; it may be the departure or the return of Regulus. Although inferior to the other picture, it is yet a superb work—but too hot in its foreground hues, and too much broken up. Its architecture is somewhat excessive.

1823. 'The Bay of Baia.' In this work will be seen the confirmation of Turner's latter system of chiaro-oscuro. As a principle, a large pine-tree is thrown up into the sky, or introduced within the composition at one third of the distance, with perhaps a counterbalance of tone and quantity on the opposite side, and these disposed with such skill as to be felt merely as accidents. This is a worthy member of the Italian series. The painter has endeavoured to give a classic emphasis to the scene, and places it before us with all the charms that attracted those Roman Sybarites (*quibus placere Baie*), the ruins of whose palaces consecrate the place to history.

1830. 'View of Orvieta' is a smaller picture, but so indifferently lighted as to render it impossible to describe it.

1832. 'Child Harold's Pilgrimage' is, we submit, the most highly qualified of the Italian subjects. Although a composition, it is most felicitous in the adjustment of its parts. It is not falsely illumined by paint instead of light; there is unexaggerated local colour, enough to instil a veritable locality; and such is the description of space, that we seem to look into the speculation of an enchanter. In some other of these works we find a profuse repetition of forms; but no passage of this work could be emended by change.

1837. 'Apollo and Daphne.' The scene is a valley, bounded in the distance by the sea. On the left is a fragment of a group of trees, and removed from the foreground stands a solitary tree, to which the artist has given the power of moving mountains, so essentially does it serve the distance.

1838. 'Phryne going to the Bath as Venus.' Here the foreground is occupied by a multitudinous procession, and the background is intended to represent Athens. It is difficult to reconcile the quantity of red, not only in the figures, but also in the ground, as introduced in the most prominent portion of the picture.

1839. 'The Fighting Temeraire tugged to her last berth.' This is the best of Turner's last works; and it is much improved since it hung on the walls of the Academy. The incident is rendered profoundly touching by the sentiment with which it is invested. It is one of those works of the painter that is distinguished by so many beauties that we cannot question the propriety of anything on the canvas.

1839. 'Agrippina landing with the Ashes of Germanicus.' It is impossible to speak of this painting, as it cannot be seen.

1840. 'Venice: the Bridge of Sighs—looking up the canal, and past the corner of the Doge's Palace, a portion of which enters the composition on the left.' As an essay in chiaro-oscuro, this is a most masterly production.

The remaining works are 'The Burial of Wilkie' (1840), and 'The Sun, of Venice, going to Sea,' but these we have no space to describe. We might have examined at greater length the materials of which these works consist, as also the sentiments which they embody, but we must wait a future occasion, when they may be seen under a suitable light.

THE SOULAGE COLLECTION.

THE arrival in this country of the collection of what is called *verlu*, made by M. Soulage, of Toulouse, has excited the warmest interest of all admirers of those rare and beautiful productions of Art which are found only in the cabinets of wealthy amateurs. Great exertions, it is true, have everywhere been made, of late years, to improve public taste, and with no small measure of success. Each nation in Europe has its collection of Art-curiosities; and this has always served as a source whence to draw for reproduction and new design; and, when it was found that such possessions were a means of conferring on the utilities of life not only an artistic, but an increased mercantile value, then we awoke to the necessity of educating artists with a view to enrich with elegant form even such objects of common usefulness as might be susceptible of chaste embellishment. Much, we say, has been done; but we are still in the wake of those nations who have already, during two centuries, preceded us in their profitable attention to design. It is impossible that in ten or fifteen years we could effect as much as those countries where, for centuries, the best models have been accessible to their artists; and hence it is that we, unwilling to be second in anything, should be desirous of possessing resources for the amelioration of all those objects to which so much of the beautiful is imparted by cultivated taste. The Soulage Collection has been purchased by certain gentlemen with the honourable desire that it should become national property. The formation of the collection was commenced by its late proprietor at a time highly favourable, in Italy, to the acquisition of remnants of ancient wealth and grandeur, that is, some ten years after the tranquillisation of Europe, distracted by the long war of the French revolution. Furniture, gems, plate, jewels, lace, porcelain, enamels, bronzes, pictures, tapestries, every genre of Art-treasure had been dispersed, and gradually fell into the hands of dealers, who found their market among those who had a taste for these rarities and could indulge it. Thus it is that all these collections are formed. Mr. Bernal did not, perhaps, go very far from home for the majority of his catalogue; but the name of Soulage is probably still remembered in some of the least promising of these dark *botteghe*, in the narrowest and most retired streets of Florence and Rome, and, perhaps, in many of those of the secondary cities of the Italian states. But it is necessary to explain how the collection came to this country. It has been purchased for eleven thousand pounds, which sum was raised by the subscription of seventy-three gentlemen, who were patriotic enough thus to secure it, in order to submit to Parliament their purchase for ratification, that the sum might be voted to reimburse them, and so confirm the collection as national property. In the event of the purchase being declined by Parliament, the entire collection will be sold by auction, and the various sums advanced by them returned to the subscribers. Should the sale realise an amount short of the eleven thousand pounds, it will be divided in sums proportionable to the subscriptions. But it is believed that a sale by auction would produce a sum considerably above the cost of the collection—and in this case it is agreed that the surplus shall be employed in furtherance of some object promotive of Art, hereafter to be determined by a majority of the subscribers. If such an opportunity as this is lost of multiplying those sources which, to us, as the first manufacturing nation in the world, are invaluable, it is impossible to say when another such opportunity may arise; for, unlike many collections of costly toys, trifles, and mere curiosities, the greater part of the Soulage catalogue are really worthy to furnish models and suggest designs. The productions are nearly all Italian, and among them are distinguished works of the cinque-centists. We cannot suppose that the purchase will be declined, for the amount demanded for these works is altogether insignificant to a government possessed of the resources which ours has at command, and in comparison with their value, as objects of study, to the country; but, should it be so, the purchase-money might be realised by the exhibition of the collection. When it is thrown open, we propose describing it in detail in a series of articles.

MINOR TOPICS OF THE MONTH.

JOHN HENRY ROBINSON and GEORGE T. DOO have been elected associate engravers by the Royal Academy under the new law, which qualifies them for full membership. Both these gentlemen have attained high eminence; their works are well known; they have long held rank among the foremost of British engravers; but they are also considered to have quitted their profession—Mr. Robinson because he is independent of it, and Mr. Doo because he has found portrait-painting more profitable than engraving. On this account, and on this account only, we may be permitted to regret that these honours were not conferred on artists in practice, to whom they would have been more valuable acquisitions. But in Mr. Robinson and Mr. Doo, the members of the Royal Academy have associates in all respects worthy of them—gentlemen of high character and acknowledged talent.

THE WELLINGTON MONUMENT.—A correspondence on this subject has taken place between Sir Benjamin Hall and the Sculptors' Institute, to which at present we can do no more than refer. To a question as to whether the author of the best design is to be entrusted with the execution of the group, the "Chief Commissioner of Public Works" has sent the following answer:—"There is nothing in the specification to bind the government to employ the author of the best design to execute the work, and no positive obligation can be incurred."

THE MANCHESTER ART-TREASURES.—The proceedings of the Committee during the past month have been so far successful as to induce conviction that they will be compelled to reject as many pictures as they accept—the consequence will be a collection that will be really Art-treasures, for it will be unnecessary to place on the walls a single inferior work. The Soulage Collection (referred to elsewhere) is also to be exhibited there. Our anxiety now only concerns the facilities to be afforded to Art-manufacturers, British and foreign; on this subject we have received many communications, but we are at present unable to answer the questions that have been put to us. Certainly objects of modern manufacture are to be exhibited, but they must be only such as specially appertain to Art. We trust the Committee will lose no time in clearly explaining their views on this important matter, for manufacturers are in doubt as to what course they are to adopt; and if the arrangement be not soon defined, there will not be the preparations necessary for a good and effective exposition in this respect.

THE MANCHESTER MECHANICS' INSTITUTION.—The prime-minister has amply compensated for the disappointment sustained by the Institution at its inauguration. He has visited the city, and, of course, the Exhibition, and has gathered "golden opinions" in Manchester, where he was the guest of Sir Oliver Heywood, whose son is the President of the Institute. Various additions have been made to the collection, which is now described to us as in all respects admirable. We earnestly hope it will fully and entirely answer the purpose of its members.

A WANTER EXHIBITION OF PICTURES is opened at the Crystal Palace; we cannot help considering this to be "a mistake," if it be contemplated to form it of works not hitherto seen here, and if otherwise, as "a winter exhibition" it is a misnomer. There has not been time to make a new collection, and to make an inefficient gathering will be greatly to weaken such an exhibition as might have been had in the spring of next year.

THE COMPANY OF CLOTHWORKERS are about to erect a new hall on the site of their now destroyed old one, on the east side of Mining Lane, Fenchurch Street. An engraving published in the *Builder* represents the entrance front of it, which has been designed and is about to be carried out by Mr. Samuel Angell.

THE MONUMENT TO THE LATE MARQUIS OF OXFORD.—During the last month, the monument to this much lamented nobleman has been fixed in its appointed position in Kilkenny Cathedral, under the immediate personal direction of the sculptor, Mr. Edward Richardson. This work takes a step in advance of the memorial to the late Earl Powis by the same artist; and it does this because it shows that the fourteenth century monumental type has

been dealt with in a manner which, while it is rigidly consistent, admits both originality of conception and freedom in working out the details. The raised tomb, with its architectural enrichments and heraldic accessories, supporting the recumbent effigy, is and must remain the most perfect form of monumental memorial. The Ormonde monument is such a composition: the tomb is panelled in lozenge-shaped compartments, and it has at the angles half panels, within each of which stands the figure of an angel; the panels themselves are severally charged either with a shield or with an achievement of arms. The inscription is carried about the upper part of the composition in the chamfer of the mouldings of the slab. Upon this slab rests the effigy, which is represented as habited in knightly robes, with the hands uplifted and clasped as in supplication. At the head and feet of the effigy there kneel two groups of youthful figures, three figures in each; they are the six children of the marquis, who thus cluster around his pillow and head down at his feet. It is a beautiful and touchingly appropriate idea: and in its execution most felicitous. The portraits are admirable; the grouping and *pose* of the figures leave nothing to be desired; and the *expression* of the whole speaks for itself, and speaks home to the heart.

The simplicity and breath—essential attributes of really noble monumental sculpture—with which the figures are modelled, and the leading architectural portions of the monument expressed, are judiciously relieved by rich clusters of foliage and flowers in the spandrels of the panel-work. These accessories combine, with great "naturalness," an appropriate and effective conventionalism. The angelic forms also claim attention—if only to show how infinitely superior in such matters is the treatment of an English sculptor to the insipid inanity which we so long were compelled to see at the Crystal Palace—four times repeated—in the so-called Sentari Monument. The chiselling of the work also deserves high commendation: it is free, earnest, and impressive throughout. We should, however, have been glad to have seen greater boldness and variety in the treatment of the heraldic accessories: but, perhaps, it will require a prolonged study, even with our ablest artists, before heraldry is practically understood and felt to be a living Art as well as a recording science. When we call to remembrance the heraldry displayed on the occasion of the funeral of the Duke of Wellington, and when we gaze at the shields of arms which seem photographed along the walls of the Palace of Westminster, we have abundant reason to feel thankful for the heraldry of the Ormonde monument.

HISTORY IN FRESCO.—A correspondent, writing to us from Rome, says that a learned Hellenist attached to the Vatican has recently made a discovery, which has its importance in reference to ancient topography, and as throwing light on a passage in the *Odyssey*. Some years ago were found beneath the foundations of a house which was demolished on the Esquiline Hill two remarkable Roman frescoes. In 1850, on taking down another house in the neighbourhood of the former, six other pictures—five of them in a state of perfect preservation—were discovered. The whole represent various episodes of the voyage of Ulysses, as related by that prince to Alcinoüs, in the *Odyssey*. These pictures are now in the Museum of the Capitol, and contribute their illustration to the solution of an historic doubt. The *sarant* in question is said to find proof in the first of the series,—the subject of which is the arrival of Ulysses amongst the Lestrigons,—that, interpreting it by a verse of the *Odyssey*, it represents the neighbourhood of Terracina. This verse—the 104th of the Seventh Book—and the pictura both agree with the perspective yet presented by the seaport in question, and would seem thus to clear up a point in ancient geography which has been hitherto considered obscure. It was not before certainly determined which was the port of the city of the Lestrigons.

MEETING OF THE SURREY ARCHAEOLOGICAL SOCIETY AT LAMBETH PALACE.—The satisfactory fulfilment of their primary and direct objects is far from comprehending, in itself, all that our county archaeological societies are able to accomplish—for example, in addition to archaeological research and record, they may be made to lead to the opening of places otherwise not generally accessible; they may

bring together, and that periodically, many persons who otherwise might not meet; and they may popularise and extend the range of the study of archaeology. The two societies which have lately (and one of them within the last twelve months) been formed with special and exclusive reference to the archaeology of Surrey and Middlesex have at once taken an advanced position on their own peculiar ground, and they also have already effected much of what we would term secondary results. This was eminently the case on the occasion of the recent meeting of the Surrey Society at Lambeth Palace. Certainly, of the many persons who are most familiar with the old towers which rise above the Thames at Lambeth, but a very few have hitherto gone further than to desire to enter within their walls, and to examine them minutely. The palace of the archbishops of Canterbury has always been felt to be replete with spirit-stirring associations, as also to contain many things that are of the highest order of historical interest and importance; yet they were exceptional individuals, who could speak experimentally upon the subject, and could describe this Palace of Lambeth, with its contents, from their own personal knowledge of them. Accordingly, when it was announced that the Surrey Archaeological Society would hold there a general meeting, by the express permission of the present Archbishop of Canterbury, and, moreover, that the brother of his grace, the Lord Bishop of Winchester, would preside, the liveliest interest was evinced in the proposed meeting, and there prevailed the utmost anxiety to obtain admission. Unfortunately the weather on Friday, October 31st, was most unfavourable; but yet nearly 500 persons, including very many ladies, showed that it was not rain which would deter them from joining the archaeological meeting in Lambeth Palace. The meeting was held in the ancient Guard Chamber, now the Great Hall of the palace. The visitors appeared unwilling to leave any of these deeply interesting places, but the "Lollards' Tower" was the principal point of attraction; it stands near the river, and opposite to the gatehouse, its basement forms an ante-chapel, or, rather, a species of porch to the chapel, and near its summit is a small prison-chamber, where many a noble victim, without doubt, was long imprisoned. This chamber is reached by means of a narrow, winding turret-stair, and it is lined throughout with thick, rough planks of oak or chestnut; upon these are incised many names, mottoes, devices and brief sentences or parts of sentences; among others the motto of Cromwell—"Nosec tripartitum," whatever its presence here may imply, is clearly to be distinguished.

PROTECTED MONUMENTS.—The monumental expressions of public or of individual grief for the heroic dead, whose graves are far away in the Crimean solitudes, are multiplying, as we predicted they would, throughout the land. Among these, the working men of Sheffield have set on foot a movement for a monument of their own; and, with the true instinct of their class, whenever that class has been truly appealed to, the thought of the distant dead at once associated itself in their minds with the gentle ministrations which sat by so many of their dying beds. To lay the first stone of their memorial, the working men of Sheffield sought the hand that, in that terrible carnage, had saved so many, and done so much to soothe where it could not save. For the heroine of the ceremonial which commonly consecrates a work of the kind, their hearts turned at once to Miss Nightingale. To this affectionate appeal, and the sentiment which suggested it, Miss Nightingale responds,—though not in the fashion sought. She takes the opportunity thus afforded her to read a lesson which, while it shows her own singleness of purpose, points anew the moral of how hard it is to keep even a holy work pure from all admixture of corrupting influences. Whenever the men of Sheffield shall "execute their proposed plan," Miss Nightingale will, she says, "be with them in spirit;" but she declines to lay the foundation stone, on the ground of her wish to avoid publicity. This publicity, she adds, she considers as having impeded the work on which she was engaged, "by arousing in some minds the care for worldly distinction."

THE ARCHITECTURAL MUSEUM.—The Committee entrusted with the direction of this important institution have determined that the lectures, for the

present session, should consist of an elementary course upon the contents of the museum itself. These lectures are now in the course of delivery on the evenings of every alternate Monday, by the Rev. Charles Boutell. In treating this subject, the lecturer classifies the various collections which form the museum, and associates with his direct descriptions of the casts themselves practical remarks upon the edifices from which they have severally been taken. Thus the students are at once and the same time familiarised with the true teaching both of the original works, and the facsimile casts from them, which form the museum. The remarkable conformity to a certain standard type, which distinguishes the details of each period in the progress of both the Romanesque and the Gothic is hence exemplified, and, at the same time, attention is directed to those distinctive peculiarities which impart to each great edifice its own individuality of character. Throughout these lectures Mr. Boutell urges the great importance to the architectural student of having placed within his reach the means and materials for instituting the widest comparison; and he shows that such comparison must always be understood to have reference as well to examples of the same details, as they were produced at or about the same time in various localities, as also to the successive changes which the advance of time developed in the same details; he also shows the necessity for dealing with mediæval architecture in the most comprehensive spirit, with the view to master its principles, and with the aim to apply those principles as the basis upon which to build up original architectural creations of our own.

We shall take occasion to advert more fully to these lectures, in consequence of the Art-teaching involved in them, when the course shall have been brought to a close; meanwhile we record, with much satisfaction, the recent accession to this museum of a fine collection of casts from the capitals of the triforium of the nave of NOTRE DAME, at Paris, together with a noble series of miscellaneous casts from Venice, these last being a contribution from Mr. Ruskin. This museum has now attained to the dimensions, and it also possesses such capabilities, as really constitute it a National Institution; it is greatly to be desired, consequently, that it should without delay be placed in a gallery that will admit of a suitable display of its contents; and we would add, that unquestionably ought to form a component of the great National Educational Art-Collection now in the act of being gathered together by the Government at Kensington Gore.

LIVERPOOL is somewhat late in the field with its WELLINGTON TESTIMONIAL, and at the time when it summoned the artists into competition had not quite made up its mind as to what the character of that testimonial should be, though it is more than probable that, by our day of publication, their decision as to the work to be executed will have been taken. Their advertisement is addressed to sculptors and architects; and they have asked for designs for a column and statue, or for a column alone. The sum at their disposal at the date of their invitation was £6000; and they express their own inclination as being for the combination of column and statue, if it can be properly carried out for that amount. The designs were to be accompanied by estimates of the cost,—for the column with its statue, or for the column alone,—and by a statement of the description of material to be employed;—and a premium of £50 is offered for the best design—for which sum the design is, in any case, to be the property of the Monument Committee.

ROYAL INSTITUTE OF BRITISH ARCHITECTS.—The first meeting of the present session was held on the evening of Monday, November 3rd, in the apartments of the Institute, when the chair was occupied by Professor Cockerell, R.A.; and Professor Donaldson read the first part of an elaborate paper upon the Duke of Northumberland's noble border-fortress and palace, Alnwick Castle. It had been intended that this entire essay should have been submitted to the Institute on the present occasion; but it was considered to be desirable to postpone the second division of it until the next meeting, in consequence of a highly interesting memoir of the Commandatore Canina, with which Professor Donaldson prefaced his paper upon Alnwick, and which elicited from the chairman and from Mr. Ashpitel warm expressions, as well of

personal friendship as of professional admiration for this remarkable and much-lamented artist. The Comendatore had been very recently engaged, with Professors Cockerell and Donaldson, in preparing a series of interior decorations, which it is proposed to have executed at Alnwick, under the general direction of Mr. Salvin, the architect of the restorations; and, consequently, the name of the Signor Canina would necessarily be associated with any notice of the works at Alnwick—an association which now derives a new and painful interest from his sudden decease.

A NEW MAGAZINE, entitled the *National Magazine*, has been recently commenced, under the joint editorship of Mr. Westland Marston and Mr. John Saunders—the former a gentleman of high literary repute, the latter an editor of matured experience; it is, therefore, conducted with very great ability, and is entitled to that public support which, we understand, it receives, and without which it would be impossible for a work produced at such large cost to prosper. We refer to it chiefly because it has already given evidence that Art is to be duly considered in its pages; this is wise as well as right—the subject is becoming daily more and more interesting; there are now very few who do not desire information upon the innumerable topics in connection with it; and a journal will hereafter fail in its mission if it do not treat this theme as frequently and as extensively as it treats any other. The "want" to which we refer is, indeed, of comparatively recent date, but it is a want none the less—the belief that Art is a great teacher being now universal. Each weekly part of the *National Magazine* contains an excellent engraving on wood, from some modern picture, and is also illustrated occasionally by engraved objects of Art-industry.

THE ARCHEOLOGICAL INSTITUTE.—The first monthly meeting of the session took place on Friday, November 7th, in the apartments of the Institute in Suffolk Street, the chair being occupied by J. M. Kemble, Esq. Among other objects exhibited was a series of very excellent original architectural sketches of early architectural and monumental remains, chiefly in the county of Kent, which were exhibited by Mr. Le Kenz, and are destined (with many other more important works by English artists) to be transferred to a collector in the United States. The meeting was well, though not numerously attended, and it gave promise of a session from which the cause of Art amongst us may anticipate much that is equally valuable and interesting.

PICTURE FORGERIES IN GERMANY.—The *Augsburg Gazette* some time since stated that the director of Prince Esterhazy's picture gallery, in Vienna, has been arrested on a charge of having purloined whole portfolios of very valuable engravings, and substituted inferior and worthless copies for many rare paintings. The extent of these depredations will only be made public on his trial, which, we believe, has not yet taken place. "He has only held his post a year and a half, and, as may naturally be supposed, these robberies, so cleverly imagined and so rapidly executed, have caused a great sensation in the artistic world of Austria." We have no doubt the matter has occasioned a great stir, but it is difficult to conceive how such wholesale robberies as are here referred to could be carried on without detection even in so short a space of time as a year and a half.

GARDEN FOUNTAINS.—We have seen in progress, and near completion, in the studio of Mr. Raymond Smith, in the New Road, a design for a garden-fountain of considerable size. We feel much pleasure in calling attention to any progress in these designs, as anything were better than the style of those in Trafalgar Square. In the present instance the design is supplied by the myth of St. George and the dragon; that version of the legend which represents St. George as having rescued from the dragon, by the slaughter of the latter, a maiden who was bound to a rock to be devoured by him. The groupment consists, therefore, of the paladin, the lady, and the dragon, the last raising its head in the agonies of death, and it from its upraised mouth that a large column of water is projected. The work is executed in Portland stone, and we doubt not will have a good effect if advantageously situated.

REVIEWS.

ART AND NATURE AT HOME AND ABROAD. By G. W. THORNBURY, Author of "The Monarchs of the Main," "Shakspeare's England," &c. &c. 2 vols. Published by HURST & BLACKETT, London.

Were it our good fortune to lead a "vagrant's life" for two or three months, when we could wander hither and thither as we listed in nooks and corners of old England, on pavements worn and dingy with weary foot-treads, by broad rivers, under venerable towers, up majestic mountains, or through dim forests, we should desire no more amusing and intelligent companion than Mr. Thornbury; there would be sunshine in the heart wheresoever we were, and with whatever sky above us. Since the first appearance of Geoffrey Crayon's "Sketch-Book," we have seen no such lively and entertaining pictures as these—pictures, moreover, of truth and life, sketched now in London, now in some ancient English mansion, in the company of beggars, in the studio of the old Dutch painter, amidst the ruins of old Rome, on the back of the Andalusian mule—everywhere, in fact, where he could pick up an idea worthy of being worked into a subject. He knows, too, a great art in a painter,—how to adapt his treatment to his subject; his "drawing" is good; his lights and shadows are effectively distributed; his colouring is brilliant or chastened, as the case demands, and "put in" with delicacy or vigour, as either quality seems essential to the specific object on his canvas. But to drop the phraseology of the studio, which the title of the book suggests, Mr. Thornbury gives his impression of people and places with the eye of a shrewd observer, and a power of description as amusing as it is true and graphic; his volumes, we doubt not, will light up many countenances, both of old and young, during the dreary months of winter: the stories are precisely the readings for a fireside party.

A curious Hibernicism, however, attracted our attention at the end of the chapter on "Old English Mansions and Housekeepers' Stories," where, in speaking of the love of the place of one's birth, he thus writes:—"But despite not, O Radical, the man who loves a birth-spot, where he emerged from eternity—where he saw his mother die—where he was first glorified by even a dearer love than that of a mother's—where he first heard a child call him father—where he hoped, sighed, prayed, wept, and fought—where he ran and walked, thought and wrote, married and—was buried!" We point out the error—in the consideration of a living man's feelings—that Mr. Thornbury may correct it in the next edition of his book, which, we presume, will not be long unaltered for.

PHOTOGRAPHIC ART-TREASURES. PART I. CHARTRÉS CATHEDRAL; THE VENUS DE MILOS. Engraved by the METROPOLITAN PHOTOGRAPHIC PROCESS; and published by the COMPANY, Holloway Place, Islington.

If our readers will take the trouble to refer back to the July number of the *Art-Journal* for the present year, they will find a full description, by Mr. Robert Hunt, of the process by which these prints are produced; it is, therefore, unnecessary for us to do more than express our opinion of the earliest works issued by the Company, and which are enumerated above.

The PHOTOGRAPHIC ART-TREASURES contains four subjects, engraved from photographs taken by Mr. ROBERT FENTON, one of the founders of the Photographic Society, and, prior to his departure for the East at the outbreak of the Russian war, its honorary secretary. The first of the four plates is a view of the street called "Lendall," in York, terminating with the Minster, whose towers rise majestically above the houses, with all their architectural details softened down—indeed, almost obliterated—by the intervening atmosphere. The houses, especially those on which the light falls, are wonderfully truthful—every line and brick marked with extraordinary precision and delicacy; but it is not difficult to perceive where the tool of the graver has aided the effect of the camera. Plate 2, "Cedars, Monmouthshire," is exquisitely beautiful, and forms a study for any "tree-painter." So also is Plate 3, the "Water-gate, Raglan Castle," where the light seems to play in very wantonness with the shadows cast by the foliage on the quiet water; and how charmingly rendered is that little passage in the distance, where the palings are seen between the overhanging trees and the "husby" bank. The picture, as a whole, is, however, spoiled by the stiff unpicturesque branch stretching along the upper parts, and concealing the tops of the distant trees: Mr. Fenton should, if possible, have had it

cut down before he took the photograph. Plate 4, the "Porch of Raglan Castle," is, perhaps, the most striking picture in the series, the broad masses of light and shade rendering it most effective; while the interest of the subject is greatly heightened by the judicious introduction of some figures which give it both light and life. We detect less of the engraver's work in this plate than in the others.

The doorway of "Chartres Cathedral" is a large print, about eighteen inches by fourteen; in it we find all the architectural details and the sculptured figures copied with the most scrupulous exactness: here the hand of the engraver is very manifest upon those portions of the building and ground which catch the light. The upper portion of the arched porch does not recede sufficiently, owing to the shadow being of an uniform tint, of a depth approaching to blackness. We know not whether this could be remedied in future impressions; but it would be advisable to attempt it, as the shadow obtrudes offensively on the eye, to the injury of the other parts of the edifice.

The "Venus" comes out very fully: this is untouched by the graver, so that the effects which age and time have given to the marble are accurately preserved. The figure has been placed in an excellent position for bringing out the beauties of form and treatment for which it is so renowned.

The impression we derive from the examination of these works is, on the whole, highly favourable to the process by which they have been executed. The invention of Mr. Paul Pretsch, of Vienna, the patentee, is a wonderful stride in the Photographic Art; but we have no apprehension that, under any circumstances, it will supersede the labours of the engraver. Nature, to be pictorially represented, always requires some assistance from Art, and must come under the laws which regulate the latter.

SCENERY OF THE ENGLISH LAKES. Photographed and published by Messrs. DOLAMORE & BULLOCK, London.

Such is the increase of photographic artists, and such their activity, that we must now expect to have our "review columns" frequently occupied with reporting their progress and productions. We have before us five large views published by Messrs. Dolamore and Bullock, an "Art-firm" whose names are new to us; the scenes are taken from that picturesque locality, the English lakes. "On the Rothay, Rydal," the first of the series we open upon, is a rich composition of mountain, tree, and stream; the whole so disposed for picturesque effect that any introduction of the painter's fancy would seem an intrusion—except a little toning down of the high lights on the lower branches of the group of trees on the right hand. "The Lower Fall, Rydal," is not successful; it is everywhere too dark—and photography cannot produce the effect of motion in water, consequently the "Fall"—a conspicuous object in the view—is a mass of graduated colour, and nothing more. "On the Stock, Ambleside," shows an old water-mill, from which the full stream is rushing down and winding its way amid masses of stone covered with weeds and lichen; portions of this scene "come" very truthfully as to detail, but the trees in the upper part are massed and heavy in their foliage, and imperfect in their forms. "An Old Mill, Ambleside," is remarkable for its perfect repose: the lower half of the picture represents a deep pool of still water, reflecting in it every object on the banks with far greater depth of colour than the objects themselves, and producing thereby a most singular effect. "Rydal Water,"—the distance is beautifully represented, and would serve an artist to paint from; but the foreground is intensely heavy, so much so as to obscure all detail. The best of the series is "Lynth's Tower, Ulleswater;" this leaves us nothing, or little, to desire more: the grey masses of stone, the dark ivy, the old yew-tree, the herbage on the ground, are vividly and distinctly pictured. Interesting as the whole of these photographs are, they are certainly unequal to many we have seen; but it is possible they may have been taken under unfavourable circumstances.

PHOTOGRAPHIC MEMORANDA. PART I. BY HENRY TAYLOR. Published by HENRY HEING, London; HENRY TAYLOR, Goldsmith, Surrey.

Another book of Photographic Art, but of rather less ambitious pretensions than those we have just noticed. Mr. Taylor has not visited the time-honoured cathedral, rib with the work of architect and sculptor, nor the vast outspreadings of the landscape, which the eye of man sometimes can scarcely take in: he has sat himself down in the shady dingle, beneath the way-side hedge, or in the angle of a cornfield, where the summer breeze plays with the yellow stalks and bright brown ears of ripening

grain; and what a world of beauty is there not manifested in things which Nature has almost concealed from our observation, unless we look for them! We know not how his PHOTOGRAPHIC MEMORANDA may impress others, but they afford us infinitely greater pleasure than we derive from scenes generally considered of a higher order of subject-matter. How full of varied forms, and delicate markings, and graceful arrangement,—by the hand of Nature, however, not that of the artist,—is that group of fern-leaves, mingled with other wild plants as varied and as beautiful as themselves! Then comes a mass of wild hops, trailing and twisting over and around dead briars and brambles, and hedge-poles, working their way through every apparent obstacle, and filling up each crevice left in the rustic boundary wall so closely, that even a field-mouse would find some difficulty in penetrating it. A magnificent group of "burdock," fluted by nettles, and associated with a legion of the wild tribes that usually bear it company, is the subject of the next plate, and exquisitely beautiful it is. Let our ornamental designers look at it, for here is a lesson all the Schools of Practical Art in the country will never teach them, and from which the most skillful draughtsman could never imitate in all their wonderful variety of detail, however nearly he might approach them. The last plate is a "Corner of a Wheat-field," backed by a hedge of weeds and wild plants; the stalks of the wheat, bent and broken at the extremity of the "rows," apparently by the hands and feet of those who have made a highway of the farmer's land, plucking the ears of corn as they pass. Nothing can exceed the delicacy and clearness with which these natural objects are represented. Mr. Taylor's photographs are among the best, as they are the most interesting, we have seen.

THE RIME OF THE ANCIENT MARINER. By S. T. COLERIDGE. Illustrated. Published by S. Low, Son, & Co., London.

Coleridge's singular "Rime" is here richly dressed up in blue and gold—not inappropriate uniform for an "Ancient Mariner" to make a public appearance in; but, internally, the veteran has not been so well attended to: the fault of this, however, is not altogether that of the artists to whom the "fittings" were intrusted. The poem does not contain a sufficient variety of subject-matter to diversify the illustrations, so as to make them, as a whole, acceptable. It suggests little else than a number of marine pictures, and a few figure-subjects—the latter more quaint and fanciful than agreeable. Messrs. B. Foster and E. Duncan have contributed several pretty examples of the former; and Mr. Wehnert, we doubt not, has done his best with the strange materials he had to work from; but the volume will not take its place with the many illustrated books that greet us at this season of the year.

LIFE IN ANCIENT INDIA. By MRS. SPIER. With a Map and Illustrations, drawn on wood by G. SCHARK, Junr., F.S.A. Published by SMITH, ELDER, & Co., London; SMITH, TAYLOR, & Co., Bombay.

The dominion of England over the vast territory of India is one of those marvellous records in the history of nations that almost defies the calculations of reason. Great conquerors have seized upon countries, and retained them for a time in their grasp, by the terror of their names and the magnitude of the armies that were employed to hold them in subjection; powerful monarchs have added neighbouring yet weaker states to their own lawful possessions; but that a company of merchants, living in a far distant island, should have been able to aggrandize to themselves, and extend their influence over, immense territories, teeming with wealth and population—holding them too chiefly by means of armies gathered from among that population—is, so to speak, a political enigma, the solution of which is difficult to explain. There is, moreover, another fact connected with our rule in India, almost as extraordinary as our hold of the country:—that, deeply interested as we are at home in our Eastern possessions, numerous as are the families throughout Great Britain who have relatives and friends resident therein, we yet know comparatively little of the history of the country, past or present, or of its social condition now or in former times. Mrs. Spier's volume supplies much valuable information on the early social, moral, and religious character of the natives of British India. After an introduction descriptive of the natural features of the country, and of the characteristics of the people,

the author divides her subject into three divisions:—the first describes it previously to the time of Alexander the Great; the second book treats of Buddhism—a "religion which bears an external perverted kind of resemblance to Christianity, giving a peculiar interest to the circumstances under which it was developed;" the third book returns to Brahmanism, giving a notice of "the poems, dramas, and *puranas*—beautiful, absurd, fanciful—which were produced subsequent to the era of Alexander." This brings the history down to the time when the Mohammedans began their conquests in the country, at which period Mrs. Spier closes her narrative, after a short inquiry as to the success which attended Brahminical regulations and Buddhist theories. It is a strange, romantic story, but no less interesting than it is strange; truth and fable seem to be so interwoven in it as to have become inseparable; while the poetical quotations now sparkle with the brilliancy of India's own native gems, and now are fragrant with the perfume of her flowers. Mr. Schark's illustrations, gathered from authentic sources, are useful addenda to the writer's descriptions of places and objects.

MEMOIRALS OF JAMES WATT. By GEORGE WILKINSON, Esq. Printed for the Watt Club, by THOMAS CONSTABLE, Edinburgh.

What the lives of Alexander, Cosar, Marlborough, Wellington, Napoleon, and other great warriors are to the student of military history, those of Davy, Watt, and a host more of a similar order, will prove to such as delight in the records of men whose names are famous in the arts of peace;—biographies that will serve as incentives to urge on the young mind along the highway of scientific pursuit; examples enforcing the principles and practice of industry, thoughtful labour, and diligent research. This memoir of the greatest mechanician of the age will be read with interest and avidity by congenial minds. We see the lad in the midst of the benches of his father's workshops, at Greenock, busy with chisels and tools, "ardent in the construction of model-works and machines;" we follow him to Glasgow, settled in that city as a mathematical instrument-maker, where his work-room became "a little University;"—"a kind of Academy," as M. Arago remarks, "whither all the notabilities of Glasgow repaired to discuss the nicest questions in Art, Literature, and Science." "Those," says his biographer, "were the hours of the young artist's most serious and most varied study, all-essential, doubtless, to the future of the great inventor. But—though standing, apparently, as it were on the very threshold of that after-fame—the die of the youth's life is not yet finally cast." We must refer our readers to the volume itself, if they desire to become acquainted with the circumstances of Watt's subsequent career and triumph: his genius is inscribed in the chronicles of his country, while the stupendous results of his labours have contributed to enrich her, and benefit the whole world: the STEAM-ENGINE has proved the mighty lever which has changed the whole surface of the earth and her inhabitants.

THE FIVE GATEWAYS OF KNOWLEDGE. By GEORGE WILSON, M.D., F.R.S.E. MACMILLAN & Co., Cambridge.

We have frequently, now-a-days, little quaint volumes bearing on the present taste, not only of mediæval ornament, but mediæval thought—picturesque modes of treating material things, adding beauty to reality—the illumination of the missal. Our readers will readily understand that "The Five Gateways of Knowledge," are the five senses; and we assure them that their operation and influence have been treated by Dr. Wilson so as to create and satisfy inquiry; this precious little volume should find a resting-place on every public and private table in the realm.

MARIAN FALCONER; OR, STARS IN DARKNESS. By E. H. W. BINNS & GOODWIN, Bath.

MARIAN FALCONER cannot be considered a book for the young, though it abounds in youthful characters. The author is peculiarly happy in delineating the thoughts and feelings of youth, and yet has abundant strength to wrestle with the passions and struggles of more matured existences. The story would be more effective if it were "closed in;" the machinery is too large and elaborate; the characters too numerous; the author crowds her canvas, and this readers what would be valuable

and clear in two pages, tedious and confused in four. The popularity of the "Wide, wide World" has in a great degree rendered this overcrowding fashionable; but it is no less a fault, and becomes dangerous to authors who, like E. H. W., are gifted with a sort of miniature-painting power in the delineation of character. There are ample materials in MARIAN FALCONER for three or four tales; but it creates a vivid interest for its principal characters, and we can recommend it as a pure and earnest book, faithful to its purpose.

THE ROYAL CRYSTAL PALACE ALMANAC FOR 1857. Published by ARTHUR HALL, VINTAGE, & Co., London.

This is the first of the Almanacs for the forthcoming new year which has reached us, and we greatly mistake the taste of the public if it does not become the first in their good opinion; for it is ornamented with very beautiful designs emblematical of the twelve months of the year, and of the four seasons—the same designs that attracted so much attention in our pages four or five years since, and which, being now collected, and following each other in consecutive pages, instead of being scattered as they were when formerly published, derive new charms from their mutual association. The letter-press affords the usual amount of information one naturally looks for in an almanac, besides an ample notice of the Crystal Palace and its contents, sufficient to justify the title given to the almanac by the publishers; while, as a frontispiece to the book, is an elegant engraving from a piece of sculpture. This is, in the true sense of the term, an Art-almanac, and a marvellously cheap shilling's worth of Art too.

ON THE SECURITY AND MANUFACTURE OF BANK-NOTES. By HENRY BRADBURY, M.R.I. Published by BRADBURY & EVANS.

In a great commercial country like our own the genuineness of the circulating medium is a matter of the highest importance. Mr. Henry Bradbury, having turned his attention to the subject, recently delivered a lecture at the British Institution upon that portion of it which refers to the manufacture of bank-notes, and has printed and published the lecture, with engraved specimens of notes he would substitute for those now in use. The subject is well handled; and his specimens are certainly beautiful in design, and admirable examples of engraving and printing. He tells us, from the best authorities, that the forgery of bank-notes is greatly on the increase. We should think it almost impossible to copy these without detection, even with all the aids which science, in the form of photography and the Auastatic process, might offer to the forger.

OUTLINES OF ENGLISH HISTORY. By HENRY INCE, M.A.—OUTLINES OF DESCRIPTIVE GEOGRAPHY. By PROFESSOR WALLACE. Published by J. GILBERT, London.

Two well-digested and comprehensive little books, each containing a large sum of information crowded into a small space: they are modestly called "Outlines," but there is enough filling in of the sketch to render the outlines really valuable in the work of education. The English history has so far met with the approval of the Educational branch of the Society of Arts as to be adopted by it in the examination of the prize students.

THE STUDIO OF RAUCH.—HUMBOLDT IN HIS LIBRARY. Published by A. SCHLOSS, 10, Portman Street, London.

A pair of German coloured lithographs, the subjects of which are explained in their titles. The great sculptor is surrounded by the models of his principal work; the "travelled" philosopher is writing in the midst of his books and maps. The portrait of each is good; and the accessories of the pictures carefully drawn, and artistically grouped.

POETICAL TENTATIVES. By LYNN ERITH. Published by SAUNDERS & UTLEY, London.

This little book contains a goodly gathering of sweet and pleasant thoughts, far removed beyond the commonplace fancies that pervade most of the fugitive poetry of the day; and the thoughts are musically and melodiously expressed. Lynn Erith—a *non de plume*, we suppose—has an ear for harmonious sounds, and a heart susceptible of gentle musings. He has not mistaken the gifts nature has bestowed upon him, nor does he misapply them.

FINIS.

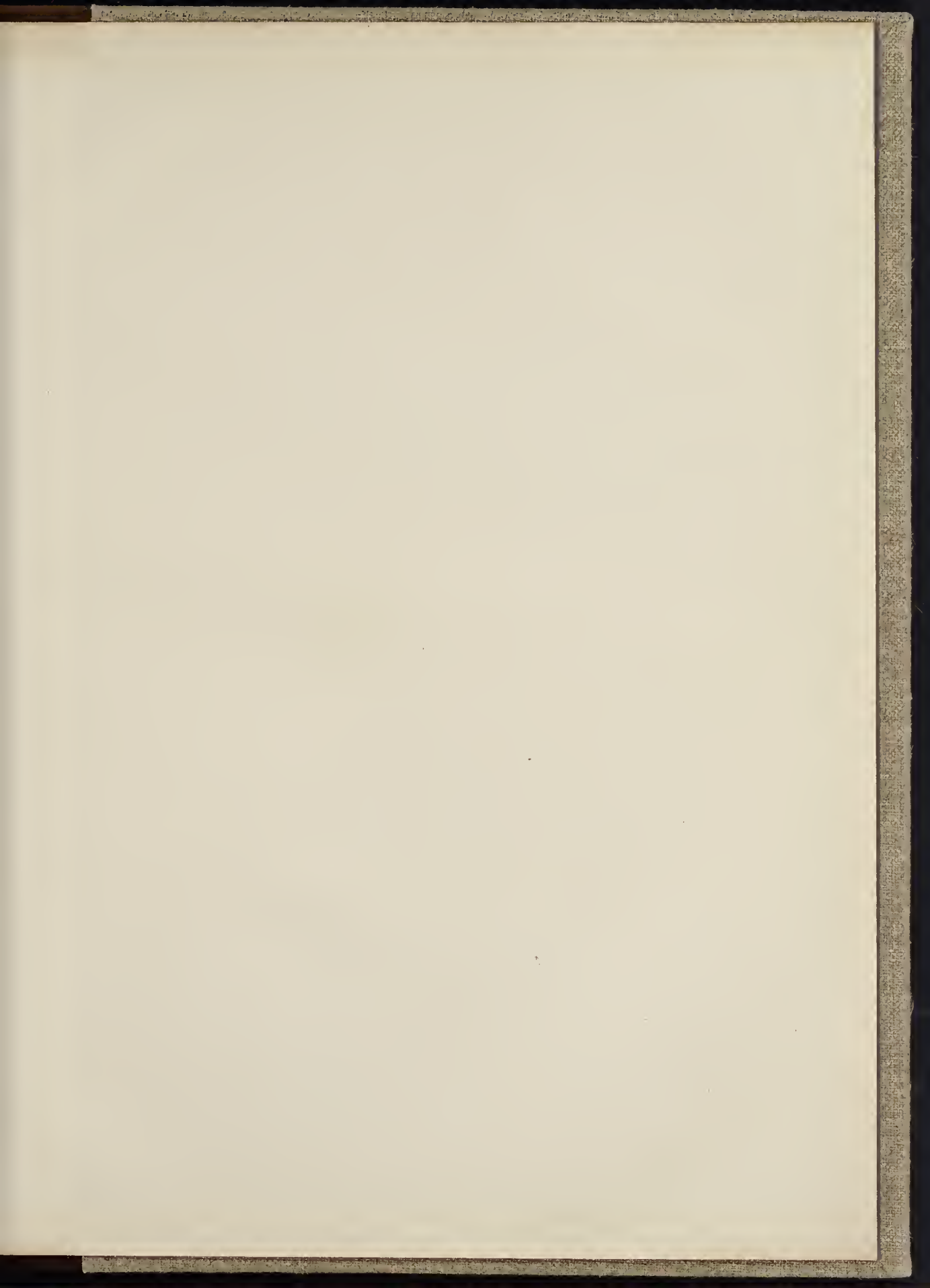

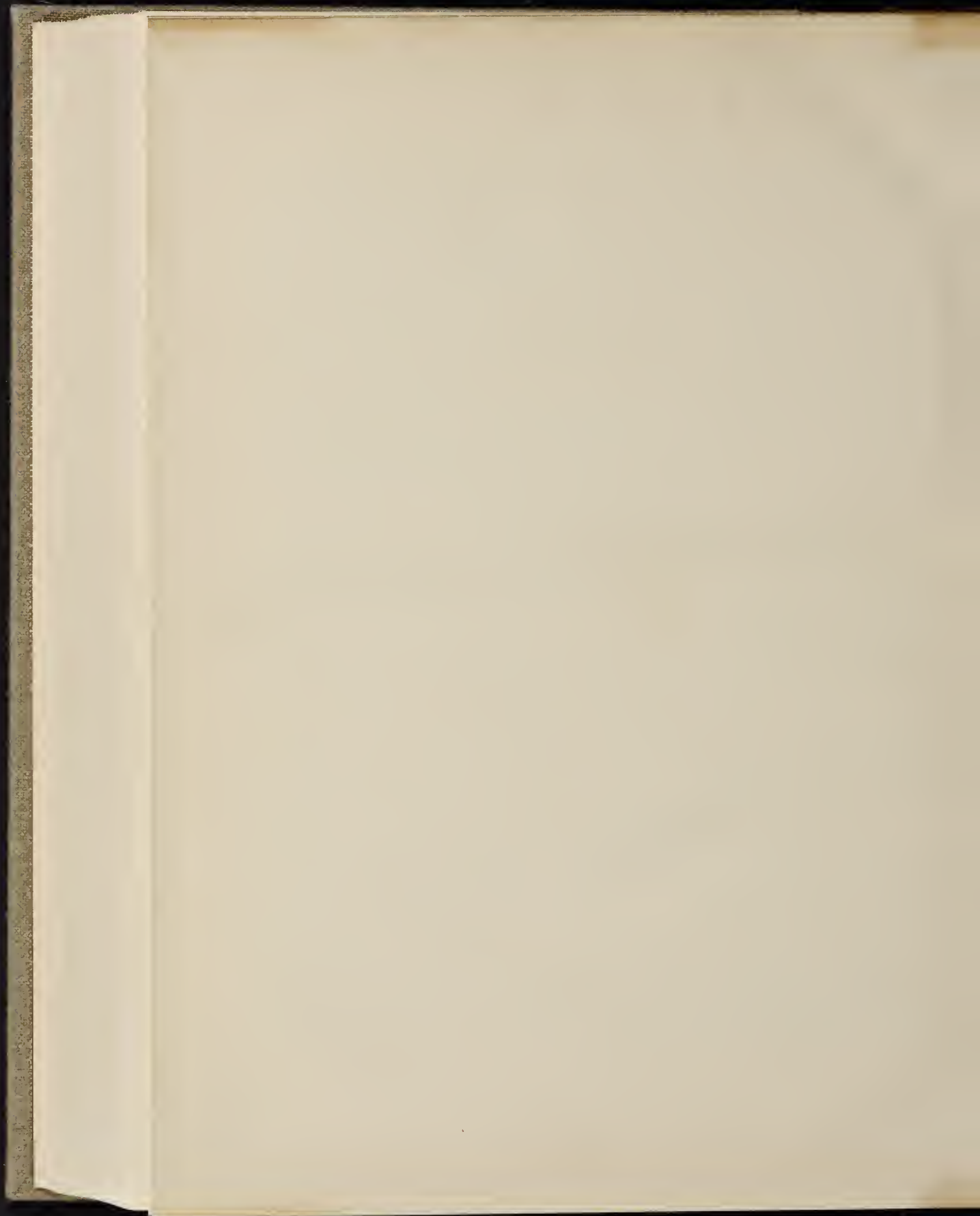

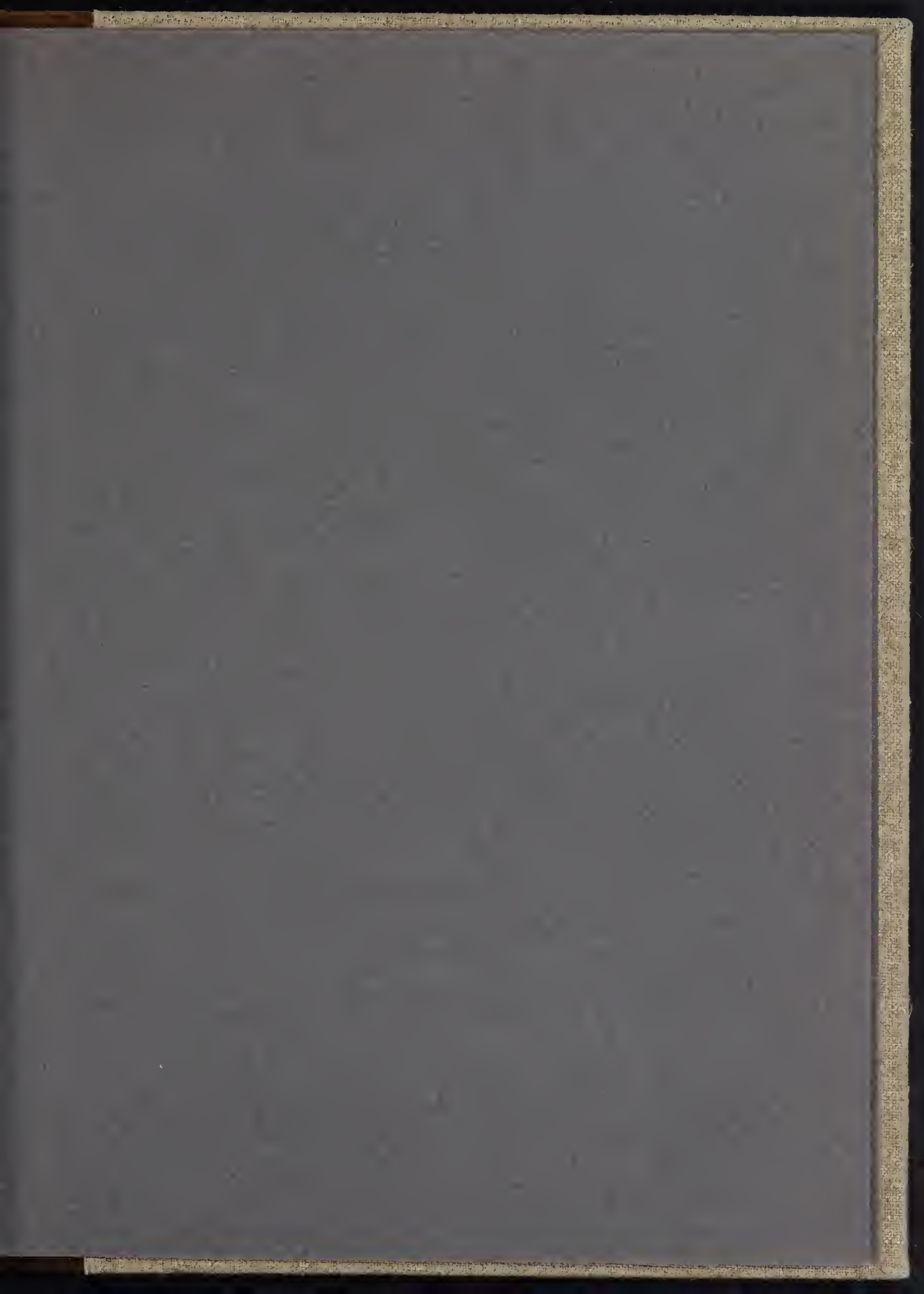



GETTY CENTER LIBRARY



3 3125 00618 7328

