

Vol. XXXV

No. 138

UC-NRLF



\$B 70 624

PORT

OF THE

**Kansas State Board of Agriculture**

FOR THE

Quarter Ending June, 1916

**ALFALFA IN KANSAS**

Published Quarterly by the  
KANSAS STATE BOARD OF AGRICULTURE

J. C. MOHLER, Secretary

TOPEKA, KANSAS

6-3601

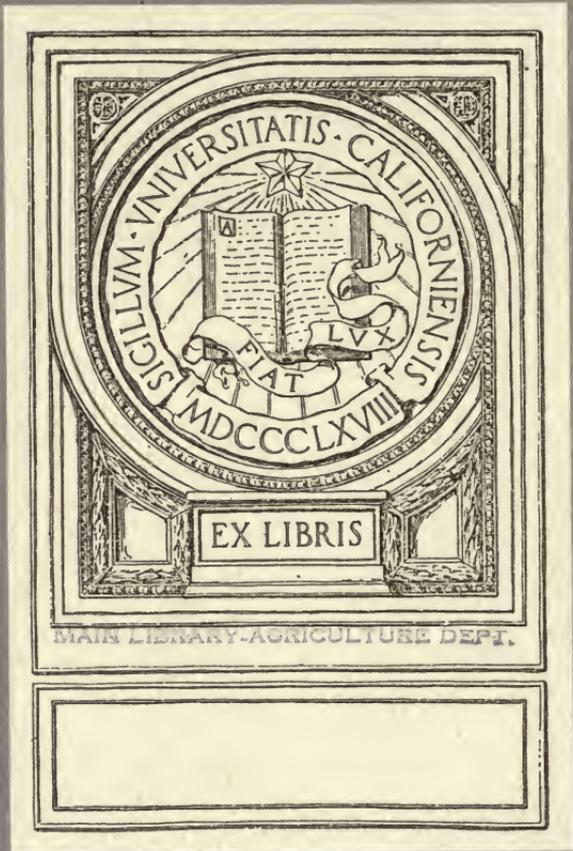

UNIVERSITATIS · CALIFORNIENSIS  
SIGILLVM ·  
FIAT UNUM  
MDCCCLXVIII

EX LIBRIS

MAIN LIBRARY-AGRICULTURE DEPT.

Doyle, H. W.

# REPORT

OF THE

## Kansas State Board of Agriculture

FOR THE

Quarter Ending June, 1916

---

### ALFALFA IN KANSAS

---

*J. C. MOHLER, Secretary,*  
TOPEKA, KANSAS

---

KANSAS STATE PRINTING PLANT.  
W. R. SMITH, State Printer.  
TOPEKA. 1916.  
6-3601

SB 205  
A4D6

# KANSAS STATE BOARD OF AGRICULTURE, 1916.

## MEMBERS.

ARTHUR CAPPER, Governor,	} <i>Ex officio</i> , Topeka.	
J. T. BOTKIN, Secretary of State,		
I. L. DIESEM, . . . . .	<i>Garden City</i> , . . . . .	Finney county.
CHAS. E. SUTTON, . . . . .	<i>Lawrence</i> , . . . . .	Douglas county.
O. O. WOLF, . . . . .	<i>Ottawa</i> , . . . . .	Franklin county.
H. W. AVERY, . . . . .	<i>Wakefield</i> , . . . . .	Clay county.
H. S. THOMPSON, . . . . .	<i>Sylvia</i> , . . . . .	Reno county.
THOS. M. POTTER, . . . . .	<i>Peabody</i> , . . . . .	Marion county.
T. A. HUBBARD, . . . . .	<i>Wellington</i> , . . . . .	Sumner county.
E. L. BARRIER, . . . . .	<i>Eureka</i> , . . . . .	Greenwood county.
H. M. LAING, . . . . .	<i>Russell</i> , . . . . .	Russell county.
E. E. FRIZELL, . . . . .	<i>Larned</i> , . . . . .	Pawnee county.

5/6/22

## OFFICERS.

PRESIDENT, . . . . .	J. T. TREDWAY, . . . . .	La Harpe.
VICE PRESIDENT, . . . . .	R. B. WARD, . . . . .	Belleville.
TREASURER, . . . . .	A. W. SMITH, . . . . .	McPherson.
SECRETARY, . . . . .	J. C. MOHLER, . . . . .	Topeka.

## OFFICERS BY APPOINTMENT.

BOTANISTS, . . . . .	{	PROF. H. F. ROBERTS, . . . . .	Manhattan.
		PROF. L. E. SAYRE, . . . . .	Lawrence.
CHEMISTS, . . . . .	{	PROF. J. T. WILLARD, . . . . .	Manhattan.
		PROF. J. T. LOVEWELL, . . . . .	Topeka.
ENTOMOLOGISTS, . . . . .	{	PROF. E. H. S. BAILEY, . . . . .	Lawrence.
		PROF. GEO. A. DEAN, . . . . .	Manhattan.
VETERINARIANS, . . . . .	{	PROF. S. J. HUNTER, . . . . .	Lawrence.
		DR. O. O. WOLF, . . . . .	Ottawa.
		DR. C. J. SIHLER, . . . . .	Kansas City.
GEOLOGIST, . . . . .	{	DR. F. S. SCHOENLEBER, . . . . .	Manhattan.
		DR. W. R. BARNARD, . . . . .	Belleville.
METEOROLOGIST, . . . . .		PROF. ERASMUS HAWORTH, . . . . .	Lawrence.
		T. B. JENNINGS, . . . . .	Topeka.

(Observer U. S. Weather Bureau.)

## PREFACE.

---

**N**OWHERE are conditions more favorable to the profitable production of alfalfa than in Kansas. The rise in importance of this legume is one of the wonders of our agriculture. Its advent was epochal in the state's history. That it has contributed handsomely to the present-day affluence of the Kansas farmer can not be gainsaid; that it will be more largely depended upon in the future is certain. Appreciating the advantages of alfalfa, the husbandmen of Kansas confidently look forward to broader expansion in the possibilities of our agriculture, to increased per capita wealth and enhanced land values, to better homes and greater comforts.

While the plant is now held in universal esteem, the fact is recalled that during the first years of its introduction there was much diversity of opinion as to the real value of alfalfa. New and strange to our agriculture, its entrance to Kansas quite naturally was not met with a spontaneous and unanimous welcome. It had, to be sure, its staunch advocates, but there were many who deemed it of doubtful worth and by some it was promptly rejected. So late as 1887 one of the correspondents of the State Board of Agriculture, a keenly observant farmer-scientist of Rooks county, wrote:

"It is a plant having many warm friends and also a squad of bitter enemies. I have read much in favor of it, and much condemning it in the severest terms."

Some persons believed alfalfa to be poisonous, doubtless because of the tendency to bloat ruminants when they were allowed to graze on it at will, and many reports were to the effect that stock refused to eat it. An example of the latter is given by a pioneer settler of Geary county, now living in Shawnee, who wrote:

"My neighbor in Geary county, along in the early seventies, tried alfalfa. The seed was sown on sandy soil and grew vigorously. When it had attained a height of about sixteen inches an armful was cut for the horses, but they would n't even taste it. The grower concluded, therefore, that it was a noxious weed."

Because of diverse opinions and experiences such as these the progress of alfalfa was slow in the years immediately following its introduction. Skepticism, however, was banished and mistaken beliefs rectified as the merits of the plant became better known through more extensive and intimate acquaintance. Those who early recognized its value persistently urged its growing, and their estimates of its worth have been more than justified by subsequent events.

A careful search of the records discloses that alfalfa was first mentioned in the reports of the State Board of Agriculture in 1877, when Alfred Gray was the Board's secretary. He observed that:

"In the West—in fact, throughout Kansas—alfalfa promises to be eminently successful. Especially in the West, where rainfall is variable

to some extent, and less than in the East, its determined fibrous roots descend to a great depth and it flourishes beyond all expectation."

In subsequent reports alfalfa was referred to now and then, but it appears that it was not until 1882 that the Board's real campaign for alfalfa in Kansas was systematically begun. In its report of that year, E. M. Shelton, of the Kansas Agricultural College, advocated the sowing of alfalfa, and gave directions believed to be best calculated for success. Among other things he wrote:

"Alfalfa is a forage plant that well deserves the attention of Kansas farmers. Wherever a soil of good sandy texture is found alfalfa will prove of incalculable benefit."

In the report of 1883 Professor Shelton was somewhat more emphatic; thus, in part:

"In regard to the value of alfalfa for Kansas, we have no hesitation in saying that, all things considered, it is the most valuable clover, especially for the western and southwestern sections of the state. In the southwestern portion, along the Arkansas river, where irrigation is practiced, it has proved a most invaluable forage plant."

To Secretary Martin Mohler belongs the credit of first according to alfalfa a place in the Board's statistical reports, which he did in 1891. In that first census the county of Finney, in the Arkansas river valley and only two counties removed from the Colorado line, had more than twice the alfalfa acreage of any other county, and more than one-fifth of the total for the state; while its neighbors, Gray on the east and Kearny on the west, were also among the leaders at that time. It is in this, the southwestern portion of the state, that alfalfa made greatest headway in the earlier years.

From 1891 to the present time yearly records have been carefully compiled with respect to the state's alfalfa acreage by counties. These annual inventories constitute a most interesting exhibit in Kansas history, and reveal alfalfa's wonderful growth in popularity—from 34,000 acres in 1891 to 1,360,000 acres in 1915, with few exceptions showing each year a steady and regular gain.

The table below gives the total alfalfa acreage in Kansas for each year since the beginning of the crop's statistical record:

Year.	Acres.	Year.	Acres.	Year.	Acres.
1891.....	34,384	1900.....	276,008	1908.....	878,283
1892.....	62,583	1901.....	319,142	1909.....	993,539
1893.....	75,200	1902.....	458,493	1910.....	926,492
1894.....	90,825	1903.....	566,592	1911.....	976,094
1895.....	139,878	1904.....	557,569	1912.....	1,000,785
1896.....	155,949	1905.....	602,560	1913.....	1,026,299
1897.....	171,334	1906.....	614,813	1914.....	1,193,641
1898.....	231,548	1907.....	743,050	1915.....	1,359,498
1899.....	278,477				

## Alfalfa in Kansas.

The following table shows the Kansas alfalfa acreage by counties, in 1891 and 1915:

COUNTY.	Acres.		COUNTY.	Acres.	
	1891.	1915.		1891.	1915.
Allen	7	8,239	Linn	2	6,890
Anderson	7	9,793	Logan	28	4,947
Atchison		7,348	Lyon	1,098	39,558
Barber	694	9,580	Marion	851	27,936
Barton	394	7,494	Marshall	135	25,303
Bourbon	6	11,482	McPherson	980	21,973
Brown	33	15,887	Meade	240	9,593
Butler	503	50,005	Miami		7,845
Chase	1,401	24,056	Mitchell	880	20,231
Chautauqua	323	16,179	Montgomery	29	15,038
Cherokee	1	1,335	Morris	120	23,960
Cheyenne	321	2,540	Morton	5	60
Clark	437	2,937	Nemaha	31	24,265
Clay	53	17,593	Neosho	10	9,231
Cloud	2,018	22,338	Ness	6	4,716
Coffey	87	17,632	Norton	442	6,850
Comanche	118	3,789	Osage	20	27,216
Cowley	416	42,798	Osborne	379	16,949
Crawford	6	2,119	Ottawa	756	12,186
Decatur	160	4,489	Pawnee	210	6,443
Dickinson	703	29,610	Phillips	111	16,258
Doniphan	2	11,709	Pottawatomie	334	28,981
Douglas	12	15,221	Pratt	50	3,184
Edwards	217	2,537	Rawlins	185	6,956
Elk	54	22,489	Reno	654	19,042
Ellis	66	2,411	Republic	496	34,840
Ellsworth	110	7,752	Rice	635	16,636
Finney	5,717	13,923	Riley	136	22,741
Ford	733	6,267	Rooks	65	8,231
Franklin	4	13,830	Rush	15	3,072
Garfield*	68		Russell	203	5,474
Geary	167	9,237	Saline	1,099	19,950
Gove	12	1,808	Scott	20	1,426
Graham	57	3,463	Sedgwick	1,023	40,734
Grant	27	270	Seward	14	
Gray	1,062	860	Shawnee	63	22,735
Greeley	31	240	Sheridan	35	3,590
Greenwood	421	31,859	Sherman	174	2,799
Hamilton	733	4,303	Smith	53	36,754
Harper	160	13,040	Stafford	123	6,575
Harvey	282	18,210	Stanton	3	95
Haskell	4	1	Stevens	51	
Hodgeman	38	1,146	Sumner	383	28,309
Jackson	59	14,236	Thomas	77	551
Jefferson	6	15,555	Trego	21	1,517
Jewell	296	50,196	Wabaunsee	1,031	25,908
Johnson		6,460	Wallace	73	5,092
Kearny	2,188	7,633	Washington	206	34,743
Kingman	59	6,902	Wichita	30	934
Kiowa	33	760	Wilson	34	22,944
Labette	10	9,828	Woodson	74	6,595
Lane	30	1,734	Wyandotte	101	2,575
Leavenworth	8	8,092			
Lincoln	131	9,352			
			The State	34,384	1,359,498

\* Garfield county became a part of Finney county in 1893.

As illustrative of the effect the introduction of alfalfa had on our agriculture, it may be cited that before its advent tame-hay plants were limited practically to the counties of the eastern third of the state. At that time Jewell, a north-central county, for example, had no tame hay; to-day Jewell is the leading tame-hay county, with more than fifty thousand acres of alfalfa alone. Other counties of the central and western portions have shown decided increases in their tame-hay acreages, as have the counties in the eastern part, for even where the clovers prosper the areas in alfalfa have been greatly widened. In 1891, alfalfa's statistical birth year, the state's hay yield, mostly clover and timothy, was about 700,000 tons, worth \$3,500,000; while in 1915 it was 5,000,000 tons, worth \$32,000,000, of which approximately \$28,500,000 represented alfalfa. In this time, also, the annual value of the products of live stock more than doubled, an increase which is largely attributed to alfalfa. In fact, alfalfa has grown in importance until its acreage is exceeded by only three cultivated crops, namely, wheat, corn, and oats, and the margin of oats is scant. Alfalfa has been a potent factor in the development and prosperity of Kansas' farming industry, and as a tame-hay plant it stands supreme in longevity, yields, feeding value, soil building and economy, and in adaptability to wide variations of soils and climate.

At the Kansas City hay market, preëminently the market of Kansas hay, alfalfa was a stranger until 1898, and the first quotations there were \$6 to \$6.50 a ton, or about the same as prairie hay, and with little demand. It was not, however, long available at such prices, because feeders, especially dairymen, outside the principal alfalfa-growing territory, were quick to recognize its merits, until in 1900, two years later, "choice" alfalfa reached the \$10 mark, and since then it has sold above that, all the way up to \$25 or more. Notwithstanding annual receipts of alfalfa at Kansas City have quadrupled in the past ten years prices have steadily held high.

No other state has so large an area devoted to alfalfa as Kansas. The following diagram, based on the United States census of 1910, which affords the latest available comparable figures, showing the six leading states in alfalfa acreage, strikingly portrays the state's enviable position with respect to alfalfa growing:

	ACRES.
KANSAS.	956,962
NEBRASKA.	685,282
COLORADO.	508,892
CALIFORNIA.	484,134
IDAHO.	308,892
UTAH.	284,183

Since 1910 there have been substantial gains—the result of the husbandmen's constantly growing appreciation for this premier farm forage crop and valued fertilizer.

From this long-continued and extensive experience with alfalfa in Kansas a vast fund of knowledge with respect to its successful management has accumulated. To make accessible, in a compact and readily understandable form, the essence of such knowledge is the purpose of this report. The book is distinctly a Kansas book, primarily for Kansans, and is the result of experience and experiments by Kansas men, under Kansas conditions, in the field, the feed lot and the laboratory. It has been the endeavor to combine, as a whole, the views and ideas of both the scientific specialist and the practical farmer. The growers themselves, in replying to the questionnaire that was sent them, have been heavy contributors to this work. Their replies, which have been painstakingly analyzed, digested and summarized, represent essentially the point of view of the farmer himself; while the excellent articles by experts represent more especially the scientific point of view. The volume is presented with the sincere hope that it may be of value to all, but particularly to the Kansas farmer.

The Board's investigation and report thereof was conducted and made by H. W. Doyle, and no words of commendation can be too strong in recognizing his intelligent industry in that connection, as well as in the editing of the entire volume, the work of which was in his hands. It is also a pleasant duty to acknowledge with hearty thanks the friendly and helpful coöperation of the staff of the Kansas State Agricultural College, and of the hundreds of practical farmers, without whom it would have been impossible to make such a book.

J. C. MOHLER, *Secretary.*



## TABLE OF CONTENTS.

---

	<i>page</i>
Alfalfa in Kansas (Investigation).....	11
From Persia to Kansas.....	171
Alfalfa Varieties, Breeding, Seed, and Inoculation.....	180
Practical Drainage of Wet Lands.....	216
Liming Soils in Kansas.....	224
Alfalfa Soils; Their Preparation and Seeding.....	230
Scientific Hay-making and Storage.....	241
A Day's Work in Haying.....	247
Hay Sheds.....	251
Combination Hay and Feeding Sheds.....	256
A Hay-curing Barn.....	258
Losses in Feeding Value and a Scheme to Prevent Them.....	259
Alfalfa for Silage.....	262
A Dairy Farmer's Estimate of Alfalfa Silage.....	266
Alfalfa Seed Production.....	267
Alfalfa in Rows for Western Kansas.....	271
Irrigation of Alfalfa.....	276
Alfalfa Machinery.....	289
A Wagon for Hauling Alfalfa Hay.....	331
Weeds in Alfalfa.....	332
Plant Diseases Affecting Alfalfa.....	339
Mammals in Relation to Alfalfa.....	353
Insects Injurious to Alfalfa.....	367
Bees and Their Relation to Alfalfa.....	401
The Feeding Constituents of Alfalfa.....	403
Alfalfa as a Feed for Beef Cattle.....	410
Alfalfa as a Feed for Dairy Cattle.....	415
Alfalfa as a Feed for Sheep.....	417
Acute Bloating of the Rumen.....	419
Alfalfa as a Feed for Hogs.....	423
Alfalfa as a Horse and Mule Feed.....	428
Alfalfa as a Poultry Feed.....	436
Alfalfa as a Human Food.....	438
The Alfalfa Milling Industry.....	439
The Kansas City Hay Market.....	447
Marketing Alfalfa Hay from the Buyer's Standpoint.....	454
Marketing Alfalfa Hay from the Shipper's Standpoint.....	457
Measuring Hay.....	461
Alfalfa's Effect Upon the Soil.....	462
Alfalfa's Place in Farm Management.....	469
General Index.....	473

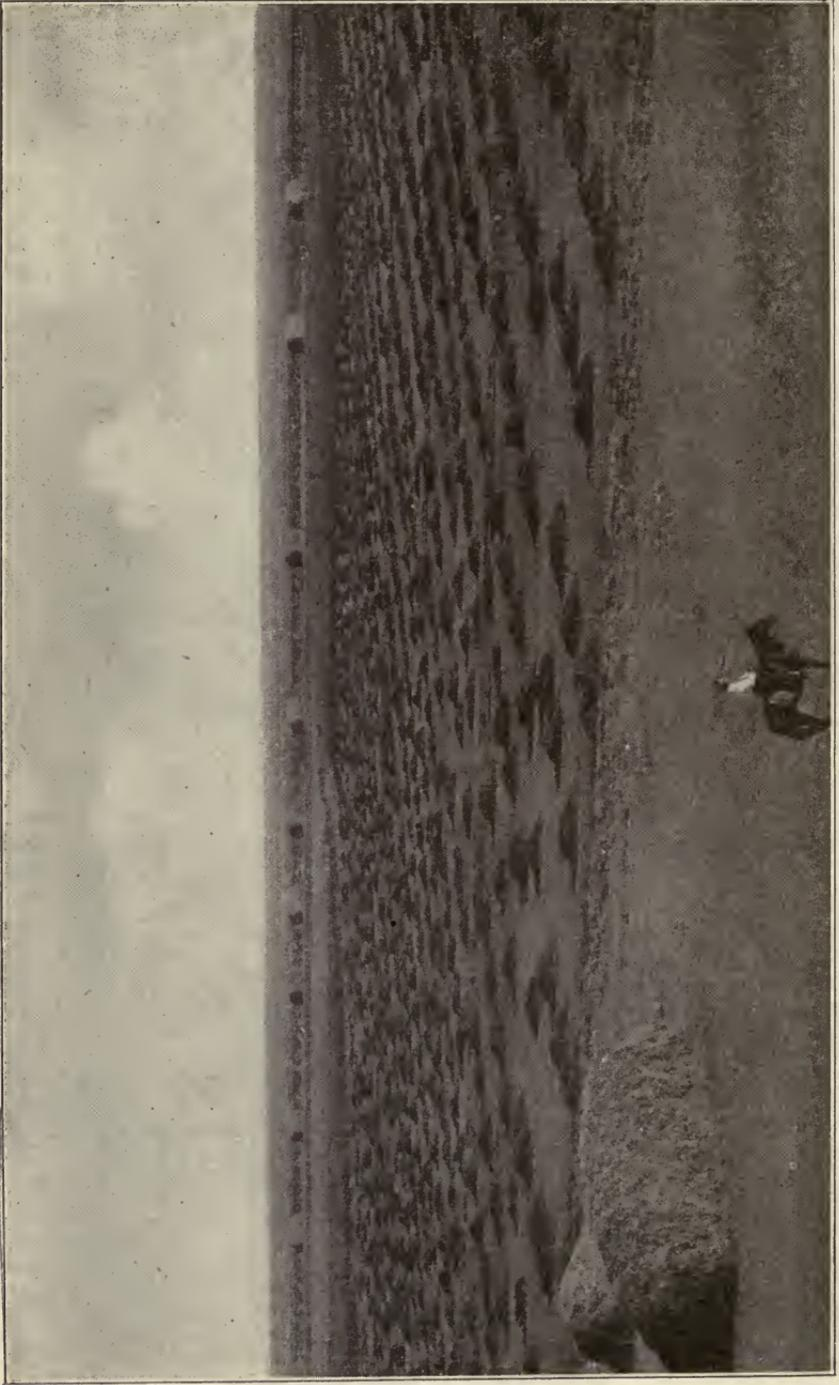

ALFALFA IS KANSAS' GREATEST FORAGE CROP.

# ALFALFA IN KANSAS.<sup>1</sup>

Compiled and edited by H. W. DOYLE.

## INTRODUCTION.

Alfalfa is Kansas' greatest forage crop. Kansas raises more alfalfa than any other state. It is therefore fitting that the methods of our best growers be investigated and that the information thus acquired be disseminated throughout the commonwealth. To this end the State Board of Agriculture sent out nearly a thousand blanks, each containing 115 questions, to prominent alfalfa growers in every county in Kansas. The replies received from hundreds of these growers have been compiled and analyzed, and the consensus of opinion on all the points and phases of the culture of alfalfa is herewith presented.

### AVERAGE NUMBER OF ACRES PER GROWER.

In selecting the growers to which blanks were mailed an effort was made to address those having the larger acreages. The reported average number of acres per grower, taking the state as a whole, is 110. The average number of acres per grower in the western third of the state is 143; in the central third, 115; in the eastern third, 99. It should be distinctly understood, however, that these average acreages are *only* those of the *growers reporting*, and do not represent the average number of acres on the farms of Kansas alfalfa growers in general. In fact, the average number of acres on the farms of Kansas alfalfa growers in general is much smaller than on those from which we have reports.

### YEARS OF EXPERIENCE.

Taking the state as a whole, the average number of years the entire reporting staff has been growing alfalfa is fifteen. Four of the growers reporting have been growing alfalfa continuously for thirty-five years, and nine other reporters have been growing it for thirty or more years. Forty-two per cent of the growers in the western third of the state have been growing alfalfa for twenty or more years, 39 per cent in the central third, and 30 per cent in the eastern third. Taking the state as a whole, 36 per cent of the growers have been growing alfalfa for twenty or more years.

### FIRST SEEDING IN KANSAS.

Considerable rivalry was in evidence among pioneers as to who made the first sowing of alfalfa in Kansas. The following is the best information that we could obtain:

"In the winter of 1868-'69 Mr. Charles J. Grosse, of Marion, Kan., received from the Trumble Seed House, on Sansom street, in San Francisco, Cal., one hundred pounds of alfalfa seed. It was delivered to him

<sup>1</sup> 1. Report of an investigation by the Kansas State Board of Agriculture.

at Junction City, Kan., and he hauled it to Marion on a wagon. He planted ninety pounds of seed and sold ten pounds to the lately deceased Charles Molahan, also of Marion. Mr. Molahan had wonderful success with his planting, and it was from the Molahan planting that Mr. Blackshere, of Chase county, got his idea to plant."

\* \* \*

"In the spring of 1869 Mr. D. B. Long, who located in Ellsworth county, section 12, township 16, range 8, sent to San José, Cal., for alfalfa seed, which he planted that spring. He got a moderate stand, and the plants grew large and coarse. Not knowing that alfalfa requires frequent cutting, he permitted it to go to seed. The seed was threshed, but as Mr. Long did not realize its value it came to nothing. Because the gophers worked in the field Mr. Long plowed it up."

\* \* \*

"What is believed to have been the first alfalfa in Atchison county was grown by Jasper Olophant, on the farm now occupied by his son, William E. Olophant, in the northwest quarter of the southeast quarter of section 24, township 7, range 21, near Oak Mills, in Walnut township. It was sown more than forty years ago. Mr. Olophant did not raise alfalfa on an extensive scale, but he planted it as an experiment and successfully grew a small patch. He was the first man to demonstrate that our [Atchison county] soil is adapted to this valuable forage crop."

\* \* \*

This item appeared under date of January 20, 1909, which would indicate that Mr. Olophant made his sowing in 1869.



FIG. 1. One of the earlier plantings of alfalfa in Norton county, the field of J. A. Gishwiller, of Almena. Planted in 1876; photographed in 1907.

The alfalfa report of the State Board of Agriculture issued in 1894 contained reports from growers all over the state. In that report James Herbin, of Jamestown, Cloud county, said: "I have had twenty-four years' experience in growing alfalfa. . . . Alfalfa attains its best yield from the third year on, until the tenth or twelfth; but it will continue to grow for twenty-five years or more." This would indicate that Mr. Herbin grew alfalfa as early as 1870. Three others—J. P. Hall, Medicine Lodge, Barber county; J. R. Blackshere, Elmdale, Chase county, and Gust. Anderson, Lindsborg, McPherson county—report having had twenty years' experience with alfalfa, which would make their sowings to have been as early as 1875.

"It was either in 1874 or 1875—Mr. Millar does not remember which—that he (G. C. Millar, now a resident of Hutchinson, Kan.) and J. R. Blackshere [evidently the same person above mentioned], who owned adjoining farms, located in section 11, township 20, range 8 east, three miles from Cottonwood Falls, Chase county, chipped in and sent to Idaho for five bushels of alfalfa seed. It cost them something like \$56 a bushel laid down in Cottonwood Falls."

\* \* \*

The Barteldes Seed Company, of Lawrence, Kan., reports as follows:

"We were the first seed house to introduce alfalfa in Kansas. I think either in 1875 or 1876 we shipped in from San Francisco some twenty-five pounds of the seed by mail. The seed was worth at that time about one dollar a pound. The next year we made some small local shipments, by express, from the same place. The next two years we bought from Sacramento, and shipped by freight, two or three bags at a time. Later on we bought from Utah, and shipped in ten- and twenty-bag lots, by freight. After that we shipped from Colorado, and mostly from the Arkansas valley. I remember that one year we had some twenty or thirty carloads from this valley. This amount was more than could be used here and we exported some of it to Germany. I can not tell exactly in what year we commenced to handle Kansas seed, but think that we purchased small lots in Kansas between 1880 and 1885. At that time we knew of none handled in New Mexico and Arizona, but California handled it quite largely, though mostly for home consumption. I do not know who has the oldest field in Kansas, but I think Mr. Blackshere, of Elmdale, was one of the earliest and largest growers of alfalfa hay and alfalfa seed." (See pages 171 to 179.)

#### THE OLDEST FIELD IN KANSAS.

An effort was made to determine the oldest field of alfalfa now in Kansas. The oldest field of which it has been possible to gain knowledge is located in Marion county, and is the planting of Mr. John A. O. Lovania. Mr. Lovania purchased his seed in 1873, in Europe, and there is alfalfa on the same ground yet, where he sowed it. This would make the field to be 43 years of age. The information was volunteered by Mr. Charles J. Grosse, of Marion, Kan. Mr. John H. Rich, of Coolidge, Hamilton county, reports as follows: "There is a field one-half mile east of Coolidge that was planted by one Joe Borders in 1882." Mr. George Yoxall, of Stockton, Rooks county, reports: "I have some good alfalfa planted in 1883." This would make these fields to be 34 and 33 years of age, respectively. Three fields were reported to be 30 years old, four 28 years old, two 27 years old, seven 25 years old, one 24 years old, and two 22 years old. Most of these older stands are located in the western third of the state.

#### PROFITABLE LENGTH OF LIFE.

The average profitable length of life of an alfalfa field is, according to reports received, about 12 years. In the eastern third of the state it is estimated at 10 years, in the central third at 12 years, and in the western third at 15 years. The indications are that alfalfa on bottom land lives much longer than that on upland. The average of the reports on this point show the usual life of alfalfa on bottom land to be 14 years and that on upland to be 6 years.



FIG. 2. A sturdy old alfalfa plant, showing development possible from a single seed. Such plants are found in the older fields.—[Courtesy Iowa Experiment Station.]

## VARIETIES.

Most reporters have had no experience with any varieties of alfalfa other than the ordinary or common variety, *Medicago sativa* L. Here and there was found a man who had tried the Turkestan variety. However, the replies indicate considerable difference of opinion as to its value. Following are some favorable reports:

*Cowley county*: "We have seeded Turkestan on light sandy soil and have succeeded with it where the other failed."

*Hodgeman county*: "Turkestan thickened, stood wind and cold in exposed places, matured, and seeded."

*Jackson county*: "My experience with Turkestan has been good."

*Sherman county*: "I have four acres of Turkestan. It grows rank— $3\frac{1}{2}$  to 4 feet."

Here are some unfavorable reports:

*Atchison county*: "Turkestan in neighboring fields is about half as good as the ordinary variety."

*Wilson county*: "I have had some experience with Turkestan, but it was not satisfactory; it did not make a good growth."

*Montgomery county*: "Common alfalfa is best. Don't like Turkestan."

*Sheridan county*: "Turkestan did not survive a bad year."

*Trego county*: "Turkestan and common alfalfa were planted side by side. The Turkestan was no good. The first cutting yielded about 50 per cent as much as the common variety and later cuttings yielded nothing at all."

*Wichita county*: "I have had experience in a small way with Turkestan. It is no better than the ordinary variety."

One grower, who lives in Lyon county, said: "I sowed 200 acres of alfalfa, one-half with home-raised seed and one-half with German seed. The German seed made the best growth."

A prominent Wabaunsee county alfalfa grower offers the following: "Some years ago we planted about twenty acres of alfalfa with foreign seed. This seed was of a remarkably hardy character. The first winter after it was seeded was an extremely trying one on alfalfa, and did considerable damage to native plants, while the plants from the foreign seed remained unharmed. On the other hand, the plants from the foreign seed grow closer to the ground but not nearly so tall, and yield much less hay in an ordinary year. During very dry periods the third and fourth crops from the foreign seed are hardly worth cutting, while our native seed gives a reasonably good crop. I certainly would not recommend the foreign seed for a hay crop, but it might be very good as hog pasture."

It would appear that while some foreign-grown varieties of alfalfa might prove valuable in this state, they have thus far failed to win widespread recognition among Kansas farmers. (See pages 180 to 205.)

## NUMBER OF CUTTINGS.

The number of cuttings of alfalfa in Kansas varies from four and one-half in the southeastern corner of the state to three cuttings in the western one-fourth. In counties representing about 72 per cent of the state's alfalfa acreage, located mostly in the eastern third and south-

central parts, the average number of cuttings is four. Eighteen counties in the north-central part of the state, representing 20 per cent of the total acreage, average three and one-half cuttings. It may be stated, in a general way, that the average number of cuttings of alfalfa hay in Kansas is four. However, in favorable years or in specially favored locations the average number of cuttings as reported may be exceeded. On the other hand, certain conditions may in some instances cause the number to fall below the average. Figure 10 and the table on page 19 give more specific information about the number of cuttings.

#### TOTAL YIELDS.

Yields vary from year to year and from place to place. Soil, climate and altitude have far-reaching effects. The average yearly yield of alfalfa in Kansas is 3.72 tons per acre. The average yield in the eastern third of the state is 3.95 tons, in the central third 3.60 tons, and in the western third 3.17 tons per acre. The apparently high yield in the western part of the state is accounted for in the fact that nearly all of the alfalfa grown there is grown in valleys, where the water table is near to the surface and a maximum amount of sunshine is had, and in the fact that practically all of the state's irrigated alfalfa is found there. A study of the data at hand reveals the information that counties through which the Arkansas river flows uniformly show higher yields than the counties adjoining. The same thing is true, in a measure, with counties along the other important streams.

Forty-three per cent of the alfalfa acreage is found in the eastern third of the state, or 584,371 acres; 49.6 per cent, or 674,387 acres, in the central third; and 7.4 per cent, or 100,699 acres, in the western third. The state's total acreage is 1,359,457. Applying the above average yields to these acreages, we have a production of 319,215 tons in the western third, of 2,427,793 tons in the central third, and of 2,308,265 tons in the eastern third, representing 6.30, 48.01 and 45.64 per cent, respectively, of the total aggregate annual yield of 5,057,180 tons.

#### YIELDS BY CUTTINGS.

The average yield of the first cutting, for the state, is 1.25 tons. It varies from .9 of a ton in some of the western counties to 1.5 tons in some of the eastern counties. However, the yield is remarkably uniform throughout the state, gradually shading from 1.3 tons in the eastern part to about 1.1 in the western part. The second cutting yields from .7 of a ton in an extreme western county to 1.2 tons in the east, averaging .98 of a ton for the state as a whole. The third cutting averages .82 of a ton, the fourth cutting .63 of a ton, and the fifth cutting .53 of a ton.

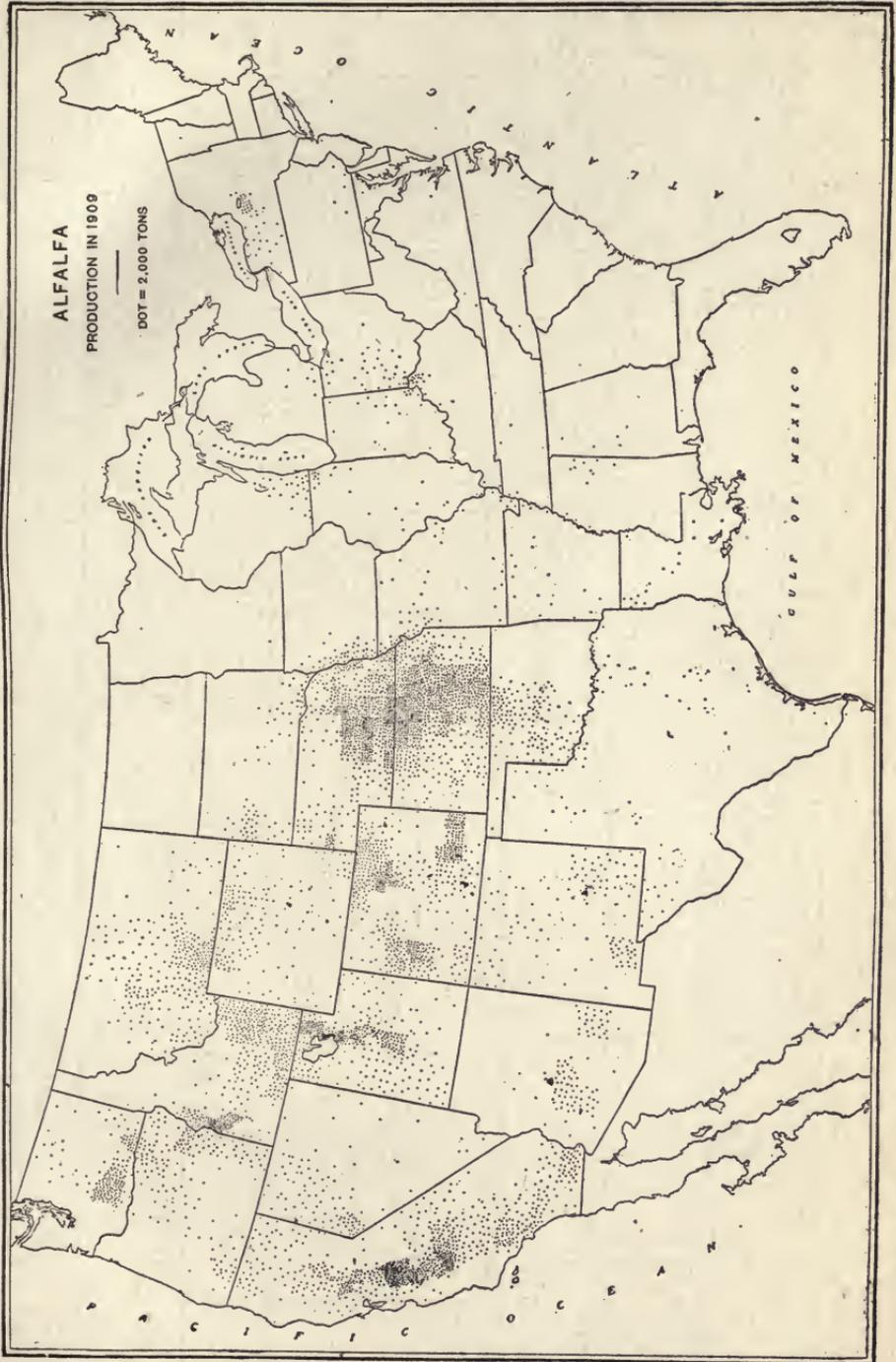

FIG. 3. Distribution of alfalfa produced in 1909, each dot representing 2000 tons.—[Courtesy United States Census Bureau.]



TABLE NO. 1. Average number of cuttings, average yield per acre of the different cuttings, and total average yield per acre, by counties.

COUNTIES.	Average No. of cuttings.	Average yield in tons.					Total for year.
		First cutting.	Second cutting.	Third cutting.	Fourth cutting.	Fifth cutting.	
The State	4	1.25	.98	.82	.63	.53	3.72
Allen	4	1.3	1.2	1.0	.7		4.2
Anderson	4	1.3	1.2	1.0	.7		4.2
Atchison	4	1.3	1.0	.9	.6		3.8
Barber	4	1.2	.8	.6	.8		3.4
Barton	4	1.2	1.0	.8	.6		3.6
Bourbon	4	1.3	1.0	.9	.7		3.9
Brown	4	1.4	1.0	.9	.6		3.9
Butler	4	1.2	.9	.7	.7		3.5
Chase	4	1.2	.9	.7	.8		3.6
Chautauqua	4½	1.0	1.0	.9	.7	.4	4.0
Cherokee	4½	1.3	.9	.9	.7	.3	4.1
Cheyenne	3	1.1	.9	.7			2.7
Clark	4	1.2	1.0	.7	.6		3.5
Clay	4	1.2	1.0	.7	.6		3.5
Cloud	3¾	1.2	1.0	.7	.5		3.4
Coffey	4	1.3	1.1	.9	.7		4.0
Comanche	4	1.1	.9	.7	.6		3.3
Cowley	4	1.2	.9	.9	.6		3.6
Crawford	4½	1.3	1.1	.9	.7	.5	4.5
Decatur	3	1.1	1.0	.8			2.9
Dickinson	4	1.2	1.2	.9	.6		3.9
Doniphan	4	1.5	1.2	.9	.6		4.2
Douglas	4	1.3	1.1	.9	.7		4.0
Edwards	4	1.2	1.0	.8	.5		3.5
Elk	4	1.3	1.0	.9	.7		3.9
Ellis	3½	1.1	.9	.7	.5		3.2
Ellsworth	3½	1.2	.9	.7	.5		3.3
Finney	4	1.2	1.0	.8	.7		3.7
Ford	4	1.2	1.0	.8	.6		3.6
Franklin	4	1.3	1.1	.9	.7		4.0
Geary	4	1.3	1.2	.9	.6		4.0
Gove	3	1.1	1.0	.7			2.8
Graham	3¾	1.1	.9	.7	.5		3.2
Grant	4	1.1	1.0	.7	.5		3.3
Gray	4	1.2	1.0	.9	.6		3.7
Greeley	3	1.1	.9	.8			2.8
Greenwood	4	1.3	.9	.9	.8		3.9
Hamilton	3	1.0	.8	.7			2.5
Harper	4	1.2	1.0	.7	.6		3.5
Harvey	4	1.2	.9	.7	.6		3.4
Haskell	3	1.1	1.0	.9			3.0
Hodgeman	3½	1.1	1.0	.7	.5		3.3
Jackson	4	1.3	1.1	.9	.7		4.0
Jefferson	4	1.3	1.1	.9	.7		4.0
Jewell	3½	1.3	1.1	.8	.5		3.7
Johnson	4	1.3	1.0	.9	.8		4.0
Kearny	3	1.0	1.0	.8			2.8
Kingman	4	1.2	.9	.7	.6		3.4
Kiowa	3½	1.0	1.0	.7	.5		3.2
Labette	4½	1.3	.9	.8	.7	.5	4.2
Lane	3½	1.0	.9	.8	.5		3.2
Leavenworth	4	1.5	1.2	.9	.7		4.3
Lincoln	3¾	1.2	1.1	.8	.5		3.6
Linn	4	1.3	1.2	1.0	.7		4.2
Logan	3	1.2	1.0	.8			3.0
Lyon	4	1.3	1.1	1.0	.7		4.1
Marion	3½	1.2	.9	.7	.6		3.4
Marshall	4	1.4	1.0	.8	.6		3.8
McPherson	3½	1.2	.9	.8	.6		3.5
Meade	4	1.2	1.0	.7	.6		3.5

TABLE No. 1—CONCLUDED.

COUNTIES.	Average No. of cuttings.	Average yield in tons.					Total for year.
		First cutting.	Second cutting.	Third cutting.	Fourth cutting.	Fifth cutting.	
Miami	4	1.3	1.0	.9	.8		4.0
Mitchell	3½	1.2	1.1	.8	.5		3.6
Montgomery	4½	1.1	1.0	.9	.7	.5	4.2
Morris	4	1.2	1.1	1.0	.7		4.0
Morton	4	1.1	.9	.7	.5		3.2
Nemaha	4	1.3	1.0	.7	.6		3.6
Neosho	4½	1.3	1.1	.9	.7	.5	4.5
Ness	3½	1.0	1.0	.8	.5		3.3
Norton	3½	1.2	1.0	.8	.4		3.4
Osage	4	1.3	1.1	1.0	.7		4.1
Osborne	3¼	1.2	1.1	.7	.5		3.5
Ottawa	4	1.2	1.0	.7	.5		3.4
Pawnee	4	1.3	1.0	.9	.6		3.8
Phillips	3½	1.3	1.1	.8	.5		3.7
Pottawatomie	4	1.3	1.1	1.0	.6		4.0
Pratt	3½	1.2	.9	.7	.6		3.4
Rawlins	3	1.1	.9	.8			2.8
Reno	4	1.3	.9	.8	.8		3.8
Republic	3½	1.3	1.0	.7	.6		3.6
Rice	4	1.1	1.0	.9	.7		3.7
Riley	4	1.2	1.1	1.0	.6		3.9
Rooks	3½	1.1	.9	.7	.5		3.2
Rush	3½	1.0	1.0	.8	.5		3.4
Russell	3¼	1.1	.9	.7	.6		3.3
Saline	4	1.2	1.0	.7	.5		3.4
Scott	3	1.1	1.0	.8			2.9
Sedgwick	4	1.5	1.0	.8	.7		4.0
Seward							
Shawnee	4	1.3	1.2	1.0	.7		4.2
Sheridan	3	1.1	1.0	.7			2.8
Sherman	3	1.1	.9	.7			2.7
Smith	3½	1.3	1.1	.8	.5		3.7
Stafford	3½	1.3	.9	.8	.5		3.5
Stanton	2	.9	.7				1.6
Stevens							
Sumner	4	1.2	.9	.9	.6		3.6
Thomas	3	1.1	.9	.8			2.8
Trego	3½	1.1	1.0	.7	.4		3.2
Wabaunsee	4	1.2	1.1	1.0	.6		3.9
Wallace	3	1.1	1.0	.7			2.8
Washington	3½	1.3	1.0	.8	.6		3.7
Wichita	3	1.1	1.0	.8			2.9
Wilson	4	1.4	1.1	.9	.7		4.1
Woodson	4	1.4	1.1	.8	.7		4.0
Wyandotte	4	1.3	1.2	1.0	.8		4.3



## FIGURES AVERAGE; NOT ARBITRARY.

There is an apparent contradiction in the yields as compared with the number of cuttings. For instance, take those counties having three and one-half cuttings. This means that during about half the time three cuttings are had and during the rest of the time four cuttings, making an average of three and one-half cuttings. Of course a man can not really have three and one-half cuttings. He must have either three cuttings or four cuttings; and in showing averages there are bound to be figures that seem not to "jibe." Therefore, in Table No. 1, page 19, in the case of those counties shown as having four and one-half cuttings, the estimated yield of the "one-half" is expressed in the column of yields labeled "Fifth cutting," and in the case of three and one-half cuttings the "one-half" is in a similar manner shown under the head labeled "Fourth cutting." These irregularities are unavoidable and are caused solely by the difficulty in showing averages for the state or portions of the state.

## CLIMATE AND LOCATION.

An accompanying outline map (Fig 10) shows the approximate number of cuttings of alfalfa as applied to the different parts of the state. This map is very striking when compared with maps having reference to the climate. Particularly is this true in regard to the map (Fig. 5) showing the average annual precipitation (rainfall, snow, etc.). It is surprising indeed to learn that the precipitation in three of the southeastern counties averages from 40 to more than 44 inches, while in Hamilton county, at the extreme western end of the state, it averages barely more than 15 inches, or practically one-third as much as it does in Cherokee county, with her 44.11 inches. In fact, the amount of precipitation gradually and rapidly diminishes from the eastern to the western line of the state, in a manner noticeably similar to the graduation of average yields.

TABLE No. 2. Precipitation in Kansas. (U. S. Weather Bureau.)

	Western third of the state, inches.	Central third of the state, inches.	Eastern third of the state, inches.	The state as a whole, inches.
Average annual precipitation . . . . .	19.20	26.12	35.05	27.58
Precipitation during growing season, April to September, inclusive . . . . .	16.84	24.44	25.97	21.86

The above-shown variations have a very great effect on the number of cuttings and the yield of alfalfa.





Maps showing the average annual precipitation, the average number of growing days, the average dates of killing frosts, the altitude, and the average number of clear days may be found on other pages (Figs 5, 6, 7, 8 and 9). A study of them will help to a better understanding of the relation of the number of cuttings and the average yields to the climate and the altitude. (See pages 231 to 234.)

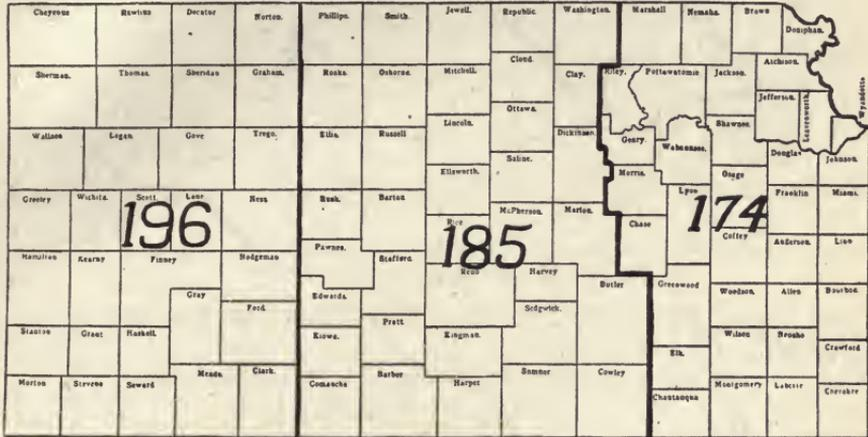

Fig. 9. The average number of clear days in a year, from the records of the United States Weather Bureau.

DATES OF CUTTINGS.

The maps on pages 26 and 27 illustrate the average dates on which the different cuttings are made in the different parts of the state. The first cutting in the season usually starts about May 15 in the southeastern corner of the state, and as one progresses in a northwesterly direction the date of cutting becomes later, through May 23, 27 and 30, until in the northwestern corner the average date of the first cutting is about June 7. The dates of the second cutting vary from June 24 in the southeast to July 10 in the northwest; those of the third cutting from August 1 to August 23; the fourth cutting from September 8 in the southeast corner to September 24 in the west-north-central portion; and the fifth cutting, which is had, as a rule, only in the southeastern corner of the state, is made about October 19. It is interesting to note that alfalfa is being cut somewhere in the state throughout the growing season, from the middle of April to the third week in October.

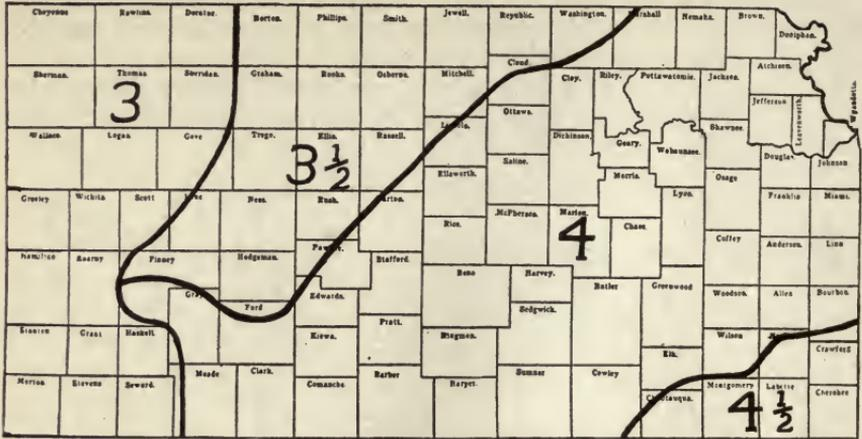

FIG. 10. The average number of cuttings.

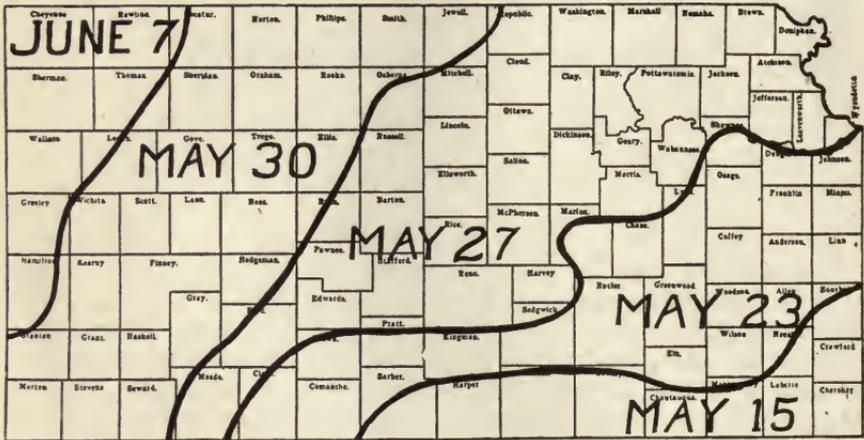

FIG. 11. Average dates of first cutting.

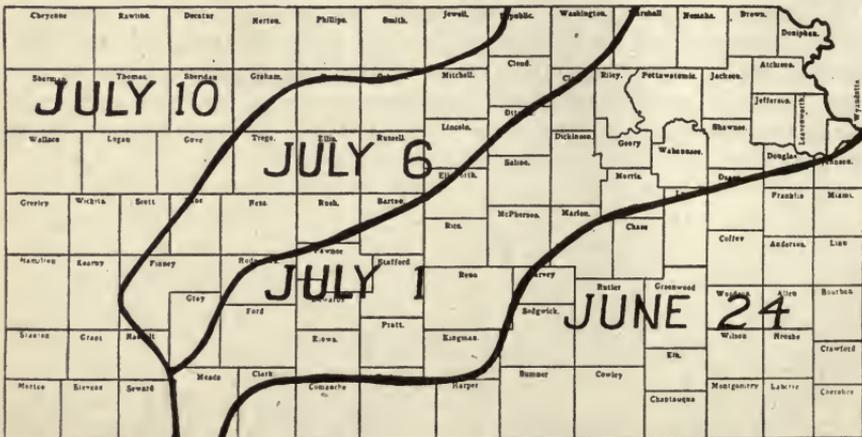

FIG. 12. Average dates of second cutting.

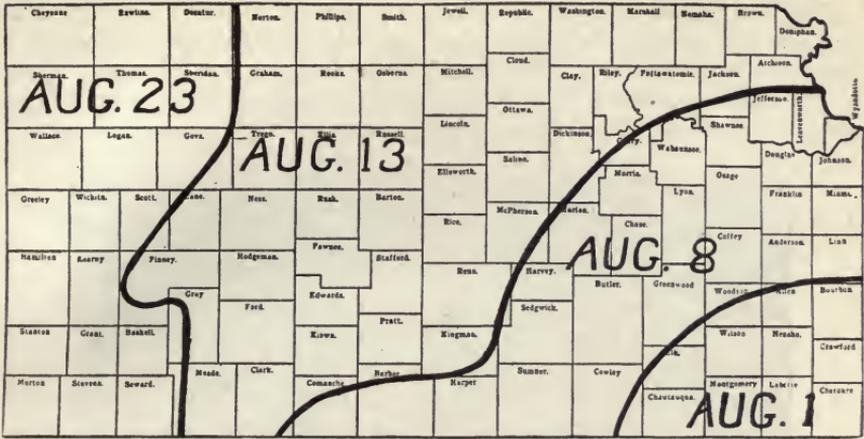

FIG. 13. Average dates of third cutting.

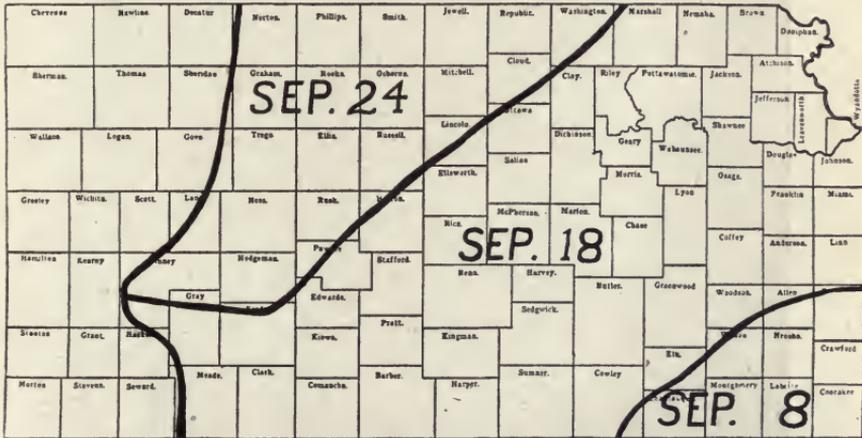

FIG. 14. Average dates of fourth cutting.

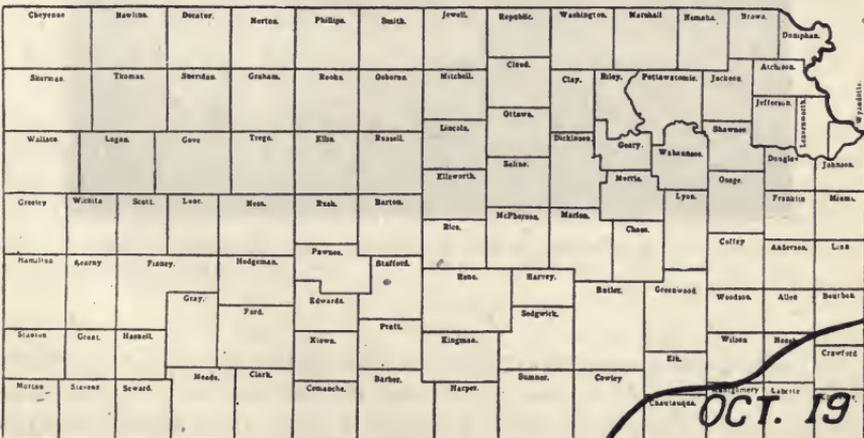

FIG. 15. Average date of fifth cutting.

While the lines on the maps make it appear that the boundaries of these regions are sharply defined, such is not the case. The progression is gradual and varies greatly in accordance with local conditions. Dates in the same locality will also vary widely from year to year. Those given are average dates for average years.



FIG. 16. Alfalfa roots penetrating six feet beneath the surface of the soil. The ideal alfalfa soil readily admits such root penetration.—[Courtesy John Deere & Co.]

#### SOILS.

An effort was made to learn the character of soil best suited to alfalfa. Alluvial bottom land is much preferred throughout the state, and particularly in the western third, where it is very hard indeed to grow alfalfa on upland in paying crops. The texture of the soil in which al-

falfa is grown ranges all the way from clay, through silt and gumbo, into sandy loams. The subsoil may be of a gravelly nature, a comparatively stiff clay, or of any of the intervening grades. In fact, we find alfalfa growing in almost every kind of soil in the state, with varying degrees of success. It may be said, in a general way, that the types of soil found in the counties having the larger acreages are the best types of alfalfa soil we have.

The ideal alfalfa soil is fertile, full of humus, strong in lime, and in first-class mechanical condition—friable and mellow. The subsoil should be of a nature to admit the penetration of alfalfa roots and the free upward and downward percolation of water; it should be deep and well drained. Alfalfa will not stand wet feet, and the water table should not come nearer than five or six feet of the surface to secure the best results. A more extended discussion of alfalfa soils may be found on pages 230 to 241.



FIG. 17. An alfalfa field on an upland farm, in Cherokee county, three years after seeding. This excellent stand was secured by manuring, liming and underdraining the field.—[Courtesy Kansas Experiment Station.]

That wet, sour soils may be corrected and made to grow paying crops of alfalfa has been brought out in this investigation. Returns indicate that the soils requiring such treatment are located chiefly in the southeastern corner of the state, where rainfall is heavy and natural drainage often poor. The methods of correction usually include draining, liming and manuring.

#### SOIL DRAINAGE.

Two methods of drainage were reported—tile and open ditches. Not a few growers report that surface ditches—modified dead furrows—are satisfactory. However, in no instance has there been an unfavorable report from those who have tried tile drainage, and most reporters are

even enthusiastic about results. Some typical testimonials for tile drainage follow:

*Osage county*: "I have a piece of heavy, black bottom land that was too wet for alfalfa or most any crop, except in a very dry year. Since tiling alfalfa does fine."

*Neosho county*: "I have used three and one-half carloads of tile on wet land, which now grows alfalfa or any other crop."

*Labette county*: "We are successfully growing alfalfa on water-oak land that has been reclaimed by tile drainage."

*Allen county*: "I have tiled some bottom land next to a bluff, using four-, five-, six- and eight-inch tile, and have been very successful."

*Crawford county*: "Our alfalfa is on drained land, except twenty acres, which is underlaid with a sandy subsoil. It is a perfect success where the top soil is over two feet thick."

*Crawford county*: "To-night the creek is all over everything. In four or five days of good drying weather I can cultivate. Were it not for tile, sixty acres of my farm would this year be unplanted."

Frequently the question arises as to whether alfalfa roots fill and choke drain tile. Not a single report complaining of this trouble was received. However, one report, which may or may not have bearing on the subject, reads:

"I have several thousand feet of drain tile in use. It has been my ex-



FIG. 18. A modern limestone grinding plant.—[Courtesy New York Experiment Station.]

perience that after the first year the alfalfa itself is superior to tile as a drain in deep soil; but, in my judgment, shallow soil should all be tiled." (See pages 216 to 224.)

#### SOIL ACIDITY.

Pale, sickly and dying plants often indicate an acid soil—a sour soil, a soil deficient in lime. Constantly wet soils are nearly always sour. There are sour soils, however, that are not wet. The usual method of testing for soil acidity (see page 237) is as follows: With a spade, trowel or other implement, make an opening in the soil. Insert a piece of blue litmus paper, obtainable at any drug store, and press the soil firmly against it. In ten minutes carefully remove the paper. If it has turned red, or if red spots appear on it, the soil is acid and needs an application of lime, and sometimes manure as well, to correct this acidity and to make it sweet and productive—a condition necessary for successful alfalfa growing. The litmus paper needs to be carefully handled, as the perspiration on a person's fingers very often reddens the paper.



FIG. 19. There are few Kansas regions in which limestone may not be had within hauling distance, and farmers will do well to look into the cooperative purchase of portable lime pulverizers.—[Courtesy Power Farming.]

## LIMING.

The counties where liming has been found necessary and most often tried with success are located chiefly in the southeastern corner of the state. Here are some reports of successful liming:

*Allen county*: "I have used raw crushed limestone on shale upland at the rate of three tons per acre, in addition to good manure at the rate of eight tons per acre."

*Bourbon county*: "I applied ground limestone at the rate of two tons per acre, sowing with an end-gate seeder."

*Cowley county*: "I have applied ground limestone with a manure spreader at the rate of two or three tons to the acre. I think it is beneficial, increasing the yield."

*Labette county*: "It takes from four to five years to reclaim water-oak land by applications of lime and manure. We have successfully used both air-slaked lime and ground limestone. We prefer the latter on account of the cost. We use one and one-half tons per acre, applied with a lime spreader, or on top of manure with a manure spreader."

*Labette county*: "Sour soil needs lime, at the rate of one ton per acre, or more, applied with a spreader."

*Montgomery county*: "We have used 60,000 pounds of crushed native limestone, scattered by putting about three inches on top of each spreader load of manure."

On the other hand, some growers report that, seemingly, no particular benefits resulted from the application of lime. Whether, in these instances, the soil really needed lime, whether lime was applied in sufficient quantities to meet the need, whether the right form and quality of lime was properly applied, or whether the land needed more thorough drainage or manuring, we can not say; but certainly it would seem that there was some irregularity about its application. The reports follow:

*Nemaha county*: "I have applied ground limestone on trial plots, but this soil does not need it."

*Harvey county*: "I have applied crushed limestone with no particular benefit."

*Jackson county*: "I don't think our soil is sour to hurt. Some of my neighbors have applied ground lime to alfalfa, and I can see no effect."

*Bourbon county*: "I put four tons on two acres of wet land (water-oak soil) two years ago. There is no difference that I can see, as yet."

*Wilson county*: "I have used some lime or land plaster on a demonstration plot, but with very poor results. I used one ton per acre, applied by hand."

The following theory about the correction of sour soil is self-explanatory:

*Crawford county*: "Our sour land was sweetened by drainage. I don't believe any amount of lime would do good if the surplus water were not taken from the soil."

Ground limestone is the most popular and apparently the most economical form of lime to apply. The rate of application depends somewhat upon the degree of acidity, varying from one and one-half to three

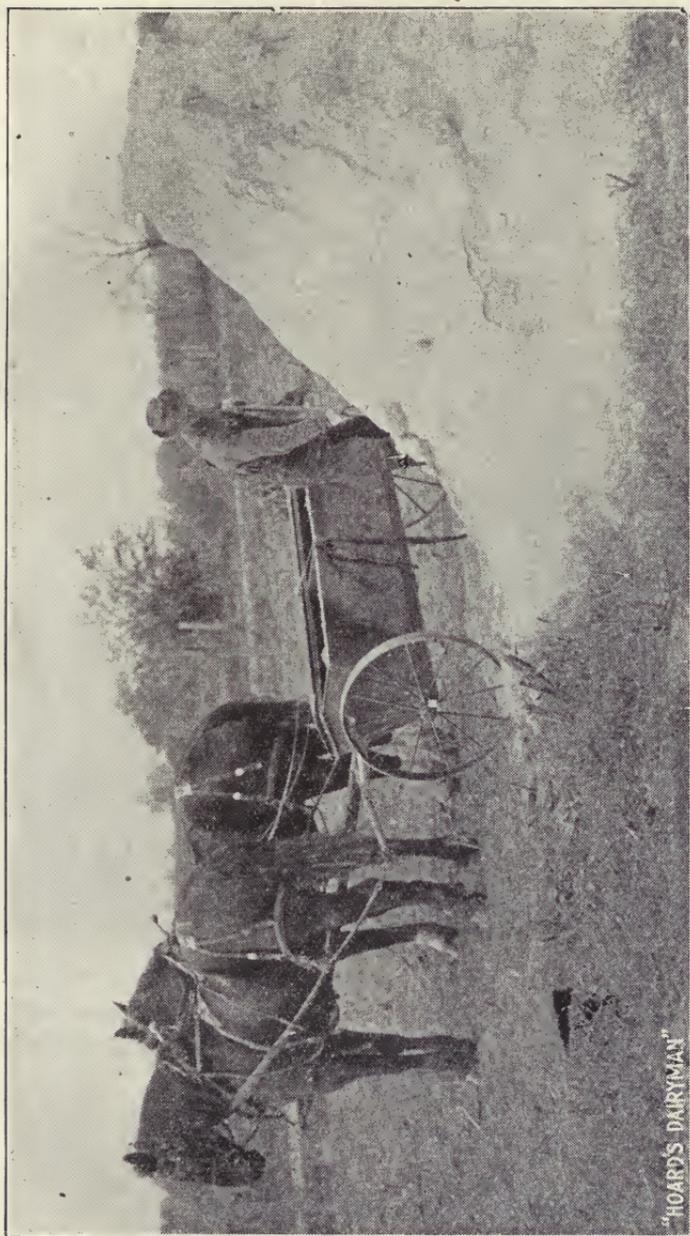

FIG. 20. Shoveling ground limestone into a distributor.—[Courtesy Hoard's Dairyman.]

tons per acre, averaging about two tons. It may be applied, after plowing, with a regular lime spreader; with a manure spreader, by placing it on top of the manure; or by hand. It is best applied six months to a year previous to the seeding of alfalfa.

*A list of firms selling ground limestone.*

Western Crushed Rock and Concrete Co., Kansas City, Mo.  
 Marblehead Lime Co., Kansas City, Mo.  
 Fort Scott Hydraulic Cement Co., Fort Scott, Kan.  
 Monarch Cement Co., Humboldt, Kan.  
 Superior Marble & Limestone Co., Carthage, Mo.  
 Carthage Limestone Co., Carthage, Mo.  
 Fredonia Portland Cement Co., Fredonia, Kan.  
 J. F. Byers, Chanute, Kan.  
 Hood Implement Co., McCune, Kan.  
 Frazer Stone Quarry, El Dorado, Kan.

The average price of ground limestone, as reported, is from \$1.50 to \$2 per ton, f. o. b. cars at shipping point.



FIG. 21. Spreading lime with a distributor.—[Courtesy *Power Farming*.]

A man in Anderson county reports as follows: "Our county owns a crusher and loans it without charge, except for the cost of fuel for the engine, and repairs." This suggests the possibility of coöperation in the purchase of portable lime pulverizers, the advertisements of which may be found in almost any of our agricultural papers. There are few regions in which limestone may not be had within hauling distance, and groups of farmers in need of ground limestone will do well to look into this matter. (See pages 224 to 230 and 237.)

PRECEDING CROP.

Correspondents were asked about their preference in regard to the crop preceding alfalfa. Where spring sowing is practiced, corn, wheat and oats, in the order named, are far in the lead in popularity, corn being considerably ahead of all the rest. In the case of fall sowing, wheat

and oats are preferred, with millet and summer fallowing strictly in the minority. Of course there are other miscellaneous and scattering crops for which preference was expressed, but these crops stood out from all others.

In response to the request for a reason for the expressed preference, three principal objects seemed to influence the selection, viz.: to keep down weeds; to leave the future seed bed in a firm condition; and to make plowing convenient at the proper time. These reasons were given by growers preferring corn, as well as by those preferring wheat or oats or millet, or summer fallowing. A grower would give one reason or another as his preference for this or that crop, and no particular reason was generally applied to any particular crop. No crop seemed to be unanimously preferred in any particular section.



FIG. 22. Spreading lime by hand.—[Courtesy *Farmers Mail and Breeze.*]



FIG. 23. Disking-in ground limestone.—[Courtesy Delaware Experiment Station.]

## FERTILIZING.

Alfalfa requires a fertile soil, and where fertilization is found necessary in Kansas barnyard manure is used almost exclusively. The little commercial fertilizer that is used is used in the southeastern corner of the state, where on the uplands there is often a shortage of phosphorus. Manure is best applied with a spreader, a year previous to seeding. The amount applied varies somewhat with the condition of the soil and the climate. About ten or twelve tons per acre seems to be the average. In the western part of the state the amount is given at about eight tons, because in that dry climate it does not decay so readily and has a tendency to fire and burn and to admit of too thorough an aëration of the soil.

A report from Wilson county in regard to fertilization reads as follows: "I have used a great deal of manure and find it very beneficial, but have watched alfalfa seedings after cowpeas, and think cowpeas the very best kind of fertilizer." (See pages 238 to 241.)



FIG. 24. Manure is best applied with a spreader, at the rate of ten or twelve tons per acre.—[Courtesy International Harvester Company.]



FIG. 25. A wasteful way of distributing manure, which is rapidly passing out of practice.—[Courtesy International Harvester Company.]



FIG. 26. A soil condition undesirable for the seeding of alfalfa.—[Courtesy John Deere & Co.]



FIG. 27. The ideal alfalfa seed bed is firm and moist, with the surface inch or so loose, mellow, and finely pulverized.—[Courtesy *The Country Gentleman.*]

## SEED-BED PREPARATION.

The ideal seed bed, according to reporters, is firm and moist. The surface should be loose, mellow and finely pulverized, to a depth only as great as it is intended to sow the seed. The field should be as smooth as it is possible to make it, and without depressions where water will stand.

Different growers have different methods of obtaining a proper condition of seed bed. Some plow deep for the preceding crop, and then very shallow for alfalfa; others plow six months or more preceding the time of sowing, and allow nature to settle the soil. In the latter instance the moisture must be conserved and the weeds kept down until seeding time



FIG. 28. The walking plow is still used on many farms.—[Courtesy Wisconsin Experiment Station.]



FIG. 29. Plowing corn ground with a sulky plow, for alfalfa.  
[Courtesy Moline Plow Company.]

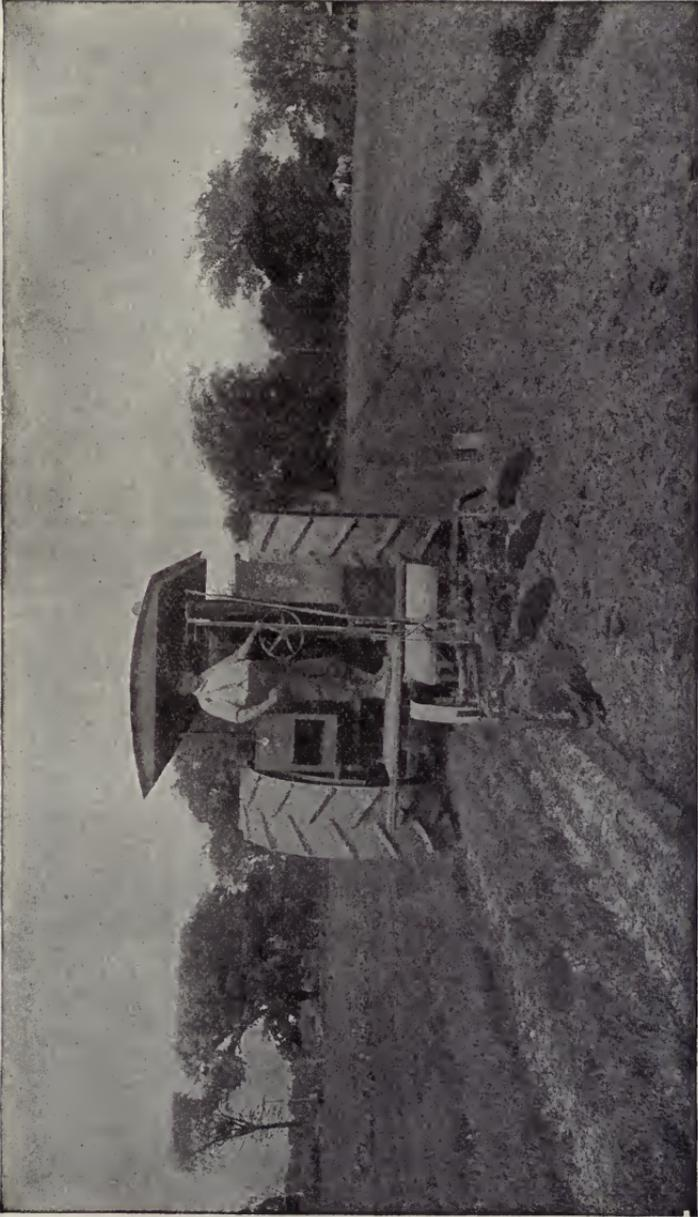

FIG. 30. The tractor is coming more and more into use for plowing.—[Courtesy Moline Plow Company.]

by frequent harrowing or cultivation, amounting, in fact, to a system of fallowing. There are growers who do not believe in plowing at all, but prefer thoroughly to disk and cross-disk wheat, oats, corn or other stubble, harrowing and smoothing well before sowing. By this method, they claim, the ground is not idle at any time, and as a good stand may thus be secured, it is a waste of time and labor to plow. The success of this method is doubtless somewhat dependent upon the amount of moisture in the soil; but the method seems to be preferable to plowing a short time before seeding.

Plowing for spring sowing of alfalfa is usually done in the fall preceding, and the ground smoothed in the spring, although there are some who wait until early spring to plow. Plowing for fall sowing is usually done in July, or as soon as possible after the preceding crop of wheat or oats or millet is off the ground. Some prefer to plow for fall sowing in the spring, and fallow, as described above, until the time of sowing. The depth of plowing may be about the same as for any other crop when it is done long enough before the time of seeding, the average depth reported being six inches. The closer to the time of seeding the plowing is done, however, the more shallow it should be. As with all operations, the better the job of plowing the better the results.

Where land is plowed immediately before seeding it is necessary artificially to firm it. A soil packer or roller is a good implement to use in this instance; but where such is not available it is the practice of many growers to set their disks straight to pack, and to follow with plank or log drags, alternating with the harrow, until the seed bed is in the desired condition. In this connection it is well to remember that the



FIG. 31. The better the job of plowing the better the results.  
[Courtesy Janesville Machine Company.]

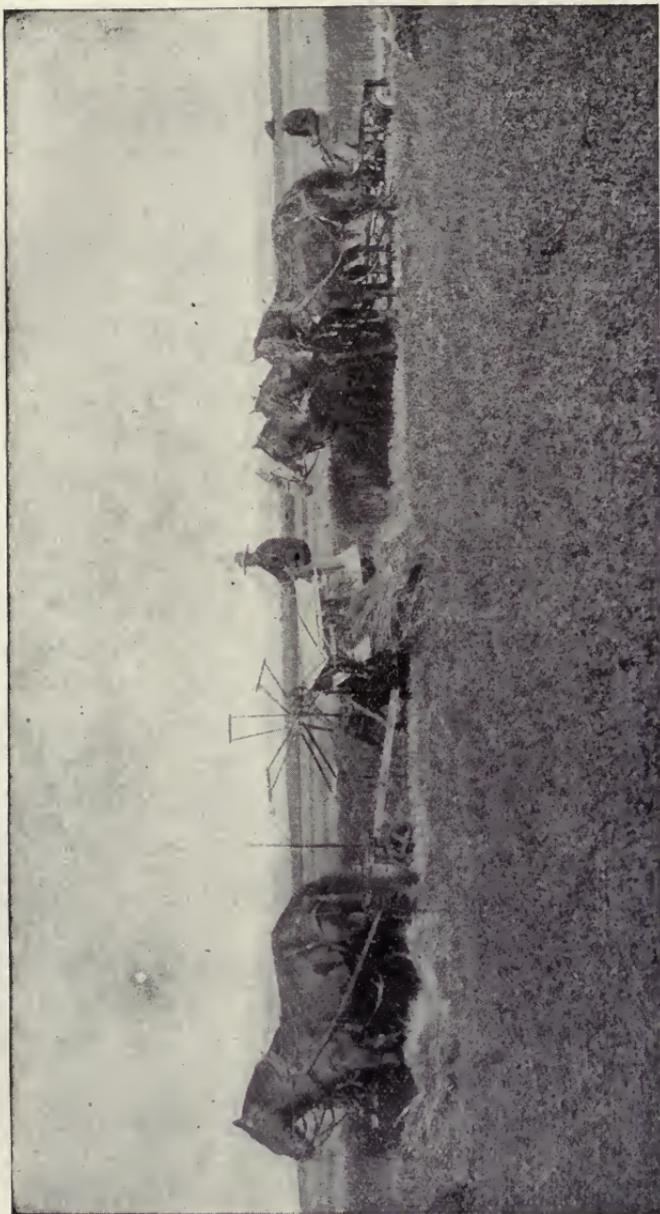

FIG. 32. Disking wheat stubble in preparation for a fall sowing of alfalfa.—[Courtesy International Harvester Company.]

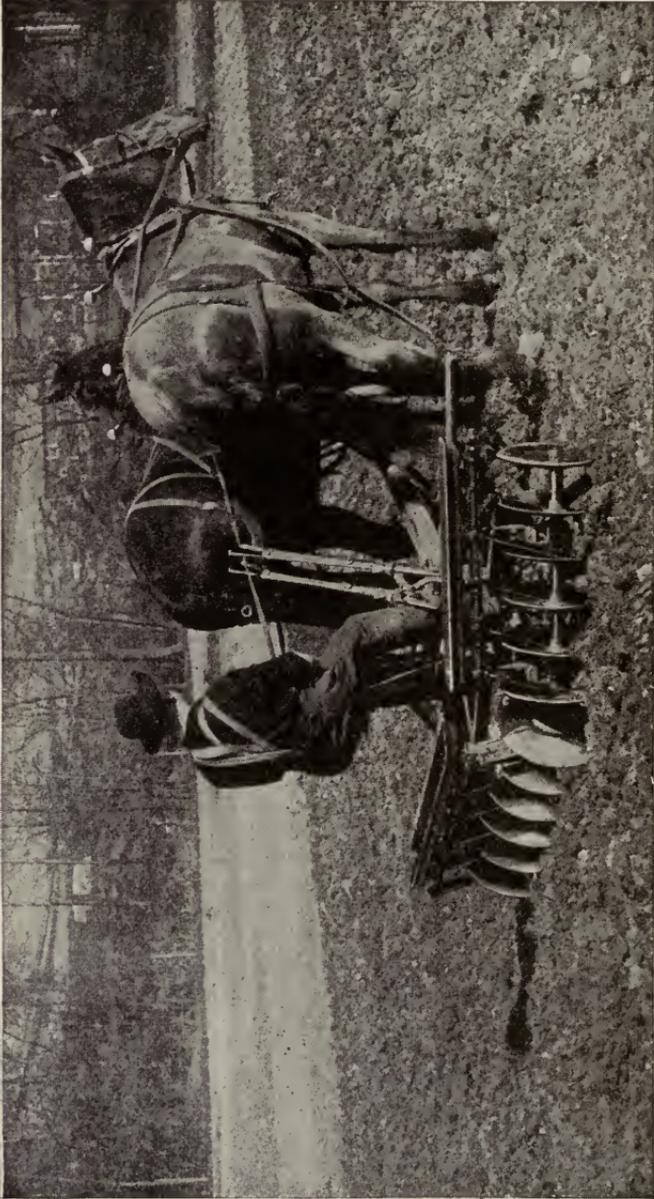

FIG. 53. Cross-disking an alfalfa seed bed helps in obtaining the right soil conditions.  
[Courtesy International Harvester Co.]

freezing and thawing and snow of winter and the beating rains of summer may be very efficient aids in settling the seed bed, and thus save considerable time and labor.

In the case of breaking sod land for alfalfa, a Wallace county reporter offers the following: "Most of my alfalfa was sown on sod ground. I prefer to break in March or April, two or two and one-half inches deep. Follow each half-day's breaking with a roller if possible, or with a disk set straight, while the sod is yet mellow. The idea is to get the sod flat and not to pulverize it. If a disk is used it is necessary to follow with a smoothing harrow and a plank drag to crush the lumps."

Another Wallace county reporter says: "In seeding alfalfa in western Kansas on buffalo grass or blue-stem grass, without irrigation, the safest method of securing a stand is to sow on freshly broken sod in early spring. On salt-grass land the grass should be killed out before seeding." (See pages 234 and 235.)



FIG. 34. A land roller is a very efficient aid in firming the seed bed.  
[Courtesy Kansas Experiment Station.]

#### INOCULATION.

Artificial inoculation is not very generally practiced among the growers reporting. There were some, however, located mostly in the eastern third of the state, who reported having inoculated soil for alfalfa. The most popular method of inoculation is that of scattering from 300 to 500 pounds of soil from an old alfalfa field over each acre of the new field by hand, just before seeding, and diking or harrowing it in. Soil from near the surface of the old field, or a sweet-clover patch, is preferred. Some

growers report having tried cultures, which are applied to the seed according to the directions sent with them. Not a few growers, upon being asked whether or not they inoculate for alfalfa, replied that they are in the habit of applying barnyard manure, with a spreader, at the rate of about ten loads per acre.



FIG. 35. The smoothing harrow levels and pulverizes the surface soil. The harrow cart is a great labor saver.—[Courtesy Moline Plow Co.]

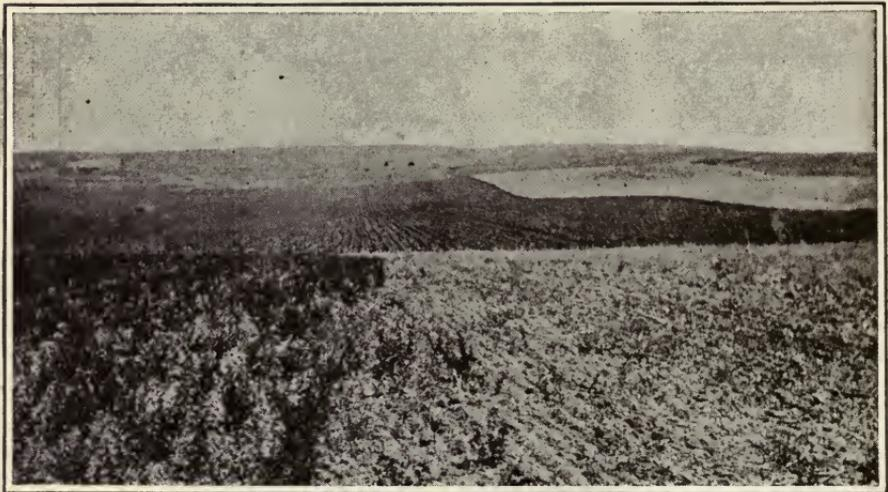

FIG. 36. Inoculated portion of alfalfa field to the left; uninoculated portion to the right. [Courtesy Nebraska Experiment Station.]

One can not be sure that inoculation is necessary until a trial seeding has been made. Then, if the plants look yellow and seem to be dying, and if upon examination no nodules are found on the roots, there is indication that inoculation is necessary. Of course, if one has reason to believe that the soil needs inoculation it will pay to inoculate without first making a trial. (See pages 215 and 236.)

## SEED.

Eighty-four per cent of the growers reporting expressed preference for home-grown seed as compared with seed grown in distant localities. Almost 16 per cent said that it made no difference to them where the

seed came from. All of those represented by this 16 per cent are located in the eastern one-third of the state. Only one grower expressed preference for foreign-grown seed.

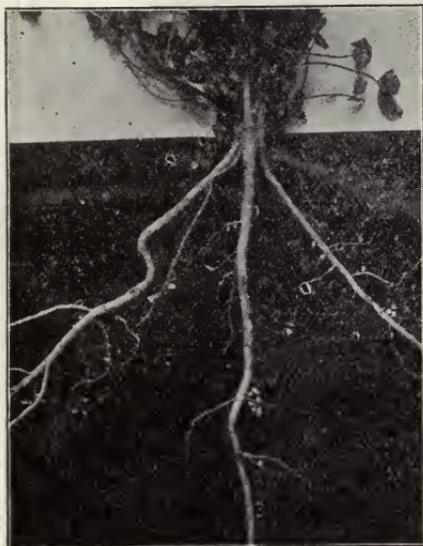

FIG. 37. Nodules on a young alfalfa plant.  
[Courtesy Wisconsin Experiment Station.]

About 35 per cent of the correspondents report testing their seed for germination. They are evenly distributed throughout the state, and it can not be said that the practice is more prevalent in any particular section. All those who have tried it consider the testing of seed well worth the time and effort, for by so doing they know the right amount to plant to get a stand, and are enabled to detect inferior seed. They report that there are large quantities of trash upon the market, sold as good alfalfa seed. Home-grown seed seems to test better than seed from

a distance. Seed grown under irrigation is said to be inferior to seed grown under ordinary methods of culture. A general opinion prevails that good seed will test from 90 to 98 per cent, most growers refusing to plant seed which will not test 90 per cent good.

Seventy-two per cent of the alfalfa growers reporting examine their seed for impurities or adulterants before planting. These examinations establish the fact that there is always more or less weed seed and dirt found among the alfalfa seeds:

*Labette county*: "Too many weed seeds in the best."

*Marion county*: "Some is nearly worthless, compared with prime seed that is 98 per cent pure."

*Coffey county*: "I would not sow some seed if it were given me."

*Sumner county*: "We find it generally from 95 to 96 per cent pure."

*Washington county*: "It leads us to think a state law should be enacted to control the same."

It is undoubtedly the part of wisdom to buy from reliable seed firms, or to know that the seed comes from weed-free fields. Here are several reports bearing on this subject:

*Crawford county*: "I buy a high grade of seed from a reliable dealer."



FIG. 38. Alfalfa nodules, greatly magnified.—[Courtesy Nebraska Station.]



FIG. 39. The surface soil from an old alfalfa field or a patch of sweet clover may be used to inoculate new fields.—[Courtesy *Hoard's Dairyman*.]



FIG. 40. Scatter inoculated soil over uninoculated fields at the rate of 300 to 500 pounds per acre and harrow it in immediately.—[Courtesy Wisconsin Experiment station.]

*Montgomery county:* "We buy the best goods we can get."

*Rush county:* "I have had little trouble when buying first-grade seed."

Many believe home-grown seed most likely to be clean, and report something like this:

*Lyon county:* "With twenty-five years' experience risking my eyes trying to find adulterants in home-grown seed, I find a very small proportion of impurities."

*Wilson county:* "We buy only tested seed, and that nearly always from neighbors we know."

That recleaning is often a profitable practice is the testimony of quite a number of growers, who report in a manner similar to the Lane county man who says, "I always thoroughly reclean my seed in a good fanning mill before planting."

The principal adulterants and impurities reported as found in alfalfa seed are the seeds of foxtail, crab grass, pigweed, Russian thistle, and dodder, in the order named. "Weed seed" is mentioned quite often, in a general way, without naming the particular kind. (See pages 205 to 214.)

As to age, one grower reports success in planting alfalfa seed that was five or six years old.

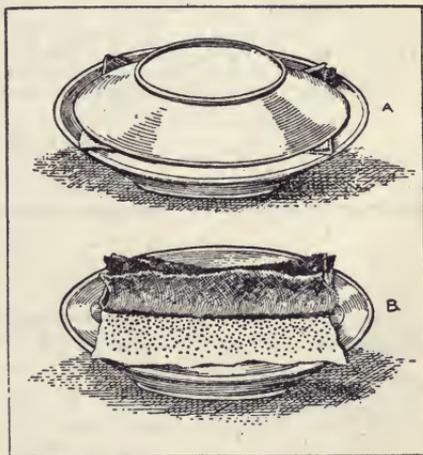

FIG. 41. A homemade device for testing seeds. "A" closed, "B" open. See page 207. —[Courtesy U. S. Department of Agriculture.]

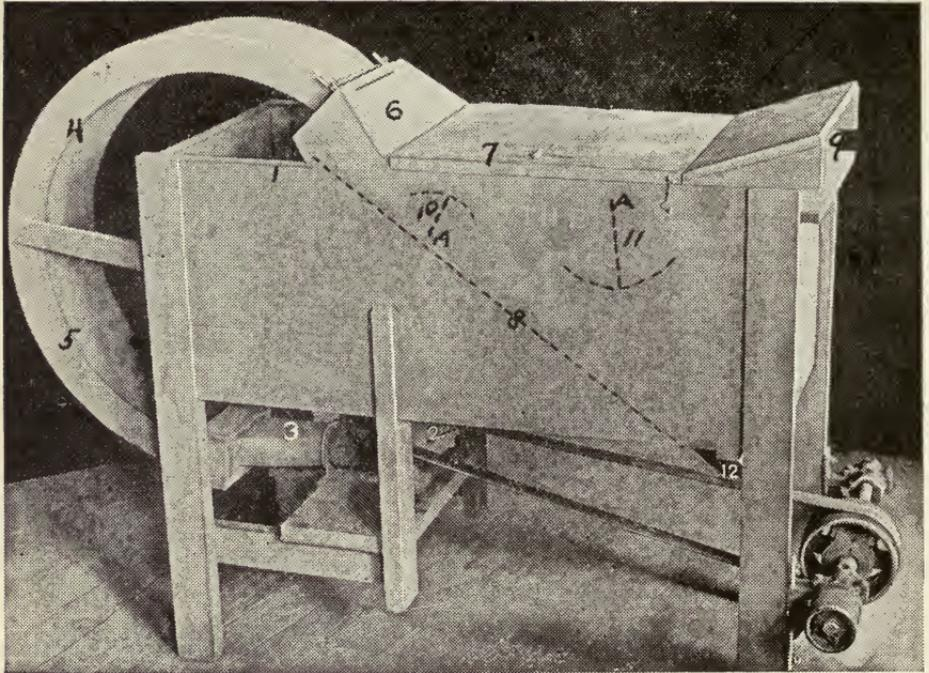

FIG. 42. An alfalfa seed scratcher. One reason why we plant so many pounds of alfalfa seed per acre is the fact that many of the seeds have such hard coats that they do not germinate the first year. Prof. H. D. Hughes, of the Iowa Experiment Station, invented this machine, with which it is possible to increase the germination to 90 per cent of seed which before scarifying did not germinate 10 per cent.—[Courtesy *Farm and Fireside*.]

TIME OF SEEDING.

TABLE No. 3. Growers' preference as to time of seeding.

	Western third of the state, per cent.	Central third of the state, per cent.	Eastern third of the state, per cent.	The state as a whole, per cent.
Prefer fall seeding .....	12	51	61	52
Prefer spring seeding .....	84	46	27	41
Have no preference .....	4	3	12	7

Growers preferring to sow alfalfa in the spring give as their principal reasons: better moisture condition of the soil; less danger from winterkilling; the avoidance of grasshoppers, which are most troublesome in the fall; and less danger from soil blowing.

The advocates of fall sowing, on the other hand, contend: that there is no trouble about weeds choking out the young plants (more than 65 per cent of them mentioning this point); that a fuller use of the land is had in the year of seeding; and that a better crop of alfalfa is obtained in the first growing season. These latter contentions are more clearly

understood when one considers that a fall sowing is usually preceded by an early maturing crop in the same season, and that a crop sown in the preceding fall and coming successfully through the winter is quite likely to give a higher yield of hay in the first growing season than a crop sown in the spring. A typical opinion, from a Wabaunsee county advocate of fall sowing, reads: "The plants get a good start in the fall, without weeds, and we have three good crops the following year; whereas by sowing in the spring there is a continual mowing of annual weeds, without getting a crop to speak of the first year."

These preferences and reasons seem entirely consistent with climatic and other conditions. For instance: in the western third of the state, where the rainfall is light, where grasshoppers are most numerous, and where the cold winter winds are more apt to sweep the prairies, the conditions are preponderantly unfavorable to fall seeding; whereas in the eastern third of the state, where the spring rains are so much greater, and favorable to the growth of weeds and to a more complete use of the soil, spring seeding is bound to be attended with much greater risk than is fall seeding. In the central third, where these two extremes merge, preference should reasonably and naturally be expected to be about evenly divided.

The answers in reply to the question about the exact dates of sowing were extremely variable, indicating the influence of varying weather and other conditions. Spring plantings are made as early as from about March 1 to as late as about June 1, and sometimes a little later. They are most often made between March 15 and May 15. Fall plantings are usually made from about August 15 to September 15, some a little earlier and some a little later. It would seem that in the spring it is the custom to wait until danger from hard freezing is past, and to sow before it becomes too hot and dry, while in the fall it is necessary to wait until the fall rains make the soil-moisture condition favorable, but not until it is so late that the plants can not become well established before winter. (See page 235.)

#### NURSE CROP.

The use of a nurse crop is not general over the state.

TABLE No. 4. Preference for or against a nurse crop.

	Western third of the state, per cent.	Central third of the state, per cent.	Eastern third of the state, per cent.	The state as a whole, per cent.
For a nurse crop.....	20	20	38	28
Against a nurse crop.....	44	43	26	36
No experience with a nurse crop.....	36	37	36	36

Analysis of the replies of those having experience with a nurse crop, as compared with the time of sowing, shows 54 per cent of the spring sowers to be against a nurse crop and 46 per cent for it, while the fall sowers stand 81 per cent against and 19 per cent for it. Nearly all of the spring sowers who favor a nurse crop are located in the eastern part

of the state. Returns indicate that a nurse crop is not successful unless there is a very abundant supply of moisture, returns from the western part of the state particularly indicating that such a crop is likely to rob the alfalfa plants of much-needed moisture. The chief value of a nurse crop is supposed to lie in its ability to choke out weeds. It is also said to be sometimes of value in pumping excessive moisture out of the soil. Oats, at the rate of one bushel per acre, are used for the nurse crop, almost exclusively. (See page 236.)

#### ALFALFA IN COMBINATION WITH GRASSES.

Eighteen per cent of our correspondents report having sown other grasses with alfalfa. Of those who have so planted, 62 per cent report success and 38 per cent report failure. Where other grasses are so sown, the object is to get pasture that will not cause bloat. Here are some of the replies:

*Allen county*: "Yes. I now have the best tame-grass pasture I ever saw. It was seeded with alfalfa, sweet clover, red clover, English blue grass, timothy, and orchard grass."

*Butler county*: "I have had good results with red clover, English blue grass and alfalfa for pasture."

*Franklin county*: "Yes, with blue grass, for pasture. Stock won't bloat."

*Rooks county*: "I have tried, but have not found a grass that will live among it here."

*Wabaunsee county*: "Yes. I have seeded alfalfa with Kentucky blue grass, orchard grass and timothy, but the blue grass soon killed out the others."

Nearly all of the successes in combining alfalfa with other grasses are reported from the eastern part of the state, where rainfall is plentiful. The only grass that seems to have succeeded where tried in combination with alfalfa is English blue grass, and that in regions where it is most commonly grown. There are no data to indicate the proportions, the amount and the time of seeding.

#### BROADCASTING VERSUS DRILLING.

Taking the state as a whole, growers are almost equally divided on the question of broadcasting versus sowing by drill. In the western third of the state, 57 per cent drill and 43 per cent broadcast; in the central third, 51 per cent drill and 49 per cent broadcast; and in the eastern third, 42 per cent drill and 58 per cent broadcast. Those using the drill prefer to have the drill rows about three or four inches apart. It would seem that there is preference for broadcasting where considerable moisture is present, and for drilling where drier conditions prevail. The opinions of some of the growers, in the matter of broadcasting versus drilling, follow:

*Barton county*: "I prefer broadcast seeding. It makes it easier to mow and there is an even stand than with drill seeding. Drilled alfalfa grows too thick in the drills to cut easily."

*Rooks county*: "The drill gives a good stand, but as it grows the alfalfa roots bind."

*Kingman county*: "I prefer to drill if it is possible to get one that will sow thin enough, though I usually broadcast."

*Cloud county*: "I prefer to sow with a drill and keep the disks so they barely touch the ground, covering very shallow."

*Logan county*: "I think the drill the best if it does not get in too deep."

*Kingman county*: "If the ground is moist and in good condition I broadcast."

*Clay county*: "I broadcast if it is wet, and drill if it is dry."

*Johnson county*: "I prefer a drill if it is dry, and broadcast if there is plenty of moisture."

*Graham county*: "Broadcast if you have cool, cloudy weather; otherwise drill."

*Sedgwick county*: "Broadcast when the weather is calm, but drill when the weather is windy."

*Trego county*: "I have most always sowed broadcast. If drilled the wind is likely to fill in the drills when the first two leaves come and bury the alfalfa, or a heavy rain will do the same."

*Clay county*: "Drilling gives a better stand, but broadcasting stands the heavy rains best."

*Osage county*: "If you drill be sure and close the drill marks with the harrow or roller, as a heavy rain will bury the young plants."

*Greenwood county*: "If I sow in the fall I prefer drilling, and broadcast in the spring."

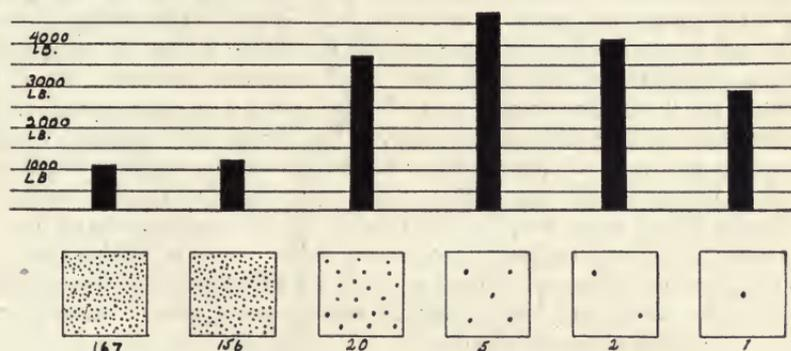

FIG. 43. Comparative yields of alfalfa from thick and thin stands. Each square represents a square yard, and the dots the number of plants growing in such an area. The columns above the squares indicate the yields of air-cured hay per acre from the corresponding stands.—[Courtesy North Dakota Experiment Station.]

#### AMOUNT TO SOW PER ACRE.

The reports on the amount of seed to sow per acre vary considerably, ranging all the way from 6 to 20 pounds. The average amount sown in the eastern third of the state is 16.09 pounds, in the central third 15.44 pounds, and in the western third 14.61 pounds. The estimates in the western third vary from 6 to 20 pounds, in the central third from 11 to 20 pounds, and in the eastern third from 12 to 20 pounds. These amounts are for high-grade seed.



FIG. 44. Grain drills with special alfalfa and grass-seed attachments are very popular for sowing alfalfa seed.—[Courtesy International Harvester Company.]

#### SEEDING IMPLEMENTS.

Of the implements used in sowing seed, grain drills with special grass-seed attachments are more in use than any other. Thirty-nine per cent of the growers reporting on the subject use them. Next in importance are the wheelbarrow, end-gate, and hand broadcast seeders. They are represented, in all, by 35 per cent of the growers reporting, the wheelbarrow seeders alone being represented by 23 per cent of the growers. Seventeen per cent of the growers reporting on the subject of seeders mentioned special alfalfa drills, 9 per cent special alfalfa broadcast seeders, and only 4 per cent reported using the old-fashioned hand method of sowing. Returns indicate that where alfalfa seed is drilled, either a special alfalfa drill or a common grain drill with grass-seed attachment is generally used; and where alfalfa seed is broadcasted, wheelbarrow and hand seeders are most popular.

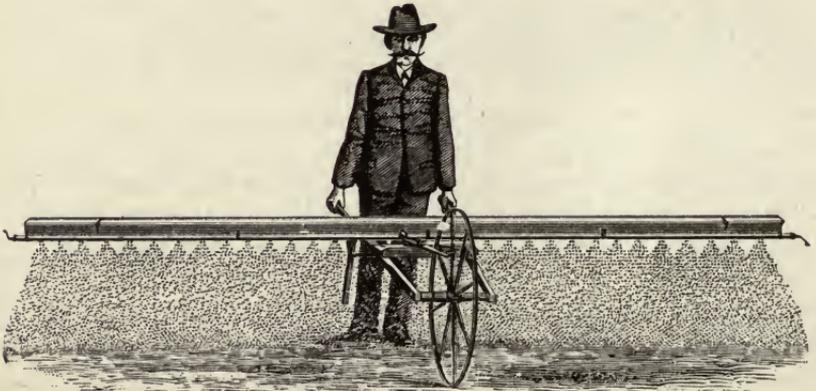

FIG. 45. Wheelbarrow seeders are used by 23 per cent of the growers reporting. [Courtesy O. E. Thompson & Sons.]

## COVERING THE SEED.

Growers were unanimous in asserting that alfalfa seed should be covered lightly. Replies specified depths varying from one-half inch to one and one-half inches, there being about the same variation in all parts of the state. The average depth preferred is about one inch. "Harrow lightly," "Cover as shallow as possible," "Harrow once," "Harrow lightly, both ways," and "Harrow just enough to cover," are typical replies. One grower said, "It depends on the soil; deeper in sandy soil"; and another said, "It must go into moist soil, and must therefore be planted at least one inch deep."

## SUCCEEDING WHERE PREVIOUSLY FAILED.

Another question asked was: "Have you succeeded with alfalfa on land where it had previously failed? How?" The majority of the growers who have tried report that it generally can be done. The first thing to consider is the reason for the previous failure. It may have been because of a need of drainage, manuring, liming or inoculation, or because of faulty soil preparation, or of temporarily unfavorable weather or soil conditions. When the cause of the failure is determined and removed or avoided, a second trial will generally prove successful.

## IMPROVING THE STAND.

The following question was asked: "With a poor stand of alfalfa, have you ever had any success in improving the stand by re-

seeding without plowing it up?" The replies to this question would indicate that while considerable success is had in reseeding patches or spots, it is not often that a stand which is thin throughout is thickened by re-seeding without plowing it up. Most of the instances of successful thickening are with alfalfa not over a year old. Old alfalfa has a tendency to shade and smother out any young plants that may start.



FIG. 46. Hand seeders are used to a considerable extent.—[Courtesy Cyclone Seeder Company.]

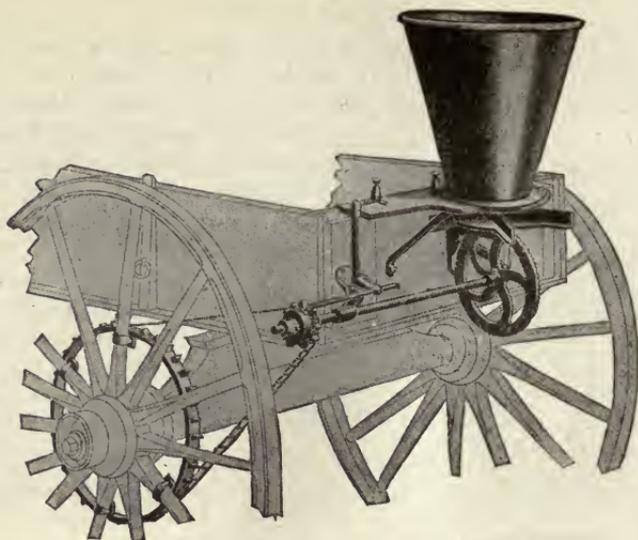

FIG. 47. An end-gate seeder.  
[Courtesy S. Freeman & Sons Mfg. Co.]

Most of the growers reporting success in improving a stand recommend disking or otherwise cultivating the field before reseeded. After reseeded a harrowing is generally given. The time to do this work is almost invariably specified as early spring before the old alfalfa starts, although there are some who, upon getting a thin stand by spring sowing, resow in the fall. An abundance of rainfall is, of course, very favorable. A method of thickening a stand, which was mentioned quite a number of times, is that of allowing a crop of alfalfa to go to seed and shatter out, later harrowing the seed into the soil. Some growers recommend frequent clipping of the old alfalfa until the young plants get a start. Here are some reports on the subject:

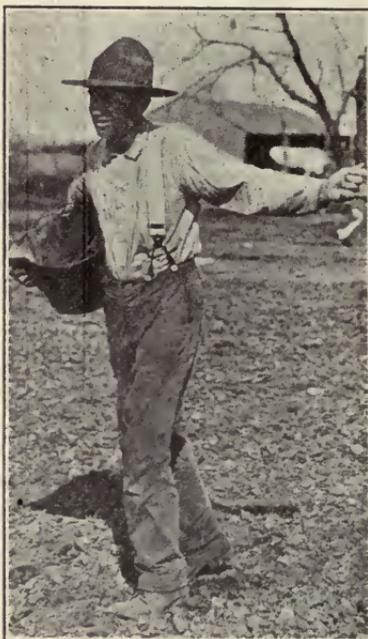

FIG. 48. Not many growers use the old-fashioned hand method of sowing.  
—[Courtesy *Farmers Mail and Breeze*.]

*Neosho county*: "Very little success if the field is thin all over. Bare patches can be brought out by reseeded, but if a thin stand I would plow up."

*Wabaunsee county*: "I have spent a great deal of money trying to thicken the stand, but always without success."

*Ness county*: "Yes. Disk, sow the seed, and then harrow. Do it in the early spring."

*Cherokee county*: "Disk twice in February or March and sow the 1st of April."

*Morris county*: "Sow very early and cut often to keep the old alfalfa from smothering the young plants."

*Mitchell county*: "Yes. Sometimes a failure. Sow with plenty of moisture before the rest of stand is too old."

*Geary county*: "Yes. If sown in fall reseed early the following spring, and if sown in spring reseed in the following fall, but never later."

*Wichita county*: "Very little, except with a young stand. After one year old I would plow it up."

*Harvey county*: "Our alfalfa improves itself when we raise a seed crop."

*Republic county*: "Let the second crop go to seed and pasture it off with horses. Harrow good in the fall."

#### WEEDS IN YOUNG ALFALFA.

Weeds in young alfalfa are sometimes a very serious pest, and the best remedy, as reported, is prevention. Preceding crops should be well cultivated, and kept as free from weeds as possible. The seed bed should be reasonably clean at time of sowing, and the alfalfa seed should be free from weed seed. The system of fallowing alfalfa land and destroying the sprouted weeds as often as they appear, with the harrow, is good. Where weeds usually give great trouble with spring-sown alfalfa, fall seeding is an excellent means of avoidance.

When weeds are very thick and troublesome young alfalfa plants are sometimes smothered out; the weeds simply take the field. The only thing to do in instances like this is to plow the field, cleanse it of weeds, and resow with pure seed. There are few fields that do not have some weeds during the first growing season, however, and certain practices have proved beneficial. The most common practice is that of clipping with the mower. There is danger in clipping young alfalfa too closely, and the cutter bar should be set to cut, as one reporter expresses it, "as much of the weeds and as little of the alfalfa as possible." Several reporters say that they wait until the alfalfa is in bloom before clipping; others watch the weeds, and endeavor to cut close to the time of their seeding, though before there is danger of the alfalfa going to seed. Still others advocate clipping "high, and as many times as necessary; often three or four times." Unless the volume is so great as to smother the alfalfa plants, the clippings of weeds are usually left lying where they fall. There are growers who, under these circumstances, fight weeds by disking or using the spike-tooth harrow, the spring-tooth harrow, the alfalfa renovator or the alfalfa cultivator, but many consider such methods too strenuous for young alfalfa in its first growing season. Following are some of the replies received in regard to this question:

*Greenwood county*: "Mowing when the alfalfa begins to bloom will destroy weeds in a young field. Mowing earlier than that will kill the young plants."

*Geary county*: "Use a good mowing machine. Don't cut the first time till you see a few blossoms, and let the first two cuttings lie on the ground, no matter how heavy the weed crop is."

*Chautauqua county*: "I don't favor too much mowing in the first year."

*Elk county:* "One of the most injurious things I know of is the practice of cutting young alfalfa too soon; it is nearly certain death to cut before in bloom."

*Labette county:* "Repeated clipping of spring-sown alfalfa with the mower set rather high will get rid of weeds. Clip often enough so that raking is not necessary."

*Kingman county:* "Big weeds can be kept down by mowing often, but crab grass and other like weeds are hard to control."

*Jackson county:* "Clip with the mower two or three times the first year. Alfalfa never yields much the first and second years on upland. Mow regularly and be patient."

*Logan county:* "Mow when the alfalfa plant is about 12 or 15 inches high, setting the cutter bar just as high as possible."

*Mitchell county:* "I find the best way to destroy weeds is to mow them off a little above the young alfalfa."

*Osage county:* "Use the mowing machine with the cutter bar set high. Coarse weeds very seldom injure a stand if clipped before they become woody."

*Mitchell county:* "Keep them clipped off but not too closely. If heavy enough to smother the young alfalfa, rake and remove."

*Seward county:* "I let them all come together till the alfalfa is in bloom and then cut with the mower."

*Scott county:* "It is impossible to destroy the weeds the first year. The second year the alfalfa will do it if you have a good stand."

*Hodgeman county:* "Mow as soon as they get above the sickle bar and fire it into 'em' every time, the first season. Disk early the second year."

*Johnson county:* "The first alfalfa I ever raised, fifteen or more years ago, the grass and weeds were about to take. I disked one way. Then I disked it the other way. It seemed to help."

(See pages 241 and 332.)

#### WEEDS IN OLD ALFALFA.

The question was asked, "When crab grass, foxtail or blue grass begin to get a hold on a field of alfalfa, how should the field be treated?" Forty-five per cent of the growers expressed the opinion that the only thing to do is to plow the field; 44 per cent suggested remedies, where the infestation is not too great; nearly 11 per cent, located in the western third of the state, said that they are not seriously troubled in this way; and some growers asserted that while nothing seems to control blue grass, crab grass and foxtail may be controlled. Of those suggesting remedies, nearly 73 per cent recommended cultivation in early spring and immediately following the different cuttings, 27 per cent recommended mowing, and a few growers reported that burning over the field in early spring will help. Here are some of the reports:

*Russell county:* "We have no crab grass here, but we have foxtail. I plow it up when it is too bad. If we can get the alfalfa one year old, foxtail won't hurt it."

*Wabaunsee county:* "If the grass is on account of a thin stand it should be plowed up and reseeded, otherwise disking may do good."

*Rawlins county:* "Disk thoroughly, running the disk plates nearly straight."

*Brown county*: "Cultivate crab grass or foxtail; plow blue grass."

*Russell county*: "If there is any surface moisture you can help by disking with a spike disk after cutting the hay."

*Chautauqua county*: "The use of a spring-tooth harrow is the best—points sharp and well weighted down."

*Finney county*: "No crab grass or blue grass here. I irrigate if possible; then the alfalfa will smother out the foxtail."

*Neosho county*: "No experience with blue grass. For crab grass and foxtail let the alfalfa stand until the sprouts of the next crop show on the crown, then cut it about two inches high, and the new crop of alfalfa will in most cases beat the crab grass and foxtail out."

*Douglas county*: "Mow before crab grass and foxtail go to seed."

*Norton county*: "Burn off early in spring, before the alfalfa starts."

*Montgomery county*: "Burning in early spring is about all that can be done."

(See pages 210 to 214 and 332 to 338.)

#### CULTIVATION.

There is great difference of opinion in regard to the cultivation of alfalfa. Some growers think it a good practice; others think it is not a good practice. The reports indicate that if properly done, with the right implements, it is often helpful. Here are some reports not favorable to the practice:

*Douglas county*: "It does not pay to disk. The disk splits the crown and lets water in, and the plant rots."

*Geary county*: "Don't disk or cultivate. It will increase the crop for a few cuttings, but it splits the crown and causes it to rot."

*Lincoln county*: "I killed one field of alfalfa by disking, weighting my disk and setting it to tear out too many crowns."

*Neosho county*: "I do not believe in disking or cultivating. I believe that such practices result in the final death of the plant, as I find where the crown is cut in two, and dirt gets in, the plant will sooner or later rot and die."

*Republic county*: "Never disk or cultivate, as you split the crown and dry rot ruins your field."

*Barton county*: "I don't believe in disking and cultivating, as it thins the alfalfa and damages the crown, thinning the crop of hay."

*Labette county*: "I have used the disk and the renovator in the spring and the disk and harrow after the second and third cuttings, and can see but little improvement, except to hold moisture in case of drouth."

*Geary county*: "I have disked frequently, always leaving a strip through the center untouched, and have never been able to distinguish any difference."

*Wabaunsee county*: "I have disked for many years, and latterly with a spiked disk, but I have failed to see any improvement on the crop by disking. The frosts during the winter seem to loosen our ground sufficiently without disking."

*Chase county*: "Results of cultivation have not been noticeable either way. I do not think the results justify it."



FIG. 49. The effect of disking alfalfa. 1, Plant injured by disking. Note decay at base. 2, Vigorous young plant from two-year-old field. 3, Plant of same age as No. 1 and from same field, not injured by disk.—[Courtesy The Country Gentleman.]

On the other hand, there are many who favor it:

*Nemaha county*: "I disk my field each year, and find it pays, as the ground takes in moisture more readily."

*Reno county*: "I have increased the yield 500 to 800 pounds per acre by disking early in the spring with a spike-tooth disk."

*Scott county*: "I increase the yield one-third by double disking with the spike disk."

*Sherman county*: "I believe after alfalfa is one to two years old the disk is of great benefit. I disked one field, where the grass was coming among the alfalfa, until you would think it was plowed, and in a few days the alfalfa came clean."

*Cloud county*: "Only old alfalfa fields should be disked and cultivated. It makes the hay finer and increases the yield."

*Comanche county*: "The spike-tooth disk opens up the soil well; other disks kill weeds."

*Dickinson county*: "I disk every field of alfalfa once each season. By this method I keep all weeds out, such as foxtail, crab grass and vines."

*Finney county*: "I have disked my alfalfa when I thought it necessary to kill out grass. Otherwise I do not disk or cultivate."

*Rooks county*: "I have used the shovel digger, common disk and the spike-tooth disk. I prefer the spike-tooth. If alfalfa is growing well let it alone."

*Douglas county*: "Cultivation proves very profitable and is the only way to keep your field free from crab grass, foxtail and blue grass."



FIG. 50. Cultivation should be with implements having narrow, blunted teeth, which are not so rigid but that they readily dodge or slip to one side when striking an alfalfa crown.— [Courtesy Light Draft Harrow Co.]

Where so many growers, all practical men, differ so widely in regard to a practice, the reason probably may be found in the manner of performing the operation and the tools with which it is performed. This is evidenced by the following:

*Norton county*: "If proper tools are used I think cultivation is a good thing."

*Osage county*: "I do not like a disk on account of its cutting and bruising the roots too much, causing decay. I sometimes use a common harrow with the teeth set straight. I think a spring-tooth harrow, with lever, is better."

*Ottawa county*: "We find that disking with a common disk thins our stand, and do not advocate the practice. A common harrow is better."

*Finney county*: "Disking is injurious, in that it injures the crowns, causing rot of the root. Cultivation with an implement having blunt teeth may be beneficial if the surface soil becomes packed."

*Russell county*: "I think it best to disk early, about the time alfalfa starts—lightly, with a spike disk or a sharp harrow. I don't like the regular disks; they thin the alfalfa too much."

*Rush county*: "After the field is sown three or four years it may be cultivated with an old hoe drill or a regular alfalfa cultivator, but not disked."

*Ness county*: "A narrow-pointed hoe drill, that will dodge the plants, is good. I do not like a disk that splits the plant."

*Jewell county*: "If you want to kill an alfalfa field just put a disk into it. Use an alfalfa cultivator."

*Thomas county*: "I do not think it good to use a disk harrow or a spike-tooth disk. They split the crown. I claim splitting the crown is injurious to the plant. I prefer a regular alfalfa cultivator of the latest improved type."

*Cherokee county*: "Use something that will not split the crowns. The alfalfa disk or spring-tooth harrow is good."

*Mitchell county*: "My experience has been that disking cuts the alfalfa crown to a great extent, whereas a cultivator does not."

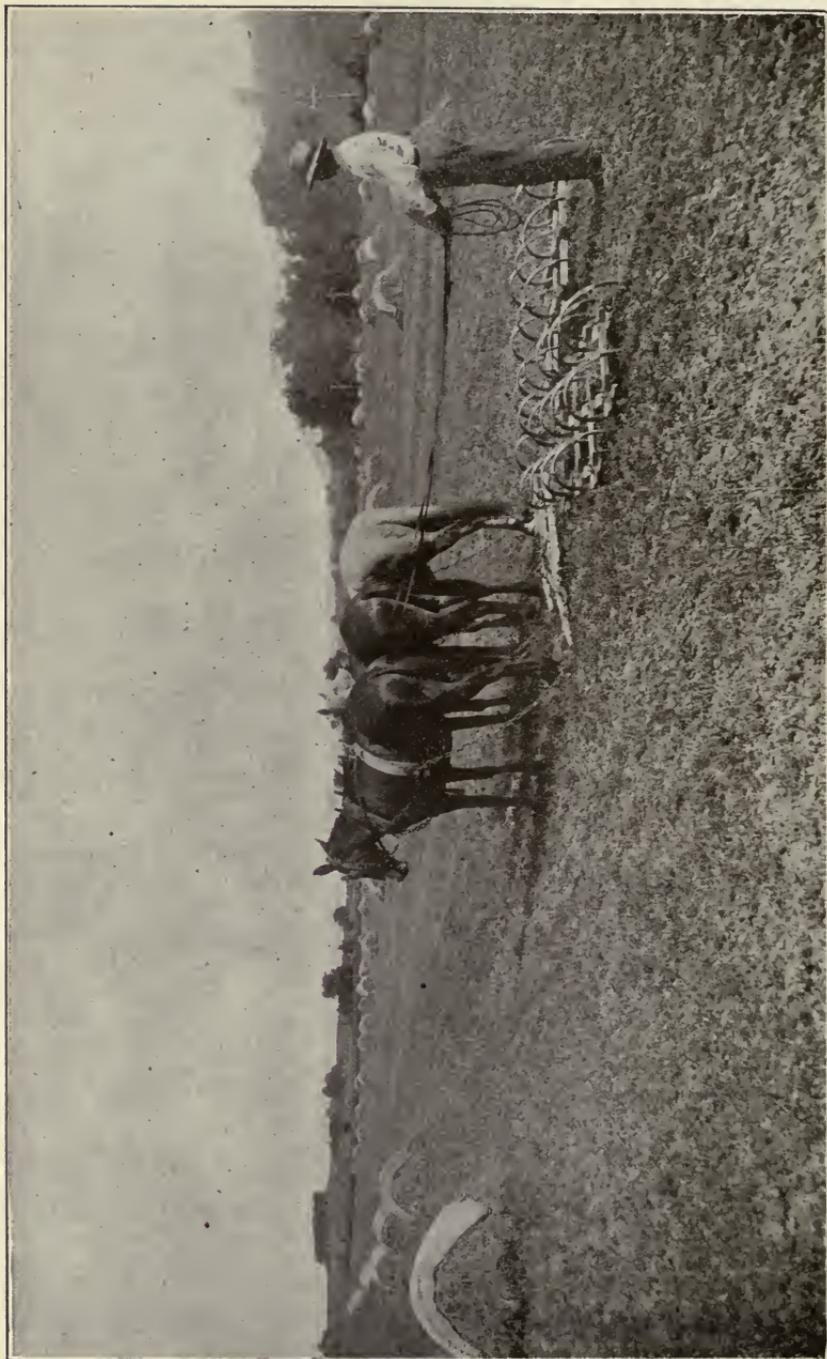

FIG. 51. The spring-tooth harrow does good work at cultivating alfalfa and is an excellent implement to have on the farm.  
[Courtesy Kentucky Experiment Station.]

*Dickinson county*: "Disking cuts into the stalk and injures the plant. I believe in loosening the ground to admit air and rain, but not in cutting roots, to get good results."

*Cowley county*: "I have done some. It is all right if done at the right time with a spring-tooth cultivator. Do it early in the spring and after each cutting."

*Ellis county*: "Disking usually does more harm than good. Shovel tools give the most desirable results."

*Greenwood county*: "I don't like the ordinary disk. I use a spike disk and think it is a good thing to open up the land."

*Brown county*: "I have found that disking makes hollow roots and the plants die out. I now harrow after each cutting."

*Chautauqua county*: "A disk is a poor implement in alfalfa. You can not afford to cut the roots. Any cultivator with sharp, narrow teeth is better."

*Montgomery county*: "Never cultivate before two years old. A disk is too risky. Better use an old hoe drill or the same principle on another machine."

*Mitchell county*: "We use the spring-tooth harrow or the spring-tooth alfalfa renovator. The full-face disk harrow does little good. The spike-tooth harrow does fair work."

From a study of the replies received it would appear that an alfalfa field should be at least two years old before cultivation is attempted; three or four years is better. The cultivation is best done in early spring, after the frost is out of the ground and before growth starts, and, if necessary, after each cutting. The alfalfa cultivator or renovator, the old hoe drill,

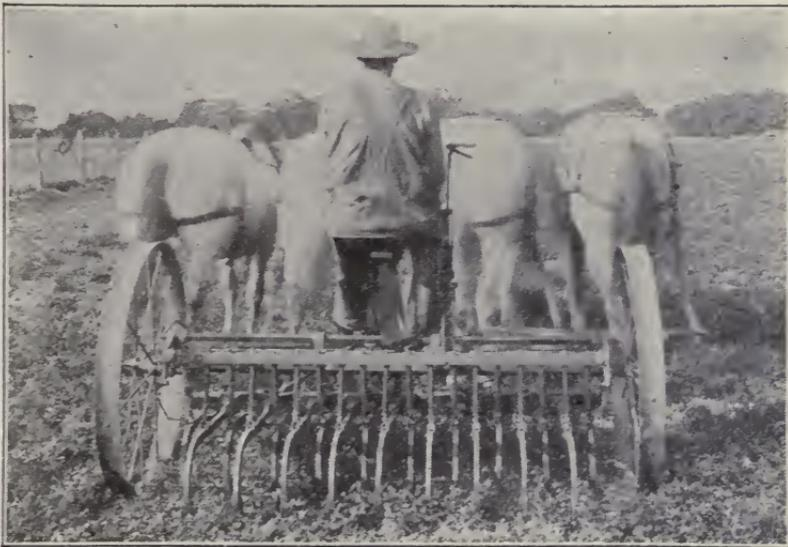

FIG. 52. The regular alfalfa cultivator is a very good implement to use.  
[Courtesy Moline Plow Co.]

the spring-tooth harrow, and the common spike-tooth or smoothing harrow with the teeth set straight, are the best implements to use. It is best that the teeth be narrow and blunted, and not so rigid but that they readily dodge or slip to one side when striking the crown of an alfalfa plant. Sharp blades or teeth that are likely to split the crowns are proving unpopular, for the wounds they make cause decay and death of the plant. The reason for cultivation is to loosen a hard, packed soil, caused by pasturing or something else, and to destroy blue grass, crab grass, foxtail or other weeds.

#### TOP-DRESSING WITH MANURE.

Growers are practically unanimous in their assertions that top-dressing with barnyard manure has a beneficial effect on alfalfa. Such replies as these indicate the value of the practice: "Prolongs life and increases the yield"; "increases the yield on some land fully one-third"; "increases yield



FIG. 53. A top-dressing of manure applied in late fall or winter at the rate of 6 to 10 spreader loads per acre has a very beneficial effect.—[Courtesy *Breeder's Gazette*.]

one-third to one-half"; "stimulates growth and increases yield"; "makes much heavier crop—too rank for seed"; "no crop responds quicker"; "grows darker and ranker"; "made old field look like new"; "prevents land from blowing in this section"; "seems to stand spring heaving better"; "can't make better use of manure"; "think it highly profitable." The effects of top-dressing with manure are particularly noticeable when followed by a wet season.

To secure best results the manure should be well rotted and fine in texture. Otherwise the course straw will be raked up with following cuttings of hay. It should also be reasonably free from foreign seeds, like those of timothy, blue grass or weeds of any kind, for the obvious reason that they will cause trouble by germinating and growing. Light applications should be made, in late fall or winter, at the rate of six to ten spreader loads per acre, the average reported being eight loads. The

manure should be scattered evenly, and while pitchforks may be used, a regular manure spreader will do the work much better and more economically. It is a good idea to harrow the field thoroughly in the following spring in either case, so that the manure may be more thoroughly and evenly scattered, torn apart and worked into closer contact with the soil, thus bringing about quicker results and reducing to a minimum the danger of raking it up with hay.

Most growers prefer to make applications every second year. It was stated by some that top-dressings of manure had best not be made until after the second growing season, although from a number of counties were received reports that light applications of manure are sometimes made to newly sown fields in the fall. Such applications help keep the ground from heaving to the detriment of the young plant. Some typical replies follow:

*Montgomery county*: "Satisfactory. It will probably bring greater returns than manure placed on other field crops."

*Mitchell county*: "Very favorable. The alfalfa grows more luxuriantly, especially with plenty of moisture in the soil. Yields heavier."

*Osage county*: "Very satisfactory. Would consider one load spread on top equal in value to two or three loads plowed under, for alfalfa."

*Douglas county*: "Good results have been obtained, but one should be very careful and not top-dress with manure which is laden with grass and weed seed."

*Coffey county*: "The results have been good when properly applied with spreader and when ground was frozen."

*Rice county*: "Quite successful, especially well-rotted or fine manure."

*McPherson county*: "Don't like to do this during the summer very well, because of making the hay dirty. I prefer the fall or winter."

*Cowley county*: "If done at the right time in winter, all right, but if done in the spring or hot weather it burns it out."

*Leavenworth county*: "Good when put on light and even after the second year's growth."

*Harvey county*: "We use barnyard manure, but do not apply it to young alfalfa."

*Lane county*: "Dress lightly during the winter and disk it in early spring. Very beneficial for several seasons."

*Jefferson county*: "I spread manure, about six tons per acre, every other year. It works fine."

#### TIME TO CUT.

The proper time to cut alfalfa hay is determined by the observation of one or more of three things, namely: the amount of bloom; the sprouts or shoots of the next crop; and the turning yellow of the under leaves of the standing growth. Of the three methods the "bloom" and "shoot" methods are by far the most popular. By the "bloom" method, growers prefer to cut when the alfalfa is from one-tenth to one-half in bloom; the majority prefer one-tenth although when the hay is for horses one-half or even two-thirds or more in bloom is not too far along. In case of a large acreage it is usually necessary to start cutting in the extreme-early stage of bloom, in order that the alfalfa cut last may

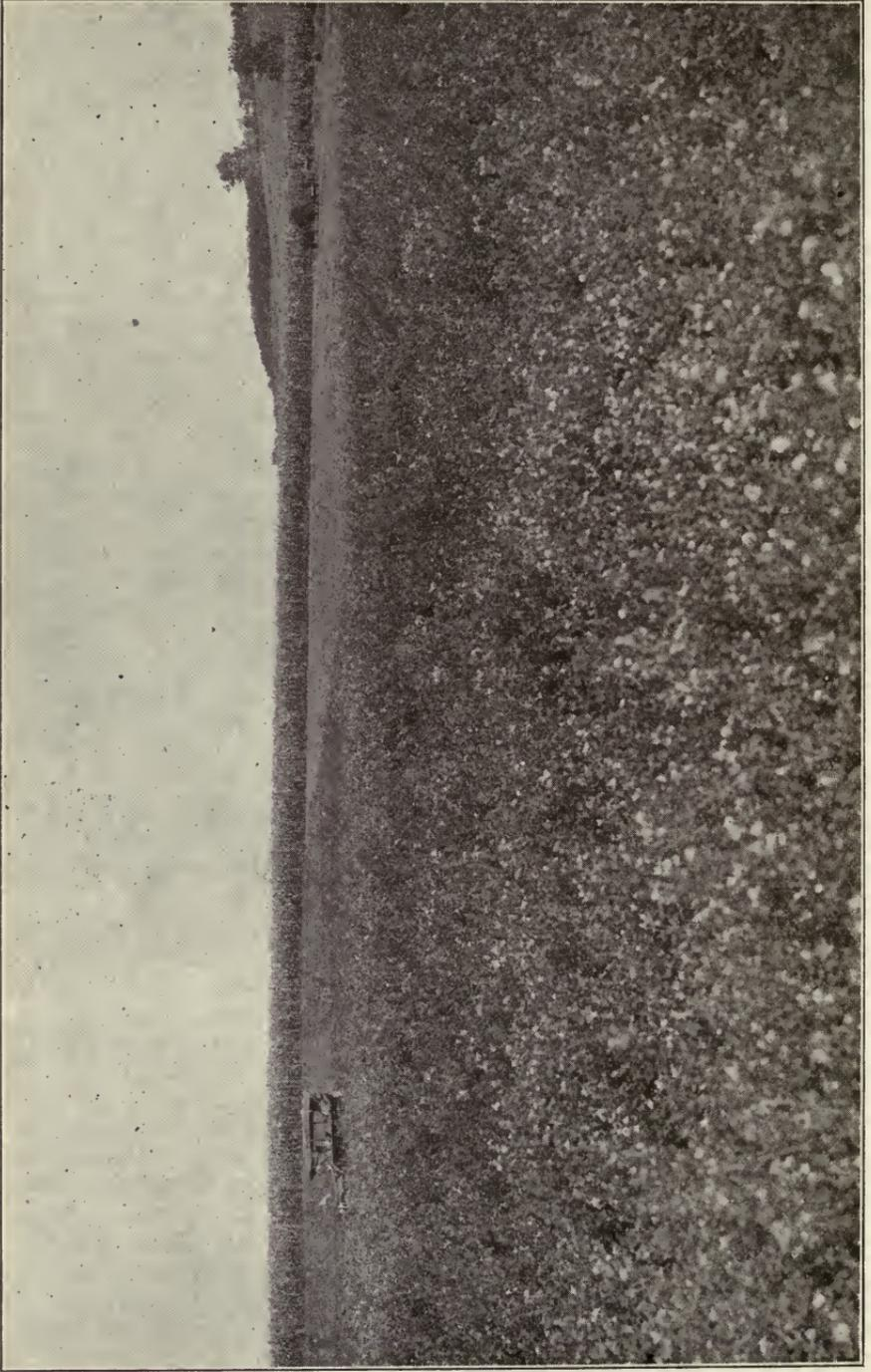

FIG. 54. Some growers cut alfalfa when it is from one-tenth to one-half in bloom. Many others, however, watch the starting of the shoots of the succeeding crop.

not become too far advanced. Often, with the first crop particularly, and in wet seasons, the shoots of the next crop may start before any blossoms show, and may become so high that it is necessary to cut at once. To cut off these young shoots will not only injure the next crop, but may also seriously endanger the life of the plants. Hence many growers, particularly in the eastern third of the state, pay little or no attention to the bloom and watch only the shoots of the next crop; others watch both indications, and some watch the new shoots for the first cut-



FIG. 55. The shoots quickly spring from the crown, and the grower must be on the alert to cut the present crop before the shoots of the next crop get too high.— [Courtesy Wisconsin Experiment Station.]

ting and the bloom for succeeding cuttings. Under certain circumstances, as when the bloom indicates that it is time to cut, it may be unwise to wait for the new shoots. The following represent the different views expressed:

*Jackson county*: "There are three ways to determine: the bloom, the young shoots, and when the under leaves get yellow. Watch all three indications."

*Osborne county*: "For cattle when about one-tenth in bloom, and for horses when one-half in bloom."

*Wyandotte county:* "By the bloom. Begin early or it will be too late when you get around."

*Chautauqua county:* "When in full bloom, unless on account of climatic conditions new growth starts before bloom appears. It should be cut before new growth becomes tall enough to be caught by the sickle."

*Brown county:* "One-tenth in bloom, but I see now, May 16, that there is no bloom on my alfalfa and shoots one to three inches long have started."

*Crawford county:* "First crop when crown sprouts start well; second, third and fourth when about one-fifth in bloom."

*Chase county:* "When it begins to sprout from bottom or when bloom begins to show."

*Miami county:* "I don't mind the bloom. Watch for the sprouts at the crown and cut when one inch high."

*Cowley county:* "We commence when shoots are two or three inches high from the roots."

*Wallace county:* "When one-tenth in bloom. I like to see the young shoots two or three inches tall, and cut above them."

*Labette county:* "Cut, if possible, when the new growth starts. In putting up a large acreage begin the first crop sooner than this. Subsequent cuttings then follow in succession."

*Greenwood county:* "I cut when the bottom leaves begin to turn yellow."

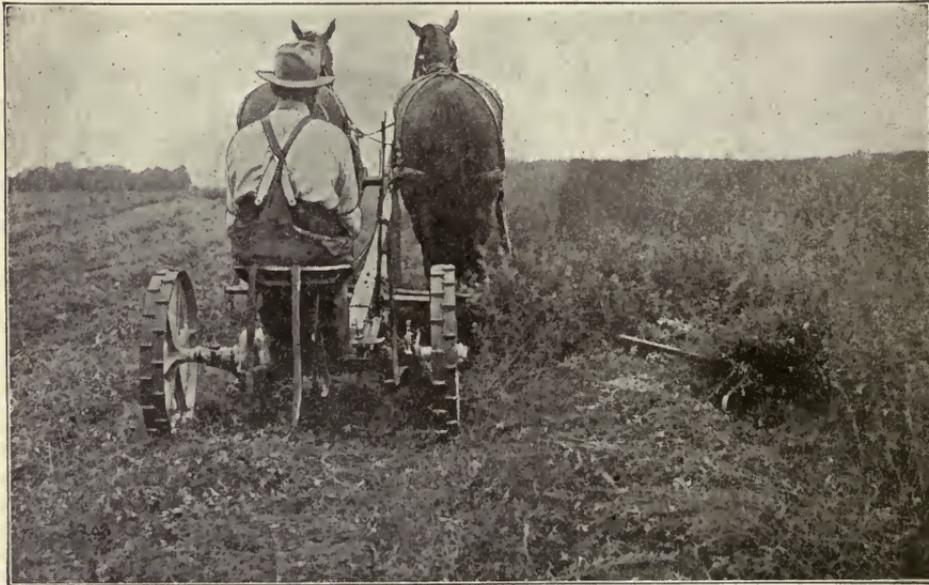

FIG. 56. In well-established alfalfa set the sickle bar about two and one-half inches from the ground.—[Courtesy Emerson-Brantingham Implement Company.]

## HEIGHT TO CUT.

In answer to a question about the height to set the sickle bar in cutting alfalfa, growers estimated the proper height to be from one and one-half to four inches, averaging about two and one-half inches. A large proportion of them advised cutting as closely as possible, frequently volunteering the information that close cutting does not injure the plants, and really seems to have a beneficial effect. Still, a goodly percentage cautioned against cutting too closely, and gave their reasons therefor. Typical warnings read like this: "Mow as high as the mower will cut. Short or close mowing, especially of the first cutting, kills more alfalfa than anything I know of." "Depends on the next crop of shoots. If before next shoots start, cut low; if shoots have started, turn the bar up so as to let them under." "Cut three to four inches high for a new seeding. Afterwards mow as close as you care to." The danger of killing young alfalfa by mowing too closely is discussed at considerable length on pages 241 and 242.

Wide-cut, two-horse mowers are recommended.



FIG. 57. Sufficient growth should be left in the fall to hold the snow for winter protection and moisture.—[Courtesy Wisconsin Experiment Station.]

## GROWTH LEFT TO GO INTO WINTER.

The amount of growth that should be left to go into winter varies from three to eight inches, averaging about four inches, according to reports. Although there are growers, mostly in the eastern third of the state, who contend that it is not necessary to leave any growth, and that late close cutting does not injure the stand, most growers consider it the best practice to make the last mowing so far in advance of the first killing frost that there will be sufficient growth for protection and for catching the winter snows. The plants are protected, to a certain extent, from the ill effects of alternate freezing and thawing, and the

moisture of the snows is retained for the use of the plants. Late, close pasturing is subject to conditions alike to those of late, close mowing. The date of the last cutting or the time to remove animals from pasture varies greatly with the season, and one may, therefore, easily make a mistake. One grower states that when he finds that he has made too late and close a mowing it is his invariable custom to cover the field with coarse manure.



FIG. 58. How late cutting killed alfalfa. That to the left of the picture was cut five times in a season, and that to the right four times.—[Courtesy *Breeder's Gazette*.]

#### RAIN AT CUTTING TIME.

“What do you do in case of rain when alfalfa is at the right stage to cut?” was asked of the growers. Of course every one “does the best he can.” The probability of more rain in the immediate future may vary with different sections, and thus have its effect on the grower’s actions under such circumstances. Also, the acreage to be cut will have its influence. In the western third of the state, where the probabilities of clearing weather in the immediate future are better, the majority of the growers prefer to wait until it is through raining; in the central and eastern thirds of the state, where the bulk of the alfalfa is grown, most growers prefer to cut and “take their chances” of getting the hay up between showers. Rain on alfalfa while it is yet green and has not started to cure seems to do little injury. It is the rain that falls on alfalfa which is partially cured that does the harm. One thing that must be constantly borne in mind is that the shoots of the next crop should not be cut off, and in case of waiting for it to stop raining one should not wait too long, especially with a large acreage, else these shoots will grow too high. The following are some of the replies received:

*Cheyenne county*: “Wait till favorable weather.”

*Hodgeman county:* "Wait till it dries off."

*Thomas county:* "I like to wait till the weather is dry—at least two days—so that I can get it shocked before it rains again."

*Ellis county:* "We cut it and cure it the best we can. Alfalfa that looks like it is rotten we find to be of about as good a feeding value as the brightest hay, for cattle. This is our experience after feeding it a good many years."

*Neosho county:* "I have 200 acres, and don't pay much attention to the rain in regard to cutting."

*Wallace county:* "I don't pay any attention to the weather, but keep on mowing, unless it is raining or is too muddy to mow. Alfalfa cured in damp, cloudy weather usually comes out of the stack in better shape than when it is cut and cured in extremely hot weather."



FIG. 59. With a large acreage it is necessary to start a number of mowers early in the maturity of the crop and early each morning, in order to get the old crop out of the way of the new.—[Courtesy *Farmers' Review*.]

*Franklin county:* "I never watch the clouds until I get it cut."

*Brown county:* "Cut. As long as it is green the rain does not seem to hurt it."

*Harvey county:* "Cut it just before a rain—just so the sun don't get at it before the rain comes."

*Republic county:* "Never stop for rain, as it will not hurt so long as it does not cure."

*Shawnee county:* "If I think it will rain I cut down all I can just before. I can have it up before the next shower."

*Geary county:* "Cut it in the rain, and be ready, when the sun shines, to put it up."

*Crawford county:* "Wait as long as you can. If it gets a rain on before it begins to cure it does no injury."

*Chautauqua county:* "Wait a few days; but if new growth starts, cut and get it off the ground regardless of consequences to that cutting."

*Montgomery county:* "Wait, and run the mower as soon as the ground will permit."



FIG. 60. Mower with windrowing attachment.  
[Courtesy Hoard's Dairyman.]

#### TIME OF DAY TO CUT.

To get hay of the best quality, most growers agree, it is best to cut when no dew or rain is on it. Hay cut with "outside" moisture on it is likely to be dusty, musty, bleached, and with less of the aroma that goes with hay of prime quality. The great majority of growers prefer to start the mower in the morning after the dew is off and run it till noon. Those who have large acreages, while agreeing that waiting until the dew is off will make better hay, usually start as early in the morning as they can and cut as late as they can, so that they may get the present cutting out of the way of the one that is to follow. There are a few who prefer to cut in late afternoon and allow the hay to lay overnight in the swath, raking in the following morning after the dew is off. They claim that dew on newly-mown hay does little damage, and they can then get the hay well cured and in the stack or mow on the afternoon of the day following mowing. Not a few assert that alfalfa cut with the dew on does not gum the sickle, and cuts easier, while there are others who say that wet alfalfa will clog the mower. However, it would appear that the effect on the hay rather than that on the mower should be the first consideration as to the time of day to mow. Here are some opinions about it:

*Nemaha county:* "As soon as dew is off in morning. Dew dries off better before than after cutting."

*Marshall county:* "After dew is off. It spoils more easily with moisture on it than with moisture in it."

*Harvey county:* "Usually let the dew dry, as it seems to bleach the hay if we cut wet and the sun comes out strong."

*Miami county:* "Soon as dew is gone. Cures better and gives hay better color."

*Miami county:* "Always after the dew is off. Dew or rain will make dust."

*Sedgwick county:* "About eight o'clock, so there won't be so much dew on it. The dust will stick on dew alfalfa and make dusty hay."

*Geary county:* "In dry, settled weather mowing in the morning usually allows raking the same evening and saves exposure to dew. Sometimes mowing in the evening allows some curing without sun, which is an advantage. When the ground is wet or the crop heavy, cut any time and rake when ready."

*Riley county:* "In the morning, generally, so as to put up in afternoon what we mow that morning."

*Ellis county:* "We start the mower in the morning, very early, and rake it in the afternoon. One day cures it here, and if you leave it too long you lose the leaves."

*Dickinson county:* "In hot, dry weather at noon; in cool weather in the morning; so it will dry and can be raked at nine or ten o'clock the next morning."

*Wallace county:* "Early, unless dew is very heavy. Would prefer to wait until dew was off, but too many acres to cut over to wait."

*Wabaunsee county:* "After the dew is off the alfalfa, because the hay does not cure as well when it is cut with the dew on it, and also because cutting it with the dew on it has an injurious effect on the next crop."

*Harvey county:* "Depends on weather conditions. If there is a heavy dew I prefer to cut in the afternoon."

*Republic county:* "About two p. m. The leaves do not wilt; they absorb moisture during the night, and we can stack the next day. We have cut our alfalfa the past four years in the afternoon and evening, and find that it cures well and the foliage never falls, even if very dry. We are always ready to stack the next afternoon, unless cloudy and rainy."

(See pages 241 to 243.)

#### CURING.

In curing we are concerned, first of all, with the time to start the rake—with just how long the alfalfa should be allowed to lie in the swath where it falls from the mower. Analysis of reports indicates that alfalfa should not be raked until it is well wilted—wilted to the point where the rake will pick it up clean, without packing or wadding; and it should be raked before it becomes so brittle that the leaves develop a tendency to fall off. Some growers say, "Rake while quite tough."

The time required for cut alfalfa to get into the right condition for raking varies with the weather, from an hour or two to as long as forty-eight or seventy-two hours. On a dry, sunny day, with a strong wind, the time may be very short, while on a damp, rainy day, with showers, possibly, the time may exceed even seventy-two hours. Under ordinary conditions hay cut in bright, warm weather is mowed in the morning and raked in the afternoon of the same day, and hay cut in cloudy weather is mowed in the morning and raked in the morning of the following day. However, the curing of alfalfa hay is a fine art, and as the best of artists fail, no absolute rule can be laid down. Some growers' reports, which are representative of the rest, follow:

*Franklin county:* "Till it is well wilted. In very dry weather rake in windrows right after mower."

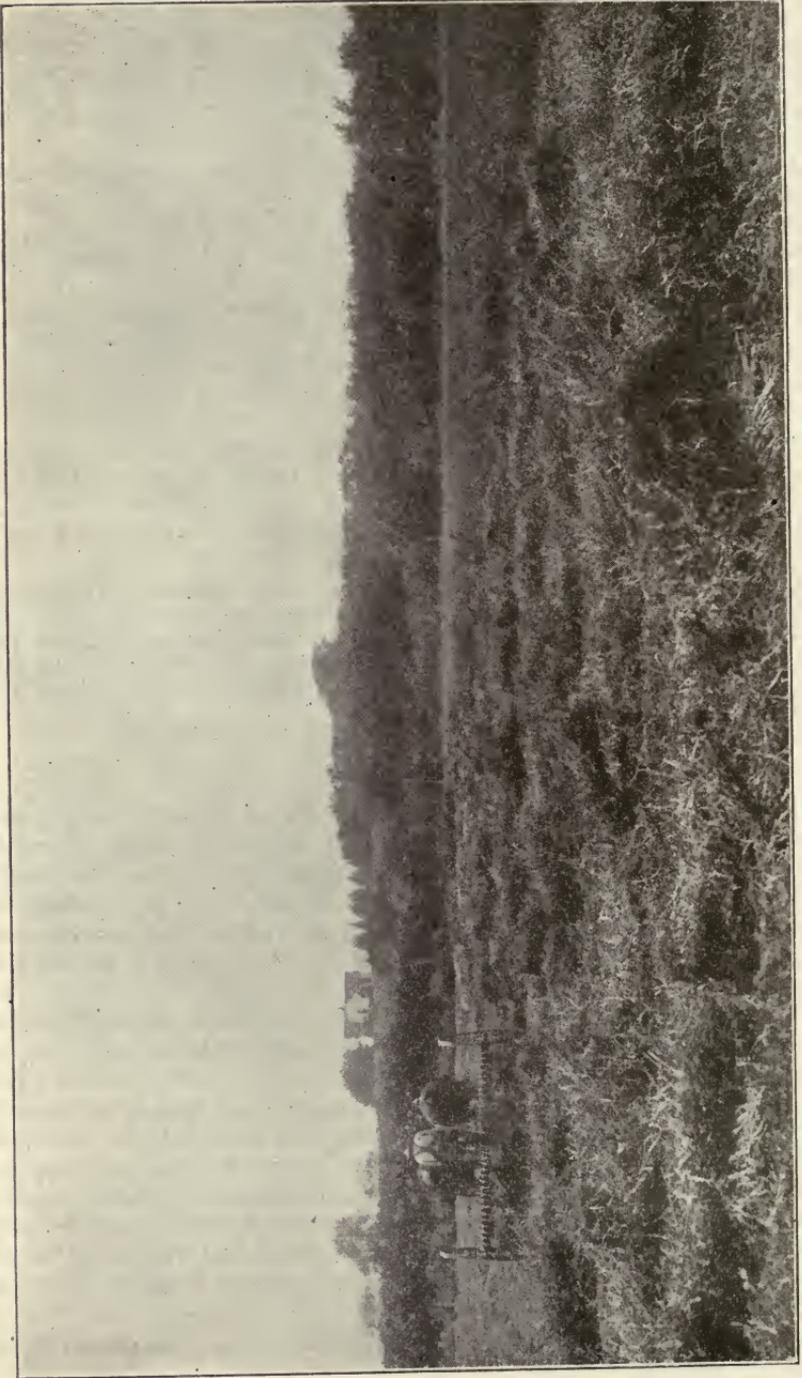

FIG. 61. Alfalfa is ready to rake when it is well wilted.

*Saline county*: "Sometimes over one day. At other times mow in morning and rake and cock in afternoon, especially if it is hot and dry."

*Labette county*: "In good drying weather let it get just well wilted. In damp weather let it cure until nearly dry enough to haul."

*Mitchell county*: "Depends on weather. If alfalfa is very heavy it ought to lie in the swath twenty-four hours; if not, it may be raked the same day it is cut. Don't let it get too dry."

*Labette county*: "One to three days; depends on sunshine."

*Pottawatomie county*: "If there is sunshine it should be raked five hours after it is cut, and left in the windrow. Most people let their alfalfa get too dry before they rake it."

*Pratt county*: "Depends on the wind. On a dry, windy day rake two hours after cutting."

*Sherman county*: "From one-half day to twenty-four hours, according to the weather."

*Sumner county*: "Owing to the weather. Let it lay longer if humidity is plentiful."

*Russell county*: "When the leaves are wilted soft, but not yet brittle."

*Ottawa county*: "Depends on condition of weather, how long it is left in swath. We start the rake as soon as it is dry enough to rake clean, and before the leaves begin to shatter."

*Rawlins county*: "I start the rake just as soon as it will rake clean."

*Morris county*: "Just as soon as wilted and the rake will take hold."

*Wichita county*: "I aim to rake as soon as the hay will not pack or wad."

Nearly all growers believe that hay of the highest quality is best obtained by slow curing, and that curing is best done by air under the more or less shaded conditions obtaining in a pile of some kind. Obviously the swath is a very poor place to cure hay, and reports indicate that hay cured in this way is of poor quality and subject to an excessive loss of leaves. The best results are usually obtained by cock curing. By this method the color and aroma are better, and the danger of spoilage from outside moisture, of getting dusty hay, and the loss of leaves, is reduced to a minimum. Yet, in spite of these facts, two-thirds of the growers reporting prefer to cure in the windrow.

The reason for the greater preference for windrow curing may be accounted for in the facts that it takes longer to put up hay by the "cock" method, and requires more hand labor, which is expensive. Haying machinery has been so developed that large quantities of hay may be most quickly and economically handled, by fewer men, where the "windrow" method is followed. This is particularly true in the handling of large acreages. Cocking seems better adapted to and is most generally preferred on the smaller acreages and in the more humid regions. Most growers would rather have hay in the cock, in case of rain, than in the windrow. Weather conditions, however, generally demand that hay that is "down" be handled as quickly as possible; and when it is cured, the sooner it is in the stack, the shed or the mow, the better, both for the present crop of hay and for the next crop.

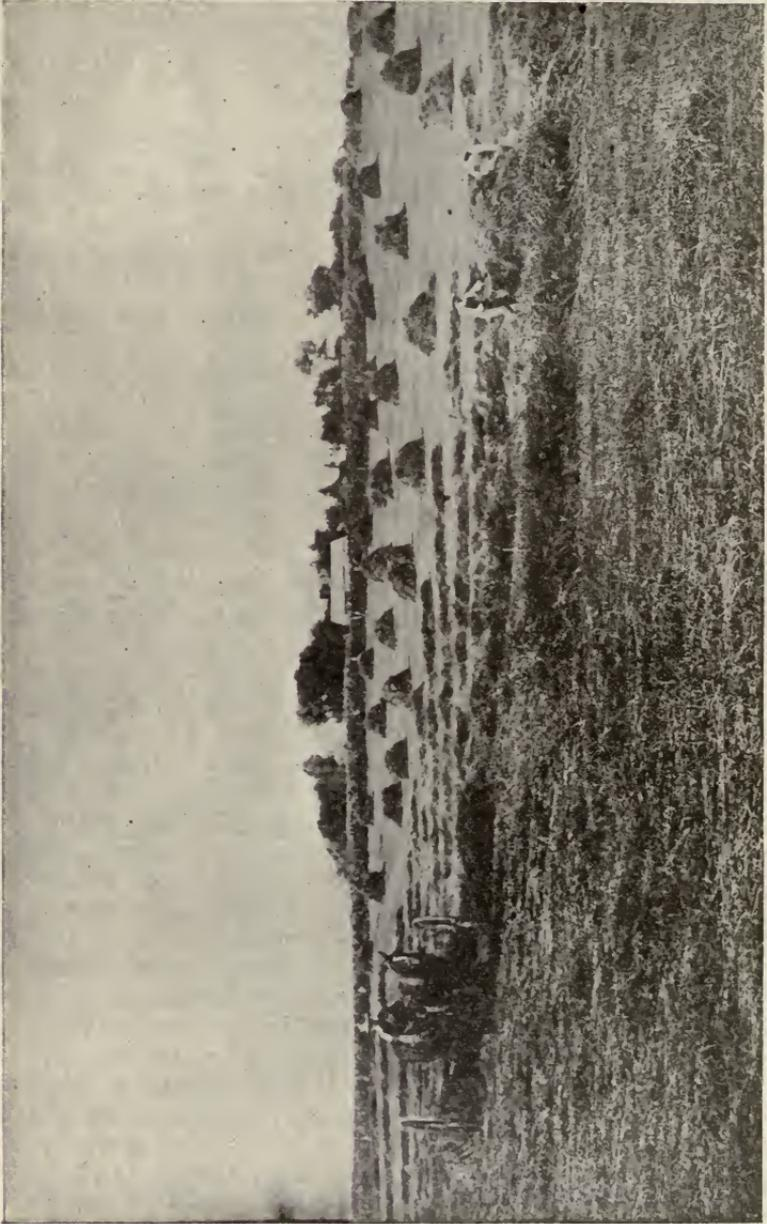

FIG. 62. Hay to be cured in the cock is raked to the windrow and cocked immediately.  
[Courtesy Iowa Experiment Station.]

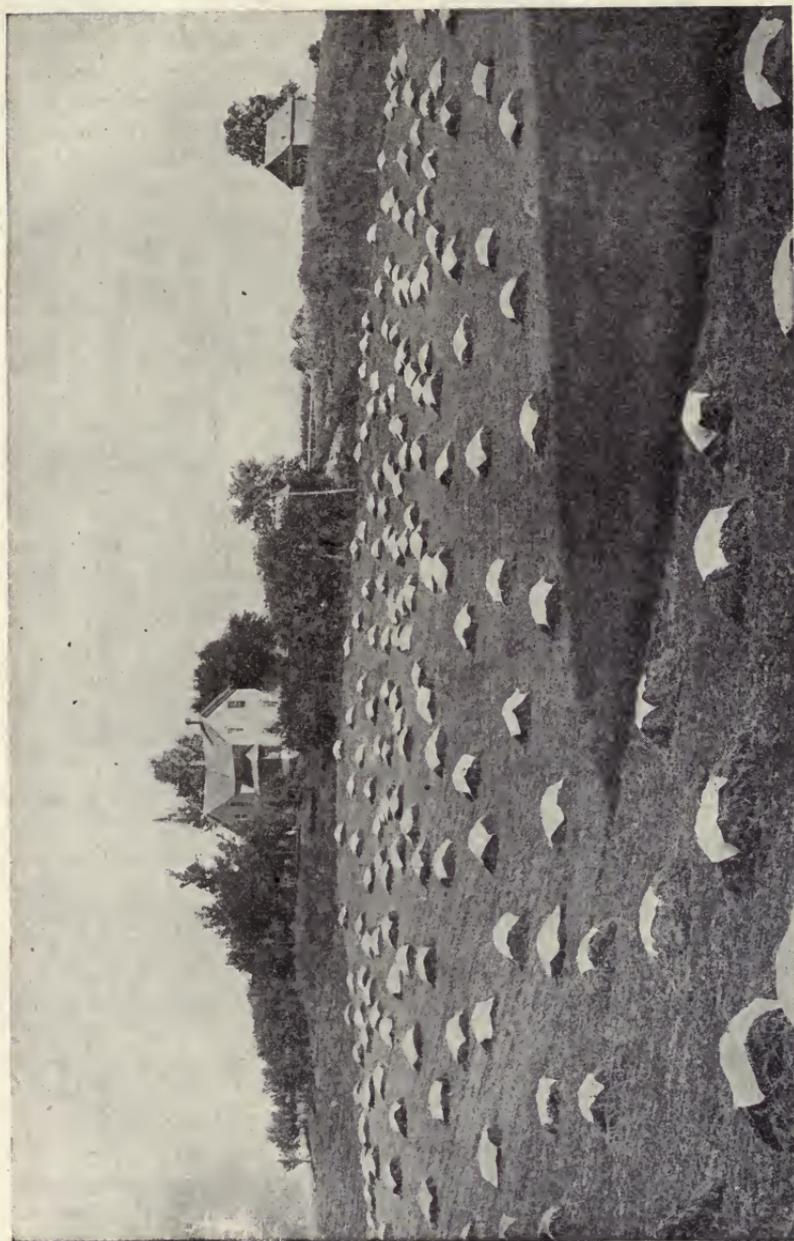

FIG. 63. Caps for hay in cocks, made of duck canvas, forty inches square, and weighted at the corners, cost from 25 to 35 cents each, and afford protection against the weather.—[Courtesy Iowa Experiment Station.]

Hay is put in the windrow with either the sulky rake or the side-delivery rake. (See Figs. 61 and 84.) If it is to be cured in the windrow it is permitted to lie where the rake leaves it; but if it is to be cured in the cock, the cocks are immediately made up from the windrow. Sometimes, to cause a more thorough drying, especially where it has been rained on, hay in the windrow is turned over with the side-delivery rake or the sulky rake, or the hay tedder may be used on it. Cocking is probably best done with pitchforks, one forkful at a time, carefully placed. Some growers make their cocks by bunching with the sulky rake and patching up a little with the pitchforks. The most popular size of cock is one that is comparatively small, of about two big pitchforkfuls. One grower says that a cock weighing 100 pounds is big enough.

The time required for hay to cure in the windrow, in good weather, is about twenty-four hours, while the time required to cure in the cock is, on the average, about forty-eight hours, and may vary from one to four or five days. On being asked, "How soon after mowing can hay be placed in stack, shed or mow?" the growers, when their replies had been analyzed and averaged, estimated as follows: Cured in the windrow, it requires an average of thirty-six to forty-eight hours from time of mowing till time of storing, in good weather, and a day or two longer in bad weather; cured in the cock, it requires sixty to seventy-two hours in good weather, and longer in bad weather. It is impossible to give a hard-and-fast rule, as conditions are so variable, in regard to weather, the moisture content, and the size of the crop.

#### CURED HAY.

Hay is reported to be cured, and ready for storage, when:

1. No moisture can be wrung out of a wisp twisted in the hand, and the stems break.
2. It is dry enough not to heat or mold, and still not so dry as to cause a preventable loss of leaves.
3. The leaves are quite dry and practically all the moisture is out of the stems.
4. The stems are almost brittle.
5. It smells cured.
6. There is no outside moisture (dew or rain) on it.
7. So dry that the tools will handle it readily and it will not roll under the sweep rakes.
8. For the mow, somewhat drier than for the stack, and for horses drier than for cattle.

(See pages 243 to 245.)

#### PLACE OF STORAGE.

To find out the general custom in storing hay the following question was asked: "Do you store alfalfa hay in the stack, the shed or mow?"

TABLE No. 5. Percentage of growers storing in stack, in shed or in mow.

	Western third of the state, per cent.	Central third of the state, per cent.	Eastern third of the state, per cent.	The state as a whole, per cent.
Store in stack.....	70	51	36	46
Store in shed.....	12	10	19	14
Store in mow.....	18	39	45	40

As may be determined from Table No. 5, more than two-thirds of the growers reporting from the western third of the state stack their hay, and less than one-third of them store it in the shed or the mow; in the central third of the state growers are evenly divided on the point; while in the eastern third of the state the conditions of the western third are reversed—that is, two-thirds of the growers store in the shed or the mow and only one-third store in the stack. The reason for this variation probably lies in the difference in the annual rainfall of the regions mentioned. Taking the state as a whole, 54 per cent of the growers reporting store their alfalfa hay in the shed or the mow. Growers seem inclined to give better protection to hay intended for the market than they give to the hay which is to be fed on the farm. Reporters, living mostly in the eastern half of the state, estimate that the loss in feeding value to hay stored in the open is from 10 to 50 per cent, averaging 29 per cent, or nearly one-third. Further discussion of loss in feeding value through exposure to the sun and the rain may be found on pages 245, 259 and 457.

Growers differ widely in their opinions about the economy of the shed or mow, as compared with the economy of the stack, as a place for storing alfalfa hay. Here are some expressions greatly favoring shed and mow storage:

*Brown county*: "I have lost enough hay by stacking and feeding outside to pay for a 24 by 80 ft. shed in two seasons."

*Cherokee county*: "You will save enough to build sheds in a few years by storing inside."

*Geary county*: "Save in two years the cost of a barn."

*Geary county*: "My shed is fifteen years old. I believe it has saved its cost twice or more."

*Jefferson county*: "Sheds will pay for themselves in three years' time."

*Miami county*: "If we should stack hay outside we would lose enough in one year to pay for building sheds for all the hay we have."

*Montgomery county*: "Sheds pay total cost in this section in three years."

*Doniphan county*: "Do not advise stacking, because you lose enough hay in a year to pay for a barn."

*Labette county*: "Hay stored in sheds will spoil only from being put in too green or damp. Uncovered stacks will often lose one-third of the hay from taking water. In a wet season sheds will pay cost the first year."

*Wabaunsee county*: "When the hay is stored in sheds it is safe against all kinds of weather, and can be hauled in winter during storms, which I believe more than makes up for the extra expense of the shed and putting the hay in it."

*Brown county*: "Stored in sheds there is no waste, there is better quality, less labor, and the hay is easier to feed."

*Logan county*: "Much more economical to store in sheds, taking quality into account."

*Hodgeman county*: "No comparison. There is always more or less loss every year by stacking."

*Marion county*: "You save a 25 per cent loss, besides the convenience of feeding during winter, by storing inside."

*Marshall county*: "A good hay barn is a very profitable investment on any farm, on account of the hay saved."

*Harvey county*: "Much better hay and no waste. I have eight large sheds, and think they pay."

*Chase county*: "A shed saves 25 per cent or more if the hay is intended for the market."

*Dickinson county*: "The hay from the shed or mow is noticeably better."

*Ellis county*: "One ton in barn is worth two in stack."

*Lyon county*: "Sheds or barn best if you don't feed to cattle."

*Norton county*: "If hay is to be kept for market it will pay to protect it."

*Jackson county*: "It is very hard to stack alfalfa so it will keep."

*Washington county*: "Don't stack valuable feed like this outside."

*Douglas county*: "I do not advise stacking in eastern Kansas, on account of the rain."

These growers do not favor storing in the shed or the mow:

*Ellis county*: "I do not think sheds or hay barns are worth what they cost in this part of Kansas."

*Geary county*: "With my method of stacking and covering stacks with old hay, kafir or straw I suffer very little loss, and my cattle eat all damaged hay."

*Harper county*: "I have only one shed, and don't think they pay, as it costs much more to put hay in a shed than to stack in the open. Our hay men cost \$2.50 per day, and I put it up as cheaply as possible, stacking second cutting on the first stack, which makes only one roof."

*Comanche county*: "If properly stacked we lose very little."

*Cowley county*: "A stack made right and covered with sheet iron is all right if rain does n't catch it uncovered."

*Franklin county*: "It costs more to use sheds or barns. The metal stack cover will keep it just as well."

*Geary county*: "With my method of stacking and covering there is very little loss."

*Jackson county*: "Stacks keep well if topped with millet or slough grass."

*Saline county*: "Very little spoils in a well-made stack."



FIG. 64. The sweep rake may be used to gather hay from the windrow, the swath or the cock, and to transport it to the stacker.—[Courtesy Missouri State Board of Agriculture.]

*Sherman county:* "Hay must be well cured to go into the barn. I prefer stacking, except what you feed in the barn."

*Kingman county:* "Hay in barns will keep a little better, but I like good stacks because they are much handier."

*Harvey county:* "I like the board cover, as one does not have to stack his hay in the same place every year."

*Neosho county:* "Sheds will pay in a small field, but not where hay is handled in large quantities by machinery."

*Osage county:* "Hay for cattle is softer and relished better when from the stack."

*Ottawa county:* "I don't think there is economy in barns or sheds over stacking, as on every farm there is stock to eat all hay that is not salable."

*Montgomery county:* "Where the hay is all fed on the farm the most economical method is stacking, as cattle will eat the waste hay."

*Finney county:* "There is not enough difference to pay."

*Russell county:* "I don't think sheds a paying proposition in our country."

*Russell county*: "Sheds are good, but it takes too long to fill them. In a dry country stacks are most economical."

*Seward county*: "It does n't pay to store in barns in this dry country."

*Trego county*: "It is too dry for building in this country. There is not enough difference."

It would appear, from the replies received, that storing in the shed or in the mow is most economical in the eastern half of Kansas, particularly in the case of the earlier and heavier cuttings. In the western half of the state it is very likely that storage in the stack is most economical. (See page 245.)

The tools used and the methods followed in gathering hay from the field depend largely on whether the hay is to be stored in the stack or in the shed or mow. When stored in the stack it is usually gathered from the windrow and transported to the stacker by means of sweep rakes; and when stored in the shed or the mow it is usually hauled from the field to the shed or barn by means of hay wagons.

#### SWEEP RAKES.

Sweep rakes are known by various names, such as "go-devil," "buck rake," "bull rake," "push rake," and so on, but will hereinafter be known only as "sweep rakes." These implements, while all working on the same principle, are of various styles. They may, as with the homemade "go-devil," merely slide over the surface of the stubble, with a horse at either end of the rake to allow a clean sweep of the teeth; or the rake may be elevated on two small wheels, for easier movement from place to place, with the horses separated in the same manner; or the rake may be elevated on three or even four small wheels, with the horses directly behind, on a tongue, pushing it. The rake proper consists of long, straight wooden teeth, sometimes capped with metal, twelve or thirteen in number, and spaced about one foot apart. These teeth slip along the surface of the ground to gather a load of hay. When the load is secured by sweep rakes equipped with wheels, the teeth are raised. The load, when gathered, is hauled to the stack, where it is deposited upon the teeth of the stacker, the sweep rake backing away and going for another load. Combinations of two or more sweep rakes to each stacker work together very nicely in economizing time at the stack. Sweep rakes may be used to gather hay out of the windrow, the swath, or to pick up cocks. Sometimes hay in the windrow is bunched with the sulky rake for easy picking up by the sweep rake. (See page 310.)

#### STACKERS.

Where alfalfa is stored in the stack some kind of a stacker is generally used to elevate the hay onto the stack. There are various kinds of these implements. Most of them have teeth for holding the hay, similar to the teeth on a sweep rake and of about the same size. In fact, stackers are built to take the load of a sweep rake. Some are portable; others are semiportable, that is, while operated in a stationary position they are provided with wheels to facilitate a change from position to position. The method of elevation, however, is the principal point of variance.

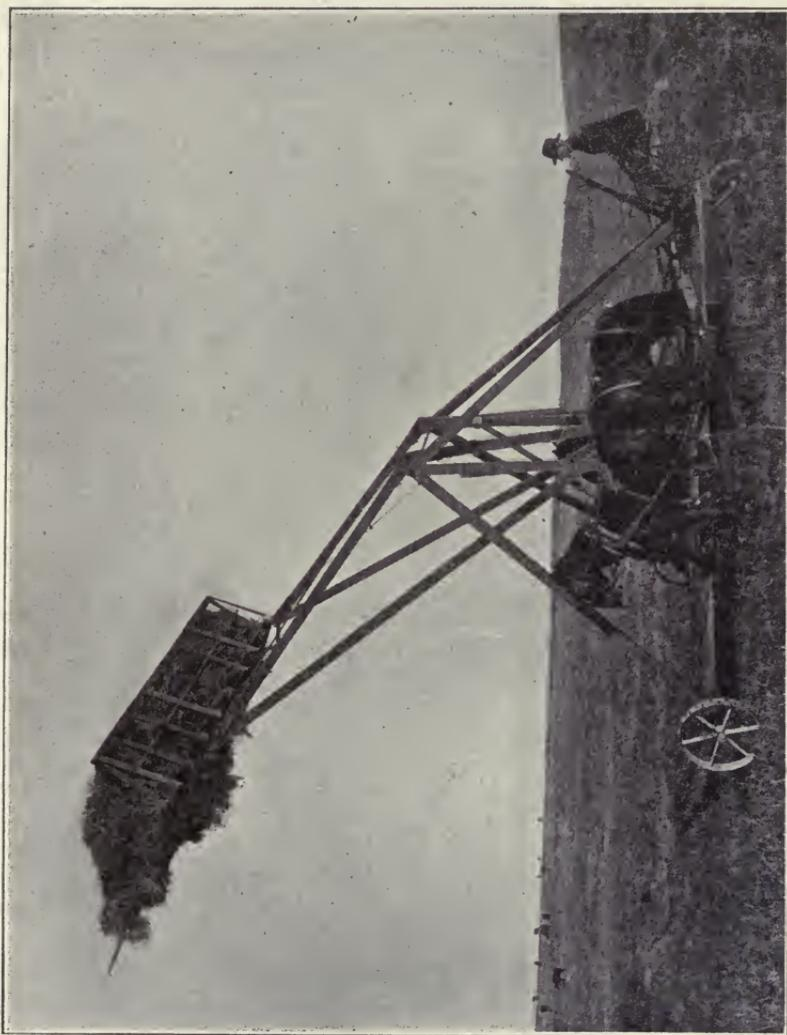

FIG. 65. A combination sweep rake and stacker.—[Courtesy F. Wyatt Mfg. Co.]

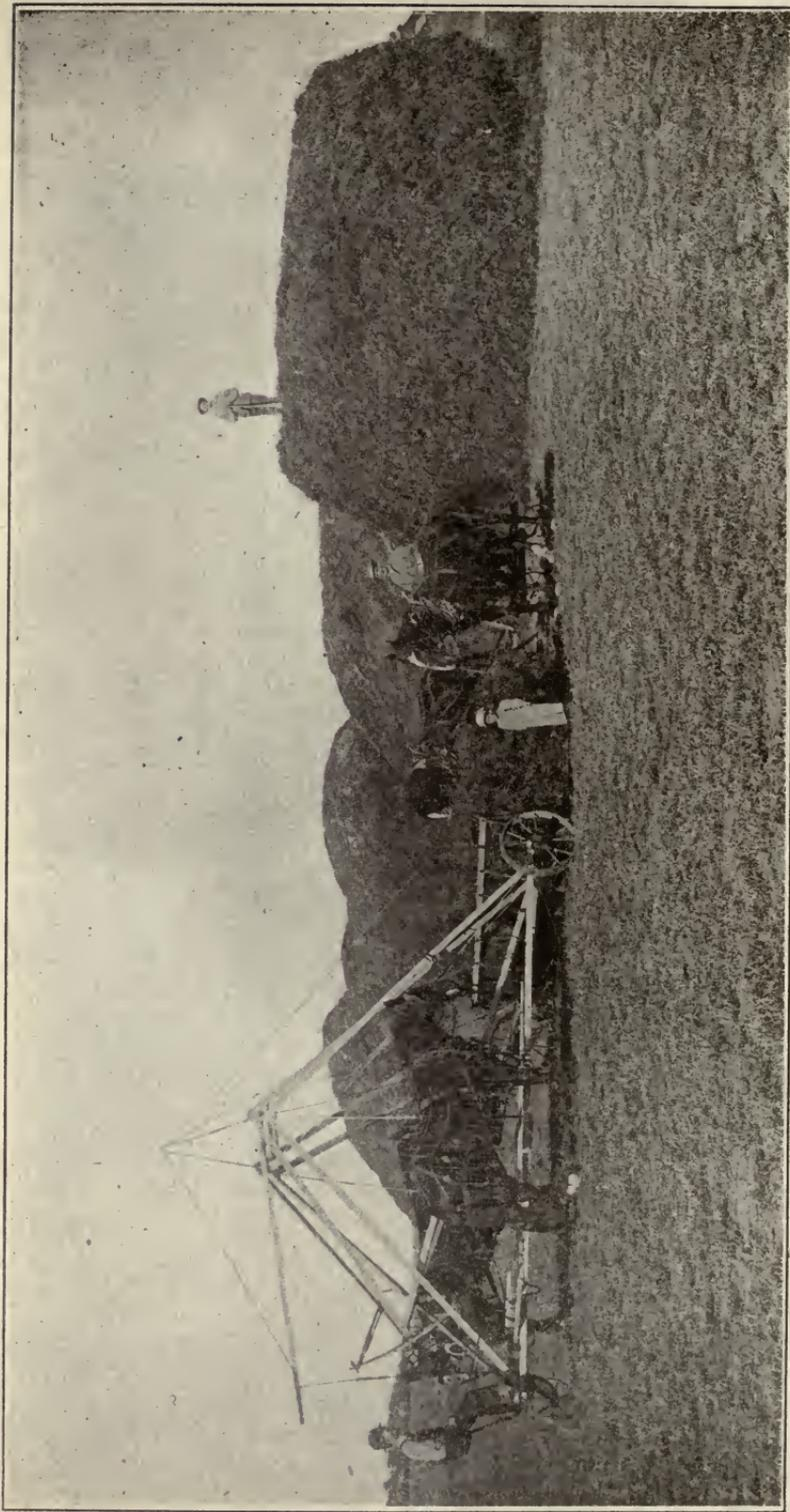

FIG. 66. The combination sweep rake and stacker receiving a load from a sweep rake. Here it is being used exclusively as a stacker.  
[Courtesy F. Wyatt Mfg. Co.]



FIG. 67. The combination sweep rake and stacker will place hay on the stack in any spot desired.  
[Courtesy F. Wyatt Mfg. Co.]

One very popular and efficient portable stacker, which is used throughout the state, receives a load of hay on its teeth from the sweep rake, and through the power transmitted by traction wheels the load is elevated to the desired height as the horses push the stacker toward the stack, a lever being released when the desired height is attained. The weight of the hay dumps the load when another lever is released. When the stacker is backed away from the stack the derrick carrying the teeth is automatically lowered; or it may be lowered by a lever and its descent controlled by a brake. It may back away from the stack, or it may be turned at right angles to the stack, to receive another load. It elevates from 500 to 700 pounds of hay in one load, and is said to go through the operation of receiving and placing a load in from three to five minutes, depending upon the skill of the operator. It will place hay on the stack in any spot desired, from either side or either end, and will build a stack from twenty to twenty-three feet in height. This implement also is said to be usable for loading wagons and for filling hay sheds, and if desired, may be used as a combination sweep rake and stacker.

Then there is the overshot stacker, which is anchored in position and receives the hay from one side only. The teeth are elevated and the load is lifted clear over the head or central pivoting point, and dumped from the opposite side of the stacker onto the stack. The power to elevate is furnished by a team of horses attached to the end of a cable running through pulleys.

Another kind of stacker is the swinging stacker. It receives the hay at one side, and then elevates and swings the load sidewise to the stack, by power like that of the overshot stacker.

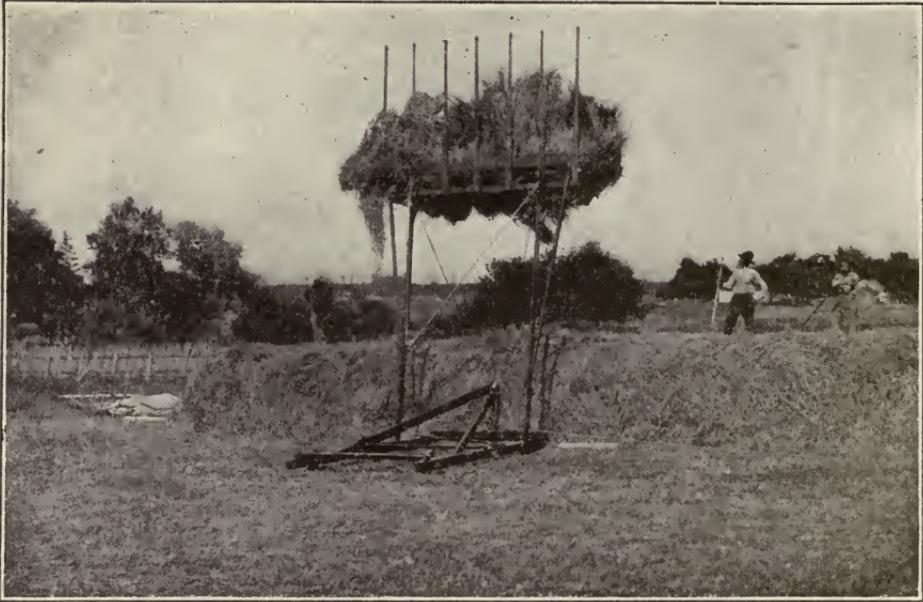

FIG. 68. The overshot stacker lifts the load over the central pivoting point and dumps it on the stack.—[Courtesy Emerson-Brantingham Implement Company.]

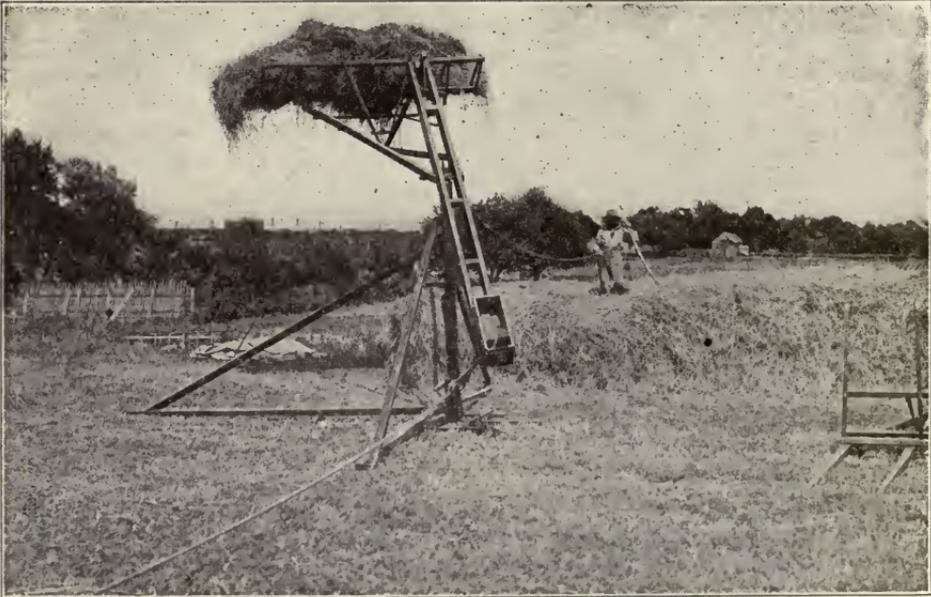

FIG. 69. The swinging stacker elevates and swings the load sidewise to the stack. [Courtesy Emerson-Brantingham Implement Company.]

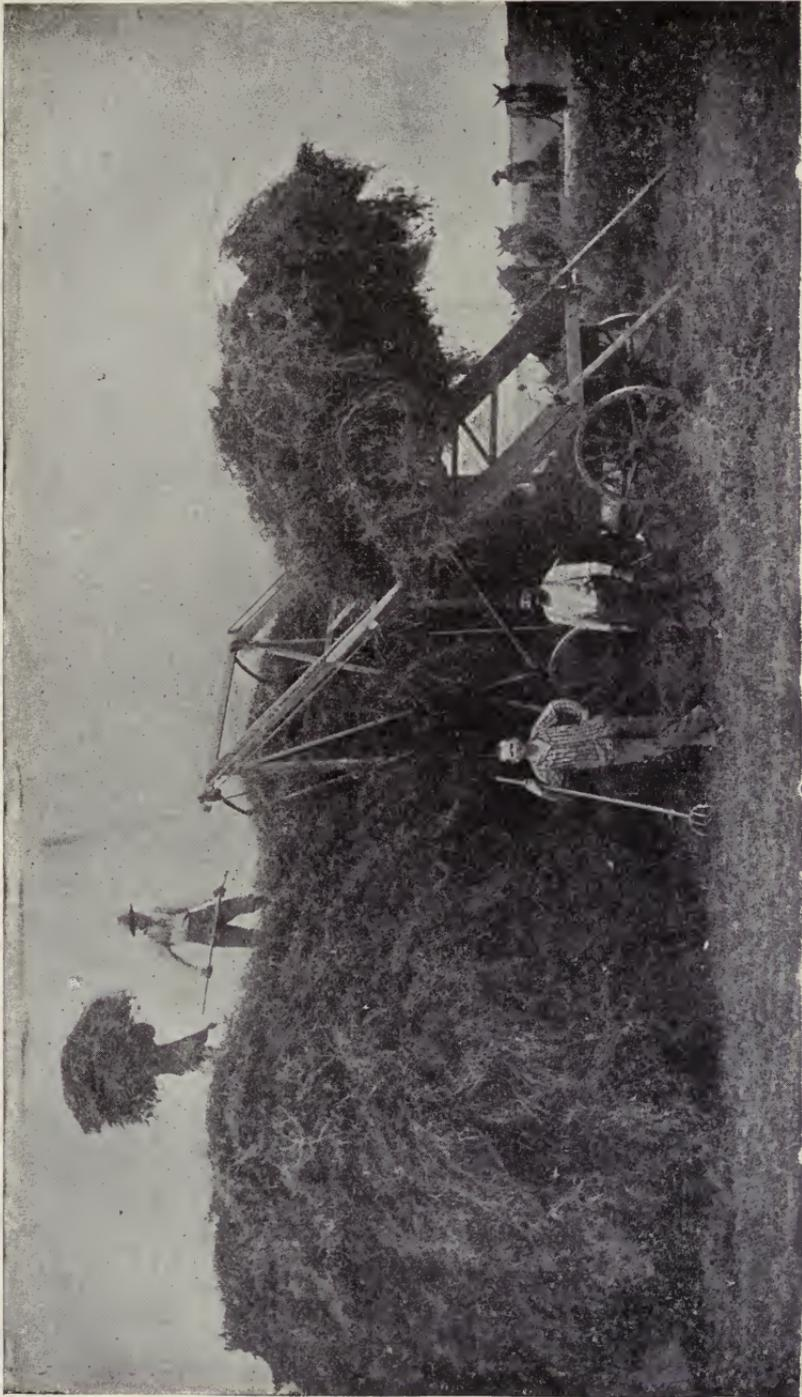

FIG. 70. Another style of overshot stacker.

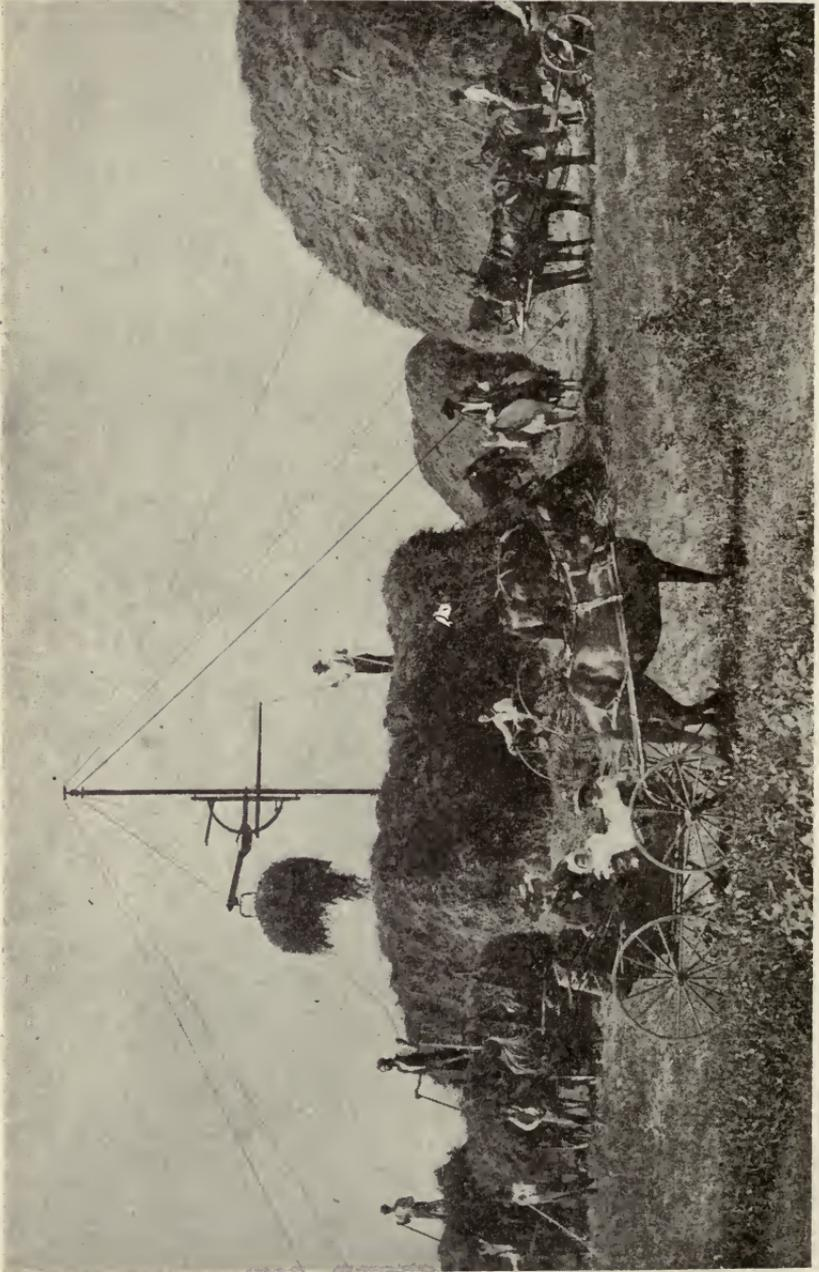

FIG. 71. A stacker with pole and swinging boom.

Still other methods of stacking are the pole-and-boom and the poles-and-cable methods. With the pole-and-boom method, a pole, held in position by guy wires, ropes, braces or other supports, has a swinging boom, to which are attached pulleys, cables and large horse hay forks or slings. With the poles-and-cable method a cable, on which hay carriers work, is stretched between two poles. With both these latter methods the hay is usually taken from wagons. They are little used. (See page 314.)

#### STACKS AND STACKING.

From those who use the stack as a means of storage an effort was made to learn the kind of stack that is preferred and the method of its construction. There are two different types of stacks, the rectangular and the round.

TABLE No. 6. Growers' preference as to rectangular vs. round stacks.

	Western third of the state, per cent.	Central third of the state, per cent.	Eastern third of the state, per cent.	The state as a whole, per cent.
Preferring round stacks.....	9	20	35	23
Preferring rectangular stacks.....	91	80	65	77



FIG. 72. A common style of pole and boom stacker.

The average size of rectangular stack reported is 16 feet in width, 37 feet in length and 19 feet in height. The width varies from twelve to 20 feet, the length from 25 to 40 feet and the height from 18 to 20 feet. Reports indicate that the best stacks are from 18 to 20 feet in width, as high as the stacker will make them, and as long as the distance to haul the hay economically will admit. Sometimes, where well-protected stacks do not reach their full height until all the cuttings for the season have been made, they are started with the first cutting, and each additional cutting is placed on top of the preceding one until the stack is topped out with the last cutting.



FIG. 73. A stacking outfit that handles from 50 to 75 tons a day.  
[Courtesy *Farmers' Review*.]



FIG. 74. The poles-and-cable method of stacking,

The diameter preferred for the round stack varies from 16 to 20 feet, averaging 17 feet, at the base or surface of the ground. About 8 feet up from the base it is customary to make a bulge, so that the diameter at the bulging point shall be about 24 or 25 feet. From the bulging point upward the stack is tapered to a rounded point. The average height reported for round stacks is 25 feet.

There is a certain amount of waste in every stack, caused by exposure to the weather, and the larger the stack the smaller will be the proportionate loss therefrom. Considerable loss also may be avoided by allowing the stack to rest upon a platform of timber or a layer of straw or old hay, rather than allowing it to rest directly upon the ground. In building any sort of stack the stacker should be careful to keep the sides



FIG. 75. The rectangular stack is most popular. It should be topped out with slough grass or old hay, or otherwise covered, and weighted down.



FIG. 76. Well-made round stacks, without the bulge.  
[Courtesy U. S. Department of Agriculture.]

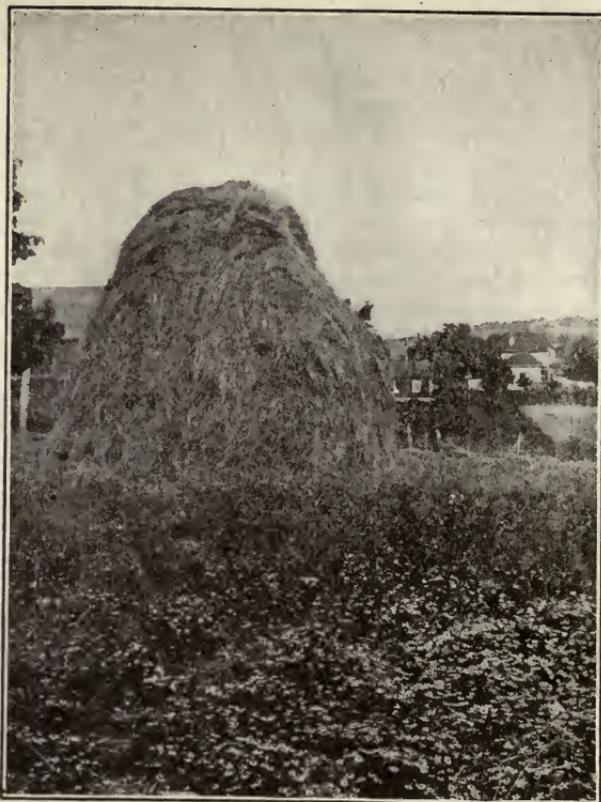

FIG. 77. A slovenly round stack, which may easily soak in rain, fall over, or be blown apart by winds.—[Courtesy U. S. Department of Agriculture.]

“squared up” at all times and the middle always rounding full. The top should be well rounded, and not of a straight, sloping nature. Alfalfa hay settles a great deal, and too much care can not be exercised in so shaping the stack that it will be least likely to soak in the rain, fall over, or be blown apart by the winds. For further insurance against damage by winds, hay is often weighted down; that is, long wires, to the ends of which are attached rocks or other weights, are thrown across the stack.

As alfalfa hay does not readily shed rain of itself, some method of protection is usually practiced. The crudest method is to top out the stack with slough grass or some cheap kind of hay. Much better for this purpose are the various kinds of stack covers, made of canvas, boards or metal, which should be well weighted down. (See Figs. 79 to 83.)

#### STORING IN SHED OR MOW.

Hay stored in the shed or mow is usually hauled in from the field with a wagon. Hay wagons may be loaded either with pitchforks or with hay loaders. Because of the fact that side-delivery rakes are generally used in connection with hay loaders, we will first consider side-delivery rakes.



FIG. 78. The bulge in a stack.  
[Courtesy *Farmers' Review*.]



FIG. 79. A stack cover of metal to protect the hay from the weather.  
[Courtesy *Farmers' Review*.]

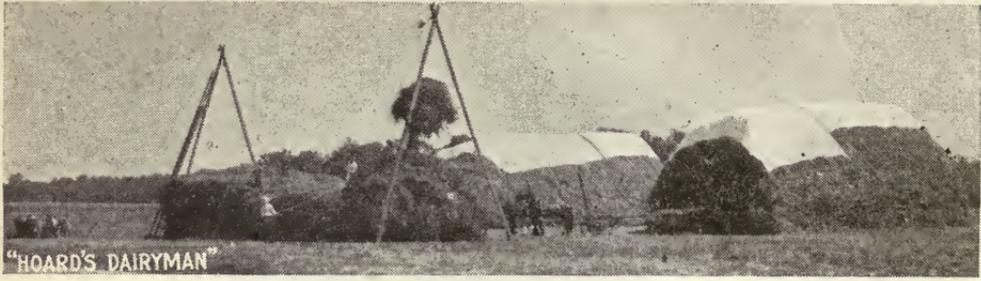

FIG. 80. A great many farmers use canvas stack covers.—[Courtesy *Hoard's Dairyman*.]

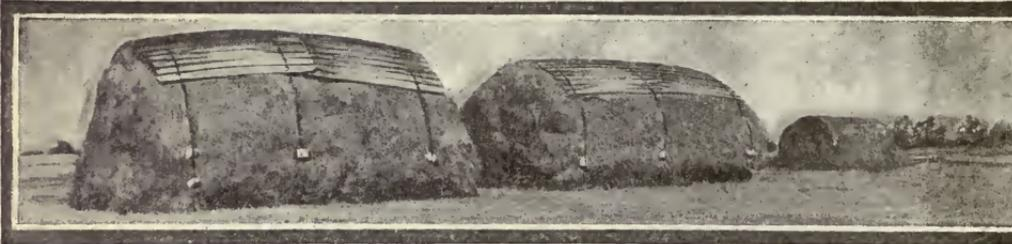

FIG. 81. Board stack covers in use.—[Courtesy Stowe Supply Company.]



FIG. 82. The details of how a board stack cover may be made.—[Courtesy Stowe Supply Company.]



FIG. 83. The chain to which boards may be attached for a stack cover.  
[Courtesy Stowe Supply Company.]

SIDE-DELIVERY RAKE.

TABLE No. 7. Popularity of the side-delivery rake.

	Western third of the state, per cent.	Central third of the state, per cent.	Eastern third of the state, per cent.	The state as a whole, per cent.
For side-delivery rake . . . . .	8	24	63	40
Against side-delivery rake . . . . .	29	38	20	30
No experience with side-delivery rake . . . . .	53	38	17	30

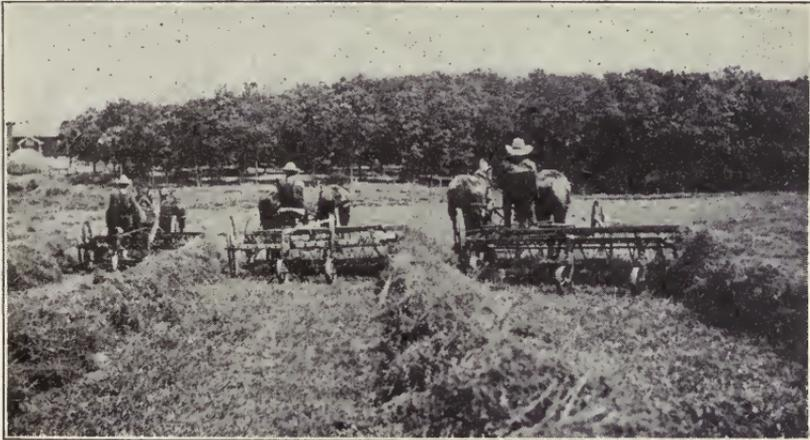

FIG. 84. The side-delivery rake works well with the hay loader. It leaves the hay in windrows for curing.—[Courtesy *Farmers' Review*.]

The arguments *for* the side-delivery rake are:

1. It leaves the hay in better shape for curing.
2. It is an excellent tool for turning hay in the windrow in case of rain.
3. It is a better tool for use in connection with a seed crop, because, it is said, less handling is necessary.
4. It is essential where a hay loader is used.
5. It is particularly useful in case of heavy hay.
6. It is economical in large fields.

The arguments *against* the side-delivery rake are:

1. It has a tendency to twist the hay and leave it in the form of a rope.
2. It does slower work than a sulky rake.
3. It does not leave the hay in so good a shape for the sweep rakes as does the sulky rake.

(See page 310.)



FIG. 85. Those who favor the hay loader usually store their hay in shed or barn. It gathers hay from the windrow or the swath.—[Courtesy Emerson-Brantingham Implement Company.]

#### THE HAY LOADER.

Hay loaders are used only in case the hay is hauled from the field in wagons (hay racks), and they may be used to gather hay only from the windrow or the swath.

TABLE No. 8. Popularity of the hay loader.

	Western third of the state, per cent.	Central third of the state, per cent.	Eastern third of the state, per cent.	The state as a whole, per cent.
For the hay loader.....	22	21	59	37
Against the hay loader.....	53	31	31	33
No experience with the hay loader.....	25	48	10	30

Those who favor the hay loader store their hay in the shed or the barn, while those who are against it store their hay in the stack, and report that the loader does not work well with their system of storage. It is also reported that the hay loader best adapted to handling alfalfa is of the kind that has endless aprons or strap carriers to take up the hay, as loaders pushing the hay up with spiked wooden strips are not efficient and knock off many leaves. The chief complaint against the hay loader is the complaint that it knocks off leaves. (See page 317.)



FIG. 86. Hay is often loaded on wagons with pitchforks, particularly by those having the smaller acreages.—[Courtesy Iowa Experiment Station.]

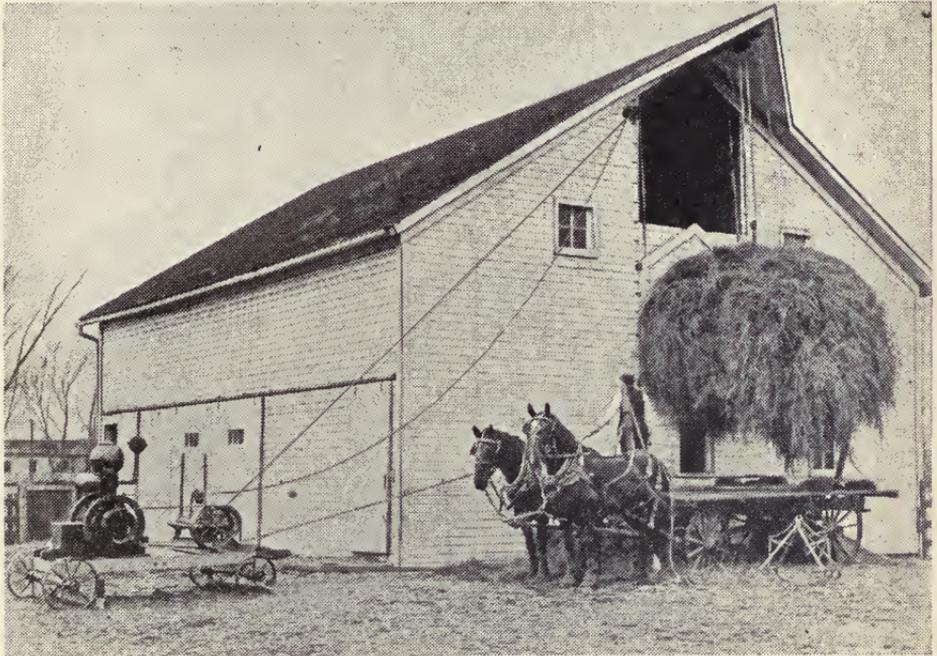

FIG. 87. Putting hay in the barn with single harpoon fork, carrier and track. The power here is furnished by gasoline engine.—[Courtesy *Farm and Fireside*.]

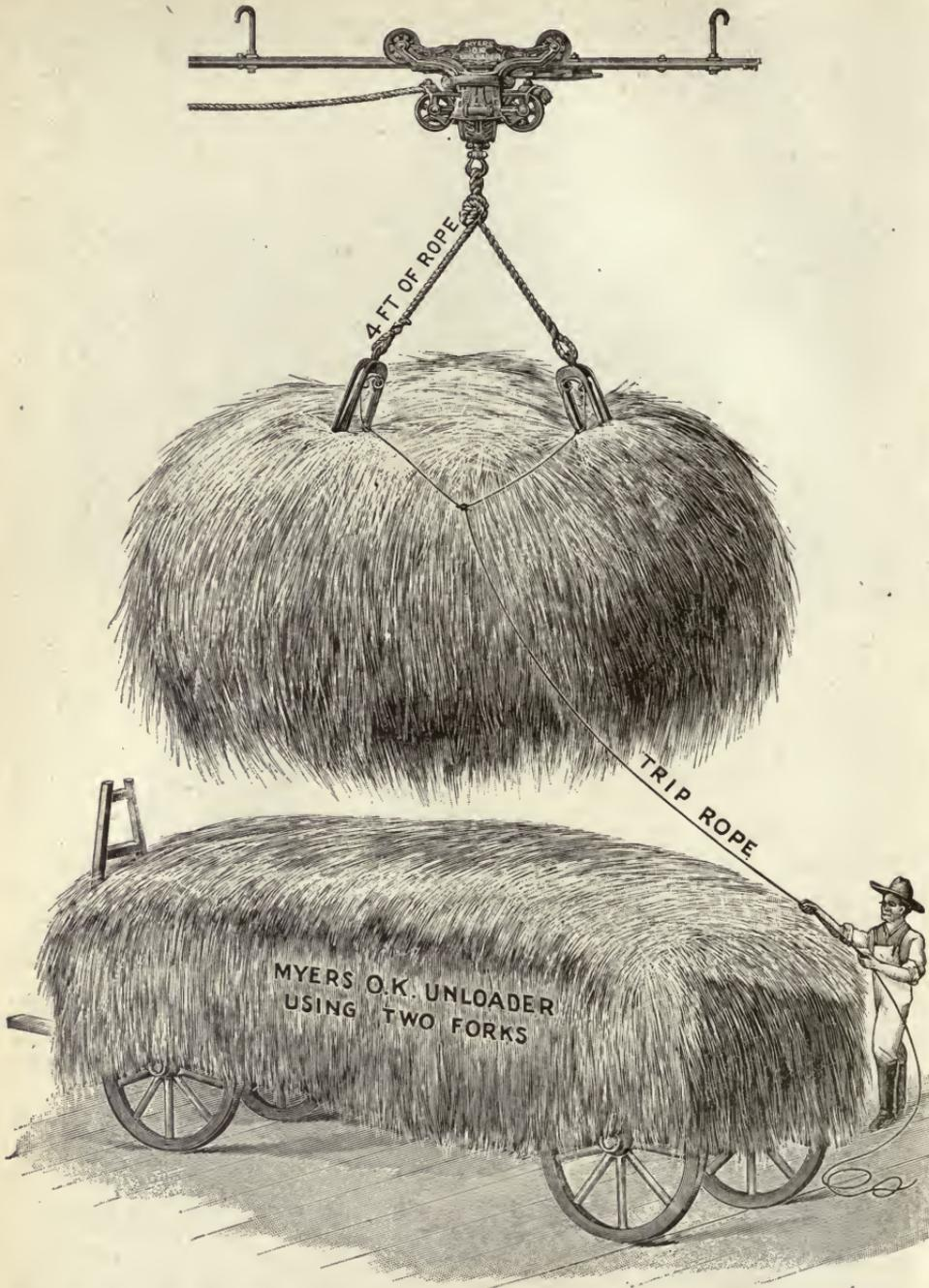

FIG. 88. Taking hay from the wagon with two double harpoon forks, carrier and track. This shows the details of the arrangement.—[Courtesy F. E. Myers & Bro.]

LOADING HAY WAGONS BY HAND.

Hay may be loaded onto wagons by means of hand labor and pitch-forks as well as by hay loaders, and this method is still practiced to a large extent, particularly by those having the smaller acreages. In loading hay on the wagon care should be exercised to see that the "sides" go up square and that the "middle" is kept well filled. It is also well to so place the hay on the wagon that it may be easily unloaded, especially if it is to be put into the mow by hand. This is accomplished by placing a layer along the outside and then filling in the middle, and repeat. A layer from the middle may then be unloaded first, followed by one from the outside, and so on to the bottom of the load. (See page 331.)

PUTTING HAY IN SHED OR BARN.

When hay is put in the barn or the shed, forks, slings, pulleys, carriers and tracks are generally used. They are occasionally used in stacking also. Of the hay forks used, the grapple forks, which work something after the manner of ice tongs, are most popular. The double-harpoon forks also are often used. Other forks used are those known as the "single-harpoon" and the "derrick." A hay sling is a net-like

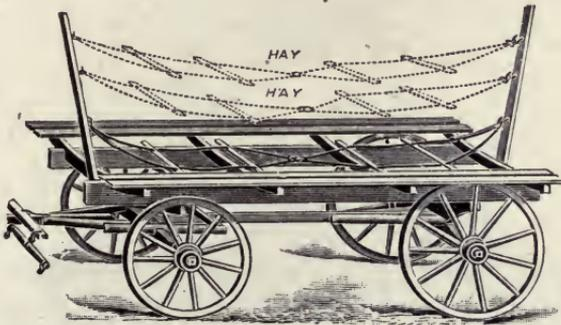

FIG. 89. Position of slings on a wagon loaded with hay, shown in outline.—[Courtesy F. E. Myers & Bro.]



FIG. 90. Gathering the ends of the sling together. [Courtesy F. E. Myers & Bro.]

arrangement of ropes and wooden bars used to lift a bundle of hay. Formerly it was the custom of many to use slings exclusively in unloading a wagon, making three or four slingloads of each wagonload; but it is now the custom to use both the fork and the sling in unloading. With the present method only one sling is used, and that for the bottom of the load, the upper portion being removed with a fork. Both forks and slings are dumped by means of a tripping arrangement, which is released with a trip rope.

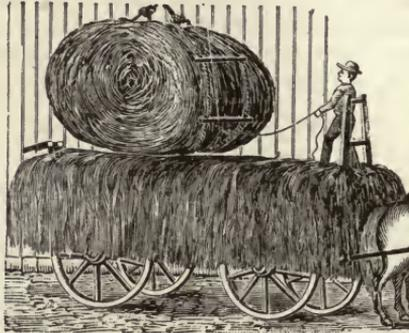

FIG. 91. When the power is applied the load is gathered into a compact bundle.—  
[Courtesy F. E. Myers & Bro.]

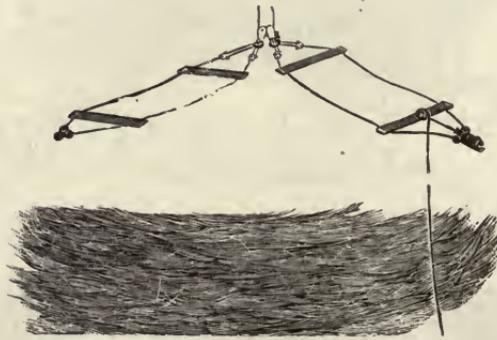

FIG. 92. When released by the trip rope the sling-load drops flat on the rest of the hay in the mow.—  
[Courtesy F. E. Myers & Bro.]

Generally, hay is taken in at the ends of sheds or barns. When it is hoisted from the wagon, the forks or slings become attached to what is known as a carrier. A carrier supports the load and transports it to the dumping point. It has small wheels that run on overhead tracks. These tracks may be arranged with switches, so that the hay can be dumped in different parts of the building. Tracks are of steel, of wood, and sometimes of wire cable. A weight attached to the end of a rope,

which runs through a pulley, returns the carrier to the point of loading. The power that hoists the hay, and also pulls it in over the track, is had by hitching a team or an engine onto the end of a long cable which runs through pulleys.

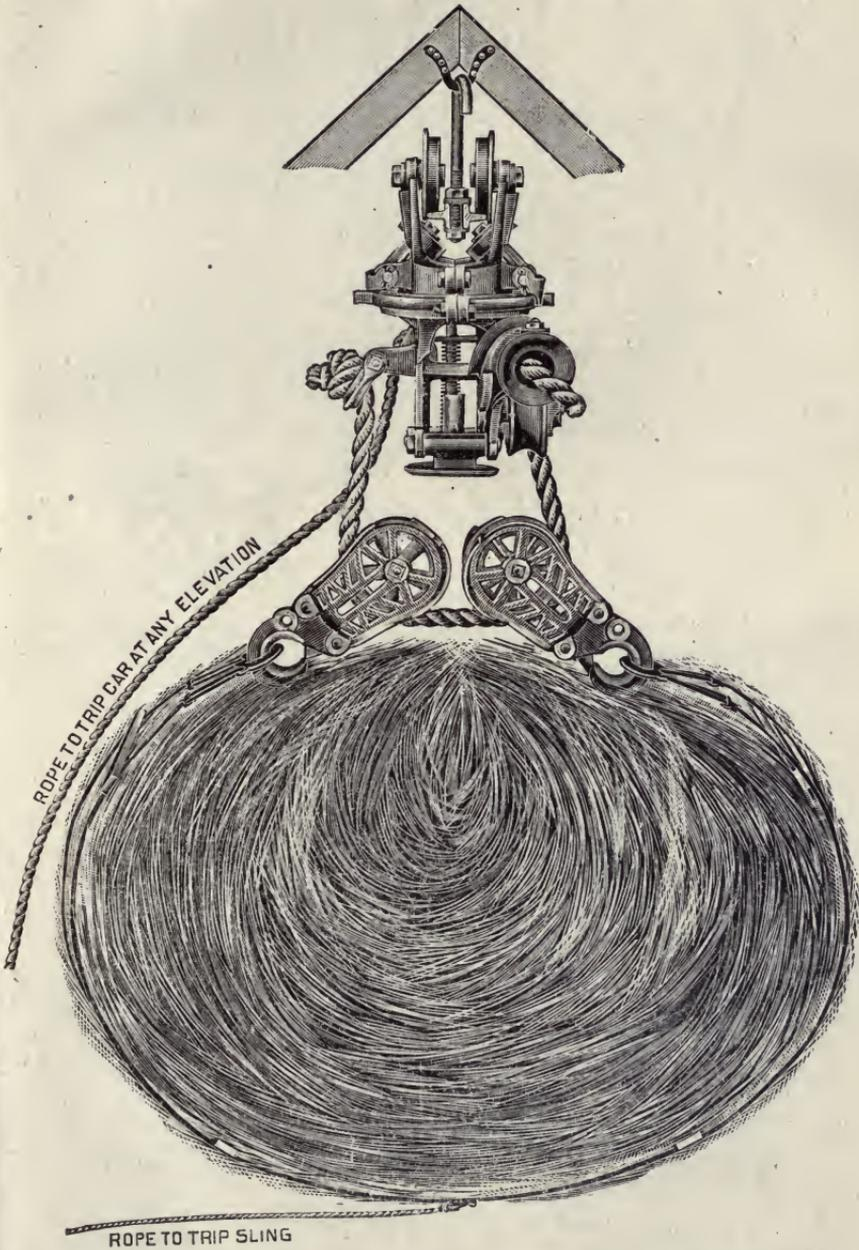

Fig. 93. The details of the sling arrangement.—[Courtesy F. E. Myers & Bro.]

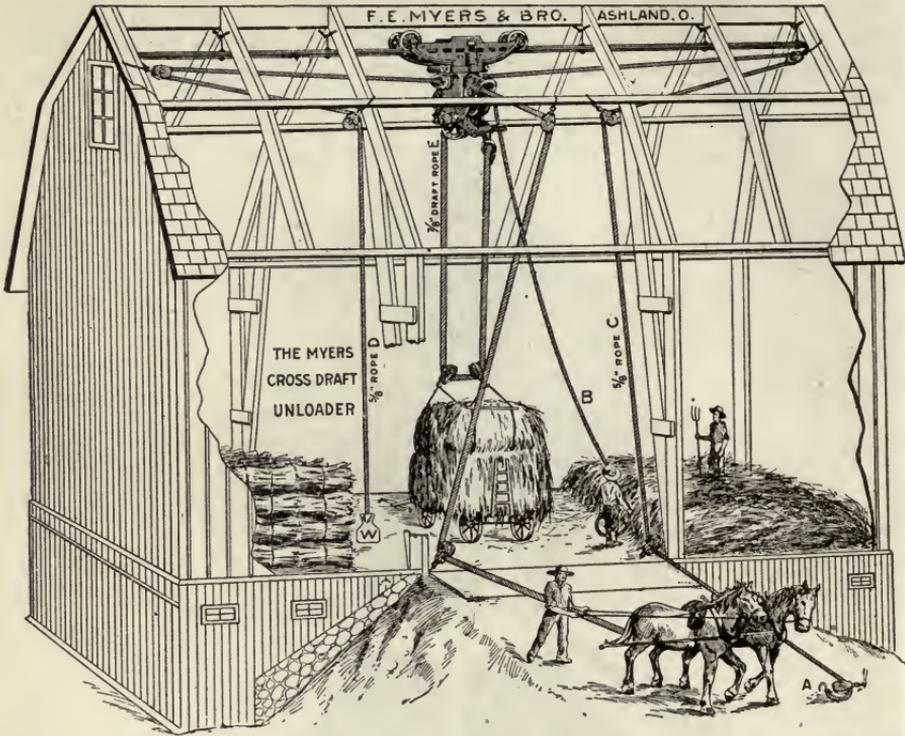

FIG. 94. The principles of unloading by machinery, somewhat out of proportion, showing how power is applied and how the load is transported to different parts of the building.— [Courtesy F. E. Myers & Bro.]

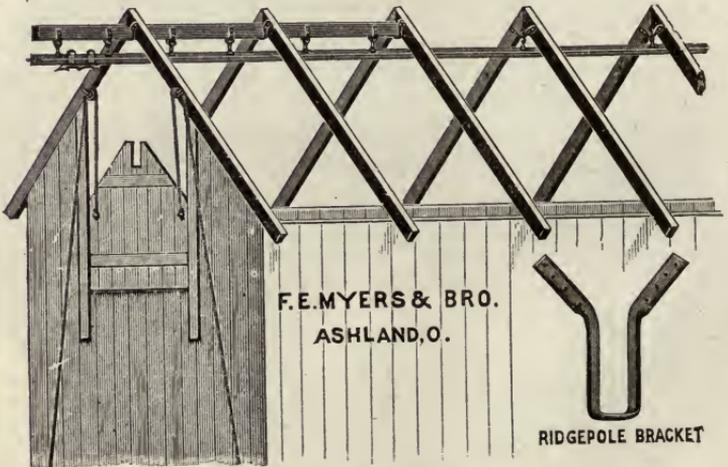

FIG. 95. How the track is fastened to the building. [Courtesy F. E. Myers & Bro.]

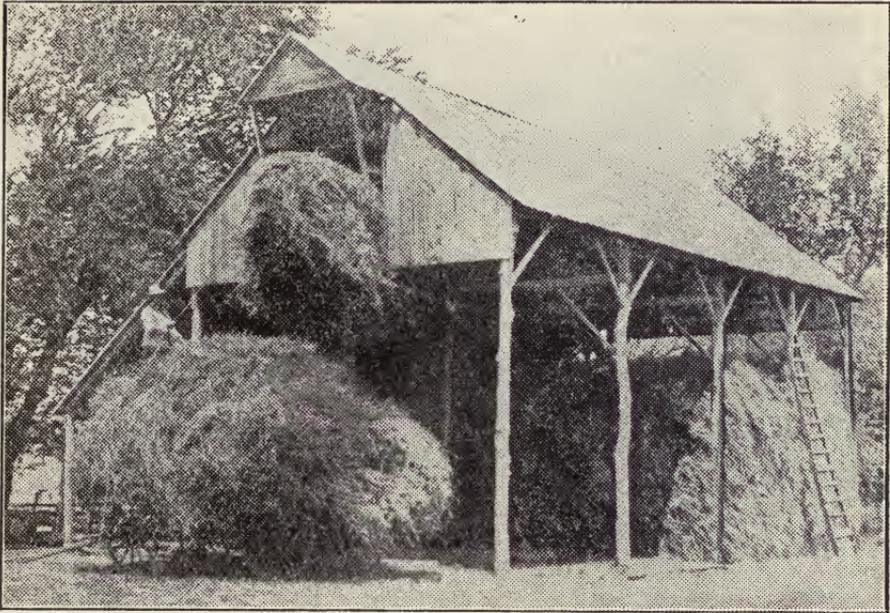

FIG. 96. Hay is generally taken in at the ends of sheds or barns.  
[Courtesy *Farmers Mail and Breeze.*]

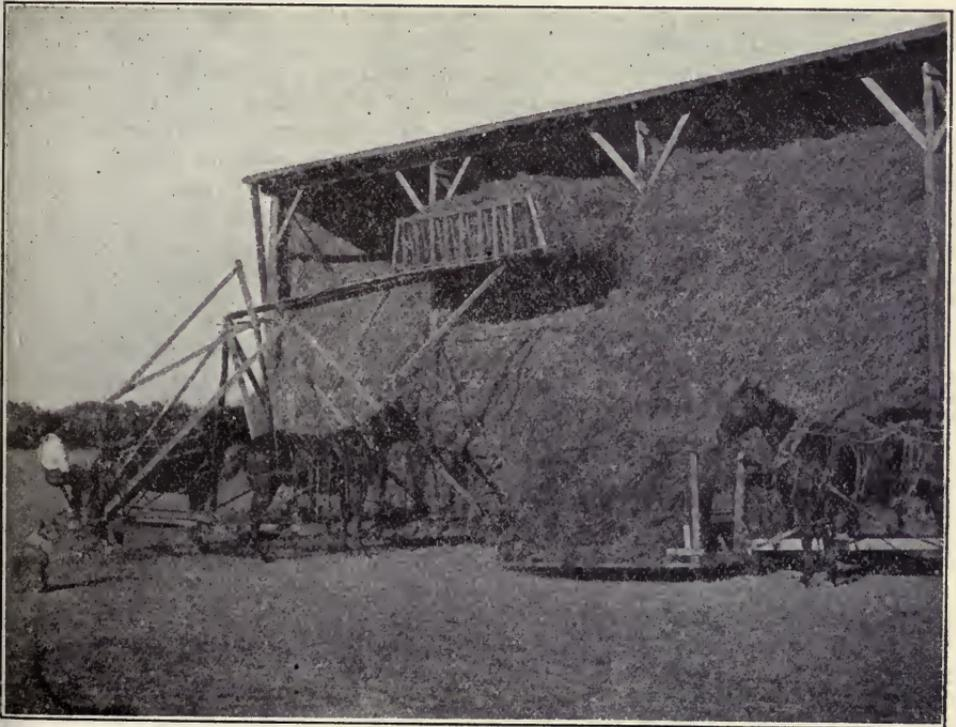

FIG. 97. Filling a shed with a portable stacker.—[Courtesy F. Wyatt Mfg. Co.]

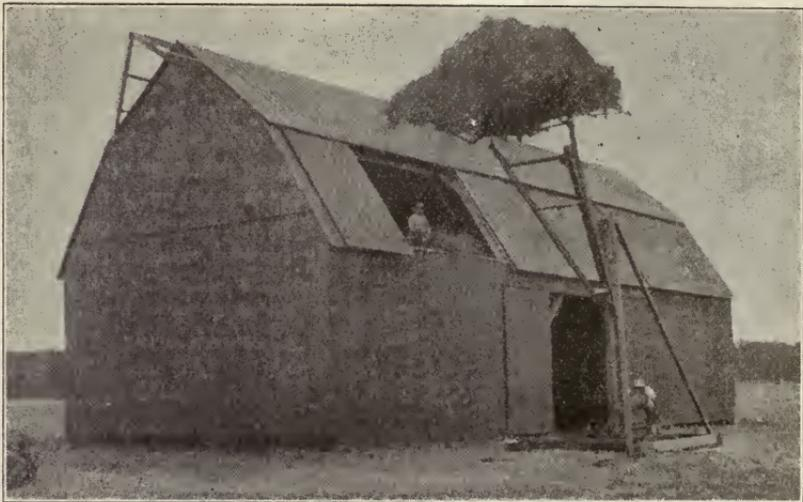

FIG. 98. Filling, with a swinging stacker, a hay barn equipped with a sliding roof door.

By these methods hay may be placed in a mow or shed with much greater ease, speed and economy than by means of pitchforks. It is well to use large pulleys and ropes and to keep the carriers and pulleys well oiled, for trouble with the apparatus when putting up hay may delay a number of men, whose "time" goes on while the trouble is adjusted. (See pages 317 to 323.)

In filling hay sheds it is the practice with some to let the space between two poles serve as a compartment or section, and to fill each compartment separately before going ahead with the next. With others it is a common custom to spread the first cutting all over the floor of the shed, and to place each succeeding cutting on top of its predecessor. By the time the second cutting is ready for storage the first cutting of hay becomes well settled, and so on, the shed thus being filled to its fullest capacity with well-settled hay.

#### HAY SHEDS.

Hay sheds are made for protection against precipitation and sunshine; hence it is necessary only to make them strong, so that the wind will not blow them down, and make the roofs and a part of the sides water-tight. The reported average length of hay sheds is about 71 feet, varying from 60 to 100 feet; the average width is 34 feet, varying from 20 to 60 feet; and the average height to the eaves is 19 feet, varying from 14 to 22 feet. In a general way, it may be said that the average shed is about 70 feet long, 34 feet wide, and 20 feet high at the eaves. Such a shed will hold about 125 tons of alfalfa hay, on a basis, estimated from the reports received, that a ton of alfalfa occupies in the neighborhood of 381 cubic feet. The cost of this average shed is estimated at \$484. The reports indicate a variation in capacity, of the different sheds reported on, of from 75 to 300 tons, and a variation in cost of from \$200 to \$1200.



Most sheds are little more than roofs supported by large posts. These supports may be of native timber, red cedar or old telephone poles, and are usually planted in the ground to a depth of four or five feet, and set in a mixture of concrete. They are spaced from twelve to seventeen feet apart on either side of the shed, with a row down the middle in case of a wide shed. The posts are topped with a plate. The plate supports an even-span roof of about one-third pitch. The ridgepole and the rafters may be of two-by-six-inch lumber, and the rafters may be spaced two feet apart. Galvanized iron is the most popular roofing material, although pine boards or other roofing material may be used. It is the custom to prevent rain and snow from beating in on the hay by boarding the ends and the sides down from the eaves to within eight or ten feet of the ground with rough one-inch boards, providing openings for putting in the hay. It is well to avoid crossbeams and other obstructions that might interfere in filling the shed. However, the whole structure should be solidly braced, as strength is one of the keynotes in the construction of good hay sheds.



FIG. 100. A hay shed with an adjustable roof. It is about twenty-five feet square, the corner posts are smooth and strong, and it is well bolted together. The roof is raised or lowered with rope and pulley, and is supported on iron pegs that fit in holes bored in the corner posts at regular intervals. With this arrangement the rain can not blow in on top of the hay, whether the shed be full or nearly empty. A practicable small-scale method of storage near or in the feed lots.

As with stacks, loss caused by placing hay directly upon the ground may be avoided by constructing a platform of native poles or old lumber for the hay to rest upon. Such platforms admit of adequate ventilation underneath the hay, prevent spoilage by surface water, and are found in all well-constructed sheds.

Some growers make twelve- to fourteen-foot driveways through their hay sheds or barns. One driveway may go lengthwise, the full length of the shed; or a number of driveways may go crosswise through the shed at regular intervals. After the spaces on either side of driveway have been filled with hay, the driveway itself may be filled.

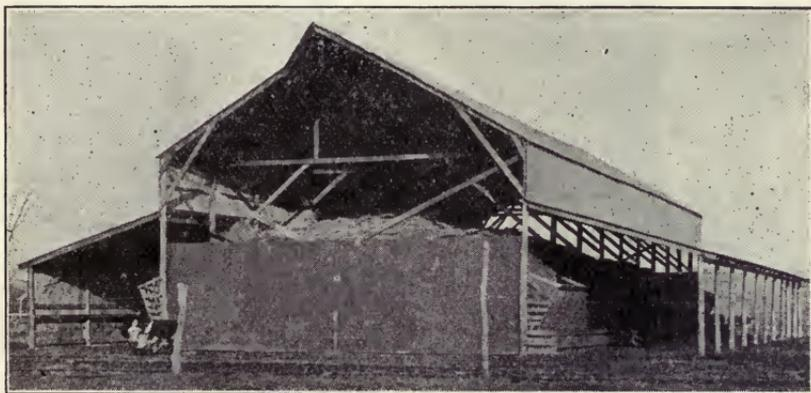

FIG. 101. A combination hay and feeding shed.  
[Courtesy Kansas Experiment Station.]

A very economical shed for hay storage, where considerable live stock enters into the farming scheme, is in use by quite a number of the larger growers. This shed is surrounded on two or three sides by feeding racks and lean-to cattle sheds. The hay is stored in the central part of the structure in the usual manner, and is fed in the racks as needed. Such a system involves a minimum amount of labor in getting the hay to the cattle. (See pages 251 to 258.)

#### SPONTANEOUS COMBUSTION.

Only 4 per cent of the growers reporting on the subject have ever had a fire, or personally known of a fire, through spontaneous combustion of alfalfa hay. They are located in Chautauqua, Greenwood, Marshall, Montgomery, Reno, Sherman, Wabaunsee and Wyandotte counties. Green or immature hay, and hay that has foreign moisture on it—rain or dew—is most apt to give trouble. The condition is said to be aggravated when green or wet hay is put on top of old and dry hay already in the mow.

The very best remedy for spontaneous combustion is prevention—storing only hay that is well cured and free from foreign moisture. A majority of the growers who discussed the point agree that the better the ventilation the less danger there is of fire. "Hay wells," or air shafts



FIG. 102. One style of hay knife.—[Courtesy Stowe Supply Co.]

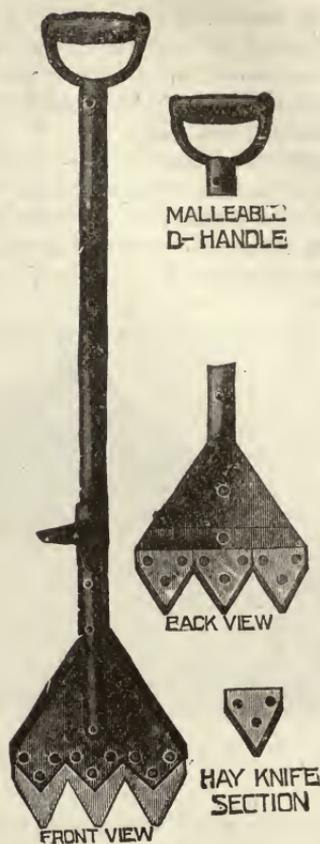

FIG. 103. Another style of hay knife.—[Courtesy Stowe Supply Company.]

from the bottom to the top of the mass, as well as good ventilation of the building in which the hay is stored, were recommended. Some specially advise against tramping or packing moist hay. On the other hand, there are growers who believe that alfalfa hay should have little or no ventilation and that it should be tightly packed. Quite a large number of growers advocate the application of from two to three gallons of salt to each ton of hay stored, as a means of fire prevention, and one grower specifies two gallons of salt and one gallon of air-slaked lime to each ton. The salt or lime is scattered over the different layers of hay as they are put into the mow. Here are some reports about spontaneous combustion:

*Sherman county*: "Properly cured hay will not take fire, but a large amount of alfalfa hay which is somewhat green when stacked will heat and that heat may create spontaneous combustion. Combustion may be avoided by proper curing and storing in not-too-large stacks."

*Geary county*: "Spontaneous combustion may be avoided by not stacking hay that is wet from rain or dew. Alfalfa's own moisture will not cause combustion. Water on hay, rather than in hay, is dangerous."

*Johnson county:* "Don't store it too green or too wet. Alfalfa will stand its own greenness better than wet from dew or rain."

*Cloud county:* "If hay is damp do not pile it too deep in the mow. About six feet of depth for loose hay is enough."

*Marion county:* "Thorough curing is the remedy. Spreading in a thin layer will help. Use 'hay wells' for ventilating shafts."

*Miami county:* "Have space enough so you can spread a not-too-deep layer of hay. It will cure out from one cutting to another, and you will have no trouble."

*Cherokee county:* "I haul from the windrow to the barn. If not well cured I put two and one-half gallons of salt to a ton of hay. That keeps it from heating. By hauling it a little green to the barn it retains the leaves better. The same will apply in stacking."

*Jefferson county:* "Cure the hay sufficiently before putting up. If you can not cure hay, add about two gallons of salt and one gallon of air-slaked lime per ton of hay."

*Hodgeman county:* "Watch your hay. Feel the heat. If it gets too hot move and air at once."

(See page 246.)

#### MOLDY HAY.

The molding of hay in stack, shed or mow is brought about by the same conditions that cause spontaneous combustion. The only difference is that the conditions are present in a lesser degree. Therefore, the same means of prevention and remedy should be applied in a case of molding as are applied in case of combustion. Heating of the hay is said to destroy the mold germ, but there is danger that the heating may become so intense as to cause combustion. Heating from the juices of the plant results in what is known as "brown" hay—a hay very palatable to cattle.

#### DUSTY HAY.

Another evil caused by dew or rain on hay is the accumulation of small particles of dust and dirt, which, when the dew or rain is no longer present, remain on the hay. Such hay is said to be "dusty."

#### BALING.

Large quantities of baled alfalfa hay are shipped out of Kansas annually. Aside from that which is shipped, considerable quantities are baled and sold locally, and some growers even bale it for feeding on the farm, as hay requires less storage space when in the baled form. The growers were asked: "Do you bale alfalfa from the swath, the windrow, the cock, the stack, or from the shed?" The replies to this question indicate that most of the baling of alfalfa hay in Kansas is done from the shed or stack, after the hay has gone through the sweat. It is claimed that hay of much higher quality is had in this way. Of the growers who have tried baling from the windrow or cock, 100 per cent of those reporting from the western third of the state declare that it is satisfactory providing the weather conditions are favorable and the hay well cured;

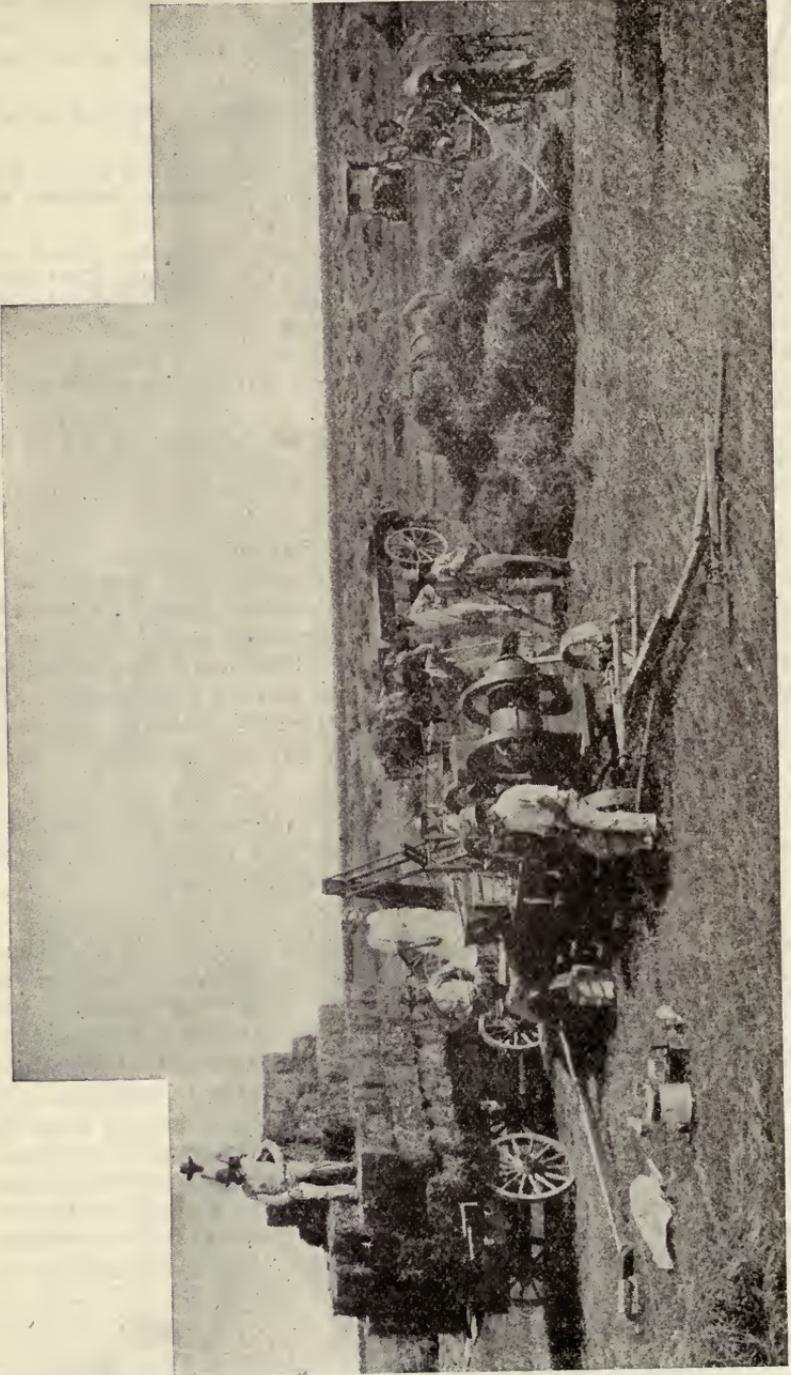

FIG. 104. Baling from the field and shipping immediately.— [Courtesy *The Country Gentleman*.]

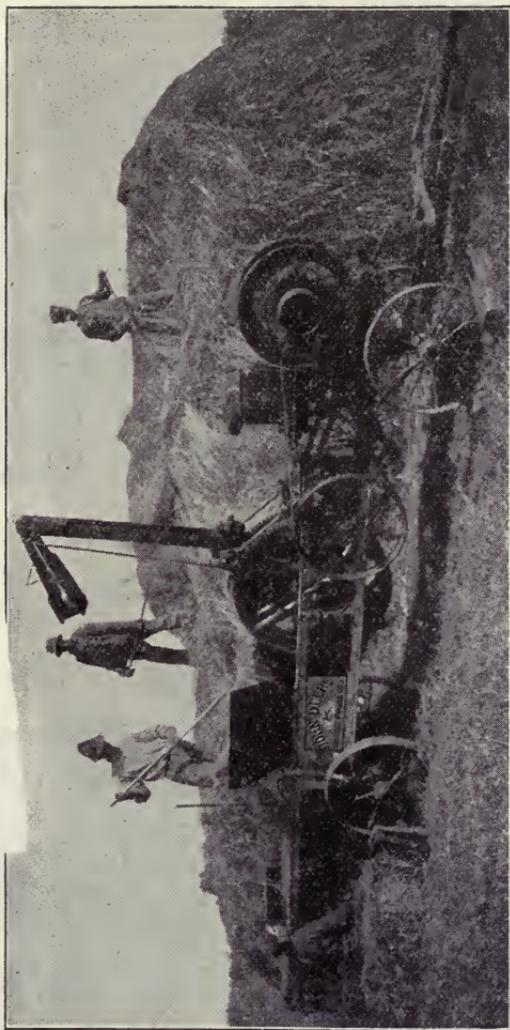

FIG. 105. Baling from the stack with a power press.—[Courtesy John Deere & Company.]

in the central third of the state 85 per cent of those who have tried it consider the practice satisfactory; while in the eastern third of the state only 56 per cent consider it satisfactory. All insist, however, that the weather *must* be dry and the hay *thoroughly cured*, and that care must be exercised in storing the bales afterwards, to prevent heating.



FIG. 106. Baling by horsepower.  
[Courtesy International Harvester Company.]

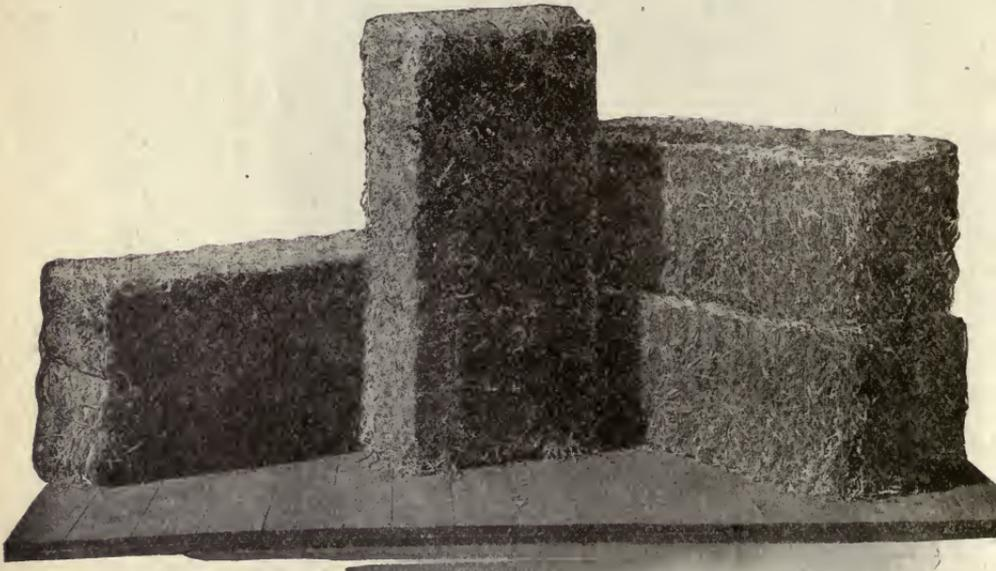

FIG. 107. A premium is paid for neat, uniform, square-ended, 75-pound bales, properly wired made up of distinct layers of approximately the same size and easily separable.—[Courtesy Ann A. Machine Company.]

A report from Neosho county reads:

"I have never been able to find a way to cure alfalfa so it can be baled in the field without bleaching so badly that the price is affected. For such hay I have been unable to get better than a No. 2 grade on at least 50 per cent of it."

#### SIZE OF BALE.

The type of bale generally used is oblong in shape, the dimensions being 14 by 18 by 36 inches. Such bales will vary in weight from about 65 pounds up to about 85 pounds, and usually weigh between 70 and 80 pounds.

#### STORING BALED HAY.

Nearly three-fourths of the growers reporting store their baled alfalfa in barns or sheds. A few are in the habit of piling the bales outside, in the field, and covering them, but this is not considered the best practice. Nearly one-fourth of the reporters stated that it is their practice to load cars direct from the baler and ship immediately. It is important that there should be no delay in getting baled alfalfa under cover, either by proper storing or by immediate shipping, to avoid exposure to the weather.



FIG. 108. A hay hook, for handling bales. [Courtesy Stowe Supply Company.]

Reporters are almost unanimous in asserting that bales should be piled on edge when stored. A Montgomery county man wrote: "Always stack on edge. Never stack flat unless you want moldy edges. Leave spaces until dry, and restack closer." A Neosho county man wrote: "Store in barns. I stack the bales on edge, laying one row of bales across the other to bind, and leave a small air space between the sides of the bales." In fact, most of the growers mentioned the advisability of plenty of ventilation around and between the bales. Some make

a practice of placing two-by-four-inch pieces of lumber on top of each layer of bales, as a means of ventilation. Baled hay should not rest directly upon the ground.



FIG. 109. It is important that there be no delay in getting alfalfa hay under cover. [Courtesy Arizona Experiment Station.]

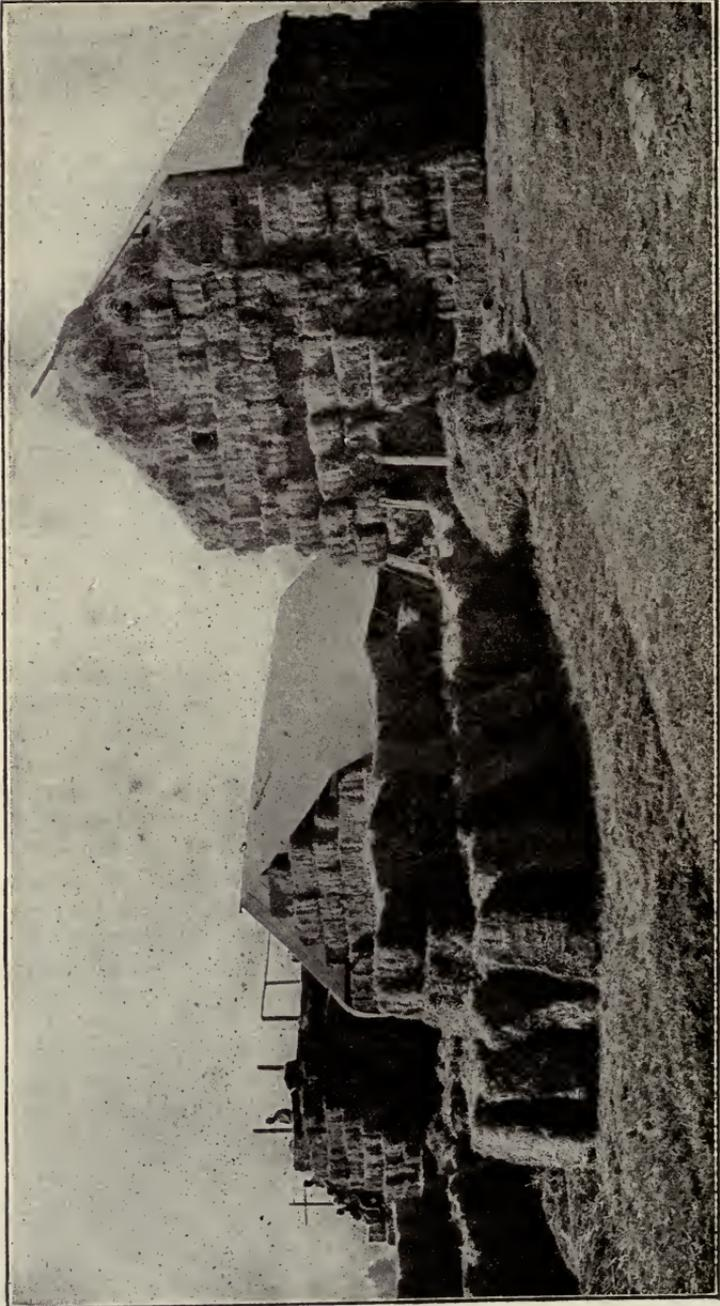

FIG. 110. Always stack alfalfa bales on edge.—[Courtesy International Harvester Company.]

A Miami county reporter writes:

"I will tell you my practice in handling and baling alfalfa. Cut when the dew is off, and when well wilted use a side-delivery rake, throwing two windrows side by side, but not touching. Let lay until the next day about noon; then bunch with a sulky rake into small cocks. Start the wagons directly after the sulky rake. This insures easy pitching and gets all from the ground without any trouble. Fill the mow in sections, so that the hay can easily be gotten out. Watch closely, but don't get excited if the top gets damp and tough for a few days, as the heat naturally comes to the surface. In from eighteen to twenty-five days bale, using a 14-by-18 self-feeding power press, making the weight of the bales to be from seventy-five to eighty pounds. Store the bales on edge. In the winter you will have as near No. 1 hay as can be found." (See page 246.)



FIG. 111. Load cars of hay to full minimum weight.

"Where the distance from market necessitates a long haul or where the produce is shipped by rail, alfalfa hay should be baled. The bulk is thus reduced to about two-sevenths of that of loose hay. The disadvantage of baling lies only in the extra cost. Where the hay is to be fed on the farm it is not worth while. When, however, the hay is to be sold in the general market, the cost of baling is more than compensated for in the increased price which may be received for it, in the facility with which it may be handled, and in the market economy of storage space when it is being held for higher prices. Whether it is better to sell the hay at once or to hold it for higher winter prices, is determined by the relation between the shrinkage in weight during storage and the increase in price so obtained; also damage from storms, sunburn, and cost of insurance."—*Bulletin No. 73, Arizona Agricultural Experiment Station.*

## LOADING HAY IN THE CAR.

The following are in answer to the question, "What particular points about loading alfalfa hay in the car should be observed?"

*Finney county*: "Hay dealers recommend loading bales on edge or end to prevent heating."

*Cowley county*: "Load long way of car and put bales in edgewise, as they will not heat as soon as if put in flat."

*Riley county*: "If the hay has not gone through the sweat it must be put in edgewise."

*Wabaunsee county*: "The bales should be placed on edge, especially when baling from the windrow."

*Montgomery county*: "With planning and a little pushing, a car can be made to hold from 1000 to 1500 pounds of hay above a careless method."

*Neosho county*: "To get in the minimum weight of a car, pack the bales the long way of the car and fit them tight."

*Marshall county*: "Always load on edge and fill car to minimum capacity, which is best done in furniture or automobile cars of forty feet or more in length."

*Mitchell county*: "Have the quality uniform in all parts of the car; load on edge; use large, smooth car; remove nails."

*Chase county*: "Bales ought to be loaded edgewise in car, and evenly so the hay shows to good advantage."

*Chautauqua county*: "Load the bales on edge. Hay must be thoroughly cured or it will heat in transit. Put one grade in each car."

*Cloud county*: "Use the same quality of hay throughout the car."

These replies are typical of the many received, and cover the different points mentioned.

## GRADING HAY FOR THE MARKET.

In response to the question, "How do you grade alfalfa hay for the market?" growers answered in this wise:

*Cheyenne county*: "The hay association grades the hay when it gets to market."

*Doniphan county*: "The buyer grades it. We do not have anything to say about it."

*Sumner county*: "The other fellow grades it at his end of the road. We have nothing to say."

Rules for grading alfalfa hay, as established by the Kansas City Hay Dealers' Association, may be found on page 457.

In conforming with the rules and grades of the hay market, growers should find the following suggestions helpful:

*Labette county*: "We follow as closely as possible the market grades, and put only one grade in a car."

*Chautauqua county*: "Put a uniform quality of hay in the car, if possible. Hay that comes from the top of the stack should not be placed in the same car with hay from the bottom of the stack."

*Franklin county*: "Try to keep each crop and grade separate."

*Wabaunsee county:* "The green hay and the brown hay should be shipped separately."

*Marshall county:* "Attempt to get evenness in quality and color."

*Riley county:* "Put the brown hay in one class and the green in another."

*Mitchell county:* "We ship good hay and try to have it of uniform quality in the car."

*Doniphan county:* "Grade by the color and texture."

*Norton county:* "Hay must be a bright color and not too stemmy."

*Riley county:* "We grade by the color, the leaves, the coarseness and the foreign grass in it."

*Neosho county:* "Grade according to color and quality."

*Geary county:* "Grade on color and amount of foreign matter contained in it."

*Smith county:* "The greener and the more leaves in hay the better."

*Dickinson county:* "I try to ship well-colored and leafy hay as No. 1. If much off color I would expect No. 2."

*Barber county:* "I use all nice, bright hay."

MARKETING HAY.

TABLE No. 9. How alfalfa hay is marketed.

	Western third of the state, per cent.	Central third of the state, per cent.	Eastern third of the state, per cent.	The state as a whole, per cent.
Market locally.....	43	69	41	55
Ship to market.....	31	17	32	24
Market both locally and by shipping.....	26	14	27	21

Kansas City, Mo., is preëminently the market to which hay from Kansas points is shipped. Hay is sent there from all parts of the state. Wichita, Kan., is a secondary hay market, to which hay is shipped from a considerable part of its tributary territory in the southwestern section of the state. Quite a large proportion of the alfalfa hay shipped to Wichita is consumed by the extensive alfalfa milling industry at that point. Other markets mentioned are Denver, Colo., St. Joseph, Joplin, St. Louis, and other points in Missouri; also points in Illinois, Iowa, Indiana, Oklahoma, Alabama and other states. The larger towns of Kansas also consume a considerable amount of alfalfa hay.

Proper and sufficient data were not brought out by the investigation accurately to estimate the amount of alfalfa hay fed on the farm as compared with the amount sold. It is apparent, however, that a much higher percentage of the total aggregate yield is sold from farms having the larger acreages than is sold from the farms having the smaller acreages. (See pages 447 to 460.)

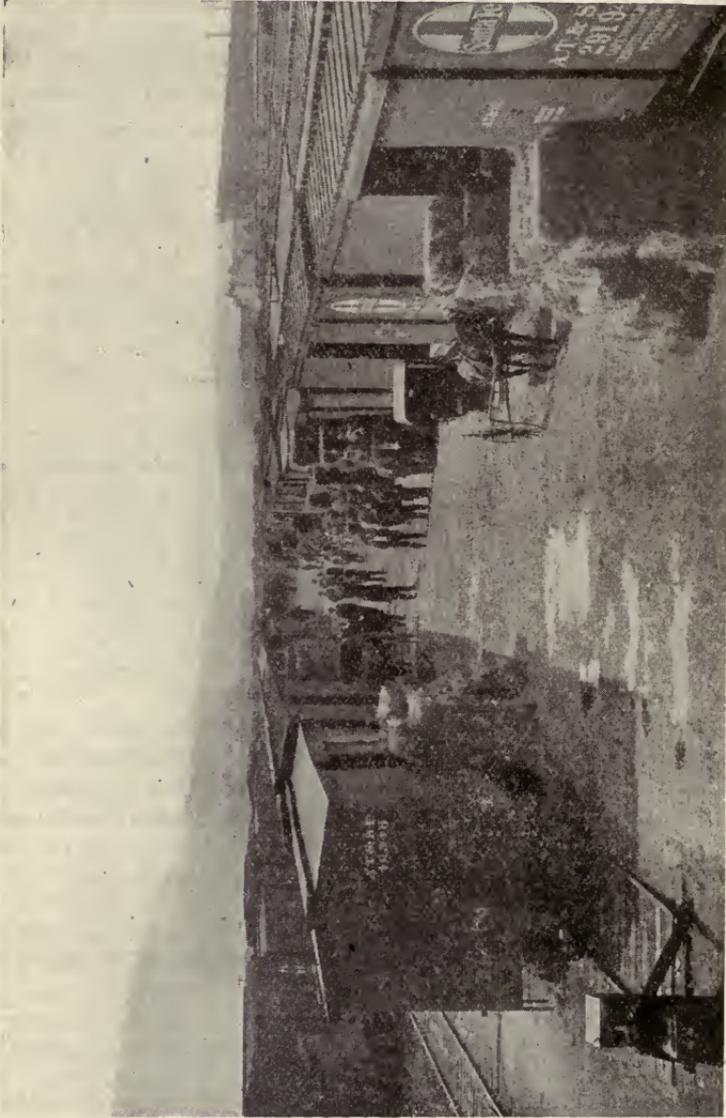

FIG. 112. The better and more uniform the quality of the hay the more money it will bring in the competition of the big hay markets.—[Courtesy American Elevator and Grain Trade.]

WHERE SEED IS GROWN.

Very few growers reported on this question, but a sufficient number reported to indicate in a general way where most of Kansas' alfalfa seed is grown.

TABLE No. 10. Location of seed-producing sections.

	Western third of the state, per cent.	Central third of the state, per cent.	Eastern third of the state, per cent.
Usually mature a seed crop.....	35	24	7
Occasionally mature a seed crop.....	17	29	35
Never mature a seed crop.....	48	47	58

At first one would think that the number of acres annually producing a seed crop might readily be computed by applying the foregoing percentages to the total alfalfa acreages in the sections mentioned. This supposition is erroneous, however, for the reason that while a grower may "usually mature a seed crop," there is nothing to show that he devotes his entire acreage to that purpose. In fact, there is very good reason to believe that it is seldom, if at all, the custom of growers annually to devote their entire alfalfa acreage to the production of seed. One Marion county grower said, "Yes, I usually mature a seed crop, but never more than 25 per cent of my acreage at a time." The Board of Agriculture has at this time no reliable data on which to base an estimate of the aggregate acreage annually devoted to maturing alfalfa seed.

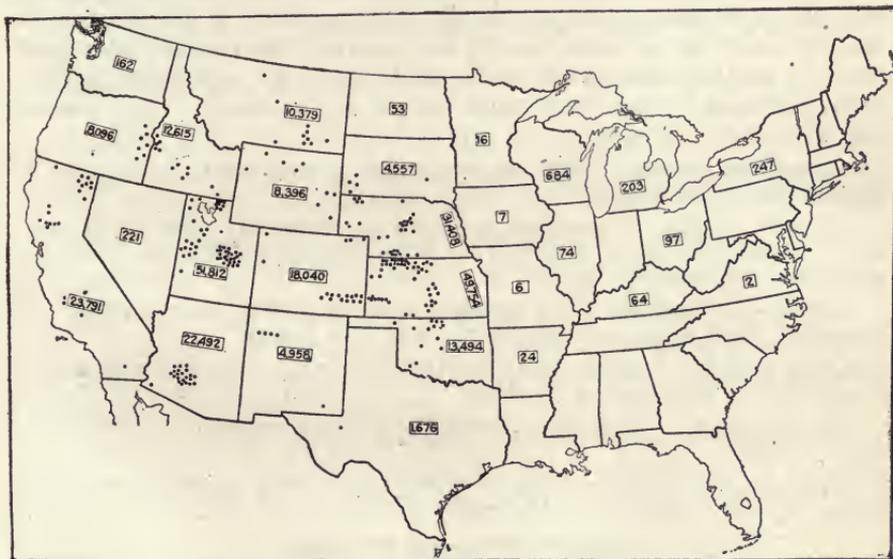

FIG. 113. Map of the United States, showing the production of alfalfa seed in 1909. Each dot represents 1000 bushels. The numerals indicate the production in bushels. The location of the dots indicates approximately the seed-producing areas.—[Courtesy U. S. Department of Agriculture.]

As one progresses from the western toward the eastern end of the state the percentage of those who usually mature a seed crop becomes steadily less: 35, 24, 7. The occasional seed growers steadily increase as one goes from west to east: 17, 29, 35. The percentage of those who do not in any year mature a seed crop is slightly more in the eastern third than in the sections further west; just about one-half of the alfalfa growers reporting on the subject are included in this class. The following replies are in answer to the question, "Do you usually mature a seed crop?"

*Marion county*: "Yes, from five to fifteen acres." [This man has 115 acres of alfalfa.]

*Rice county*: "Usually on some piece, but not on all. Select the cleanest piece, not too thick on the ground."

*Cheyenne county*: "Sandy soil is best for maturing seed."

*Dickinson county*: "When it will seed, I do. In wet seasons it won't seed."

*Douglas county*: "No. I can very seldom get a paying seed crop in eastern Kansas."

*Miami county*: "No. The seed is too cheap and the hay is worth more money."

*Rawlins county*: "No. Hay usually pays better than seed."

*Sumner county*: "No. It is hard on the stand. I mature a crop every other year."

#### CONDITIONS FAVORING A SEED CROP.

Most growers prefer sufficient moisture to start the crop that is to be left for seed. They are practically unanimous in their preference for dry, hot weather at time of blossoming and up until time of maturity. The degree of dryness should not be too great, as it is possible for atmosphere and soil to become so dry as to prevent the proper maturity of seed. A few light showers after the seed has set are considered by some to be beneficial, though heavy rains are not at all desired. Some reports follow:

*Greenwood county*: "I want a dry season to raise seed. If it is wet it sprouts from the bottom."

*Mitchell county*: "Plenty of moisture in subsoil at start of growth, and dry, windy weather afterward. Enough moisture in subsoil to give plants a good start."

*Chautauqua county*: "Dry during the latter part of the growth of the second or third crop, particularly while it is in bloom."

*Cloud county*: "Heavy rains to start the crop; then dry weather at blooming and maturing of the seed."

*Marion county*: "Wet before blooming and dry weather after the pods begin to set."

*Montgomery county*: "Seed best not from a big growth. In a wet season it may bloom, but will blight."

#### WHICH CROP LEFT FOR SEED.

About two-thirds of the growers report in favor of leaving the second crop of the season for seed, nearly one-third in favor of the third crop,

and a few, located in the northwest corner of the state, in favor of the first crop. These preferences prevail in a comparatively uniform way throughout the state. As much time is required to mature a seed crop as is required to mature two hay crops, for where four crops of hay in a season may ordinarily be expected, a seed crop and two crops of hay are all that can be secured. July, August and September are the seed-maturing months.

#### SEED CROP'S EFFECT ON THE STAND.

As to whether or not the maturing of a seed crop is injurious to the stand of alfalfa there is considerable difference of opinion. Two-thirds of the growers reporting are of the opinion that maturing seed does not injure the stand, at least not so far as they have been able to discover. Their reports read something like this:

*Pratt county*: "Not that I have ever noticed."

*Allen county*: "Not here. It does not seed often enough to hurt."

*Wabaunsee county*: "I have not discovered any deterioration, but we cut seed only in very dry seasons."

*Gray county*: "Under some conditions seeding improves it."

*Wallace county*: "I have seen no indications of it doing so. I have noticed where fallen seed helped thicken the stand."

*Lincoln county*: "Never affected mine, but thickened it by shattering."

On the other hand, nearly one-third of the growers believe that seeding does injure the stand, and report as follows:

*Marion county*: "It shortens the life of the field and decreases the quality and quantity of hay for at least one year."

*Harvey county*: "It allows the grass and weeds to start, and injures the stand."

*Cloud county*: "A small per cent of the plants die after maturing seed."

*Geary county*: "It lowers the vitality of the plant and thins the stand."

*Logan county*: "It exhausts the plant very much. The following hay crop is very light. But the seed that is shattered produces new plants."

Some believe that only continuous seeding is injurious, as:

*Neosho county*: "If continued year after year it does."

*Norton county*: "If continued will soon kill alfalfa."

*Meade county*: "Regular seeding injurious; occasional beneficial."

Growers caution against maturing a seed crop on fields of young alfalfa:

*Sherman county*: "It is best not to let a newly-sown field go to seed."

*Scott county*: "I don't know that it injures an old stand, but I do know that it is not good to mature seed till the stand is three years old or over."

#### SEED CROPS FROM WEEDY FIELDS.

Weedy fields produce unclean seed. It is best that a weedy field be not allowed to go to seed. A few growers report going over a field left for seed and cutting off the weeds with a hoe, a sickle or a scythe. This may

do as a last resort, when the crop is too far along to cut profitably for hay, or to clean up spots here and there, but it is impractical with any considerable acreage. The usual means of eradicating weeds from alfalfa fields, as discussed on foregoing pages, should be effectively applied before a seed crop is allowed to mature. Where weed seed is present among the alfalfa seed thorough cleaning and recleaning will be found profitable.

#### CUTTING THE SEED CROP.

Reports indicate that the proper stage for cutting a seed crop has arrived when from two-thirds to three-fourths of the pods have turned brown. A few say that they wait until the first seeds begin to shatter, while others cut when the first pods begin to turn brown. Most of the growers, however, prefer to cut when a majority of the pods are brown.

In harvesting an alfalfa seed crop the most important thing is to prevent loss of seed. This is kept in mind throughout every operation. Starting with the cutting operation, it has been found that the most popular machines for that purpose are those that cut the crop and automatically rake it, leaving it in small unbound bunches, or gavels. This may be accomplished by any one of several machines: the self-rake reaper, the common mower with windrowing and bunching attachments, or the grain binder without the binding attachment. The modern self-rake reaper has a platform in the form of a quarter circle. The alfalfa is reeled to this platform by rakes, and is deposited from the platform far enough to one side to permit the free passage of the machine on the next round. The cutting mechanism on a self-rake reaper is like that on a binder. The self-rake reaper may also be equipped with a buncher.



FIG. 114. Most growers prefer to cut a seed crop when a majority of the pods are brown. — [Courtesy U. S. Department of Agriculture.]

The windrowing attachment of the common mower is a set of curved steel fingers attached to the rear of the cutter bar, which rolls the falling alfalfa into a windrow; and the bunching attachment consists of additional fingers, made to hold accumulated alfalfa until tripped. If the alfalfa plants are of sufficient height to permit binding, the binding attachment on the binder may be used.

About two-thirds of the growers reporting use either the self-rake reaper or the mower with the windrowing and bunching attachments; 15 per cent use the common grain binder, usually without the binding attachment; 3 per cent use the grain header without the elevator; and 15 per cent use an ordinary mower and rake, the same as for hay.

#### CURING THE SEED CROP.

A preponderant majority of the seed growers cure their seed crops in the cock; only a few cure in the windrow. It is considered wise to get the crop into the cock as soon as possible, while it is yet damp or tough, for

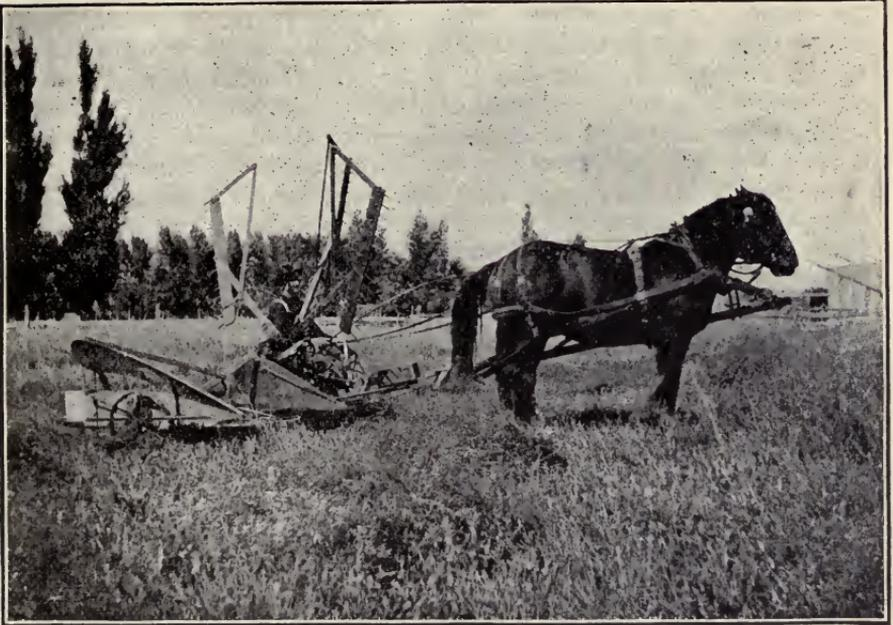

FIG. 115. The modern self-rake reaper is much used for cutting seed crops.  
[Courtesy U. S. Department of Agriculture.]

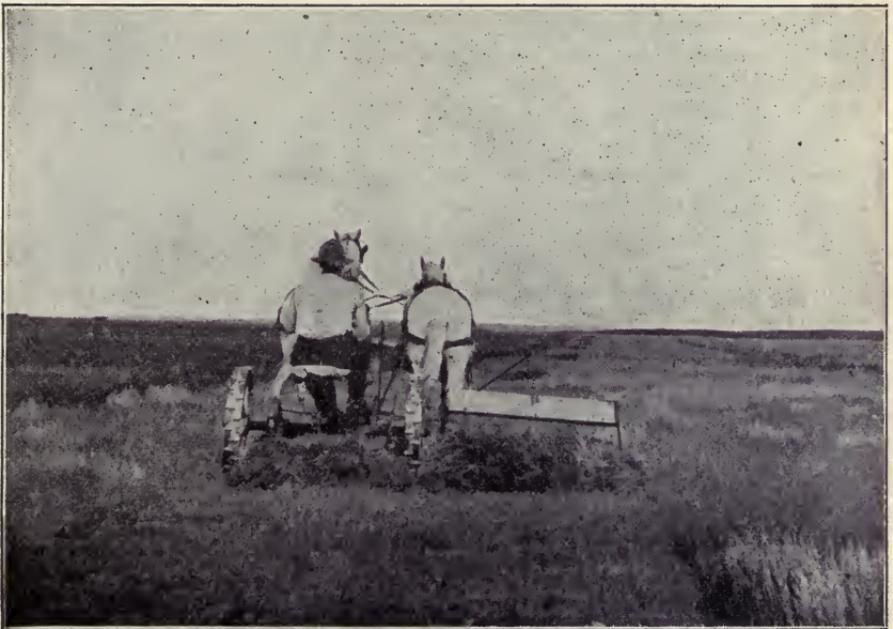

FIG. 116. Cutting a seed crop with a common mower equipped with windrowing and bunching attachment.—[Courtesy *National Alfalfa Journal*.]

there is less shattering when it is handled in a damp condition than when dry. The preference is for small cocks, put up with pitchforks. Cocks no larger than may conveniently be placed on the wagon by one man, a forkful at a time, are preferred by many. The bunches left by the self-rake reaper and the mower with windrowing and bunching attachments are especially adapted to rapid cocking with a minimum amount of shattering. Where the crop is bound the sheaves are shocked like grain.

In case of rain the cocks must be turned for thorough drying; and there are growers who turn the cocks even in good drying weather, in order that they may be quickly dried on both sides. As a rule, from five to ten days are required for the crop to become sufficiently cured and dry for threshing or storing. *In no case should a seed crop be threshed or stored until it is well cured and thoroughly dry.* The aim, however, should be to get it off the field at the earliest possible moment, for there is always danger of rain while it is yet in the open.

#### TRANSPORTING THE SEED CROP FROM THE FIELD.

When it comes to transporting the seed crop from the field to the thresher or the stack, particular care is necessary to prevent shattering. At this time the pods are dry, and any rough handling will cause a considerable loss. The usual practice is to haul the crop on canvas-covered hay wagons. The canvas is placed directly on the wagon bed, and will catch quite a quantity of shattered seed. If the cocks are small, a whole cock may be carefully lifted to the wagon at one time with pitchforks, and the tearing apart of the cocks and shattering of the seed be thus avoided. Not a few of the larger growers "slip under the shocks with a sweep rake, taking three shocks to a load, and move the shocks to the thresher or the stack." While this method may cause a greater loss by shattering than the wagon method, it is probably most economical for large acreages.

#### STACKING THE SEED CROP.

The stacking of a seed crop is accomplished very much like the stacking of a hay crop. The differences lie in the more frequent use of the hay wagon, the more careful handling, the abstinence from tramping, and the greater effort used to protect the stack. There are some who use the sweep rakes and stacker, but they are in the minority. As with hay, the stack should not rest directly upon the ground. Some growers alternate layers of alfalfa with layers of dry straw, with the object of taking up any surplus moisture. The alfalfa must be dry before stacking, because stack-burning is one of the worst things that can happen to a seed crop. The stack should be covered in the very best manner possible, with the same kinds of covers as are used for hay.

#### RAIN ON SEED CROP.

Rain, particularly rain that is heavy or long continued, causes serious damage when it falls on a cut and unthreshed seed crop. It is a common cause of discoloring and sprouting of seed, of bursting and shattering of the seed pods, and of molding and heating in the stack and the consequent destruction of vitality in the seed. Such damage considerably

depreciates the market value of seed, the usual loss from this source being estimated by some growers at 5 to 15 per cent or more. Hence the wisdom of early threshing.

#### THRESHING.

Threshing is best done during dry weather, and while the crop is perfectly dry. Eighty-six per cent of the growers reporting prefer to thresh direct from the shocks in the field, if the weather permits and a machine can be obtained. It is not wise to wait long for a machine after the crop is dry, a week or ten days being the limit expressed by some. Only fourteen per cent prefer to stack and thresh later. When threshed direct from the field the seed is no longer subject to the weather, there is less handling, and no danger from stack-burning or molding. On the other hand, as claimed by some, if the crop is permitted to go through the sweat in the stack more seed may be threshed out. However, the gain of this additional seed may in a measure, if not wholly, be offset by the loss in shattering caused by the extra handling. There are no data as to the relative merits of seed threshed direct from the field as compared with seed threshed from the stack. Bound alfalfa is generally threshed from the field. Where the seed crop is stacked it is always allowed to go through the sweat, and is threshed at some convenient dry time in fall or winter, most often during October or November.



FIG. 117. Threshing alfalfa seed from the stack.

Reports indicate that fully 75 per cent of the growers consider the regular alfalfa or clover huller the best machine to thresh alfalfa seed with. Most of the later models of grain-threshing machines may be equipped with special alfalfa attachments, and as many as 25 per cent of the growers reporting think it the best machine to use. The old-fashioned thresher is generally too wasteful for economical use. One grower, from Trego county, states that he can get only about one-half the seed when using one of these machines. A properly adjusted grain separator, with attachments, will do pretty good work, however, if rightly used.

## AVERAGE YIELD OF SEED.

The average yield of alfalfa seed in the state of Kansas, according to the growers reporting, is 4.2 bushels per acre. The average yield per acre in the western third of the state is 3.7 bushels, in the central third 3.9 bushels, and in the eastern third 5.1 bushels. The United States Department of Agriculture estimated that in 1909 the total production of alfalfa seed in the United States was 2,063,828 bushels, crediting Kansas with 49,754 bushels. Kansas ranked second as an alfalfa-seed producer according to those figures, Utah being first, with 51,812 bushels. Nebraska was third, with 31,408 bushels.

Climatic variations cause very great fluctuations in the size of Kansas' annual alfalfa seed crop, however. In dry seasons like 1901, 1911 or 1913 a large surplus is produced and considerable quantities are shipped out of the state. In a normal year not a great deal is shipped away, because Kansas herself, with her constantly increasing acreage and replanting, consumes large quantities every year. In seasons of heavy rainfall at time of seeding, the alfalfa seed crop is not of sufficient size to meet home demands, and it is necessary to import seed from other states, and even from foreign countries.

## RECLEANING SEED.

Eighty-two per cent of the growers report that it is their custom carefully to reclean seed before harvesting. Most of the hullers on the market to-day are equipped with recleaning attachments, but where seed is threshed with a machine not so equipped, a good fanning mill, costing approximately \$25, will be found a profitable investment.

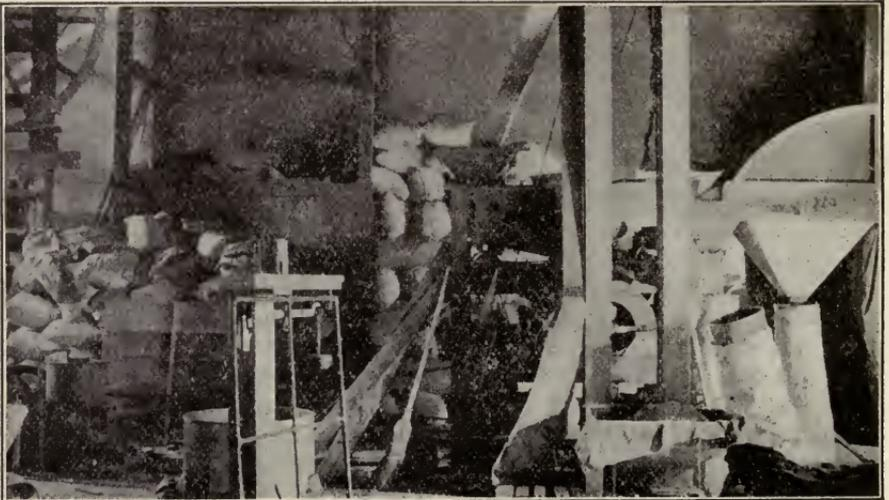

FIG. 118. Recleaning alfalfa seed before marketing. It pays to take out the foreign seeds and the dirt.—[Courtesy U. S. Department of Agriculture.]



FIG. 119. A Decatur county load of alfalfa seed which sold for \$794.15.

## STORING SEED.

Alfalfa seed is generally put in heavy, seamless cotton bags. It may be sold direct from the machine or it may be stored in these bags. Few growers store their seed in bulk in bins. If the seed is green or damp when threshed it had best be spread twelve or eighteen inches deep on a tight floor, in a dry place, and shoveled over once or twice before bagging. The place of storage should have sufficient ventilation to prevent heating, should be dry, and should afford protection against mice and rats.

## MARKETING SEED.

Seventy-seven per cent of the growers sell their seed locally, either direct to the consumer or to local dealers. These dealers, while they ordinarily may be engaged in conducting merchandise stores or elevators, buy the seed and sell it to regular seedsmen. To communities where seed is raised in sufficient quantities to justify, seedsmen send buyers. Only three per cent of the growers sell their seed direct to seedsmen. Twenty per cent report selling their seed both locally and to seedsmen. (See pages 267 to 271.)

## FEEDING VALUE OF ALFALFA STRAW.

The growers reporting estimate that alfalfa straw, where it is properly cared for and not allowed to get wet, has a feeding value of nearly 50 per cent of the value of good alfalfa hay. A number of growers report its feeding value to be equal to that of prairie hay, ton for ton. It is good for horses especially, although beef cattle are reported as



FIG. 120. Growers estimate that alfalfa straw when properly cared for has a feeding value of nearly 50 per cent of the value of good alfalfa hay.—[Courtesy U. S. Department of Agriculture.]

doing well on it. The important point is that it should not get wet. The following reports bear on this subject:

*Cowley county*: "If handled as I handle it—threshed and blown into the barn without getting wet—it is worth \$6 per ton when hay is worth \$8."

*Cheyenne county*: "Same as good prairie hay."

*Geary county*: "Same as prairie hay."

*Greenwood county*: "Good as prairie hay."

*Labette county*: "Better than prairie hay."

*Miami county*: "About like prairie hay."

*Neosho county*: "Better than prairie hay for horses."

*Wallace county*: "Better than prairie hay."

*Woodson county*: "Cut at the right stage and not rained on, it is equal to the best prairie hay."

*Jackson county*: "Better than timothy if not rained on."

*Nemaha county*: "About like timothy."

*Wabaunsee county*: "About like millet."

*Cloud county*: "Very little more than wheat straw."

*Rush county*: "Same as wheat straw."

*Marshall county*: "Preferable to oat straw for cattle."

*Comanche county*: "As good or better than corn fodder, ton for ton."

*Barber county*: "Good for horses especially."

*Douglas county*: "All stock will eat it."

*Geary county*: "Stock seem to thrive on it."

*Ellis county*: "When bright have fed it to cattle, horses, and even brood sows, with good results."

*Finney county*: "A good horse feed; not as good as hay for cattle."

*Grant county*: "Old growers say it is better for horses after threshing."

*Marion county*: "Better threshed than unthreshed. Old cows and young calves especially fond of it."

*Greenwood county*: "Good as hay for beef; no good for milk."

*Harvey county*: "Good for both cattle and horses."

*Marion county*: "If not spoiled it is fine. I often use it to start steers on feed; throw in boxes with chop on it."

*Montgomery county*: "For horses I like it as well as the first cutting."

*Morris county*: "Not exposed to the weather, it is good for stock."

*Pratt county*: "Almost equal to hay for horses; less for cattle."

*Rooks county*: "Good, especially for horses."

*Saline county*: "If dry and not musty it is almost as good as hay for horses."

*Wabaunsee county*: "I can't say what the feeding value is, but cattle seem to like it as well as alfalfa hay."

*Ness county*: "It has 50 per cent feeding value unless broken in fine particles."

*Russell county*: "Very good if not allowed to lie in the field."

*Marshall county*: "Pretty good, but not as good as hay; coarse and dry."

*Meade county*: "It may be entirely worthless or very valuable."

*Sumner county*: "Poor, as too woody."

#### FEEDING VALUE OF ALFALFA MEAL.

Only 15 per cent of the growers reporting on the question have fed alfalfa meal to their stock, and of that 15 per cent only 32 per cent regard meal of greater value than its equivalent in hay. Among those who are

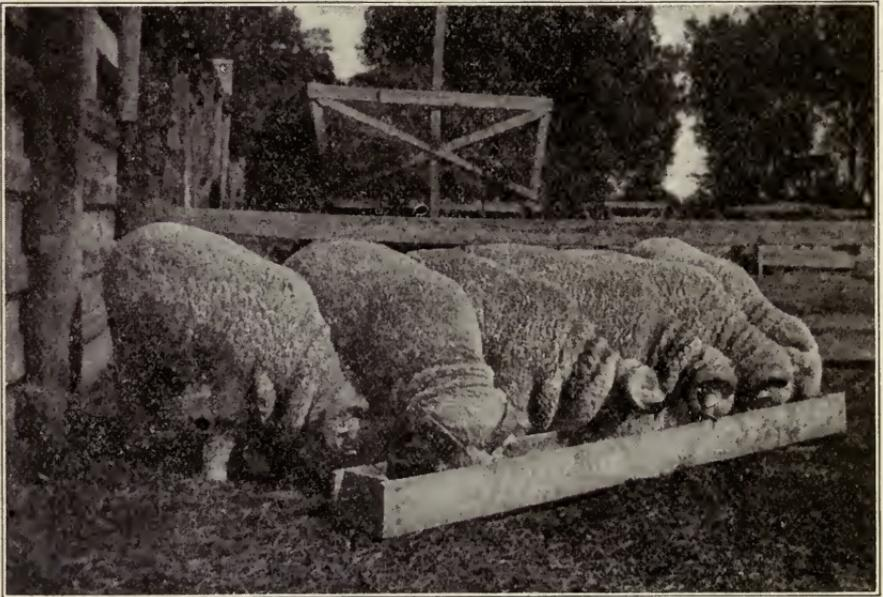

FIG. 121. Sheep eating alfalfa meal.—[Courtesy *National Alfalfa Journal*.]



FIG. 122. A Kansas alfalfa mill.—[Courtesy *The Earth*.]

against it, it is considered that any advantage is more than offset by the expense of grinding. There are some, however, who use alfalfa meal in mixture with ground corn or other elements, and seem to like it. Others think alfalfa meal good poultry feed. (See pages 403 to 446.)

## ALFALFA SILAGE.

Very few growers have had experience with alfalfa as silage. One man in Gray county states that he has tried it; that he did not put the crop through a cutter, and that he put it into the silo in a wet condition. His estimate of alfalfa as silage is, "It is fine." A Sumner county correspondent reports having used "some" alfalfa as silage. He put it through the cutter and filled the silo on the same day. His estimate of alfalfa as silage is, "Good, but expensive." Then there is a Pottawatomie county man who has tried using alfalfa straw for silage. It was put through a cutter. He said, "Don't think it pays." From Barton county comes the report of a man who "stacked alfalfa hay in the rain, while it was green. It cured like silage and made good feed." The general opinion among growers, however, is that well-cured hay is to be preferred to alfalfa silage. Some typical opinions follow:

*Atchison county*: "No better than alfalfa hay; don't keep so well; not economically stored."

*Chase county*: "Don't improve feed enough to justify."

*Crawford county*: "No better than hay, and more work."

*Doniphan county*: "Makes silage too soft."

*Pratt county*: "More successful as hay."

*Riley county*: "Expensive."

*Smith county*: "From what I have seen it does n't pay."

(See pages 262 to 266.)

## PASTURING SWINE.

Nearly four-fifths of the growers reporting pasture hogs on alfalfa. This practice is equally prevalent throughout the state. Reporters estimate that a good stand of alfalfa will comfortably pasture from eight to ten average-sized hogs per acre, and at the same time yield a small quantity of hay. As many as twenty small shoats are sometimes pastured on an acre. Others report fifteen head of swine of mixed ages as a reasonable number. Still another man estimates that an acre will support 2500 pounds of live weight. The luxuriance of the growth and the size and age of the animals are the chief limiting factors. It is impossible to lay down an ironclad rule, and the farmer will need to use good judgment. As one grower expresses it, "Whenever you see that the hogs are getting the best of the alfalfa, take them off."

Here is the report of a Brown county farmer on this subject:

"I have forty-five acres in one field, sown ten years ago. I pasture 40 sows and from 100 to 200 pigs in this field every season. They have destroyed about two acres where they enter the field, and it has grown up to grass, but they do not make much impression on the rest of the field."

It is inadvisable to pasture in the spring until the alfalfa has made a growth of eight or ten inches. After that swine may pasture during the growing season and up until about the time the last cutting would be made in the fall. The same conditions for going into the winter that apply to alfalfa cut for hay should apply to pastured alfalfa; that is, a certain amount of growth should remain for protection and for the catching of the winter's snows. When the growth is not large the number of hogs per acre should be reduced, and when the growth is coming on rapidly the number may be increased. Most growers believe, however, that it is best not to pasture an alfalfa field to full capacity.

Very little hay should be expected from a pastured alfalfa field. The amount that is harvested depends upon the extent of pasturing. It is the usual practice to cut a pastured field two or three times during the season, handling the hay in the customary manner, in order to "freshen up the stand." While this is being done the hogs should be taken off and not put back until the next crop has made a good start. A method practiced by some growers is to alternate alfalfa pastures. Two or more fields are separated and the hogs taken from one field to another. By this method more hay is gotten and the effects of pasturage are not so noticeable.



FIG. 123. Hogs pasturing on alfalfa at the J. W. Lough farm, Scott county. Separated fields or lots enable the grower the better to control the pasturage.

Because of the tendency of hogs to root in alfalfa, which is injurious, it is the custom among about three-fourths of the growers reporting to "ring" or to "snout" them. Ringing is accomplished by putting rings in the noses, and snouting by cutting the noses of the animals—the upper rim of the noses, the "rooters."

There can be little doubt that pasturage injures alfalfa to a certain extent, and when it is overdone it will cause the death of the field. It is such an economical method of producing pork, however, that a judicious use of alfalfa for this purpose is to be recommended. Swine, young and old, do well on alfalfa pasturage. Growing pigs make a wonderfully vigorous growth. Alfalfa makes large bone and muscle with a great saving in grain. From Labette county comes a report reading, "Alone it is satisfactory; with a little grain they do exceptionally well on it."

Some of the descriptions applied by the reporters to the effect of alfalfa on pigs are: good, fine, excellent, beneficial, wonderful, magical, very helpful, best results, saves one-half the grain, very satisfactory, rapid and economical growth, cheap gains, and so on.



FIG. 124. Pigs make wonderfully vigorous growth on alfalfa pasturage.  
[Courtesy International Harvester Company.]

Old hogs live in fair condition, though in thin flesh, on alfalfa pasturage alone. With the addition of a little grain they will keep in a wonderfully healthy and thrifty condition. A grower in Wallace county reports, "Would n't think of raising hogs without alfalfa pasture; it keeps them healthy;" an Osborne county grower, "A fine conditioner;" and a Thomas county grower, "Gives appetite and makes them thrive better." It is particularly good for brood sows. All growers agree that corn, kafir or other grain is necessary in the ration, to obtain satisfactory results with swine on pasture. Skim milk, tankage and other feeds are also frequently mentioned. (See pages 423 to 428.)



FIG. 125. Most growers consider the pasturage of beef cattle on alfalfa to be dangerous.—[Courtesy *Farmer and Stockman*.]

## PASTURING BEEF CATTLE.

Most growers report that the pasturage of beef cattle on alfalfa is unsafe, because of the danger of "bloat." Fairly good success with fall and spring pasturing is occasionally reported, particularly in the case of weanling calves. The extent of this sort of pasturing is limited by the amount of growth at those seasons, and care must be exercised not to pasture too closely. The number of growers who pasture during the midseason is very much in the minority. From the replies of those who make a practice of pasturing beef cattle it is estimated that a mature steer will require from one to three acres of alfalfa as pasturage, depending on the luxuriance of growth and the quantity and character of supplementary feed. It can not be said that the pasturage of beef cattle on alfalfa is more prevalent in any particular section, as conditions appear quite uniform throughout the state. (See pages 410 to 415.)



FIG. 126. Were it not for the danger of "bloat" alfalfa would make wonderfully fine pasturage for dairy cattle.—[Courtesy *Farmers Mail and Breeze*.]

## PASTURING DAIRY CATTLE AND SHEEP.

Almost the same things that have been written about pasturing beef cattle on alfalfa may be written about the pasturing of dairy cattle and of sheep. The same risk of "bloat" is present, probably in a greater degree in the case of sheep than in the case of dairy cattle. Were there no danger of "bloat," alfalfa pasturage would, no doubt, make wonderfully fine feed for any of these animals, but under the circumstances nearly all growers consider pasturing with cattle and sheep entirely too dangerous. (See pages 415 and 419.)

## PASTURING HORSES AND MULES.

The pasturage of horses or mules on alfalfa is less dangerous. Results are especially satisfactory with young, growing stock, brood mares, and stock not hard at work. Reports as to the number of horses or mules pastured on an acre of alfalfa vary considerably, averaging from one to



FIG. 127. Sheep also are very susceptible to "bloat" on alfalfa pasturage.  
[Courtesy Kansas Experiment Station.]

two and one-half. It is important not to overpasture with these animals, for with their habit of eating closely there is great danger of killing the alfalfa. There are many growers who pasture during the growing season only, while just as many pasture during the fall and early winter only. The following reports very clearly indicate the general trend of opinion as regards alfalfa for horse and mule pasturage:

*Shawnee county*: "I pasture the first and last crops with horses. The first crop the pasturing cuts short about one-third; the last crop the horses consume entirely. It pays me best. As soon as they have no prairie grass in the fall I put them on the alfalfa, and they remain there until spring. If there is not too much snow they winter without any other feed—no grain at all. It certainly is a cheap way to raise horses, and in my judgment is much the best way. I pasture at the rate of one head per acre."

*Allen county*: "Fine conditioner."

*Chautauqua county*: "It is good for horses and mules; a splendid tonic."

*Dickinson county*: "Pasture them in the fall and it makes them fat."

*Geary county*: "With grain, nothing fattens more quickly."

*Geary county*: "There is no feed that will put fat on horses or mules like a good alfalfa pasture."

*Hodgeman county*: "Stock in poor condition, especially horses, will pick up and get fat even in the winter."

*Neosho county*: "Good results with colts or horses, and especially with brood mares with suckling colts."

*Clark county*: "Good for young stock."

*Jackson county*: "It is safe and profitable pasture for horses and mules."

*Montgomery county*: "Practical and profitable for short periods and in winter."

*Mitchell county*: "Good pasture, but little good for hard-worked animals. About two per acre."

*Smith county*: "All right for young colts, and mules or horses that are not at too heavy work."

*Mitchell county*: "Keep in good condition, but soft. One head per acre for about four months."

*Gray county*: "Fine for them, but question the advisability for the crop."

*Marshall county*: "Good for horses, but should be pastured lightly for the good of the alfalfa."

*Cloud county*: "I do not like to have horses and mules on alfalfa, as they eat it too closely."

*Logan county*: "Eat too closely and tramp it out."

*Meade county*: "It is good for them, but too close grazing will kill the alfalfa."

*Brown county*: "Whatever of crop is left after frost I pasture with horses all winter when no snow."

*Cherokee county*: "I only pasture in the fall after the last cutting."

*Greenwood county*: "Turn the horses in the fields in the fall and take them out in the spring."

*Harvey county*: "We have pastured mules on alfalfa in the fall after the last cutting until nearly the first of the year."

(See pages 428 to 436.)

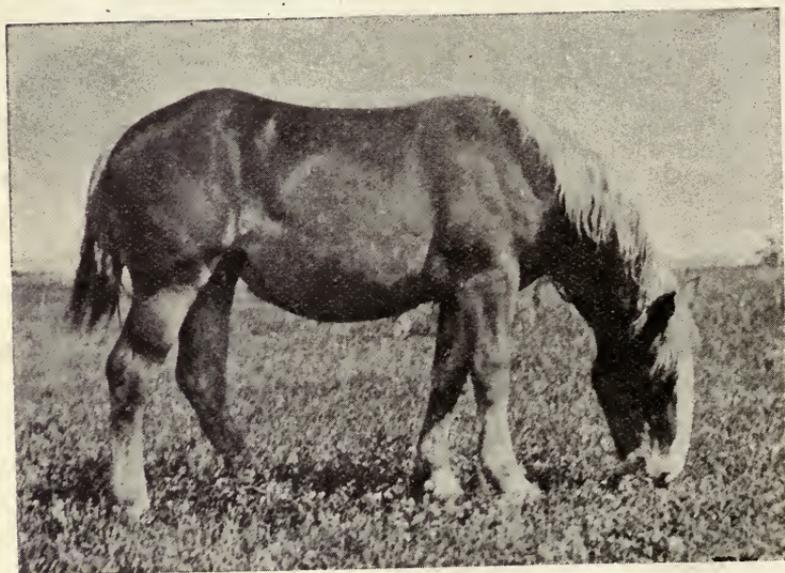

FIG. 128. Many growers report excellent results from pasturing colts on alfalfa. [Courtesy Nebraska Experiment Station.]

## EFFECT PASTURING HAS ON THE STAND.

Probably there is no point upon which alfalfa growers hold so many opinions as upon the effect pasturing has on the stand. A large proportion of the growers consider that pasturing in any season or at any time is injurious to the stand and are entirely against the practice. Still others believe no serious damage results where good judgment is used. Of course, if market hay is the object, pasturage is not practicable, but it would seem from the data acquired, where judicious care is exercised and the animals are not permitted to abuse the field, that the excellent results obtained in pasturing swine and young growing stock (horses particularly) would warrant the use of alfalfa as pasture, at least to a limited extent.

The worst damage caused by pasturing is usually brought about by overpasturing—pasturing too closely and continuously. Another great cause of damage is the trampling and puddling of the fields in wet weather, which packs the soil into a hard, compact and very undesirable condition. Weeds and grasses often gain easy entrance to pastured fields. Early spring cultivation is a necessity with a packed or weedy field. Contrary to a theory often expressed, most growers believe that no appreciable injury is done to the stand when a frozen field is trampled or driven over. Fields of alfalfa under two or three years of age will not stand pasturing. Abstinence in times of continued wet weather, and until the alfalfa has made a good start, say eight or ten inches; waiting until the field is old enough; regular and proper clipping as a means of refreshing the stand; alternation of fields as pasturage,\* and the removal of the animals before the growth has been eaten too short, are measures recommended for practice.

## "BLOAT."

Cattle and sheep are peculiarly susceptible to "bloat" when on alfalfa pasturage. Only now and then is a horse lost from this cause, and never a hog. Age seems to have little influence, as the reports mention animals of all ages, and there is no indication that animals of any particular age are especially liable to "bloat."

There are growers who believe the only preventive of "bloat" worthy of consideration is that of keeping the animals off the alfalfa. Reports from those who practice pasturing, however, indicate that there are certain conditions which influence the susceptibility of an animal to this trouble. Turning stock on alfalfa pasturage that is wet with dew or other moisture is said by many to be a dangerous practice, and it is recommended that the stock be not turned on until the moisture has dried off. Another measure which is said to aid in the prevention of "bloat" is that

---

\* Continuous close pasturing of alfalfa damages the plants by root starvation, while the tramping of the soil when wet from rains or irrigation does further damage; the result is a rapid thinning of the stand. This allows noxious weeds to gain a foothold, and the productivity of the fields rapidly decreases. To obviate these difficulties a system of rotation pasturing is being adopted in Arizona, in which the live stock is kept off the fields until the alfalfa is sufficiently mature to make hay, and then the animals are turned into the fields in large enough numbers to harvest the crop quickly. This system is proving much more profitable than any other system of pasturing alfalfa so far known.—U. S. Department of Agriculture, Office of the Secretary, Circular No. 54.

of always giving the animals a goodly quantity of dry feed before giving them access to alfalfa pasturage—hay, corn fodder and straw being especially mentioned for that purpose. When fed dry feed animals are not so likely ravenously to devour and gorge themselves with the green succulence of alfalfa and thus acquire "bloat." It is also a good plan to allow the animals gradually to become accustomed to pasturing, starting by permitting them to graze but a short time, and gradually increasing the time until the grazing has become continuous.



FIG. 129. The trocar and canula should be on every farm, for the relief of bloated animals. See pages 421 and 422.

The remedies proposed for "bloat" are many and diverse. A very popular remedy for mild cases consists of placing a bit, a stick or a rope in the mouth and fastening it there; meanwhile the animal is violently exercised. Some coat the stick with lard or axle grease to stimulate the flow of saliva. Another means of treating mild cases, sometimes used in connection with the "stick in mouth" method and sometimes alone, is to drench the back of the animal with cold water. Some cover the back of the animal with burlap or an old sack and drench that with cold water. Others drench with kerosene instead of cold water. Then there are those who put a rubber hose down the throat, and those who pull the tongue, and so on.

The ultimate and sure remedy for "bloat"—the remedy used in all severe cases and always when other remedies fail—is to "stick" them. The regular trocar and canula, the operation of which is described on pages 421 and 422, is best for this purpose; but where it is necessary to act at once in order to save the life of the animal, any sharp implement, as a knife, will serve to stab or "stick" a hole through the skin and abdominal wall to let out the accumulated gas. (See instructions on pages 419 to 423.) Here are some typical replies about remedies for "bloat."

*Wallace county:* "Pour cold water on them and put a gag in the mouth. The best preventive is to keep them off entirely. Feeding hay or straw, and being sure that they all drink before going in, will help."

*Geary county:* "Do not pasture hungry cattle on alfalfa nor let them eat it wet."

*Chase county:* "Feed them before turning out. In bad cases stab them, and in mild cases throw cold water on their backs."

*Bourbon county:* "Don't turn them onto it in spring until dew is off."

*Jefferson county:* "Cold water on their backs and a stick in their mouths. As a last resort tap them."

*Elk county:* "My remedy is to put a gunny bag on the back and pour on cold water."

*Riley county:* "Put a round stick of wood in the mouth. Tie a rope or strap to each end and fasten over the head."

*Butler county*: "I put a large bit in the mouth and run the animal about. As a last resort I would stick with a knife in the paunch."

*Ellis county*: "If bad case, tap them. If not, tie a stick crossways in the mouth."

*Marshall county*: "A thick, round stick held securely in the mouth, and tapping in desperate cases. Either is effective if in time."

*Morton county*: "Tie a stick in the mouth and keep the animal moving. If very bad, puncture and use tube."

*Comanche county*: "Stick with pocket knife four inches in front of the hip bone, two inches deep."

*Wabaunsee county*: "If a steer or cow be bloated so bad that it would die if left alone, it can be saved usually by stabbing on the upper left side of the paunch to allow the gas to escape."

*Kingman county*: "Don't let them have water. Get them in out of the wind. Watch them. If one drops be quick to use the trocar."

(See pages 419 to 423.)

#### ALFALFA SOILAGE.

Less than half of the growers reporting have had experience with alfalfa as a soiling crop (cutting and feeding "green," without curing). The results reported indicate that under certain circumstances, and where good judgment is used, the practice is fairly good. It is excellent feed for hogs, particularly sows penned up at farrowing time. Dairy cows respond to it with a generous flow of milk. It is also good for beef cattle, horses, sheep and poultry. However, to all animals except hogs, "green" alfalfa must be fed carefully and not too freely, as it may have a laxative effect on the bowels of the animals, and too much might even cause "bloat" in the case of cattle and sheep. Some declare that while it may be fed fresh to hogs, it should be wilted for at least twelve hours for horses or cattle. The method itself involves more labor and is probably more expensive than any other method of harvesting or disposing of the crop, hence it is possible that economy may warrant its use only in special cases where animals are confined or penned up and where pasturing is not desirable. The effect of soiling on the alfalfa field is probably not so hard as pasturing, although cutting before maturity is anything but beneficial. The following replies express the growers' sentiments on this subject:

*Woodson county*: "Good if fed in a moderate way."

*Sherman county*: "If fed carefully and not too freely it is safe and good."

*Stafford county*: "Good, but use judgment in feeding."

*Ellis county*: "Results good when used judiciously."

*Hodgeman county*: "All right; must use judgment."

*Brown county*: "To cut and wilt is a fairly safe way."

*Cowley county*: "All right for hogs. Let it cure for cattle."

*Finney county*: "Good results with horses. For cattle it should be wilted."

*Wallace county*: "Good results with all stock. Let it cure twelve hours for cattle or horses; fresh for hogs."

*Jefferson county*: "Good with swine. Be careful with cattle."

*Neosho county*: "Can be fed to cows in small quantities, without 'bloat' if wilted."

*Dickinson county*: "Get better results with hogs."

*Montgomery county*: "Sometimes for brood sows penned up for farrowing."

*Saline county*: "Good for horses and hogs, but dangerous for cattle."

*Harper county*: "Satisfactory for beef steers."

*Labette county*: "Not so good with hogs as pasturing. Milk cows respond well to this feed."

*Doniphan county*: "Was very soft and caused scours."

*Mitchell county*: "Causes horses to become soft and liable to colic."

*Montgomery county*: "Good for hogs. Use care with other stock. Too loosening of the bowels for horses."

*Norton county*: "Too washy."

*Reno county*: "Very washy."

*Montgomery county*: "Too loosening for horses. All right for cattle in small doses."

*Rawlins county*: "Very good, but prefer letting horses and hogs run in it."

*Russell county*: "Good for hogs, but not as good as pasture."

*Osage county*: "About the same as pasturing, but it is poor practice, as it makes extra work and is a sure way to ruin a stand, cutting it out of season."

*Pottawatomic county*: "It is apt to kill the stand, cutting immature."

*Harvey county*: "Good, but labor is too expensive."

*Mitchell county*: "Good for sows, though an expensive method."

*Allen county*: "Good, but it takes too much time."

(See pages 403 to 438.)

#### ALFALFA HAY AS AN EXCLUSIVE FEED.

The question was asked, "Do you make alfalfa hay the exclusive feed for any animals on the farm?" The replies to this question, "Yes" or "No," were tabulated and are represented in the following:

TABLE No. 11. Alfalfa hay as an exclusive feed.

	Western third of the state, per cent.	Central third of the state, per cent.	Eastern third of the state, per cent.	The state as a whole, per cent.
Those replying "Yes".....	39	29	41	36
Those replying "No".....	61	71	59	64

The growers were also asked to name the animals to which they give alfalfa hay as an exclusive feed. The animals mentioned most frequently are cattle and horses, although hogs, mules and sheep, in the order given, were also mentioned. The following is a tabulation of the replies of the growers reporting, and shows in percentages the frequency with which the different animals were mentioned by reporters from the different thirds of the state and as from the state as a whole. It serves as an indication of the animals best able to get along on alfalfa hay alone.

TABLE No. 12. Animals fed alfalfa hay alone.

	Western third of the state, per cent.	Central third of the state, per cent.	Eastern third of the state, per cent.	The state as a whole, per cent.
Sheep.....	4	7	10	7
Mules.....	7	16	15	14
Horses.....	39	34	34	35
Cattle.....	34	33	30	32
Hogs.....	16	10	11	12

Horses not at hard work; young "stuff" of all kinds, as colts, calves, pigs, lambs, etc.; cattle stockers; and breeding animals are the animals that do best on alfalfa as an exclusive feed, according to reports. Here are some of the replies of growers who make alfalfa an exclusive feed:

*Barton county*: "Both cattle and horses. No injurious effects."

*Brown county*: "Cows, hogs and sheep, and some to horses, but not in such quantities."

*Butler county*: "Either horses or cattle do all right on alfalfa alone."

*Chase county*: "After the pigs are weaned we turn our sows on pasture with no other feed."

*Cowley county*: "Colts, or any horses or mules not at heavy work."

*Dickinson county*: "Cattle and hogs; horses in the winter."

*Douglas county*: "Sheep from the 1st of January till grass."

*Douglas county*: "Stock cattle; sometimes winter mules."

*Harper county*: "To dairy cows."

*Jackson county*: "Stock cattle or idle horses do well on hay alone."

*Labette county*: "Occasionally we winter idle work stock."

*Pratt county*: "Have wintered horses on alfalfa without grain."

*Riley county*: "Young horses and mules not at work."

*Anderson county*: "Mules, colts and calves. With the calves I find it better to have some other hay to give with the alfalfa."

*Coffey county*: "All young animals."

*Cowley county*: "In winter, to horses, mules and cattle."

*Crawford county*: "To breeding ewes in the winter."

*Crawford county*: "Horses, cows and breeding swine."

*Leavenworth county:* "Horses, mules and dairy cows."

*Linn county:* "Brood sows and young mules."

*Lyon county:* "Very good both to swine and cows."

*Reno county:* "Stock cattle."

*Riley county:* "Horses not worked and stock cattle."

*Dickinson county:* "Cattle. I don't think it best, but have sometimes had nothing else."

Then there are those, MUCH IN THE MAJORITY, who do not believe in making alfalfa hay an exclusive feed for any animal on the farm, replying after this fashion:

*Pottawatomie county:* "Don't give best results as sole feed."

*Wichita county:* "Animals do better when they get a change of feed."

(See pages 403 to 438.)

#### RATIONS INCLUDING ALFALFA HAY.

Contrary to our expectations, the questions about rations failed to bring out data sufficient and conclusive enough to warrant the publication of amounts and proportions. Many replies were received in answer to these questions, but they were, as a rule, neither specific nor definite. There were some replies, it is true, that seemed all that could be desired, but the number of such was so small that the necessary verifying effect, one upon the other, could not be had; hence it was considered best to make no attempt to quote the rations suggested.

The data at hand indicate that alfalfa hay may be used as a part of the ration of any animal on the farm, and of poultry as well. The wonderful increase in acreage and present large area is sufficient evidence of the appreciation the Kansas farmer has of alfalfa as a feed for live stock. It is wise, however, in most instances to supplement alfalfa hay with other feeds, in order to balance the ration. (See pages 403 to 438.)

Alfalfa hay should be fed in racks, wherever possible, so that it will not be trampled under foot and be wasted. Good types of feeding racks are illustrated in Figs. 352 to 361.

#### *Rations for Beef Animals.*

The rations suggested for beef animals include various feeds in varying quantities. On the question of whether the animals are stockers, feeders or breeding stock, with or without young, depends in large part the sort of ration to be fed. A fattening ration, or a ration fed to breeding stock with young, should contain a higher proportion of grain than a maintenance ration for breeding stock without young, or a ration for stockers. The weight of the animals is another important limiting factor.

Corn is the supplementary grain most frequently mentioned for beef animals. It is fed in various forms—in the ear, shelled, as chop, meal, or corn-and-cob meal. In other instances the grain mentioned consists of kafir, milo or other of the sorghum grains, which may be substituted for corn, not pound for pound, but in proportion to the percentage of



FIG. 130. Alfalfa is easily queen of the feed lot.—[Courtesy Great Northern Railway.]

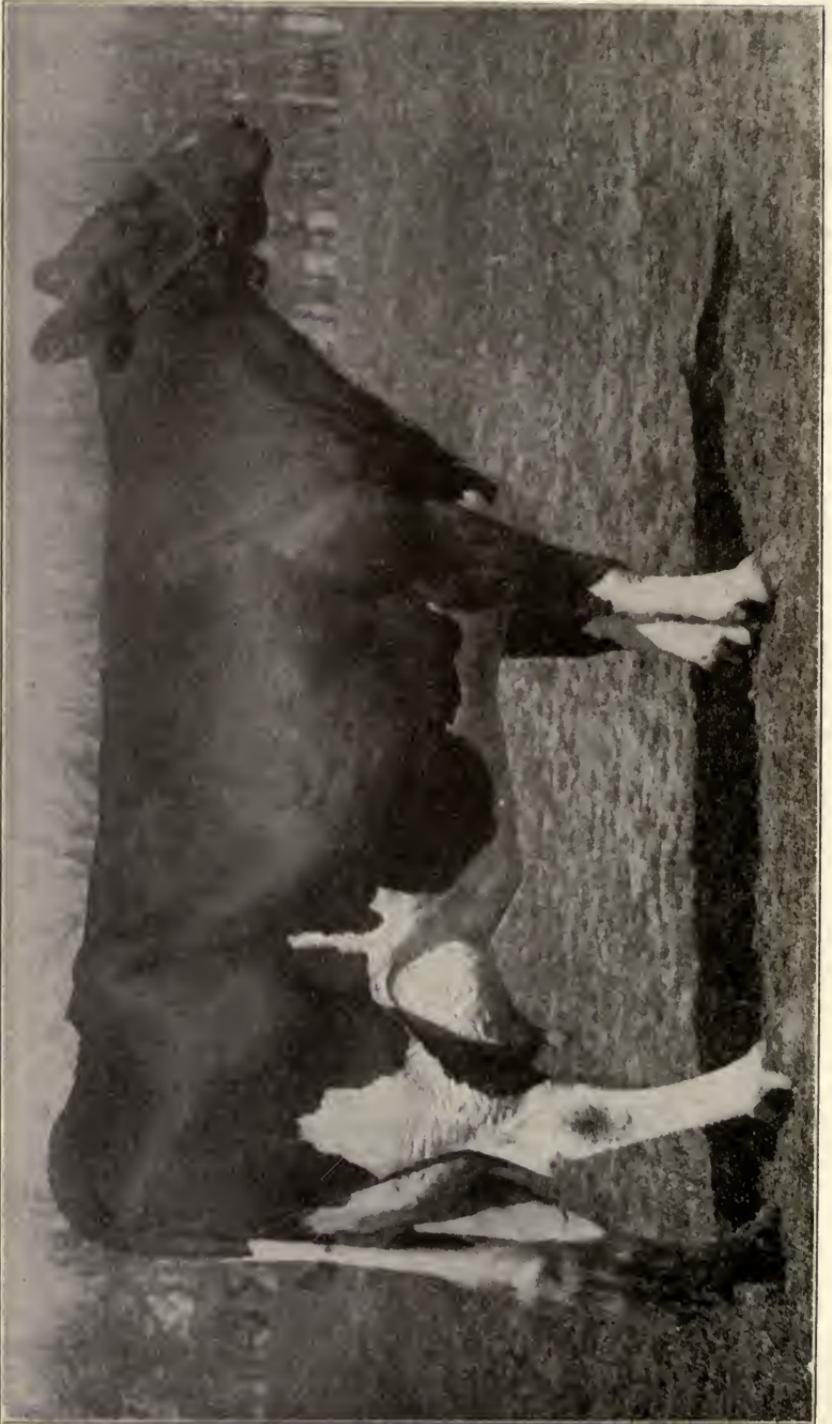

FIG. 131. The dairy cow responds to alfalfa hay with a generous flow of milk.

digestible nutrients contained in them. The sorghum grains should be soaked or ground before feeding. In addition to alfalfa hay and grain, other kinds of roughage and concentrates are frequently fed. Corn or kafir silage, corn or kafir stover, straw and "cane" are the kinds of roughage named. Among the concentrates, cottonseed meal and cottonseed cake are often added to the ration, and now and then a little wheat bran or a little oats. These additions naturally alter the amounts of alfalfa fed. (See pages 410 to 415.)

#### *Rations for Dairy Animals.*

In addition to a specific amount of alfalfa, sometimes with other roughage and sometimes not, a certain amount of grain is usually fed to dairy cows, for best results. The amount of grain is regulated by the number of pounds of milk the cow is giving, and sometimes by the per cent of butter fat as well. Practically the same kinds of feed were suggested for dairy cows as for beef cattle, though in different proportions and amounts. Bran was much more frequently mentioned as a feed for dairy cows. (See pages 415 to 417.)

#### *Rations for Swine.*

The rations for swine are much more concentrated than those for cattle. A high proportion of protein and of other valuable food elements, however, makes alfalfa hay a most excellent feed for these animals. Corn is the great grain feed for hogs, and, as with cattle, it may be fed either in the ear or ground to varying degrees of fineness. Ground sorghum grains are sometimes fed in place of corn, especially in those sections where they are more commonly grown. Shorts, wheat bran and middlings are frequently fed, and oats only occasionally. Tankage, meat meal, milk or skim milk and linseed oil meal are other elements commonly introduced into swine rations. Silage, stover and the coarser roughages are seldom mentioned by the reporters. Slops made of different combinations of ground grains are very popular with swine feeders.

The amounts and proportions of the above feeds it is proper to give swine depend upon the animals themselves. Reports indicate that brood sows not suckling get along nicely with alfalfa and very little grain or other rich, concentrated feed. Brood sows suckling are given more liberal quantities of feed, with a much higher proportion of concentrates. Growing pigs after weaning, while not given the full fattening ration, are fed sufficient quantities of concentrates to cause them to make rapid and steady gains. The fattening ration is the most highly concentrated and liberal of all. The rations of growing and fattening swine are regulated by the weight of the animals. (See pages 423 to 428.)

#### *Rations for Horses and Mules.*

Most growers agree that alfalfa hay makes good feed for horses, particularly work horses. The amount to be fed is limited by the weight of the horses and the kind of work they are doing, as well as the quality of the hay. It is necessary to supplement alfalfa with other roughages and concentrates. The other roughages mentioned are prairie, timothy and

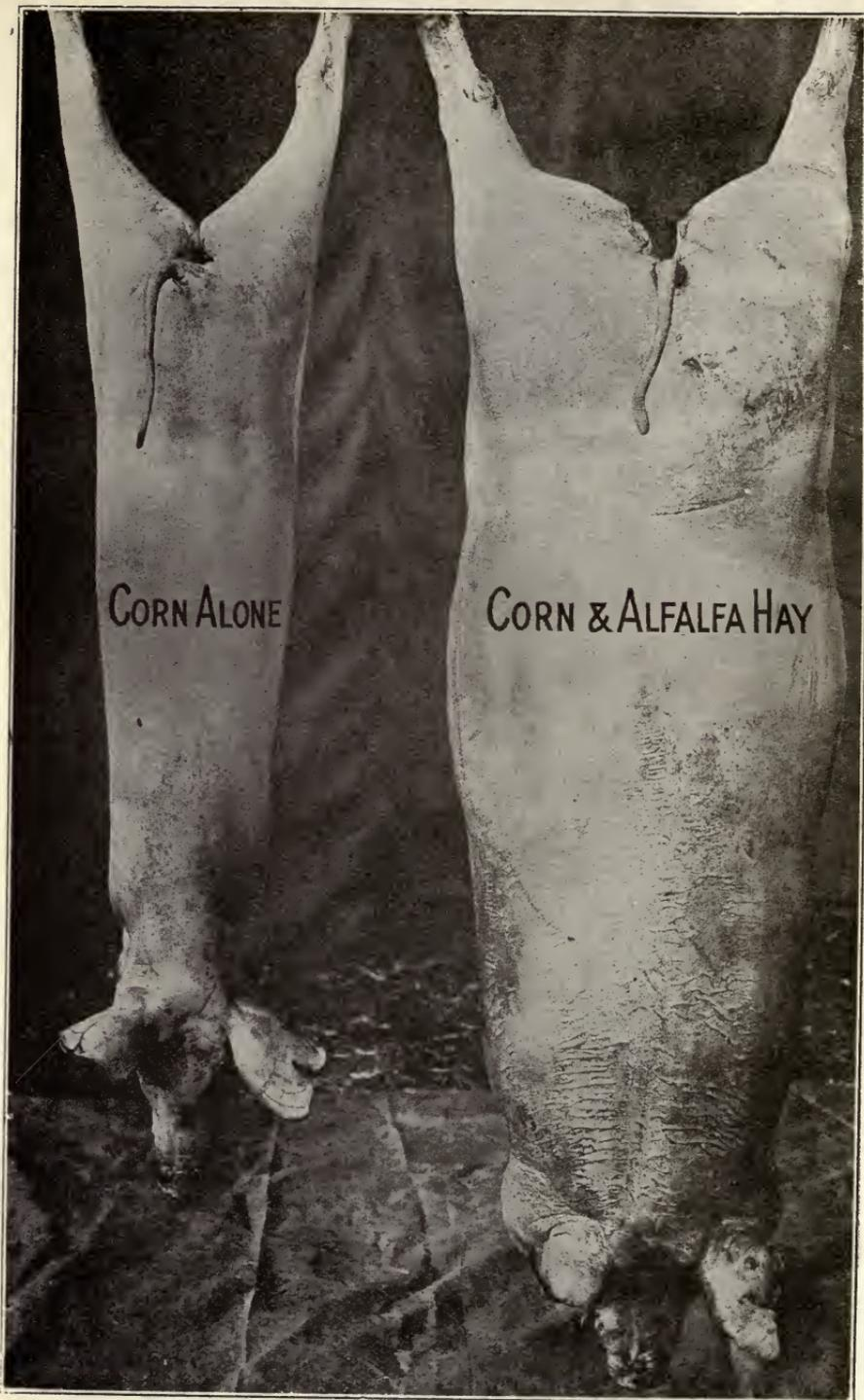

FIG. 132. Carcasses of hogs of the same litter and given the same treatment except in the matter of feed, showing the value of alfalfa hay as a swine ration balancer.—  
[Courtesy Kansas Experiment Station.]

sorghum hay; corn and grain-sorghum fodder and stover; wheat and oat straw; and pasturage. Of the concentrated feeds corn is most generally fed, with oats next in importance, followed by the ground sorghum grains (kafir, milo and feterita), barley, bran and linseed oil meal.

Horses at heavy work, such as plowing, require the most liberal amounts of feed and a much higher proportion of concentrates. The most popular ration mentioned consists of alfalfa and prairie hay, with corn and oats, and perhaps a little linseed oil meal. Idle horses require little grain. Alfalfa hay that is exceptionally well matured is preferred for horses. (See pages 428 to 436.)



FIG. 133. The quantity of alfalfa hay fed to horses should be limited.  
[Courtesy Nebraska Experiment Station.]

#### *Rations for Sheep.*

Our reports on alfalfa as a feed for sheep are rather scant, but the indications are that it makes excellent feed for them. Alfalfa hay is supplemented with silage, fodder or other coarse roughage, with pasturage and with small amounts of grain. Of course, the rations, as with other animals, vary with the sheep and the object in feeding—whether they are breeding stock, sheep for wool, or for mutton. (See pages 417 to 419.)

#### ALFALFA FOR POULTRY.

Growers are unanimous in their praises of alfalfa as a feed for poultry. The leaves constitute the valuable part of the alfalfa plant, and are eaten by all kinds of poultry with great relish. This is a very happy circumstance so far as economy is concerned, for the shattered leaves left in the barns, the mangers, the feeding racks, the feed lots, and by the baler, may be saved and readily converted into cash through the medium of laying hens. Alfalfa leaves increase egg production wonderfully, and are excellent to put the hens in a healthy condition—to “tone them up,” as one grower expresses it.



FIG. 134. Feeding alfalfa hay to sheep by the thousand.

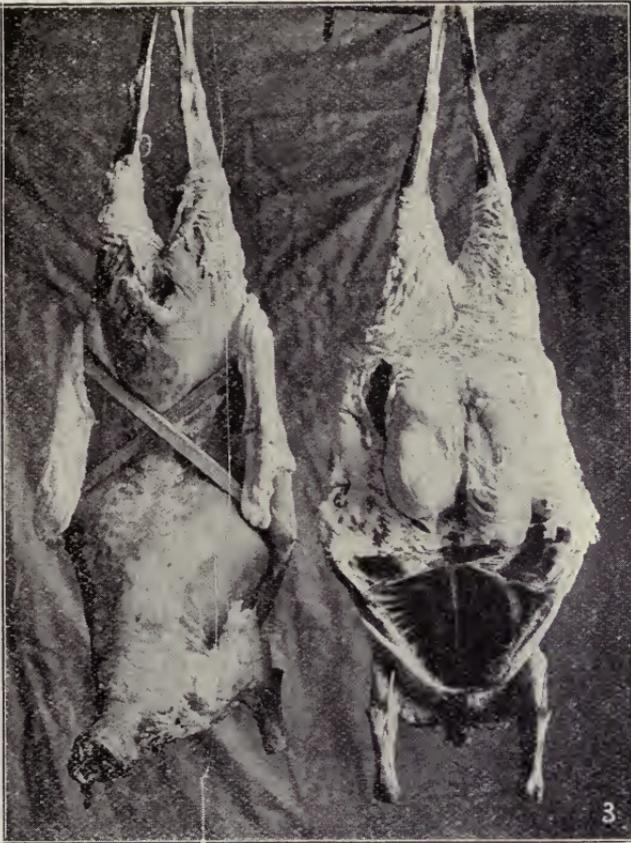

FIG. 135. Carcasses of range lambs fattened on alfalfa and corn.  
[Courtesy Kansas Experiment Station.]



FIG. 136. A cutter for chopping alfalfa hay into short lengths, to be used  
as feed for chickens.—[Courtesy Smalley Mfg. Co.]

It is the practice of a few growers to save their last cutting of alfalfa hay for poultry, although any cutting is good. The hay is generally put through a cutter. Some people cut it in six- or eight-inch lengths, while others cut it as fine as possible. Still others grind it into a meal.

Alfalfa as a winter feed for poultry is very frequently scalded or soaked. It is often fed in this condition with bran or grain as a warm mash on winter mornings. Still there are many growers who prefer to feed it dry. Few growers mention the amount of alfalfa it is proper to feed. One grower reports that 100 hens will consume three bushels of leaves per week. However, grain should always form a very large part of the poultry ration.



FIG. 137. Alfalfa pasturage keeps the hens in good condition and makes them lay.  
[Courtesy *National Alfalfa Journal*.]

During the growing season alfalfa is most economically fed by permitting the poultry to have free range over the fields.

The following reports indicate the ideas of growers about alfalfa as a poultry feed:

*Logan county*: "It is great for laying hens. Winter morning feed on this farm consists of scalded alfalfa leaves and shorts, all they can eat."

*Wallace county*: "Take alfalfa leaves and mix some ground milo shorts, bran or corn meal with them; pour boiling water over the mixture at night; cover the vessel and let it steam. It will be fine feed in the morning, especially in the winter."

*Crawford county*: "We bale leaves and store them for winter feed, with excellent results."

*Harper county*: "Horses shatter the leaves, which I find are relished by all fowls."

*Meade county*: "We feed cured leaves in the winter. They keep the fowls healthy and increase the laying."

*Grant county*: "The hens roam the field all the year except during the three winter months. They do fine on it."

(See pages 436 to 438.)

#### FEEDING VALUE OF BROWN HAY.

Twelve per cent of the growers reporting have found the feeding value of alfalfa hay which has turned brown in the stack to be better than that of bright, well-cured hay; 33 per cent have found it to be as good; 23 per cent have found it to be nearly as good; 25 per cent have found it to be three-fourths as good; and 7 per cent have found it to be one-half as good, or less. It is considered good for cattle especially, although swine and sheep are also mentioned. All those who mention horses seem to think that it is *not* good horse feed. It is agreed by practically all reporters that brown alfalfa hay is good only when it has become discolored through the fermentation of its own juices and not through the effects of outside moisture or the weather. The fermentation takes place when the hay is put up a little "green"; not so green, though, that it is blackened or burned. Individual reports about brown hay read like this:

*Mitchell county*: "I have found that cattle like it better and give better gains."

*Wabaunsee county*: "I think it better than green, but am not prepared to say how much. Cattle relish it more."

*Russell county*: "Better than green, and more relished by cattle and hogs."

*Russell county*: "On first crop very good if fed to beef cattle. It is not good for horses."

*Johnson county*: "Good for dairy cattle."

*Douglas county*: "We want our hay to brown in mow or stack, but not from rain or dew. The process of heating and going through the sweat softens the stem so that lambs will eat it more readily. Also the leaves will not shatter off while handling the hay. We have tried placing brown and bright hay in racks alternately. Lambs will always eat the brown hay first. Last winter we fed 2000 lambs; in the winter before 4000 lambs. We have been feeding for seven years."

*Wallace county*: "If not moldy or dusty it is better than lots of brighter-looking hay that has been left too long in the swath or the windrow."

*Harvey county*: "If from heating in the stack or shed, and not moldy, it has lost in weight but not in feeding value."

*Marshall county*: "If browned without foreign moisture it is good—equal to well-cured hay."

*Allen county*: "If discolored by storing too green the feeding value is still very good, while if discolored by constant exposure to sun and rain the quality is very poor."

*Osage county:* "There is a certain stage of curing alfalfa when if stacked it will pack together and turn brown, but not mold. It is then very palatable to stock. I have read a great deal about this kind of hay being better than any other, and also have been told that it is sought after on the market."

*Pottawatomie county:* "Alfalfa should be put up green enough to make it light brown in the middle of the stack. Then it makes the best feed."

#### BEES AND ALFALFA.

The benefits from bees in alfalfa, where a seed crop is raised, are mutual. The bees are most efficient pollinizers and cause an excellent "set" of seed, while the nectar from alfalfa blossoms makes honey of the highest quality. The benefits to be derived are limited, however, to the period of blossoming. When hay is cut, and the plants are allowed to become only 10 per cent in bloom, the pasturage is especially limited. Those alfalfa growers who keep bees are, as a rule, well pleased with the results. (See pages 401 to 403.)

#### EFFECT OF ALFALFA ON SUCCEEDING CROPS.

That alfalfa has, in the long run, a beneficial effect on succeeding crops is the opinion of practically all growers. In the first few seasons immediately following the plowing up of an alfalfa field, however, the crops planted have a tendency to grow too luxuriantly and to suffer therefor in times of little moisture. When there is an abundance of moisture, crops immediately following alfalfa give phenomenal yields. After two or three years, crops grown on alfalfa ground are reported uniformly to give much higher yields than those grown on other similar ground, and the difference is noticeable for some time afterward.

To show the effect on the soil, the following reports are quoted:

*Chautauqua county:* "Alfalfa is the best and cheapest fertilizer Kansas has."

*Washington county:* "Alfalfa is a great soil builder. The first succeeding crop is not usually as good as the following crops."

*Greenwood county:* "It makes the ground loose and rich. It is better the second year than the first."

*Nemaha county:* "Alfalfa enriches the soil in nitrogen, but seems to exhaust the subsoil moisture, so that corn suffers in a dry year following alfalfa."

*Chautauqua county:* "Alfalfa materially improves the soil."

*Decatur county:* "Alfalfa enriches the ground and causes it to produce large yields of corn."

*Reno county:* "I think alfalfa makes the ground as good as if thirty loads of manure had been applied."

*Crawford county:* "Alfalfa builds up land and saves the farmer from buying commercial fertilizer."

*Riley county:* "After ground has been in alfalfa a few years it is as good as new."

*Montgomery county:* "It simply puts the land back in its original stage."

The necessity of moisture for crops immediately succeeding alfalfa is indicated by such reports as these:

*Mitchell county*: "Leaves the soil very dry usually. The soil is rich in plant-food elements left in the roots, especially the nitrates. These cause luxuriance in small grains in early spring and suckering in maize. Crops burn without plenty of moisture."

*Montgomery county*: "Increases plant growth in wheat, kafir and all field crops. Sometimes this stimulus causes too much leaf surface, that must be maintained during the dry months."

*Cloud county*: "In cornfields, wet year, heavy crop; dry year, nothing, even less than on ground where alfalfa has not been planted."

*Lane county*: "Depends on the season. If plenty of moisture, corn will do well; if dry, will not do anything. It is the same with wheat."

*Morris county*: "It seems to enrich the land, producing lots if a wet season. Corn sometimes burns quickly if the year following happens to be dry."

*Reno county*: "Corn seems to go too much to stalk, and can not stand drouth. Wheat goes too much to straw, and lodges. Kafir is best to follow."

*Cloud county*: "Crops after alfalfa are usually light unless there is abundant moisture."

*Republic county*: "It takes lots of moisture to mature crops following alfalfa."

*Shawnee county*: "Corn in a dry year is almost a failure; in a wet year it gives large yields."

*Labette county*: "It increases the growth of stalk and leaf particularly. Kafir gave us eighteen tons of silage per acre in 1914 on alfalfa sod broken the winter before. Corn is likely to be injured by drouth on alfalfa sod, due to excessive growth."

(See pages 462 to 468, and Fig. 138.)

#### BEST CROPS TO FOLLOW ALFALFA.

Analysis of the data at hand indicates that the best crops immediately to follow alfalfa are those best able to resist dry weather, or crops not expected to mature grain. The grain sorghums, such as kafir, milo and feterita, silage crops, and crops intended for forage, such as "cane," are best. Potatoes are also said to do quite well in regions where they are ordinarily successful. Corn is preferred before oats and oats before wheat. However, small grains grow too rank, and lodge; corn for grain is liable to "fire" or "burn"; and neither small grains nor corn may be depended upon to mature grain unless there is a great abundance of moisture.

A few reports on this subject are quoted:

*McPherson county*: "Some of the sorghums, or next best, corn for the silo, because unless conditions are very good only a drouth-resistant plant will produce grain."

*Jewell county*: "'Cane,' kafir or some similar crop, more drouth-resisting."

*Labette county*: "Kafir or some other surghum for grain or silage. We do not use 'cane,' on account of lodging. Kafir will stand up well and mature a crop well without injury from drouth."

MOISTURE CONTENT OF ALFALFA, WHEAT, AND CORN GROUND.

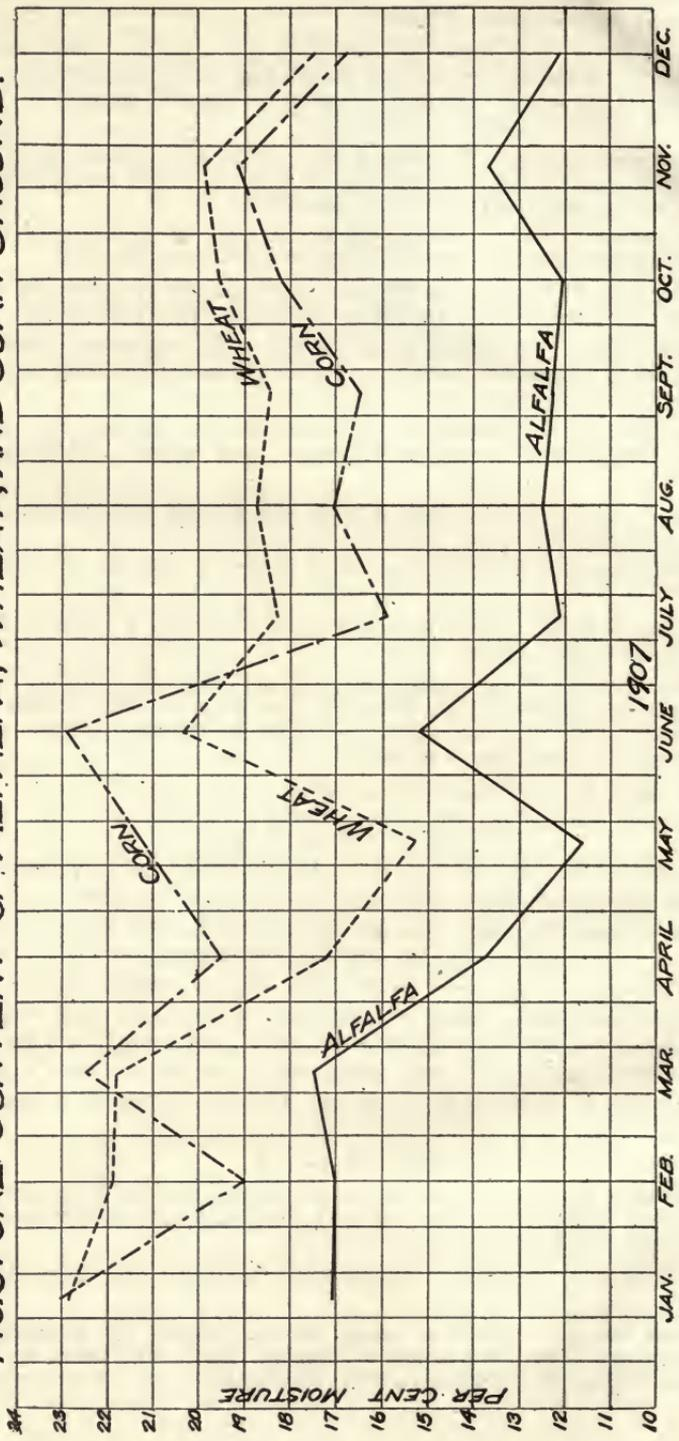

FIG. 138. The moisture content of alfalfa ground is lower than that of wheat or corn ground.—[Courtesy Kansas Experiment Station.]

*Chase county*: "Kafir first year, as it takes more moisture than we generally get to raise anything else on alfalfa sod."

*Harvey county*: "Kafir, as it stands dry weather, and if rank makes good silage."

*Marshall county*: "Corn or kafir. On my kind of land sorghum gets too rank to handle; wheat or oats lodge badly; kafir stands drouth well, but makes less tonnage than corn, so is not best for silage."

*Marshall county*: "Causes heavy growth of corn. If this does not ear well it is used for silage."

*Mitchell county*: "Sorghums (feterita or kafir), as they stand lack of moisture."

*Rooks county*: "In this locality 'cane' or kafir, because they will die and yet live."

*Jewell county*: "Oats or kafir. Oats get their moisture early in the season. Kafir is not affected by the oversupply of nitrogen as is corn."

*Reno county*: "Potatoes. They make a big yield, with no scab."

*Washington county*: "Wheat following alfalfa grows rank, with poor yield. Corn 'fires' during a week or two of dry weather. Oats seem to be best adapted to follow. These results agree with neighborhood experience."

*Osborne county*: "My experience is that after plowing you don't realize much unless it is an exceptionally wet season. After the first and second crops you get good results for several years. It is a good soil builder."

*Rooks county*: "Have met with no success. The roots extract all moisture from soil to a great depth, consequently the first crop is a failure if it is not an extra wet season."

*Marshall county*: "Causes very rapid and rank growth of almost any kind of succeeding crop, and makes said crop of such tenderness as to be easily injured by drouth, especially corn."

*Mitchell county*: "Causes tremendous growth of stalk in either wheat or corn, with very little grain in the ear."

*Ottawa county*: "We find that unless we have plenty of moisture the crop will burn the first few years on ground that has been in alfalfa for ten to fifteen years."

*Pawnee county*: "Subsoil too dry to raise a crop first year after plowing; the succeeding crops improve."

*Russell county*: "My first crop usually burns. After that it is all right."

*Dickinson county*: "Seems to dry out the first year. Thereafter crops have a dark rich color and are heavy."

*Riley county*: "It depends on the season. If dry, corn will not do well the first year, but it is all right after that."

However, if there is plenty of moisture in the years immediately following the plowing of alfalfa, the succeeding crops make wonderful yields.

*Ottawa county*: "Causes any crop following to grow very rank, and in case of corn, if plenty of rainfall, makes phenomenal yield."

*Wabaunsee county*: "Ventilates and enriches the soil. Generally have excellent crops for some years after."



FIG. 139. A crop of kaffir in Rooks county, immediately following alfalfa.

*Harvey county:* "Corn grows very rank, also wheat, a few years after breaking. I have a field broken six years ago. The beneficial effects are plainly to be seen yet."

*Wyandotte county:* "Fine. Boosts potatoes."

*Comanche county:* "Increases the yield first year 60 per cent."

*Coffey county:* "I plowed under a heavy crop of alfalfa on black river land and then planted it to wheat. The yield was 34 bushels per acre for two years. The field adjoining yielded 24 bushels of the same kind of wheat in these two years."

*Cloud county:* "The second year after plowing alfalfa ground the difference in the same field of wheat was 20 bushels—38 bushels on alfalfa ground and 18 bushels on the other ground."

*Clay county:* "Wheat 40 bushels to the acre when the rest of the wheat froze out on the farm."

*Cowley county:* "It is great. I knew of one field making 54 bushels of wheat per acre after it had been plowed two years."

*Sheridan county:* "I plowed thirty acres that was four years old, and sowed to barley. It yielded twice as much as that on corn ground."

*Harvey county:* "It increases the yield wonderfully, except in very dry times. We got 50 bushels of wheat to the acre last year on alfalfa ground and 35 bushels on other ground, and 75 bushels of oats one year on alfalfa ground and 50 bushels on other ground. There are less weeds and clods and more humus in alfalfa ground."

*Marion county:* "Very good with wheat and oats. It has about doubled in yield."

*Lyon county:* "It has doubled the yield on oats, wheat and corn."

*Washington county:* "Corn yield nearly doubled; also wheat yields."

*Pratt county:* "I have raised double the amount on alfalfa land that I raised on adjoining land."

*Lyon county:* "After four or five years it will double the yield of corn on the same ground."

*Butler county*: "Increase corn yield 33½ per cent."

*Geary county*: "It renews the land and will produce 50 per cent more corn than land of the same kind that has been in other crops."

*Harper county*: "I have raised 30 per cent more corn on old alfalfa ground than on the same kind of land in other crops."

*Riley county*: "Corn will make 50 per cent more after alfalfa."

*Kingman county*: "Increased yield of corn 100 per cent. If followed with wheat there will be too much straw."

*Washington county*: "Corn this year (1915) on alfalfa ground will yield from 25 to 50 per cent more than on wheat or corn ground."

*Woodson county*: "We have never followed alfalfa with any crop that was not benefited as much as 25 per cent. One field we had in corn for several years, and it still shows good effects of the alfalfa. Last year this field made an average of 70 bushels to the acre."

*Norton county*: "Corn makes 80 bushels to the acre on alfalfa ground."

*Marshall county*: "It has a very good effect. A great upbuilder of soils. It makes 60 bushels of corn where only 35 grew before. Corn makes a very rank growth after alfalfa and is easily hurt by drouth."

*Shawnee county*: "Corn, 30 bushels; alfalfa five years; corn, 70 bushels."

*Jefferson county*: "It increases growth if there is plenty of moisture. Corn made 80 bushels to the acre, while wheat fell down and failed to fill."

*Greenwood county*: "I raised 90 bushels of corn on ground that had been in alfalfa ten years."

*Riley county*: "The effect is great. I have known of land raising 20 bushels of corn more to the acre."

*Greenwood county*: "Always followed with corn. Last year (second year) I harvested 15 tons kafir per acre, some of which threshed 60 bushels to the acre."

#### ROTATION WITH ALFALFA.

Few if any of the growers reporting have worked out a definite scheme of rotation with alfalfa as one of the crops. It is the custom to follow alfalfa with the ordinary farm crops, such as sorghums, corn, wheat, oats, millet, "cane" and potatoes. Probably the long life of the average field makes orderly rotation with other crops somewhat inconvenient.

#### PLOWING ALFALFA.

TABLE No. 13. Preference of growers as to time of plowing alfalfa.

	Western third of the state, per cent.	Central third of the state, per cent.	Eastern third of the state, per cent.	The state as a whole, per cent.
Favoring fall plowing . . . . .	57	66	77	70
Favoring spring plowing . . . . .	39	31	18	27
Favoring winter plowing . . . . .	4	3	5	4

There is considerable difference of opinion in regard to the depths of plowing alfalfa sod.

TABLE No. 14. Preference of growers as to depth to plow alfalfa sod.

	Western third of the state, per cent.	Central third of the state, per cent.	Eastern third of the state, per cent.	The state as a whole, per cent.
Favoring deep plowing.....	44	38	61	48
Favoring medium plowing.....	9	15	15	15
Favoring shallow plowing.....	47	47	24	37

Here are a few reports:

*Cherokee county*: "The deeper you plow the smaller the roots and the easier cut."

*Russell county*: "You can't break shallow and keep the plow in and do a good job."

*Jefferson county*: "Shallow if you want to kill the plants. Then follow by deep tillage."

*Rice county*: "Deep if stand is thin; if not, plow shallower, disk well, and harrow."

*Trego county*: "Turn it shallow in summer or fall and plow deep the following spring."

*Osage county*: "We plow shallow, just below the crowns, to make a seed bed. The alfalfa has done the rest far better than we could with all the teams and tools on the place."

#### ENEMIES OF ALFALFA.

The chief enemies of alfalfa in Kansas are grasshoppers, gophers, foxtail, crabgrass, webworms and army worms, in the order named.

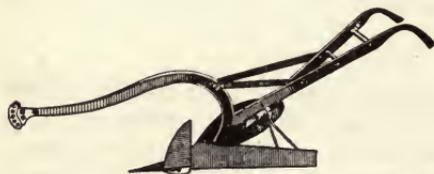

FIG. 140. Plow for turning alfalfa sod, with attachment for cutting the roots at the outer edge of the succeeding furrow.— [Courtesy U. S. Department of Agriculture.]

Minor enemies, mentioned here and there, are Russian thistles, dodder, cutworms, sandburs, prairie dogs, and some of the native grasses. The following figures, tabulated from the replies, indicate in percentages the relative importance of the chief enemies of alfalfa in the different parts of the state:

TABLE No. 15. Enemies of alfalfa.

	Western third of the state, per cent.	Central third of the state, per cent.	Eastern third of the state, per cent.	The state as a whole, per cent.
Grasshoppers.....	68	34	20	34
Gophers.....	16	24	14	18
Foxtail.....	11	14	18	15
Crab grass.....	4	15	16	14
Webworms.....	1	10	13	10
Army worms.....		3	19	9

A study of this table reveals the fact that grasshoppers and gophers are the most troublesome in the western third of the state, and as one progresses eastward their relative importance decreases. On the other hand, the troublesome weeds and grasses, foxtail and crab grass, increase as one progresses eastward, the same being true with webworms. Reports of Russian thistles, dodder, prairie dogs, sandburs and native grasses practically all come from the western third of the state, while those of cutworms come chiefly from the eastern and central thirds of the state. (See pages 332 to 400.)

#### *Grasshoppers.*

The depredations of the grasshopper in the eastern third of the state are not regularly serious. The damage usually occurs in the late summer or fall along the edges of the newly-sown fields, in a strip, say, one to three rods wide. As one progresses westward the damage becomes greater; parts of new fields are sometimes destroyed, and the insects are especially injurious to seed crops.

*Marion county:* "They spoil some seed nearly every year and often take parts of new fields."

*Dickinson county:* "In 1914 they took eighteen acres of spring seedling after it was cut once."

*Ellis county:* "One of the greatest obstacles to growing alfalfa in western Kansas."

*Ellis county:* "Thirty acres eaten bare last spring."

*Rawlins county:* "I have had them take the seed crop, and sometimes almost take the hay crop."

*Pratt county:* "My worst enemy."

*Wichita county:* "We have had them keep the alfalfa down all summer, after the first crop."



FIG. 141. A flock of turkeys in an alfalfa field is said to be an economical means of fighting grasshoppers. They destroy the grasshoppers and thrive on them.

Reports like these indicate that grasshoppers may at times become a very serious pest. However, returns also indicate that they may be controlled. The most popular and effective remedy reported is that of poisoned bran mash, the formulæ and the method of application of which is treated on page 377 of this volume. Another remedy used is the hopperdozer, described on page 378. Not a few growers declare a flock of turkeys or chickens to be the most efficient and economical means of fighting grasshoppers. They not only destroy the grasshoppers, but also derive great benefit from the food thus consumed. Disking or harrowing in early spring to destroy grasshopper eggs is seldom mentioned.

A few reports follow:

*Ford county*: "We have 'hoppers' here nearly every year, but they can easily be controlled with poison."

*Wichita county*: "Poisoned bran mash does the work. It is sometimes applied several times a season."

*Montgomery county*: "Last year grasshoppers damaged our alfalfa very much. We used Paris green and bran mixture with good results."

*Ness county*: "We use the 'dozer,' poisoned bran mash, and keep clean hedgerows."

*Gray county*: "I run over the field after each cutting with a tank filled with kerosene, fastened to a go-devil, and catch them. Make tank out of galvanized iron and set on go-devil; fill pan with water and have a skim of kerosene on top. Drive over the field several times."

*Pratt county*: "We fight grasshoppers with turkeys, and find it profitable."

*Logan county*: "We fight grasshoppers with young chicks, having portable concrete coops, which we distribute throughout the field."

*Jackson county*: "The part of the field near the chicken house is never hurt by grasshoppers."

*Greenwood county*: "Hogs our best remedy—sure cure; turkeys, second; hopperdozer, third; poison and bran, last."

*Ottawa county*: "Keep a big flock of turkeys."

(See pages 374 to 379.)

#### *Gophers.*

The seriousness of the gopher pest in alfalfa fields is second only to that of the grasshopper. Their burrows and mounds interfere with the operations of harvesting, while they themselves destroy many alfalfa plants. Instances are reported where fields have been completely destroyed, or at least so damaged that it was necessary to plow them. Nearly two-thirds of the growers believe poisoning to be the most efficient and economical means of destroying gophers. Trapping ranks second in popularity. Another method of extermination is to offer small boys a bounty of ten or fifteen cents a head for catching them, which, in addition to the bounty offered by the county, is often sufficient to control them. Several other methods are mentioned, such as suffocation with carbon bisulphide, shooting, keeping cats, and the encouragement of snakes, but these are not in general use. On irrigated land they may be

readily drowned. A peculiarity reported is that gophers do not usually work in black gumbo land. (See pages 353 to 365.)

The following reports bear on the subject:

*Geary county*: "I have had lots of grief—getting dirt in the mower sickle, horses stepping in the runway and so forth—and have hired them trapped at fifteen cents each."

*Jefferson county*: "They make vexatious mounds. We poison and trap."

*Marshall county*: "Gophers are bad, as they make it so hard to mow. We have tried trapping, but that is pretty slow. I think poison is better."

*Riley county*: "Gophers throw up mounds and make it bad to mow. Poison with strychnine in prunes, raisins, apples or sweet potatoes. Patented preparations are not worth anything."

*Comanche county*: "They have ruined some fields for me. We plowed the fields because it was too big a job to kill them."

*Mitchell county*: "Gophers took one field for me. I used potatoes and prunes poisoned with strychnine to exterminate them."

*Doniphan county*: "Trap and poison them. We fight all the time to hold them in check."

*Jackson county*: "I load raisins with strychnine and drop in runs. Gophers are very troublesome if you don't."

*Marshall county*: "They are bad unless you keep them in check by poisoning."

*Mitchell county*: "A great nuisance. Trap them and poison them."

*Nemaha county*: "They have been very troublesome. I use strychnine, placing a grain in a small potato and introducing it into their runs. Leave the hole open."

*Pottawatomie county*: "I have kept gophers out of 100 acres of alfalfa with potatoes and strychnine."

*Kingman county*: "Cats will catch them near the buildings. I pay the boys ten cents apiece for trapping and see that they get their pay from the county."

*Barber county*: "My alfalfa is mostly on heavy ground, with no gophers. I had sixty acres a few years ago on light ground; they got it."

The elimination of weeds and grasses is treated on pages 55 to 62, and 332 to 338.

#### Webworms.

The extent of the damage by webworms and the method of fighting them are clearly set forth in the following reports:

*Franklin county*: "The webworm destroyed one crop by eating and forming a web over the field. They disappeared in a short time."

*Sedgwick county*: "We have never fought the webworms, as they usually last only a week to ten days."

*Labette county*: "When the web-forming caterpillar, which eats the top of the growing stem as well as spins a web over it, appears, we cut at once, no matter what the stage of growth. They seldom attack the subsequent growth. They have either starved or completed their life cycle."

*Chase county*: "Sometimes the webworm strikes a field. I think it best to cut at once to give the next crop a chance."

*Montgomery county*: "The webworm has done us some damage. We have mowed as quickly as possible and disk-harrowed."

*Comanche county*: "Webworms bother some years. We try to mow when we see them come."

*Crawford county*: "Mow it or pasture it when you find it infested."

*Marion county*: "The webworm has ruined several crops. I mowed the fields at once, regardless of the stage of growth."

*Montgomery county*: "We have never fought except to cut as soon as the webworm makes its appearance."

*Russell county*: "Once when in bloom for seed crop the webworm tied the blossoms. We cut the crop for hay and they did not return."

(See page 386.)

#### *Army Worms.*

On the subject of army worms the following reports are submitted:

*Brown county*: "I have had army worms twice in sixteen years. Each time they stayed a month and then left. I lost a crop each time."

*Russell county*: "We have had the army worm once or twice in the last twenty years, but they don't last long."

*Atchison county*: "The spring army worm ate it down after it was mown for about ten days last year. They disappeared until the second cutting was about ready to cut, and then stripped it."

*Nemaha county*: "The army worm was troublesome in 1914 and delayed the starting of the second crop by eating off the new growth when it appeared."

*Ottawa county*: "Army worms have bothered some in wet years. A good way to do after cutting and getting the hay off, is to harrow the field on a bright sunshiny day. They can not stand the hot sun, and uncovering them with the harrow gets the most of them."

*Linn county*: "When I find army worms working in my alfalfa I turn in a lot of young shoats and scatter shelled corn where the worms are working. The shoats will get the corn and worms."

*Crawford county*: "Army worms made a raid and the hogs did the work."

*Jefferson county*: "A lot of complaint was heard here of army worms last year. I let the hogs eat them."

*Anderson county*: "Army worms took possession and ate a near-by field. A herd of sows and pigs met them at the alfalfa fence and they did not go any further. I gave the sows and pigs free range over the place and they cleaned up the worms."

*Wilson county*: "I used poisoned bran mash for army worms quite successfully, after mowing."

*Cherokee county*: "Army worms were bad last year. I used poisoned bran mash and cleared the field over night."

*Woodson county*: "For destroying the army worm running a heavy iron roller over them has proved a great benefit. After cutting our first 1914 crop the ground was almost covered with various worms, mostly cutworms, and I believe the birds got most of them. *Be sure and protect the birds.*"

(See pages 379 to 384.)

*Cutworms.*

Cutworms are treated in like manner:

*Osage county*: "Cutworms seem to come about the last of May each year, and as they last only a few days I do not think they will cause much damage, especially where hogs have the run of the field."

*Miami county*: "Cutworms and army worms poisoned with bran mash with good results."

*Montgomery county*: "For cutworms the strip affected must be sown with poisoned bran mash."

(See page 384.)

*Russian Thistles.*

Reports about Russian thistles are few, and one from Barber county just about covers the ground: "If Russian thistles start in the field get them, or eventually they will get the alfalfa. If alfalfa is of a thick, heavy stand you will have little trouble, but spots will grow them and they will spread from one spot to another until they have soon ruined nearly the entire field for hay, and entirely ruined it for seed." (See page 334.)

*Dodder.*

Here are some of the reports in regard to dodder:

*Brown county*: "Burn the spots as soon as discovered."

*Chase county*: "Take a load of straw, drive over the field and burn the dodder wherever we find any."

*Cherokee county*: "Take a hoe and chop it out."

*Ellis county*: "Cover infested area with straw and burn. Some report good results from close pasturing."

*Finney county*: "Cut infested area with scythe, throw on wagon, haul off and burn."

*Geary county*: "Pull it up wherever I see it."

*Clay county*: "Cut carefully and burn."

*Hodgeman county*: "Cut alfalfa close as soon as dodder is seen."

*Logan county*: "Pasture with horses."

*Marion county*: "Mow infected field early and destroy dodder at once by burning hay."

(See page 336.)

*Prairie Dogs.*

The different remedies suggested for the extermination of prairie dogs are as follows:

*Cheyenne county*: "Feed poisoned wheat. It kills lots of them in early spring."

*Ellis county*: "Poison them with the 'dope' the state sends out."

*Hodgeman county*: "I have trapped, shot, and used the Manhattan formula successfully."

*Ellis county*: "Put a short hose in the burrow and pour a pint of gasoline into it. After five minutes set it on fire and plug it."

*Pratt county*: "Carbon bisulphide puts them out of business without delay."

*Wallace county*: "Use prairie-dog poison on wheat in early spring before the grass starts. Use bisulphide of carbon any time. Take large corn cobs, cut in lengths equal to their diameters, pour about a tablespoonful of the liquid on a couple of the pieces of cob and put them in the hole. Cover the hole with a spadeful of dirt and tamp solid."

(See page 365.)

#### WINTERKILLING.

It is universally reported that young alfalfa is much more susceptible to winterkilling than old alfalfa. The kind of weather that most often winterkills alfalfa in the western half of the state is a dry, cold atmosphere accompanied by driving winds, especially where there is a loose topsoil. In the eastern half of the state winterkilling of alfalfa is usually caused either by heavy sleet or ice remaining over the field for a considerable period of time or by very wet soil with hard and sudden alternate freezing and thawing, which causes the ground to heave and the roots to break, sometimes lifting the alfalfa plants far out of the ground. The following are representative reports covering the different phases of the subject:

*Rawlins county*: "Alfalfa sowed too late in the fall, and a hard winter."

*Brown county*: "I never had any killed after one year old."

*Cowley county*: "I never had any to winterkill after it got a start."

*Finney county*: "I never lost any alfalfa over one year old by winterkilling."

*Geary county*: "Freezing and thawing when not well rooted."

*Russell county*: "I have never had any winterkilled when it got a good start in the fall."

*Leavenworth county*: "Thawing and freezing on newly-sown fields."

*Allen county*: "Thawing and freezing for young alfalfa; never had old alfalfa to winterkill."

*Cheyenne county*: "Young alfalfa in dry and cold winters."

*Coffey county*: "Freezing and thawing will kill young alfalfa."

*Lane county*: "I have never known a spring sowing to winterkill here. Dry, hard, freezing weather will kill a fall sowing."

*Ellsworth county*: "A dry fall and a dry, cold winter."

*Hodgeman county*: "Extremely dry fall, loose dry surface, and extremely cold weather."

*Phillips county*: "Cold, bare winter."

*Seward county*: "Mine was killed by having the ground get dry and loose on top, and then blowing out in the winter."

*Sherman county*: "Close pasturing and an open, dry winter with heavy winds."

*Stafford county*: "When the ground is dry and bare, with hard freezing."

*Woodson county*: "A very severe dry freeze in the beginning of the winter will kill alfalfa mowed late and immature."

*Butler county*: "Freezing and thawing—heaving—will kill young alfalfa. A dry, cold winter will kill old alfalfa where the wind strikes hard."

*Rice county*: "Dry, windy, freezing weather for young, and wet freezing and thawing for old."

*Pottawatomie county*: "Extremely wet and then freezing is the only trouble we have had with old alfalfa. Any dry winter weather will kill young alfalfa."

*Rice county*: "Heavy sleet; severe cold with heavy wind."

*Shawnee county*: "Our alfalfa winterkilled when covered with sleet a few years ago."

*Brown county*: "Heavy sleet or snow melting to slush and freezing hard."

*Cloud county*: "The ground covered with ice for a long period in winter."

*Meade county*: "Water standing and freezing will kill it."

*Reno county*: "Rain in winter or spring and quick freezing, or water standing over and freezing."

*Riley county*: "A heavy sleet followed by a long cold spell."

*Wabaunsee county*: "Alfalfa will not live long if it is covered with water. The only serious winterkilling we ever had was when a sudden thaw of snow came on the frozen ground and left water on top, followed by a severe frost, leaving a sheet of ice over the field."

*Washington county*: "Rainy weather in winter when the ground has thawed out, and water stands three to six inches in depth, will kill alfalfa."

*Geary county*: "Sleet that covers the ground; thawing and freezing in a wet time breaks the roots."

*Nemaha county*: "Icy or sleety weather; wet, together with alternate hard freezing and thawing."

*Cloud county*: "Where it is wet and weather is very radical in changing from thawing to freezing."

*Jewell county*: "Hard freezing in wet ground will heave alfalfa and cause roots to be pulled up or broken in two."

*McPherson county*: "Young alfalfa winterkilled by heaving of soil, caused by freezing and thawing in wet weather."

*Wilson county*: "Severe freezing just after a long-continued wet spell."

*Chase county*: "Freezing, thawing and heaving."

*Geary county*: "Excessive wet weather followed by severe freezing, causing ground to heave."

*Harvey county*: "Wet, with alternate freezing and thawing."

*Lincoln county*: "Freezing and heaving of the top soil."

*Marion county*: "Wet fall, and intermittent freezing and thawing of the ground where ground is level and the water stands."

*Marshall county*: "A wet winter with very hard freezes after thawing, thus heaving it out. Young alfalfa is worst to winterkill."

*Marshall county*: "A very hard freezing of a water-soaked soil is the worst."

*Miami county*: "Wet spring, freezing at night and thawing in the day. Have seen alfalfa raised six inches."

*Neosho county*: "Freezing at night and thawing during the day will pull it out of the ground and kill it, particularly in shallow soil."

*Reno county*: "Alternate freezing and thawing if the ground is bare and loose."

(See pages 67 and 241.)

#### OVERFLOWED ALFALFA.

The effect of overflowing water upon alfalfa is a matter about which there is considerable diversity of opinion. Some think alfalfa is injured least when it is completely submerged, stating that when a part is exposed the plants scald badly; others think alfalfa is injured least when only partially submerged, so that it can get air. Then there are those who believe that alfalfa will live if the water moves in a current and will die if the water stands still. Finally, and considerably in the majority, are those who hold the opinion that the length of time the water inundates the field determines whether the alfalfa shall live or die. The following reports bear on this subject:

*Montgomery county*: "I find that standing water can completely cover alfalfa for quite a time without injuring it; but if water stands, only partially covering the alfalfa, the plants will scald in a short time."



FIG. 142. Pumping water for irrigation.

*Wabaunsee county*: "I have had some experience regarding flood water. I had about forty acres of alfalfa which were many times flooded, and I am quite convinced that water running over alfalfa a moderate length of time will not kill it. However, when the water stands on the alfalfa it scalds very quickly and dies. There is no question in my mind but that the length of time the water remains on the alfalfa has much, if not everything, to do with its life and death, and it does not take very long in hot, sunny weather to kill alfalfa if water stands on it."

*Shawnee county*: "It is simply a matter of suffocation; the water excludes the air and the plants die."

*Shawnee county*: "The water causes the roots to rot."

*Shawnee county*: "It all depends on how long the water remains over the field. My experience has been that twenty-four hours is often long enough to kill overflowed alfalfa."

*Linn county*: "Alfalfa which stands where there is a current most of the time, and the tops stick out of the water, will live. After the water goes down the tops may be cut off and a new crop of hay will grow. Alfalfa completely under water is killed. It takes a complete submersion of more than five days to kill alfalfa; headwaters which run off in a day or two do not hurt it much."

*Montgomery county*: "Flooded alfalfa should be cut and hauled off."

#### IRRIGATED ALFALFA.

The United States Census Bureau credits Kansas with 11,195 acres of irrigated alfalfa in 1909. Of this acreage 94.7 per cent is irrigated from streams, 5.2 per cent from wells, and .1 per cent from springs. Reports to the State Board of Agriculture, however, come mostly from growers who irrigate by pumping from the underflow; some irrigate from streams, and one, living in Morton county, irrigates from an artesian well. Practically all the irrigated alfalfa in Kansas is located in the western third of the state.

The average yield of irrigated alfalfa in Kansas is 5.4 tons per acre, as against 3.17 tons of nonirrigated alfalfa in the same territory—an increase, due to irrigation, of 2.23 tons per acre, or more than 70 per cent. The average annual cost of irrigation is from two to five dollars per acre.

The usual method of preparing soil for irrigated alfalfa is to plow deeply, harrow, and then level. Leveling land for irrigation is fully covered on pages 277 to 279. There is little difference in the methods of after-culture, except that water is applied to irrigated alfalfa and is not applied to nonirrigated alfalfa.

None of the irrigators reporting, except the one having the artesian well, has a reservoir. The custom is to conduct the water from the pump directly to the field by means of ditches. All the reporters apply water by means of flooding, most of them using the "check" method. From two to eight irrigations are given each year, averaging four or five.

The time to irrigate is determined by the condition of the soil and the appearance of the crop, as evidenced by the following reports: "Examine the ground and never let it get dry, or even begin to get dry. Keep plenty of moisture in the ground." "When it is dry and needs water the leaves will start to dry up and turn yellow."

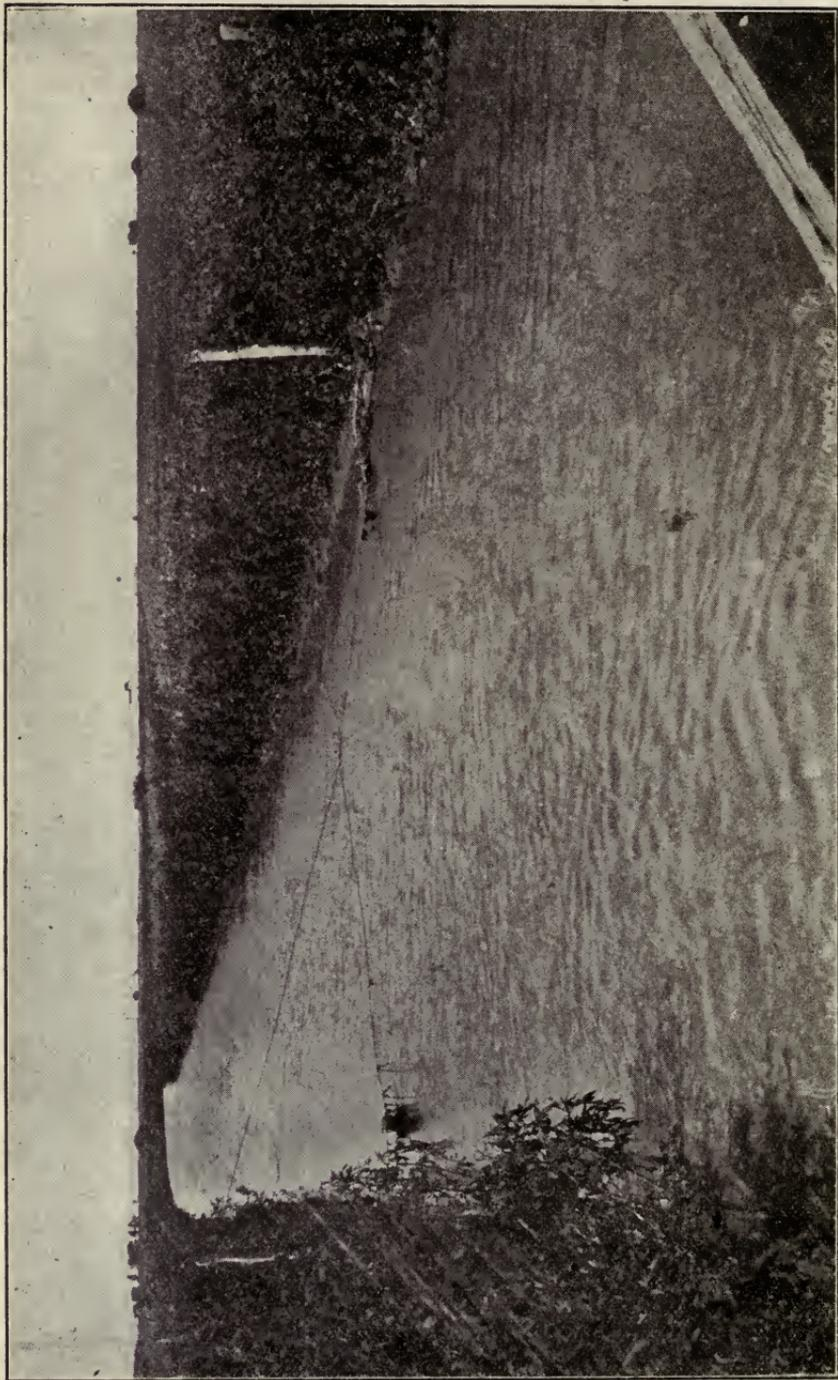

FIG. 143. Water is conducted to the fields by means of ditches.

Some growers prefer to have the soil quite moist at the time the seed is sown, and do not irrigate again until the plants are two to four inches in height; others sow the seed and irrigate immediately afterwards. On established stands the time of applying water is either just before or just after each cutting, or both, and perhaps early in the spring. From three to five inches of water are applied at each irrigation. A prominent alfalfa grower irrigates as follows: "Three inches of water, early in the spring, just a few days before we cut, and a week or ten days after we cut."



FIG. 144. The yield of irrigated alfalfa is 70 per cent greater than that of nonirrigated alfalfa.

Here are some opinions of growers in regard to irrigated alfalfa as compared with near-by dry-land alfalfa:

*Finney county*: "The irrigated alfalfa is always growing and has a bright color, while the dry-land alfalfa has a sallow appearance."

*Scott county*: "It is so different that there is no comparison."

*Gray county*: "Without irrigation it is a failure; with irrigation it is a source of wealth."

*Finney county*: "In ordinary seasons irrigated alfalfa will yield one-third to one-half more hay per acre than alfalfa grown on valley land without irrigation."

*Scott county*: "Seventy-five per cent better."

*Wallace county*: "Double or more in yield."

*Wallace county*: "One acre of irrigated alfalfa equals two of dry-land alfalfa."

*Morton county*: "We irrigate from an artesian well, and find winter irrigation to be good. In the summer we give two irrigations for each cutting, which will produce better crops. It is hard to give alfalfa too much water in this locality. It is much better to irrigate just one week before cutting, as the ground will not dry out like it will if irrigated on

the short stubble. This is important where water is scarce. We have baled and weighed as high as 4300 pounds of alfalfa from one acre of the first cutting."

(See pages 276 to 287.)

ALFALFA IN ROWS.

The subject of alfalfa in rows is covered on pages 271 to 275.

FIVE OR ONE PROFIT CROPS

LEGEND:

- 1-PROFIT FROM CROP AT MARKET VALUE.
- 2-PROFIT FROM FEEDING CROP.
- 3-PROFIT FROM MANURE.
- 4-PROFIT-PREPARES LAND FOR OTHER CROPS.
- 5-PROFIT-INSURANCE-MOST SURE TO PRODUCE A CROP.

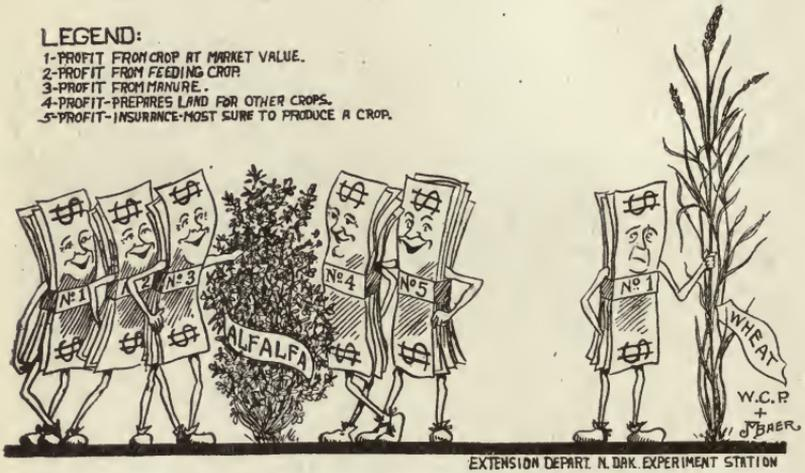

EXTENSION DEPART. N. DAK. EXPERIMENT STATION

FIG. 145. Alfalfa is an all-round crop. [Courtesy North Dakota Experiment Station.]

COSTS AND PROFITS.

The average costs and profits in growing ONE ACRE of alfalfa, under the best methods of culture, compiled from reports of growers, are here-with presented:

TABLE NO. 16. Cost of getting a stand.

Fertilizing with barnyard manure.....	\$3.00
Plowing .....	1.50
Disking twice .....	.75
Harrowing three times.....	.75
Smoothing or dragging once.....	.35
Seed .....	2.00
Sowing .....	.40
<b>Total cost of planting.....</b>	<b>\$8.75</b>

TABLE NO. 17. Cost after field is established.

Share of cost of planting, field living twelve years.....	\$0.73
Mowing, four cuttings.....	1.60
Curing and storing in stack, shed or mow, four cuttings.....	3.40
Cultivation once .....	.57
Top-dressing with barnyard manure.....	1.90
Interest on value of land @ 6 per cent, or rent.....	4.20
Taxes on land.....	.56
Share of interest, taxes and depreciation on machinery and equipment, and on machinery sheds .....	1.26
Share of interest, taxes and depreciation on hay sheds or barns.....	.50
<b>Total cost of producing an acre of hay.....</b>	<b>\$14.72</b>

TABLE NO. 18. Profit when hay is fed on farm.

Total cost of producing an acre of hay.....	\$14.72
Value on farm of 3.72 tons of hay, @ \$7.57 per ton.....	28.16
Net profit an acre from hay fed on farm.....	*\$13.44

\* To which should be added the value of the manure.

TABLE NO. 19. Profit when loose hay is sold from farm.

Total cost of producing an acre of hay.....	\$14.72
Hauling from the farm.....	1.85
Total cost of producing and hauling from farm.....	\$16.57
Value of 3.72 tons of hay sold from farm, @ \$8 per ton.....	29.76
Net profit from an acre of loose hay sold from farm.....	\$13.19

TABLE NO. 20. Profit when baled hay is sold from farm.

Total cost of producing an acre of hay.....	\$14.72
Cost of baling.....	5.22
Hauling from the farm.....	1.85
Total cost an acre of producing, baling and hauling from farm.....	\$21.79
Value of 3.72 tons of baled hay, @ \$9.45.....	35.15
Net profit from an acre of baled hay sold from farm.....	\$13.36

TABLE NO. 21. Cost and profit when seed crop is raised.

Share of cost of planting.....	\$0.73
Mowing two crops of hay and one seed crop.....	1.20
Curing and storing two crops of hay and one seed crop.....	2.55
Threshing the seed.....	2.80
Bags and storing the seed.....	.65
Cultivation once.....	.57
Top-dressing with barnyard manure.....	1.90
Interest on value of an acre of land @ 6 per cent, or rent.....	4.20
Taxes on land.....	.56
Share of interest, taxes and depreciation on machinery and equipment, and on machinery sheds.....	1.26
Share of interest, taxes and depreciation on hay sheds or barns.....	.50
Total cost per acre of production when seed crop is raised.....	\$16.92
Value of two crops of hay, 1.86 tons, @ \$7.57.....	\$14.08
Value of 4.2 bushels of seed, @ \$7.75.....	32.55
Value of straw from seed crop, .93 tons, @ \$3.78.....	3.51
Total value of production when seed crop is raised.....	\$50.14
Net profit per acre when seed crop is raised.....	\$33.22

Emphasis should be placed on the fact that these figures represent an *average for the state* where the *best methods of culture*, as described on other pages, are followed. Any one or all of the items are subject to such changes as may be brought about by the particular combination of circumstances and conditions prevalent in a given instance. For example: If a grower bale from the windrow and ship at once the charge against curing and storing would be greatly modified. If a man grows alfalfa on 100-dollar land the charge against interest and taxes on land would be twice as much as it would be on 50-dollar land. If a man's average yield were 4.5 tons the cost of handling and the profit per acre would be quite different from what they would be if his average yield were 2.5 tons. The costs and profits of a grower in Lyon county differ considerably from those of a grower in Wallace county. Hence the estimates as shown above are not arbitrary; they serve merely as an indication of the approximate average expense and income, when the opera-

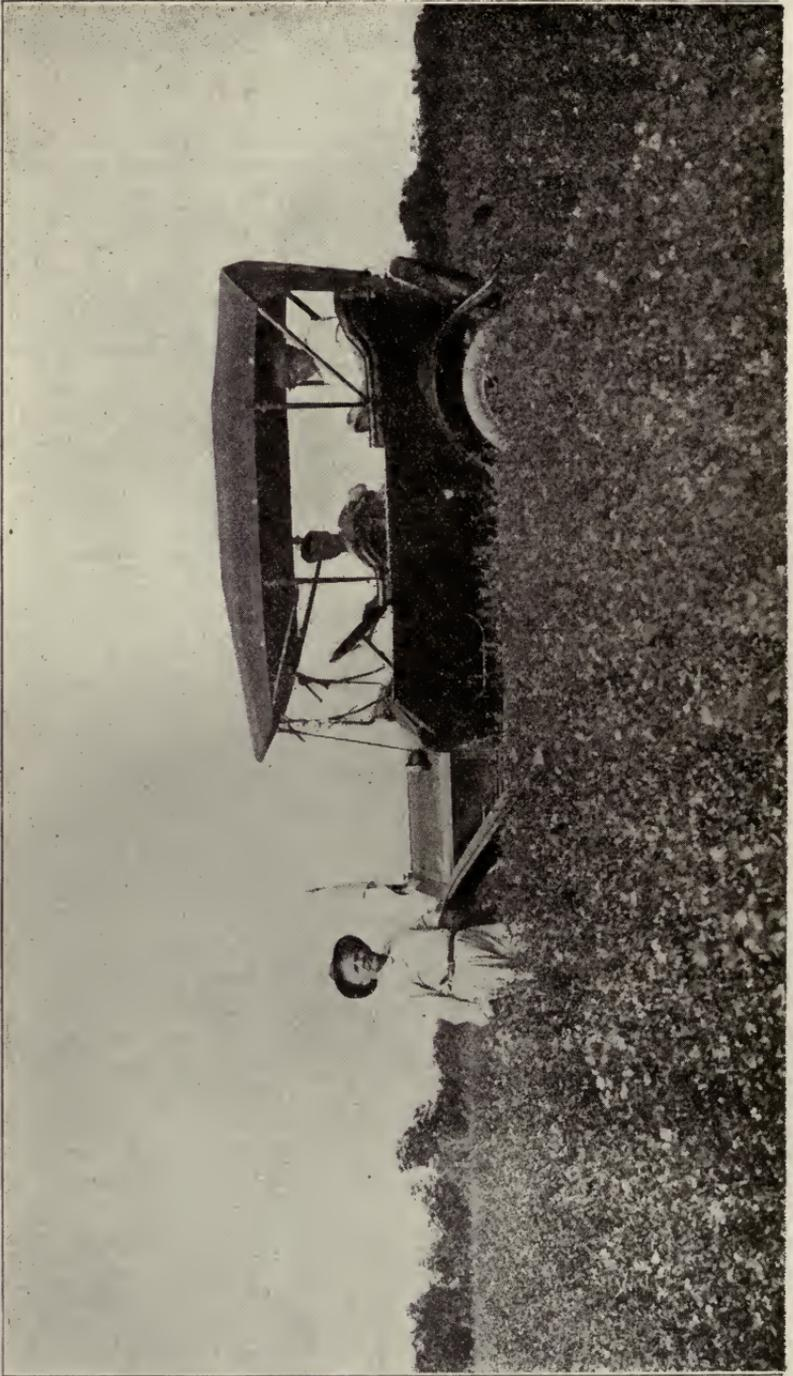

Fig. 146. Some say that the connection between more alfalfa and more motor cars is analogous.

tions as mentioned are practiced and when the yields and prices are as stated.

It is interesting to note that, except where a seed crop is raised, the net profit per acre is greatest when the hay is fed on the farm. A peculiarly happy circumstance is that an alfalfa seed crop, the most profitable crop of all, usually comes in those dry years when all other crops are at their worst. Baled alfalfa hay brings a better profit than loose alfalfa hay, when sold. When shipped to a distant market the transportation charges and the commission charges are usually offset by a higher price.

**GIVING AN ACCOUNT OF THEMSELVES**

**THE FOOD THEY PRODUCED FROM AN ACRE**



FIG. 147. Alfalfa probably is Kansas' most profitable crop. [Courtesy North Dakota Experiment Station.]

It is doubtful whether any of the field crops common to Kansas will show a greater net profit than alfalfa, and few will show so great a net profit. (See pages 469 to 472.)

**FROM PERSIA TO KANSAS.**

By H. J. WATERS, President Kansas State Agricultural College.

It's a long way from Persia to Kansas, nearly half way around the world, even as the crow flies. Yet this is the distance alfalfa traveled from Persia, the place of its birth, to Kansas, the place of its most effectual fruition. It's a long time from 500 B. C. to 1869 A. D. Yet this is the time that elapsed from the date of the earliest extant record of alfalfa to the date of the plant's first entrance into Kansas.

It was in the land of Media, a well-watered, fertile and wealthy country in what is now northern Persia, that alfalfa had its ancient home. The first word of the botanical name of the plant, *Medicago sativa*, is a reminiscence of the ancient land of the Medes, of whom we read so much in the Old Testament Scriptures and secular history. The word *sativa* means cultivated. In England, where words live longer than in the United States, the name "purple medic," suggesting both the origin and the color of the flower of the plant, is commonly applied to alfalfa.



FIG. 148. Media. The original home of alfalfa. A land that was well-watered and rich in vegetation. Map of Asia, 500 B. C.



FIG. 149. Greece. The first step in the progress of alfalfa toward Kansas.

Alfalfa played in its travels the part of the leisurely tourist, who travels about the world, stopping now here, now there, as his health or fancy may suggest. Alfalfa zigzagged across Asia to Europe, into Africa, then back to Europe again, and up and down and across North and South America. It tarried for centuries in some countries, such as Greece and Spain, before proceeding again on its way. Occasionally it lost ground by venturing into a region of unfriendly soil and climate, such as New York, or into a country, such as Mexico, where the people did not know how to treat it. Sometimes the seed was carried by men, at other times by birds, while in other cases the way it made its journeys is unknown.



FIG. 150. Italy. Where the ancient Roman horses and cattle were fed on alfalfa.

The Medes were for centuries leaders in Asiatic civilization, and they carried alfalfa, as they carried many another discovery, to their neighbors, the Persians, who at one time were united with them in one great kingdom. The place occupied by alfalfa among the ancient Persians is shown by the name which they gave to it—*aspect*, which means horse fodder. The plant was brought to Greece by Persian invaders. In some manner it reached northern Africa, and from there was introduced into Italy, where the Romans used it extensively.

Greek and Roman writers on botany and agriculture testify to the high esteem in which alfalfa, or *Medica*, was held in ancient civilizations.

Strabo, who died about A. D. 25, says of alfalfa: "The herb which nourishes horses best we call the Median herb, from its abounding natively there [in Media]." Several references are made to alfalfa by other Greek writers. Pliny, the Roman writer on natural history, ascribes the original spread of alfalfa to the Persian wars carried on by Darius.



FIG. 151. Spain. Into which the Moors introduced alfalfa in the early Middle Ages.

The Roman agricultural writer, Columella, who lived in the first century of the Christian era, says, in speaking of the various kinds of fodder: "The best is *herba Medica* [our alfalfa], because when it is once sown it lasts ten years; because it can be mowed regularly four times a year, sometimes even six times; because it fertilizes the land; because all emaciated stock fatten on it; because it is a remedy for sick cattle; because a *jugerum* [about three-fifths of an acre] suffices abundantly for three horses for a whole year."

For the introduction of alfalfa into medieval and modern agriculture the Arabs, or Moors, are largely responsible. Their invasions in the seventh and eighth centuries of the Christian era brought northern Africa and Spain under their control.

Whether they knew alfalfa originally in Arabia, having obtained it from the Persians, or came into contact with it for the first time in Africa, is not known. At all events, the name which they gave it, *alfaçfaçah*, which means the "best fodder," is the name which the Arabs



FIG. 152. France and Germany. Into whose rich regions alfalfa came on its way through Europe.

carried into Spain with the plant itself, and from this name comes our word alfalfa. From Spain alfalfa appears to have reached France, and from France to have entered Germany in the fifteenth century. From Italy the plant probably also crept into southern Europe, under the name *lucerne*, the origin of which is uncertain. *Lucerne*, or some modification of the word, is the name of alfalfa in most of the countries of Europe, and has come into use in a few localities in the United States, as, for example, in Utah and central New York.



FIG. 153. Mexico. Where alfalfa stopped on its way to Chile.



FIG. 154. Chile. Where the gold-hunters on their way to California found alfalfa.



FIG. 155. California. Alfalfa's first permanent residence in the United States.



FIG. 156. Kansas. Where alfalfa has reached its highest point of development.

From Spain alfalfa was carried by the Spaniards to Mexico after the conquest, and thence into South America. Gold seekers, on their way around Cape Horn to California, brought it up from Chile in the late forties or early fifties of the nineteenth century. From California its spread was steadily eastward. Although alfalfa, under the name of lucerne, had been introduced into the eastern states from southern Europe before its eastern emigration from California began, it had never proved a successful crop in the east.

On its eastward way from California alfalfa finally reached Kansas, where it found the conditions more suitable, perhaps, than in any other land it had visited in its more than twenty centuries of wandering. Indeed, so successfully has the plant been grown in this state that many persons who have not read history carefully have not unnaturally drawn the inference that alfalfa originated in Kansas. (See "History," in index.)

## ALFALFA VARIETIES, BREEDING, SEED, AND INOCULATION.

By H. F. ROBERTS,  
Professor of Botany, Kansas State Agricultural College.

### SPECIES.

The group *Medicago*, called botanically a genus, contains about sixty different species. Very few of these have any agricultural value.

*Medicago arborea*, the *Cytisus* of the ancient Greeks, is a good-sized woody shrub, growing in the Mediterranean region, and much valued there as a feed for browsing animals. It is not hardy in the northern United States, is slow growing and woody, and therefore inferior to alfalfa. However, the fact that it grows in a region of little rainfall may make it useful in crossing to produce more drouth-resistant alfalfas.

*Medicago falcata*, or Sickle alfalfa, is distributed widely over eastern Europe and Asia, from the western Siberian border east into Chinese territory, a distance of about 4000 miles, but occurs especially abundantly in the southern portion of the eastern half of Siberia, in the provinces of Tomsk and Irkutsk. Here the character of the country resembles that of the northwestern prairie region of the United States. In this part of Siberia the Sickle alfalfa is one of the characteristic and dominant wild plants of the open range, and is cut by the peasants for wild hay.

According to Hansen, the plants of Sickle alfalfa, growing wild in Siberia, grow from three to three and one-half feet in height, and he mentions the fact of finding plants on the banks of the Irtisk river, in western Siberia, the stems of which were five feet eight inches in length. None of the Sickle alfalfas received from Hansen, and in cultivation at the Kansas station, reach the height of ordinary alfalfa.

Hansen says further regarding the distribution of this plant:\*

"It extends throughout a large part of western Europe, central and southern Russia, the Crimea, the Caucasus, and through approximately the western two-thirds of Siberia, at least as far as 64° north latitude, through north China, the Trans-Caspian regions, including Turkestan and Persia, and through Afghanistan, western India, and Asia Minor."

At the Russian Experiment Station of Besentsug, situated about thirty miles east of Samara, in the eastern part of Russia proper—a typical semiarid high-plains region—the Sickle alfalfa grows wild, is perfectly hardy and drouth-resistant, and endures pasturing for ten years. The general information gathered by Hansen would indicate that Sickle alfalfa is a desirable plant for pasture lands in western Kansas and for breeding drouth-resistant and hardy alfalfas. The plants of Sickle alfalfa at the Kansas station are, for the most part, low and spreading, although some of them have a more upright habit. All Sickle alfalfa plants have finer foliage than cultivated alfalfa, and all have yellow flowers and more or less sickle-shaped pods, whence the name of Sickle alfalfa.

\* Bull. 141, South Dakota Ex. Sta., p. 140.

The lighter yield of forage and seed, as compared with common alfalfa, will not make *Medicago falcata* desirable where ordinary alfalfa can be grown successfully, but in view of the fact, as Hansen says, that it "endures very severe summer drouths, stands dry upland soils underlaid with hardpan, and is considered resistant to alkali," there is every reason for introducing it into Kansas for growing under special conditions and for breeding purposes. The department of botany and plant breeding is making extensive use of the plant in breeding operations. Many hybrids have been made this season between the more upright-growing plants of Sickle alfalfa and a superior selection of pure-bred Kansas alfalfa.

*Medicago media*. This plant is supposed to be a natural hybrid between the common and the Sickle alfalfas. It is found wild most commonly where the boundaries of these two species overlap in Europe and Asia. The hybrid, furthermore, grows farther north than common alfalfa, in which respect it shares the characteristics of the Sickle alfalfa. The plants of *Medicago media* show considerable variation. This is most striking in the case of the flowers, which vary from pale yellow to greenish yellow and greenish purple, for which reason the name Variegated alfalfa, proposed by the United States Department of Agriculture, has come into use. The seed pods are spiral, but they are not so closely coiled as in the case of alfalfa. *Medicago media* is often called Sand alfalfa, because it has been found growing in Germany in sandy soil, and has been recommended, therefore, for sandy regions. It is, however, doubtful whether much of the alfalfa seed sold as Sand alfalfa is really anything but common alfalfa seed from plants grown on sandy ground.

The fact that Variegated alfalfa will grow farther north than common alfalfa is due to the circumstance of its being a hybrid of common alfalfa with the hardier Sickle alfalfa.

*Medicago ruthenica*. This is a species of alfalfa found growing wild, from the east shore of Lake Baikal, in eastern Siberia, to the Pacific ocean, and in Siberia as far south as Manchuria, Mongolia, Korea, and northern China. The plants are low and spreading, with small, narrow leaves, yellow flowers, and flat, oval pods, tapering toward both ends, and not containing over four seeds, as a rule. The forage value of this species is small in comparison with that of common alfalfa, but it will undoubtedly be of some use for pastures in dry regions. Perhaps its chief value will be for crossing with *Medicago sativa*, to produce hardier alfalfas.

#### VARIETIES.

This concludes our discussion of the species of alfalfa that give most promise to agriculture. We have next to consider the so-called "varieties" of the species *Medicago sativa*, or ordinary alfalfa, that have come into prominence.

Common alfalfa has well been called "the most important forage plant in the world," by reason of the very great series of variations it possesses, which make it adaptable to such a wide range of climates. The fundamental essential needs of all alfalfa varieties are four, viz., (1) a rich soil, (2) a well-drained soil, (3) a soil free from acidity, (4) a porous subsoil.

No variety of alfalfa known will be entirely successful anywhere if one of these essential characteristics is lacking to the soil. But, on the other hand, when we come to consider variations in climate, we find the world-wide adaptability of alfalfa to be most striking. When we speak about varieties of alfalfa, however, we must remember that generally the name of a "variety"—so-called—of alfalfa is really the name of the region where it originated or from whence it has been brought. Hence, we prefer at present to speak of "regional varieties." This is illustrated by the names Arabian, Peruvian, Chilean, Turkestan, etc., which are very indefinite as variety names, but which simply refer to the country from which the given strain of alfalfa has been imported. Oftentimes, as is the case of alfalfa from Turkestan, where different importations of seed have been made from different parts of this wide territory, which is two-fifths as large as the United States, it is plain that there are several varieties, types or strains lumped together under the name of Turkestan. In fact, the number of different pure strains of different



FIG. 157. Two types of common alfalfa, having broad and narrow leaves, respectively. There are many variations of this kind in every alfalfa field.

value that may be gotten out of any regional variety, by saving the seed separately from different selected mother plants, is always very large. As a matter of fact a thorough study of the alfalfas of the world from the strictly botanical and scientific standpoint has yet to be made.

For practical purposes, however, we may say that where alfalfa has been grown for a long time in any region the plants unfitted to survive there are gradually sifted out by Nature, and we finally come to have a tolerably uniform type in each region *as long as it is kept growing there*. When it is moved elsewhere and exposed to different climatic conditions, Nature begins a new process of sifting, and perhaps does not sift out the same kinds of plants as before. This is what happens, for example, when Arabian or Peruvian alfalfa, which is adapted to a warm region, is grown in the colder parts of North America.

If we follow alfalfa in its historic westward course from Persia to Arabia, Egypt, Northern Africa, Spain, France and Germany, and from Spain across the ocean to Mexico, Peru and Chile; if we follow its other track into Asia Minor, Greece and Italy; or if we trace its eastern trail up into Turkestan or Siberia, and down into India; and if we visit any of the stopping places on this extensive pilgrimage, where anything like settled and permanent agricultural conditions prevail, we shall find characteristic types of alfalfa growing in each region, each having its own peculiarities, owing to the fact that Nature's subtle sieve has sifted out the plants unadapted to the region in question, and has left the rest to propagate. Through the efforts of the agricultural explorers of the United States Department of Agriculture especially, many importations of alfalfa seed have been made for trial from all the principal alfalfa-growing regions of the earth. Following are a few of the principal regional varieties that have been introduced, and that have proved to be of agricultural value in different parts of the United States: Turkestan, Grimm or Old Franconian, Arabian, Peruvian, and Chilean.

#### *Turkestan Alfalfa.*

Turkestan alfalfa was first introduced by the United States Department of Agriculture in 1898. The seeds individually are indistinguishable from those of common alfalfa, but the bulk seed has a duller, rather dusty appearance, instead of the bright yellow color of common alfalfa seed. The plants so closely resemble ordinary alfalfa that it is practically impossible to say whether any given plant is Turkestan alfalfa or not. The chief value of Turkestan alfalfa lies in its resistance to drouth. In respect to yield it is generally inferior to common alfalfa. In the matter of winter hardiness the strains of alfalfa introduced from the different parts of Turkestan vary exceedingly, owing to the wide range of differences in climate existing in the different parts of this large territory. Some of the Turkestan strains have poor seeding habits, and the habit of making an early spring growth, and of going into a dormant condition early in the fall. The early spring growth is apt to be caught by spring frosts, and a late fall cutting is lost by early dormancy.

#### *Grimm Alfalfa.*

In 1857 Wendelin Grimm came to America from his home in Kùlsheim, in the province of Baden, in southwestern Germany, bringing with him a fifteen- or twenty-pound packet of alfalfa or "lucerne" seed of the variety generally grown around his home, and known as the "Old Ger-

man" or "Old German Frankish" lucerne. This alfalfa, planted in the spring of 1858, has undergone gradual acclimatization until it is now the recognized type of alfalfa for the extreme northern United States. Common alfalfa from Utah, Kansas and California, and from many other sources, has been tested in Minnesota, but with the solitary exception of the Grimm, none has stood the test of the cold of Minnesota. The United States Department of Agriculture had its attention attracted to the hardy Grimm alfalfa in 1904, and extensive experiments conducted since that time show conclusively that Grimm is thus far the most winter-hardy strain of alfalfa known. At the Minnesota Experiment Station farm at St. Anthony Park, in 1907, seven different lots of Grimm alfalfa showed percentages of loss from winterkilling varying from 0 to 11 per cent, with an average of 4.2 per cent. For the same period, three strains of ordinary alfalfa from Utah and Montana showed an average of 84.5 per cent of loss due to winterkilling. At Dickinson, N. Dak., in the winter of 1908-'09, there were 68 strains of alfalfa under experiment from all the chief alfalfa-growing regions of the world. The average loss of the Grimm alfalfa was under 5 per cent, while the average for the whole experiment was 78 per cent of loss—twelve strains out of the sixty-eight winterkilling 100 per cent. These experiments show graphically the superiority of Grimm alfalfa in respect to winter hardiness.

#### *Arabian Alfalfa.*

This type of alfalfa was introduced from Bassorah and Bagdad in Arabia by the Lathrop and Fairchild Expedition in 1902, and through a later importation in 1905. This alfalfa comes from a region of exceedingly hot summers and mild winters, where it has been growing since, perhaps, prehistoric times. It has a longer growing season than common alfalfa. In rapidity of growth it lies between common and Peruvian alfalfa. The leaflets are broad in proportion to their length, while those of Peruvian alfalfa are long. The Arabian alfalfa is short-lived, its period of profitable growth being about five years. In California it is considered desirable to plant Arabian alfalfa in young orchards, since it dies out by the time the trees come into bearing. It is more productive than ordinary alfalfa and a more vigorous grower, with a more upright habit, but it winterkills badly in Kansas, and completely in such northern states as North Dakota and Minnesota.

#### *Peruvian Alfalfa.*

In 1903 seed of the native Peruvian alfalfa was sent to the United States Department of Agriculture from Limache, Peru. The exact locality in Peru from which the seed came is not recorded, but it appears to be a type of alfalfa that had become acclimatized to high altitudes. Alfalfa was, of course, introduced into Peru by the Spaniards after the conquest, and the alfalfa that they brought was adapted to a hot, dry climate. Nevertheless, the Peruvian alfalfa in question, while it will not generally winter over in Kansas, or at all in any more northern state, is capable of growing in cooler weather than any other alfalfa we have. It commences its growth earlier in the spring and continues growing later in the fall than any other sort. For this reason it has great value

for Arizona and the southwest, where it grows through the winter months, which have a mean temperature of a little above 50° F. Here we have the strange fact that a plant which will not survive *cold* winters will grow in a climate with mild but *cool* winters—so cool as to check growth entirely in other varieties of alfalfa. The Peruvian alfalfa is hairy, like the Arabian, has taller and more succulent stems than common alfalfa, and is more productive.

The leaflets are long, and the leaves frequently have four and five leaflets, instead of the three of ordinary alfalfa.

#### *Chilean Alfalfa.*

This may be taken as the type of our alfalfa commonly grown in the United States, the seed of which was originally brought from Chile, in the early fifties of the last century, by gold seekers who sailed around Cape Horn to California, and which has spread from California eastward across the country. This type of alfalfa is the kind commonly grown in Kansas, and is too well known to need description. It is a fact, however, that this alfalfa is by no means of a uniform type, but that differences in yield, winter-hardiness and drouth-resistance exist, which are made use of by the breeder. It is generally known, for example, that northern-grown alfalfa seed, where the seed comes from an old stand of northern-grown alfalfa, produces plants that are hardier than those which come from the southern-grown seed. (See "Varieties," in index.)

#### ALFALFA BREEDING.

Generally speaking, five principal results are to be sought for in alfalfa breeding, viz: (1) winter-hardiness, (2) resistance to drouth, (3) increased forage yield, (4) increased seeding capacity, (5) immunity from disease. These ends, of course, are not all to be sought for to the same degree in all regions. For the most part the different strains of the ordinary American alfalfa, which, from its origin, we have called Chilean, is capable of adaptation to all parts of the United States, except the most northern portions.

#### *Breeding for Winter-Hardiness.*

North of central Nebraska the ordinary American or Chilean alfalfa tends to winterkill more or less completely, and with one or two exceptions, the only alfalfa that has proven absolutely hardy in Minnesota and the Dakotas is the Grimm variety. Peruvian alfalfa is the variety best adapted to the hot, irrigated lands of the Southwest, but it usually winterkills even as far north as Kansas. In the semiarid West generally, where alfalfa is grown without irrigation, and under limited rainfall, Turkestan has given good results.

In breeding alfalfa the first thing to be done is to select, as a foundation stock, a "regional variety" of alfalfa that carries some of the characteristics desired. For example, in the preliminary experiments in breeding alfalfa for North Dakota, experiments were made with sixty-eight such varieties of alfalfa, which were grown in drill and in hill rows at Dickinson, N. Dak.

The effects of the winter of 1908-'09 upon these different varieties were very striking. All of the alfalfa strains imported from Arabia, the

north coast of Africa, Spain, southern France, South America, and even dry-land alfalfa from Utah, and several lots from Turkestan, winter-killed from 90 to 100 per cent. A number of alfalfas from Mexico, France, Germany and Turkestan, and from Utah, Montana, Colorado and Kansas winterkilled from 80 to 90 per cent. Without giving further details, it may be said, briefly, that the only alfalfa strain out of the sixty-eight in which practically no winterkilling whatever occurred was Grimm. Furthermore, it is interesting to note that of the twelve strains from Turkestan one winterkilled as little as 9 per cent, while another winterkilled 100 per cent, the rest being distributed all the way between these two extremes.

This example shows graphically the mistake of assuming that all alfalfa from a given country is necessarily alike, especially when that country is very large and has a considerable range of differences in climate. As Brand and Waldron say, "When one considers that Turkestan has an area almost as great as that part of the United States lying west of the Mississippi, and a climate that ranges from as cold as Montana to as hot as Arizona, this range in hardiness of commercial samples of seed is not surprising." (Bull. 185, Bureau of Plant Industry.)

On the basis of the results obtained by such a winter's test the North Dakota Experiment Station was able to lay an intelligent foundation for the breeding of hardy alfalfas.

It is plain that but for the accidental importation of Grimm alfalfa, and of one or two of the strains from Turkestan, alfalfa growing in Minnesota and the Dakotas would be doomed to failure, since none of the other alfalfas from East Asia, Africa, South America or the United States has proved sufficiently hardy for that rigorous climate. Several trips have been made to Russia, Siberia and Turkestan by Prof. N. E. Hansen, of the South Dakota State College of Agriculture, as explorer for the United States government. As a result we now have numerous alfalfas which, while not all of them are completely hardy in the extreme northwest, have shown that they contain material out of which hardier alfalfas may be produced by selection, after acclimatization tests.

As a matter of fact, work in alfalfa breeding has probably gone far enough for definite statements to be made regarding some of the real underlying reasons for both winter-hardiness and drouth-resistance. From the experiments in Minnesota and the Dakotas, as we have seen, a practical demonstration has been furnished of the fact that certain strains of alfalfa will survive the intensely cold winters of the north with little or no injury. The winter conditions which kill alfalfa are, however, not all of one kind. A moist fall, which prevents the plants from becoming dormant, is conducive to winterkilling, whereas a dry fall, followed by a winter of the same intensity, will result in a much lower mortality. A winter of alternate freezing and thawing, resulting in heaving of the soil, will destroy many alfalfa plants, through the breaking up of the root system. The tissues of the plants may themselves also be killed by successive thawings and freezings, just as the tissues of the buds of peach trees are often killed in our climate. Winterkilling also occurs ex-

tensively where an ice sheet forms over the fields. On the other hand, a very severe winter, in the sense that there is a long period of extremely low temperature, may result in little winterkilling of alfalfa, if the fall is dry and if the ground is continuously under a deep cover of snow. It is therefore plain that to be absolutely winter-hardy under all kinds of winter conditions, alfalfa will have to have quite a combination of characteristics.

Thus far, the Grimm alfalfa, certain Turkestan strains, and a strain of common alfalfa found growing near the village of Baltic, S. Dak., by Professor Wheeler of the Agricultural College of that state, and called Baltic alfalfa, all stand preëminent in respect to resistance to winterkilling. Now Blinn, of the Colorado experiment station, has found that, in the case of the winter-hardy types of alfalfa, the plants stool earlier in life than the nonhardy forms, and stool more extensively, forming extensive underground stems or root stocks, loaded with buds. These root stocks, being underneath the soil, are thus protected by the soil covering from extreme exposures. With this extensively stooling crown, and this mass of underground buds, Grimm alfalfa, for example, is enabled to go through winters that kill alfalfas of our common Kansas type, with their upright crowns and without protected buds. Furthermore, there is a tendency among the hardier types of alfalfa to have a branched root system instead of a single tap root. The Baltic strain of alfalfa shows this characteristic in a high degree. It is also true that, while drouth-resistant alfalfa strains may not be cold-resistant, the winter-hardy types are, generally speaking, drouth-resistant. The underground stems, bearing buds, and the branched root system, characteristic of the winter-hardy alfalfas—Grimm, Baltic, and certain alfalfas from Turkestan—are also characteristics which help the plants in question to live over dry seasons.

Finally, there is a difference among the alfalfa plants of almost any hardy strain with respect to the susceptibility of the foliage to frost injury. Side by side, plants of the same so-called "variety" will show the greatest differences in this regard. Blinn, of the Colorado Experiment Station, thinks that the darker green plants are less susceptible to frost injury than are those with light-green leaves. We may then sum up the steps thus far achieved in the work of breeding for winter-hardiness in alfalfa as follows:

- A. The introduction of hardy foundation stocks. Four important foundation stocks lie at the basis of breeding for cold-resistance in America, viz.:
  1. The Grimm importation in 1858 of a strain of the "Old German Franconian" alfalfa from Baden, Germany.
  2. Various Turkestan importations, and—
  3. The introduction of *Medicago falcata*, or Sickle alfalfa, by Prof. N. E. Hansen, of the South Dakota College of Agriculture.
  4. The discovery, near the village of Baltic, S. Dak., of a hardy strain of common alfalfa by Prof. W. A. Wheeler, of the South Dakota Agricultural College, which has been named "Baltic alfalfa."

- B. The discovery by Mr. P. K. Blinn, of the Colorado Experiment Station, of the fact that all winter-hardy types of alfalfa, from whatever source, are alike in producing underground stems with buds, which are protected by the soil from injury; that the winter-hardy plants stool earlier in life than the nonhardy types, and tend to have a highly branched root system, instead of a single tap root.



FIG. 158. Common American or Chilean alfalfa. Pedigree No. 92, an exceedingly upright type, produced on the plant-breeding grounds of the Department of Botany, Kansas State Agricultural College. Crown and root system have more branches than Peruvian alfalfa.

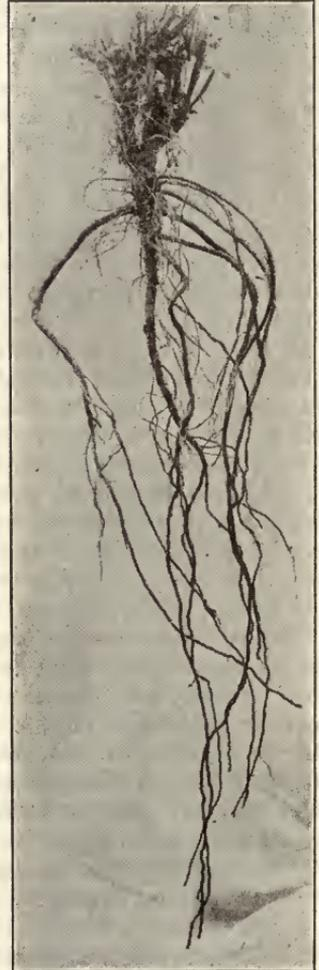

FIG. 159. Peruvian alfalfa. This alfalfa is closely related to the American or Chilean type, commonly grown in this country. It will, however, grow and make a crop in cooler weather. It is not winter-hardy in the north, or even in Kansas, with any certainty. Note the single tap root, associated with tender types of alfalfa.



FIG. 160. Sickle alfalfa (*Medicago falcata*). A cold- and drouth-resistant type of alfalfa native to eastern and central Asia. This alfalfa has a branching crown, and a branching root system, instead of a single tap root. It also has horizontal propagating stems (rhizomes, "r, r"), which grow at some depth underground, and help the plant to survive unfavorable conditions.

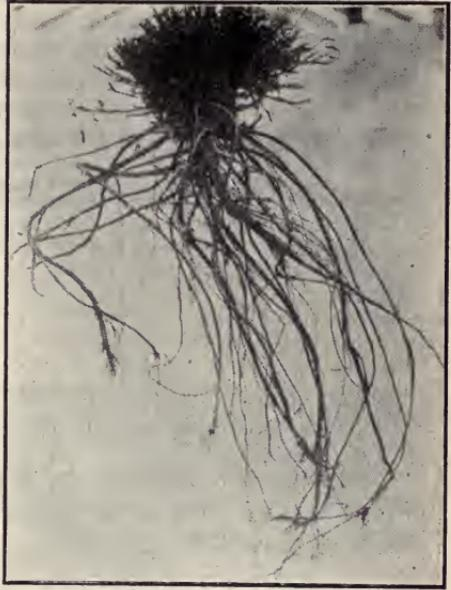

FIG. 161. Grimm alfalfa. This alfalfa is probably the result of a cross between ordinary alfalfa and Sickle alfalfa. It has the hardiness of the latter. Note the richly branching crown and root system, like that of the Sickle alfalfa. This type of root system in alfalfa has been found to go with winter and drouth hardiness.

By means of Grimm, Baltic, and one or two Turkestan strains, alfalfa has thus been brought to the cold northwestern states, where alfalfa growing had hitherto been, and would otherwise remain, a failure. It should be added that the introduction of the yellow-flowered alfalfas, *Medicago falcata* and *Medicago ruthenica*, found by Professor Hansen growing wild on the cold, dry steppes of Siberia, may result in carrying alfalfa growing, as Professor Hansen suggests, up to the arctic circle. These extremely hardy alfalfas do not seem to be so productive as common alfalfa, but it is likely that no strain of *Medicago sativa* will ever grow as far north as some of the strains of Sickle alfalfa.

#### *Breeding for Drouth-resistance.*

As already stated, the alfalfas which show cold-resistance in a marked degree are also adapted to resist drouth. In general, however, the Turkestan strains, which are not all winter-hardy, are yet very drouth-resistant. One of the difficulties in breeding for drouth-resistance in alfalfa is the fact that the alfalfa tops do not lie dormant during a scarcity in the water supply, as in the case of the sorghums, but wilt, and new shoots start from the crown. The deep-rooting habits of alfalfa, and the branching-root habits of some strains, as mentioned above, give alfalfa

a greater volume of soil from which to draw water than other crops have. Alfalfa makes heavy drafts upon the soil for water. The experiments of Briggs and Shantz, of the United States Department of Agriculture,\* to determine the number of pounds of water taken from the soil by crops, for the production of a pound of dry matter, are very instructive. The following data are given for alfalfa:

TABLE NO. 22. Amount of water used by different varieties of alfalfa.

Variety.	Number of years tested.	Pounds of water required per pound of dry matter produced.
Grimm: Average of two strains.....	2	903
Peruvian.....	1	651
Sickle alfalfa.....		865

In comparison with alfalfa, it is interesting to note the amounts of water used by some other common plants in making a pound of dry matter:

TABLE NO. 23. Amount of water used by different kinds of plants.

Plant.	Pounds.
Sunflower.....	705
Potato.....	636
Watermelon.....	600
Oats.....	597
Barley.....	534
Wheat.....	513
Corn.....	368
Sorghums, all kinds (av.)....	322
Millet.....	310

These experiments simply record the amounts of water that pass from the ground into the air through the stems and leaves of the plants experimented with, and the ratio, in pounds, of this water to the number of pounds of dry matter produced by the plants.

In a rough way, these results measure drouth-resistance, in that they show that some plants are more economical crop producers than others, so far as the amount of water drawn from the soil is concerned. Alfalfa, it is seen, takes nearly twice as much water out of the ground as wheat, in proportion to the number of pounds of dry matter made, and there are evidently differences among the alfalfas themselves in this respect. From the tests thus far made, Peruvian seems to be more economical than Grimm, or even Sickle alfalfa.

For the purpose of the breeder, many more such experiments with a wide range of strains and varieties of alfalfa will be necessary before he can come to definite conclusions as to the most economical strain of alfalfa from the water standpoint.

Strictly speaking, alfalfa is not a dry-land crop in the sense that Sudan grass is, for example, and present prospects do not afford much hope that it can be made into one. Alfalfa plants do not cease growing

\* "Relative Water Requirement of Plants," by Briggs and Shantz, Journal of Agricultural Research, vol. 3, No. 1, Oct. 15, 1914.

during a drouth, as do the sorghums. Their tops wilt, and new shoots start immediately from the crown. The only improvement thus far made in getting more drouth-resistant alfalfas seems to be in the introduction of the Turkestan strains and the Sickle alfalfas from the dry steppes of Siberia. Among the experiments along this line are those of Dillman, at the Bellefourche Experiment Station in western South Dakota.

In 1909 nineteen pure strains of Grimm and twelve of Turkestan were grown at Bellefourche, in rows, under strictly dry-land conditions. It was found that the average yield of dried hay per plant was different in the different strains. The nineteen strains of Grimm showed a variation in this respect ranging from an average of 4.8 ounces of dried hay per plant in the lowest-yielding row to 6.8 ounces in the highest. In the Turkestan plots the range was almost exactly the same, but the average

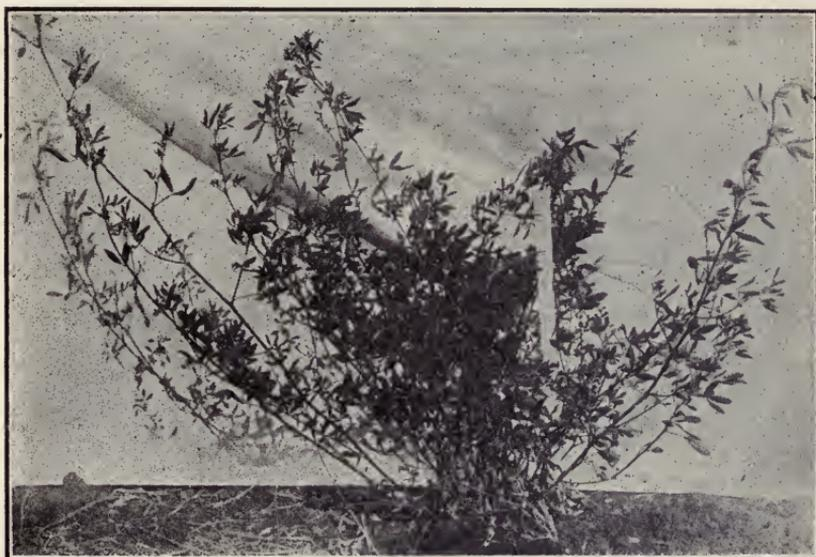

FIG. 162. Type of common alfalfa, with sprawling branches sparsely set with leaves.

for the Grimm plots was slightly higher than for the Turkestan, being at the rate of 5.7 ounces per plant as against 5.3 ounces for the latter.

There is need of a very much wider range of dry-land experiments of this nature with alfalfa to discover the most productive and economical types for semiarid or dry-land agriculture. Perhaps the crossing of Turkestan with Peruvian (which is not hardy in Kansas) may give better types of alfalfa for semiarid conditions.

The variegated alfalfa, or so-called "Sand lucerne," produced by crossing, whenever common alfalfa and Sickle alfalfa grow near together, has proved not only more winter-hardy but more drouth-resistant than the common Chilean or American alfalfa. Its semiprostrate habit, resembling that of the Sickle alfalfa, is its most objectionable feature. By

selection of the more upright types to breed from, this difficulty may possibly be eliminated. With this end in view the department of botany of the Kansas Experiment Station has this past summer made a large number of crosses between an extremely upright type of common alfalfa and the most upright plants of Sickle alfalfa found in the nursery rows.

It is possible, also, that crosses with the *Cytisus*, or shrubby alfalfa of the Mediterranean (*Medicago arborea*), which endures extremely dry conditions similar to those existing in southern California, may give promising results. This line of experimentation is also being followed out at Manhattan.



FIG. 163. Tall type of alfalfa, with slender stems and narrow leaves.



FIG. 164. Type of alfalfa with short, thick stems and numerous large, closely-set leaves.

*Breeding for Forage Yield.*

The first thing necessary, as in all other cases, is to secure the best foundation stocks for breeding work. This is done by growing a large number of regional and commercial varieties in nursery rows three feet apart, with the plants thinned so that they stand two feet apart in the row. These nursery rows are cultivated throughout the season. The



FIG. 165. Type of common alfalfa having short stiff branches thickly set with leaves.

weight in forage of the different varieties is determined for several years in succession. This is, perhaps, the best method of beginning in a region in which alfalfa has not been grown to any extent. Otherwise, in a successful alfalfa-growing region, it is just as well to begin with seed from a typical first-class old stand of alfalfa, growing under usual conditions. The seed should be sown in the fall, in rows three feet apart, and the plants thinned the following spring until they stand two feet apart in the rows. This will admit of horse cultivation lengthwise of the rows, hoeing being necessary between the plants in the rows. Great differences will soon manifest themselves among the plants. Some will be upright, some prostrate, some with narrow and others with broad leaflets; some with long, wiry branches, sparsely set with foliage; others with shorter branches, thickly set with leaves. An almost infinite variety of types will be found, testifying to the vast amount of intercrossing that has gone on in the past.

The first thing to do now is to close-pollinate the plants of the best types. This can be done by "tripping" the blossoms by hand. Alfalfa is one of a small number of leguminous plants in which there is a trigger-like arrangement of the petals, the release of which allows the pistil and stamens to spring upward with force. The alfalfa flower consists of five petals—an upright one, called the *standard*; two side petals, called the *wings*; and two lower ones, which are joined together into a boat-like

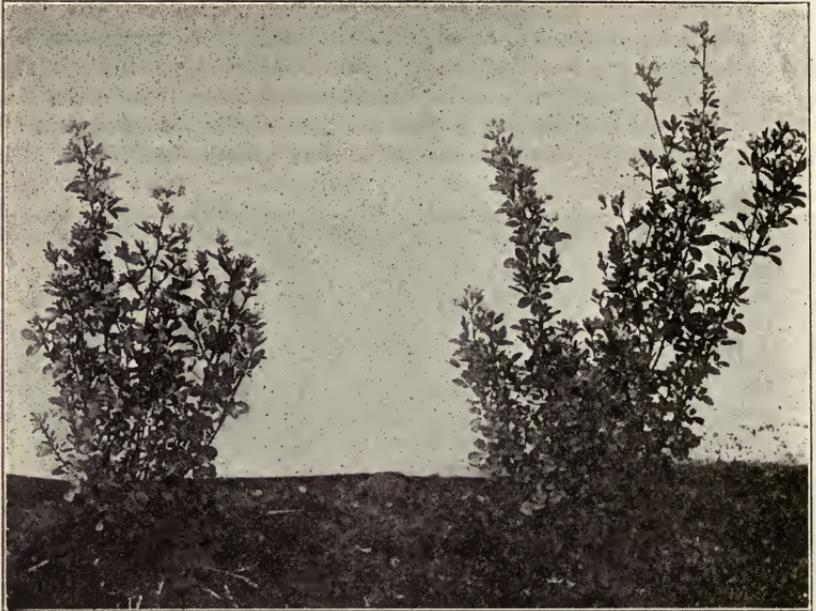

FIG. 166. Tall, upright type of alfalfa, with heavy stems and numerous broad leaves.



FIG. 167. Cluster of alfalfa flowers. "Tripping" the flowers by hand.

structure called the *keel*. Within this keel are enclosed the *stamens* and *pistil*. The stamens are ten in number, nine of them being joined together in a membranous ring around the pistil, the tenth being free. The central pistil is straight, or nearly so, in the flowers of all alfalfas, becoming curved later as the pod grows and ripens. It is this pistil which, after fertilization of the ovules within, grows into the pod, while the ovules become the seeds. The stamens bear, at their summits, yellow sac-like bodies called the *anthers*, which are filled at maturity with the pollen. At the summit of the pistil is the surface called the *stigma*, to which the pollen grains adhere, and on which alone they can germinate.

For close-pollinating alfalfa flowers select a warm, sunny day. Taking a flower that is fully opened, *i. e.*, in which the standard is fully spread, press down upon the keel with a toothpick or other similar small instrument. Instantly the keel will burst apart, and the pistil, with its



FIG. 168. Flower of alfalfa with petals removed from one side to show the organs of fertilization. *c*, The column of stamens that surrounds the pistil; *s*, a stamen; *a*, anthers or pollen-sacs, which terminate the stamens. In the center, among the stamens, stands the pistil, the tip of which is covered with feathery hairs and is called the stigma, *st*. It is here that the fertilizing pollen falls. In the background is one of the keel petals, *k*, and a wing petal, *w*.

surrounding ring of stamens, will spring upward and towards the standard, striking it with the stigma. The pollen is jarred out of the anthers by the spring-like jerk of the pistil, and flies up around the stigma in a tiny cloud of fine yellowish dust, settling upon it and completing *pollination*. The pollen grains germinate, send their germ tubes down the stalk of the pistil, or *style*, to the ovules, which they enter and fertilize the egg cells therein. This constitutes the process of *fertilization*, and starts the young embryo in its growth within the seed. Ordinarily, in the field, alfalfa flowers are visited by insects which trip the flowers. This is not accomplished by the honeybees very extensively, but chiefly by the small,

wild leaf-cutter bee (*Megachile*). The wind, threshing the branches about, causes the springing or tripping of many flowers. Many are also tripped automatically on sunny, dry days. On such days one can often, sitting in the midst of an alfalfa field in full bloom, hear distinctly the succession of tiny "clicks" caused by the tripping flowers.



FIG. 169. Alfalfa flower (magnified) after tripping, showing the column of stamens and pistil, *c*, which have escaped from the keel and have struck against the standard.

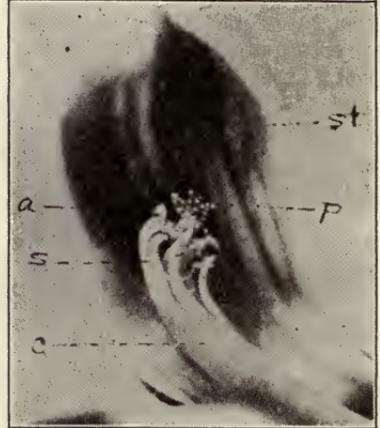

FIG. 170. Highly magnified view of the column of stamens and pistil after tripping. Column of stamens, *c*; single stamen, *s*; anther or pollen sack, *a*; pollen escaping, *p*; standard petal, *st*. The tip of the pistil is surrounded by the anthers and is not visible.

In order to trip many flowers of a plant rapidly, and secure many seeds, it is necessary to adopt a more rapid method than that of tripping each individual flower singly. This is accomplished by taking a head, or *raceme*, of flowers between the thumb and forefinger, and gently twisting the thumb and finger about the flowers, pinching them, and thus springing the mature flowers in rapid succession.\* If extensive field work is being done, the more rapid method, suggested by Westgate,† of grasping the entire plant at the base with the hands, working the hands up the plant and squeezing the plant at intervals, is to be preferred. These successive compressions result in tripping a majority of the flowers. By repeating the process a day or two later most of the remaining flowers will also be tripped. By this means a considerable quantity of self-fertilized seeds can be obtained, and a desirable type of plant can be extensively increased. By first increasing a single plant by means of cuttings, several hundred individuals identical with the original may easily be obtained, and by the rapid method of self-pollination the progeny may then be vastly increased in a very short time.

\* "Alfalfa Breeding, Materials and Methods," by Roberts and Freeman, Bull. 151, Kansas Exp. Sta.

† "Methods of Breeding Alfalfa by Selection," by V. M. Westgate, Am. Breeders Ass'n Rept., vol. 5, p. 144 (1909).

Having selected a considerable number of mother plants of desirable types to begin with, and having increased them by the methods described, it now remains to sow the seed of the close-fertilized offspring of these mother plants side by side in nursery rows, to be tested for yield. The field should be level, of uniform texture, and should have been previously subjected to uniform cropping treatment. A field previously divided into small strips sown to different kinds of plants should be avoided, on account of the consequent differences resulting in soil fertility and soil moisture content, which will materially affect the yield. It is well to have the series of rows in duplicate, with a check row of a single variety (which should be as pure a strain as can be gotten) placed at the beginning and at the end of each series. The rows should be three feet apart, and the plants should be thinned until they stand two feet apart in the rows. The rows should all contain the same number of plants—say one hundred. Each row should be cut separately, and the forage yield determined.

It is advisable to continue these comparisons of forage yield for three years in succession, if possible, since a single year's test is not conclusive. A further test is necessary which should be carried on at the same time as the general yield tests, viz., a determination of the relative proportion, by weight, of leaves to stems. The most valuable part of the alfalfa plant is in the leaves, and in breeding a high-yielding plant the object should be to secure the greatest possible weight of leaves as compared with the weight of the stems.

Having thus determined which rows are the highest yielders of gross forage, and which give the highest percentage weight of leaves, the time has come to eliminate the inferior rows, and these should be plowed up. Every effort should now be devoted to increasing the superior strains. Cuttings should be made in quantities, and, if possible, rooted in a greenhouse in the fall. They can be grown indoors over winter and transplanted into the field in the spring. The second year a considerable quantity of close-pollinated seed may be obtained from these plants.

A field plot should now be sown for increase. The danger of contamination from foreign pollen brought by insects now begins, but this can not well be avoided. The best that

can be done is to have the breeding plot in a locality as remote from other alfalfa as possible. Yield tests on the fractional-acre plan should follow, and finally the seed should be distributed among reliable, progressive farmers for coöperative seed-growing purposes.

#### *Breeding for Yield of Seed.*

The method outlined above will hold in this case, except that the yield of seed by weight takes the place of the yield of forage. It may be said, in general, that the yield of seed is in an inverse ratio to the yield of



FIG. 171. Alfalfa flower magnified, showing calyx, *c*; keel petal, *k*; two wing petals, *w, w*; and standard, *s*.

forage. In other words, plants that produce much forage seldom produce much seed. Most of our alfalfa seed is produced under semiarid conditions, where the plants are dwarfed and stunted in their growth from lack of water. Under these conditions, plants that would not ordinarily set seed in a region of abundant rainfall produce an abundance of seed. We can not, therefore, expect to create a double-purpose alfalfa plant, and we must content ourselves with moderate demands in the way of seed production, if we expect to have at the same time a heavy yield of forage.

*Breeding for Disease-resistance.*

Nothing has thus far been done in this direction in the case of alfalfa. The method to be pursued consists simply in the selection, first, of regional varieties, and finally of individual plants, that seem the least affected by the disease in question. Close-pollinated seed should be secured from such selected plants, and the immune or partially immune race should now be grown between rows of the varieties or strains that seem most badly infested, in order to determine effectively the degree of immunity which it actually has. Once certain that the new strain of alfalfa is wholly or partially immune it should be increased as before indicated.

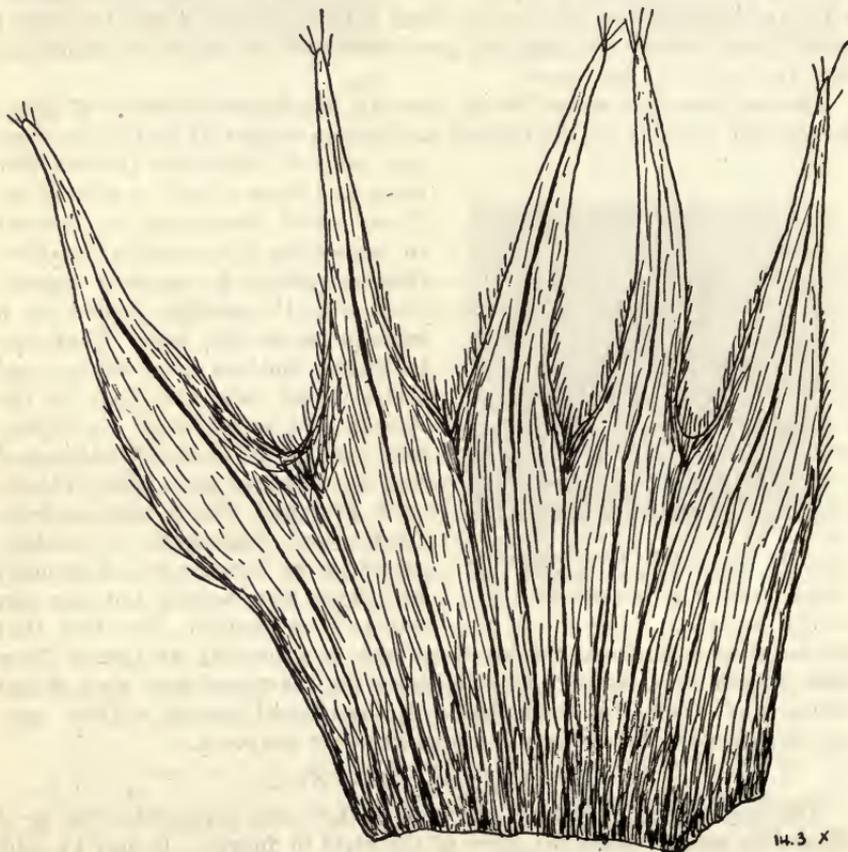
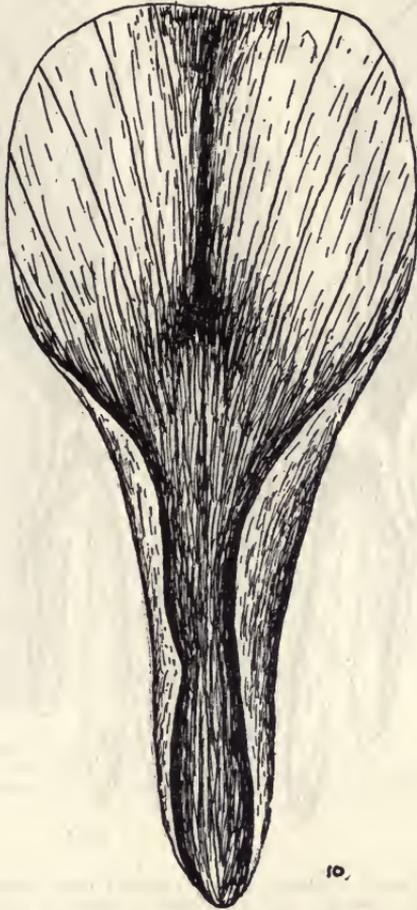

FIG. 172. Calyx of alfalfa flower, spread out. This forms a ring around the base of the flower. The individual posts or teeth are called the sepals.

*Crossing Alfalfa.*

The method thus far described is the method of selection. By this means nothing new is originated. We have simply found out, and sorted out superior alfalfa plants from the general lot.

Suppose we now wish to put together, into a new plant, characters existing only in different plants. To do this we must resort to crossing.



alfalfa flower.

FIG. 173. Standard or upper petal of

Let us now study the structure of an alfalfa flower. If we examine the flower we notice that at the base there is an outside green hull with pointed segments. This hull is called the *calyx*, and its five segments are called the *sepals*. The purple flower portion protruding from the *calyx* is the *corolla*, consisting of five petals, viz., the standard, the two wings, and the two petals joined together, which form the keel. Removing the petals, we find within a column-like structure of a whitish color. This

is the *pistil*, surrounded by a ring of ten stamens, which are joined together in a kind of whitish sheath or envelope, surrounding the green pistil within. At the top of the stamens are the anthers, or pollen sacs, which contain the fertilizing pollen. Roughly speaking, we may dis-

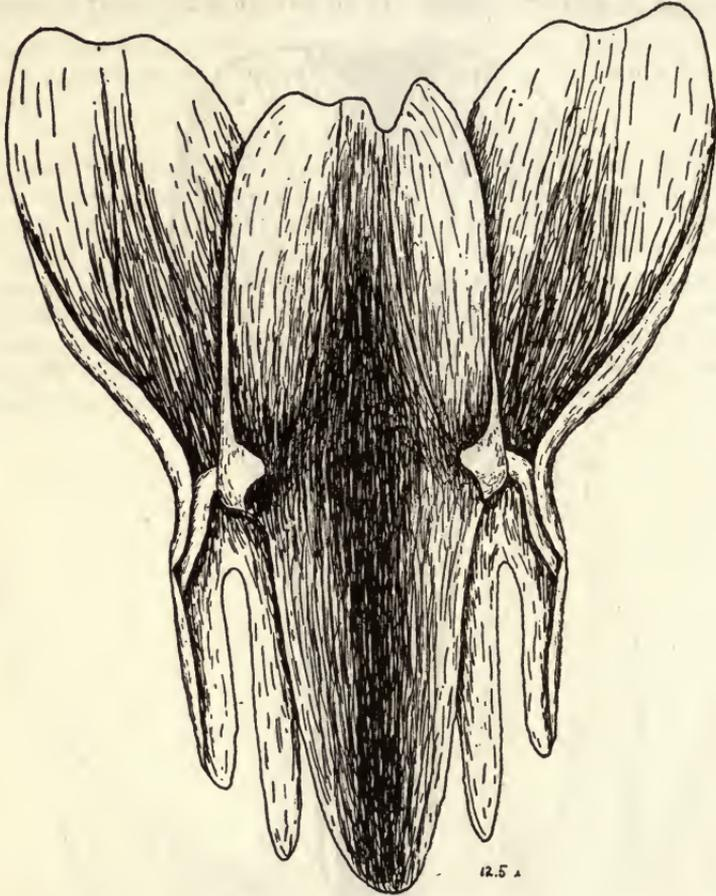

FIG. 174. Keel petal of alfalfa (center) spread open, with pockets, into which fit projections from the two wing petals, shown at either side. The keel petal is closed over the column of the stamen and pistil, holding it down through the locking device made by the projections from the wings fitting into the pockets in the keel. When the keel is depressed these projections are released and no longer pin the keel and its contents down. The pistil accordingly springs up.

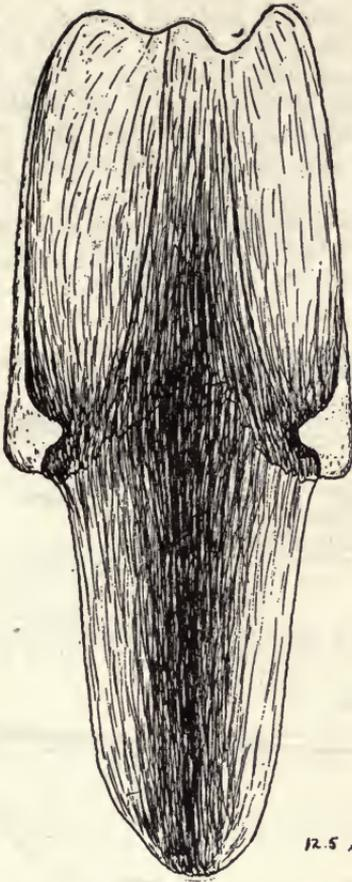

FIG. 175. Keel petal of alfalfa flower, spread open, showing the pockets for the wing petal projections.



FIG. 176. Wing petal of alfalfa, showing projection which fits into pocket in keel petal, locking it shut.

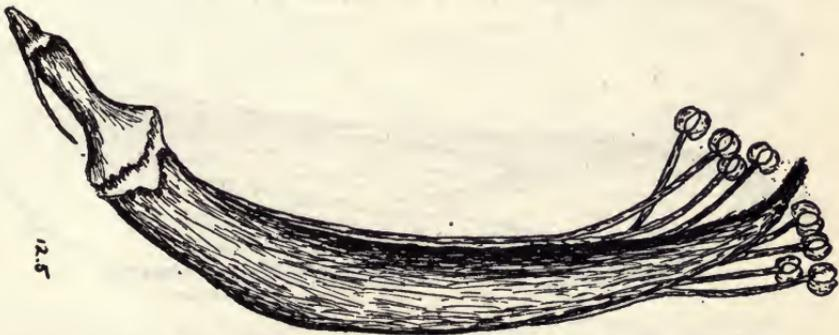

FIG. 177. Pistil of alfalfa flower, surrounded by the ring of ten stamens. Nine of these are joined together; one is free. At the top of each stamen is an anther, which contains the pollen.

tinguish three stages in the development of the alfalfa flower, and which we may speak of, respectively, as the *straight bud*, the *curved bud* and the *hooded bud* stages. When the corolla is first seen in the bud all the petals seem to be drawn together into a straight, pointed tip. (Fig. 178.) Soon the standard begins to detach itself from the rest of the petals and its elevation forms a sort of beak or upwardly curved tip. (Fig. 180.) Finally the standard begins to open and we have the hooded stage (Fig. 181.)

Investigation of the condition of the stamens in these various stages, in the plant-breeding laboratory of the College this summer, show that the pollen is shed by the anthers upon the stigma of the pistil very

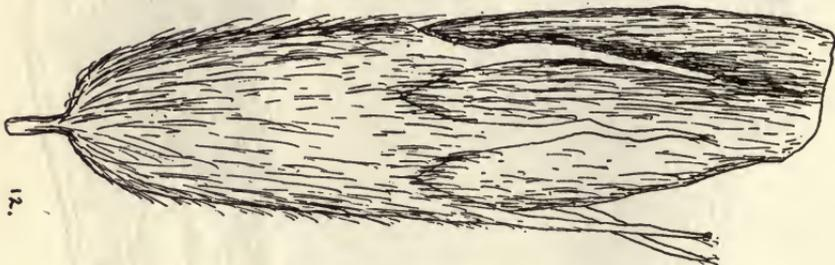

FIG. 178. Young alfalfa bud. The calyx is nearly as long as the corolla within. Of the latter only the standard petal can be seen. It is folded around all the others.

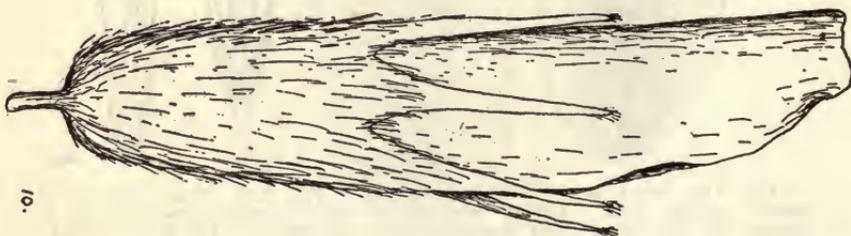

FIG. 179. Alfalfa bud. The corolla has grown out beyond the calyx, and the standard petal is getting ready to rise.



FIG. 180. Alfalfa bud. The standard petal is now seen to be distinctly curving upward in its growth. The lower edges of the wing petals, which together fold down over the keel, now become visible.

early in the development of the flower. A careful examination of a large number of alfalfa flowers shows that the pollen is shed long before the bud is opened, and the chances of the flower pollinating itself, even before the flower opens, are very great.

From these results it appears that alfalfa is easily self-pollinated. In order to cross a plant it is necessary to remove the stamens from the flower before they have had time to shed their pollen and pollinate the stigma of the pistil of the same flower. In the case of the alfalfa flower, its very small size, especially in the straight-bud stage, makes almost an impossibility the removal of the ring of stamens before they have begun to shed their pollen. To get rid of the pollen before the flower is ready to be tripped seems almost impracticable in the case of alfalfa, and yet pollen is already scattered upon the stigma of the flower long

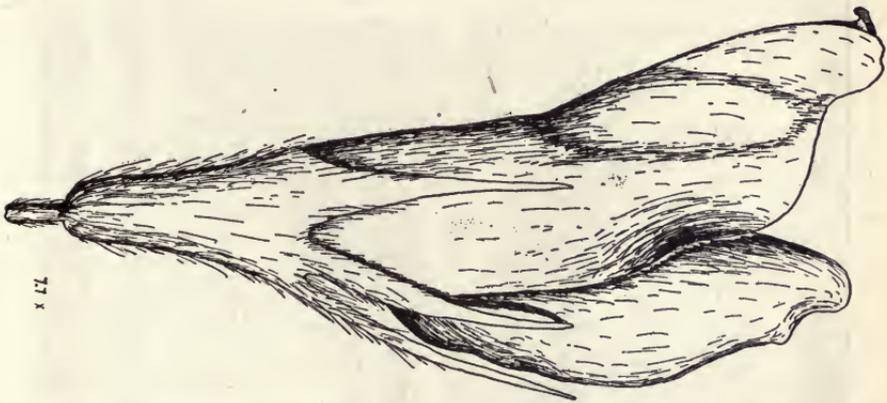

FIG. 181. Young alfalfa flower. The standard petal has risen nearly to its full height and is now beginning to spread. The wing petals are now distinctly seen protruding, folded over the keel, which is not yet visible.

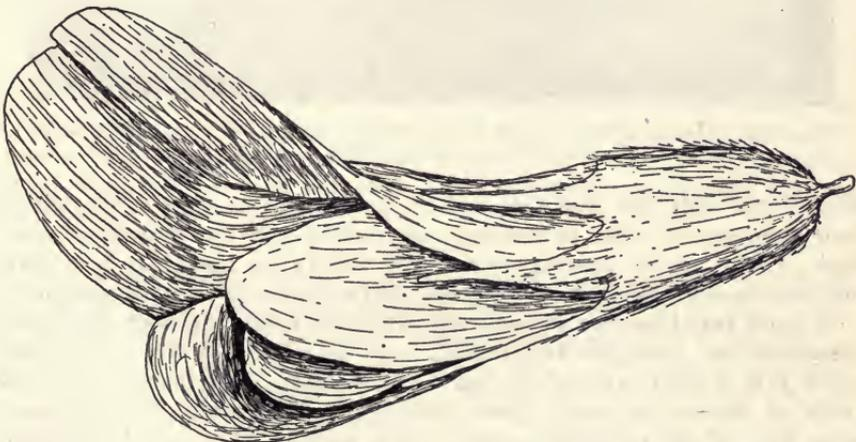

FIG. 182. Alfalfa flower fully open and ready for tripping. Wing petals separating and showing the keel within. Standard fully risen and spread.

before the flower is ready for tripping. The method we have generally followed, however, in crossing alfalfa, is as follows:

When the flowers are ready to be tripped, a pin is inserted between the standard and the keel, and the latter is gently depressed. Instantly it opens, and the column of pistil and stamens flies up. It is not allowed to strike the standard, but is turned to one side past the standard. The pin is then removed, and the pollen is washed out of the anthers and off the surface of the stigma by means of an atomizer spray, a binocular lens being worn to facilitate observation of the work. The stigma is now ready to be pollinated with pollen from another flower, which being done, the flower head is enclosed in a parchment paper bag, and left

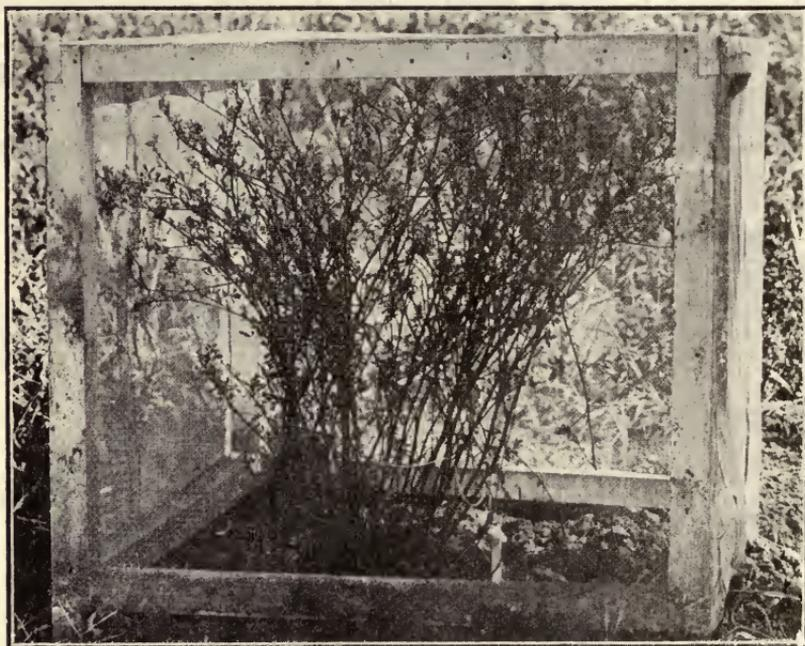

FIG. 183. Plant of alfalfa enclosed in cage to prevent access of insects to flowers. Used in work of crossing alfalfa by hand.

undisturbed until the seed sets and the pod begins to grow. The bag is then removed, in order to prevent overheating and the growth of mold. Such, briefly, is the process of crossing alfalfa by hand. It is a slow and tedious operation, requiring great skill and care in the manipulations.

A more rapid method of securing alfalfa hybrids, although the exact parentage can never be ascertained, is to set plants of the two strains which it is desired to cross alternately in the same row, depending on the visits of insects to secure cross-pollination. Of course a great many seeds will be self-pollinated—many more, usually, than will be crossed. The problem will be to distinguish the hybrid plants from the others. No distinctions, of course, can be detected in the seeds. However, all the seed ripening on the plants of such a mixed row should be harvested and

planted. If the two strains which it is desired to cross are of markedly different types, as is the case with common and Sickle alfalfas, which, among other differences, have purple and yellow flowers, respectively, then it will be comparatively easy, when they come into flower, to distinguish the hybrids from the ordinary self-pollinated plants. In the case just mentioned, of crossing common and Sickle alfalfas, the hybrids will all have variegated flowers, varying from light yellow, through yellowish green and bluish green, to blue and purple, on the same plant. These plants can then be close-pollinated by the rapid method before mentioned and rapidly increased. For scientific purposes, where it is desired to study the inheritance of characters in the plants, this method is not used, since the male parentage is always uncertain wherever insects are used as the means of transporting the pollen. For careful scientific work the hand method of pollination is followed. The other method, however, is useful in a practical way where it is desirable to produce in a short time a large number of hybrids which are to be grown on a considerable scale. For instance, in producing a hardy alfalfa by crossing common with Sickle alfalfa, if a large number of hybrids can be produced at once between two strains of these species, the plants can be rapidly increased at the breeding station and afterwards sent as a whole to the place where they are to be tested. Nature can then be left to do the selecting, winter by winter, as has occurred in the case of the Grimm alfalfa, and finally the most hardy survivors will propagate the new race. It will be seen that this is a practical way of getting new types of alfalfa rapidly into the field.

Alfalfa offers unrivaled opportunities for the breeder. There are so many types, having so many different characteristics, that a very wide range of conditions can be supplied. The abundant intercrossing that has always gone on in the case of the alfalfas has given rise to such a vast number of different types that the most that is usually necessary is to select the desired type and grow a pure stand of it. However, as we have seen, all of the desirable features of cold-resistance, drouth-endurance, forage yield, seeding capacity, and resistance to the various diseases to which alfalfa is subject, are never combined in any single alfalfa plant. To combine these, or as many of them as possible, in the same strain of alfalfa, calls for the constructive work of a skilled and experienced breeder, who should possess, or should know how to utilize, the combined knowledge of the trained scientist, the experienced agronomist and the practical farmer.

#### THE SEED.

The spirally coiled pod of alfalfa contains from three to five seeds. The shape of the seeds is generally curved, sloping to an angular point at one end. Many seeds are kidney shaped, and some few are rounded, or rather oblong. The seed when dead ripe is of a deep golden yellow color. Seed with a greenish tinge is slightly immature, but will grow. Brown or blackened alfalfa seed is generally poor. Frequently it is seed that has sweated and in which the embryo has died. It is always wise to reject any sample of alfalfa seed containing many brown, black or shriveled seeds. Good alfalfa seed should be plump, yellow, and free from weed seeds,



FIG. 184. Seed pods of alfalfa, magnified.

dirt or debris. The standard weight for alfalfa seed is 60 pounds to the bushel. As a matter of curiosity it may be interesting to know that there are about 220,000 alfalfa seeds to the pound, which would mean, if sown at the rate of fifteen pounds to the acre, if 90 per cent of the seed germinated, 3,300,000 plants per acre, or 75 to each square foot of ground. A pound to the acre would give five plants per square foot, which would be ample for a good stand, except for failure of some seeds to grow, the death of seedlings, and the competition of weeds. As a matter of fact, in a few years most of the alfalfa plants with which a field begins are crowded out by competition, or die from other causes. The number of plants to the acre in an alfalfa field has been found to range from as low as 70,000 to as high as 653,000.\*

The inside of an alfalfa seed is much the same as the inside of a bean, which belongs to the same family. The entire interior of the alfalfa seed coat is filled with the embryo or young plant, of which the larger part consists of the two *cotyledons*, or seed leaves. Just above the scar, or *hilum* of the seed, where it was attached to the pod, is a small opening called the *micropyle*, which can be seen with a lens, but which is scarcely visible to the naked eye, through which the moisture first enters the seed when it is planted, thus stimulating the growth of the root, a minute structure lying between the seed leaves. The root then grows out through the micropyle.

---

\* Bull. 110, Colo. Experiment Station.

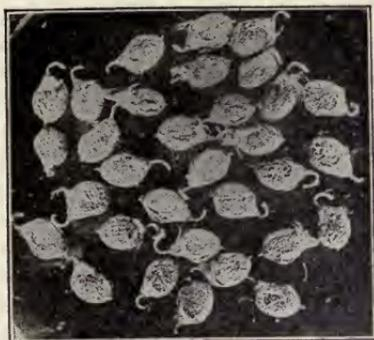

FIG. 185. Seed pods of Sweet clover, magnified.

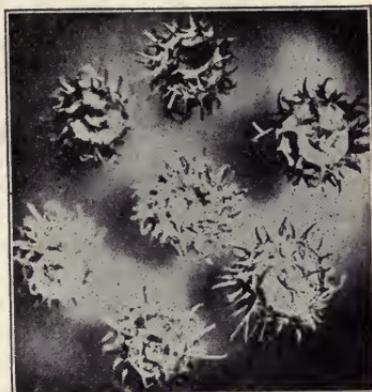

FIG. 186. Seed pods of Bur clover, magnified.



FIG. 187. Seed pods of Yellow Trefoil, magnified.

The tiny embryo stem, which lies partly below and partly above the junction of the two cotyledons, or seed leaves, now begins to grow. The part below the seed leaves (called the *hypocotyl*) grows very fast—so fast that it curves up in a loop, while the two seed leaves are still held fast to the buried seed. By its growth it pulls the seed leaves out and pushes its bent neck up through the soil, just like a bean, dragging the seed leaves after it, and germination is then completed.

The vitality or germinating power of alfalfa seed is easily tested. Take two lots of one hundred seeds each at random from a sample, exercising care not to choose or select the best-looking seeds, but simply taking them as they come, rejecting all trash and broken seeds. Take a piece of clean white blotting paper, 5 by 8 inches in size, folded across the middle, and well moistened in clean, warm water. Lay a lot consisting of one hundred seeds upon one of the halves of the blotter, scattering them out over the surface so that they will not touch one another; fold the other half of the blotter down, and place the folded blotter between two ordinary dinner plates, the upper one inverted over the lower to

serve as a cover. The pair of plates is then set in a warm place where the temperature can be kept at from 70° to 75° F. Every twenty-four hours the plates and blotters are opened, and the seeds which have sprouted in the meantime are counted and the count recorded. In the case of the best alfalfa seed, fully half the seeds that will germinate are found to have sprouted within the first forty-eight hours. The test is always continued, however, for five days. As stated, this germination test should be carried out in duplicate, and, if possible, three or four lots of one hundred seeds each should be tested.

After the five days' germination test it frequently happens that a larger or smaller number of seeds are left which refuse to germinate, despite the fact that they appear perfectly sound. These so-called hard seeds will germinate in time in the soil. It is the custom in seed laboratories to add one-third of the hard seeds remaining at the end of the germination test to the total number that have actually sprouted, to make the final germination percentage, assuming that approximately this number of the hard seeds will germinate in the soil. If properly cared for alfalfa seed will live for a long time. The data at hand indicate that absolutely first-class seed kept under the best conditions should not fall below a germination percentage of 90 in six years, while seed that

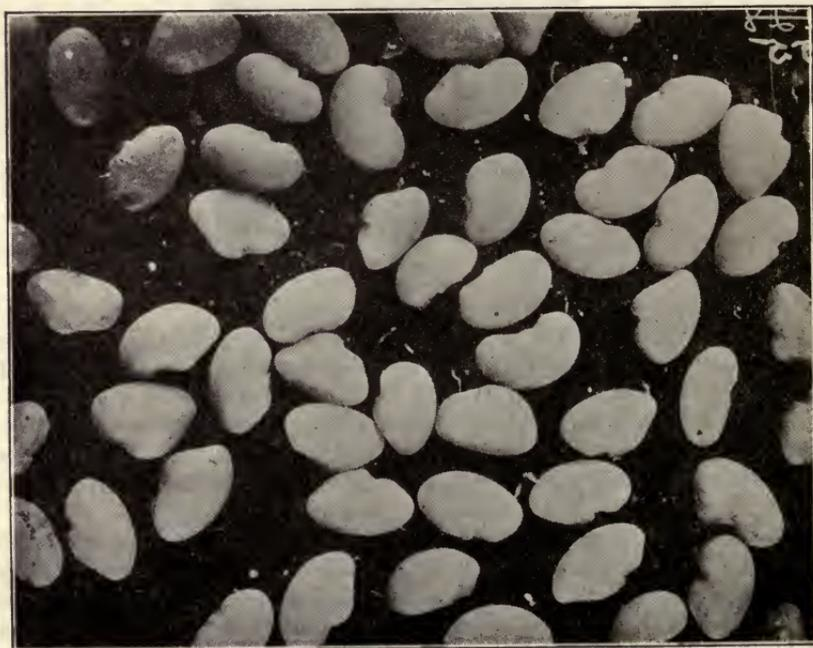

FIG. 188. Alfalfa seeds, highly magnified.

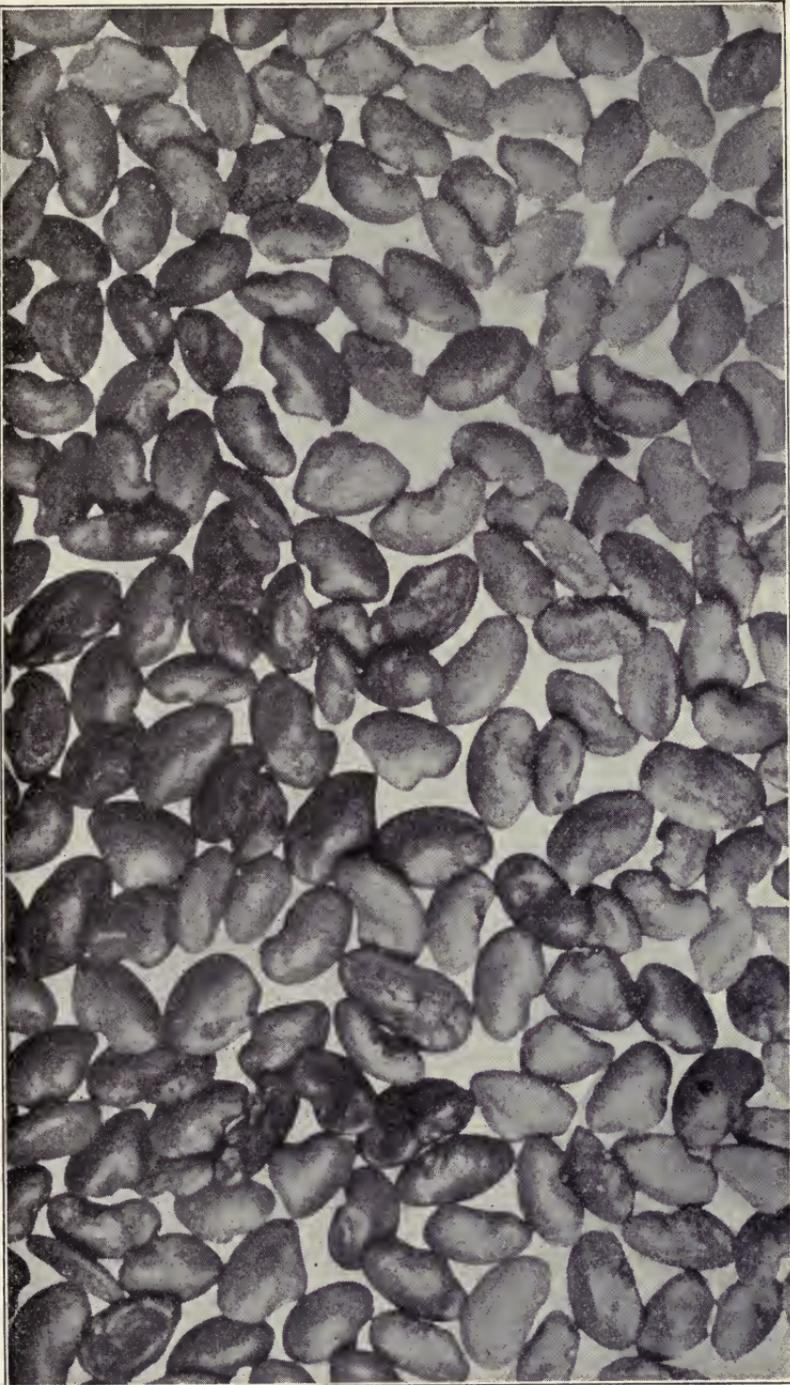

FIG. 189. Sample of commercial alfalfa seed (magnified), showing general appearance of average seed on the market.

has been kept even twelve years should germinate anywhere between 50 and 90 per cent. In the seed laboratory of the department of botany at the Agricultural College, in the case of one sample of alfalfa seed thirty years old, over 80 per cent of the seed germinated.

#### BAD SEED.

As stated, alfalfa seed that is shriveled and dark brown in color will not grow. Seed of this character, according to the United States Department of Agriculture, is actually imported, at a cost of about two cents a pound, for mixing with good alfalfa seed. This is done at the farmer's expense, and to his loss. In six months of one year nearly 67,000 pounds of alfalfa seed were imported that contained from 12 to 70 per cent of broken seed and trash, and in which but 5 to 7 per cent of the seed would grow, as determined by actual germination tests. One of these imported lots of alfalfa seed contained nearly 7 per cent of weed seeds, or 32,500 per pound, of which 5495 were dodder. It is plain that seed of the above description consists simply of screenings, and no other object for its importation exists than to use it for "grading down" good native seed. Farmers should beware of any alfalfa seed in the market that looks brown or shriveled. In the Kansas market there is always a certain amount of bad seed similar to the above.

#### *Weed Seeds in Alfalfa.*

In the eighteen months preceding November 1, 1914, the seed laboratory at Manhattan analyzed 487 samples of alfalfa seed sent in from all parts of the state.

TABLE NO. 24. Kinds of weed seed found in alfalfa seed.

74	of the samples	contained	dodder.
91	of the samples	contained	Russian thistle.
34	of the samples	contained	star thistle.
18	of the samples	contained	bindweed.
16	of the samples	contained	chicory.
5	of the samples	contained	Canada thistle.

All of these, without exception, are *bad weeds*, and most of them are *noxious weeds*. One sample of alfalfa seed contained 57 dodder seeds per five grams (a rounded teaspoonful). This would mean over 5500 dodder seeds to the pound of alfalfa seed. If sown on the land at the rate of 15 pounds to the acre, it would mean 82,500 dodder seeds sown on an acre, or nearly two seeds to every square foot—enough dodder, if only half the seeds grew, to blot out a field of alfalfa completely.

Another alfalfa sample contained enough seeds of bindweed to make over 1700 to the pound—enough to sow 25,500 per acre, which means that a little less than every two square feet of ground in an acre would be planted with a seed of the worst weed scourge known to Kansas.

Another alfalfa sample contained chicory seed in about the same amount, and still another contained about the same amount of wild mustard.

One sample of alfalfa seed analyzed contained 470 Russian thistle seeds in five grams. This was enough Russian thistle seed to run

690,900 seeds to the acre—enough to make 16 seeds of *Russian thistle* for every square foot in an acre of ground, if this brand of so-called alfalfa seed were sown at the rate of 15 pounds to the acre.

One sample contained 1147 seeds of foxtail in a teaspoonful, besides 175 seeds of crab grass, and considerable numbers of other seeds. Of this sample, 22.6 per cent consisted of weed seeds, and 4.2 per cent trash.

One lot of alfalfa, which the sender alleged to have bought as "pure seed," contained eighteen kinds of weeds, including black bindweed and 1000 seeds of foxtail and other weed seeds per five-gram sample analyzed. In addition, there was 6 per cent of trash, making 36.5 per cent foreign matter of all kinds in this "pure seed."

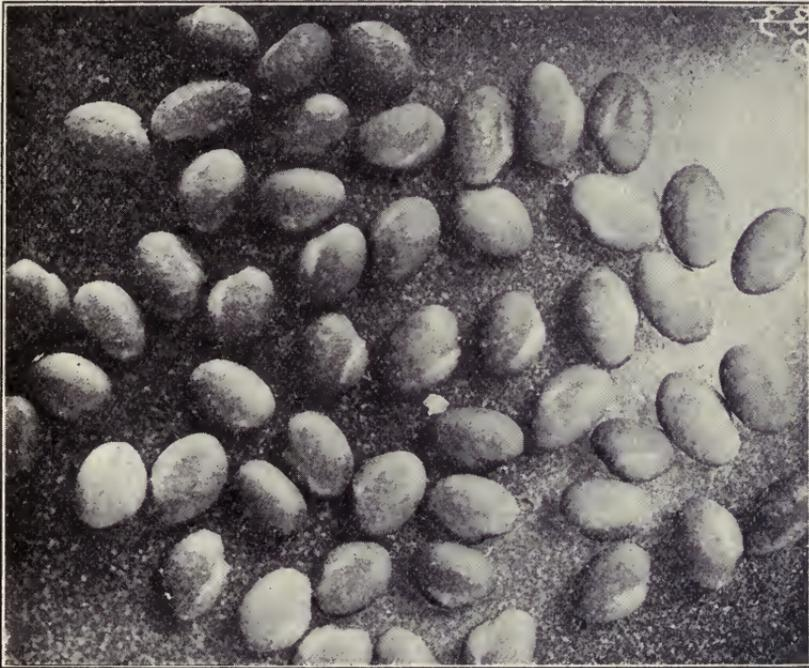

FIG. 190. Sweet clover seeds, highly magnified.

It is bad enough when a man is deceived, and plants poor and bad seed unwittingly. How much worse is it where a man wilfully plants or compels another to sow the land down with bad seed? Here is the case of a man whose "alfalfa" seed, so-called, contained 10.2 per cent trash and 5.5 per cent weed seed—about *three times* the amount of weed seed that should ever be allowed to pass. Among these weeds were dodder and large quantities of foxtail and crab grass—fourteen kinds altogether. *The sample germinated only 15 per cent. And yet a landowner insisted on his tenant planting this seed.* With a proper seed law such seed could not get on the market at all.

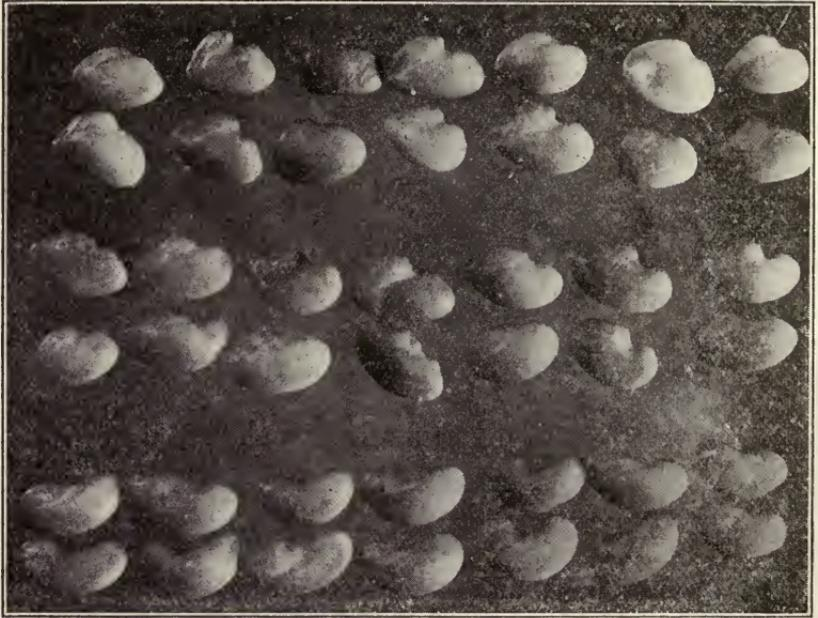

FIG. 191. Three types of alfalfa seeds. Kidney bean type (lower rows); pointed type (middle rows); and oblong type (upper rows). Some of the latter can scarcely be distinguished from Sweet clover seeds.

Here are three alfalfa cases that came to our attention.

One was alfalfa seed, containing 22.5 per cent of weed seeds, one-fifth of which was foxtail. In addition there was 5.9 per cent trash.

In another sample was 28.48 per cent of foreign seed, of which 22 per cent was foxtail. In this sample there was also 31.6 per cent trash.

A third sample contained 43.3 per cent foxtail.

If Kansas had an efficient seed law seed like this could not get on the market.

#### *Adulterated Seed.*

Adulterated alfalfa seed is not so common on the Kansas market now as formerly. The chief adulterants, when they occur, are yellow trefoil and bur clover. Yellow trefoil (*Medicago lupulina*) is a biennial plant with yellow flowers, closely related to alfalfa, but vastly inferior. It is grown to some extent on poor soils in Europe for sheep pasture. Yellow trefoil is practically never grown in this country, but considerable quantities of the seed are imported, apparently to use in adulterating alfalfa seed. Yellow trefoil seed is difficult for an ordinary person to distinguish when mixed with alfalfa seed. The yellow trefoil seed, however, has a small beak or projection just back of the scar, which is lacking in alfalfa seed, by means of which it can be most easily identified. The identification of yellow trefoil in alfalfa seed, however, requires the services of an

expert using a good hand lens. Occasionally seed of two of the bur clovers (*Medicago arabica* and *Medicago denticulata*) are used in the adulteration of alfalfa seed. Fortunately, however, the number of cases of actual adulteration of alfalfa seed in this country is comparatively small. The situation that the farmer ordinarily has to contend with is seed of low vitality and seed containing a considerable percentage of weed seeds.

#### KEEPING THE WEEDS OUT.

In order to get a stand of alfalfa free from weeds two things are plainly necessary. First, land free from weed seeds, and second, alfalfa seed free from weed seeds. No matter how clean the alfalfa seed, if the land is foul with crab grass, foxtail and other weeds the alfalfa crop will suffer, and the seedsman will often get the blame that properly belongs to the grower himself. To get alfalfa land free from weeds it is often the best plan to run it in a succession of cultivated crops for several years until most of the weed seeds in the soil have sprouted and died.



FIG. 192. Dodder seeds, highly magnified.

Where alfalfa is to be sown in the spring, the land should be plowed as early as possible and then disked or cultivated with either the common or the Acme harrow every week or ten days until planting time, which is usually well into May. This will re-

sult in killing a vast number of weeds. The alfalfa seed should then be planted as soon as possible after a rain, in order that it may germinate and the seedlings may grow as rapidly as possible and thus crowd out the remaining weeds.

In case of fall seeding after wheat or other spring grain, the stubble should be plowed or disked immediately after harvest and kept disked and harrowed until seeding time. Millet, or cowpeas to be cut for hay make good catch crops to hold the land from the time the spring grains come off until seeding time. In the case of land that is very foul with weed seeds, however, summer fallowing, with frequent harrowings previous to fall seeding, is the best practice. (See "Weeds" in index.)

#### HAVE THE ALFALFA SEED TESTED.

Having cleaned up the ground, the next thing necessary is to be certain of planting clean seed. Almost any person can tell when a considerable quantity of weed seeds are present in a sample of alfalfa seed, but the grower will often overlook smaller amounts of weed seeds that are still present in sufficient quantity to be harmful. This is especially true of dodder, the seeds of which so closely resemble alfalfa in color.



FIG. 193. Buckhorn seeds, highly magnified.

The only safe plan for the farmer, where alfalfa seed is bought away from the neighborhood, is to order by sample and *have the samples analyzed at the seed laboratory of the Agricultural College at Manhattan* before buying a bulk lot. Much trouble, annoyance and loss are frequently saved by taking these precautions. The best way of proceeding is to obtain from local dealers and from several seed houses samples of their better grades of seed offered, and mail these samples to the laboratory for purity and germination tests. On receipt of the reports, buy from the best sample. A common way, and the worst possible way, is to wait until a few days before planting time and then go to town and buy from the local dealer the best-looking seed he has left. (See "Seed," in index.)

Alfalfa is the most expensive crop to prepare for well, and to plant, that we have in Kansas, and it is at the same time our most profitable and certain crop when properly prepared for and when a good stand, free from weeds, is obtained on rich, fertile land. Under these conditions there is no crop in Kansas that year in and year out will compare with alfalfa as a producer of income. This being the case, slovenly preparation of the soil and poor, cheap seed are inexcusable. In buying alfalfa seed but one rule will apply—the rule of the man who said, "The best is none too good for me."

## INOCULATION.

It seems like a contradiction in terms to say that alfalfa both makes a soil rich and needs a rich soil in which to grow, but it is a literal fact.

Alfalfa makes heavy drafts on the soil for mineral food. It is estimated that a ton of alfalfa hay, producing a four-ton crop for five years, requires 90 pounds of phosphates, 480 pounds of potash and 1000 pounds of nitrates, worth altogether about \$180.\* The potash and phosphates can be obtained from the soil alone, but the nitrates, *after the plants have gotten well started*, can be obtained from the nitrogen gas of the air which permeates the soil. Certain bacteria, or germs in the soil, attack the roots of all legumes, enter them, and cause the development of root tubercles on the roots, in the cells of which they live and multiply. These bacteria are able to use the free nitrogen gas, which constitutes 80 per cent of the air, and which no green plant can use in its raw state. This gas they build up into nitrates, which then become available as plant food. By means of these powerful aids to growth the alfalfa plants are finally rendered independent of the supply of nitrates in the soil, and, by the decaying of their roots, considerable quantities of nitrates from the plant bodies are released into the soil, enriching it for succeeding crops.

It must be remembered, however, that *nitrates must be present in the soil at the outset*, in order to supply the demands of the alfalfa plants until their roots become equipped with the necessary nodules. This occurs ordinarily by the end of the first season. It is a prime essential to ascertain whether the nodule-forming bacteria are in the soil or not. If not, inoculation is necessary.

There are many physiological varieties of the root-tubercle organisms. Those which live on red clover or peas, for example, will not grow on the roots of alfalfa. However, the common sweet clover, now coming into such popularity, harbors on its roots the same kind of germs that infect alfalfa. Any kind of land that will grow a luxuriant crop of sweet clover, showing tubercles on its roots, is then already properly inoculated for alfalfa. In the case of soil that needs inoculation, two methods are possible—the soil method and the pure-culture method.

The soil method has been found by most of the experiment stations to be the more certain and satisfactory. By this method not less than 400 to 500 pounds of soil per acre are recommended. This may be broadcasted, or sifted, and applied with a fertilizer drill. If the inoculated soil has to be brought from a long distance, then 200 to 300 pounds may be used, mixed with a large quantity of the soil from the field to be inoculated, and applied as before stated. The inoculated soil *should be kept in a cool, shady place* until ready for use. If the inoculated soil is broadcasted, it is best to put it on in the late afternoon of a cloudy day, since the sun's rays soon kill the bacteria. Immediately after broadcasted the soil should be well harrowed.

Another method, recommended by the California Experiment Station, is to take soil from an alfalfa or sweet-clover field in which the roots

\* Mo. Exp. Sta. Circular No. 6, August, 1915.

show an abundance of nodules. To this volume of soil two or three times its volume of water is added. The mixture is then stirred vigorously several times a day for two days and the soil is then allowed to settle. The alfalfa seed to be inoculated is then dipped into the water, which is now more or less filled with the nodule-forming bacteria. The seed is then dried in the shade, sufficiently to enable it to run through the drill easily, and it is then planted. If preferred, the inoculated soil may be puddled, the seed mixed with it, and the whole mixed with dry soil and planted.

The only objection to the use of the soil method of inoculation is the risk of bringing in weed seeds.

The pure-culture method of inoculation consists in the use of a liquid culture of the root-tubercle germs. This may be obtained free, in small quantities for experiment, from the United States Department of Agriculture. Several commercial concerns are now also putting these cultures on the market. "Farmogerm," sold by the Earp-Thomas Farmogerm Co., of Bloomfield, N. J., and "Nitrogin," sold by the German-American Nitrogin Co., of Milwaukee, Wis., are commercial cultures that have proved successful under experiment. Full directions for the use of these nitro-cultures are sent out by the United States Department of Agriculture and by the commercial concerns referred to.

In conclusion it may be said that every alfalfa field, in order to be profitable and successful, must have the root-tubercle organisms in the roots of the plants. If there is any reason to doubt their presence in the soil before planting, then the soil should be inoculated. Generally speaking, most of our Kansas bottom lands are already infected with the root-tubercle bacteria. A simple way of finding out is to grow a crop of sweet clover on the land first. If the sweet-clover roots are well infected with the tubercles the land is ready for alfalfa without inoculation. If not, or if only scattered plants are provided with root nodules, or if the nodules are few and scattering on the roots, then additional inoculation is required. (See "Inoculation," in index.)

---

## PRACTICAL DRAINAGE OF WET LANDS.

By H. W. ALBRECHT, Farmer, Monmouth, Crawford county.

In 1910 I bought eighty acres of low, wet land. It never dried out early enough in the spring for any spring crop, and it was too wet for alfalfa. When it was wet it was a bog, and when dry enough to get onto safely with a team it broke up in big chunks. Before I got it thirty acres of the worst of it was absolutely unfarmable and was growing up in ash grubs and red-haw brush; some of it was a sour-grass pasture, and about forty acres of the driest was farmed. Knowing all this, I bought the place, with the idea of draining it, for I recognized in it a valuable piece of land when drained as I now have it drained.

I blew out the grubs and stumps the first season. I used about 800 pounds of 40 per cent antifreezing dynamite, so you see there were some stumps and grubs there. I could not see that this shooting did any good

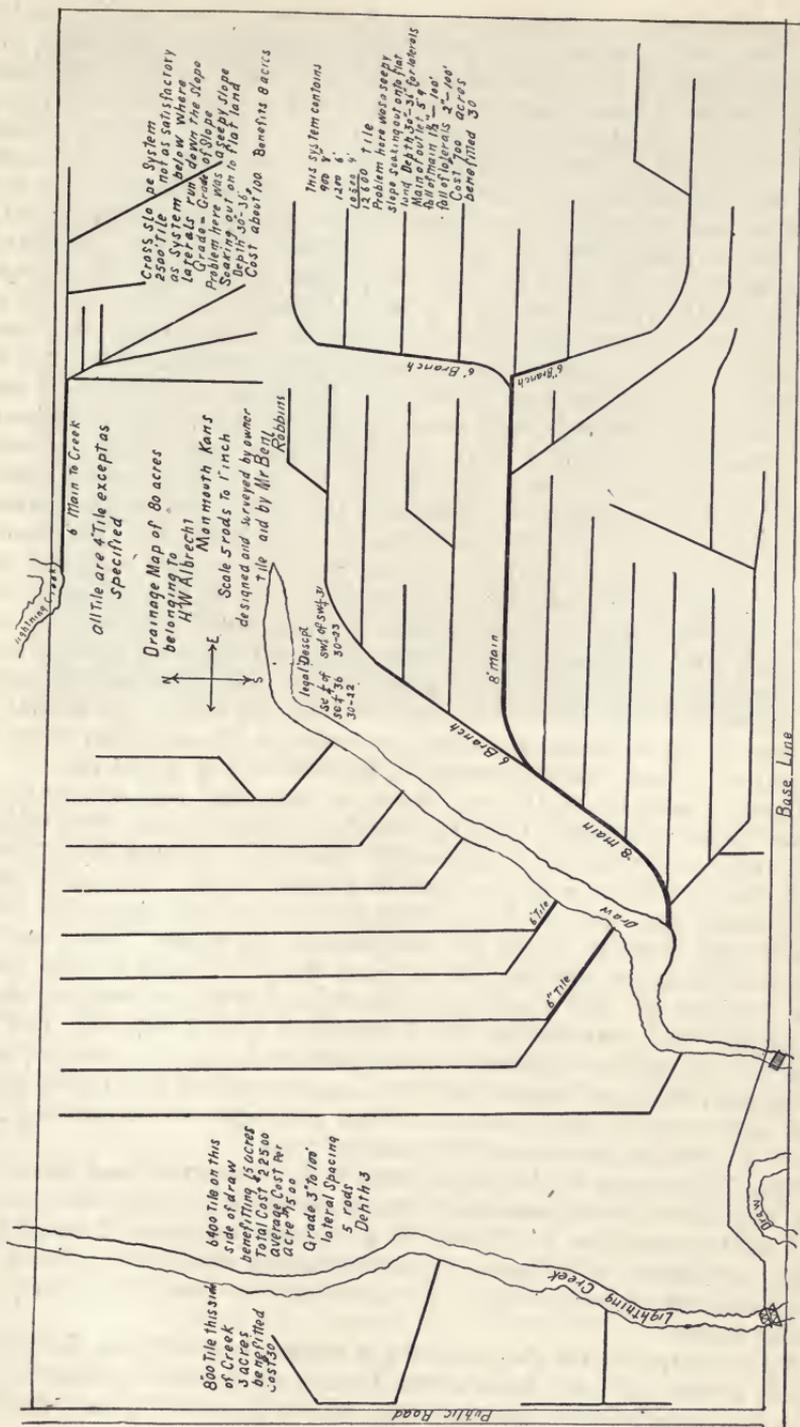

Fig. 194. The plan of Mr. Albrecht's drainage system. A well-made plan is a great aid in getting the desired results.

so far as drainage was concerned, as I had hoped it would. My experience has not given me any confidence in dynamite as an agency for drainage where there is no strata of gravel or sand under the hardpan.

Turning to the accompanying map, you will see that this eighty lies in the Lightning creek bottom, and the land all slopes toward a small draw shown and marked on the map. Most of the tile run to the draw parallel with the natural slope of the land. In the field west of the draw the natural slope of the land is about thirty-two inches in sixty rods, and the fall of the tile as laid is one inch in two rods. The little field west of the creek is practically flat. East of the draw the surface is also practically flat, there being about seven inches surface fall in fifty rods, from where the eight-inch main turns east from the draw, and the fall of the main tile is one-half inch to two rods. The fall of the laterals joining the east branches of the main tile is nowhere less than one inch to two rods, and where possible we gave more, as the east end of the eighty is from five to eight feet higher than where the main tile branches at its eastern or upper end. So much for the topography.

The hardpan or tough clay subsoil of this eighty lies in undulations or ridges of varying width and closeness to the surface. The general course of these ridges lies across the natural slope of the land, and the pockets or valleys between them hold water. Until we tile through these ridges the land between them remains wet and sour. The surface soil varies as does the subsoil—deep subsoil, deep surface soil; shallow subsoil, shallow surface soil. Some places we reached no subsoil at three and one-half to four feet—black muck all the way down. At others, in the same ditch, we found the subsoil at twelve to fifteen inches, where it had raised up just like a horseback of sulphur rock in a coal pit.

The soil particles of the land here are very fine, and one must be careful to lay the joints of the tile closely to prevent them from taking dirt. When tile takes dirt it is usually caused by a crawfish hole. These holes generally are in some low spot, as a dead furrow. The water during a heavy rain gathers in the dead furrow and runs down the hole made by the crawfish, to the tile, and bores it out bigger. Some say to plow the field across the tile. I have tried this, and do not like the plan. I am breaking the field west of the draw now, and aim to leave my dead furrow *not* right over the tile, but, at most, not more than a rod from it. This puts the ridge or backfurrow about midway between the laterals, and should shed the water toward the tile gradually and not all at once, as it does when collected in a dead furrow and allowed to run across the tile drain in a stream, to bore out the crawfish holes.

When I got ready to drain this place I first bought a farm level. It is a very useful little instrument, and, considering its cost—\$15—has a very good telescope on it. Were I to get a new instrument I would get a \$30 instrument, as it has a stronger telescope and enables one to be more accurate at long range. My instrument is good up to sixty or eighty rods.

As to spades, I first got solid-backed spades, but owing to the sticky nature of the soil I got three of the Iowa King or muck spades, or, as some call them, skeleton spades. They can be procured by any retailer



FIG. 195. Some of the tools useful in draining land.  
[Courtesy International Harvester Company.]

through any big wholesale hardware company. They are made in 16- to 22-in. lengths and have 4½- to 6-in. bits. A 20-in. length with a 6-in. bit is the most practical size for any work that I have ever yet met with. They are surely time-savers—no friction and no mud-gathering, as with the solid-backed spades. They should not cost over \$2.50 each for the large size. Don't pry with them, for they are made to dig with.

I got two drain hoes, one 4-in. and one 6-in. They are to remove the crumbs that fall from the spades in digging the bottom or last spade-layer, before you lay the tile, and to surface the bottom of the ditch preparatory to laying the tile. I also got a tile hook. This is a piece of ½-in. round bar iron, bent to a right angle and fitted to a garden rake handle. The part standing at right angles with the handle is about ten inches long. This is to lay the tile with, and is also a time-saver, as you do not have to get down into the trench to lay the tile. Therefore, by using the hook, it is unnecessary to make your trench any wider than for the tile, making quite a saving of time and labor in a big job.

One will need also a guide line for the top-digger; a grade line for the tile layer, and two good, stout stakes to tie it to; and the grade stakes. The grade stakes should be four feet long, and can be used many times if you always remember to cut out the notch of the previous survey. If you don't cut out the notch you are liable to make serious mistakes.

I drained the field west of the draw first. The problem in this field was the removal of the water that came from rains and occasional overflows and gathered in a wide, flat basin in the east fifteen acres of the field. Part of it would soak away. In digging our ditches we found, about a foot below the surface, a narrow ridge of hardpan that extends along the draw, at no place over fifty yards from it. This ridge is what prevented the water from getting away. We used 4-in. tile in this field, except where we joined two laterals, where we used 6-in. tile to the outlet.

We used no intakes or manholes, as they are unnecessary. Where an intake is used it is a nuisance unless properly constructed. A good intake should be of concrete construction and big enough for a man to get down into and clean the settling basin with a shovel. The bottom of the settling basin should be at least two feet below the mouth of any inflowing or outflowing tile.

Between the first and second joints of tile at the outlet we put in  $\frac{1}{2}$ -in. iron rods to keep skunks and rabbits from using the tile as dens in dry weather. We used rock to construct our retaining walls at the outlet. Solid concrete would be better. Also, if the tile were laid in, and slightly covered with a coarse grout for ten or twelve feet from the outlet it would be well, as it would prevent animals from digging back along the tile and dislodging them.

We used the skeleton spades exclusively to dig our trenches, removing no more dirt than was absolutely necessary. I do not like plowing as it makes an awful muck when wet and when dry the clods are always rolling back into the ditch.

The main part of the after-care of a drainage system is the care of the outlets. Keep out the "varmints" and you will have little or no trouble if your tile is laid and graded properly.

On the east side of the draw is the big system. There over 12,600 tile gather the water from about 30 acres and empty it out at one 8-in. outlet. The problem there was the same as in the field west of the draw, and added to it was the problem of caring for the seep water from the slope at the east end of the eighty. The map best describes the placing of the tile. The most difficult element of the problem was that of arranging for enough fall, and we had to lay the main quite deep in order that the branches and laterals might have plenty of fall. It is impossible properly to solve such a problem without a careful survey with a good telescope level. Any person of reasonable intelligence and education can use the levels if they first read the directions and *follow* them *exactly*. So if you are thinking of tackling any such problem a good level may save you a lot of grief and expense.

The first effect of drainage on this land was the making of thirty acres of the place capable of the production of crops instead of ash grubs, malaria and crawfish. It loosened the soil by taking out the surplus moisture, leaving just the right amount for the proper condition of the soil. It deepened the soil, as the stationary water level in the ground was lowered, and the plant roots can go down instead of rotting off in the stale, poisonous water that formerly was just below the surface. One can get into the field sooner after a rain or overflow. I have cul-

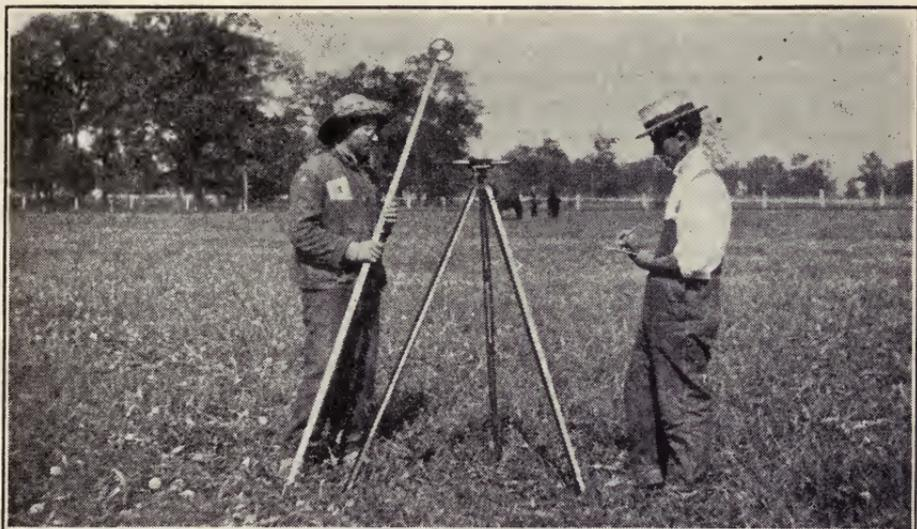

FIG. 196. A good level will save a lot of grief and expense.—[Courtesy *Ohio Farmer*.]

tivated corn after two days of good drying weather following a two-inch rain. I have broken ground after five days of good drying weather following an overflow. In five days after an overflow the water had lowered to sixteen inches below the surface, as seen in the crawfish holes midway between the laterals. This was where there is no hardpan and the surface soil is from two and one-half to four feet deep. The tiled lands stand the drouth better than the untilled, as plants can root deeper and have thereby a larger root system to draw moisture and plant food. I have found this particularly true with alfalfa here in our bottom land. Alfalfa does well when corn does well, and they both grow rankest right over the tile. Where they fail in tiled land you will find a hardpan spot if you dig for it. You will not have to dig deep. Use plenty of manure on this spot so that the roots will not need to go so deep for plant food.

The drainage system described cost from \$1050 to \$1100 for the whole eighty, including cartage one and one-half miles from the railroad, survey, laying, and covering. It has more than doubled the value of the farm. This season (1915), one of the wettest on record, we had overflows and very heavy, continuous rains. From 21 acres of the wettest ground we got 300 bushels of corn, and from 20 acres more we cut about 40 tons of alfalfa. It would have been impossible to farm any of this land without drainage.

I have never used any lime or fertilizer on such land as yet, for I believe it useless to use lime when the land is so full of water. Drainage sweetens land—this I know—and lime may do some good later, when used with manure, for alfalfa, clover or some other legume.

## THE DETAILS OF TILING.

From now on I will try to handle this subject as though I were on your place trying to help solve a drainage proposition interesting you. We will go out and look the ground over. We will set up our level, and, if you need it, I will instruct you in the use of the rod. We will then take a reading where we want our outlet, and set it down in our notebook. Then you will start to where you want the upper end of your ditch, following the general course that you want the ditch to take. You will take various readings as you go along, and set them down in the notebook, till you get to where you expect to finish your ditch. Now we have an idea of the general fall of the surface where your intended ditch is to be. If that is great enough—say 3 inches to 100 feet—we



FIG. 197. The main tile should be sufficiently large.—[Courtesy *Ohio Farmer*.]

will give the tile the same fall as the surface. If the surface is flat we must put the fall in the bottom of the ditch—that is, dig our outlet deep enough so that the tile at the upper end of the ditch, being at least 30 to 36 inches in the ground, will have fall enough—at least 2 or 3 inches to each 100 feet.

Now we will drive our stakes, placing the first one at the outlet. From it step off 11 steps, or about 2 rods, and drive another stake; 11 steps more and another stake, and so on until you have reached the other end. We will suppose it is 30 rods away, and as we have 2 rods between stakes we will call it 15 "stations." Now suppose we give the ditch 1 inch fall to the "station," which is about 3 inches to 100 feet. Cut a notch on the stake at your outlet, about 12 inches from the ground. Rest the lower end of your rod on your knife blade sticking in the notch, and adjust the target to my level, as I shall instruct you. Get your reading, slide your target down one inch and clamp it. Move to the next stake, place the

cutting edge of your knife to the next stake, somewhere near the place you think it should be, resting the lower end of your rod on it. Adjust to my level, as I shall instruct you, and when correct cut your notch, lower your target one inch, and proceed to the next stake, and so on till the last one. Now we have our grade.

Next we will dig a few rods of the top soil, so stretch out the top-digger's guide line, so that you can dig a straight, smooth-finished ditch. This makes it much easier for the bottom man or tile layer, and the better you can make conditions for him the faster he will get along. He is the man that draws the big pay. The top-digger is supposed to dig the top layer or spade-length of soil and shovel out the crumbs that fall back from his spade. A round-nosed shovel is the best for removing the crumbs.

Now, having thrown off some of the top, let us get ready to throw out the next spade-length and lay some tile. First we will drive two stout stakes right by the first and second grade stakes, and stretch a stout mason's line between them, each end being tied exactly at the same height as the notches on the grade stakes. This line is exactly parallel to the line of notches on the grade stakes, and is therefore parallel to the surface of the bottom of the ditch on which you will lay the tile. As you dig the last spade-length you will need a wooden square to measure the depth of the ditch below the grade line. Make this of light, straight lath, having the long arm of the square equalling the depth of the ditch below the grade line and the short arm from 18 to 24 inches long. Now start digging the last spade-length, leaving about one-half to one inch of solid dirt in the bottom of the ditch to plane out with your drain hoe. With the drain hoe leave a smooth, rounded channel in the bottom of the ditch for the tile. Use your square as you need it, to see if you are keeping the bottom of your ditch parallel with your grade line, thereby insuring an even fall all along your ditch.

Now we will "lay" the first "station." Get your hook, which I have previously described, and lay in your first tile; now another one, making it fit up against the first one as well as you can. If any of your tile are chipped, put the hole on top so you can see it, and before you cave off the side of your ditch to bed your tile cover these holes with pieces of broken tile. If you leave holes in the bottom the crawfish will sometimes throw mounds up through them and stop the tile. The tiler should close the upper end of the ditch with a flat stone over the end of the tile and tramp the dirt solidly behind it.

Always pick out the hardest tile for the outlet of your ditch or system. They are not so apt to crumble from freezing and thawing.

Where you join a lateral onto a main or branch, use "Y's." If you have to break a joint to fit, use a monkey wrench, setting the jaws on the tile and prying *in*, never *out*. David Lessen, a well-known German tiler of Central Illinois, is the originator of this trick; so please give him the credit. It is a time-saver. When you get your joint made lay a piece of heavy building paper over it and throw on a shovelful or two of good-wet grout or concrete. This makes a perfect union.

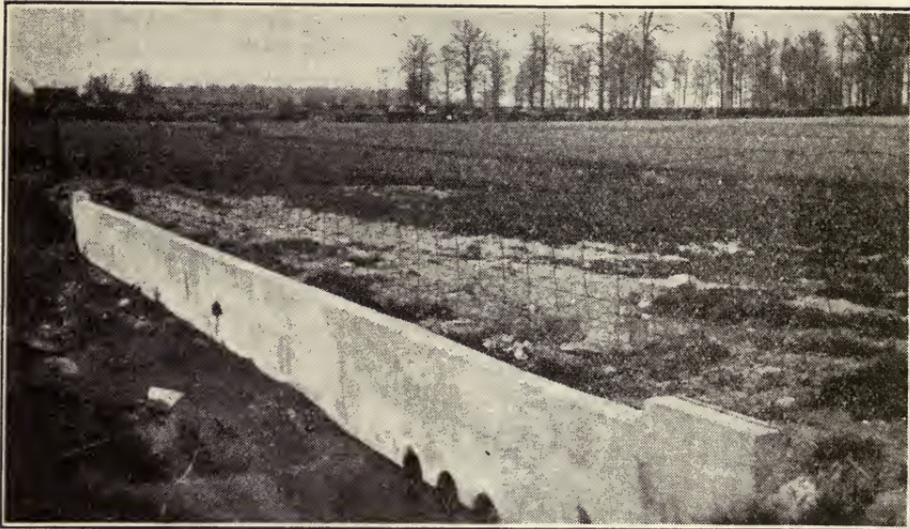

FIG. 198. A well-constructed outlet is one of the keynotes of a successful drainage system. [Courtesy *Ohio Farmer*.]

Now cave off the side of your ditch, leaving the tile bedded. This is the end of the tiler's responsibility, and the employer must take charge after this and fill the ditch. He may fill it with a plow. Use a long evener with a team at each end, a man to hold the plow and one to drive, and you can fill lots of ditch in a short time.

Counting ten hours as a day, and paying two men \$3 a day each for working two wagons, on good roads, 4-in. tile can be moved at a cost of \$1 to \$1.25 per mile per 1000, 6-in. tile at from \$2 to \$2.50 per mile per 1000, and 8-in. tile at from \$4 to \$5 per mile per 1000. Two men working together—top-digger and tiler—in good digging, should lay from 20 to 25 rods of tile, two spades deep, a day, at a cost of \$2.50 a day for the tiler and ten cents per rod for the top-digger, generally with board included. (See "Drainage," in index.)

### LIMING SOILS IN KANSAS.

By ERASMUS HAWORTH, Professor of Geology, University of Kansas.

Should one travel across the eastern half of the state of Kansas from southeast to northwest he would find himself passing continuously across zones or strips of country that show quite a variation in the kind of crops ordinarily grown by the farmers. Perhaps the most noticeable variation would be that of the growth of red clover and alfalfa. Here is a zone throughout which the farmers generally are raising both. Beyond it is a zone with neither. A few miles further one finds that clover and alfalfa are raised abundantly, and beyond this similar alternations.

The traveler who is thus passing across the state, however, rarely travels more than a day with the old-fashioned horse team, or its equiva-

lent in distance, until he passes out of the zone throughout which clover will not grow, and into a zone where clover grows luxuriantly and is a common crop.

No sooner had I begun the study of the geology of Kansas than I observed that the outcropping of our limestone masses formed zones trending north and south, corresponding closely with the zones throughout which red clover would grow luxuriantly, while the zones of no clover lie in between the zones of limestone soils. It is now well understood that the growth of leguminous plants in general, including all the clovers, is helped greatly by the growth in the soil of friendly bacteria which draw nitrogen from the air. Acid soils kill these friendly bacteria, so that clovers grow very poorly in all acid soils.

The limestones of Kansas form great beds outcropping on the east in irregular lines at the surface, and dipping back to the west at a very low angle. In between these limestone shelves are great beds of shales and sandstones. Kansas soils in general are made from local rocks by weathering agents acting upon them in place. Therefore, the soils made from weathering the limestones form narrow zones stretching across the state from north to south, and the soils made from weathering the shales form zones lying in between the limestone soils.

The accompanying block map of Kansas shows the relations of shale and limestones to each other, and how and why we have these zones of limestone soils alternating with shale soils.

Now it happens that the Kansas shale beds have in them large quantities of the well-known mineral, pyrite, a double sulphide of iron, which by oxidation produces large quantities of sulphuric acid as the shales weather into soils, and such soils, being acid in character, will not let the friendly bacteria grow, and so the clovers can not grow.

The presence of lime makes it possible for alfalfa or clover to grow. It is, therefore, desirable for the farmers of the state to have a clear and definite statement put before them of how and where they may obtain lime for liming their acid soils.

For more than twenty years the Geological Survey of Kansas has been studying and mapping in detail the location of the various limestone formations within our state. The accompanying map is an abridgement of other maps already published in the Geological Survey reports. It is intended to show that the limestones of the eastern part of the state particularly, and of the western part to some extent, cover such large areas that a farmer at almost any place will have to haul or transport his lime but a short distance.

#### CHARACTER OF KANSAS LIMESTONES.

The limestones of Kansas have been studied very extensively, not only with reference to where they occur, their thickness, their general position and other geological features, but their chemical composition as well has been studied in sufficient detail so that one may speak with a certainty regarding their chemical composition. It is one of the surprising features or facts of nature that our limestones should be so nearly uniform in composition. The hard limestones in the eastern part of the state, which are so abundant, have not enough difference in composition throughout



FIG. 199. Map of Kansas, showing outcroppings of principal limestone formations. Each one of the heavy, irregular lines trending northeast and southwest represents the outcropping of such a limestone. By a study of this map one can determine the distance limestone must be transported to make it available for any farm in the state.

the entire area to be of any special concern to the farmer who is liming soils. As we progress westward we find the limestones changing in hardness and color, and one would expect their chemical composition would change also. In this, however, one is mistaken, because, with minor exceptions, the composition remains substantially the same. If we travel still further west into the regions of the limestone so extensively used for fence posts throughout a zone reaching entirely across the state, we find here that the chemical composition is almost the same. Still further west we have the chalk beds of Kansas, which are nothing but limestone, and the composition of those is substantially the same as that of the hardest limestones in the eastern end of the state.

Pure limestone, could we find such, would be 100 per cent carbonate of lime ( $\text{CaCO}_3$ ). We may take this as our standard for purity, and gauge other samples by it. No limestone anywhere in the world has ever been found that would analyze 100 per cent pure. Kansas limestones rarely fall under 90 per cent pure, and with equal rarity exceed 95 per cent in purity. We may say, therefore, that limestones in the east will analyze from 88 to 96 per cent pure; also, that the softer limestones in the middle part of the state have substantially the same composition, and the chalk beds in the west do not differ from this in any material respect. This is so high a degree of impurity that our Kansas limestones are of little value for the production of ordinary lime. It is one of the strange features of commerce in Kansas that lime is shipped into the state from outside, although perhaps no other state in the Union is better supplied with large amounts of limestone than Kansas. The impurities ranging from little more than 10 per cent in extreme cases down to less than 5 per cent make Kansas limestones impossible for the production of a high-grade lime.

What are these impurities? Are they anything which would injure the soil should we apply such limestone to the soil as a fertilizer? Or, are they of such a nature that their effect would be neutral, so that their presence is objectionable only on account of their acting as a dilutant? An affirmative answer should be given to the last question. The impurities are of such a nature that they do no harm when added to the soil. Their main objection—in fact, their only objection—therefore, is on account of their diluting the limestone to that extent. This makes it so that one may feel perfectly safe in applying Kansas lime to the soil for agricultural purposes, because one may know that he is adding nothing whatever that would be in any way objectionable. Chemical analysis shows that the impurities consist almost entirely of silica ( $\text{SiO}_2$ ), aluminum ( $\text{Al}_2\text{O}_3$ ), and iron oxide ( $\text{Fe}_2\text{O}_3$ ). We have probably a very slight trace of the alkalis, and in some cases an appreciable amount of magnesia, but not to any considerable degree. The soft limestone in middle and western Kansas which for a quarter of a century or more have been called "magnesian limestone" do not carry magnesia to any considerable extent. The name is a misnomer which should be done away with and forgotten. The soft limestones in general will make just as high-grade lime as the harder limestones throughout the state.

The impurities—silica, aluminum and iron oxide—that constitute from 5 to 10 per cent of our Kansas limestones, are substantially the same as soil. Pick up a handful of soil from a wheatfield or cornfield, have it analyzed, and ordinarily more than 90 per cent of it will be silica, aluminum and iron oxide. One may dismiss the impurities in our limestone, then, with an assurance that they in no way will injure the soil, and are objectionable only by acting as a dilutant.

A careful study of the accompanying map will show where limestone may be found, and how far one will have to transport it to his farm. It is probable that some farmers will find it desirable to have the limestone shipped to them by rail. For others it will be desirable to have local crushers supply crushed limestone for wagon trade. Crushed limestone may be shipped as the cheapest kind of freight, so that if it becomes necessary to ship it by rail it can be carried for a very small expense.

#### WHAT SOILS NEED TO BE LIMED.

All acid soils will be improved greatly by having lime added to them. Soils formed from shales have too much sulphuric acid, and need lime to destroy the acid. Other soils which for years have had excessive growths of grass and weeds are likely to be acid from the vast amount of organic acids produced by a partial decomposition of weeds and grass. This is generally true of freshly-drained swamp lands. The soils have so much decaying organic matter in them that at times they are good for little until the organic acids have been neutralized or destroyed. All such soils should be limed.

#### FORM OF LIME TO APPLY.

It is important to know the form of lime to apply to soil. Should one use raw limestone or quicklime? The answer is that either will do good. It is merely a question of time. Quicklime will act immediately and accomplish its purpose largely the first season, after which its beneficial results will gradually decline for years. Crushed limestone added to an acid soil acts more slowly, but ultimately accomplishes the same results. The finer it is crushed the more quickly it will act, so that if ground to an impalpable powder it will act almost as rapidly as quicklime. The extreme in coarseness would be fragments of any size not too large to interfere with the plow. Such large pieces will have but little effect during any one year, but nevertheless each piece will gradually yield to weathering and slowly rectify an acid soil, and will continue in its well-doing as long as it lasts, or until it is finally all dissolved.

A word of caution should be given regarding the use of quicklime. If used in excess it becomes injurious to growing crops, so that at first it may prove a detriment if applied in too large quantities. Its ability to do harm, however, is but temporary, for in the course of time it absorbs carbonic acid from the air and passes back into the form of lime carbonate again, from which it came, or as it was in the original limestone, after which it acts precisely as finely pulverized limestone.

Limestone may be burned into quicklime very economically in places where fuel is cheap. Our fathers and grandfathers generally burned lime for their own uses by making piles of broken limestone, well mixed with wood or other fuels, and then burning the fuel. Often the larger pieces

of limestone would be only partly burnt, leaving a cone of unchanged limestone. Of course the charcoal and cone ash of the fuel will be more or less mixed with the lime, but for liming soils this will do no harm. As is well known, the burnt lime can be crushed very easily, so that its application to the soil will be readily effected.

Should one ship lime or limestone very far it might become economically desirable to have it all burnt in order to reduce weight. In burning lime from limestone the heat drives off carbonic acid gas, thereby reducing the weight. For theoretically pure lime carbonate, each 100 pounds will be reduced to 56 pounds by burning. In other words, a pure limestone is 56 per cent quicklime and forty-four per cent carbonic acid gas. As our Kansas limestones are about 10 per cent impure, we would have a reduction in weight of 44 per cent of 90 per cent, or a little less than 40 per cent. This is a great reduction in freight and drayage, and should be considered carefully by each one for himself. The 56 pounds of quicklime obtained from 100 pounds of limestone does exactly the same good as the original 100 pounds of limestone.

#### MODE OF PULVERIZING LIMESTONE.

We now have in the state of Kansas quite a number of Portland-cement plants, each of which is using limestone in the manufacture of Portland cement. Every factory, perhaps, could be prevailed upon to sell crushed limestone, and the rate at which it could be bought would depend upon the degree of fineness to which it was ground. It costs money to grind limestone to a fine powder, especially if it is ground to an impalpable powder. These Portland-cement plants, of course, are located on railroads, and if one would wish to buy finely ground limestone and have it shipped to his station it might be best to buy of them. It is a business not yet worked up, and the farmer should not be discouraged if the cement companies at first should ask too high a price, or ignore him entirely.

We also have a few factories built especially for selling crushed limestone for concrete and for railroad ballast. Each of these could supply a large amount of the raw limestone for use if it is not desired too finely ground.

It is probable, however, that if liming soils becomes general in Kansas, portable crushers will be used to a great extent, so as to save freight and drayage. A number of the large manufacturers of rock-crushing machinery already have on the market portable crushers and grinders that crush and grind limestone to a degree of fineness amply sufficient for liming soils. Such portable crushers could be taken from point to point along the outcropping ledges of limestone, so that the distance farmers would have to haul the crushed rock would not be prohibitive.

#### GOOD ROADS AND LIMING.

I can not close this paper without calling attention to the close relation which might be made to exist between liming soils in eastern Kansas and building good roads. It is well known that in many parts of the state our country roads are actually worse now than they were twenty and thirty years ago. In the western part of the state, where rainfall is

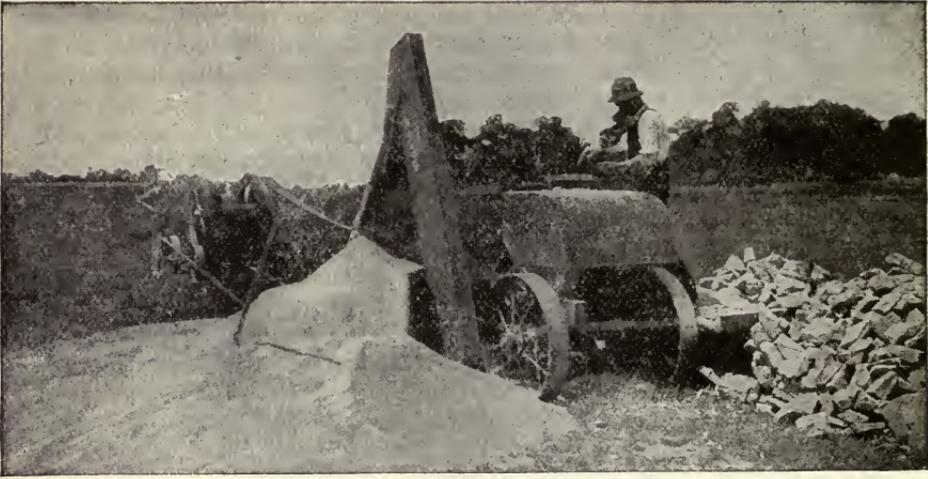

FIG. 200. It is probable that, if liming soils becomes general in Kansas, portable crushers will be used to a great extent, so as to save freight and drayage.—[Courtesy New York Experiment Station.]

not so great, roads are much better than in the eastern end, where rainfall often is excessive.

Nowhere else in the world is good, hard limestone more abundant, nor more easily quarried and crushed, and no better road-building material is known than this same broken limestone, when properly mixed with good Portland-cement mortar. In crushing rock for road making there is a portion broken too finely for good service, and this could be sent to the farms for liming soils. (See "Lime," in index.)

## ALFALFA SOILS; THEIR PREPARATION AND SEEDING.

By L. E. CALL, Professor of Agronomy, Kansas State Agricultural College.

### SOILS.

Alfalfa is undoubtedly more exacting in its soil requirements than any other crop that is extensively grown on the farms of Kansas. The crop, for its best development, must make a deep root growth. Consequently, a soil to be well adapted to it must have a subsoil that is deep and at the same time mellow enough to be readily penetrated by plant roots. A good alfalfa soil must also be well drained, for alfalfa roots are very sensitive to standing water. This crop is killed out in a very short time if water stands in the soil within three feet or less of the surface of the ground.

While alfalfa is a crop that will improve the fertility of the soil, it is at the same time one that requires a soil in a fairly high state of fertility if it is to develop at its best. This is especially true of young alfalfa plants. The young plants are not ravenous feeders, and must have an abundance of readily available plant food if they are to be-

come healthy, vigorous plants. Alfalfa more often fails in eastern Kansas because the young plants are starved than from any other one cause.

Alfalfa also requires for its growth an abundance of lime, and is therefore very sensitive to sour or acid soil conditions. Consequently, the best alfalfa soils in the state are those that have been derived from limestone or that contain in them a large quantity of calcarous material.

Alfalfa is not exacting as to the texture of soil upon which it will grow, yet it does the best upon the loam, silt loam, and sandy loam soils. While it grows best on soils of this texture, it will grow satisfactorily, however, when once established on heavy clay soils, if they are well drained. Because of the difficulty of working soils of this type for other crops, alfalfa is often the most profitable crop that can be grown upon them. It will also grow upon soils of a fairly sandy character. The chief difficulty with the crop on soils of this kind is the uncertainty of securing a stand, but when once established it usually grows well, and if supplied with a top-dressing of manure occasionally, produces very profitable yields.

#### ALFALFA REGIONS OF KANSAS.

The state of Kansas can be divided into four alfalfa regions, based partly upon the formation of the soil and partly upon climatic conditions. The accompanying map (Fig. 201) shows these regions.

Region I is located in the northeast corner of Kansas, and is composed of soils that were formed by ice. It is supposed that at one time this region was covered by an immense glacier which moved down from the north, carrying with it rock and soil material from the northern states and Canada. This material which was carried in from the north was mixed by the ice with fragments of the underlying rock of this region. It is from this mixture of rock material that the soils of northeastern Kansas were formed.

Due to the manner in which these soils were formed, they are usually deep and rich in mineral elements or plant food, but deficient in organic matter. Because of the deficiency in organic matter, and because the mineral elements of plant food are not in a readily available condition, it is often difficult to start alfalfa upon these soils unless they are manured. It is advisable, therefore, when alfalfa is to be started, to manure the field six months or a year before the crop is sown. Manure applied in this way furnishes organic matter, which, after partially decaying, will furnish the young alfalfa plants with plant food, especially nitrogen, that they need during the early stages of their growth, before they are able to obtain nitrogen from the atmosphere. In this way a light application of manure assures a stand of alfalfa which otherwise would be difficult to obtain. The soil in this region often contains too little lime for the best growth of alfalfa, consequently lime must frequently be applied before alfalfa can be successfully grown.

While the soils of this region are usually of sufficient depth to grow alfalfa well, they are frequently of too impervious a nature to permit the alfalfa roots to penetrate the soil rapidly, and in some cases the impervious layer of the subsoil holds water to such an extent that the



soils become too poorly drained for alfalfa. Such soils will not make as valuable alfalfa soils as those which are naturally well drained, but where they are the only soils available, alfalfa can usually be started by means of tile underdrainage.

Region II, located in the southeastern corner of the state, consists of residual soils—that is, soils which have been formed from the decay of rock in place. The rock from which the majority of the soils in this region were formed was shale, although small areas of soil formed from sandstone and limestone occur. Of these three types of soil, the limestone is by far the best for the growth of alfalfa. Two kinds of limestone soils are found—the red limestone and the black limestone. The red limestone soil is usually open, porous and well drained, while the black limestone soil is usually less porous, and sometimes so impervious that drainage is poor, and thus not well adapted to alfalfa. The red limestone soils and the well-drained black limestone soils grow alfalfa successfully, although it is advisable to manure these soils for the purpose of supplying plant food before attempting to start alfalfa upon them. Some of these soils are so shallow that they do not furnish sufficient root development for the best growth of the crop. Where this occurs, yields are usually small, sometimes only one good cutting of alfalfa being obtained in a season. But even under such conditions alfalfa is usually the most profitable crop that can be grown upon them.

The sandstone soils occupy areas of higher elevation than the surrounding shale soils, and because of their location and the material from which the soil has been formed, are generally well drained. However, they are often in a low state of fertility and will not grow alfalfa successfully until after they have been fertilized or manured. These soils are frequently shallow and drouthy, and some of them must be limed before alfalfa will grow well.

The shale soils are the least adapted to alfalfa of any of the soils in the region. They are poorly drained, deficient in lime, often deficient in organic matter and plant food, and have such an impervious subsoil that it is practically impossible for the alfalfa roots to penetrate to a suitable depth. Such soils should not be utilized for alfalfa where other soils, such as the limestone and sandstone soils, occur, but where the shale soils are the only soils on the farm, alfalfa can usually be made to grow if the soil is underdrained and if the field is limed and manured before the crop is sown. On all of the soils in southeastern Kansas, with the exception of the stream valleys, inoculation is necessary, and alfalfa should never be seeded unless inoculation material has been applied.

Region III constitutes the principal alfalfa-growing region of the state. There is undoubtedly no equal area of land in the United States that has a larger portion of the cultivated land in alfalfa. In 1912, 4.8 per cent of all of the cultivated land in this area was in alfalfa, while in region I only 2.5 per cent of the cultivated land was in this crop, and in region II but .66 per cent of the cultivated land was seeded to alfalfa.

The soil of this region is well adapted to alfalfa. Upon the whole, the soils are deep, well supplied with lime, well drained, and there is usually

ample rain for the best development of the crop. Inoculation is seldom necessary, with the exception of the eastern edge of the area. In this part of the region the soils are more shallow, drainage is usually not as good, lime is present in smaller quantities, and many of the soils are not well enough supplied with available plant food to grow alfalfa well, but over the rest of the territory alfalfa can usually be successfully grown if a good seed bed is prepared for the crop.

Region IV constitutes that part of Kansas where the rainfall is too light for alfalfa to be successfully grown unless supplied by irrigation, flood or subsoil moisture. Consequently, practically no alfalfa is grown in this region without irrigation, except on the alluvial bottom soils, where the crop is supplied with subsoil moisture or where overflow water has an opportunity to penetrate the soil.

Alfalfa is sometimes utilized on the high land of this region for grazing, but seldom makes a profitable hay crop. The creek and river bottom soils of this region are well adapted to alfalfa. The climate is ideal for curing hay, consequently hay of the finest quality is produced. The climatic conditions are also of the best for seed production, and it is in this region that a large part of the alfalfa seed in the state is produced. (See "Soil," in index.)

#### THE ALFALFA SEED BED.

A good seed bed is the most important factor in securing a stand of alfalfa, while a poor seed bed is the most frequent cause for failure in starting the crop. A good seed bed must be well settled, firm, and have a finely pulverized and mellow surface in which to sow the seed. A firm seed bed is necessary in order to enable the crop to make the necessary root development to successfully resist the heavy freezing weather of the first winter, and to permit of ready movement of capillary moisture to the plants. In order to secure a firm seed bed it is necessary to start the preparation of the ground for the crop several weeks in advance of seeding. This is especially true when the ground is plowed. The cultivation and lapse of time between plowing and seeding not only furnishes time for the proper settling of the seed bed, but also enables the bacteria of the soil to liberate plant food in sufficient quantities to start the crop with promptness and vigor. When alfalfa is to be sown in the fall, ground that has previously grown wheat or some spring grain makes the best kind of a seed bed. The ground should be plowed as soon as possible after removing the grain crop. The plowing should be comparatively shallow. In fact, if the soil is turned just deep enough to cover the stubble and any weed growth that has started, it will be sufficient. It is not desirable to plow deep in preparing a seed bed for alfalfa, for ordinarily there is not sufficient time after the deep plowing is done for the seed bed to become firmed and well settled. Where the field has been plowed continuously at a shallow depth, and it is considered advisable to plow deep before planting alfalfa upon it, the deep plowing should be done for the crop which precedes alfalfa rather than in advance of alfalfa itself. After the field has been plowed it should be cultivated sufficiently to keep down weed growth, to firm the soil, and

to produce a fine, mellow surface. If several heavy rains fall after the ground has been plowed it will not be necessary to use a roller or packer in preparing the seed bed, but should the weather following the plowing remain dry it is usually advisable to roll or pack the ground, both for the purpose of firming the seed bed and of pulverizing the clods which would otherwise interfere with the seeding of the crop. On good, clean ground, a satisfactory seed bed can often be prepared with the disk. In fact, if the plowing can not be done reasonably early in the summer, disked ground will usually make a better seed bed for alfalfa than ground that has been plowed late. While wheat or spring grain stubble usually makes the best seed bed for alfalfa, the crop can often be seeded with success following cowpeas, flax, millet or corn. When seeded after a crop of this kind, which is harvested late in the summer, a better seed bed can be prepared with the disk than with the plow. Ordinarily, a single or double disking, followed by the harrow, will put the ground in condition for the alfalfa seed.

It is customary in western Kansas and in some sections of eastern Kansas to sow alfalfa in the spring. This is the best time to sow alfalfa in western Kansas, because the fall is either too dry to start the crop, or grasshoppers are so numerous that the young plants are destroyed by these insects. The best seed bed for spring seeding can be secured by plowing the ground the fall preceding, leaving it rough over winter, and then working it into good seed-bed condition with the disk and harrow. In the eastern part of the state the alfalfa should be sown as soon as danger of severe freezing weather is past, but in the western part it is best to delay seeding until the spring rains start and there is no danger of the soil blowing.

Another satisfactory method of preparing a seed bed, and one that is adapted to land that is deficient in available plant food, or to parts of the state where conditions are too dry to start alfalfa readily, is to plow the land in the fall or spring and cultivate it sufficiently thereafter to kill the weeds and maintain a soil mulch. In western Kansas the alfalfa seeded after this plan had best be sown late in the spring, while in eastern Kansas the ground should be cultivated throughout the summer and the alfalfa seeded in the fall. Soil that is kept cultivated over a long period of time in this way is free of weed seeds and accumulates a reserve of available plant food and moisture. With favorable weather conditions thereafter, a stand of alfalfa will be secured on soil so infertile or foul with weeds that difficulty is ordinarily experienced in starting the crop. (See "Seed-bed Preparation," in index.)

#### SEEDING.

##### *Time to Plant Alfalfa.*

In the eastern two-thirds of Kansas alfalfa can be started as easily, and often more easily, in the fall than in the spring. When the crop can be started in the fall, one year's crop is usually saved. As an example of this, two fields were seeded to alfalfa on the Kansas State Agricultural College farm in 1914. One field was seeded in the spring, following corn, while the other field was seeded in the fall, following wheat. The field

sown in the spring made a good stand, but did not produce a hay crop the first season, while the field that was in wheat produced forty bushels of grain to the acre, and a good stand of alfalfa was secured following the wheat. This season (1915) the field sown in the fall has produced within a ton as much hay as the field sown in the spring. Thus, the wheat crop grown in 1914 preceding alfalfa was secured without sacrificing to any great extent the alfalfa crop this season. (See "Seeding," in index.)

In sections of Kansas where the rainfall is usually abundant in the spring, satisfactory stands are sometimes obtained by planting alfalfa with a nurse crop, such as oats, barley, or even by spring planting in winter wheat. The nurse crop should be planted thinner than when it is planted alone, and if the season turns dry, should, in order to save the alfalfa, be cut early for hay. This method of planting alfalfa is not satisfactory as a rule, and is not to be recommended except in special cases. (See "Nurse Crop," in index.)

#### *Starting Alfalfa on Sandy Soils.*

It is sometimes desirable to seed alfalfa on sandy soils, especially along the creek and river valleys. Such soils, if not too sandy, will usually grow alfalfa successfully after it is once established. It is difficult to start the crop on account of the sand drifting in high winds and cutting off the young alfalfa plants. A number of farmers along the Arkansas river valley have succeeded in starting alfalfa on soils of this character by preceding the alfalfa with sown sweet sorghum or cane. The cane is cut in the fall for hay in such a way that the stubble is left high. The next spring, after danger of high winds is past and when spring rains start, the alfalfa is drilled in the cane stubble, which is left standing to protect the young alfalfa plants. In this way good stands of alfalfa have been secured on soils too sandy otherwise to grow the crop. Old fields of alfalfa on soils of this character should usually be allowed to make some growth in the fall to protect the crown of the plant during winter and the following spring. Light applications of barnyard manure applied in the winter also serve as a protection to the crop and supply plant food and organic matter to the soil, which eventually is beneficial to the alfalfa.

#### INOCULATING FOR ALFALFA.

Alfalfa requires for its growth large quantities of nitrogen. It is this large amount of nitrogen in the plant that makes the crop so rich in protein and, therefore, such a valuable feed. Most soil can not supply from the soil itself the large quantity of nitrogen that the crop requires. Fortunately, alfalfa is not usually dependent upon the soil for its supply of nitrogen. There are tiny bacteria that live in nodules upon the roots of the alfalfa plants that secure nitrogen from the inexhaustible supply of this material in the air. The nitrogen gathered in this way is used by the bacteria in their life processes, but is eventually given off by these organisms in such a way that it is available to the alfalfa plants. Very few soils are rich enough in nitrogen to grow alfalfa without the aid of these bacteria, consequently, when the alfalfa bacteria are not present in the

soil, the crop if planted turns sickly and yellow at the end of the first or beginning of the second year of its growth, and eventually dies or thins out until it is an unprofitable crop to leave. Alfalfa bacteria are usually present in overflow land along creeks and rivers and in the soils of the central and western parts of the state, but in eastern Kansas, where alfalfa has not been extensively grown, the bacteria are not present in the soil and inoculation is necessary except on bottom soils.

There are two common ways of inoculating soil with alfalfa nitrogen-gathering bacteria. One way is to use soil from alfalfa or sweet-clover fields, the other to use pure cultures of these bacteria. Almost any seed house can supply the pure cultures of these organisms, and if the directions are followed closely in using the cultures, good results are usually obtained. The soil method of inoculation is the surest, safest, and generally the best method to follow. An old field of alfalfa or sweet clover should be found that is well set with nodules. The surface inch of soil should be scooped off and the next four or five inches of soil taken for inoculating purposes. This soil should be broadcasted, without drying, as soon as possible over the field to be inoculated. The work should be done on a cloudy day if possible, and the soil harrowed-in immediately after it is scattered. From 300 to 500 pounds of soil applied to each acre will usually be sufficient to produce inoculation, and will often mean a successful stand of alfalfa when neglect to inoculate may mean failure. (See "Inoculation," in index.)

#### LIMING FOR ALFALFA.

Acid soils or soils deficient in lime will not grow alfalfa successfully. The nitrogen-fixing bacteria will not thrive under acid soil conditions, consequently when alfalfa is seeded on acid soils it can not obtain nitrogen from the air, and thus can not make a satisfactory growth. It is not an easy matter to determine whether or not a soil is in need of lime. There are practically no acid soils in the western four-fifths of Kansas, but in the eastern one-fifth of the state large areas of acid soils occur, and it is advisable in this section of the state to have the soil tested for acidity before seeding the crop. *The best plan is to send a sample of soil which is representative of the field to the Agricultural College at Manhattan for the purpose of having the soil examined.* If the soil is found to be acid the acid condition can be corrected by applying ground limestone, hydrated lime or air-slaked lime. Ground limestone is usually the cheapest form in which to apply the lime. An application of from one to three tons should be made to the acre. The lime should be applied after plowing. The limestone applied should be finely ground and thoroughly worked into the soil with a disk and harrow. Where a large area is to be covered with lime, a lime spreader is needed, but a small quantity can be spread satisfactorily by hand with a shovel, or a manure spreader may be used. When a manure spreader is used the bottom of the spreader should be covered with manure or fine straw and the lime placed on top at the proper thickness for the spreader to spread the quantity of lime desired. (See "Lime," in index.)

## MANURING FOR ALFALFA.

There is no crop grown in Kansas that responds more quickly to barnyard manure than alfalfa, or upon which it is safer to apply manure without danger of its reducing the yield of a crop in a dry season. While manure is beneficial when applied to an old-established stand of alfalfa, it can be applied with the greatest benefit in advance of seeding the crop. Young alfalfa plants require large quantities of plant food for their growth, and unlike the older plants, which are able to secure nitrogen from the air, the young plants must be supplied with nitrogen from the soil until the plant becomes inoculated with nitrogen-fixing bacteria, which does not take place until the plant is several weeks old. Barnyard manure, if applied long enough in advance of seeding to have practically rotted, will supply the young plants with the nitrogen they require and often insures a stand of alfalfa on soils low in fertility upon which alfalfa would otherwise fail.

It is generally believed that alfalfa will restore the fertility of impoverished soils if once established upon them. While it is true that alfalfa will do better than most other crops on soils of this character, and will gradually enrich soils of this kind in nitrogen, it is nevertheless true that such soils can not be made very productive until the soil is manured or fertilized.

In 1910 a series of experiments with manures and fertilizers was started at the Kansas Experiment Station at Manhattan. A number of plats of ground was seeded to alfalfa that season, and have been in alfalfa continuously since that time. The soil upon which the work was started was a very poor one—in fact, the field is more or less rolling and the soil was somewhat eroded. Upon these plats manure has been applied annually at the rate of  $2\frac{1}{2}$  tons to the acre, or a total of  $12\frac{1}{2}$  tons of manure applied during the past five years. One of these plats receiving manure received also an annual application of 380 pounds of raw rock phosphate, which cost \$2.08 for the quantity applied. Another plat received 1000 pounds of lime in 1910 and the same quantity in 1914. The third plat received barnyard manure only. Another plat was manured annually at the rate of 5 tons, or has received during the five years a total of 25 tons of manure to the acre. Other plats left as checks were unmanured. In 1911 the alfalfa winterkilled and was reseeded in the spring of 1912. The yield of alfalfa obtained during the past five years is shown in the following table:

TABLE No. 25. Effect of barnyard manure on alfalfa. Manure applied annually, 1911-1915. Yield in pounds.

Plat.	Treatment.	1911.	1912.	1913.	1914.	1915.*	Average yield.
7	Manure, $2\frac{1}{2}$ tons, rock phosphate.....	4,649	1,800	3,724	4,323	8,834	4,666
9	Manure, $2\frac{1}{2}$ tons.....	3,659	1,620	3,041	4,342	8,537	4,239
10	Manure, 5 tons.....	3,805	1,920	4,366	5,418	10,050	5,112
12	Manure, $2\frac{1}{2}$ tons, and lime...	3,463	1,680	3,491	4,640	8,964	4,447
Check	No treatment.....	2,463	820	1,901	2,330	4,409	2,384

\* First three cuttings only. Data compiled before fourth crop was harvested.

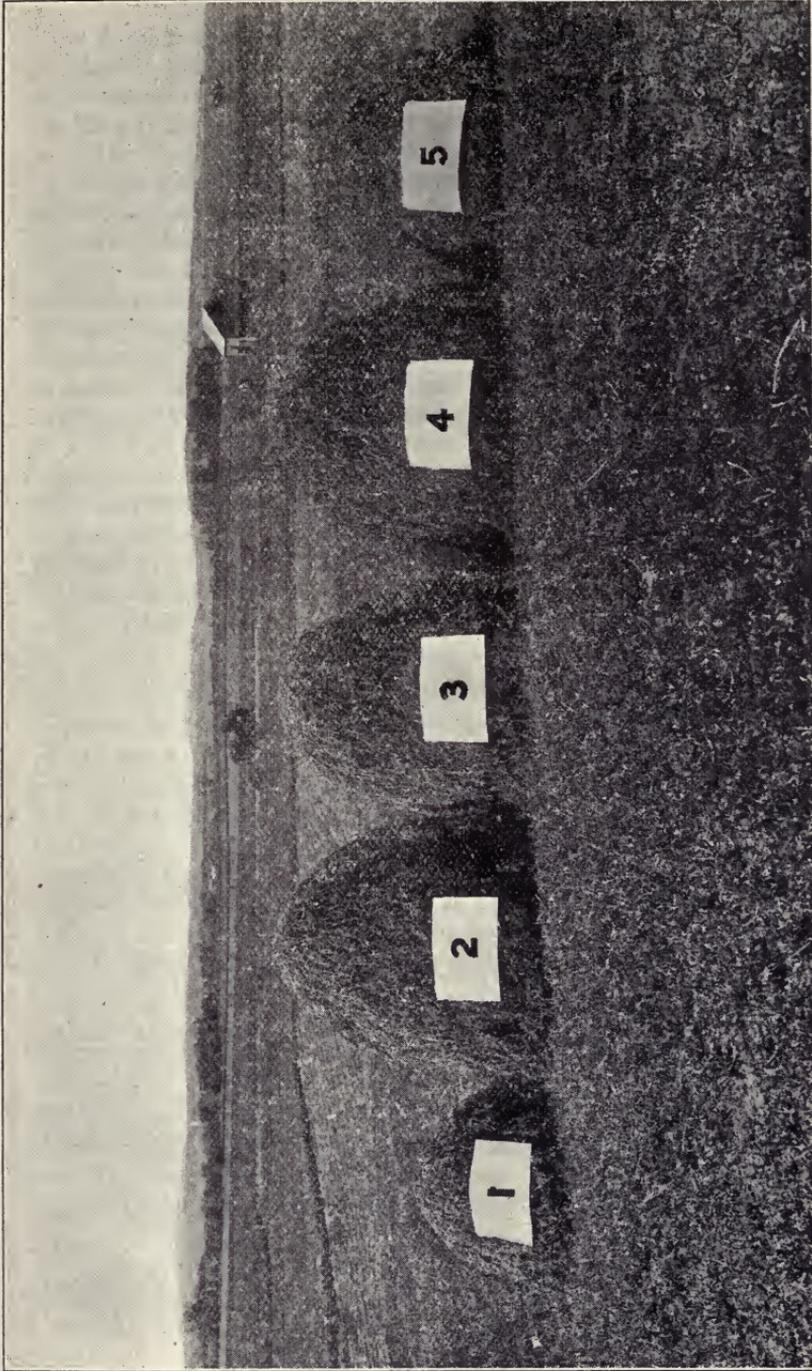

FIG. 202. The yield from one-tenth of an acre of alfalfa, first cutting. 1, Unfertilized. 2, Fertilized with five tons of manure to the acre annually. 3, Fertilized with two and one-half tons of manure annually. 4, Fertilized with two and one-half tons of manure and 380 pounds of rock phosphate annually. 5, Unfertilized.

The plat fertilized with 2½ tons of manure annually, produced an average yield of 4239 pounds of hay; and the plat fertilized with 5 tons of manure annually, produced an average yield of 5112 pounds of hay; while the unfertilized plat produced an average of but 2384 pounds of hay to the acre. An application of 2½ tons of manure increased the yield 1855 pounds per acre annually, or 77 per cent, while an annual application of 5 tons of manure increased the yield 2728 pounds, or 114 per cent. The heavier application of manure gave the biggest increase in yield, and would have been the most profitable if a large quantity of manure had been available for use, but where manure is limited in amount it is better to apply at the lighter rate and to cover a larger area. This is readily seen when we see that the 2½-ton rate of application increased the yield 1855 pounds per acre over the unmanured plat, while the 5-ton rate of application increased the yield but 873 pounds over the 2½-ton manured plat. In other words, the first application of 2½ tons of manure increased the yield 1855 pounds, while the second 2½ tons of manure increased the yield but 873 pounds.

Rock phosphate applied at the rate of 380 pounds per acre annually with 2½ tons of manure, costing \$2 for the rock phosphate, increased the yield but 427 pounds per acre, which is not a sufficient increase in yield to make its application profitable. Ground lime rock applied at the rate of 1000 pounds every four years on a plat receiving 2½ tons of manure increased the yield of hay 208 pounds per acre annually. This is not a sufficient increase to make the use of lime profitable.

#### COMMERCIAL FERTILIZERS FOR ALFALFA.

When barnyard manure is not available, some commercial fertilizer rich in phosphorus, such as bone meal or acid phosphate, can usually be used with profit in starting alfalfa on the poorer areas of soil in the eastern third of the state. At the Kansas Experiment Station alfalfa was seeded on a poor upland field in the fall of 1909. Upon one plat in this field the alfalfa was fertilized with 190 pounds of acid phosphate per acre each year. This quantity of acid phosphate supplied fourteen pounds of phosphorus annually, and cost \$2 per acre. Another plat adjoining was unfertilized. The following table gives the results of this trial:

TABLE NO. 26. Effect of phosphorus applied in acid phosphate on alfalfa. Season 1910-1913.

	Pounds per acre.				Total for season.	Value at \$10 per ton.	Cost of fertilizing.	Value less cost of fertilizing.
	First cutting.	Second cutting.	Third cutting.	Fourth cutting.				
	Yield of alfalfa, season 1910.							
Fertilized . . . . .	1,608				1,608	\$8.04	\$2.09	\$5.95
Unfertilized . . . . .	1,438				1,438	7.19		7.19
	Yield of alfalfa, season 1911.							
Fertilized . . . . .	2,690	1,080	900	1,660	6,330	31.65	2.09	29.56
Unfertilized . . . . .	2,720	910	660	1,160	5,450	27.25		27.25
	Yield of alfalfa, season 1912.							
Fertilized . . . . .	1,780	1,930	1,260	400	5,370	16.80	2.09	24.76
Unfertilized . . . . .	1,860	1,470	960	200	4,390	21.95		21.95
	Yield of alfalfa, season 1913.							
Fertilized . . . . .	3,400	1,350			4,750	23.75	2.09	21.66
Unfertilized . . . . .	2,360	1,000			3,360	16.80		16.80

## TOTAL, FOUR YEARS.

	Value, less cost of fertilizer.
Fertilized.....	\$81.93
Unfertilized.....	73.19
Difference.....	\$8.74

The result of this test, extending over a period of four years, shows each season an increased yield of hay on the fertilized plat, and with the exception of the first year the increase in the crop was more than sufficient to pay for the cost of fertilizing. During the four years the unfertilized plat produced \$73.19 worth of hay per acre, while the plat fertilized produced \$81.93 worth of hay, after paying the cost of fertilizing, leaving a difference of \$8.74 per acre, as a total of the four years, in favor of the fertilized plat.

While paying returns have been obtained where phosphorus was used as a fertilizer for alfalfa, it does not follow that any kind or brand of fertilizer will pay. In this test other plats fertilized with materials supplying potassium and nitrogen did not produce an increased yield sufficient to pay the cost of fertilizing. From our present knowledge we would advise for alfalfa, in this section of the state, the use of fertilizer supplying phosphorus only. (See "Fertilizing," in index.)

## SCIENTIFIC HAY MAKING AND STORAGE.

By R. KENNEY, Assistant Professor of Crops, Kansas State Agricultural College.

### CUTTING THE CROP.

During the first season of its growth the alfalfa plant is establishing a deep root system which will furnish the food and moisture necessary for the enormous quantities of hay removed during succeeding years. It is of the greatest importance that all conditions shall be made favorable for the development of this root system. It depends almost entirely on the manufacture of suitable food in the green leaves and stems above ground, aided by sunshine. The green growing parts must be protected as much as possible, and any hay made the first season must be cut and harvested at such a stage and in such a manner as will do the least damage to young plants, irrespective of the quantity or quality of hay obtained. The clipping should be delayed as long as possible without letting weeds get too much start. On the other hand, no seed should be allowed to form during the early growth of the plants, for seed formation requires much plant food which should go to the roots. They need all they can get to penetrate deep into the soil and get ready for the next year's work.

*Second and Third Years.*

During the second season the roots are still enlarging rapidly, and one should not expect too much of the field if he wishes to harvest maximum hay crops in succeeding years.

It is just as important that the plants shall not be robbed by close clipping for hay during the first year or two of growth as it is that they shall not be robbed by close grazing of stock during the same period. The maximum yield of hay harvested in any one season is usually obtained in either the third or fourth season. After this the yield gradually declines and the plants suffer more and more from competition with grass and weeds, from fungus injury, insects, and gophers.

*Factors to Consider in Cutting Alfalfa.*

Cattle relish alfalfa hay best when it is cut before the period of full bloom, while horses give best results when fed on hay at least well out in bloom and approaching nearer to maturity. However, since alfalfa hay in most cases does not make up the entire ration for horses, it may be best to consider other factors than that of physiological effect on the animals eating it.

Various criteria have been used for deciding when it is proper to cut, the two most common being, first, when the blossoms have reached a certain stage, say one-tenth bloom or full bloom, depending on the preference of the individual; and second, when the new shoots are arising at the crown. Both are excellent at times of normal growth, but either may fail under unusual conditions.

When wet seasons occur, such as was that of 1915, alfalfa does not bloom readily, and the second growth in many cases is six to ten inches high before a single blossom appears. This condition is more frequent in the more humid states than it is in Kansas. In such a case it is best to depend on the new growth arising at the crown to decide when to cut. In rare cases, flowers appear in considerable number before the new growth is noticed, and the forage may approach nearer maturity than is desirable if one waits for the new shoots to appear.

It is necessary to combine these two characters of growth in making a decision, and cut whenever one or the other has appeared; *i. e.*, the new growth should not be high enough to be cut off by the sickle, nor should the flowers indicate greater maturity than is desired.

The time of cutting will depend most largely on just what stage of maturity of the plant will yield the most tons of hay containing the greatest amount of digestible nutrients per ton. Since protein is the most valuable food element in alfalfa hay, the protein contents of the cured hay is the determining factor.

The protein content of alfalfa stems ranges from about 14 per cent in the bud state to about 11 per cent when the first seeds are forming. In the leaves it ranges from about 28 per cent in the bud stage to about 24 per cent in the stage of seed formation. In the bud stage 55 to 66 per cent of the hay is leaves, while in the stage of seed formation only 40 to 45 per cent of the hay is made up of leaves alone.

The above figures, determined by the department of chemistry of the

Kansas State Agricultural College, show that when composition of hay alone is considered the best hay is that harvested at an early stage of maturity. Work conducted by the department of agronomy at the Agricultural College at Manhattan shows an average yield of less than one-half ton more of hay from alfalfa cut in the bud stage than from adjoining ground mowed in the one-tenth bloom stage in 1914. Cutting every time the crop reached the bud stage required one more mowing, raking and hauling than was required for cutting in the one-tenth bloom. Such early cutting has a tendency to weaken the roots, for they can not receive so much food from the green parts above ground. This weakening results in slower growth of succeeding crops and becomes more marked from year to year. It allows greater chance for fungus to become well established, and does not smother out crab grass and foxtail nearly so well as does a more vigorous-growing crop.

Plats on the Experiment Station farm, which have been cut every time they reached the bud stage during 1914 and 1915, have been almost completely taken by crab grass and foxtail during the 1915 season. The fourth cutting of hay was the first to show a noticeable amount of grass. It was cut on August 4, and contained 30 per cent of crab grass and foxtail in the weight of air-dry material. The fifth cutting contained a much larger per cent of grass, and the alfalfa was short, with a very thin stand. Adjoining plats cut in the later stages were either entirely free from grass or contained only a trace. Much alfalfa in eastern Kansas in 1915 was completely taken by these grasses. Mowing a little later and less often may tend to smother the young grass sprouts in such cases, while frequent mowing both weakens the alfalfa and gives the grass air and sunshine for rapid growth. Later cutting than full bloom results in a decided decrease in yield and a hay crop made up largely of unpalatable stems.

The greater portion of all alfalfa hay harvested is cut between the appearance of the first bloom and the full bloom stage, and the one-tenth bloom stage may be recommended as an excellent time to cut hay for ordinary purposes. It must be remembered that few fields are free from alfalfa leaf spot or other fungus doing similar damage to the leaves. This attack results in the dropping of the leaves, often on three-fourths of the height of the stem. It usually causes such loss after the first bloom and before the full bloom is reached, so that cutting before the leaves drop will add greatly to the value of the hay provided they are cured intact. (See "Cutting," in index.)

#### CURING THE HAY.

Two desirable changes take place in curing of hay, *i. e.*, the loss of water and the production of aroma. Both are favored by slow curing, while rapid curing, in addition to being unfavorable to them, results in bleaching and loss of leaves. Slow curing requires more time and labor, for the hay must be raked and cocked at the proper time, and most of the curing goes on in the windrow and cock.

Moisture passes out of the leaves more readily than from the stems, and they are easily burned and bleached on a hot day. Proper slow curing enables the moisture to be drawn from the stems into the leaves and

off from their surfaces. If the leaves are burned they no longer draw moisture from the stems, and they may be so dry as to drop off when handled, while the stems are far too green to stack or mow. Such loss of leaves may often be considerable. The average loss in harvesting forty-one different lots of alfalfa on the agronomy farm at Manhattan in 1914 was 12.43 per cent of the entire crop. In some cases as high as 48 per cent of the leaves were lost, which resulted in a loss of 27 per cent of the entire crop. As little as 6 per cent loss of leaves and 3 per cent loss of total crop was secured in several instances.

There can be no certain rule made as to how much time should elapse between cutting, raking, cocking, or hauling. Weather conditions vary greatly. The first crop of the season is usually heavy and cut when rains are apt to occur; succeeding crops are light and harvested in good drying weather, while the last cutting is usually quite green and is cut in cool weather and is frequently difficult to cure. In midsummer alfalfa may usually be cut in the forenoon, raked in the afternoon or succeeding morning, and stacked or placed in the mow at once. The first cutting usually requires one or more full days' curing in the swath, and as much or longer time in the windrow. The tedder may frequently be used with profit in curing the first cutting when it is tall and heavy, but is seldom used in succeeding cuttings.

Alfalfa wet with rain immediately after cutting will suffer little damage if the rainfall is not excessive. Where rain falls after partial curing the loss is greater, but in few cases is it so great as to render the crop a total loss. The hay, of course, is discolored and can not be readily marketed, but it is yet a good feed when dried thoroughly before stacking. Much injury is often done to the new growth in such cases because the cut crop is lying on the ground and smothering it. Spots are easily killed out unless the wet hay is turned and the crowns of the plants covered by the hay exposed to air and sunlight. (See "Curing," in index.)

#### STORING.

##### *Stacking and Mowing.*

Good judgment is necessary in putting alfalfa hay in the stack or mow. A mistake easily made is that of stacking as soon as the leaves are dry but before the stems have thoroughly cured. It is very difficult to say just when hay is dry enough to store. A slight excess of moisture within the plant due to the incomplete loss of natural sap will result in far less damage in storage than will a like amount of moisture on the outside of the hay, resulting from rain or dew.

The green alfalfa plant contains about 75 per cent moisture in the bud stage. The moisture content decreases as the plant matures, and may be as low as 60 per cent when seeds are beginning to form. The average moisture content of field-cured hay in the above forty-one cuttings in 1914 was 28.8 per cent. The lowest was 18.79 per cent; the highest was 39.82 per cent, and could not have been successfully stacked or mowed in large quantities.

The greater part of all hay stacked or mowed contains 25 to 30 per cent of moisture, and there is danger of loss in storage if there is more than

30 per cent. After hay has been stored long enough to reach a constant moisture content it contains 8 to 10 per cent moisture. There is no easy method of determining the moisture content in the field, and judgment is based on appearance and touch. When a few stems are twisted and break readily, showing no juice at the twisted portion, it is generally safe to stack. However, if they are tough and do not twist apart easily, even though no juice may be forced out, there is danger of loss if the hay is stacked. This is not a certain rule, but will serve as a guide until more definite rules are established.

The greater portion of alfalfa hay in Kansas is stored in the stack. The hay barn is used mostly on smaller farms, but a cheap shed, con-

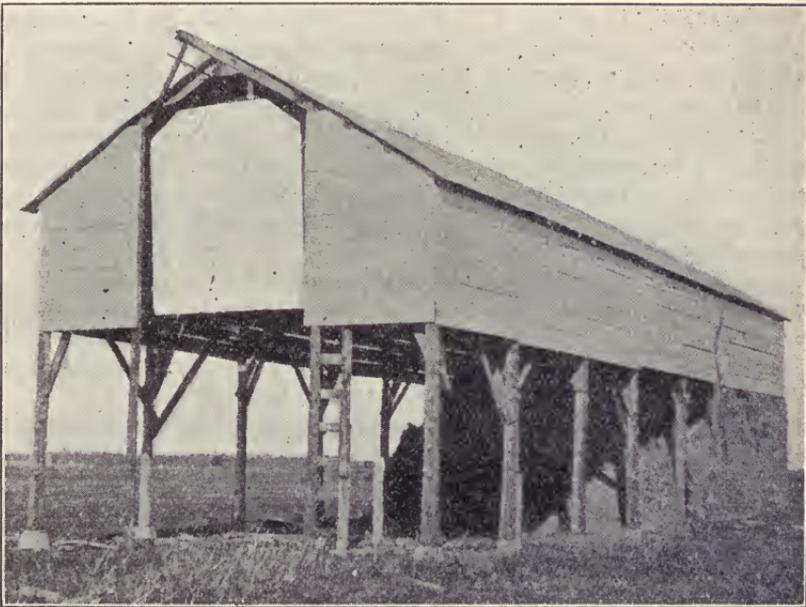

FIG. 203. A cheaply-constructed, yet efficient, alfalfa hay barn.

sisting of a roof with pole supports and boarded in along the sides five or six feet down from the eaves, would be a paying investment for many of the larger producers. Such a shed will turn off the water which soaks into alfalfa hay very easily, and the sides closed in at the top prevent the rain from blowing in as the hay settles. The shed should be provided with some form of horse fork, and can be filled as readily as a stack can be made.

Where alfalfa is stacked there is considerable loss from bleaching and weathering. The larger the stack the less will be the proportionate loss from such injury, and all stacks should be made as large as men and machinery will readily build them.

Hay near the bottom of a stack will spoil unless there is some foundation to keep it off the ground. Stack bottoms are best made of two layers

of poles, or a layer of poles covered with old boards. Old hay or straw which is thoroughly dry may be used where poles are not at hand. The top of the stack should be covered with canvas, boards, or metal covers. If nothing better can be found, a load of green alfalfa spread over the top will serve very well. Slough grass or old hay can be used to advantage. (See "Storing," in index.)

#### BALING.

When hay has been stacked or housed it goes through the process of sweating, which requires five to eight weeks. After it has been through the sweat there is practically no danger of heating in the bale, and unless circumstances are unusual, hay should not be baled before the process of sweating is complete. Hay which is baled in the field must pass through the sweat afterward, and considerable loss is often sustained from molding on the edges. If sufficient ventilation between all bales is secured the sweating may be prevented, but the quality of hay is not as good as that which has sweated in the mow or stack. Much dissatisfaction results all along the line when the shipper puts hay on the market direct from the baler in the field. Baling in the field requires from one to three days longer curing than does stacking or mowing. The first crop of the season is most difficult to handle in this manner, and requires longer curing than succeeding cuttings. It should not be attempted while any dew or rain is remaining on the hay.

Ownership of a power press will prove profitable only when a large acreage is grown by one individual or when there is considerable hay grown in one locality. Such a press should bale 20 to 30 tons a day. Unless there are at least 200 tons to be baled, a two-horse press is advisable.

Bales should be neat, uniform, square-ended, properly wired, and made up of distinct layers of approximately the same size and easily separable. Such bales command a better price, especially on a crowded market. Bales of uniform length pack better in a car, square ends tend to prevent falling apart, and distinct layers permit of easy feeding. In making a bale each feed should be uniform, and special care should be given the start and finish of a bale to secure square ends. A receiver is always on the lookout when once he has received a sandwiched bale, and only one grade of hay should be put in a bale. Great loss is always sustained from putting in bleached or burned hay.

The Kansas City market prefers bales of 65- to 75-pound size, and careful attention to condition of bales is profitable. (See "Baling" and "Marketing," in index.)

#### SPONTANEOUS COMBUSTION.

Hay which is reasonably well cured will rarely become so hot as to burn if it has been put up free from dew or rain. Where part of a heavy dew or rain is still on hay that was otherwise well cured there is great danger of spontaneous combustion when large quantities are placed in the mow or stack. If it does not actually burn, the middle of the mass will be browned or charred so as to be unfit for sale. Stock will often eat such hay greedily, but their desire for it is more in the nature of a desire for a change of feed, and they will not do well when fed large quantities.

During the present season many stacks have burned to the ground as the result of stacking under unfavorable weather conditions when much of the hay was too wet.

When such a stack begins to heat there is nothing one can do absolutely to prevent fire. Opening the center will only admit air, which starts the flames at once. Burning may often be prevented by using some means to keep air away from the heated portion. Pouring water on the sides, covering completely with saturated blankets and canvas, will help on stacks which are small enough to be treated by such means. Fire extinguishers can do little good, because they can not reach the fire. Steam from traction engines can not be confined sufficiently to help. As a last resort, a small portion of the hay may be saved by pulling it away after the flames are beyond control. The stack should never be opened, however, until flames actually appear.

Such a loss will sufficiently emphasize the advisability of thorough curing before storing alfalfa hay.

#### SALTING AND LIMING HAY.

Sprinkling each load with salt or lime as it is put down is frequently done to prevent heating. There is not sufficient accurate information at hand to say that such practice is worth while. Lime does not improve the quality of hay for feeding purposes, and it is doubtful if either salt or lime have any value in the prevention of heating.

Either of them will prevent the growth of molds if present in sufficient quantity, but when enough for such a purpose is added the feeding value of the hay is greatly reduced. (See "Spontaneous Combustion" and "Molding," in index.)

---

### A DAY'S WORK IN HAYING.

From Weekly News Letter of U. S. Department of Agriculture.

In order that haying or any other farm work may be planned in advance or performed properly from season to season, it is essential to know what may fairly be expected daily of a workman for each kind of work. It is also necessary to know what may be expected from any kind and size of implement, from each horse or team, or other source of power. Finally, it is important to know how much should be accomplished by different-sized groups of workmen working with different machinery, power and tools. With such knowledge at hand, the farmer can with fair accuracy assign a given number of days as being necessary to handle a given acreage of a crop, and can, therefore, arrange to have the work done systematically and without pressure that may call for the sudden employment of extra teams or the hiring of emergency help. In any such calculations, of course, the farmer's plans may be upset by weather which prevents the carrying on of operations, but in each locality the average weather conditions are fairly well known and are taken into account in planning the work in the field.

The Office of Farm Management of the department, with the object of getting definite information with regard to how much work could be expected in the different haying operations, as well as in other field

operations, wrote to 25,000 farmers in all parts of the country, asking them to report on the work accomplished by their men, horses, plowing machinery and equipment. In addition, representatives of the department went into the field and timed crews at work. The returns were then averaged and figures obtained for a day's work in many kinds of operations. These figures as averages represent neither a minimum nor a maximum that can be expected of an individual worker who may be unusually skilled and energetic, or may be unskilled and not a quick worker. Moreover, because a great bulk of replies were from states where climate, soil and farming conditions are a little better than the average, the investigators felt that the actual average was possibly too high for all parts of the country, and therefore gave in addition what is called an adjusted figure, which probably represents more nearly the amount of work that might normally be set as a standard. Following are the averages and the adjusted figures for the various haying operations:

## MOWING, RAKING, TEDDING, AND COCKING.

TABLE No. 27. What constitutes a normal day's work in mowing, raking, tedding, and cocking hay, giving the average acreages reported for sizes of machines most frequently used. [Net hours in the field: For mowing, 9.52; for raking, 8.44; for tedding, 8.26; and for cocking, 9.12]

OPERATION.	Most common width.	Number of horses.	Acreage per day.	Adjusted acreage.
	<i>Feet.</i>			
Mowing.....	5	2	8.85	8.0
Raking.....	8	1	11.99	10.8
	10	2	17.91	17.0
Tedding.....	6	1	9.75	8.7
	10	2	15.88	14.3
Cocking (1 man).....			6.29	5.7

The adjusted acreage figures given are the investigators' computation of a fair average after discounting abnormal performances and taking into account the unusual work done on farms which afford especially good working conditions.

In mowing hay, the two-horse unit is practically universal. The limit of mechanical efficiency appears to be approached as the sickle reaches seven feet in width. It appears that a two-horse team is about 45 per cent more efficient than one horse when used with rakes of the widths reported. The eight-foot width is the most used with one horse and the ten-foot width with two horses. In tedding hay with a hay tedder or kicker, two horses appear to be 45 per cent more efficient than one.

## HAULING HAY FROM WINDROWS TO BARN WITH A HAY LOADER.

TABLE NO. 28. A normal day's work in hauling hay from windrows to barn with a hay loader, giving average acreages reported for crews most frequently used.  
[Net hours in the field, 9.53.]

NUMBER OF MEN.	Number of horses.	Unloading by hand.		Unloading with sling or fork.	
		Acreage per day.	Adjusted acreage.	Acreage per day.	Adjusted acreage.
Two.....	2	5.29	4.25	7.66	6.15
	4	6.50	5.20	6.62	7.30
Three.....	2	5.86	5.00	7.84	6.70
	4	7.05	6.00	8.98	7.90
Four.....	4	7.81	7.00	10.16	9.15
	6	7.66	8.00	10.37	10.25

## HAULING HAY FROM COCKS TO BARN.

TABLE NO. 29. A normal day's work in hauling hay from cocks to barn, giving the daily average quoted for the crews most frequently used.  
[Net hours in the field 9.38.]

NUMBER OF MEN.	Number of horses.	Unloading by hand.		Unloading with sling or fork.	
		Acreage per day.	Adjusted acreage.	Acreage per day.	Adjusted acreage.
Two.....	2	4.39	3.50	6.14	4.90
	4	5.30	4.30	7.94	6.10
Three.....	2	4.55	3.90	6.44	5.50
	4	6.14	4.75	8.16	6.65
Four.....	4	7.17	6.45	10.14	9.10
	6	9.33	7.25	14.25	10.25
Five.....	4	7.70	7.70	10.70	10.70
	6	9.71	8.66	12.33	11.90
Six.....	4	8.03	8.80	10.52	12.45
	6	9.11	9.85	11.53	13.60
	8	5.00	10.80	11.60	14.80

The hay fork and sling add from 30 per cent to 50 per cent to the efficiency of the crews in this work. It was also found that those who used hay loaders and hauled hay direct from the field can put away about one-third of an acre more daily per man than those who haul it from cocks, other conditions being equal. With hay loaders the operation of bunching and cocking is also eliminated. In hauling hay from cocks to barn 41 per cent of the farmers reporting used two men, 40 per cent used three men, and 19 per cent used larger crews. Seventy-three per cent used only two horses and 19 per cent used four. Although three-men crews seemed to be much less efficient from the standpoint of acres cleared in a day than two- and four-men crews, nearly as many farmers report three-men crews as two-men crews.

## STACKING IN THE FIELD.

TABLE No. 30. A normal day's work in stacking hay in the field with and without sweep rakes.  
[Net hours in the field, 9.70.]

NUMBER OF MEN.	Using sweep rakes.			Without sweep rakes (by hand).		
	Number of horses.	Stacked per day.	Adjusted acreage.	Number of horses.	Stacked per day.	Adjusted acreage.
		<i>Acres.</i>			<i>Acres.</i>	
Two.....	2	9.70	6.10	2	4.85	3.90
	4	13.75	9.20	4	.....	5.90
Three.....	2	9.77	7.80	2	5.38	5.10
	4	15.48	10.90	4	8.03	7.15
	6	14.55	13.80	.....	.....	.....
Four.....	2	11.32	9.40	2	8.30	6.60
	4	15.22	12.20	4	9.52	8.90
	6	18.75	15.00	6	14.06	11.20
Five.....	4	12.80	12.90	2	9.00	7.40
	6	19.70	15.80	4	9.37	9.60
	8	23.50	18.60	6	12.50	11.90
Six.....	6	24.66	18.20	4	7.50	11.20
	8	20.33	20.40	6	12.20	13.00
				8	10.00	14.80

Comparison of the results attained in haying with sweep rakes and without them shows an advantage in favor of this simple and inexpensive addition to the equipment of about 40 per cent. Much of the cost of raking and cocking is also eliminated. An analysis of the data also shows a decreasing efficiency per man and per horse as the crews become larger. Thirty-two per cent of farmers use a crew of four men, and about equal numbers use three- and five-men crews, while only 9 per cent undertake this operation with two men. Different-sized teams up to six horses are equally common.

## BALING HAY.

TABLE No. 31. A normal day's work in baling hay from the stack or barn with sweep power and with an engine.

## USING HORSEPOWER.

[Net hours at work, 10.10.]

TYPE OF BALER.	Number of men.	Baled per day.
		<i>Tons.</i>
One-horse sweep.....	2	3.6
	3	7.2
	4	9.1
	5	12.5
Two-horse sweep.....	2	10.0
	3	8.6
	4	9.6
	5	10.7
	6	10.9
	7	15.5
	8	15.5

USING GASOLINE ENGINE.

NUMBER OF MEN.	Horsepower of engine.	Baled per day.
		<i>Tons.</i>
Three.....	5.44	13.56
Four.....	6.28	10.63
Five.....	8.29	13.20
Six.....	10.41	16.26
Seven.....	12.09	20.17
Eight.....	12.53	20.29
Nine.....	16.00	26.66
Ten.....	11.90	27.50
Eleven.....	14.00	31.25

**HAY SHEDS.**

By A. M. TEN EYCK,

Formerly Professor of Agronomy and Farm Management at the Kansas State Agricultural College, and Superintendent of the Fort Hays Branch Experiment Station.

By carefully stacking hay and covering the stacks well it is possible to preserve the hay in large stacks with comparatively little loss. However, haying time is a hard-working, busy time with the farmer, and he may be careless and neglect to stack the hay well or cover the stacks properly. Rains will come sometimes when they are not wanted and least expected, and some stacks will blow over or wet in, so that on the average stacking out of doors is expensive and wasteful.

When alfalfa is put up in a large way with sweep rakes and stackers, stacking in the field seems to be about the only practical method; but on the average farm, where the hay is largely fed to live stock, the hay shed becomes a hay-saver, a labor-saver, and a profitable investment. Some farmers who have built sheds estimate that the saving of hay and labor will pay for the shed in two years. This may be figuring the value of shedding hay a little too high.

From experiment station reports, and from the experiences of farmers, the writer concludes that the ordinary loss on hay stored in a shed will be, on the average, 10 per cent less than on hay stacked out of doors. A shed large enough to store 70 tons of alfalfa will cost about \$420. The value of 10 per cent of 70 tons of alfalfa hay, valued at \$10 per ton, is \$70. If the hay is stacked it must, as a rule, be handled twice in feeding it, while if stored in the shed or barn one handling may get it to the live stock. The extra handling of the hay will cost at least 50 cents per ton, or \$35. Again, many leaves are shattered by the extra handling, which may easily reduce the feeding value of the hay 50 cents per ton, which makes another loss of \$35. The shed would save \$140 a year. At this rate the original cost of the shed will have been paid for in three years, and a good shed ought to last fifteen or twenty years.

On a stock farm it will usually be advisable to build a combination hay and feeding shed. This may consist simply of a main shed for hay with lean-tos for the stock. Feeding mangers should surround the sides of the hay shed, into which the hay may be thrown. The lean-tos may be closed or open at the ends as desired.

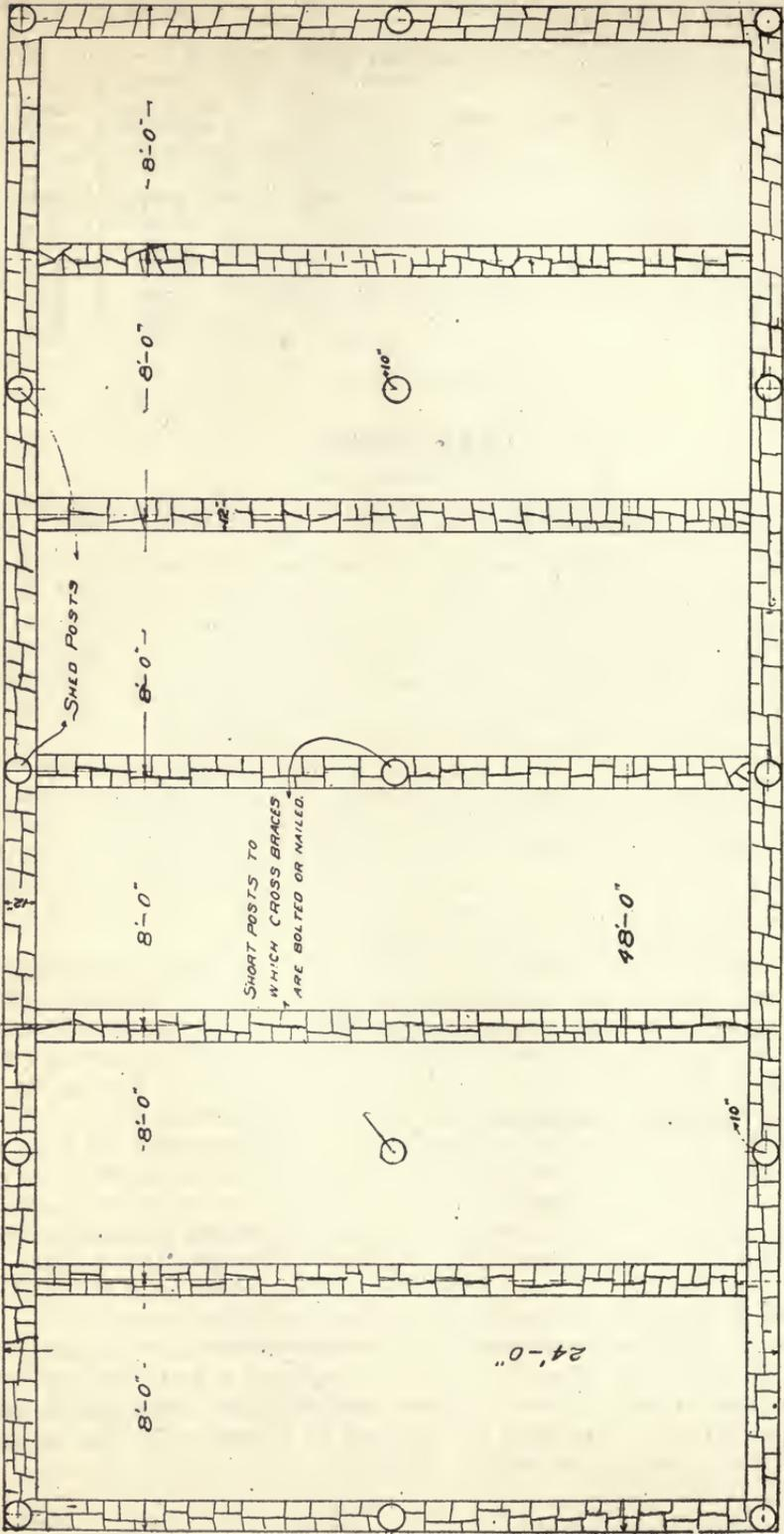

FIG. 204. Ground plan of hay barn. (Walls do not extend lengthwise of shed, as shown in plan, but the spaces between cross-walls are left open for ventilation.)  
 [Courtesy Kansas Experiment Station.]



Forty-eight to 60 feet long, 24 feet wide and 16 feet to the eaves are good dimensions for a single shed, and a shed 60 by 24 by 16 feet should hold about 60 tons of well-settled hay, or the annual crop from 12 to 15 acres of good alfalfa land. A pair of such sheds may be built end to end with a driveway between them, the roof being continuous. The hay should be taken in at the end of each shed by a hay fork and carrier.

A hay shed should be well braced and strongly constructed. The system of long bracing, such as is shown in the accompanying figures, gives great rigidity and strength, and is much preferable to the method of short bracing commonly practiced. The short braces readily work loose, and the shed soon becomes "rickety" and unsafe, and is apt to blow over in a strong wind.

The roof should be strongly constructed and securely fastened to the posts. Galvanized iron or steel roofing makes a durable roof covering, and the same material or boards may be used for siding. It is advisable to side hay sheds, at least part of the way down, otherwise there may be considerable damage from drifting rain or snow. If the hay is stored a bent at a time the side protection is not so necessary, but if the plan is

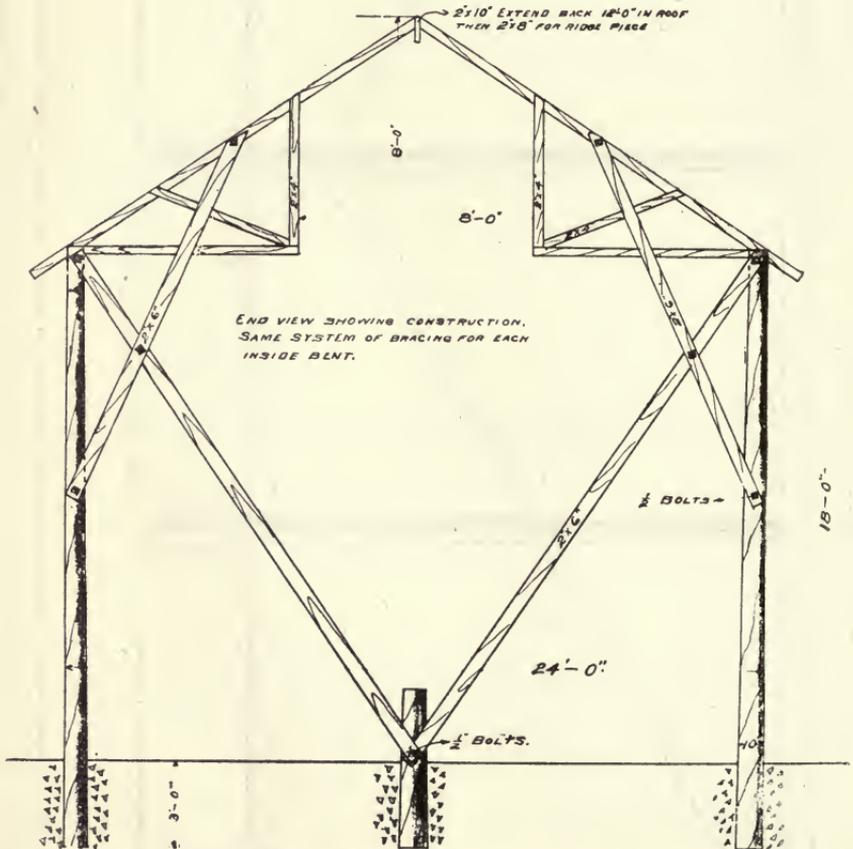

FIG. 206. Plan of construction of end section of hay barn and general plan of bracing for middle sections.—[Courtesy Kansas Experiment Station.]

practiced of spreading the hay over the whole area of the shed, side protection should be given from driving rains during the summer.

Figs. 204, 205, 206 and 207 illustrate the plan of construction of an alfalfa shed which the writer built on his home ranch on College Hill, near the Agricultural College. The shed is 48 by 24 by 18½ or about 17 feet high in the clear from the floor or ground walls to the eaves. The plan of construction of this shed may readily be understood from the illustrations. The floor walls average about 18 inches in height and are made of loosely laid rock which was near at hand. The posts were set in cement, which was rounded at the surface about the posts in order to shed water. The floor of the shed consists of loosely laid poles—young trees which were being grubbed in clearing a neighboring piece of land.

The posts are white oak trees, averaging about 7 inches in diameter at the top and 10 to 12 inches at the base. The frame timbers and braces

were fastened to the posts with lag screws and were usually bolted together rather than nailed. Some nails were used along with the bolts.

The roof is braced as shown in Figs. 205 and 206, and securely tied to the frame by braces at each post, as shown in plans, and each rafter was securely nailed to the plate.

The hay carrier track is attached to a 2 by 10 ridge timber for the first 10 feet, and a 2 by 8 for the remaining 36 feet, the 2 by 10 extending four feet over the end of the shed, from which the fork is lowered to the load. The ends of the rafters are flush with the top edge of the roof timbers and are securely nailed.

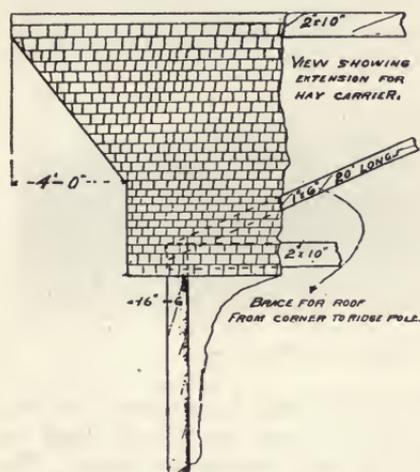

Fig. 207. Section of roof of hay barn, showing extension for hay-carrier track and plan for bracing roof.—[Courtesy Kansas Experiment Station.]

When built this shed was left open, but it was later sided with boards to within four feet of the floor at an estimated cost of \$86.50.

A fairly accurate account was kept of the material and labor required to build this shed. Most of the labor was done by unskilled workmen, an expert carpenter being hired only seven days while framing the shed. The cost of this shed may be stated as follows:

TABLE NO. 32. Cost of a hay shed.

10 long posts and 4 short posts, including cost of labor for cutting and hauling,	\$19.05
Lumber for frame and roof.....	65.73
1850 sq. ft. galvanized steel roofing, @ \$4.15 per square, including ridge pole..	89.50
Bolts and nails.....	6.00
Lime, cement, sand, etc.....	9.80
Poles for bottom.....	6.00
Construction labor, carpenter work, etc.....	91.75
Painting .....	12.00
Hay fork, pulleys, track, carrier, complete.....	31.26
Siding, estimated cost of labor and lumber.....	86.60
<b>Total .....</b>	<b>\$417.69</b>

This is a strong and durable shed and was built at a relatively low cost, yet on the average farm it might be built at an even less cost. From the above discussion, considering the cost of a shed and the saving in hay and labor which may result from shedding alfalfa, every farmer who has a fifteen-acre field of alfalfa should build a shed. (See "Sheds," in index.)

### COMBINATION HAY AND FEEDING SHEDS.

By J. D. JOSEPH, Whitewater, Butler county.

I use the combination hay and feeding sheds. Fig 208 shows one of my old hay barns. Though it has stood eighteen years it is still in fair repair. It was built out of ordinary hard pine, roof and all, and the cattle shed at the side is supported with hedge posts. It is 20 by 120 feet, 12 feet to the eaves, with a shed extension on one side only.



FIG. 208. A combination hay and feeding shed.

The frame of this barn consists of three rows of uprights of 4 by 4 stuff, set 8 feet apart—one row on each side and one row through the middle—and is braced every 24 feet, midway between the doors. The rafters are 2 by 6's, extending from each upright. The 2 by 4 stringers are set on top of the rafters, and are anchored to the rafters by a 2 by 4 by 8 in. block nailed to both. The frames of all my barns are nailed and bolted together—nothing toenailed.

The shed extension is 7 feet wide and about 5 feet 2 inches high at the eaves. I built it narrow so it would keep dry and at the same time not cause the cattle to bunch up, and I built it low down so as to furnish better protection from the winds. The principal purpose of the shed is to shelter the stock from snows and cold rains. I doubt the advisability of making sheds tight and warm. Stock, it appears to me, keep healthier when practically in the open—only shelter from cold winds, rain and snow. Such sheds as this keep much drier than wide ones, especially when the wide sheds are closed on all sides.

The manger of this barn is built on the shed side and consists of a 2 by 10 above, a 2 by 8 below, and a space of about 18 inches between. I usually place the lower board so that its upper edge will be about 22 to 30 inches above the ground.

The side of the barn opposite to the cattle shed is boarded up from the ground to the roof. It has double doors, 24 feet apart from center to center. These doors extend 6 feet down from the eaves. They are swung on strap hinges and fastened with buttons. Don't use hooks to fasten the doors shut, because they leave the door loose to shake in the winds.



FIG. 209. A combination hay and feeding shed, without shelter for the cattle.

Fig. 209 shows a barn of the same general form as Fig. 208, except that it is 36 feet wide, has doors on both sides, and no shed. This barn is 144 feet long and 12 feet to the eaves, boarded up at the ends, and on the sides down 6 feet. It is braced in a manner very similar to that shown in Fig. 208. The frame at the corners and ends is bolted to large hedge posts, 4 feet in the ground and extending about 4 feet above the ground. The doors are 24 feet apart and the same as those shown in Fig. 208. One door is shown open in the illustration. The button for fastening is on the 2 by 4 at the bottom of the door, in the middle. Notches are cut in the doors, so the button, when perpendicular, lets the door shut, and when turned horizontally it fastens the door securely. This button is bolted on with a quarter-inch machine bolt.

I have another barn similar to that shown in Fig. 209, except that telephone poles were used for uprights. They are much better than 4 by 4's. I would recommend, for uprights, white cedar telephone poles, 5 inches in diameter at the tops, and would set them 3 feet in the ground in cement. I would use 7-inch tops for the corners and the centers of the ends, and set them 4 feet in the ground in cement. Where poles are used for uprights I brace them the same as when I use 4 by 4's. Care must be taken to tie the rafters with diagonal ties from center to center, and brace the rafters also to the center row of uprights.

I use the old way of storing my hay, pitching it off the hay racks by hand. I do not use slings and hay forks, because they necessitate a much more expensive barn than I use and one that it is much more difficult to feed the hay from. When hay is stored in a high barn adapted to the use of slings or hay forks, not only is the expense of building much in excess of the barns I use for the same capacity, but when a high barn is full there must be shoots or a vacant space partitioned off between the hay and the side of the barn to get the hay down to the manger. Such arrangements do not appear to me desirable. I build my hay barns so as to get a maximum of utility at a minimum of cost. (See "Sheds," in index.)

## A HAY-CURING BARN.

By E. I. BURTON, Farmer, Coffeyville, Montgomery county.

Three years ago we built a barn for the purpose of curing and storing alfalfa. The dimensions are 36 by 84 feet, walls 18 feet high and constructed of Denison interlocking hollow tile, laid in cement. The roof is one-third pitch and of Ludoecci—Celladon roofing tile. The tile for both the side walls and roof came from factories located in Coffeyville, making a short haul for us. The next season we built an addition 72 feet in length, using the same material as for the first building.

We think there are no walls for all kinds of farm buildings so good as hollow tile, and no roofing equal to tile. However, any other material in general use would, of course, be all right for a barn for curing and storing alfalfa. Here, where he can haul the tile direct from factories, without having any freight or handling charges added to the price, we find tile the cheapest material we can use for good buildings. The tile, both for walls and roofing, does not cost as much as the better grades of lumber and shingles. Then, after the building is completed, there is no painting to be done.

In the walls, every 13 feet, are 11-foot openings. These openings have double sliding doors. When the doors are all open we have nearly one-half the side-wall space for sun and ventilation. Our ventilating doors make the putting in or taking out of hay very convenient.

The three floors of the barn are all made of two-inch native lumber, and are laid open to give perfect ventilation. The two upper floors are loose, so when we are storing baled hay they may be easily shifted to the outer sides.

The barn is equipped with hay carriers running the full length and operated from the center driveway. They will throw the hay either way desired. We use this carrier for loading and unloading both baled and loose hay.

At the beginning of the haying season we have about 15,000 square feet of drying floors. When the weather will permit of proper curing we bale the alfalfa in the field. If the weather is threatening, when the hay is but *partially cured*,\* we rush it into the barn and scatter it out

---

\* It was for a number of years the practice of J. W. Berry, of Jewell county, Kansas, to do a large part of the curing of his alfalfa hay in the shed. By his method, it is said, he got better color and quality and was able to bale in the winter and sell at an average of \$2 per ton above the market price for prime alfalfa.

The usual practice in good haying weather was to start the mower when the dew and all foreign moisture was off in the morning, about eight a. m.; rake as soon as partly wilted, about eleven a. m.; and haul to the shed for storage when half cured, about two p. m. The floor of the shed was elevated a foot or two above the ground and consisted of narrow boards or poles spaced a few inches apart. The hay was spread evenly and loosely, without tramping; in fact, a spreading platform was provided to make walking over the hay unnecessary. The shed was so large that a single cutting would cover the floor to a depth not to exceed four or five feet. The second cutting was spread over the first, the third over the second, and so on, until the shed was full. The natural heating of the hay and the consequent rise of the warm, moist air, coupled with the open space below and the loose condition of the hay, caused a circulation of air, which removed the moisture, prevented excessive heating, and gradually cured the hay. Because of the unusual care necessary to its success, the method is not recommended for general practice.

on the slatted floors, where it is left until cured dry enough to bale and store away. In this way we are able to save a much higher percentage of bright, leafy hay than we could save before having this large drying space. As the season advances the weather is usually more favorable for outdoor curing, and the barn space is gradually filled with baled hay.

One great convenience we have found is that of being able to use our power baler in the barn, baling the alfalfa that has dried there, while the weather is so wet that we can not work outdoors. (See "Sheds," in index.)

---

## LOSSES IN FEEDING VALUE, AND A SCHEME TO PREVENT THEM.

By OSCAR ERF, formerly of the Kansas State Agricultural College, now Professor of Dairying at the Ohio State University, Columbus.

There is a marked degree of increase in production between the western alfalfa and alfalfa that is grown in the east. Taking average hays into consideration, this seemed rather strange, and an analysis of eastern- and western-grown hays was made. The result from a number of samples showed the western-grown hay to be more or less uniform in composition, while the eastern-grown hay varied to a great extent.

The variation in composition was always characterized by a darker color, which seemed to indicate that the hay was mow-burnt or had not been well cured. This suggested the idea that some of these hays must have been rained upon during the making process and that this was responsible for the difference in composition. Thereupon green alfalfa hay was taken and allowed to cure until dry. It was then placed in a sink under a faucet and the water permitted to rain upon or wash it for about two hours, corresponding to a heavy rainfall.

Analyses taken before the sample was washed and afterwards showed a loss of 14 per cent in protein. Determinations of the fat and ash were not taken at this particular time. Repeated analyses were made and indicated various degrees of losses, ranging from 20 per cent to as high as 52 per cent. The drier the hay and the harder it was washed, the greater was the loss in per cent of protein. A considerable amount of the ash was also washed out, usually from 4 to 8 per cent and from 2 to 5 per cent of the fat. The fat loss, however, in all the tests was rather slight.

The degree of washing represented the different amounts of rainfall, which are not uniform, and the resulting conditions corresponding to the conditions resulting from the different degrees of rainfall. Similar tests were made with clover, and the results showed the loss approximately one-half that of alfalfa hay. However, in some extreme cases as much as 34 per cent was lost, in the case of clover hay, by washing and leaching. (See "Damage," in index.)

This was sufficient evidence to lead us to believe that the difference in results might have been due to the fact that some of the alfalfa hay was made during rainy weather. However, this is not the only factor that seems to reduce the feeding value. Alfalfa hay, if not properly cured or if

cured for a long time, when put into the mow is usually mow-burnt and the loss in the center is invariably very great. Like rained hay, the loss in protein exceeded 56 per cent. The fluctuation in the loss depended upon the degree of heating.

Large areas in the center of the mow of hay, that had been mowed and supposedly well dried before it was raked, and allowed to remain in wind-rows for a day, was put up in the mow, with an average loss of 40 per cent in protein within six feet of the outside of a twenty-foot mow. This was not a uniform distance, on account of the different degrees of packing when it was put into the mow.

Most of the growers throughout the more humid regions have found it necessary to cure alfalfa hay in cocks under caps. This is probably the most desirable and most practical method of curing at the present time, but much care must be taken, for if the hay caps are too thin, so as to allow ventilation, with continued rains they will not shed the water, and consequently prevent the cock from drying out. On the other hand, if the cloth is too thick, the moisture driven off by the fermentation of the hay is held under the cap, and as a result the hay will mold.

These are factors that are difficult to control, and probably the most reliable method for curing hay is to put it under large sheds, spreading it out in thin layers, not to exceed four feet of loose hay, and leaving it until it is thoroughly dried out before mowing it away. Since the leaves are

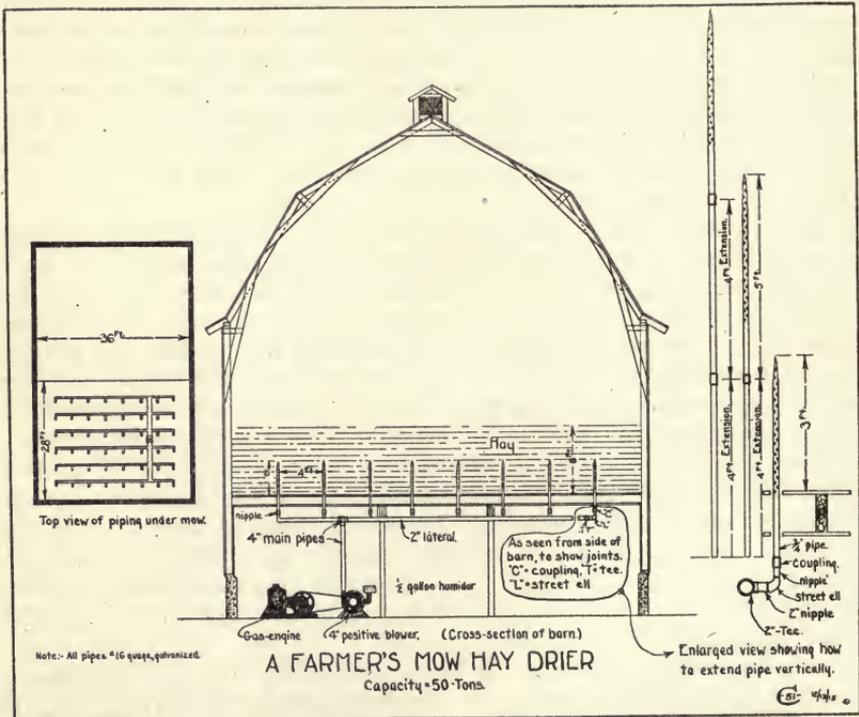

FIG. 210. The plan of Professor Erf's scheme for drying and curing hay in the mow.

the most nutritious part of the alfalfa plant and give the best results it is necessary to adopt a method by which the greatest per cent of leaves can be preserved. When the hay is dried too much in the field, and raked up and handled in that dry state, there is a great loss in the leaves, and the result is that there is largely stemmy hay, which is less palatable and less digestible.

The past year (1915) has probably been one of the most unfavorable years for the curing of hays that we have had for some time, and one which has resulted in millions of dollars loss throughout the country, on account of the improper curing of hay, especially alfalfa. With this idea in mind it was the intention to devise a scheme by which hay could be properly cured in the mow of the average good dairy barn, without destroying its nutritive value, and at the same time to have this done economically without an original great outlay of capital.

Consequently, a four-horse gasoline engine was put into operation with a pressure blower which forced large volumes of air through the hay during the day, through a perforated pipe, penetrating the floor below and escaping into the hay above. The engine was operated during the day for three consecutive days to cure out one cutting of hay, which was approximately six feet thick in the mow. This was partially dried in the field before being put into the barn, but was still very tough.

At the end of the day's run a humidor was placed at the end of the suction pipe, into which one-half gallon of formaldehyde was emptied, and was then forced into the hay, thus completely checking any fermentation that might arise during the night and at the same time sterilizing the hay. This left the hay in a very bright condition, apparently with very little loss of protein. It was considered a success from the standpoint of conserving the constituents—a fact proved by chemical determination. However, in regard to the actual feeding value no statement can be made, but there is no reason to believe that the result would be other than that obtained by chemical analysis.

It can readily be seen that this method saves considerable labor. However, it necessitates the use of gasoline; but the cost of this is less than the expense for labor to cock the hay, and the saving of the protein in the leaves is a decided economical advantage.

The probable cost would not exceed \$1.50 per ton, depending upon the price of gasoline. As nearly as can be estimated, the saving in the nutritive value of the leaves and the labor for cocking and pitching will overbalance the cost of the gasoline. There is no doubt but what the farmer who is obliged to depend upon field curing during the rainy season will be greatly benefited by the use of this apparatus.

## ALFALFA FOR SILAGE.

By J. B. FITCH,

Associate Professor of Dairy Husbandry, Kansas State Agricultural College.

During normal years the Kansas farmer has but little trouble curing alfalfa hay. The most difficulty is experienced with the first cutting which comes in the spring or early summer, when rains are quite frequent. The summer of 1915 was exceptionally wet, and in most sections of the state the first three cuttings of alfalfa were damaged by rains while trying to cure. Thousands of tons of alfalfa rotted in the field, and much of the alfalfa hay that was stacked was of inferior quality.

During summers like the one we have just experienced, and during wet periods at the time of the first cutting of alfalfa, farmers are at a loss to know what to do with alfalfa that is cut but will not cure. With the quite general adoption of the silo on Kansas farms has come many inquiries and some experiences in making alfalfa into silage. The use of leguminous crops in the silo has been practiced with more or less success in the East, but the best results have been obtained where they were mixed with corn or other carbonaceous plants. The experience at the Kansas Station and of many farmers who have used alfalfa alone as silage seems to point to the fact that alfalfa will not keep in the silo as well nor for as long a time as the more common silage crops.

When corn, cane, kafir or any like plant is cut and placed in the silo, in the absence of air, the sugars of the plant change to acids, which preserve the crop as silage, and it will keep indefinitely. In the case of alfalfa, however, the high per cent of nitrogen in the plant causes other changes, which perhaps check the action of the favorable acids, and the result is more uncertain.

When alfalfa is run through a cutter and put into a silo it acts, from external appearance, quite similar to the common silage crops. When the silo is opened, however, the results are quite different. The alfalfa changes to a dark-brown color and has a very pungent odor, which is perhaps characteristic of nitrogenous fermentation. Alfalfa silage of this nature is relished by stock, and they do well on it, but they will probably not eat as much of it as they will of corn silage.

One objection to alfalfa silage for dairy cattle is the strong odor it carries with it, which will make it objectionable to feed in the milking barn. The person who has been accustomed to feeding corn silage will be disappointed with alfalfa as a silage crop, and the same person who has fed good alfalfa hay may be disappointed in the results he gets by using alfalfa for silage.

But very little work has been done in regard to the feeding value of alfalfa silage. We would expect, however, that it would be less valuable than alfalfa hay, and perhaps less palatable. In the case of poor curing weather at the time of the first cutting of alfalfa, or during summers like the one just experienced, the silo method may prove a means of changing alfalfa that is doomed to rot in the field to good stock feed.

Under normal conditions it can be said that alfalfa is too valuable as hay to be put into the silo. Silos, which are generally empty at this time, can be filled with alfalfa silage and fed out before the silage begins to deteriorate and before the silos are needed for other crops in the fall.

In order to obtain first-hand information upon the subject of alfalfa silage, and perhaps suggest methods of improving alfalfa silage, the dairy department of the Kansas State Agricultural College has erected six 7 by 16 ft. experimental silos, and in cooperation with the bacteriology and chemistry departments is trying to find suitable and practical mixtures with alfalfa for making silage. The silos were made of  $\frac{3}{4}$ -inch

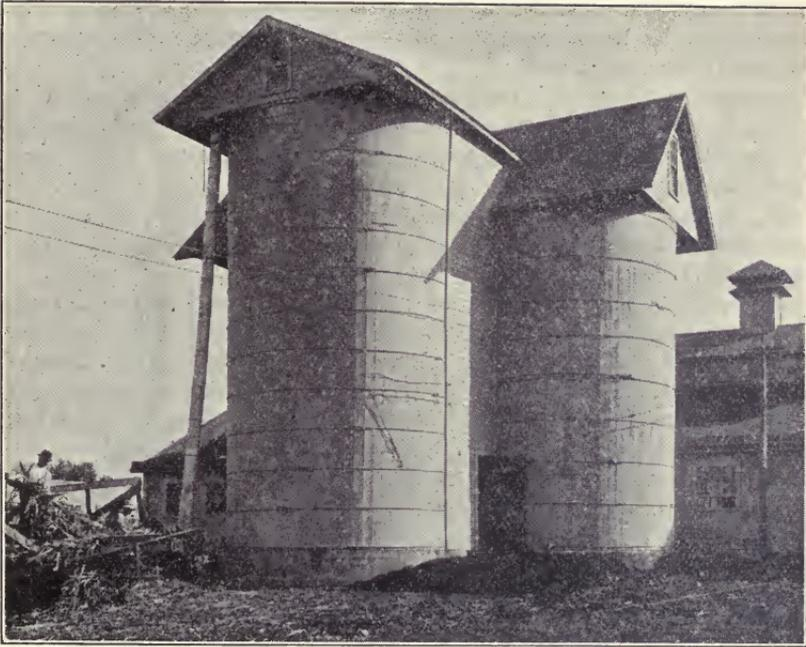

FIG. 211. The silo can be made the safeguard of the alfalfa crop.

tongue-and-groove flooring, and were built on a cement foundation. The silos were filled with first-cutting alfalfa in the following combinations in May, 1914: alfalfa alone; alfalfa and corn chop; alfalfa and black-strap molasses; alfalfa and molasses feed; alfalfa and rye; and alfalfa and straw.

The alfalfa was cut in the early bloom and was run through the silage cutter in a very moist condition. The silos were allowed to stand until January 1, 1915, a period of eight months, before being opened. The silage had all kept quite well, but was a very dark-brown color, with a very strong odor. A difference in odor could be noticed for the different mixtures. The odors were so strong that it was not considered safe to feed the silage to the dairy cattle in the milking barn.

To find the difference in palatability of the mixtures, six feed bunks were lined up in a feed lot and a different kind of alfalfa silage placed in each bunk. After trying this method several days it was noticed that the animals ate the alfalfa and molasses and the alfalfa and corn chop silage first, with the other mixtures in the following order: alfalfa alone, alfalfa and rye, alfalfa and molasses feed, and alfalfa and straw last. The alfalfa and straw made a very poor silage and was eaten very little by the stock. The alfalfa and molasses, alfalfa and corn chop and alfalfa alone were eaten most by the cattle. No comparison was made of the feeding value of the above mixtures.

As mentioned above, it is believed that sufficient sugars are not present in alfalfa to cause enough acid to be produced to preserve the alfalfa at its best. The object in adding carbohydrates is to bring this about, and it seems to have accomplished the desired result in the case of corn chop and molasses at least.

In the spring of 1915 the silos were again filled with mixtures of alfalfa. The silos had previously been painted on the inside, and after filling the silos weights were placed on top of the silage to insure packing. The following mixtures were used in 1915: alfalfa alone, alfalfa and corn chop (10 to 1), alfalfa and blackstrap molasses (10 to 1), alfalfa and blackstrap molasses (20 to 1), alfalfa and rye (2 to 1), and alfalfa and cane butts (6 to 1).

When these silos were opened the last week of December, 1915, the silage was found to be in excellent condition. As in the previous test, the mixtures had certain peculiar odors, and, as before, the alfalfa alone had the most pungent and offensive odor. The odors of the mixtures were more nearly like the well-known silage odor. In a test to determine which mixture was liked best by cattle it was found that the alfalfa alone was eaten less than any of the mixtures with alfalfa. There could be but little difference noticed between the five mixtures mentioned above. A slight preference seemed to be in favor of the one-to-twenty mixture of molasses and alfalfa, with the one-to-ten mixture second, and the mixtures of cane butts, corn chop and rye following in the order named.

In choosing the above mixtures the object has been to select combinations that would be practical and could be easily obtained on the farm at the time the first cutting of alfalfa is ready. From the above it would seem that one would be justified in using mixtures of blackstrap molasses, corn chop, rye and cane butts mixed with the green alfalfa for silage.

The corn chop used above was soaked in water a few hours before being mixed with the alfalfa as it went through the cutter. The rye used was planted early in the fall and used as pasture during the winter and spring, and then allowed to grow until it reached the milk stage, when it was cut and run through the silage cutter with the alfalfa. The cane butts used were from a crop of cane that had been headed for seed the previous fall. Kafir and corn fodder could no doubt be utilized in this way if protected during the winter. The blackstrap molasses can be diluted and run into the blower during cutting, or when very thick can be added to the alfalfa as it goes into the cutter.

An interesting example of the use of what might be called alfalfa

silage is the method of caring for alfalfa on the V. V. Akin farm, near Manhattan, Kan. Mr. Akin generally has on hand a large number of steers. Some are sold from grass and others are full fed during the winter. The steers that are full fed during the winter months receive alfalfa silage along with cottonseed meal, corn, and oftentimes molasses feed. This so-called alfalfa silage is made by cutting the hay as soon as any bloom appears. If allowed to come to full bloom before being cut it becomes hard and does not make good silage by this method. After mowing the alfalfa is immediately raked into windrows and then stacked while in the green condition. If any of the alfalfa becomes dry it is cured for hay. The stacks are made round, about 25 to 35 feet in diameter and 20 feet high. Round stacks are preferred on account of having less outside surface than rectangular stacks, and they also cut down the amount of spoiled material that would be found at the corners. When the stacks are made they are generally covered with old hay, fodder, manure or other cheap material and allowed to stand.

Upon standing the stacks gradually settle into very compact masses. The exposed hay dries and the outside appears as any stack does upon standing. Inside this six- or eight-inch outer coating of alfalfa hay will be found six or eight inches of charred and moldy alfalfa, which perhaps forms the seal to the stack, just as the rotten portion at the top of the silo keeps the silage from spoiling. On the inside the alfalfa is found with a dark-brown color and characteristic odor, which resembles alfalfa silage in every way, with the exception of not being cut into short lengths. Mr. Akin states that the hardest work of the whole method is in getting the alfalfa out of the stack. The feed is taken from the top and is generally packed very hard. It can not be cut with a hay knife, and it is impossible to get it out with a fork. Thus far a good sharp axe has been most satisfactory in getting the feed out. Steers eat the feed greedily, and even the dry and moldy parts on the outside are eaten without any loss. During the ten years that Mr. Akin has been using this method of handling alfalfa he has full-fed thousands of cattle, and has always found it a most satisfactory feed. He prefers alfalfa in this condition to alfalfa hay. At present they have 150 acres of alfalfa on the Akin farm, and when they start putting up the crop they do not stop unless the fields are in too soft a condition for the teams. In a few cases dry hay has been placed on partly made stacks of green alfalfa without any bad results. In Mr. Akin's experience he has never lost a stack by spontaneous combustion, and he attributes this to the rule he follows of either stacking the alfalfa very wet or in a perfectly dry condition. The stacks are generally fed out after standing six or eight months. At present Mr. Akin has two stacks of alfalfa silage, which he estimates will contain about 400 tons each.

This method of making silage has been used by other men in the state, but Mr. Akin is, perhaps, the most extensive user of alfalfa silage in Kansas. If equally as good silage can be made by stacking the alfalfa as putting it in the silo the stack method would be cheapest. It has been Mr. Akin's experience, however, that small stacks are not a success, and for the farmer with a small amount of alfalfa for silage it is best to run it through an ensilage cutter and put it into the silo. The

small stacks do not cause enough pressure to be exerted thoroughly to exclude the air.

It would seem from what has been said above that by either putting alfalfa in the silo or by stacking it green the handling of the crop can be made a more certain operation, and a farmer is less dependent upon the kind of weather he has for making hay. (See "Silage," in index.)

---

## A DAIRY FARMER'S ESTIMATE OF ALFALFA SILAGE.

By H. F. MEILLER, Minneapolis, Ottawa county.

Under ordinary conditions the making of alfalfa into silage is not profitable. A ton of good hay is ordinarily worth \$10 on the farm where it is produced. Since by careful test it has been learned that it takes 5000 pounds of green alfalfa to make a ton of hay, a ton of alfalfa silage costs a little over \$4, as the putting of a ton of green alfalfa into the silo costs a little more than the handling of the 800 pounds of hay it would have made. It is easily determined that it is more economical to use cane, kafir or corn in the silo, as a very much larger tonnage per acre can be secured. This season part of an upland field yielded 3½ tons of alfalfa hay per acre, and the other part yielded 17 tons of cane silage per acre.

On this farm dairying is the main business. As the land is worth \$170 per acre pasture is out of the question. Soiling is expensive, not always practicable nor always profitable. For a cow to do her best part of her ration must be succulent as well as nutritious. Silage is one of the most inexpensive of the succulent feeds. When the silos are emptied, before the succeeding corn and cane crops are ready, we use alfalfa silage. We have done this a number of times, with less expense and better results than by soiling. We have used all cuttings except the last, and have not been able to detect any difference in the quality of silage produced by the different cuttings.

The alfalfa is cut for silage when in proper stage to cut for hay. The rake follows the mowers and the green alfalfa is hauled at once to the silo. We put it in the silo without running it through the cutter. This materially lessens the cost of filling. We are extremely careful in spreading the alfalfa evenly, so as to insure even settling and to avoid "pockets." It is also well dampened when put in, which aids very much in getting it tramped in tightly.

Fermentation begins within twelve hours and progresses rapidly. The silage may be fed after thirty-six hours without danger of bloat.

In color alfalfa silage is a light brown, nearly tobacco-colored, has an agreeable odor, and is relished by the stock. If fed outside it should be fed in racks instead of bunks, so as to avoid waste.

According to reliable authority, alfalfa does not make as good silage as many other crops that are used for silage, as it is lacking in sufficient sugar to produce the proper fermentation. However, we have secured better results from alfalfa silage than from any kind used, but not enough better to warrant its use in place of the crops ordinarily used. (See "Silage," in index.)

## ALFALFA SEED PRODUCTION.

By C. C. CUNNINGHAM,

Assistant Professor of Agronomy, Kansas State Agricultural College.

Alfalfa is one of the most profitable forage crops when grown under conditions to which it is adapted. The acreage is rapidly increasing, not only in the western states, but in the eastern part of the United States, where the farmers are rapidly learning how to grow alfalfa under conditions not naturally adapted to the crop. Because of the gradual increase in acreage, and due to the fact that alfalfa has to be re-seeded every twelve years, on the average, the production of alfalfa seed must necessarily be an important industry.

The United States does not produce sufficient alfalfa seed to supply the domestic demand, and several million pounds are imported annually. The indications are that the demand for alfalfa seed will exceed the domestic supply for years to come, and that this industry will continue to be a highly profitable one under conditions adapted to the production of seed. Portions of Kansas are well adapted for growing alfalfa seed.

### FACTORS CONTROLLING THE PRODUCTION OF ALFALFA SEED.

Alfalfa seed production is governed to a greater extent by seasonal conditions than any other crop. In fact, seed can be successfully produced only when a certain combination of climatic and soil conditions prevail. These factors can not be controlled by the grower except under irrigation, where the moisture content of the soil can usually be regulated to suit the requirements of the crop.

In Kansas the seasons may or may not be favorable for a seed crop of alfalfa, and the amount of seed produced annually varies greatly. Under favorable conditions a considerable acreage of alfalfa is permitted to "go to seed," while in unfavorable years seed production may be confined entirely to limited areas in western Kansas, where conditions are normally suitable for growing seed. Even in this part of the state conditions are not always such that seed can be produced. It is very important that the growers thoroughly understand the factors influencing the production of alfalfa seed in order that they may be able to take advantage of opportunities to grow a crop and to avoid losses usually sustained in endeavoring to produce seed under conditions that are not suitable.

### STAND.

The thickness of the stand of alfalfa often influences the yield of seed. Comparatively thin stands may produce more seed than thick ones. When the stand is thin the individual plants have an opportunity to produce numerous seed branches and a corresponding heavy "set" of seed pods results. In the case of thick stands most of the seed pods form on the top branches, as the other portions of the plants do not make seed, due to lack of sunlight, and perhaps to failure of the flowers to become fertilized. Where alfalfa is grown primarily for the production of seed a thin stand should be preferred to a thick one.

## CLIMATIC AND SOIL CONDITIONS.

Climatic conditions are probably the most important factors in growing alfalfa for seed. Hot, dry weather during the time the plants are blossoming is necessary for best results. Conditions of drouth and heat that produce a somewhat stunted growth of the alfalfa plants usually favor seed production, while conditions that result in a rapid and luxuriant development of foliage are unfavorable. Good seed crops are rarely produced in Kansas when seasonal conditions are favorable for the production of good crops of hay throughout the year. Climatic conditions may be suitable for a seed crop of alfalfa, but if the soil contains an abundance of moisture too rank a growth of alfalfa may result. The soil should contain sufficient moisture to insure a fair growth of the alfalfa plants, but not enough to start new shoots when the alfalfa begins to blossom. Occasionally the soil may become too dry to even produce alfalfa seed.

## FERTILIZATION OF THE BLOSSOMS.

Honey-gathering insects appear to have an important part in causing the fertilization of the flowers or the "setting on" of alfalfa seed. This legume produces flowers that are dependent on some foreign agency to bring about fertilization. The flowers are perfect; that is, both the pollen and the pistil are produced in the same blossom, but they are so arranged that certain parts of the flower have to be released before the pollen comes in contact with the pistil, thus causing fertilization to take place. The process of releasing the flower parts is known as "tripping." Tripping is usually caused by honey-gathering insects coming in contact with the flower parts, but it may be accomplished artificially by inserting a pointed object into the flower or by pressing the flower between the thumb and finger. Ordinarily the presence of honey-gathering insects is necessary to insure a good crop of seed, although there may be other agencies that cause the "tripping" of the blossoms. As a rule, the alfalfa flower is cross-fertilized, the pollen being carried from flower to flower by insects, but it is able to "set" seed when self-fertilized.

## WHICH CROP TO LEAVE FOR SEED.

In Kansas the second or the third hay crop is left for seed, depending on the season and the locality. In the western portion of the state the seed is usually produced from the second cutting, while in central and eastern Kansas the third cutting is most often utilized for this purpose. Good seed may be produced from any one of the season's crops, providing soil and weather conditions are suitable. As a general rule the crop that would otherwise be the next to the last cutting of hay is the most practical one to leave for seed. The time required to produce a crop of seed is about the same as that for two cuttings of hay. When the seed crop is produced the latter part of the summer the chance of losing part of the growing season for the production of hay is greatly lessened. Alfalfa that has made a crop of seed usually does not produce a satisfactory cutting of hay, in that its normal function for the season has been performed after seed has been produced. Climate and soil condi-

tions are normally more favorable for seed production during the last half of the season than during the first part, and this is the most important reason why the later cuttings of alfalfa are usually left for seed.

#### WHEN AND WHERE NOT TO LEAVE ALFALFA FOR SEED.

Profitable seed crops of alfalfa are uncertain, especially in central and eastern Kansas. At best the grower is taking chances in leaving alfalfa for seed, since conditions that are favorable for seed production may suddenly change, making it impossible to obtain a profitable crop. It is important that the grower be able to determine as early as possible whether or not there will be secured a seed crop sufficiently heavy to warrant losing the two crops of hay that would otherwise be obtained. The appearance and the development of the alfalfa plants are the best indications on which to base judgment regarding seed production, soil and climatic conditions being favorable. If medium-sized stocky plants with numerous branches have been produced, which blossom heavily within six or seven days after the first flowers appear, and no heavy rains occur during the blooming period, the chances of obtaining a heavy yield of seed are good. The grower should always watch the alfalfa closely while it is flowering to note whether or not the blossoms have fertilized properly. If fertilization fails to take place the blossoms will drop off in a short time, while if the flowers fertilize as they should the petals dry and remain on the stem for a few days.

If excessive rains fall before the seed crop is well along towards maturity it is usually best to cut the alfalfa immediately and get the crop off of the field in order to give the next cutting of hay a chance to start, since under these conditions the hay will probably prove more profitable than the seed.

Probably the best indications that a satisfactory crop of seed will not be produced is the starting of new shoots from the alfalfa crowns. If these new shoots develop abundantly at the time the alfalfa is, or should be, blooming, the crop should be cut for hay by all means.

#### WHEN TO HARVEST FOR SEED.

The alfalfa pods do not set on and ripen uniformly, and therefore pods in all stages of development may be found on the same plant. Individual plants also vary in maturity. It is impossible to cut the crop at a time when all the seed can be saved. If the late pods are allowed to mature the early ones will probably have become overripe and some loss of seed will occur from shattering.

The best results can ordinarily be obtained by cutting the crop when from two-thirds to three-fourths of the seed pods have turned brown. The seed in the pods that vary from a light brown to nearly green may produce seed that is viable, although it will not be plump. As a rule, it is better to cut the alfalfa a trifle green than to let it become overripe. In the latter case considerable loss of seed from shattering will likely take place in handling the crop, while if the alfalfa is cut a little too early very little if any shattering will occur if the crop is properly handled under favorable conditions. The loss of seed from shattering due to its becom-

ing overripe, and the risk involved by damage from unfavorable weather, will more than offset the loss from immature seed where the alfalfa is cut slightly green.

#### HARVESTING THE SEED CROP.

Most of the alfalfa grown in Kansas for seed is cut with a mower and raked into windrows in much the same way as for hay. This method of handling the crop is not entirely satisfactory, but is employed because of a lack of more suitable implements. Where the mower is used without attachments some seed is shattered by the tramping of the alfalfa by the horses, by the mower wheels running over it, and by raking the crop into windrows. Loss from this cause may be avoided by using an attachment to the sickle bar which removes the swath to one side. Such an attachment is known as the "swather," and it can usually be used to a good advantage. An old-fashioned self-rake reaper is a satisfactory implement for cutting seed alfalfa. This machine leaves the crop in bunches, which are dropped to one side, and the tramping of the alfalfa is avoided. The grain binder is sometimes used for cutting the seed crop of alfalfa.

Where bunching implements are used for harvesting, the alfalfa should be put in shocks to cure soon after it is cut. If cut with a mower it is necessary to rake the crop into windrows for bunching, and this operation should be done before the alfalfa becomes dry. Where the other implements are employed in cutting the crop best results are secured by putting the alfalfa in the shocks so that they can be loaded onto the wagon in one forkful, as the pulling apart of the shocks results in some loss of seed by shattering. In handling seed alfalfa previous to threshing as much of the work as is possible should be done when the crop is slightly damp.

As soon as the alfalfa in the shocks becomes thoroughly cured it should be threshed, or if a machine is not available within a short time it will pay to stack the crop. Exposure to frequent rains results in considerable damage by discoloring the seed and by shattering. Discolored and weather-stained seed commands a lower price than that which is good in color. The alternate wetting and drying of the pods will often cause them to burst and scatter the seed. The longer the alfalfa is exposed to the elements the more readily the seed shatters and the pods drop off. Therefore, the maximum amount of seed will be obtained by stacking or threshing the crop as soon as it is fit after harvesting.

#### STACKING AND THRESHING THE SEED.

Care should be taken to see that the alfalfa is thoroughly cured before it is stacked, in order to prevent heating while in the stacks, as the heating would result in destroying the vitality of the seed. In hauling the alfalfa to the stack, tight-bottomed racks or racks covered with canvas should be used. This applies equally well to hauling alfalfa from the field to the threshing machine or huller. Much of the seed will shatter off regardless of the care exercised in handling the alfalfa, and if racks with tight bottoms are employed in hauling the crop a large per cent of the shattered seed can be saved. If old hay, straw or similar material is available it can be profitably utilized as a stack bottom, thus avoiding the loss of considerable seed which would otherwise be spoiled by the

lower portion of the stack absorbing moisture from the ground. Similar material should be used in topping out the stack. Alfalfa straw from which a seed crop has been produced is poor material to shed water, and if heavy rains occur much seed will be damaged because of the rain absorbed by the stack. Old hay, millet or sorghum hay makes a much better stack top than alfalfa, and it can be profitably used in a covering for a seed-alfalfa stack. In the absence of these or similar materials a canvas stack cover can be used to a good advantage.

The alfalfa huller is the most satisfactory implement with which to thresh alfalfa. However, very few of these machines are available in Kansas, and it is only in limited sections that the purchase of an alfalfa huller is warranted. An ordinary threshing machine with a hulling attachment does good work when the machine is properly operated. Best results are obtained by threshing during dry cold weather, as alfalfa is most brittle at that time. Alfalfa can be threshed satisfactorily at any time when conditions are dry, but threshing should be avoided if possible during damp, humid weather, as the straw is tough under these conditions and the seed will not thresh out readily.

#### HANDLING THE SEED.

Threshing machines and hullers very rarely clean the alfalfa seed thoroughly, and in order to obtain seed that will command the highest market prices, recleaning is necessary. Very often the increase in price received for the seed will more than pay for the extra work in recleaning it. However, very few growers have the necessary equipment for grading alfalfa, and unless the amount of seed on hand is considerable it may not be practical to invest in a machine for this purpose.

Alfalfa seed when properly stored will keep for several years without any material deterioration in the vitality of the seed. Growers who obtain an occasional crop can hold over seed for their own use for several years without any fear of the seed becoming devitalized. Growers can also take advantage of this characteristic and hold seed for a year or two for better prices, during periods of abnormal production. (See "Seed Crops," in index.)

---

## ALFALFA IN ROWS FOR WESTERN KANSAS.

By W. A. BOYS, District Agricultural Agent, West Central Kansas, Hays.

Rowed alfalfa for western Kansas is not recommended as a "bonanza" crop. However, on dry upland it can be substituted for alfalfa planted in the ordinary manner, and several divide-land farmers in west central Kansas have found it to be as profitable as any other crop they can grow. One of the great needs of this part of the state is a leguminous crop which can be fed with the sorghum crops that are grown in such abundance. By growing alfalfa in this way a more nearly balanced ration will be grown on the farm, and the farmer can produce beef, milk or pork more economically than is done at the present time.

Five or ten acres of rowed alfalfa will pasture as many hogs as the average-farmer will try to grow. It will not require a large amount of alfalfa hay to feed a few brood sows and pigs during the winter months,



FIG. 212. Rowed alfalfa in full bloom.

and it will greatly reduce the amount of grain required. Ten or fifteen tons of alfalfa hay, in addition to the other rough feeds produced, will be a very material help to the dairy cows during the winter.

In this part of the state rowed alfalfa has not been profitable from a seed-production standpoint. What it may do in this line in the next few years remains to be seen. None of the fields under observation have been seeded longer than four years.

It can not be expected that any crop will grow satisfactorily without moisture, but alfalfa has proved to be one of the most drouth-resistant legumes that has been tried on the divide land in this section of the state. In 1913—perhaps as dry a year as western Kansas has ever witnessed—two men report yields of one ton of alfalfa hay per acre from rowed alfalfa.

Cultivation and fewer plants in a given area evidently have helped materially in the production of this crop in very dry seasons.

#### PREPARATION OF THE SEED BED.

The principles that apply to the preparation of the seed bed for broadcasted alfalfa will apply to the seeding of rowed alfalfa. At least two different methods of preparing the ground have been followed, and each with success. There are at least three difficulties in getting a stand of alfalfa, and one should bear these in mind and use his best efforts to overcome them. Perhaps the greatest of these is weed growth. Unless the weeds are fairly well subdued there is little use in seeding alfalfa, as the young plants will soon be smothered. For the destruction of weeds, as well as for other reasons, the preparation of the ground should begin in the early spring. Weeds should be allowed to start in the

spring, and then the ground should be double-disked. It will be well to wait a while for more weeds to start, after which plow the ground from six to eight inches deep, depending on the amount of moisture present. Then work the soil down to a good, firm seed bed, taking care always to keep it rough enough so that soil blowing will not occur.

#### SEEDING.

One may be successful in getting a stand of alfalfa by either early or late seeding, but for average conditions the last of May or first of June will be a desirable time to seed. This will give opportunity to destroy weeds and get the soil worked down to a good, firm seed bed. Grasshoppers at this time will not give as much trouble as with later seeding. The grain drill, lister and garden drill have all been used with success, so it would probably be best to use whichever tool one may happen to



FIG. 213. Rows thirty-six inches apart can be cultivated satisfactorily.  
[Courtesy North Dakota Experiment Station.]

have. With most grain drills it will be advisable to mix bran with the alfalfa seed in about the proportion of two parts bran to one of alfalfa seed. By this means you will be able to get the seed sufficiently thin. If the lister is to be used it is best to drill special holes, not larger than one-fourth inch, in a blank plate.

Rows thirty-six inches apart can be cultivated satisfactorily and will usually give the best results.

Two pounds of good seed per acre is sufficient for a good stand, and with favorable weather it is possible to get a stand with a smaller amount. The seed should be covered about one-half inch deep and the soil left as nearly level as possible to avoid covering of the young plants by dashing rains. Heavy, dashing rains often cover up the young plants or

crust the soil so that they can not break through. In such cases the ground should be worked, to kill the weeds that have started, and reseeded at once.

#### CULTIVATION.

The cultivation of rowed alfalfa is very similar to that of any rowed crop. It is important to have the ground free from weeds before seeding, so the alfalfa plants will have time to grow to a size convenient for cultivation before it becomes necessary for this operation. For the first cultivation a harrow-tooth garden cultivator will be found to be a good tool. If this is not at hand a six-shovel cultivator may be used—the smaller the shovels the better. Sufficient cultivation should be given to keep down weeds and conserve the moisture. After the crop is once established two or three cultivations for the season should be sufficient. Cultivations early in the season are most important. If the weeds are thoroughly killed at that time they will not give so much trouble later.

It is well to use a harrow occasionally after the cultivations, running it across the rows, so as to level the soil as much as possible. If this is not done the loose soil will give trouble by getting in the sickle and the hay.

#### HARVESTING.

Harvesting is done with the mowing machine. This does the work fairly well, but when the alfalfa plants are spreading in growth the machine will not get quite all the lower branches. Extension guards



FIG. 214. A mowing machine with dropper attachment in operation in a field of rowed alfalfa. Extension guards, that extend out farther than the regular guards and pick up the lower parts of the alfalfa plants, are useful in harvesting alfalfa in rows.—[Courtesy U. S. Department of Agriculture.]

that extend out farther than the regular guards and pick up the lower parts of the alfalfa plants can be obtained from implement dealers.

The first season will seldom yield a hay crop, but the alfalfa is usually cut once and left on the ground to protect the soil and prevent drifting.

This year (1915) yields that have been reported run from two and one-half to three tons per acre for the season (three cuttings). Mr. W. E. Young, of Wallace, obtained from his oldest stand of alfalfa two hay crops and one seed crop. Ordinarily one hay crop and one seed crop or two hay crops are all that might be expected, and in very dry years one crop is probably all that will be obtained. The following gives some of the methods used by a few men who are growing rowed alfalfa:

Mr. J. H. Flora, Quinter, plows his ground eight inches deep in the spring, after weeds have started, and then works the soil down with the harrow to a firm seed bed. The alfalfa is seeded the last of May. Mr. Flora first used the grain drill, but this left the seed in small furrows made by the discs, and heavy rains which fell soon after the young plants were up completely destroyed the stand. A garden drill was then used with very satisfactory results. This left the ground more level and the seed was not covered so deeply. With two men and two garden drills eight acres per day were seeded in 36-inch rows. The preceding crop was potatoes. Mr. Flora has fifteen acres of rowed alfalfa and expects to have much more.

Mr. A. Yale, Grinnell, first gives his field a top-dressing, during the winter, of three tons of sheep manure per acre. The ground is plowed six inches deep in the spring and worked down to a good, firm seed bed with the harrow. Seeding is done the last of May or the first of June, using the grain drill for seeding. Rows are thirty-six inches apart. Mr. Yale has eight acres of rowed alfalfa and expects to seed forty acres more. He obtained three cuttings this season (1915), yielding nearly three tons per acre.

Mr. W. E. Young, Wallace, prefers corn ground for seeding rowed alfalfa. He lists the ground early in April and harrows the ridges after each rain till the last of May. He then splits the ridges, running the lister about four inches deep and the subsoiler one-half inch deep. Mr. Young has had good success in securing a stand by this method. Some farmers in his county have complained that the rabbits eat the alfalfa crowns and destroy the stand. Mr. Young has had no trouble from this source, as by listing the crowns are covered with soil and the rabbits are unable to get to them. To level the ridges Mr. Young uses a weed cutter with knives, followed with the harrow, and once with the shovel cultivator.

From the results that have been obtained by these farmers it would seem well worth while for others in the western fourth of the state to try a few acres of rowed alfalfa, but do not expect too much of the crop at first.

---

At present prices forty acres of alfalfa would keep an ordinary family in good circumstances year after year. I think it the most profitable crop we can raise. If it gets the proper culture it will not die out in a long time. It helps to enrich the rest of the farm, especially if fed to stock and the manure is put back on the land. I have built up two worn-out farms with it.—*A Brown county correspondent.*

## IRRIGATION OF ALFALFA.

By H. B. WALKER, State Irrigation Engineer, Kansas State Agricultural College.

### ESSENTIALS FOR ALFALFA.

Experience in the growing of alfalfa indicates that this valuable legume thrives best in a rich, deep, well-drained soil, where there is an abundance of sunshine, comparatively high summer temperatures, and a well-regulated moisture supply. Where irrigation can be practiced the western part of Kansas affords these essential conditions. The deep, loamy soils of this region have unquestioned fertility, sunshine is abundant, and the summer temperatures average rather high. Quite naturally, however, where sunshine is so abundant moisture by natural precipitation is often lacking. This is true of a considerable area in Kansas. Much of our otherwise naturally best-adapted land for the culture of alfalfa must be artificially supplied with moisture to produce paying crops of this legume. It is only natural that our principal irrigated crop should be alfalfa.

### KANSAS IRRIGATION.

Irrigation in Kansas has never been extensively practiced, due largely to the fact that our watercourses have never furnished an ample water supply for gravity irrigation systems. Within the past ten years, however, very rapid and satisfactory progress has been made in pumping from wells for irrigation. The development of the immense underground water supplies which are known to underlie such a great part of this territory is destined to be an important factor in western Kansas alfalfa production. While it is not probable that extensive areas of this underflow district will be developed in the near future, the experiences of the practical irrigation farmers so far indicate that all the desirable alfalfa land in the shallow-water regions can unquestionably be economically developed, and encouraging results obtained in the deep-well districts give promise of the development of comparatively large areas of the uplands.

### REQUIREMENTS FOR SATISFACTORY IRRIGATION.

A very desirable and essential condition for satisfactory and successful irrigation is a smooth surface with a uniform slope. Kansas land which is subject to irrigation is usually fairly smooth, but even under the most favorable conditions it is hardly probable that a single field can be found which will not require some leveling before satisfactory irrigation can be carried out. A rough, uneven surface permits the water to collect in pools at some points, thereby resulting in injury to the crops and the wasteful use of the water; in other places too little water will reach the land, and the crops will accordingly suffer from lack of moisture. Where both water and land are cheap uneven surfaces might be irrigated without complete failure, but the Kansas farmer must fully appreciate the value of the correct spreading of the water at the outset; otherwise he is sure to meet with failure. Generally speaking, pumped water is more expensive than water taken from a canal. The pumped irrigation water

in Kansas is no exception, for lifting water requires power; power costs money. Consequently, waste of water is a waste of money. Alfalfa is the most profitable irrigated crop, but the margin of profit is measured very largely by the economy with which the water is applied.

REASONABLE PREPARATION NECESSARY.

It is evident, therefore, that successful irrigation depends upon a reasonable preparation of the land to receive the water. Alfalfa is a "long-time" crop; that is, it does not require frequent reseeding. This permanency of the crop renders it highly important that the field should be placed in the very best possible condition before seeding. The farmer can not afford to leave his land in a poor condition to receive the water, as this would mean not only the inconvenience and inefficiency of irrigation for a single season, but for a period of perhaps fifteen or twenty years. Small losses collectively make large ones; accordingly the little details in land preparation must not be neglected.

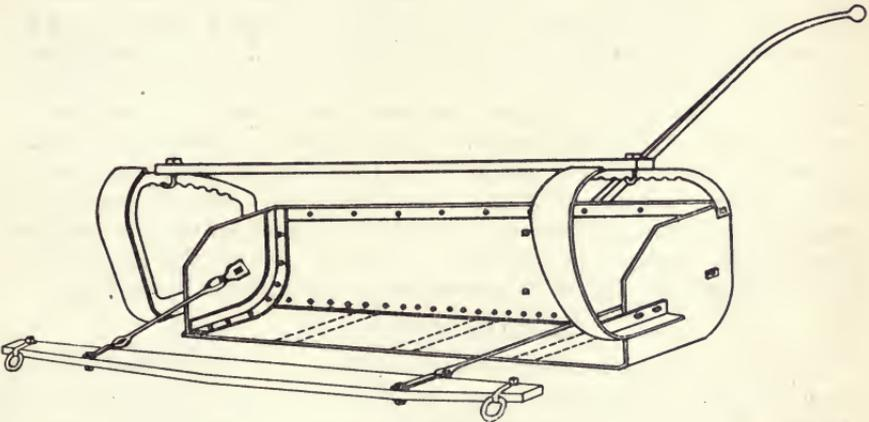
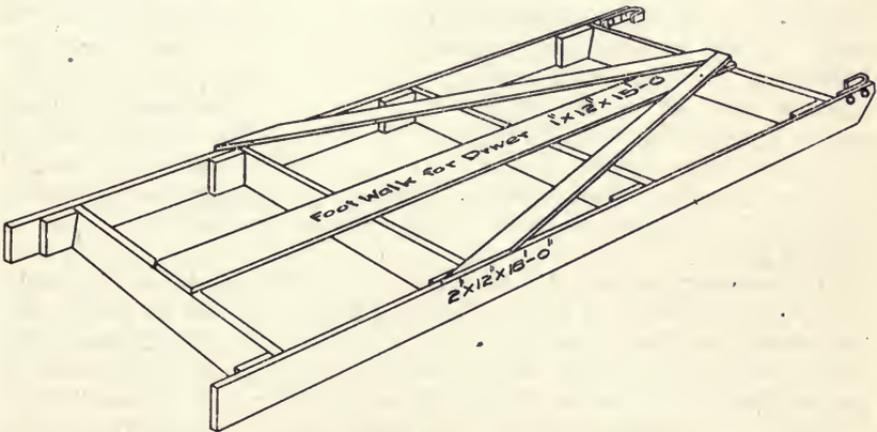

FIG. 215. Fresno scraper.  
[Sketch made from cut in U. S. Department Bulletin 373.]



LAND LEVELER

FIG. 216. Land leveler or float.

## PRELIMINARY PREPARATIONS.

The first step in the preparation of a field for irrigation is the removal of any dry or bulky vegetable matter. The entire field should then be carefully surveyed by a competent engineer or surveyor, to determine the relative slope of the land as well as the high and low places. Such a survey will enable the owner to estimate roughly the quantity or amount of leveling necessary. Not an uncommon method of leveling practiced by the inexperienced is to turn the water over the field and let it seek its level. This, however, is a crude, expensive, and sometimes misleading method, and should never be practiced where pumping is necessary. An engineer with his leveling instrument, in a few hours and at a fraction of the cost, can give the farmer more information than could be secured by "water levels" in several days.

## LEVELING WITH SCRAPERS.

Where the ground surface is very uneven the higher places must be scraped off and the dirt carried to the depressions. For such leveling the Fresno scraper is convenient and efficient. These scrapers are made in various sizes suitable for two- or four-horse teams, and are filled or loaded in much the same way as the ordinary "slip" scraper. They have, however, a wider bit and greater capacity, and when filled they may be conveniently hauled to the low places and emptied. These scrapers when dumped do not deposit the earth in a lump but smooth it out evenly. (Fig. 215 shows a cut of one of these scrapers.) Wheel scrapers are sometimes used for the same purpose, but on account of the low first cost, as well as the efficiency in operation, the Fresno scraper is more generally used and is better adapted to the smoothing of land for irrigation.

## LEVELING WITH FLOATS.

After the ridges have been lowered and the depressions filled with the Fresno scraper the surface may be finally smoothed by floating the ground. To successfully accomplish this the area must be free from dry or bulky vegetable matter, and the entire field should be plowed reasonably deep and the surface harrowed. A homemade timber float, constructed as shown in Fig. 216, is perhaps the best and simplest implement for this work. It will be noted that the float is so constructed that it will ride heaviest on its center when being drawn across a ridge, thereby collecting a quantity of dirt between the long runners. As the implement is drawn across a depression it will ride upon the ends of the runners, and the earth previously collected from the ridges will be automatically dumped in the depression. Deep plowing, thorough harrowing and systematic floating will often be all that is necessary for leveling many acres of Kansas land.

In operating the float it is first drawn on a diagonal across the field; that is, if the field has a slope east and west, and was so plowed, the float should first be drawn across the land in a northeasterly and southwesterly direction until the field is covered; then again in a northwesterly and southeasterly direction for the second floating, with a final floating in the general direction in which the water is to be carried. Three float-

ings are usually sufficient, but in some cases more will be required. In the latter case the final floating should always be in the same direction as the water will be carried across the field.

#### THE DISTRIBUTING SYSTEM.

In addition to a level surface, proper ditches to conduct the water over the area to be irrigated are very essential. The main supply ditch should of course be located upon the highest land, and from this main ditch laterals or field ditches should radiate over the alfalfa land. A well-located and carefully constructed ditch system is an important factor in the efficient application of water. The main ditch should be as direct as possible and large enough to convey the water. The size of the ditch will depend upon the slope of the land, the quantity of water to be carried, and the method of application. The usual pumping plant does not have a high capacity, consequently the main distributing ditches need not be very large. If the field has been previously surveyed the location is easily determined, and an engineer should be consulted to determine the size of cross-section of the ditches. For small quantities of water the judgment of the farmer will usually enable him to determine the required size of channel.

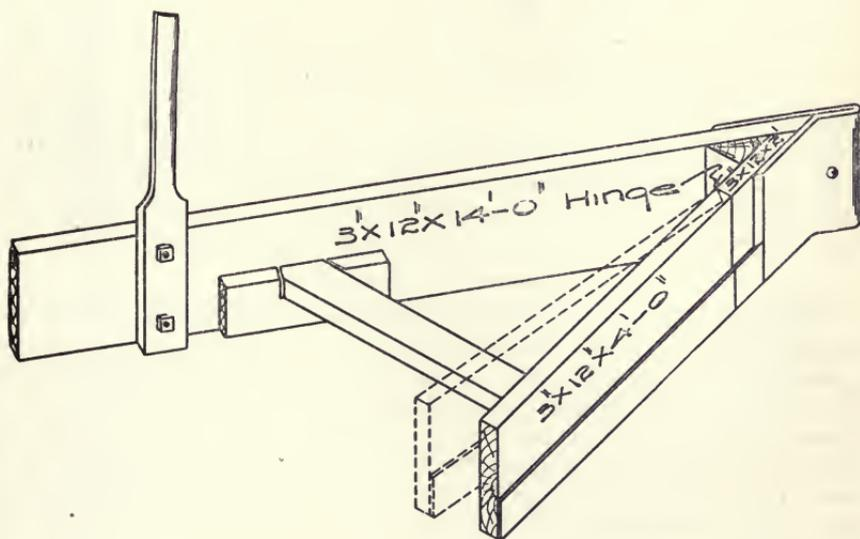

FIG. 217. Crowder used for ditch construction.

A common method of construction after the ditches have been located is to plow out the ditch line with a plow or lister. If with a plow the dirt should be thrown away from the center line of the ditch. For the irrigated section of Kansas, however, a lister is convenient. The main ditches may be constructed by plowing out two parallel lister furrows and then "splitting the middle" with a third lister furrow. In this furrow the crowder (see Fig. 217) is drawn to push the dirt out to form the

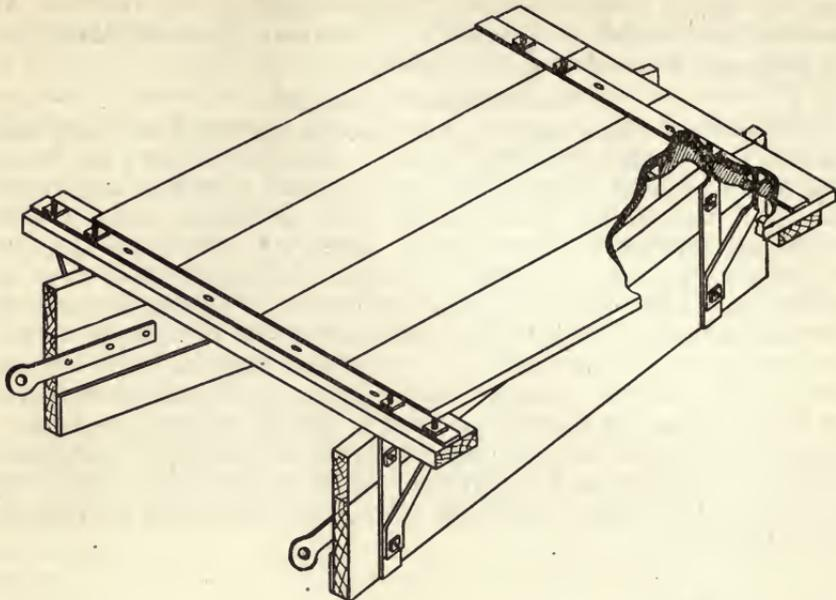

FIG. 218. Ridger for making borders.  
[Sketch made from cut in U. S. Department Bulletin 373.]

side banks of the ditch. In this manner the ditch is cheaply and efficiently constructed, and when it is completed and the water turned in the surface of the water is above the ground surface to be irrigated. Lateral ditches over the area to be irrigated may be constructed in a similar manner, but these smaller ditches may require only a single lister furrow.

#### METHODS OF DISTRIBUTION.

The location of the distributing system must conform to the lay of the land and the method of applying the water. Where the surface is on a general slope and flooding from laterals is practiced, the lateral ditches should be located, in general, with the contour of the slope, and the area between laterals is then flooded as shown by the sketch in Fig. 219. This practice is favored quite largely in the upland areas, the distance between field laterals being about 100 to 350 feet, depending to some extent upon the steepness of the slope. The land is then flooded as shown by Fig. 223.

Another method followed extensively in Kansas, and more particularly in the valley regions, is to lay out the field laterals in much the same manner as for flooding. These laterals are usually about 250 to 350 feet apart. The spaces between are then divided into checks by throwing up borders every 50 or 80 feet at right angles to the field laterals. These borders are low ridges 8 to 10 inches high and 6 to 8 feet wide. In applying the water the space between the borders, and extending from lateral to lateral, is flooded. This is known in many localities as the strip-check system of irrigation. This last-mentioned

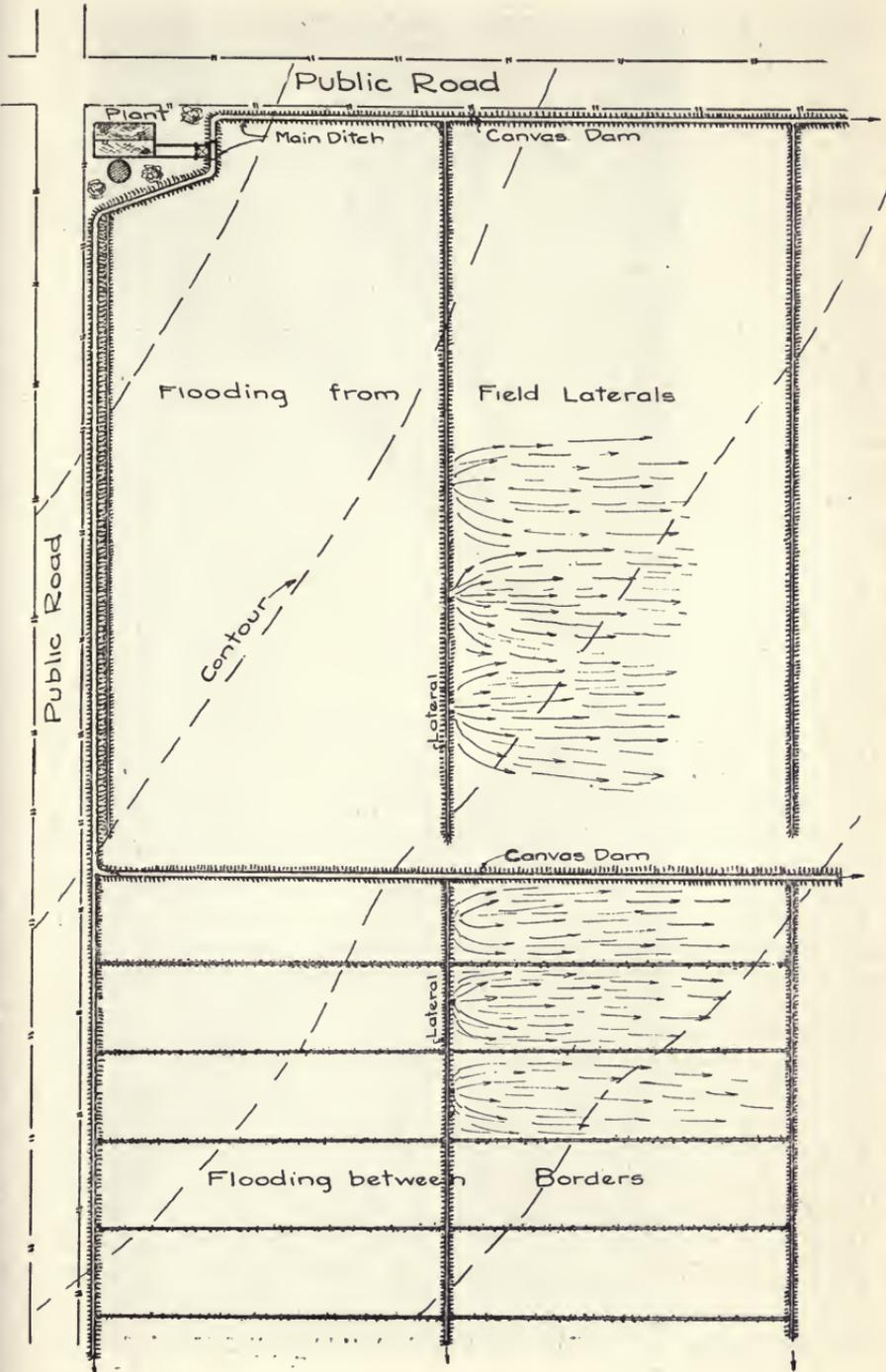
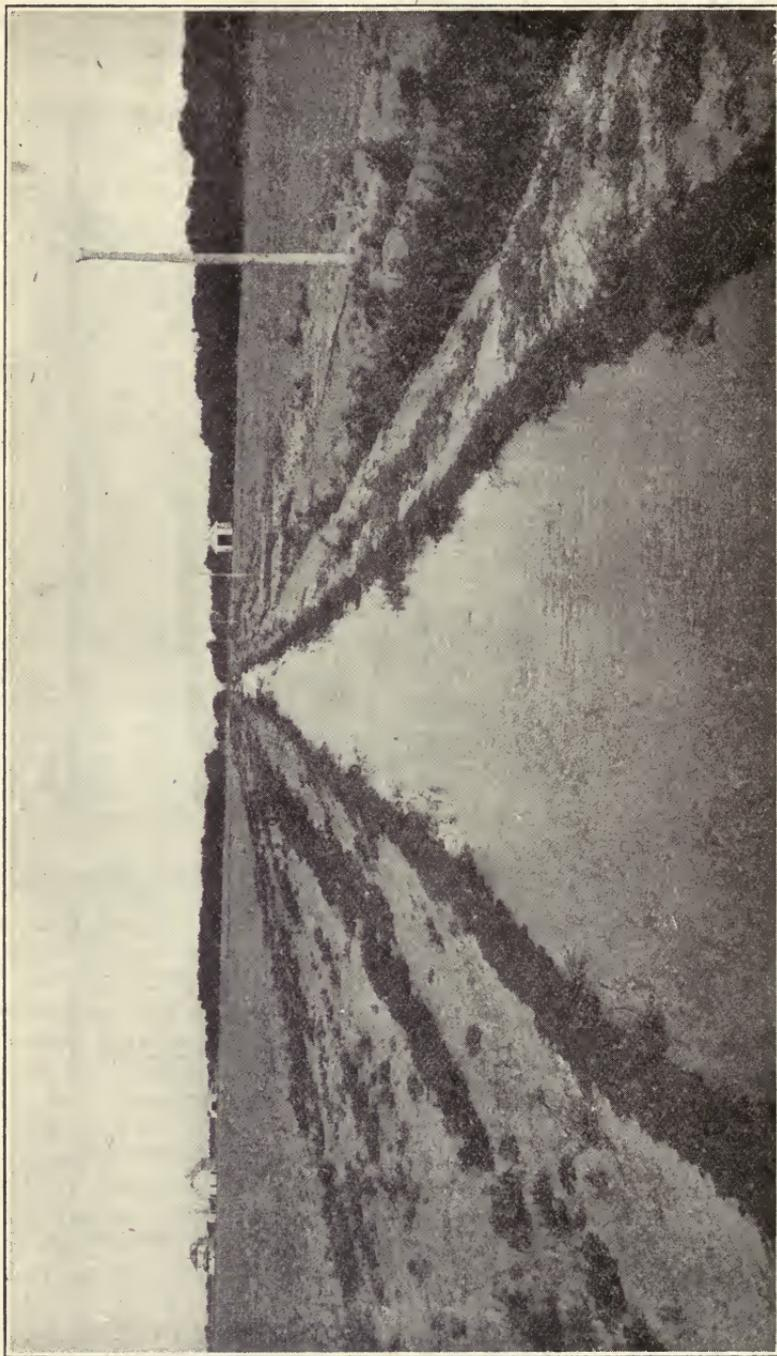

FIG. 219. Sketch showing arrangement of ditches for flooding alfalfa field laterals and also flooding between borders.



· FIG. 220. A well-constructed irrigation ditch.

system is perhaps less wasteful of water than the former, yet the cost of preparing the land is much greater. The borders may be constructed by a "ridger," as shown in Fig. 218, or with an orchard disk turned to throw the dirt toward the center.

Furrow irrigation is not used for the watering of alfalfa, but a modification of this system is sometimes used by making shallow depressions across the field in rows about two feet apart. This is known as the corrugated system. While satisfactorily and extensively used in certain western localities, this method has been but little used in Kansas.

#### PRACTICAL KNOWLEDGE.

The farmer must make a careful study of his local problems and adopt the methods best suited to these particular conditions. It is practically impossible to tell a farmer in detail how to prepare land for irrigation. Much of his knowledge must come from practical experience in the field. In Kansas the practice seems to indicate that the alfalfa should be seeded before the field laterals are constructed. In case the area should be laid off in checks by the construction of borders, these borders should be thrown up before seeding, but the laterals may be subsequently made. The alfalfa should be seeded fairly thick and drilled to a shallow depth. Immediately after the construction of the lateral ditches the entire area should be irrigated. The warm sunshine, the rich, deep soil and the irrigation water act rapidly, and a heavy stand of alfalfa is practically assured. Alfalfa seeded upon newly broken buffalo-grass sod has been known to yield three cuttings of good hay the first season. Some farmers favor a thorough irrigation before seeding, and this practice has been very satisfactory.

#### THE PROPER TIME TO IRRIGATE.

Alfalfa requires a liberal moisture supply. The general appearance of the plant is a good guide as to when water should be applied. Alfalfa has a light-green color when healthy and vigorous. If moisture is deficient the leaves darken and droop, and if irrigation is not soon practiced both stems and leaves may wither and die. The soil at all times should have enough moisture some four to six inches below the surface to cause it to stick together when pressed in the hands. Kansas practice indicates that each cutting should receive, in ordinary seasons, at least one irrigation, and preferably the time of application should be a week or ten days before cutting. Here again practice differs, since many prefer to irrigate soon after cutting, while others prefer to irrigate twice for each cutting. Perhaps the heaviest yields have been secured where two light irrigations are applied, the first one about one week after cutting and the second four to seven days before cutting. This system, however, is not extensively practiced, since many dislike to go to the expense of spreading the water twice for one cutting, and the majority seem to favor one heavy irrigation about a week before the cutting.



FIG. 221. Reasonable preparation of the land is very essential with small water supplies.

#### THE QUANTITY OF WATER TO APPLY.

The quantity of water to apply per irrigation will depend largely upon the season. Irrigation in Kansas is supplemental to the natural precipitation, consequently more water is needed in some years than others. Other factors also enter in, such as the character of the soil and the head of water used. Sandy soils require more water than the heavier loam soils. For instance, less water is required for an upland region than for the sandy valleys. In the valley districts, or sandy loam soils, about 6 inches of water is applied for each irrigation, and in some cases as much as 9 inches are used. In the upland areas 2.5 to 6 inches are applied for each irrigation. Where the alfalfa is irrigated twice about 2.5 inches are applied for each irrigation. Under extreme conditions on the sandy lands alfalfa may receive as much as 36 inches of water annually. However, under the best farming conditions in the valleys 24 inches annually should be sufficient, and in the upland areas from 12 inches to 20 inches should be ample for a season.

#### THE HEAD OF WATER TO USE.

The amount of water available for farm irrigation is known as the "head of water." A small amount is, therefore, a "small head" and a large quantity is a "high head." Where the water must be pumped the farmer must usually content himself with a small head of water, and where small heads must be utilized the greatest care is necessary in application. Irrigation water is lost by seepage, evaporation and deep percolation. When the water is applied in small quantities seepage is relatively large, a high percentage evaporates, and a considerable portion percolates so deep in the ground as to be beyond the feeding roots of the



FIG. 222. Alfalfa should grow on the ditch edges.

alfalfa plant. Where higher heads are available the water is conducted more rapidly over the surface and the losses above enumerated are accordingly diminished. Moreover, the time required to spread the water is reduced and the cost of application relatively decreased. On account of the tendency for sandy soils readily to absorb water, such areas should be irrigated with higher heads than the heavier upland regions. It is always advisable to use relatively high heads of water. For this reason large-capacity pumping plants are preferred. One thousand gallons per minute capacity will afford a water supply for nearly three times the area that 500 gallons per minute capacity will supply.

#### WINTER IRRIGATION.

The application of water to a soil outside of the usual irrigation season is termed winter irrigation. Winter irrigation of alfalfa in Kansas is proving very satisfactory. This is due in a measure to the use of pumping plants. Even in fairly cold weather pumped water can be run in the farm ditches without experiencing trouble with ice floes. Ditch or reservoir water can not be successfully handled in cold-weather, because of ice troubles. Moreover, it is advisable to use the pumping plant as many days as possible, provided the acreage irrigated is proportionately large. The most favorable time of application is during the latter part of February, although December irrigation has given satisfactory results. It appears from the practice of Kansas farmers that enough

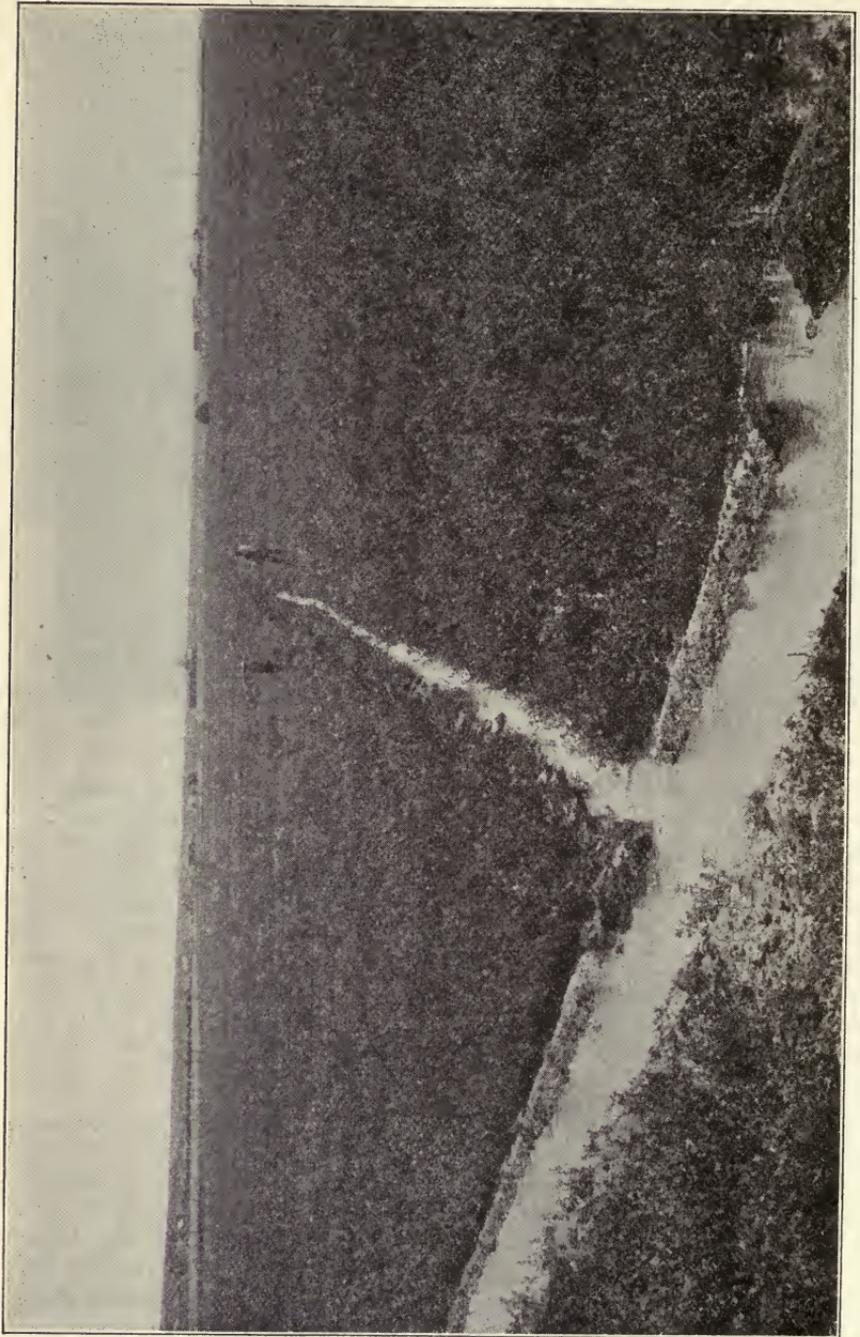

FIG. 223. Flooding alfalfa from field laterals.

water can be stored in the soil during the winter months to insure a heavy first cutting of alfalfa, and a reasonable second cutting, even if further irrigation is not practiced. The stored water in the soil releases the plant food during the winter months, and with the approach of the warm spring sunshine the alfalfa starts its growth early and matures rapidly. In fact, winter irrigation has a tendency to prolong the growing season of this legume.

Abundant sunshine is essential in the production of first-quality alfalfa. The irrigated sections of Kansas, with a self-controlled, reliable water supply by means of pumping, offer favorable conditions for growing alfalfa of the highest quality, and when good soil, irrigation water and common-sense farming are combined, alfalfa production in such regions will be successful.

## READING REFERENCES.

- (1) Farmers' Bulletin No. 373. Irrigation of Alfalfa. U. S. Department of Agriculture.
  - (2) Farmers' Bulletin No. 158. How to Build Small Irrigation Ditches. U. S. Department of Agriculture.
  - (3) Farmers' Bulletin No. 263. Practical Information for Beginners in Irrigation. U. S. Department of Agriculture.
- (See "Irrigation," in index.)

---

Results of extensive experiments at the Iowa Experiment Station show a marked superiority of the forage system of feeding over the dry lot for young, rapidly growing pigs. The best dry-lot gain cost, with 50-cent corn, \$4.36 per cwt., as compared to \$2.88 on alfalfa, \$3.69 to \$3.84 on red clover, and \$3.63 to \$3.95 on rape. The gains were also less rapid in a dry lot. All in all the forage system is clearly in the lead with growing pigs.

Alfalfa is a superior hog forage. In 1911 an acre of alfalfa pasture carried 16.5 hogs for 180 days. These hogs had an average weight of 89 pounds and consumed a grain ration consisting of ear corn, plus 5 per cent of meat meal. The daily allowance was 4.05 pounds of concentrates per 100 pounds live weight. With corn at 50 cents a bushel and meat meal at \$2.50 per cwt., the gains cost \$2.88 per cwt. Counting the production cost of the crop at \$10.75 an acre, the net profits, with hogs selling at \$5 to \$6, were \$65.99 and \$97.09. After paying all expenses of the crop and the meat meal, the hogs returned for every bushel of corn 86.6 cents when selling at \$5, and \$1.04 at \$6.

This alfalfa was sown in the fall of 1910 and was pastured in 1911 from May 19 to November 15. The alfalfa growth was allowed to keep well ahead of the hogs, so that extra cuttings could be made. Altogether 3838 pounds of alfalfa hay was cut from the acre, credit for which is given at \$14 a ton in the computations. Our experience has been that alfalfa pasture will withstand grazing well if handled in this manner.—*J. M. Evvard, in Breeder's Gazette.*

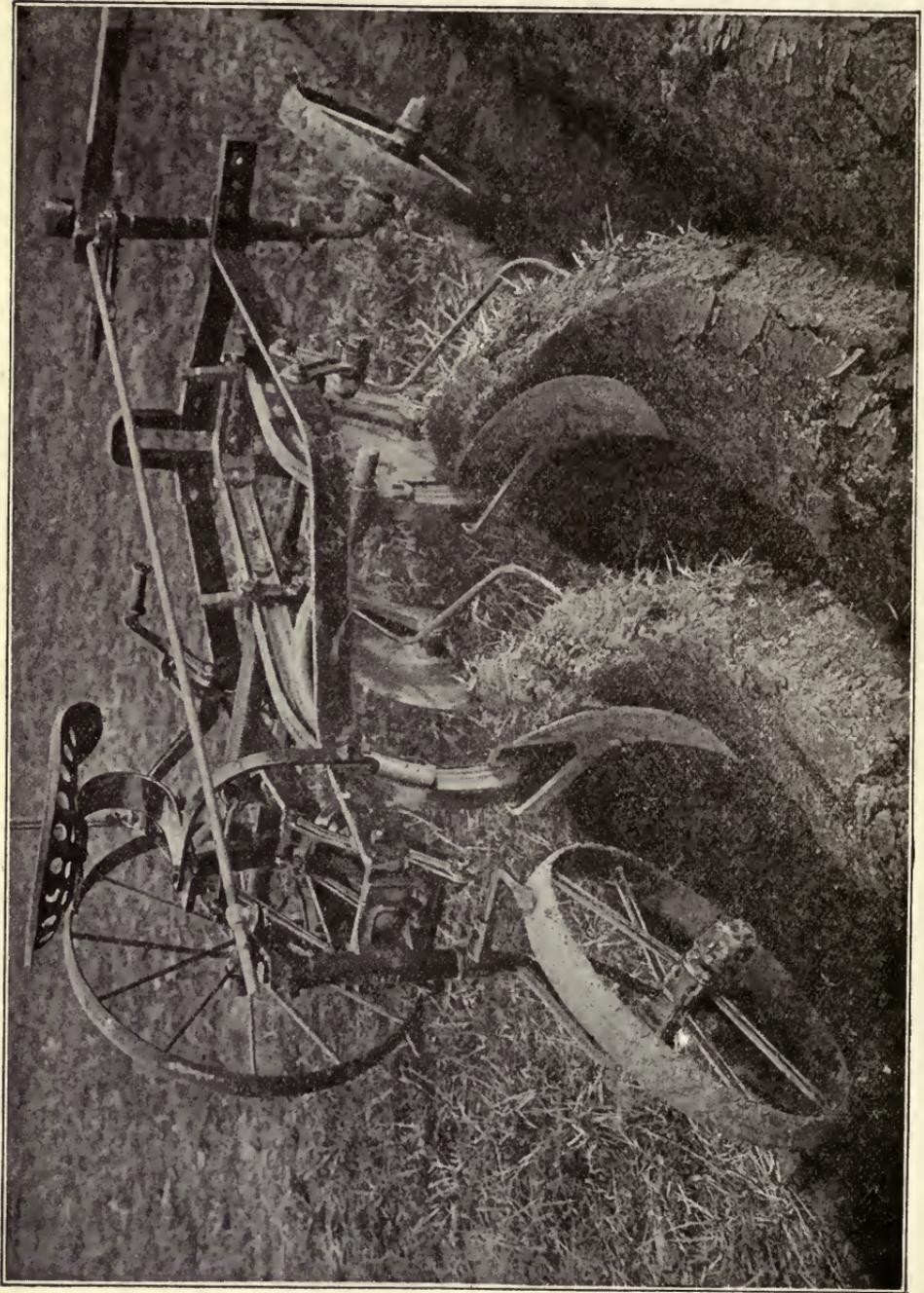

FIG. 224. The two-gang sulky plow.—[Courtesy Janesville Machine Company.]

## ALFALFA MACHINERY.

By F. A. WIRT and R. E. WISEMAN,

Department of Farm Machinery, Engineering Division, Kansas State Agricultural College.

The title of this article will be used in the broadest sense of the word, and will include machinery used in the preparation of the seed bed, planting, cultivating, harvesting, threshing, cleaning seed, and maintaining fertility. Under the name of the machine a short description will be given, followed by a few words on operation and care. Selection and care of machinery in general will be treated briefly.

### PREPARATION OF SEED BED.

#### *Plows.*

These are so well known that a description hardly seems necessary. Of the three general kinds—the walking plow, sulky plow, and engine gang—the second named is used by far the most. Walking plows in 12, 14 and 16 in. sizes are used for gardens and small irregular fields. Two horses will do for the 12 in. and three on the larger sizes. The common sizes of riding plows in Kansas are the 16-in. sulky and 12-in. gangs. The frame machine with a tongue is preferred to the frameless. If more than three horses on the sulky and four on the gang are to be worked, the teams should be hitched in tandem. When more than the number mentioned is worked abreast, side draft becomes very troublesome.

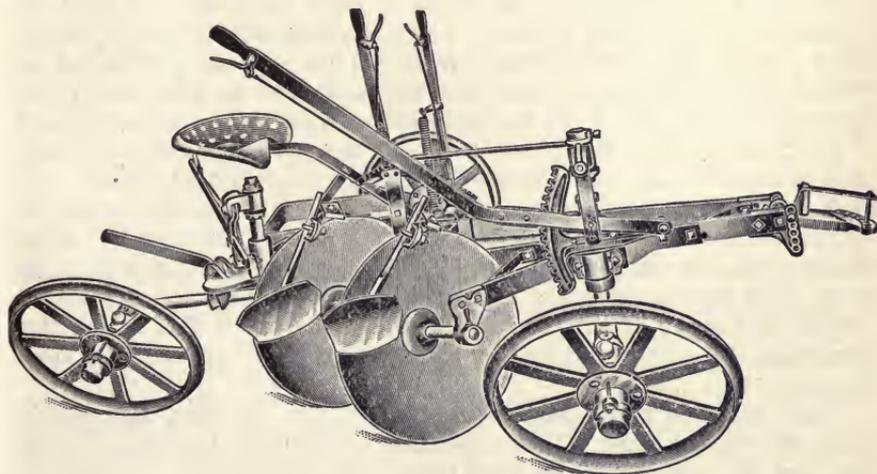

FIG. 225. The rotary disk plow.—[Courtesy Moline Plow Company.]

For tractor use several companies have put out attachments for their horse gangs. By removing the depth lever and adding a lever that can be handled from the tractor, and with the proper hitch, these plows are giving good results. Tractor gangs of the 2-3 and 3-4 sizes have been sold in great numbers the past two years. The self-lift construction makes it possible for one man to operate both the tractor and the plow.

By pulling on a rope the bottoms can be raised or lowered. Where more than one wheel supports the plow it is best to have the wheel on the right run in the furrow. Guiding the engine will be much easier.

The moldboard plow is unsatisfactory for hard, dry soils, and black, waxy soils. The disk plow can then be used to good advantage. It will turn a furrow regardless of the scouring qualities, as a scraper cleans the disk. Disk plows will not work in extremely hard ground. Where the moldboard plows will give good results, their use is preferable.

**OPERATION AND CARE.** Never use a very dull share longer than is necessary. The draft is increased materially and the work is not as good. It is advisable to keep an extra set of shares on hand to guard against delays.

Suction on riding plows should be about one-half of an inch. A hard, tough soil requires more suction than one that is easily worked. It is measured from the heel of the land side to the surface upon which the share is resting evenly. Means are usually provided for quickly changing suction.

All springs should be kept at the proper tension for easy handling of the levers to which they are attached. Always keep the plow leveled when the bottom is in the ground. For any one depth of plowing there is just one position for the front furrow-wheel lever. This is of more importance on the gang than on the sulky.

If in stony ground, the floating feature of the foot-lift plows should be set so that in case an obstruction is hit the plow bottom will not be locked rigidly in the frame. Making use of this device will save broken eveners and a nasty fall for the operator more than once.

The hitch often gives trouble. The horses should be neither too far apart nor too close. If it is the former the line of draft will be out too far, and if the latter the horses will not be able to do good work. The right-hand horse should not be compelled to walk in the plowed ground.

On the high-lift riding plow attach the tongue and connecting rod in such a manner that both furrow wheels will run straight ahead. The hitch is often so arranged that a slight lead from the land is necessary for the front furrow wheel of the sulky, and toward the land if a gang. At the same time the rear furrow wheel is set with a slight lead from the land. This lead is necessary whenever a point of hitch is more than a few inches outside of the true line of draft. It is for this reason that more than three horses on sulkies and four on gang plows should never be used.

Draft of riding plows should be very little if at all more than for the same size walking plow. This is obtained by carrying the weight of the plow and the furrow slice on the wheels. The importance of proper adjustment can thus be seen readily.

On engine gangs these same adjustments are found, only applied differently. One adjustment in particular deserves mention—that is, the method of hitch. Straight chains, cross chains and the semirigid type of steel bars are all used. On the smaller gangs the latter is very common. Care should be taken to see that no parts bind. When a plow must be set over some distance from the line of draft of the tractor, the cross

chain is better than the straight. At other times use the straight chains if a steel bar hitch is not on the plow. The angle of hitch should be such that the tractor does not tend to pull the plow into the ground; instead, it should lift up. Of course, the entire weight should not be taken off the wheels. The angle of hitch must be determined for each particular outfit. Be very careful to arrange the hitch so that the wheels will not track on the next round. This will prevent unduly packing the ground.

Set the center of the coulter above the plow point and high enough to swing from side to side. The cut outside of the land side can vary from one-fourth to three-fourths of an inch. If in rocky soil, and not plowing more than six inches deep, rolling coulters can be used as a safeguard against buried rocks. This is of special importance on tractor plows. Set the coulter so it will cut about one-half inch deeper than the point of the plow and will swing across in front of the point.

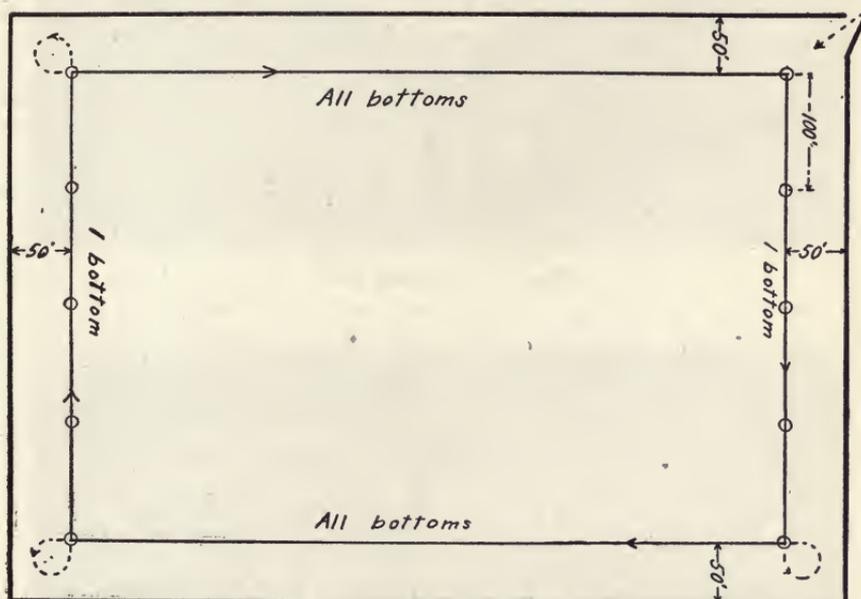

FIG. 226. Diagram showing method of laying off the ground for tractor plowing.

Laying off the ground for tractor plowing is very important. The accompanying diagram shows a method that has proven very successful. Set the stakes 50 feet from the fence or edge of the field. This distance can vary from 30 to 100 feet. Starting at one corner with a single bottom, plow a light furrow across the short end. This will serve as a guide to go by in raising or lowering the bottoms. With all bottoms down, plow the long way. Do the same thing on the other two sides. Previous to the first round, or at this time, stake off the fields into narrow lands. The width of these lands is often 100 feet; although many farmers lay off their lands for a certain number of rounds, less the width of one or more 14-inch furrows, to offset any unevenness in plowing that may

creep in. In this way very little time will be spent going empty across ends. The border is plowed out last, usually throwing in one year and out the next. Another method is to start in the center and plow around without lifting the bottoms. This method has the disadvantage of leaving corners that must be plowed out later with horse plows. (See "Plows," in index.)

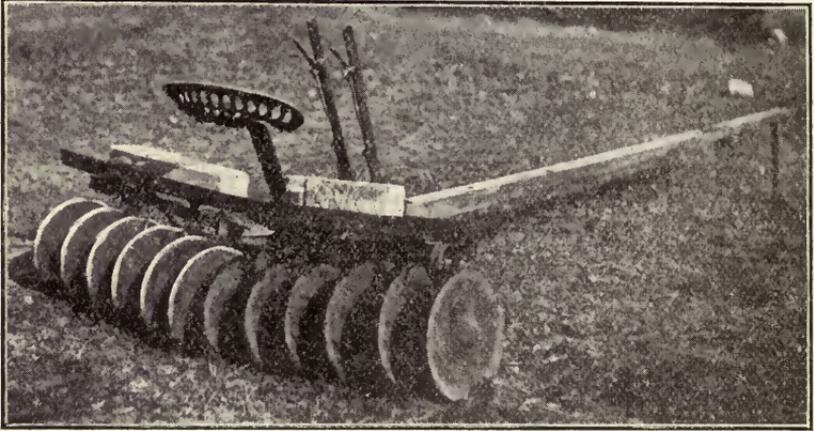

FIG. 227. The single disk.

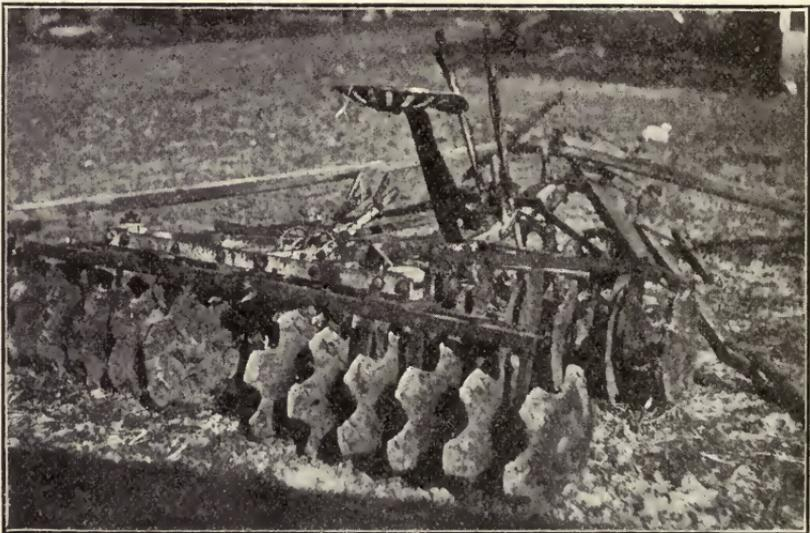

FIG. 228. The double disk.

*Disk Harrows.*

These machines are indispensable in this section of the country. While made in various sizes, the 16-inch disk seems to be the best. From 8 to 24 disks are used, the following being very common: 14 by 16 and 16 by 16.

Bearings are either of oil-soaked wood or chilled iron, and are very important. The oiling device must be of good construction and should be handy.

The full blade is better than the cutaway or spading for a single disk. If double, the cutaway is commonly preferred. The notched parts of the disk do not cut into soil, but the unnotched portions will go deeper than the full blade. With a double disk the ground is really gone over twice.

Attachments can be purchased to place around the seat of a double disk. These ought to be used more, for a jar could easily throw the operator between the front and rear gangs.

Tongue trucks or fore carriages make a harrow more convenient. They can then be used without a tongue, tongue set in the center, or set over for three horses. However, many harrows are sold without the fore carriage.

**OPERATION AND CARE.** By setting over the tongue when using a three-horse team side draft will not be a troublesome factor.

Better work can be obtained by lapping, although this requires more time. The gangs must be set at different angles if one gang is passing over soft ground and the other gang is in undisked land.

As the work done by a disk blade depends upon their penetration, the governing factors are as follows: the line of draft, angle at which the gangs are set, curvature and sharpness of the disk blades, and weight of the harrow.

Transport trucks are of considerable value whenever the conditions are such that the harrow must be hauled some distance across meadows or over rocky roads. They make it easier to draw the harrow by hand in the shed. (See "Disk Harrow," in index.)

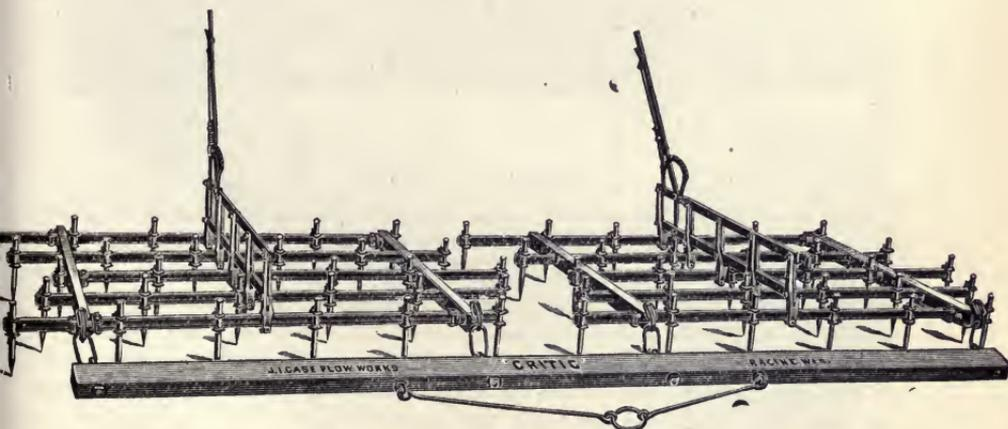

FIG. 229. The smoothing or spike-tooth harrow.

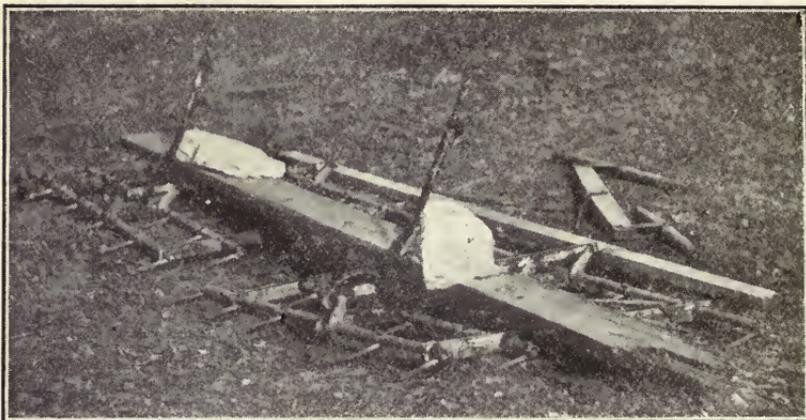

FIG. 230. The smoothing harrow used as a drag.

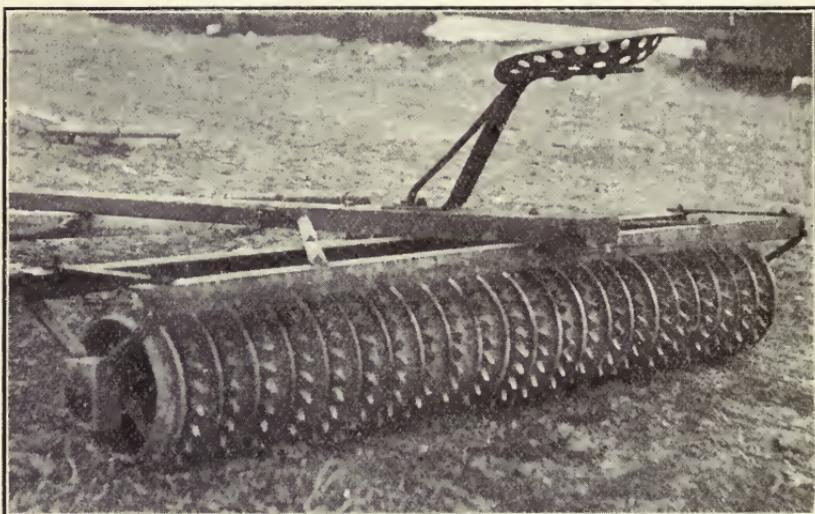

FIG. 231. A land roller.

#### SMOOTHING HARROWS.

Often called spike-tooth or drag harrows. They are made of pipe, U-bar or wood frames. There is very little difference between the first two; the latter is not quite as good. Teeth are made in two sizes,  $\frac{1}{2}$ - and  $\frac{3}{8}$ -inch, with round, square or diamond-shaped cross section. Tooth fasteners are usually constructed so that the teeth will not be lost if the fasteners become loose. On different harrows the teeth per foot width of ground passed over varies from five to eight, and on lever harrows the teeth can be angled to obtain the work desired.

Harrow carts permit the operator to ride without unduly adding to the draft. Wide tires and good bearings should be looked for when pur-

chasing. It might be well to mention in this connection that harrow carts can also be attached to weeders and spring harrows.

**OPERATION AND CARE.** The teeth can be slanted for smoothing, and set almost straight up and down for breaking clods. They are used to break up clods, cover seeds sown broadcast, form dust mulches, kill weeds just starting, and to cultivate a few of the crops while they are still small.

For heavy work the  $\frac{5}{8}$ -inch tooth is better than the  $\frac{1}{2}$ -inch. Harrows 10 to 15 feet wide require three horses; if more than 15 feet, four horses are necessary.

One point that is almost invariably overlooked is the fact that the position of the teeth can be changed in the fasteners. Two edges of a square or diamond-shaped tooth should be made use of before the harrow is discarded. (See "Harrow," in index.)

#### *Land Rollers.*

Alfalfa requires a firm seed bed, so this machine is quite a factor in the preparation of the ground.

Two general kinds of surfaces are used—the smooth and the corrugated. The latter is made in many different styles, among which may be mentioned the tubular, V-shaped, and so-called crowfoot wheels, or a combination of V-shaped and notched disks. The subsurface packer will not be discussed.

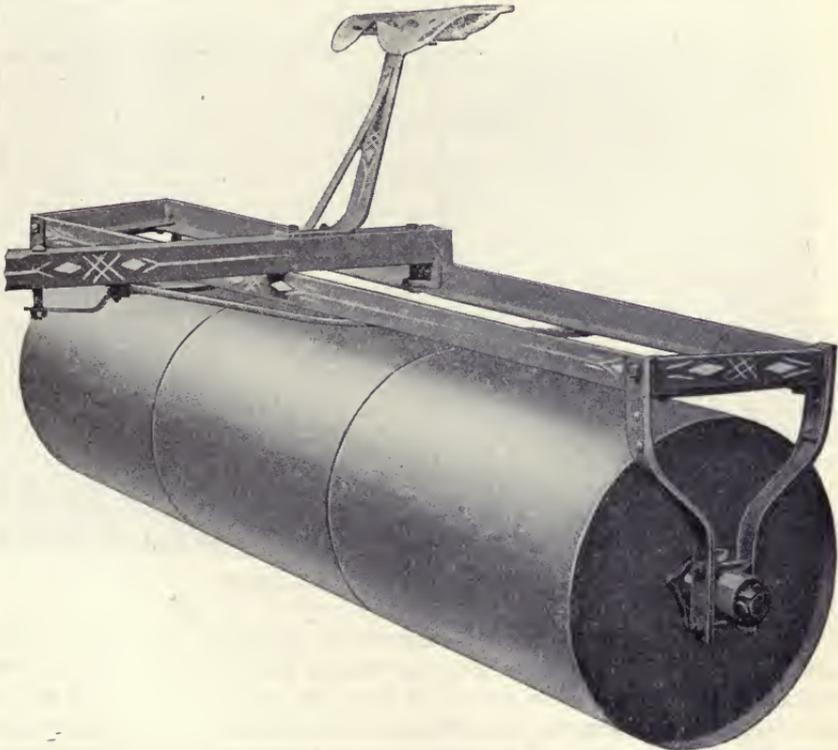

FIG. 232. Another type of land roller.—[Courtesy The Dunham Company.]

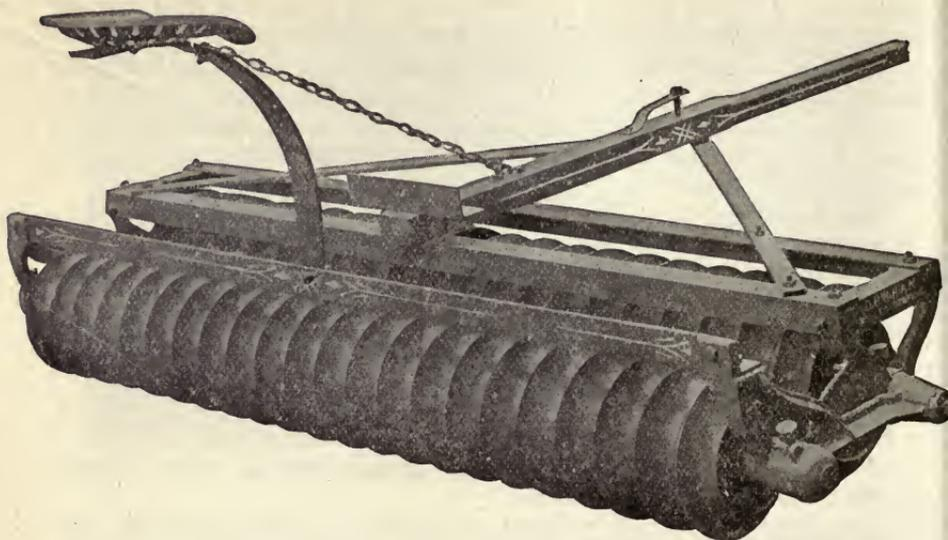

FIG. 233. A double land roller.--[Courtesy Dunham Company.]

#### PLANTING.

##### *Seeders.*

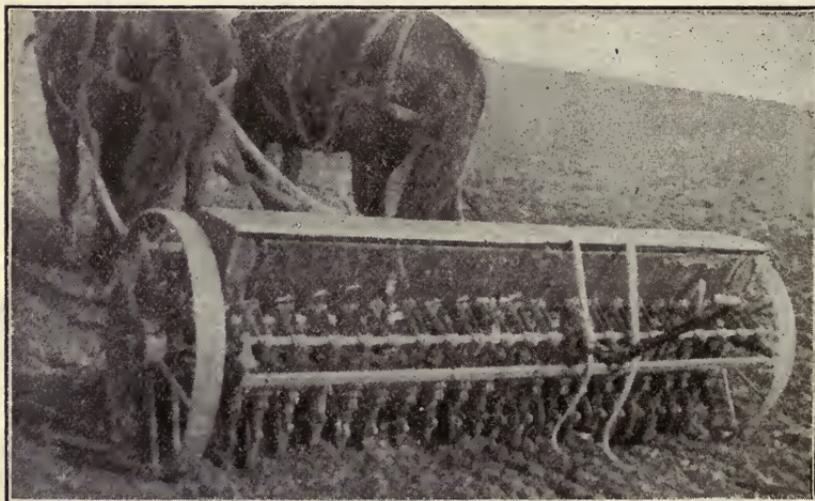

FIG. 234. Alfalfa- and grass-seed drill.

Packers with V-shaped wheels are built single and in tandem. They can also be had in a three-gang form, like the others, in from 12- to 15-ft. widths. Weight pans are placed on some of the machines. As a rule, the weight of the machine is sufficient. Bearings are of oil-soaked wood or of the roller variety. If of wood very little precaution is usually taken to keep out the dirt.

**OPERATION AND CARE.** The packer or roller is used primarily to firm the soil and pulverize the clods. Smooth-drum rollers must be followed by a spike-tooth harrow; therefore one of the other types is preferable. Care should be taken not to go on the field when too wet, and to pay some attention to the bearings. Two horses are commonly used on the 8-foot machine. (See "Roller," in index.)

Broadcast seeding has been known since the time crops were first planted. Even now the first method of seeding by hand is resorted to for small patches of ground. To-day there are several broadcast machines on the market, the names of which will suffice: the knapsack, wheelbarrow, endgate narrow-tread broadcast, and wide-tread broadcast seeders. In addition there are seeding attachments for many machines. These will be discussed later.

The broadcast seeders as commonly built plant alfalfa seed too thickly. Knapsack and endgate seeders are seldom used for alfalfa.

**OPERATION AND CARE.** Look under seeding attachments.

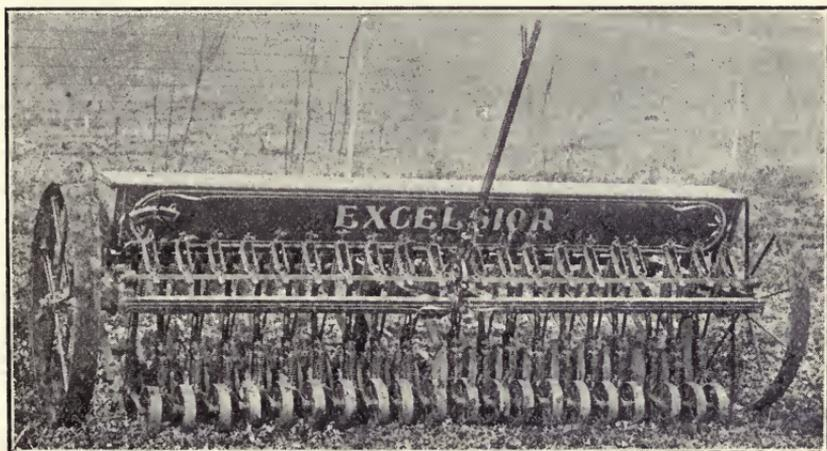

FIG. 235. Grass seeder often used in seeding alfalfa.

### *Seeding Attachments.*

These can be placed on disk harrows, weeders, alfalfa cultivators, and grain drills.

A hopper is often attached to one or both gangs of a disk harrow if one gang laps one-half. The feed shaft is driven by a chain from one gang bolt. Seed hoppers about 10½ feet long are placed on many weeders, the feed shaft being driven from one of the barrow cart wheels. The cut gives a general idea of how the attachment is put on.

Grain-drill attachments are placed in front of the regular hopper and the seed is carried down to the ground through the regular feed tubes. However, they are often poorly constructed and after a few years become unfit for use.

**OPERATION AND CARE.** With the machines and attachments as above described the seed is covered at the same time it is sown. This makes



FIG. 236. Weeder with seeder attachment.

harrowing later unnecessary, which is often too late on account of the changes in the weather. The weeder and the broadcast seeders equipped with cultivator covering shovels, cover the most ground.

For the first few rounds it is a good plan to watch carefully the amount seeded; the gauge may need changing. Working crosswise to the direction of the harrowing, the seed will be planted at a more uniform depth. This also applies to drills. Other points to watch are the clogging of the feed cup by some foreign substance and the amount of seed in the hopper.

#### *Drills.*

When grain drills are used for sowing alfalfa cross-drilling is commonly practiced. Due to the inaccuracy of grain drills, depth of planting, and space between disks, alfalfa- and grass-seed drills were put on the market. These drills are similar to the grain drills, only smaller in size, and need very little description.

Single-disk furrow openers, 4 or 5 inches apart and 20 or 16 in number, are used. Sometimes small press wheels are attached. Both wheels should drive.

**OPERATION AND CARE.** Hitch so the drill will run level.

The importance of clean seed can not be overemphasized if inaccurate feeding or twisted feed shafts are to be guarded against (not to mention fields free from weeds). Feed cups are not built to handle straw, nails, nuts, and similar substances.

When through for the season be sure that all feed cups are empty. Oftentimes seed left in the drill germinates and causes trouble later. This is applicable to all drills.

One or two gauges are always placed on the hopper. Even if accurate when new the chances are that they will not remain so. For this and another reason mentioned later it is well to test the accuracy in the following manner:

Jack up the machine so the wheels do not rest on the ground. Place seed in the hopper; set the gauge at a certain amount per acre, and then turn one of the wheels for 200 revolutions. Catch the seed in paper sacks, and then weigh. If the cups sow at different rates it will be shown up at this time, and then the necessary steps can be taken to remedy the difficulty.

The following example explains more clearly how the test is carried on:

Conditions: 16 by 5 drill; 40-inch wheel; gauge set to sow 15 pounds to the acre; wheels are turned 200 revolutions. The amount collected in the sacks will be a certain part of the 15 pounds. The amount that should be collected can be calculated thus:

$$\begin{aligned} \text{Circumference in feet} &= \text{diameter of wheel in feet} \times 3\frac{1}{4}. \\ &= 40\frac{1}{2} \times 3\frac{1}{4}. \\ &= 10.5 \text{ feet.}^* \end{aligned}$$

Remember that the wheels were turned 200 times.

$$\begin{aligned} \text{Distance gone} &= \text{circumference} \times 200. \\ &= 10.5 \times 200 = 2100 \text{ feet.} \end{aligned}$$

$$\begin{aligned} \text{Width of ground seeded} &= \text{number of disk} \times \text{distance apart.} \\ &= 16 \times 5. \\ &= 80 \text{ inches, or } 6\frac{2}{3} \text{ feet.} \end{aligned}$$

$$\begin{aligned} \text{Area in sq. ft. seeded} &= \text{width seeded} \times \text{distance gone.} \\ &= 6.67 \times 2100. \end{aligned}$$

$$\begin{aligned} \text{Per cent of an acre seeded} &= \text{area seeded} \times 100. \\ &= 14,000 \text{ sq. ft. in an acre} \times 100. \\ &= 14,000 \times 100 = 32.2\%. \end{aligned}$$

43,560

As this per cent of an acre was covered, only 32.2 per cent of 15 pounds should be found in the sacks:

$$32.2 \times 15 = 4.83 \text{ pounds.}$$

4.83

$$\frac{4.83}{16} \text{ (number of furrow openers)} = .302 \text{ pounds per feed cup.}$$

If the amount obtained in the test varies from this by an appreciable amount it will be well to repeat the test and then set the gauge lever, making the proper allowance.

Drills are often used to reseed bare spots and old fields.

The flute-feed grain drills can be adapted by shutting off the feed entirely or almost so. On the double-run feed-cup type, reducers for decreasing the size of the opening are added. Such use of grain drills has already been commented upon.

It is necessary to keep all bearings oiled, boots and scrapers adjusted properly, and to clean out the bearing if the disk fails to turn easily, and, if need be, to replace with a new bearing. The spring tension on furrow openers should be kept uniform. Never use the drill with a few of the disks running deeper than the others.

Without doubt the alfalfa- and grass-seed drill is best, but it is too expensive for small fields. Grain drills are next, probably, in point of use,

\* Slide-rule calculation.

closely followed by machines that can be equipped with seeding attachments. Broadcast, knapsack and wheelbarrow seeders come last.

The drills have one advantage over seeders in that usually a lesser amount of seed per acre is necessary.

Planting in rows. This practice is not followed extensively in this country, although a few farmers in Kansas have fields so planted. In some localities it has been found desirable to double-row, leaving two holes of the grain drill open and stopping up 3 or 4. The double rows will then be 8 inches apart (disks are spaced 8 inches), while the space left for cultivating will be 32 or 40 inches apart.

Cultivators are good for keeping down the weeds, which are troublesome the first year. A spring-tooth harrow or weeder will do if a few teeth are removed where the rows come. (See "Seeders," in index.)

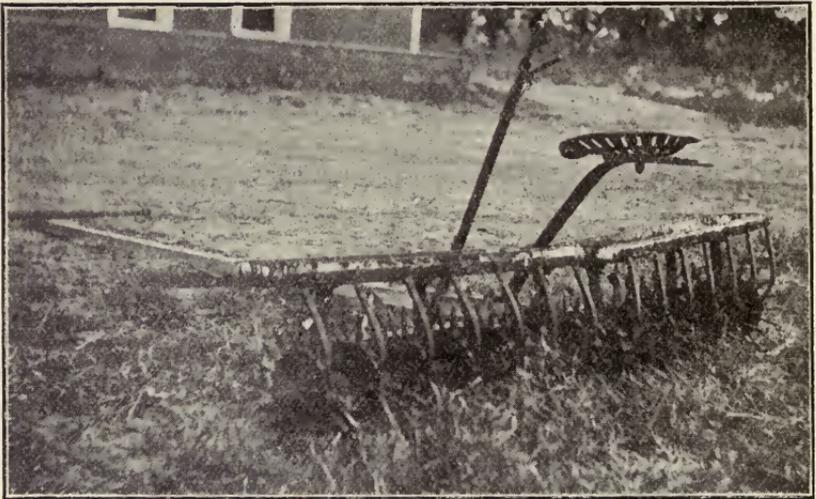

FIG. 237. Spike-tooth disk, or alfalfa renovator.

#### CULTIVATION.

##### *Disk Harrows.*

In the spring before the plants are very high the regular disk is often used as an alfalfa cultivator. The gangs are set straight, or nearly so, without any additional weight being added to the pans. If it turns off dry after such a cultivation more harm than good results. This machine is seldom used in this way at the present time.

##### *Alfalfa Renovators.*

Porcupine harrows is another name. The machine resembles a disk harrow, the difference being that spikes radiate from the center instead of having a full blade. It was about the first alfalfa cultivating machine brought out, and was in answer to a demand for a machine that would destroy the weeds and loosen up the surface.

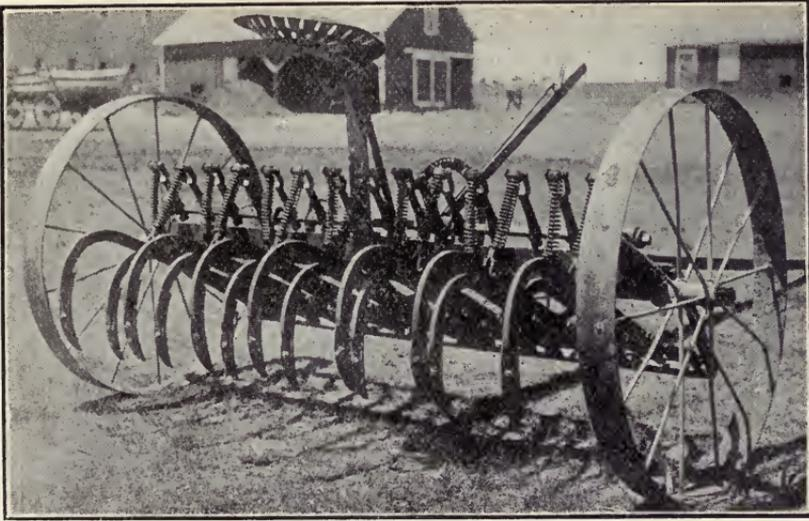

FIG. 238. Alfalfa cultivator.

**OPERATION AND CARE.** Much the same as for the ordinary disk, which has been discussed under "Preparation of the Ground" and immediately above. Trouble with warping is often experienced, and it has been found best not to split the crowns unless conditions are exceptional.

It is well to mention at this time that only thoroughly rooted alfalfa of a year's growth or more should be cultivated. If the plants are too young much harm may result.

The use of this machine seems to be on the decline in this state as compared with the special spring-tooth harrows and alfalfa cultivators mentioned below.

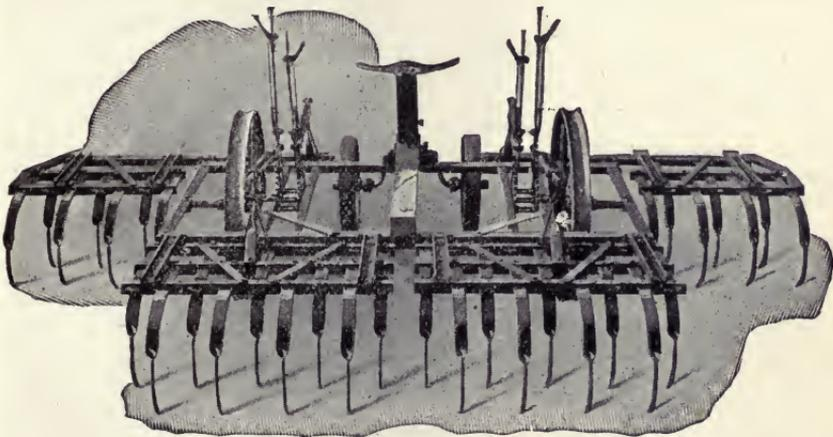

FIG. 239. Another type of alfalfa cultivator.  
[Courtesy of Light Draft Harrow Company.]

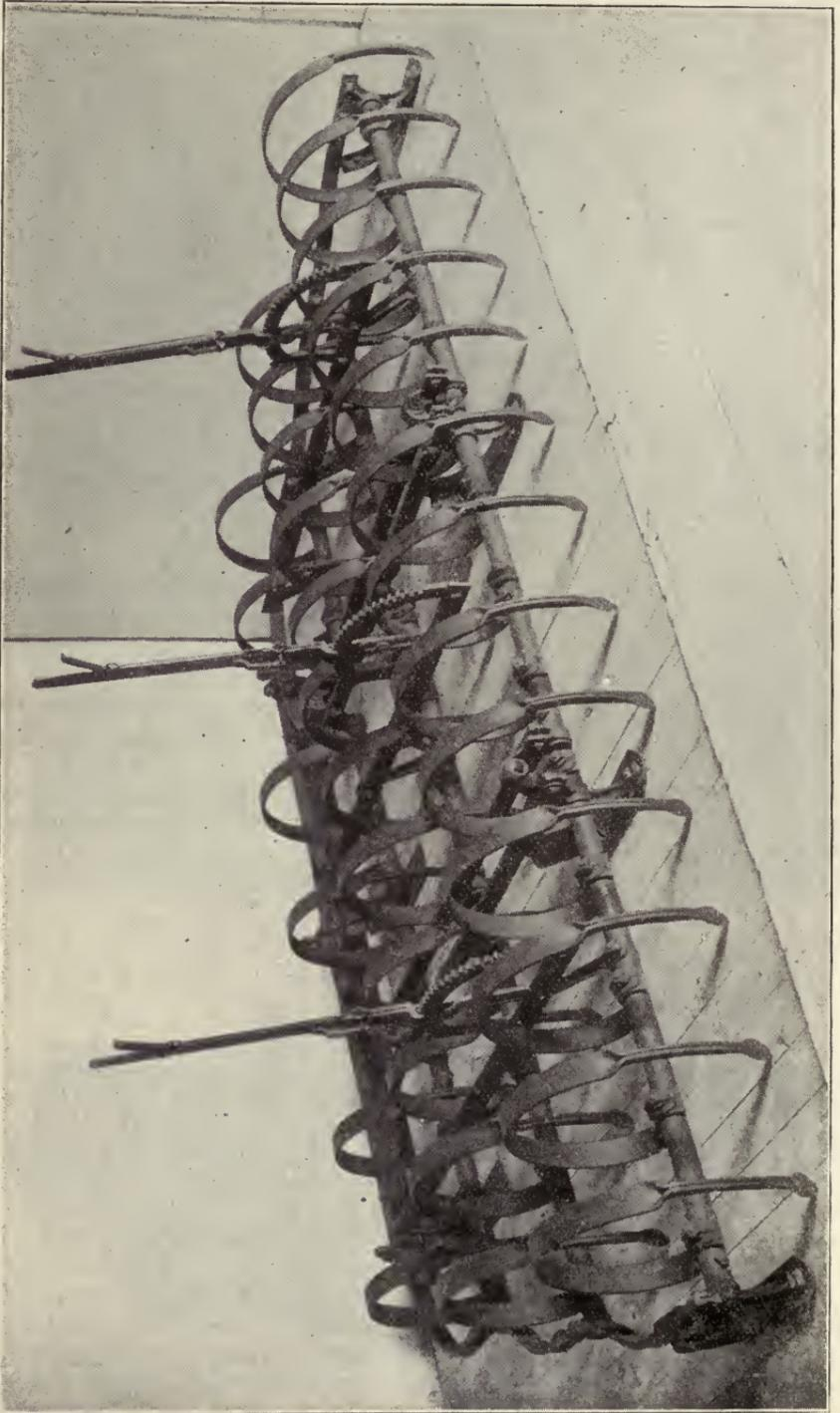

Fig. 240. The spring-tooth harrow, equipped with teeth for cultivating alfalfa.

*Alfalfa Cultivators.*

Several different machines are called alfalfa cultivators. Here, however, it will be applied to the machine described in the cut. The teeth, 14 in number, are hung independently in the frame and are under spring pressure. The amount of pressure can be regulated by a lever. The teeth are of such shape that only rounded edges touch the alfalfa plants. The width cultivated is 6½ feet.

**OPERATION AND CARE:** The teeth pass to the side of plants, stirring up the ground and tearing out the small weeds. This machine is giving good results, although the draft, as on all alfalfa cultivating machines, is quite heavy. Two horses are necessary.

*Spring-tooth Harrows.*

These are common in the East but very seldom found in Kansas. The cut shows a spring-tooth harrow with special alfalfa teeth. The regular spring-tooth harrow was tried out by an enterprising farmer, who found that better work could be done if the shank was rounded and the blunt



FIG. 241. The modern manure spreader.

point changed to a spear-head shape. These machines are built in sections. Two sections of 21 and 22 teeth cover 6 feet; three sections of 31 and 33 teeth cover 9 feet.

**OPERATION AND CARE.** When cultivating, the teeth act very much like the teeth of alfalfa cultivators already described. The teeth will spring back if caught on an obstruction, depth being regulated by levers. A horse for each section is necessary, and if the teeth are set so very deep more power will be needed. This harrow, with the special form of alfalfa teeth, has only been sold for the last four years. It is gaining favor rapidly as an alfalfa cultivator. Good results have been reported.

This same harrow, either in the regular form or the alfalfa type, can be used as an ordinary harrow. The farmer owning the machine shown in the cut has used it in the spring on fall-plowed ground. He reports that better work was done with it than with the smoothing harrow, although less ground was covered in a day. (See "Cultivators," in index.)

## MAINTAINING SOIL FERTILITY.

*Manure Spreaders.*

Several features of the manure spreader are important. Endless aprons are found on more spreaders to-day than either the return or web types, although it is more easily fouled and it is difficult to unload evenly at the last. It is preferred on account of its simplicity as compared with the web apron.

As little as possible of the mechanism should be in motion when the beater or cylinder is thrown out of gear.

Apron drives are of two kinds—ratchet and worm. Both have advantages and disadvantages. The ratchet drive gives a great range of speeds, but is more complicated and the motion is intermittent, thus increasing the chance of breakage. Racing when ascending a hill with a load is prevented on a few machines by either a brake or some other device. The power is also taken from the cylinders.

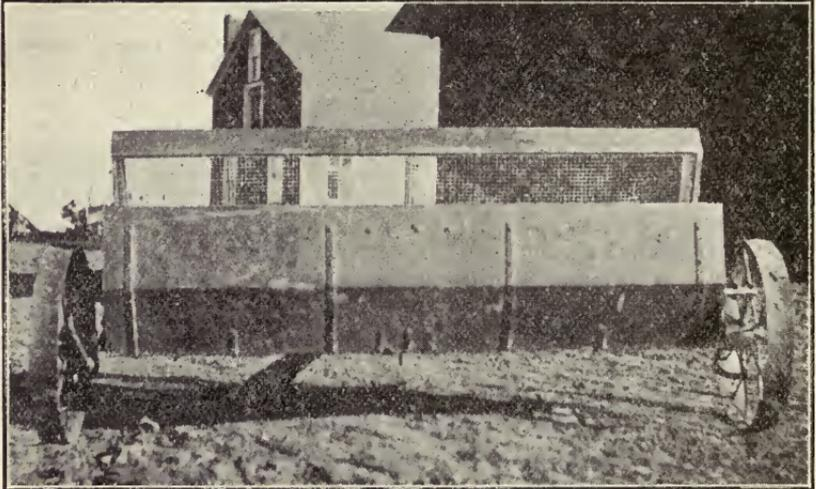

FIG. 242. The lime and fertilizer sower.

The worm drive, on the other hand, gives constant motion, and the power is taken direct from one of the rear wheels, but the apron has only three or four speeds, and the gears are apt to wear out quickly. To prevent this rapid wearing a few companies enclose their worm gear in an oil-tight case. Both styles of drives are very common.

The low-down feature of the construction makes loading much easier. On many farms obstructions of one kind or another make it almost impossible to use machines of the lowest type, for the clearance is not sufficient.

Wide-spread attachments of widely different design have been brought out within the past two years. The object is to spread wider than the box, so one trip across the field will cover more ground. No reports as yet have come in, so a comparison can not be made.

Capacity ratings are not all uniform, so comparisons should be made on the calculated contents of the box level full, providing that there is 1.25 cubic feet in one bushel.

If loaded too high the distribution is apt to be uneven, regardless of how good a pulverizing or leveling rake is on the spreader.

If the apron becomes too loose it can be tightened up by two bolts, one on each side, and at the front end of the machine.

Lubrication is extremely important and should never be neglected. (See "Manure Spreaders," in index.)

#### *Lime and Fertilizer Sowers.*

These are two-wheeled machines from 6 to 10 feet wide and have hoppers holding from  $7\frac{1}{2}$  to 15 bushels. The amount sown, ranging from 5000 to 6000 pounds of dry stock per acre, is regulated by the size of the openings in the bottom. An attachment 11 feet wide is made for attaching to the rear end of wagons. A two-canvas conducting apron is placed so that the material is dropped to within 8 inches of the ground. The amount per acre can be varied from 400 to 4000 pounds.

OPERATION AND CARE. Whenever possible the lime should be screened before placing in the machine. Many of the lime and fertilizer sowers have screens built in. When using such a machine it is always best to take advantage of the screen. This will prevent clogging of the hopper and feed opening. (See "Lime Spreader," in index.)

#### HARVESTING MACHINERY.

##### *Mowers.*

The modern mower has become a standard machine and varies only in slight details. Various cutting devices have been patented, but they have nearly all given way to the reciprocating knife and stationary guards.

Many attempts have been made to make a center-cut machine, in which the cutter was carried in front of the machine. The prime object sought in these machines was to eliminate side draft and keep the team from tramping the hay into the stubble. This is offset by the horses walking in the standing grass, so that very few of these machines are made.

Mowers may be had in sizes from the one-horse  $3\frac{1}{2}$ - to 4-ft. cut up to the 6- and 8-ft. cut in the two-horse size.

The driving power of a mower is determined to some extent by the weight of the machine and the construction of the drivewheels. The drivewheels should be from  $3\frac{1}{2}$  to 5 inches broad and must be provided with good lugs. They should also be provided with a sufficient number of pawls to engage the ratchets, so there will be no lost motion between the main wheels and the sickle, as this would allow the guards to fill with grass before the sickle started.

Roller bearings and a good method of oiling is necessary for light draft.

The majority of mowers have two sets of gears, although some have three, and others have only one set of gears and a chain drive. The

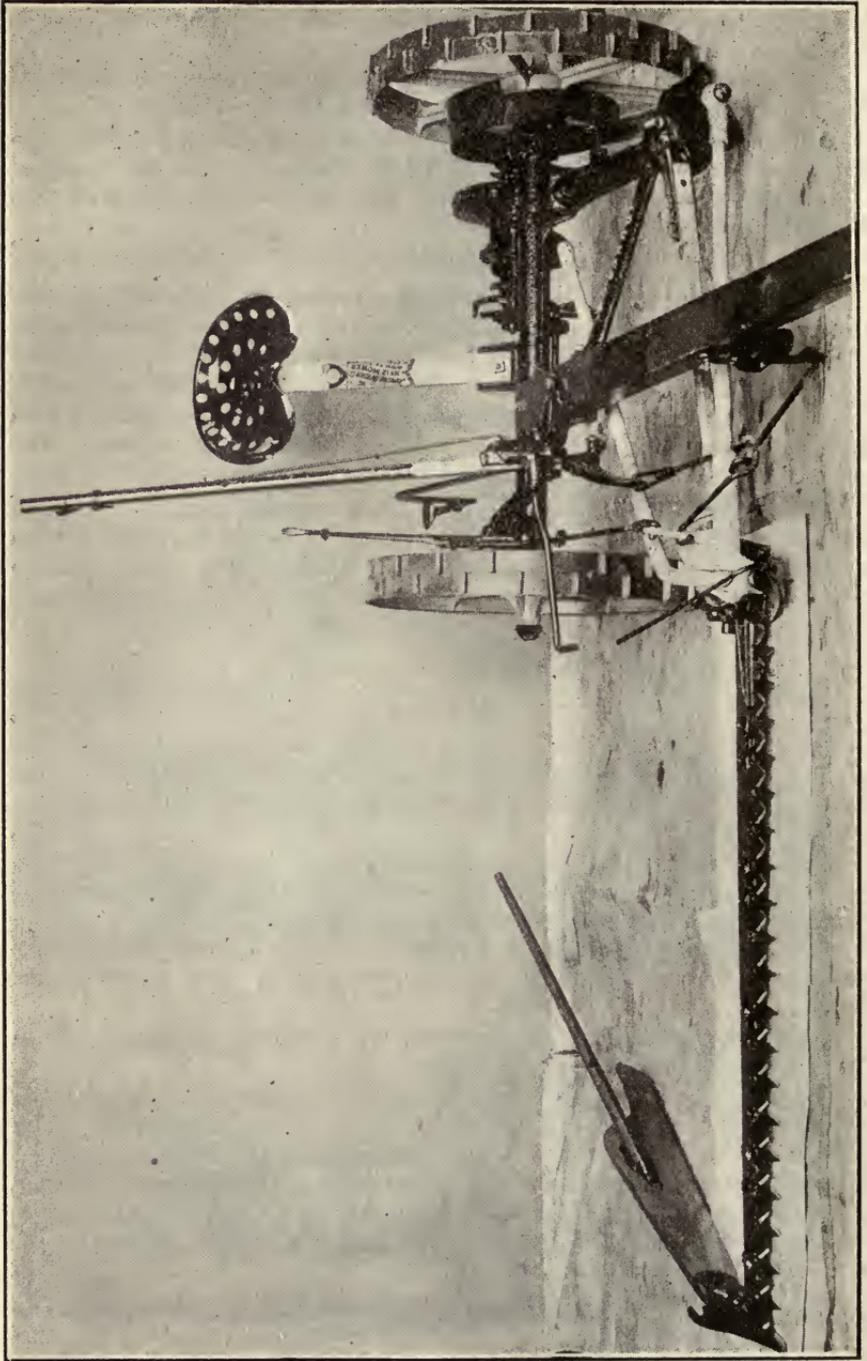

FIG. 243. The mower.

gears should be of ample size to withstand the strain. Warped gears are to be looked out for, as they wear and give trouble more quickly and the noise they make is annoying. Steel-cut gears would be a good thing in a mower, but the first cost seems to be too great. The small pinion on the pitman shaft usually wears out first, so means are usually provided so that it can be kept in mesh. Ball bearings or hardened steel washers are used to take up end thrust due to the bevel gears.

Chain drives on mowers do not give as good service as gears, for they wear out more quickly and have more play.

Nearly all standard makes of mowers have the principal wearing parts replaceable. The majority of them have brass bronze composition-metal bushings at both ends of the pitman shaft. If the bearings become worn or loose it is only necessary to replace the bushing with a new one.

The wrist-pin bearings are generally made solid, as it is hard to keep the nuts tight on a split box at this place on account of the vibration. Removable bushings are usually provided, and in most machines these bushings are free to turn.

The most common method of securing the pitman to the sickle head is by a ball-and-socket joint. This form of connection seems to be the most convenient and the easiest to keep tight. This bearing should not be kept too tight, as it not only increases friction, but causes the sickle back to bend up and down at each stroke of the sickle, and is apt to cause it to break off. Neither should it be left loose enough to have much play, or the socket will soon be beaten into an oblong shape; then the bearing can not be kept tight until the damaged parts are replaced by new ones.

**CARE OF THE MOWER.** Heavy draft in a mower is caused by three things—poor lubrication, dull sickles, and nonalignment. The remedy for the two former is obvious, but the latter is often overlooked. The pitman and sickle should work in a straight line. If the outer end of the cutter bar has dropped back, part of the power is taken up by friction on the mower. All cutter bars need an occasional realignment; that is, the wrist pin, sickle head, and outer end of the sickle should be brought into a straight line. This may be accomplished by having one of the hinge pins in the shoe set in an eccentric cam, and by changing the position of the hinge bar and the pitman head; or it may be done to a limited amount by shortening the drag bar and lengthening the push bar. The common notion that the cutter bar can be aligned by shortening the drag bar or lengthening the push bar alone is erroneous and should be discarded, as the shortening of the drag bar affects the centering of the sickle. If there is no other provision for aligning the bar a new shoe or hinge pin should be purchased. However, a more or less skilled mechanic or careful workman may align the cutter bar by removing one of the hinge pins and bringing the outer end of the bar up in position and filing one side of the hole out with a round file until the pin can be replaced and bushed up on the loose side of the pin. The bushing should be notched to keep it in place.

**CENTERING THE SICKLE.** If a new pitman is to be replaced, great care should be taken to get the new one the same length as the old, in order

to have the knives center in the guards. By centering we mean to have the knives pass to the same position in the guards either way. In machines having the push bar nearly at right angles to the drag bar, centering may be accomplished by lengthening or shortening the latter.

**CAUSES OF UNEVEN STUBBLE AND SIDE DRAFT.** Side draft is not caused by the cutter bar lagging at the outer end, as many farmers suppose, but may be due to one or more of the following causes: sickle not centering, guards bent, sickle sections loose or nicked, ledger plates loose or nicked, or the clip over the cycle being worn.

The first cause has already been discussed. One of the requisites of a new cutter bar is that the ledger plates on the guards shall all be in line when it leaves the factory, but they may be used only a short time until some of the guards are bent. If one is out of line, the shear cut that the sickle should have is destroyed. If one of the guards is bent up, the sickle may be held off of several ledger plates, and the condition is much worse. By sighting along the guards it can be seen whether or not one has been bent. A few blows from the hammer or a large monkey wrench on the end of a guard will remedy matters.

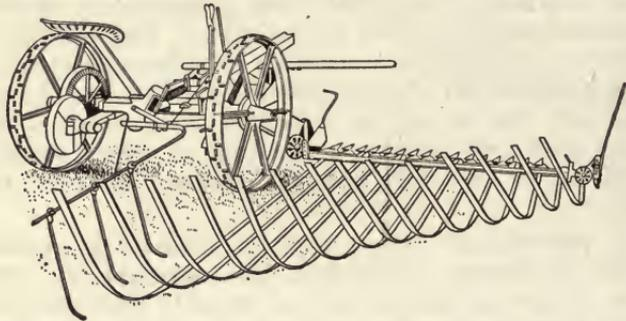

FIG. 244. The mower with windrowing and bunching attachments.

If a section on the sickle becomes loose or is nicked it loses its shear cut and should be replaced.

Ledger plates becoming loose, nicked or badly worn materially offset the cutting qualities and deserve immediate attention.

The clips over the sickle may become worn so they do not hold the sections down on the ledger plates. These plates are made of malleable iron or steel and may be bent down with a hammer. However, if new and old sickles are used in the same machine the clips must be set for the newest sickle unless new sections are put on the old sickle where the clips wear.

It goes without saying that mowers should be housed when not in use, as it lengthens the life and greatly enhances the working qualities of the machine. (See "Mower," in index.)

#### *The Clover Windrower.*

The clover windrower, or, as it is often called, the clover rake, is sometimes used with alfalfa. This consists of a series of light iron bars of unequal length, which are turned up at the rear end. The long

bars are attached next to the mower, and decrease in length to the outer end of the cutter bar. The cut grass falling on the windrower is rolled off at the inner edge. This is especially valuable in cutting alfalfa for seed. (See "Windrower," in index.)

*The Sulky Rake.*

The sulky or common hay rake may be had in sizes from 6½ to 11 feet in width and should be wide enough to rake two full swaths cut by the mower. They are made either hand or self dump. The self-dump rake has a foot lever which engages a ratchet in the wheels, which raises the teeth as the wheels rotate. When the teeth are raised to the proper height the ratchet is automatically released, allowing the teeth to drop down. This type of rake is generally preferred.

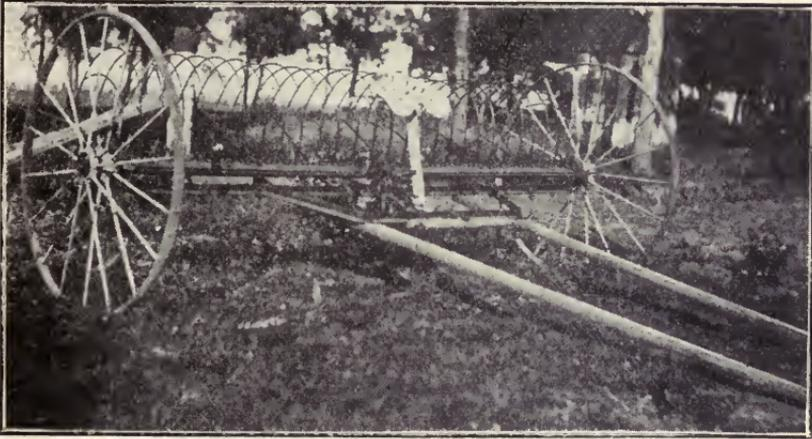

FIG. 245. The sulky rake.

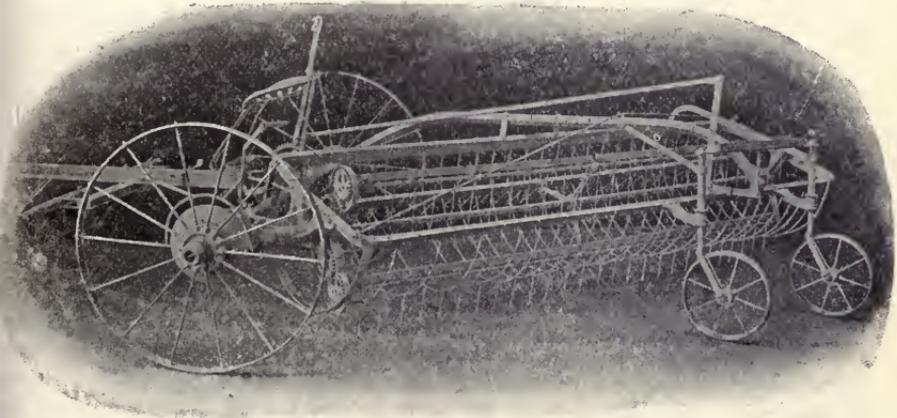

FIG. 246. The side-delivery rake.  
[Courtesy Emerson-Brantingham Implement Co.]

The teeth of the rake are made of spring steel, and generally have one or two small coils near the upper end of the teeth to give more flexibility. They may have either pencil or chisel points. The chisel points generally enter the hay a little more readily. Cleaning teeth are essential to good raking.

Some rakes are provided with a short tooth at either side to keep the hay from working out at the side. These are especially valuable where the hay is short and dry. (See "Rake," in index.)

#### *Side-delivery Rakes.*

The side delivery rake has two wheels in front and one or two castor wheels in the rear. On the reel type the reel is set diagonally with the swath and revolves backward, rolling the hay to the front and side and delivering it at the side in a loose windrow. The reels are made with two or three bars and on some machines are made reversible for tedding.



FIG. 247. The iron cap for protecting sweep rake teeth.  
[Courtesy Stowe Supply Company.]

The fork type of side-delivery rake has arms with forks at the lower end, which are worked by the wheels through a suitable mechanism, and throw the hay to front and side of the machine. Some makes of these machines are also reversible for tedding.

The main advantages of the side-delivery rake are that it leaves the windrow suitable for satisfactory operation of the self loader and that the hay will cure better. (See "Side-delivery Rake," in index.)



FIG. 248. The two-wheeled sweep rake.  
[Courtesy John Deere & Company.]

#### *Sweep Rakes.*

The sweep rake may be a simple affair, drawn over the stubble on skids or runners, or it may be mounted on wheels with a mechanism for raising the teeth. With some of the rakes the team is divided and one horse placed at either side, while others have the team hitched to a tongue in the rear. The latter type is the more expensive and the harder to guide. Some of the rakes that have the team at the sides also have provision for raising the teeth.

OPERATION. The main principle in the sweep rake is the long teeth which run under the hay and carry it along. They are unloaded by backing the rake from under the hay.

As the rakes are made of wood they should be kept well painted and nuts kept tight. (See "Sweep Rake," in index.)

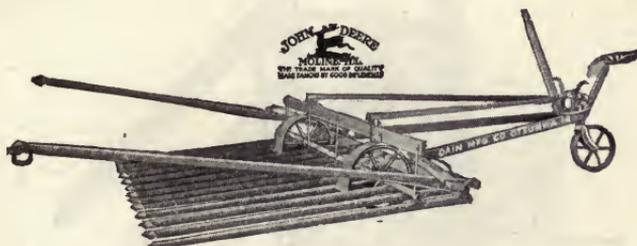

FIG. 249. The three-wheeled sweep rake.  
[Courtesy John Deere & Company.]

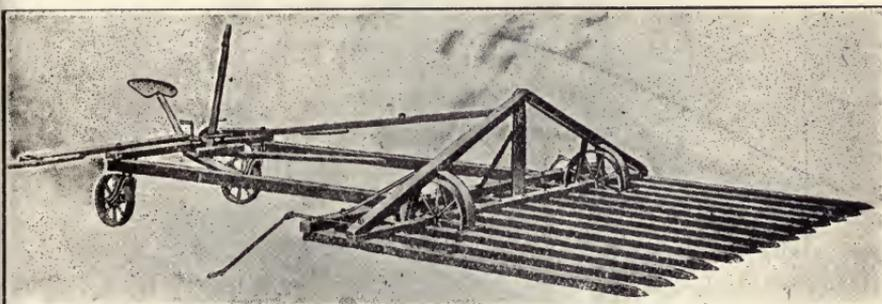

FIG. 250. The four-wheeled sweep rake.  
[Courtesy Arizona Experiment Station.]

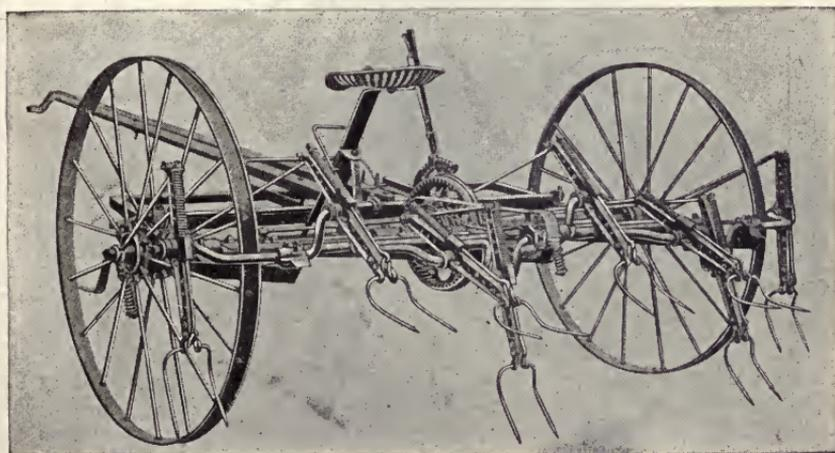

FIG. 252. The hay tedder.—[Courtesy Iowa Experiment Station.]



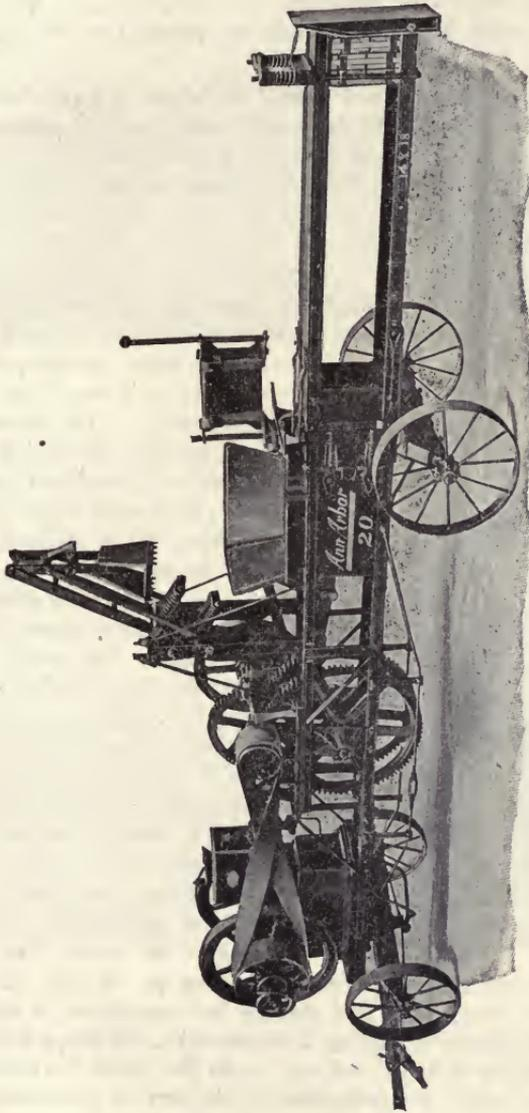

FIG. 253. The modern hay baler.—[Courtesy Ann Arbor Machine Company.]

*Hay Balers.*

These machines may be had in sizes to suit the purchaser, from the small one-horse sweep press to the larger sizes driven by power. Many of the power presses have a gasoline engine attached to the front of the baler.

A self-feed is desirable, although not necessary, on the small press, but the larger power presses can not be operated at full capacity without one.

**OPERATION AND CARE.** Care should be taken in hand feeding to push the tailings down and get the feed well into the feed chambers. It is a very dangerous policy to use one foot as a self feeder.

It is a great advantage in handling, shipping and storing hay to have the bales as smooth and as nearly an even length as possible. (See "Baling," in index.)

*Stackers.*

The field stackers are divided into two classes—the overshot and the swinging stacker. The overshot stacker has a row of teeth, corresponding to those on the sweep rake, on the end of a long arm hinged near the ground. By means of a rope and pulleys the arm and teeth are raised to a vertical position. The hay is placed upon the teeth by pushing it on with a sweep rake and backing away the rake. When the teeth of the stacker are raised to a vertical position the hay slides back onto the stack. With the most of these stackers the hay can only be raised to a certain height. However, there is at least one make that is arranged so that the stacker arms are 12 feet long when the stacker head is on the ground, and the arms will extend up to 25 feet, depending upon how it is adjusted by the operator. The maximum height at which the hay is delivered ranges from 25 to 32 feet, depending on the size used.

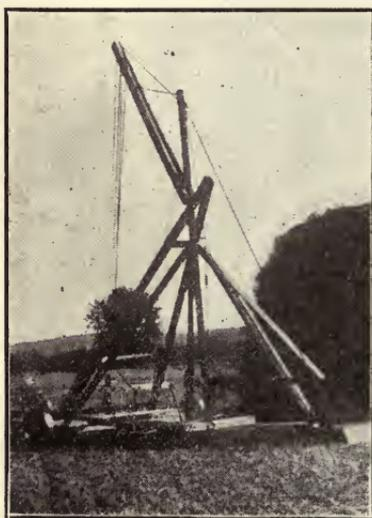

FIG. 254. One form of swinging stacker.

The combined sweep rake and stacker is constructed in such a manner that the whole machine is used as a sweep rake. When a load is collected it is raised from the ground and run up to the stack. As the machine is approaching the stack a mechanism is thrown in gear and the wheels turning on the ground raise the stacker arms. When the load is raised it is automatically held in position until unloaded onto the stack. As the machine is backed from the stack the arms recede. This machine may be used as a stacker in conjunction with sweep rakes. Its chief advantage is that a load can be put on the stack at any place desired.

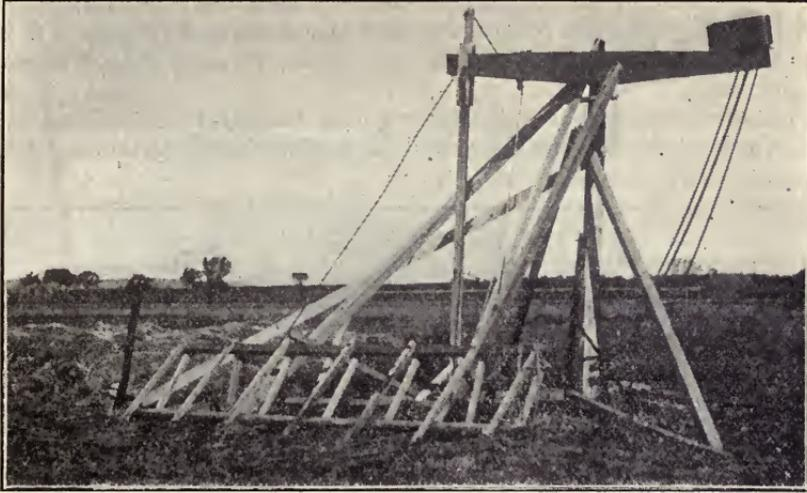

FIG. 255. Another form of swinging stacker.

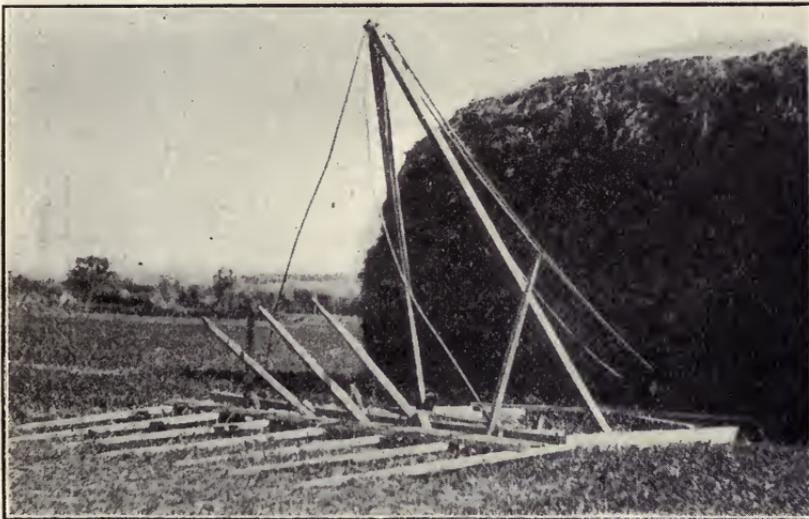

FIG. 256. The overshot stacker.

The swinging stacker has a row of teeth on arms which may be raised to any height and locked in place by a brake engaging the rake. Then it may swing around any place desired and the load dumped.

*The Pole-and-boom Stacker.*

This type of stacker is generally homemade and is used with a hay fork for unloading from wagons. It consists of an upright pole and a boom. There are several different methods used to hold the upright

pole in position. Sometimes the stacker is constructed on a sled or skid so it can be moved easily; again the pivot is secured to a small skid so the base of the pole may be moved, the top of the pole being held in place by guy lines.

The stackers which are built on a sled usually have a long boom pole, which is secured near its center (by a hinge joint) to the top of the

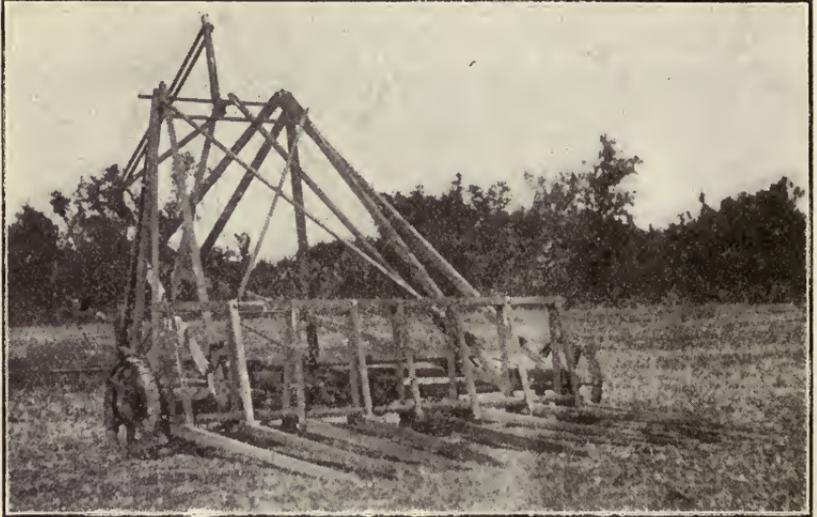

FIG. 257. Combined sweep rake and stacker.

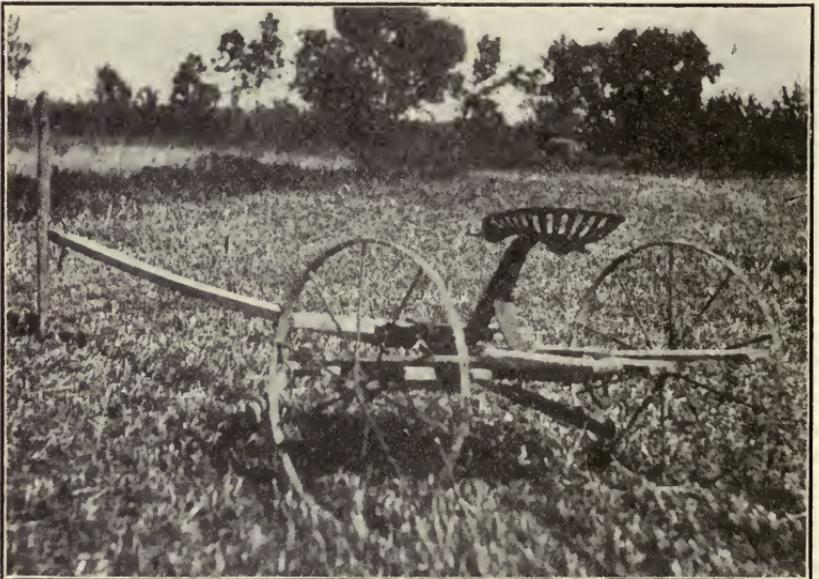

FIG. 258. The stacker cart, for use with stacker where stacker head is let down by a brake. The rope is worked into the ring seen below the seat.

upright, one end being secured by a rope or cable to the base of the upright, while the fork is used on the other end.

This type of stacker can not be used to build very high stacks, as the weight, being carried at the end of the boom, has a tendency to tip the stacker over.

The stackers which have a tall upright, and the boom hinged by one end at a distance slightly less than the length of the boom from its top, have the upright held in position at the top by guy lines, which are screwed to a ring. The base of the upright is set in a skid, so the back of the stacker can be moved without lowering it to the ground. The boom is held in position by a rope and tackle running from its outer end to the top of the upright. This allows the boom to be raised and lowered from the ground. The upright is bent a little over the stack, so the loaded fork tends to swing around over it.

This type of stacker may be used to build stacks up to 35 or 40 feet in height, and is used where wagons are unloaded with slings or forks.

**OPERATION.** One end of the rope which raises the fork is screwed to the end of the boom and runs down through a pulley fastened to the fork, then back up over a pulley fastened to the end of the boom, then through a pulley secured to the upright at the base of the boom, and then over a pulley at the base of the

upright and out along the side of the stack to the horse. (See "Stacker," in index.)

#### *Hay Loaders.*

In general there are two types of hay loaders. The fork loader and the endless apron loader. The former has a series of forks and oscillating arms, which are driven by chains, gears or cranks from the wheels, which take the hay off of the ground and force it up a carrier onto the wagon. The latter has a cylinder with protruding teeth, which takes the hay off the ground, and it is then raised up on an endless apron. (See "Hay Loader," in index.)

#### *Forks.*

There are at least four types of hay forks in use, each of which is adapted to certain conditions. The single harpoon has a single tine with spurs which stand out at right angles to the point. These are tripped

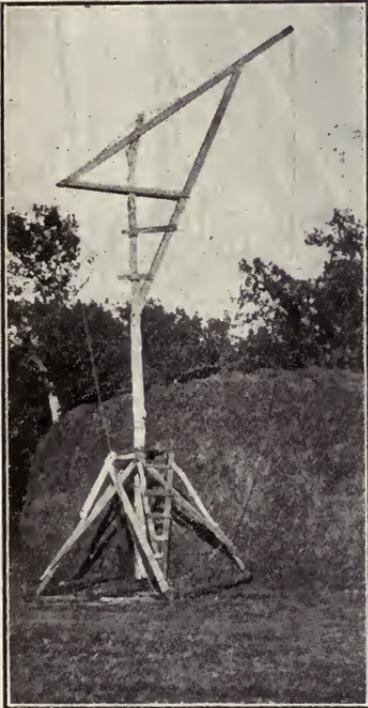

FIG. 259. Pole and boom stacker.

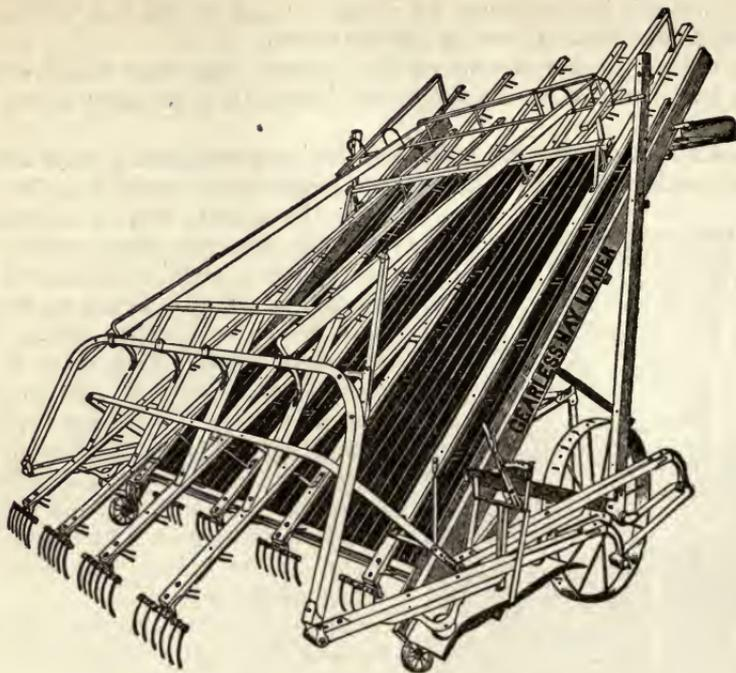

FIG. 260. Gearless or fork type hay loader.  
[Courtesy Emerson-Brantingham Implement Company.]

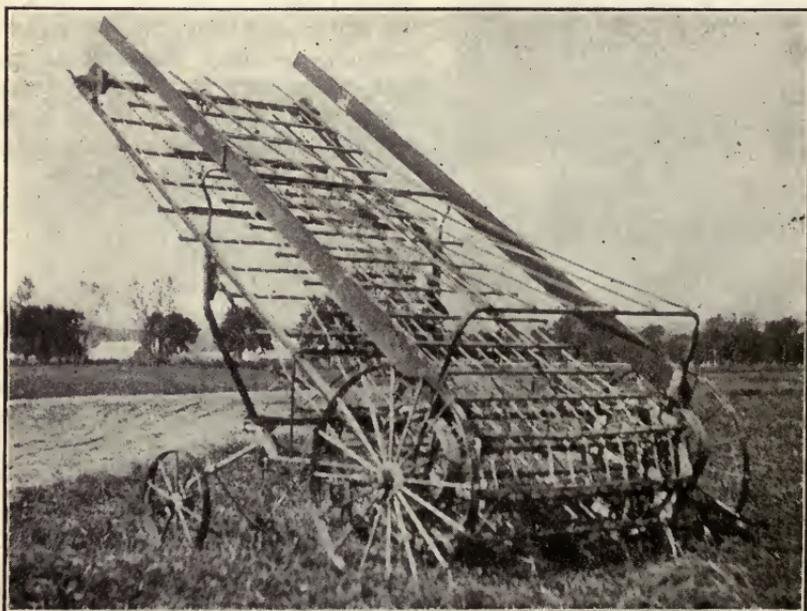

FIG. 261. The cylinder type hay loader.

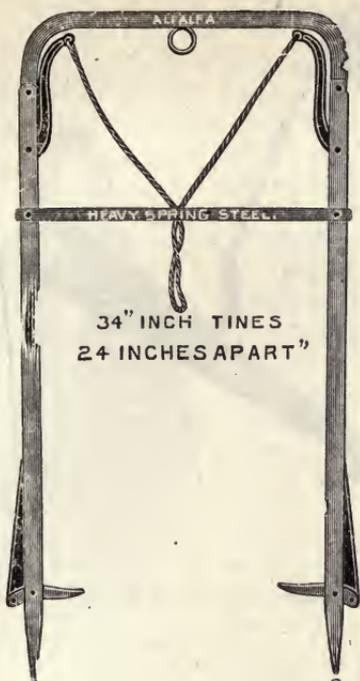

FIG. 262. The double harpoon hay fork.—[Courtesy F. E. Myers & Bro.]



FIG. 263. The single harpoon hay fork.—[Courtesy F. E. Myers & Bro.]

when it is desired to unload the fork. The double harpoon is much the same except that it has two tines. Sometimes these are used in pairs, making a four-tined fork.

The Jackson patent or derrick fork has a triangular frame made of wood with an iron bale hinged close to the piece which holds the tines, and is secured to the vertex of the triangle by a clip while the load is being raised. To unload the fork the clip is released by a rope from the wagon and the tines turn back, allowing the hay to slide off. It has four tines, which are set at right angles to the frame and curved under it.

The grapple fork is provided with tines which swing toward each other like ice tongs, firmly gripping the hay. The tines are of various lengths to suit conditions, and vary from four to eight in number.

USES. The single harpoon is used in hay that is long and hangs together well. It is light and easily handled. The double harpoon is used under much the same conditions, but will work in shorter and looser hay.

The Jackson fork is used in any kind of hay, and is an especial favorite with threshermen in handling headed grain. It is simple and easily handled with a little experience. The grapple fork is used in short hay and the eight-tined forks are sometimes used to handle manure. (See "Forks," in index.)

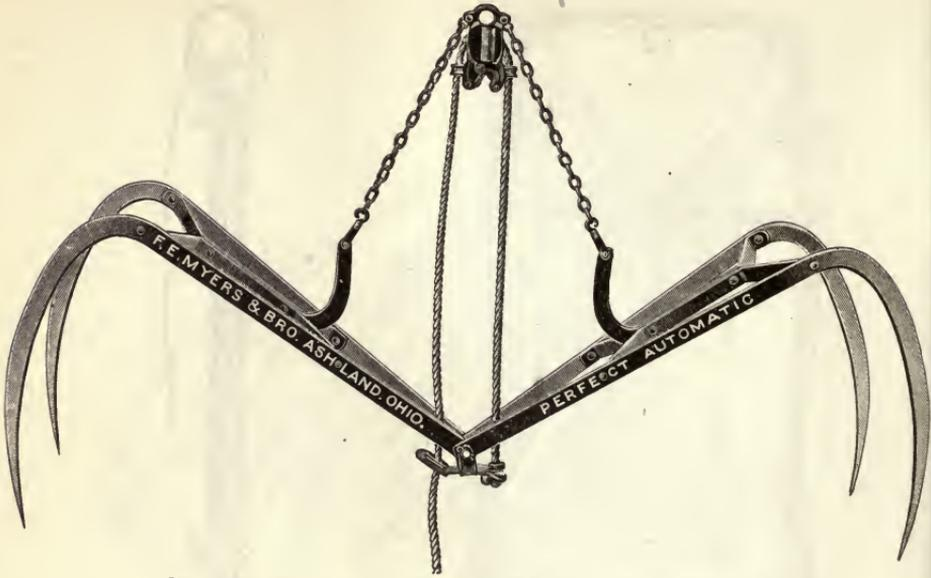

FIG. 264. The grapple fork.—[Courtesy F. E. Myers & Bro.]

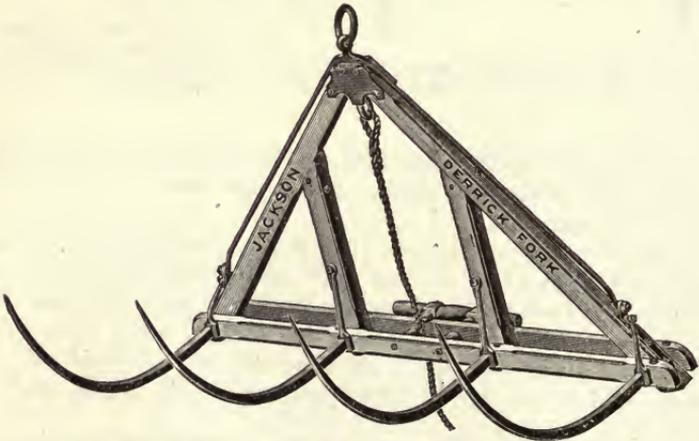

FIG. 265. The Jackson or derrick hay fork.—[Courtesy F. E. Myers & Bro.]

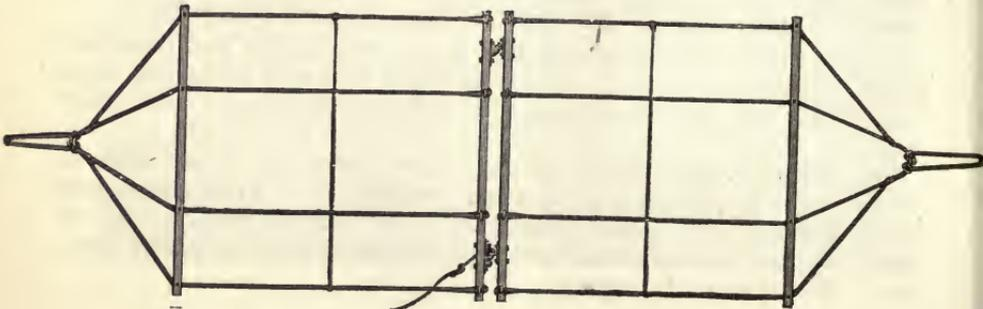

FIG. 266. The hay sling.—[Courtesy F. E. Myers & Bro.]

*Slings.*

Hay slings are webs made up of rope, or ropes and sticks, which are placed under the load of hay in such a way that the projecting ends may be brought together and all of the hay lying in the sling raised at one time. To release the hay a spring catch is provided in the middle which allows the sling to part when tripped.



FIG. 267. Use strong pulleys.  
—[Courtesy F. E. Myers & Bro.]

**OPERATION.** The sling is placed in the rack lengthwise with the ends secured, and hooks to an upright at the ends of the rack, where they are convenient to reach when unloading. A slingload of hay is put on the wagon, which may be as much as 1000 pounds if the equipment is strong enough. Then another sling is placed over this, and so on until a full wagonload is on, which is usually three slings. The rope and the derrick, or the barn equipment, usually has two pulley blocks, which have hooks on them, one of which is hooked in either end of the sling. As the load starts up the two ends of the sling are brought together, making the bulk compact enough to pass through the door in the mow of the barn. When the sling

is released the hay unfolds and is left lying flat in the mow or in the stack. (See "Slings," in index.)

*Carriers and Tracks.*

Special carriers are made for forks or slings or for both. The latter kind is known as a combined carrier. The size varies with the service. The light carriers are used with forks. The heavy double-track carriers are used with slings. Some may be used in either direction, and are called two-way carriers. If the lower part can be turned about without removal the carrier is said to be reversible.

A large variety of wood and steel tracks are to be found upon the market. The steel tracks are made T-shaped, channel steel placed back to back; cross form of cross section, or two T's placed top to top. Wood tracks are usually made of 4- by 4-in. timber and are often steel plated on the top edges where the carrier wheels run.

Various forms of switches are used to convey the hay in different directions from the point of loading. When the track turns a corner or is curved a system of pulleys must be provided to keep the rope in position. (See "Carriers" and "Tracks." in index.)

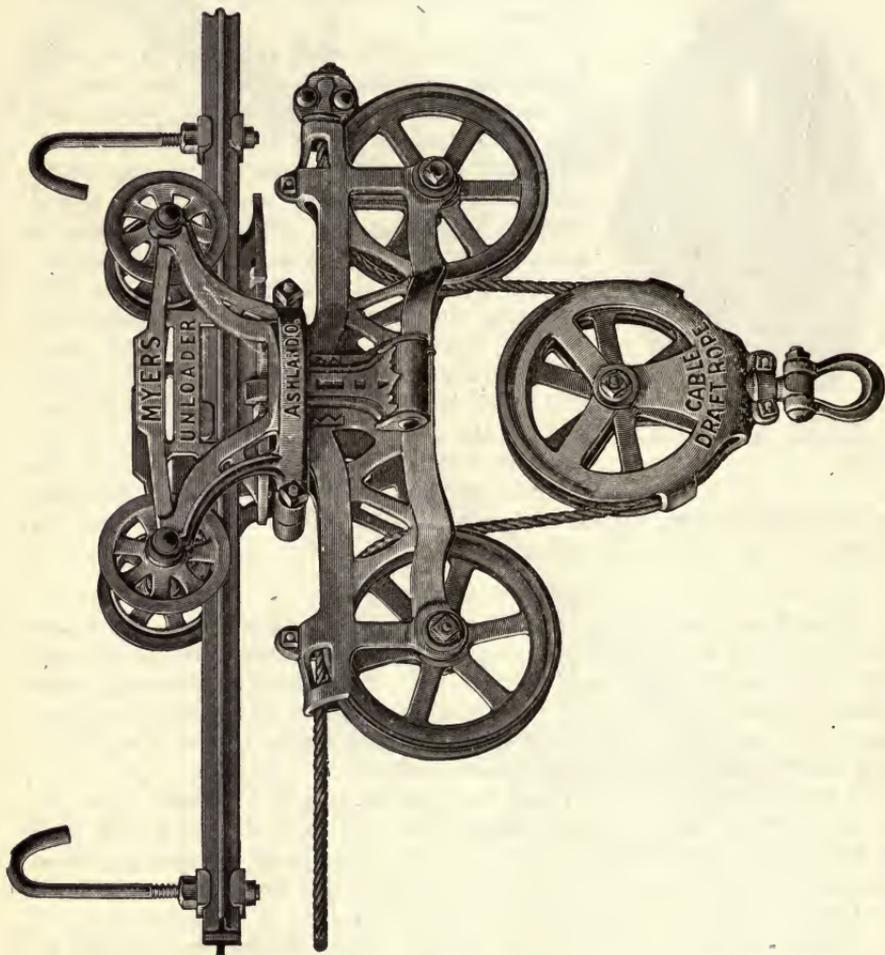

FIG 268. Carrier for forkloads. [Courtesy F. E. Myers & Bro.]

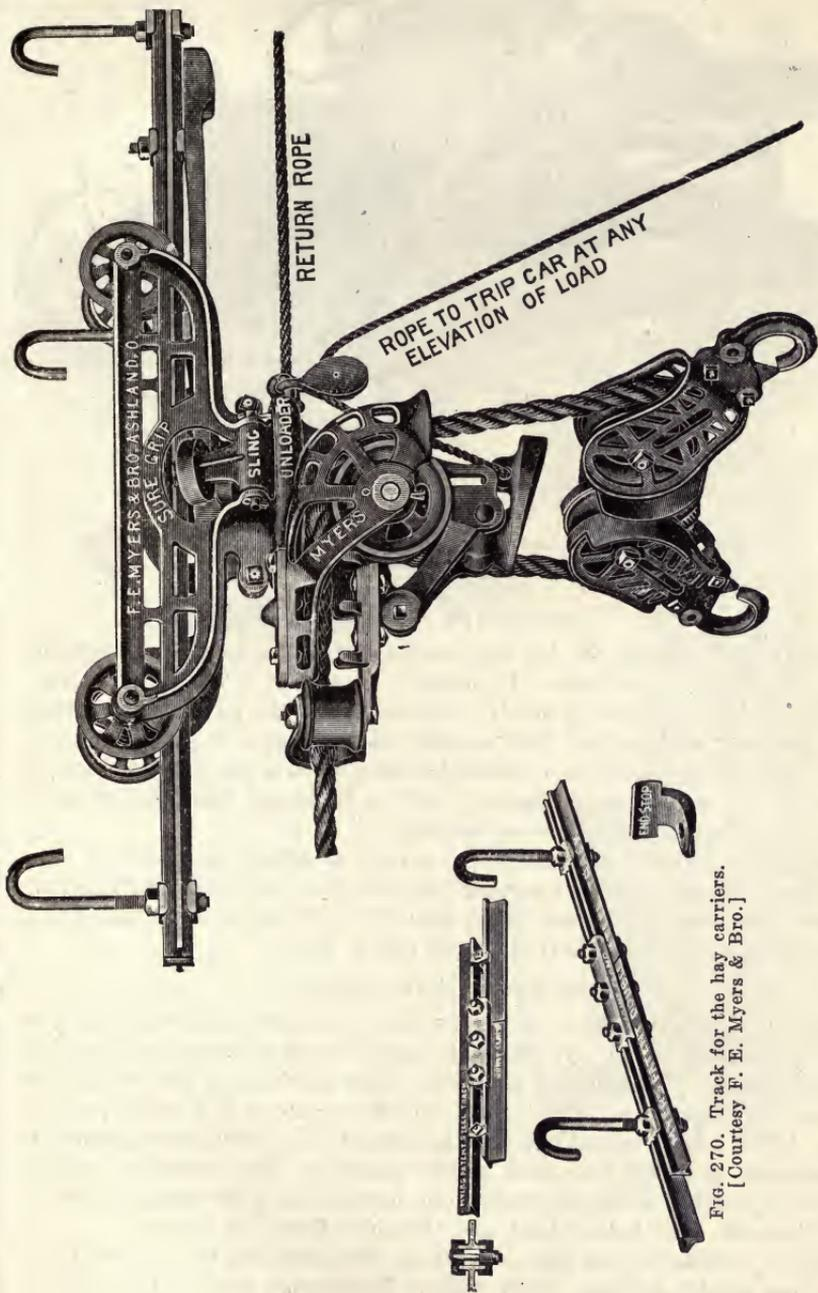

FIG. 269. Carrier for sling loads.—[Courtesy F. E. Myers & Bro.]

FIG. 270. Track for the hay carriers.  
[Courtesy F. E. Myers & Bro.]

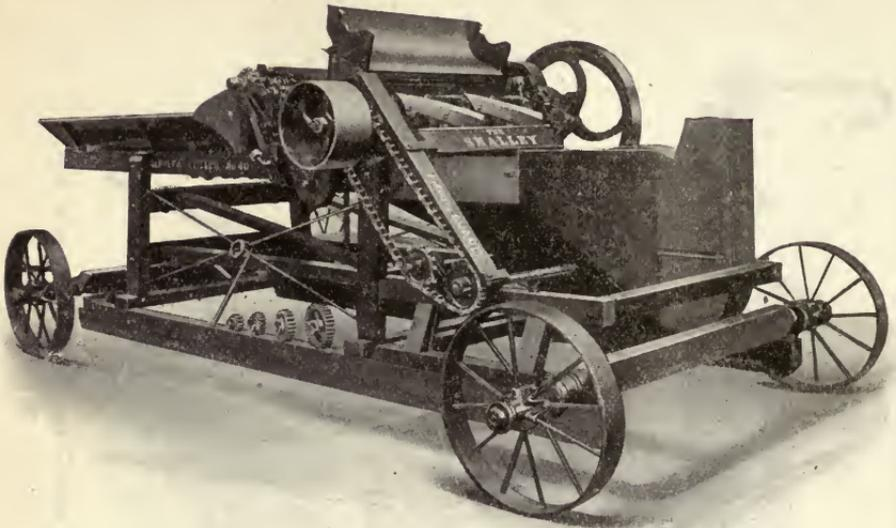

FIG. 271. A cutting machine for chopping alfalfa into short lengths.  
[Courtesy Smalley Manufacturing Company.]

#### HARVESTING FOR SEED.

Alfalfa that is being cut for seed should be handled as little as possible, especially after it has cured. In order to do this it is desirable to leave the alfalfa in windrows or small bunches. This can be done by cutting with a mower and raking with a side-delivery rake, if raked before it cures. Or it may be placed in small bunches as it is cut, by using one of the clover rakes (described before) with a bunching attachment, which leaves the alfalfa in small, loose bunches.

One of the writers once harvested a crop of alfalfa seed with a common grain header, after removing the elevator, and obtained excellent results. The header will not work, however, if there is much fine grass, as the corrugated sickle knives do not cut it well.

#### *Alfalfa and Clover Hullers.*

Special alfalfa threshers are constructed somewhat differently from grain separators. Two cylinders are used, the first removing the pods from the straw. By the time all of the straw has passed the racks all of the pods are removed. The second cylinder removes the seed from the pods. After being cleaned the seed is bagged, or a recleaner attached to the machine is sometimes used before bagging. The machine requires constant watching, as the separating mechanism has a tendency to clog up with the pods and leaves that are threshed from the straw.

Quite a number of the grain-threshing machines can be converted into clover and alfalfa hullers. They will do fairly good work if the straw is dry and in good condition for threshing.

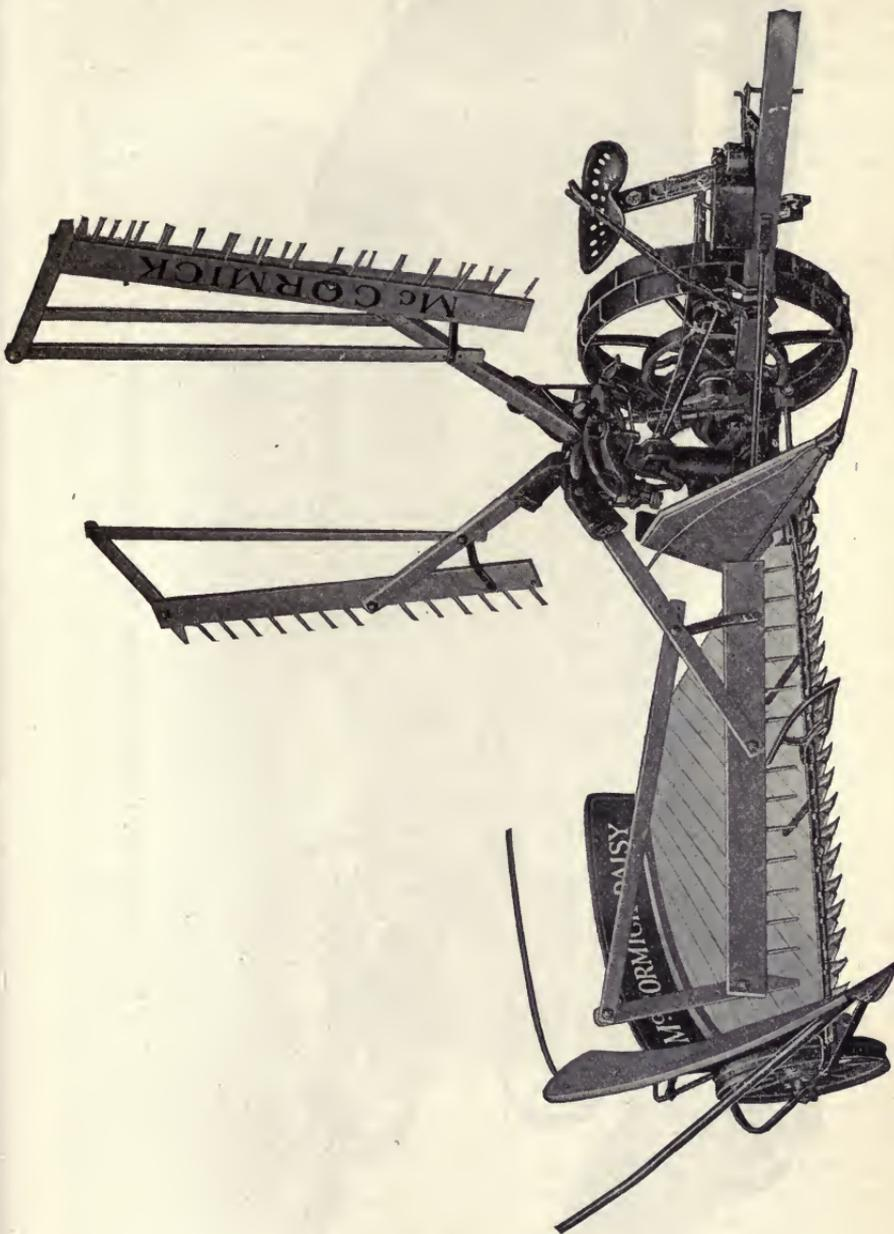

FIG. 272. The modern self-rake reaper.—[Courtesy International Harvester Company.]

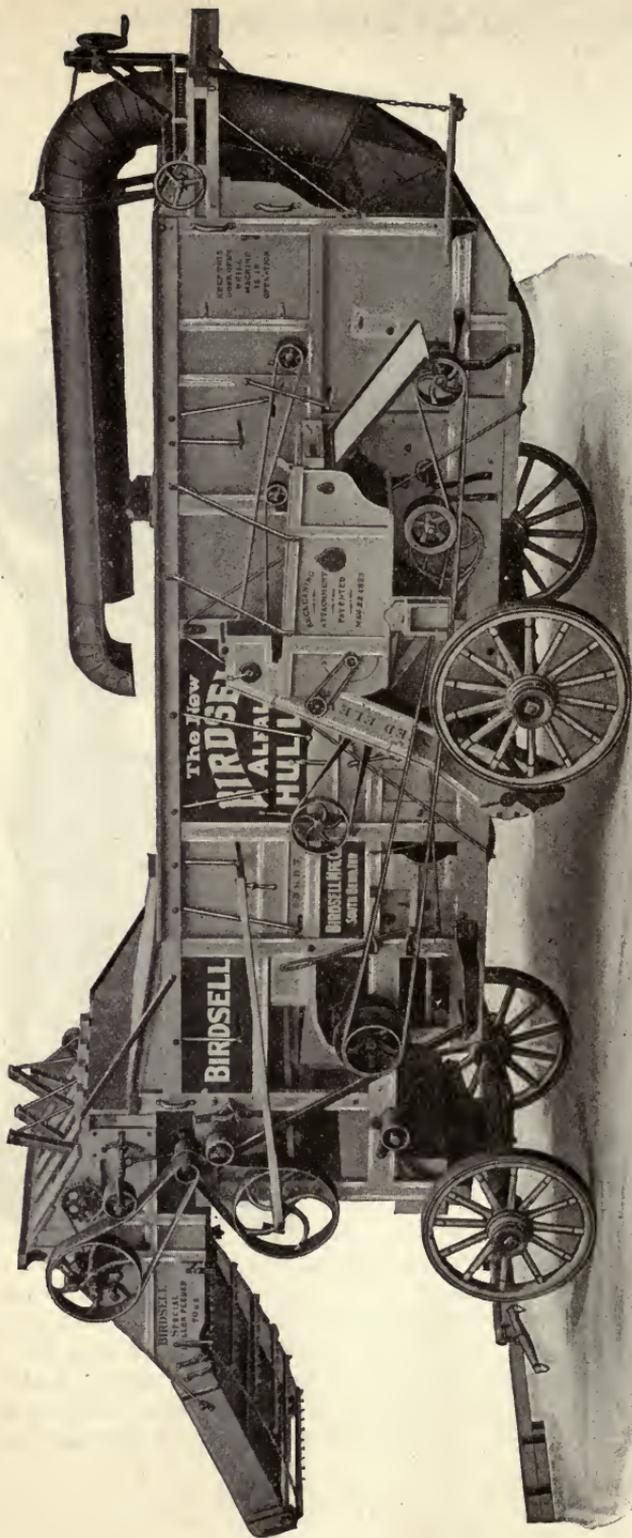

FIG. 273. An alfalfa huller.—[Courtesy Birdsell Manufacturing Company.]

On one machine the clover-hulling attachment, consisting of concaves with rasp teeth, is used. More often one or more of the regular three-row concaves is filled with corrugated teeth. This is on account of the fact that it is easier to remove the alfalfa from its pods than the clover from its heads. A recleaner can be added which will preform the function of a fanning mill.

Directions from the company should be on hand at all times and referred too frequently. This will save many an hour in the field and many a bushel of seed. (See "Threshing," in index.)

#### *Cleaning and Grading Machines.*

There are but few cleaning and grading machines on the market that will clean and grade alfalfa seed successfully. Some of the foul seed in

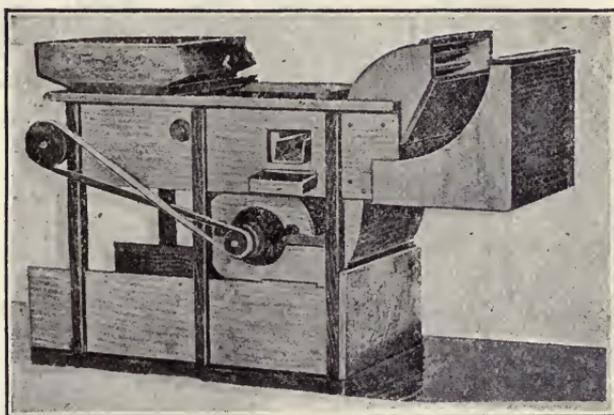

FIG. 274. A fanning mill adapted to recleaning alfalfa seed.  
[Courtesy U. S. Department of Agriculture.]

alfalfa is so near the size that the majority of fanning mills will not remove them.

The machines that seem to give the best results are those that have a vertical air blast and the seed passes down through the blast.

With any of the mills it requires very careful operation and selecting of screens to do satisfactory work, and a great deal of dependence will have to be placed in the air blast for removing shrunken or light seeds.

A machine known as the S. S. & S., put out by a company at Denver, Colo., and at Dallas, Tex., can not be recommended too highly for grading seed of any kind. This machine was brought out for grading oats of different specific gravity, and has just recently been put on the market as a seed and grain grader. The machine will grade grain into about ten different gravities, varying only a few ounces or more to the bushel, and is the only machine brought out that will successfully separate dodder from alfalfa seed. The machine requires from three to five horsepower to operate it and costs about \$300. It is intended for use in seed houses, but may be handled by a community very nicely, and ought to

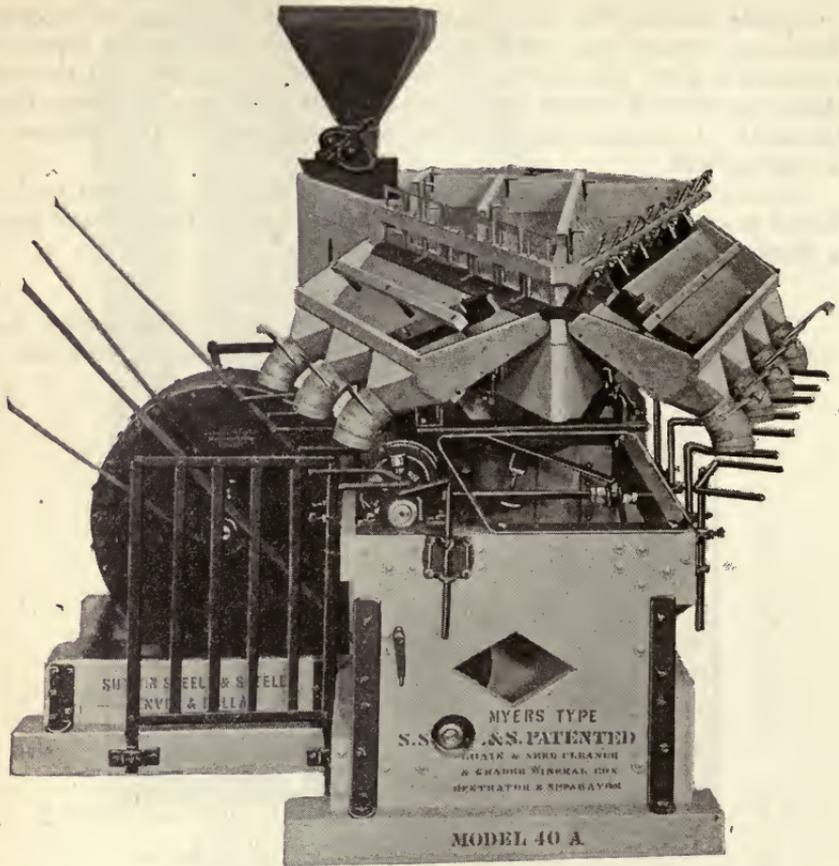

FIG. 275. A grain and seed cleaner and grader.  
[Courtesy Sutton, Steele & Steele Mfg. M. and M. Co.]

make a valuable asset to the farmers' union elevator, where all of the farmers in a community could use it. Seed graded in one of these machines must first be graded as to size by a good screen mill. (See "Cleaning," in index.)

#### SELECTION.

All of the machines that have been discussed are already found on the Kansas farms. In the selection of these and special machines there are several points to bear in mind. A few farms are overstocked with machinery, with the result that depreciation, interest on the money invested and repairs take too much of the profits. Ordinarily the opposite condition is true—not enough machinery is used.

Before deciding to buy a new machine, the elements of cost with and without the new machine, and with the old machine on hand, should be carefully considered. Items of cost with the machines are labor cost, fixed annual charges, and efficiency. The fixed annual charges include

interest on the money invested in the machine, depreciation, repairs and storage.

A practical case: An alfalfa- and grass-seed drill is not needed by a farmer who will never have more than ten acres in alfalfa. Some other machine would be better.

Oftentimes a machine can be rented for less than it would cost to own it. While this practice could be followed more than it is, it has certain disadvantages that are readily apparent; for instance, the machine could not be obtained just when it was needed.

When deciding between two makes of the same kind, compare simplicity, durability, workmanship, materials and construction, and oiling devices. The latter often indicate the care with which a machine is built. Never look at the price mark closely. A few dollars more can frequently be spent very advantageously in this way.

The best machines will need repair occasionally. It is extremely important that they can be had quickly if necessary. Many and many a good machine has been discarded because a new part costing a few cents could not be obtained at all, or at least very quickly.

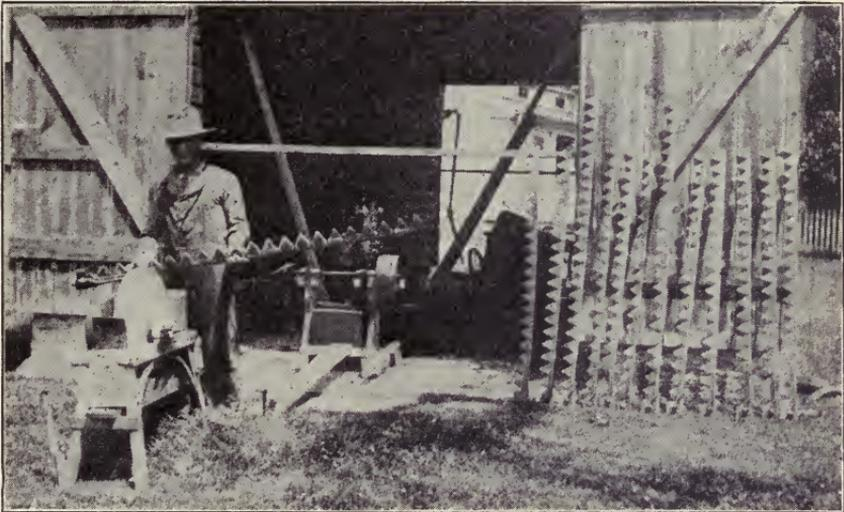

FIG. 276. Always keep tools sharp and in first-class repair.  
[Courtesy Wisconsin Experiment Station.]

#### CARE OF MACHINERY.

This article would hardly be complete without a few words in regard to the care of machinery:

Exercise care when the machine is in use.

Keep all instructions.

Thorough understanding of machine essential.

Improper adjustments cause inferior work and increased draft.

Dull implements do inferior work and draft is increased unnecessarily.

Oil is cheaper than repairs.

Special oil and grease for special conditions.

Always use lubricant recommended by the manufacturer, or a better grade.

Oil little at a time and frequently.

When through for season tag parts needing repair:

Order repairs early.

Have machine ready for season's work before the spring rush is on.

Paint acts as a preservative to both wood and steel.

Rust is as destructive as wear.

Grease polished surfaces when implement is not in use.

Life of machine and the quality of work is lessened by lack of care.

Machine sheds are good investments. But if a shed can not be had, it is still possible to give the machine good care by—

(1) Painting.

(2) Removing polished parts, such as sickles and cultivator shovels, and placing them in a dry room over winter.

A workshop is very important. Slight repairs can be made at home on rainy days, thus saving a trip to town. Buy a few carpenter and blacksmith tools.

#### SUMMARY.

With few exceptions, the machines discussed are very common and are used for other crops besides alfalfa. A few points should be emphasized:

First. Utilize every machine on hand to the fullest extent before buying a new implement.

Second. Consider well all items of expense with or without a machine.

Third. Select new machines carefully.

Fourth. Understand fully the methods of operation.

Fifth. All machines deserve good care.

---

Approximately one-fifth of the alfalfa seed used in the United States is imported, and practically all of this imported seed now comes from Russian Turkestan. Commercial Turkestan is the cheapest alfalfa seed in the European market, and its wholesale price in this country is less than that of domestic-grown seed, while the retail price of Turkestan alfalfa seed in this country is usually higher than that of domestic seed; consequently the seedsman's profit on it is greater than on domestic seed. Commercial Turkestan alfalfa is particularly unsuited to the humid eastern portion of the United States, while it is not as hardy as other strains in the North, and everywhere it recovers slowly after cutting, thus reducing the hay yield. It is relatively short-lived and is a poor seed producer. Russian knapweed, a weed similar in manner of growth to quack grass, Johnson grass and Canada thistle, is constantly being introduced in Turkestan alfalfa seed, and by the presence of this weed seed commercial Turkestan seed may be easily identified.—*Department Bulletin No. 138, U. S. Department of Agriculture.*

## A WAGON FOR HAULING ALFALFA HAY.

By H. W. McAFEE, Farmer, Topeka, Shawnee county.

I use a specially constructed wagon for hauling alfalfa hay. This wagon consists, in brief, of a 9- by 18-ft. platform built on two sets of low wheels. There is no coupling pole, or reach, and the bolsters are so built up that the floor clears the top of the wheels. The wagon can turn around in a space of its own length.



FIG. 277. One of Mr. McAfee's strong, durable hay wagons.

The sills, which rest on the outer ends of the bolsters, are made of 3- by 8-in. yellow pine, twenty feet in length, and are placed on edge. Two feet of the sills project at the rear of the wagon, and in these projecting ends a lathed wooden roller turns. A one-inch rope is tied to each side of the front of the rack, and when the wagon is loaded with hay the ropes are stretched across the top of the load and fastened on each end of the roller, and wound tight. This holds the load firmly in place.

Five 3- by 4-in. yellow-pine crosspieces are bolted onto and at right angles with the sills, evenly spaced. Braces are fastened underneath the sills with the same bolts that fasten the cross pieces. These braces project two inches beyond the sills on either side. Resting on these projecting ends are other braces which reach out and up to the ends of and support the crosspieces above. All braces are of 2- by 4-in. yellow-pine lumber, and are bolted tight.

The floor, which is boarded solid, is made of 1- by 12-in. white pine, 18 feet long, bolted to the crosspieces. The standards, placed at either end, are made of two 2- by 4-in. pieces, 4½ feet long, to which are nailed four crosspieces. These standards turn on bolted rods which go through

both sills, and when the wagon is not loaded with hay may be laid down in the central depression of the wagon floor. If desired the central depression may be covered with loose boards, making the wagon floor level all the way across, although the depression helps to hold a load of hay solidly on the wagon.

Such a hay wagon is strong, durable and saves a maximum amount of alfalfa leaves. As much as 6890 pounds of hay have been hauled upon it. It is easy to load and to unload, and has the additional good feature of being usable for other purposes. The total cost of material for the rack is approximately \$11, to which must be added the cost of the running gear.

---

## WEEDS IN ALFALFA.

By ROBERT SCHMIDT, Seed Analyst, Department of Botany, Kansas State Agricultural College.

Pernicious weeds are commonly introduced on the farm by the sowing of impure seeds;\* that is to say, by sowing seed that has mixed with it the seeds of many noxious weeds. This is often due to the ignorance of the person sowing such seed, but more often to the unwillingness of farmers to pay the comparatively small difference in price between good and poor seed. Good, clean seed should always be sown; the best obtainable is often none too good. If there is any question as to its purity the seed should be tested to ascertain what weed seeds are present.

Weeds are alfalfa's worst enemy, especially so during the first year of the crop's growth. Very often a good stand of alfalfa has been ruined by vigorous weeds that have choked it out before it had become well established. Weeds also constitute a rather serious menace to the successful production of alfalfa seed. They not only crowd the plants in the field, but their seeds are harvested with the alfalfa seed, and are thus often sold with it and carried to other sections.

The problem of weed destruction in stands of alfalfa is difficult. Alfalfa is less aggressive than many weeds. The alfalfa plants do not spread by runners or rootstocks as do many of the grasses and weeds, while old alfalfa stands do not ordinarily thicken up from self-sown seed, as is the case with most of the weeds. The weeds in an alfalfa field tend to increase more rapidly when the stand is allowed to remain for seed each year than when the field is mown regularly for hay. When this weedy condition develops a year or two of regular mowing for hay will do much toward reducing the number of weeds present in the field.

There is a large number of species of weeds which infest our alfalfa fields. Their seeds are generally present in clover and alfalfa seed, and the weeds themselves have been associated with these forage plants so long that it is now difficult to get seed in the market that is absolutely free from such pests. Descriptions of some of the worst follow.

Dodder, foxtail, Russian thistle, pigweed, crab grass and star thistle are annual weeds; that is, they live for only one year, depending on their seeds for further propagation. Curled dock, sorrel, buckthorn, and chicory

---

\* See "Weeds" and "Seeds," in index.

are perennial weeds, their roots living over the winter and sending up stems each year to produce seeds. Sorrel, or sour dock, propagates also by means of running underground rootstocks, from which many new stems are sent up. The perennial weeds are the most persistent, because they can not be eradicated by merely preventing them from producing seed for a few seasons. The plant and root must be entirely destroyed. In the case of those weeds which possess running underground rootstocks, eradication is a difficult problem.

**GREEN FOXTAIL.** (*Setaria viridis* [L.] Beauv.). Green foxtail is a very common annual plant closely resembling common millet. It ranges from one to three feet high, the spreading branches springing up from the crown of the plant. The flower head is from one to three inches long and covered with greenish bristles. The root is fibrous. The seeds ripen from July on. Yellow foxtail is very similar to green foxtail, and is almost always closely associated with it as a weed. These foxtail grasses are bad weeds only because they are so numerous that they choke out crop plants. They also produce an enormous crop of seed.



FIG. 278. Curled dock.

The flowers and seeds are produced on slender finger-like spikes, from which characteristic it is often called finger grass. Crab grass, as also the foxtails, is primarily a weed of cultivated land, but seems to do well in alfalfa fields and grass fields also, sometimes making such a vigorous growth that it chokes the crop plants.

This grass is more difficult to remove than foxtail because it roots so readily at the joints. Cultivation will kill it. Do not let it go to seed.

**CURLED DOCK** (*Rumex crispus* L.). Curled dock is a perennial weed with a large tap root, sometimes two feet long. The plant is from two to three feet high and has large leaves with a wavy margin. The name "curled dock" comes from the wavy appearance of its leaves. The flowers and seeds are found at the top of the plant in dense whorls, extended into racemes or heads. The mature seeds are shiny brown, and triangular in

The foxtails are easily killed by cultivation. In the case of alfalfa, cultivation with a spring-tooth harrow or spike-tooth disk harrow will help to keep them in check.

**CRAB GRASS** (*Digitaria sanguinalis* [L.] Scop.). Crab grass is an annual grass, much branched and leafy. It grows from one to three feet high, the stems spreading along the ground and taking root at the lower nodes or joints.

shape. The plant flowers in June and ripens its seeds in July or a little later. It is commonly found in waste places, clover and alfalfa fields, and meadows.

Curled dock is readily eradicated by short rotations and cultivated crops. Where this is impracticable, hand pulling when the ground is soft and wet is the best way to get rid of it. Avoid sowing the seed with crop seeds.

**SHEEP SORREL or SOUR DOCK** (*Rumex acetosella* L.). Sheep sorrel is a perennial weed with shallow-running rootstocks, from which it sends up new plants in all directions. It rarely grows taller than eight or ten inches, otherwise resembling the other docks in general characteristics. It produces an abundance of small triangular seeds during July, August and September. This is not a very common weed in this section as yet, but is sure to become so, because its seeds are so abundant in commercial grass and clover seeds.



FIG. 279. Rough pigweed.

Sheep sorrel grows best in thin or worn-out meadows and clover fields. Breaking the meadow and growing some cultivated crop will usually subdue the weed. The soil should also be limed.

**RUSSIAN THISTLE** (*Salsola kali tenuifolia*, G. F. W. Mey).—This is an annual weed which is supposed to have come from Russia in some imported flaxseed. The plant is from one to three feet high and sometimes has a diameter of six feet. It branches very profusely, giving it a bushy appearance, sometimes almost spherical. The plant is light green in color, has a small white taproot, and small leaves tapering down to

sharp spines. Because of these spines it is called a "thistle," although it does not belong to the true thistle family. The plant matures its seeds in August. The seeds are spiral shaped, covered with a thin gray hull. It is estimated that a large plant will produce from 100,000 to 200,000 seeds. The seed is found in commercial flax and clover seeds, but more especially in western-grown alfalfa seed. Its rapid spread is due partly to this fact and partly to the fact that the plant is a so-called tumbleweed. In autumn the weed breaks away from its stem and is carried for long distances by the wind, scattering seeds as it goes.

Prevent Russian thistles from maturing by cultivation or harrowing. The plants are easily destroyed while small. If allowed to mature they

should be gathered up and burned before they break loose and scatter their seeds far and wide. The removal of the weeds along the roadsides is important, because they are a large factor in the spread of this pest. Careful seeding so as to occupy the land fully with the crop will check this weed to a large extent.

**PIGWEEED OR RED ROOT.** (*Amaranthus retroflexus* L.). Pigweed is an annual weed growing from a fairly deep-rooted tap root. The root is generally red in color, whence the plant is sometimes called "red root." Pigweed grows from one to three or four feet high, and is somewhat branched. The stems and leaves are very rough to the touch. The flowers are inconspicuous. The small, oval, shiny, black seeds mature in July and August. The seeds occur in those of almost all other crops, particularly those of clover, alfalfa, and some of the grasses, but are not difficult to remove by means of the proper cleaning machinery. The weed is common in all parts of the country.



FIG. 280. Dodder on alfalfa.

Prevent pigweeds from going to seed, and avoid sowing the seed in grain, grass and clover seeds. Frequent and thorough cultivation of the seed bed before sowing the crop will destroy a large part of the seeds of this weed which are in the surface soil.

**DODDER** (*Cuscuta*, species). Dodder is a parasite deriving its food, not from the soil, but directly from the crop plants which it infests. In this respect it is not like the ordinary weeds of the farm. It starts from a seed, at first deriving its nourishment from the food supply stored in the seed. It develops a slender, threadlike and leafless stem, which twines around the clover alfalfa or other suitable host plant with which it comes in contact. Suckers are sent out which penetrate the tissues of the host plant. From this time on the dodder is dependent on its host for its food supply, and by means of the suckers penetrating the sap-conveying tissues, begins to drain the host plant of the food prepared by the latter for its own use. After becoming established on the host plant the part of the dodder below the point of attachment dies. Above this point the plant makes rapid growth, branching out until under favorable conditions it forms a tangled mass of threadlike filaments. Since dodder does not manufacture its own food, but uses that prepared by the host plant, it is devoid of leaves and root.

Dodder plants are to be distinguished by their slender, threadlike stems, which are lemon yellow, orange or pink in color. They may appear to confine their attack to a single plant in a place, or may spread uniformly from plant to plant, either near the ground or from the tops of the plants. Small white flowers, mostly in clusters, are produced by midsummer. Seeds ripen throughout the central United States from the middle of July into September. As a rule the dodders are profuse seed producers, but seed production is strongly influenced by the character of the host, its treatment as a crop, and by climatic conditions.

Dodder is commonly thought to be just one species or kind of plant, but there are several different kinds of dodder that are very common and others that are not so common. Alfalfa and clovers alone are infested by four common species, viz., field dodder, clover dodder, small-seeded alfalfa dodder, and large-seeded alfalfa dodder. Dodder is peculiar in that the different species show a marked preference for certain kinds of host plants.

The seed of dodder becomes an important impurity of commercial seeds, both on account of the injurious nature of the plants and the fact that they occur in nearly all the regions in which clover and alfalfa seeds are produced. The size and weight of the dodder seeds and the period of their maturity agree so closely with those of red clover and alfalfa seeds that their presence in the seed crop is practically sure to follow the occurrence of maturing dodder plants in fields devoted to these crops.

Success in the eradication of this pest depends very largely on the early discovery of the plants, followed by immediate work in subduing them. It is important to gain control before the plants have spread far from the point of attack, and to destroy them before they produce seed. Cutting the infested area close to the ground, and burning the plants on

the spot, is the safest method. This may or may not destroy the roots of the crop plants, but if it does the area may be reseeded. In removing the dodder plants to be burned elsewhere, there is always danger of dropping some of the stems in other parts of the field and starting new infested areas. In clearing infested areas care must be taken to carry the work far enough around the borders to include all of the dodder, otherwise the work will be of little value.

The above method is very effective for small patches of dodder. On the other hand, if a whole field is badly infested, plowing under the



FIG. 281. Buckhorn.

stand will be found necessary. This must be done before the dodder has produced seed.

**BUCKHORN** (*Plantago lanceolata* L.). Buckhorn is without question one of the most common and worst weeds of the alfalfa and clover fields. Its seeds are commonly found in commercial alfalfa and clover seed, which accounts for the wide dissemination of this weed. Buckhorn is a perennial plant, introduced into this country from Europe. It produces a large rosette of ribbed, lanceolate leaves, sometimes erect and sometimes lying close to the ground. In place of a stem it sends out long slender stalks, at the top of which are borne the dense spikes of flowers, and later the seeds. The root system of this weed is composed of a short perennial rootstock with many fibrous roots. It propagates by means of seed and also by the rootstock of the previous year. Buckhorn flowers throughout the summer, and mature seed may be found by the first part of July.

Buckhorn is a persistent weed in clover meadows and alfalfa fields. However, it is easily suppressed by the use of hoed crops and short rotations. Since this pest is found commonly in commercial alfalfa and clover seed, it is almost unnecessary to say that only first-quality seed should be sown. If any buckhorn happens to come up with the young crop it should be hand-pulled whenever practicable.

**CHICORY** (*Cichorium intybus* L.) Chicory is a perennial plant closely allied to endive, which is cultivated as a salad plant. The plant is usually much branched, with deep roots, blue flowers, and a rosette of basal leaves spreading on the ground. It is common along roadsides and in waste places, and is becoming a common weed in alfalfa fields, where it has been introduced by the agency of impure seed.

Though a perennial, chicory is not difficult to destroy where rotation of crops is practiced. The roots can be killed by repeated cultivation. Merely cutting the plant off, however, does not destroy it.

**STAR THISTLE** (*Centaurea solstitialis* L.) This is an erect, branched annual with yellow flowers and cottony stem. It has been introduced here with alfalfa seed, and threatens to become a bad weed in the seed-producing districts. It is extremely objectionable on account of its spiny heads.

Star thistle is easily killed by cultivation, as it is only an annual weed. Nevertheless, the labor of eradicating it can be forestalled by sowing clean seed.

The above weeds are the ones the seeds of which are most commonly found in commercial alfalfa seed. There are few weeds that are very noxious, but which are not of common occurrence in alfalfa in this part of the country. These are Canada thistle, horse nettle, bindweed, quack grass, Johnson grass, and dandelion. The fact that the seeds of these weeds are easily separated from alfalfa seed explains why they are not more common. (See "Weeds" and "Seeds," in index.)

## PLANT DISEASES AFFECTING ALFALFA.

By L. E. MELCHERS, Department of Botany, Kansas State Agricultural College.

The extent of damage caused by various plant diseases attacking alfalfa in Kansas is generally not realized. At present no specific data are at hand by which the writer can cite figures for the extent of injury brought about by each different alfalfa disease, but from the plant-disease survey records it is not difficult to see that the various diseases listed below are found to a greater or less extent in all the alfalfa regions of this state. Even basing the extent of damage at 1 per cent, which would be very conservative, the combined loss from the nine diseases already known to occur in this state would amount to over \$140,000 for 1914.

Unfortunately the alfalfa crop is one in which its diseases can only be partially combated—that is, in preventing losses from disease—and this only lies within the scope of the cultural methods of this crop. In other words, spraying with fungicides would be impracticable; therefore, it behooves the farmer at times to practice rotation, or cutting the hay sometimes a little earlier than is ordinarily advisable, in order to prevent the loss of foliage.

Generally speaking, alfalfa diseases may be grouped into two classes: (1) those caused by parasitic organisms (fungi or bacteria, and higher types of plants like dodder), and (2) those which are nonparasitic (not due to any known organism).

Under the first group we have occurring in Kansas the alfalfa dodder, leaf rust, three different leaf-spot diseases, the bacterial stem blight, the red or violet root rot, the downy mildew, and a *Phomopsis* stem disease. Other diseases attacking alfalfa which have not been reported in this state thus far are the brown root rot, the crown wart and the root knot.

Under the second group we have the stem-cracking disease and the yellow-top disease of alfalfa. These are different maladies from those before mentioned, in that they are nonparasitic—that is, no organism or germ is responsible for them. It will be seen that most of the alfalfa diseases are caused by fungi, one by bacteria, and one by a higher type of parasitic plant, namely, dodder. The fungi and bacteria which cause the alfalfa diseases are very minute parasitic plants of a much lower order than the dodder. In both cases, however, these parasitic plants live upon or inside the tissues of the alfalfa plant, robbing it of its nourishment, and thereby reducing its vitality.

**ALFALFA DODDER.** A discussion of alfalfa dodder will be found under the topic on weeds, for in fact it is a weed, producing a diseased condition in the alfalfa plant. (See "Dodder," in index.)

**ALFALFA RUST (*Uromyces striatus* Schræet).** Although generally not considered a serious disease of alfalfa, it did cause a slight amount of damage in 1914, on the last crop in some localities. The extent of injury varied from approximately one to three per cent, *i. e.*, this percentage of affected foliage dropped on account of the rust infection.

The rust of alfalfa attacks the leaves, occurring on the under side. It is different in appearance from the ordinary leaf spots, in that the epidermis (outer layer) of the leaflets is ruptured, exposing a mass of reddish-brown spores or reproductive bodies of the fungus. (See Fig. 282.) This spore mass when viewed under the magnifying lens appears to rest in a rupture in the leaf blade. (See Fig. 283.) These ruptures or pustules are only about one thirty-second of an inch in diameter, and they may occur numerously or sparingly on the leaves. (See Fig. 282.)

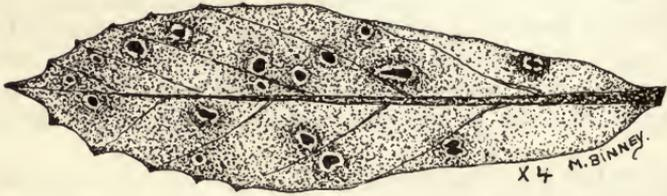

FIG. 282. Alfalfa leaf (under side), showing rust pustules (enlarged).

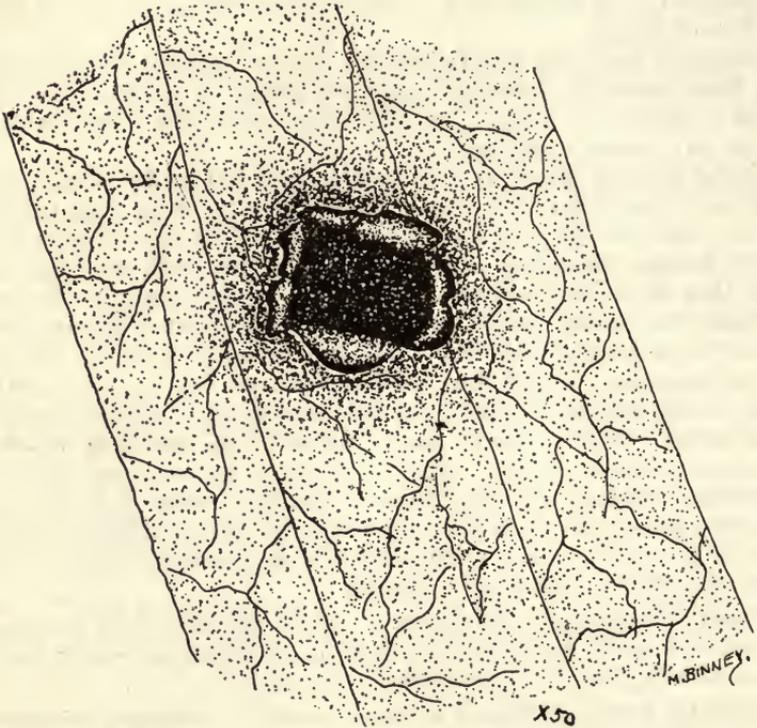

FIG. 283. A rust pustule on an alfalfa leaf, greatly enlarged.

## ALFALFA LEAF-SPOT DISEASES.

These are caused by specific fungi which penetrate the tissues of the leaves and kill definite areas. On account of their invasion the vital functions of the leaves are interfered with, and as a result they die; this, in turn, reduces the vigor of the entire alfalfa plant. Not only do the leaves die, but they dry up and drop off from the stems more readily than under normal conditions. In fact, a great share of the hay crop is oftentimes sacrificed on account of this loss of foliage.



FIG. 284. Alfalfa leaf spot (*Pseudopeziza medicaginis* Lib. Sacc.), showing characteristic spotted condition of the foliage. The leaves have dropped from the alfalfa stem as a result of this disease.

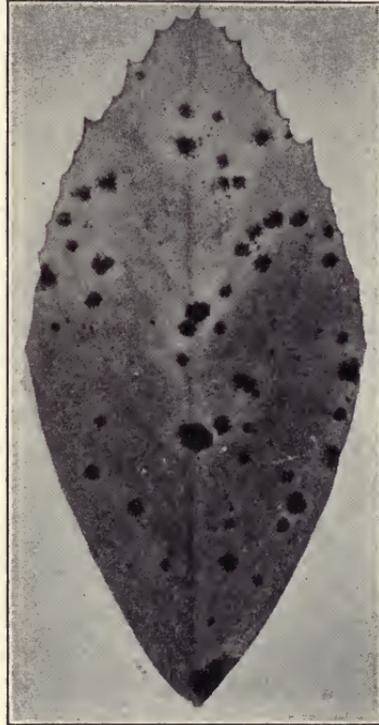

FIG. 285. Alfalfa leaf spot (*Pseudopeziza medicaginis* Lib. Sacc.). The spots are circular in outline and only about one-sixteenth of an inch in diameter.

**ALFALFA LEAF SPOT** (*Pseudopeziza medicaginis* [Lib.] Sacc.). This disease is recognized by its small, sooty-brown or blackish spots, which are most characteristic on the upper surfaces of the leaves. (See Fig. 284.) The spots are circular in outline and only about one-sixteenth of an inch in diameter. (See Fig. 285.) They occur so abundantly, however, that they injure the foliage sufficiently to cause it to drop. It is very frequently called a "rust" or "blight." It may attack plants which are growing even under the best of soil conditions, and is very often more severe during a dry season than during a wet one. It may practically ruin or destroy a young field, and older fields are likewise very

susceptible to severe infestations. In this state it attacks most generally the second, third and fourth crops. The bottom leaves are the first to become infected, and gradually the characteristic spots appear upon the uppermost leaves. The leaves turn more or less yellowish and the dark spots become pronounced. Later such diseased foliage drops, and before the cutting stage has arrived the loss of foliage has become very noticeable. (See Fig. 284.)



FIG. 286. Alfalfa leaf spot (*Phyllosticta* sp.), showing the characteristic symptoms of this disease. Note the pin-point-like dots, the bodies containing the spores of the fungus.



FIG. 287. The fungus (alfalfa leaf spot, *Phyllosticta* sp.) may attack the stem, causing blackened spots.

This fungous disease is widespread, and generally prevalent wherever alfalfa is grown. The only practical measure to be employed is to mow the crop as soon as the growth of the plant is checked by this leaf spot and before the foliage has begun to drop. Should the disease establish itself on young plants it is advisable merely to clip the tops of the plants, allowing three or four inches of the stems to remain.

ALFALFA LEAF SPOT (*Phyllosticta*, sp.). Another leaf spot which was very prevalent in the first and second crops throughout the state the past season is one which is caused by an entirely different fungus from the aforementioned. It is quite different in appearance, and proved to be even more destructive. (See Fig. 286.) This leaf spot is caused by a fungus which so infects the alfalfa foliage that it soon turns yellow, drops, and falls from the stem. In many cases over 40 per cent of the foliage was lost on the first and second crops. It was also present, to a lesser extent, however, on the third and fourth crops.

This particular leaf spot is most easily recognized by the fact that it does not produce definite spots on the leaves, but scattered over their entire upper surface are very minute, pin-point-like dots. (See Fig. 286.) These little fungus bodies contain the spores of the fungus. Generally the diseased leaves turn a sulphur-yellow color, and curl more or less at the margins during the later stages of the disease. This same fungus may attack the stems, where it causes blackened spots, but generally it does not kill them. (See Fig. 287.)

Although this disease may have been present in the state before, it has never been reported prior to this season. Nothing can be done to prevent this disease from attacking the alfalfa crop. It is advisable to mow the crop as soon as one discovers it causing the foliage to drop.

ALFALFA LEAF SPOT (*Pleosphaerulina briosiana* Pollacci). This is a new alfalfa leaf spot in America, and was discovered in this state by the writer last year. It is different in appearance from the other two already described in that it forms definite grayish spots with a dark-brown margin. (See Figs. 288 and



FIG. 288. Alfalfa leaf spot (*Pleosphaerulina briosiana* Pollacci).

289.) The spots may occur on any part of the leaves, but most frequently they appear along the margins of the leaflets. It is similar to the other leaf spots mentioned in that it causes the foliage to drop previous to their maturity. This disease does not attack the alfalfa stems.



FIG. 289. Alfalfa leaf spot (*Pleosphaerulina briosiana* Pollacci), magnified.

The same treatment recommended for the other alfalfa leaf spots applies here.

**DOWNY MILDEW OF ALFALFA** (*Pernospora trifoliorum* De. By.). This disease was present in 1914 and again in increased quantities in the first crop of 1915. It is especially noticeable on the young alfalfa plants, but it does not confine its attack to one-year-old plants. The first crop appears to be the only one attacked in Kansas, and up to the present no particular damage has resulted except in a slight loss in yield in the first crop. Warm, damp weather in May is especially favorable for its development and spread.

The uppermost leaves seem to show the disease first; they turn a pale green or slightly yellowish color. If such leaves are examined on the under side they will show a very fine mold-like growth, slightly grayish in color. (See Figs. 290 and 291.) This is the fungus causing the disease. It sometimes happens that the entire tips of the shoots become affected with this fungus. (See Fig. 292.) In such case the plant is stunted, and the affected shoots will cease further growth.

Generally speaking, this disease is not serious enough to warrant early cutting to prevent loss.

**RED OR VIOLET ROOT ROT OF ALFALFA** (*Rhizoctonia violaceæ* Tul.). The records on hand seem to indicate that this disease is increasing in this state. It was first reported in Kansas seventeen years ago. The

acreage of alfalfa has increased materially since that time, and the disease has consequently spread. It has been known in Europe for many years, and not infrequently has caused the death of half the crop. It is certain to become more serious in this state every year, and since the entire plant is at the mercy of this fungus its damage is lasting.

The first external symptom which attracts one's attention is the yellowing of the entire plant, which soon begins to wither, and eventually dies. If the roots of such a plant are carefully examined one will notice a mat of brownish-red or violet fungus threads covering them. (See Fig. 293.)



FIG. 290. Downy mildew of alfalfa, showing the mold-like growth, on the under side of the leaf.

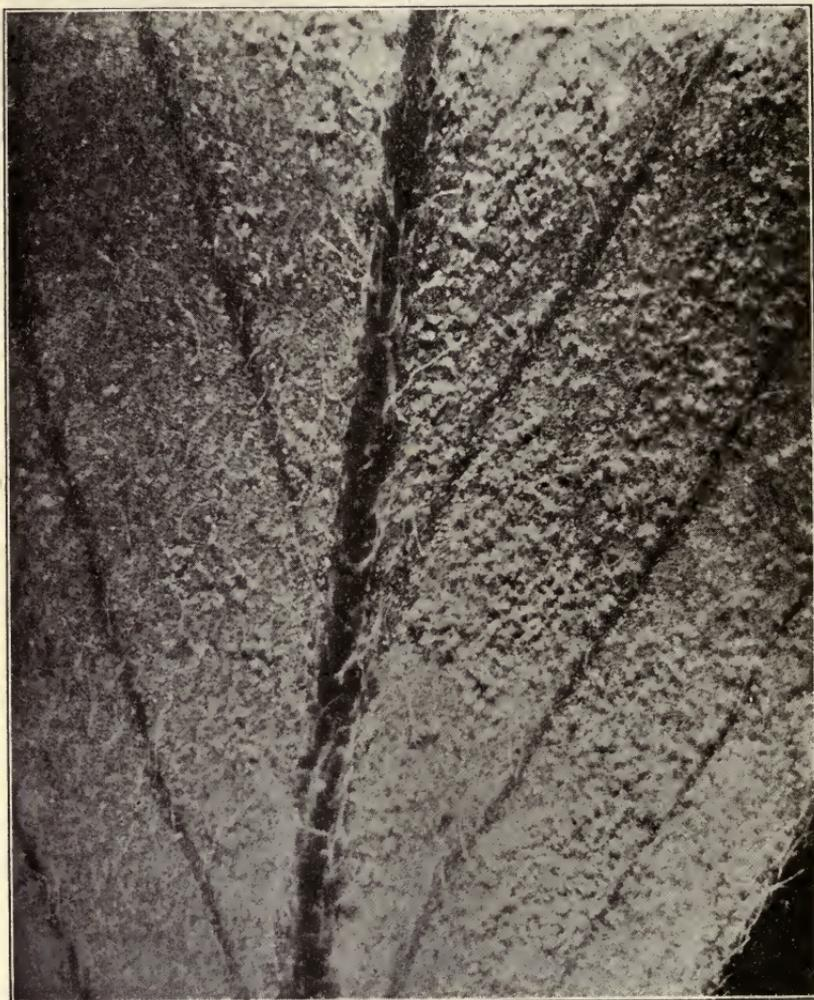

FIG. 291. Downy mildew of alfalfa. Same as Fig. 290, but greatly enlarged, showing the tufts of the fungus.

These threads penetrate the vital layers of the roots. Later the roots begin to rot and the outer layers slough off. (See Fig. 294.) About this time little roughened knots about the size of a pin-head begin to form in the violet mass of fungus threads. (See Fig. 295.) These are part of the fungus, and tide the disease over from year to year, and are said to have the power of remaining alive in the soil for two and three seasons.

The disease starts from a center of infection. From this center the fungus grows in all directions through the soil, killing the plants as it progresses. Each year finds the circle growing larger, until after a few years large areas have been killed out in the alfalfa fields. (See Figs. 296 and 297.)

This disease is often most prevalent in fields where inadequate drainage exists. Unfavorable soil conditions for alfalfa make conditions favorable for the development of the fungus.

Since this disease may live over in the soil for a number of years, it will not do to replant these vacant spots until the disease has been killed out. Generally this disease is worse in fields which are eight years old or older. If a field contains a number of patches in which the plants have been killed, the entire field should be plowed up and not replanted



FIG. 292. Downy mildew of alfalfa. Note the mold-like growth at the tip of the plant.

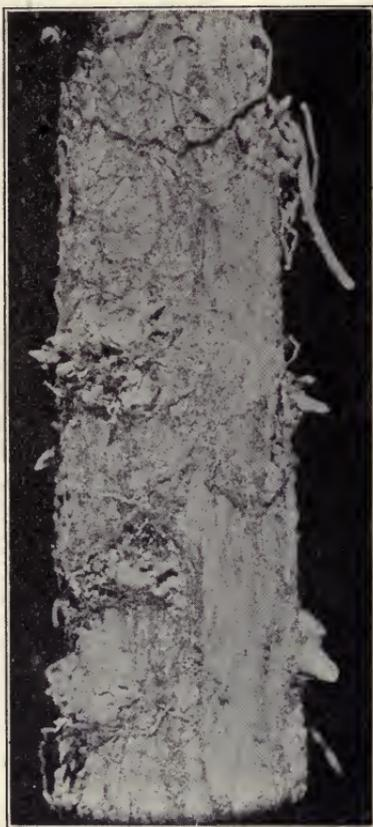

FIG. 293. Red or violet root rot. Note the fungus threads creeping over the surface of the root.

to alfalfa or clover for at least three years. As soon as the disease is observed, and before it has advanced very far, it may be checked by digging up all the diseased plants and burning them. A trench should be dug around the entire patch, beginning at least five feet beyond the outer limits of the area where the plants show wilting or yellowing. All plants and soil should be thrown toward the center of the patch, otherwise the disease will be disseminated. Later the diseased plants should

be burned. By such means the ravages from this disease may be checked. The patches should lie bare for at least three years, for the fungus must be starved out of the soil.

**BACTERIAL STEM BLIGHT** (*Pseudomonas medicaginis*). Although this disease was reported in Kansas some years ago, it has not been seen lately, nor has it been brought to the writer's attention. The disease was first reported in Colorado, where, according to the plant pathologist's reports, it has caused considerable damage. Farmers should be on the lookout for this disease as well as all other alfalfa diseases.\*



FIG. 294. Red or violet root rot of alfalfa during various stages. Note the sloughing off of the outer layers of the roots.

This blight may be recognized by the fact that it makes its appearance on the first crop. The stems appear watery and semitransparent during the early stages. Soon the affected stems assume a yellowish, olive-green color, which transforms to amber color, due to the drying of a thick, sticky liquid, which gives the stems a shiny or varnished appearance. Later such stems blacken and become brittle, which fact

\* The department of botany desires to cooperate with all parties interested in plant diseases. Specimens may be sent to the college free of postage if parties will write for franked tags.

causes considerable shattering. The disease is said to run its course in the first crop and is not noticed again until the following year.

No variety of alfalfa is resistant to it. The bacteria causing this disease live over in the soil and gain entrance into those stems which are cracked or split by late freezing.

**YELLOW TOP OF ALFALFA.** Occasionally this trouble is found in fields where unfavorable soil conditions exist. The disease is recognized, as the name indicates, by a yellowing of the leaves. Generally this is most noticeable at the tips. As far as known, no parasitic organism is associated with its occurrence. The disease is merely indicative of an unthrifty growth, brought about by unfavorable growing conditions.

**STEM CRACKING OF ALFALFA.** A peculiar cracking or splitting of alfalfa stems has been observed very frequently in the first crop. These splits may occur on any part of the stem, and not infrequently two and three cracks are found on a single stem. (See Fig. 298.) They vary in length from half an inch to two inches and extend to the center of the stem. As high as 15 per cent of the stems in some fields have shown this affliction. In itself this splitting would not be serious, since the stems do not wilt as a result, but the tissues generally callous over sufficiently to prevent this. These openings do form a means of entrance for diseases, however, and one species of fungus in particular (*Phomopsis*, sp.) figures materially in causing trouble whenever there is an injury. This fungus develops rapidly after it has once



FIG. 295. Red or violet root rot in later stage, showing the little projecting knots of fungus, which are violet in color.

gained entrance into the stem. It produces a blackened condition, causing the tissues to dry out. (See Fig. 287.) The weakened stems become brittle and frequently lop over and wilt. The exact cause of the cracking is unknown, but it appears to be related to extremely rapid growth brought about by excessive moisture.

Losses from these troubles can be prevented by mowing the crop as soon as possible, and since it occurs mainly on the first crop, a little earlier mowing may be advised.

## SOME ALFALFA DISEASES UNREPORTED IN KANSAS.

The farmers of this state are urgently requested to be on the lookout for the occurrence of the following diseases:

**CROWN WART OF ALFALFA** (*Urophlyctis alfalfæ*). The chief characteristic of this disease is the presence of a gall or wart at the base of the stem. (See Fig. 299.) This gall is produced by a fungus parasite which gains entrance into the crown of the plant, and, stimulating the tissues, it produces a malformation. Occasionally the warts may occur on the stems several inches from the ground. They vary in size from that of



FIG. 296. A dead patch in an alfalfa field caused by red or violet root rot, second season's attack.



FIG. 297. Red or violet root rot attack; dead area 100 by 150 feet in an old field.

a pea to the size of a man's fist, being irregular in contour. The surface of these galls is irregular, coral-like, due to the undulations. Very many fine, thread-like root hairs are seen growing from these galls. If such a gall is cut in two, many cavities filled with a dusty mass of brown spores will be observed.



FIG. 298. Stem cracking disease of alfalfa. Notice the depth to which these cracks extend.



FIG. 299. Crown wart of alfalfa. The wart is seen at the crown of the plant. [After E. C. Fields, U. S. Department of Agriculture.]

The disease is serious in Europe, and recently it has been found in the western part of the United States. Although it is said to be restricted in Europe to fields which are wet, seldom appearing in drier land, such does not appear to be the case in this country, for it has been reported on both well-drained and poorly drained land, and on "sticky" soils. How and whence the disease was introduced into the Salt Lake valley, Utah, is not known. In all probability the spores or germs of

the fungus were brought in with seed coming from infected areas in South America or Europe.

So far as is known alfalfa and clover are the only crops affected, and it is not yet certainly known whether the alfalfa crown wart will affect clover. Crop rotation is the only known remedy.

**BROWN ROOT ROT OF ALFALFA** (*Ozonium omnivorum* Shear). This disease is given the common name of brown root rot in order to distinguish it from the violet root rot already described. It occurs in Texas and neighboring states, where it has caused considerable damage to the cotton and alfalfa crops. The dying of the plants and the spreading of the disease from centers of infection is very similar to the symptoms of violet root rot. There is generally little evidence of its presence until the plant begins to wilt and dry up. Cotton and alfalfa are not the only hosts attacked, but the fungus lives on a number of weeds. Sources of infection are therefore very easily carried over from one season to the next. When diseased plants are examined carefully one will find that all the smaller roots have disappeared, for they break off readily when the plants are pulled.



FIG. 300. Root knot or eelworm attacking tomato roots. Similar symptoms would be found on the alfalfa root if infested with the eelworm.

The fungus penetrates the root tissues much as in the case of the violet root rot, but it may be distinguished from the latter in that the color of the fungus threads is brown or brownish-yellow rather than violet.

Application of chemicals to the soil does not seem to be effective in controlling the disease in the regions where it occurs. It is claimed, however, that a lack of proper soil aëration is a prominent factor in the development of this disease. It is

advisable to fall plow whenever possible without injury to the land, to be followed by thorough disking in the spring. A two- or three-year rotation is deemed necessary to insure against the source of the infection being carried over.

**EELWORM OR ROOT KNOT** (*Heterodera radicicola*). The nematode, eelworm or root knot are various names applied to a peculiar plant malformation produced by a microscopic worm. They live in the soil and gain entrance into the young roots, where they cause swelling or "nodules." At first sight these little knots might be mistaken for large

nitrogen "nodules," but their effect on the alfalfa plants is quite different. The knots are full of egg-filled female nematodes. The vitality of the plant is seriously impaired by their presence so much, in fact, that eventually the roots rot and liberate the eggs into the soil. These soon hatch and the worms penetrate the roots of other plants. It might be stated here that the eelworms are known to attack hundreds of different kinds of plants, and the total destruction of crops is frequent. Although no specimens of alfalfa root knot have been found in this state up to the present time, it is quite possible that this disease may occur in Kansas, for the eelworm has been found attacking and ruining various crops in this state, such as the tomato and cucumber, not only in the greenhouse but in the field. (See Fig. 300.)

### MAMMALS IN RELATION TO ALFALFA.

By ROBERT K. NABOURS, Zoölogist, Kansas State Agricultural College.

The pocket gopher is an extremely destructive underground enemy of alfalfa. Besides the direct damage wrought by the actual consumption of the roots, a large percentage of badly infested areas are covered up, and the resulting mounds make difficult the harvesting of the crop that is spared. During late years, due perhaps to the excellent conditions afforded them by alfalfa fields, the gopher has multiplied greatly in numbers, and has spread its range over much greater areas than formerly.

In general appearance the common gopher is short and stubby, from ten to eleven inches from tip of nose to tip of tail, the tail being about three and one-fourth inches long. The weight averages about twelve ounces, the males being heavier and broader in the shoulders than the

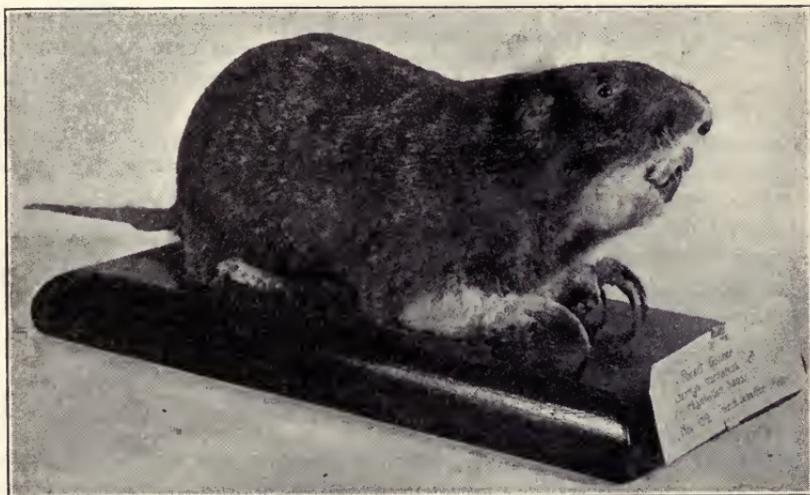

FIG 301. The Pocket Gopher

females. Gophers have large external cheek pockets, which are entirely outside of the mouth. The shoulders and fore legs are extremely stout and full of strength. The lengthy, strong claws on the fore feet, together with the pair of long, sharp incisor teeth, outfit the gopher as one of the most efficient of the burrowers, especially among root entanglements. The eyes are diminutive, and the range of vision perhaps very much limited.

The following account of the gopher is taken from T. H. Scheffer's excellent bulletin (No. 172, Kansas Experiment Station):

The greater number of burrowing mammals, like the prairie dog, the spermophile and the woodchuck, spend most of the daylight hours in fine weather above ground. The pocket gopher sticks to the darkness of his tunnels. In watching gophers push out the earth when extending their burrows I have never seen one expose more of the body than the head, and usually one can catch a glimpse of the nose only, as with a



FIG. 302. Head of prairie pocket gopher, showing entrance to cheek pockets and grooved upper incisors. [Courtesy Kansas Experiment Station.]

quick upward flirt of this member the animal flings the dirt from the exit. As the earth is sometimes pushed to a considerable distance from the temporary opening it is likely that the gopher must of necessity emerge entirely from his burrow at times. This he no doubt does under cover of darkness, for it is a matter of common observation that after a busy hour or so in the early morning very little dirt flies until near sunset, except perhaps on dark, cloudy days. No evidence of tracks or traces of foraging indicates that the animal ordinarily ventures farther than its mound of earth, however, even in the night. At certain seasons, though, particularly when many of the young generation of that year are setting up in business for themselves, the natural instinct of all animals to extend the limits of their range impels the gopher to roam



FIG. 303. Front foot of prairie gopher. [Courtesy Kansas Experiment Station.]

about. This is evidenced by the sudden appearance in late summer and in autumn of new mounds, like pioneer shanties, in fields remote from other gopher habitations. At this season we occasionally encounter a claim seeker abroad even in the day time. In late autumn and early winter, too, the males no doubt wander about more or less.



FIG. 304. View of a gopher-infested alfalfa field.  
[Courtesy Kansas Experiment Station.]

**THE BURROW.** Except where an invader has recently established himself in new territory, it is practically impossible to determine the limits of a gopher's burrow. The work of excavating is usually carried on at a depth of eight to ten inches below the surface of the ground, but the animal sometimes ranges lower in loose, sandy soil, where succulent roots penetrate deeper. The average diameter of the burrow of the prairie pocket gopher is about three inches; large enough that one may usually thrust the hand and arm back into it as far as he can reach. These data are easily obtained, but when one undertakes to map out the course of the main runway, the branch tunnels and their intersections, the pockets and the short laterals, he has before him a task that might well appall a military engineer in the wilds of a jungle. In a field that is even fairly well populated by gophers the runways of different individuals must of necessity frequently intersect each other, for it can not be supposed that all the numerous subway crossings one exposes in digging along the tunnels are parts of one animal's private labyrinth. A prairie

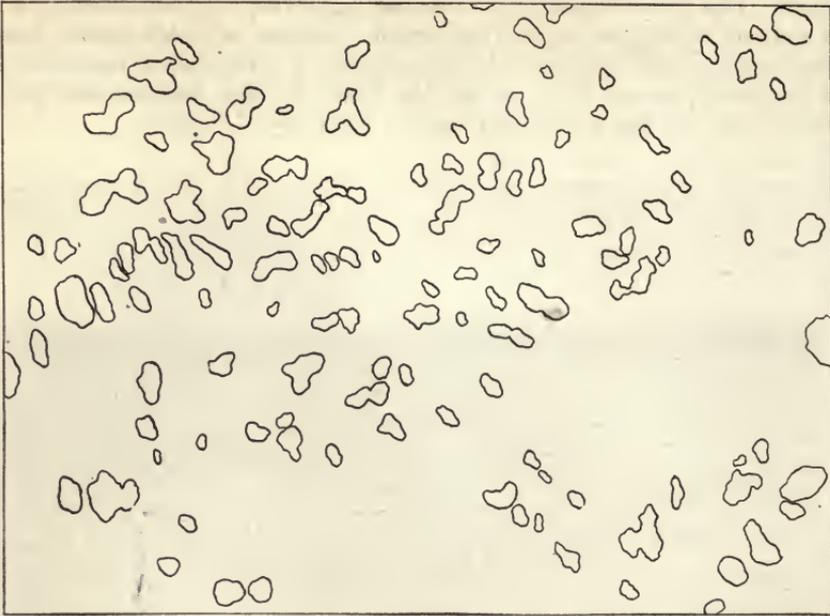

FIG. 305. Typical area of badly infested alfalfa field. This tract (54 ft. x 72 ft.) was carefully mapped after first dividing it into small squares by tightly stretched lines. The small irregular patches show the shape, relative size and location of the mounds thrown up by the gophers.—[Courtesy Kansas Experiment Station.]

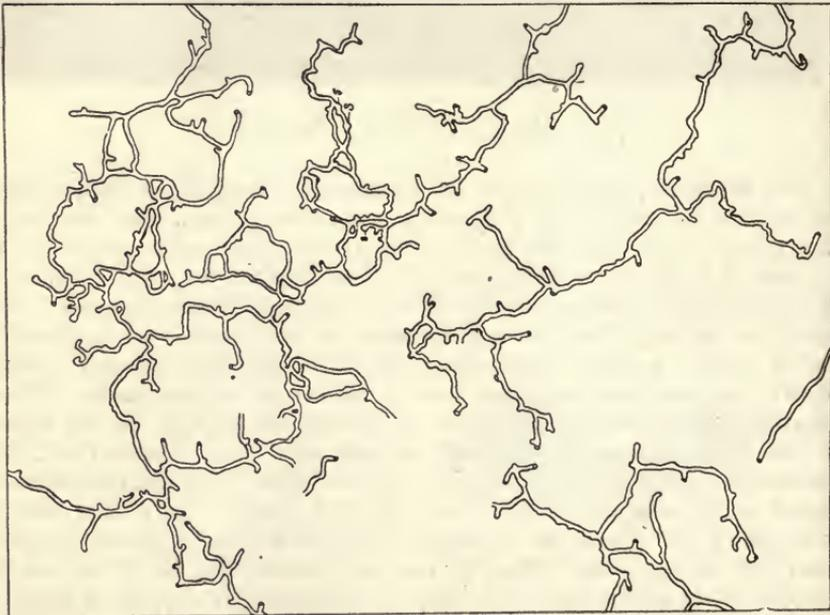

FIG. 306. Same tract as above, with all the runways carefully excavated and mapped. [Courtesy Kansas Experiment Station.]

dog or a spermophile digs a burrow very much like that of his neighbor, but it must be borne in mind that these animals are constructing homes, not extending passageways in search of food. The gopher follows his own sweet will in mining. Here a chance for easier digging turns him aside; there a promising lead of succulent roots entices him the other way. Heading everywhere in general and nowhere in particular, he may in the course of a year explore the length and breadth of a field of many acres. At irregular intervals he excavates a short lateral obliquely upward to the surface of the ground. Through these the loosened dirt is carried and thrust out in heaps. The presence of a gopher is thus easily detected by the lines of mounds, varying in size, from a hatful to one or even several bushels of dirt. A study of a fresh mound reveals the plan of construction. The dirt is carried out of the opening and distributed radially, very much as miners dispose of the useless shale from a coal pit. Usually the dump extends only part way around the opening, but sometimes the mound has the shape of a cone with a crater at the top. Where surface vegetation hinders the work the piles of dirt are more irregular.

**MOLE RUNWAYS.** The ridges and mounds of earth thrown up by moles are often incorrectly supposed to be the work of gophers. A little careful scrutiny will soon reveal the difference. The gopher piles up the dirt on the surface of the ground, building a mound by the addition of load after load on top of that already deposited. A mole simply heaves up the dirt from beneath, forming piles which show radiating cracks. Associated with these piles are the surface ridges made by the animal when ranging in search of food. The feeding runways of the gopher never show in surface ridges.

**BREEDING.** As might be expected of animals living in such comparative security, the pocket gopher is not a very prolific breeder. It certainly rears but one litter a year in this locality, for I have examined scores of specimens in all months of the year and have found the embryos only in late winter and early spring. The number of young in a litter varies from three to six, and averages a little more than four. Very rarely only two embryos are found in the uteri.

**NATURAL FOOD.** The natural food of the pocket gopher consists of the fleshy roots and underground stems of various plants growing wild on the prairies. To this bill of fare he adds occasionally a small quantity of succulent vegetation drawn down into his burrow from the surface at points where exits are dug for removing earth. When foraging thus above ground he loses no time in cramming supplies into his cheek pockets and hurrying below to eat the stuff at his leisure. The underground stems and roots he encounters in extending his burrows are cut into short pieces of convenient length to carry, provided he does not care to dine upon the spot. The sections thus made are commonly an inch or two in length, sometimes shorter, but I have found stores of alfalfa roots in which dozens of the pieces ranged from four to eight inches long. These, of course, the animal must carry or drag to the storeroom without the aid of his pockets. The same is necessarily

true of the large cultivated tubers he often steals from the fields or bins of the unlucky farmer. Observations on the habits of a pocket gopher kept in captivity by Doctor Merriam, of Washington, D. C., seemed to indicate that the animal when thus storing his larder can travel as easily and as readily backward as forward. The writer states that the gopher moved back and forth from food supply to storeroom like a shuttle on its track, rarely turning around after securing a load. In its backward progression the sensitive tail served as an organ of touch.

The popular idea that the gopher uses his cheek pockets for carrying out the earth from his burrow is certainly erroneous. I have watched many gophers at work, and noted that the process of removing the earth is always the same: the dirt is pushed ahead of the animal in armfuls. Examination of the pockets of gophers shot in the act of removing earth, or trapped at any time, reveals no traces of contained earth. At this point it might be well to state also that no part of a gopher's runway necessarily extends down to a supply of water, as currently supposed. Like many other animals that feed upon more or less succulent vegetation, sufficient water for the tissues of the body is obtained in the food.

**ACTIVE SEASON.** The pocket gopher seems to be busy at any season of the year when the ground is not frozen too hard and too deep for mining operations. Not uncommonly we see mounds of fresh earth thrown up from beneath the snows of midwinter. It is unlikely, therefore, that, strictly speaking, the animal ever hibernates in this part of the country. During the briefer periods of particularly inclement weather in the winter no mounds are thrown up, and if the animal burrows lower than to escape the frost, as some have observed, he must dispose of the earth in tunnels or pockets previously excavated. It is my belief, however, that the gopher spends these stormy periods near the supplies of stored food. Evidence of this habit is given by certain mounds thrown up in the spring that are made up almost wholly of crumbling pellets of excrement and fragments of nest material. October and November is a season of particular activity. Impelled by instinct, that exacts obedience without forecasting the winter, the gophers then extend their runways in all directions in search of food for their underground cellars. At this time of year the best results can usually be obtained in poisoning or trapping the animals. In the spring, again, after the frost has left the ground, this activity is renewed for a time; but when the season for breeding and rearing the young comes on extension of the burrows receives less attention.

It has been said that the gopher is a solitary animal; that no two individuals ever occupy the same burrow except in the mating season. This statement is not in accordance with my observations, for I have on several occasions trapped a second gopher by resetting at the same opening into a burrow. This was in the early fall, too; not in the mating season.

**NATURAL ENEMIES.** Since the pocket gopher so seldom shows itself outside of its subterranean galleries, it has little to fear from the natural enemies of the rodent race. It is not entirely safe from attack,

however, for a few sharp-eyed and vigilant foes habitually capture numbers of gophers when they come to the mouths of their burrows to push out a load of earth. Hawks and owls take toll at these favorable moments, and many a house cat has learned the trick of capturing a meal then with little difficulty.

The gopher's habit of confining active operations in mining mainly to the hours of twilight particularly favors the owls and the cat. The great horned owl, the long-eared owl, and the barn owl, particularly the last named, render valuable service in keeping down the numbers of these destructive rodents. A single pair of owls nesting on the farm has been known to destroy scores of gophers in a brief season. Sometimes they live on nothing else for a time, as evidenced by the pellets of bones and fur which, like most birds of prey, they invariably disgorge after a meal.

Instances of a house cat becoming addicted to the gopher habit are not uncommon. In a number of cases that were reported directly to me, mother cats brought in several gophers a day, regularly as clockwork, to their families of kittens. In many instances of reported gopher catching, however, the informant has had in mind the little striped "gopher," or ground squirrel.

Two enemies that in some localities are said to hold the pocket gopher in check more than all others are the weasel and the bull snake. The former is too scarce in most parts of Kansas to be worth considering in this relation, but the bull snake is common enough on farms whose owners or tenants have had the wisdom and forethought to protect the natural enemies of the destructive rodent tribe. The snake would, of course, be able to gain entrance to the gopher's burrow only when the latter was temporarily left open, but once inside he would probably remain there for some time and make things interesting for the occupants. When one is trapping gophers he will occasionally surprise a bull snake in the act of trying to swallow the captured animal, trap and all. I have also found this snake in the burrow of the striped spermophile, helping himself to a nestful of the young of the latter, and have seen him capture and kill the adult spermophile at the mouth of its burrow.

The little striped skunk (*Spilogale interrupta*) should not be left out of account in discussing the natural enemies of the pocket gopher. I had not supposed that these animals could make their way through the burrows of the gopher, and had laid to the charge of weasels a number of cases of killing and feeding on gophers imprisoned in steel traps. Finally I resorted to setting traps a second time in the mouths of the burrows where a gopher had been partly eaten, and in two instances succeeded in capturing a little striped skunk. There was no question in either case but that the skunk had entered the burrow at some point remote from the location of the trap, for the opening through which the trap had been introduced had been carefully covered with a board and loose earth; this covering was undisturbed. In comparing this slender little skunk's body with the diameter of many of the gopher burrows in alfalfa fields it will be seen at once that it is not a difficult matter for the skunk to make his way through the underground passages. The additional fact that, by digging, he can enter the burrow at any point and corner the occupant in

some lateral or pocket tunnel renders the little striped skunk especially valuable as a gopher catcher.

In summary it may be said that we can not, except in a few favored localities, depend upon the natural forces to keep in check the increase of the pocket gopher. By increasing the acreage of alfalfa we are producing the very conditions that are favorable to the most rapid multiplication of the species; and, on the other hand, by thoughtlessly or wantonly destroying harmless owls, hawks, bull snakes, and certain mammals, we still further interfere with nature's efforts to preserve the balance of power in the animal world. The worst that can be said of the enemies of the pocket gopher is that the great horned owl, the weasel and the skunk sometimes destroy domestic fowls. But a little wise precaution in shutting up coops at night would prevent these inroads on the poultry industry.

#### *Crops Damaged.*

The economic status of the pocket gopher has changed in the last few decades. There was a time when their work was of real benefit to the future interests of agriculture. For untold centuries they have been mixing the soil of the prairies, bringing up the subsoil to mellow, and covering up vegetation to molder and add humus to the clays and sand. But now that the virgin soil has been prepared for us we would gladly dispense with their services, for their presence is now seriously detrimental to our interests.

**ALFALFA.**—The damage to cultivated plants results not only from the animal's eating roots or stems, but also from its habit of throwing up numerous mounds of earth, which very often cover considerable areas of the growing crops and obstruct the later harvesting of the remainder. Indeed, it would scarcely be worth while in many instances to make such vigorous warfare on the gopher if the only issue at stake was the kind or quantity of food he pilfered. This is especially true in the case of alfalfa. No other one of the important crops of the state has suffered so much from the ravages of the pocket gopher as this valuable plant. From a gopher's standpoint conditions of life are easy in a field of alfalfa. The ground is not worked for years at a time, at least not deep enough to interfere with the underground runways. Again, the roots of the plant are fleshy and toothsome and penetrate deep into the soil, where they may be encountered in abundance at the usual depth at which the animal ranges. They are there, too, at any time of the year to satisfy the appetite of the hungry rodent. As a result of these favorable conditions gophers have multiplied at an alarming rate in recent years wherever alfalfa is extensively grown. In the river valleys of central Kansas particularly I have seen fields of thirty or forty acres in which one might walk over the entire tract by stepping from one gopher mound to another. It is safe to say that in these cases not less than one-fourth to one-third of the actual acreage of the field was covered, and therefore a total loss. Much of that which remains is necessarily weakened by the loss of portions of the root system.

Even a few gophers in an alfalfa field become an intolerable nuisance by obstructing the work of mowing the crop. The man who is running

the machine must be constantly on the lookout for the mounds, so that he may raise the sickle-bar until the obstruction is passed. Thus much extra work is entailed and a portion of the crop is lost by running the sickle too high. If the operator does not see the mound in time it is very likely to clog the machine, or at least one or more sections of the sickle may be dulled or nicked by encountering gravel or pebbles. If the ground is reasonably mellow the horses drawing the mower stumble frequently, their feet breaking through into the runways of the gopher. Sometimes the holes thus formed are not filled again from below, and the rains washing in enlarge the openings to a pit a foot or more in diameter.



FIG. 307. A prod for locating runways of the pocket gopher and making openings for the introduction of poisoned bait.—[Courtesy Kansas Experiment Station.]

### *Methods of Combating.*

**POISONING.** Gophers do not possess the shrewdness and cunning that have become instinctive in many other wild creatures because of the constant necessity imposed upon the latter of avoiding and escaping enemies. Later experience in the wiles of man has evidently taught them nothing, for they seldom reject any kind of poisoned food offered them.

As stated before, poisoning is the more thorough and easily applied method of ridding a badly infested farm of the pest. It is also the best method if the territory to be freed from gophers is of considerable extent. In either of the above cases one man can accomplish as much with poisoned bait as a half dozen could in the same time with traps. The danger of killing stock or useful birds and animals, attending the use of poison for prairie dogs, English sparrows and the like, is entirely eliminated by the plan of introducing the bait through small openings into the gophers' burrows.

Since the pocket gopher lives naturally on the roots and tubers of native plants, or on succulent vegetation drawn down into the burrow

from the surface, it follows that a close substitute for these articles will make the best bait for poisoning. Knowledge gained by personal experiments and by careful inquiry among farmers and fruit growers goes to show that pieces of potato, apple or sweet potato,



FIG. 308. A handy tool for use in setting traps.  
[Courtesy Kansas Experiment Station.]

poisoned by inserting a few crystals of strychnine into slits made with the point of a knife, answer the purpose very well. Some correspondents have reported good results from soaking the baits in a solution of arsenic or strychnine. Only a mechanical mixture of the former substance can be obtained in water, however, and the presence of particles of the free poison on the surface of the bait would be more likely to cause its rejection than if they were concealed in small slits. Raisins and prunes, treated like the pieces of potato or apple, seem to be very effective baits also. Our ex-

perience with specially prepared tablets sold under patented formulas does not warrant us in recommending them.

Several years ago the state, through a special agent, Prof. D. E. Lantz, purchased the right to manufacture and distribute a certain proprietary poison, the active principles of which are strychnine and cyanide of potassium. This poison was intended to be used in destroying the prairie dogs on the cattle ranges of the West, but it was found that by leaving out one ingredient—the cyanide of potassium—a very efficient poison for pocket gophers could be prepared. After the state's contract with the special agent had expired by time limit the work of manufacturing and distributing this poison was turned over to the department of zoölogy in the college. The poison is put up in the form of a syrup and sent out in quart cans to any part of the state. On each can is a printed label giving the formula used in preparing the poison and full directions for its use. Experiments personally conducted on the station grounds and elsewhere have borne out the uniformly favorable reports, from alfalfa growers particularly, as to the merits of the poison. We therefore recommend this poison syrup as the best means we have discovered so far for the destruction of pocket gophers. The syrup is sold by the college at 90 cents per quart can.

The method of using this poison commends itself as a time saver. Pour boiling water over as much shelled corn as you will need—the quart of syrup will poison a half bushel—and let it stand several hours to swell and soften. Drain off the water and pour over the grain enough of the syrup to render it sticky when thoroughly stirred together. Sweeten the mass with a little good table syrup and add a little cornmeal to take up the excess moisture, but not enough to leave any dry meal. Cork up the syrup can tightly and place it out of reach of children and domestic animals. It will keep indefinitely and is ready for use at any time.

The soaked corn, poisoned as above, is introduced into the burrows of the gophers, a few grains at a place, by means of an old spoon. Openings into the burrows must first be made with a sharp stick—a sharpened broom handle will serve the purpose—or a spade handle shod with an iron point and having an iron foot-bar some distance from the end to aid in making the thrust. Experience will soon enable one to tell when he has struck the burrow, which can be located approximately by getting on a line between two mounds of earth. After dropping in the poisoned grain the hole may be left open, or if closed care should be taken not to allow dirt to fall in and cover up the bait. If the hole is left open the gopher is likely to be attracted by the light and find the bait the sooner.

The same method of introducing the poison into the burrows is employed also when raisins and prunes or pieces of apple and potato are used. The presence of freshly thrown-up mounds indicates that the animal is extending his runways in that quarter, and it is best to confine one's poisoning operations to such places. If the field can be dragged over with a harrow or plank a few days after the poison has been put out new mounds can be readily detected and fresh poison distributed. If the work was thoroughly done in the first place it usually takes but a few

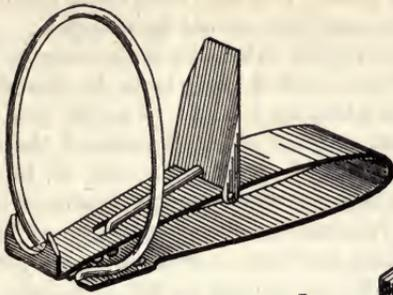

Fig. 1.

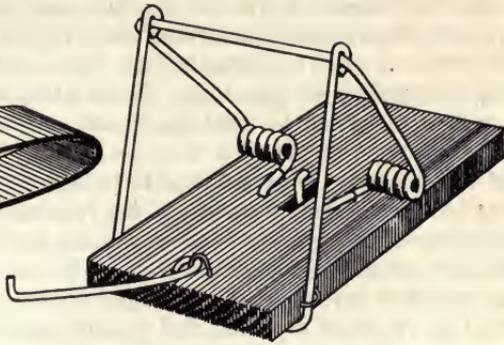

Fig. 2.

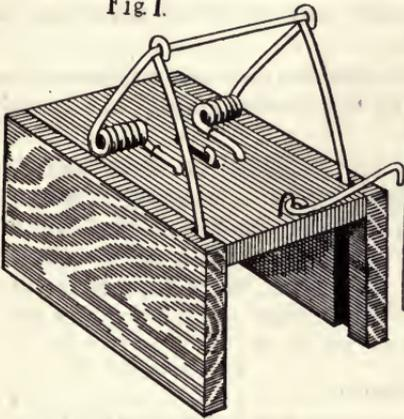

Fig. 3.

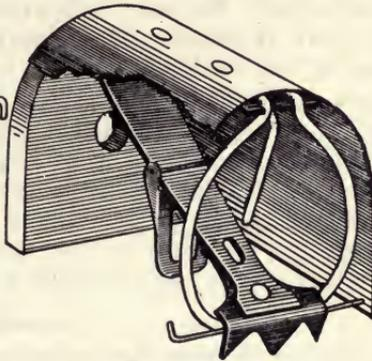

Fig. 4.

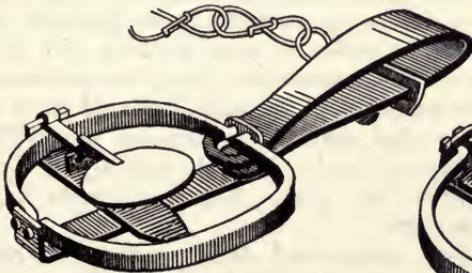

Fig. 5.

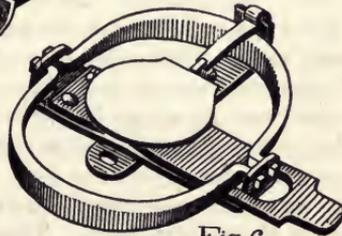

Fig. 6.

FIG. 309. 1. Newhouse gopher trap. 2. Out O' Sight gopher trap. 3. California gopher trap. 4. Newhouse trap as modified for use at the Kansas Experiment Station. 5. Steel trap No. 0. 6. The steel jump trap.  
[Courtesy Kansas Experiment Station.]

minutes to go over the field a second time. The few remaining gophers, if any, may become wary, and in that case they should be trapped.

A few experiments performed on a rather extensive scale seem to indicate that a more acceptable bait than soaked corn is to be found in finely chopped sweet potatoes. These potatoes are put in a box and cut up with a sharp spade until the pieces average about the size of the end of one's finger. They are then treated with poisoned syrup as in the case of the corn. This bait should be put out when freshly made, as it is likely to mold if left standing about for any considerable length of time.

The best time of the year to poison gophers is when they are most active in extending their burrows. This is usually in the late fall, for they are then laying in stores of provisions for the winter. Spring is a period of renewed activity, and poison may be successfully used at this time also. In fact, it will pay to make war on pocket gophers at any time when they are seen to be active.

**FUMIGATION.** The use of carbon bisulphide vapor or the fumes of burning sulphur as agents for destroying the pocket gopher is not recommended by this station.

**TRAPPING.** Although somewhat slow, there is no surer method of ridding one's premises of pocket gophers than by trapping. When you have the animal fast in the jaws of a trap you are certain that his career of uselessness is over. If the gopher were as wise as a rat we would not be permitted to indulge this feeling very often, but a long series of experiments has convinced me that he will blunder into almost any sort of trap that is set for him, no matter how we set it.

#### *Summary.*

1. The prairie pocket gopher is most abundant in the central and north-eastern parts of the state, particularly in the region drained by the Kansas river and the lower courses of its main tributaries. The plains pocket gopher is found in more scattering numbers in the western third of the state and down the Arkansas valley to some distance east of the great bend. Southeastern Kansas is comparatively free from gophers.

2. The gopher digs extensive runways in the subsoil of wild lands and cultivated fields, piling the excavated earth in mounds on the surface. These runways have no exit above ground. A single animal will throw up several mounds a day for weeks at a time. A gopher spends his entire time in his underground burrow.

3. Gophers breed in the late winter and early spring. Pregnant females may be found from January to May, but the young are nearly all born in March and April. There is but one brood a year. The number of young varies from three to six, and averages a little more than four.

4. The natural food of the pocket gopher consists of the fleshy roots it encounters in extending the runways, with the addition of some succulent vegetation drawn down into the burrow from above ground. Some food is stored in underground chambers for winter use.

5. Gophers are active at all seasons, but particularly so in the fall and spring. They do not hibernate. They throw up mounds any day in the year when the ground is not frozen too hard for mining operations.

6. The pocket gopher, by reason of his secluded life, has but few natural enemies. Bull snakes, weasels, owls, cats and striped skunks destroy some of them, but can not be depended upon to keep them in check.

7. Cultivated crops are damaged by the attacks of gophers on their root systems and by being covered with excavated earth. Much loss to the farmer also occurs through the obstruction of harvesting operations occasioned by the presence of the mounds. The alfalfa grower has the most ground for complaint, but nurserymen, orchardists, truckers and potato farmers also suffer heavy losses.

8. We have in Kansas two laws affecting the gopher—one a compulsory extermination law, the other a bounty law. The compulsory extermination law has two weak points, which render it practically inoperative. The bounty law has been tried and found wanting. Better results can be obtained, and at much less cost, by the plan of furnishing poison at the expense of the county or township.

9. Poisoning is the best method of combating the pocket gopher we have so far discovered. Trapping is effective, but slower than poisoning. Fumigation does not give good results, and therefore we do not recommend it. The poisoned baits that have given us the best results are soaked corn or finely chopped sweet potatoes treated with a syrup prepared by the Experiment Station. Raisins, prunes and pieces of apple, potato and sweet potato, into which crystals of strychnine have been inserted, also make excellent baits, but require much more time in preparation than the syrup-treated corn or sweet-potato baits.

10. Extermination of the pocket gopher in Kansas is not to be looked for, but communities may be entirely freed from the pest by persistent and concerted action on the part of landowners. (See "Gopher," in index.)

#### THE PRAIRIE DOG.

In the past the prairie dog has been harmful principally to wheat, barley and pasture lands. However, with the increasing acreage of alfalfa this rodent has come into a new importance. Complaint is coming not only from Kansas but from neighboring states that the prairie dog is doing considerable damage to alfalfa. On account of the succulence, general desirability and abundance of this new food, prairie dogs not only thrive on it, but their destruction by means of poisoned baits is made more difficult.

Of all means so far tested, poisoning with a syrup manufactured by the zoölogy department of the Agricultural College at Manhattan has proven the most successful. This poisoned syrup was so effectively used during the period 1900-1910 that the prairie dog was largely eradicated from the state. However, in late years, due to a let-up in the work of eradication, there has been a reinvasion. The College has published a

circular on the prairie-dog situation which describes the methods of eradication. This circular will be sent free on application. (See "Prairie Dog," in index.)

#### THE MOLE.

Since the diet of moles consists almost entirely of various insects, grubs and worms found in the soil, and scarcely of any vegetable matter at all, and since the near-surface roots of alfalfa interfere with the work of burrowing, moles are not usually abundant in alfalfa fields. However, the mounds thrown up by gophers are frequently mistaken for the work of moles.

---

I like to say something for alfalfa, for it has made me thousands of dollars.—*A Barber county correspondent.*

We have learned some expensive alfalfa lessons during the past winter. The trouble is that we like it too well. We appreciate its unexcelled feeding value, and it breaks our heart to keep the hungry cows and pigs away from it. It looks like a shameful waste to leave five or six inches of growth in the field when there are hungry cattle and hogs in the barn. So we cut a late fall hay crop, or turn the stock into it, and the next year, likely as not, do without. It is a dear price to pay for that last crop or that last month's pasturage. We will learn to appreciate alfalfa more, perhaps, by doing without it this year, and maybe we will take to heart the lesson we have learned.—*Prairie Farmer.*

I regard alfalfa as the product necessary to make this western portion of the state a prosperous stock-raising locality. It is a feed that can be fed profitably to horses, to cattle, to hogs and to sheep. Because of the valleys with streams of running water, and the shallow-water localities, the western tier of counties is well suited to its growth. Alfalfa, together with the large acreage of grass land which furnishes pasture, will make this western part of Kansas a successful and prosperous part of the state for raising and feeding horses, cattle, hogs and sheep, because we have not only the best kind of a climate in which to care for the crop, but also we have the best kind of winters in which to feed the stock.—*A Sherman county correspondent.*

Economy of soil fertility demands that a gross-feeding crop like alfalfa be fed at home and not sold as hay. Perhaps in the course of years alfalfa hay will become plentiful enough even in the corn belt to make its sale unprofitable. That would be a good thing for the land. In the meantime some figuring on its utilization at home is in order. No man is in a better position to make money feeding alfalfa hay than the man who grows it. It should be worth as much to him as to anybody else. Since he gets it without baling and transportation cost, he has a big advantage. A crop of hay worth \$50 to \$75 per acre, and sometimes even \$100, looks like easy money, but if it can be fed to stock, and make gains worth that much, there is the cash return and the valuable manure besides.—*Breeder's Gazette.*

## INSECTS INJURIOUS TO ALFALFA.

By GEO. A. DEAN, Entomologist, Kansas State Agricultural College.

Like most of the field crops, alfalfa suffers from the attacks of many kinds of insects. No part of the plant escapes attack. The roots, stems, leaves, flowers and seed are eaten by a great variety of them. Even alfalfa hay is the special food of certain caterpillars. A field of alfalfa, especially when in bloom, is alive with insects, some of which are beneficial while others are very injurious. Many of those which rely wholly or in part on alfalfa for their food are too scarce to do appreciable damage. However, there are several species which may appear in such large numbers that the crop in large sections is destroyed and great damage is done. It is with these injurious species that this discussion is concerned. It should also be noted that many of the insects that are attacking alfalfa are those that are classed as clover insects, and thus are named after the clover plant rather than the alfalfa.

### THE CLOVER-ROOT BORER.

(*Hylastinus obscurus* Marsham.)

The adult, a small, dark-brown, hard-bodied beetle, about one-eighth of an inch long. The larva a dirty-white, footless, maggot-like worm about one-eighth of an inch long, yellow head, brown jaws, and is found within the main root of the plant, eating out the contents. (Fig. 310.)

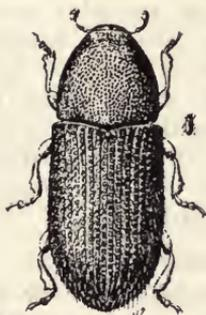

FIG. 310. Clover-root borer (*Hylastinus obscurus*). Adult insect; 12 times natural size. (After Webster, U. S. Dept Agr.)



FIG. 311. Clover-root borer. Larva or grub; enlarged. (After Webster, U. S. Dept. Agr.)

### History and Distribution.

This insect is a native of Europe, where it has been known for more than a century. In 1878 it became destructive in New York, but probably occurred in the United States long before that date. It is now distributed from the Atlantic to the Mississippi valley states, and since it is working rapidly westward it will probably not be many years before it is as serious a pest in the alfalfa-growing states as it is in the clover-growing states.

*Habits and Life History.*

"There is certainly but one generation annually, though this appears to be long-drawn-out, and scattering individual larvæ and pupæ may be found throughout every month of the year. (Fig. 311.) As a rule, however, the insects pass the winter in the adult stage within the roots where they develop. During May they abandon the old roots and seek out fresh plants or fields in which to lay their eggs. The female gouges out a shallow cavity, more often in the crown of the plant (Fig. 312), sometimes at the sides of the root, even two or three inches below the crown, and in this places singly, but not far apart, about half a dozen pale, whitish, elliptical, very minute eggs. These hatch in about a week, and the larvæ, for a time, feed in the excavation made by the mother, but soon burrow downward into the root, and before the first of August the majority of them have become fully grown and passed into the pupal stage. By October nearly all have become fully developed beetles, but make no attempt to leave the plant until the following spring."<sup>1</sup>



FIG. 312. Clover root showing work of the clover-root borer; slightly enlarged. (After Webster, U. S. Dept. Agr.)

Usually the insect does not attack alfalfa and clover the first year on account of the roots being too small to furnish sufficient accommodations. Infested plants will die sooner or later, the time depending upon the weather conditions. The presence of the insect is indicated by the alfalfa dying out in patches. If the season is dry these spots will appear shortly after the first cutting, but if there is plenty of rain or good growing conditions these patches will not appear until late fall, or maybe not until spring.

*Methods of Control.*

The only reliable measure to be suggested is to plow up the field as soon as the first crop is removed. This plowing must not be delayed, for the larvæ will then have passed into the pupal stage, and plowing would not injure them to any extent.

## CLOVER-ROOT CURCULIO.

(*Sitones hispidulus* Fab.)

The adult, black, hard-bodied beetle, about one-eighth of an inch long. Found eating irregular patches from the margin of the leaf. (Fig. 313.) The larva, a white, footless baggot-like grub, with a light chocolate-brown head, when full grown about one-fourth of an inch long. Found eating cavities along the main roots. (Fig. 314.)

1. Cir. 67, Div. Ent., U. S. Dept. Agr.

*History and Distribution.*

This insect, which is of foreign origin, was first noticed in the country in 1876, when the beetles were found about the roots of grass in New Jersey. It is now widely distributed over the United States. It occurs more often on clover growing along roadsides, but within the last few years it has been found doing serious injury in several parts of the country.

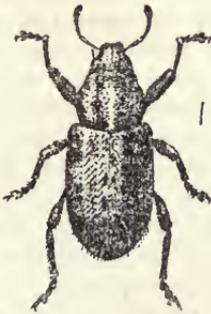

FIG. 313. Clover-root curculio (*Sitona hispidulus*). Adult; greatly enlarged. (After Wildermuth, U. S. Dept. Agr.)



FIG. 314. Clover-root curculio. Larva; greatly enlarged. (After Wildermuth, U. S. Dept. Agr.)

*Habits and Life History.*

The following paragraphs relating to the life history of the clover-root curculio are taken in substance from Mr. Wildermuth.<sup>2</sup>

The clover-root curculio passes the winter in the adult form, hiding under rubbish and leaves close to the ground. With the first warm days of spring the beetles come forth and the females begin to lay their eggs upon the plants on the roots of which the larvæ are to feed. The adults feed on the leaves, eating out irregular patches from the margin of the leaf. (Fig. 315.) The adults endeavor to escape injury by feigning death. If the leaf upon which the beetle is feeding or resting is touched the beetle drops to the ground and lies there as if dead. The eggs may not only be laid on the under side of the clover and alfalfa leaves, but may also be laid on the ground near the plant. The eggs when first laid are whitish, but within less than a day change in color to shiny black. In about two weeks the eggs hatch and the larvæ immediately go down into the ground.

At first the larvæ feed on small, tender, fibrous roots, but as they reach maturity they attack the larger roots, eating large cavities or grooves into them. (Fig. 315.) Within about three weeks the larvæ are full grown, and after making an earthen cell pass into the pupal stage. The pupal stage is from eight to ten days. There seems to be only one generation of this insect annually. Although the clovers have appeared

2. Bul. 85, pt. III, Bu. Ent., U. S. Dept. Agr.

to be the most common food plants for this insect, alfalfa also seems to be a common food plant for both the larvæ and adults, and the fact that alfalfa is usually grown continuously on the same land for a number of years will probably make it very favorable for this pest to increase in numbers.

#### Methods of Control.

The following paragraphs relating to the methods of control are quoted from F. M. Webster:<sup>3</sup>

"BIRD ENEMIES. The Biological Survey, in its work on the food habits of birds, has found that the following birds feed upon the adults of this beetle: Upland plover, killdeer or killdee, ruffed grouse, broad-winged hawk, flicker, nighthawk, chimney swift, wood pewee, crow, blackbird, meadowlark, Lincoln finch, song sparrow, chipping sparrow, and the white-throated sparrow.

"Of these birds the chimney swift and song sparrow were found to be the greatest feeders on the insect, as many as fifteen adult beetles being found in the stomach of one chimney swift, while but few less were found in stomachs of song sparrows.

"REMEDIAL AND PREVENTIVE MEASURES. Undoubtedly a short rotation of the alfalfa crop will have a tendency to limit the abundance of the pest in the fields. Of course this will not in any way affect the continuous breeding of the insect in waste lands where clover or alfalfa occur uninterruptedly.

"The limited amount of food consumed by the adults would of itself place the application of poisons out of practical consideration. While the burning



FIG. 315. Clover-root curculio. a, Red clover root showing effects of attack by larvæ; b, Red clover leaf showing work of adult beetles; about natural size. (After Wildermuth, U. S. Dept. Agr.)

over of fields in winter when the ground is frozen might destroy some of the hibernating adults, in many cases they would probably be so near the soil, or so intermingled with the surface soil, as to escape the effects of the burning, and especially would this be true if they were further protected by a covering of matted green grass.

"Therefore, at the present time the only practical suggestion that can be made is the disking or harrowing of the fields as soon as the first crop is removed. We know that the larvæ, as a rule, do not descend much more than an inch below the surface. If, therefore, the surface of the

3. Farmers' Bulletin 649, Bu. Ent., U. S. Dept. Agr.

ground were disked and then harrowed it would seem as though the pupal cells would be broken up, and as the pest is helpless in this stage, vast numbers would be destroyed in this way. While, as stated, there has not been sufficient time to carry out any exact experiments in this direction, it would be well for the farmers, until some better methods have been devised, to take the precaution of disking and harrowing immediately after removing the first hay crop in order to destroy as many as possible of the insects in their development. This, of course, can not be done early enough in the season to prevent injury, but it will in all probability reduce largely the abundance of the pest the following season."



FIG. 316. Clover Sitone (*Sitones flavescens*). Adult; ten times natural size. (After Folsom, Ill. Exper. Sta.)

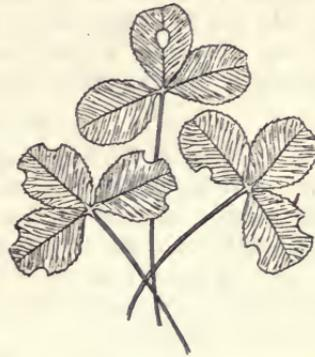

FIG. 317. Leaves of white clover showing characteristic injury by adult beetles of *Sitones flavescens*; natural size. (After Folsom, Ill. Exp. Sta.)

#### CLOVER SITONES.

(*Sitones flavescens* All.)

The adult, a small, dark-brown or rusty-brown, hard-bodied beetle, about one-fourth of an inch long. Found eating out U-shaped patches from the margin of the leaves of alfalfa and clover. (Fig. 316.) The larva, a yellowish-white, footless, maggot-like grub, with a small yellowish-brown head, and when full grown about one-fourth of an inch long, Found feeding at the crown or at the roots of clover and alfalfa.

#### History and Distribution.

Everything indicates that this insect came from Europe, where it is known to work on clover and alfalfa. It is now not only abundant in the Atlantic states, but is also distributed in many of the Mississippi and Missouri valley states.

*Habits and Life History.*

These insects pass the winter chiefly as young larvæ in earthen cells in the clover or alfalfa sod. Occasionally a few of the beetles may hibernate and survive the winter, but it is doubtful whether the hibernating beetles lay any eggs in the spring. About the first of June the wintering larvæ, which have been working on the roots of clover and alfalfa, begin to pass into the pupal stage, and from the middle of June on through July, August and September the beetles are common in the field, where they may be found cutting out the U-shaped patches from the margin of the leaves. (Fig. 317.) The female beetles probably lay most of their eggs in September. The eggs are yellowish-white at first, turning greenish, and becoming black in two or three days. The young larvæ work at the bases of the stems or the bases of the roots. Most of the injury is done by the larvæ working on the roots. Some of them may bite out the roots at the crown, causing the plant to wilt. By late fall they are from a third to half grown, and then enter the sod to hibernate in earthen cells. There is only one generation each year.

*Methods of Control.*

The cutting of the hay crop has little or no effect in controlling this insect. The larvæ continue to feed on the roots, and the beetles on the leaves as soon as they appear.

Probably the most effective method of control would be late fall and early spring disking of the alfalfa. This will not only break open many of the earthen cells and expose the larvæ to the weather, but it will also crush many of them.

## WHITE GRUBS.

*(Lachnosterna sp.)*

Thick, fleshy, white grubs, about one and one-half inches long when full grown; dark-brown head and mouth parts; three pairs of legs, curved body, heaviest at rear end; devouring the roots of the alfalfa plants and causing dead patches in the field.

*Life History.*

The parent of the white grub is the common blundering May beetle or June bug that flies about lights at night and lands against the screens with a thump, or if it succeeds in entering, flies about the room with a loud buzz and strikes the walls and ceiling with a thump. The beetles emerge from the wintering pupæ in the soil in May and June and the females deposit their eggs in grass lands, meadows, alfalfa and clover fields. The grubs hatching from these eggs live in soil almost three years before reaching maturity, and thus the adult beetle rarely emerges until three years after the egg from which it develops was deposited. (Fig. 318.) However, different individuals complete growth each year, and thus the June bug is common every year. The grubs consume the roots of the alfalfa plants, thereby depriving the plant of a part of the normal food supply, checking its growth, and many times completely killing it.

*Methods of Control.*

**NATURAL ENEMIES.** The white grubs fall prey to birds whenever they are exposed. Large numbers of the grubs and adult beetles are consumed by skunks. Many of the grubs are devoured by moles. A small percentage of the grubs are killed by parasitic fungi. Sometimes a large per cent of the grubs are destroyed by parasitic insects, chief among which may be mentioned a small wasp-like insect (*Tephia inornata* Say.).

**ROTATION.** Allowing the land to remain in alfalfa year after year is conducive to the increase of the grubs. If the grubs have become well established in the alfalfa there is no practical method of control, except rotation. A badly infested field should be thoroughly pastured with

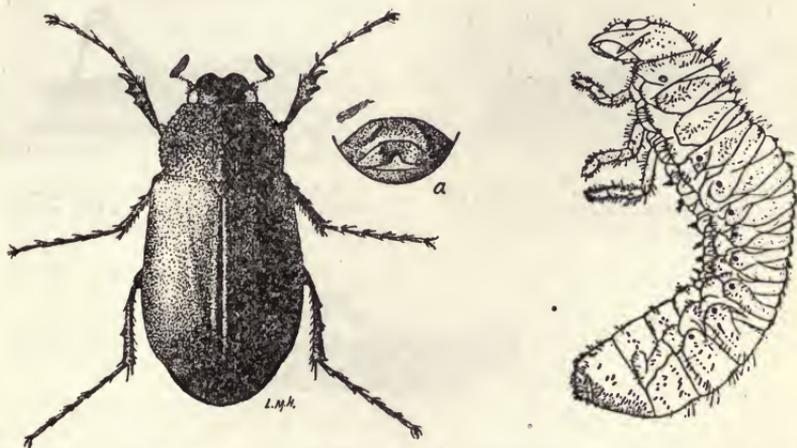

FIG. 318. White grub (*Lachnosterna negosa*). Adult beetle and larva;  $1\frac{1}{2}$  times natural size. (After Forbes.)

hogs during the summer, allowing them to root it over. In the fall or in the early spring it should be plowed deep and thoroughly harrowed. This will not only kill large numbers of the pupæ by breaking open the pupal cells and exposing them to the weather, but it will also expose the grub to birds and other enemies. Chickens and turkeys following the plow will catch a large number of grubs.

In pasturing alfalfa with hogs it should be remembered that the giant thorn-headed worm, one of the serious intestinal parasites of the hog, infests the white grub. Inasmuch as the grubs must obtain this parasite from infested hog feces, and since the life of the grub is three years, it is plain that hogs may be safely used to clean the land if it has not been pastured with hogs at any time in the previous three years.

## GRASSHOPPERS.

(Acrididæ.)

While there are many species of grasshoppers in Kansas, only three species—the differential grasshopper (*Melanoplus differentialis* Thos.), the two-striped grasshopper (*Melanoplus bivittatus* Say.), and the lesser migratory grasshopper (*Melanoplus atlantis* Riley)—appear in sufficient numbers to do serious harm to alfalfa.

*Description.*

The differential grasshopper has a large, yellow, robust body, about one and one-half inches long, which is marked by black lines on the sides. (Fig. 319.) A row of black V's is on the outside of the hind thighs,



FIG. 319. Differential grasshopper (*Melanoplus differentialis*). Adult female;  $\frac{3}{4}$  natural size. (Original.)



FIG. 320. Two-striped grasshopper (*Melanoplus bivittatus*). Adult female;  $\frac{3}{4}$  natural size. (Original.)



FIG. 321. Lesser migratory grasshopper (*Melanoplus atlantis*). Adult female; natural size. (Original.)

with a row of black dots just below. This species, which is the most common in alfalfa, is present on both lowland and upland in all parts of the state.

The two-striped grasshopper has a brownish-yellow body about one and one-half inches in length, with a distinct yellow stripe extending on each side from the upper part of the eye to the end of the wing. (Fig. 320.) This species is also found in all parts of the state associated with the differential grasshopper, but usually is present in lesser numbers.

The lesser migratory grasshopper is the smallest of the species injuring alfalfa. It has a slender body about one inch in length and varies in color from yellow to dark brown. The narrow front wings have longitudinal V-shaped areas extending through the middle, in which are found a number of squarish black spots. (Fig. 321.)

*Habits and Life History.*

The female grasshoppers begin to deposit their eggs about the first of September and continue until cold weather. They prefer a moderate compact, rather damp, but not wet, soil which is rarely disturbed by the

plow or other cultivating implements, undisked alfalfa fields thus constituting an ideal breeding place. Roadsides, fence rows, waste places, and edges of pastures also constitute ideal breeding places. The female digs a hole in the ground with the tip of her abdomen, extending it as far down as the abdomen will reach (Fig. 322) and deposits from fifty

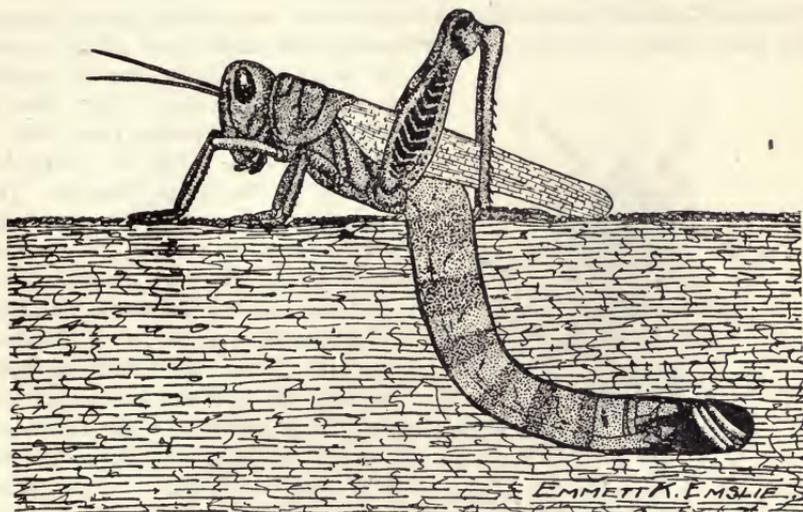

FIG. 322. Drawing representing the position assumed by the female differential grasshopper in laying her eggs; slightly enlarged. (After Milliken, Kan. Exp. Sta.; Emslie, Del.)

to one hundred eggs, neatly arranged in a kidney-shaped pod or mass. She then packs the earth in over them, and here they remain throughout the winter. With the coming of warm spring weather they hatch and the young come to the surface, where they feed on the alfalfa all summer long. They reach full size the latter part of summer, mate, and lay the eggs that are to produce the next year's brood.

#### *Methods of Control.*

**NATURAL ENEMIES.** Upward of one hundred species of birds are known to feed on grasshoppers. Some of the most useful ones in this respect are quails, prairie chickens, sparrow hawks, the shrike, all cuckoos, the meadow lark, catbird, all blackbirds, and the cowbird. Barnyard fowls, such as guineas, chickens, ducks, turkeys and geese, are continually in search of grasshoppers. Skunks, toads, ground squirrels and snakes are very fond of them.

Mites often infest grasshoppers, collecting in large numbers under the base of the wings. Probably the mites do not kill many of the grasshoppers. However, they may so weaken the female as to prevent her from developing her eggs. There are several species of parasitic flies that frequently destroy very large numbers of the grasshoppers; in fact, they sometimes destroy nearly all of them over large districts. These parasitic flies deposit the small maggots on the surface of the bodies of

the grasshoppers, and the young, on hatching, make their way at once into the bodies of the grasshoppers. Here they grow and develop rapidly, feeding upon the living grasshoppers and causing them to die. When full grown the maggot enters the ground, pupates within a brown case, and within a short time the pupæ transforms to a fly, about the size of a house fly, but lighter in color. (Fig. 323.)

Another class of insects that is very useful in checking grasshoppers is the blister-beetle family. Unfortunately the adults are often known

to us as very injurious to alfalfa and garden crops. The female blister beetle deposits from 400 to 500 yellowish eggs in irregular masses in the loose ground. The eggs hatch in a few days and the active larvæ run about everywhere seeking the eggs of grasshoppers.

Some seasons immense numbers of grasshoppers die of a fungous disease. This disease, like so many of the fungous diseases, depends for its propagation upon favorable climatic conditions. If there are several weeks of cloudy, rainy weather this disease may become very pronounced and sweep the grasshoppers off in myriads. The diseased

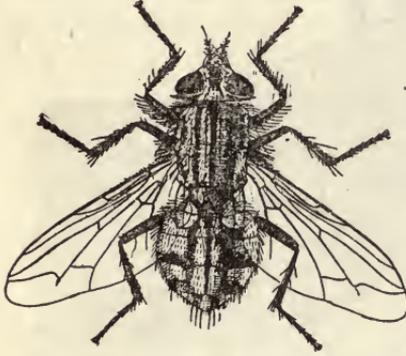

FIG. 323. Parasitic fly (*Sarcophaga georgina*) that destroys grasshoppers. Much enlarged. (After Webster, U. S. Dept. Agr.)

'hoppers, just before dying, crawl upon the plants, usually crawling well to the top of the alfalfa, weeds and grasses. (Fig 324.) They turn dark in color and cling very closely or tightly to the plant. The disease has literally rotted them. In a short time after dying they dry up, crumple, and fall to pieces. Many inquiries are made as to whether alfalfa on which many of the diseased grasshoppers have died would be safe to feed stock. The writer believes there is no danger whatever in using this hay. In so far as we know it is not a poisonous fungus. The cutting, curing, raking and handling of the hay, which is necessary before the hay is placed in the barn or stack, will dislodge and break to pieces the dead 'hoppers to such an extent that very little of them will be left on or in the hay.

**PREVENTIVE AND REMEDIAL METHODS.** While there is a large number of natural enemies of the grasshoppers, and all of them are a benefit to the farmer in helping him to control the 'hoppers, they do not, and probably never will, afford absolute protection from the ravages of these pests in alfalfa fields, and thus preventive and remedial measures must be put in operation in order to prevent serious injury to the crop.

**Disking.** During the egg stage is the best time to attack the grasshoppers. The eggs may be destroyed by plowing, harrowing, disking or cultivating roadsides, margins of cultivated fields, grassy margins along fences and all waste places, in the fall or early winter. In an alfalfa field it is not necessary to cultivate or disk deeply, two inches being sufficient.

This will break up and turn out a large portion of the egg packets, so that they will be exposed to the natural enemies and the inclemencies of the weather. The farmer must use his judgment as to the best implement to use for this purpose, and as to whether the soil and climate are such as to make it safe to use the alfalfa cultivator or disk.

*Poisoned Bran Mash.* Where the eggs have been left undisturbed and allowed to hatch the best method of destroying the grasshopper, whether young or old, is to distribute poisoned bran mash prepared and distributed in the following manner:

Bran .....	20 lbs.
Paris green .....	1 lb.
Syrup .....	2 qts.
Oranges or lemons .....	3
Water .....	3½ gals.



FIG. 324. Photograph taken of grasshoppers dead and dying from fungous disease; greatly reduced. (Original.)

In preparing the bran mash mix the bran and Paris green thoroughly in a washtub while dry. Squeeze the juice of the oranges or lemons into the water, and chop the remaining pulp and the peel to fine bits and add them to the water. Dissolve the syrup in the water and wet the bran and poison with the mixture, stirring at the same time so as to dampen the mash thoroughly.

The bait when flavored with oranges or lemons is not only more attractive, but also seems to be more appetizing, and thus is eaten by more of the grasshoppers.

The damp mash or bait should be sown broadcast in the infested areas early in the morning, or about the time the grasshoppers are beginning to move about from their night's rest. It should be scattered in such a man-

ner as to cover from four to five acres with the amount of bait made by using the quantities of ingredients given in the above formula. Since very little of the bran mash is eaten after it becomes dry, scattering it broadcast in the morning, and very thinly, places it where the largest number will find it in the shortest time. Sowing it in this manner also makes it impossible for birds, barnyard fowls, or live stock to secure a sufficient amount of the poison to kill them.

Where the alfalfa has just been cut the poisoned bait may be sown broadcast in strips about one rod apart over the area to be treated. In case a second application is made, sow the strip opposite to those of the first sowing. If the grasshoppers are moving into the alfalfa from the surrounding fields, roadsides, or pastures, which they often do in the case of new alfalfa, simply sow a strip of the bran mash along the edge of the field into which they are moving. Inasmuch as the grasshoppers may continue to come from the surrounding fields, it may be necessary to make a second and even a third application of the bait at intervals of from three to four days.

*Hopperdozer.* Coal oil has been used in many ways for the destruction of grasshoppers, but is most commonly used in the hopperdozer, a device

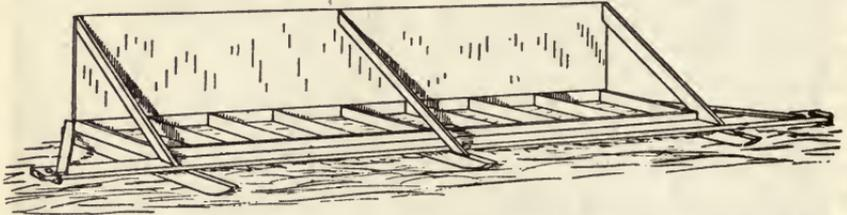

FIG. 325. Drawing showing the construction of a hopperdozer sixteen feet long. (After Milliken, Kan. Exp. Sta.).

which consists of a long, shallow, galvanized-iron pan, mounted on very low runners. The hopperdozer is very effective where it can be drawn over an infested area near the surface of the ground. It is a necessary device wherever grasshoppers become destructive. On infested bare areas or fields where it does not injure the crop, grasshopper damage can be quickly checked by its use. It can be used without injury in an alfalfa field for two or three weeks after a crop has been cut. A good kind of a hopperdozer is made after the following plan: The pan is made from a piece of galvanized sheet iron,  $2\frac{1}{2}$  feet wide and 16 feet long, by turning up about 4 inches of the edge all around and soldering partitions across it at intervals of about 2 feet. The sled is made of inch boards nailed on 2- by 4-in. runners, with a 3-foot screen made by fastening oilcloth, smooth side forward, on upright pieces at the back. (Fig 325.) About an inch of water is put in the compartments of the pan, and a sufficient amount of oil added to make a good film over the top. Horses hitched at either end draw the dozer over the infested ground, and grasshoppers that attempt to jump back over it strike the screen and fall into the water and oil. Many hop out again, but it is an advantage, as they die and save the operator the trouble of later removing them. The dead

that accumulate in the pan must be removed from time to time and more oil and water added. On smooth, level ground old wagon tires will make good runners, and let the pan run close to the surface, where it will do the most effective work.

Where large areas are to be gone over with the dozer, two sleds should be constructed, each long enough to hold one of the pans. Place these sleds end to end with an 8 ft. "2 by 4" between the runners of the ends that come together. With half-inch bolts fasten the two runners loosely together through the middle "2 by 4," leaving the latter projecting behind as far as it may. Run a heavy wire through a hole in the rear end of the "2 by 4" and fasten each of the ends to the outer back corner of each dozer. This gives a machine about 32 feet in length that is flexible in the middle, so that it may be drawn over rolling land by a team hitched to each end. The hitch should be to the end of a 10 ft. "2 by 4," which extends from the middle runner of each sled and projects at its outer end. This makes the pull in front of the pans, and it will be almost impossible to upset the machine.

Any grade of kerosene may be used in a hopperdozer. Since some of the oil is removed by every grasshopper that gets into it it will be necessary to add fresh quantities at intervals. In case the oil and water is slopping out, which it will do on rough or uneven ground, burlap or gunny-sack cloth should be placed in the pans.

The first cost of the hopperdozer, made according to the above directions, should not be more than \$8, and should be operated at a cost not to exceed 20 cents an acre.

*Poultry and Young Hogs.* In many cases where grasshoppers have been numerous, poultry and hogs have been very effective in destroying them. Not only are instances of this kind often reported to us, but observations and experiments show that where barnyard fowls and young hogs can be let run on an infested field they furnish one of the surest and most effective means of destroying the grasshoppers. Poultry and hogs are fond of the 'hoppers and pursue them eagerly. Except in gardens, poultry can be used almost anywhere, and if they are placed where they can begin on the young 'hoppers as soon as they are large enough to attract the attention of the fowls, a small flock will destroy all that can be found on a surprisingly large area, and will keep their number down throughout the summer.

Hogs can be let run on alfalfa, weed patches, and pasture lands where the grasshoppers are numerous. A bunch of young shoats will protect a considerable area.

To make a successful fight against grasshoppers too much emphasis can not be laid upon the necessity of beginning promptly, as soon as the insects are present in sufficient numbers to threaten the crops, and continuing it vigorously so long as the grasshoppers are present.

#### ARMY WORM.

(*Leucania unipuncta* Haw.)

Plump, greenish-black to dark gray caterpillars; when full grown from one and one-half to two inches long, having three stripes along each side—the middle one dark and other two light—and a narrow

broken stripe of white down the middle of their backs; usually migrating in enormous numbers from adjoining grass lands or rye fields and doing great damage in a very short time. (Fig 326.)

*Habits and Life History.*

The army worms occur throughout the United States east of the Rocky Mountains. They live in low, rank growth of grasses, which form their normal breeding grounds. They also breed in rye that has been sown early for fall and winter pasture. Sometimes, owing to un-



FIG. 326. Army worms (*Leucania unipuncta*) at work on a corn plant; about  $\frac{2}{3}$  natural size. (After Slingerland.)

usually favorable conditions, there is an enormous increase in numbers, and, unable to find food in their usual haunts, they assume the army habit and crawl in great numbers into alfalfa fields, consuming all in their path. The next year their natural enemies usually will have them under control again, and they will not be observed as injurious for a number of years, though the adult moths are always fairly common.

The army worms pass the winter as partly grown larvæ in the soil. Probably in some instances the adult moths pass the winter. With the

coming of spring the worms resume their feeding, and, attaining full growth, pupate in the soil. (Fig. 327.) The moths emerging from these pupæ lay their eggs during May behind the sheaths of the grass, fastening them to the leaf by means of a gummy cement. (Fig. 328.) The worms hatching from these eggs reach maturity within a few weeks, pupate, and transform into the second brood of moths in the latter part of June. A third brood of moths appears in August and September. This brood lays the eggs from which the larvæ that, after becoming partly grown, pass the winter in the soil.



FIG. 327. Army worm. Larvæ, pupæ and moths; about  $\frac{2}{3}$  natural size. Eggs greatly enlarged. (After Forbes.)

#### *Methods of Control.*

**NATURAL ENEMIES.** Fortunately, parasitic and predaceous foes attack the army worms to such an extent that they are seldom seriously abundant in the same locality two years in succession. Large numbers are destroyed by predaceous ground beetles and their larvæ, but the most deadly enemies attacking them are the tachina flies. (Fig. 329.) These parasitic flies lay a dozen or more eggs on the worms, usually

along the back close to the head, and the maggots hatching from these eggs enter the body and feed on the tissues and blood of the caterpillar, thus soon killing it.

**REMEDIAL MEASURES.** In spite of the fact that the army worm has so many foes, it occasionally becomes so abundant that the grower must use artificial measures of control. As soon as the army worms are detected measures of control should be put into operation at once, if the loss of the crop is to be prevented, for they move rapidly and destroy all in their path. Efforts should be centered on keeping the worms out of the alfalfa not yet attacked, and on confining their injury to as small an area as possible.

The most effective method of control is the poisoned bran mash prepared the same as for grasshoppers (see "Poisoned Bran Mash," in index), and distributed in the following manner:

FIG. 328. Army-worm moth, pupa and eggs in natural position in a grass leaf; natural size. (After Comstock.)

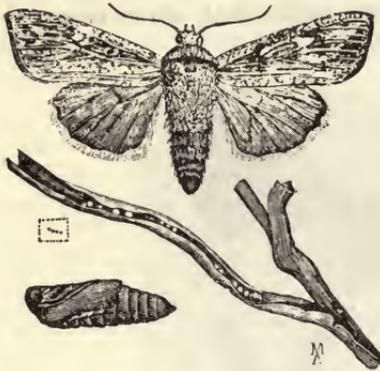

If the worms are moving into an alfalfa field a strip of the bran mash should be sown broadcast along the edge of the field into which they are moving. If they are already abundant in the field the crop should be cut at once and the worms poisoned as they are moving into an adjoining field. If they are working on alfalfa that is

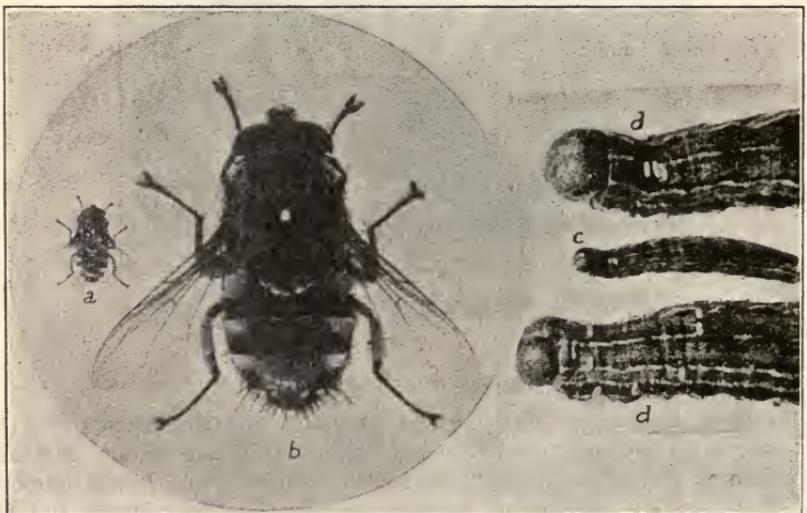

FIG. 329. The farmers' friend, the red-tailed tachina fly (*Winthemia quadripostulata*). a, natural size; b, much enlarged; c, army worm on which fly has laid eggs, natural size; d, much enlarged. (After Slingerland.)

just starting up after it has been cut, the poisoned bait should be sown broadcast over the infested field in such a manner that the amount recommended in the formula will cover about three acres. The worms do not eat the poisoned mash so readily when it is dry, and for this reason it should be scattered on the infested areas in the evening, because the worms work mostly at night. If they are working on the alfalfa in the daytime, which they will do on cloudy days, place it out in the morning or during the day just as they are beginning to feed.

As a barrier to their progress there is nothing better than a dust furrow, made the same as the one for the chinch bug. If the weather is cool and a fine dust can not be maintained it may be necessary to have two or three furrows. Postholes are made in the bottom of the furrows at intervals of from ten to fifteen feet, where the caterpillars may collect in quantity as they travel up and down the furrows seeking to escape. Here they may be readily killed by pouring kerosene upon them or by crushing them.

By a thorough spraying of the vegetation on which they are feeding with an arsenical spray, large numbers may be killed. If they are just moving into a cornfield or an alfalfa field, a strip should be thoroughly sprayed along the edge of the field into which they are moving. In making the sprays either lead arsenate should be used at the rate of three pounds to fifty gallons of water or Paris green at the rate of one pound to fifty gallons of water. In using Paris green two pounds of stone lime should be used to every pound of Paris green.

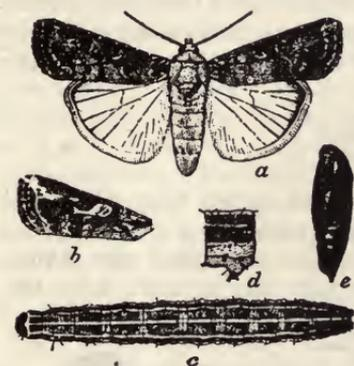

FIG. 330. Fall army worm (*Laphygma frugiperda*). a, Moth; b, fore wing; c, larva extended; d, abdominal segment of larva, side view; e, pupa. All about natural size. (After Chittenden, U. S. Dept. Agr.)

To make a successful fight against these worms too much emphasis can not be laid upon the necessity of beginning promptly. By a few hour's delay acres of alfalfa and other crops may be sacrificed.

#### FALL ARMY WORM.

(*Laphygma frugiperda* S. and A.)

Caterpillars much like the true army worm but distinguished by being slightly more hairy, having four prominent black tubercles or spots on each segment, and by the presence of a white inverted V on the forehead. (Fig. 330.)

#### Habits and Life History.

The fall army worms pass the winter in the pupal stage. The pupæ are shining light brown, about five-eighths of an inch in length, and are found in cells from one-half to one and one-half inches below the surface of the ground. The moths emerge in the spring and lay their eggs in clusters of fifty or more on grasses. The eggs hatch in about ten days,

and the first brood of caterpillars are found during May and June. These worms, when full grown, descend an inch or two into the ground and pass into the pupal stage. A little later the moths emerge and lay the eggs for the second generation of worms. It is this second brood that often becomes so injurious on alfalfa during the latter part of August and the first week or two in September. By the last of September the third generation of moths will appear to lay the eggs for the third generation of worms. This is the brood that passes the winter in the soil as pupæ.

*Methods of Control.*

The habit of this insect of entering the ground to pupate is of great importance in the control of it. Shallow cultivation of the alfalfa with a spiked-tooth harrow, alfalfa cultivator or disk will destroy from 60 to 90 per cent of them, depending upon the thoroughness of the work. When alfalfa fields are threatened with an invasion, or if they have become established in the field, the same treatment that is recommended for the army worm should be used.

VARIEGATED CUTWORM.

(*Peridroma saucia* Hubn.)

Plump caterpillar, about one and three-fourths inches long when full grown; color variable from a brownish or grayish to a greenish hue, marked with longitudinal dashes along the sides and with a row of four or six pale dots extending from the neck half way or more down the back. (Fig. 331.)

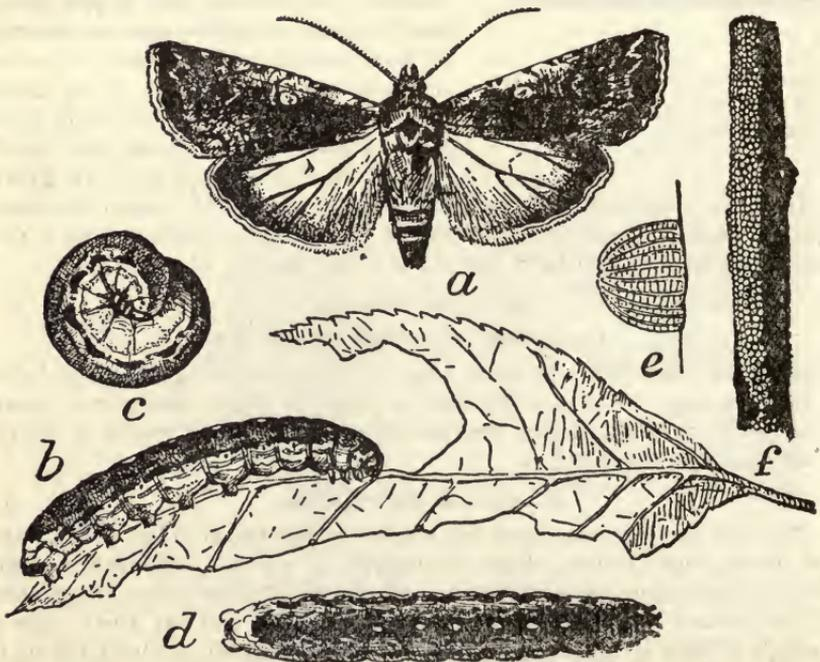

FIG. 331. Variegated cutworm (*Peridroma saucia*). *a*, adult; *b*, *c*, *d*, full-grown larvæ; *e*, *f*, eggs. All natural size except *e*, which is greatly enlarged. (After Howard, U. S. Dept. Agr.)

*Habits and Life History.*

This insect breeds abundantly, not only in alfalfa and wheat fields, but also in garden crops, and when abundant it sometimes migrates in hordes, like the army worm, in search of food, and has been known to destroy hundreds of acres of alfalfa. The life history of this species is not well known. It may be taken in the winter as larva, pupa, and even as adult, but in Kansas the great majority pass the winter as larvæ in the soil, emerging from their winter quarters in the late spring. The second generation of worms appears in July and August. There may be even a partial third generation in the fall, but there is nothing conclusive upon this point. The variegated cutworm is a wide feeder, working not only on field, garden and greenhouse plants, but also on the foliage and fruit of trees. In the spring of 1909 the infestation of this insect, which was more serious than usual, extended over several counties in the south central part of the state. At that time they appeared early in the spring and destroyed thousands of acres of wheat and many acres of alfalfa. In the spring and early summer of 1915 the infestation was a much wider one, extending over the eastern third of the state. Instead of injuring crops early in the season and confining their attack almost entirely to wheat, as they did in 1909, they appeared almost sixty days later, or about the first of June, and the main injury was confined to the alfalfa, although in a few cases, after alfalfa had been cut, they migrated into garden truck and corn.

*Methods of Control.*

This insect, like the army worm, has many parasitic and predaceous foes, the principal ones being the same parasitic flies that parasitize the army worms.

The same poisoned bran mash that has proved so effective for the control of grasshoppers and army worms is also very effective in destroying the variegated cutworms. (See "Poisoned Bran Mash," in index.) In the evening the bran mash is sown broadcast over the infested fields in such a manner that the amount of bait prepared by beginning with twenty pounds of bran will cover about five acres. If they appear late in the season, as they did in 1915, they probably will not be noticed until the first crop of alfalfa has been cut. Within two or three days the farmer will notice that the alfalfa is not growing and that the ground is almost as bare as the day it was cut, although the season may be very favorable for a rapid second growth. If he will examine the field he will discover that the worms are eating the new growth of alfalfa just as soon as it appears. The worms may not get enough entirely to satisfy their hunger during the night, but will get enough to eat to keep them from migrating, and with the advent of day they enter the ground to wait for the next night's meal. This makes conditions ideal for poisoning them, and in the evening the bran mash flavored with lemons or oranges should be sown over the infested portions. One application usually will be sufficient.

## GARDEN WEBWORM.

*(Loxostege similalis Gn.)*

Small, green, black-dotted web-spinning caterpillars, appearing in June, July and August, and binding up the alfalfa plants with webs.

*Distribution.*

Although this insect occurs throughout the United States, it is most serious in the central Mississippi states. Several times it has proven a serious enemy to alfalfa in this state. The larvæ feed normally on the pigweed or careless weed, from which they sometimes receive the local name "careless worm." Usually it is only when they become abundant on the weeds that they migrate from them to attack crops, such as alfalfa, corn and garden truck.

*Habits and Life History.*

The moth is yellowish, buff, or grayish-brown in color, with a wing expanse of about three-quarters of an inch. The eggs, which are laid on the food plants, soon hatch, and the tiny worms begin feeding. In feeding the worms spin a fine web, which gradually envelops the plant, of which nothing is left but the skeleton of the leaves when the worms are abundant. The worms vary in color from pale and greenish-yellow to dark yellow, and are marked with numerous black dots. (Fig. 332.)

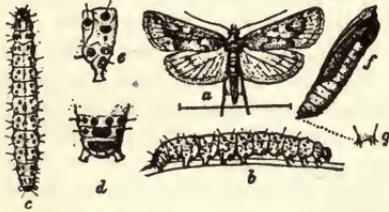

FIG. 332. Garden webworm (*Loxostege similalis*). *a*, male moth; *b*, *c*, larvæ; *d*, anal segment of same; *e*, abdominal segment of same from side; *f*, pupa; *g*, tip of abdomen of same; *a*, *b*, *c*, *f*, somewhat enlarged; *d*, *e*, *g*, more enlarged. (After Riley and Chittenden, U. S. Dept. Agr.)

The worms become full grown in about three weeks in summer, when they descend to the ground and pupate in small silken cells on or just below the surface. The moths emerge in about one week, so that in midsummer the complete life cycle occupies about one month. In Kansas there are three or four generations a year, the last generation passing the winter either as larvæ or pupæ in silken-lined cocoons in the soil.

*Methods of Control.*

Usually the farmer does not notice the trouble until the plants are covered with webs and are seriously injured. Just as soon as the worms are noticed the alfalfa should be cut in order to save as much of it as possible for hay. If it is full of the web and the droppings of the worms it should not be fed to horses, but may be fed to cattle. In raking and handling the hay many of the worms will be killed, while others will perish in the hay.

The plowing of infested weed fields in late fall or winter and thorough disking of alfalfa will be found largely to control the pest. When it appears on garden crops it may be readily destroyed by at once spraying or dusting with Paris green or lead arsenate. The destruction of the weeds upon which it feeds is very important in preventing the undue increase of the pest.

## THE ALFALFA CATERPILLAR.

*(Eurymus eurytheme* Boisd.)

Caterpillar, dark grass-green color, with a white stripe on each side of the body, and when full-grown about one inch in length. (Fig. 333.) The adult, a butterfly, with a wing expanse of nearly two inches, varying in color from yellow to almost white, but usually sulphur-yellow above, with black outer wing margins, a black spot in the center of each fore wing and a yellowish spot in the center of each hind wing. (Figs. 334 and 335.)

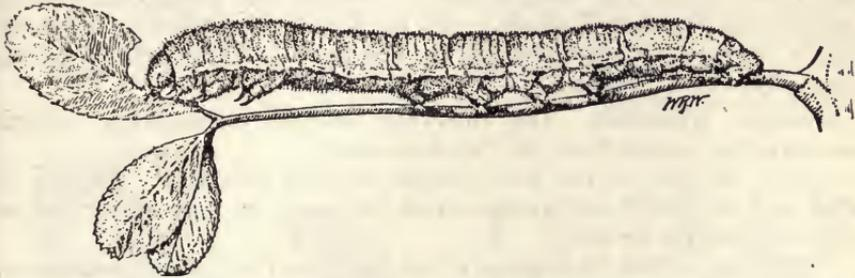

FIG. 333. Alfalfa caterpillar (*Eurymus eurytheme*). Full-grown larva or caterpillar; about three times natural size. (After Wildermuth, U. S. Dept. Agr.)



FIG. 334. Female moth or adult of the alfalfa caterpillar;  $1\frac{1}{2}$  times natural size. (After Wildermuth, U. S. Dept. Agr.)

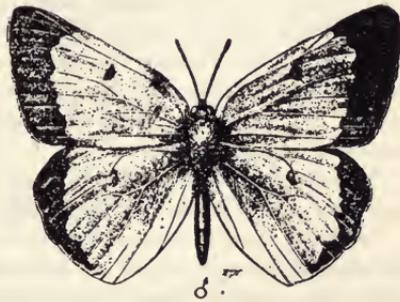

FIG. 335. Male moth or adult of the alfalfa caterpillar;  $1\frac{1}{2}$  times natural size. (After Wildermuth, U. S. Dept. Agr.)

*Distribution.*

Although this insect is found throughout the greater part of the United States and southern Canada, it is much more abundant in the states west of the Mississippi river, thus covering the principal alfalfa-growing section of this country. However, it is in the regions where irrigation is extensively carried on that it is very abundant and has proved a serious pest.

*Habits and Life History.*

The life history of this insect has not been worked out for Kansas. However, in view of the fact that the butterflies are present throughout the spring and summer months, there are probably three generations in

one year. The winter is probably passed in the pupal stage, the pupæ being attached to the stems of weeds, grasses and other plants in sheltered places. During the summer the pupæ may be found hanging head upward, attached to the alfalfa stems. It is the caterpillar, or worm, that does the damage and not the butterfly that is so frequently seen flying over alfalfa fields.

*Methods of Control.*

**NATURAL ENEMIES.** In speaking of the natural enemies Mr. Wildermuth<sup>4</sup> says: "Were it not for the fact that this species is preyed upon by a great many natural enemies it would indeed prove a much more serious pest than it is at the present time. Parasites and predaceous insects, fungous and bacterial diseases, birds, toads, and even domestic fowls, all play a large part toward keeping the species well within bounds during certain seasons of the year."

**CONTROL MEASURES.** The following conclusions regarding control measures are quoted from Mr. Wildermuth:<sup>5</sup>

"Keep the soil in the best possible cultural condition. Irrigate it often and thoroughly and as soon after cutting as the crop of hay can be removed from the ground.

"Renovate, either by disking or by the use of an alfalfa renovator, thus disturbing any pupæ that may be present, and putting the land and alfalfa in condition for good growth of succeeding crops."

"Cut the alfalfa close to the ground and clean, especially along the ditch banks, borders, and turning rows, as well as in the main part of the field.

"Cut the alfalfa earlier than is the general rule. The proper time is when it is just coming in bloom or is one-tenth in bloom. Watch for caterpillars in the early spring crop, and if many are observed about grown, cut the hay a few days before it is in bloom, and thus save the next and future crops.

"A minimum amount of damage occurs in fields that are systematically pastured all or a part of the time.

"A field should never be abandoned because the caterpillars threaten the destruction of a crop of alfalfa before the hay can possibly mature. Mow it at once, cutting it low and clean, thus saving part of the present crop, and in so doing starve, and allow the heat of the sun to kill, a great many of this generation of worms. Follow this by disking, and then by either rolling or brush dragging, and a great majority of any remaining larvæ will be killed. The ground should then be thoroughly irrigated, and by these efforts the coming crop will be assured.

"Turkeys and chickens when allowed the run of a field will keep the numbers of the caterpillars at a minimum.

"The protection of toads should be encouraged, as they eat many of these insects, as well as other injurious forms.

"It has been noted that a carrying out of only part of these recommendations will not at all times save one's crop. The best results come to the one who is thorough in methods.

4. Bul. 124, U. S. Dept. Agr., p. 19.

5. Bul. 124, U. S. Dept. Agr., pp. 39, 40.

“Coöperation among all farmers is necessary to suppress an insect attack completely. An occasional outbreak has been known to occur upon a farm or ranch that is under the best possible condition of crop culture, but in each case it was noted that the careless methods of a neighbor were responsible for the reinfestation.”

## THE ALFALFA WEEVIL.

*(Phytonomus murinus* Fab.)

A small, oval, dark brown snout beetle marked with black and gray hairs, giving them a mottled appearance; about three-sixteenths of an inch long; attacking alfalfa in Utah, the adults feeding on the stems, leaves and buds for several weeks. The larvæ are small, footless, alfalfa-green worms with a black head, about one-fourth of an inch in length, and feed in the stalk, in the leaf buds and on the leaves. They have the habit of feeding and resting in a curved position. (Fig. 336.)

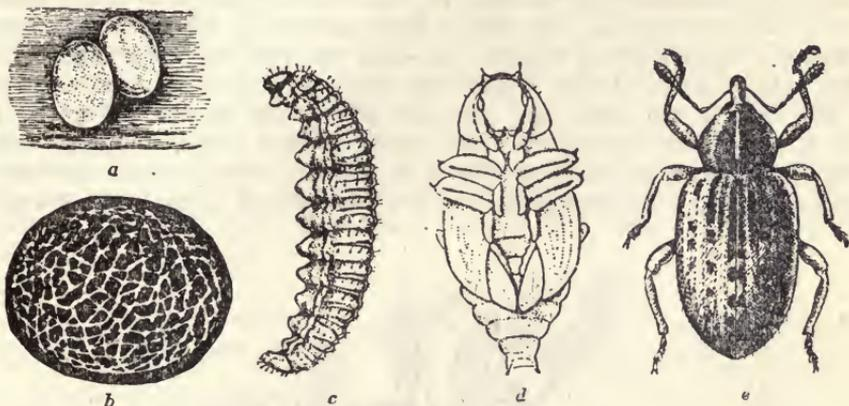

FIG. 336. Alfalfa weevil (*Phytonomus murinus*). a, eggs; b, cocoon; c, larva; d, pupa; e, adult. All much enlarged. (After Webster, U. S. Dept. Agr.)

At the present time we do not know of an infestation of this serious pest in Kansas, but inasmuch as there are millions of the beetles in the infested district of Utah, and since the beetles have been found in considerable numbers in freight and passenger cars coming from the infested regions of Utah, and since these freight and passenger cars are constantly traversing the alfalfa districts of Kansas, it is probably only a question of a short time until the weevil will be distributed in the alfalfa fields of Kansas. It is therefore highly important that our alfalfa growers be on guard, and just as soon as this insect is discovered, or has gained a foothold, the entomologists of the Kansas State Experiment Station should be notified in order that measures for its control and destruction may be put in operation at once.

*History and Distribution.*

The alfalfa weevil is a native of Europe, Western Asia and Northern Africa. It was first noticed in America in an alfalfa field near Salt Lake City, Utah, in 1904. However, it was not brought to the attention

of the Utah Experiment Station until 1907. It has been increasing and spreading until now it has spread not only over several counties in Northern Utah, but has extended its area of diffusion northeastward into Wyoming and northward into Idaho.

*Habits and Life History.*

The insect passes the winter as an adult beetle hibernating in the crowns of the alfalfa plant, under thick grass, weeds, rubbish and leaves; in hay or straw stacks, in barns where hay is stored, or in any well-sheltered place available at the time they are going into hibernation. In the spring, as soon as the alfalfa is started sufficiently to furnish food, the beetles emerge and attack the young plants. About April the females begin laying their eggs in the stems or on the buds and leaves, and this continues until early July. In the early spring, while the plants are small, the females often push their eggs down between the leaves or into the bud, but the usual method is to insert them in punctures made in the stem. This puncturing of the stem often seriously injures young plants. In about ten days the eggs hatch, and the young larvæ, at first white, but soon turning to an alfalfa-green color, feed in the stems and the buds and on the leaves. (Fig. 337.) They attack the young leaves and crown, so that a badly infested field will not make a sufficient growth to be mowed. The larvæ do not have true legs, and when full grown are from one-fourth to near a half inch



FIG. 337. Alfalfa weevil. Adults, clustering on and attacking sprig of alfalfa; natural size. (After Webster, U. S. Dept. Agr.)

in length. When full grown, which is from fifty to sixty days after hatching, the larvæ crawl or drop to the ground and spin around themselves a cocoon composed of a network of rather loose, white threads. This cocoon is usually in among the dead leaves or rubbish. The insect remains in the pupal stage from ten to fourteen days, and then the beetle emerges. The adult feeds on the stems, leaves and buds until autumn or their hibernating time. Professor Webster, of the United States Bureau of Entomology, says: "The entire life of the insect, from the deposition of the egg to the emergence of the adult, may be anywhere from forty to seventy days, while the beetle itself may live, including the winter, from ten to fourteen months."

#### *Methods of Control.*

Although methods of control have not as yet been satisfactorily determined, Professor Titus, entomologist of the Utah Experiment Station, has made extensive experiments with various methods, and in summarizing the methods of control recommends: "That alfalfa be disked in early spring to stimulate it to better growth; that the first growth be cut when most of the eggs have been laid (middle of May in Utah) and then brush-drag the field thoroughly. Fields should be brush-dragged again after the first crop has been cut. All weeds and rubbish should be cleaned from the field, yards, ditches and fence rows, so that there will be less opportunity for the weevil to find winter shelter. Alfalfa should not be allowed to grow more than seven or eight years in the infested districts."

#### *The Brush Drag.*

The following pattern and construction of a brush drag is recommended by Professor Titus: "Many patterns of the brush drag are in use, but the one which seems to be the best for our work is made by laying the butts of rather short brush, five or six feet long, in a row on a plank twelve or fourteen feet long, then another row should be laid upon the first, consisting of longer brush, with the butts trimmed a little further back, so that you will have in effect two brush harrows, one following the other. Another plank should then be laid on the brush butts and bolted to the under plank. In weighting this harrow, lay an ordinary tooth harrow, with the teeth down, directly on the brush drag. (Fig. 338.) This makes a very even weight, at the same time it is so flexible that the drag will work its way down into the small depressions as well

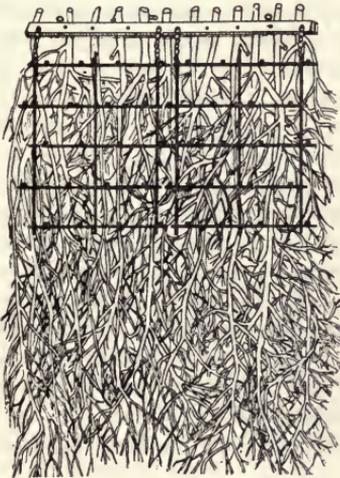

FIG. 338. Brush drag. (After Titus, Utah Exp. Sta.)

as over the larger elevations of the field.

"The brush drag has for its main object the knocking of the larvæ feeding on the stubble to the ground, where it mangles many of them

and suffocates others by the dust stirred up, and tears up the cocoons that are present on the plant and on the ground. If the brush drag is built right there will be parts of the brush tearing through every crown of alfalfa in the field and stirring up the soil sufficiently to cause a dense fine dust, in which many of the younger larvæ are suffocated and which the older ones find it very hard to crawl through to reach the plants, many of them perishing in the heat of the sun."

CLOVER LEAF-WEEVIL.

(*Phytonomus punctatus* Fab.)

The adult is a stout, oval, hard-bodied beetle, about one-third inch long, with a long, thick snout; brownish in color, with several narrow gray lines above and broad gray stripes on each side; twenty rows of small deep punctures on the wing covers. (Fig. 339.) The larvæ are footless, at first light yellowish-green, but becoming deeper green as they grow older, head brown; feed at night upon the leaves, eating out irregular patches from the edges of the leaves; hardly noticeable in the day, when they lie protected around the base of the plant lying curled up head to tail. (Fig. 340.)

*History and Distribution.*

This insect is a native of Europe; first made its appearance in Western New York in 1881. Since then it has spread eastward and southward until it is now distributed in many of the states east of the Rocky Mountains. During the year of 1914 it was found injuring alfalfa in eastern and south central Kansas.

*Habits and Life History.*

The larvæ, which hatch from eggs that are laid in the early winter on the stems near the base of the plants, feed on the leaves and become partially grown before winter, when they hibernate in rubbish or just beneath the soil. They come out in the spring and continue to feed on the leaves until about June. When full grown they go just under the surface of the soil and make an earthen cell in which they pupate. (Fig. 341.) The cells are lined with coarse brown threads. They remain in the pupal stage about three weeks. In July the beetles emerge, and for several weeks feed on the leaves, doing equally as much damage as the larvæ. By early fall the females are ready to lay their eggs.



FIG. 339. Clover leaf-weevil (*Phytonomus punctatus*). Adult beetle; nearly six times natural size. (After Folsom.)

*Methods of Control.*

NATURAL ENEMIES. That this insect does not become a more serious pest is probably due to the fact that large numbers of the larvæ are destroyed by a fungous disease. When affected by this disease the

larvæ climb to the top of the plant, curl tightly around the top of a blade of grass or a leaf, and soon die. They are first covered with a white mold, but later turn to a jelly-like mass. The larvæ are also destroyed by birds and barnyard fowls.



FIG. 340. Larva of the clover leaf-weevil, greatly enlarged. (After Folsom.)



FIG. 341. Pupa of the clover leaf-weevil; greatly enlarged. (After Folsom.)

**REMEDIAL MEASURES.** Infestations of this insect have almost always been suppressed by the fungous disease, and thus repeated injury has been so rare that no means of artificial control has been necessary. If the larvæ are injuring the alfalfa, the use of the brush drag, as recommended for killing the larvæ of the alfalfa weevil, would be an excellent means of destroying the larvæ of the clover leaf-weevil. If a field has been infested, and damage is anticipated for the next season, the wintering larvæ (just below the surface of the soil, or in rubbish, should be disturbed by disking or by using the alfalfa renovator, cultivator or spiked-tooth harrow. This should be done late in the fall and early in the spring before the larvæ come out of their wintering quarters. Disking or cultivating again after the larvæ have entered the ground to pupate would probably destroy many of the pupæ, not only by crushing but also by exposing them to various foes.

#### MOUND-BUILDING PRAIRIE ANT.

(*Pogonomyrmex occidentalis* Cresson.)

Large, red ants, constructing gravel-covered mounds, each surrounded by its bare circular area.

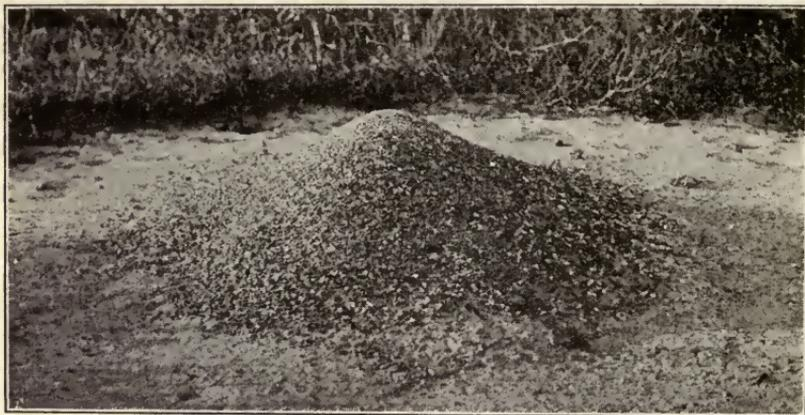

FIG. 342. External view of a nest of the mound-building prairie ant (*Pogonomyrmex occidentalis*). (Original.)

#### *Distribution.*

This ant is found throughout Kansas west of a line running across the state through Belleville, in Republic county, and Oxford, in Sumner county. The mounds are small and scarce in the eastern border, but become larger and more plentiful westward.

#### *Habits and Life History.*

The ants clear away the vegetation from a small area and construct their mounds near its center. (Fig. 342.) They excavate an extensive series of chambers and connecting galleries that reach far down into the earth, in many cases ten or more feet. Above the excavations they pile the mined soil, cementing it together to form a mound ranging from a few inches to two feet in height, itself honeycombed with chambers and passageways. A layer from one-half to one inch in thickness over the top of the mound is composed of coarse particles. The sides of the mound thus constructed are pierced by from one to three or more funnelshaped openings.

The entire colony, consisting of a limited number of males and fertile females (queens) and, in large nests, of an immense number of workers (sterile females), lives and reproduces within these ever-dark chambers and galleries. During summer, when the weather is clear, the workers go into the field between eight and nine o'clock in the morning. They return to the nest about noon and remain there until the hottest part of the day is past, then come forth and work until evening. On cloudy days they do not return at noon. Just before sundown a small force of workers collects little pebbles and other coarse particles like those of which the gravelly roofing is composed, and stop up the openings so carefully that one must look a long time to discover their location. On the approach of a storm a large force is employed and the gateways are closed in haste, but when it has passed they are reopened and the ants return to their work.

The ant colonies are too few seriously to decrease the yield, although occasionally they will destroy the alfalfa on from one to two per cent of the total area of a badly infested field. Their claim to rank as alfalfa pests lies principally in the increased difficulty of harvesting the crop when they are present.

*Methods of Control.*

Extended experiments have shown that the ants can most easily and efficiently be controlled by fumigating the nest with carbon bisulphide, as follows: Set fumigation only when gateways are open. Invert a galvanized-iron vessel, such as a common washtub, over one or more of the openings, covering as much of the mound as possible; firmly pack soil over such holes as the tub will not reach. Introduce under the tub and near the holes a shallow dish containing from one to three ounces (depending on the size of the nest) of carbon bisulphide. Set the tub down and quickly pack soil about the rim, making it as nearly air-tight as possible; allow to stand for five hours. The forming vapor, being heavier than air, sinks downward and comes to fill every chamber and gallery, destroying all the occupants.

**CAUTION.** It must be remembered that carbon bisulphide is as explosive as gasoline and must be used with equal care.

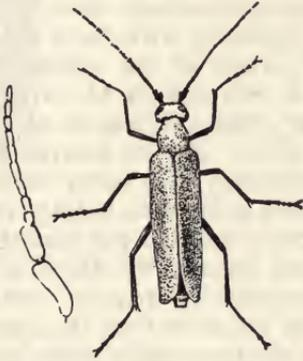

FIG. 343. Ash-gray blister-beetle (*Macrobasis unicolor*). Female beetle; nearly twice natural size. (After Chittenden, U. S. Dept. Agr.)



FIG. 344. Three-lined blister-beetle (*Epicauta lemniscata*); about twice natural size. (After Headlee, Kan. Exp. Sta.)

**BLISTER-BEETLES.**

(Meloidæ.)

Ash-gray, black, yellowish, or black and yellow striped beetles with long legs and elongated bodies, that sometimes suddenly appear in alfalfa fields and quickly destroy the foliage. (Figs. 343 and 344.)

*Habits and Life History.*

Several species of blister-beetles are common in central and western Kansas, and sometimes very destructive to alfalfa. Some of these have sort of a migratory habit; that is, they suddenly come in large numbers in a field, ruin a part or all of the crop in a few days, when they go

elsewhere or disappear, and may be seen no more until the following year. However, after the departure of one species, a second and even a third may come during the season.

The life history of the blister-beetles is not only peculiar but also complicated. The adult female beetle lays a large number of eggs in a small cavity in the ground, and in about ten days there hatches from the eggs small, long-legged larvæ, which run about searching for the pods of grasshopper eggs, upon which they feed. During the summer the larvæ pass through several rather distinct forms, hibernate in the ground during the winter, appear again as larvæ the next spring, pupate later, and transform to adult beetles in the summer.

#### Methods of Control.

There is no question but that the larvæ of the blister-beetle destroy large numbers of grasshopper eggs and thus aid in keeping these insects under control. However, in many cases the alfalfa grower finds that the benefits derived are more than counterbalanced by the losses caused by the beetles, and thus measures must be used to destroy them.

Inasmuch as blister-beetles usually make their attack on alfalfa during the latter part of July and through August, and since they usually move in from some adjoining field or appear in some local place in the field, a close watch should be kept, and just as soon as they appear methods of control should be put into operation. Spraying with Paris green is one of the best remedies. The infested portion of the alfalfa should be thoroughly sprayed, using from one to two pounds of Paris green to fifty gallons of water. In using Paris green two pounds of stone-lime should be used to every pound of Paris green. Alfalfa sprayed with Paris green should not be used for hay. However, it is better to sacrifice a portion of the crop by spraying with Paris green than to leave the beetles to continue their ravages and thus destroy a much larger part of the crop. Since the poisoned beetles are sometimes replaced by others, it is necessary on such occasions to repeat the applications of spray. Inasmuch as the beetles are wild, and when disturbed will drop from the plants to the ground and run rapidly, seeking some sheltered place under which they

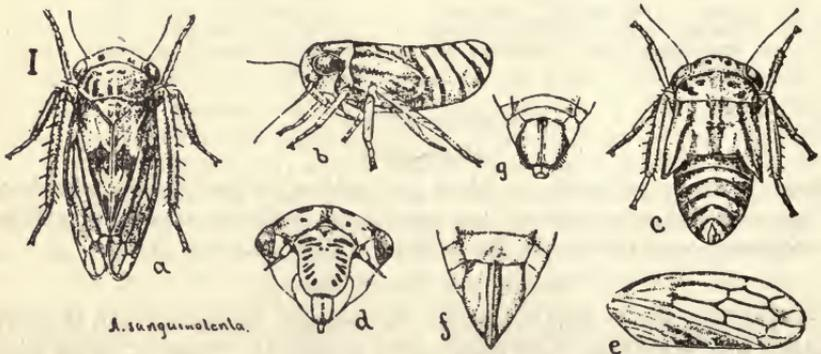

FIG. 345. Clover leaf-hopper (*Agallia sanguinolenta*). a, adult; b, nymph, side view; c, nymph, dorsal view; d, face; e, front wing. All much enlarged. (After Osborn and Ball.)

may crawl, a line of men and children may go into the field and slowly drive the beetles ahead of them with branches. Before doing this, windrows of hay, straw or other dry vegetable material should be prepared or placed along the side of the field. When the beetles have run in under or have taken refuge in the windrows, it is fired and the beetles burned. This method has been used with success in the West and Southwest. The important thing in the successful control of blister-beetles is to apply whatever remedy is used just as soon as the beetles are discovered.

## LEAF-HOPPERS.

## (Jassidæ.)

Small, green, gray or yellowish insects that, when disturbed, hop and fly swiftly about among the plants. They suck the sap from the leaves and tender shoots, causing the leaves to turn yellow.

While there are several species of leaf-hoppers attacking alfalfa, probably the most injurious and the most widely distributed one in the alfalfa districts is the clover leaf-hopper (*Agallia sanguinolenta*). (Fig. 345.) Another one that is also fairly common in the alfalfa fields is the apple leaf-hopper (*Empoasca mali*). In several districts species of the genus *Deltoccephalus* are rather common. (Fig. 346.)

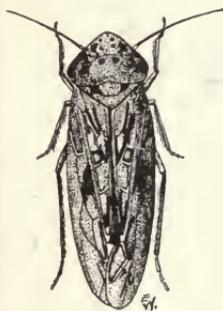

FIG. 346. Leaf-hopper (*Deltoccephalus*); 8 times natural size. (After Headlee, Kan. Exp. Sta.)

*Habits and Life History.*

The leaf-hoppers can usually be distinguished from other insects in the alfalfa field by their habit, when disturbed, of hopping, jumping and flying swiftly about. When abundant, swarms of them will jump up as one walks through the field. So far as has been determined, the species affecting alfalfa lay their eggs in the leaves or stems of the leaves. In some cases the eggs are pushed into the margin of the leaf or the stem, and thus are protected by the thin covering of the leaf. The eggs hatch in a few days, except in the case of hibernating eggs, and the young forms, instead of consuming the stems and foliage, thrust their heads into the leaves and tender shoots and suck the sap. The feeding punctures cause pale yellowish spots, and if very numerous give the foliage a distinctly yellowish or bleached appearance. With most of our species there are probably two generations in a single season. The leaf-hoppers winter mostly as adults, in rubbish. In some cases the winter is passed in the egg stage.

*Methods of Control.*

Owing to the habit of the adults hibernating during the winter, the fall, winter or early spring burning of dead leaves and rubbish around the edges of the field, along ravines and bordering on orchards and woodlands, is undoubtedly one of the most effective means of destroying them. Where they occur in destructive numbers the spraying of alfalfa fields with a nicotine sulphate or kerosene emulsion spray directly after cutting the crop would kill large numbers of them. It is claimed by some that the most efficient method of destroying them lies in the use of

a hopperdozer of a special type. One style consists of a strip of sheet iron coated with coal tar. The apparatus is drawn over the field after the crop has been cut, and the insects, hopping at its approach, fall upon the surface coated with tar, and thus many are killed.

THE ALFALFA-SEED OR CLOVER-SEED CHALCIS-FLY.

(*Bruchophagus funebris* How.)

The adult is a small, four-winged, wasp-like insect, compact in form, less than one-tenth of an inch long, black in color. (Fig. 347.) The larva is a tiny grub that lives in the ripening seeds of alfalfa or clover.



FIG. 347. Clover-seed chalcis-fly (*Bruchophagus funebris*). Adult; 15 times natural size. (After Headlee, Kan. Exp. Sta.)

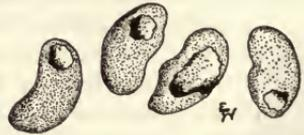

FIG. 348. Work of the clover-seed chalcis-fly in alfalfa seed. (After Headlee, Kan. Exp. Sta.)

*Distribution.*

This insect, a native of the Old World, probably occurs over the entire United States wherever its food plants are grown. It formerly devoted its attention to clover seed, but of recent years has proved very serious on alfalfa seed, and is causing a large annual loss.

*Habits and Life History.*

The chalcis-fly hibernates or passes the winter as a full-grown larva within alfalfa seeds, on the ground, in neglected fields and along fence lines and ditch banks. Many of them are also found in the alfalfa seed pods left in the field in removing the crop, and in the screenings around alfalfa straw stacks. The adults emerge in the latter part of spring or in early summer, and the females deposit or insert their eggs in the young seed at the time it is in a semifluid state, and the tiny grub, as it develops, consumes the contents of the seed. (Fig. 348.) It undergoes its pupal transformations within the seed and emerges as an adult through a little opening in the seed shell. The second generation of adults appear about the middle of August and lay their eggs in the second or third growth. Some adults from these appear the same season, and the rest not until the following year. There are at least two generations a year, and probably a third.

*Methods of Control.*

Inasmuch as the larvæ of the chalcis-fly are able to pass completely through the first generation in the earliest-maturing pods, and since the early pods have an especially large percentage of the seeds infested, every effort should be made to cut the alfalfa and get it in the barns or stacks before the larvæ mature. The early-maturing pods developing on plants in waste places, along ditch banks and fence lines, are a source of danger and should be cut or destroyed. If these methods of control are practiced it will greatly lessen the numbers of the second generation and thus protect the main seed crop.

The screenings which are left after the alfalfa is threshed often contain large numbers of infested seeds, and unless the screenings are burned or piled up so as to decay, the adult chalcis-flies will emerge from them the following spring.

## THE CLOVER-HAY WORM.

(*Hypsopygia costalis* Fab.)

Dirty-white to brownish worms, with head more or less reddish, when fully grown measuring about three-fourths of an inch in length, matting and injuring alfalfa hay in stack and mow, giving the hay a moldy appearance.

The clover-hay worm has become quite abundant over Kansas wherever alfalfa and clover are grown. This worm attacks alfalfa, clover and timothy hay, both in the mow and the stack, cutting the leaves into chaffy pieces and webbing the mass together by an abundance of silken threads, which it is the habit of the worm to spin at all times. Hay so infested looks moldy and matted, and the abundance of silken threads mingled with the excrement of the worms renders the hay distasteful and even unfit for stock.

*History and Distribution.*

It is generally supposed that this insect is a native of Europe and early became introduced into this country. It now occurs over Europe, southern Canada, and the greater part of the United States. With the extensive growing of alfalfa it has become a serious pest throughout the alfalfa- and clover-growing states.

*Habits and Life History.*

The worms are usually noticed toward the bottom of the stack. However, in hay kept over the second year, they may be all through the stack. The "worms" when young are of a dirty-white color, but as they grow older they become brown, with the head more or less reddish, and when mature measure about three-fourths of an inch in length. The larvæ are very active and wriggle forward or backward with equal ease. They spin silken webs in the hay, and frequently suspend themselves by a thread when moving about. The worms work in the hay all through the fall, winter and the early part of spring. The pupal stage is passed in a thin silken cocoon, spun in some protected nook or near where the larval life is passed. The adult moth, which appears from the middle of May on through June and early July, is a little insect with wings spreading

about four-fifths of an inch. (Fig. 349.) The color is lilac brown, with two bands of lighter shade, each starting from a yellow spot on the front of the wing. The females deposit their eggs directly upon the hay in the stack or mow, and probably upon the hay in the windrow. The worms of the second brood appear in July and August, and the moths of this brood emerge in August, and the larvæ produced by this brood are those which remain in the stack through the winter.

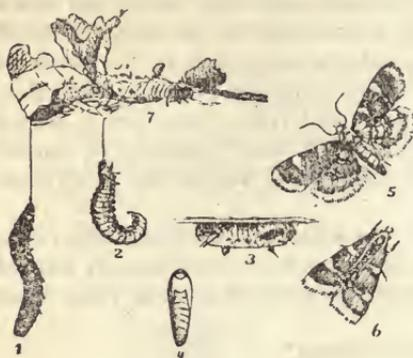

FIG. 349. Clover-hay worm (*Hypsopygia costalis*). 1, 2, larvæ suspended by thread; 3, cocoon; 4, pupa removed from cocoon; 5, 6, adult moth; 7, larva covered by silken thread. All natural size. (After Riley, 6th Mo. Rep.)

This insect is always more abundant where old hay remains over summer in stack bottoms rebuilt in the same places year after year of the waste hay remaining over. The moths may often be seen resting on the walls and timbers within barns where alfalfa or clover hay has been stored. The abundance of the moths in such places should warn the owner to clean out the mow thoroughly before storing the new crop.

#### Methods of Control.

Never stack alfalfa, clover or timothy hay on old bottoms and tops left over in the stacking places. Burn all of the old bottoms and tops. Clean out the mow thoroughly before storing the new crop. Never put new hay on the top of old, whether in the stack or the mow. (See "Insects," in index.)

Alfalfa uses to advantage more water than any other crop.

It will live and grow with less water in the soil than any common crop.

Its roots penetrate effectively to a depth of fifteen feet or more, and may draw water through ten or more feet of dry soil.

An alfalfa field contains less moisture in the first ten feet of soil than any other field.—*W. P. Snyder, in the Nebraska Farmer.*

Where hay sheds are not used, stack covers often pay big dividends. Ordinary unbleached muslin may be used to make stack covers. The covers used by one grower are fifteen feet square, and are held to the stacks by means of concrete blocks. A small rope is sewed into the cover every five feet, making three to a side. Concrete blocks are then tied on, and the covers never blow off. As soon as the hay in the stack is moved the cover is dried and stored in a dry place for future use. Covers which he has used for three years are still in good shape. Of course the covers may be made to fit any style of stack.—*Wallace's Farmer.*

## BEES AND THEIR RELATION TO ALFALFA.

By S. J. HUNTER, Entomologist, University of Kansas.

Every alfalfa grower should be a beekeeper. In industry, productivity, adaptability and utility the honeybee is second to none. The alfalfa grower who is likewise a beekeeper receives two-fold return from his alfalfa crop. He will, therefore, do well to take advantage of the usefulness of this remarkable little co-worker.



FIG. 350. A honey bee in the act of gathering nectar, and at the same time cross-fertilizing the alfalfa blossom.

In the case of the alfalfa blossom, a study of its structure shows, both from its shape and size, that it is not probable that cross-fertilization could be safely depended upon by means of currents of air. It becomes evident, then, that outside agencies must be called upon, and the plant must provide for these agencies. The agents in this case we find to be insects, and the reward offered by the plant for favors rendered is a sweet drop of nectar; that is, the flower in an enticing way places a tempting sip of nectar in such a position that when the insect has favored the flower with a few grains of pollen unconsciously brought from an adjoining flower, and just as unconsciously left, the coveted sip may be enjoyed.

### INFLUENCE OF BEES UPON THE SEED CROP.

The process of fertilization in a typical flower is not complex. The stamens have long filaments which bear the pollen-producing anthers high above the ovary. When the pollen is ripe it falls naturally upon the stigma of the ovary, and fertilization of the seed is soon accomplished.

The writer conducted a number of experiments upon the fertilization of the alfalfa blossom. The first work consisted in covering a large number of blossoms with fine cheesecloth. It soon became evident that this would exclude all insects, and the good services of the bee would not be demonstrated, so that this line was discontinued and another taken up.

### BEES INCREASE THE SEED CROP.

A large number of representative ripened pods were gathered from an alfalfa field less than one-half mile away from a large apiary, and a like number from another field of much the same soil and practically under

like conditions as the first field, except that the second field was situated twenty-five miles away from a colony of bees. No bees were observed in the field, and the character of the surroundings, there being no timber or probable living places, were such as to preclude the possibility of wild bees in the vicinity. The pods from each locality were carefully opened and the number of seeds in each counted. The results and comparison to be made therefrom are certainly of interest.

In seeds taken a half mile from bees, 87 pods being examined, there was found to be an average number of  $5.58 +$  seeds in a pod. The seeds were plump, the pods numerous in cluster and having several spirals.

In seeds taken twenty-five miles from bees, 80 pods being examined, there was found to be an average number of 3.35 seeds in a pod. The seeds in at least one-third of the pods were small and shriveled, the pods few in a cluster, short, and with but few spirals.

This shows a per cent of increase of the first field over the second of 66%.

#### ALFALFA AS A HONEY PLANT.

My observations upon this subject during the season in which this work was carried on have been that it will yield the greatest amount of nectar under circumstances which tend to give the plant the most vigorous growth; that is, proper amount of heat and moisture, upon suitable soil. If the plant is upon upland, dry weather will affect the secretion of nectar before it will be affected in a valley, such as the Arkansas valley, where the roots of the plants extend to the water. In September the bees were busy in the alfalfa in the Arkansas valley, while on the higher ground of one of the counties on the eastern border I visited a beautiful piece of alfalfa near an apiary, but no bees were found. They were at that time flying over the alfalfa to the knotweeds beyond. A strong point in favor of this plant, as shown by Muller, is that it continues to secrete nectar as long as the blossom flourishes. A greater part of the alfalfa produced in this state is cultivated for forage, and, since for this purpose it is not often cut while in full bloom, the honey crop is materially less than it would be if alfalfa were allowed to mature. During a dry period bees will fly over alfalfa fields in bloom to a field which has been irrigated a few days previously and has begun to bloom.

The bees gather the nectar from the blossoms, and at the same time insure the formation of seed where the blossom was. The results noted show that seed crops upon which bees worked were two-thirds greater than the crops taken from alfalfa dependent upon other insects for pollination.

Many flowers cease to secrete nectar after being pollinated. Alfalfa continues to secrete nectar until the blossom begins to wither. The only objection found with alfalfa is the not infrequent removal of the plant for hay during the blooming stage. It is no unusual thing, however, to find within range of the apiary several thousand acres of alfalfa. Here the second crop is in bloom before the first is all in the swath, and this continual blossoming places the coveted nectar before the bee from the 15th of June until the middle of October.

The pecuniary value of the honey itself should not be overlooked. In an alfalfa region 100 pounds of comb honey often is yielded by a single hive in one season. The authentic daily record from the Colorado State Beekeepers' Association of one hive of bees shows 182 pounds.

Alfalfa honey always finds a ready market. Regarding the quality, Chesire defines ideal honey as: "An ideal sample would have a delicate but characteristic aroma, a rich flavor, leaving a distinct impression on the back of the palate, and would be of a straw or pale amber color. It should possess perfect clearness, and, as distinct from clearness, brightness due to a high refractive index, with density almost amounting to toughness, so that the air beneath the cork should rise very slowly through the mass upon the inversion of the bottle."

Of six samples submitted, a competent judge placed the alfalfa honey as the one most nearly approaching this standard.

The greatest enthusiasm manifested in apiculture is found in localities where large areas of alfalfa exist. For example, if you will refer to the tables of the Kansas State Board of Agriculture, published from time to time, you will note that the largest production of honey comes from those counties characterized by the largest acreage of alfalfa. (See "Bees," in index.)

---

## THE FEEDING CONSTITUENTS OF ALFALFA.

By C. O. SWANSON, Assistant Professor of Chemistry, Kansas State Agricultural College.

The feeding constituents which are usually determined in a feed are: water, ash, crude protein, crude fiber, nitrogen-free extract, and ether extract. Water is usually present in all feeds. Well-cured alfalfa will contain about 8 per cent water, or 160 pounds per ton. The amount of water in a feed depends on the treatment given the feed, the nature of the feed, and the condition of the atmosphere. The amount of water in a feed is of great economic importance. Alfalfa hay, field cured, having 25 per cent moisture, or 500 pounds per ton, has not the same value per ton as the same hay thoroughly cured, when the moisture content is 8 per cent, or 160 pounds per ton.

The ash is the mineral portion of the feed. It contains, with the exception of nitrogen, all of the materials which the plant obtains from the soil. The elements present in the ash figure largely, therefore, in all soil-fertility problems. The ash furnishes to the animal the elements necessary for building bones, and contributes to its general well-being. The two elements in the ash of greatest importance in nutrition are phosphorus and calcium. Alfalfa contains large amounts of these elements. Well-cured alfalfa cut in one-tenth bloom contains 0.23 per cent phosphorus and 1.50 per cent calcium, or 4.6 pounds of phosphorus and 30 pounds of calcium per ton. This phosphorus is equivalent to very nearly 32 pounds of bone phosphate.

Crude protein includes all of the nitrogenous matter in the plant. It furnishes material for growth and repair. It can also be used by the animal for the production of heat and energy. In the absence of a proper amount of protein growth does not take place. Alfalfa is classed with

the feeds particularly rich in protein. The comparatively large quantity of protein which alfalfa contains is its chief characteristic.

Crude fiber includes those compounds which make up the "framework" of the plant. These compounds are not worthless for feed, but they are tough, and to masticate and digest them requires a great amount of energy. The crude-fiber content of concentrates is low as compared with feeds classed as roughage. The crude-fiber content of alfalfa increases as the plant approaches maturity.

The ether extract includes the fats and oils, but not all of the ether extract is fat or oil. The ether extract of concentrates is nearly all fat or oil, while only a small portion of the ether extract of roughage is fat or oil. The ether extract of roughage is of very little importance from the feeder's standpoint.

All compounds not contained in the above constituents are included under the term "nitrogen-free extract." In concentrates the nitrogen-free extract is made up mostly of starch. In roughage the nitrogen-free extract contains large amounts of pentosans and other compounds that have a higher feeding value than crude fiber, but lower than starch. There are also small amounts of other compounds present, most of which should be considered as having about the same value as starch. Sugar is one of these.

In considering the percentage of constituents in any feed it is necessary to take into account the amount of water which the feed contains. Corn silage which contains 74 per cent of water can not be compared, pound for pound, in feeding value with corn silage which contains 68 per cent water. Suppose that alfalfa cut in one-tenth bloom were analyzed when green, when field cured, and when thoroughly cured in the barn. The green material would contain about 72 per cent of moisture, the field cured ready to stack about 26 per cent, and the thoroughly cured about 8 per cent. Having determined the constituents under any known moisture condition, it is a matter of calculation to get the percentage composition under any other known moisture condition. In comparing the composition of feeds it is customary to calculate either to a uniform moisture basis or to the basis of no moisture. The variations in the percentage of constituents of alfalfa under different moisture conditions are shown by the following figures:

TABLE No. 33.—Percentage of constituents of alfalfa under different moisture conditions.

	Moisture.	Ash.	Crude protein.	Crude fiber.	Nitrogen-free extract.	Ether extract.
Completely dry.....	0.00	9.53	17.79	27.13	42.59	3.18
Barn cured.....	8.00	8.77	16.37	24.96	39.17	2.93
Field cured.....	26.00	7.05	13.16	19.39	31.52	2.35
Green.....	72.00	2.67	4.98	7.34	11.93	0.89

It can easily be seen that the lower the per cent of water the higher the per cent of all the other constituents. The same fact can be brought out more forcibly by calculating the pounds of constituents in a ton, under the above moisture percentages. The less water in the alfalfa the more pounds of other constituents.

TABLE No. 34. Pounds of constituents in a ton of alfalfa, with different moisture content.

PER CENT MOISTURE.	Water.	Ash.	Crude protein.	Crude fiber.	Nitrogen-free extract.	Ether extract.
0.00.....	0.00	190.6	355.8	542.6	851.8	63.6
8.00.....	160.00	175.0	327.4	499.2	783.6	58.6
26.00.....	520.00	141.0	263.2	401.6	630.4	47.0
72.00.....	1440.00	53.0	99.6	152.0	238.6	17.8

THE PERCENTAGE OF FEEDING CONSTITUENTS OF ALFALFA AS INFLUENCED BY STAGE OF MATURITY.

The percentage of the different constituents of alfalfa will also depend on the stage of maturity at which it is cut. In an experiment at the Experiment Station, alfalfa was cut in the bud stage, in one-tenth bloom, in full bloom, and at the time of seed formation. Samples of the green material were taken, and these were dried without any loss of leaves; therefore the percentage composition represents that of the entire plant. The results are all calculated to a uniform moisture basis of 10 per cent, and are strictly comparable.

TABLE No. 35. Feeding constituents of alfalfa cut at different stages of maturity.

STAGE OF MATURITY.	Ash.	Crude protein.	Crude fiber.	Nitrogen-free extract.	Ether extract.
Cut in bud.....	10.62	19.65	22.50	35.06	2.36
Cut in one-tenth bloom.....	9.59	18.38	23.58	35.42	2.93
Cut in full bloom.....	8.79	16.30	25.01	36.07	3.77
Cut in seed.....	7.53	14.98	26.52	37.36	3.34

The figures show that the percentages of crude fiber and nitrogen-free extract increase as the plant matures. Ether extract does not seem to show any uniform change. Other things being equal, the alfalfa cut early will contain more of the most valuable feeding constituent—protein—than the alfalfa which is cut late. Whether or not it is best to cut alfalfa at one-tenth bloom, or earlier, is another question, and is not discussed here. These figures simply show that the alfalfa cut in the earlier stages is more valuable as a feed rich in protein than alfalfa cut in later stages. This fact is emphasized if we calculate the pounds of constituents there would be in a ton of alfalfa cut at different stages of maturity.

TABLE No. 36. Pounds of feeding constituents in alfalfa cut at different stages of maturity.

STAGE OF MATURITY.	Ash.	Crude protein.	Crude fiber.	Nitrogen-free extract.	Ether extract.
Cut in bud.....	212.4	393.0	450.0	701.2	47.2
Cut in one-tenth bloom.....	191.8	367.6	471.6	708.4	58.6
Cut in full bloom.....	175.8	326.0	500.2	721.40	75.4
Cut in seed.....	150.6	299.6	530.4	747.2	66.8

The earlier alfalfa is cut the greater the total amount of ash and protein per ton, and the later the alfalfa is cut the greater the amount of crude fiber and nitrogen-free extract. There are 68 pounds more protein in a ton of alfalfa cut in one-tenth bloom than in a ton of alfalfa cut at the time of seed formation.

## COMPARATIVE VALUE OF LEAVES AND STEMS.

The leaves are the most valuable part of alfalfa and the stems are least valuable. The relative amount of leaves and stems in the alfalfa cut at different stages of maturity was determined by taking a handful of the alfalfa sample as soon as it was wilted and separating the leaves from the stems by stripping. As soon as thoroughly dry the relative weights were determined. The following figures show the averages from several determinations made on each stage of cutting:

TABLE No. 37. Relative per cent of leaves and stems cut at different stages.

STAGE OF MATURITY.	Relative per cent of leaves.	Relative per cent of stems.
Cut in bud.....	57.42	42.43
Cut in one-tenth bloom.....	56.40	43.61
Cut in full bloom.....	51.54	48.22
Cut in seed formation.....	43.50	56.51

Up to and beyond the time of full bloom the leaves make up more than half of the plant. It is probable that the alfalfa cut at the time of seed formation had lost a large part of the leaves before it was cut. The comparative amounts of constituents present in the leaves and stems are shown by the following figures:

TABLE No. 38. Percentage of feeding constituents in leaves and stems of alfalfa cut at different stages of maturity.

## LEAVES.

STAGE OF MATURITY.	Ash.	Crude protein.	Crude fiber.	Nitrogen-free extract.	Ether extract.
Cut in bud.....	10.78	26.17	13.64	36.01	3.27
Cut in one-tenth bloom.....	10.52	24.16	14.06	37.40	4.06
Cut in full bloom.....	9.10	22.10	13.66	39.32	5.72
Cut in seed.....	8.90	21.25	14.55	39.66	5.48

## STEMS.

Cut in bud.....	8.78	12.57	33.54	33.92	1.23
Cut in one-tenth bloom.....	7.97	10.63	35.12	32.97	1.33
Cut in full bloom.....	7.02	9.72	36.33	34.93	1.22
Cut in seed.....	7.12	10.22	36.41	34.86	1.39

The leaves contain a higher per cent of ash, nitrogen-free extract and ether extract than the stems. They also contain more than twice as much protein.

## CONSTITUENTS OF ALFALFA HAY AND ALFALFA MEAL.

Grinding alfalfa hay into meal does not change its chemical composition. A load of alfalfa hay was sampled before grinding, and then a sample was taken from the meal after grinding. These two samples were as near alike in composition as two samples usually are when both are taken from the same lot of hay or the same lot of meal.

TABLE No. 39. Feeding constituents in alfalfa hay, and alfalfa meal made from the same hay.

	Water.	Ash.	Protein.	Crude fiber.	Nitrogen-free extract.	Ether extract.
Alfalfa hay.....	10.28	8.54	15.47	32.71	31.40	1.61
Alfalfa meal.....	9.78	8.53	15.10	32.42	32.70	1.48

## THE FEEDING CONSTITUENTS IN CORN SILAGE, KAFIR SILAGE, AND SORGHUM SILAGE.

Silage is a feed that goes well with alfalfa. The average composition of a number of samples of corn silage, kafir silage and sorghum silage are given here. The first set of figures is calculated to a 10 per cent moisture basis in order to be more comparable with dry alfalfa hay. The second set is calculated to a 70 per cent moisture basis. This is the usual moisture content of silage. The protein content of alfalfa is more than twice that of silage, if they are compared on the same moisture basis. The ash and crude fiber are higher in alfalfa than in silage, while the nitrogen-free extract and ether extract are lower.

TABLE No. 40. Percentage composition of corn silage, kafir silage and sorghum silage.

## 10 PER CENT MOISTURE BASIS.

KIND OF SILAGE.	Ash.	Crude protein.	Crude fiber.	Nitrogen-free extract.	Ether extract.
Corn silage.....	5.27	7.73	20.39	52.73	3.87
Kafir silage.....	7.96	5.76	30.74	41.71	3.84
Sorghum silage.....	5.19	6.35	24.41	49.14	4.09

## 70 PER CENT MOISTURE BASIS.

Corn silage.....	1.76	2.58	6.80	17.58	1.16
Kafir silage.....	2.65	1.92	10.25	13.90	1.28
Sorghum silage.....	1.73	2.12	8.14	16.38	1.36

HOW DIFFERENT FOODS BALANCE

SHOWING THE EXCESS OR LACK OF PROTEIN

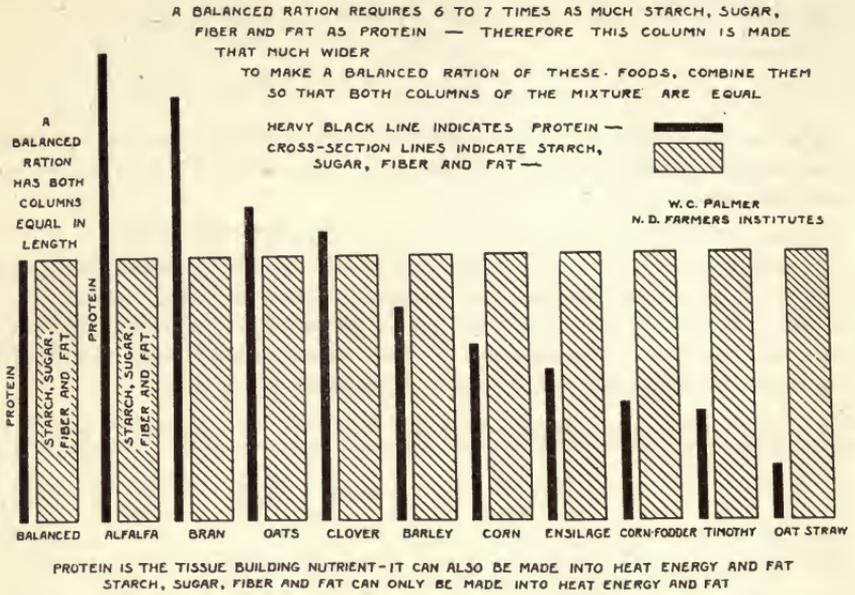

Fig. 351. A graphic illustration of alfalfa's place as a ration balancer. [Courtesy North Dakota Experiment Station.]

The chemical constituents in some of the feeding stuffs available to the Kansas farmer are given here for comparison with alfalfa.

Alfalfa has more protein than most of the concentrates except cottonseed meal. Some samples of alfalfa, notably that cut in the early stages, have more protein than wheat bran and wheat shorts. Ordinary alfalfa

TABLE No. 41. Percentage composition of some American feeding-stuffs.\*  
CONCENTRATES.

KIND.	Water.	Ash.	Crude protein.	Crude fiber.	Nitrogen-free extract.	Ether extract.
Corn.....	10.60	1.50	10.30	2.20	70.40	5.00
Wheat.....	10.50	1.80	11.90	1.80	71.90	2.10
Oats.....	10.40	3.20	11.40	10.80	59.40	4.80
Cottonseed meal.....	7.00	6.60	45.30	6.30	24.60	10.20
Wheat bran.....	11.90	5.80	15.40	9.00	53.90	4.00
Wheat shorts.....	11.20	4.40	16.90	6.20	56.20	5.10

ROUGHAGE.

Fodder corn.....	42.20	2.70	4.50	14.30	34.70	1.60
Corn stover.....	40.50	3.40	3.80	19.70	31.50	1.10
Hay from mixed grasses..	15.30	5.50	7.40	27.20	42.10	2.50
Prairie hay.....	7.77	7.85	5.34	29.89	46.93	2.21
Timothy.....	13.20	4.40	5.90	29.00	45.00	2.50
Red clover.....	15.30	6.20	12.30	24.80	38.10	3.30
Cow peas.....	10.50	8.90	14.20	21.20	42.60	2.60
Wheat straw.....	9.60	4.20	3.40	38.10	43.40	1.30
Oat straw.....	9.20	5.10	4.00	37.00	42.40	2.30

\*These figures, except for prairie hay, are taken from Henry's "Feeds and Feeding."

hay has about the same protein content as wheat bran and wheat shorts. Alfalfa has a higher protein content than the hay from red clover and cow peas. The high protein content of alfalfa makes it the best supplement to the low-protein-content roughage feeds, as well as to some of the concentrates, such as corn.

TABLE No. 42. Percentage composition of alfalfa cut at different stages of maturity. 10 per cent moisture basis.

CUT IN BUD.

CUTTING NUMBER.	Ash.	Crude protein.	Crude fiber.	Nitrogen-free extract.	Ether extract.
1.....	10.04	18.76	23.84	34.54	2.81
2.....	11.93	19.43	24.34	33.39	1.27
3.....	10.60	19.86	23.90	33.77	2.05
4.....	10.49	18.17	22.42	36.32	2.81
5.....	9.35	21.10	20.53	37.11	2.04
6.....	10.76	20.59	20.05	35.20	3.19
Average.....	10.53	19.65	22.50	35.06	2.36

CUT IN ONE-TENTH BLOOM.

1.....	9.14	17.17	25.79	33.18	4.69
2.....	9.70	17.90	25.93	34.71	1.67
3.....	10.20	16.86	24.13	35.73	3.28
4.....	8.77	20.05	20.57	38.68	1.74
5.....	10.12	20.41	21.49	34.77	3.25
Average.....	9.59	18.38	23.58	35.41	2.93

## CUT IN FULL BLOOM.

1.....	8.89	14.39	30.30	33.20	3.24
2.....	8.42	17.11	23.90	36.31	4.23
3.....	9.31	16.00	22.18	39.76	2.37
4.....	8.54	17.69	23.68	35.02	5.26
Average.....	8.79	16.30	25.01	36.07	3.77

## CUT IN SEED.

1.....	6.64	13.55	29.91	37.26	2.29
2.....	7.25	14.15	25.90	39.64	2.93
3.....	8.72	17.22	23.77	35.21	4.81
Average.....	7.54	14.97	26.53	37.37	3.34

## ALFALFA AS A FEED FOR BEEF CATTLE.

By W. A. COCHEL, Animal Husbandman, Kansas State Agricultural College.

The grain, hay and grass which occupies over 90 per cent of the land in Kansas are crops which are especially adaptable to the production of fat and energy, all of them being decidedly deficient in proteins and the kind of ash which is necessary for normal growth in meat-making an-

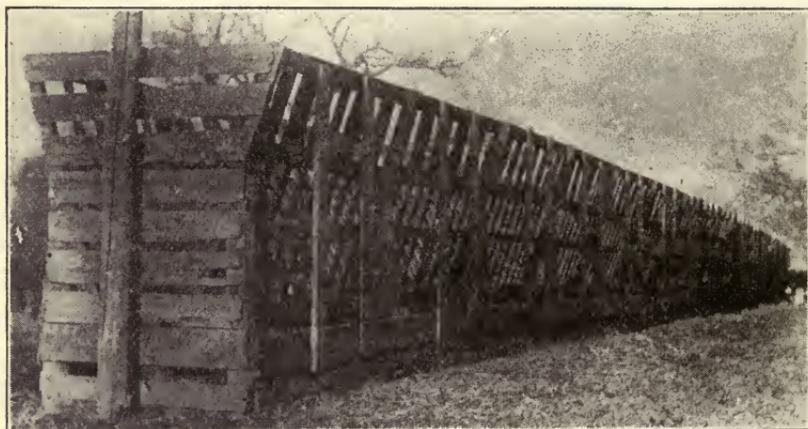

FIG. 352. A rack for feeding alfalfa hay to cattle, in use on the W. J. Tod ranch, Wabaunsee County.

imals. When animals are produced without legumes or other feeds that are native to or widely cultivated in the state, without the purchase of the by-products of mills and factories, they are slow to mature, undersized, fine in bone, and deficient in thick, heavy muscles which give extreme value to their carcasses. Under such methods of management they usually fail to increase in weight in winter, in many instances actually weigh less in the spring than in the fall. The result is that the first

month to six weeks in the spring they utilize in making up for their lack of progress in winter. Calves handled in this manner usually weigh from 400 to 500 pounds when weaned in the fall of the year; from 450 to 500 in the spring; gain 250 pounds their second summer; remain stationary the second winter; make 950 to 1000 pounds the third summer; going through this process, until finally, at the age of four years, they are ready for market at 1200 to 1300 pounds as native grass-fat cattle, or heavy feeders suitable for 60 to 90 days of corn feeding to get them ready for market.

Increased weights are sometimes secured by the use of heavy-boned, rugged bulls of the ton type; sometimes by the purchase of quantities of high-priced commercial feeds rich in protein, such as linseed meal or cottonseed cake; sometimes by preserving the rougher and coarser materials in succulent form in the silo. But the true stockman not only utilizes these methods, but considers them as secondary in importance to alfalfa, the king of all forage crops, which gives to cattle the size, the capacity, the condition of coat and skin which indicates thrift, bone and maximum growth at the least possible expenditure of cash and of food nutrients in the production of increase in live weight.

On soils and under climatic conditions where it can be successfully grown, alfalfa produces the greatest yield of protein per acre of any crop which the farmer or the scientist has yet discovered. In dry years it is the last to recognize a deficiency in moisture and the quickest to respond to the combination of rain and sunshine. In wet years it may be decidedly damaged in the curing process; yet when winter comes, even the moldy, black and dusty hay yet contains sufficient nourishment and a vestige of palatability which enables a stock cow or a stocker or feeder steer to amply supply all of their needs as measured by digestible nutrients. During the winter of 1915-'16 thousands of tons of such feeds were utilized by the farmers of the state in wintering beef cattle which would otherwise have had little value except as an addition to the supply of plant food in the form of decayed vegetation or manure. Its cash value would have been much less than the expenses incurred in getting it to market. Yet even at its worst, alfalfa is a desirable addition to the usual supply of roughage on the farm.

Although alfalfa is a boon to the live-stock farmer under adverse conditions, its real or true value is appreciated when the climatic conditions are such as to result in a maximum yield of hay of the very best quality. The animal husbandry department at the Agricultural College has found that one ton of good alfalfa will replace 307 pounds of cottonseed meal and 1½ tons of silage in wintering beef calves, having a commercial value at the present time of \$10.30, which would be decidedly increased when roughage is limited. An ideal method of producing cattle for the feed lot is to use alfalfa and silage, using an abundance of straw for bedding. With these feeds available an acre of alfalfa and an acre of silage will winter four mature breeding cows in excellent condition. The same acreage of crops will winter ten calves in such manner as to enable them to gain 150 pound each, replacing entirely all the purchased feeds from the system of farming. Fed in this manner, calves would

weigh 600 pounds at one year of age, gain 200 pounds on grass, 200 pounds as yearlings and 200 pounds the summer when they were two-year-olds, making them weigh 1200 pounds when approximately 30 months old, instead of at an age of 48 months when they are wintered without alfalfa. The result is that the use of alfalfa as a roughage during winter will eliminate from 12 to 18 months time in bringing a steer up to a weight of 1200 pounds, as compared with an attempt to develop him on other nonleguminous roughages which do not permit of an increase in live weight during winter.

When fattening cattle on corn and alfalfa hay, as compared with corn and prairie hay, or corn and timothy, the use of alfalfa results in more rapid gains, higher dressing percentages, higher selling value, and a carcass which is more acceptable because of better distribution of fat within the muscle and more even distribution of covering of the entire carcass. In the feed lot alfalfa furnishes a portion of the protein usually purchased in the form of linseed or cottonseed meal, thus reducing the expense of the ration without influencing the behavior of the cattle adversely.

There is considerable difference of opinion among the cattle feeders as to the comparative feeding value of alfalfa hay cut in different stages of growth and cured in such manner as to secure the various shades of color, such as pea-green, dark, and brown alfalfa. Undoubtedly the best grade of alfalfa hay for fattening cattle would be that which comes from the fourth cutting and is cured in such manner as to classify as pea-green alfalfa hay. This cutting is usually more palatable, has less fiber in it and carries a larger percentage of leaves than any other cutting. The second choice among the cattle feeders is for what is usually termed brown alfalfa. This grade comes from stacking the hay before it is thoroughly cured, with the result that it heats and turns brown in the stack. Apparently this method of curing softens the fiber and retains practically all the leaves that are on the hay. On account of its containing such a large percentage of moisture it is usually not profitable for cattlemen to purchase this hay by weight, but rather by measure. These two grades of hay should be very largely used for finishing cattle for market. The lower grades from the first, second and third cuttings can be used for the maintenance of breeding cattle or for roughing stockers and feeders through the winter.

During the past two years there has been a considerable quantity of alfalfa all over the state that has been badly damaged by rains at harvest. The result has been that the only method of securing a market for this hay was to purchase thin cattle and allow them access to all of the hay they will eat during the winter. While there are no experimental results which indicate the true value of this hay, yet the results secured under practical conditions indicate that the apparent damage is very much greater than the real damage to its feeding quality. During the winters of 1913-'14 and 1914-'15 the Hays Station used damaged alfalfa and kafir stover for wintering mature cattle with excellent results. Both of these feeds were in such condition that little or no commercial value could have been given to them in that section of the state.

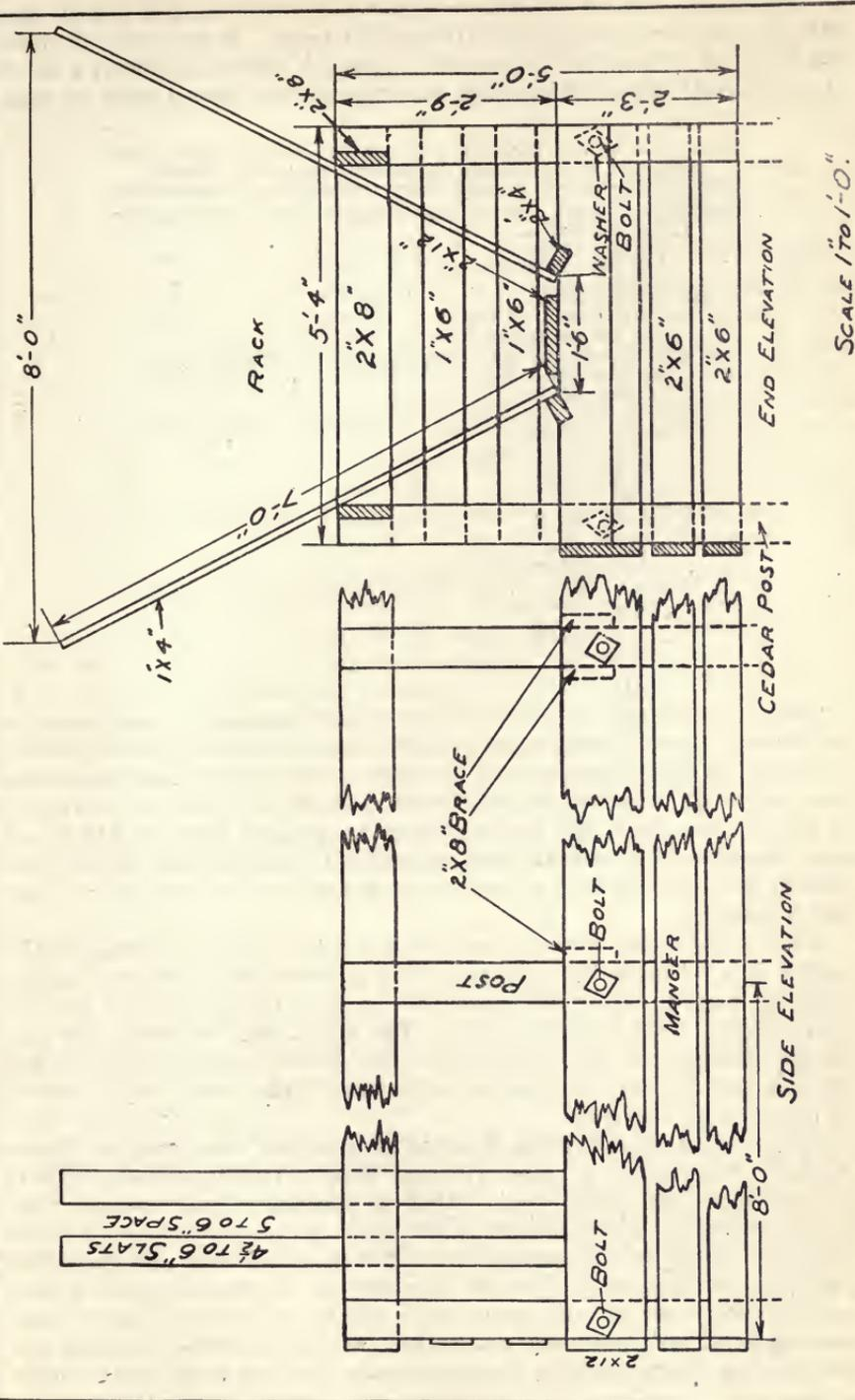

FIG. 353. A working plan of the W. J. Tod rack for feeding alfalfa hay to cattle.

For mature cattle a ration made up of corn or kafir, and alfalfa hay, will give excellent results for fattening purposes. When younger cattle are full fed it is necessary to add to such a ration a limited amount of commercial concentrates, such as cottonseed or linseed meal or cake.

TABLE NO. 43. Rations for beef animals, which include alfalfa. Suggested by the Kansas Agricultural Experiment Station.

---

FATTENING CATTLE (for each 1000 pounds of live weight, daily):	
I.	5 lbs. alfalfa.
	15 lbs. silage.
	2 lbs. cottonseed cake.
	16 lbs. corn.
II.	10 lbs. alfalfa.
	18 lbs. corn or kafir.
	2 lbs. cottonseed cake.
STOCKER CATTLE (for each 1000 pounds of live weight, daily):	
I.	15 lbs. alfalfa hay.
	15 lbs. silage.
BREEDING CATTLE (for each 1000 pounds of live weight, daily):	
I.	15 lbs. alfalfa.
	1 lb. linseed meal.
	10 lbs. silage.
	5 lbs. straw.
WINTERING CALVES (for each 500 pounds of live weight, daily):	
I.	5 lbs. alfalfa.
	10 lbs. silage.
	1 lb. cottonseed meal.
FATTENING CALVES (for each 500 pounds of live weight, daily):	
I.	4 lbs. alfalfa.
	8 lbs. silage.
	1 lb. linseed meal.
	7 lbs. corn or kafir.

---

During the winter of 1915-'16 the animal husbandry department of the Kansas State Agricultural College fed ninety head of experimental calves, all of which received alfalfa hay as a portion of their roughage. After allowing 60 cents per bushel for corn, \$1 per cwt. for kafir, and \$3 per ton for silage, the steers showed an average profit of \$12.50 per head through a six months' feeding period. It would have been impossible to have secured such results by the substitution of any other roughage for alfalfa.

Very satisfactory results have been secured from grinding alfalfa, mixing it with molasses, and using this mixture as a source of a considerable portion of the food nutrients for both fattening cattle and the maintenance of the breeding cattle. The advisability of using this particular combination will depend upon the relative cost of grinding and the comparative cost of molasses with other feeds which could be used as a substitute for same.

The main advantage which alfalfa has over any other crop in Kansas is that it will produce a larger yield per acre of roughage that is rich in protein than any other crop. That it maintains and increases the supply of humus and nitrogen in the soils of the state, both of which are fundamental in crop production. That it is palatable and nutritious, regardless of the season in which it is grown. That it serves as a most excellent supplement to the main crops which are produced in the state, such as corn, sorghums and prairie hay, and it furnishes not only protein for the development of young animals, but also is an ideal constit-

uent of the ration for breeding animals. There is no other crop that we grow, when properly used, that will produce as much growth in the same length of time as alfalfa supplemented with corn and other feeds that are rich in fat- and energy-making elements. (See "Beef Cattle," in index.)

## ALFALFA AS FEED FOR DAIRY CATTLE.

By O. E. REED, Professor of Dairy Husbandry, Kansas State Agricultural College.

Alfalfa is generally conceded to be the choicest of all roughage for dairy cows. This fact is due to the protein and mineral matter contained in the alfalfa plant. In many sections of the country, particularly in the irrigated sections, alfalfa is the sole feed for large herds of dairy cattle. It is fed green in summer and as dry roughage in winter. Mr. William Bigger, a dairyman near Topeka, and other farmers in Kansas, have followed this system with good results. The fact that alfalfa contains a high percentage of protein makes it an excellent foundation for the dairy ration. Protein is the most expensive feed element on the market, and when it can be grown on the farm in the form of alfalfa or other legumes the feed bill for dairy cattle is considerably reduced. When one is forced to buy protein he must purchase such feed as cottonseed meal, linseed meal, etc., and these feeds are the most concentrated feeds that we have on the market; hence we may conclude that the farmer who can grow alfalfa and other leguminous hay can produce milk and butter fat more economically than the farmer who lives in the country where such crops can not be grown. A number of experiments have been conducted relative to the feeding value of alfalfa. Alfalfa compares very closely to wheat bran.

TABLE No. 44. The digestible nutrients of 100 pounds of wheat bran and alfalfa.

	Protein.	Carbohydrates.	Fat.
Wheat bran.....	11.9	42.0	2.5
Alfalfa.....	10.5	40.5	0.9

Several attempts have been made to substitute alfalfa hay, or ground alfalfa, for bran. At the Vermont Experiment Station it has been found that on substituting ground alfalfa hay for the same weight of bran, that the cows decreased from 3 to 6 per cent in their milk flow. The Pennsylvania Experiment Station also found that the cows lost about 5 per cent when the alfalfa was substituted for wheat bran. These trials show that alfalfa is nearly as useful as the same amount of wheat bran. When the cost of the two feeds is considered, alfalfa furnishes digestible nutrients much cheaper than the bran. At the Illinois Experiment Station a trial was conducted with dairy cows to show the comparative feeding

value of timothy and alfalfa hay. The following table shows the results of this trial:

TABLE No. 45. Comparative feeding value of timothy and alfalfa to dairy cows.

	Hay fed.	Milk per cow, pounds.	Hay fed.	Milk per cow, pounds.
December 25 to February 18.....	Timothy.	1531.7	Alfalfa...	1475.1
February 25 to April 22.....	Alfalfa...	1667.7	Timothy.	1191.1
Increase on alfalfa.....		136.0		284.0
Total increase in each lot (9 cows).....		1224.0		2556.0

Increase in lot 1.....  $1224 \times \$1.60 = \$19.58$

Increase in lot 2.....  $2556 \times 1.60 = 40.89$

Total increase on alfalfa hay.....\$60.47

The value of the milk produced was figured at \$1.60 per hundred pounds, the average market price. Five tons of alfalfa were fed during the trial, and this amount of hay produced \$60.47 worth more milk than timothy hay, and we can conclude that alfalfa hay, according to this trial, is worth \$12.09 more per ton than timothy, when milk is selling at \$1.60 per hundred pounds.

Very few farmers realize the importance of good roughage in the dairy cow's ration. No other part of the feed plays so important a part as the roughage, and principally the hay, that an animal receives. In making up a ration for milk cows one should begin with the roughage and give them all they will clean up nicely. The kind and condition of the hay and other roughage fed will determine the amount and kind of grain to be fed. Where alfalfa hay is used as the roughage the principal grain used may be made largely of corn or kafir or similar grain. Alfalfa and corn make a good ration for the average milch cow. It contains the proper nutrients and is a balanced ration. Cows giving a large quantity of milk should have other grain.

Following are several good rations with alfalfa as the principal roughage. The amounts given in these rations are calculated as the daily amount used by a cow weighing about 1000 pounds and producing 25 pounds of 4 per cent milk:

TABLE No. 46. Rations for dairy cows, which include alfalfa, in pounds.

Alfalfa.....	12	Alfalfa.....	10
Silage.....	35	Dried-beet pulp.....	5
Corn chop.....	4	Corn chop.....	4
Bran.....	2	Gluten feed.....	1
Linseed meal.....	1		
Alfalfa.....	18	Alfalfa.....	18
Corn chop.....	4	Corn-and-cob meal.....	5
Bran.....	2	Cottonseed meal.....	2
Linseed meal.....	1		

The second, third and fourth crops of alfalfa hay are considered the best for dairy cattle. The popularity of alfalfa as a dairy feed is also emphasized by the fact that many mills grind the alfalfa and sell it in 100-pound bags, dairymen being the principal consumers of such feed.

## PASTURING ALFALFA.

Many farmers pasture alfalfa with their cows. Alfalfa is usually the first green crop in the spring and the last one in the fall, and many make use of this early and late pasturage. There is quite a risk attached to the grazing of cows on alfalfa, but where it is properly handled the losses are very slight. Cattle should not be turned on the alfalfa unless they have previously had access to some dry feed. If the cows are put on the pasture in an empty, hungry condition they gorge themselves with the hay, and usually bloat, and in some cases fatalities result.

## SOILING ALFALFA.

In communities where soiling is practiced it is found that alfalfa fits into the soiling system exceptionally well. It is one of the first crops to be fed in the spring and furnishes a more continuous supply all summer than any other soiling crop. (See "Dairy cattle," in index.)

---

**ALFALFA AS A FEED FOR SHEEP.**

By A. M. PATERSON, Assistant Animal Husbandman, Kansas State Agricultural College.

Less use has been made of alfalfa as a sheep feed than for any other class of live stock. However, experience and experiments have both shown that alfalfa is a very valuable sheep feed. It is imperative that alfalfa as a feed for sheep become more generally appreciated in Kansas.

When alfalfa is pastured great care should be taken to prevent bloat, which may cause serious loss. After alfalfa has become mature, or is mixed with other grasses, the danger is somewhat eliminated. However, care should be taken at all times. Before the sheep are turned on alfalfa pasture they should be fed a large amount of dry feed, such as hay or fodder, and turned out to graze when the alfalfa is free from dew or



FIG. 354. A rack for feeding alfalfa hay to sheep.—[Courtesy *Breeder's Gazette*.]

moisture of any kind. The sheep should be left on the alfalfa only a short time, and the length of time increased each day until the sheep become accustomed to the feed. Flock masters have found, as a rule, that it is never safe to give sheep free access to alfalfa pasture.

Alfalfa hay is adapted to the feeding of sheep because of the fact that it is a very cheap source of protein, and also supplies enough bulk to maintain the breeding flock satisfactorily during the winter months on alfalfa alone. However, best results are secured if some grain is fed with it.

The amount of alfalfa fed will depend upon the amount and price of the hay. When alfalfa is cheap and plentiful and other roughages scarce the sole ration for the flock could consist of alfalfa hay. On the other hand, when the hay is scarce and high-priced, the ration could be partially made up of straw, fodder and roughages of like nature. A comparison of alfalfa hay with other roughages for sheep-feeding pur-

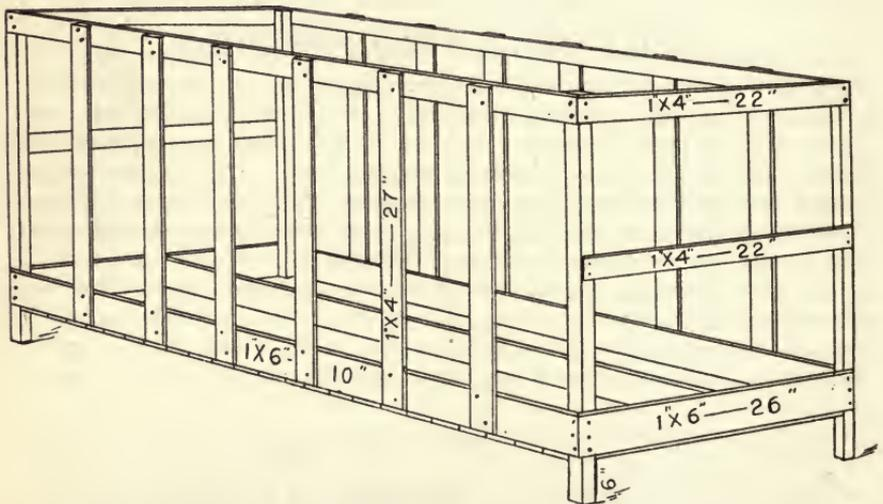

FIG. 355. Another rack for feeding alfalfa hay to sheep.—[Courtesy *Breeder's Gazette*.]

poses shows many advantages in favor of alfalfa hay, and this is especially true in Kansas, where alfalfa is grown so extensively.

In five trials, averaging 100 days, where alfalfa was compared with timothy and prairie hay in lamb-fattening experiments, the lots fed alfalfa hay made larger and cheaper gains and required less feed per 100 pounds gain than did the lots fed timothy and prairie hay.

The comparative value of alfalfa and clover hay as a roughage for sheep is a much-disputed point. However, tests have shown that there was a slight difference in favor of alfalfa hay. One test which was conducted for several years showed that the sheep fed clover made a little larger gains than those fed alfalfa, but the alfalfa lots showed a superior dressed carcass.

Experiments conducted at the Kansas Station to determine the relative value of alfalfa and cowpea hay gave the following results: The lambs fed alfalfa hay made more rapid and less expensive gains, showed the same finish and a much greater profit than did the lambs fed cowpea hay.

TABLE NO. 47. Rations for sheep, which include alfalfa. Suggested by the Kansas Agricultural Experiment Station.

---

FATTENING LAMBS, weighing from 50 to 85 pounds (daily):*	
I.	1.2 lbs. corn. .16 lbs. cottonseed meal. 1.5 lbs. alfalfa hay. 1.25 lbs. silage.
II.	1.5 lbs. kafir. .16 lbs. cottonseed meal. 1.5 lbs. alfalfa. 1.28 lbs. silage.
III.	1.2 lbs. corn or kafir. .16 lbs. cottonseed meal. 2.5 lbs. alfalfa.
BREEDING EWES (daily):†	
I.	$\frac{1}{4}$ lb. corn. $\frac{1}{4}$ lb. bran. 2 to 4 lbs. alfalfa. Some other cheap roughage.

---

Sheep, as well as other classes of live stock, show a decided preference for a certain kind of alfalfa hay. To secure best results hay for sheep must be fine and leafy. Ordinarily the last cutting of alfalfa is the best if it is cured and handled in such a manner that all the leaves are saved. (See "Sheep," in index.)

## ACUTE BLOATING OF THE RUMEN.

By R. R. DYKSTRA, Professor of Veterinary Medicine,  
Kansas State Agricultural College.

**SYNONYMS.** Gaseous indigestion, hoven, bloating of the paunch, tympanites.

**DEFINITION.** This is an abnormal condition occurring in cattle, sheep, and more rarely in goats. It consists in an unusually large accumulation of gas in the first stomach, or rumen, causing an excessive distention of that organ, and frequently associated with paralysis of its walls. The condition may be primary or it may be secondary, meaning that it is due to a disease of some other organ.

**CAUSE.** It is usually the result of eating very large quantities of easily fermenting feed, such as clover, alfalfa, vetches, peas, buckwheat, or it may also take place following the ingestion of other green feeds, such as leaves of cabbage, beets, young potatoes, etc. Such feeds are especially dangerous if they are at all wet with dew or frosted. Secondary bloating, which is almost always chronic in character, is frequently

---

\* These rations are based on the average amount of feed fed daily for a period of 80 to 100 days. However, if these rations are fed the lambs should be started slowly and gradually increased to full feed.

† The amount of grain and alfalfa hay for breeding ewes will depend upon the condition of the animals. When ewes come into winter quarters in good condition they can be wintered on roughage alone, consisting of alfalfa, corn stover, etc. Where a light grain ration is added the ewes will raise more and stronger lambs and clip a heavier fleece.

a symptom of tuberculosis. In this condition a lymph gland located just above the gullet becomes very much enlarged, and pressing upon the gullet prevents the normal belching of gas. This form of bloating can be positively diagnosed by applying the tuberculin test. Occasionally the condition is caused by a sudden change from dry feed to green feed or to feed that is unusually succulent.

**SYMPTOMS.** Usually these appear very suddenly. There is an increased rotundity of the abdomen and symptoms of uneasiness in the animal. The most characteristic symptom is the rapid increase in size of the left upper flank, which will protrude so greatly that its apex reaches the level or may often be higher than the back. The abdominal walls are very tense and can be pressed in only with difficulty, and at once protrude again after removal of the pressure. Striking the enlarged region with the hand produces a hollow, resonant sound. The animal no longer chews its cud, but stands with back arched and feet drawn together. In the early stages, kicking at the abdomen, stamping, and switching of the tail are observed.

As the distention of the paunch increases, the latter organ exerts increasing pressure against other organs in the chest cavity, such as the lungs and heart. This causes an interference with the normal heart action and with the breathing, so that the latter becomes labored, the animal moans and pants in pain, the nostrils are widely dilated, the mouth is held open, the tongue protrudes, and saliva dribbles out of the mouth. In a short time the lining membrane of the nostril, mouth, etc., assumes a bluish-red color, which indicates that suffocation is imminent.

The heart action is interfered with to a considerable extent, so that the pulse is rapid, gradually becoming uncountable and imperceptible. The animal soon exhibits symptoms of dizziness, the eyes become blood-shot, and finally the victim reels and staggers, and eventually falls insensible.

**CAUSE OF DEATH.** Death occurs as the result of suffocation, impaired heart action, or absorption of the poisonous gases contained in the paunch, or it may be due to a combination of these agents. If the body is opened immediately after death we may find that the paunch has been partially ruptured, and in some cases the diaphragm is ruptured. In some instances rupture of the heart has been recorded, and we always find all the lesions of suffocation, such as redness of the lungs, frothy fluid in the lungs, black, tarry blood, and redness under the peritoneum and pleura, or the membranes lining the abdominal cavity and chest. If the paunch is opened it may contain either a large amount of free gas, or the gas may be intimately mixed with the feed, so that the latter is of a frothy character.

**COURSE OF THE DISEASE.** If relief is not offered the animal may die in thirty minutes in those cases in which the formation of gas is very rapid. In other cases the development of gas is slower, there is frequent belching and some vomiting, and the animal frequently recovers without treatment.

**PREVENTION.** Animals should never be turned into a field of alfalfa, clover, etc., when the latter is wet with dew or frost. If animals have been accustomed to other feed than a succulent green feed they should gradually be accustomed to new feed by turning them out into the field for the first few days for from one-half to one hour periods, and they should be herded so as to detect the bloating at its onset. Doctor Schoenleber, of the Kansas State Agricultural College, recommends that the animals be filled up on dry feed before turned out to pasture. These precautions insure that only a small amount of the green feed will be consumed. It is a peculiar fact that when animals have been gradually accustomed to such feed they can consume large quantities of it, wet or dry, without apparent ill results. Animals should never be fed frozen turnips or other roots, but when these are the only source of feed supply the feed for each day may be defrosted by being stored inside for twenty-four hours or longer, and then fed sparingly.



FIG. 356. Proper position of the operator when opening the paunch to permit the escape of gas. The canula and trocar is passed into the rumen on the animal's left side in the center of the hollow of the upper flank or at a point equally distant from the last rib, the angle of the haunch and the backbone.

**CURATIVE TREATMENT.** This depends largely upon the rapidity with which the gas is forming in the paunch. In case the distention is so severe as to threaten suffocation the animal should immediately have the paunch opened from the outside. The instrument employed for this purpose is spoken of as a cattle trocar and canula. It may be purchased for about \$1 through any retail druggist. All cattle owners should have such an instrument constantly at hand. The instrument is passed into the rumen on the animal's left side in the center of the hollow of the upper flank, or at a point equally distant from the last rib, the angle of the haunch and the backbone. (See Fig. 356.) If

time permits, the operative area should be washed with soap and water and then rinsed off with a two per cent watery solution of carbolic acid, but this may be dispensed with in urgent cases. The operator should stand on the animal's right side, reach over the back, place the instrument in position, directing it downward and forward, or toward the point of the elbow of the right front limb, and with a sharp blow of the open hand, cause it to pass into the paunch. The trocar is removed, the canula or tube remaining in position until all the gas has been evacuated. The operator, by standing on the animal's right side, avoids the danger of being kicked by the left hind limb, which is always lifted.

Sometimes instead of gas issuing from the canula, a greenish, frothy substance oozes out of the wound, which indicates that the gas is intimately mixed with the food. In these cases the tube should be withdrawn and a large incision made into the paunch. The incision should be about three and one-half inches long, and should pass completely through the wall of the abdomen and paunch. As soon as this has been done the gaseous food will issue forth more or less forcibly. It is advisable to grasp the edges of the incision in the paunch and attach them to the edges of the incision through the wall of the abdomen by means of a strong needle and a piece of string, because otherwise as soon as the greatest distention has been relieved the paunch will fall away from the abdominal wall, after which food will pass from the paunch into the abdominal cavity, unless it is prevented by sewing the incision in the paunch to the incision in the abdominal wall. The string may be removed in a week or ten days, as permanent adhesions will have formed by this time. If the food is too coarse to escape through such an incision without assistance, then a long spoon or the operator's hand and arm may be introduced into the paunch, removing the food in this way. It is not advisable to remove all of the food, but to permit one-third of the contents of the paunch to remain, as otherwise an attack of fainting with a fatal termination will result. As much as five to eight pailfuls may frequently be removed. If an experienced operator is at hand, and the operation has been carefully performed, it is probably best to close the opening in the paunch and abdominal wall after sufficient feed has been removed, but when performed as an emergency measure by an inexperienced person it is probably best to leave the wound open, washing it daily with an antiseptic solution. The animal should be kept warmly blanketed for some time after the operation.

When cases of gaseous indigestion are detected in their beginning the formation of gas may frequently be stopped by administering a drench consisting of the following ingredients:

Turpentine .....	2 oz.
Raw linseed oil .....	1 pint.

If raw linseed oil is not at hand, six tablespoonfuls of turpentine may be mixed with a pint of milk. This medicine will not affect the gas which is already present, but will stop the fermentation, so that no more gas is formed. It is a good plan for owners of cattle to have this mixture constantly on hand, so that it may be used in cases of emergency. Mild

cases of this condition are sometimes treated by means of a rope passed over the head to hold a bit in the mouth. The bit is usually of wood and smeared with tar, lard, or similar substance. This makes the animal move its jaws and tongue vigorously, causing saliva to pass into the gullet, and these factors favor the belching of gas.

If the rumen has been opened the fermentation of gas may be stopped by administering an ounce of pure creolin directly into the paunch through the artificial opening. Sometimes, after all danger of a fatal termination is passed, the animal will have indigestion for some time afterwards, owing to the complete or partial paralysis of the walls of the rumen as a result of the great distention. This may be treated by administering the following mixture:

Powdered nux vomica .....	2 oz.
Powdered ginger root .....	2 oz.
Powdered gentian root .....	4 oz.
Powdered nitrate of potash .....	2 oz.

These ingredients are to be mixed and divided into eight powders, and the animal is to receive one powder every twelve hours in a little water, as a drench. Food should always be withheld from the animal for some time after an attack of bloating. (See "Bloat," in index.)

---

## ALFALFA AS A FEED FOR HOGS.

By RAY GATEWOOD, Assistant Animal Husbandman, Kansas State Agricultural College.

While alfalfa may be fed to some classes of hogs with a greater profit than to others, it may be rated as a desirable feed for all classes. It may be utilized in several different forms, either as pasture, hay, meal or silage.

Alfalfa is the best pasture crop that can be grown for hogs. Among the many advantages are that it comes early in the spring, remains late in the fall, and provides a nourishing, succulent feed throughout the summer. While it will not fatten a young growing pig when used alone, because of its bulk, it will develop a large frame and capacity for feed, which results in tremendous gains during a short finishing period. It furnishes adequate nutrients for dry brood sows and stock hogs, during favorable seasons, without the use of supplementary grain in any form. When hogs are fattened on corn alone in a dry lot, as compared with corn and alfalfa pasture, the differences are so great as to create doubt in the minds of those who have not watched the comparison very closely under controlled conditions.

The hay also makes a very desirable feed, especially during the winter when there is special need of some cheap feed for maintenance and growth. The last cutting is generally preferable, as it is not as coarse and stemmy as the earlier crops. It is best fed from racks, as in this way it is easily accessible to the hogs and may be eaten with but little waste.

The meal has not been brought into common use, as but few farms are equipped with special mills for grinding the hay, and it is hardly

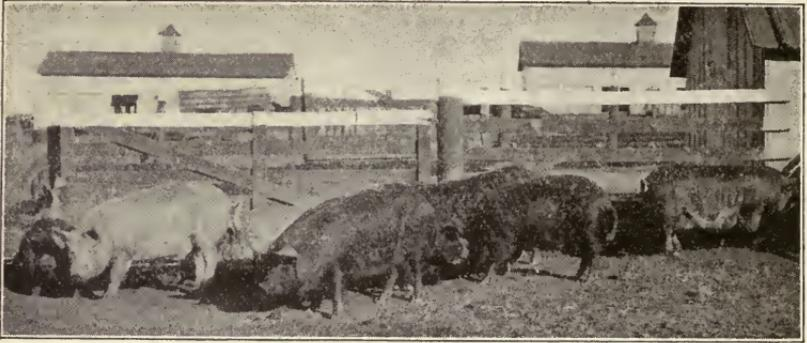

FIG. 357. Hogs fed corn alone.—[Courtesy Kansas Experiment Station.]

practical to buy it on the market when the price and quality are to be considered. The meal has no advantage over the hay unless a very coarse grade of hay is to be used, so that its general use is not to be recommended. It may find a use when growing hogs are to be run on a self-feeder. In this connection it should be finely ground and mixed with the grain ration. Feeding in this manner makes it possible to limit the amount of grain which can be consumed and thus prevent the hogs from becoming too fat.

Where alfalfa silage is available it may be fed to brood sows, but it has no advantages over the hay. In fact it has several disadvantages. It costs more per ton when figured on a dry basis, it is more difficult to handle, and is not as satisfactory to feed, especially during the cold weather, as it must be fresh if the hogs are to eat it to advantage. During the cold weather hogs will not leave their houses, and it becomes frozen and unpalatable. Small pigs pay but little attention to it, especially if hay is available.

Alfalfa should constitute one of the principal feeds for the maintenance of the breeding herd. Open mature sows, when allowed the run



FIG. 358. Hogs fed corn and alfalfa hay.—[Courtesy Kansas Experiment Station.]

of alfalfa pasture alone, have been found to gain in weight. Bred sows have also been carried over the summer on alfalfa pasture up until two or three weeks before farrowing and have produced good-sized litters of strong, healthy pigs. The season will have considerable influence on this, however. In dry seasons care should be taken that the pasture does not become too short. In wet seasons sows will not do so well, as the plants are of a washy nature, and they will not come through in as good condition as in drier seasons. Running sows on pasture has a particular advantage, in that the sows must take exercise in order to gain a livelihood.

The herd boar, too, should have the run of a small lot in which there is alfalfa, as it will tend toward keeping him in good physical condition, which is so important during the breeding season.

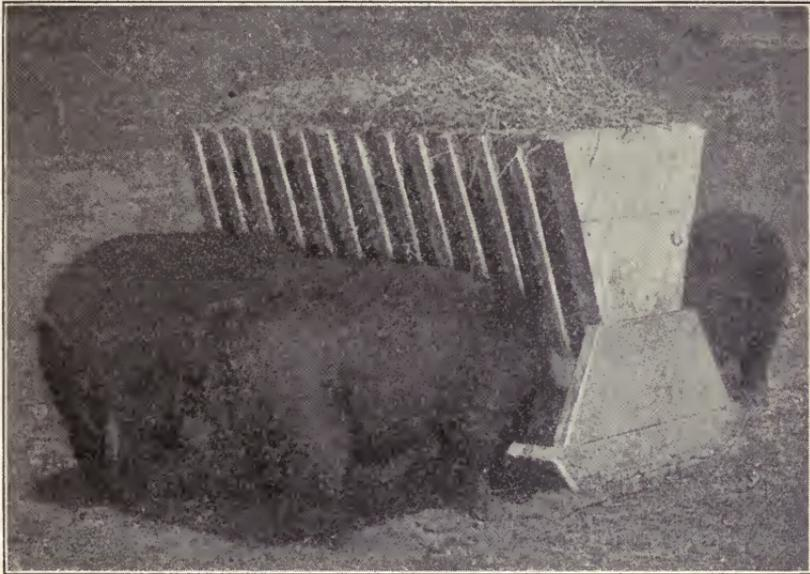

FIG. 359. A rack for feeding alfalfa hay to swine.  
[Courtesy Idaho Experiment Station.]

Sows suckling litters may have the run of an alfalfa pasture. This will give them opportunity to exercise, which will take the pigs out into the open away from the houses. The pigs will soon begin to eat at the green plants, and this will help to develop their digestive tract, which is important in their further development. The fresh green feed increases the milk flow of the mother, and will in that way hasten the growth of the pigs. Care should be taken when first turning the sows out, as they will overeat, and this is sure to cause digestive trouble in the pigs. When starting them it is well to begin by feeding a small amount of green alfalfa, and when turned out allow them to stay only for a short time until the pigs become accustomed to the change of feed.

For growing shoats alfalfa will produce more gain than any other pasture obtainable. Shoats on alfalfa alone will just about maintain their body weight. Grain which is given in addition is used very largely for increase in weight. The amount they should receive will depend upon whether they are to be used for breeding or market purposes, time of marketing, and the price of grain. If they are to be kept for the breeding herd the grain should be limited to a certain extent, allowing them enough to promote growth but not enough to become fat. Shoats weighing from 50 to 100 pounds will make better use of alfalfa than hogs of any other weight. With corn at 60 cents a bushel young hogs will make gains at a cost of \$2.50 to \$4 per hundred.

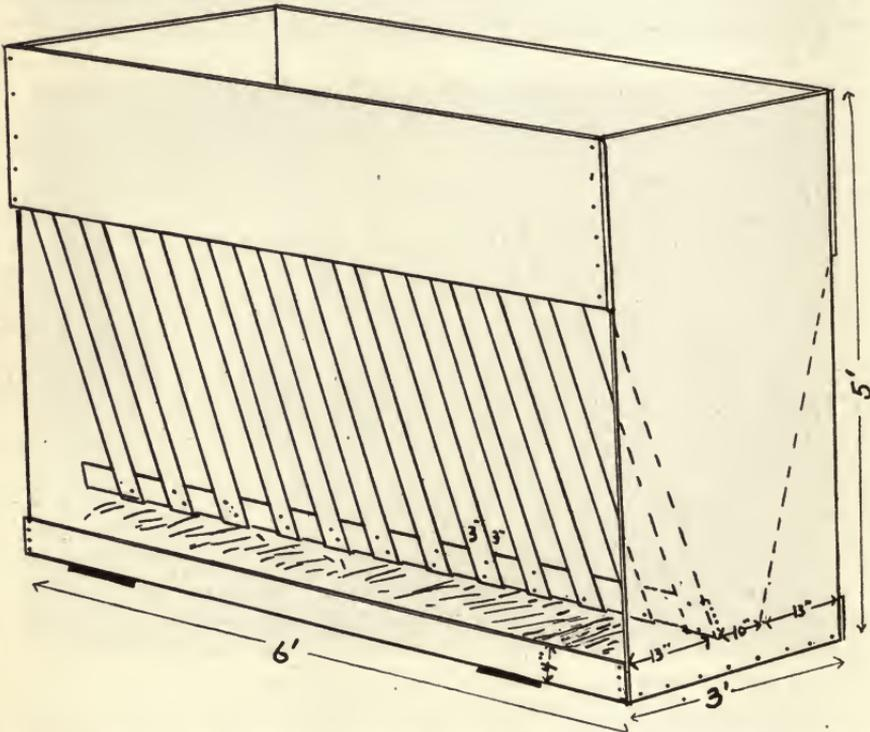

FIG. 360. The plan of a rack for feeding alfalfa hay to swine.—[Courtesy *Breeder's Gazette*.]

The Kansas Experiment Station has conducted an experiment in which pigs were full fed on ground corn, and on a mixture of ground corn (62 per cent), shorts (30 per cent), and tankage (8 per cent), in the dry lot, and on alfalfa pasture. The lot receiving ground corn in the dry lot made only one-third the gain made by the lot receiving ground corn on alfalfa pasture, and consumed twice as much grain to produce a pound of gain. Of the lots receiving the grain mixture, the lot fed in the dry lot made two-thirds as much gain as the lot fed on alfalfa pasture, and required more grain per pound of gain. In another experiment, in which older pigs were fattened on ground corn in the dry lot,

the addition of alfalfa hay produced gains one-fourth greater than the gains from corn alone and decreased the amount of grain necessary to produce a pound of gain eighteen per cent.

In a recent sixty-day pig-feeding trial at the Hays Branch Experiment Station, a grain mixture of ground kafir (62 per cent), shorts (30 per cent), and tankage (8 per cent), was fed on alfalfa pasture. The lot which received no grain during the first forty days, and was then full fed, made one-half the gains made by the lot which was full fed during the entire period, and required  $3\frac{1}{2}$  pounds grain per pound of gain, as compared with 5 pounds required by the full-fed lot. While the pigs made a daily gain of one-third of a pound per head on alfalfa pasture without grain, their daily gains averaged slightly more than 2 pounds per head. The lot which received a limited amount of grain on alfalfa pasture made two-thirds the gain made by the lot which received no grain for forty days, and required more grain to produce a pound of gain than the latter did.

It has been found that from 100 to 200 pounds of alfalfa have saved 100 pounds of corn. If 100 pounds of corn will produce 20 pounds of pork, figuring corn at 60 cents, the alfalfa would return a value of \$18.50 per ton. Figuring 3 tons per acre, the total returns would be \$55. In some cases it has run as high as \$80, but this is an exception and can not be expected in common practice. An acre of pasture producing 800 pounds of pork worth 7 cents per pound would return \$56, which allows a very good profit.

TABLE No. 48. Rations for swine, which include alfalfa. Suggested by the Kansas Agricultural College Experiment Station.

---

**BROOD SOWS, DRY:**

- I. Alfalfa pasture alone best during dry season.
- II. Alfalfa pasture.  
1 pound of grain daily.

**BROOD SOWS WITH LITTERS:**

- I. Allow 3.5 pounds of grain per 100 pounds of live weight, daily, consisting of:  
Corn, 60 parts.  
Bran, 10 parts.  
Shorts, 30 parts.

Alfalfa pasture or hay at will.

**FATTENING HOGS:**

- I. Allow 3.5 to 4 pounds of grain per 100 pounds of live weight, daily, consisting of:  
Corn.  
Alfalfa pasture or hay at will.
- II. Allow 3.5 to 4 pounds of grain per 100 pounds of live weight, daily, consisting of:  
Corn, 6 parts.  
Shorts, 1 part.  
Alfalfa pasture or hay at will.

**GROWING PIGS:**

- I. Allow 2.5 pounds of grain per 100 pounds of live weight, daily, consisting of:  
Corn, 65 parts.  
Shorts, 30 parts.  
Tankage, 5 parts.

Alfalfa pasture or hay at will.

---

In running hogs on alfalfa judgment should be used not to pasture too heavily. The number of hogs is limited by the yield, the size of the hogs, and the amount of grain they are receiving. Under ordinary conditions an acre should carry from eight to ten mature hogs which are receiving no grain. The pasturing should allow two or three cuttings of hay to be removed. In this way the crowns of the plant will not be injured. The

ground will be kept more shaded which will hold the weeds in check. Any weeds which start will be destroyed and fresh supply of new shoots will be available to the hogs. Even under the best management it will be necessary to reseed the fields from time to time, as the stand will be more or less thinned by tramping and rooting.

All experimental and practical results indicate that the farmer who is most successful in the production of market hogs is the one who makes large use of alfalfa both as a pasture and as a hay crop. Where alfalfa does not furnish a major portion of the rations used a successful hog farm may undoubtedly be established and maintained, but the expense for mill feeds and the use of corn could be largely reduced, thus increasing profits to the maximum if alfalfa entered into the system of management and feeding. Considering the length of the pasture season, the conditions under which it may be grown, its adaptability to all classes of hogs, and the economy of producing pork, alfalfa stands without a peer. (See "Swine," in index.)

---

### ALFALFA AS A HORSE AND MULE FEED.

By W. C. McCAMPBELL, Assistant Professor of Animal Husbandry,  
Kansas State Agricultural College.

Statistics show that Kansas had 34,384 acres seeded to alfalfa in 1891, while the report for 1914 shows 1,193,641 acres, an increase of 3371 per cent. This tremendous increase in alfalfa production is the result of a rapidly growing appreciation of the feeding value of the alfalfa plant, and with such a wonderful increase one might be led to believe that every possible use had been made of alfalfa as a food for live stock, but such is not the case, for we are just beginning to realize its immense value in our horse-feeding operations, especially in the feeding of work horses. The prejudice against feeding alfalfa hay to work horses is an honest sentiment, many times based upon personal experience, but in practically every case the unsatisfactory experiences have resulted from a lack of proper understanding of the nutritive value and physical properties of the alfalfa plant. For this reason a brief discussion of the chemical and nutritive constituents of alfalfa will be given.

The nutritive elements that must be taken into consideration in placing a value on any feed are protein, carbohydrates and fats. Of the three, protein is the most important, the most expensive, and, when fed in excessive quantities, causes the most trouble; hence the necessity of giving special attention to the protein content of all feeds used in compounding a ration. A comparison of the available amounts of protein, carbohydrates and fats of alfalfa hay and some of our more common feed-stuffs, reveals the fact that alfalfa hay is very rich in protein. This is shown in the following table:



FIG. 361. A rack for feeding alfalfa hay to horses.  
[Courtesy Nebraska Experiment Station.]

TABLE No. 49. Available nutrients per 100 pounds of some of the common horse feeds.

FEED.	Protein, pounds.	Carbo- hydrates, pounds.	Fat, pounds.
Alfalfa hay.....	11.0	39.6	1.2
Oats.....	9.2	47.3	4.2
Barley.....	8.7	65.6	1.6
Shelled corn.....	7.9	66.7	4.3

We note from the table that there are 11 pounds of available usable protein in 100 pounds of alfalfa hay, and only 7.9 pounds of available protein in 100 pounds of shelled corn. In other words, there is approximately 35 per cent more available protein in one pound of alfalfa hay than there is in one pound of shelled corn. These facts and figures impress upon us the necessity of looking upon alfalfa hay as a concentrate rather than a roughage. A man would be considered very foolish were he feeding a bushel of shelled corn a day to a 1200-pound horse, and yet many are doing a more foolish thing when they feed their horses all the alfalfa hay they will eat. Such a practice is not only wasteful but it is dangerous, for practically all of the protein which is not utilized by the body must be eliminated through the kidneys. This results in hyperstimulation or even inflammation of these organs, and excessive urination.

Feeding excessive amounts of protein also has a cloying effect upon the whole animal system, resulting in impaired nutrition, filling and swelling of the legs and hocks, inability to stand hard work, excessive sweating, and impaired respiration. So it must be remembered that if the feeder hopes to secure satisfactory results in feeding alfalfa hay to horses and mules he must feed it in limited amounts—less to work horses than to idle horses.

Another important consideration in feeding alfalfa hay to horses and mules is the state of maturity at which the hay has been cut. We have been taught that alfalfa should be cut when the field is about one-tenth in bloom. At this state of maturity it makes excellent hay for cattle, hogs and sheep, but such hay is too "washy" for horses. For horse hay alfalfa should not be cut until the full-bloom stage has been reached. This has been demonstrated by experience as well as by experiment.

#### ALFALFA HAY FOR WORK HORSES.

The value of the right kind of alfalfa hay for work horses when fed in limited amounts was nicely demonstrated in the horse-feeding experiment conducted at Fort Riley under the direction of the Kansas Experiment Station. A summary of these results is shown in the table on page following.

Comparing lots 12 and 5, we find that these two lots received daily practically the same amounts of corn per thousand pounds live weight. In addition to the corn the horses in lot 5 received daily 3.36 pounds of oats per thousand pounds live weight, while the horses in lot 12 received daily, in addition to the corn, only 1.7 pounds of oats per thousand pounds live weight. Thus the horses in lot 5 received daily 10.08 pounds of grain, while those in lot 12 received daily 8.5 pounds of grain per thousand pounds live weight. The horses in lot 5, receiving 10.08 pounds of grain, were fed daily 11.75 pounds of prairie hay per thousand pounds live weight, while the horses in lot 12, receiving 8.5 pounds of grain, were fed daily only 8.5 pounds of alfalfa hay per thousand pounds live weight. The horses in lot 12, receiving the smaller amounts of both grain and hay, showed better thrift and condition than those in lot 5, did their work just as well in every respect, and made a gain of 25.6 pounds per horse, while those in lot 5 showed a loss of 13.3 pounds per horse. The ration used in lot 12 resulted in a reduction of 15.57 per cent in the grain portion of the daily ration per thousand pounds live weight and 27.7 per cent in the hay.

Comparing lots 12 and 2, we find that the horses in lot 12 made a gain of 25.6 pounds per horse, while the horses in lot 2 lost 29.3 pounds per horse during the test. In lot 12 the grain fed daily per thousand pounds live weight was reduced 17.23 per cent, the hay 29.1 per cent, and the cost of the daily ration per thousand pounds live weight 26.2 per cent. To repeat, here was fed a ration satisfactory in every respect and 26.2 per cent cheaper than a ration commonly fed.

In the two comparisons above, the substitution of alfalfa hay reduced the amount of hay required almost 30 per cent, at the same time reducing the amount of grain, on an average, about 16 per cent. While

TABLE No. 50. Alfalfa hay for work horses.

Lot No.	Number of horses.	Average age of horses.	Number of days of fed.	Average weight of horses at beginning of test	Gain or loss per horse during test.	Grain daily per 1000 pounds live weight.	Hay daily per 1000 pounds live weight.	Nutritive ratio.	Cost of daily ration per 1000 pounds live weight.
12...	17	Years. 12	140	Pounds. 1,163.2	Pounds. +25.6	Oats..... 1.70 Corn..... 6.80	Alfalfa hay..... 8.50	1:5.8	\$0.1295
5.....	69	11	110	1,196.8	-13.3	Oats..... 3.36 Corn..... 6.72	Prairie hay.....11.75	1:10.1	.1796
2.....	76	8.34	140	1,180.9	-29.3	Corn.....10.27	Prairie hay.....11.98	1:11.5	1.754

these results do not give a direct comparison in the value of alfalfa and prairie hay, one is yet justified in concluding that in a properly balanced ration one pound of alfalfa hay is probably worth two pounds of prairie or timothy hay.

The method practiced by a majority of those who have fed alfalfa to work horses in the past, and even by those who feed it at present, has been to fill the manger morning, noon and night, thus allowing the horse to gorge himself. Prairie hay has been fed in this way without any serious results. Alfalfa hay being very palatable, horses eat very large amounts, and the results have been very unsatisfactory. This has led to a verdict that alfalfa hay is absolutely unfit to feed a work horse. Such has been the experience of hundreds of horsemen, but the trouble has been with the method of feeding, not with the alfalfa hay.

If alfalfa hay is fed properly it is the most valuable horse feed available for the average Kansas farmer, but it should be remembered that the hay must not be cut until quite mature; it must be free from dust, mold or smut, and it must be fed in limited quantities. As to the amount to be fed, experience seems to indicate that about one pound per day per hundred pounds live weight is the maximum amount for work horses.

Because of its high proportion of digestible protein, alfalfa balances very well with corn, and these two feeds make the most economical ration the Kansas farmer who grows alfalfa can feed, and probably as satisfactory as any, for the farmer can control the time of cutting and the manner of curing and caring for the hay. But wherever possible, horses fed alfalfa hay should also have access to prairie, cane or kafir hay or corn fodder to add bulk to the ration and satisfy the craving that always results when very rich feeds are fed for long periods of time. The man who buys alfalfa hay on the market usually chooses the hay showing the brightest green color, which is often the poorest for work horses, because it has been cut too green and will be very "washy." If, however, he will purchase average, well-cured, clean alfalfa hay he will be able to reduce the cost of feed very materially by substituting alfalfa hay for a part of the prairie or timothy hay. He may substitute one pound of alfalfa hay for one and one-half to two pounds of prairie or timothy hay until from one-third to one-half or more of the prairie or timothy hay has been replaced by alfalfa hay, the amount used depending upon the quality of the alfalfa substituted for the other hays.

Care should be exercised in feeding alfalfa hay to old horses with poor teeth, as they can not properly masticate the hay, and impaction is liable to result. In fact, this is a common cause of impaction in old horses in alfalfa-feeding districts.

#### ALFALFA MEAL FOR HORSES AND MULES.

The feeding value of alfalfa meal is not well understood. As the value of bran as a horse feed has long been recognized, a comparison of alfalfa meal with bran will probably give as practical an idea as can be given of the feeding value of the latter. One pound of alfalfa meal is almost equal in feeding value to one pound of bran. There are, however, some objections to its use as a horse feed. It is a disagreeable feed to handle, because, as it is finely pulverized and very light, a large part of it rises in

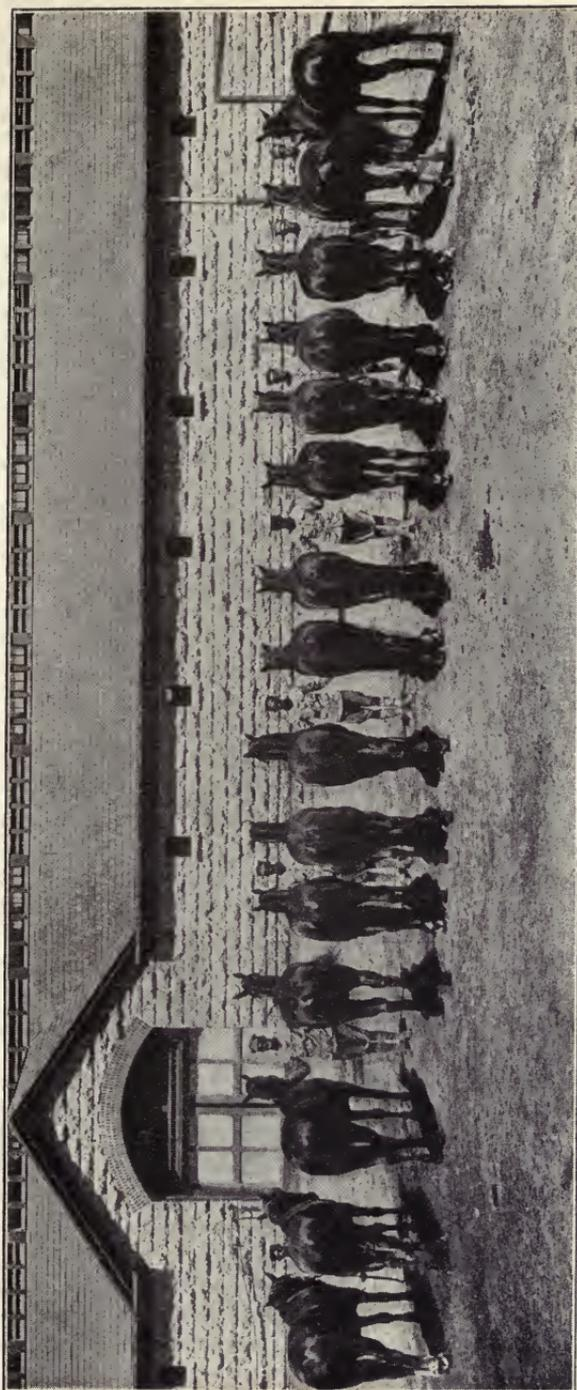

FIG. 362. Horses at Fort Riley, fed alfalfa hay, corn and oats for a period of 140 days. These horses averaged 25.6 pounds more in weight at the end of the experiment than they did at the beginning, while horses receiving corn and prairie hay weighed 29.3 pounds less at the close than at the beginning of the experiment.

a cloud of dust whenever handled in bulk. If fed dry, even when mixed with other feeds, a large amount of this dust is continually getting into the air passages of the horse. The mucous membranes lining these passages are tender and easily irritated, and the use of dry alfalfa meal for any length of time may cause serious irritation and inflammation of the respiratory tract. This objection may be overcome by wetting the alfalfa meal, but to prevent souring or molding this wetting must be done immediately before feeding. This is a task involving no little time and inconvenience, especially in winter.

Another objection is the fact that one does not know what kind of hay he is getting when it is bought in the form of alfalfa meal. Most mills are putting out a very good quality of meal, but wet, moldy and even rotten hay is sometimes ground into meal. It has been claimed that much less is wasted in feeding alfalfa in the form of meal than in the form of hay; but if the hay is properly fed very little, if any, will be wasted.

Experience has shown that when alfalfa hay is available alfalfa meal is not a desirable or economical feed for horses and mules.

#### ALFALFA PASTURE FOR HORSES AND MULES.

The advisability of pasturing alfalfa is a question upon which horsemen do not agree, but after a careful study of the question it would seem that as a general practice, under average Kansas conditions, pasturing horses and mules on alfalfa is not to be recommended. Some of the more important reasons for this conclusion are as follows:

First. More feed can be secured from an acre of alfalfa in the form of hay than in the form of pasture.

Second. The general practice of pasturing will kill the alfalfa plant unless special precautions are observed, and we are all more or less prone to neglect precautionary measures, especially if they involve very much work or inconvenience. Some of the more important precautionary measures that must be observed if alfalfa is to be pastured are: alfalfa must not be pastured while the plant is young or immature; close grazing must always be avoided; horses should be removed during the middle of the day, as they will congregate in groups at this time and kill out large areas in fighting flies, giving foxtail and other plants an opportunity to secure a foothold from which they will spread very rapidly; pasturing heavily in the fall leaves the field bare and unprotected, as well as prevents the catching and retaining of the snow and rain. This is a very important consideration, as the moisture caught and retained during the fall and winter months has a decided influence upon the yield the following season.

Third. Pasturing horses and mules on alfalfa involves some risk and danger from colic and indigestion. To minimize this danger a plentiful supply of water must be provided, so that the horses may drink often. If this precaution is not observed the horses will fill up on alfalfa and later gorge themselves with water. This often results in colic. Usually the attack is rather mild, but not infrequently it becomes very serious. Another precaution that should be observed for the sake of safety is the rack or stack of straw or coarse hay from which horses may eat at will when pastured on alfalfa.



FIG. 363. An army horse which received a ration consisting of alfalfa hay 10 pounds, corn 8 pounds, and oats 2 pounds. This horse did his work in a very acceptable manner and maintained his weight through the whole experiment of 140 days.—[Courtesy Kansas Experiment Station.]

To sum up the situation, one might say that with proper precaution horses and mules thrive on alfalfa pasture, but from the standpoint of economy and profit it is not a good practice to pasture alfalfa when the value of the plant, the value of a good stand, and the cost of reseeding is taken into consideration. These conclusions are in keeping with the experiences of our most successful Kansas horsemen, who have given these matters particular attention and study. (See "Horses and Mules," in index.)

---

### ALFALFA AS A POULTRY FEED.

By W. A. LIPPINCOTT, Professor of Poultry Husbandry,  
Kansas State Agricultural College.

Alfalfa finds a place in two of the four divisions of the poultry ration. A poultry ration is for convenience classified into grains, green feed, mash, and mineral feed. Alfalfa is one of the very best forms of green feed that can be furnished, and is also very freely used in the ground or mealed form in the mash. As a green feed or succulence, alfalfa must be considered from the standpoint of its medicinal or hygienic value rather than from the standpoint of nutrition. Alfalfa, in common with the legumes in general, possesses a much higher feed value than many of the other forms of green feed, such as mangel beets, kale, cabbage, rape and the like. Some green stuff should always be given fowls as a separate feed where it is at all possible to do so. The alfalfa meal fed in the mash does not take the place of the fresh greenness.

During the spring and summer the best way to feed it is to allow the birds to pasture upon it. Besides having a desirable effect upon the digestive tract, it serves as an appetizer, adds variety to the ration, and tends to give a good color to the yolk, owing to the iron which it contains. It has been frequently claimed by commercial egg men that alfalfa is responsible for an undesirable condition in eggs which appears in the spring, known as "green whites," or "grass eggs." At the Kansas Station, however, Mauer and Harris kept six Barred Plymouth Rock hens in an alfalfa field for several weeks. The birds were given no feed beyond that which they secured in the alfalfa field itself, and which was largely made up of alfalfa and grasshoppers. The eggs from half the hens were subjected to careful inspection and bacterial analysis. Half the eggs were kept at room temperature and blood temperature for four weeks, and were then broken into white porcelain dishes and examined for greenish discoloration. No "grass eggs" were found. The half of the eggs which was subjected to bacterial analysis was found to contain no pigment-producing organisms. More recently a pigment-forming organism has been isolated from "green whites" by the Bureau of Chemistry of the United States Department of Agriculture, which accounts for them, but which has nothing at all to do with alfalfa. There is no reason at all why birds should not be allowed to pasture freely upon it. In fact, in the western part of the state it has been frequently shown during grasshopper years that both chickens and turkeys may be pastured on the alfalfa fields by the use of portable colony houses, and thrive on the grass-

hoppers and alfalfa, at the same time so protecting the alfalfa from the ravages of the grasshoppers that a fairly good crop could be cut. One man reported that he not only saved his alfalfa, but marketed the chickens which he used for \$15 more than he paid for them, thereby finding a means of marketing the grasshoppers.

Alfalfa and clover are generally considered to furnish the very finest pasturage for fowls. Cut alfalfa hay that is cured green furnishes an excellent temporary substitute for succulence when steamed.

The amount of digestible nutrients found in 100 pounds of green alfalfa as determined by digestion experiments with ruminants are 3.6 pounds of protein, 0.4 pounds of fat, and 8 to 11 pounds of nitrogen-free extract. It contains 2.7 pounds of ash, and has a nutritive ratio of 1 to 2.7.

During the last few years finely ground alfalfa hay has appeared on the market as alfalfa meal, and if of good quality, is a good substitute for wheat bran, as it is high in protein, ash, and fat. In buying this feed, however, the guaranteed analysis should be carefully considered, and a careful examination should be made as to the crude fiber content. A large proportion of fiber would indicate that the meal was ground chiefly from stalks, which are of little feed value, rather than the leaves, which contain most of the nutrients. Crude fiber, of which the stalks contain a large proportion, is almost altogether indigestible for poultry. Other alfalfa feeds, known as chopped and shredded alfalfa, are more easily examined and much less liable to be of a poor grade, because of the coarser condition, than alfalfa meal.

Although alfalfa feed contains a large proportion of nitrogen compounds, it must be remembered that they are made from the alfalfa hay and not concentrates, and therefore should not be fed to excess because of their high crude-fiber content and low availability. They may be used with good results up to 20 per cent of the mash portion of the ration, provided no bran is used. The total amount of bran and alfalfa meal should not exceed 25 per cent of the mash at any time. Alfalfa meal has the same composition as does the best quality of alfalfa hay. In protein content it is ahead of that reported for bran or middlings, but the total food value of the latter is greater because they contain comparatively little fiber (average 5 per cent) as compared with alfalfa meal (over 25 per cent).

The mealed alfalfa is also exceedingly valuable as a first bed for the brooder. When chickens are first put in the brooder after hatching they are capable of exercising very little choice in the matter of feed. Where the litter is made up of sand, chaff or other indigestible material, they not infrequently start to eating this, and large numbers of them become impacted and die. Where alfalfa is used it is digestible enough so that it does not do the birds any harm if they do fill up on it.

A ration for egg production that has given very good results throughout the middle states is the following:

The scratching ration is made up of three parts (by weight) of wheat, two of corn or kafir, and one of oats. This is fed in a litter, so that the birds will be compelled to scratch for it. A mash feed, which may be

fed either wet or dry, contains 60 pounds of corn meal, 60 pounds of wheat middlings or shorts, 50 pounds of meat scrap, 20 pounds of mealed alfalfa, 20 pounds of wheat bran, 10 pounds of linseed oil meal, and one pound of salt. At the same time grit, oyster shell and charcoal should be kept before the birds, and all the green alfalfa they will clean up in a half hour once a day, if the birds are confined. In the wintertime, when green alfalfa is not available, it will probably be necessary to substitute mangel beets or sprouted oats. (See "Poultry," in index.)

### **ALFALFA AS A HUMAN FOOD.**

By MARGARET H. HAGGART, Professor of Domestic Science,  
Kansas State Agricultural College.

Manufacturers of alfalfa products for human consumption submitted to the department of domestic science samples of a blended flour, tea, and coffee, made from alfalfa, together with manufactured products of crackers, cookies and candy. The crackers and cookies were palatable. The candy was of such a pronounced alfalfa flavor that it was not relished by those who sampled it.

The flour submitted was made from the alfalfa leaf, prepared by a patent method, and mixed with wheat flour for better results. This flour was not analyzed, but it was used in making griddle cakes, muffins, biscuits, doughnuts and cake. The batter and dough mixtures behaved in all respects like those made from ordinary flour. The finished products were sampled by a number of people. All agreed that the decided greenish tint was undesirable in a food, though, of course, this was a matter of mere prejudice. The griddle cakes, muffins, doughnuts and cake were very palatable and agreeable to the taste; but in the biscuits the alfalfa flavor was very pronounced, and many people objected to it.

The manufacturers do not claim that alfalfa flour can be substituted for wheat flour in bread making. Their claim for it is, like the claim now made for potato flour in Germany, that it is a saver of the king of cereals—wheat.

Tea made from the dried leaves of alfalfa tasted very much like an ordinary herb tea, and one might be able to cultivate a taste for it. Coffee made from the baked leaves of alfalfa was quite as agreeable to the taste as that of any cereal coffee. The odor of the boiling liquid very strongly suggested alfalfa.

As to the particular therapeutic value of alfalfa for human food investigation has not furnished conclusive evidence. The large amount of fiber contained adds greatly to its value as a laxative. The large amounts of all kinds of mineral matter necessary to the living organism would greatly increase its value as a food.

However, even though a food may contain large amounts of the various food nutrients—carbohydrates, proteins, fats, and mineral matter—it has not always been found under scientific investigation that the nutrients in the form in which they exist are available to the human organism.

## THE ALFALFA MILLING INDUSTRY.

By C. W. WRIGHT, Editor *Southwestern Grain and Flour Journal*.

Unique among the western industries created during the past twelve years is the manufacture of alfalfa meal. Alfalfa has long been recognized as a good forage crop—and more: its chemical properties give it a place in feeding-stuffs economy for which no satisfactory substitute has been found. And it is fitting that a citizen of Kansas, the state that leads in the production of the legume, should be first to reduce alfalfa hay to a shredded or chopped form and successfully employ it in the manufacture of a commercial feed.

This honor belongs to Otto Weiss, of Wichita, whose discovery and the practical use thereof has done more the past ten years to direct the favorable attention of the world to the genuine goodness of alfalfa meal than any other half dozen contributing agencies.



FIG. 364. A big alfalfa mill at Wichita.

It was along in 1903 that Mr. Weiss, who divided his time between his wholesale feed business and the raising of fancy and practical poultry, found that the fowls fed upon a hand-mixed ration, in which chopped alfalfa was an ingredient, were chronically addicted to the habit of acquiring the blue ribbon wherever exhibited. This fact became impressed upon the minds of competing exhibitors, who began to call for the kind of feed that contributed so largely to the prize-winning proclivities of Mr. Weiss' fowls. Hand chopping and mixing of the feed soon became inadequate and Mr. Weiss endeavored to secure machinery equipment that would do the work on a larger scale, but was only partly successful until he had equipment built in accordance with his own ideas.

He was soon putting out a special alfalfa feed, not only for poultry, but for beef steers, for driving horses, for work horses and mules, and for dairy use. From the small equipment, that at the start occupied but a corner of his warehouse, the Otto Weiss plant at Wichita now occupies a solid block of ground, while additional mills for the pro-

duction of straight alfalfa meal have been built or acquired by the company in western Kansas during the present year, which of itself furnishes a fairly comprehensive idea of the growth and development of the alfalfa feed milling industry during its comparatively brief existence. To-day the Otto Weiss Milling Company sells alfalfa meal, or its feeds containing an alfalfa meal mixture, in almost every feed-consuming state. When a representative of the company appeared on the New York Produce Exchange in 1906 and exhibited samples of these feeds, business was suspended for a half hour while the members of that organization received their first lesson concerning the new wonders of alfalfa.

In the meantime M. C. Peters, of Omaha, had established a plant in the Nebraska City, which produced not only the chopped alfalfa and the dry feeds in which it was a component part, but Mr. Peters went further; he added beet syrup or molasses to the list of ingredients. To-day the alfalfa meal and molasses mixture is undoubtedly one of the most popular feeds on the market, and is in particular favor among cattle feeders.

For two or three years Mr. Weiss, Mr. Peters and one or two other pioneers in the alfalfa milling industry experienced little competition. Then, almost overnight it seemed, the obsession became prevalent throughout Kansas, Nebraska, Oklahoma and Colorado—in fact, wherever a community could boast of a few hundred acres of growing alfalfa—that a very necessary feature incidental to the plans and specifications for an alfalfa mill was a spout through which the profits—happy residue from successful milling operation—might be conveniently carried direct to the growing balance over at the bank.

The citizens of a hundred towns in the alfalfa belt encouraged the establishment of mills, but in nearly every instance the stockholders in the companies thus organized eventually discovered that, through some error in the flow sheet, the suction fan seemed to pull money through the "profit" spout the wrong way; the more continuous the operation of the plant the greater the resulting drain on the bank account.

The difficulties were many, but the more important may be classified as mechanical, climatic and marketing.

Most of the alfalfa-milling machinery first put on the market was neither practical nor dependable. Even to-day the equipment for collecting the dust-like particles of pulverized alfalfa leaves is far from perfect, and in the early days of the industry one could readily ascertain, even at a distance of four or five miles, whether or not an alfalfa mill was in operation. If it was, the escaping dust mingling with the surrounding atmosphere gave the plant the appearance of being centrally located in a dense green fog—a fog that represented a money loss just as certainly as though actual greenbacks were floating to the breezes, for it was that most valuable element, protein, contained in the pulverized alfalfa leaves, that was lost in the dust cloud.

Sparks caused by friction or the presence of a piece of metal in the hay, or from locomotives passing the mill, when they came in con-

tact with this inflammable dust not infrequently resulted in fires which destroyed a number of plants, and insurance rates became prohibitive, protection for the owner of the more cheaply constructed wooden mills being unobtainable in many instances.

Marketing difficulties were numerous. Except in the irrigated sections of the alfalfa-producing territory, where rains and dew were largely absent, much of the hay offered at the mills was lacking in the conventional "pea-green" shade that, even to-day, the average buyer of alfalfa meal considers vitally essential to the feeding value of the product. Brown-colored meal was considered meal milled from spoiled hay at first, though of recent years the meal from the "tobacco-cured" or "silo-cured" hay, that western feeders really prefer to the green-cured hay, is recognized in the eastern or southern markets as possessing genuine merit, though a material premium is still offered for meal showing the nearest approach to the appearance of the uncut alfalfa.

Naturally this preference for alfalfa meal of green color afforded endless opportunity for trouble between the miller and his customers. Even at the larger markets, where the services of official grain or hay inspectors might be available, this difficulty was not appreciably overcome, since these inspectors had had no experience in grading alfalfa meal. Probably no commercial product loaned itself more readily to the creation of honest or dishonest difference of opinion than alfalfa meal, and when a shipment of meal arrived at a point, perhaps a thousand miles from the mill, with the draft representing its value unpaid, and no official inspection obtainable, mutually satisfactory adjustment of such a difference became increasingly difficult.

The official grades established for alfalfa meal were based both upon color and protein content, but the latter was not usually considered, provided the meal possessed the desired green shade, while a higher percentage of protein could not be depended upon to offset the lack of color.

Another factor that renders alfalfa milling more hazardous than the milling of flour or other product of grains is the necessity that the operator of an alfalfa mill buy his raw material in competition with the hay dealer or stock feeder, while on his finished product he must compete with the seller of whole or milled grain. Therefore the price paid for alfalfa hay or obtained for the meal often lacked the uniform relationship that should exist to insure profitable milling. Hay prices may be high, while those for corn or oats may be relatively low. This condition has sometimes resulted in the price of the sacked meal being no higher than that which the baled hay would have brought the same day on the same market.

The foregoing portrays in some measure the difficulties experienced by those who entered the alfalfa milling industry eight or ten years ago. Three out of every five of the companies then organized are now out of business, while two of every three remaining operate their plants but intermittently. To-day there is but slight inclination manifested to build mills in the rain belt, the new plants being almost invariably located in the irrigated sections of Colorado, Wyoming, Montana or



FIG. 365. Alfalfa mills are located largely in the irrigated districts.

California, with now and then one appearing in western Kansas or Nebraska.

But this does not mean that the production of alfalfa meal has decreased. On the contrary, each year shows a consistent increase over the output of the preceding season, for the reason that where a half dozen small mills, located in sections where excess of rain or a shipping and feeding demand for the hay renders profitable operation difficult, have discontinued business, a newer plant, equaling their combined capacity, has been established at a point in Colorado, or perhaps Wyoming, where an abundance of irrigated alfalfa is usually harvested without interference from rain or heavy dews, and admits of uninterrupted milling operations six or eight months in the year.

Thus it is that Kansas, where the alfalfa milling industry originated, has already lost its early prestige in this respect—a loss that the State Agricultural College officials believe is more than offset by the constantly increasing marketing of alfalfa in the shape of beef, butter fat, pork, or big-boned, heavy horses and mules.

Very few growers of alfalfa grind the hay before feeding it to their own animals. They do not believe that the increased value justifies the extra trouble and expense. However, there are those who take a contrary view. For example, the writer is reminded of one of the most successful stock feeders of Marion county, Kansas, who invariably springs the top market quotations on the Wichita hog market ten cents a hundred pounds whenever he sends down a load of porkers.

This interesting farmer is totally blind, but he can judge the condition of a hog or steer better by the sense of touch than most men can with the assistance of their eyesight. He feeds a mixture of corn chop, alfalfa meal and linseed meal, and his finished hogs usually average around 340 pounds and dress out to the delight of the packers. He can

not tell you just the proportions of each ingredient contained in the ration fed, since he conducts his own experiment station and varies the mixture according to weather conditions, the quality of the hogs and the growth they are making. But the important thing is that he obtained the desired balance to the ration by increasing or decreasing the quantity of alfalfa meal used. It was two or three years ago that the writer met this gentleman, and at that time the average weight of the hogs arriving on the Wichita market was around 225 pounds, as corn was scarce and high in price. Admittedly many other feeders might have taken lessons from this Marion county farmer, who habitually topped the market with hogs weighing a hundred pounds more. It seems safe to credit alfalfa meal with at least a portion of the gain.

Otto Weiss maintains that two bushels of corn and one bushel of alfalfa meal exceed three bushels of corn in feeding value. The price of the meal, he says, should never fall below that of corn, pound for pound. The alfalfa meal causes the nutritive elements of the corn to be fully assimilated by the animal to which the mixture is fed. Experiments conducted at the feed yards of the M. C. Peters Mill Company proved that hogs following cattle that were fed on a well-balanced alfalfa meal and grain ration would starve, so completely was the feed assimilated by the larger animals.

One of the largest concerns that feed cattle in Nebraska has found it possible to shorten the feeding period from six or eight months to three or four months merely by incorporating alfalfa meal in the ration fed. Another enthusiastic exponent of the goodness of alfalfa meal claims that 1200 pounds of the meal put more meat on a bunch of steers than a ton of alfalfa hay. Dairymen have found alfalfa meal a wonderful stimulant to milk production, some reporting a gain of one-third by actual test.

One of the finest bunches of sheep that ever arrived at the Kansas City stockyards was fattened exclusively on alfalfa meal in two-thirds of the time ordinarily required where grain is fed.

It would appear by no means an established fact that the grower of alfalfa can reap no advantage from grinding the alfalfa he feeds to his own animals. The Colorado Experiment Station states, in Bulletin No. 187, that four years of experimenting seems to have established that it will pay the feeder to reduce his common quality of alfalfa hay to meal, provided the cost of the meal, delivered at the farm, is not more than one dollar per ton in excess of the value of the hay, where the meal is coarsely milled, or three to four dollars where it is finely floured. It does not encourage the milling of top-quality hay, but says the alfalfa grinder has a legitimate place on the farm and enables the farmer to make a better clean-up and secure a much closer consumption of coarse, poor-quality alfalfa hay, stack tops and bottoms, straw, and other fodder.

Anticipating the need for just such a grinder on the farm, a manufacturing concern located at Wichita, Kan., has placed on the market a small, light-running, all-purpose mill that has caused many users to see new possibilities in feeding-stuffs economy as practiced on the farm, as this machine grinds with equal facility alfalfa hay, kafir heads, ear or

shelled corn, straw, pea-vine hay, and even the finer seeds, such as millet, cane or broom-corn seed.

It seems reasonable to predict that within a few years every progressive farmer will find it desirable to use some such grinder in connection with his feeding activities, though the writer does not believe it will ever become a common practice for him to haul his alfalfa hay to a mill in town several miles distant and have it ground into meal which must be hauled back to the farm, even if it might prove profitable in certain feeding operations.

Returning to a consideration of the commercial alfalfa mill, which depends upon distant, not local, territory for its market, not only is it being located farther west in the alfalfa-producing territory, in Colorado, Utah, Wyoming, Montana, New Mexico, Arizona, and even California, but quite as radical a change has occurred of recent years in the methods of marketing the product. The early efforts of the millers who put out only a straight alfalfa meal were directed quite as largely toward creating a demand among the small feed-consuming trade as among the large manufacturers of concentrated feeds. The efforts in the first-mentioned direction were disappointing, since the individual feeder did not understand the best methods of feeding the meal, nor were there many millers who could or did tell him how.

The meal, which is very dusty, should properly be mixed with ground grain or molasses for best results, and often too much of it was given by inexperienced feeders as a ration, as the average owner of horses or cows found it difficult to realize that a ground hay was essentially different from just merely hay. And few recognized the fact that alfalfa hay was not "just hay," though no less an authority than *Hoard's Dairyman*, in the issue of September 22, 1911, states that, because of its high protein content, ordinarily around 14 per cent, alfalfa hay of good quality is worth \$70 per ton if timothy is selling at \$20 per ton. When too much alfalfa, either in the hay or meal form, is fed, particularly to horses, it overstimulates the animal's digestive organs and kidneys. For the above and the further reason that sometimes the miller failed, through inability or disinclination, to ship the quality of meal that he had sold, perhaps a majority of the small feed consumers were not immediately impressed with alfalfa meal.

But in the meantime the manufacturers of concentrated feeds of various kinds were quick to recognize in alfalfa meal a product for which they had urgent need; a product that contained protein in its most desirable form. Immediately they began incorporating it in their mixed feeds with highly beneficial results. It practically revolutionized the mixed-feed industry. Under the watchful eye of an expert chemist the meal was added to ground corn, oats, barley, kafir, wheat screenings, cottonseed meal, the by-products from oatmeal and other breakfast-food plants, molasses, and even peat moss. It might be putting it none too strongly to state that alfalfa meal has been largely responsible for the exceptional development of the commercial mixed-feed industry during the past few years, nor to maintain that the elimination of alfalfa meal to-

day would undoubtedly cause quite a number of these large concerns to discontinue business.

The total production of alfalfa meal in the principal milling states, exclusive of California, is estimated, by those in best position to know, at something over 200,000 tons annually. Of this Colorado produces about one-half, Wyoming 40,000 tons, Nebraska 25,000 tons, Kansas 20,000 tons, New Mexico and Oklahoma each 10,000 tons.

The southern states are ordinarily expected to consume 65 to 70 per cent of this output, though this year, owing to an abundance of home-grown grain and forage crops, a smaller quantity will doubtless suffice. The central and eastern states furnish a market for the rest.

But, as has already been described, the meal now reaches the consumer almost entirely as an ingredient of a balanced mixed feed. There-



FIG. 366. A good plant that never turned a wheel, owing to lack of alfalfa. The machinery and equipment were hauled overland from the railroad forty miles away.

fore the meal miller looks to the mixed-feed concerns located at large distributing centers for his market. Eight such plants in St. Louis consume about 60,000 tons of meal annually, while others are located at such points as Kansas City, Omaha, Chicago, Memphis, Nashville, Pittsburg, Peoria, New Orleans, Atlanta and Milwaukee. Several concerns, located principally at Kansas City, Omaha and Council Bluffs, specialize in a straight alfalfa meal and molasses mixture, which they sell direct to large cattle feeders or to mixed-feed concerns, which incorporate still other ingredients before placing the balanced ration on the market.

All of these balanced rations have a feed value, though some are better than others. Sometimes the reputation of alfalfa meal, which is an honest feed that when unmixed with other products shows for itself just what it is, has not been enhanced by the admixture of screenings, peanut hulls, weed seeds, oat hulls, etc. But with the state and federal authorities watching more and more carefully and intelligently the quality

of the feeds that come under their observation, it can safely be stated that the interests of the consumer were never better protected than at the present time, even though the manufacturer of an honest feed may sometimes feel that he is the object of persecution because of the restrictions, the registrations, the special taxes and the tagging systems that are imposed upon the industry. But this is a single-angled view to take of the matter, since many of the positively bad feeds that were on the market a few years ago can no longer be safely marketed. Thus unfair competition is eliminated, and after all the ultimate consumer is pretty likely to pay the added cost due to state and federal supervision of the industry.

To conclude these pages with a bit of advice to the person who contemplates engaging in alfalfa milling, the writer would suggest, first of all, a good bank account—say \$15,000 to \$40,000. Next, a favorable location in an irrigated section of the country where 4000 or 5000 acres of growing alfalfa lie within a radius of a half dozen miles from the mill. The plant should provide large facilities for the storage of hay and the sacked meal as sometimes the hay does not come in fast enough and at other times cars for loading the meal may be lacking, or the state of the market renders accumulating the meal desirable. The grinder should have a capacity of at least a half dozen tons of meal per hour and, to keep down the overhead expense, should be operated day and night, if possible, from August until the following spring. You may be told that the cost of milling and putting the sacked meal aboard the cars is \$3 per ton, but if you would realize a fair profit on the investment, pay yourself or someone else a manager's salary, allow for depreciation, and—if you can secure insurance protection—the policy premiums, better figure on \$6 a ton between the cost of the hay delivered at the mill and the cost of the meal loaded out of the mill.

Then if you are able to contract for delivery of several thousand tons of good hay at the mill, and can go to St. Louis or other large market and sell an equal amount of meal at a figure sufficiently above the cost of the hay, you are in position to "go to it." However, the blue book of alfalfa milling fails as yet to record the name of any one who has become a millionaire because of his activities as "hay miller."

And the midwestern alfalfa miller must not overlook California. While the writer is not accurately informed regarding alfalfa milling conditions in the coast state, he is told that there are some twenty mills, mostly portable and therefore capable of being moved from one alfalfa-producing section to another, which are becoming large producers of meal. Within the past few months California meal has been shipped via the Panama canal and offered on the Atlantic seaboard at figures one to two dollars per ton below the price that must be obtained by the Colorado, Wyoming, Nebraska or Kansas miller. (See "Meal," in index.)

## THE KANSAS CITY HAY MARKET.

By RICHARD PRIDE, in *The American Elevator and Grain Trade*.

The Kansas City hay yards! I had never seen them, nor had any idea of what such a place would be. My hay had always been delivered in a dinky cart by a German person who stuttered, so that conversation on the subject had been discouraging, even if I had given it thought, which I had n't. But here was a new aspect of hay. In front of me stretched long wagon lanes, flanked on each side by freight cars, hundreds of them in solid ranks of commercial power. Many of the cars were open and in front of each door was a high pile of bales with moving figures on every pile, hauling, checking, marketing, each doing his part in the complex system of the greatest hay market in the world.

### KANSAS CITY THE GATEWAY FOR HAY.

How does Kansas City happen to occupy this exalted place in the hay trade of the country? Replies came eagerly from many quarters, and indeed the explanation is simple and quite obvious. It is on the threshold of the prairie, on the very shore of that sea of grass which feeds so much of the live stock of the world. It is in fact like the hub of a great wheel, whose spokes on one side represent the lines of hay cars from the farm to the market, and on the other side the great arteries of trade which carry out the hay, north, east and south, to the consuming centers of the world. The rim of this wheel is bounded on the west by the Rocky Mountains, and its distributing side is bounded only by the farthest market where hay is needed. There is no mystery about it, for Nature picked the place long before man saw the design and set about improving it.

But it is one thing to have opportunity knock at the door, and quite another to open the portal and show it hospitality. And this brings us to a brief consideration of the Kansas City Hay Dealers' Association.

### HISTORY OF THE MARKET.

The hay trade of the country as a whole has been curiously indifferent to the power of coöperative effort, particularly in the matter of market organization. In this Kansas City stands out a conspicuous exception, as for years it stood alone as our only organized exclusive hay market. In this forehandedness as much as in its geographical location lies its preëminence.

A receiving market stands or falls on a single word: that word is "service." To the extent that it can give shippers and buyers good service in rates, weights, inspection and prices will it progress, and no farther. This service can not be brought to its highest point of efficiency by individual effort, and twenty-two years ago the hay dealers at Kansas City realized the fact.

On April 10, 1893, about fifty dealers, responding to a call from a few progressive spirits, met at the Midland Hotel and organized the Kansas City Hay Dealers' Association. J. B. Spellman, the pioneer



FIG. 367. Group of car pluggers at Kansas City.—[Courtesy American Elevator and Grain Trade.]



FIG. 368. The Missouri Pacific hay yards, Kansas City.—[Courtesy American Elevator and Grain Trade.]

dealer in the community, was elected president and Charles Greicher was the first secretary.

The value of the association was demonstrated immediately. An organization known as the Hay Exchange had been organized by some stockyard people, seemingly for the sole purpose of exploiting the business which the hay dealers had been building up. They built a warehouse that would hold about 1500 tons of hay, and the railroads helped the plan along by issuing an order not to allow any hay to stop on team tracks. All the receivers had to pay the Hay Exchange 50 cents per ton for handling the hay, and if the hay was not removed within ten days there would be a further charge of 25 cents for each additional ten days.

This was very pleasant, in theory, for the Hay Exchange, but as a matter of fact they could not make deliveries, and so the Hay Dealers' Association took it up with the Railroad Commission, who ordered the railroads to set the hay on team tracks. This put the Hay Exchange out of business and stimulated the association to further effort. The lesson of coöperation had been learned.

The next step that the association took was to put in three sets of team-track scales for the use of members, and within a few years an inspection service was organized, which marked the real beginning of that efficient system which has put the Kansas City market in the lead.

In 1899 a constitution and by-laws were adopted, and were amended in 1904. These rules were milestones in the path of progress, and were the substantial basis of the splendid rules which govern the market today. During all these years the railroads had made frequent attempts to raise the rates or to increase the minimum car weight. In every emergency the association was on the job and induced the Interstate Commerce Commission to frustrate the attempts. The most threatening catastrophe occurred in 1905, when the state of Missouri passed a law to inspect all hay offered for sale in Missouri. A state inspector was appointed, but the hay men refused to pay for the inefficient service offered. The next year G. Peters, who had been inspector for the association, went into the state service, and matters looked very gloomy until 1907, when Mr. Peters was elected secretary of the association to fill the vacancy made by the resignation of E. R. Boynton, and at the same time took up inspection again for the hay dealers. The next year the state of Missouri sued a member for back bills for inspection. The suit was thrown out on demurrer, and as a result state hay inspection went out of business. From this time on, through the activity of successive presidents and the devotion of Secretary Peters, who has continued in that office, the association has gained in strength and prestige. The membership is limited to sixty, and at the present time each membership is valued at \$800.

#### RULES OF THE ASSOCIATION.<sup>1</sup>

The rules of the association have grown through a process of elimination and addition till they are models for strict justice and fairness between buyer and seller. Every provision is made for the protection of

---

1. See "Rules of Kansas City Hay Dealers' Association," in index.

the interests of shippers, and the spirit as well as the letter of every rule is religiously adhered to.

One rule that is distinctive to this market relates to the plugging of cars for inspection. Plugging is the process of excavating a lane through the center of the car so that the hay from end to end can be inspected. Paragraph C, rule 3, section 2, reads as follows:

“A regular inspection means that the inspector shall inspect a car on the plug. He shall examine all the hay, or straw, taken out of the car and shall get up into the car that he may see all the different kinds shown and note their condition, in order that his inspection shall be thorough, complete and impartial, and about which there can be no mistake or question, and shall register the grade in the regular inspection column of the inspection book.”

The plugging, weighing and warehouse rules are very specific and exacting, and the liability of error in every department of the service is reduced to a minimum which is almost negligible.

The day's routine at the yards is interesting, particularly to shippers, for it shows with what care all these details are attended to.

At 6:30 in the morning the weighmasters are on duty at the “Katy” tracks, and at seven weighmasters, watchmen, pluggers and inspectors are at their places in all the yards ready to start in the business of the day. The watchmen locate all new car arrivals on the inspection tracks, mark the car with consignee's pro number and make a record of number, initials, track number, name of consignee, condition of car, and whether full or not. This information he gives to the weighmaster under whom he works, and before eight o'clock reports all cars to the secretary of the association. He sees that each new car is opened and properly plugged for inspection, if the weather permits.

The inspectors are in all the yards at the stroke of seven, and immediately begin going through the plugged cars to grade the hay that they contain. Practically the entire contents of the car are inspected. The advantage of this method over the car-door inspection is obvious. Rain or dampness may stain the hay next the door, and a car of choice alfalfa might get only a standard grade, or No. 1 prairie a lower grade, if the bales at the door alone were inspected. While this method protects the buyer against a dishonestly loaded car, the greatest advantage in the system accrues to the honest shipper, who can be sure that his hay will be graded to its full value.

Before the association took hold of the methods of trading in hay on the market, car-door inspections and sales were made. This led to frequent rejections by purchasers, and consequent resales at greatly reduced prices. It became evident that to build up the market this trouble must be obviated. From this sprung the system of plugging cars, which has resulted in the most satisfactory method of marketing hay known. A car which is sold on “plugging” examination is the property of the purchaser without recourse, except in flagrant cases of misrepresentation in loading. Fully 95 per cent of the cars now handled here are unloaded at a uniform price of 85 cents without car service charges. This record can not be approached by that of any other market. This system has



FIG. 369. Chief Inspector G. Peters inspecting a plugged car.—[Courtesy American Elevator and Grain Trade.]

been built and it is being maintained at considerable expense by the association. It has saved shippers thousands of dollars.

But these employees of the association are not the only ones who are down to work at an early hour. Hay trading isn't like banking, where all things come to him who waits. If a hay dealer wants business he must be up with the birds, for the competition at the yards is sharp, and late comers lose the choice pickings both of sales and purchases. The traders, armed with their notifications of arrivals, and purchasing orders, make the rounds of the yards, giving a certain amount of time to each one. A dozen dealers may have orders for certain grades of hay, and the bidding for that grade is as keen as possible. There is nothing cut and dried about it, the whole business is open and strictly competitive, and every shipper can be assured of as high a price for his shipment as the demand of the market will warrant. Of course there are times when there is a surplus of certain grades. Then the market sags. But the traders are not responsible; they must follow the inexorable law of supply and demand, but so far as far-reaching system can control, the hay market of Kansas City is in a position to give its patrons the very best of the market.

#### THE VOLUME OF BUSINESS.

An idea of what this system means can be gained by a glance at the following figures:

TABLE No. 51. Kansas City hay receipts, by kinds and carloads, for 10 years.

YEAR.	Prairie.	Alfalfa.	Clover.	Clover and timothy mixed.	Timothy.	Straw.	Total.
1915.....	21,872	12,131	81	442	1,058	838	36,422
1914.....	13,088	11,558	106	483	1,442	683	27,360
1913.....	13,200	9,270	210	1,156	1,925	597	26,353
1912.....	20,095	8,016	140	670	1,700	561	31,182
1911.....	16,819	6,227	227	970	1,688	442	26,373
1910.....	15,074	3,990	136	883	2,455	500	23,038
1909.....	11,069	2,884	90	733	1,294	374	16,444
1908.....	9,112	2,550	140	1,096	1,738	315	14,950
1907.....	12,417	2,841	124	867	2,840	522	19,611
1906.....	11,197	2,257	53	474	1,945	415	16,188

This hay comes from Kansas, Oklahoma, Nebraska, Missouri, Colorado, Utah, Wyoming, Idaho, New Mexico, Texas, Iowa, Montana, and even Wisconsin and Michigan. It is distributed to every state in the South and East. The development of outlets for this great volume of hay shows the great ability of the Kansas City dealers and the splendid results of their inspection and handling systems. The latter are unsurpassed.

The railroad facilities of Kansas City give the traders there an advantage over all but two or three markets in the country. Sixteen trunk lines converge at this point, besides numerous branches. These lines reach by direct routing to the farthest bounds of the country. At first the roads were rather averse to handling hay, but as the magnitude of the business was gradually impressed upon them, they have cooperated fully with the association. In the past ten years the capacity of the hay tracks has been doubled. At the present time a total of 700 cars per

day can be handled. The various hay yards are laid parallel, the Santa Fe having a capacity for 150 cars, the Missouri Pacific for 120, the Union Pacific, Rock Island and 'Frisco for 75 cars each, and the other roads for lesser numbers.

#### PRAIRIE AND ALFALFA HAY.

The hay trade of Kansas City has grown largely with the increasing popularity of prairie hay and alfalfa. The hay baler has also much to do with the growth of the hay business throughout the country, but the energy of western shippers in advertising the value of prairie hay and encouraging the growth of alfalfa has been the great factor in making Kansas City the hay center of the country.

Prairie hay is native to the plains. The feeding value is not so great as that of the legumes or timothy, and for many years it was set at a much lower estimate than it deserves. Now, however, thanks to the consistent pressure of good advertising, it has gained the recognition and commands a price commensurate with its value. From offerings at \$2 per ton with little demand in former years, prairie reached as high as \$24.50 in 1912, and holds a place consistently at about \$2 to \$4 under timothy and alfalfa.

Alfalfa deserves far more space than we have at our disposal, for it is unquestionably the king of hays, in feeding value, productiveness, soil upbuilding and economy. It ranks with wheat bran in protein content, and mixed with a corn ration is the greatest feed in the world.

The history of alfalfa is interesting, but its familiarity makes it unnecessary to repeat it here. Although one of the oldest feeding stuffs known, if we may believe the archæologists and ancient historians, its use in this country is of recent origin, and even yet is not so widely grown or used as its value warrants. Each year, however, sees an increased acreage and greater popularity among feeders, so that the Kansas City market, which has been foremost in developing knowledge and interest in the legumes, will continue to reap the benefits.

The largest handlers of alfalfa in the world are at Kansas City, and if the market had no other mark of distinction than this it would always be famous as the first to welcome and nourish alfalfa. (See "Marketing," in index.)

---

## MARKETING ALFALFA HAY, FROM THE BUYER'S STANDPOINT.

By J. A. BRUBAKER, of J. A. Brubaker & Co., Kansas City, Mo.

Clearly to point out the greatest good to the alfalfa producer from a buyer's standpoint we must not only study the world's greatest hay market—namely, Kansas City—but also the hay salesman, as well as the hay buyer, the salesman representing the producer and the buyer the consumer, each recognizing that his success depends on his ability to satisfy his client. In fact, they must each guard the interests of their clients to hold their trade. These two representatives, governed by rules of the Kansas City Hay Dealers' Association, protecting both the producer and the consumer, have made this market famous.

The amount of Kansas alfalfa coming to the Kansas City market varies with the season. The heaviest receipts of alfalfa in 1914 were from Colorado; in 1915, as nearly as I can estimate, about 60 per cent of the alfalfa arriving here originated in Kansas. The counties of Kansas that are shipping the bulk of the alfalfa coming to this market are Lyon, Marion, Greenwood, Chautauqua, Cowley, Harper, Morris, Saline, Wabaunsee, Ottawa, Clay, Marshall, Republic, Osborne, Phillips, Chase, Butler, Elk, Sumner, Barber, Dickinson, Geary, Shawnee, Cloud, Riley, Washington, Mitchell, and Smith.

Let us assume that 75 to 85 per cent of the hay arriving here is sold for reshipment, and that the buyer knows whether the consumer wants the hay for horses, mules, cattle, or fancy dairy feeding. The requirements and points he most considers are: feeding value, regardless of color; the general character and condition; the loading, whether full minimum weight, whether bales loaded flat or on edge, the size of the bales (75-pound preferred); and whether well baled. He watches for musty or grass-mixed hay, for stack-spotted bales, for floor bales, ground bales, or otherwise stained bales. To get a more practical understanding of the buyer's needs the reader might imagine himself in Kansas City and follow the writer to the hay tracks where the trading is done.

First let me explain that all hay coming to this market is placed on team track for inspection and sale. A gang of men, called "pluggers," pulls out fifty to seventy bales and piles them on the pavement. The car is opened from end to end. The inspector examines and grades each car. The hay, however, is not sold on his inspection, but is sold on its merits. The buyer and salesman thoroughly examine the car, the one arguing in favor of the quality and the other against it, until finally the trade is made. Here are some practical illustrations:

*First illustration:* Here is a car plugged out. We call every buyer on the market, but they pass by. They do not even get into the car. They are not interested. We work on it the second day with the same results; and the third day, plugged out again. No one wants it. What is the matter? The hay is musty, damaged, hot, has no color. There is no cheap-feed demand. It is a car of hay on which the commission man may earn his commission but upon which he often loses his reputation as a hay salesman. It is the kind of hay the producer should sell or feed at home.

*Second illustration:* This car is of fairly good color, with high feeding value, but the plug shows a few bales slightly stack-stained, or a few ground-stained or otherwise stained bales. It is sold at \$1 to \$2 per ton under what it would have brought had a few bales been kept at home. It officially grades "standard alfalfa, part stained." In other words, do not spoil a good car of hay with a few off bales.

*Third illustration:* Here is a car of high-colored alfalfa, attracting four or five buyers. It is finally sold at \$12. It would have brought \$1 per ton more had it not been for the fact the bales are loaded flat instead of on edge, and a further fact that the hay was sweaty. Remember, hay damages worse when bales are loaded flat. It officially grades "No. 1 alfalfa, part hot."

*Fourth illustration:* This car is strictly uniform, good stock, attracting several buyers, but it sells at some reduction, for the reason the car is loaded below minimum weight and the bill of lading is not protected by inserting "smaller-sized car ordered," naming size of car ordered. Remember the buyer must pay excess freight to its final destination, and the producer must stand the difference, which is considered in the selling price. Remember also that hay poorly baled will cause a loss by breakage and that many markets do not pay for broken bales. The car officially grades "No. 1 alfalfa."

*Fifth illustration:* Here is a car of hay that really needs no introduction. It has the color, the feeding value, is of uniform grade and is loaded to full minimum weight. It attracts all buyers. They bid for it, and it finally sells at 50 cents to \$1 per ton above market quotations. This should be an incentive to the producer, as a premium is generally paid for such high-class goods. It officially grades "choice alfalfa."

The above show how the hay buyer must work for the interest of the consumer and how the hay salesman must work for the interest of the producer. Now let us see for whose interest the Kansas City Hay Dealers' Association is working. In this connection we find it has established scales, weighmasters, track watchmen and inspection. It has brought about uniform minimum weights. It has fought inspection bills at Jefferson City, which otherwise would have cost the producer 50 cents per car extra. It has fought advances in freight rates, both directly and also through the Kansas City Transportation Bureau, at a cost of thousands of dollars, resulting in the building up of the world's greatest hay market for the producer. Not only does the association work for the producer, but its individual members also work for the producer.

The question may arise: Can a producer ship his own hay to market and obtain the same results as a regular shipper? My judgment is that he can. Often he can do it better, if he will take a personal interest in preparing his hay for market and observing the following rules:

1. Always load bales on edge.
2. Load cars of uniform grade. Otherwise advise amount of each grade loaded.
3. Load cars full minimum weight or have bill of lading protected by agent.
4. Send itemized list of bales and weights with bill of lading.
5. Do not load any damaged or spotted bales with good hay.
6. Do not bale hay containing artificial moisture, caused by dew or rain. Remember that hay will cure and take care of its own moisture, while artificial moisture is damaging.

Careful baling and loading are also important. We often receive consignments even of "No. 2 alfalfa" so carefully baled and loaded that it sells for one of two grades higher. This also applies to other grades.

I suggest to the producer that before consigning a car of hay to market that he first prepare his hay as nearly as possible as suggested; and then carefully select a reliable dealer—one that is working for the general good—and be sure such dealer is a member of the Kansas City Hay Dealers' Association, thus affording absolute protection.

Rules of the Kansas City Hay Dealers' Association for grading alfalfa hay:

*Choice alfalfa* shall be reasonably fine, leafy alfalfa of bright green color, properly cured, sound, sweet, and well baled.

*No. 1 alfalfa* shall be reasonably coarse alfalfa of a bright green color, or reasonably fine, leafy alfalfa of a good color, and may contain 2 per cent of foreign grasses; 5 per cent of air-bleached hay on outside of bale allowed, but must be sound and well baled.

*Standard alfalfa* may be of green color, of coarse or medium texture, and may contain 5 per cent foreign matter; or it may be of green color, of coarse or medium texture, 20 per cent bleached and 2 per cent foreign matter; or it may be of greenish cast, of fine stem and clinging foliage, and may contain 5 per cent foreign matter. All to be sound, sweet, and well baled.

*No. 2 alfalfa* shall be of any sound, sweet and well-baled alfalfa, not good enough for standard, and may contain 10 per cent foreign matter.

*No. 3 alfalfa* may contain 25 per cent stack-spotted hay, but must be dry and not to contain more than 8 per cent of foreign matter; or it may be of a green color and may contain 50 per cent of foreign matter; or it may be set alfalfa and may contain 5 per cent foreign matter. All to be reasonably well baled.

*No grade alfalfa* shall include all alfalfa not good enough for No. 3. (See "Marketing," in index.)

---

## MARKETING ALFALFA HAY, FROM THE SHIPPER'S STANDPOINT.

By A. B. HALL, Manager Lyon County Farmers' Produce Association, Emporia.

No one realizes so much the loss by careless handling and poor judgment in caring for alfalfa hay as the shipper. In Lyon county our first crop is usually harvested about the 15th of May, if the weather is favorable and other work out of the way. This year (1915) some growers cut as early as May 1, and others did not get through until about July 1 and harvested two crops together, on account of the very wet season. On account of the first crop coming on so early in the spring, when the days are short and the nights cool, together with heavy dews, it is very difficult to get all well cured, keep the green color, and save the leaves. To have high-grade alfalfa one must have the "clinging foliage" and the color, and the man who has not the patience to *wait until just the right time*, and who has not the judgment to *know just the right time*, will never succeed in producing high-grade alfalfa hay.

It is a fact that some farmers never have any first-grade alfalfa, for the simple reason they do not care for it when it should be raked, and often a good grade will be spoiled by sun-cured streaks through the bales and depreciate the value as much as \$2 per ton, when there is no other reason than carelessness or lack of judgment. Any one can mow hay, but the man who knows just when to rake it, and does it, to get the most leaves and save the color, is the man to be patterned after.

The most economical way is to bale from the windrow. Here again judgment must be used. We have learned that hay can be baled as green as when stacked, but "judgment" again must be used in caring for it after the baling. It is a fact that if hay is put in large stacks or put in the mow with a fork, that where the large forkfuls fall it will shatter the leaves and press down so hard that it will exclude the air and cause the hay to burn, and will come out brown instead of green; whereas, if it is baled instead of stacked, piled on edge in the same position that it comes from the press, and piled loosely to allow air to pass through the pile, this hay will be in better shape than the hay that is put loose in the barn. The difficulty in putting hay loose in the barn and baling afterward is, first, the extra expense; second, it is hard to find a time when the hay can be baled to save all the leaves like when it is raked at the right time and baled from the windrow.



Fig. 370. Usually the baler is kept busy all the afternoon, and the bales are covered with tarpaulins over night, and hauled-in the next morning by the extra men, while the mowers are busy getting down more hay.

It is usually the case that the baler is kept busy all the afternoon, and that bales are covered with tarpaulins over night, and are hauled-in the next morning by the extra men, while the mowers are busy getting down more hay. When hay is to be piled in the field overnight, loose hay should be piled under the bales to keep moisture from being drawn from the ground. In storing baled hay, unless it is good and dry, it should be piled in the barn loosely to prevent heating, and later repiled more closely if storage room is scarce.

The first crop of alfalfa hay is, as a rule, not salable early in the season, and should be sold in the winter season for best results. This crop is best adapted for horse and mule feeding, as it is richer in protein than the later crops. To bring the best price alfalfa hay must be cut before the stems get harsh. The dairymen will not use harsh or woody hay, but will pay fancy prices for "soft," fine-stemmed alfalfa. Our farmers here feed the off-colored alfalfa, having learned that the color

makes no great difference where the hay has been properly cured and baled dry.

With the second and the later crops we have very different conditions. The days are much longer and the ground usually drier, and the stems finer, making it much easier to cure. If the weather is favorable we can ship these crops from the windrow direct, as there is always a demand for good, high-grade alfalfa hay.

The "five-man" hay press is a curse to this country. To get them to pull into your field you must have twenty acres cut down at one time. If something happens that they are a day behind time your hay is in the windrow "sunburning," and it will show in every bale, or it is too dry and the leaves are wasting. We have seen twenty acres of alfalfa in the swath and windrow, a big press just starting on the job, and a rain in sight. This means a loss of not less than \$100. We advocate smaller presses. Instead of cutting down twenty acres, make it ten. Then if the rain slips up on you there is only half the loss, with a prospect of



FIG. 371. Feeding a power baler.

getting the other ten up when the weather is better. We believe we are in a position to criticize when we have shipped hay by the hundred cars, and no one knows the loss to the farmers more than we do.

A hay rack for baled hay should be made with a tight floor, and at the edge a 2 by 4 should be used to make it stronger and keep the bales from slipping. To load bales to ride well one should load the end of the bale that comes from the press first on the inside, and turn the bale over and put the top, or rough, edge down and the large end out. After the first tier is complete, pile a row lengthways of the wagon, four bales wide, laid flat, and the full length of the rack, which ties the load. Then pile the next tier crossways, the same as the first tier.

We prefer the 36-foot car to load. Instead of crowding in all the bales we can, we place six bales edgeways across the end of the car. This will leave a space between each bale. Finish the tier the same way, all edgeways, six bales wide and five high, making thirty to the tier. If the hay is properly baled there is no trouble in getting the minimum, 22,000 pounds, in the car. If the bales should be less than 60-pound, order a high, 40-foot car, which takes a minimum of 24,000 pounds, and will hold about one-fourth more.



FIG. 372. Place the bales on the wagon so that the load is tied and will ride well.

In conclusion I would say that too many farmers use the same methods in taking care of their alfalfa that they used in taking care of prairie hay years ago—mow a lot down, rush it up in any shape, then wonder why there is a difference of \$6 per ton between fancy and common hay. Every farmer should spend some time on a large market and see how the buyers will stop when they come to an extra fine car of alfalfa hay. Out of 150 cars of hay one may not find this car of fancy hay every day, but you will find the man who takes the best care of his hay gets the most money for it. The old saying, "Anything well bought is half sold," let us change to "Alfalfa hay well made is half sold." (See "Marketing," in index.)

---

I will say that I have yet to learn the value of alfalfa. It is the main stand-by of this dry country. My alfalfa has made good on all the land that I have, at the rate of fully ten per cent on a valuation of one hundred dollars per acre.—*A Rawlins county correspondent.*

Too much can not be said about the usefulness of alfalfa as a stock feed and as a pasture for grazing hogs. It reduces the cost of hog production one-half, in my estimation, and keeps them healthy and in good growing condition. There is no roughage that equals alfalfa for all kinds of live stock. Furthermore, it is one of the very best means of renewing worn-out soils, as nothing will renew depleted wheat lands so cheaply as will alfalfa.—*A Russell county correspondent.*

**MEASURING HAY.**

By A. M. TEN EYCK, in Kansas Agricultural Experiment Station Bulletin No. 155.

The rules for measuring hay in the stack may vary according to the length of time the hay has been stacked, the kind and quality of the hay, and also according to the character of the stack. With alfalfa hay which has been stacked for thirty days it is usual to compute an 8-foot cube, or 512 cubic feet, as a ton. When the hay has been stacked five or six months a 7½-foot cube, or 422 cubic feet, is usually calculated for a ton. In old, fully-settled stacks it is usual to allow a 7-foot cube, 343 cubic feet, for a ton; or sometimes, in very large stacks or mows, only 216 cubic feet, a 6-foot cube, are allowed per ton in weight.

The volume of mow is readily secured by multiplying together the length, width and height. There are different methods for measuring hay in the stack, depending upon the shape of the stack and also upon its size. With a long stack or rick the usual method is to throw a line over the stack, measuring the distance in feet from the bottom of the stack on one side to the bottom on the other; add to this the average width of the stack in feet, divide this sum by 4 (which gives one side of the square), and multiply the quotient by itself, and this product by the length of the stack in feet. This will give the number of cubic feet in the stack, which may be divided by 512, 422, or 343 (the number of cubic feet in a ton), in order to find the number of tons. For small, low ricks the rule is to subtract the width from the "over," divide by 2, multiply by the width, and multiply the product by the length, dividing the result by the number of cubic feet in a ton.

There is no established rule for measuring round stacks, but this one will approximate the contents of a stack of ordinary conical form: Find the circumference at or above the base or "bulge," at a height that will average the base from there to the ground; find the vertical height of the measured circumference from the ground, and the slant height from the measured circumference to the top of the stack, taking all measurements in feet. Multiply the circumference by itself and divide by 100 and multiply by 8, then multiply the result by the height of the base, plus one-third of the slant height of top. The hay in a round stack is usually less compact than in a rectangular stack, hence a greater number of feet should be allowed for a ton, with well-settled hay probably 512 cubic feet.

The rules given may also be used in measuring any kind of hay, or cane or kafir fodder, but with cane or kafir only approximate results may be secured by stack measurements, because the fodder is apt to vary greatly in weight according to the moisture it contains.

## ALFALFA'S EFFECT UPON THE SOIL.

By J. T. WILLARD, Dean of the Division of General Science and Professor of Chemistry, Kansas State Agricultural College.

The most imperative duty of all cultivators of the soil is to conduct their art in such a manner as to conserve fertility. The world can no longer send its waves of surplus population over unpeopled areas or against savage aborigines. At least if the foregoing is not literally true, it will be within a century, and at the present time the effect of diminished returns from the soil must be corrected by treating the soil, not by abandoning it and exploiting fresh areas.

That crops differ in their effect upon a soil is well known, and the benefits following seeding to grass, especially if clover accompanies it, and from growing clovers alone, have been known from time immemorial. There are several elements that participate in the general results, and a clear recognition of these is not always made by practical men. Lack of knowledge on some phases of the practice leads to misapplication of effort, and misunderstanding of the results obtained. To set some of these considerations in a clear light is the object of this article.

All crops take up from the soil certain chemical elements necessary to their growth. These are deposited in the roots, stems, leaves and seeds, and in so far as these parts are removed from the land it suffers a loss of the absorbed material. Some of the elements in plants come from the air, and of these there is thus an amount available that is practically unlimited. The carbon, oxygen and hydrogen of plants are furnished chiefly by carbon dioxide in the air, and water in the air and soil. The nitrogen of plants may be traced to the atmosphere as its original source, but the soil contains the immediate supply of this element for most species of plants. The phosphorus and sulphur which plants contain comes entirely from the earth, and the same is true of the metals, iron, sodium, potassium, magnesium and calcium. In considering the problem of the fertility of the land, the chemical elements usually considered are calcium, potassium, phosphorus and nitrogen. The residue from plant or animal life existing as the humus or organic matter of the soil is of high importance also. This contains much carbon, and more or less of all of the chemical elements which enter into the plants.

The purpose of crop production is to obtain something that may be removed from the soil and converted to the use of man. Any crop that is raised merely to be plowed under is a means to the general end of obtaining something that may be removed. It is this removal of material that lies at the foundation of soil exhaustion. Unfortunately agricultural operations also cause loss of material that never gets into the crops. The relation of alfalfa-growing to soil fertility will now be presented in the light of the foregoing fundamental considerations.

Alfalfa is commonly classified as a legume, and belongs to one of the most important families of plants, many species of which are of great economic value to man as sources of food for himself or domestic ani-

mals. A notable feature of their nutritional characteristics is the high per cent of nitrogenous material, especially proteins, present in them. The presence of these nitrogenous substances constitutes one of the most important factors involved in the relation of alfalfa to soil fertility. In respect to metals present, alfalfa, like red clover, beans, peas and other leguminous plants, is notable for the large amount of calcium in its tissues. This metal is that found in limestone and lime, and in gypsum or land plaster. The needs of alfalfa for calcium extends to the requirement that the calcium carbonate of limestone be present in the soil in such quantities as to insure neutralization of the acids produced by the decay of organic matter, as well as to supply the necessary calcium. The accompanying table shows a comparison of the percentages of potassium, phosphorus and nitrogen present in the feeds named.

TABLE No. 52. Fertilizing constituents in certain feeds. Pounds per hundred-weight of the substances.\*

	Potassium.	Phosphorus.	Nitrogen.
Alfalfa.....	1.48	0.27	2.34
Red clover.....	1.55	0.24	1.97
Timothy.....	1.18	0.14	0.94
Corn silage.....	0.31	0.05	0.43
Corn stover.....	0.90	0.17	0.61
Corn grain.....	0.47	0.31	1.65
Wheat straw.....	0.52	0.10	0.50
Wheat grain.....	0.72	0.24	1.90
Wheat bran.....	1.26	1.17	2.46
Oats straw.....	1.47	0.13	0.58
Oats grain.....	0.40	0.34	1.82
Linseed meal.....	1.11	0.78	6.00
Tankage.....	0.25	0.61	8.62
Potatoes.....	0.48	0.07	0.34

\*Data obtained from Henry's "Feeds and Feeding."

The draft of any crop on the fertility of the soil depends not only on the composition of the crop but on the total weight of the crop. Taking as a basis the composition shown in Table 52, Table 53 shows the quantities of the several constituents that would be removed per acre with the yields stated. The yields assumed, and the relation of grain to stover or straw, have been chosen largely on the advice of Prof. L. E. Call, who has made numerous observations at the Kansas Experiment Station. The yields assumed are very moderate when compared with possibilities and with actual products often obtained, but are in excess of the average in this state. It need hardly be stated that with the great differences in the yields of grain, depending on seasonal characteristics, there are correspondingly great differences in the relation between grain and straw.

Inspection of Table 53 shows that alfalfa exceeds all of the other crops in the list in total yield, and far exceeds them in the weights of potassium, phosphorus and nitrogen contained in the crop. Attention may be drawn to the fact that such tables serve only as general guides, as the composition of crops varies considerably with the differences in composition of soils. The most favorable results require at least certain supplies of mineral substances, and probably definite quantitative re-

lations among them, but, in the presence of lavish or excessive supplies, plants will take up unnecessary quantities of one or more. The kind and amount of substances absorbed depends on a number of conditions besides the actual needs of the plants. The differences shown by alfalfa as set forth in Tables 52 and 53 compared with Table 54 bring out clearly the variability of such data.

TABLE No. 53. Pounds of fertilizing constituents per acre removed by certain crops when producing the yields stated; the composition shown in Table No. 52 being assumed.

	Yield, pounds.	Potassium.	Phosphorus.	Nitrogen.
Alfalfa.....	5,000	74.00	13.50	117.00
Red clover.....	2,500	38.75	6.00	49.25
Timothy.....	3,000	35.40	4.20	28.20
Corn Stover.....	2,450	22.05	4.17	14.95
Corn grain.....	1,400	6.58	4.34	23.10
Corn, entire crop.....	3,850	28.63	8.51	38.05
Wheat straw.....	1,620	8.42	1.62	8.10
Wheat grain.....	1,080	7.78	2.59	20.52
Wheat, entire crop.....	2,700	16.20	4.21	28.62
Oats, straw.....	1,125	16.54	1.46	6.53
Oats, grain.....	900	3.60	3.06	16.38
Oats, entire crop.....	2,025	20.14	4.52	22.91
Potatoes.....	2,800	13.44	1.96	9.52

For more detailed exposition of the relation of the alfalfa crop to soil fertility attention may be given to Table 54. This exhibits results obtained by the analysis of alfalfa cut at the Kansas State Agricultural

TABLE No. 54. Fertilizing constituents in alfalfa cut at different stages of maturity.

	In bud.		One-tenth in bloom.		Full bloom.		In seed.	
	Per cent.	Pounds per acre.	Per cent.	Pounds per acre.	Per cent.	Pounds per acre.	Per cent.	Pounds per acre.
Total yield.....		6281.50		5822.90		4886.60		3879.40
Nitrogen in crop...	3.40	213.61	3.13	182.16	2.81	137.10	2.52	97.98
Phosphorus in crop,	0.28	17.77	0.23	13.65	0.18	8.88	0.18	7.11
Potassium in crop..	3.79	238.20	3.25	189.63	2.57	125.68	2.24	87.05
Calcium in crop....	1.37	85.77	1.45	84.66	1.52	74.53	1.47	56.95

College during the season of 1914.\* The total yield and the composition as to fertilizing constituents is shown for alfalfa cut throughout the season at the several stages of development stated. Thus the yield when each crop on one plot was cut at the bud stage of growth was 6281.5 pounds. This was obtained in six cuttings. At the other stages five, four and three cuttings, respectively, were obtained. Not only are great differences in the totals of the fertilizing constituents shown such as must be expected from the difference in the total yield, but the several products are materially different in the percentages of these ele-

\* Published by permission of the director of the Agricultural Experiment Station.

ments. In selling or buying alfalfa hay these differences in composition should never be overlooked.

The raw materials used in the manufacture of commercial fertilizers could be furnished, just before business was demoralized by the Great War, at prices that were the basis for the following valuation of the elements: Potassium, 6.02 cents a pound; phosphorus, 9.16 cents; nitrogen, 16.5 cents. Leaving the calcium out of account, the alfalfa crop per acre for the season, obtained by cutting the plant when about one-tenth in bloom, carried potassium that in a commercial fertilizer would have cost \$11.42, phosphorus worth \$1.25, and nitrogen worth \$30.06, besides the cost of manufacture of the fertilizer, marketing it, and transporting it to the point of consumption. These figures give a fair idea of the actual fertilizing value of a crop of less than three tons of alfalfa hay cut when one-tenth in bloom, if the elements could all be returned to the land.

In the preceding paragraph data derived from the alfalfa crop cut when one-tenth in bloom have been used, as that stage is one frequently taken for cutting the crop. Comparison of these data with those for alfalfa cut at other stages shows that in respect to percentage composition the calcium varies least, indicating that, on the College soil, as the plant matures the calcium, or lime, compounds continue to be absorbed at about the same rate. With nitrogen, phosphorus and potassium there is a steady diminution in the percentages present as the crop advances in maturity. As the total yield for the season is less the more mature each cutting is permitted to become, the conjunction of lower yield and lower percentage of the several elements causes very great differences in the total quantities removed. Thus the six cuttings of alfalfa in the bud removed more than twice as much nitrogen, phosphorus and potassium as did the three cuttings made when the plant was in seed. At the same time the calcium removed was over 50 per cent greater.

It is seen, thus, that the actual quantity of the elements of fertility removed in the alfalfa crop will vary with yield and time of cutting, and it also varies with the soil. Since all agriculture works toward the removal of as large crops as can be obtained, it will be seen that the tendency is toward a system that removes much fertility from the land, and that the actual money value of the fertility in an alfalfa crop is very large.

The element in the alfalfa that contributes most to its fertilizing value is the nitrogen, and we should be making a grave mistake if we considered that this element is all drawn from the soil. As is now well known, leguminous plants harbor bacteria on their roots which have the power to absorb nitrogen from the air in the soil and to build it into their organic tissues, and later these tissues undergo changes and their nitrogen becomes available to the host plant. Alfalfa possesses this power to a high degree, and by means of it a large part of the nitrogen of the crop is obtained indirectly, but with little delay, from the limitless store of the atmosphere.

The extent to which the nitrogen of the alfalfa crop is supplied by the air can not be stated with any degree of certainty. Observations and analyses directed towards the solution of this problem are very

complicated and difficult. Alfalfa roots penetrate to such depths that it is not possible to know how great a mass of soil is subject to draft. Accurate sampling of soils, and especially taking account of the alfalfa roots, etc., in the soil, is very difficult. The relation of the weight of the roots left in the soil to that of the crops removed is a vital part of the problem, but it is practically impossible to handle this satisfactorily for field conditions. One thing well established is that on soils rich in nitrogen alfalfa will get much of its supply of that element from the soil, but on soils poor in nitrogen it depends more upon the help of the bacteria. We may say with comparative safety that alfalfa grown on soils poor in nitrogen will, by means of the roots, and stubble and dropped leaves, add to the soil more nitrogen than it removes, and that, therefore, although much nitrogen may be removed in the crops, the soil will be enriched in that element. On the other hand, soils rich in nitrogen will lose some of their store even when planted to alfalfa or other legumes. With a certain intermediate composition there would be equilibrium, and on the whole neither gain nor loss of nitrogen.

This capacity of alfalfa to add nitrogen to soils that are deficient in that element constitutes one of the most important characteristics that the plant possesses in relation to fertility. Nitrogen is likely to be the element that is first to become deficient in Kansas soils, and alfalfa culture is in many parts of the state the most readily available means of restoring it. To do this most effectively, however, one should not depend merely upon the residues of roots, stubble, etc., left in the ground, but should feed the alfalfa crop on the place as much as possible, and apply the manure produced to the farm. This procedure has the additional merit that the potassium, phosphorus and other elements will also be largely returned at the same time.

Another important benefit to the soil accompanying alfalfa production is due to the addition of organic matter or humus that takes place. Organic matter is the storehouse of nitrogen, and to an extent of mineral substances, and it confers highly important physical and chemical properties. Soil well supplied with humus departs itself more favorably toward drouth, flood, heat and cold. By its decay it yields acids that attack the silicates, phosphates and other difficult soluble mineral constituents of the soil, and brings them into a condition to be used by plants. A complete discussion of the relations of humus to soil value would require many pages, but here it must suffice to have pointed out the important function that alfalfa serves in adding this substance to fields on which it grows.

In respect to potassium and phosphorus, which are taken wholly from the land on which the crops grow, inspection of Table 53 shows that alfalfa removes two, three, four, or even more, times as much as do most other crops. Hence, whatever may be the capacity of a soil to supply these elements, it is taxed much more by alfalfa than by ordinary crops. This is a fact very frequently unrecognized by farmers. Their attention is so closely fixed upon the beneficial results accruing to a soil by the addition of humus and nitrogen that they fail to attend to the equally important fact that calcium, potassium and phosphorus are

TABLE No. 55. Composition of soils in alfalfa, and of adjacent soils kept in other crops or native grass.\*

CONSTITUENT.	Stratum, inches.	1a. Alfalfa 13 years.		1b. Corn, kafir corn, and other small grain.		1c. Native meadow.		2a. Alfalfa, 10 years.		2b. General grain farming.	
		Per cent.	Pounds per acre.	Per cent.	Pounds per acre.	Per cent.	Pounds per acre.	Per cent.	Pounds per acre.	Per cent.	Pounds per acre.
Nitrogen	0-7	0.131	2,620	0.110	2,200	0.186	3,720	0.168	3,360	0.135	2,700
	7-20	0.106	4,240	0.094	3,760	0.114	4,560	0.087	3,480	0.076	3,040
	20-40	0.054	3,240	0.050	3,000	0.067	4,020	0.038	2,280	0.043	2,580
	0-40	0.084	10,100	0.075	8,960	0.103	12,300	0.076	9,120	0.069	8,320
Phosphorus	0-7	0.036	720	0.034	680	0.046	920	0.043	860	0.038	760
	7-20	0.022	880	0.028	1,120	0.034	1,360	0.034	1,360	0.016	640
	20-40	0.029	1,740	0.025	1,500	0.037	2,220	0.023	1,380	0.026	1,560
	0-40	0.028	3,340	0.028	3,300	0.038	4,500	0.030	3,600	0.025	2,960
Potassium	0-7	1.080	21,600	1.120	22,400	1.070	21,400	1.410	28,200	1.430	28,600
	7-20	1.200	48,000	1.200	48,000	1.070	42,800	1.430	57,200	1.470	58,800
	20-40	1.320	79,200	1.310	78,600	1.140	68,400	1.460	87,600	1.480	88,800
	0-40	1.240	148,800	1.240	149,000	1.110	132,600	1.440	173,000	1.470	176,200
Calcium	0-7	0.429	8,580	0.510	10,200	0.580	11,600	1.410	28,200	1.050	21,000
	7-20	0.485	19,400	0.570	22,800	0.630	25,200	1.190	47,600	1.330	77,200
	20-40	0.506	30,360	0.640	38,400	0.530	31,800	2.170	130,200	2.460	147,600
	0-40	0.486	58,340	0.595	71,400	0.572	68,600	1.720	206,000	2.048	245,800
Organic carbon	0-7	2.070	41,400	1.730	34,600	2.590	51,800	2.280	45,600	2.040	40,400
	7-20	1.350	54,000	1.250	50,000	1.640	65,600	1.130	45,200	1.050	42,400
	20-40	0.800	48,000	0.710	42,600	0.910	54,600	0.600	36,000	0.590	35,400
	0-40	1.200	143,400	1.060	127,200	1.430	172,000	1.060	126,800	0.980	117,800
Inorganic carbon	0-7	None.	.....	None.	.....	None.	.....	0.260	4,000	0.070	1,400
	7-20	None.	.....	None.	.....	None.	.....	0.090	3,600	0.370	14,800
	20-40	None.	.....	0.010	600	None.	.....	0.290	31,800	0.610	36,600
	0-40	None.	.....	0.005	600	None.	.....	0.330	39,400	0.440	52,800

\*Published by permission of the director of the Agricultural Experiment Station.

diminishing rapidly. On ordinary soils it can scarcely be doubted that when alfalfa is grown for a long series of years the productivity can be maintained only by surface application of manures that will restore these elements, though the humus that the alfalfa provides will assist in unlocking the soil stores of these elements contained in difficultly soluble minerals. So, too, when alfalfa fields are broken up and put into other crops, while the nitrogen may be more than adequate, the other critically essential elements may have been reduced to insufficiency.

Study of Table 55 will be profitable from several points of view. It gives results of the analysis of two soils, three samples from one and two from the other. The first is located in the west central part of Montgomery county. The samples *a*, *b* and *c* are from points in close proximity, which have been very differently treated; *a* has been in alfalfa for thirteen years, *b* in corn, kafir corn and small grains, and *c* was unbroken native grass meadow. The second soil is located in the south-east part of Montgomery county. The part from which *a* was taken had been in alfalfa for ten years, while *b* was from a field that had been used for general grain farming. With both of these soils the fields to be compared lay in such a way that it seems that they were very similar in composition originally. The results of the analyses are not consistent in all cases with what might be expected, and possibly this is due to original soil differences. The table shows the composition of the upper seven inches, the next thirteen inches, the next twenty inches, and all of these together, or the surface forty inches. Doubtless alfalfa roots penetrated to a greater depth, but those of other crops would do so to but a very limited extent.

The figures show that in almost every case the native meadow was richer in nitrogen, phosphorus, potassium, calcium and organic carbon, the last of which represents the humus, than the field in alfalfa, or that which had been cropped to grains. When the fields in alfalfa are compared with those used for grain farming it is seen that the figures for nitrogen are slightly higher for the alfalfa fields; those for phosphorus and potassium are almost identical; those for calcium lower for the alfalfa fields; those for the organic carbon notably higher in one case and slightly higher in the other case for the alfalfa field. Considering the difficulties of such investigation, the analyses are, on the whole, a remarkable confirmation of what should be expected, viz., that all crops exceed native meadow in their draft upon the minerals of the soil; that grain crops reduce the nitrogen and the organic matter greatly; that alfalfa, while removing metals as rapidly as do grain crops, tends to maintain the nitrogen and the organic matter. (See "Soil," in index.)

---

The secretary of the Kansas City Hay Dealers' Association says: "Ninety per cent of our inquiries are for pea-green hay, and of these inquiries only about 5 per cent can be satisfied. This causes buyers to pay \$3 to \$4 a ton premium for color, and until such time as the inquirers learn that color is not the most important element it is to the producer's interest to preserve the color, if possible."—*Farmers Mail and Breeze*.

## ALFALFA'S PLACE IN FARM MANAGEMENT.

By P. E. CRABTREE, Specialist in Farm Management, Kansas State Agricultural College.

The growth of the alfalfa industry in the state of Kansas indirectly suggests the adaptability of this crop to our soils and our climates. Very few states in the Union have the variation in altitude, rainfall, wind velocity and nightly temperature that Kansas has. Geologically, the variation in our soil and subsoil is equally as great. We have reason to be thankful that a very large area of it is especially adapted to the heavy production of alfalfa.

Alfalfa is well suited to farm use. It is always well for the *producer* of a product to be also the *consumer*, as largely as he can profitably utilize the product, for in so doing he eliminates all middlemen's profits and usually two or more items of transportation. Definite application of thought along this line will usually disclose that a general plan of producing the commodities required on the farm is associated with highly satisfactory returns for any effort thus put forth.

In the use of alfalfa on the farm where it is grown, the general practice of animal husbandry, without which a really permanent system of agricultural pursuit has never yet been found possible, is encouraged. Probably the fundamental consideration in the encouragement of animal husbandry is the conservation of soil fertility. In addition to this, the farm product is manufactured into a more condensed form, in which there is often distinct advantage. A farm may be located a considerable distance from transportation lines and in the condensed form of animals or their products the crops may be more cheaply and conveniently transported to market.

Alfalfa scores another point for farm use in that it is a ration balancer. In this capacity it combines properly with many home-grown products, enabling them in turn to be utilized on the farm, for in its protein content it is by far the cheapest source available for general farm use. Indeed, where alfalfa is lacking on the farm, I am sorry to admit, too often no definite attempt is made properly to balance the live-stock rations, greatly at the expense of health of the animals and at the restriction of the profits obtainable.

With any living animal one of the important considerations with proper digestion is palatability. Without palatability the necessary digestive secretions are not called into action, and consequently the eaten food does not receive proper chemical treatment. On account of its palatability, no better relish has ever been found for live stock and poultry than alfalfa.

As a farm pasture, on the whole, nothing else compares favorably with alfalfa. It is early, it is late, it is constant, it is almost continuous. As to its palatability, ask the hog, ask the hen, ask the horse. True, it is, on the average, a dangerous plant on which to pasture "ruminating" animals; so please otherwise provide for the pasture of the cow, the sheep, and the goat.

We can well afford to consider the "manurial" value of any foodstuff. On reference to circular No. 25, Michigan Experiment Station, we are told "a ton of alfalfa hay contains 46.5 pounds of nitrogen, 12.2 pounds of phosphoric acid, and 35.8 pounds of potash, and that its total present value, if purchased as commercial fertilizer, would be \$10.82." Think of the opportunity thus offered to a person wishing to build up a depleted farm in cheerfully becoming a large buyer of alfalfa hay, and by feeding it to animals *worth their feed*, thus practically secure its full feeding value free of cost; for the hay can often be procured at the said \$10.82 per ton—in other words, its fertilizer value.

When we come to realize that 77 per cent of the air is "free nitrogen," in connection with the ability of alfalfa to capture this nitrogen, we must conclude that no thoughtful farmer can neglect to "cash his opportunity" by a somewhat liberal use of the plant, Kansas air being plentiful and nitrogen now selling at eighteen cents per pound. Our humble servant, alfalfa, is easily queen of all the legume family of plants for this purpose.

In utilizing man labor and horsepower alfalfa easily heads the list. In most instances only one cultivation is required, and it may be performed at almost any season of the year when the field is unoccupied by growth and the soil found in workable condition.

The harvesting date is not condensed and exacting, as is the case with wheat and many other crops, but instead is distributed over a few months of the year, which besides being a relief to both man and beast, also greatly assists in storage space required, wherever the crop is to be placed under roof, for the lapse of time permits the mass to settle very materially and thus occupy so much less space.

Again, if a definite limited space under roof or stack cover is to be utilized for the care of the season's crops, this separation of harvest dates enables one in the meantime nicely to dispose of the previous cutting by sale or use, or at least greatly to condense it by baling at his leisure between successive cuttings.

Few crops enjoy the popularity as a "selling crop" that alfalfa enjoys. It is considered an "article of commerce" in one or more of its various forms throughout almost the entire civilized world. From the farmer's point of view, selling the crop is excusable only when he is sure that he can spare the soil fertility which it contains, which in some special instances is even true.

Next, selling from the farm might be indulged in where the farmer finds he can purchase soil fertility in other form that will repay that contained in the crop, and at such price as to leave him a margin of profit on the double transaction (which is almost never possible).

We have a few isolated instances wherein selling outright can be indulged in rather freely. There are places in Colorado where the irrigating water fully supplies the drain on potash, and largely also that on phosphoric acid, while the alfalfa plant utilizes the nitrogen from the atmosphere, thus reducing soil-exhaustion to a minimum. In our own state what is called the "Garden City district," in Finney county, is most favorably located for the production of alfalfa in very large quantities. There the soil is specially adapted to its most perfect develop-

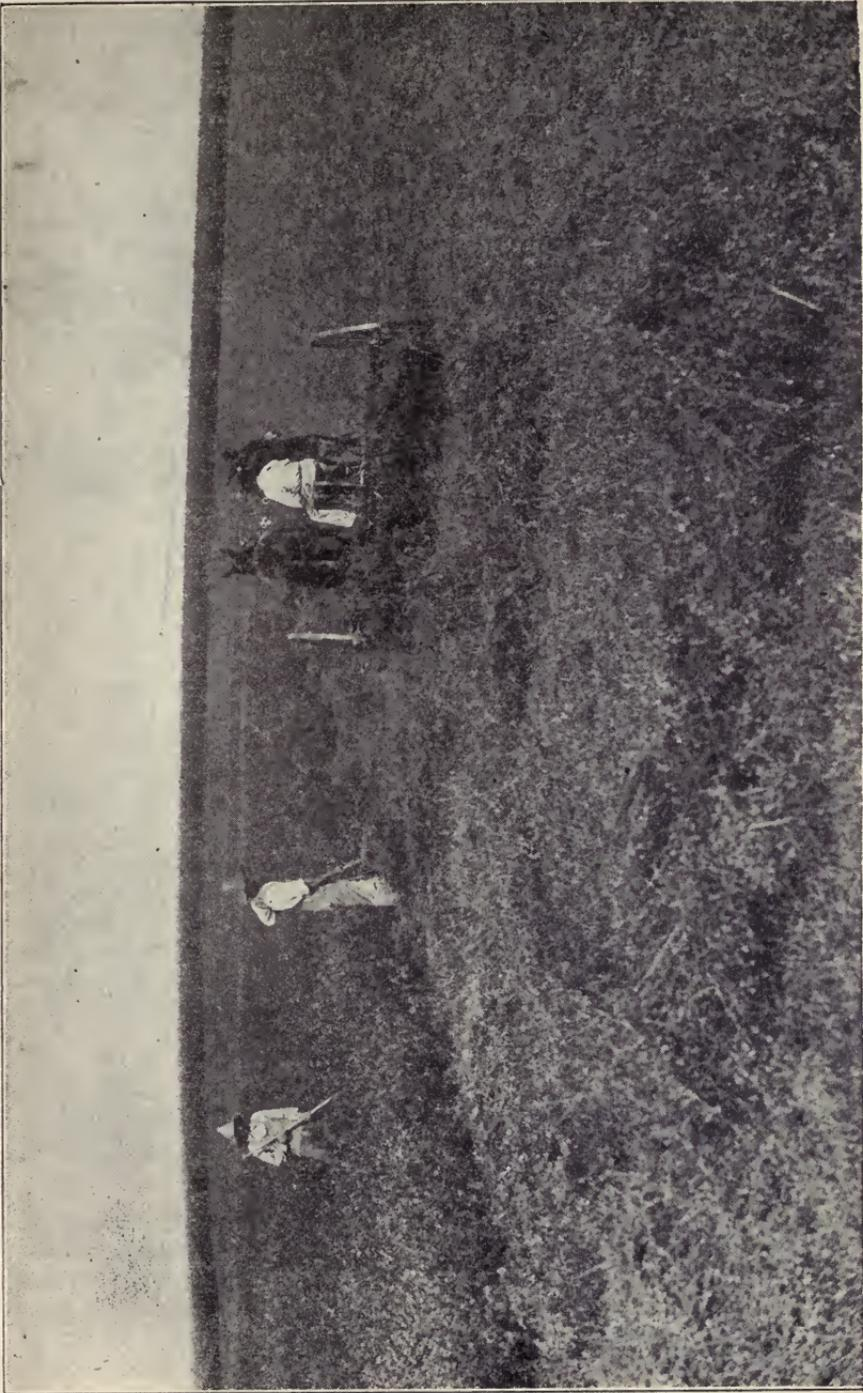

FIG. 373. Alfalfa and corn make a profitable combination.

ment. Besides vast areas of "underflow" land, where irrigation is seldom or never needed, there are some hundreds of irrigating plants. Under these unusually favorable conditions it is not strange that the farmers are often willing to sell the crop entire.

In this connection there are other points to consider, one of which is the *selling value*. Corn has a great range in selling value, and last year reached the handsome figure of \$28.57 per ton. Alfalfa, likewise, has had selling values varying all the way from \$6.50 to \$17 per ton. Be that as it may, we are told that when alfalfa hay is intelligently fed to a good class of market animals it has an average *feed value* of not less than \$21 per ton. This conclusion is not hazarded on the cost price of the feeds, but instead is based on the selling prices of the animals produced by correct feeding, the same disposed of on the general market. Before selling alfalfa hay from the farm the farmer should reckon the profits to be made from feeding it.

No one for a moment questions the permanency of the growing demand for alfalfa in its various forms. On the farm it is in increasing demand as a pasture, most especially for hogs and for poultry, and regularly supplies a fair amount of winter pasture for horses as we more nearly approach the western border of our state.

As a roughage it is preëminently the best, outranking by far any other roughage that is to be used *alone*, and in addition *combines* best of all with the various available grains and chopped feeds for the finishing or heavy feeding of grain-fed animals.

As a base for condimental stock foods it is practically never overlooked. Its absorbent powers commend it highly as a base for molasses and other liquid or semiliquid substances, and its chemical content is in pleasing contrast to the great majority of materials available for such manufacture, which explains the tremendous demand for first-class alfalfa to be sent to the manufactories.

With the above advantages, alfalfa stands very high in its encouragement of a desirable husbandry. It also is a great help in supplying constancy of labor at home, thus enabling the farmer to keep competent help regularly occupied. For these and other reasons, but particularly because of the encouragement of animal husbandry, alfalfa as a farm crop ranks at the top, from a farm management point of view. (See "Profits," in index.)

---

I had one bottom field that made me over \$30 profit per acre last year, and some have done even better. I think much of alfalfa.—*A Bourbon county correspondent.*

From a recent farm-management survey, the Wisconsin College of Agriculture concludes: "That alfalfa is a profitable crop is shown by the fact that the farms that grow it are making large profits. This is illustrated by the following figures taken in connection with our farm-management work:

377 farms growing alfalfa made a profit of \$1200 per farm.

511 farms with no alfalfa made a profit of \$728 per farm."

—*Hoard's Dairyman.*

## GENERAL INDEX.

- Acid soils (see "Soils, acid")  
Acreage, in Kansas, by counties, 1891 and 1915, 5  
— by thirds, 16  
— distribution (Fig. 4), 18  
— irrigated, 165  
— seed, annually, 117, 124  
— total, 1891 to 1915, inclusive, 4  
— in other states, 6  
Acres per grower, 11  
Adaptability, 182, 469  
Africa, history in, 173, 175  
Age, fields, 13  
— seed, will keep, 47, 208  
Air, forcing through hay in mow (Fig. 210), 261  
Albrecht, H. W., article, 216  
Altitude of Kansas (Fig. 7), 23  
Analysis, chemical, of alfalfa (see "Composition")  
— seed, by Agricultural College, 210, 214  
— soil, by Agricultural College, 237  
Anderson, Gust., early seeding in Kansas, 12  
Ant, mound-building prairie (Fig. 342), 393  
Arabian alfalfa, 184  
Arabs, history with, 175  
Army worm (Figs. 326 to 330), 156, 160, 379, 383  
Aroma, in hay, 73, 243  
Asia, history in, 171, 173  
Bacteria, acid soils kill, 225, 237  
— inoculation with (Figs. 36 to 40), 43, 44, 215, 236  
— on roots (Figs. 37 and 38), 215, 236, 465  
Bacterial stem blight, 348  
Bags, seed, 126  
Balers (see "Machinery, baler")  
Bales, covering (Figs. 110, 370), 111, 458  
— how to make (Fig. 107), 111, 246  
— loading on cars and wagons (Figs. 111, 372), 114, 455, 459  
— piling (Figs. 109, 110, 370), 111, 458  
— size and weight (Fig. 107), 111, 246, 455  
— storing (Figs. 109, 110, 370), 111, 246, 258, 458  
— sweating, 246  
— ventilation, 111, 246, 458  
Baling hay (Figs. 104, 105, 106, 371, 372), 107, 246, 250, 458  
— cost, 169  
— practice of Miami county reporter, 113  
— reduction of bulk, 113  
Baltic alfalfa, 187, 189  
Bare spots, reseeding, 53  
Barley, composition, 429  
— nurse crop, 236  
Barn, hay (see "Sheds")  
— curing in, 102, 258, 260, 261  
Barteldes Seed Company's early importations, 13  
Beef cattle (see "Cattle, beef")  
Bees in relation to alfalfa (Fig. 350), 150, 195, 268, 401  
Beetle, blister (Figs. 343, 344), 395  
Berry, J. W., curing hay in shed, 258  
Binder, grain (see "Machinery, binder, grain")  
Bins, seed, 126  
Biscuits, alfalfa, 438  
Bisulphide of carbon, 161, 162, 364, 395  
Blackshere, J. R., early seeding, 12, 13  
Blanks mailed out, 11  
Bleaching hay, 243, 457  
Blinn, P. K., tests of varieties (Figs. 158 to 161), 187  
Blister beetles (Figs. 343, 344), 395  
"Bloat" of cattle and sheep, 132, 135, 419  
— prevention, 135, 136, 421  
— remedies (Fig. 129), 136, 421  
— sticking for (Fig. 356), 421  
Bloom, indication of time to cut (Fig. 54), 63, 242  
Blossom, parts of (Figs. 168 to 182), 193, 199  
— pollinating (Figs. 167 to 183, 350), 150, 193, 195, 203, 204, 268, 401  
Blower, curing hay in mow (Fig. 210), 261  
Blue grass in alfalfa, 55, 56  
— English, in mixture with alfalfa, 50  
Borders, Joe, old field, 13  
Borer, clover-root (Figs. 310 to 312), 367  
Botany of alfalfa, 171, 180  
Bottom land versus upland, 13, 16, 38, 234  
Bottoms, stack, 89, 105, 245  
Boys, W. A., article, 271  
Bran, poisoned mash for insects, 157, 160, 161, 377, 382, 385  
— mash formula, 377  
Bran, wheat, composition, 408, 415  
Breaking alfalfa sod (Fig. 140), 155  
Breaking sod land for seedbed, 43  
Breeding for disease resistance, 198  
— drouth resistance, 189  
— forage yield, 193  
— seed yield, 197  
— winter hardiness, 185  
Broadcasting versus drilling seed, 50  
Brown hay, feeding value of, 149, 246, 412  
— root rot, 352  
Brubaker, J. A., article, 454  
Brush drag (Fig. 338), 391  
Buckhorn (Figs. 193, 281), 337  
Buck rake, 80  
Buds, indication of time to cut, 63, 242  
Building-up soils with alfalfa, 150, 275, 466  
Bulge in stacks (Fig. 78), 89  
Bull rake, 80  
Bur clover as adulterant (Fig. 186), 212  
"Burning" crops, on alfalfa sod land, 151  
— to 155  
Burning, hay, spontaneous combustion, 105, 246  
Burning over alfalfa field to destroy pests, 57, 370  
Burton, E. I., article, 258  
Buyers', hay-marketing from standpoint of, 454  
Cakes, alfalfa, 438  
California's acreage, 6  
California, history in (Fig. 155), 178, 179  
Call, L. E., article, 230  
Campaign for alfalfa in Kansas, 4  
Candy, alfalfa, 438  
"Cane" preceding alfalfa, 236  
— succeeding alfalfa, 151 to 155  
— stubble, sowing in on sandy soils, 236

- Canula and trocar** for "bloat" (Fig. 129), 136, 421  
 — **how to use** (Fig. 356), 421  
 Cape Horn, history about, 179  
 Caps, hay (Fig. 63), 75, 260  
 Carbon bisulphide, 161, 162, 364, 395  
 Cars, capacity, minimum, for hay, 459  
 — **loading with baled hay** (Fig. 111), 114, 455, 456, 459  
 Carriers and tracks (Figs. 88, 93, 94, 95, 267, 268, 269, 270), 98, 321  
 Carts, harrow (Figs. 35, 258), 294  
 Caterpillar, alfalfa (Figs. 333 to 335), 387  
 Cattle, "bloat" (see "Bloat")  
 Cattle, beef, feeding, hay, 140, 149, 410  
 — — — **cutting preferred**, 412  
 — — — **gains on alfalfa**, 411  
 — — — **maintenance on alfalfa alone**, 139, 412  
 — — — **pasturing** (Fig. 125), 132  
 — — — **rations for, including alfalfa**, 140, 414  
 — — — **sheds for, and for hay, combined** (Figs. 101, 208, 209), 105, 251, 256  
 — — — **silage for, made in stack**, 265  
 — — — **soilage for**, 137  
 — — — **straw, alfalfa, for**, 126  
 — **dairy, feeding, hay** (Fig. 131), 143, 415  
 — — — **cuttings preferred**, 416  
 — — — **maintenance on alfalfa alone**, 139, 415  
 — — — **pasturing** (Fig. 126), 132, 417  
 — — — **rations for, including alfalfa**, 143, 416  
 — — — **silage for**, 262, 266  
 — — — **soilage for**, 137, 415, 417  
 Chalcis-fly, alfalfa-seed or clover-seed (Figs. 347, 348), 398  
 Charred hay, 246  
 Chickens (see "Poultry")  
 Chicory, 210, 338  
 Chile, history in (Fig. 154), 177, 179  
 Chilean alfalfa (Fig. 158), 185, 191  
 Cleaning and grading machines (Figs. 274, 275), 327  
 Cleaning seed, 47, 271  
 Climate, altitude's effect on (Fig. 7), 23  
 — **clear days, number in year** (Fig. 9), 23, 25  
 — **effect on yields and cuttings**, 22 to 28  
 — **frost, killing, last in spring and first in fall, dates** (Fig. 8), 24  
 — **growing season, length of** (Fig. 6), 23  
 — **precipitation, variation in** (Fig. 5), 21, 22  
 — **winterkilling**, 162, 186  
 Clipping (see "Cutting")  
 Clover, red, composition, 409  
 Clover-hay worm (Fig. 349), 399  
 Clover huller for threshing seed, 123  
 Clover leaf-weevil (Figs. 339 to 341), 392  
 Clover-root borer (Figs. 310 to 312), 367  
 Clover-root curculio (Figs. 313 to 315), 368  
 Clover sitones (Figs. 316 to 317), 371  
 Cochel, W. A., article, 410  
 Cocking, hay (Figs. 62, 63), 73, 76, 248, 249  
 — **seed**, 120, 270  
 — **socks, caps for** (Fig. 63), 75, 260  
 Coffee, alfalfa, 438  
 Cold, resistance to, 185  
 — **winterkilling caused by**, 162, 187  
 Color in hay, 73, 243, 468  
 Colorado's acreage, 6  
 Columella, estimate of alfalfa, 174  
 Combination, grasses with alfalfa, 50  
 Combustion, spontaneous, of hay, 105, 246  
 Composition of alfalfa, 403, 415, 429  
 — **feeding-stuffs, various**, 408, 429  
 — **leaves and stems at different stages**, 242, 403, 415, 429  
 — **soils, alfalfa compared with other crops**, 467  
 Constituents, feeding, of alfalfa, 403, 415, 429  
 — **fertilizing, of alfalfa and other feeds**, 463  
 Cookies, alfalfa, 438  
 Corn, composition, 408, 429  
 — **preceding alfalfa**, 34, 35, 235  
 — **succeeding alfalfa**, 151 to 155  
 Cost and profit, producing hay and seed, detailed (Figs. 145, 147), 168  
 — **drainage**, 221, 224  
 — **storage in sheds or mow vs. in stacks**, 77, 245, 251  
 Cottonseed meal, composition, 408  
 Covering hay, bales (Figs. 109, 110, 370), 111, 458  
 — — **cocks** (Fig. 63), 75, 260  
 — — **stacks** (Figs. 79 to 83), 90, 246, 400  
 — **seed, depth**, 53  
 Cowpeas, composition, 409  
 — **fertilizer**, 36  
 — **preceding alfalfa**, 235  
 Crabgrass in alfalfa, 55, 56, 156, 211, 243, 333  
 Crabtree, P. E., article, 469  
 Crackers, alfalfa, 438  
 Crew, haying, size, 247  
 Crops, alfalfa, dates of cutting, 25, 26, 27  
 — — **left for seed, which ones**, 118, 268  
 — — **number cut in a season** (Fig. 10), 15, 19, 20  
 — — **yields per acre of different ones**, 16  
 — **preceding alfalfa**, 34, 213, 234  
 — **rotation with alfalfa**, 155  
 — **succeeding alfalfa**, 151 to 155  
 — — **effect of alfalfa on**, 150  
 Crossing alfalfa (Fig. 183), 199, 204  
 Crowder, ditch (Fig. 217), 279  
 Crown wart (Fig. 299), 350  
 Crown, splitting by disking (Fig. 49), 57 to 62  
 Crushers, limestone (Figs. 18, 19, 200), 34, 229  
 Cubic feet in a ton of hay, 461  
 Cultivating, age at which permissible, 61  
 — **Cost**, 168, 169  
 — **diseases controlled by**, 339  
 — **insects controlled by**, 158, 367  
 — **loosens ground**, 57 to 62  
 — **machinery to use**, 57 to 62  
 — **splits crowns** (Fig. 49), 57 to 62  
 — **time to do it**, 61  
 — **weeds destroyed by**, 55, 56, 57, 332  
 — **yields effected by**, 57 to 62  
 Cultivator, alfalfa (Figs. 50, 52, 238, 239), 57 to 62, 303  
 Cultures, pure, method of inoculation, 216, 237  
 Cunningham, C. C., article, 267  
 Curculio, clover-root (Figs. 313 to 315), 368  
 Cured, hay is, when, 76, 244  
 Curing hay, 71, 243, 457  
 — — **baled**, 246  
 — — **cocks vs. windrow, day's work**, 249  
 — — **cost, and storing**, 168, 169  
 — — **losses from rain during**, 68, 71, 244, 259, 459  
 — — **mow, with blower**, 261  
 — — **process of moisture elimination**, 243  
 — — **shed- or mow-, put in green** (Fig. 210), 102, 258, 260  
 — — **slow versus fast**, 73, 243  
 — — **time required for**, 76, 244  
 — **seed**, 120, 270  
 — — **time required for**, 122, 270  
 Cutter, alfalfa (Figs. 136, 271), 324  
 Cutting hay, 63, 67, 241, 366  
 — — **closeness of**, 55, 56, 67, 241, 242

- Cutting hay, cost, 168, 169  
 — day's work in, 248  
 — diseases controlled by, 339  
 — height to set sickle bar, 55, 56, 67, 241, 242  
 — insects controlled by, 159, 367  
 — killing alfalfa by wrong methods, 55, 56, 67, 241, 242, 366  
 — late, effect of (Fig. 58), 67, 366  
 — pastures, to refreshen stand, 130  
 — rain at time of, 68  
 — stage of growth to do it, 63, 242  
 — time to do it (Figs. 54, 55), 25, 63, 242  
 — time of day to do it, 70  
 — young alfalfa, especial care, 55, 56, 67, 241, 332  
 — seed (Figs. 114, 115, 116), 120, 269, 270  
 — weeds in alfalfa, 55, 56, 67, 241, 332  
 Cuttings, dates of (Figs. 11 to 15), 25, 26, 27  
 — left for seed, which ones, 118, 268  
 — number in year (Fig. 10), 15, 19, 20, 26  
 — yield of each, 16, 19, 20  
 Cutworms (Fig. 331), 161, 384  
 Dairy cattle (see "Cattle, dairy")  
 Day's work in haying, 247  
 Dean, Geo. A., article, 367  
 Decay of crown caused by disking (Fig. 49), 57 to 62  
 Demand for hay, 6, 447, 454, 457, 470  
 — seed, 267  
 Depreciation on equipment, 168, 169  
 Depth, covering seed, 53  
 Dew, bloat in relation to, 135  
 — effect of cutting hay with it on, 70, 244  
 Discolored hay (see "Brown hay")  
 — seed, 270  
 Diseases, bacterial stem blight, 348  
 — brown root rot, 352  
 — crown wart (Fig. 299), 350  
 — disking as cause of (Fig. 49), 57 to 62  
 — downy mildew (Figs. 290 to 292), 344  
 — eelworm or root knot (Fig. 300), 352  
 — leaf-spot (Figs. 284 to 289), 341, 343  
 — red or violet root rot (Figs. 293 to 297), 344  
 — resistance, breeding for, 198  
 — root knot or eelworm (Fig. 300), 352  
 — root rot, brown, 352  
 — root rot, red or violet (Figs. 293 to 297), 344  
 — rust (Figs. 282, 283), 339  
 — stem cracking (Fig. 298), 349  
 — yellow top, 349  
 Disk (Figs. 32, 33, 49, 227, 228), 40, 57, 235, 293, 300  
 Disking, cost, 168  
 — cultivation by, splits crowns (Fig. 49), 57 to 62  
 — seed-bed preparation (Figs. 32, 33), 40, 235  
 — weeds in alfalfa, 55, 56, 57  
 Distribution, acreage, in Kansas (Fig. 4), 18  
 Distribution, production, in United States (Fig. 3), 17  
 Ditches, drainage, 29, 223  
 — irrigation (Figs. 143, 220, 222), 165  
 Dock, curled (Fig. 278), 333  
 — sour, or sheep sorrel, 334  
 Dodder (Figs. 192, 280), 161, 210, 336  
 Doughnuts, alfalfa, 438  
 Downy mildew (Figs. 290 to 292), 344  
 Doyle, H. W., 7, 11  
 Dozer, hopper (Fig. 325), 158, 378  
 Drag, brush (Fig. 338), 391  
 Dragging, and drags (Fig. 230), 40, 168, 235  
 Drainage, soil (Figs. 17, 194 to 198), 29, 216  
 Drilling, distance apart of rows, 50  
 Drilling vs. broadcasting seed, 50  
 Drills (Fig. 234), 298  
 — hoe, for cultivating, 59, 61  
 — regulating, 299  
 Drought-resistance, breeding for, 189  
 Dusty hay, 70, 107  
 Dykstra, R. R., article, 419  
 Economy of raising alfalfa (Figs. 145, 147, 373), 469  
 Eelworm or root knot (Fig. 300), 352  
 Enemies of alfalfa, 156  
 English blue grass, mixture with alfalfa, 50  
 Enriches soil, alfalfa, 215, 465  
 Erf, Oscar, article, 259  
 Europe, history in, 172 to 179  
 Examining seed for adulterants and impurities, 45, 210  
 Expense, growing an acre of alfalfa, 168, 169  
 Experience, years of, with alfalfa, 11  
 Fallowing, for seed bed, 35, 38, 40, 235  
 Fanning mill (Fig. 274), 327  
 Fanning seed (Fig. 118), 47, 124, 271  
 Farmogerm, 216  
 Farm management, alfalfa's place in (Figs. 145, 147, 373), 469  
 Feeding cattle, beef (Fig. 130) (see "Cattle, beef"), 139, 140, 410  
 — dairy (Fig. 131) (see "Cattle, dairy"), 143, 262, 266, 415  
 — constituents of alfalfa, 403, 415, 429  
 — economy of, versus selling, 169, 366, 470  
 — hay, 128 to 150, 403 to 438  
 — alone, 138  
 — brown, 149  
 — horses and mules (Figs. 133, 361, 362, 363) (see "Horses and Mules"), 139, 143, 428  
 — meal (Fig. 121), 128, 414, 415, 423, 432, 437, 442  
 — mules (see "Horses and Mules")  
 — poultry, 148, 436  
 — racks (Figs. 352, 353, 354, 355, 359, 360, 361), 140  
 — rations, 140, 414, 416, 419, 427, 432, 437  
 — sheds, combination hay and (Figs. 101, 208, 209), 105, 251, 256  
 — sheep (Figs. 121, 134, 135, 354) (see "Sheep"), 129, 137, 139, 145, 149, 415, 417, 419, 424  
 — straw, alfalfa, 126  
 — swine (Figs. 132, 357, 358, 359) (see "Swine"), 129, 139, 143, 149, 287, 423  
 — value of alfalfa, 128 to 150, 403 to 438, 469  
 — brown hay, 149  
 — leaves and stems, comparative, 242, 403, 406, 415, 429  
 — losses in, and a scheme to prevent them (Fig. 210), 259  
 — affected by size of stack and platform, 89, 245  
 — stacking as a cause, 77, 245, 251  
 — meal, alfalfa, 128, 442  
 — silage, alfalfa, 129, 262, 266  
 — straw, alfalfa (Fig. 120), 126  
 — versus selling off the farm, 169, 366, 470  
 Fermented hay, from own juices (brown hay), 149  
 Fertility, economy demands feeding of hay, 366  
 — increased by alfalfa, 150, 275, 466  
 — removed from soil by alfalfa, 462

- Fertility requirements of alfalfa, 215, 230, 462
- Fertilizer and lime sower (Fig. 242), 305
- Fertilizers, tests of, 238, 240
- Fertilizing blossoms (Figs. 167 to 183, 401), 150, 193, 401
- constituents in alfalfa and other feeds, 463
- cost, 168
- soils (Figs 24, 25, 202), 36, 238
- top-dressing with manure (Fig. 53), 62, 238
- value of alfalfa, 150, 465, 470
- Feterita succeeding alfalfa, 151 to 155
- Fire in hay, spontaneous combustion, 105, 246
- “Firing” of crops on alfalfa sod land, 151 to 155
- Firming soils for seed bed (Fig. 34), 40, 235
- First seedings in Kansas, 11, 12, 13
- Fitch, J. B., article, 262
- Flax, preceding alfalfa, 235
- Flooded alfalfa, 164
- Flooding, irrigation (Figs. 219, 223), 165, 280
- Flour, alfalfa, 438
- Flowers (see “Blossoms”)
- Fodder, corn, composition, 409
- Food, human, alfalfa as a, 438
- Forks, hay (Figs. 87, 88, 262 to 265), 97, 317
- Fork or sling, day’s work unloading with, 249
- Forks, pitch, for loading hay (Fig. 86), 97
- Foxtail, green, in alfalfa, 55, 56, 156, 211, 243, 333
- France, history in (Fig. 152), 175
- Freezing and thawing, alternate winterkills alfalfa, 162, 186
- Freshening pastures, 130
- Fresno scraper (Fig. 215), 277
- Frost, killing, last in spring and first in fall, dates (Fig. 8), 24
- Fumigating pests, to control, 161, 162, 364, 395
- Garden webworm (Fig. 332), 386
- Gas, “bloating,” 419
- Gasoline, prairie dog control with, 161
- Gatewood, Ray, article, 423
- Gathering hay from field, 80
- seed from field, 122, 270
- Geological survey for limestone, 224
- German seed, 15, 183
- Germany, history in (Fig. 152), 175
- Germination, seed, 206, 207
- testing for, 207
- Gishwiller, J. A., early seeding (Fig. 1), 12
- Go-devil, 80
- Gopher, pocket (Figs. 301 to 309), 156, 158, 353
- Grading and cleaning machines (Figs. 274, 275), 327
- Grading hay, 114, 455, 457, 468
- rules of Kansas City Hay Dealers’ Association, 457
- Grain binder for seed harvesting, 120, 270
- header for seed harvesting, 120
- preceding alfalfa, 234
- separator for threshing seed, 123
- small, succeeding alfalfa, 151 to 155
- “Grass eggs” from eating alfalfa, 436
- Grasses, mixture with alfalfa, 50
- Grasshoppers (Figs. 141, 319 to 325), 156, 157, 374
- Grazing (see “Pasturing”)
- Gray, Alfred, remarks in 1877 about alfalfa, 3
- Greece, history in (Fig. 149), 173, 174
- “Green” alfalfa (soilage), 137, 415, 417
- Grimm alfalfa (Fig. 161), 183, 184, 186, 187, 189, 191
- Grinding alfalfa, 439
- Grosse, Charles J., first seeding, 11
- reports oldest field, 13
- Grub, white (Fig. 318), 372
- Haggart, Margaret H., article, 438
- Hall, A. B., article, 457
- Hall, J. P., early seeding, 12
- Hansen, N. E., plant explorer, 180, 186
- Hardiness, winter, breeding for, 185
- Harrow carts (Figs. 35, 258), 294
- Harrow, spike-tooth, or smoothing (Figs. 35, 40, 229, 230), 57 to 62, 294
- spring-tooth, for cultivating (Figs. 51, 240), 57 to 62, 303
- Harrowing, cost, 168
- seed, depth, 53
- seed bed (Fig. 35), 40
- Hauling hay from field, 80, 249
- seed from field, 122, 270
- Haworth, Erasmus, article, 224
- Hay, aroma in, 73, 243
- baler (see “Machinery, baler”)
- baling (see “Baling”)
- bales (see “Bales”)
- barn (see “Sheds”)
- brown, or tobacco-colored, feeding value, 149, 246, 412
- caps (Fig. 63), 75, 260
- carriers and tracks (see “Machinery, carriers and tracks”)
- charred, 246
- cocking (see “Cocks” and “Cocking”)
- combustion, spontaneous, 105, 246
- color in, 73, 243, 468
- cured and ready for storage, when, 76, 244
- curing (see “Curing”)
- cutting (see “Cutting”)
- demand for, 6, 447, 454, 457, 470
- dusty, 70, 107
- feeding (see “Feeding”)
- forks (see “Machinery, forks”)
- grading for market, 114, 455, 457
- hauling to barn, 80, 249
- heating, 105, 246, 247
- hook (see “Machinery, hook”)
- inspection (Fig. 369), 451
- knives (see “Machinery, knives”)
- liming, 106, 246
- loader (see “Machinery, loader”)
- loading on cars and wagons (Figs. 111, 372), 97, 114, 455, 456, 459
- losses in feeding value from rain (Fig. 210), 68, 71, 77, 89, 244, 259, 459
- making, and storing, 63, 241, 247
- marketing (Figs. 111, 112, 367, 368, 369), 113, 115, 246, 454, 457, 470
- markets (Figs. 112, 367, 368, 369), 115, 447
- measuring, 461
- mixed grasses, composition, 409
- moisture content, 244
- moldy, 107
- mowing (see “Cutting”)
- mowing away (see “Storing”)
- packing, 106
- pasture furnishes some, 130
- press (see “Machinery, baler”)
- price per ton, average, 169
- quotations on Kansas City market, 6
- rack (see “Machinery, wagon, hay”)
- rained on, 68, 71, 77, 89, 244, 259, 459
- rake (see “Machinery, rake”)
- raking (see “Raking”)
- receipts for ten years on Kansas City market, 453
- salting, 106, 247

- Hay, sheds (see "Sheds")  
 — shipping, 133 to 115, 447 to 460  
 — slings (see "Machinery, slings")  
 — stacking (see "Stacking")  
 — stacks (see "Stacks")  
 — storing (see "Storing")  
 — sweating, 246  
 — tracks and carriers (see "Machinery, tracks and carriers")  
 — tramping, 106  
 — value per ton, average, 169  
 — ventilation, 105, 111, 246, 258, 458  
 — wagons (see "Machinery, wagons, hay")  
 Haying, day's work in, 248  
 — horses and crew required, 247  
 Header, grain, for seed harvesting, 120  
 Heating, hay, 105, 246, 247  
 Heaving, soil, 67, 162, 186  
 Height growth left for winter protection (Fig. 58), 67, 366  
 Height to cut, 67  
 — pasture, 135  
 Herbin, James, early seeding, 12  
 History, earliest records of State Board of Agriculture, 3  
 — first seeding in Kansas, 11, 12, 13  
 — "From Persia to Kansas" (Figs. 148 to 156), 171  
 — introduction, into Kansas (Fig. 156), 3  
 — oldest field now in Kansas, 13  
 Hoes, drain, 219  
 Hogs (see "Swine")  
 Honey, alfalfa, 402  
 Hook, hay (Fig. 108), 111  
 — tile, 219  
 Hopperdozer (Fig. 325), 158, 378  
 Horses and mules, feeding (Figs. 133, 361, 362, 363), 143, 428  
 — hay alone for, 139  
 — brown for, 149  
 — pasturing (Fig. 128), 132, 434  
 — rations including alfalfa hay, 143, 432  
 — required in haying, 247  
 — soilage, for, 137  
 — straw, alfalfa, for, 126  
 Hoven, or "bloat," 419  
 Huller, alfalfa or clover (Fig. 273), 123, 271, 324  
 Human food, alfalfa as, 438  
 Hunter, S. J., article, 401  
 Ice, winterkilling caused by, 162, 187  
 Idaho's acreage, 6  
 Implements (see "Machinery")  
 Importing seed, 124, 180  
 Improving the stand, 53  
 Impure seed, 45, 210  
 Inoculation, soils, with nitrogen-gathering bacteria (Figs. 36 to 40), 43, 44, 215, 236  
 Insects affecting alfalfa, 156, 367  
 — alfalfa caterpillar (Figs 333 to 335), 387  
 — weevil (Figs. 336 to 338), 389  
 — ant, mound-building prairie (Fig. 342), 393  
 — army worm (Figs. 326 to 329), 160, 379  
 — fall (Fig. 330), 160, 383  
 — beetles, blister (Figs. 343, 344), 395  
 — borer, clover-root (Figs. 310 to 312), 367  
 — bran mash, poisoned, formula, 377  
 — caterpillar, alfalfa (Figs. 333 to 335), 387  
 — chalcis-fly, alfalfa-seed or clover-seed (Figs. 347, 348), 398  
 — clover-hay worm (Fig. 349), 399  
 — clover leaf-weevil (Figs. 339 to 341), 392  
 — clover-root borer (Figs. 310 to 312), 367  
 — curculio (Figs. 313 to 315), 368  
 Insects, clover sitones (Figs. 316, 317), 371  
 — controlling, 156, 367  
 — curculio, clover-root (Figs. 313 to 315), 368  
 — cutworm, variegated (Fig. 331), 161, 384  
 — dozer hopper (Fig. 325), 378  
 — fall army worm (Fig. 330), 383  
 — fertilizing blossoms (Figs. 183, 350), 150, 195, 268, 401  
 — garden webworm (Fig. 332), 157, 159, 386  
 — grasshoppers (Figs. 141, 319 to 325), 157, 374  
 — grub, white (Fig. 318), 372  
 — hopperdozer (Fig. 325), 378  
 — leaf-hoppers (Figs. 345, 346), 397  
 — leaf-weevil, clover (Figs. 339 to 341), 392  
 — mound-building prairie ant (Fig. 342), 393  
 — poisoned bran mash, formula, 377  
 — pollinating blossoms (Figs. 183, 350), 150, 195, 268, 401  
 — poultry destroying (Fig. 141), 157, 367  
 — sitones, clover (Figs. 316, 317), 371  
 — swine destroying, 157, 367  
 — variegated cutworm (Fig. 331), 161, 384  
 — webworm, garden (Fig. 332), 156, 159, 386  
 — weevil, alfalfa (Figs. 336 to 338), 389  
 — white grub (Fig. 318), 372  
 Inspection, hay (Fig. 369), 451  
 Intakes, drainage system, 220  
 Interest on land and equipment, 168, 169  
 Introduction, alfalfa into Kansas (Figs. 148 to 156), 3, 4, 11, 12, 13  
 Investigation, how conducted, 11  
 Irrigation, alfalfa, 165, 276  
 — capacity of pumping plants, 285  
 — corrugated system, 283  
 — distributing system, 165, 279  
 — ditches (Figs. 143, 220, 222), 165, 279  
 — evaporation, 284  
 — flooding system (Figs. 219, 223), 165, 280  
 — furrow system, 283  
 — head of water to use, 284  
 — leveling land for, 165, 278  
 — number of times a year, 167, 283  
 — preparation, preliminary, 165, 278  
 — requirements, 276  
 — seed grown under, 45  
 — seeding under, 167, 283  
 — seepage, 284  
 — strip-check system, 165, 280  
 — surveying land for, 278  
 — water, distribution of, 165, 280  
 — amount to apply, 167, 284  
 — when to apply, 165, 283  
 — winter, 285  
 Italy, history in (Fig. 150), 173, 174  
 Joseph, J. D., article, 256  
 Kafir after alfalfa (Fig. 139), 151 to 155  
 Kansas City Hay Dealer's Association, 447, 450, 454, 457  
 — rules for grading hay, 450, 457  
 Kansas City hay market (Figs. 112, 367, 368, 369), 115, 447  
 — quotations on alfalfa, 6  
 — receipts for ten years, 453  
 Kenney, R., article, 241  
 Knives, hay (Figs. 102, 103), 106  
 Laying tile, 223  
 Leaf-hoppers (Figs. 345, 346), 397  
 Leaf-spot (Figs. 284 to 289), 341, 343  
 Leaf-weevil, clover (Figs. 339 to 341), 392  
 Leaves and stems, feeding value, comparative, 242, 408, 406, 415, 429  
 Leaves for poultry, 145

- Leaves, loss of, 73, 243  
 — lower, falling, indication of time to cut, 63  
 Level, for farm drainage surveying (Fig. 196), 218, 220, 222  
 Leveler, land (Fig. 216), 277  
 Leveling land for irrigation, 165, 278  
 — seed bed (Fig. 35), 40  
 Life, profitable length of, 13  
 Lime, amount to apply, 32, 228, 237  
 — disking and harrowing-in (Fig. 23), 237  
 — distributors and spreaders (Figs. 20, 21, 22, 23, 242), 32, 237, 305  
 — fire preventive, in hay, 106, 247  
 — form to apply, 32, 228, 237  
 — shipping, 228, 229  
 — soils needing, 31, 224, 237  
 — spreader (see "Lime distributors and spreaders")  
 Limestone, cement from, 229  
 — composition in Kansas, 225, 227  
 — fineness of grinding, 228  
 — ground, applying, 32, 228, 237  
 — list of firms selling, 34  
 — hardness, 227  
 — impurities, 227  
 — location in Kansas (Fig. 199), 224  
 — outcropping of (Fig. 199), 224  
 — pulverizers (Figs. 18, 19, 200), 34, 229  
 — pulverizing, 228, 229  
 — purity, 227  
 — road-building qualities, 230  
 — zones (Fig. 199), 225  
 Liming hay, 106, 247  
 — soils (Figs. 17, 20, 21, 22, 23), 32, 224, 237  
 — — roads in relation to, 229  
 Lippincott, W. A., article, 436  
 Litmus paper test for soil acidity, 31  
 Loader, hay (Figs. 85, 260, 261), 94, 249, 317  
 Loading cars with baled hay (Fig. 111), 114, 455, 456, 459  
 — wagons with hay (Figs. 85, 86, 372), 97, 459  
 Lodging crops on alfalfa sod land, 151 to 155  
 Long, D. B., early seeding in Kansas, 12  
 Longevity of seed, 47, 208  
 — stand, 13  
 Lovania, John A. O., oldest field in Kansas, 13  
 Lucerne, name for alfalfa, 175, 183  
 McAfee, H. W., article, 331  
 McCampbell, C. W., article, 428  
 Machinery, alfalfa, article on, 289  
 — baler (Figs. 104, 105, 106, 253), 108, 246, 250, 314, 459  
 — binder, grain, for seed harvesting, 120, 270  
 — buck rake, 80  
 — bull rake, 80  
 — care (Fig. 276), 329  
 — carriers and tracks (Figs. 88, 93, 94, 95, 267, 270), 98, 321  
 — carts, harrow (Figs. 35, 258), 294  
 — cleaning and grading (Figs. 274, 275), 327  
 — crowder, ditch (Fig. 217), 279  
 — cultivator (Figs. 50, 52, 238, 239), 57 to 62, 303  
 — cutter, alfalfa (Figs. 136, 271), 324  
 — depreciation, taxes and interest on, 168, 169  
 — disk, in cultivating (Figs. 40, 227, 228), 57 to 62, 300  
 — — in seed-bed preparation (Figs. 32, 33, 227, 228), 40, 235, 293  
 — drags (Fig. 230), 40  
 — drill, old hoe, for cultivating, 57 to 62  
 Machinery, fanning mill (Fig. 274), 124, 327  
 — fertilizer and lime sower (Fig. 242), 305  
 — forks, hay (Figs. 87, 88, 262, 265), 97, 249, 317  
 — — pitch (Fig. 86), 76, 97  
 — go-devil, 80  
 — grading and cleaning (Figs. 274, 275), 327  
 — harrow carts, 294  
 — harrow, spike-tooth, or smoothing, in cultivating, 57 to 62  
 — — — in seed-bed preparation (Figs. 35, 229, 230), 40, 294  
 — — spring-tooth, in cultivating (Figs. 51, 240), 57 to 62, 303  
 — haying (see specific name under "Machinery")  
 — header, grain, for seed harvesting, 120  
 — hook, hay (Fig. 108), 111  
 — huller, alfalfa or clover (Fig. 273), 23, 271, 324  
 — interest, taxes and depreciation on, 168, 169  
 — knives, hay (Figs. 102, 103), 106  
 — leveler, land (Fig. 216), 277  
 — lime and fertilizer spreader (Figs. 20, 21, 22, 23, 242), 32, 34, 237, 305  
 — limestone pulverizer (Figs. 18, 19, 200), 34, 229  
 — loader, hay (Figs. 85, 260, 261), 94, 317  
 — manure spreader (Figs. 24, 53, 241), 36, 62, 304  
 — mower (Figs. 56, 243) 67, 248, 270, 305  
 — — windrowing and bunching attachments (Figs. 60, 116, 214, 244), 120, 270, 308  
 — packer, soil, 40  
 — plows (Figs. 28, 29, 30, 224, 225), 38, 39, 40, 289  
 — — for breaking sod, 156  
 — press (see "Machinery, baler")  
 — pulley (Fig. 267)  
 — push rake, 80  
 — rake, hay, day's work, with, 248  
 — rake, side-delivery (Figs. 84, 246), 76, 93, 310  
 — — sulky (Figs. 61, 245), 76, 309  
 — — sweep (Figs. 64, 247 to 251), 80, 122, 250, 310  
 — reaper, self-rake, for seed harvesting (Figs. 115, 272), 120, 270, 325  
 — renovator, or spike-tooth disk (Fig. 237), 57 to 62, 300  
 — ridger (Fig. 218), 280  
 — roller (Figs. 34, 231, 232, 233), 40, 295  
 — scraper, Fresno (Fig. 215), 277  
 — seeders (Figs. 44, 45, 46, 47, 48, 235, 236), 52, 296  
 — — regulating, 299  
 — selection, 328  
 — slings, hay (Figs. 89 to 93, 266), 97, 249, 321  
 — spike-tooth disk (see "Machinery, renovator")  
 — spreaders (see "Machinery, lime spreader," and "manure spreader")  
 — stackers (Figs. 65 to 74, 254 to 259), 80, 314  
 — — combined with sweep rake (Figs. 65, 66, 67, 257, 258), 83, 314  
 — — overshot (Figs. 68, 70, 256), 83, 314  
 — — pole and boom (Figs. 71, 72, 259), 87, 315  
 — — poles and cable (Figs. 73, 74), 87  
 — — swinging (Figs. 69, 254, 255), 83, 314  
 — sweep rake (Figs. 64, 247 to 251), 80, 122, 250, 310

- Machinery, sweep rake and stacker combined (Figs. 65, 66, 67, 257, 258), 83, 314  
 — taxes, interest and depreciation on, 168, 169  
 — tedder, hay (Fig. 252), 244, 248, 311  
 — tracks and carriers (Figs. 88, 93, 94, 95, 267 to 270), 98, 321  
 — tractor plowing, laying-off ground for (Figs. 30, 226), 291  
 — wagons, hay (Figs. 86, 277), 80, 97, 331, 459  
 — — seed, canvas-covered, 122, 270  
 — windrowing and bunching attachments on mower (Figs. 60, 116, 214, 244), 120, 270, 308  
 Maintaining animals on alfalfa alone, 133, 139, 412, 415, 418, 425  
 Making hay and storage, 63, 241, 247  
 Manure spreader (Figs. 24, 25, 53, 241), 36, 62, 304  
 — lime applied by, 237  
 Manuring, late cutting making necessary for winter protection, 68  
 — soils (Figs. 17, 24, 25, 202), 36, 238  
 — top-dressing fields (Fig. 53), 62  
 — — cost, 168, 169  
 Mammals in relation to alfalfa, 156, 158, 161, 353  
 Manholes, drainage system, 220  
 Market, grading hay for, 114, 455, 457  
 — Kansas City hay (Figs. 112, 367, 368, 369), 115, 447  
 — quotations on hay, 6  
 — receipts at Kansas City for ten years, 453  
 Marketing hay (Figs. 111, 112, 367, 368, 369), 113, 115, 246, 470  
 — — color as a factor in, 468  
 — — economy demands feeding, 366  
 — — from the buyer's standpoint, 454  
 — — — shipper's standpoint, 457  
 — — loading cars (Fig. 111), 114, 455, 456, 459  
 — — — wagons (Figs. 85, 86, 372), 459  
 — — seed (Fig. 119), 126, 271  
 Markets, hay (Figs. 112, 367, 368, 369), 113, 115, 246, 470  
 Meal, constituents, compared with hay, 407  
 — feeding value, 128, 442  
 — for cattle, beef, 414  
 — — — dairy, 415  
 — — — horses and mules, 432  
 — — — humans, 438  
 — — — poultry, 437  
 — — — sheep (Fig. 121)  
 — — — swine, 423  
 — — — milling (Figs. 122, 364, 365, 366), 439  
 — — — stock foods from, 444, 472  
 Measuring hay, 461  
 Media, history in (Fig. 148), 171  
 Medicago arborea, 180  
 — falcata, 180  
 — media, 181  
 — ruthenica, 181  
 — sativa, 171, 180, 181  
 Meiller, H. F., article, 266  
 Melchers, L. E., article, 339  
 Men required in haying, 247  
 Mexico, history in (Fig. 153), 176, 179  
 Millar, G. C., early seeding, 13  
 Millet, preceding alfalfa, 34, 235  
 Milling industry, alfalfa (Figs. 122, 364, 365, 366), 439  
 Milo succeeding alfalfa, 151 to 155  
 Mixture, grasses with alfalfa, 50  
 Mohler, J. C., Secretary, 2, 3  
 Mohler, Martin, first census of acreage, 4  
 Moisture content, hay, 244  
 — — — soil (Fig. 138), 151, 400  
 Moisture, on outside of hay, effect on time to cut, 70, 244  
 — passes out of stems and leaves, process, 243  
 — requirements, alfalfa and other plants, 190, 400  
 Molahan, Charles, first seeding, 12  
 Mold in hay, 107  
 — lime or salt to prevent, 106, 247  
 Moles, in relation to alfalfa, 357, 366  
 Moors, history with, 175  
 Mound-building prairie ant (Fig. 342), 393  
 Mow, curing hay in, with blower, 261  
 — storing in (see "Storing")  
 Mower (Figs. 56, 59, 243), 67, 248, 270, 305  
 — windrowing and bunching attachments (Figs. 60, 116, 214, 244), 120, 270, 308  
 Mowing (see "Cutting")  
 Mowing away (see "Storing")  
 Muffins, alfalfa, 438  
 Mulching with manure in case of too-late cutting, 68  
 Mules (see "Horses and Mules")  
 Nabours, Robert K., article, 353  
 Name of "alfalfa," 171, 180  
 Nebraska's acreage, 6  
 Net profit (see "Profit")  
 Nitrogen-gathering bacteria (see "Bacteria")  
 Nitrogen, 216  
 Nodules on roots, nitrogen-gathering (Figs. 37, 38), 45, 46, 215, 236  
 North America, history in, 176 to 179  
 Nurse crop, 49, 236  
 Nursery, alfalfa, 193  
 Oats, composition, 408, 429  
 — nurse crop, 49, 236  
 — preceding alfalfa, 34  
 — succeeding alfalfa, 151 to 155  
 Oldest field in Kansas, 13  
 Old German Frankish alfalfa, 183  
 Olophant, Jasper, early seeding, 12  
 Origin of alfalfa and of its name, 171  
 Outlet, drainage system (Fig. 198), 220, 223  
 Overflowed alfalfa, 164  
 Overpasturing, 129, 130, 133, 135  
 Packer, soil, 40  
 Packing hay, in storage, 106  
 — of pastures, 135  
 — seed bed, 235  
 Pasture, cutting hay from and freshening, 130, 135, 287  
 — hog, foreign seed for, 15  
 Pasturing, age of field when permissible, 135, 242  
 — alternate or rotation (Fig. 123), 130, 135  
 — — cattle, beef (Fig. 125), 132  
 — — — dairy (Fig. 131), 132, 417  
 — — closeness of, 135  
 — — effect on stand, 130, 135  
 — — height of growth before permissible, 135  
 — — horses and mules (Fig. 128), 132, 434  
 — — late, effect of, 67, 366  
 — — poultry (Fig. 137), 148, 436  
 — — sheep (Fig. 127), 132, 417  
 — — swine (Figs. 123, 124), 129, 287, 432, 425, 460  
 — — wet weather in relation to, 135  
 Paterson, A. M., article, 417  
 Persia, history in, 171  
 Peruvian alfalfa (Fig. 159), 184, 191  
 Pests, affecting alfalfa, 156, 332, 339, 353, 367  
 Peters, G., inspector of hay, Kansas City market (Fig. 369), 450  
 Peters, M. C., alfalfa miller, 440  
 Phosphorus, fertilizing alfalfa soils with, 238

- Pigweed, or red root (Fig. 279), 335  
 Pitchforks in haying (Fig. 86), 76, 97  
 Plans, feeding racks (Figs. 353, 355, 360).  
 — hay sheds (Figs. 96 to 101, 203 to 207)  
 — irrigation (Fig. 219).  
 — mow hay-drier and curer (Fig. 210).  
 Plant diseases affecting alfalfa, 339  
 Planting (see "Seeding")  
 Plants, number per acre (Fig. 43), 206  
 — number per square yard (Fig. 43), 51  
 Platform for hay to rest upon, 89, 105, 245  
 Pliny, estimate of alfalfa, 174  
 Plows (Figs. 140, 224, 225), 156, 289  
 Plowing alfalfa sod (Fig. 140), 155  
 — cost, 163  
 — seed-bed preparation (Figs. 28, 29, 30, 31), 38, 234  
 — sod land, for seed bed, 43  
 — tractor (Figs. 30, 226), 291  
 Plugging cars of hay (Figs. 367 to 369), 451  
 Pods, seed (Figs. 114, 184 to 187), 205  
 Poisoned bran mash for insects, 157 to 161, 367  
 — formula, 377  
 Poisoning gophers and prairie dogs, 158, 159, 161, 361, 365  
 Pollinating blossoms (Figs. 167 to 183, 350), 150, 193, 195, 203, 204, 268, 491  
 Potatoes, succeeding alfalfa, 153, 154  
 Poultry, feeding alfalfa hay (Figs. 136, 271), 148, 436  
 — insects destroyed by (Fig. 141), 157, 367  
 — leaves for, 145  
 — meal for, 129  
 — pasturing (Fig. 137), 148, 436  
 — rations for, 437  
 — soilage for, 137  
 Prairie dogs, 156, 161, 365  
 Prairie hay, composition, 409  
 — sod, plowing, 43  
 Preceding crops, 34, 213, 234  
 Precipitation (Fig. 5), 21, 22  
 Preface, 3  
 Preparation, seed-bed, 38, 230  
 Press, hay (see "Machinery, baler")  
 Price, hay, per ton, average, 6, 169, 472  
 — seed, per bushel, average, 169  
 Pride, Richard, article, 447  
 Prod for locating gopher runways (Fig. 307)  
 Production, cost (see "Yields"), 163, 169  
 Profits and cost, producing hay and seed, itemized (Figs. 145, 147), 168  
 Protection, hay, in cocks (Fig. 63), 75  
 — in storage (see "Storing")  
 — winter, of fields, growth left for (Figs. 57, 58), 67, 366  
 Puddling of pastures, 135  
 Pulley (Fig. 267)  
 Pulverizers, limestone (Figs. 18, 19, 200), 34, 229  
 Pumping water for irrigation (Figs. 142, 221, 222), 165, 276, 285  
 Push rake, 80  
 Putting up hay (see "Hay Making" and specific names)  
 Questionnaire, how handled, 11  
 Racks, feeding (Figs. 352, 353, 354, 355, 359, 360, 361), 140  
 — hay (see "Machinery, wagon, hay")  
 Rain at cutting time, 68  
 — in winter, that freezes, 162, 186  
 — on hay, losses from, 68, 71, 77, 89, 244, 259, 459  
 — on seed, effect of, 118, 122, 270  
 Rainfall (Fig. 5), 21, 22  
 Rake, buck, 80  
 — bull, 80  
 — push, 80  
 — side-delivery (Figs. 84, 246), 76, 93, 310  
 — sulky (Figs. 61, 245), 76, 309  
 Rake, sweep (Figs. 64, 247 to 251), 80, 122, 250, 310  
 Raking hay (Figs. 61, 84), 71, 76, 244, 248  
 Rank, counties, in acreage (Fig. 4), 18  
 — Kansas, in acreage, compared with other states, 6  
 — in hay production (Fig. 3), 17  
 — in seed production, 124  
 Rations, balanced (Fig. 351), 140, 403, 438  
 Rations for cattle, beef, 140, 414  
 — dairy, 143, 416  
 — horses and mules, 143, 432  
 — poultry, 148, 437  
 — sheep (Fig. 135), 145, 419  
 — swine (Fig. 132), 143, 427  
 Reaper, self-rake, for seed harvesting (Figs. 115, 272), 120, 325  
 Receipts, market, 10 years, Kansas City, 453  
 Recleaning seed (Figs. 118, 274), 47, 124, 271  
 Records, reports of Board of Agriculture, early attempts at introduction, 3, 4  
 Red or violet root rot (Figs. 293 to 297), 344  
 Reed, O. E., article, 415  
 Regions, alfalfa, in Kansas (Fig. 201), 231  
 Regulating seeders, drill, 299  
 Renovator, or spike-tooth disk (Fig. 237), 57 to 62, 300  
 Rent on land, 168, 169  
 Reseeding, bare spots, 53  
 — thickening the stand, 53  
 — where previously failed, 53  
 Rich, John H., old field, 13  
 Ridger (Fig. 218), 280  
 Ringing swine, on pasture, 130  
 Roads, liming in relation to, 229  
 Roberts, H. F., article, 180  
 Roller, land (Figs. 34, 231, 232, 233), 40, 295  
 Rolling seed beds (Fig. 34), 40, 235  
 Romans, history with, 173, 174  
 Root knot, or eelworm (Fig. 300), 352  
 — rot, brown, 352  
 — red or violet (Figs. 293 to 297), 344  
 Root system, developing, importance (Figs. 2, 16), 241  
 — different varieties (Figs. 158 to 161), 137, 189  
 Roots, depth of penetration (Fig. 16), 28  
 — tubercles on, 215, 236, 465  
 Rooting, swine, on pasture, 130  
 Rotation, alfalfa in, 155  
 — pasturing, 135  
 — preceding crops, 34  
 — succeeding crops, 151 to 155  
 Rotting crown caused by disking (Fig. 49), 57 to 62  
 Rows, alfalfa in (Figs. 212, 213, 214), 271  
 Rules, grading hay, Kansas City Hay Dealer's Association, 450, 457  
 Russian thistle, 161, 210, 334  
 Rust, alfalfa (Figs. 282, 283), 339  
 Salting hay, 106, 247  
 Sand lucerne (alfalfa), 181, 191  
 Sandy soils, seeding, 236  
 Scarifying or scratching seed (Fig. 42), 43  
 Schmidt, Robert, article, 332  
 Scraper, Fresno (Fig. 215), 277  
 Season, growing, length of, 23  
 Seed, acreage in Kansas, 117, 124  
 — adulterated, 45, 212  
 — age, still good, 47, 208, 271  
 — amount to sow per acre, 51, 206  
 — analyzing, 45, 210, 214  
 — bad, 45, 210, 332  
 — bees in relation to, 150, 268, 401  
 — breeding for yield of, 197  
 — bur clover as adulterant (Fig. 186), 212  
 — climatic conditions influencing production, 118, 268, 269  
 — cocking, 120, 270

- Seed, conditions favorable and unfavorable to crop, 118, 268, 269
- cost of, for planting, 168
  - production, 169
  - crop left for seed, 118, 268
  - curing, 120, 270
  - cutting the crop (Figs. 114, 115, 116), 120, 269
  - cutting left for seed, which one, 118, 268
  - damage from rain, 270
  - demand for, 267
  - depth to plant, 53
  - description of (Figs. 184, 188, 189, 191), 205
  - discolored, 270
  - effect on stand of raising a crop, 119
  - examining for adulterants and impurities, 45, 210
  - fanning (Figs. 118, 274), 47, 124, 271
  - fertilizing of blossoms (Figs. 167 to 182, 350), 150, 193, 195, 203, 204, 268, 401
  - foreign-grown versus home-grown, 15, 45, 180
  - germination tests (Fig. 41), 45, 207, 213, 214
  - harvesting (Figs. 114, 115, 116), 120, 269, 270
  - hauling to stack or thresher, 122, 270
  - holding, 208, 271
  - imported, 124, 210, 330
  - impure, 45, 210
  - insects in relation to (Figs. 183, 350), 150, 268, 401
  - irrigated, 45
  - longevity, 47, 208, 271
  - loss from rain, 122, 270
  - marketing (Fig. 119), 126, 271
  - mowing (see "Seed, cutting")
  - number in a pound, 206
  - parts of, 206
  - pods (Figs. 114, 184 to 187), 205
  - pollinating blossoms (Figs. 167 to 182, 350), 150, 193, 195, 203, 204, 268, 401
  - pounds in bushel, 206
  - price per bushel, average, 169
  - production (see "Seed, yields") (Fig. 113), 117, 267
  - profit in production, 169
  - rains on, effect, 122, 270
  - recleaning (Figs. 118, 274), 47, 124, 271
  - rowed alfalfa for, 272
  - samples to Agricultural College, 210, 214
  - scarifier or scratcher (Fig. 42), 48
  - shattering, 120, 122, 270
  - shocking, 120, 270
  - soil conditions influencing, 118, 268
  - stacking, 122, 270
  - stand, thickness of, influencing, 118, 267
  - storing, 126, 270
  - sweet clover (Figs. 185, 190)
  - testing for germination (Fig. 41), 45, 207, 213, 214
  - threshing (Fig. 117), 123, 271
  - time required to produce a crop, 119, 268
  - time to cut, 120, 269
  - time to stack or thresh, 123, 270
  - transporting from field, 122, 270
  - value, per bushel, average, 169
  - weather, conditions influencing, 118, 268, 269
  - weed, in alfalfa, 45, 119, 210, 332
  - weight per bushel, 206
  - when to leave for, 269
  - where grown (Fig. 113), 117, 267
  - yellow trefoil, as adulterant (Fig. 187), 212
  - yields, average per acre, 124
- Seed, yields, total in Kansas and United States, 117, 124
- Seed bed, disking (Figs. 32, 33), 40, 235
- fallowing, 35, 38, 40, 235
  - firming (Fig. 34), 40, 235
  - ideal (Figs. 26, 27, 31), 38, 234
  - plowing, 38, 234
  - preparation (Figs. 26, 27, 31), 38, 230
  - pulverizing, 40, 235
  - rolling (Fig. 34), 40, 235
  - sod land, plowing, 43
- Seeders (Figs. 44, 45, 46, 47, 48, 235, 236), 52, 296
- regulating, 299
- Seeding, 48, 235
- amount to sow per acre, 51, 206
  - bare spots in field, 53
  - broadcasting versus drilling, 50
  - cost, 168
  - covering, 53
  - dates, 49
  - depth to plant, 53
  - fall, plowing for, 40, 234
  - fall versus spring, 48, 49, 235
  - mixture, grasses with alfalfa, 50
  - nurse crop with alfalfa, 49, 236
  - plants per square yard (Fig. 43), 51, 206
  - sandy soils, 236
  - sod land, 43
  - spring, plowing for, 40, 235
  - spring versus fall, 48, 49, 235
  - succeeding where previously failed, 53
  - thickening stand, 53
  - thickness of stand (Fig. 43), 51, 206
  - when to sow, 48, 49, 235
- Seedsmen buy seed, 126
- Selection, natural, of varieties, 183
- Selling hay or seed (see "Marketing")
- Selling versus feeding hay, 169, 366, 470
- Separator, grain, for threshing seed (see "Machinery, thresher")
- Shattering seed, 120, 122, 270
- Sheds, hay, adjustable roof (Fig. 100), 104
- combination hay and feed (Figs. 101, 208, 209), 105, 251, 256
  - construction (Figs. 96 to 101, 203 to 207), 102, 251
  - cost, 102, 255
  - curing hay in, 102, 258, 260, 261
  - filling (Figs. 96, 97, 98), 102
  - interest, taxes and depreciation on, 168, 169
  - longevity, 251
  - plans (Figs. 96 to 101, 203 to 207), 102, 251
  - versus stacks as place of storage, 77, 245, 251
- Sheep, "bloat" (see "Bloat")
- feeding hay (Figs. 121, 134, 135, 354), 145, 149, 417
  - cutting preferred, 419
  - maintenance on alfalfa alone, 139, 418
  - pasturing (Fig. 127), 132, 417
  - rations including alfalfa hay (Fig. 135), 145, 419
  - silage, 129, 424
  - soilage for, 137, 415, 417
- Sheep sorrel or sour dock, 334
- Shelton, E. M., remarks about alfalfa, 4
- Shipper's, hay-marketing from standpoint of, 457
- Shipping hay (see "Marketing")
- Shocking seed, 122, 270
- Shoots, indication of time to cut (Fig. 55), 63, 242
- Shorts, wheat, composition, 408
- Siberian alfalfa, 180, 186

- Sickle alfalfa (Fig. 160), 180, 187, 189, 191  
 Sickle-bar, height to set in cutting, 67  
 Silage, alfalfa (Fig. 211), 129, 262, 266  
 — made in stack, 265  
 — mixtures used in making, 264  
 — feeding cattle, dairy, 262, 264  
 — swine, 424  
 — corn, feeding constituents, 407  
 — crop following alfalfa, 151 to 155  
 — kafir, feeding constituents, 407  
 — sorghum, feeding constituents, 407  
 Sitones, clover (Figs. 316, 317), 371  
 Size of fields, average, 71  
 Sleet, winterkilling caused by, 162, 186  
 Slings, hay (Figs. 89 to 93, 266), 97, 249, 321  
 Slush, freezing, 162, 187  
 Smoothing, in seed-bed preparation, 40, 168, 235  
 Smothering plants with hay, 244  
 Snouting swine, on pasture, 130  
 Sod, alfalfa, crops grown on, 150 to 155  
 — plowing (Fig. 140), 155  
 — land, plowing for alfalfa seed bed, 43  
 Soilage, alfalfa, 137, 415, 417  
 Soils, acid (Figs. 17, 20 to 25, 202), 31, 224, 237  
 — bacteria will not live in, 225, 237  
 — cause, 228  
 — lime for (see "Liming")  
 — location, 237  
 — testing, 31, 237  
 — adapted to alfalfa, 38, 224, 230  
 — blowing, sandy, cane stubble preventing, 236  
 — bottom land versus upland, 13, 16, 28, 234  
 — breaking alfalfa sod (Fig. 140), 155  
 — breaking sod-land for seed bed, 43  
 — building up with alfalfa, 150, 275, 466, 470  
 — central Kansas, 233  
 — composition, alfalfa compared with other crops, 467  
 — correction when wet and sour (Figs. 17, 20 to 25, 202), 29, 216, 224, 237, 238  
 — disking for seed bed (Figs. 32, 33), 40, 235  
 — drainage (Figs. 17, 194 to 198), 29, 216  
 — effect of alfalfa upon, 150, 462  
 — enriched by alfalfa, 150, 275, 466, 470  
 — following for seed bed, 35, 38, 40, 235  
 — fertility, economy demands feeding hay, 366  
 — increased by alfalfa, 150, 275, 466, 470  
 — removed by alfalfa, 215, 462  
 — requirements of alfalfa, 215, 230, 462  
 — fertilizing for alfalfa (Figs. 17, 24, 25, 202), 36, 238, 240  
 — fertilizing, top-dressing with manure, 62, 238  
 — firming for seed bed (Fig. 34), 40, 235  
 — geological survey for limestone, 224  
 — glacial, 231  
 — ideal for alfalfa, 28, 230  
 — inoculation with nitrogen-gathering bacteria (Figs. 36 to 40), 43, 44, 215, 236  
 — leveling (Fig. 35), 40, 278  
 — limestone (Fig. 199), 224, 233  
 — liming (Figs. 17, 20, 21, 22, 23), 32, 224, 237  
 — manuring (Figs. 17, 24, 25, 202), 36, 238  
 — top-dressing fields (Fig. 53), 62  
 — moisture content of alfalfa fields (Fig. 138), 151, 400  
 Soils, northeastern Kansas, 231  
 — packed and their cultivation, 57 to 62, 135  
 — packing, for seed bed, 235  
 — phosphorus for, 240  
 — plowing for seed bed (Figs. 28, 29, 30, 31), 38, 234  
 — preparation for seeding, 38, 230, 234  
 — pulverizing for seed bed, 40, 235  
 — regions in Kansas (Fig. 201), 231  
 — residual, 233  
 — rolling for seed bed (Fig. 34), 40, 235  
 — sandstone, 233  
 — sandy, seeding, 236  
 — shale, 233  
 — sod, alfalfa, breaking (Fig. 140), 155  
 — sod-land, breaking, 43  
 — sour (see "Soils, acid")  
 — southeastern, Kansas, 233  
 — subsoil, 29, 181, 230  
 — summer fallowing for seed bed, 35, 38, 40, 235  
 — testing for acidity, 31, 237  
 — texture on which alfalfa may be grown, 29, 231  
 — top-dressing with manure (Fig. 53), 62  
 — upland versus bottom land, 13, 16, 28, 234  
 — water table, distance from surface, 29, 230  
 — western Kansas, 234  
 — wet, drainage (Figs. 194 to 198), 29, 216  
 Sorghums preceding alfalfa, 236  
 — succeeding alfalfa, 151 to 155  
 Sour soils (See "Soils, acid")  
 South America, history in, 177, 179  
 Sowing (see "Seeding")  
 Spades, skeleton for ditch digging, 218  
 Spain, history in (Fig. 151), 173 to 179  
 Species, 180  
 Spike-tooth disk, or renovator (Fig. 237), 57 to 62, 300  
 Spike-tooth harrow, or smoothing, in cultivating, 57 to 62  
 — in seed-bed preparation (Figs. 35, 229, 230), 40, 294  
 Splitting crowns by disking (Fig. 49), 57 to 62  
 Spraying formula for destroying insects, 383, 396  
 Spraying, insects controlled by, 367  
 Spreader, lime and fertilizer (Figs. 20 to 23, 242), 32, 237, 305  
 — manure (Figs. 24, 53, 241), 36, 62, 304  
 Spreading lime (see "Liming")  
 — manure (see "Manuring")  
 Spring-tooth harrow, for cultivating (Figs. 51, 240), 57 to 62, 303  
 Sprouts, indication of time to cut, 63, 242  
 Stack bottoms and platforms, 89, 105, 245  
 — bulge (Fig. 78), 89  
 — covers (Figs. 79 to 83), 90, 246, 400  
 Stacks (Figs. 75, 76, 77), 87, 245  
 — losses as related to size and shape, and platform beneath, 89  
 — in feeding value from storing in, 77, 245, 251  
 — rectangular versus round (Figs. 75, 76, 77), 87, 88, 89  
 — silage made in, 265  
 — storage in, versus sheds or mows, 77, 245, 251  
 — weighting, 90  
 Stackers (Figs. 65 to 74, 254 to 259), 80, 314  
 — combined with sweep rake (Figs. 65, 66, 67, 257, 258), 83, 314  
 — overshoot (Figs. 68, 70, 256), 83, 314  
 — pole and boom (Figs. 71, 72, 259), 87, 315  
 — pole and cable (Figs. 73, 74), 87  
 — swinging (Figs. 69, 254, 255), 83, 314

- Stacking (Figs. 75, 76, 77), 87, 245, 250  
 — green alfalfa, 265  
 — hay is cured and ready for, when, 76, 245  
 — seed, 122, 270  
 Star thistle, 210, 338  
 Statistical birthyear, 4  
 Statistics, acreage of alfalfa, 1891 to 1915,  
 inclusive, 4  
 — acreage of alfalfa, by counties, 1891 and  
 1915, 5  
 — average number of cuttings and average  
 yield per acre for each cutting, and  
 all cuttings, by counties, 19, 20  
 — rank of Kansas in alfalfa acreage, 6  
 Stems and leaves, feeding value, compara-  
 tive, 242, 403, 406, 415, 429  
 Stem cracking disease (Fig. 298), 349  
 Stinking for "bloat" (Fig. 356), 136, 421  
 Stock foods, meal in, 444, 472  
 Storing hay, baled (Figs. 109, 110, 370),  
 111, 246, 258, 458  
 — cost, 168, 169  
 — cured and ready for, when, 76, 245  
 — loose, green, in shed, barn or stack  
 (Fig. 210), 102, 258, 260, 261, 265  
 — shed or mow versus stack, as place  
 of, 77, 245, 251  
 — sheds, filling (Figs. 96, 97, 98),  
 102, 245, 249  
 — mowing away (Figs. 87 to 95),  
 97, 245, 249  
 — stacking, 87, 245, 250  
 — ventilation, 105, 111, 246, 258  
 — seed, before threshing, 122  
 — threshed, 126  
 Stover, corn, composition, 409  
 Strabo, estimate of alfalfa, 174  
 Strains of alfalfa (see "Varieties, types")  
 Straw, alfalfa, feeding value (Fig. 120),  
 126  
 — oats, composition, 409  
 — wheat, composition, 409  
 Strychnine to poison gophers, 158, 159, 361  
 Subsoil, texture, for alfalfa, 29, 181, 230  
 Succeeding crops, best to follow alfalfa,  
 151 to 155  
 — effect of alfalfa on, 150  
 Summer fallowing for seed bed, 35, 38, 40,  
 235  
 Sunshine, number of clear days in year  
 (Fig. 9), 23, 25  
 Survey, geological, for limestone, 224  
 Surveying for drainage (Fig. 196), 222  
 Swanson, C. O., article, 403  
 Swath, curing, 71, 73, 244  
 Sweating, hay, 246  
 Sweep rake (Figs. 64, 247 to 251), 80, 122,  
 250, 310  
 — combined with stacker (Figs. 65, 66, 67,  
 257, 258), 83, 314  
 Sweet clover, inoculates for alfalfa, 43, 215,  
 237  
 — seed (Figs. 185, 190)  
 Swine, feeding hay (Figs. 132, 357, 358,  
 359), 143, 149, 423  
 — cutting preferred, 423  
 — gains on alfalfa, 130, 287, 426  
 — insects destroyed by, 157, 367  
 — maintenance on alfalfa alone, 131, 139,  
 425  
 — pasturing (Figs. 123, 124), 129, 287,  
 423, 425, 460  
 — rations including alfalfa (Fig. 132),  
 143, 287, 427  
 — ringing and snouting on pasture, 130  
 — soilage for, 137  
 Tachina fly (Fig. 329)  
 "Tapping" for "bloat" (Fig. 356), 136, 421  
 Taxes on land and equipment, 168, 169  
 Tea, alfalfa, 438  
 Tedder, hay (Fig. 252), 244, 248, 311  
 Ten Eyck, A. M., articles, 251, 461  
 Testing acid soils, 31, 237  
 — seed, for germination (Fig. 41), 45, 207,  
 213, 214  
 Tests of fertilizers, 238, 240  
 — winter-hardiness, 185  
 Thawing and freezing, winterkills alfalfa,  
 162, 186  
 Thickening the stand, 53, 119  
 Thickness of stand (Fig. 43), 51, 201  
 Thistles, Russian, 161, 210, 334  
 Threshers, for seed (Fig. 273), 123, 271,  
 324  
 Threshing seed (Fig. 117), 123, 271  
 Tile, barn built with, 258  
 Tiling land for drainage (Figs. 194 to 198),  
 29, 216  
 Timothy, composition, 409  
 — feeding value compared with alfalfa for  
 dairy cattle, 416  
 Tobacco-colored hay (see "Brown hay")  
 Tod, W. J., feeding rack (Figs. 352, 353)  
 Ton, cubic feet in, 461  
 Ton, pounds of green alfalfa hay in, 266  
 Tons per acre (see "Yields")  
 Tools (see "Machinery")  
 Top-dressing with manure (Fig. 53), 62,  
 168, 169  
 Tracks and carriers (Figs. 88, 93, 94, 95,  
 267 to 270), 98, 321  
 Tramping hay, stored, 106  
 Trampling of pastures, 135  
 Transporting hay from field, 80, 249  
 — seed from field, 122, 270  
 Trapping gophers (Fig. 309), 158, 159, 364  
 Tripping blossoms (Figs. 167 to 182, 350),  
 150, 193, 195, 203, 204, 268, 401  
 Trocar and canula for "bloat" (Fig. 129),  
 136, 421  
 — how to use (Fig. 356), 421  
 Trowel for setting gopher traps (Fig. 308)  
 Tubercles on roots, nitrogen-gathering (Figs.  
 37, 38), 45, 46, 215, 236  
 Turkestan alfalfa, 15, 183, 186, 187, 189,  
 191, 330  
 Turkeys (see "Poultry") (Fig. 141)  
 Twisting hay to tell if cured, 76, 245  
 Tympanites, or "bloat," 419  
 Types of alfalfa (see "Varieties")  
 Underflow, pumping from, for irrigation  
 (Figs. 142, 221, 222), 165, 276  
 Unloading hay, 97, 98, 245, 249  
 Upland versus bottom land, 13, 28, 234  
 Utah's acreage, 6  
 Ventilation of hay, 105, 111, 246, 258  
 Valleys (see "Bottom land")  
 Value, alfalfa to Kansas agriculture, 6  
 — feeding (see "Feeding value")  
 — hay, per ton, average, 6, 169, 472  
 — seed, per bushel, average, 169  
 — total, for annual crop in Kansas, 6  
 Variegated alfalfa, 181  
 — cutworm (Fig. 331), 384  
 Varieties, 15, 181 to 185  
 — Arabian, 184  
 — Baltic, 187  
 — Chilean (Fig. 158) (Common), 185  
 — foreign-grown seed versus home-grown,  
 15, 45, 180  
 — Grimm (Fig. 161), 183  
 — Peruvian (Fig. 159), 184  
 — regional, 182  
 — sickle (Fig. 160), 180  
 — Turkestan, 15, 183, 330  
 — types (Figs. 157, 162 to 166), 182  
 Wagons, canvas-covered for hauling seed,  
 122, 270  
 — hay (Figs. 86, 277), 80, 97, 331, 459  
 Walker, H. B., article, 276

- Water, irrigation (see "Irrigation")  
 — requirements of alfalfa and other plants, 190, 400  
 — standing on alfalfa, overflow, 162, 164  
 Watertable, distance from surface, 29, 230  
 Waters, H. J., article, 171  
 Weather (see "Climate")  
 Webworm, garden (Fig. 332), 157, 159, 386  
 Weeds affecting alfalfa, 55, 56, 156, 161, 210, 243, 332  
 — buckhorn (Figs. 193, 281), 337  
 — burning over field to destroy, 57  
 — chicory, 210, 338  
 — controlling, 55, 56, 57, 119, 213, 243, 332  
 — crab grass, 55, 56, 156, 211, 243  
 — cultivation, 55, 56, 57, 332  
 — cutting, in alfalfa, 55, 56, 67, 241, 332  
 — dock, curled (Fig. 278), 333  
 — — sour, or sheep sorrel, 334  
 — dodder (Figs. 192, 280), 161, 210  
 — foxtail, green, 55, 56, 156, 211, 243, 333  
 — pigweed, or red root (Fig. 279), 335  
 — Russian thistle, 161, 210  
 — seed, in alfalfa seed, 45, 119, 210, 332  
 — star thistle, 210, 338  
 Weedy fields, seed from, 119  
 Weevil, alfalfa (Figs. 336 to 338), 389  
 Weighting stacks, 90  
 Weiss, Otto, first alfalfa miller, 439  
 Wells, irrigation, for alfalfa (Figs. 142, 221, 222), 165, 276  
 Wheat, composition, 408  
 — nurse crop, 236  
 — preceding alfalfa, 34, 35, 234  
 — succeeding alfalfa, 151 to 155  
 Wheeler, W. A., and Baltic alfalfa, 187  
 Wichita hay market, 115  
 Willard, J. T., article, 462  
 Wilting hay to right condition for raking, 71  
 Windrow, baling hay from (Fig. 104), 107, 246, 458  
 Windrow, curing in, 73, 243, 249, 270  
 Windrowing and bunching attachments on mower (Figs. 60, 116, 214, 244), 120, 240, 308  
 Winds, cold, dry, winterkilling alfalfa, 162  
 Wintering animals on alfalfa alone, 133, 139, 412, 415, 418, 425  
 Winter-hardiness, breeding for, 185  
 Winterkilling, 162, 186  
 — cutting improperly as a cause (Fig. 58), 55, 56, 67, 241, 242, 366  
 Winter protection, growth left for (Figs. 57, 58), 67, 366  
 Wirt, F. A., article, 289  
 Wiseman, R. E., 289  
 Wright, C. W., article, 439  
 Years of experience with alfalfa, growers', 11  
 Yellow top, 349  
 Yellow trefoil, as adulterant of seed (Fig. 187), 212  
 Yield, breeding for forage, 193  
 — — seed, 197  
 — hay, effect on, of climate, 22 to 28  
 — — — of cultivation, 57 to 62  
 — — — of cutting at certain stage of growth, 243  
 — — — of fertilizing, 238, 240  
 — — — of irrigation (Fig. 144), 165, 167  
 — — — of thickness of stand (Fig. 43), 51, 201  
 — — — of top-dressing with manure, 62  
 — — per acre, average, by cuttings for seasons (Fig. 146), 16  
 — — — by cuttings for season, by counties, 19, 20  
 — — — by irrigation, 165, 167  
 — — — in rows, 275  
 — — total in Kansas as whole and by thirds (Figs. 3, 4), 16  
 — — — United States, distribution (Fig. 3), 17  
 — seed, per acre, average and total, 124  
 — — total in Kansas and United States (Fig. 113), 117, 124  
 — succeeding crops, on alfalfa land, 153 to 155  
 Yoxall, George, old field, 13

OS.

. Y.

ON

468372

SB206  
AAD6

UNIVERSITY OF CALIFORNIA LIBRARY

THIS BOOK IS DUE ON THE LAST DATE  
STAMPED BELOW

**AN INITIAL FINE OF 25 CENTS**  
WILL BE ASSESSED FOR FAILURE TO RETURN  
THIS BOOK ON THE DATE DUE. THE PENALTY  
WILL INCREASE TO 50 CENTS ON THE FOURTH  
DAY AND TO \$1.00 ON THE SEVENTH DAY  
OVERDUE.

DEC 4 1946	

